



Зип Общепит

vsezip.ru

Spare Parts for

+7(812)987-08-81 Dishwashing

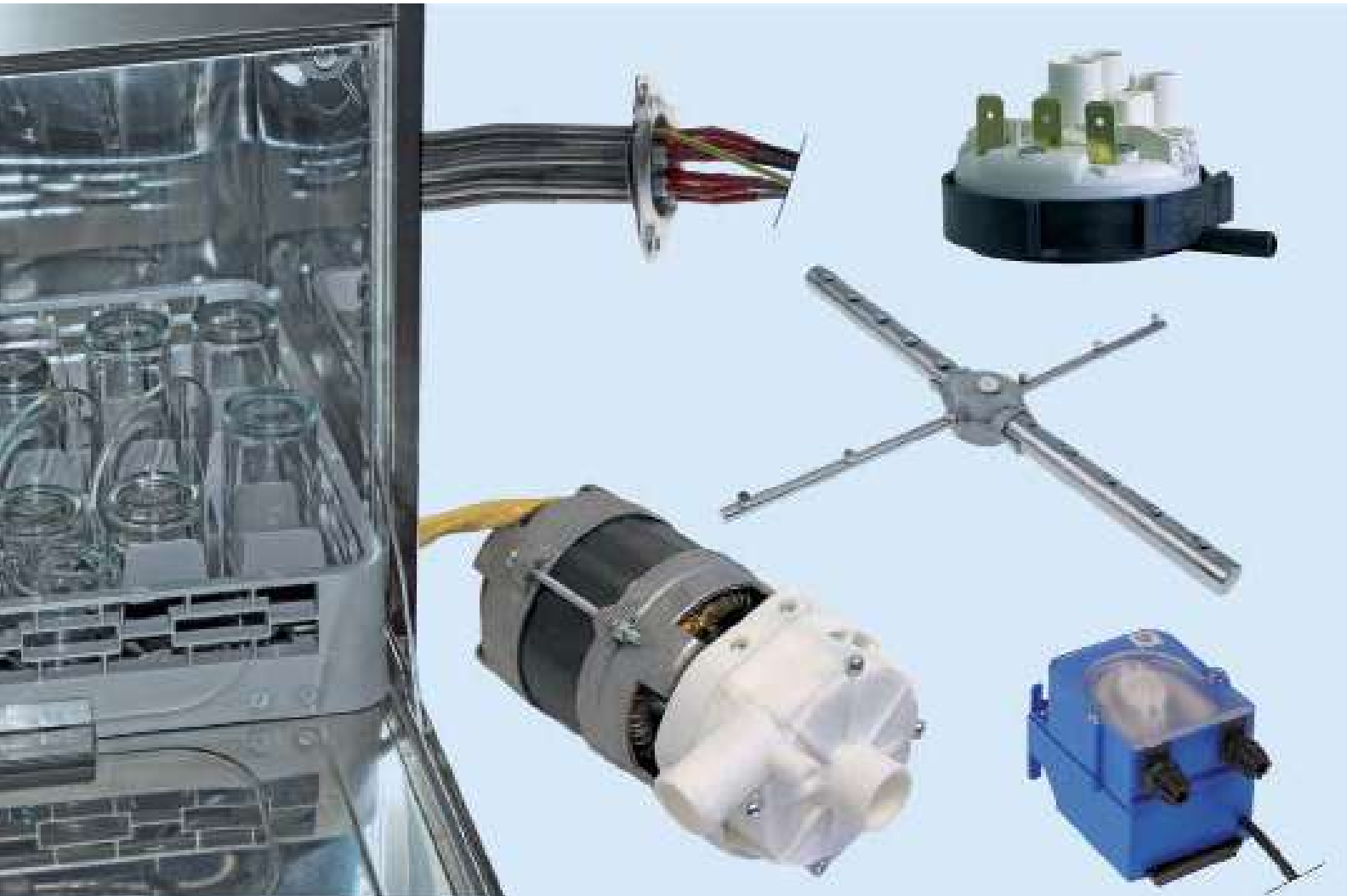

Spare parts suitable for

**FAGOR**

2018

Find the complete and up-to-date range of products in our GEV Webshop

## heating elements

## dry heating elements for dishwashers



<b>GEV No.</b>	420561	<b>Ref. No.</b>	12048965
<b>description</b>	heating element 2800W 230V heating circuits 1 L 325mm W 55mm H 40mm tube ø 6.5mm connection F6.3x0.8 dry heating element dishwasher		
<b>For models:</b>	CO-500, CO-500B, CO-500BDD, CO-500DD, CO-501, CO-501B, CO-501BDD, CO-501DD, CO-501-SOFT, CO-502B, CO-502BDD, CO-502DD, CO-502W, COP-503, COP-503B, COP-503BDD, COP-503DD, COP-503-SOFT, COP-504, COP-504B, COP-504BDD, COP-504DD, COP-504W		

## coil heating elements

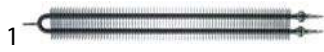



<b>GEV No.</b>	418969	<b>Ref. No.</b>	12024856 Z276391
<b>description</b>	heating element 1500W 230V L 455mm W 50mm H 25mm tube ø 8mm thread M12x1.25 connection M4 heating circuits 1		
<b>For models:</b>	ECO-160, ECO-160D, ECO-160I, ECO-200, ECO-200D, ECO-200H, ECO-200HD, ECO-200HI, ECO-200I, ECO-2700D, ECO-2700I, ECO-280D, ECO-280I, ECO-370D, ECO-370I, ECO-4000D, ECO-4000I, ECO-460D, ECO-460I, ECO-550D, ECO-550I, ECO-6000D, ECO-6000I, FI-160, FI-160AR, FI-160D, FI-160I, FI-200, FI-200AR, FI-200D, FI-200H, FI-200HD, FI-200HI, FI-200I, FI-200W, FI-200WL, FI-200WR, FI-2700D, FI-2700I, FI-280D, FI-280I, FI-370D, FI-370I, FI-4000D, FI-4000I, FI-460D, FI-460I, FI-550D, FI-550I, FI-6000D...(Other models you can see in the webshop)		

## immersion heating elements

## 3 hole flange ø57.5mm





<b>GEV No.</b>	415021	<b>Ref. No.</b>	12024713 Z313601
<b>description</b>	heating element 6000W 230V mounting ø 57.5mm heating circuits 3 L 343mm W 37mm H 50mm number of thermostat sleeves 1 thermostat sleeves ø 7mm length thermostat sleeves 294mm thermostat sleeve not clinging tube ø 8.5mm hole distance 72mm hole ø 8mm connection M5 3 hole flange		
<b>For models:</b>	ECO-2700D, ECO-2700I, ECO-280D, ECO-280I, ECO-370D, ECO-370I, ECO-4000D, ECO-4000I, ECO-460D, ECO-460I, ECO-550D, ECO-550I, ECO-6000D, ECO-6000I, FI-2700D, FI-2700I, FI-280D, FI-280I, FI-370D, FI-370I, FI-4000D, FI-4000I, FI-460D, FI-460I, FI-550D, FI-550I, FI-6000D, FI-6000I		
<b>spare parts for</b>	415021		
	<b>GEV No.</b>	510409	<b>Ref. No.</b> 12010040 Q307044
	O-ring EPDM thickness 5.34mm ID ø 56.52mm Qty 1 pcs		
<b>accessories for</b>	415021		
	<b>GEV No.</b>	550002	<b>Ref. No.</b> —
	tension strap H 10mm L 21mm W 10mm hole ø 6.5mm for heating element		

Зип Общепит

vsezip.ru

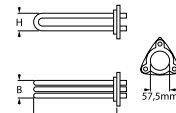
+7(812)987-08-81



<b>GEV No.</b>	418798	<b>Ref. No.</b>	12024214 12040415 Z121740 Z121741
<b>description</b>	heating element 9600W 230V mounting ø 57.5mm heating circuits 3 L 545mm W 36mm H 53mm number of thermostat sleeves 1 thermostat sleeves ø 7mm length thermostat sleeves 190mm tube ø 8mm hole distance 73mm hole ø 8mm connection M4		
<b>For models:</b>	ECO-160, ECO-160D, ECO-160I, ECO-200, ECO-200D, ECO-200H, ECO-200HD, ECO-200HI, ECO-200I, ECO-2300, ECO-2700D, ECO-2700I, ECO-3000, ECO-4000D, ECO-4000I, ECO-6000D, ECO-6000I, FI-160, FI-160D, FI-160AR, FI-160I, FI-200, FI-200AR, FI-200D, FI-200H, FI-200HD, FI-200HI, FI-200I, FI-200WL, FI-200WR, FI-2300, FI-2700D, FI-2700I, FI-280D, FI-280I, FI-3000, FI-370D, FI-370I, FI-4000D, FI-4000I, FI-460D, FI-460I, FI-550D, FI-550I, FI-6000D, FI-6000I		
<b>accessories for</b>	418798		
	<b>GEV No.</b>	510409	<b>Ref. No.</b> 12010040 Q307044
	O-ring EPDM thickness 5.34mm ID ø 56.52mm Qty 1 pcs		

## 3 hole flange ø60.0mm

## connection straight

## group 1



<b>GEV No.</b>	420325	<b>Ref. No.</b>	12024721 Z129502
<b>description</b>	heating element 12000W 230V mounting ø 60mm heating circuits 3 L 545mm W 36mm H 41mm number of thermostat sleeves 1 thermostat sleeves ø 7mm length thermostat sleeves 175mm thermostat sleeve eccentric, non clinging tube ø 8.5mm hole distance 73mm hole ø 10mm connection M4 3 hole flange immersion heater		
<b>For models:</b>	ECO-6000D, ECO-6000I, FI-160D, FI-160I, FI-200AR, FI-200D, FI-200HD, FI-200HI, FI-200I, FI-200W, FI-2700D, FI-2700I, FI-4000D, FI-4000I, FI-460D, FI-460I, FI-550D, FI-550I, FI-6000D, FI-6000I		





<b>GEV No.</b>	420324	<b>Ref. No.</b>	12024740 Z101720 Z101740
<b>description</b>	heating element 6000W 230V mounting ø 60mm heating circuits 3 L 545mm W 36mm H 41mm number of thermostat sleeves 1 thermostat sleeves ø 7mm length thermostat sleeves 175mm thermostat sleeve eccentric, non clinging tube ø 8.5mm hole distance 73mm hole ø 10mm connection M4 3 hole flange immersion heater		
<b>For models:</b>	ECO-1600, ECO-2300, ECO-280D, ECO-280I, ECO-3000, ECO-370D, ECO-370I, ECO-460D, ECO-460I, ECO-550D, ECO-550I, FI-1600, FI-2300, FI-280D, FI-280I, FI-3000, FI-370D, FI-370I, FI-460D, FI-460I, FI-550D, FI-550I		





Зип Общепит  
vsezip.ru  
(812) 987-08-81

with expansion flange 70 x 18mm



<b>GEV No.</b>	416380	<b>Ref. No.</b>	12024985 Z733601
<b>description</b>	heating element 1000W 230V heating circuits 1 flange 70x18mm L 273mm W 63mm H 27mm connection M4 immersion heater expansion flange tube ø 6.5mm		
<b>For models:</b>	ECO-120, LVC-12, LVC-15, LVC-21, LVR-10		
<b>accessories for</b>	416380		
	<b>GEV No.</b>	510429	<b>Ref. No.</b> —
	gasket L 76mm W 23mm hole distance 25mm 3 holes for heating element type DB 70 without thermostat sensor hole		



<b>GEV No.</b>	416381	<b>Ref. No.</b>	12024951 R223005
<b>description</b>	heating element 2000W 230V heating circuits 1 flange 70x18mm L 280mm W 78mm H 22mm connection M4 immersion heater expansion flange tube ø 8.5mm		
<b>For models:</b>	AD-15, AD-15D, AD-20C-UK, AD-21, AD-21B, AD-21BDD, AD-21C, AD-21D, AD-21DD, AD-21W, AD-45BBT, BME7-05, BME7-10, BME9-10, BME9-10AD, BME9-10PLUS, BME9-10V-T, FI-30, FI-30AR, FI-30AR+DD, FI-30B-BT-UK, FI-30-UK, LVC-12, LVC-15, LVC-15D, LVC-21, LVC-21B, LVC-21C, LVC-21D, LVC-21W, LVR-14, LVR-14D, LVR-20, LVR-20B, LVR-20D, MF-21		
<b>accessories for</b>	416381		
	<b>GEV No.</b>	510429	<b>Ref. No.</b> —
	gasket L 76mm W 23mm hole distance 25mm 3 holes for heating element type DB 70 without thermostat sensor hole		



<b>GEV No.</b>	416382	<b>Ref. No.</b>	12024645 Z203601
<b>description</b>	heating element 2800W 230V heating circuits 1 flange 70x18mm L 370mm W 102mm H 27mm immersion heater tube ø 8.5mm		
<b>For models:</b>	AD-48, AD-48B, AD-48BDD, AD-48C, AD-48D, AD-48DD, AD-48HY, AD-48W, AD-64, AD-64B, AD-64BBT, AD-64BDD, AD-64BTDD, AD-64C, AD-64CW, AD-64D, AD-64DD, AD-64HY, AD-72, AD-72W, BME9-05, BME9-05AD, BME9-05PLUS, BME9-05V-T, EASY-500, EASY-500B, EASY-500DD, EASY-500HP, EASY-500HPWBDD, ECO-120, ECO-120B, FI-100, FI-120, FI-120W, FI-30, FI-30AR, FI-30AR+DD, FI-30B, FI-30-UK, FI-48, FI-48AR, FI-48B, FI-48B-BT-UK, FI-48C, FI-48D, FI-48HY-CLINIC, FI-48W, FI-50, FI-60DD, FI-64...(Other models you can see in the webshop)		



<b>GEV No.</b>	418800	<b>Ref. No.</b>	12024577 12041359 P533001
<b>description</b>	heating element 2x3000W 230V heating circuits 2 flange 70x18mm L 510mm W 60mm connection M4 tube ø 8mm expansion flange		
<b>For models:</b>	LA-25M, LA-AC-25M, LA-AC-25MA, LA-AC-25MP, LAC-25, LAC-25MP, LAC-25MPP, LAC-55, LAC-55MP, LAC-55MPP, LA-E-25M, LA-E-25MA, LA-E-25MP, LC-25, LC-E-25, LF-25MPP, LF-E-25, LF-E-25MP, LF-E-25MPP, LF-E-55, LF-E-55MP, LF-E-55MPP, LR-AC-25M, LR-AC-25MA, LR-AC-25MP, LR-E-25M, LR-E-25MA, LR-E-25MP		



<b>GEV No.</b>	418832	<b>Ref. No.</b>	12018752 P143002
<b>description</b>	heating element 3000W 230V heating circuits 1 flange 70x18mm L 350mm W 63mm H 27mm connection M4 tube ø 8mm immersion heater		
<b>For models:</b>	LAC-10, LAC-10MP, LAC-10MPP, LC-10, LC-E-10, LC-E-10A, LF-E-10, LF-E-10A, LF-E-10MP, LF-E-10MPP		



<b>GEV No.</b>	418885	<b>Ref. No.</b>	12023242 P633002
<b>description</b>	heating element 4000W 230V heating circuits 1 flange 70x18mm L 350mm W 63mm H 18mm L1 23mm L2 19mm L3 308mm tube ø 8mm connection M4 immersion heater connection length 37mm expansion flange EPDM		
<b>For models:</b>	LA-18MP, LA-AC-18M, LA-AC-18MA, LA-AC-18MP, LA-E-18M, LA-E-18MA, LA-E-18MP, LF-18MPP, LR-AC-18M, LR-AC-18MA, LR-E-18M, LR-E-18MA, LR-E-18MP		



<b>GEV No.</b>	418529	<b>Ref. No.</b>	12023778 Z743601
<b>description</b>	heating element 4500W 230V heating circuits 3 flange 70x18mm L 365mm W 65mm H 27mm connection male faston 6.3mm immersion heater expansion flange tube ø 6.7mm		
<b>For models:</b>	AD-120, AD-120B, AD-120BBTDD-UK, AD-120C, AD-120CW, AD-120HY, AD-90, AD-90BA, AD-90BBT, AD-90BDD, AD-90DD, ADE-120, ADE-120B, ECO-120, ECO-120B, FI-100, FI-100AR, FI-100B, FI-100BBT-UK, FI-120, FI-120AR+DD, FI-120B, FI-120C, FI-120HY-CLINIC, FI-120W, FI-80, FI-80AR, FI-80BBT-UK, FI-80W, FI-E-100, MF-120		

miscellaneous







<b>GEV No.</b>	416386	<b>Ref. No.</b>	12024146 Z728306
<b>description</b>	heating element 12000W 230V mounting ø 60mm heating circuits 3 L 428mm W 45mm H 44mm thermostat sleeves ø 6.7mm length thermostat sleeves 250mm number of thermostat sleeves 1 thermostat sleeve not clinging tube ø 6.3mm hole distance 82mm hole ø 7mm connection M4 immersion heater 6 hole flange		
<b>For models:</b>	AD-120, AD-120B, AD-120C, AD-120HY, CO-110, CO-110B, CO-110BDD, CO-110DD, CO-170, CO-170B, CO-170BDD, CO-170DD, CO-170HRS, CO-170HRSDD, CO-170HRS-SOFT, CO-170-SOFT, CO-172, CO-172B, CO-172BDD, CO-172DD, ECO-120, ECO-120B, FI-120, FI-120AR+DD, FI-120B, FI-120C, FI-120HY-CLINIC, FI-120W, LABP-1200, MF-120		
<b>spare parts for</b>	416386		
	<b>GEV No.</b>	691033	<b>Ref. No.</b> 12010051 Q307035
	O-ring EPDM thickness 5.34mm ID ø 62.87mm Qty 1 pcs		



electric components





Зип Общепит  
vsezip.ru  
7(812)987-9879



			
<b>GEV No.</b>	416383	<b>Ref. No.</b>	12017951 12024559 Z401711 Z401738
<b>description</b>	heating element 2400W 230V heating circuits 1 mounting ø 42mm L 278mm W 39mm H 39mm hole distance 64mm hole ø 7mm connection M4 immersion heater 5 hole flange		
<b>For models:</b>	AD-15, AD-15D, LVC-12, LVC-15, LVC-15D, LVC-21D, LVR-10, LVR-14, LVR-14D		
<b>accessories for</b>	416383		
	<b>GEV No.</b>	505092	<b>Ref. No.</b>
			12010062 12016701 Q307053 S312113
O-ring EPDM thickness 5.34mm ID ø 43.82mm Qty 1 pcs			

			
<b>GEV No.</b>	416375	<b>Ref. No.</b>	12024907 Z421712
<b>description</b>	heating element 2800W 230V heating circuits 1 mounting ø 42mm L 290mm W 37mm H 32mm tube ø 8mm hole distance 42mm hole ø 7mm connection M4 5 hole flange		
<b>For models:</b>	AD-21, AD-21B, AD-21BDD, AD-21C, AD-21D, AD-21DD, AD-21W, LVC-15D, LVC-21, LVC-21B, LVC-21C, LVC-21D, LVC-21W		
<b>accessories for</b>	416375		
	<b>GEV No.</b>	505092	<b>Ref. No.</b>
			12010062 12016701 Q307053 S312113
O-ring EPDM thickness 5.34mm ID ø 43.82mm Qty 1 pcs			
	<b>GEV No.</b>	524478	<b>Ref. No.</b>
			—
O-ring Viton thickness 5.7mm ID ø 44.2mm Qty 1 pcs			

			
<b>GEV No.</b>	416384	<b>Ref. No.</b>	12024683 Z201706
<b>description</b>	heating element 2800W 230V mounting ø 63mm heating circuits 1 L 427mm W 44mm H 43mm thermostat sleeves ø 6.5mm length thermostat sleeves 190mm number of thermostat sleeves 1 thermostat sleeve not clinging hole distance 41mm hole ø 7.5mm connection M4 3 hole flange round flange		
<b>For models:</b>	AD-48, AD-48B, AD-48BDD, AD-48C, AD-48D, AD-48DD, AD-48HY, EASY-500, EASY-500B, EASY-500DD, FI-30, FI-30AR, FI-30AR+DD, FI-30B, FI-48, FI-48AR, FI-48B, FI-48B-BT-UK, FI-48C, FI-48D, FI-48HY-CLINIC, FI-48W, FI-50, FI-64W		
<b>accessories for</b>	416384		
	<b>GEV No.</b>	691033	<b>Ref. No.</b>
			12010051 Q307035
O-ring EPDM thickness 5.34mm ID ø 62.87mm Qty 1 pcs			

			
<b>GEV No.</b>	416385	<b>Ref. No.</b>	12024732 Z241701
<b>description</b>	heating element 6000W 230V mounting ø 63mm heating circuits 3 L 420mm W 30mm H 49mm thermostat sleeves ø 6.3mm length thermostat sleeves 190mm number of thermostat sleeves 1 thermostat sleeve not clinging tube ø 8mm hole distance 41mm hole ø 7mm connection M4 immersion heater 6 hole flange		
<b>For models:</b>	AD-120BBTDD-UK, AD-45BBT, AD-64, AD-64B, AD-64BBT, AD-64BDD, AD-64BTDD, AD-64C, AD-64D, AD-64DD, AD-64HY, AD-72, AD-90, AD-90BA, AD-90BBT, AD-90BDD, AD-90DD, CO-110, CO-110B, CO-110BDD, CO-110DD, CO-112, CO-112B, CO-112BDD, CO-112DD, EASY-500HP, EASY-500HPWBDD, FI-100, FI-48D, FI-60DD, FI-64, FI-64AR, FI-64B, FI-64B-BT-UK, FI-64C, FI-64D, FI-64HY-CLINIC, FI-64W, FI-72, FI-72AR, FI-80, FI-80AR, FI-80BBT-UK, FI-80W, FI-900, LABP-800, MF-48, MF-64		
<b>accessories for</b>	416385		
	<b>GEV No.</b>	691033	<b>Ref. No.</b>
			12010051 Q307035
O-ring EPDM thickness 5.34mm ID ø 62.87mm Qty 1 pcs			

			
<b>GEV No.</b>	420326	<b>Ref. No.</b>	12017495 Z691751
<b>description</b>	heating element 9000W 220V mounting ø 63mm heating circuits 3 L 454mm W 48mm H 38mm thermostat sleeves ø 7mm length thermostat sleeves 180mm number of thermostat sleeves 1 thermostat sleeve centre not clinging tube ø 8mm hole distance 41mm hole ø 7mm connection M4 immersion heater 6 hole flange		
<b>For models:</b>	FI-1200, ME9-10BM, ME9-15BM		

			
<b>GEV No.</b>	416614	<b>Ref. No.</b>	12023926 Z721701
<b>description</b>	heating element 9600W 230V mounting ø 63mm heating circuits 3 L 425mm W 50mm H 45mm thermostat sleeves ø 6.5mm length thermostat sleeves 200mm number of thermostat sleeves 1 thermostat sleeve eccentric, non clinging tube ø 6.5mm hole distance 82mm hole ø 7mm connection M4 immersion heater 6 hole flange		
<b>For models:</b>	CO-142W, CO-142WDD, FI-100, FI-100AR, FI-100B, FI-100BBT-UK, FI-120, FI-80, FI-80W, FI-E-100, LABP-1000, ME9-10BM, ME9-10BMS, ME9-15BM, ME9-15BM316, ME9-15BMS, MPE9-10BM, MPE9-10BMS, MPE9-15BM, MPE9-15BMS		
<b>spare parts for</b>	416614		
	<b>GEV No.</b>	532163	<b>Ref. No.</b>
			—
O-ring EPDM thickness 5.34mm ID ø 62.87mm Qty 10 pcs			
	<b>GEV No.</b>	691033	<b>Ref. No.</b>
			12010051 Q307035
O-ring EPDM thickness 5.34mm ID ø 62.87mm Qty 1 pcs			









Зип Общежит  
accessories

vsezip.ru

+7(812)987-08-81

			
<b>GEV No.</b>	417222	<b>Ref. No.</b>	12017628 Z603601
<b>description</b>	heating element 2000W 230V heating circuits 1 L 280mm W 140mm H 23mm thread 1/4" mounting distance 132mm tube ø 8mm connection male faston 6.3mm immersion heater 2 hole fixing stainless steel		

			
<b>GEV No.</b>	416235	<b>Ref. No.</b>	12030300 EU80677
<b>description</b>	heating element 3000W 230V heating circuits 1 L 320mm W 50mm H 40mm thread M10x1 mounting distance 44mm tube ø 6.3mm connection male faston 6.3mm 2 hole fixing L1 32mm L2 288mm		

<b>spare parts for</b>	416235		
	<b>GEV No.</b>	510893	<b>Ref. No.</b> —
	O-ring EPDM thickness 2.62mm ID ø 9.92mm Qty 1 pcs		
<b>accessories for</b>	416235		
	<b>GEV No.</b>	510416	<b>Ref. No.</b> —
	flat gasket fibre ED ø 19mm ID ø 10.5mm thickness 1.5mm for thread M10 Qty 1 pcs		
	<b>GEV No.</b>	510893	<b>Ref. No.</b> —
	O-ring EPDM thickness 2.62mm ID ø 9.92mm Qty 1 pcs		
	<b>GEV No.</b>	521129	<b>Ref. No.</b> —
	nut thread M10 H 6mm SS WS 17 Qty 1 pcs DIN/ISO DIN 439		
	<b>GEV No.</b>	560192	<b>Ref. No.</b> —
	tooth lock washer ID ø 10.4mm ED ø 18mm SS DIN/ISO DIN 6798A Qty 1 pcs for thread M10		

			
<b>GEV No.</b>	560131	<b>Ref. No.</b>	12009839 Q162020
<b>description</b>	hexagonal nut thread M4 H 3.2mm WS 7 SS DIN/ISO DIN 934 / ISO 4032/8673 Qty 20 pcs		
<b>For models:</b>	ACE-201, ACE-202, AD-120, AD-120B, AD-120BTTDD-UK, AD-120C, AD-120CW, AD-120HY, AD-15, AD-15D, AD-20C-UK, AD-21, AD-21B, AD-21BDD, AD-21C, AD-21D, AD-21DD, AD-21W, AD-45BBT, AD-48, AD-48B, AD-48BDD, AD-48C, AD-48D, AD-48DD, AD-48HY, AD-48W, AD-64, AD-64B, AD-64BBT, AD-64BDD, AD-64C, AD-64CW, AD-64D, AD-64DD, AD-64HY, AD-72, AD-72W, AD-90, AD-90BA, AD-90BBT, AD-90BDD, AD-90DD, ADE-120, ADE-120B, AE-061, AE-061W, AE-101, AE-101W, AE-102...(Other models you can see in the webshop)		

			
<b>GEV No.</b>	560132	<b>Ref. No.</b>	12010194 12010284 Q162030 Q163030
<b>description</b>	hexagonal nut thread M5 H 4mm WS 8 SS DIN/ISO DIN 934 / ISO 4032/8673 Qty 20 pcs		
<b>For models:</b>	ACE-061, ACE-101, ACE-102, ACE-201, ACE-202, ACG-061, ACG-101, ACG-102, ACG-201, ACG-202, AD-120, AD-120B, AD-120BTTDD-UK, AD-120C, AD-120CW, AD-120HY, AD-15, AD-15D, AD-20C-UK, AD-21, AD-21B, AD-21BDD, AD-21C, AD-21D, AD-21DD, AD-21W, AD-45BBT, AD-48, AD-48B, AD-48BDD, AD-48C, AD-48D, AD-48DD, AD-48HY, AD-48W, AD-64, AD-64B, AD-64BBT, AD-64BDD, AD-64BTDD, AD-64C, AD-64CW, AD-64D, AD-64DD, AD-64HY, AD-72, AD-72W, AD-90, AD-90BA, AD-90BBT...(Other models you can see in the webshop)		

			
<b>GEV No.</b>	550261	<b>Ref. No.</b>	12016635 X163012 Z600603
<b>description</b>	nut thread M14x1 H 4mm WS 19 SS Qty 1 pcs		
<b>For models:</b>	BG9-05, BG9-05I, BG9-10, BG9-10I, FE-710, FE-720, FE-920, FG-710, FG-720, FG-920, FI-300B, FI-300R, FI-650R, LVC-15, LVC-21, LVR-14, LVR-20, LVR-20B		

heating elements for convection

			
<b>GEV No.</b>	417658	<b>Ref. No.</b>	12031112 12043757 D01AC02257 D01AC02254 D01AC02257
<b>description</b>	heating element 2000W 230V L 500mm W 86mm connection male faston 6.3mm		
<b>For models:</b>	SF-13, SF-8		

electric components



## Зип-Общепит

tooth lock washers

vsezip.ru

## washers



1

<b>GEV No.</b>	560111	<b>Ref. No.</b>	12009987 Q232020
<b>description</b>	plain washer ID $\varnothing$ 4.3mm ED $\varnothing$ 9mm thickness 0.8mm SS Qty 20 pcs DIN 125A for thread M4		
<b>For models:</b>	ACE-061, ACE-101, ACE-102, ACE-201, ACE-202, ACG-061, ACG-101, ACG-102, ACG-201, ACG-202, AD-120, AD-120B, AD-120BBTDD-UK, AD-120C, AD-120CW, AD-120HY, AD-15, AD-15D, AD-21, AD-21B, AD-21BDD, AD-21C, AD-21D, AD-21DD, AD-21W, AD-48, AD-48B, AD-48C, AD-48D, AD-48DD, AD-64, AD-64B, AD-64BTDD, AD-64C, AD-64D, AD-64DD, AD-72, AD-90, AD-90BA, AD-90BBT, AD-90BDD, AD-90DD, ADE-120, ADE-120B, AE-061, AE-061W, AE-101, AE-101W, AE-102, AE-102W...(Other models you can see in the webshop)		

1

<b>GEV No.</b>	560125	<b>Ref. No.</b>	12009928 Q242020
<b>description</b>	tooth lock washer ID $\varnothing$ 4.2mm ED $\varnothing$ 8mm SS DIN/ISO DIN 6798A Qty 20 pcs for thread M4		
<b>For models:</b>	ACE-061, ACE-101, ACE-102, ACE-201, ACE-202, ACG-061, ACG-101, ACG-102, ACG-201, ACG-202, AD-120, AD-120B, AD-120BBTDD-UK, AD-120C, AD-120CW, AD-120HY, AD-15, AD-15D, AD-20C-UK, AD-21, AD-21B, AD-21BDD, AD-21C, AD-21D, AD-21DD, AD-21W, AD-45BBT, AD-48, AD-48B, AD-48BDD, AD-48C, AD-48D, AD-48DD, AD-48HY, AD-48W, AD-64, AD-64B, AD-64BDD, AD-64BTDD, AD-64C, AD-64CW, AD-64D, AD-64DD, AD-64HY, AD-72, AD-72W, AD-90, AD-90BA, AD-90BBT, AD-90BDD...(Other models you can see in the webshop)		



2

<b>GEV No.</b>	560112	<b>Ref. No.</b>	12009944 Q232030
<b>description</b>	plain washer ID $\varnothing$ 5.3mm ED $\varnothing$ 10mm thickness 1mm SS Qty 20 pcs DIN 125A for thread M5		
<b>For models:</b>	ACE-061, ACE-101, ACE-102, ACE-201, ACE-202, ACG-061, ACG-101, ACG-102, ACG-201, ACG-202, AD-120, AD-120B, AD-120BBTDD-UK, AD-120C, AD-120CW, AD-120HY, AD-15, AD-15D, AD-20C-UK, AD-21, AD-21B, AD-21BDD, AD-21C, AD-21D, AD-21DD, AD-21W, AD-45BBT, AD-48, AD-48B, AD-48BDD, AD-48C, AD-48D, AD-48DD, AD-48HY, AD-48W, AD-64, AD-64B, AD-64BBT, AD-64BDD, AD-64BTDD, AD-64C, AD-64CW, AD-64D, AD-64DD, AD-64HY, AD-72, AD-72W, AD-90, AD-90BA, AD-90BBT...(Other models you can see in the webshop)		

## sealing washers

## fibre gaskets

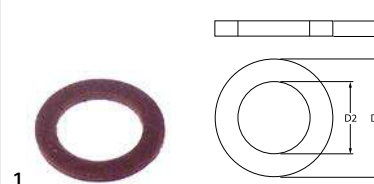

1

<b>GEV No.</b>	507332	<b>Ref. No.</b>	12010260 Q306024
<b>description</b>	flat gasket fibre ED $\varnothing$ 18mm ID $\varnothing$ 12mm thickness 2mm Qty 1 pcs		
<b>For models:</b>	AD-120, AD-120B, AD-120BBTDD-UK, AD-120C, AD-120CW, AD-120HY, AD-45BBT, AD-48, AD-48B, AD-48BDD, AD-48C, AD-48D, AD-48DD, AD-48HY, AD-48W, AD-64, AD-64B, AD-64BBT, AD-64BDD, AD-64BTDD, AD-64C, AD-64CW, AD-64D, AD-64DD, AD-64HY, AD-72, AD-72W, AD-90, AD-90BA, AD-90BBT, AD-90BDD, AD-90DD, ADE-120, ADE-120B, BME7-05, BME7-10, BME9-05, BME9-05AD, BME9-05PLUS, BME9-05V-T, BME9-10, BME9-10AD, BME9-10PLUS, BME9-10V-T, BMG7-10, BMG-9045, BMG9-05, BMG9-05V-T, BMG9-10, BMG9-10V-T...(Other models you can see in the webshop)		



1

<b>GEV No.</b>	560113	<b>Ref. No.</b>	12009868 12038251 Q232040 RT13060120
<b>description</b>	plain washer ID $\varnothing$ 6.4mm ED $\varnothing$ 12mm thickness 1.6mm SS Qty 20 pcs DIN 125A for thread M6		
<b>For models:</b>	ACE-061, ACE-101, ACE-102, ACE-201, ACE-202, ACG-061, ACG-101, ACG-102, ACG-201, ACG-202, AD-120, AD-120B, AD-120BBTDD-UK, AD-120C, AD-120CW, AD-120HY, AD-15, AD-15D, AD-20C-UK, AD-21, AD-21B, AD-21BDD, AD-21C, AD-21D, AD-21DD, AD-21W, AD-45BBT, AD-48, AD-48B, AD-48BDD, AD-48C, AD-48D, AD-48DD, AD-48HY, AD-48W, AD-64, AD-64B, AD-64BBT, AD-64BDD, AD-64BTDD, AD-64C, AD-64CW, AD-64D, AD-64DD, AD-64HY, AD-72, AD-72W, AD-90, AD-90BA, AD-90BBT...(Other models you can see in the webshop)		

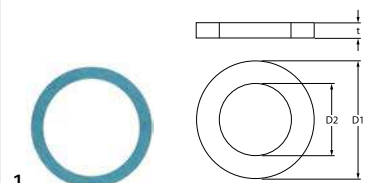

1

<b>GEV No.</b>	510406	<b>Ref. No.</b>	12035981 ICR09387
<b>description</b>	flat gasket fibre ED $\varnothing$ 60mm ID $\varnothing$ 48mm thickness 3mm for thread 1½" Qty 1 pcs		



Зип Общепит

vsezip.ru

+7(812)987-08-81

O-rings

1

<b>GEV No.</b>	505092	<b>Ref. No.</b>	12010062 12016701 Q307053 S312113
<b>description</b>	O-ring EPDM thickness 5.34mm ID $\varnothing$ 43.82mm Qty 1 pcs		
<b>For models:</b>	AD-15, AD-15D, AD-20C-UK, AD-21, AD-21B, AD-21BDD, AD-21C, AD-21D, AD-21DD, AD-21W, LVC-12, LVC-15, LVC-15D, LVC-21, LVC-21B, LVC-21C, LVC-21D, LVC-21W, LVR-10, LVR-14, LVR-14D, LVR-20, LVR-20B, LVR-20D, MF-21		

protection caps

1

<b>GEV No.</b>	520357	<b>Ref. No.</b>	12024282 Z101723
<b>description</b>	protection cap for flange $\varnothing$ 57.5mm $\varnothing$ 62mm H 42mm		
<b>For models:</b>	AD-45BBT, AD-48, AD-48B, AD-48BDD, AD-48C, AD-48D, AD-48DD, AD-48HY, AD-48W, AD-64, AD-64B, AD-64BBT, AD-64BDD, AD-64BTDD, AD-64C, AD-64CW, AD-64D, AD-64DD, AD-64HY, AD-72, AD-72W, EASY-500, EASY-500B, EASY-500DD, EASY-500HP, EASY-500HPWBDD, ECO-160, ECO-1600, ECO-200, ECO-200H, ECO-2300, ECO-2700D, ECO-2700I, ECO-280D, ECO-280I, ECO-3000, ECO-370D, ECO-370I, ECO-4000D, ECO-4000I, ECO-460D, ECO-460I, ECO-550D, ECO-550I, ECO-6000D, ECO-6000I, FI-160, FI-1600, FI-160AR, FI-160D...		

(Other models you can see in the webshop)

2

<b>GEV No.</b>	510408	<b>Ref. No.</b>	12039760 eu456002 Q307020
<b>description</b>	O-ring EPDM thickness 5.34mm ID $\varnothing$ 47mm Qty 1 pcs		
<b>For models:</b>	ECO-1200, FI-1200, FI-300B, FI-300R, FI-650R, FI-900		

1

<b>GEV No.</b>	510034	<b>Ref. No.</b>	12025258 Z401713
<b>description</b>	protection cap for heating element $\varnothing$ 53mm mounting distance 74mm plastic L 35mm		
<b>For models:</b>	AD-15, AD-15D, AD-20C-UK, AD-21, AD-21B, AD-21BDD, AD-21C, AD-21D, AD-21DD, AD-21W, LVC-12, LVC-15, LVC-15D, LVC-21, LVC-21B, LVC-21C, LVC-21D, LVC-21W, LVR-10, LVR-14, LVR-14D, LVR-20, LVR-20B, LVR-20D, MF-21		

1

<b>GEV No.</b>	510409	<b>Ref. No.</b>	12010040 Q307044
<b>description</b>	O-ring EPDM thickness 5.34mm ID $\varnothing$ 56.52mm Qty 1 pcs		
<b>For models:</b>	ECO-160, ECO-1600, ECO-160D, ECO-160I, ECO-200, ECO-200D, ECO-200H, ECO-200HD, ECO-200HI, ECO-200I, ECO-2300, ECO-2700D, ECO-2700I, ECO-280D, ECO-280I, ECO-3000, ECO-370D, ECO-370I, ECO-4000D, ECO-4000I, ECO-460D, ECO-460I, ECO-550D, ECO-550I, ECO-6000D, ECO-6000I, FI-160, FI-1600, FI-160AR, FI-160D, FI-160I, FI-200, FI-200AR, FI-200D, FI-200H, FI-200HD, FI-200HI, FI-200I, FI-200W, FI-200WL, FI-200WR, FI-2300, FI-2700D, FI-2700I, FI-280D, FI-280I, FI-3000, FI-370D, FI-370I, FI-4000D...(Other models you can see in the webshop)		

1

<b>GEV No.</b>	505208	<b>Ref. No.</b>	12022859 Z603602
<b>description</b>	bracket for heating element		
<b>For models:</b>	AD-15, AD-15D, AD-20C-UK, AD-21, AD-21B, AD-21BDD, AD-21C, AD-21D, AD-21DD, AD-21W, AD-45BBT, AD-48, AD-48B, AD-48BDD, AD-48C, AD-48D, AD-48DD, AD-48HY, AD-48W, AD-64, AD-64B, AD-64BBT, AD-64BDD, AD-64BTDD, AD-64C, AD-64CW, AD-64D, AD-64DD, AD-64HY, AD-72, AD-72W, BME7-05, BME7-10, BME9-05, BME9-05AD, BME9-05PLUS, BME9-05V-T, BME9-10, BME9-10AD, BME9-10PLUS, BME9-10V-T, EASY-500, EASY-500B, EASY-500DD, EASY-500HP, EASY-500HPWBDD, ECO-120, ECO-1200, ECO-120B, FI-100...		

(Other models you can see in the webshop)

electric components



## thermostats

## bi-metal thermostats

## safety bi-metal thermostats



1

<b>GEV No.</b>	390451	<b>Ref. No.</b>	12025141 R213004
<b>description</b>	bi-metal safety thermostat hole distancemm switch-off temp. 115°C 1NC 1-pole 16A connection F6.3		
<b>For models:</b>	AD-120, AD-120B, AD-120BBTDD-UK, AD-120C, AD-120CW, AD-120HY, AD-90, AD-90BA, AD-90BBT, AD-90BDD, AD-90DD, ADE-120, ADE-120B, BME7-05, BME7-10, BME9-05, BME9-10, ECO-120, ECO-120B, FI-100, FI-100AR, FI-100B, FI-100BBT-UK, FI-120, FI-120AR+DD, FI-120B, FI-120C, FI-120HY-CLINIC, FI-120W, FI-80, FI-80AR, FI-80BBT-UK, FI-80W, FI-E-100, LABP-1000, LABP-1200, MF-120		
<b>accessories for</b>	390451		
	<b>GEV No.</b>	505093	<b>Ref. No.</b> 12024049 N503017
gasket for thermostat ED ø 35mm ID ø 24mm thickness 7mm equiv. no. N503017			

## bi-metal thermostats



1

<b>GEV No.</b>	391045	<b>Ref. No.</b>	12095019
<b>description</b>	bi-metal thermostat hole distance 23.5mm switch-off temp. 51°C 1NC 1-pole 10A connection F6.3 threaded probe ø 16mm		
<b>For models:</b>	ACE-061, ACE-101, ACE-102, ACE-201, ACE-202, ACG-061, ACG-101, ACG-102, ACG-201, ACG-202, AE-061, AE-101, AE-102, AE-201, AE-202, AG-061, AG-101, AG-102, AG-201, AG-202, CO-350, CO-350-B, CO-350-B-DD, CO-350-COLD, CO-350-COLD-B, CO-350-COLD-B-DD, CO-350-COLD-DD, CO-350-DD, CO-400, CO-400-B, CO-400-B-DD, CO-400-COLD, CO-400-COLD-B, CO-400-COLD-B-DD, CO-400-COLD-DD, CO-400-DD, CO-400-SOFT		



1

<b>GEV No.</b>	390450	<b>Ref. No.</b>	12023708 Z653013 Z718405
<b>description</b>	bi-metal thermostat hole distancemm switch-off temp. 66/57°C NC/NO 2-pole 16A connection F6.3		
<b>For models:</b>	EASY-500, EASY-500B, EASY-500DD, EASY-500HP, EASY-500HPWBDD, ECO-120, ECO-120B, ECO-120B, FI-100, FI-100AR, FI-100B, FI-100BBT-UK, FI-120, FI-120C, FI-120AR+DD, FI-120B, FI-120C, FI-120HY-CLINIC, FI-120W, FI-30, FI-300B, FI-300R, FI-30AR, FI-30AR+DD, FI-30B, FI-30B-BT-UK, FI-30-UK, FI-48, FI-48B, FI-48B-BT-UK, FI-48D, FI-48W, FI-60DD, FI-64, FI-64AR, FI-64B, FI-64C, FI-64D, FI-64W, FI-650R, FI-72, FI-72AR, FI-80, FI-80AR, FI-80BBT-UK, FI-80W, FI-900, LABP-1000, LABP-1200, LABP-800...(Other models you can see in the webshop)		
<b>accessories for</b>	390450		
	<b>GEV No.</b>	505093	<b>Ref. No.</b> 12024049 N503017
gasket for thermostat ED ø 35mm ID ø 24mm thickness 7mm equiv. no. N503017			

Зип Общепит

vsezip.ru

+7(812)987-08-81

<b>GEV No.</b>	390428	<b>Ref. No.</b>	12023814 P503025
<b>description</b>	bi-metal thermostat hole distancemm switch-off temp.°C 1NO/1NC 2-pole 15A 250V connection F6.3		
<b>For models:</b>	LA-13M, LA-18MP, LA-25M, LA-AC-10M, LA-AC-10MA, LA-AC-10MP, LA-AC-13M, LA-AC-13MA, LA-AC-13MP, LA-AC-18M, LA-AC-18MA, LA-AC-18MP, LA-AC-25M, LA-AC-25MA, LA-AC-25MP, LAC-10MP, LAC-10MPP, LAC-14MP, LAC-14MPP, LAC-25MP, LAC-25MPP, LAC-55MP, LAC-55MPP, LAC-7MP, LAC-7MPP, LA-E-10M, LA-E-10MA, LA-E-10MP, LA-E-13M, LA-E-13MA, LA-E-13MP, LA-E-18M, LA-E-18MA, LA-E-18MP, LA-E-25M, LA-E-25MA, LA-E-25MP, LA-V-10M, LA-V-10MP, LA-V-13M, LA-V-13MP, LA-V-18M, LA-V-18MP, LA-V-25M, LA-V-25MP, LB-AC-10M, LB-E-10M, LB-V-10M, LF-13MPP, LF-18MPP...(Other models you can see in the webshop)		
<b>accessories for</b>	390428		
	<b>GEV No.</b>	505093	<b>Ref. No.</b> 12024049 N503017
gasket for thermostat ED ø 35mm ID ø 24mm thickness 7mm equiv. no. N503017			

## control and safety thermostats

## EGO

## control thermostats

## 55.13\_series



1

<b>GEV No.</b>	375414	<b>Ref. No.</b>	12024648 R343100
<b>description</b>	thermostat t.max. 85°C temperature range 30-85°C 1-pole 1CO 16A probe ø 6mm probe L 73mm capillary pipe 1540mm capillary pipe isolated 1400mm gland nut M9x1 shaft ø 6x4.6mm shaft L 23mm shaft position upper rotation 270°		
<b>For models:</b>	FI-120W, FI-80W, HCV-10-11, HCV-10-21, HCV-2-10-21, HCV-6-11, HEI-10-21, HEM-10-11, HEM-20-11, HEM-6-11, HEP-10-11, HEP-20-11, HEP-6-11, HGV-10-11, HGV-20-11, HME-10-11, HME-20-11, HME-20-11, HME-2-10-11, HME-2-20-11, HME-6-11, HMM-10-11, HMM-10-11UL, HMM-10-21, HMM-10-21UL, HMM-20-11, HMM-20-11UL, HMM-20-21, HMM-20-21UL, HMM-2-10-11, HMM-40-11-USMC, HMM-6-11, HMM-6-11UL, HMP-10-11, HMP-10-21, HMP-20-11, HMP-20-21, HMP-2-10-11, HMP-6-11, HVG-10-11, HVG-10-11UL, HVG-10-21, HVG-10-21UL, HVG-20-11, HVG-20-21, HVG-2-10-11, HVG-2-20-21, MFHMM-20-11, MFHVG-10-11...(Other models you can see in the webshop)		







Зип-Общепит

vsezip.ru

+7(812)987-08-81

 			
<b>GEV No.</b>	375400	<b>Ref. No.</b>	12024096 Z393005
<b>description</b>	thermostat t.max. 90°C temperature range 30-90°C 1-pole 1CO 16A probe ø 6mm probe L 98mm capillary pipe 2380mm capillary pipe isolated 1700mm gland nut M9x1 shaft ø 6x4.6mm shaft L 18mm shaft position upper rotation 270°		
<b>For models:</b>	AD-15, AD-15D, AD-20C-UK, AD-21, AD-21B, AD-21BDD, AD-21C, AD-21D, AD-21DD, AD-21W, AD-90, AD-90DD, FI-30, FI-30AR, FI-30AR+DD, FI-30B, FI-30B-BT-UK, FI-30-UK, FI-80, FI-80AR, FI-80W, LABP-800, LVC-12, LVC-15, LVC-15D, LVC-21, LVC-21B, LVC-21C, LVC-21D, LVC-21W, LVR-10, LVR-14, LVR-14D, LVR-20, LVR-20B, LVR-20D, MF-21		

 			
<b>GEV No.</b>	375130	<b>Ref. No.</b>	12024573 12030953 AL00000121 Z203014
<b>description</b>	thermostat t.max. 90°C temperature range 32-90°C 1-pole 1CO 16A probe ø 6mm probe L 129mm capillary pipe 710mm capillary pipe isolated 500mm gland nut shaft ø 6x4.6mm shaft L 23mm shaft position upper rotation 270°		
<b>For models:</b>	AD-120, AD-120B, AD-120BBTDD-UK, AD-120C, AD-120CW, AD-120HY, AD-45BBT, AD-48, AD-48B, AD-48BDD, AD-48C, AD-48D, AD-48DD, AD-48HY, AD-48W, AD-64, AD-64B, AD-64BBT, AD-64BDD, AD-64C, AD-64CW, AD-64D, AD-64DD, AD-64HY, AD-72, AD-72W, AD-90, AD-90BA, AD-90BBT, AD-90BDD, AD-90DD, ADE-120, ADE-120B, BME6-05, BME7-05, BME7-10, BME9-05, BME9-05AD, BME9-05PLUS, BME9-05V-T, BME9-10, BME9-10AD, BME9-10PLUS, BME9-10V-T, ECO-120, ECO-120B, ECO-160, ECO-1600, ECO-160D, ECO-160I...(Other models you can see in the webshop)		

<p>safety thermostats</p> 			
<b>GEV No.</b>	390452	<b>Ref. No.</b>	12023830 R34312400 Z213014
<b>description</b>	safety thermostat switch-off temp. 125°C 1-pole 16A probe ø 6mm probe L 73mm capillary pipe 870mm capillary pipe isolated 690mm gland nut M9x1 probe SS		
<b>For models:</b>	AD-120, AD-120B, AD-120BBTDD-UK, AD-120C, AD-120CW, AD-120HY, AD-125, AD-125HRS, AD-125-SOFT, AD-21W, AD-45BBT, AD-48, AD-48B, AD-48BDD, AD-48C, AD-48D, AD-48DD, AD-48HY, AD-48W, AD-505, AD-505-SOFT, AD-64, AD-64B, AD-64BBT, AD-64BDD, AD-64BTDD, AD-64C, AD-64CW, AD-64D, AD-64DD, AD-64HY, AD-72, AD-72W, AD-90, AD-90BA, AD-90BBT, AD-90BDD, AD-90DD, BME6-05, BME7-05, BME7-10, BME9-05, BME9-05AD, BME9-05PLUS, BME9-05V-T, BME9-10, BME9-10AD, BME9-10PLUS, BME9-10V-T, CO-110...(Other models you can see in the webshop)		

			
<b>GEV No.</b>	376078	<b>Ref. No.</b>	12038157 12135898 DO1DG11154
<b>description</b>	thermostat switch-off temp. 180°C 2-pole 16A probe ø 6mm probe L 59mm capillary pipe 2000mm capillary pipe isolatedmm shaft ømm 240V		
<b>For models:</b>	SF-13, SF-8, SR-10MP-PSM, SR-13MP-PSM, SR-32MP-PSM		

accessories

plunger sockets

			
<b>GEV No.</b>	505207	<b>Ref. No.</b>	12022418 Z263002
<b>description</b>	thermowell thread M12x1.75 IT ET M12x1.75 ID ø 8mm L 95mm SS/brass single ø 10mm		
<b>For models:</b>	ECO-120, ECO-1200, ECO-120B, ECO-160, ECO-160D, ECO-160I, ECO-200, ECO-200D, ECO-200H, ECO-200HD, ECO-200HI, ECO-200I, ECO-2700D, ECO-2700I, ECO-280D, ECO-280I, ECO-370D, ECO-370I, ECO-4000D, ECO-4000I, ECO-460D, ECO-460I, ECO-550D, ECO-550I, ECO-6000D, ECO-6000I, FI-100, FI-100AR, FI-100B, FI-100BBT-UK, FI-120, FI-1200, FI-120AR+DD, FI-120B, FI-120C, FI-120HY-CLINIC, FI-120W, FI-160, FI-160AR, FI-160D, FI-160I, FI-160I, FI-200, FI-200AR, FI-200D, FI-200H, FI-200HD, FI-200HI, FI-200I, FI-200W, FI-200WL...(Other models you can see in the webshop)		

electric components



## switches and momentary switches

## rocker/momentary rocker switches

28x13.5mm



1

<b>GEV No.</b>	347873	<b>Ref. No.</b>	12024372 Z20307
<b>description</b>	momentary rocker switch mounting measurements 27.4x12.4mm black 1NO 250V 16A connection male faston 6.3mm ambient temperature max. 85°C protection IP40		
<b>For models:</b>	FI-48D, FI-64D, LVC-15, LVC-15D, LVC-21, LVC-21D		

30x11mm



1

<b>GEV No.</b>	345489	<b>Ref. No.</b>	12023616 Z403033
<b>description</b>	momentary rocker switch mounting measurements 30x11mm orange 1NO 250V 16A connection male faston 6.3mm ambient temperature max. 90°C protection IP40		
<b>For models:</b>	FI-48, FI-48AR, FI-48B, FI-48B-BT-UK, FI-48C, FI-48D, FI-48HY-CLINIC, FI-48W, FI-64, FI-64AR, FI-64B, FI-64B-BT-UK, FI-64C, FI-64D, FI-64HY-CLINIC, FI-64W, LVC-12, LVC-15, LVC-15D, LVC-21, LVC-21B, LVC-21C, LVC-21D, LVC-21W, LVR-14, LVR-14D, LVR-20, LVR-20D		

30x22mm



1

<b>GEV No.</b>	301002	<b>Ref. No.</b>	12024356 12035989 12036781 12037293 6001507003 6021130001 Z203003 Z203033 ZAINTE0009
<b>description</b>	rocker switch mounting measurements 30x22mm orange 2NO 250V 16A illuminated 0-I connection male faston 6.3mm ambient temperature max. 85/125°C protection IP65		
<b>For models:</b>	AC-120, AC-180, AEP-1402, AEP-1403, AEP-1404, AEP-1602, AEP-1603, AEP-1604, AEP-2103, AEP-701, AEP-702, AEP-801, AEP-802, AF-1402-MIX, AF-1403-C, AF-1403-P, AF-1404-C, AF-1404-P, AF-1602-MIX, AF-1603-C, AF-1603-P, AF-1604-C, AF-1604-P, AF-2104-C, AF-2104-P, AF-2105-C, AF-2105-P, AF-2106-C, AF-2106-P, AF-702-C, AF-702-P, AF-802-C, AF-802-P, AFN-1402, AFN-1403, AFN-1404, AFN-1602, AFN-1603, AFN-1604, AFN-701, AFN-702, AFN-801, AFN-802, AFP-1402, AFP-1402-FORZ, AFP-1402-MIX, AFP-1403, AFP-1403-C, AFP-1403-FORZ, AFP-1403-P...(Other models you can see in the webshop)		
<b>accessories for</b>	301002		
	<b>GEV No.</b>	301036	<b>Ref. No.</b> —
	protective cover internal size 30x22mm for rocker switch mounting measurementsmm		

Зип Общепит

vsezip.ru

+7(812)987-08-81

<b>GEV No.</b>	345491	<b>Ref. No.</b>	12039115 Z213001 Z213033
<b>description</b>	momentary rocker switch mounting measurements 30x22mm orange 1NO/indicator light 250V 16A connection male faston 6.3mm ambient temperature max. 100/55°C protection IP40		
<b>For models:</b>	EASY-500, EASY-500B, EASY-500DD, EASY-500HP, EASY-500HPWBDD, FI-48, FI-48AR, FI-48B, FI-48B-BT-UK, FI-48C, FI-48D, FI-48HY-CLINIC, FI-48W, FI-64, FI-64AR, FI-64B, FI-64B-BT-UK, FI-64C, FI-64D, FI-64HY-CLINIC, FI-64W, FI-72, GA-20, GA-20D, GA-40, GA-40D, HCG-10-11, HCG-10-21, HCG-20-11, HCG-20-21, HCG-2-10-11, HCG-2-20-11, HCG-6-11, HGC-10-11, HGC-20-11, HGC-6-11, HGV-10-11, HGV-20-11, HVG-10-11, HVG-10-11UL, HVG-10-21, HVG-10-21UL, HVG-20-11, HVG-20-21, HVG-2-10-11, HVG-2-20-21, LAC-10MP, LAC-10MPP, LAC-14MP, LAC-14MPP...(Other models you can see in the webshop)		
<b>accessories for</b>	345491		
	<b>GEV No.</b>	301036	<b>Ref. No.</b> —
	protective cover internal size 30x22mm for rocker switch mounting measurementsmm		

	<b>GEV No.</b>	346689	<b>Ref. No.</b>	12024213 Z203080
<b>description</b>	momentary rocker switch mounting measurements 30x22mm orange 1NO/indicator light 230V 16A illuminated connection male faston 6.3mm ambient temperature max. 125°C protection IP40			
<b>For models:</b>	FI-48, FI-48AR, FI-48B, FI-48B-BT-UK, FI-48C, FI-48D, FI-48HY-CLINIC, FI-48W, FI-64, FI-64AR, FI-64B, FI-64B-BT-UK, FI-64C, FI-64D, FI-64HY-CLINIC, FI-64W, FI-72, FI-72AR, FI-72W, GA-20, GA-40, LVC-15, LVC-15D, LVC-21, LVC-21B, LVC-21C, LVC-21D, LVC-21W			

	<b>GEV No.</b>	301061	<b>Ref. No.</b>	12025209 Z203071
<b>description</b>	rocker switch mounting measurements 30x22mm orange 2NO 250V 16A illuminated connection male faston 6.3mm ambient temperature max. 125/55°C protection IP40			
<b>For models:</b>	FI-30, FI-30AR, FI-30AR+DD, FI-30-UK, FI-60DD, LVC-12, LVC-15, LVC-21			

## push/momentary push switches

30x22mm



1

<b>GEV No.</b>	301047 <sup>1</sup>	<b>Ref. No.</b>	12024373 Z853001
<b>description</b>	push switch mounting measurements 30x22mm green 2NO 250V 16A illuminated connection male faston 6.3mm ambient temperature max. 85°C protection IP40 latching		
<b>For models:</b>	FE-18, FE-25, FE-4, FE-6, FE-71-15, FE-8, FE-91-20, FI-300R, FI-650R, HCV-10-11, HCV-10-21, HCV-2-10-21		

<sup>1</sup>illuminated



Зип Общепит

vsezip.ru

+7(812)987-08-81

electric components

ø22mm





<b>GEV No.</b>	348220	<b>Ref. No.</b>	12115383
<b>description</b>	momentary push switch mounting ø 22mm silver 1NO/1NC/indicator light 220V 5A connection male faston 2.8mm round		
<b>For models:</b>	CO-350, CO-350-B, CO-350-B-DD, CO-350-COLD, CO-350-COLD-B, CO-350-COLD-B-DD, CO-350-COLD-DD, CO-350-DD, CO-400, CO-400-B, CO-400-B-DD, CO-400-COLD, CO-400-COLD-B, CO-400-COLD-B-DD, CO-400-COLD-DD, CO-400-DD, CO-400-SOFT, CO-500, CO-500B, CO-500BDD, CO-500DD, CO-501, CO-501B, CO-501BDD, CO-501DD, CO-501-SOFT		



<b>GEV No.</b>	345032	<b>Ref. No.</b>	12040850 GMP831318
<b>description</b>	microswitch with plunger thread M10x1 thread L 12mm 250V 16A 1CO connection male faston 6.3mm stroke 7mm mounting distance 22mm L 28mm ambient temperature max. 125°C type SP9603 actuating force: 180g		
<b>For models:</b>	FE-18, FE-25, FE-4, FE-6, FE-8, SBE7-10, SBE9-10, SBE9-10I, SBE9-10IM, SBE9-10IMS, SBE9-10IS, SBE9-10M, SBE9-10MS, SBE9-10PLUS-I, SBE9-10PLUS-IM, SBE9-10PLUS-SI, SBE9-10PLUS-SIM, SBE9-10S, SBE9-15IM, SBE9-15IMS, SBE9-15M, SBE9-15MS, SBE9-15PLUS-IM, SBE9-15PLUS-SIM, SBE9-10I, SBE9-10M, SBE9-10S, SBE9-10IS, SBE9-10MS, SBE9-10PLUS-I, SBE9-10PLUS-IM, SBE9-10PLUS-SI, SBE9-10PLUS-SIM, SBE9-10S, SBE9-15IM, SBE9-15IMS, SBE9-15PLUS-IM, SBE9-15PLUS-SIM		

ø25mm



<b>GEV No.</b>	345039	<b>Ref. No.</b>	12036803 FX40100036
<b>description</b>	protective cover round ED ø 33mm external size 23mm internal size 21mm H 12mm clear mounting ø 25mm		
<b>accessories for</b>	345039		
	<b>GEV No.</b>	345001	<b>Ref. No.</b> —
<b>description</b>	momentary push switch mounting ø 25mm yellow 1NO/indicator light 250V 16A cover connection male faston 6.3mm ambient temperature max. 85°C protection IP65		

accessories



<b>GEV No.</b>	505166	<b>Ref. No.</b>	Z653010
<b>description</b>	actuator for microswitch		
<b>For models:</b>	FI-300B, FI-300R, FI-650R		

microswitches

lever actuated



<b>GEV No.</b>	345254	<b>Ref. No.</b>	12033747 GMP831613
<b>description</b>	microswitch with lever 250V 16A 1CO connection male faston 6.3mm ambient temperature max. 120°C mounting distance 22mm actuating force: 60g lever length 58mm		

pin-plunger actuated



<b>GEV No.</b>	345105	<b>Ref. No.</b>	12037903 BR00023055
<b>description</b>	microswitch with plunger 250V 16A 1CO connection male faston 6.3mm L 28mm ambient temperature max. 125°C mounting distance 22mm type SM-51 actuating force: 280g black		

system switches (ROLD)



<b>GEV No.</b>	345650	<b>Ref. No.</b>	12024804 X022109
<b>description</b>	momentary switch unit 2CO 250V 16A connection male faston 6.3mm		
<b>For models:</b>	SBE9-10, SBE9-10I, SBE9-10IM, SBE9-10IM-AD, SBE9-10IM-AD-S, SBE9-10IMS, SBE9-10IS, SBE9-10M, SBE9-10MS, SBE9-10PLUS-IM, SBE9-10PLUS-SIM, SBE9-10S, SBE9-15IM, SBE9-15IM-AD, SBE9-15IM-AD-S, SBE9-15IMS, SBE9-15M, SBE9-15MS, SBE9-15PLUS-IM, SBE9-15PLUS-SIM, SBE9-10IM, SBE9-10IM-AD, SBE9-10IM-AD-S, SBE9-10IMS, SBE9-10M, SBE9-10MS, SBE9-10PLUS-IM, SBE9-10PLUS-SIM, SBE9-15IM, SBE9-15IM-AD, SBE9-15IM-AD-S, SBE9-15IMS, SBE9-15PLUS-IM, SBE9-15PLUS-SIM		



## cam switches

Зип Общежит

## 3 operating positions

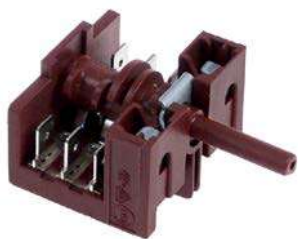

1

<b>GEV No.</b>	345492	<b>Ref. No.</b>	12025105 Z213003
<b>description</b>	cam switch 3 operating positions 3NO sequence 1-0-2 16A shaft ø 6x4.6mm shaft L 23mm connection male faston 6.3mm		
<b>For models:</b>	FI-48, FI-48B, FI-48W, FI-64, FI-64W, FI-72, FI-72AR, FI-72W		

## 4 operating positions

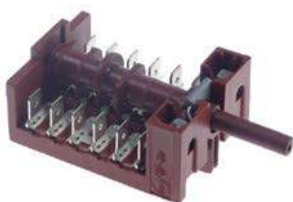

1

<b>GEV No.</b>	347386	<b>Ref. No.</b>	12024733 Z273005
<b>description</b>	cam switch 4 operating positions 6NO sequence 0-1-2-3 16A shaft ø 6x4.6mm shaft L 23mm connection male faston 6.3mm 7LA 840601		
<b>For models:</b>	ECO-160, ECO-160D, ECO-160I, ECO-200, ECO-200D, ECO-200H, ECO-200HD, ECO-200HI, ECO-200I, ECO-2700D, ECO-2700I, ECO-280D, ECO-280I, ECO-370D, ECO-370I, ECO-4000D, ECO-4000I, ECO-460D, ECO-460I, ECO-550D, ECO-550I, ECO-6000D, ECO-6000I, FI-160, FI-160AR, FI-160D, FI-160I, FI-200, FI-200AR, FI-200D, FI-200H, FI-200HD, FI-200HI, FI-200I, FI-200W, FI-200WL, FI-200WR, FI-2700D, FI-2700I, FI-280D, FI-280I, FI-370D, FI-370I, FI-4000D, FI-4000I, FI-460D, FI-460I, FI-550D, FI-550I, FI-6000D...(Other models you can see in the webshop)		



1

<b>GEV No.</b>	347817	<b>Ref. No.</b>	12024445
<b>description</b>	cam switch 4 operating positions 8NO sequence 1-0-2-3 16A shaft ø 6x4.6mm shaft L 23mm connection male faston 6.3mm plastic		
<b>For models:</b>	CO-500, CO-500B, CO-500BDD, CO-500DD, CO-501, CO-501B, CO-501BDD, CO-501DD, CO-501-SOFT, EASY-500, EASY-500B, EASY-500DD, EASY-500HP, EASY-500HPWBDD		



1

<b>GEV No.</b>	348225	<b>Ref. No.</b>	12024972 new version
<b>description</b>	cam switch 4 operating positions sequence 1-0-2-3 momentary 16A(4)A shaft ø 6x4.6mm shaft L 23mm connection male faston 6.3mm plastic		

6 operating positions



1

<b>GEV No.</b>	347578	<b>Ref. No.</b>	12024290 Z683085
<b>description</b>	cam switch 6 operating positions 7NO sequence 0-1-2-3-4-5 16A shaft ø 6x4.6mm shaft L 23mm connection male faston 6.3mm plastic		
<b>For models:</b>	ECO-120, ECO-120B, FI-100, FI-100AR, FI-100B, FI-120, FI-1200, FI-120AR+DD, FI-120B, FI-120W, FI-900, LABP-1000, LABP-1200, MF-120		

## 7 operating positions



1

<b>GEV No.</b>	301298	<b>Ref. No.</b>	12024932 Z713097
<b>description</b>	cam switch 7 operating positions 12NO sequence 0-1-2-3-4-5-6 16A shaft ø 6x4.6mm shaft L 23mm connection male faston 6.3mm plastic 12-pole		
<b>For models:</b>	CO-110, CO-110B, CO-110BDD, CO-110DD, CO-170, CO-170B, CO-170BDD, CO-170DD, CO-170HRS, CO-170HRSDD, CO-170HRS-SOFT, CO-170-SOFT, ECO-120B, FI-100B, FI-100BBT-UK, FI-120B, FI-120C, FI-120HY-CLINIC		

## rotary switches

## GOTTAK



1

<b>GEV No.</b>	347874	<b>Ref. No.</b>	12023965 Z743019
<b>description</b>	rotary switch 5 0-1-2-3-4 sets of contacts 10 type 46RCTH 400V 16A shaft ø 6x4.6mm shaft L 23mm shaft 6x4.6 connection male faston 6.3mm		
<b>For models:</b>	FI-80BBT-UK		



Зип Общепит

vsezip.ru

+7(812)987-08-81

magnetic switches

32x15mm

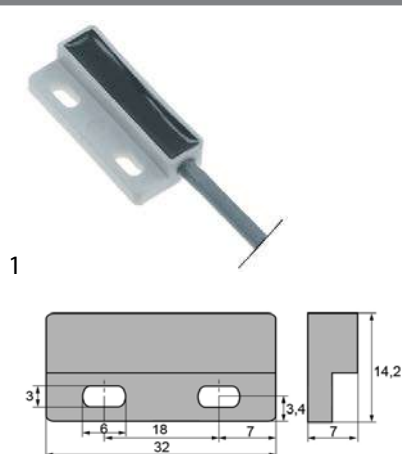

<b>GEV No.</b>	345109	<b>Ref. No.</b>	12034091 RT30161415
<b>description</b>	magnetic switch L 32mm W 15mm 1NO 250V 1A P max. 40W connection cable length 2000mm		

<b>GEV No.</b>	345202	<b>Ref. No.</b>	12024477 Z203009
<b>description</b>	magnetic switch 250V 0.04A P max. 10W probe L 29mm 1NO connection plug cable length 1400mm		
<b>For models:</b>	AD-120, AD-120B, AD-120BBTDD-UK, AD-120C, AD-120CW, AD-120HY, AD-125, AD-125HRS, AD-125-SOFT, AD-15, AD-15D, AD-20C-UK, AD-21, AD-21B, AD-21BDD, AD-21C, AD-21D, AD-21DD, AD-21W, AD-45BBT, AD-48, AD-48B, AD-48BDD, AD-48C, AD-48D, AD-48DD, AD-48HY, AD-48W, AD-505, AD-505-SOFT, AD-64, AD-64B, AD-64BBT, AD-64BDD, AD-64BTDD, AD-64C, AD-64CW, AD-64D, AD-64DD, AD-64HY, AD-72, AD-72W, AD-90, AD-90BA, AD-90BBT, AD-90BDD, AD-90DD, ADE-120, ADE-120B, ATA-061...(Other models you can see in the webshop)		

65x20mm

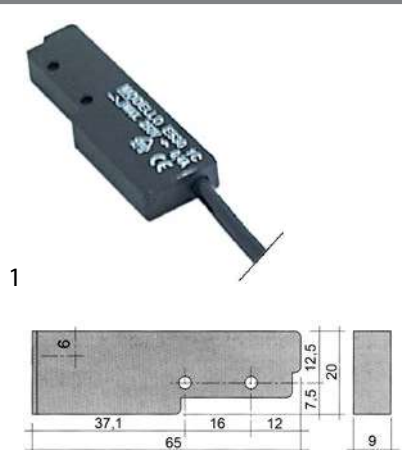

<b>GEV No.</b>	345116	<b>Ref. No.</b>	12024560 Z100522
<b>description</b>	magnetic switch L 65mm W 20mm 1NO 250V 0.4A P max. 100W connection cable length 3000mm		
<b>For models:</b>	ACE-061, ACE-101, ACE-102, ACE-201, ACE-202, ACG-061, ACG-101, ACG-102, ACG-201, ACG-202, AE-061, AE-061W, AE-101, AE-101W, AE-102, AE-102W, AE-201, AE-202, AG-061, AG-061W, AG-101, AG-101W, AG-102, AG-102W, AG-201, AG-202, APE-061, APE-061W, APE-101, APE-101W, APE-102, APE-102W, APE-201, APE-202, APG-061, APG-061W, APG-101, APG-101W, APG-102, APG-102W, APG-201, APG-202, COE-061, COE-101, COE-102, COE-201, COE-202, COG-061, COG-101, COG-102...(Other models you can see in the webshop)		
<b>accessories for</b>	345116		
	<b>GEV No.</b>	345399	<b>Ref. No.</b> —
	magnet ø 3.3mm L 40mm H 8mm W 13mm hole distance 30mm M3		

accessories

magnets

<b>GEV No.</b>	347093	<b>Ref. No.</b>	12024499 Z271207
<b>description</b>	magnet ø 31mm Lmm H 15mm Wmm M5		
<b>For models:</b>	ECO-160, ECO-160D, ECO-160I, ECO-200, ECO-200D, ECO-200H, ECO-200HD, ECO-200HI, ECO-200I, ECO-280D, ECO-280I, ECO-370D, ECO-370I, ECO-460D, ECO-460I, ECO-550D, ECO-550I, FI-160, FI-160AR, FI-160D, FI-160I, FI-200, FI-200AR, FI-200D, FI-200H, FI-200HD, FI-200HI, FI-200I, FI-200W, FI-200WL, FI-200WR, FI-280D, FI-280I, FI-370D, FI-370I, FI-460D, FI-460I, FI-550D, FI-550I		

<b>GEV No.</b>	505004	<b>Ref. No.</b>	12024303 Z200506
<b>description</b>	magnet ømm L 17mm H 12mm W 14mm		
<b>For models:</b>	ACE-061, ACE-101, ACE-102, ACG-061, ACG-101, ACG-102, AD-120, AD-120B, AD-120BBTDD-UK, AD-120C, AD-120CW, AD-120HY, AD-15, AD-15D, AD-20C-UK, AD-21, AD-21B, AD-21BDD, AD-21C, AD-21D, AD-21DD, AD-21W, AD-45BBT, AD-48, AD-48B, AD-48BDD, AD-48C, AD-48D, AD-48DD, AD-48HY, AD-48W, AD-64, AD-64B, AD-64BBT, AD-64BDD, AD-64BTDD, AD-64C, AD-64CW, AD-64D, AD-64DD, AD-64HY, AD-72, AD-72W, AD-90, AD-90BA, AD-90BBT, AD-90BDD, AD-90DD, ADE-120, ADE-120B...(Other models you can see in the webshop)		

electric components

Зип.Общепит

lamps  
vsezip.ru

+7(812)987-08-81

magnetic holders



<b>GEV No.</b>	700816	<b>Ref. No.</b>	12024094 Z200507
<b>description</b>	protection cap for magnet internal size 14x17mm H 17mm for dishwasher		
<b>For models:</b>	AD-120, AD-120B, AD-120BBTDD-UK, AD-120C, AD-120CW, AD-120HY, AD-15, AD-15D, AD-20C-UK, AD-21, AD-21B, AD-21BDD, AD-21C, AD-21D, AD-21DD, AD-21W, AD-45BBT, AD-48, AD-48B, AD-48BDD, AD-48C, AD-48D, AD-48DD, AD-48HY, AD-48W, AD-64, AD-64B, AD-64BBT, AD-64BDD, AD-64BTDD, AD-64C, AD-64CW, AD-64D, AD-64DD, AD-64HY, AD-72, AD-72W, AD-90, AD-90BA, AD-90BBT, AD-90BDD, AD-90DD, ADE-120, ADE-120B, COE-061, COE-101, COE-102, COG-061, COG-101, COG-102...(Other models you can see in the webshop)		

indicator lights

indicator lights 3-piece (housing, lens and bulb)

lamps  
light bulbs



<b>GEV No.</b>	359807	<b>Ref. No.</b>	12039863 Z103056
<b>description</b>	light bulb socket Ba9s 24V 2W ø 10mm L 28mm clear		
<b>For models:</b>	ECO-1600, ECO-2300, ECO-3000, FI-1600, FI-2300, FI-3000		

indicator lights (complete)

ø 9mm



<b>GEV No.</b>	359137	<b>Ref. No.</b>	12024344
<b>description</b>	indicator light ø 9mm 230V yellow connection male faston 6.3mm temp.-resist. 120°C with lens		
<b>For models:</b>	ECO-120, ECO-120B, FI-100, FI-100AR, FI-100B, FI-100BBT-UK, FI-120, FI-120AR+DD, FI-120B, FI-120C, FI-120HY-CLINIC, FI-120W, FI-80, FI-80AR, FI-80BBT-UK, FI-80W, GA-20, GA-20D, GA-40, GA-40D		

ø12mm

with screw socket



<b>GEV No.</b>	359048	<b>Ref. No.</b>	12035239 ICR13205
<b>description</b>	indicator light ø 12mm 230V yellow connection male faston 6.3mm		



<b>GEV No.</b>	359027	<b>Ref. No.</b>	12025211 12036324 DO1DL14313 R693055
<b>description</b>	indicator light ø 12mm 250V green connection male faston 6.3mm		
<b>For models:</b>	BME6-05, BME7-05, BME7-10, BME9-05, BME9-05AD, BME9-05PLUS, BME9-05V-T, BME9-10, BME9-10AD, BME9-10PLUS, BME9-10V-T, CE6-41, CE7-41, CE7-41Q, CE9-41, CGE6-41, CGE7-41, CGE7-41H, CGE9-11, CGE9-41, CGE9-41AD, CGE9-41PLUS, CMF6-05, CPE6-05, CPE7-05, CPE7-05NC, CPE9-05, CPE9-05AD, CPE9-05AD-S, CPE9-05NC, CPE9-05PLUS, CPE9-05PLUS-S, CPE9-05S, CPE9-05SNC, EASY-500, EASY-500B, EASY-500DD, EASY-500HP, EASY-500HPWBDD, EPC-350, FE-18, FE-25, FE-4, FE-6, FE6-05, FE6-05TE, FE6-10, FE6-10TE, FE7-05-1C, FE7-05-2C...(Other models you can see in the webshop)		

control equipment

TELEMECANIQUE (EFA)

XB2 series

rotary switches



<b>GEV No.</b>	345222	<b>Ref. No.</b>	12024490 Z103044
<b>description</b>	rotary selector mounting measurements ø22mm black latching sequence 0-1		
<b>For models:</b>	ECO-1600, ECO-2300, ECO-3000, FI-1600, FI-2300, FI-3000		

lamps



<b>GEV No.</b>	359807	<b>Ref. No.</b>	12039863 Z103056
<b>description</b>	light bulb socket Ba9s 24V 2W ø 10mm L 28mm clear		
<b>For models:</b>	ECO-1600, ECO-2300, ECO-3000, FI-1600, FI-2300, FI-3000		



# Зип.Общепит

timers  
vsezip.ru

+7(812)987-08-81

with plug-in socket

			
1			
<b>GEV No.</b>	359493	<b>Ref. No.</b>	12023599 X143017
<b>description</b>	indicator light ø 12mm 250V green connection male faston 6.3mm temp.-resist. 120°C		
<b>For models:</b>	CE9-41AD, CE9-41PLUS, ME7-10BM, SBE7-10, SBE9-10, SBE9-10I, SBE9-10I-AD, SBE9-10I-AD-S, SBE9-10IM, SBE9-10IM-AD, SBE9-10IM-AD-S, SBE9-10IMS, SBE9-10IS, SBE9-10M, SBE9-10MS, SBE9-10PLUS-I, SBE9-10PLUS-IM, SBE9-10S, SBE9-10USMC, SBE9-15IM, SBE9-15IM-AD, SBE9-15IM-AD-S, SBE9-15IMS, SBE9-15M, SBE9-15MS, SBE9-15PLUS-IM, SBG7-10, SBG9-10, SBG9-10I, SBG9-10I-AD, SBG9-10I-AD-S, SBG9-10IM, SBG9-10IM-AD, SBG9-10IM-AD-S, SBG9-10IMS, SBG9-10IS, SBG9-10M, SBG9-10MS, SBG9-10PLUS-I, SBG9-10PLUS-IM, SBG9-10PLUS-SI, SBG9-10PLUS-SIM, SBG9-10S, SBG9-15IM, SBG9-15IM-AD, SBG9-15IM-AD-S, SBG9-15IMS, SBG9-15PLUS-IM, SBG9-15PLUS-SIM		

ø14mm

with plug-in socket

			
1			
<b>GEV No.</b>	359148	<b>Ref. No.</b>	12021153 12039891 R343123 U183044
<b>description</b>	indicator light ø 14mm green 230V connection male faston 6.3mm temp.-resist. 120°C voltage AC		
<b>For models:</b>	CE-410, FE-18, FE-25, FE-4, FE-6, FE-8, FE-9I-20, HCV-10-11, HCV-10-21, HCV-2-10-21, HE-10-11, HE-10-21, HE-2-10-11, HE-6-11, HG-10-21, HG-2-10-11		

			
1			
<b>GEV No.</b>	359149	<b>Ref. No.</b>	12039886 R343125
<b>description</b>	indicator light ø 14mm yellow 230V connection male faston 6.3mm temp.-resist. 105°C		
<b>For models:</b>	CE-410, FE-18, FE-25, FE-4, FE-6, FE-8, FE-9I-20, HCV-10-11, HCV-10-21, HCV-2-10-21, HE-10-11, HE-10-21, HE-2-10-11, HE-6-11, HG-10-21, HG-2-10-11		

screw-on/push-on fit

light bulbs

for indicator lights

			
1			
<b>GEV No.</b>	359807	<b>Ref. No.</b>	12039863 Z103056
<b>description</b>	light bulb socket Ba9s 24V 2W ø 10mm L 28mm clear		
<b>For models:</b>	ECO-1600, ECO-2300, ECO-3000, FI-1600, FI-2300, FI-3000		

programme timers

			
1			
<b>GEV No.</b>	361350	<b>Ref. No.</b>	12024867 Z613003
<b>description</b>	timer 4803F1 engines 1 chambers 3 operation time 20min 230V shaft ømm shaft Lmm		
<b>For models:</b>	CO-170-SOFT, CO-400-SOFT, CO-501-SOFT, FI-48, FI-48AR, FI-48B, FI-48B-BT-UK, FI-48C, FI-48D, FI-48HY-CLINIC, FI-48W, FI-64, FI-64AR, FI-64B, FI-64B-BT-UK, FI-64C, FI-64D, FI-64HY-CLINIC, FI-64W, LVC-15D, LVC-21D, LVR-14D, LVR-20D		

			
1			
<b>GEV No.</b>	361358	<b>Ref. No.</b>	12017510 Z728302
<b>description</b>	timer CDC 4905DV engines 2 chambers 5 operation time 6s / 2min 230V 60Hz shaft ømm shaft Lmm motor type M48R ATS / M48L ATS		
<b>For models:</b>	ECO-120, ECO-120B, FI-100, FI-100AR, FI-100B, FI-120, FI-120B, FI-120W, MF-120		

			
1			
<b>GEV No.</b>	360683	<b>Ref. No.</b>	12024571 Z713055
<b>description</b>	timer CDC 4905DV engines 2 chambers 5 operation time 6s / 2min 230V shaft ømm shaft Lmm		
<b>For models:</b>	FI-100, FI-100AR, FI-100B, FI-120, FI-120AR+DD, FI-120B, FI-120C, LABP-1000, LABP-1200		

			
1			
<b>GEV No.</b>	360696	<b>Ref. No.</b>	12023458
<b>description</b>	timer CDC 4906DV engines 2 chambers 6 operation time 6s / 2min 230V 50Hz shaft ømm shaft Lmm manuf. no. 4906DV0A0E000.1010		



Зип Оффенит

vsezip.ru

+7(812)987-08-81



1

<b>GEV No.</b>	360441	<b>Ref. No.</b>	12023466 Z728412
<b>description</b>	timer CDC 4906DV engines 2 chambers 6 operation time 6s / 2min 230V 60Hz shaft ømm shaft Lmm manuf. no. 4906DV0ADY000.0000		
<b>For models:</b>	FI-120W, MF-120		



1

<b>GEV No.</b>	360440	<b>Ref. No.</b>	12024203 Z213002
<b>description</b>	timer CDC 7805DV engines 2 chambers 5 operation time 6s / 3min 230V 50Hz shaft ømm shaft Lmm		
<b>For models:</b>	FI-48, FI-48AR, FI-48B, FI-48B-BT-UK, FI-48C, FI-48D, FI-48HY-CLINIC, FI-48W, FI-64, FI-64B, FI-64W, MF-48, MF-64		

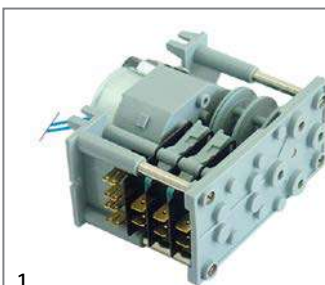

1

<b>GEV No.</b>	361357	<b>Ref. No.</b>	12024873 Z433002
<b>description</b>	timer CDC 7803 engines 1 chambers 3 operation time 120s 230V shaft ømm shaft Lmm motor type M37LN		
<b>For models:</b>	CO-350, CO-350-B, CO-350-B-DD, CO-350-COLD, CO-350-COLD-B, CO-350-COLD-B-DD, CO-350-COLD-DD, CO-350-DD, CO-400, CO-400-B, CO-400-B-DD, CO-400-COLD, CO-400-COLD-B, CO-400-COLD-B-DD, CO-400-COLD-DD, CO-400-DD, CO-400-SOFT, EASY-500, EASY-500B, EASY-500DD, LVC-21B, LVC-21C, LVR-20, LVR-20B		



1

<b>GEV No.</b>	360438	<b>Ref. No.</b>	12024202 Z258412
<b>description</b>	timer CDC 7805DV engines 2 chambers 5 operation time 6s / 3min 230V 60Hz shaft ømm shaft Lmm		
<b>For models:</b>	FI-48W, FI-64B, FI-64W, FI-72, FI-72W, FI-80BBT-UK, FI-80W, MF-48, MF-64		



1

<b>GEV No.</b>	361354	<b>Ref. No.</b>	12024178 Z213008
<b>description</b>	timer CDC 7804DV engines 2 chambers 4 operation time 6s / 3min 230V shaft ømm shaft Lmm motor type M37RN/M37LN		
<b>For models:</b>	FI-48, FI-48B, FI-48D, FI-48W		



1

<b>GEV No.</b>	360439	<b>Ref. No.</b>	12024204 Z243001
<b>description</b>	timer CDC 7805DV engines 2 chambers 5 operation time 6s/180s 230V 50Hz shaft ømm shaft Lmm		
<b>For models:</b>	EASY-500HPWBDD, FI-48, FI-48B, FI-48W, FI-64, FI-64B, FI-64B-BT-UK, FI-64HY-CLINIC, FI-64W, MF-48, MF-64		



1

<b>GEV No.</b>	361355	<b>Ref. No.</b>	12024177 Z243004
<b>description</b>	timer CDC 7804DV engines 2 chambers 4 operation time 6s / 3min 230V shaft ømm shaft Lmm motor type M37RN/M37LN		
<b>For models:</b>	EASY-500HP, FI-64, FI-64AR, FI-64B, FI-64C, FI-64D, FI-72, FI-72AR, FI-80, FI-80AR, LABP-800		



1

<b>GEV No.</b>	361352	<b>Ref. No.</b>	12024089 Z403002
<b>description</b>	timer CDC 7903F engines 1 chambers 3 operation time 120s 230V shaft ø 6x4.6mm shaft L 13mm dishwasher		
<b>For models:</b>	LVC-12, LVC-15, LVC-15D, LVC-21, LVC-21D, LVC-21W, LVR-10, LVR-14, LVR-14D, LVR-20, LVR-20D		





Зип Общежит

contactors

vsezip.ru

power contactors

+7(812)987-08-81



1

<b>GEV No.</b>	361351	<b>Ref. No.</b>	12017667 12024087 Z203030 Z268302
<b>description</b>	timer CDC 7903F engines 1 chambers 3 operation time 4min 230V shaft ø 6x4.6mm shaft L 13mm		
<b>For models:</b>	FI-30, FI-30AR, FI-30AR+DD, FI-30B, FI-30B-BT-UK, FI-30-UK, FI-60DD, FI-64, FI-64B, FI-64W, FI-72, FI-80, FI-80W		



1

<b>GEV No.</b>	361356	<b>Ref. No.</b>	12017561 Z703004
<b>description</b>	timer M48L ATS engines 2 chambers 5 operation time 6s / 2min 230V shaft ømm shaft Lmm		
<b>For models:</b>	ECO-120, ECO-1200, ECO-120B		

mechanical timers



1

<b>GEV No.</b>	360732	<b>Ref. No.</b>	12030066 12049916 DO1DI13315 DO1DL13350
<b>description</b>	timer MT59 2-pole operation time 60min impulse mechanical 2NO at 250V 16A permanent position no shaft ø 6x4.6mm shaft L 21mm mounting distance 28mm connection lateral shaft flat lower		
<b>For models:</b>	SF-10, SF-13, SF-15, SF-22, SF-31, SF-8, SR-10MP-PSM, SR-13MP-PSM, SR-32MP-PSM		

GENERAL ELECTRIC (AEG)



1

<b>GEV No.</b>	380245	<b>Ref. No.</b>	12031082 RT30280550
<b>description</b>	power contactor resistive load 25A 230VAC (AC3/400V) 9A/4kW main contacts 3NO auxiliary contacts 1NC connection screw connection type AEG LS4K 01A type GE CL00A 301 H 85mm		



1

<b>GEV No.</b>	380244	<b>Ref. No.</b>	12018159 12027320 12029911 12031081 R663031 RT30280551 RT4001554 RT4001556
<b>description</b>	power contactor resistive load 25A 230VAC (AC3/400V) 9A/4kW main contacts 3NO auxiliary contacts 1NO connection screw connection type AEG LS4K 10A type GE CL00A 310		
<b>For models:</b>	ECO-1600, ECO-160D, ECO-160I, ECO-200D, ECO-200HD, ECO-200HI, ECO-200I, ECO-2300, ECO-280D, ECO-280I, ECO-3000, ECO-370D, ECO-370I, ECO-460D, ECO-460I, ECO-550D, ECO-550I, FE-18, FE-25, FE-710, FI-120, FI-120B, FI-1600, FI-160D, FI-160I, FI-200D, FI-200HD, FI-200HI, FI-200I, FI-2300, FI-280D, FI-280I, FI-3000, FI-370D, FI-370I, FI-460D, FI-460I, FI-550D, FI-550I, HME-10-11, HME-10-21, HME-20-11, HME-20-21, HME-2-10-11, HME-6-11, HMI-10-11, HMI-10-11UL, HMI-10-21, HMI-10-21UL, HMI-2-10-11...(Other models you can see in the webshop)		

electric components



Зип Общепит

vsezip.ru

+7(812)987-08-81



1

<b>GEV No.</b>	380261	<b>Ref. No.</b>	12028282 12029618 12030540 ICR13042 RT30280552 RT4001555
<b>description</b>	power contactor resistive load 32A 230VAC (AC3/400V) 17A/7.5kW main contacts 3NO auxiliary contacts 1NO connection screw connection type AEG LS7K 10A type GE CL02A 310		



1

<b>GEV No.</b>	380390	<b>Ref. No.</b>	12024075 12039754 12040142 R143002 R673007 X183011
<b>description</b>	power contactor resistive load 40A 230VAC (AC3/400V) 12A/5.5kW main contacts 3NO auxiliary contacts connection screw connection type 3RT10-24-1AL20 50/60Hz		
<b>For models:</b>	COE-102, COE-201, ECO-160, ECO-1600, ECO-160D, ECO-160I, ECO-200, ECO-200D, ECO-200H, ECO-200HD, ECO-200HI, ECO-200I, ECO-2300, ECO-2700D, ECO-2700I, ECO-280D, ECO-280I, ECO-3000, ECO-370D, ECO-370I, ECO-4000D, ECO-4000I, ECO-460D, ECO-460I, ECO-550D, ECO-550I, ECO-6000D, ECO-6000I, FE9-05, FE9-05-1C, FE9-05-2C, FE9-05AD, FE9-05PLUS, FE9-05PLUS-S, FE9-05S, FE9-05S-1C, FE9-05S-2C, FE9-05S-AD, FE9-05USMC, FE9-10, FE9-10-2C, FE9-10-4C, FE9-10AD, FE9-10PLUS, FE-920, FI-160, FI-1600, FI-160AR, FI-160D, FI-160I...(Other models you can see in the webshop)		

## ISKRA (FANAL)

## power contactors



1

<b>GEV No.</b>	380212	<b>Ref. No.</b>	12000219 P453023
<b>description</b>	power contactor resistive load 20A 230VAC (AC3/400V) 8.5A/5.5kW main contacts 3NO auxiliary contacts 1NC connection screw connection type Fanal K07M 01 type ISKRA DSL7 01		
<b>For models:</b>	FE-6, FE-8, FI-300B, FI-300R, FI-650R		

## auxiliary contacts



1

<b>GEV No.</b>	380539	<b>Ref. No.</b>	12023704 Z103070
<b>description</b>	auxiliary contact contacts 1NO AC15 3A for contactors 3RT102 3 RT103 connection screw connection type 3RH1921-1CA10 resistive load 10A AC-12 10A		
<b>For models:</b>	ECO-160, ECO-1600, ECO-160D, ECO-160I, ECO-200, ECO-200D, ECO-200H, ECO-200HD, ECO-200HI, ECO-200I, ECO-2300, ECO-2700D, ECO-2700I, ECO-280D, ECO-280I, ECO-3000, ECO-370D, ECO-370I, ECO-4000D, ECO-4000I, ECO-460D, ECO-460I, ECO-550D, ECO-550I, ECO-6000D, ECO-6000I, FI-160, FI-1600, FI-160AR, FI-160D, FI-160I, FI-200, FI-200AR, FI-200D, FI-200H, FI-200HD, FI-200HI, FI-200I, FI-200W, FI-2300, FI-2700D, FI-2700I, FI-280D, FI-280I, FI-3000, FI-370D, FI-370I, FI-4000D, FI-4000I, FI-460D...(Other models you can see in the webshop)		

## SIEMENS

## power contactors



1

<b>GEV No.</b>	380614	<b>Ref. No.</b>	12024040 12111795 Z203050
<b>description</b>	power contactor resistive load 22A 230VAC (AC3/400V) 9A/4kW main contacts 3NO auxiliary contacts 1NO connection elastic terminals type 3RT2016-2AP01		
<b>For models:</b>	ACE-061, ACE-101, AD-120, AD-120B, AD-120BBTDD-UK, AD-120C, AD-120CW, AD-120HY, AD-125, AD-125HRS, AD-125-SOFT, AD-90, AD-90BA, AD-90BBT, AD-90BDD, AD-90DD, ADE-120, ADE-120B, AE-061, AE-061W, AE-101, AE-101W, APE-061, APE-061W, APE-101, APE-101W, CO-110, CO-110B, CO-110BDD, CO-110DD, CO-112, CO-112B, CO-112BDD, CO-112DD, CO-142W, CO-142WDD, CO-170, CO-170B, CO-170BDD, CO-170DD, CO-170HRS, CO-170HRSDD, CO-170HRS-SOFT, CO-170-SOFT, CO-172, CO-172B, CO-172BDD, CO-172DD, COE-061, COE-101...(Other models you can see in the webshop)		



Зип ОбщеПИТ

vsezip.ru

+7(812)987-08-81

small relay switches



1			
<b>GEV No.</b>	380696	<b>Ref. No.</b>	12024012 Z683087
<b>description</b>	small relay switch 230V (AC3/400V) 9A/4kW main contacts 3NO auxiliary contacts 1NC connection male faston 6.3mm resistive load 16A		
<b>For models:</b>	AD-15, AD-15D, AD-20C-UK, AD-21, AD-21B, AD-21BDD, AD-21C, AD-21D, AD-21DD, AD-48, AD-48BDD, AD-48C, AD-48D, AD-48DD, AD-64, AD-64B, AD-64BDD, AD-64C, AD-64D, AD-64DD, AD-72, CO-110, CO-110B, CO-110BDD, CO-110DD, CO-112, CO-112B, CO-112BDD, CO-112DD, CO-170, CO-170B, CO-170BDD, CO-170DD, CO-170HRS, CO-170HRSDD, CO-170HRS-SOFT, CO-170-SOFT, CO-172, CO-172B, CO-172BDD, CO-172DD, COP-173, COP-173B, COP-173BDD, COP-173DD, COP-173HRS, COP-173HRSDD, COP-173-SOFT, COP-174, COP-174B...(Other models you can see in the webshop)		

relay sockets



1			
<b>GEV No.</b>	380136	<b>Ref. No.</b>	12024185 R743009
<b>description</b>	relay socket 11-pole connection plug-in connection round 11-pole dimensions 65x28x40mm 250V voltage AC 10A Italiana Relè manuf. no. ZVE11		
<b>For models:</b>	GA-20, GA-20D, GA-40, GA-40D, HGV-10-11, HGV-20-11, HMM-10-11, HMM-10-11UL, HMM-10-21, HMM-10-21UL, HMM-20-11, HMM-20-11UL, HMM-20-21, HMM-20-21UL, HMM-2-10-11, HMM-40-11-USMC, HMM-6-11, HMM-6-11UL, HVG-10-11, HVG-10-11UL, HVG-10-21, HVG-10-21UL, HVG-20-11, HVG-20-21, HVG-2-10-11, HVG-2-20-21, ME9-10PLUS-BM, ME9-10PLUS-BMS, ME9-15BM-AD, ME9-15PLUS-BM, ME9-15PLUS-BMS, MFHMM-20-11, MFHVG-10-11, MFHVG-10-21, MG9-10BMAD, MG9-10BMSAD, MG9-10PLUS-BM, MG9-10PLUS-BMS, MG9-15BMAD, MG9-15BMSAD, MG9-15PLUS-BM, MG9-15PLUS-BMS		
<b>accessories for</b>	380136		
	<b>GEV No.</b>	380805	<b>Ref. No.</b> —
	support bracket		

relays

power relays

with bracket mounting



1			
<b>GEV No.</b>	380139	<b>Ref. No.</b>	12031875 EU929115
<b>description</b>	power relays FINDER 230VAC 16A 2CO connection F6.3 bracket mounting dimensions 68x38.2x35.8mm manuf. no. 62.82.8.230.0000		

time relays

time relays



1			
<b>GEV No.</b>	360554	<b>Ref. No.</b>	12024079 Z123022 Z123022000
<b>description</b>	time relay TELEMECANIQUE RE17RMMU time range 0.1s-100h 24-240VAC/24VDC 8A mounting measurements DIN railmm 1CO connection screw connection		
<b>For models:</b>	ECO-160, ECO-1600, ECO-160D, ECO-160I, ECO-200, ECO-200D, ECO-200H, ECO-200HD, ECO-200HI, ECO-200I, ECO-2300, ECO-2700D, ECO-2700I, ECO-280D, ECO-280I, ECO-3000, ECO-370D, ECO-370I, ECO-4000D, ECO-4000I, ECO-460D, ECO-460I, ECO-550D, ECO-550I, ECO-6000D, ECO-6000I, FI-160, FI-1600, FI-160AR, FI-160D, FI-160I, FI-200, FI-200AR, FI-200D, FI-200H, FI-200HD, FI-200HI, FI-200I, FI-200W, FI-2300, FI-2700D, FI-2700I, FI-280D, FI-280I, FI-3000, FI-370D, FI-370I, FI-4000D, FI-4000I, FI-460D...(Other models you can see in the webshop)		

electric components



electric components

Зип.Общепит electronics

vsezip.ru +7(812)987-08-81

### probes

#### universal probes

##### temperature probes

<b>GEV No.</b>	379630	<b>Ref. No.</b>	6021350083
<b>description</b>	temperature probe NTC 10kOhm cable thermoplastic probe -40 up to +110°C cable -40 up to +110°C probe ø6x14mm cable length 2.5m without screw connection 2-wire resistor 10kOhm		

<b>GEV No.</b>	379142	<b>Ref. No.</b>	12033839 6021350026
<b>description</b>	temperature probe PTC 1kOhm cable PVC probe -50 up to +150°C cable -10 up to 100°C probe ø6x30mm cable length 1.5m without screw connection 2-wire		
<b>For models:</b>	ATM-101, VTP-139-C, VTP-139-CD, VTP-139-P, VTP-139-PD, VTP-139-RC, VTP-139-RCD, VTP-139-RP, VTP-139-RPD, VTP-175-C, VTP-175-CD, VTP-175-P, VTP-175-PD, VTP-175-RC, VTP-175-RCD, VTP-175-RP, VTP-175-RPD		

#### producer-specific probes

##### probes

<b>GEV No.</b>	379550	<b>Ref. No.</b>	12019258 Z233007
<b>description</b>	temperature probe NTC 10kOhm cable silicone probe -40 up to +110°C cable -50 up to +180°C connection male faston thread probe ø6x30mm cable length 0.35m		
<b>For models:</b>	FI-50		

<b>GEV No.</b>	378339	<b>Ref. No.</b>	12025036 Z713028
<b>description</b>	temperature probe NTC 64kOhm cable silicone probe -40 up to +110°C cable -50 up to +180°C connection plug thread probe ø6x14mm cable length 2.5m		
<b>For models:</b>	AD-120, AD-120B, AD-120BBTDD-UK, AD-120C, AD-120CW, AD-120HY, AD-125, AD-125HRS, AD-125-SOFT, AD-15, AD-15D, AD-20C-UK, AD-21, AD-21B, AD-21BDD, AD-21C, AD-21D, AD-21DD, AD-21W, AD-45BBT, AD-48, AD-48B, AD-48BDD, AD-48C, AD-48D, AD-48DD, AD-48HY, AD-48W, AD-505, AD-505-SOFT, AD-64, AD-64B, AD-64BBT, AD-64BDD, AD-64BTDD, AD-64C, AD-64CW, AD-64D, AD-64DD, AD-64HY, AD-72, AD-72W, AD-90, AD-90BA, AD-90BBT, AD-90BDD, AD-90DD, ADE-120, ADE-120B, CO-112...(Other models you can see in the webshop)		

### PCBs

<b>GEV No.</b>	400810	<b>Ref. No.</b>	12016516 Z233005
<b>description</b>	control PCB dishwasher FI-50 with display		
<b>For models:</b>	FI-50		

<b>GEV No.</b>	403743	<b>Ref. No.</b>	12024634 Z218030 Z218030000
<b>description</b>	control PCB for dishwasher L 75mm W 35mm suitable for FAGOR		
<b>For models:</b>	LA-AC-10M, LA-AC-10MP, LA-AC-13M, LA-AC-13MP, LA-AC-18M, LA-AC-18MP, LA-AC-25M, LA-AC-25MP, LA-E-10M, LA-E-10MP, LA-E-13M, LA-E-13MP, LA-E-18M, LA-E-18MP, LA-E-25M, LA-E-25MP, LA-V-10M, LA-V-10MP, LA-V-13M, LA-V-13MP, LA-V-18M, LA-V-18MP, LA-V-25M, LA-V-25MP, LB-AC-10M, LB-E-10M, LB-V-10M, LR-AC-10M, LR-AC-10MP, LR-AC-13M, LR-AC-13MP, LR-AC-18M, LR-AC-18MP, LR-AC-25M, LR-AC-25MP, LR-E-10M, LR-E-10MP, LR-E-13M, LR-E-13MP, LR-E-18M, LR-E-18MP, LR-E-25M, LR-E-25MP, LR-V-10M, LR-V-10MP, LR-V-13M, LR-V-13MP, LR-V-18M, LR-V-18MP, LR-V-25M...(Other models you can see in the webshop)		

<b>GEV No.</b>	403237	<b>Ref. No.</b>	12024028 Z713017
<b>description</b>	display PCB dishwasher AD15/21/48 L 100mm W 35mm		
<b>For models:</b>	AD-120, AD-120B, AD-120BBTDD-UK, AD-120C, AD-120HY, AD-15, AD-15D, AD-20C-UK, AD-21, AD-21B, AD-21BDD, AD-21C, AD-21D, AD-21DD, AD-45BBT, AD-48, AD-48B, AD-48BDD, AD-48C, AD-48D, AD-48DD, AD-48HY, AD-64, AD-64B, AD-64BBT, AD-64BDD, AD-64BTDD, AD-64C, AD-64D, AD-64DD, AD-64HY, AD-72, AD-90, AD-90BA, AD-90BBT, AD-90BDD, AD-90DD, ADE-120, ADE-120B, CO-112, CO-112B, CO-112BDD, CO-112DD, CO-172, CO-172B, CO-172BDD, CO-172DD, CO-352-COLD, CO-352-COLD-B, CO-352-COLD-B-DD...(Other models you can see in the webshop)		



Зип Общепит

keypads

vsezip.ru

+7(812)987-08-81

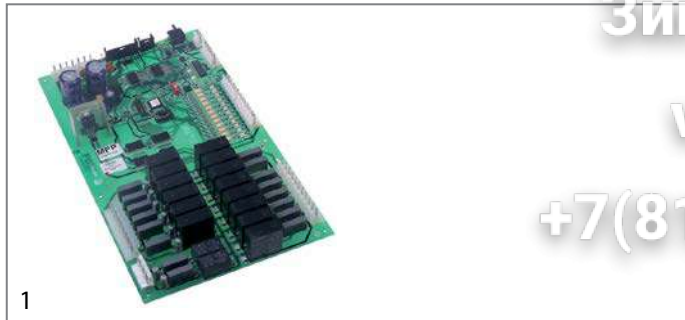

<b>GEV No.</b>	401788	<b>Ref. No.</b>	12024457 P613005
<b>description</b>	main PCB washing machine LA 10-13-18-25		
<b>For models:</b>	LA-18MP, LA-AC-10MP, LA-AC-13MP, LA-AC-18MP, LA-AC-25MP, LA-E-10MP, LA-E-13MP, LA-E-18MP, LA-E-25MP, LA-V-10MP, LA-V-13MP, LA-V-18MP, LA-V-25MP, LF-13MPP, LF-18MPP, LF-25MPP, LF-8MPP, LR-AC-10MP, LR-AC-13MP, LR-AC-18MP, LR-AC-25MP, LR-E-10MP, LR-E-13MP, LR-E-18MP, LR-E-25MP, LR-V-10MP, LR-V-13MP, LR-V-18MP, LR-V-25MP		



<b>GEV No.</b>	403308	<b>Ref. No.</b>	12008750 Z213073
<b>description</b>	PCB dishwasher AD-72/48/64 L 128mm W 118mm suitable for FAGOR with housing H 55mm for dishwasher Qty 1 pcs		
<b>For models:</b>	AD-120, AD-120B, AD-120BTDD-UK, AD-120C, AD-120CW, AD-120HY, AD-15, AD-15D, AD-20C-UK, AD-21, AD-21B, AD-21BDD, AD-21C, AD-21D, AD-21DD, AD-21W, AD-45BBT, AD-48, AD-48B, AD-48BDD, AD-48C, AD-48D, AD-48DD, AD-48HY, AD-48W, AD-64, AD-64B, AD-64BBT, AD-64BDD, AD-64BTDD, AD-64C, AD-64CW, AD-64D, AD-64DD, AD-64HY, AD-72, AD-72W, AD-90, AD-90BA, AD-90BBT, AD-90BDD, AD-90DD, ADE-120, ADE-120B, CO-112, CO-112B, CO-112BDD, CO-112DD, CO-142W, CO-142WDD...(Other models you can see in the webshop)		

central units

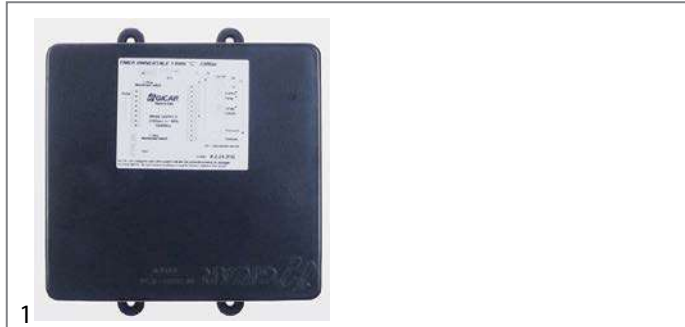

<b>GEV No.</b>	402991	<b>Ref. No.</b>	12024809 Z213069
<b>description</b>	control box for dishwasher 230V		
<b>For models:</b>	AD-120, AD-120B, AD-120C, AD-120HY, AD-15, AD-15D, AD-20C-UK, AD-21, AD-21B, AD-21BDD, AD-21C, AD-21D, AD-21DD, AD-45BBT, AD-48, AD-48B, AD-48BDD, AD-48C, AD-48D, AD-48DD, AD-48HY, AD-64, AD-64B, AD-64BBT, AD-64BDD, AD-64C, AD-64D, AD-64DD, AD-64HY, AD-72, AD-90, AD-90DD, ADE-120, ADE-120B		

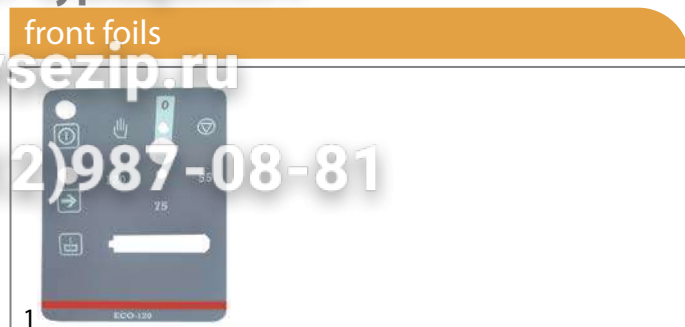

<b>GEV No.</b>	505205	<b>Ref. No.</b>	12020129 Z732901
<b>description</b>	front foil dishwasher ECO120		
<b>For models:</b>	ECO-120, ECO-120B		



<b>GEV No.</b>	401843	<b>Ref. No.</b>	12017916 Z322902
<b>description</b>	front foil dishwasher ECO200 L 645mm W 173mm		
<b>For models:</b>	ECO-200, ECO-200D, ECO-200H, ECO-200HD, ECO-200HI, ECO-200I		



<b>GEV No.</b>	505125	<b>Ref. No.</b>	12020028 Z710516
<b>description</b>	front foil dishwasher FI-100		
<b>For models:</b>	ECO-120, ECO-120B, ECO-160D, ECO-160I, ECO-200D, ECO-200I, ECO-280D, ECO-280I, ECO-370D, ECO-370I, ECO-460D, ECO-460I, ECO-550D, ECO-550I, FI-100, FI-100AR, FI-100B, FI-120, FI-120B, FI-120W, FI-160D, FI-160I, FI-200D, FI-200I, FI-280D, FI-280I, FI-370D, FI-370I, FI-460D, FI-460I, FI-550D, FI-550I, FI-80, FI-80W		



<b>GEV No.</b>	505117	<b>Ref. No.</b>	12020315 Z202909
<b>description</b>	front foil dishwasher FI30		
<b>For models:</b>	FI-30		



<b>GEV No.</b>	403240	<b>Ref. No.</b>	12025130
<b>description</b>	front foil dishwasher FI30 grey model FI30 suitable for FAGOR L 585mm W 62.5mm		
<b>For models:</b>	FI-30, FI-30AR, FI-30AR+DD, FI-30-UK		



Зип Общепит

vsezip.ru

+7(812)987-08-81



1	<b>GEV No.</b>	403238	<b>Ref. No.</b>	12023961 Z222903
	<b>description</b>	front foil dishwasher FI48 grey model FI-48B suitable for FAGOR L 585mm W 62.5mm		
	<b>For models:</b>	FI-48, FI-48B		



1	<b>GEV No.</b>	505122	<b>Ref. No.</b>	12019191 Z258501
	<b>description</b>	front foil warewashing FI-64B/FI64W model FI-64B/FI64W drain pump		
	<b>For models:</b>	FI-64B, MF-64		



2	<b>GEV No.</b>	505119	<b>Ref. No.</b>	12020146 Z212910
	<b>description</b>	front foil dishwasher FI-48 run-time 120/180s		
	<b>For models:</b>	FI-48, FI-48W		



1	<b>GEV No.</b>	505126	<b>Ref. No.</b>	12019909 Z742906
	<b>description</b>	keypad foil dishwasher F180		
	<b>For models:</b>	FI-80		



1	<b>GEV No.</b>	505120	<b>Ref. No.</b>	12020147 Z222902
	<b>description</b>	front foil dishwasher FI-48B model FI-48B drain pump		
	<b>For models:</b>	FI-48B		



1	<b>GEV No.</b>	505118	<b>Ref. No.</b>	12019162 Z232901
	<b>description</b>	front foil dishwasher FI-50 model FI-50		
	<b>For models:</b>	FI-50		



1	<b>GEV No.</b>	505127	<b>Ref. No.</b>	12019473 Z748404
	<b>description</b>	keypad foil dishwasher F180		
	<b>For models:</b>	FI-80W		



1	<b>GEV No.</b>	505121	<b>Ref. No.</b>	12018990 Z242901
	<b>description</b>	front foil dishwasher FI-64 run-time 90/180s		
	<b>For models:</b>	FI-64, FI-64W		



1	<b>GEV No.</b>	505204	<b>Ref. No.</b>	12019475 Z722901
	<b>description</b>	keypad foil dishwasher FI120		
	<b>For models:</b>	FI-120, FI-120B		



1	<b>GEV No.</b>	505124	<b>Ref. No.</b>	12018622 Z262906
	<b>description</b>	front foil dishwasher FI-72		
	<b>For models:</b>	FI-72		



1	<b>GEV No.</b>	505123	<b>Ref. No.</b>	12018989 Z252901
	<b>description</b>	front foil warewashing FI-64B/FI64W		
	<b>For models:</b>	FI-64B		



1	<b>GEV No.</b>	505108	<b>Ref. No.</b>	12020486 Z462901
	<b>description</b>	keypad foil dishwasher LVC12		
	<b>For models:</b>	LVC-12, LVC-15, LVC-21, LVR-10, LVR-14, LVR-20		

Зип Общепит  
vsezip.ru  
+7(812)987-08-81



1

<b>GEV No.</b>	505109	<b>Ref. No.</b>	12018909 Z412901
<b>description</b>	keypad foil dishwasher LVC15		
<b>For models:</b>	LVC-12, LVC-15, LVC-21, LVR-10, LVR-14, LVR-20		



1

<b>GEV No.</b>	505105	<b>Ref. No.</b>	12019135 Z392901
<b>description</b>	keypad foil dishwasher LVR10		
<b>For models:</b>	LVC-12, LVC-15, LVC-21, LVR-10, LVR-14, LVR-20		



1

<b>GEV No.</b>	505115	<b>Ref. No.</b>	12019307 Z482901
<b>description</b>	keypad foil dishwasher LVC15D		
<b>For models:</b>	LVC-15D		



1

<b>GEV No.</b>	505106	<b>Ref. No.</b>	Z402909
<b>description</b>	keypad foil dishwasher LVR14		
<b>For models:</b>	LVC-12, LVC-15, LVC-21, LVR-10, LVR-14, LVR-20		



1

<b>GEV No.</b>	505113	<b>Ref. No.</b>	12018973 Z472902
<b>description</b>	keypad foil dishwasher LVC15D/21D/14D/20D		
<b>For models:</b>	LVR-14D		



1

<b>GEV No.</b>	505202	<b>Ref. No.</b>	12020127 Z712908
<b>description</b>	keypad foil warewashing FI100		
<b>For models:</b>	FI-100, FI-100AR, FI-100B		



1

<b>GEV No.</b>	505114	<b>Ref. No.</b>	Z492902
<b>description</b>	keypad foil dishwasher LVC15D/21D/14D/20D		
<b>For models:</b>	LVR-20D		



1

<b>GEV No.</b>	505203	<b>Ref. No.</b>	12020324 Z728501
<b>description</b>	keypad foil warewashing FI120		
<b>For models:</b>	FI-120W, MF-120		



1

<b>GEV No.</b>	505110	<b>Ref. No.</b>	12020451 Z442901
<b>description</b>	keypad foil dishwasher LVC21		
<b>For models:</b>	LVC-12, LVC-15, LVC-21, LVC-21W, LVR-10, LVR-14, LVR-20		



1

<b>GEV No.</b>	505112	<b>Ref. No.</b>	12019096 Z452901
<b>description</b>	keypad foil dishwasher LVC21B		
<b>For models:</b>	LVC-21B, LVR-20B		

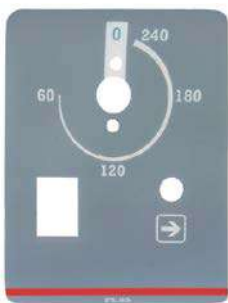

1

<b>GEV No.</b>	505201	<b>Ref. No.</b>	Z742901
<b>description</b>	keypad foil warewashing FI80		
<b>For models:</b>	FI-80		



1

<b>GEV No.</b>	505116	<b>Ref. No.</b>	12018125 Z502901
<b>description</b>	keypad foil dishwasher LVC21D		
<b>For models:</b>	LVC-21D		

1 electric components



## membrane keypads

Зип-Общепит  
ROBENETA INVENSYS

<b>GEV No.</b>	403466	<b>Ref. No.</b>	12024723
<b>description</b>	membrane keypad dishwasher AD48/AD64 buttons 4 suitable for FAGOR Qty 1 pcs L 585mm W 50mm		
<b>For models:</b>	AD-45BBT, AD-48B, AD-48BDD, AD-48C, AD-64B, AD-64BBT, AD-64BDD, AD-64C		

<b>GEV No.</b>	403467	<b>Ref. No.</b>	12023437
<b>description</b>	membrane keypad dishwasher AD90 buttons 4 suitable for FAGOR Qty 1 pcs L 200mm W 120mm		
<b>For models:</b>	AD-90, AD-90DD		

<b>GEV No.</b>	402579	<b>Ref. No.</b>	12023215
<b>description</b>	membrane keypad warewashing LA13 buttons 6 L 640mm W 160mm		
<b>For models:</b>	LA-13M, LB-AC-10M, LB-E-10M, LB-V-10M		

medium temperature: 90°C 90°C 60°C  
 ambient temperature: 60°C 25°C 60°C  
 duty cycle: 40% 100% 100%

<b>GEV No.</b>	372025	<b>Ref. No.</b>	12003285 Z611124
<b>description</b>	solenoid valve triple straight 230VAC inlet 3/4" outlet 11.5mm DN10 EATON (INVENSYS)		
<b>For models:</b>	AD-15D, AD-21D, LVC-15D, LVC-21D, LVR-14D, LVR-20D		

<b>GEV No.</b>	370021	<b>Ref. No.</b>	12023794 12032085 EU929172 P255001
<b>description</b>	solenoid valve double straight 230VAC inlet 3/4" outlet 11.5mm DN10 TP flow regulating valve inlet white		
<b>For models:</b>	ACE-061, ACE-101, ACE-102, ACE-201, ACE-202, ACG-061, ACG-101, ACG-102, ACG-201, ACG-202, AD-15, AD-20C-UK, AD-21, AD-21B, AD-21BDD, AD-21C, AD-21DD, AD-21W, AD-48D, AD-64D, AE-061, AE-101, AE-102, AE-201, AE-202, AG-061, AG-101, AG-102, AG-201, AG-202, COE-061, COE-101, COE-102, COE-201, COE-202, CPE9-05, CPE9-05AD, CPE9-05AD-S, CPE9-05NC, CPE9-05PLUS, CPE9-05PLUS-S, CPE9-05S, CPE9-05SSNC, CPG9-05, CPG9-05AD, CPG9-05AD-S, CPG9-05NC, CPG9-05PLUS, CPG9-05PLUS-S, CPG9-05S...(Other models you can see in the webshop)		

<b>spare parts for</b>	370021			
	<b>GEV No.</b>	371013	<b>Ref. No.</b>	—
	solenoid coil TP 230VAC 50/60Hz			
<b>accessories for</b>	370021			
	<b>GEV No.</b>	371220	<b>Ref. No.</b>	—
	reducer TP flow rate 3l/min red tolerance ±15%			
	<b>GEV No.</b>	371221	<b>Ref. No.</b>	—
	reducer TP flow rate 5.5l/min yellow tolerance ±15%			
	<b>GEV No.</b>	371222	<b>Ref. No.</b>	—
	reducer TP flow rate 6l/min grey tolerance ±15%			
	<b>GEV No.</b>	371223	<b>Ref. No.</b>	—
	reducer TP flow rate 10l/min white tolerance ±15%			
	<b>GEV No.</b>	371224	<b>Ref. No.</b>	—
	reducer TP flow rate 12l/min bronze tolerance ±15%			
	<b>GEV No.</b>	371225	<b>Ref. No.</b>	—
	reducer TP flow rate 16l/min light brown tolerance ±15%			

## solenoid valves

## solenoid valves (water)

ELBI

straight

<b>GEV No.</b>	373025	<b>Ref. No.</b>	12023921 Z611123
<b>description</b>	solenoid valve triple straight 230VAC inlet 3/4" outlet 11.5mm DN10 ELBI		
<b>For models:</b>	AE-061, AE-061W, AE-101, AE-101W, AE-102, AE-102W, AE-201, AE-202, AG-061, AG-061W, AG-101, AG-101W, AG-102, AG-102W, AG-201, AG-202, APE-061, APE-061W, APE-101, APE-101W, APE-102, APE-102W, APE-201, APE-202, APG-061, APG-061W, APG-101, APG-101W, APG-102, APG-102W, APG-201, APG-202, HEM-10-11, HEM-20-11, HEM-6-11, HEP-10-11, HEP-20-11, HEP-6-11, LA-13M, LA-18MP, LA-25M, LA-AC-10M, LA-AC-10MA, LA-AC-10MP, LA-AC-13M, LA-AC-13MA, LA-AC-13MP, LA-AC-18M, LA-AC-18MA, LA-AC-18MP...(Other models you can see in the webshop)		

Table continues overleaf









Зип-Общепит

vsezip.ru

+7(812)987-08-81

accessories for		370021		
GEV No.	Ref. No.	Ref. No.	Ref. No.	Ref. No.
	371226	—	—	—
reducer TP flow rate 20l/min red tolerance ±15%				
	371230	—	—	—
reducer TP flow rate 0.25l/min red tolerance ±25%				
	371231	—	—	—
reducer TP flow rate 0.35l/min violet tolerance ±25%				
	371232	—	—	—
reducer TP flow rate 0.5l/min orange tolerance ±25%				
	371233	—	—	—
reducer TP flow rate 0.8l/min white tolerance ±25%				
	371234	12025263 P305013	—	—
reducer TP flow rate 1l/min light blue tolerance ±25%				
	371235	—	—	—
reducer TP flow rate 1.2l/min brown tolerance ±25%				
	371236	—	—	—
reducer TP flow rate 1.5l/min light brown tolerance ±25%				
	371237	—	—	—
reducer TP flow rate 2.5l/min yellow tolerance ±25%				
	371238	—	—	—
reducer TP flow rate 3.4l/min dark green tolerance ±25%				
	371239	—	—	—
reducer TP flow rate 5l/min black tolerance ±25%				
	371240	—	—	—
reducer TP flow rate 8l/min blue tolerance ±20%				

				
				
<b>GEV No.</b>	370017	<b>Ref. No.</b>	12025161 Z701135	
<b>description</b>	solenoid valve single straight 230VAC inlet 3/4" outlet 11.5mm DN10 TP p max 10bar			
<b>For models:</b>	ACE-061, ACE-101, ACE-102, ACE-201, ACE-202, ACG-061, ACG-101, ACG-102, ACG-201, ACG-202, AD-120, AD-120B, AD-120BTTDD-UK, AD-120C, AD-120HY, AD-45BBT, AD-48, AD-48B, AD-48BDD, AD-48C, AD-48DD, AD-48HY, AD-48W, AD-64, AD-64B, AD-64BBT, AD-64BDD, AD-64BTDD, AD-64C, AD-64CW, AD-64D, AD-64DD, AD-64HY, AD-72, AD-72W, AD-90, AD-90BA, AD-90BBT, AD-90BDD, AD-90DD, AE-061, AE-061W, AE-101, AE-101W, AE-102, AE-102W, AE-201, AE-202, AG-061, AG-061W...(Other models you can see in the webshop)			
<b>spare parts for</b>	370017			
	GEV No.	371013	Ref. No.	—
solenoid coil TP 230VAC 50/60Hz				



accessories for		370017		
GEV No.	Ref. No.	Ref. No.	Ref. No.	Ref. No.
	371220	—	—	—
reducer TP flow rate 3l/min red tolerance ±15%				
	371221	—	—	—
reducer TP flow rate 5.5l/min yellow tolerance ±15%				
	371222	—	—	—
reducer TP flow rate 6l/min grey tolerance ±15%				
	371223	—	—	—
reducer TP flow rate 10l/min white tolerance ±15%				
	371224	—	—	—
reducer TP flow rate 12l/min bronze tolerance ±15%				
	371225	—	—	—
reducer TP flow rate 16l/min light brown tolerance ±15%				
	371226	—	—	—
reducer TP flow rate 20l/min red tolerance ±15%				
	371230	—	—	—
reducer TP flow rate 0.25l/min red tolerance ±25%				
	371231	—	—	—
reducer TP flow rate 0.35l/min violet tolerance ±25%				
	371232	—	—	—
reducer TP flow rate 0.5l/min orange tolerance ±25%				
	371233	—	—	—
reducer TP flow rate 0.8l/min white tolerance ±25%				
	371234	12025263 P305013	—	—
reducer TP flow rate 1l/min light blue tolerance ±25%				
	371235	—	—	—
reducer TP flow rate 1.2l/min brown tolerance ±25%				
	371236	—	—	—
reducer TP flow rate 1.5l/min light brown tolerance ±25%				
	371237	—	—	—
reducer TP flow rate 2.5l/min yellow tolerance ±25%				
	371238	—	—	—
reducer TP flow rate 3.4l/min dark green tolerance ±25%				
	371239	—	—	—
reducer TP flow rate 5l/min black tolerance ±25%				
	371240	—	—	—
reducer TP flow rate 8l/min blue tolerance ±20%				

Зип-Общепит

vsezip.ru

+7(812)987-08-81

			
			
<b>GEV No.</b>	370018	<b>Ref. No.</b>	12034078
<b>description</b>	solenoid valve single straight 230VAC inlet 3/4" outlet 14mm DN10 TP		
<b>spare parts for</b>	370018		
			
<b>GEV No.</b>	371013	<b>Ref. No.</b>	—
<b>description</b>	solenoid coil TP 230VAC 50/60Hz		
<b>accessories for</b>	370018		
			
<b>GEV No.</b>	371220	<b>Ref. No.</b>	—
<b>description</b>	reducer TP flow rate 3l/min red tolerance ±15%		
			
<b>GEV No.</b>	371221	<b>Ref. No.</b>	—
<b>description</b>	reducer TP flow rate 5.5l/min yellow tolerance ±15%		
			
<b>GEV No.</b>	371222	<b>Ref. No.</b>	—
<b>description</b>	reducer TP flow rate 6l/min grey tolerance ±15%		
			
<b>GEV No.</b>	371223	<b>Ref. No.</b>	—
<b>description</b>	reducer TP flow rate 10l/min white tolerance ±15%		
			
<b>GEV No.</b>	371224	<b>Ref. No.</b>	—
<b>description</b>	reducer TP flow rate 12l/min bronze tolerance ±15%		
			
<b>GEV No.</b>	371225	<b>Ref. No.</b>	—
<b>description</b>	reducer TP flow rate 16l/min light brown tolerance ±15%		
			
<b>GEV No.</b>	371226	<b>Ref. No.</b>	—
<b>description</b>	reducer TP flow rate 20l/min red tolerance ±15%		
			
<b>GEV No.</b>	371230	<b>Ref. No.</b>	—
<b>description</b>	reducer TP flow rate 0.25l/min red tolerance ±25%		
			
<b>GEV No.</b>	371231	<b>Ref. No.</b>	—
<b>description</b>	reducer TP flow rate 0.35l/min violet tolerance ±25%		
			
<b>GEV No.</b>	371232	<b>Ref. No.</b>	—
<b>description</b>	reducer TP flow rate 0.5l/min orange tolerance ±25%		
			
<b>GEV No.</b>	371233	<b>Ref. No.</b>	—
<b>description</b>	reducer TP flow rate 0.8l/min white tolerance ±25%		
			
<b>GEV No.</b>	371234	<b>Ref. No.</b>	12025263 P305013
<b>description</b>	reducer TP flow rate 1l/min light blue tolerance ±25%		
			
<b>GEV No.</b>	371235	<b>Ref. No.</b>	—
<b>description</b>	reducer TP flow rate 1.2l/min brown tolerance ±25%		
			
<b>GEV No.</b>	371236	<b>Ref. No.</b>	—
<b>description</b>	reducer TP flow rate 1.5l/min light brown tolerance ±25%		
			
<b>GEV No.</b>	371237	<b>Ref. No.</b>	—
<b>description</b>	reducer TP flow rate 2.5l/min yellow tolerance ±25%		

			
<b>GEV No.</b>	371238	<b>Ref. No.</b>	—
<b>description</b>	reducer TP flow rate 3.4l/min dark green tolerance ±25%		
			
<b>GEV No.</b>	371239	<b>Ref. No.</b>	—
<b>description</b>	reducer TP flow rate 5l/min black tolerance ±25%		
			
<b>GEV No.</b>	371240	<b>Ref. No.</b>	—
<b>description</b>	reducer TP flow rate 8l/min blue tolerance ±20%		

<b>solenoid valves with reducers</b>			
			
<b>GEV No.</b>	370427	<b>Ref. No.</b>	12033258 BR00023001
<b>description</b>	solenoid valve single angled 230VAC inlet 3/4" outlet 11.5mm input/ min output 1.2l/min DN10 t.max. 90°C TP plastic flow regulating valve outlet dark brown		

			
<b>GEV No.</b>	370245	<b>Ref. No.</b>	EPGC3120530
<b>description</b>	solenoid valve single straight 24VAC inlet 3/4" outlet 11.5mm input 16l/min t.max. 90°C TP plastic flow regulating valve inlet light brown		

			
<b>GEV No.</b>	370250	<b>Ref. No.</b>	P443018000
<b>description</b>	solenoid valve triple straight 230VAC inlet 3/4" outlet 11.5mm t.max. 90°C TP plastic output B 0.25l/min flow regulating valve outlet B red		



Зип Общепит

vsezip.ru

+7(812)987-08-81

spare parts and accessories

reducers

outlet side

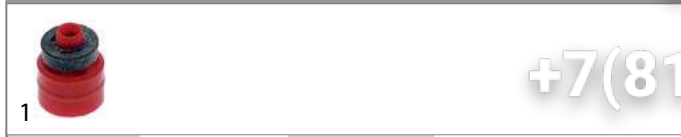

<b>GEV No.</b>	691082	<b>Ref. No.</b>	12024045 Z601156
<b>description</b>	reducer flow rate 8l/min violet tolerance ±25%		
<b>For models:</b>	AD-45BBT, AD-48HY, AD-64BBT, AD-64BTDD, AD-64HY, AE-061, AE-101, AE-102, AE-201, AE-202, AG-061, AG-101, AG-102, AG-201, AG-202, APE-061, APE-101, APE-102, APE-201, APE-202, APG-061, APG-101, APG-102, APG-201, APG-202, BME7-05, BME7-10, BMG7-10, CPE9-05, CPE9-05AD, CPE9-05AD-S, CPE9-05NC, CPE9-05PLUS, CPE9-05PLUS-S, CPE9-05S, CPE9-05SNC, CPG9-05, CPG9-05AD, CPG9-05AD-S, CPG9-05NC, CPG9-05PLUS, CPG9-05PLUS-S, CPG9-05S, CPG9-05SNC, ECO-2700D, ECO-2700I, ECO-4000D, ECO-4000I, ECO-550D, ECO-550I...(Other models you can see in the webshop)		



<b>GEV No.</b>	371234	<b>Ref. No.</b>	12025263 P305013
<b>description</b>	reducer TP flow rate 1l/min light blue tolerance ±25%		
<b>For models:</b>	ACE-061, ACE-101, ACE-102, ACE-201, ACE-202, ACG-061, ACG-101, AD-48D, AD-64D, AE-061, AE-101, AE-102, AE-201, AE-202, AG-061, AG-101, AG-102, AG-201, AG-202, APE-061, APE-101, APE-102, APE-201, APE-202, APG-061, APG-101, APG-102, APG-201, APG-202, COE-202, FI-48, FI-48AR, FI-48B, FI-48B-BT-UK, FI-48C, FI-48D, FI-48HY-CLINIC, FI-48W, FI-64, FI-64AR, FI-64B, FI-64B-BT-UK, FI-64C, FI-64D, FI-64HY-CLINIC, FI-64W, HCV-10-11, HCV-5-11, HE-10-11, HE-10-21...(Other models you can see in the webshop)		

metal



<b>GEV No.</b>	370488	<b>Ref. No.</b>	1200000139 12005276 12038329 Z718415
<b>description</b>	solenoid valve 2-ways 240VAC L 90mm DANFOSS 60Hz		
<b>For models:</b>	AD-120CW, FI-100, FI-120, FI-120W, FI-200WL, FI-200WR, FI-80W		



<b>GEV No.</b>	370725	<b>Ref. No.</b>	12023551 Z102305
<b>description</b>	solenoid valve brass 2-ways inlet 3/4" IT outlet 3/4" IT L 90mm without coil t.max. 90°C DANFOSS type series EV220B 18 p max 10bar p min 0.3bar		
<b>For models:</b>	ECO-1600, ECO-2300, ECO-280D, ECO-280I, ECO-3000, ECO-370D, ECO-370I, ECO-460D, ECO-460I, ECO-550D, ECO-550I, FI-120W, FI-1600, FI-2300, FI-2700D, FI-2700I, FI-280D, FI-280I, FI-3000, FI-370D, FI-370I, FI-4000D, FI-4000I, FI-460D, FI-460I, FI-550D, FI-550I, FI-6000D, FI-6000I, LA-25M, LA-AC-25M, LA-AC-25MA, LA-AC-25MP, LAC-25, LAC-25MP, LAC-25MPP, LAC-55, LAC-55MP, LAC-55MPP, LA-E-25M, LA-E-25MA, LA-E-25MP, LA-V-25M, LA-V-25MP, LC-25, LC-AC-25, LC-E-25, LC-V-25, LF-25MPP, LF-AC-25...(Other models you can see in the webshop)		

drain valves

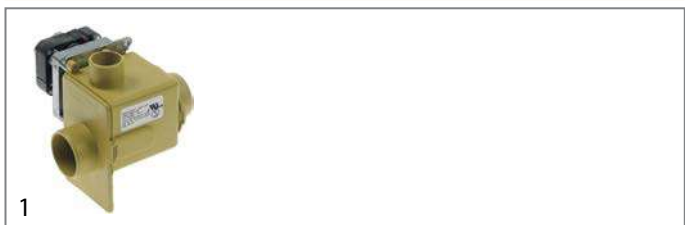

<b>GEV No.</b>	370789	<b>Ref. No.</b>	12024781 P302120
<b>description</b>	drain valve 220-240V 50/60Hz NO inlet 50mm outlet 50/35mm MDB-O-2-SO		
<b>For models:</b>	LA-13M, LA-18MP, LA-AC-10M, LA-AC-10MA, LA-AC-10MP, LA-AC-13M, LA-AC-13MA, LA-AC-13MP, LA-AC-18M, LA-AC-18MA, LA-AC-18MP, LAC-10, LAC-10MP, LAC-10MPP, LAC-14, LAC-14MP, LAC-14MPP, LAC-7, LAC-7MP, LAC-7MPP, LA-E-10M, LA-E-10MA, LA-E-10MP, LA-E-13M, LA-E-13MA, LA-E-13MP, LA-E-18M, LA-E-18MA, LA-E-18MP, LA-V-10M, LA-V-10MP, LA-V-13M, LA-V-13MP, LA-V-18M, LA-V-18MP, LB-AC-10M, LB-E-10M, LB-V-10M, LC-10, LC-14, LC-7, LC-AC-10, LC-AC-10A, LC-AC-14, LC-AC-14A, LC-AC-7, LC-AC-7A, LC-E-10, LC-E-10A, LC-E-14...(Other models you can see in the webshop)		



## pressure switches

for warewashing

ø 58mm with male faston 6.3mm

with connection horizontal



1

<b>GEV No.</b>	541137	<b>Ref. No.</b>	12025063 Z513001
<b>description</b>	pressure control pressure range 155/40mbar connection 6mm ø 58mm pressure connection horizontal warewashing		
<b>For models:</b>	ECO-2700D, ECO-2700I, ECO-4000D, ECO-4000I, ECO-6000D, ECO-6000I, FI-120HY-CLINIC, FI-2700D, FI-2700I, FI-4000D, FI-4000I, FI-6000D, FI-6000I		



2

<b>GEV No.</b>	541776	<b>Ref. No.</b>	12023804 Z713002
<b>description</b>	pressure control pressure range 170/95mbar connection 6mm ø 58mm pressure connection horizontal warewashing		
<b>For models:</b>	AD-120, AD-120B, AD-120BBTDD-UK, AD-120C, AD-120CW, AD-120HY, AD-45BBT, AD-48HY, AD-64BBT, AD-64HY, AD-90, AD-90BA, AD-90BBT, AD-90BDD, AD-90DD, ADE-120, ADE-120B, ECO-120, ECO-120B, FI-100, FI-100AR, FI-100B, FI-100BBT-UK, FI-120, FI-120AR+DD, FI-120B, FI-120C, FI-120HY-CLINIC, FI-120W, FI-80, FI-80AR, FI-80BBT-UK, FI-80W, FI-E-100, LABP-1000, LABP-1200, LABP-800, MF-120		



1

<b>GEV No.</b>	541885	<b>Ref. No.</b>	12023855 Z273006
<b>description</b>	pressure control pressure range 205/40mbar connection 6mm ø 58mm pressure connection horizontal pressure connection ø 5.5mm		
<b>For models:</b>	ECO-160, ECO-160D, ECO-160I, ECO-200, ECO-200D, ECO-200H, ECO-200HD, ECO-200HI, ECO-200I, ECO-280D, ECO-280I, ECO-370D, ECO-370I, ECO-460D, ECO-460I, ECO-550D, ECO-550I, FI-160, FI-160AR, FI-160D, FI-160I, FI-200, FI-200AR, FI-200D, FI-200H, FI-200HD, FI-200HI, FI-200I, FI-200W, FI-200WL, FI-200WR, FI-280D, FI-280I, FI-370D, FI-370I, FI-460D, FI-460I, FI-550D, FI-550I		

Зип Общепит

vsezip.ru

+7(812)987-08-81

<b>GEV No.</b>	541832	<b>Ref. No.</b>	12023856 Z713098
<b>description</b>	pressure control pressure range 24.7/22.2mbar connection 6mm ø 58mm pressure connection horizontal warewashing pressure connection ø 6mm		
<b>For models:</b>	AD-120B, AD-120BBTDD-UK, AD-120C, AD-120HY, AD-90BA, AD-90BBT, AD-90BDD, ADE-120B, ECO-120B, FI-100, FI-100AR, FI-100B, FI-100BBT-UK, FI-120B, FI-120C, FI-120HY-CLINIC, FI-80BBT-UK		

<b>GEV No.</b>	541864	<b>Ref. No.</b>	12023803 Z403021
<b>description</b>	pressure control pressure range 28/13mbar connection 6mm ø 58mm pressure connection horizontal warewashing suitable for FAGOR		
<b>For models:</b>	AD-15, AD-15D, AD-21, AD-21B, AD-21C, AD-21D, AD-21DD, CO-350, CO-350-B, CO-350-B-DD, CO-350-COLD, CO-350-COLD-B, CO-350-COLD-B-DD, CO-350-COLD-DD, CO-350-DD, CO-352-COLD, CO-352-COLD-B, CO-352-COLD-B-DD, CO-352-COLD-DD, CO-400, CO-400-B, CO-400-B-DD, CO-400-COLD, CO-400-COLD-B, CO-400-COLD-B-DD, CO-400-COLD-DD, CO-400-DD, CO-400-SOFT, CO-402-COLD, CO-402-COLD-B, CO-402-COLD-B-DD, CO-402-COLD-DD, ECO-280D, ECO-280I, ECO-370D, ECO-370I, ECO-460D, ECO-460I, ECO-550D, ECO-550I, FI-160AR, FI-160D, FI-160I, FI-200AR, FI-200D, FI-200HD, FI-200HI, FI-200I, FI-200WL, FI-200WR...(Other models you can see in the webshop)		

<b>GEV No.</b>	541302	<b>Ref. No.</b>	12023802 Z203023
<b>description</b>	pressure control pressure range 40/15mbar connection 6mm ø 58mm pressure connection horizontal warewashing		
<b>For models:</b>	AD-45BBT, AD-48, AD-48B, AD-48BDD, AD-48C, AD-48D, AD-48DD, AD-48HY, AD-48W, AD-64, AD-64B, AD-64BBT, AD-64BDD, AD-64BTDD, AD-64C, AD-64CW, AD-64D, AD-64DD, AD-64HY, AD-72, AD-72W, EASY-500, EASY-500B, EASY-500DD, EASY-500HP, EASY-500HPWBDD, FI-120HY-CLINIC, FI-30, FI-30AR, FI-30AR+DD, FI-30B, FI-30B-BT-UK, FI-30-UK, FI-48, FI-48AR, FI-48B, FI-48B-BT-UK, FI-48C, FI-48D, FI-48HY-CLINIC, FI-48W, FI-50, FI-60DD, FI-64, FI-64AR, FI-64B, FI-64B-BT-UK, FI-64C, FI-64D, FI-64HY-CLINIC...(Other models you can see in the webshop)		



Зип Общепит

Ø 94mm with coded plug

vsezip.ru

+7(812)987-08-81



1

<b>GEV No.</b>	541593	<b>Ref. No.</b>	12023854 Z313006
<b>description</b>	pressure control pressure range 50/35mbar connection 6mm ø 58mm pressure connection horizontal		
<b>For models:</b>	ECO-2700D, ECO-2700I, ECO-280D, ECO-280I, ECO-370D, ECO-370I, ECO-4000D, ECO-4000I, ECO-460D, ECO-460I, ECO-550D, ECO-550I, ECO-6000D, ECO-6000I, FI-2700D, FI-2700I, FI-280D, FI-280I, FI-370D, FI-370I, FI-4000D, FI-4000I, FI-460D, FI-460I, FI-550D, FI-550I, FI-6000D, FI-6000I		



1

<b>GEV No.</b>	541296	<b>Ref. No.</b>	12024981 Z433011
<b>description</b>	pressure control 2 pressure ranges pressure range 28/13 65/50mbar connection 6mm ø 84mm pressure connection horizontal warewashing pressure connection ø 5.5mm		
<b>For models:</b>	AD-20C-UK, AD-21B, AD-21BDD, AD-21C, AD-21W, CO-350, CO-350-B, CO-350-B-DD, CO-350-COLD, CO-350-COLD-B, CO-350-COLD-B-DD, CO-350-COLD-DD, CO-350-DD, CO-352-COLD, CO-352-COLD-B, CO-352-COLD-B-DD, CO-352-COLD-DD, CO-400, CO-400-B, CO-400-B-DD, CO-400-COLD, CO-400-COLD-B, CO-400-COLD-B-DD, CO-400-COLD-DD, CO-400-DD, CO-400-SOFT, CO-402-COLD, CO-402-COLD-B, CO-402-COLD-B-DD, CO-402-COLD-DD, CO-402W, LVC-21B, LVC-21C, LVC-21W, MF-21		



1

<b>GEV No.</b>	541594	<b>Ref. No.</b>	12020076 Z683071
<b>description</b>	pressure control pressure range 85/50mbar connection 6mm ø 58mm pressure connection horizontal pressure connection ø 6mm		
<b>For models:</b>	ECO-1200, FI-1200, FI-900		



1

<b>GEV No.</b>	541592	<b>Ref. No.</b>	12024269 Z213059
<b>description</b>	pressure control 3 pressure ranges pressure range 40/15 120/60 150/95mbar connection 6mm ø 84mm pressure connection ø 6mm		
<b>For models:</b>	AD-120BBTDD-UK, AD-120HY, AD-45BBT, AD-48HY, AD-64BBT, AD-64BTDD, AD-64HY, AD-90BA, AD-90BBT, AD-90BDD, EASY-500HPWBDD, FI-100BBT-UK, FI-120HY-CLINIC, FI-30B-BT-UK, FI-48B-BT-UK, FI-48HY-CLINIC, FI-64B-BT-UK, FI-64HY-CLINIC, FI-80BBT-UK		



1

<b>GEV No.</b>	541299	<b>Ref. No.</b>	12023805 Z223005
<b>description</b>	pressure control pressure range 95/75mbar connection 6mm ø 58mm pressure connection horizontal warewashing pressure connection ø 6mm		
<b>For models:</b>	AD-48B, AD-48BDD, AD-48C, AD-48HY, AD-48W, AD-64B, AD-64BBT, AD-64BDD, AD-64C, AD-64CW, AD-64HY, AD-72W, EASY-500B, EASY-500HPWBDD, FI-30, FI-30AR, FI-30AR+DD, FI-30B, FI-30B-BT-UK, FI-30-UK, FI-48, FI-48AR, FI-48B, FI-48B-BT-UK, FI-48C, FI-48D, FI-48HY-CLINIC, FI-48W, FI-64, FI-64AR, FI-64B, FI-64B-BT-UK, FI-64C, FI-64D, FI-64HY-CLINIC, FI-64W, MF-48, MF-64		

**accessories**



1

<b>GEV No.</b>	541598	<b>Ref. No.</b>	12023163 Z602923
<b>description</b>	bracket stainless steel H 37mm L 60mm W 12mm for pressure switch		
<b>For models:</b>	AD-120, AD-120B, AD-120BBTDD-UK, AD-120C, AD-120CW, AD-120HY, AD-45BBT, AD-48HY, AD-48W, AD-64BBT, AD-64BTDD, AD-64CW, AD-64HY, AD-72W, AD-90, AD-90BA, AD-90BBT, AD-90BDD, AD-90DD, ADE-120, ADE-120B, CO-350, CO-350-B, CO-350-B-DD, CO-350-COLD, CO-350-COLD-B, CO-350-COLD-B-DD, CO-350-COLD-DD, CO-350-DD, CO-352-COLD, CO-352-COLD-B, CO-352-COLD-B-DD, CO-352-COLD-DD, CO-400, CO-400-B, CO-400-B-DD, CO-400-COLD, CO-400-COLD-B, CO-400-COLD-B-DD, CO-400-COLD-DD, CO-400-DD, CO-400-SOFT, CO-402-COLD, CO-402-COLD-B, CO-402-COLD-B-DD, CO-402-COLD-DD, CO-402W, EASY-500, EASY-500B, EASY-500DD... (Other models you can see in the webshop)		

electric components



# Зип-Общепит

vsezip.ru

+7(812)987-08-81



1

<b>GEV No.</b>	541109	<b>Ref. No.</b>	12023510 Z103077
<b>description</b>	Y-piece plastic hose ø 8-6-8mm for pressure switch		
<b>For models:</b>	AD-120B, AD-120BBTDD-UK, AD-120C, AD-120HY, AD-45BBT, AD-48B, AD-48BDD, AD-48C, AD-48HY, AD-48W, AD-64B, AD-64BBT, AD-64BDD, AD-64BTDD, AD-64C, AD-64CW, AD-64HY, AD-72W, AD-90BA, AD-90BBT, AD-90BDD, ADE-120B, CO-500, CO-500B, CO-500BDD, CO-500DD, CO-501, CO-501B, CO-501BDD, CO-501DD, CO-501-SOFT, CO-502B, CO-502BDD, CO-502DD, CO-502W, COP-503, COP-503B, COP-503BDD, COP-503DD, COP-503-SOFT, COP-504, COP-504B, COP-504BDD, COP-504DD, COP-504W, EASY-500B, EASY-500HPWBDD, ECO-120B, ECO-160, ECO-1600...(Other models you can see in the webshop)		

## accessories

### fan guards



1

<b>GEV No.</b>	692519	<b>Ref. No.</b>	12025177 Z713015
<b>description</b>	guard L 120mm W 120mm plastic		
<b>For models:</b>	AD-120, AD-120B, AD-120BBTDD-UK, AD-120C, AD-120CW, AD-120HY, AD-90, AD-90BA, AD-90BBT, AD-90BDD, AD-90DD, ADE-120, ADE-120B, ECO-120, ECO-120B, FI-100, FI-100AR, FI-100B, FI-100BBT-UK, FI-120, FI-120AR+DD, FI-120B, FI-120C, FI-120HY-CLINIC, FI-120W, FI-80, FI-80AR, FI-80BBT-UK, FI-80W, FI-E-100, LABP-1000, LABP-1200		
<b>accessories for</b>	692519		



<b>GEV No.</b>	601080	<b>Ref. No.</b>	12023862 12031028 12031777 12032776 6021050006 RT31011008 ST25000040 Z103066
----------------	--------	-----------------	---

axial fan L 119mm W 119mm H 38mm 230VAC 50/60Hz 23/20W bearing ball bearing connection male faston 2.8mm metal ADDA fan wheel ø 110mm temp.-resist. 70°C

## fans

### axial fans

#### import



1

<b>GEV No.</b>	601080 <sup>1</sup>	<b>Ref. No.</b>	12023862 12031028 12031777 12032776 6021050006 RT31011008 ST25000040 Z103066
<b>description</b>	axial fan L 119mm W 119mm H 38mm 230VAC 50/60Hz 23/20W bearing ball bearing connection male faston 2.8mm metal ADDA fan wheel ø 110mm temp.-resist. 70°C		
<b>For models:</b>	ACE-061, ACE-101, ACE-102, ACG-061, ACG-101, ACG-102, AD-120, AD-120B, AD-120BBTDD-UK, AD-120C, AD-120CW, AD-120HY, AD-90, AD-90BA, AD-90BBT, AD-90BDD, AD-90DD, AE-061, AE-101, AE-102, AG-061, AG-101, AG-102, APE-061, APE-101, APE-102, APG-061, APG-101, APG-102, CI9-20, CI9-40, COE-061, COE-101, COE-102, COE-201, COG-061, COG-101, COG-102, COG-201, ECO-120, ECO-120B, ECO-160, ECO-1600, ECO-160D, ECO-160I, ECO-200, ECO-200D, ECO-200H, ECO-200HD, ECO-200HI...(Other models you can see in the webshop)		
<b>accessories for</b>	601080		
	<b>GEV No.</b>	550898	<b>Ref. No.</b> —
	connecting cable cable length 2000mm connection F 2.8 connection distance 7.9mm for axial flow fan		
	<b>GEV No.</b>	692519	<b>Ref. No.</b> 12025177 Z713015
	guard L 120mm W 120mm plastic		

<sup>1</sup>with ball bearings

## motors

### gear motors

#### for dishwashers



1

<b>GEV No.</b>	601662	<b>Ref. No.</b>	12023304 Z315001 Z315006
<b>description</b>	gear motor C.M.E type 71 B 6/4 0.18/0.25W 230V 50Hz 1 phase 1380rpm MI 50 transmission 60/1 for dishwasher		
<b>For models:</b>	ECO-280D, ECO-280I, ECO-370D, ECO-370I, ECO-460D, ECO-460I, ECO-550D, ECO-550I, FI-280D, FI-280I, FI-370D, FI-370I, FI-460D, FI-460I, FI-550D, FI-550I		



Зип Общепит

vsezip.ru

+7(812)987-08-81



1

<b>GEV No.</b>	500783	<b>Ref. No.</b>	12024739 Z275073 Z275074
<b>description</b>	gear motor type 71E00147 250W 230/400V 50/60Hz 3 phase L 365mm W 200mm H 170mm MI 50 transmission 100/1 for dishwasher		
<b>For models:</b>	ECO-160, ECO-160D, ECO-160I, FI-160, FI-160AR, FI-160D, FI-160I		



1

<b>GEV No.</b>	500705	<b>Ref. No.</b>	12024812 Z101001
<b>description</b>	pump inlet ø 63mm outlet ø 53mm type 1243 230/400V 50Hz 3 phase 2.39kW 3.2HP L 363mm rotation direction left FIR		
<b>For models:</b>	ECO-1600, ECO-2300, ECO-280D, ECO-280I, ECO-3000, ECO-370D, ECO-370I, ECO-460D, ECO-460I, ECO-550D, ECO-550I, FI-1600, FI-2300, FI-280D, FI-280I, FI-3000, FI-370D, FI-370I, FI-460D, FI-460I, FI-550D, FI-550I		
<b>spare parts for</b>	500705		
	<b>GEV No.</b>	<b>Ref. No.</b>	—
	510357		
	impellor ø 124mm H 34/16mm thread M8R blades 6		

accessories

vibration absorber



1

<b>GEV No.</b>	524000	<b>Ref. No.</b>	12025159 Z710316
<b>description</b>	vibration damper H 15mm ø 20mm thread M6 thread L 14mm		
<b>For models:</b>	AD-120, AD-120B, AD-120BBTDD-UK, AD-120C, AD-120CW, AD-120HY, AD-90, AD-90BA, AD-90BBT, AD-90BDD, AD-90DD, ADE-120, ADE-120B, ECO-120, ECO-120B, FI-100, FI-100AR, FI-100B, FI-100BBT-UK, FI-120, FI-120AR+DD, FI-120B, FI-120C, FI-120HY-CLINIC, FI-120W, FI-80, FI-80AR, FI-80BBT-UK, FI-80W, FI-E-100, LABP-1000, LABP-1200, LABP-800, LAC-25, LAC-25MP, LAC-25MPP, LAC-55, LAC-55MP, LAC-55MPP, LC-25, MF-120		

pumps

wash and rinse pumps

FIR

pumps



1

<b>GEV No.</b>	499353	<b>Ref. No.</b>	12024782 T360715 T360715000
<b>description</b>	pump inlet ø 30mm outlet ø 26mm type 5213E2451 230V 50Hz 1 phase 0.22kW 0.1HP L 190mm rotation direction left capacitor 5µF FIR		
<b>For models:</b>	APE-201, APE-202, APG-201, APG-202, HEP-10-21, HEP-20-21, HGP-10-21, HGP-20-21, VPE-102, VPE-201, VPE-202, VPG-102, VPG-201, VPG-202		

HANNING

pumps



1

<b>GEV No.</b>	499166	<b>Ref. No.</b>	12024233
<b>description</b>	pump inlet ø 28mm outlet ø 26mm type UP60-414 220-240V 50/60Hz 1 phase 0.25kW L 190mm rotation direction right capacitor 5µF HANNING p max 1bar Qmax. 150l/min		
<b>For models:</b>	AD-125, AD-125HRS, AD-125-SOFT, AD-45BBT, AD-48HY, AD-505, AD-64BBT, AD-64BTDD, AD-64HY, COP-173, COP-173B, COP-173BDD, COP-173DD, COP-173HRS, COP-173HRSDD, COP-173-SOFT, COP-174, COP-174B, COP-174BDD, COP-174DD, COP-174HRS, COP-174HRSDD, COP-174W, COP-174WHRS, COP-503, COP-503B, COP-503BDD, COP-503DD, COP-503-SOFT, COP-504, COP-504B, COP-504BDD, COP-504DD, COP-504W, EASY-500HPWBDD, FI-30B-BT-UK, FI-48B-BT-UK, FI-48HY-CLINIC, FI-64B-BT-UK, FI-64HY-CLINIC		
<b>spare parts for</b>	499166		
	<b>GEV No.</b>	<b>Ref. No.</b>	—
	365017		
	operating capacitor capacity 5µF 450V tolerance 5% 50/60Hz ambient temperature max. -25 to +85°C ø 28mm L 54mm M8 plastic connection male faston 6.3mm 16.10.08 protection		

Table continues overleaf



electric components

Зип Общепит

vsezip.ru

+7(812)987-08-81



<b>GEV No.</b>	501562	<b>Ref. No.</b>	12043287
<b>description</b>	pump inlet ø 38mm outlet ø 38mm type 2/123 FA-22 230V 50Hz 1 phase 0.59kW 0.8HP rotation direction right capacitor 10µF INSERT-STAR		
<b>For models:</b>	AD-120C, AD-120HY, AD-125, AD-125HRS, AD-125-SOFT, AD-505, AD-505-SOFT, AD-64BTDD, CO-110, CO-110B, CO-110BDD, CO-110DD, CO-112, CO-112B, CO-112BDD, CO-112DD, CO-170, CO-170B, CO-170BDD, CO-170DD, CO-170HRS, CO-170HRSDD, CO-170HRS-SOFT, CO-170-SOFT, CO-172, CO-172B, CO-172BDD, CO-172DD, CO-500, CO-500B, CO-500BDD, CO-500DD, CO-501, CO-501B, CO-501BDD, CO-501DD, CO-501-SOFT, CO-502B, CO-502BDD, CO-502DD, COP-173, COP-173B, COP-173BDD, COP-173DD, COP-173HRS, COP-173HRSDD, COP-173-SOFT, COP-174, COP-174B, COP-174BDD...(Other models you can see in the webshop)		

<b>spare parts for</b>	499166			
	<b>GEV No.</b>	507558	<b>Ref. No.</b>	—
	mechanical shaft seal for shaft ø 7mm height counter ring 5mm ID ø 6.75mm ED ø 20mm mounting ø counter ring 18.5/slide ring 20mm			
	<b>GEV No.</b>	532644	<b>Ref. No.</b>	—
	O-ring EPDM thickness 3mm ID ø 78mm Qty 1 pcs			

INSERT STAR pumps



<b>GEV No.</b>	500321	<b>Ref. No.</b>	12023429 Z401001
<b>description</b>	pump inlet ø 38mm outlet ø 38mm type 2/102FA10 230V 50/60Hz 1 phase 0.26kW 0.35HP L 195mm rotation direction right capacitor 6µF INSERTSTAR		
<b>For models:</b>	AD-120BBTDD-UK, AD-120HY, AD-15, AD-15D, AD-20C-UK, AD-21, AD-21B, AD-21BDD, AD-21C, AD-21D, AD-21DD, AD-21W, AD-90BBT, ADE-120, ADE-120B, CO-350, CO-350-B, CO-350-B-DD, CO-350-COLD, CO-350-COLD-B, CO-350-COLD-B-DD, CO-350-COLD-DD, CO-350-DD, CO-352-COLD, CO-352-COLD-B, CO-352-COLD-B-DD, CO-352-COLD-DD, CO-400, CO-400-B, CO-400-B-DD, CO-400-COLD, CO-400-COLD-B, CO-400-COLD-B-DD, CO-400-COLD-DD, CO-400-DD, CO-400-SOFT, CO-402-COLD, CO-402-COLD-B, CO-402-COLD-B-DD, CO-402-COLD-DD, CO-402W, ECO-120, ECO-1200, ECO-120B, ECO-160, ECO-160D, ECO-160I, ECO-200, ECO-200D, ECO-200H...(Other models you can see in the webshop)		

<b>spare parts for</b>	500321			
	<b>GEV No.</b>	504578	<b>Ref. No.</b>	—
	O-ring EPDM thickness 3.53mm ID ø 94.84mm Qty 1 pcs			
	<b>GEV No.</b>	510693	<b>Ref. No.</b>	12018735 Z201081
	mechanical shaft seal for shaft ø 12mm slide ring ext. ø 24mm slide ring H 15.5mm slide ring int. ø 11mm counter ring mounting ø 24mm height counter ring 8mm counter ring int. ø 13.5mm			
	<b>GEV No.</b>	650240	<b>Ref. No.</b>	—
	impeller ø 75mm H 27mm pump type 2/102FA10 shaft intake ø 8mm rotation direction right thread M8L suitable for INSERTSTAR blades 6			
<b>accessories for</b>	500321			
	<b>GEV No.</b>	365093	<b>Ref. No.</b>	12024346 V817100
	operating capacitor capacity 6µF 400V tolerance 5% 50/60Hz ambient temperature max. -25 to +85°C ø 31.5mm L 55mm M8 plastic connection male faston 6.3mm protection			



<b>GEV No.</b>	499075	<b>Ref. No.</b>	12024270 Z203501 Z203511
<b>description</b>	pump inlet ø 38mm outlet ø 38mm type 2/123 FA31 230V 60Hz 1 phase 0.59kW L 240mm rotation direction right capacitor 10µF INSERTSTAR		
<b>For models:</b>	AD-120, AD-120B, AD-120CW, AD-120CW, AD-48, AD-48W, AD-64, AD-64CW, AD-72, AD-72W, AD-90, AD-90BA, AD-90BDD, AD-90DD, ADE-120, ADE-120B, EASY-500, EASY-500B, EASY-500DD, EASY-500HP, EASY-500HPWDD, ECO-120, ECO-1200, ECO-120B, ECO-160D, ECO-160I, ECO-200D, ECO-200HD, ECO-200HI, ECO-200I, ECO-370D, ECO-370I, ECO-550D, ECO-550I, FI-100, FI-100AR, FI-100B, FI-100BDD, FI-100BT-UK, FI-120, FI-1200, FI-120AR+DD, FI-120B, FI-120C, FI-120HY-CLINIC, FI-120W, FI-160AR, FI-160D, FI-160I, FI-200AR, FI-200D...(Other models you can see in the webshop)		

<b>spare parts for</b>	499075			
	<b>GEV No.</b>	510693	<b>Ref. No.</b>	12018735 Z201081
	mechanical shaft seal for shaft ø 12mm slide ring ext. ø 24mm slide ring H 15.5mm slide ring int. ø 11mm counter ring mounting ø 24mm height counter ring 8mm counter ring int. ø 13.5mm			
	<b>GEV No.</b>	521000	<b>Ref. No.</b>	12019782 Z201085
	pump cover FAGOR inlet ø 38mm outlet ø 38mm			
	<b>GEV No.</b>	532491	<b>Ref. No.</b>	—
	O-ring EPDM thickness 3.53mm ID ø 120.2mm Qty 1 pcs			
	<b>GEV No.</b>	650238	<b>Ref. No.</b>	—
	impeller ø 77mm H 32mm pump type 2/123 FA31 shaft intake ø 8mm rotation direction right thread M8L suitable for INSERTSTAR shaft ø 12mm shaft length 26mm blades 6			

Table continues overleaf



Зип Общедит  
booster pumps

vsezip.ru

+7(812)987-08-81

<b>accessories for</b> 499075			
	<b>GEV No.</b> 365015	<b>Ref. No.</b> 12024376 V321300	
operating capacitor capacity 10µF 400V tolerance 5%Hz ambient temperature max. -25 to +85°C ø 35.5mm L 59mm M8 plastic connection male faston 6.3mm protection			

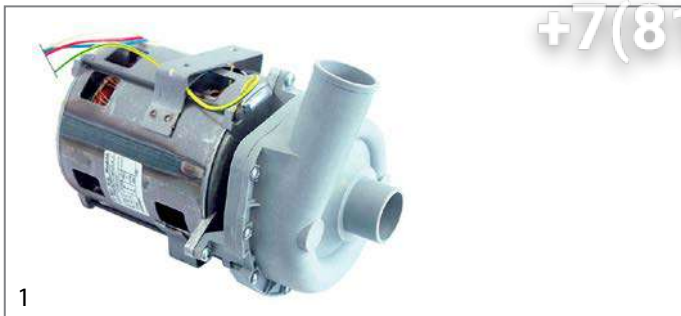



<b>GEV No.</b> 500320	<b>Ref. No.</b> 12024265 Z201001 Z201011
-----------------------	--

**description** pump inlet ø 38mm outlet ø 38mm type 2/123/FA30 230V 50Hz 1 phase 0.59kW 0.8HP L 235mm rotation direction right capacitor 10µF INSERTSTAR

**For models:** AD-120, AD-120B, AD-120BBTDD-UK, AD-120C, AD-120HY, AD-45BBT, AD-48, AD-48B, AD-48BDD, AD-48C, AD-48D, AD-48DD, AD-48HY, AD-64, AD-64B, AD-64BBT, AD-64BDD, AD-64BTDD, AD-64C, AD-64D, AD-64DD, AD-64HY, AD-72, AD-90, AD-90BA, AD-90BBT, AD-90BDD, AD-90DD, ADE-120, ADE-120B, EASY-500, EASY-500B, EASY-500DD, EASY-500HP, EASY-500HPWBDD, ECO-120, ECO-1200, ECO-120B, ECO-160, ECO-1600, ECO-160D, ECO-160I, ECO-200, ECO-200D, ECO-200H, ECO-200HD, ECO-200HI, ECO-200I, ECO-2300, ECO-3000...(Other models you can see in the webshop)

**spare parts for** 500320

	<b>GEV No.</b> 510693	<b>Ref. No.</b> 12018735 Z201081
mechanical shaft seal for shaft ø 12mm slide ring ext. ø 24mm slide ring H 15.5mm slide ring int. ø 11mm counter ring mounting ø 24mm height counter ring 8mm counter ring int. ø 13.5mm		

	<b>GEV No.</b> 521000	<b>Ref. No.</b> 12019782 Z201085
pump cover FAGOR inlet ø 38mm outlet ø 38mm		

	<b>GEV No.</b> 521255	<b>Ref. No.</b> 12018550 Z201082
impellor ø 88mm H 33mm M8L pump type 2/123/FA30 shaft ø 12mm		

	<b>GEV No.</b> 532491	<b>Ref. No.</b> —
O-ring EPDM thickness 3.53mm ID ø 120.2mm Qty 1 pcs		

**accessories for** 500320

	<b>GEV No.</b> 365015	<b>Ref. No.</b> 12024376 V321300
operating capacitor capacity 10µF 400V tolerance 5%Hz ambient temperature max. -25 to +85°C ø 35.5mm L 59mm M8 plastic connection male faston 6.3mm protection		

	<b>GEV No.</b> 551227	<b>Ref. No.</b> —
female faston size 6.3x0.8mm 1.0-2.5mm <sup>2</sup> straight CuZn gal Sn t.max. 110°C Qty 10 pcs		



<b>GEV No.</b> 499155	<b>Ref. No.</b> 12023344 Z209508
-----------------------	-------------------------------------

**description** pump inlet ø 1" IT outlet ø 1" IT type PRISMA15 230V 50Hz 0.6kW L 400mm capacitor 12µF

**For models:** ECO-120, ECO-1200, FI-100, FI-120, FI-1200, FI-120W, FI-30, FI-30AR, FI-30AR+DD, FI-30-UK, FI-48, FI-48AR, FI-48B, FI-48B-BT-UK, FI-48C, FI-48D, FI-48HY-CLINIC, FI-48W, FI-50, FI-64, FI-64AR, FI-64B, FI-64B-BT-UK, FI-64C, FI-64D, FI-64HY-CLINIC, FI-64W, FI-72, FI-72AR, FI-72W, FI-900, MF-48, MF-64



<b>GEV No.</b> 499073	<b>Ref. No.</b> 12017575 12017826 12024708
-----------------------	--

**description** pump inlet ø 31 outlet ø 27 type 887084885 230V 50Hz 0.75kW L 146mm capacitor 2.5µF NIDEC

**For models:** APE-061, APE-101, APE-102, APG-061, APG-101, APG-102, FI-30B-BT-UK, FI-48B-BT-UK, FI-48HY-CLINIC, FI-64B-BT-UK, FI-64HY-CLINIC, VPE-061, VPE-101

drain pumps

COPRECI



<b>GEV No.</b> 500322	<b>Ref. No.</b> 12024273 Z220901
-----------------------	-------------------------------------

**description** drain pump inlet ø 25mm outlet ø 22mm 230V 30W 50Hz COPRECI

**For models:** AD-20C-UK, AD-21B, AD-21BDD, AD-21C, AD-45BBT, AD-48B, AD-48BDD, AD-48C, AD-48HY, AD-64B, AD-64BBT, AD-64BDD, AD-64C, AD-64HY, FI-30, FI-30AR, FI-30AR+DD, FI-30B, FI-30B-BT-UK, FI-30-UK, FI-48, FI-48AR, FI-48B, FI-48B-BT-UK, FI-48C, FI-48D, FI-48HY-CLINIC, FI-48W, FI-64, FI-64AR, FI-64B, FI-64B-BT-UK, FI-64C, FI-64D, FI-64HY-CLINIC, FI-64W, GA-20, GA-20D, GA-40, GA-40D, HEM-10-21, HEM-20-21, HEP-10-21, HEP-20-21, HGP-10-21, HGP-20-21, HGV-10-21, HGV-20-21, LVC-21B, LVC-21C...(Other models you can see in the webshop)



# Зип Общепит

сервис центр

vsezip.ru

+7(812)987-08-81

## HANNING



<b>GEV No.</b>	500573	<b>Ref. No.</b>	12029471 RT4400207P
<b>description</b>	drain pump 30W 4-piece 230V inlet ø 24/30mm outlet ø 24mm 50Hz HANNING type DPS25-032 1x pump, 3x pump cover		



<b>GEV No.</b>	501561	<b>Ref. No.</b>	12094265
<b>description</b>	drain pump 38W 200-240V inlet ø 30mm outlet ø 24mm 50/60Hz type DP25R-396 HANNING		
<b>For models:</b>	AD-505, AD-505-SOFT, CO-350-B, CO-350-B-DD, CO-350-COLD-B, CO-350-COLD-B-DD, CO-352-COLD-B, CO-352-COLD-B-DD, CO-400-B, CO-400-B-DD, CO-400-COLD-B, CO-400-COLD-B-DD, CO-402-COLD-B, CO-402-COLD-B-DD, CO-402W, CO-500B, CO-500BDD, CO-501B, CO-501BDD, CO-502B, CO-502BDD, CO-502W, COP-503B, COP-503BDD, COP-504B, COP-504BDD, COP-504W, EASY-500B, EASY-500DD		



<b>GEV No.</b>	500737	<b>Ref. No.</b>	12023456 Z711007
<b>description</b>	drain pump 95W 230V inlet ø 24mm outlet ø 24mm 50Hz type BE38B5-017 HANNING		
<b>For models:</b>	AD-120B, AD-120BBTDD-UK, AD-120C, AD-120HY, AD-125, AD-125HRS, AD-125-SOFT, AD-90BA, AD-90BBT, AD-90BDD, ADE-120B, CO-110B, CO-110BDD, CO-112B, CO-112BDD, CO-170B, CO-170BDD, CO-172B, CO-172BDD, COP-173B, COP-173BDD, COP-174B, COP-174BDD, ECO-120B, FI-100, FI-100AR, FI-100B, FI-100BBT-UK, FI-120B, FI-120C, FI-120HY-CLINIC, FI-80BBT-UK		



<b>GEV No.</b>	500573	<b>Ref. No.</b>	12029471 RT4400207P
<b>description</b>	drain pump 30W 4-piece 230V inlet ø 24/30mm outlet ø 24mm 50Hz HANNING type DPS25-032 1x pump, 3x pump cover		

## accessories

### holders



<b>GEV No.</b>	500735	<b>Ref. No.</b>	12022664 Z430902
<b>description</b>	fastening angle for drain pump		
<b>For models:</b>	AD-20C-UK, AD-21B, AD-21BDD, AD-21C, AD-21W, LVC-21B, LVC-21C, LVC-21W, LVR-20B, MF-21		



<b>GEV No.</b>	500736	<b>Ref. No.</b>	12022443 Z220904
<b>description</b>	fastening angle for drain pump		
<b>For models:</b>	AD-45BBT, AD-48B, AD-48BDD, AD-48C, AD-48HY, AD-48W, AD-64B, AD-64BBT, AD-64BDD, AD-64C, AD-64CW, AD-64HY, FI-30, FI-30AR, FI-30AR+DD, FI-30B, FI-30B-BT-UK, FI-30-UK, FI-48, FI-48AR, FI-48B, FI-48B-BT-UK, FI-48C, FI-48D, FI-48HY-CLINIC, FI-48W, FI-64, FI-64AR, FI-64B, FI-64B-BT-UK, FI-64C, FI-64D, FI-64HY-CLINIC, FI-64W, MF-48, MF-64		



booster pumps II

Зип Общепит

vsezip.ru

+7(812)987-08-81

accessories



1			
<b>GEV No.</b>	365015	<b>Ref. No.</b>	12024376 V321300
<b>description</b>	operating capacitor capacity 10µF 400V tolerance 5%Hz ambient temperature max. -25 to +85°C ø 35.5mm L 59mm M8 plastic connection male faston 6.3mm protection		
<b>For models:</b>	AD-120, AD-120B, AD-120BBTDD-UK, AD-120C, AD-120CW, AD-120HY, AD-125, AD-125HRS, AD-125-SOFT, AD-45BBT, AD-48, AD-48B, AD-48BDD, AD-48C, AD-48D, AD-48DD, AD-48HY, AD-48W, AD-505, AD-505-SOFT, AD-64, AD-64B, AD-64BBT, AD-64BDD, AD-64BTDD, AD-64C, AD-64CW, AD-64D, AD-64DD, AD-64HY, AD-72, AD-72W, AD-90, AD-90BA, AD-90BBT, AD-90BDD, AD-90DD, ADE-120, ADE-120B, CO-110, CO-110B, CO-110BDD, CO-110DD, CO-112, CO-112B, CO-112BDD, CO-112DD, CO-142W, CO-142WDD, CO-170...(Other models you can see in the webshop)		



1			
<b>GEV No.</b>	365012	<b>Ref. No.</b>	SAM4420032
<b>description</b>	operating capacitor capacity 6.3µF 450V tolerance 5% 50Hz ambient temperature max. -25 to +85°C ø 30mm L 61mm M8 plastic connection male faston 6.3mm protection		

condensators & interference suppression filters

operating capacitors

plastic



1			
<b>GEV No.</b>	365015	<b>Ref. No.</b>	12024376 V321300
<b>description</b>	operating capacitor capacity 10µF 400V tolerance 5%Hz ambient temperature max. -25 to +85°C ø 35.5mm L 59mm M8 plastic connection male faston 6.3mm protection		
<b>For models:</b>	AD-120, AD-120B, AD-120BBTDD-UK, AD-120C, AD-120CW, AD-120HY, AD-125, AD-125HRS, AD-125-SOFT, AD-45BBT, AD-48, AD-48B, AD-48BDD, AD-48C, AD-48D, AD-48DD, AD-48HY, AD-48W, AD-505, AD-505-SOFT, AD-64, AD-64B, AD-64BBT, AD-64BDD, AD-64BTDD, AD-64C, AD-64CW, AD-64D, AD-64DD, AD-64HY, AD-72, AD-72W, AD-90, AD-90BA, AD-90BBT, AD-90BDD, AD-90DD, ADE-120, ADE-120B, CO-110, CO-110B, CO-110BDD, CO-110DD, CO-112, CO-112B, CO-112BDD, CO-112DD, CO-142W, CO-142WDD, CO-170...(Other models you can see in the webshop)		

1			
<b>GEV No.</b>	365020	<b>Ref. No.</b>	12020898 R293000
<b>description</b>	operating capacitor capacity 14µF 400V tolerance 5%Hz ambient temperature max. -25 to +85°C ø 35mm L 70mm M8 plastic connection male faston 6.3mm protection		
<b>For models:</b>	HCG-10-11, HCG-10-21, HCG-2-10-11, HCG-6-11, HCV-10-11, HCV-10-21, HCV-2-10-21, HCV-5-11, HCV-6-11, HE-5-11, HG-10-11, HG-10-21, HG-2-10-11, HMG-10-11, HMG-10-11UL, HMG-10-21, HMG-10-21UL, HMG-2-10-11, HMG-6-11, HVG-10-11, HVG-10-11UL, HVG-10-21, HVG-10-21UL, HVG-2-10-11, MFHVG-10-11, MFHVG-10-21		



1			
<b>GEV No.</b>	365012	<b>Ref. No.</b>	SAM4420032
<b>description</b>	operating capacitor capacity 6.3µF 450V tolerance 5% 50Hz ambient temperature max. -25 to +85°C ø 30mm L 61mm M8 plastic connection male faston 6.3mm protection		



1			
<b>GEV No.</b>	365093	<b>Ref. No.</b>	12024346 V817100
<b>description</b>	operating capacitor capacity 6µF 400V tolerance 5% 50/60Hz ambient temperature max. -25 to +85°C ø 31.5mm L 55mm M8 plastic connection male faston 6.3mm protection		
<b>For models:</b>	AD-120BBTDD-UK, AD-120HY, AD-15, AD-15D, AD-20C-UK, AD-21, AD-21B, AD-21BDD, AD-21C, AD-21D, AD-21DD, AD-21W, AD-90BBT, ADE-120, ADE-120B, CO-350, CO-350-B, CO-350-B-DD, CO-350-COLD, CO-350-COLD-B, CO-350-COLD-B-DD, CO-350-COLD-DD, CO-350-DD, CO-352-COLD, CO-352-COLD-B, CO-352-COLD-B-DD, CO-352-COLD-DD, CO-400, CO-400-B, CO-400-B-DD, CO-400-COLD, CO-400-COLD-B, CO-400-COLD-B-DD, CO-400-COLD-DD, CO-400-DD, CO-400-SOFT, CO-402-COLD, CO-402-COLD-B, CO-402-COLD-B-DD, CO-402-COLD-DD, CO-402W, ECO-120, ECO-120B, ECO-160, ECO-160D, ECO-160L, ECO-200, ECO-200D, ECO-200H, ECO-200HD...(Other models you can see in the webshop)		

metal



1			
<b>GEV No.</b>	365139	<b>Ref. No.</b>	12032744 EU206002
<b>description</b>	operating capacitor capacity 10µF 450V tolerance 5% 60Hz ambient temperature max. -25 up to +70°C ø 40mm L 83mm M8 aluminium connection male faston 6.3mm C.87.8BF2 MKP protection		

electric components



fuses

fine fuses



1			
<b>GEV No.</b>	358671	<b>Ref. No.</b>	12039844 R663101
<b>description</b>	fine fuse size ø5x20mm 1A fast-acting rated 250V Qty 10 pcs		
<b>For models:</b>	HME-10-11, HME-10-21, HME-20-11, HME-20-21, HME-2-10-11, HME-2-20-11, HME-6-11, HMP-10-11, HMP-10-21, HMP-20-11, HMP-20-21, HMP-2-10-11, HMP-6-11		



1			
<b>GEV No.</b>	358677	<b>Ref. No.</b>	12024333 12035393 P184011 RT30190112
<b>description</b>	fine fuse size ø5x20mm 4A fast-acting rated 250V Qty 10 pcs		
<b>For models:</b>	CE-15, CE-9, ECO-160, ECO-1600, ECO-160D, ECO-160I, ECO-200, ECO-200D, ECO-200H, ECO-200HD, ECO-200HI, ECO-200I, ECO-2300, ECO-280D, ECO-280I, ECO-3000, ECO-370D, ECO-370I, ECO-460D, ECO-460I, ECO-550D, ECO-550I, FF-35, FI-160, FI-1600, FI-160AR, FI-160D, FI-160I, FI-200, FI-200AR, FI-200D, FI-200H, FI-200HD, FI-200HI, FI-200I, FI-200W, FI-2300, FI-280D, FI-280I, FI-3000, FI-370D, FI-370I, FI-460D, FI-460I, FI-550D, FI-550I, GA-20, GA-40, HCV-10-11, HCV-10-21... (Other models you can see in the webshop)		

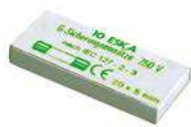

1			
<b>GEV No.</b>	358603	<b>Ref. No.</b>	12034888 RT30190120
<b>description</b>	fine fuse size ø5x20mm 2A slow-acting rated 250V Qty 10 pcs		



1			
<b>GEV No.</b>	358792	<b>Ref. No.</b>	12035115 RT40010225
<b>description</b>	fine fuse size ø6.3x32mm 10A slow-acting rated 250V Qty 10 pcs		



1			
<b>GEV No.</b>	358791	<b>Ref. No.</b>	12037374 RT40010224
<b>description</b>	fine fuse size ø6.3x32mm 6.3A slow-acting rated 250V Qty 10 pcs		

Зип Общепит

fine fuse holders



vsezip.ru

+7(812)987-08-81

<b>GEV No.</b>	550536	<b>Ref. No.</b>	12025158 R073005
<b>description</b>	fuse holder suitable fuse ø10x38mm 30A rated 600V		
<b>For models:</b>	ACE-061, ACE-101, ACE-102, ACE-201, ACE-202, ACG-061, ACG-101, ACG-102, ACG-201, ACG-202, AD-120, AD-120B, AD-120BBTDD-UK, AD-120C, AD-120CW, AD-120HY, AD-125, AD-125HRS, AD-125-SOFT, AD-90, AD-90BA, AD-90BBT, AD-90BDD, AD-90DD, ADE-120, ADE-120B, AE-061, AE-061W, AE-101, AE-101W, AE-102, AE-102W, AE-201, AE-202, AG-061, AG-061W, AG-101, AG-101W, AG-102, AG-102W, APE-061, APE-061W, APE-101, APE-101W, APE-102, APE-102W, APE-201, APE-202, APG-061, APG-061W...(Other models you can see in the webshop)		

screw locks

D0-system (NEOZED)



1			
<b>GEV No.</b>	358043	<b>Ref. No.</b>	12033846 RT30190401
<b>description</b>	fuse size D01 16A rated 250/400V E14 ø 11mm L 36mm Qty 10 pcs		



1			
<b>GEV No.</b>	358047	<b>Ref. No.</b>	12032709 RT30190405
<b>description</b>	fuse size D02 63A rated 250/400V E18 ø 15mm L 36mm Qty 10 pcs		

gauge pieces (NEOZED)



1			
<b>GEV No.</b>	358064	<b>Ref. No.</b>	12037278 RT40011238
<b>description</b>	gauge piece size D02 suitable for 16A		

fuse holders



1			
<b>GEV No.</b>	358060	<b>Ref. No.</b>	12032263 RT40011234
<b>description</b>	fuse holder suitable fuse D02 3-pole-pole 63A rated 400V		



Зип Общепит  
vsezip.ru

			
1			
<b>GEV No.</b>	358061	<b>Ref. No.</b>	12016497 RT40011235
<b>description</b>	fuse holder suitable fuse D02 ø 25mm mounting ø 18mm rated 400V L 30mm		

			
1			
<b>GEV No.</b>	550311	<b>Ref. No.</b>	12018128 N023064
<b>description</b>	cable gland ID ø 6mm mounting ø 9mm ED ø 14mm Neoprene -30 up to +90°C Qty 10 pcs		
<b>For models:</b>	ECO-120, ECO-120B, FI-100, FI-100AR, FI-100B, FI-120, FI-120B, FI-120W, FI-30, FI-48, FI-48B, FI-48W, FI-50, FI-64, FI-64B, FI-64W, FI-72, MF-120, MF-48, MF-64		

electric accessories

cables

accessories

protection hoses

JOHN GUEST

			
1			
<b>GEV No.</b>	550788	<b>Ref. No.</b>	12008694 X033027
<b>description</b>	screw connection ID ø 14mm for protection hose plastic Qty 1 pcs thread PG11		
<b>For models:</b>	FE7-05-1C, FE7-05-2C, FE-710, FE7-10-2C, FE7-10-4C, FE-71-15, FE-720, FE9-05, FE9-05-1C, FE9-05-2C, FE9-05AD, FE9-05PLUS, FE9-05PLUS-S, FE9-05S, FE9-05S-1C, FE9-05S-2C, FE9-05S-AD, FE9-05USMC, FE9-10, FE9-10-2C, FE9-10-4C, FE9-10AD, FE9-10PLUS, FE-91-20, FE-920, FG-710, FG-720, FI-200W		

miscellaneous

			
1			
<b>GEV No.</b>	550787	<b>Ref. No.</b>	11000146 3712300
<b>description</b>	protection pipe ID ø 23mm ED ø 28mm Qty 1m plastic for cable		
<b>For models:</b>	ECO-120, ECO-120B, ECO-160, ECO-160D, ECO-160I, ECO-200, ECO-200D, ECO-200H, ECO-200HD, ECO-200HI, ECO-200I, ECO-2700D, ECO-2700I, ECO-280D, ECO-280I, ECO-370D, ECO-370I, ECO-4000D, ECO-4000I, ECO-460D, ECO-460I, ECO-550D, ECO-550I, ECO-6000D, ECO-6000I, FE7-05-1C, FE7-05-2C, FE-710, FE7-10-2C, FE7-10-4C, FE-720, FE9-05, FE9-05-1C, FE9-05-2C, FE9-05AD, FE9-05PLUS, FE9-05PLUS-S, FE9-05S, FE9-05S-1C, FE9-05S-2C, FE9-05S-AD, FE9-05USMC, FE9-10, FE9-10-2C, FE9-10-4C, FE9-10AD, FE9-10PLUS, FI-160, FI-160AR, FI-160D...(Other models you can see in the webshop)		

cable glands

cable glands

			
1			
<b>GEV No.</b>	551102	<b>Ref. No.</b>	6003010082
<b>description</b>	cable gland ID ø 10mm mounting ø 12mm Neoprene -30 up to +120°C Qty 1 pcs		
<b>For models:</b>	ATM-031, ATM-031-60Hz, ATM-051VCH, ATM-051VCH-60Hz, ATM-081VCH, ATM-081VCH-60Hz, ATM-101VCH, ATM-101VCH-60Hz, ATM-121VCH, ATM-121VCH-60Hz, ATM-121VCHP, ATM-161VCH		

threaded cable glands

fastening nuts

			
1			
<b>GEV No.</b>	550578	<b>Ref. No.</b>	12009764 Q223016
<b>description</b>	nut thread PG21 H 4.6mm WS 32 nickel-plated brass Qty 1 pcs mounting ømm cable ømm		
<b>For models:</b>	ECO-120, ECO-120B, FI-100, FI-100AR, FI-100B, FI-120, FI-120B, FI-120W, FI-30, FI-48, FI-48B, FI-48W, FI-50, FI-64, FI-64B, FI-64W, FI-72, FI-80, FI-80W, LA-13M, LA-18MP, LA-AC-10M, LA-AC-10MA, LA-AC-10MP, LA-AC-13M, LA-AC-13MA, LA-AC-13MP, LA-AC-18M, LA-AC-18MA, LA-AC-18MP, LA-AC-25M, LA-AC-25MA, LA-AC-25MP, LA-E-10M, LA-E-10MA, LA-E-10MP, LA-E-13M, LA-E-13MA, LA-E-13MP, LA-E-18M, LA-E-18MA, LA-E-18MP, LA-E-25M, LA-E-25MA, LA-E-25MP, LA-V-10M, LA-V-10MP, LA-V-13M, LA-V-13MP, LA-V-18M...(Other models you can see in the webshop)		

			
1			
<b>GEV No.</b>	550974	<b>Ref. No.</b>	12010063 R023025
<b>description</b>	nut thread PG21 WS 34 plastic Qty 1 pcs thickness 7.5mm mounting ømm cable ømm		
<b>For models:</b>	ACE-061, ACE-101, AE-061, AE-101, AE-101W, APE-061, APE-101, APE-101W, CE9-20, CE9-20AD, CE9-20PLUS, CE9-40, CE9-40AD, CE9-40PLUS, CE9-41, CGE9-41, COE-061, CPE7-05, CPE7-05NC, CPE9-05, CPE9-05AD, CPE9-05AD-S, CPE9-05NC, CPE9-05PLUS, CPE9-05PLUS-S, CPE9-05S, CPE9-05SNC, CPG9-05, CPG9-05NC, CPG9-05S, CPG9-05SNC, ECO-160, ECO-160D, ECO-160I, ECO-200, ECO-200D, ECO-200H, ECO-200HD, ECO-200HI, ECO-200I, ECO-2700D, ECO-2700I, ECO-280D, ECO-280I, ECO-370D, ECO-370I, ECO-4000D, ECO-4000I, ECO-460D, ECO-460I...(Other models you can see in the webshop)		



Зип Общежит

vsezip.ru

+7(812)987-08-81

## strain reliefs



<b>GEV No.</b>	506222	<b>Ref. No.</b>	12024230 Z203020
<b>description</b>	cable gland		
<b>For models:</b>	AD-15, AD-15D, AD-20C-UK, AD-21, AD-21B, AD-21BDD, AD-21C, AD-21D, AD-21DD, AD-21W, AD-45BBT, AD-48, AD-48B, AD-48BDD, AD-48C, AD-48D, AD-48DD, AD-48HY, AD-48W, AD-505, AD-505-SOFT, AD-64, AD-64B, AD-64BBT, AD-64BDD, AD-64BTDD, AD-64C, AD-64D, AD-64DD, AD-64HY, AD-72, CG-210G, CG-310G, CO-350, CO-350-B, CO-350-B-DD, CO-350-COLD, CO-350-COLD-B, CO-350-COLD-B-DD, CO-350-COLD-DD, CO-350-DD, CO-352-COLD, CO-352-COLD-B, CO-352-COLD-B-DD, CO-352-COLD-DD, CO-400, CO-400-B, CO-400-B-DD, CO-400-COLD, CO-400-COLD-B...(Other models you can see in the webshop)		

## ribbon cables

## group 1



<b>GEV No.</b>	402970	<b>Ref. No.</b>	12034267 EU41523
<b>description</b>	ribbon cable 10-pole L 1200mm plug type 2 row coded Qty 1m		

## cable harnesses



<b>GEV No.</b>	691855	<b>Ref. No.</b>	Z743001
<b>description</b>	cable harness for dishwasher		
<b>For models:</b>	FI-80		

## terminals

## terminal blocks



<b>GEV No.</b>	550239	<b>Ref. No.</b>	12025086 Z743006
<b>description</b>	lustre terminal 12-pole cross section 16mm <sup>2</sup> max. 75A max 500V temp.-resist. 150°C		
<b>For models:</b>	AD-90, AD-90DD, ADE-120, ADE-120B, ECO-120, ECO-120B, FI-80, FI-80AR, FI-80BBT-UK, FI-80W		

## connector terminals with screw/faston connections



<b>GEV No.</b>	505212	<b>Ref. No.</b>	12024110 Z603025
<b>description</b>	power terminal block 2-pole max. 20A max 600V connection ø2.5mm <sup>2</sup> / F6.3 temp.-resist. 150°C cross section 4mm <sup>2</sup>		
<b>For models:</b>	AD-15, AD-15D, AD-20C-UK, AD-21, AD-21B, AD-21BDD, AD-21C, AD-21D, AD-21DD, AD-21W, AD-505, AD-505-SOFT, CG-210G, CG-310G, CO-500, CO-500B, CO-500BDD, CO-500DD, CO-501, CO-501B, CO-501BDD, CO-501DD, CO-501-SOFT, CO-502B, CO-502BDD, CO-502DD, CO-502W, COP-503, COP-503B, COP-503BDD, COP-503DD, COP-503-SOFT, COP-504, COP-504B, COP-504BDD, COP-504DD, COP-504W, LVC-12, LVC-15, LVC-15D, LVC-21, LVC-21B, LVC-21C, LVC-21D, LVC-21W, LVR-10, LVR-14, LVR-14D, LVR-20, LVR-20B...(Other models you can see in the webshop)		



<b>GEV No.</b>	550278	<b>Ref. No.</b>	12024382 U183046
<b>description</b>	power terminal block 3-pole max. 40A max 400V connection ø6mm <sup>2</sup> / F6.3 temp.-resist. 150°C cross section 6mm <sup>2</sup>		
<b>For models:</b>	BME6-05, BME7-05, BME9-05, BME9-05AD, BME9-05PLUS, BME9-05V-T, CE-410, CO-350, CO-350-B, CO-350-B-DD, CO-350-COLD, CO-350-COLD-B, CO-350-COLD-B-DD, CO-350-COLD-DD, CO-350-DD, CO-352-COLD, CO-352-COLD-B, CO-352-COLD-B-DD, CO-352-COLD-DD, CO-400, CO-400-B, CO-400-B-DD, CO-400-COLD, CO-400-COLD-B, CO-400-COLD-B-DD, CO-400-COLD-DD, CO-400-DD, CO-400-SOFT, CO-402-COLD, CO-402-COLD-B, CO-402-COLD-B-DD, CO-402-COLD-DD, CO-402W, CPG9-05, CPG9-05NC, CPG9-05S, CPG9-05SNC, CV6-20, CV6-40, FE-4, FG7-05-1C, FG7-05-2C, FG-710, FG7-10-2C, FG7-104C, FG7-10-4C, FG-720, FG9-05, FG9-05-1C, FG9-05-2C...(Other models you can see in the webshop)		



<b>GEV No.</b>	550411	<b>Ref. No.</b>	12025183 12034943 EU220011 R253044
<b>description</b>	power terminal block 6-pole max. 40A max 450V connection ø6mm <sup>2</sup> / F6.3 temp.-resist. 150°C cross section 6mm <sup>2</sup>		
<b>For models:</b>	AD-45BBT, AD-48, AD-48B, AD-48BDD, AD-48C, AD-48D, AD-48DD, AD-48HY, AD-48W, AD-505, AD-505-SOFT, AD-64, AD-64B, AD-64BBT, AD-64BDD, AD-64BTDD, AD-64C, AD-64CW, AD-64D, AD-64DD, AD-64HY, AD-72, AD-72W, BME7-10, BME9-10, BME9-10AD, BME9-10PLUS, BME9-10V-T, CE6-20, CE6-40, CE6-41, CE7-20, CE7-20Q, CE7-40, CE7-40Q, CE7-41, CE7-41Q, CGE6-41, CGE7-231, C19-20AD, C19-20PLUS, C19-40AD, C19-40PLUS, CMF6-05, CO-500, CO-500B, CO-500BDD, CO-500DD, CO-501, CO-501B...(Other models you can see in the webshop)		



Зип Общежит

vsezip.ru

+7(812)987-08-81

rail-mounted terminals

WEIDMÜLLER

feed-through terminals



<b>GEV No.</b>	550792	<b>Ref. No.</b>	12024229 Z103029
<b>description</b>	rail-mounted terminal 2.5mm <sup>2</sup> for DIN rail 35mm grey 1-pole		
<b>For models:</b>	ECO-160, ECO-1600, ECO-160D, ECO-160I, ECO-200, ECO-200D, ECO-200H, ECO-200HD, ECO-200HI, ECO-200I, ECO-2300, ECO-2700D, ECO-2700I, ECO-280D, ECO-280I, ECO-3000, ECO-370D, ECO-370I, ECO-4000D, ECO-4000I, ECO-460D, ECO-460I, ECO-550D, ECO-550I, ECO-6000D, ECO-6000I, FI-160, FI-1600, FI-160AR, FI-160D, FI-160I, FI-200, FI-200AR, FI-200D, FI-200H, FI-200HD, FI-200HI, FI-200I, FI-200W, FI-200WL, FI-200WR, FI-2300, FI-2700D, FI-2700I, FI-280D, FI-280I, FI-3000, FI-370D, FI-370I, FI-4000D...(Other models you can see in the webshop)		



<b>GEV No.</b>	551230	<b>Ref. No.</b>	12024942 R143011
<b>description</b>	rail-mounted terminal 70mm <sup>2</sup> for DIN rail 35mm grey 1-pole		
<b>For models:</b>	ACE-202, AE-202, APE-202, COE-202, ECO-280D, ECO-280I, ECO-370D, ECO-370I, ECO-460D, ECO-460I, ECO-550D, ECO-550I, FI-160, FI-160AR, FI-160D, FI-160I, FI-200, FI-200AR, FI-200D, FI-200H, FI-200HD, FI-200HI, FI-200I, FI-200W, FI-200WL, FI-200WR, FI-2700D, FI-2700I, FI-280D, FI-280I, FI-370D, FI-370I, FI-4000D, FI-4000I, FI-460D, FI-460I, FI-550D, FI-550I, FI-6000D, FI-6000I, HEI-20-21, HEM-20-21, HEP-20-21, HME-20-21, HME-2-20-11, HMM-20-21, HMM-20-21UL, HMM-40-11-USMC, HMP-20-21, VE-202...(Other models you can see in the webshop)		

accessories



<b>GEV No.</b>	550789	<b>Ref. No.</b>	12024199 Z263303
<b>description</b>	rail-mounted terminal grey for DIN rail 35mm		
<b>For models:</b>	ACG-061, ACG-101, ACG-102, ACG-201, ACG-202, AD-125, AD-125HRS, AD-125-SOFT, AG-061, AG-061W, AG-101, AG-101W, AG-102, AG-102W, AG-201, AG-202, APG-061, APG-061W, APG-101, APG-101W, APG-102, APG-102W, APG-201, APG-202, CE6-20, CE6-40, CE6-41, CE7-20, CE7-20Q, CE7-40, CE7-40Q, CE7-41, CE9-20, CE9-20AD, CE9-20PLUS, CGE6-41, CGE7-211, CGE7-41, CGE7-41H, CGE9-11, CGE9-41, CGE9-41AD, CGE9-41PLUS, CO-110, CO-110B, CO-110BDD, CO-110DD, CO-112, CO-112B, CO-112BDD...(Other models you can see in the webshop)		

rail-mounted terminals type 9700A



<b>GEV No.</b>	550374	<b>Ref. No.</b>	12025191 12035926 RT40011250 Z683097
<b>description</b>	rail-mounted terminal WIELAND type 9700A/10 S35 1.5-16mm <sup>2</sup> top-hat rail 35mm blue W 10mm L 49mm		
<b>For models:</b>	AD-120, AD-120B, AD-120BBTDD-UK, AD-120C, AD-120HY, AD-90, AD-90BA, AD-90BBT, AD-90BDD, AD-90DD, ADE-120, ADE-120B, CE6-20, CE6-40, CE6-41, CE7-41, CE9-40, FE9-05, FE9-05-1C, FE9-05-2C, FE9-05AD, FE9-05PLUS, FE9-05PLUS-S, FE9-05S, FE9-05S-1C, FE9-05S-2C, FE9-05S-AD, FE9-05USMC, FE9-10, FE9-10-2C, FE9-10-4C, FE9-10AD, FE9-10PLUS, FE-920, FI-100, FI-100AR, FI-100B, FI-100BBT-UK, FI-120, FI-1200, FI-120AR+DD, FI-120B, FI-120C, FI-120HY-CLINIC, FI-120W, FI-80BBT-UK, FI-80W, FI-900, FI-E-100, FTE9-10L...(Other models you can see in the webshop)		



<b>GEV No.</b>	550373	<b>Ref. No.</b>	12025214 12035988 RT40011202 Z683069
<b>description</b>	rail-mounted terminal WIELAND type 9700A/10 S35 1.5-16mm <sup>2</sup> top-hat rail 35mm grey W 10mm L 49mm		
<b>For models:</b>	AD-120, AD-120B, AD-120BBTDD-UK, AD-120C, AD-120HY, AD-90, AD-90BA, AD-90BBT, AD-90BDD, AD-90DD, ADE-120, ADE-120B, CE-410, CE9-40, CE9-41, CE9-41AD, CE9-41PLUS, FE9-05, FE9-05-1C, FE9-05-2C, FE9-05AD, FE9-05PLUS, FE9-05PLUS-S, FE9-05S, FE9-05S-1C, FE9-05S-2C, FE9-05S-AD, FE9-05USMC, FE9-10, FE9-10-2C, FE9-10-4C, FE9-10AD, FE9-10PLUS, FE-920, FI-100, FI-100AR, FI-100B, FI-100BBT-UK, FI-120, FI-1200, FI-120AR+DD, FI-120B, FI-120C, FI-120HY-CLINIC, FI-120W, FI-650R, FI-80BBT-UK, FI-80W, FI-900, FI-E-100...(Other models you can see in the webshop)		



<b>GEV No.</b>	550375	<b>Ref. No.</b>	12023727 Z683070
<b>description</b>	rail-mounted terminal WIELAND type 9700A/10 SL2 S35 1.5-16mm <sup>2</sup> top-hat rail 35mm yellow/green W 10mm L 53mm		
<b>For models:</b>	AD-120, AD-120B, AD-120BBTDD-UK, AD-120C, AD-120CW, AD-120HY, AD-90, AD-90BA, AD-90BBT, AD-90BDD, AD-90DD, ADE-120, ADE-120B, CE-410, CE9-40, FE9-05, FE9-05-1C, FE9-05-2C, FE9-05AD, FE9-05PLUS, FE9-05PLUS-S, FE9-05S, FE9-05S-1C, FE9-05S-2C, FE9-05S-AD, FE9-05USMC, FE9-10, FE9-10-2C, FE9-10-4C, FE9-10AD, FE9-10PLUS, FE-920, FI-100, FI-100AR, FI-100B, FI-100BBT-UK, FI-120, FI-1200, FI-120AR+DD, FI-120B, FI-120C, FI-120HY-CLINIC, FI-120W, FI-650R, FI-80BBT-UK, FI-80W, FI-900, FI-E-100, FTE9-10L, FTE9-10L+R...(Other models you can see in the webshop)		

electric components

Зип Общежит  
vsezip.ru  
+7(812)987-08-81



<b>GEV No.</b>	550378	<b>Ref. No.</b>	12033543 RT40011233
<b>description</b>	rail-mounted terminal WIELAND type 9700A/16 SL2 S35 2.5-35mm <sup>2</sup> top-hat rail 35mm yellow/green W 16mm L 53mm		



<b>GEV No.</b>	550381	<b>Ref. No.</b>	12023373 P453025
<b>description</b>	rail-mounted terminal WIELAND type 9700A/8 S35 1.0-10mm <sup>2</sup> top-hat rail 35mm grey W 8mm L 46.6mm		
<b>For models:</b>	ACE-061, AD-125, AD-125HRS, AD-125-SOFT, AE-061, AE-061W, APE-061, APE-061W, CE6-20, CE6-40, CE6-41, CE7-20, CE7-20Q, CE7-40, CE7-40Q, CE7-41, CE9-20, CE9-20AD, CE9-20PLUS, CGE6-41, CGE7-208, CGE7-41, CGE7-41H, CGE9-11, CGE9-41, CGE9-41AD, CGE9-41PLUS, CO-110, CO-110B, CO-110BDD, CO-110DD, CO-112, CO-112B, CO-112BDD, CO-112DD, CO-142W, CO-142WDD, CO-170, CO-170B, CO-170BDD, CO-170DD, CO-170HRS, CO-170HRSDD, CO-170HRS-SOFT, CO-170-SOFT, CO-172, CO-172B, CO-172BDD, CO-172DD, COE-061...(Other models you can see in the webshop)		

**accessories**

**marking labels**



<b>GEV No.</b>	505000	<b>Ref. No.</b>	12017607 12023957 Z213005 Z743005
<b>description</b>	signboard R/S/T/N		
<b>For models:</b>	AD-45BBT, AD-48, AD-48B, AD-48BDD, AD-48C, AD-48D, AD-48DD, AD-48HY, AD-48W, AD-64, AD-64B, AD-64BBT, AD-64BDD, AD-64BTDD, AD-64C, AD-64CW, AD-64D, AD-64DD, AD-64HY, AD-72, AD-72W, ECO-120, ECO-120B, FI-48, FI-48AR, FI-48B, FI-48B-BT-UK, FI-48C, FI-48D, FI-48HY-CLINIC, FI-48W, FI-50, FI-60DD, FI-64, FI-64AR, FI-64B, FI-64B-BT-UK, FI-64C, FI-64D, FI-64HY-CLINIC, FI-64W, FI-72, FI-72AR, FI-72W, FI-80, FI-80W, MF-48, MF-64		

**DIN rails**



<b>GEV No.</b>	551017	<b>Ref. No.</b>	12022603 Z103084
<b>description</b>	DIN rail W 35mm L 138mm hole distance 118mm		
<b>For models:</b>	COE-102, ECO-1600, ECO-2300, ECO-3000, FI-1600, FI-2300, FI-3000, FI-48, FI-48B, FI-48W, FI-50, FI-64, FI-64B, FI-64W, FI-72, HEI-10-21, HEM-10-11, HEM-10-21, HEM-20-11, HEM-6-11, HEP-10-11, HEP-10-21, HEP-20-11, HEP-6-11, HGC-10-21, HGP-10-21, HGV-10-21, HME-10-11, HME-10-21, HME-20-11, HME-2-10-11, HME-6-11, HMM-10-11, HMM-10-11UL, HMM-10-21, HMM-10-21UL, HMM-20-11, HMM-20-11UL, HMM-2-10-11, HMM-6-11, HMM-6-11UL, HMP-10-11, HMP-10-21, HMP-20-11, HMP-2-10-11, HMP-6-11, LC-AC-10, LC-AC-10A, LC-AC-14, LC-AC-14A...(Other models you can see in the webshop)		



<b>GEV No.</b>	551016	<b>Ref. No.</b>	12022790 Z123018
<b>description</b>	DIN rail W 35mm L 55mm hole distance 35mm		
<b>For models:</b>	CE6-41, CE7-41, CGE6-41, CGE7-220, CGE7-41, CGE7-41H, CMF6-05, COE-102, COE-202, CPE6-05, ECO-1600, ECO-2300, ECO-3000, FE6-05, FE6-05TE, FE6-10, FE6-10TE, FI-1600, FI-2300, FI-30, FI-3000, FI-30AR+DD, FI-30B-BT-UK, FI-30-UK, FI-48, FI-48B, FI-48B-BT-UK, FI-48D, FI-48HY-CLINIC, FI-48W, FI-50, FI-64W, FTE6-05L, FTE6-05R, FTE6-10L, FTE6-10L+R, FTE6-10R, FTE7-05, FTE7-05L, FTE7-05R, FTE7-10, FTE7-10L, FTE7-10L+R, FTE7-10R, FTE9-05L, FTE9-05L-AD, FTE9-05PLUS-CL, FTE9-05PLUS-CR, FTE9-05PLUS-L, FTE9-05PLUS-R...(Other models you can see in the webshop)		



<b>GEV No.</b>	551018	<b>Ref. No.</b>	12022528 Z103083
<b>description</b>	DIN rail W 35mm L 72mm hole distance 52mm		
<b>For models:</b>	ACE-061, ACE-101, ACE-102, ACE-201, ACE-202, AD-120, AD-120B, AD-120BBTDD-UK, AD-120C, AD-120CW, AD-120HY, AD-90, AD-90BA, AD-90BBT, AD-90BDD, AD-90DD, ADE-120, ADE-120B, AE-061, AE-101, AE-102, AE-201, AE-202, APE-061, APE-101, APE-102, APE-201, APE-202, CE6-20, CE6-40, CE6-41, CE7-20, CE7-20Q, CE7-40, CE7-40Q, CE7-41, CE7-41Q, CE9-20, CE9-40, CGE6-41, CGE7-207, CGE7-41, CGE7-41H, ECO-120, ECO-120B, ECO-1600, ECO-2300, ECO-3000, FF-35, FI-100...(Other models you can see in the webshop)		

**chains**

**connectors**



<b>GEV No.</b>	693276	<b>Ref. No.</b>	12023767 Z105012
<b>description</b>	connector single DIN/ISO 08 B-1 splitting 1/2" links 1 L 23mm internal width 11.8mm rollers 4.3mm metal		
<b>For models:</b>	ECO-160, ECO-1600, ECO-160D, ECO-160L, ECO-200, ECO-200D, ECO-200H, ECO-200HD, ECO-200HI, ECO-200L, ECO-2300, ECO-2700D, ECO-2700L, ECO-280D, ECO-280L, ECO-3000, ECO-370D, ECO-370L, ECO-4000D, ECO-4000L, ECO-460D, ECO-460L, ECO-550D, ECO-550L, ECO-6000D, ECO-6000L, FI-160, FI-1600, FI-160AR, FI-160D, FI-160L, FI-200, FI-200AR, FI-200D, FI-200H, FI-200HD, FI-200HI, FI-200L, FI-200W, FI-200WL, FI-200WR, FI-2300, FI-2700D, FI-2700L, FI-280D, FI-280L, FI-3000, FI-370D, FI-370L, FI-4000D...(Other models you can see in the webshop)		





Зип Общепит

vsezip.ru

+7(812)987-08-81

brewing units

filter holder gaskets

O-rings



1

<b>GEV No.</b>	510409	<b>Ref. No.</b>	12010040 Q307044
<b>description</b>	O-ring EPDM thickness 5.34mm ID ø 56.52mm Qty 1 pcs		
<b>For models:</b>	ECO-160, ECO-1600, ECO-160D, ECO-160I, ECO-200, ECO-200D, ECO-200H, ECO-200HD, ECO-200HI, ECO-200I, ECO-2300, ECO-2700D, ECO-2700I, ECO-280D, ECO-280I, ECO-3000, ECO-370D, ECO-370I, ECO-4000D, ECO-4000I, ECO-460D, ECO-460I, ECO-550D, ECO-550I, ECO-6000D, ECO-6000I, FI-160, FI-1600, FI-160AR, FI-160D, FI-160I, FI-200, FI-200AR, FI-200D, FI-200H, FI-200HD, FI-200HI, FI-200I, FI-200W, FI-200WL, FI-200WR, FI-2300, FI-2700D, FI-2700I, FI-280D, FI-280I, FI-3000, FI-370D, FI-370I, FI-4000D...(Other models you can see in the webshop)		

cleaning system

nozzles



1

<b>GEV No.</b>	505230	<b>Ref. No.</b>	12017281 Z651931
<b>description</b>	rinse jet H 12mm thread M10x1 WS 14 hole ø 1.6mm		
<b>For models:</b>	FI-300B, FI-300R, FI-650R, HCV-10-11, HCV-10-21, HCV-2-10-21, HCV-6-11, HEM-10-11, HEM-20-11, HEM-6-11, HEP-10-11, HEP-20-11, HEP-6-11, HME-10-11, HME-10-21, HME-20-11, HME-20-21, HME-2-10-11, HME-2-20-11, HME-6-11, HMM-10-11, HMM-10-11UL, HMM-10-21, HMM-10-21UL, HMM-20-11, HMM-20-11UL, HMM-20-21, HMM-20-21UL, HMM-2-10-11, HMM-2-20-11, HMM-40-11-USMC, HMM-6-11, HMM-6-11UL, HMP-10-11, HMP-10-21, HMP-20-11, HMP-20-21, HMP-2-10-11, HMP-2-20-11, HMP-6-11		



1

<b>GEV No.</b>	505232	<b>Ref. No.</b>	12021186 Z651932
<b>description</b>	swirl H 10.7mm ø 6mm 1.5mm H1 5mm		
<b>For models:</b>	FI-300B, FI-300R, FI-650R, HCV-10-11, HCV-10-21, HCV-2-10-21, HCV-6-11, HEM-10-11, HEM-20-11, HEM-6-11, HEP-10-11, HEP-20-11, HEP-6-11, HME-10-11, HME-10-21, HME-20-11, HME-20-21, HME-2-10-11, HME-2-20-11, HME-6-11, HMM-10-11, HMM-10-11UL, HMM-10-21, HMM-10-21UL, HMM-20-11, HMM-20-11UL, HMM-20-21, HMM-20-21UL, HMM-2-10-11, HMM-2-20-11, HMM-40-11-USMC, HMM-6-11, HMM-6-11UL, HMP-10-11, HMP-10-21, HMP-20-11, HMP-20-21, HMP-2-10-11, HMP-2-20-11, HMP-6-11		

miscellaneous



1

<b>GEV No.</b>	696553	<b>Ref. No.</b>	12017801 Z883001
<b>description</b>	compression spring ø 7.5mm L 23mm wire gauge ø 0.7mm		
<b>For models:</b>	ECO-280D, ECO-280I, ECO-370D, ECO-370I, ECO-460D, ECO-460I, ECO-550D, ECO-550I, FI-280D, FI-280I, FI-370D, FI-370I, FI-460D, FI-460I, FI-550D, FI-550I, HEI-10-11, HEI-20-11, HEI-6-11, HEM-10-11, HEM-20-11, HEM-6-11, HEP-10-11, HEP-20-11, HEP-6-11, HME-10-11, HME-10-21, HME-20-11, HME-20-21, HME-2-10-11, HME-2-20-11, HME-6-11, HMI-10-11, HMI-10-11UL, HMI-10-21, HMI-10-21UL, HMI-2-10-11, HMI-6-11, HMI-6-11UL, HMM-10-11, HMM-10-11UL, HMM-10-21, HMM-10-21UL, HMM-20-11, HMM-20-11UL, HMM-20-21, HMM-20-21UL, HMM-2-10-11, HMM-2-20-11, HMM-40-11-USMC...(Other models you can see in the webshop)		

<b>GEV No.</b>	696427	<b>Ref. No.</b>	12009970 Q222011
<b>description</b>	rivet nut unthread M5 DIN 4mm L 12mm SS Qty 1 pcs ø 7mm WS 6		
<b>For models:</b>	ACE-061, ACE-101, ACE-102, ACE-201, ACE-202, ACG-061, ACG-101, ACG-102, ACG-201, ACG-202, AD-45BBT, AD-48HY, AD-64BBT, AD-64BTDD, AD-64HY, AE-061, AE-061W, AE-101, AE-101W, AE-102, AE-102W, AE-201, AE-202, AG-061, AG-061W, AG-101, AG-101W, AG-102, AG-102W, AG-201, AG-202, APE-061, APE-061W, APE-101, APE-101W, APE-102, APE-102W, APE-201, APE-202, APG-061, APG-061W, APG-101, APG-101W, APG-102, APG-102W, APG-201, APG-202, CE9-40, CE9-41, CG-2000...(Other models you can see in the webshop)		

for dishwashers

drain and intake components

FAGOR

drain /intake bodies



1

<b>GEV No.</b>	505162	<b>Ref. No.</b>	12025238 Z602101
<b>description</b>	drain connection ED ø 45/27mm ID ø 21/18mm		
<b>For models:</b>	ECO-1200, ECO-1600, ECO-2300, ECO-2700D, ECO-2700I, ECO-280D, ECO-280I, ECO-3000, ECO-370D, ECO-370I, ECO-4000D, ECO-4000I, ECO-460D, ECO-460I, ECO-550D, ECO-550I, ECO-6000D, ECO-6000I, FI-1200, FI-1600, FI-2300, FI-2700D, FI-2700I, FI-280D, FI-280I, FI-3000, FI-300R, FI-370D, FI-370I, FI-4000D, FI-4000I, FI-460D, FI-460I, FI-550D, FI-550I, FI-6000D, FI-6000I, FI-650R, FI-900		



1

<b>GEV No.</b>	515000	<b>Ref. No.</b>	12037642 6003010062
<b>description</b>	drain connection for refrigerated counters thread 1/2" ID ø 146mm L 93.5mm		
<b>For models:</b>	ADM CN-135, ADM CN-180, ADM CN-225, ADM CP-135, ADM CP-180, ADM CP-225, ADM FN-135, ADM FN-180, ADM FN-225, ADM FP-135, ADM FP-135-GR, ADM FP-135HD, ADM FP-135HH, ADM FP-135PC, ADM FP-180, ADM FP-180-GR, ADM FP-180HDD, ADM FP-180HHD, ADM FP-180HHH, ADM FP-180PC, ADM FP-225, ADM FP-225-GR, ADM FP-225HDDD, ADM FP-225HHDD, ADM FP-225HHHD, ADM FP-225HHHH, ADM FP-225PC, ATA-061, ATA-061-60Hz, ATA-101, ATA-101-60Hz, ATM-051ECO, ATM-051VCH, ATM-051VCH-60Hz, ATM-081VCH, ATM-081VCH-60Hz, ATM-101VCH, ATM-101VCH-60Hz, ATM-121VCH, ATM-121VCH-60Hz, ATM-121VCHP, ATM-161VCH, MCP-135-AD, MCP-180-AD, MCP-225-AD, MEP-100, MEP-100G, MFP-135-AD, MFP-135-AD-2C, MFP-135-AD-4C...(Other models you can see in the webshop)		

mechanical components, equipment accessories

Зип Общепит

vsezip.ru

+7(812)987-08-81



1

<b>GEV No.</b>	505259	<b>Ref. No.</b>	12024339 Z102104
<b>description</b>	drain fitting thread 1½" H 42mm		
<b>For models:</b>	ECO-1600, ECO-2300, ECO-2700D, ECO-2700I, ECO-280D, ECO-280I, ECO-3000, ECO-370D, ECO-370I, ECO-4000D, ECO-4000I, ECO-460D, ECO-460I, ECO-550D, ECO-550I, ECO-6000D, ECO-6000I, FI-1600, FI-2300, FI-2700D, FI-2700I, FI-280D, FI-280I, FI-3000, FI-370D, FI-370I, FI-4000D, FI-4000I, FI-460D, FI-460I, FI-550D, FI-550I, FI-6000D, FI-6000I		



1

<b>GEV No.</b>	505193	<b>Ref. No.</b>	12024234 Z710902
<b>description</b>	drain fitting thread 1¾" ID ø 44mm		
<b>For models:</b>	AD-120, AD-120B, AD-120BBTDD-UK, AD-120C, AD-120CW, AD-120HY, AD-90, AD-90BA, AD-90BBT, AD-90BDD, AD-90DD, ADE-120, ADE-120B, ECO-120, ECO-120B, ECO-160, ECO-160D, ECO-160I, ECO-200, ECO-200D, ECO-200H, ECO-200HD, ECO-200HI, ECO-200I, ECO-2700D, ECO-2700I, ECO-280D, ECO-280I, ECO-370D, ECO-370I, ECO-4000D, ECO-4000I, ECO-460D, ECO-460I, ECO-550D, ECO-550I, ECO-6000D, ECO-6000I, FI-100, FI-100AR, FI-100B, FI-100BBT-UK, FI-120, FI-120AR+DD, FI-120B, FI-120C, FI-120HY-CLINIC, FI-120W, FI-160, FI-160AR...(Other models you can see in the webshop)		



1

<b>GEV No.</b>	505104	<b>Ref. No.</b>	12024603 Z220902
<b>description</b>	drain unit ED ø 32/56mm		
<b>For models:</b>	AD-45BBT, AD-48B, AD-48BDD, AD-48C, AD-48HY, AD-48W, AD-64B, AD-64BBT, AD-64BDD, AD-64C, AD-64CW, AD-64HY, FI-30, FI-30AR, FI-30AR+DD, FI-30B, FI-30B-BT-UK, FI-30-UK, FI-48, FI-48AR, FI-48B, FI-48B-BT-UK, FI-48C, FI-48D, FI-48HY-CLINIC, FI-48W, FI-64, FI-64AR, FI-64B, FI-64B-BT-UK, FI-64C, FI-64D, FI-64HY-CLINIC, FI-64W, MF-48, MF-64		



1

<b>GEV No.</b>	505085 <sup>1</sup>	<b>Ref. No.</b>	12024914 Z430901
<b>description</b>	drain unit hose ø 32/38mm		
<b>For models:</b>	AD-20C-UK, AD-21B, AD-21BDD, AD-21C, AD-21W, LVC-21B, LVC-21C, LVC-21W, LVR-20B, MF-21		

<sup>1</sup>for drain pump

1

<b>GEV No.</b>	515018	<b>Ref. No.</b>	12009947 Q307032
<b>description</b>	flat gasket rubber ED ø 32mm ID ø 21mm thickness 3mm Qty 1 pcs		
<b>For models:</b>	AD-120, AD-120B, AD-120BBTDD-UK, AD-120C, AD-120CW, AD-120HY, AD-90, AD-90BA, AD-90BBT, AD-90BDD, AD-90DD, ADE-120, ADE-120B, BME7-05, BME7-10, BME9-05, BME9-05AD, BME9-05PLUS, BME9-05V-T, BME9-10, BME9-10AD, BME9-10PLUS, BME9-10V-T, BMG7-10, BMG9-05, BMG9-05V-T, BMG9-10, BMG9-10V-T, CO-142W, CO-142WDD, COP-174W, COP-174WHRS, ECO-120, ECO-1200, ECO-120B, ECO-160, ECO-1600, ECO-160D, ECO-160I, ECO-200, ECO-200D, ECO-200H, ECO-200HD, ECO-200HI, ECO-200I, ECO-2300, ECO-2700D, ECO-2700I, ECO-280D, ECO-280I...(Other models you can see in the webshop)		



1

<b>GEV No.</b>	505161	<b>Ref. No.</b>	12010028 Q307027
<b>description</b>	flat gasket rubber ED ø 45mm ID ø 35mm thickness 2mm Qty 1 pcs		
<b>For models:</b>	BMG-9045, ECO-1200, ECO-1600, ECO-2300, ECO-2700D, ECO-2700I, ECO-280D, ECO-280I, ECO-3000, ECO-370D, ECO-370I, ECO-4000D, ECO-4000I, ECO-460D, ECO-460I, ECO-550D, ECO-550I, ECO-6000D, ECO-6000I, FI-1200, FI-1600, FI-2300, FI-2700D, FI-2700I, FI-280D, FI-280I, FI-3000, FI-300B, FI-300R, FI-370D, FI-370I, FI-4000D, FI-4000I, FI-460D, FI-460I, FI-550D, FI-550I, FI-6000D, FI-6000I, FI-650R, FI-900		



1

<b>GEV No.</b>	505224	<b>Ref. No.</b>	12009960 Q307058
<b>description</b>	flat gasket rubber ED ø 60mm ID ø 44mm thickness 2mm Qty 1 pcs		
<b>For models:</b>	AD-120, AD-120B, AD-120BBTDD-UK, AD-120C, AD-120CW, AD-120HY, AD-90, AD-90BA, AD-90BBT, AD-90BDD, AD-90DD, ADE-120, ADE-120B, ECO-120, ECO-120B, ECO-160, ECO-160D, ECO-160I, ECO-200, ECO-200D, ECO-200H, ECO-200HD, ECO-200HI, ECO-200I, ECO-370D, ECO-370I, ECO-550D, ECO-550I, FI-100, FI-100AR, FI-100B, FI-100BBT-UK, FI-120, FI-120AR+DD, FI-120B, FI-120C, FI-120HY-CLINIC, FI-120W, FI-160, FI-160AR, FI-160D, FI-160I, FI-200, FI-200AR, FI-200D, FI-200H, FI-200HD, FI-200HI, FI-200I, FI-200W...(Other models you can see in the webshop)		



1

<b>GEV No.</b>	505223	<b>Ref. No.</b>	12009939 Q307009
<b>description</b>	flat gasket rubber ED ø 70mm ID ø 48mm thickness 1.5mm Qty 1 pcs		
<b>For models:</b>	BMG-9045, ECO-1200, ECO-1600, ECO-2300, ECO-2700D, ECO-2700I, ECO-280D, ECO-280I, ECO-3000, ECO-370D, ECO-370I, ECO-4000D, ECO-4000I, ECO-460D, ECO-460I, ECO-550D, ECO-550I, ECO-6000D, ECO-6000I, FI-1200, FI-1600, FI-2300, FI-2700D, FI-2700I, FI-280D, FI-280I, FI-3000, FI-300B, FI-300R, FI-370D, FI-370I, FI-4000D, FI-4000I, FI-460D, FI-460I, FI-550D, FI-550I, FI-6000D, FI-6000I, FI-650R, FI-900		





Зип Общепит

vsezip.ru

812)987-08-81

			
1			
<b>GEV No.</b>	505194	<b>Ref. No.</b>	12009937 Q307059
<b>description</b>	flat gasket rubber ED $\varnothing$ 72mm ID $\varnothing$ 57mm thickness 2mm Qty 1 pcs		
<b>For models:</b>	AD-120, AD-120B, AD-120BBTDD-UK, AD-120C, AD-120CW, AD-120HY, AD-90, AD-90BA, AD-90BBT, AD-90BDD, AD-90DD, ADE-120, ADE-120B, ECO-120, ECO-120B, ECO-160, ECO-160D, ECO-160I, ECO-200, ECO-200D, ECO-200H, ECO-200HD, ECO-200HI, ECO-200I, ECO-2700D, ECO-2700I, ECO-280D, ECO-280I, ECO-370D, ECO-370I, ECO-4000D, ECO-4000I, ECO-460D, ECO-460I, ECO-550D, ECO-550I, ECO-6000D, ECO-6000I, FI-100, FI-100AR, FI-100B, FI-100BBT-UK, FI-120, FI-120AR+DD, FI-120B, FI-120C, FI-120HY-CLINIC, FI-120W, FI-160, FI-160AR...(Other models you can see in the webshop)		

			
1			
<b>GEV No.</b>	518609	<b>Ref. No.</b>	12023618 Z310901
<b>description</b>	inlet valve thread 2 1/4" ED $\varnothing$ 90mm H 131mm		
<b>For models:</b>	ECO-2700D, ECO-2700I, ECO-280D, ECO-280I, ECO-370D, ECO-370I, ECO-4000D, ECO-4000I, ECO-460D, ECO-460I, ECO-550D, ECO-550I, ECO-6000D, ECO-6000I, FI-2700D, FI-2700I, FI-280D, FI-280I, FI-370D, FI-370I, FI-4000D, FI-4000I, FI-460D, FI-460I, FI-550D, FI-550I, FI-6000D, FI-6000I		

			
1			
<b>GEV No.</b>	510832	<b>Ref. No.</b>	12023571 Z310902
<b>description</b>	flat gasket rubber ED $\varnothing$ 92mm ID $\varnothing$ 66mm thickness 2mm Qty 1 pcs equiv. no. 200906/33456		
<b>For models:</b>	ECO-2700D, ECO-2700I, ECO-280D, ECO-280I, ECO-370D, ECO-370I, ECO-4000D, ECO-4000I, ECO-460D, ECO-460I, ECO-550D, ECO-550I, ECO-6000D, ECO-6000I, FI-2700D, FI-2700I, FI-280D, FI-280I, FI-370D, FI-370I, FI-4000D, FI-4000I, FI-460D, FI-460I, FI-550D, FI-550I, FI-6000D, FI-6000I		

			
1			
<b>GEV No.</b>	519617	<b>Ref. No.</b>	12023627 Z330787000
<b>description</b>	intake body ED $\varnothing$ 48mm H 49mm ID $\varnothing$ 30mm		
<b>For models:</b>	ECO-160D, ECO-160I, ECO-200D, ECO-200HD, ECO-200HI, ECO-200I, ECO-280D, ECO-280I, ECO-370D, ECO-370I, ECO-460D, ECO-460I, ECO-550D, ECO-550I, FI-160AR, FI-160D, FI-160I, FI-200AR, FI-200D, FI-200HD, FI-200HI, FI-200I, FI-200WL, FI-200WR, FI-280D, FI-280I, FI-370D, FI-370I, FI-460D, FI-460I, FI-550D, FI-550I		

			
1			
<b>GEV No.</b>	505222	<b>Ref. No.</b>	12009817 Q307026
<b>description</b>	gasket conical ED $\varnothing$ 72mm ID $\varnothing$ 45mm		
<b>For models:</b>	BMG-9045, ECO-1200, ECO-1600, ECO-2300, ECO-2700D, ECO-2700I, ECO-280D, ECO-280I, ECO-3000, ECO-370D, ECO-370I, ECO-4000D, ECO-4000I, ECO-460D, ECO-460I, ECO-550D, ECO-550I, ECO-6000D, ECO-6000I, FI-1200, FI-1600, FI-2300, FI-2700D, FI-2700I, FI-280D, FI-280I, FI-3000, FI-300B, FI-300R, FI-370D, FI-370I, FI-4000D, FI-4000I, FI-460D, FI-460I, FI-550D, FI-550I, FI-6000D, FI-6000I, FI-650R, FI-900		

			
1			
<b>GEV No.</b>	524780	<b>Ref. No.</b>	12025261 Z710903
<b>description</b>	intake body thread 1 1/2" ED $\varnothing$ 60mm H 42mm hose $\varnothing$ 38mm		
<b>For models:</b>	AD-120, AD-120B, AD-120BBTDD-UK, AD-120C, AD-120CW, AD-120HY, AD-90, AD-90BA, AD-90BBT, AD-90BDD, AD-90DD, ADE-120, ADE-120B, ECO-120, ECO-120B, ECO-160, ECO-160D, ECO-160I, ECO-200, ECO-200D, ECO-200H, ECO-200HD, ECO-200HI, ECO-200I, ECO-370D, ECO-370I, ECO-550D, ECO-550I, FI-100, FI-100AR, FI-100B, FI-100BBT-UK, FI-120, FI-120AR+DD, FI-120B, FI-120C, FI-120HY-CLINIC, FI-120W, FI-160, FI-160AR, FI-160D, FI-160I, FI-200, FI-200AR, FI-200D, FI-200H, FI-200HD, FI-200HI, FI-200I, FI-200W...(Other models you can see in the webshop)		

			
1			
<b>GEV No.</b>	505249	<b>Ref. No.</b>	12009936 Q307011
<b>description</b>	gasket ED $\varnothing$ 56mm ID $\varnothing$ 39mm thickness 1mm Qty 1 pcs		
<b>For models:</b>	ECO-1600, ECO-2300, ECO-280D, ECO-280I, ECO-3000, ECO-370D, ECO-370I, ECO-460D, ECO-460I, ECO-550D, ECO-550I, FI-1600, FI-2300, FI-280D, FI-280I, FI-3000, FI-370D, FI-370I, FI-460D, FI-460I, FI-550D, FI-550I		

			
1			
<b>GEV No.</b>	505160	<b>Ref. No.</b>	12025225 Z600905
<b>description</b>	intake body thread 1 1/2" ED $\varnothing$ 71mm ID $\varnothing$ 36mm		
<b>For models:</b>	ECO-1200, ECO-2700D, ECO-2700I, ECO-280D, ECO-280I, ECO-370D, ECO-370I, ECO-4000D, ECO-4000I, ECO-460D, ECO-460I, ECO-550D, ECO-550I, ECO-6000D, ECO-6000I, FI-1200, FI-2700D, FI-2700I, FI-280D, FI-280I, FI-370D, FI-370I, FI-4000D, FI-4000I, FI-460D, FI-460I, FI-550D, FI-550I, FI-6000D, FI-6000I, FI-900		

mechanical components, equipment accessories

Зип Общепит

vsezip.ru

87(812)987-08-81



1

<b>GEV No.</b>	505156	<b>Ref. No.</b>	12024215 Z702101
<b>description</b>	nut thread 1½"		
<b>For models:</b>	BMG-9045, ECO-1200, ECO-1600, ECO-2300, ECO-2700D, ECO-2700I, ECO-280D, ECO-280I, ECO-3000, ECO-370D, ECO-370I, ECO-4000D, ECO-4000I, ECO-460D, ECO-460I, ECO-550D, ECO-550I, ECO-6000D, ECO-6000I, FI-1200, FI-1600, FI-2300, FI-2700D, FI-2700I, FI-280D, FI-280I, FI-3000, FI-300B, FI-300R, FI-370D, FI-370I, FI-4000D, FI-4000I, FI-460D, FI-460I, FI-550D, FI-550I, FI-6000D, FI-6000I, FI-650R, FI-900		



1

<b>GEV No.</b>	505163	<b>Ref. No.</b>	12025276 Z602102
<b>description</b>	nut thread 1½"		
<b>For models:</b>	ECO-1200, ECO-1600, ECO-2300, ECO-2700D, ECO-2700I, ECO-280D, ECO-280I, ECO-3000, ECO-370D, ECO-370I, ECO-4000D, ECO-4000I, ECO-460D, ECO-460I, ECO-550D, ECO-550I, ECO-6000D, ECO-6000I, FI-1200, FI-1600, FI-2300, FI-2700D, FI-2700I, FI-280D, FI-280I, FI-3000, FI-300B, FI-300R, FI-370D, FI-370I, FI-4000D, FI-4000I, FI-460D, FI-460I, FI-550D, FI-550I, FI-6000D, FI-6000I, FI-650R, FI-900		



1

<b>GEV No.</b>	518080	<b>Ref. No.</b>	12023537 Z710708
<b>description</b>	nut thread 1½" WS 50 duct thickness 15mm		
<b>For models:</b>	AD-120, AD-120B, AD-120BBTDD-UK, AD-120C, AD-120CW, AD-120HY, AD-90, AD-90BA, AD-90BBT, AD-90BDD, AD-90DD, ADE-120, ADE-120B, ECO-120, ECO-120B, ECO-160, ECO-160D, ECO-160I, ECO-200, ECO-200D, ECO-200H, ECO-200HD, ECO-200HI, ECO-200I, ECO-370D, ECO-370I, ECO-550D, ECO-550I, FI-100, FI-100AR, FI-100B, FI-100BBT-UK, FI-120, FI-120AR+DD, FI-120B, FI-120C, FI-120HY-CLINIC, FI-120W, FI-160, FI-160AR, FI-160D, FI-160I, FI-200, FI-200AR, FI-200D, FI-200H, FI-200HD, FI-200HI, FI-200I, FI-200W...(Other models you can see in the webshop)		

**spare parts for** 518080



<b>GEV No.</b>	507425	<b>Ref. No.</b>	12018740 Z710707
duct D1 ø 38mm D2 ø 45mm L 72mm int. ø 1 31mm int. ø 2 39mm			



1

<b>GEV No.</b>	505155	<b>Ref. No.</b>	12009844 Q220001
<b>description</b>	nut thread 1¾"		
<b>For models:</b>	AD-120, AD-120B, AD-120BBTDD-UK, AD-120C, AD-120CW, AD-120HY, AD-90, AD-90BA, AD-90BBT, AD-90BDD, AD-90DD, ADE-120, ADE-120B, ECO-120, ECO-120B, ECO-160, ECO-160D, ECO-160I, ECO-200, ECO-200D, ECO-200H, ECO-200HD, ECO-200HI, ECO-200I, ECO-2700D, ECO-2700I, ECO-280D, ECO-280I, ECO-370D, ECO-370I, ECO-4000D, ECO-4000I, ECO-460D, ECO-460I, ECO-550D, ECO-550I, ECO-6000D, ECO-6000I, FI-100, FI-100AR, FI-100B, FI-100BBT-UK, FI-120, FI-120AR+DD, FI-120B, FI-120C, FI-120HY-CLINIC, FI-120W, FI-160, FI-160AR...(Other models you can see in the webshop)		



1

<b>GEV No.</b>	517432	<b>Ref. No.</b>	12025231 Z310903
<b>description</b>	nut thread 2¼"		
<b>For models:</b>	ECO-2700D, ECO-2700I, ECO-280D, ECO-280I, ECO-370D, ECO-370I, ECO-4000D, ECO-4000I, ECO-460D, ECO-460I, ECO-550D, ECO-550I, ECO-6000D, ECO-6000I, FI-2700D, FI-2700I, FI-280D, FI-280I, FI-370D, FI-370I, FI-4000D, FI-4000I, FI-460D, FI-460I, FI-550D, FI-550I, FI-6000D, FI-6000I		



1

<b>GEV No.</b>	505244	<b>Ref. No.</b>	12009949 Q228006
<b>description</b>	nut thread M39x3		
<b>For models:</b>	ECO-1600, ECO-2300, ECO-280D, ECO-280I, ECO-3000, ECO-370D, ECO-370I, ECO-460D, ECO-460I, ECO-550D, ECO-550I, FI-1600, FI-2300, FI-280D, FI-280I, FI-3000, FI-370D, FI-370I, FI-460D, FI-460I, FI-550D, FI-550I		



1

<b>GEV No.</b>	505159	<b>Ref. No.</b>	12009815 Q228005
<b>description</b>	nut thread M48x1.5		
<b>For models:</b>	ECO-1200, ECO-2700D, ECO-2700I, ECO-280D, ECO-280I, ECO-370D, ECO-370I, ECO-4000D, ECO-4000I, ECO-460D, ECO-460I, ECO-550D, ECO-550I, ECO-6000D, ECO-6000I, FI-1200, FI-2700D, FI-2700I, FI-280D, FI-280I, FI-370D, FI-370I, FI-4000D, FI-4000I, FI-460D, FI-460I, FI-550D, FI-550I, FI-6000D, FI-6000I, FI-900		



Зип Общепит  
vsezip.ru  
(812)987-08-81

filters



1

<b>GEV No.</b>	505141	<b>Ref. No.</b>	12003451 Z270803
<b>description</b>	flat filter H 15mm L 315mm W 223mm		
<b>For models:</b>	ECO-160, ECO-160D, ECO-160I, ECO-200, ECO-200D, ECO-200H, ECO-200HD, ECO-200HI, ECO-200I, FI-160, FI-160AR, FI-160D, FI-160I, FI-200, FI-200AR, FI-200D, FI-200H, FI-200HD, FI-200HI, FI-200I, FI-200W, FI-200WL, FI-200WR		



1

<b>GEV No.</b>	505137	<b>Ref. No.</b>	12003450 12038499 Z270801
<b>description</b>	flat filter H 15mm L 315mm W 225mm		
<b>For models:</b>	ECO-160, ECO-160D, ECO-160I, ECO-200, ECO-200D, ECO-200H, ECO-200HD, ECO-200HI, ECO-200I, FI-160, FI-160AR, FI-160D, FI-160I, FI-200, FI-200AR, FI-200D, FI-200H, FI-200HD, FI-200HI, FI-200I, FI-200W, FI-200WL, FI-200WR		



1

<b>GEV No.</b>	505187	<b>Ref. No.</b>	12003519 12038373 12Z7108010
<b>description</b>	flat filter H 16mm L 630mm W 220mm		
<b>For models:</b>	AD-120, AD-120B, AD-120BBTDD-UK, AD-120C, AD-120CW, AD-120HY, AD-90, AD-90BA, AD-90BBT, AD-90BDD, AD-90DD, ADE-120, ADE-120B, ECO-120, ECO-120B, FI-100, FI-100AR, FI-100B, FI-100BBT-UK, FI-120, FI-120AR+DD, FI-120B, FI-120C, FI-120HY-CLINIC, FI-120W, FI-80, FI-80AR, FI-80BBT-UK, FI-80W, FI-E-100, LABP-1000, LABP-1200, LABP-800, MF-120		



1

<b>GEV No.</b>	505142	<b>Ref. No.</b>	12004370 12011137 12022559 12Z2108010
<b>description</b>	flat filter H 8mm L 263mm W 200mm		
<b>For models:</b>	AD-45BBT, AD-48, AD-48B, AD-48BDD, AD-48C, AD-48D, AD-48DD, AD-48HY, AD-48W, AD-64, AD-64B, AD-64BBT, AD-64BDD, AD-64BTDD, AD-64C, AD-64CW, AD-64D, AD-64DD, AD-64HY, AD-72, AD-72W, EASY-500HP, EASY-500HPWBDD, FI-48, FI-48AR, FI-48B, FI-48B-BT-UK, FI-48C, FI-48D, FI-48HY-CLINIC, FI-48W, FI-50, FI-64, FI-64AR, FI-64B, FI-64B-BT-UK, FI-64C, FI-64D, FI-64HY-CLINIC, FI-64W, FI-72, FI-72AR, FI-72W, MF-48, MF-64		



1

<b>GEV No.</b>	505078	<b>Ref. No.</b>	12024556 Z200907
<b>description</b>	gasket external height 23.5mm for sump ED ø 225mm ID ø 200mm		
<b>For models:</b>	AD-45BBT, AD-48, AD-48B, AD-48BDD, AD-48C, AD-48D, AD-48DD, AD-48HY, AD-48W, AD-64, AD-64B, AD-64BBT, AD-64BDD, AD-64BTDD, AD-64C, AD-64CW, AD-64D, AD-64DD, AD-64HY, AD-72, AD-72W, EASY-500, EASY-500B, EASY-500DD, EASY-500HP, FI-30, FI-30AR, FI-30AR+DD, FI-30B, FI-30B-BT-UK, FI-30-UK, FI-48, FI-48AR, FI-48B, FI-48B-BT-UK, FI-48C, FI-48D, FI-48HY-CLINIC, FI-48W, FI-50, FI-60DD, FI-64, FI-64AR, FI-64B, FI-64B-BT-UK, FI-64C, FI-64D, FI-64HY-CLINIC, FI-64W, FI-72...(Other models you can see in the webshop)		



1

<b>GEV No.</b>	505077	<b>Ref. No.</b>	12024113 Z400902
<b>description</b>	gasket external height 23mm for sump		
<b>For models:</b>	AD-15, AD-15D, AD-20C-UK, AD-21, AD-21B, AD-21BDD, AD-21C, AD-21D, AD-21DD, AD-21W, CO-350, CO-350-B, CO-350-B-DD, CO-350-COLD, CO-350-COLD-B, CO-350-COLD-B-DD, CO-350-COLD-DD, CO-350-DD, CO-352-COLD, CO-352-COLD-B, CO-352-COLD-B-DD, CO-352-COLD-DD, CO-400, CO-400-B, CO-400-B-DD, CO-400-COLD, CO-400-COLD-B, CO-400-COLD-B-DD, CO-400-COLD-DD, CO-400-DO, CO-400-DO-B, CO-400-DO-B-DD, CO-400-DO-DD, CO-400-SOFT, CO-402-COLD, CO-402-COLD-B, CO-402-COLD-B-DD, CO-402-COLD-DD, CO-402W, LVC-12, LVC-15, LVC-15D, LVC-21, LVC-21B, LVC-21C, LVC-21D, LVC-21W, LVR-10, LVR-14, LVR-14D, LVR-20, LVR-20B, LVR-20D...(Other models you can see in the webshop)		



1

<b>GEV No.</b>	505274	<b>Ref. No.</b>	12025229 Z310906
<b>description</b>	intake filter ø 88mm H 82mm		
<b>For models:</b>	ECO-2700D, ECO-2700I, ECO-280D, ECO-280I, ECO-370D, ECO-370I, ECO-4000D, ECO-4000I, ECO-460D, ECO-460I, ECO-550D, ECO-550I, ECO-6000D, ECO-6000I, FI-2700D, FI-2700I, FI-280D, FI-280I, FI-370D, FI-370I, FI-4000D, FI-4000I, FI-460D, FI-460I, FI-550D, FI-550I, FI-6000D, FI-6000I		



1

<b>GEV No.</b>	505186	<b>Ref. No.</b>	12003428 12038374 Z710804
<b>description</b>	rectangular filter H 73mm L 150mm W 100mm		
<b>For models:</b>	AD-120, AD-120B, AD-120BBTDD-UK, AD-120C, AD-120CW, AD-120HY, AD-90, AD-90BA, AD-90BBT, AD-90BDD, AD-90DD, ADE-120, ADE-120B, ECO-120, ECO-120B, FI-100, FI-100AR, FI-100B, FI-100BBT-UK, FI-120, FI-120AR+DD, FI-120B, FI-120C, FI-120HY-CLINIC, FI-120W, FI-80, FI-80AR, FI-80BBT-UK, FI-80W, FI-E-100, LABP-1000, LABP-1200, LABP-800, MF-120		



mechanical components, equipment accessories

Зип Общепит

vsezip.ru

+7(812)987-08-81

			
1			
<b>GEV No.</b>	505234	<b>Ref. No.</b>	12016636 12025219 Z400920
<b>description</b>	round filters ø 143mm H 125mm		
<b>For models:</b>	AD-15, AD-15D, AD-20C-UK, AD-21, AD-21B, AD-21BDD, AD-21C, AD-21D, AD-21DD, AD-21W, LVC-12, LVC-15, LVC-15D, LVC-21, LVC-21B, LVC-21C, LVC-21D, LVC-21W		

			
1			
<b>GEV No.</b>	505098	<b>Ref. No.</b>	12024410 Z200922
<b>description</b>	round filters ø 204mm H 140mm		
<b>For models:</b>	AD-45BBT, AD-48, AD-48B, AD-48BDD, AD-48C, AD-48D, AD-48DD, AD-48HY, AD-48W, AD-64, AD-64B, AD-64BBT, AD-64BDD, AD-64BTDD, AD-64C, AD-64CW, AD-64D, AD-64DD, AD-64HY, AD-72, AD-72W, EASY-500, EASY-500B, EASY-500DD, EASY-500HP, FI-30, FI-30AR, FI-30AR+DD, FI-30B, FI-30B-BT-UK, FI-30-UK, FI-48, FI-48AR, FI-48B, FI-48B-BT-UK, FI-48C, FI-48D, FI-48HY-CLINIC, FI-48W, FI-60DD, FI-64, FI-64AR, FI-64B, FI-64B-BT-UK, FI-64C, FI-64D, FI-64HY-CLINIC, FI-64W, FI-72, FI-72AR...(Other models you can see in the webshop)		
<b>accessories for</b>	505098		
	<b>GEV No.</b>	505071	<b>Ref. No.</b>
			12024323 12153291 Z200909
overflow pipe L 180mm ø 40mm			

			
1			
<b>GEV No.</b>	505164	<b>Ref. No.</b>	12024284 Z600906
<b>description</b>	round filters ø 80mm H 63mm		
<b>For models:</b>	ECO-1200, ECO-2700D, ECO-2700I, ECO-280D, ECO-280I, ECO-370D, ECO-370I, ECO-4000D, ECO-4000I, ECO-460D, ECO-460I, ECO-550D, ECO-550I, ECO-6000D, ECO-6000I, FI-1200, FI-2700D, FI-2700I, FI-280D, FI-280I, FI-370D, FI-370I, FI-4000D, FI-4000I, FI-460D, FI-460I, FI-550D, FI-550I, FI-6000D, FI-6000I, FI-900		

			
1			
<b>GEV No.</b>	505012	<b>Ref. No.</b>	12023617 Z400901
<b>description</b>	sump for filter ø 158mm H 67mm		
<b>For models:</b>	AD-15, AD-15D, AD-20C-UK, AD-21, AD-21B, AD-21BDD, AD-21C, AD-21D, AD-21DD, AD-21W, LVC-12, LVC-15, LVC-15D, LVC-21, LVC-21B, LVC-21C, LVC-21D, LVC-21W, LVR-10, LVR-14, LVR-14D, LVR-20, LVR-20B, LVR-20D, MF-21		

			
1			
<b>GEV No.</b>	505013	<b>Ref. No.</b>	12024367 Z200906
<b>description</b>	sump for filter ø 220mm H 67mm		
<b>For models:</b>	AD-45BBT, AD-48, AD-48B, AD-48BDD, AD-48C, AD-48D, AD-48DD, AD-48HY, AD-48W, AD-64, AD-64B, AD-64BBT, AD-64BDD, AD-64BTDD, AD-64C, AD-64CW, AD-64D, AD-64DD, AD-64HY, AD-72, AD-72W, EASY-500, EASY-500B, EASY-500DD, EASY-500HP, EASY-500HPWBDD, FI-30, FI-30AR, FI-30AR+DD, FI-30B, FI-30B-BT-UK, FI-30-UK, FI-48, FI-48AR, FI-48B, FI-48B-BT-UK, FI-48C, FI-48D, FI-48HY-CLINIC, FI-48W, FI-50, FI-60DD, FI-64, FI-64AR, FI-64B, FI-64B-BT-UK, FI-64C, FI-64D, FI-64HY-CLINIC, FI-64W...(Other models you can see in the webshop)		

## overflow pipes

			
1			
<b>GEV No.</b>	505073	<b>Ref. No.</b>	12010282 Q307041
<b>description</b>	O-ring EPDM thickness 2.62mm ID ø 20.63mm Qty 1 pcs		
<b>For models:</b>	AD-15, AD-15D, AD-20C-UK, AD-21, AD-21B, AD-21BDD, AD-21C, AD-21D, AD-21W, CG-1002, CG-1502, CG-2000, CG-2000-2P, CG-2002, CG-2002P, CG9-11, CG9-11AD, CG9-11PLUS, CG9-31PLUS-D, CG9-31PLUS-I, CG9-41, CG9-41AD, CG9-41AD-H, CG9-41H, CG9-41PLUS, CG9-41PLUS-H, CG9-51L, CG9-51LC, CG9-51R, CG9-51RC, CG9-61, CG9-61AD, CG9-61AD-H, CG9-61H, CG9-61OP, CG9-61PLUS, CG9-61PLUS-H, CG9-82, CG9-82AD, CG9-82PLUS, CGF9-121D, CGF9-121D-AD, CGF9-121I, CGF9-121PLUS-D, CGF9-121PLUS-I, FF-35, FI-5420, FI-7630, FTG9-11L, FTG9-11L+R...(Other models you can see in the webshop)		

			
1			
<b>GEV No.</b>	532494	<b>Ref. No.</b>	12010165 Q307051 Q307061
<b>description</b>	O-ring EPDM thickness 2.62mm ID ø 36.14mm Qty 1 pcs		
<b>For models:</b>	AD-120, AD-120B, AD-120BBTDD-UK, AD-120C, AD-120CW, AD-120HY, AD-45BBT, AD-48, AD-48B, AD-48BDD, AD-48C, AD-48D, AD-48DD, AD-48HY, AD-48W, AD-64, AD-64B, AD-64BBT, AD-64BDD, AD-64BTDD, AD-64C, AD-64CW, AD-64D, AD-64DD, AD-64HY, AD-72, AD-72W, AD-90, AD-90BA, AD-90BBT, AD-90BDD, AD-90DD, ADE-120, ADE-120B, EASY-500, EASY-500B, EASY-500DD, EASY-500HP, ECO-120, ECO-120B, ECO-160, ECO-160D, ECO-160I, ECO-200, ECO-200D, ECO-200H, ECO-200HD, ECO-200HI, ECO-200I, ECO-2700D...(Other models you can see in the webshop)		



			
1			
<b>GEV No.</b>	505158	<b>Ref. No.</b>	12040035 Z602104
<b>description</b>	overflow pipe		



Зип Общепит  
vsezip.ru  
(812)987-08-81

			
1			
<b>GEV No.</b>	518608	<b>Ref. No.</b>	12023593 Z652101
<b>description</b>	overflow pipe L 150mm ø 42mm		
<b>For models:</b>	ECO-280D, ECO-280I, ECO-370D, ECO-370I, ECO-460D, ECO-460I, ECO-550D, ECO-550I, FI-280D, FI-280I, FI-300R, FI-370D, FI-370I, FI-460D, FI-460I, FI-550D, FI-550I, FI-650R		



			
1			
<b>GEV No.</b>	691024	<b>Ref. No.</b>	12019791 R205018
<b>description</b>	overflow pipe L 165mm ø 20mm		
<b>For models:</b>	BME7-05, BME7-10, BME9-05, BME9-10, BMG7-10, BMG9-05, BMG9-10		

			
1			
<b>GEV No.</b>	505070	<b>Ref. No.</b>	12025249 Z400907
<b>description</b>	overflow pipe L 165mm ø 25mm		
<b>For models:</b>	AD-15, AD-15D, AD-20C-UK, AD-21, AD-21B, AD-21BDD, AD-21C, AD-21D, AD-21DD, AD-21W, LVC-12, LVC-15, LVC-15D, LVC-21, LVC-21B, LVC-21C, LVC-21D, LVC-21W, LVR-10, LVR-14, LVR-14D, LVR-20, LVR-20B, LVR-20D, MF-21		
<b>accessories for</b>	505070		
	<b>GEV No.</b>	505073	<b>Ref. No.</b>
			12010282 Q307041
O-ring EPDM thickness 2.62mm ID ø 20.63mm Qty 1 pcs			

			
1			
<b>GEV No.</b>	501337	<b>Ref. No.</b>	12008044 H216111
<b>description</b>	overflow pipe L 172mm ø 16mm		
<b>For models:</b>	BME7-05, BME7-10, BMG7-10		

			
1			
<b>GEV No.</b>	505071	<b>Ref. No.</b>	12024323 12153291 Z200909
<b>description</b>	overflow pipe L 180mm ø 40mm		
<b>For models:</b>	AD-45BBT, AD-48, AD-48B, AD-48BDD, AD-48C, AD-48D, AD-48DD, AD-48HY, AD-48W, AD-64, AD-64B, AD-64BBT, AD-64BDD, AD-64C, AD-64CW, AD-64D, AD-64DD, AD-64HY, AD-72, AD-72W, EASY-500, EASY-500DD, EASY-500HP, FI-30, FI-30AR, FI-30AR+DD, FI-30B, FI-30B-BT-UK, FI-30-UK, FI-48, FI-48AR, FI-48B, FI-48B-BT-UK, FI-48C, FI-48D, FI-48HY-CLINIC, FI-48W, FI-50, FI-60DD, FI-64, FI-64AR, FI-64B, FI-64B-BT-UK, FI-64C, FI-64D, FI-64HY-CLINIC, FI-64W, FI-72, FI-72AR, FI-72W... (Other models you can see in the webshop)		
<b>accessories for</b>	505071		
	<b>GEV No.</b>	505098	<b>Ref. No.</b>
			12024410 Z200922
round filters ø 204mm H 140mm			
	<b>GEV No.</b>	517004	<b>Ref. No.</b>
			—
O-ring EPDM thickness 2.62mm ID ø 34.6mm Qty 1 pcs			

			
1			
<b>GEV No.</b>	512022	<b>Ref. No.</b>	12016680 Z682101
<b>description</b>	overflow pipe L 195mm ø 42mm plastic dishwasher		
<b>For models:</b>	ECO-1200, FI-1200, FI-900		

			
1			
<b>GEV No.</b>	505072	<b>Ref. No.</b>	12023658 Z710901
<b>description</b>	overflow pipe L 395mm ø 42mm		
<b>For models:</b>	AD-120, AD-120B, AD-120BBTDD-UK, AD-120C, AD-120CW, AD-120HY, AD-90, AD-90BA, AD-90BBT, AD-90BDD, AD-90DD, ADE-120, ADE-120B, ECO-120, ECO-120B, FI-100, FI-100AR, FI-100B, FI-100BBT-UK, FI-120, FI-120AR+DD, FI-120B, FI-120C, FI-120HY-CLINIC, FI-120W, FI-80, FI-80AR, FI-80BBT-UK, FI-80W, FI-E-100, LABP-1000, LABP-1200, LABP-800, MF-120		
<b>accessories for</b>	505072		
	<b>GEV No.</b>	532494	<b>Ref. No.</b>
			12010165 Q307051 Q307061
O-ring EPDM thickness 2.62mm ID ø 36.14mm Qty 1 pcs			

mechanical components, equipment accessories

Зип.Общепит

dosing containers

vsezip.ru

7(812)987-08-81

			
1			
<b>GEV No.</b>	518607	<b>Ref. No.</b>	12024449 Z270901
<b>description</b>	overflow pipe L 480mm $\varnothing$ 44mm		
<b>For models:</b>	ECO-160, ECO-160D, ECO-160I, ECO-200, ECO-200D, ECO-200H, ECO-200HD, ECO-200HI, ECO-200I, FI-160, FI-160AR, FI-160D, FI-160I, FI-200, FI-200AR, FI-200D, FI-200H, FI-200HD, FI-200HI, FI-200I, FI-200W, FI-200WL, FI-200WR		

## drive shafts

			
1			
<b>GEV No.</b>	692327	<b>Ref. No.</b>	12024595 Z275011
<b>description</b>	spindle D1 $\varnothing$ 16.5mm warewashing $\varnothing$ 20mm L 165mm D2 $\varnothing$ 20mm FAGOR		
<b>For models:</b>	ECO-160, ECO-160D, ECO-160I, ECO-200, ECO-200D, ECO-200H, ECO-200HD, ECO-200HI, ECO-200I, FI-160, FI-160AR, FI-160D, FI-160I, FI-200, FI-200AR, FI-200D, FI-200H, FI-200HD, FI-200HI, FI-200I, FI-200W, FI-200WL, FI-200WR		

## containers

## container lids

			
1			
<b>GEV No.</b>	510001	<b>Ref. No.</b>	12018055 Z211108
<b>description</b>	lid $\varnothing$ 66mm suitable for rinse aid container		

			
1			
<b>GEV No.</b>	505263	<b>Ref. No.</b>	12021190
<b>description</b>	dosing container L 90mm W 80mm H 105mm		

## salt tanks

			
1			
<b>GEV No.</b>	505229	<b>Ref. No.</b>	12023847 Z471105
<b>description</b>	filter L 71mm $\varnothing$ 10mm salt tank conical		
<b>For models:</b>	AD-15D, AD-21D, AD-48D, AD-64D, FI-48, FI-48AR, FI-48B, FI-48B-BT-UK, FI-48C, FI-48D, FI-48HY-CLINIC, FI-48W, FI-64, FI-64AR, FI-64B, FI-64B-BT-UK, FI-64C, FI-64D, FI-64HY-CLINIC, FI-64W, LVC-15D, LVC-21D		

			
1			
<b>GEV No.</b>	505220	<b>Ref. No.</b>	12025267 12047154 Z471107
<b>description</b>	flat gasket for salt tank rubber thickness 3.9mm ID $\varnothing$ 68mm ED $\varnothing$ 86mm		
<b>For models:</b>	AD-15D, AD-21D, AD-48D, AD-64D, CO-400-SOFT, FI-48, FI-48AR, FI-48B, FI-48B-BT-UK, FI-48C, FI-48D, FI-48HY-CLINIC, FI-48W, FI-64, FI-64AR, FI-64B, FI-64B-BT-UK, FI-64C, FI-64D, FI-64HY-CLINIC, FI-64W, LVC-15D, LVC-21D		







Зип-Общепит



vsezip.ru

+7(812)987-08-81

			
1			
<b>GEV No.</b>	524177	<b>Ref. No.</b>	12025273 Z471108
<b>description</b>	lid ø 69mm H 20mm for salt tank ID ø 50mm		
<b>For models:</b>	AD-15D, AD-21D, AD-48D, AD-64D, CO-400-SOFT, FI-48, FI-48AR, FI-48B, FI-48B-BT-UK, FI-48C, FI-48D, FI-48HY-CLINIC, FI-48W, FI-64, FI-64AR, FI-64B, FI-64B-BT-UK, FI-64C, FI-64D, FI-64HY-CLINIC, FI-64W, LVC-15D, LVC-21D		
<b>accessories for</b>	524177		
	<b>GEV No.</b>	<b>Ref. No.</b>	—
		524148	—
	O-ring EPDM thickness 3.53mm ID ø 40.86mm Qty 1 pcs		

			
1			
<b>GEV No.</b>	517401	<b>Ref. No.</b>	12025272 Z471106
<b>description</b>	nut ø 92mm H 10.5mm for salt tank ID ø 64.5mm		
<b>For models:</b>	AD-15D, AD-21D, AD-48D, AD-64D, CO-400-SOFT, FI-48, FI-48AR, FI-48B, FI-48B-BT-UK, FI-48C, FI-48D, FI-48HY-CLINIC, FI-48W, FI-64, FI-64AR, FI-64B, FI-64B-BT-UK, FI-64C, FI-64D, FI-64HY-CLINIC, FI-64W, LVC-15D, LVC-21D		

			
1			
<b>GEV No.</b>	505101	<b>Ref. No.</b>	12025142 Z471102
<b>description</b>	salt tank ø 90mm H 86mm		
<b>For models:</b>	AD-15D, AD-21D, AD-48D, AD-64D, FI-48, FI-48AR, FI-48B, FI-48B-BT-UK, FI-48C, FI-48D, FI-48HY-CLINIC, FI-48W, FI-64, FI-64AR, FI-64B, FI-64B-BT-UK, FI-64C, FI-64D, FI-64HY-CLINIC, FI-64W, LVC-15D, LVC-21D, LVR-14D, LVR-20D		
<b>accessories for</b>	505101		
	<b>GEV No.</b>	<b>Ref. No.</b>	12025267 12047154 Z471107
		505220	—
	flat gasket for salt tank rubber thickness 3.9mm ID ø 68mm ED ø 86mm		
	<b>GEV No.</b>	<b>Ref. No.</b>	12024031 Z471109
		506015	—
	O-ring EPDM thickness 3.53mm ID ø 39.69mm Qty 1 pcs		

<b>accessories for</b>	505101		
	<b>GEV No.</b>	<b>Ref. No.</b>	12025272 Z471106
		517401	—
	nut ø 92mm H 10.5mm for salt tank ID ø 64.5mm		
	<b>GEV No.</b>	<b>Ref. No.</b>	12025273 Z471108
		524177	—
	lid ø 69mm H 20mm for salt tank ID ø 50mm		

boilers

boilers for dishwashers

			
1			
<b>GEV No.</b>	505209	<b>Ref. No.</b>	1200002017 12022893 12038284 Z401701 Z401730
<b>description</b>	boiler ø 130mm L 310mm		
<b>For models:</b>	AD-15, AD-15D, AD-20C-UK, AD-21, AD-21B, AD-21BDD, AD-21C, AD-21D, AD-21DD, AD-21W, LVC-12, LVC-15, LVC-15D, LVC-21, LVC-21B, LVC-21C, LVC-21D, LVC-21W, LVR-10, LVR-14, LVR-14D, LVR-20, LVR-20B, LVR-20D, MF-21		

			
1			
<b>GEV No.</b>	505210	<b>Ref. No.</b>	1200005017 12022943 12038293 Z201701 Z201710
<b>description</b>	boiler ø 150mm L 460mm inlet ø 10		
<b>For models:</b>	AD-120, AD-120B, AD-120C, AD-120CW, AD-48, AD-48B, AD-48BDD, AD-48C, AD-48D, AD-48DD, AD-48W, AD-64, AD-64B, AD-64BDD, AD-64C, AD-64CW, AD-64D, AD-64DD, AD-72, AD-72W, AD-90, AD-90BA, AD-90BDD, AD-90DD, EASY-500, EASY-500B, EASY-500DD, EASY-500HP, FI-100, FI-100AR, FI-100B, FI-120, FI-120AR+DD, FI-120B, FI-120C, FI-120W, FI-30, FI-30AR, FI-30AR+DD, FI-30B, FI-30-UK, FI-48, FI-48AR, FI-48B, FI-48C, FI-48D, FI-48W, FI-50, FI-60DD, FI-64...(Other models you can see in the webshop)		

			
1			
<b>GEV No.</b>	505296	<b>Ref. No.</b>	12038196 WX0116204
<b>description</b>	boiler ø 180mm L 410mm		

mechanical components, equipment accessories

## gaskets



1

<b>GEV No.</b>	699343	<b>Ref. No.</b>	12046365
<b>description</b>	gasket L 118mm W 73mm H 9mm thickness 9mm		
<b>For models:</b>	AD-125, AD-125HRS, AD-125-SOFT, CO-110, CO-110B, CO-110BDD, CO-110DD, CO-112, CO-112B, CO-112BDD, CO-112DD, CO-170, CO-170B, CO-170BDD, CO-170DD, CO-170HRS, CO-170HRSDD, CO-170HRS-SOFT, CO-170-SOFT, CO-172, CO-172B, CO-172BDD, CO-172DD, COP-173, COP-173B, COP-173BDD, COP-173DD, COP-173HRS, COP-173HRSDD, COP-173-SOFT, COP-174, COP-174B, COP-174BDD, COP-174DD, COP-174HRS, COP-174HRSDD		

## rotation plates

## rotation plates



1

<b>GEV No.</b>	505144	<b>Ref. No.</b>	12019337 12020267 Z645901 Z645920
<b>description</b>	rotation plate		



1

<b>GEV No.</b>	505170	<b>Ref. No.</b>	12019954 Z405901
<b>description</b>	rotation plate ø 290mm plastic seat ø 22mm overall height 54mm		
<b>For models:</b>	LVR-10, LVR-14, LVR-14D, LVR-20, LVR-20B, LVR-20D		

## rotation plate bearings



1

<b>GEV No.</b>	505165	<b>Ref. No.</b>	12019578 12039828 Z605911
<b>description</b>	bearing rotation plate		



1

<b>GEV No.</b>	505154	<b>Ref. No.</b>	12019027 Z645909
<b>description</b>	bearing rotation plate complete		

## softener cartridges

## softening columns



1

<b>GEV No.</b>	505102	<b>Ref. No.</b>	12024874 Z471101
<b>description</b>	softener 4-fold L 380mm W 180mm		
<b>For models:</b>	AD-15D, AD-21D, AD-48D, AD-64D, CO-400-SOFT, FI-48, FI-48AR, FI-48B, FI-48B-BT-UK, FI-48C, FI-48D, FI-48HY-CLINIC, FI-48W, FI-64, FI-64AR, FI-64B, FI-64B-BT-UK, FI-64C, FI-64D, FI-64HY-CLINIC, FI-64W, LVC-15D, LVC-21D, LVR-14D, LVR-20D		



1

<b>GEV No.</b>	530000	<b>Ref. No.</b>	270064
<b>description</b>	softener 4-fold L 380mm W 180mm		

## spare parts and accessories



1

<b>GEV No.</b>	691865	<b>Ref. No.</b>	12018145 Z643013
<b>description</b>	actuator for door for switch L 102mm ext. ø 11.4		
<b>For models:</b>	FI-300B, FI-300R, FI-650R		

Зип-Общепит

vsezip.ru

+7(812)987-08-81



Зип Общепит  
vsezip.ru

			
1			
<b>GEV No.</b>	530905	<b>Ref. No.</b>	12024487 Z105055000
<b>description</b>	spacer bush for impulse L 24.5mm ID ø 17.5mm ED ø 20mm suitable for FAGOR		
<b>For models:</b>	ECO-160D, ECO-160I, ECO-200D, ECO-200HD, ECO-200HI, ECO-200I, FI-160AR, FI-160D, FI-160I, FI-200AR, FI-200D, FI-200HD, FI-200HI, FI-200I, FI-200WL, FI-200WR		

			
1			
<b>GEV No.</b>	505325	<b>Ref. No.</b>	12023093 Z850111
<b>description</b>	mounting flange for thermostat stainless steel L 48mm W 35mm thickness 1.2mm H 17mm		
<b>For models:</b>	ECO-160, ECO-160D, ECO-160D, ECO-160I, ECO-200, ECO-200D, ECO-200H, ECO-200HD, ECO-200HI, ECO-200I, ECO-2300, ECO-2700D, ECO-2700I, ECO-280D, ECO-280I, ECO-3000, ECO-370D, ECO-370I, ECO-4000D, ECO-4000I, ECO-460D, ECO-460I, ECO-550D, ECO-550I, ECO-6000D, ECO-6000I, FI-160, FI-160D, FI-160AR, FI-160D, FI-160I, FI-200, FI-200AR, FI-200D, FI-200H, FI-200HD, FI-200HI, FI-200I, FI-200W, FI-200WL, FI-200WR, FI-2300, FI-2700D, FI-2700I, FI-280D, FI-280I, FI-3000, FI-370D, FI-370I, FI-4000D...(Other models you can see in the webshop)		

housing and bezels

fastening angles

			
1			
<b>GEV No.</b>	650103	<b>Ref. No.</b>	12015774 Z400106
<b>description</b>	cross rail L 380mm W 50mm H 10mm mounting distance 355mm		
<b>For models:</b>	LVC-12, LVC-15, LVC-15D, LVR-10, LVR-14, LVR-14D		

fascias

			
1			
<b>GEV No.</b>	505337	<b>Ref. No.</b>	12025012 Z208918
<b>description</b>	front foil for dishwasher FI-48C L 583mm W 62mm		
<b>For models:</b>	FI-48AR, FI-48C		

			
1			
<b>GEV No.</b>	505239	<b>Ref. No.</b>	12021876 Z276354
<b>description</b>	fastening angle L 80mm W 80mm H 38mm		
<b>For models:</b>	ECO-120, ECO-120B, ECO-160, ECO-160D, ECO-160I, ECO-200, ECO-200D, ECO-200H, ECO-200HD, ECO-200HI, ECO-200I, ECO-280D, ECO-280I, ECO-370D, ECO-370I, ECO-460D, ECO-460I, ECO-550D, ECO-550I, FI-100, FI-100AR, FI-100B, FI-120, FI-120B, FI-120W, FI-160, FI-160AR, FI-160D, FI-160I, FI-200, FI-200AR, FI-200D, FI-200H, FI-200HD, FI-200HI, FI-200I, FI-200W, FI-200WL, FI-200WR, FI-280D, FI-280I, FI-370D, FI-370I, FI-460D, FI-460I, FI-550D, FI-550I, FI-80, FI-80W, MF-120		

trapdoors

			
1			
<b>GEV No.</b>	505241	<b>Ref. No.</b>	12014320 Z212902
<b>description</b>	door for rinse aid container W 120mm H 110mm thickness 8mm		
<b>For models:</b>	FI-30, FI-48, FI-48B, FI-50, FI-64, FI-64B, FI-72		

mechanical components, equipment accessories

Зип Общежит

spring holder

vsezip.ru

+7(812)987-08-81



1

<b>GEV No.</b>	505235	<b>Ref. No.</b>	1200002020 12038297
<b>description</b>	trapdoor for dishwasher W 460mm H 340mm thickness 25mm		
<b>For models:</b>	AD-21W, LVC-21, LVC-21B, LVC-21C, LVC-21D, LVC-21W		

## hood mechanics for dishwashers

## bolts



1

<b>GEV No.</b>	505219	<b>Ref. No.</b>	12023966 Z710542
<b>description</b>	shaft for roller		
<b>For models:</b>	AD-120, AD-120B, AD-120BBTDD-UK, AD-120C, AD-120CW, AD-120HY, AD-90, AD-90BA, AD-90BBT, AD-90BDD, AD-90DD, ADE-120, ADE-120B, ECO-120, ECO-120B, FI-100, FI-100AR, FI-100B, FI-100BBT-UK, FI-120, FI-120AR+DD, FI-120B, FI-120C, FI-120HY-CLINIC, FI-120W, FI-80, FI-80AR, FI-80BBT-UK, FI-80W, FI-E-100, LABP-1000, LABP-1200, LABP-800, MF-120		

## bushes



1

<b>GEV No.</b>	505272	<b>Ref. No.</b>	12025255 Z710515
<b>description</b>	bush ED ø 22mm ID ø 10mm L 7mm plastic		
<b>For models:</b>	AD-120, AD-120B, AD-120BBTDD-UK, AD-120C, AD-120CW, AD-120HY, AD-125, AD-125HRS, AD-125-SOFT, AD-90, AD-90BA, AD-90BBT, AD-90BDD, AD-90DD, ADE-120, ADE-120B, CO-110, CO-110B, CO-110BDD, CO-110DD, CO-112, CO-112B, CO-112BDD, CO-112DD, CO-142W, CO-142WDD, CO-170, CO-170B, CO-170BDD, CO-170DD, CO-170HRS, CO-170HRSDD, CO-170HRS-SOFT, CO-170-SOFT, CO-172, CO-172B, CO-172BDD, CO-172DD, COP-173, COP-173B, COP-173BDD, COP-173DD, COP-173HRS, COP-173HRSDD, COP-173-SOFT, COP-174, COP-174B, COP-174BDD, COP-174DD, COP-174HRS...(Other models you can see in the webshop)		



<b>GEV No.</b>	505261	<b>Ref. No.</b>	12023671 Z270512
<b>description</b>	spring holder hood mechanics D1 ø 46mm D2 ø 36mm W 27mm		
<b>For models:</b>	ECO-160, ECO-160D, ECO-160I, ECO-200, ECO-200D, ECO-200H, ECO-200HD, ECO-200HI, ECO-200I, ECO-2700D, ECO-2700I, ECO-280D, ECO-280I, ECO-370D, ECO-370I, ECO-4000D, ECO-4000I, ECO-460D, ECO-460I, ECO-550D, ECO-550I, ECO-6000D, ECO-6000I, FI-160, FI-160AR, FI-160D, FI-160I, FI-200, FI-200AR, FI-200D, FI-200H, FI-200HD, FI-200HI, FI-200I, FI-200W, FI-200WL, FI-200WR, FI-2700D, FI-2700I, FI-280D, FI-280I, FI-370D, FI-370I, FI-4000D, FI-4000I, FI-460D, FI-460I, FI-550D, FI-550I, FI-6000D...(Other models you can see in the webshop)		

## linkage



1

<b>GEV No.</b>	501482	<b>Ref. No.</b>	12019124 Z680522
<b>description</b>	tie bar L 500mm for hood mechanics for dishwasher		
<b>For models:</b>	ECO-1200, FI-1200, FI-900		

## friction rings



1

<b>GEV No.</b>	505226	<b>Ref. No.</b>	12018644 Q308009
<b>description</b>	slide ring PTFE ED ø 19mm ID ø 7.5mm thickness 2mm Qty 1 pcs		
<b>For models:</b>	FI-300B, FI-300R, FI-650R		



1

<b>GEV No.</b>	505225	<b>Ref. No.</b>	12009922 Q308012
<b>description</b>	slide ring PTFE ED ø 30mm ID ø 10mm thickness 3mm for hood joint Qty 1 pcs		
<b>For models:</b>	AD-120, AD-120B, AD-120BBTDD-UK, AD-120C, AD-120CW, AD-120HY, AD-90, AD-90BA, AD-90BBT, AD-90BDD, AD-90DD, ADE-120, ADE-120B, ECO-120, ECO-120B, FI-100, FI-100AR, FI-100B, FI-100BBT-UK, FI-120, FI-120AR+DD, FI-120B, FI-120C, FI-120HY-CLINIC, FI-120W, FI-80, FI-80AR, FI-80BBT-UK, FI-80W, FI-E-100, LABP-1000, LABP-1200, LABP-800, MF-120		



Зип Общепит

vsezip.ru

+7(812)987-08-81

rollers			
			
1			
<b>GEV No.</b>	505218	<b>Ref. No.</b>	12025210 Z710546
<b>description</b>	roller ø 37mm H 12mm plastic hole ø 12.1mm		
<b>For models:</b>	AD-120, AD-120B, AD-120BBTDD-UK, AD-120C, AD-120CW, AD-120HY, AD-90, AD-90BA, AD-90BBT, AD-90BDD, AD-90DD, ADE-120, ADE-120B, ECO-120, ECO-120B, FI-100, FI-100AR, FI-100B, FI-100BBT-UK, FI-120, FI-120AR+DD, FI-120B, FI-120C, FI-120HY-CLINIC, FI-120W, FI-80, FI-80AR, FI-80BBT-UK, FI-80W, FI-E-100, LABP-1000, LABP-1200, LABP-800, MF-120		

<b>GEV No.</b>	691890	<b>Ref. No.</b>	12023973 Z270516
<b>description</b>	rubber pad D 13mm ID 7mm H 10mm		
<b>For models:</b>	ECO-160, ECO-160D, ECO-160I, ECO-200, ECO-200D, ECO-200H, ECO-200HD, ECO-200HI, ECO-200I, ECO-280D, ECO-280I, ECO-370D, ECO-370I, ECO-460D, ECO-460I, ECO-550D, ECO-550I, FI-160, FI-160AR, FI-160D, FI-160I, FI-200, FI-200AR, FI-200D, FI-200H, FI-200HD, FI-200HI, FI-200I, FI-200W, FI-200WL, FI-200WR, FI-280D, FI-280I, FI-370D, FI-370I, FI-460D, FI-460I, FI-550D, FI-550I		

miscellaneous			
			
1			
<b>GEV No.</b>	517431	<b>Ref. No.</b>	12011392 Z270515
<b>description</b>	bracket for roller spring ømm L 105mm W 44mm H 20mm		
<b>For models:</b>	ECO-160, ECO-160D, ECO-160I, ECO-200, ECO-200D, ECO-200H, ECO-200HD, ECO-200HI, ECO-200I, FI-160, FI-160AR, FI-160D, FI-160I, FI-200, FI-200AR, FI-200D, FI-200H, FI-200HD, FI-200HI, FI-200I, FI-200W, FI-200WL, FI-200WR		

basket guides			
guide bars			
			
1			
<b>GEV No.</b>	505329	<b>Ref. No.</b>	12038483 12Z3150290
<b>description</b>	basket guide L 593mm H 75mm		
<b>For models:</b>	ECO-280D, ECO-280I, ECO-370D, ECO-370I, ECO-460D, ECO-460I, ECO-550D, ECO-550I, FI-280D, FI-280I, FI-370D, FI-370I, FI-460D, FI-460I, FI-550D, FI-550I		

			
1			
<b>GEV No.</b>	529240	<b>Ref. No.</b>	12010068 Q308000
<b>description</b>	flat washer ED ø 16.5mm ID ø 8.2mm plastic thickness 4mm		
<b>For models:</b>	AD-120, AD-120B, AD-120BBTDD-UK, AD-120C, AD-120CW, AD-120HY, AD-90, AD-90BA, AD-90BBT, AD-90BDD, AD-90DD, ADE-120, ADE-120B, ECO-120, ECO-120B, ECO-160, ECO-160D, ECO-160I, ECO-200, ECO-200D, ECO-200H, ECO-200HD, ECO-200HI, ECO-200I, ECO-2300, ECO-280D, ECO-280I, ECO-3000, ECO-370D, ECO-370I, ECO-460D, ECO-460I, ECO-550D, ECO-550I, FI-100, FI-100AR, FI-100B, FI-100BBT-UK, FI-120, FI-120C, FI-120AR+DD, FI-120B, FI-120C, FI-120HY-CLINIC, FI-120W, FI-160, FI-160D... (Other models you can see in the webshop)		

			
1			
<b>GEV No.</b>	505327	<b>Ref. No.</b>	12041428 12Z3350250
<b>description</b>	basket guide mounting pos. left bottom L 590mm H 70mm		
<b>For models:</b>	ECO-370I, ECO-550I, FI-370I, FI-550I		

			
1			
<b>GEV No.</b>	529241	<b>Ref. No.</b>	12010132 Q308002
<b>description</b>	plain washer for dishwashers ED ø 13mm ID ø 6mm plastic thickness 3.5mm		
<b>For models:</b>	AD-120, AD-120B, AD-120BBTDD-UK, AD-120C, AD-120CW, AD-120HY, AD-90, AD-90BA, AD-90BBT, AD-90BDD, AD-90DD, ADE-120, ADE-120B, CE-15, CE-9, EASY-500, EASY-500B, EASY-500DD, EASY-500HP, EASY-500HPWBDD, ECO-120, ECO-120B, ECO-160, ECO-160D, ECO-160I, ECO-200, ECO-200D, ECO-200H, ECO-200HD, ECO-200HI, ECO-200I, ECO-2300, ECO-2700D, ECO-2700I, ECO-280D, ECO-280I, ECO-3000, ECO-370D, ECO-370I, ECO-4000D, ECO-4000I, ECO-460D, ECO-460I, ECO-550D, ECO-550I, ECO-6000D, ECO-6000I, FI-100, FI-100AR... (Other models you can see in the webshop)		

mechanical components, equipment accessories



Зип Общепит

vsezip.ru

+7(812)987-08-81



1

<b>GEV No.</b>	505328	<b>Ref. No.</b>	12038478 12Z3350050
<b>description</b>	basket guide mounting pos. right bottom L 590mm H 70mm		
<b>For models:</b>	ECO-370D, ECO-550D, FI-370D, FI-550D		

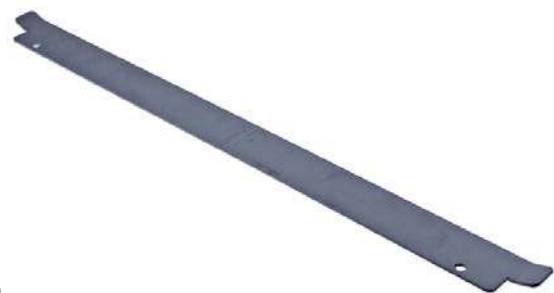

1

<b>GEV No.</b>	971056	<b>Ref. No.</b>	12014772 12021776 Z710317 Z710326
<b>description</b>	basket guide mounting pos. upper L 490mm H 36mm hole ø 6mm hole distance 400mm		
<b>For models:</b>	AD-120, AD-120B, AD-120BBTDD-UK, AD-120C, AD-120CW, AD-120HY, AD-90, AD-90BA, AD-90BBT, AD-90BDD, AD-90DD, ADE-120, ADE-120B, ECO-120, ECO-120B, FI-100, FI-100AR, FI-100B, FI-100BBT-UK, FI-120, FI-120AR+DD, FI-120B, FI-120C, FI-120HY-CLINIC, FI-120W, FI-80, FI-80AR, FI-80BBT-UK, FI-80W, FI-E-100, LABP-1000, LABP-1200, LABP-800, MF-120		

## basket holders



1

<b>GEV No.</b>	504248	<b>Ref. No.</b>	12023365 Z312509
<b>description</b>	basket support L 435m W 420mm H 90mm 90°		



<b>GEV No.</b>	970861	<b>Ref. No.</b>	12024644 Z105027
<b>description</b>	bush for basket transport system mounting pos. rotation plate ext. ø 40 ID ø 33.5mm H 31.5mm brass		
<b>For models:</b>	ECO-160, ECO-1600, ECO-160D, ECO-160I, ECO-200, ECO-200D, ECO-200H, ECO-200HD, ECO-200HI, ECO-200I, ECO-2300, ECO-280D, ECO-280I, ECO-3000, ECO-370D, ECO-370I, ECO-460D, ECO-460I, ECO-550D, ECO-550I, FI-160, FI-1600, FI-160AR, FI-160D, FI-160I, FI-200, FI-200AR, FI-200D, FI-200H, FI-200HD, FI-200HI, FI-200I, FI-200W, FI-200WL, FI-200WR, FI-2300, FI-280D, FI-280I, FI-3000, FI-370D, FI-370I, FI-460D, FI-460I, FI-550D, FI-550I		



1

<b>GEV No.</b>	524591	<b>Ref. No.</b>	12024307 Z275041 Z275075
<b>description</b>	sliding block for guide bar L 50mm W 27mm H 16mm		
<b>For models:</b>	ECO-160, ECO-160D, ECO-160I, ECO-200, ECO-200D, ECO-200H, ECO-200HD, ECO-200HI, ECO-200I, ECO-280D, ECO-280I, ECO-370D, ECO-370I, ECO-460D, ECO-460I, ECO-550D, ECO-550I, FI-160, FI-160AR, FI-160D, FI-160I, FI-200, FI-200AR, FI-200D, FI-200H, FI-200HD, FI-200HI, FI-200I, FI-200W, FI-200WL, FI-200WR, FI-280D, FI-280I, FI-370D, FI-370I, FI-460D, FI-460I, FI-550D, FI-550I		

## air traps

## air traps



1

<b>GEV No.</b>	505094	<b>Ref. No.</b>	12024350 Z203011
<b>description</b>	air trap		
<b>For models:</b>	AD-120, AD-120B, AD-120BBTDD-UK, AD-120C, AD-120CW, AD-120HY, AD-15, AD-15D, AD-20C-UK, AD-21, AD-21B, AD-21BDD, AD-21C, AD-21D, AD-21DD, AD-21W, AD-45BBT, AD-48, AD-48B, AD-48BDD, AD-48C, AD-48D, AD-48DD, AD-48HY, AD-48W, AD-64, AD-64B, AD-64BBT, AD-64BDD, AD-64BTDD, AD-64C, AD-64CW, AD-64D, AD-64DD, AD-64HY, AD-72, AD-72W, AD-90, AD-90BA, AD-90BBT, AD-90BDD, AD-90DD, ADE-120, ADE-120B, EASY-500, EASY-500B, EASY-500DD, EASY-500HP, EASY-500HPWBDD, ECO-120...(Other models you can see in the webshop)		



<b>accessories for</b>	505094			
	<b>GEV No.</b>	505096	<b>Ref. No.</b>	12024157 Z201312 Z203012
	elbow			
	<b>GEV No.</b>	505184	<b>Ref. No.</b>	12024222 Z203013
	eye bolt			

Table continues overleaf







Зип Общепит

vsezip.ru

+7(812)987-08-81

accessories for 505094			
	GEV No.	529412	Ref. No. 12009873 Q307003
O-ring EPDM thickness 2.62mm ID ø 10.78mm Qty 1 pcs			

			
1			
GEV No.	510103	Ref. No.	12090549 12134442
description air trap L 85mm W 20mm H 80mm hose ø 6mm plastic			
For models: CO-350, CO-350-B, CO-350-B-DD, CO-350-COLD, CO-350-COLD-B, CO-350-COLD-B-DD, CO-350-COLD-DD, CO-350-DD, CO-352-COLD, CO-352-COLD-B, CO-352-COLD-B-DD, CO-352-COLD-DD, CO-400, CO-400-B, CO-400-B-DD, CO-400-COLD, CO-400-COLD-B, CO-400-COLD-B-DD, CO-400-COLD-DD, CO-400-DD, CO-400-SOFT, CO-402-COLD, CO-402-COLD-B, CO-402-COLD-B-DD, CO-402-COLD-DD, CO-402W			

spare parts for 510103			
	GEV No.	505045	Ref. No. 12009912 Q307036
O-ring EPDM thickness 1.78mm ID ø 5.28mm Qty 1 pcs			
	GEV No.	505094	Ref. No. 12024350 Z203011
air trap			
	GEV No.	510016	Ref. No. —
eye bolt for rinse aid container connection			
	GEV No.	510105	Ref. No. —
hose connector for air trap			

mechanics for flight type dishwashers			
			
1			
GEV No.	505240	Ref. No.	12018670 Z331202
description actuator			
For models: ECO-370D, ECO-550D, FI-370D, FI-550D			

			
1			
GEV No.	505338	Ref. No.	12002678 1222712130
description bracket L 70mm W 70mm H 30mm thread M5			
For models: ECO-160, ECO-160D, ECO-160I, ECO-200, ECO-200D, ECO-200H, ECO-200HD, ECO-200HI, ECO-200I, ECO-280D, ECO-280I, ECO-370D, ECO-370I, ECO-460D, ECO-460I, ECO-550D, ECO-550I, FI-160, FI-160AR, FI-160D, FI-160I, FI-200, FI-200AR, FI-200D, FI-200H, FI-200HD, FI-200HI, FI-200I, FI-200WL, FI-200WR, FI-280D, FI-280I, FI-370D, FI-370I, FI-460D, FI-460I, FI-550D, FI-550I			

			
1			
GEV No.	51 826	Ref. No.	12024682 Z270336 Z270336000
description door guides L 620mm W 37mm H 13mm mounting pos. right			
For models: ECO-160, ECO-160D, ECO-160I, ECO-200, ECO-200D, ECO-200H, ECO-200HD, ECO-200HI, ECO-200I, ECO-280D, ECO-280I, ECO-370D, ECO-370I, ECO-460D, ECO-460I, ECO-550D, ECO-550I, FI-160, FI-160AR, FI-160D, FI-160I, FI-200, FI-200AR, FI-200D, FI-200H, FI-200HD, FI-200HI, FI-200I, FI-200WL, FI-200WR, FI-280D, FI-280I, FI-370D, FI-370I, FI-460D, FI-460I, FI-550D, FI-550I			

			
1			
GEV No.	519525	Ref. No.	12023176 Z275021
description flange for drive shaft ø 44mm ID ø 35mm ED ø 119mm suitable for FAGOR			
For models: ECO-160, ECO-160D, ECO-160I, ECO-200, ECO-200D, ECO-200H, ECO-200HD, ECO-200HI, ECO-200I, FI-160, FI-160AR, FI-160D, FI-160I, FI-200, FI-200AR, FI-200D, FI-200H, FI-200HD, FI-200HI, FI-200I, FI-200WL, FI-200WR			

			
1			
GEV No.	697775	Ref. No.	12024102 Z275007
description gear wheel DIN/ISO 08 B-1x26T splitting 1/2" teeth 26 shaft intake ø 20mm H 28mm hub ø 43mm			
For models: ECO-160, ECO-160D, ECO-160I, ECO-200HD, ECO-200HI, ECO-280D, ECO-280I, FI-160, FI-160AR, FI-160D, FI-160I, FI-200HD, FI-200HI, FI-200WL, FI-200WR, FI-280D, FI-280I			

			
1			
GEV No.	505333	Ref. No.	120000140 12038281 Z335011
description holder frame for rack conveyor dishwashing machine L 595mm W 480mm H 40mm			
For models: ECO-370D, ECO-370I, ECO-550D, ECO-550I, FI-370D, FI-370I, FI-550D, FI-550I			

mechanical components, equipment accessories

Зип Общепит

vsezip.ru

+7(812)987-08-81



1

<b>GEV No.</b>	505321	<b>Ref. No.</b>	12022145 Z271206
<b>description</b>	magnet holder for transport system $\varnothing$ 35mm hole $\varnothing$ 6mm hole distance 21mm thickness 2mm		
<b>For models:</b>	ECO-160, ECO-160D, ECO-160I, ECO-200, ECO-200D, ECO-200H, ECO-200HD, ECO-200HI, ECO-200I, ECO-280D, ECO-280I, ECO-370D, ECO-370I, ECO-460D, ECO-460I, ECO-550D, ECO-550I, FI-160, FI-160AR, FI-160D, FI-160I, FI-200, FI-200AR, FI-200D, FI-200H, FI-200HD, FI-200HI, FI-200I, FI-200W, FI-200WL, FI-200WR, FI-280D, FI-280I, FI-370D, FI-370I, FI-460D, FI-460I, FI-550D, FI-550I		



1

<b>GEV No.</b>	530905	<b>Ref. No.</b>	12024487 Z105055000
<b>description</b>	spacer bush for impulse L 24.5mm ID $\varnothing$ 17.5mm ED $\varnothing$ 20mm suitable for FAGOR		
<b>For models:</b>	ECO-160D, ECO-160I, ECO-200D, ECO-200HD, ECO-200HI, ECO-200I, FI-160AR, FI-160D, FI-160I, FI-200AR, FI-200D, FI-200HD, FI-200HI, FI-200I, FI-200WL, FI-200WR		



2

<b>GEV No.</b>	504451	<b>Ref. No.</b>	12009828 12021015 Q362000 Z105026
<b>description</b>	roll pin $\varnothing$ 6.3mm L 50mm SS		
<b>For models:</b>	ECO-160, ECO-160D, ECO-160I, ECO-200, ECO-200D, ECO-200H, ECO-200HD, ECO-200HI, ECO-200I, ECO-2300, ECO-280D, ECO-280I, ECO-3000, ECO-370D, ECO-370I, ECO-460D, ECO-460I, ECO-550D, ECO-550I, FI-160, FI-160D, FI-160AR, FI-160D, FI-160I, FI-200, FI-200AR, FI-200D, FI-200H, FI-200HD, FI-200HI, FI-200I, FI-200W, FI-200WL, FI-200WR, FI-2300, FI-280D, FI-280I, FI-3000, FI-370D, FI-370I, FI-460D, FI-460I, FI-550D, FI-550I		



1

<b>GEV No.</b>	504387	<b>Ref. No.</b>	12024391 Z271204
<b>description</b>	spring right for transport system shaft diametermm $\varnothing$ 10.5mm L 36mm Wmm Hmm wire gauge $\varnothing$ 1.4mm		
<b>For models:</b>	ECO-160, ECO-160D, ECO-160I, ECO-200, ECO-200D, ECO-200H, ECO-200HD, ECO-200HI, ECO-200I, ECO-280D, ECO-280I, ECO-370D, ECO-370I, ECO-460D, ECO-460I, ECO-550D, ECO-550I, FI-160, FI-160AR, FI-160D, FI-160I, FI-200, FI-200AR, FI-200D, FI-200H, FI-200HD, FI-200HI, FI-200I, FI-200W, FI-200WL, FI-200WR, FI-280D, FI-280I, FI-370D, FI-370I, FI-460D, FI-460I, FI-550D, FI-550I		



1

<b>GEV No.</b>	505330	<b>Ref. No.</b>	12031651 12048195 INXC401001
<b>description</b>	roller for rack conveyor dishwashing machine L 500mm $\varnothing$ 40mm plastic shaft $\varnothing$ 10mm shaft L 15mm		



1

<b>GEV No.</b>	504450	<b>Ref. No.</b>	12024681 Z275022 Z275025
<b>description</b>	tension bolt for transport system L 98mm ID $\varnothing$ 45mm ED $\varnothing$ 50/34mm		
<b>For models:</b>	ECO-160, ECO-160D, ECO-160I, ECO-200, ECO-200D, ECO-200H, ECO-200HD, ECO-200HI, ECO-200I, ECO-280D, ECO-280I, ECO-370D, ECO-370I, ECO-460D, ECO-460I, ECO-550D, ECO-550I, FI-160, FI-160AR, FI-160D, FI-160I, FI-200, FI-200AR, FI-200D, FI-200H, FI-200HD, FI-200HI, FI-200I, FI-200W, FI-200WL, FI-200WR, FI-280D, FI-280I, FI-370D, FI-370I, FI-460D, FI-460I, FI-550D, FI-550I		



1

<b>GEV No.</b>	505331	<b>Ref. No.</b>	12032894 6020000446
<b>description</b>	roller for rack conveyor dishwashing machine L 505mm $\varnothing$ 40mm thread M8		

accessories for 504450

	<b>GEV No.</b>	504451	<b>Ref. No.</b>	12009828 12021015 Q362000 Z105026
roll pin $\varnothing$ 6.3mm L 50mm SS				



1

<b>GEV No.</b>	505332	<b>Ref. No.</b>	12033009 6020000447
<b>description</b>	roller for rack conveyor dishwashing machine short L 100mm $\varnothing$ 40mm		





Зип-Общепит

vsezip.ru

+7(812)987-08-81

backflow preventers

backflow preventers



<b>GEV No.</b>	505183	<b>Ref. No.</b>	12023857 1210305189 Z718418
<b>description</b>	backflow preventer dishwasher		
<b>For models:</b>	AD-120CW, CO-142W, CO-142WDD, FI-120W, FI-200W, FI-200WL, FI-200WR, FI-48, FI-48B, FI-48W, FI-64, FI-64B, FI-64W, FI-80W, MF-120, MF-48, MF-64		



<b>GEV No.</b>	516101	<b>Ref. No.</b>	12024568 Z231106
<b>description</b>	backflow preventer dishwasher hose ø 12mm		
<b>For models:</b>	AD-120, AD-120B, AD-120C, AD-20C-UK, AD-21, AD-21B, AD-21BDD, AD-21C, AD-21DD, AD-21W, AD-48, AD-48B, AD-48BDD, AD-48C, AD-48DD, AD-48W, AD-64, AD-64B, AD-64BDD, AD-64C, AD-64CW, AD-64D, AD-64DD, AD-72, AD-72W, AD-90, AD-90BA, AD-90BDD, AD-90DD, CO-110, CO-110B, CO-110BDD, CO-110DD, CO-112, CO-112B, CO-112BDD, CO-112DD, CO-170, CO-170B, CO-170BDD, CO-170DD, CO-170HRS, CO-170HRSDD, CO-170HRS-SOFT, CO-170-SOFT, CO-172, CO-172B, CO-172BDD, CO-172DD, CO-350...(Other models you can see in the webshop)		
<b>spare parts for</b>	516101		

	<b>GEV No.</b>	506367	<b>Ref. No.</b>	—
	flat gasket rubber ED ø 40mm ID ø 28mm thickness 1.8mm Qty 1 pcs			

miscellaneous



<b>GEV No.</b>	505151	<b>Ref. No.</b>	Z850603
<b>description</b>	pin plastic		

<b>GEV No.</b>	506160	<b>Ref. No.</b>	Q231450000
<b>description</b>	plain washer ID ø 8.6mm ED ø 16mm thickness 1.5mm SS Qty 1 pcs		

door mechanics

springs

roller springs



<b>GEV No.</b>	519451	<b>Ref. No.</b>	12024689 Z270513
<b>description</b>	roller spring W 40mm ID ø 35mm lug length 50mm		
<b>For models:</b>	ECO-160, ECO-160D, ECO-160I, ECO-200, ECO-200D, ECO-200H, ECO-200HD, ECO-200HI, ECO-200I, ECO-2700D, ECO-2700I, ECO-280D, ECO-280I, ECO-370D, ECO-370I, ECO-4000D, ECO-4000I, ECO-460D, ECO-460I, ECO-550D, ECO-550I, ECO-6000D, ECO-6000I, FI-160, FI-160AR, FI-160D, FI-160I, FI-200, FI-200AR, FI-200D, FI-200H, FI-200HD, FI-200HI, FI-200I, FI-200W, FI-200WL, FI-200WR, FI-2700D, FI-2700I, FI-280D, FI-280I, FI-370D, FI-370I, FI-4000D, FI-4000I, FI-460D, FI-460I, FI-550D, FI-550I, FI-6000D...(Other models you can see in the webshop)		

sliding plates

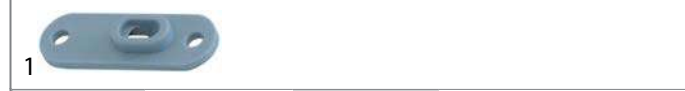

<b>GEV No.</b>	505195	<b>Ref. No.</b>	12024180 Z200310
<b>description</b>	sliding plate sliding plate		
<b>For models:</b>	AD-20C-UK, AD-21, AD-21B, AD-21BDD, AD-21C, AD-21D, AD-21DD, AD-21W, AD-45BBT, AD-48, AD-48B, AD-48BDD, AD-48C, AD-48D, AD-48DD, AD-48HY, AD-48W, AD-64, AD-64B, AD-64BBT, AD-64BDD, AD-64BTDD, AD-64C, AD-64CW, AD-64D, AD-64DD, AD-64HY, AD-72, AD-72W, EASY-500, EASY-500B, EASY-500DD, EASY-500HP, EASY-500HPWBDD, FI-30, FI-30AR, FI-30AR+DD, FI-30B, FI-30B-BT-UK, FI-30-UK, FI-48, FI-48AR, FI-48B, FI-48B-BT-UK, FI-48C, FI-48D, FI-48HY-CLINIC, FI-48W, FI-50, FI-60DD...(Other models you can see in the webshop)		

mechanical components, equipment accessories

Зип.Общепит

hinges



1

<b>GEV No.</b>	505005	<b>Ref. No.</b>	12022324 Z400514
<b>description</b>	door hinge hinge left mounting pos. left		
<b>For models:</b>	AD-15, AD-15D, AD-20C-UK, AD-21, AD-21B, AD-21BDD, AD-21C, AD-21D, AD-21DD, AD-21W, AD-45BBT, AD-48, AD-48B, AD-48BDD, AD-48C, AD-48D, AD-48DD, AD-48HY, AD-48W, AD-64, AD-64B, AD-64BBT, AD-64BDD, AD-64BTDD, AD-64C, AD-64CW, AD-64D, AD-64DD, AD-64HY, AD-72, AD-72W, EASY-500, EASY-500B, EASY-500DD, EASY-500HP, EASY-500HPWBDD, FI-30, FI-30AR, FI-30AR+DD, FI-30B, FI-30B-BT-UK, FI-30-UK, FI-48, FI-48AR, FI-48B, FI-48B-BT-UK, FI-48C, FI-48D, FI-48HY-CLINIC, FI-48W...(Other models you can see in the webshop)		



1

<b>GEV No.</b>	505006	<b>Ref. No.</b>	12022325 Z400515
<b>description</b>	door hinge hinge right mounting pos. right		
<b>For models:</b>	AD-15, AD-15D, AD-20C-UK, AD-21, AD-21B, AD-21BDD, AD-21C, AD-21D, AD-21DD, AD-21W, AD-45BBT, AD-48, AD-48B, AD-48BDD, AD-48C, AD-48D, AD-48DD, AD-48HY, AD-48W, AD-64, AD-64B, AD-64BBT, AD-64BDD, AD-64BTDD, AD-64C, AD-64CW, AD-64D, AD-64DD, AD-64HY, AD-72, AD-72W, EASY-500, EASY-500B, EASY-500DD, EASY-500HP, EASY-500HPWBDD, FI-30, FI-30AR, FI-30AR+DD, FI-30B, FI-30B-BT-UK, FI-30-UK, FI-48, FI-48AR, FI-48B, FI-48B-BT-UK, FI-48C, FI-48D, FI-48HY-CLINIC, FI-48W...(Other models you can see in the webshop)		



1

<b>GEV No.</b>	501479	<b>Ref. No.</b>	12036714 12037269 6009990017 A169090003
<b>description</b>	door hinge L 130mm for fridge FAGOR		
<b>For models:</b>	AEP-1402, AEP-1403, AEP-1404, AEP-1602, AEP-1603, AEP-1604, AEP-702, AEP-802, AF-1403-C, AF-1403-P, AF-1404-C, AF-1404-P, AF-1603-C, AF-1603-P, AF-1604-C, AF-1604-P, AF-2104-C, AF-2104-P, AF-2105-C, AF-2105-P, AF-2106-C, AF-2106-P, AFN-1402, AFN-1403, AFN-1404, AFN-1603, AFN-1604, AFN-702, AFN-802, AFP-1402, AFP-1403, AFP-1403-C, AFP-1403-FORZ, AFP-1403-P, AFP-1404, AFP-1404-C, AFP-1404-FORZ, AFP-1404-P, AFP-1603, AFP-1603-2, AFP-1604, AFP-2104, AFP-2104-C, AFP-2104-P, AFP-2105, AFP-2105-C, AFP-2105-P, AFP-2106, AFP-2106-C, AFP-2106-P...(Other models you can see in the webshop)		

doors

vsezip.ru

+7(812)987-08-81



1

<b>GEV No.</b>	507443	<b>Ref. No.</b>	12015782 Z420531
<b>description</b>	door W 455mm H 370mm thickness 35mm FAGOR suitable for LVC / LVR		
<b>For models:</b>	LVC-21, LVC-21B, LVC-21D, LVC-21W, LVR-20, LVR-20B, LVR-20D, MF-21		



1

<b>GEV No.</b>	507442	<b>Ref. No.</b>	1200005030 12006603 12013502 12038302 12Z2005410
<b>description</b>	door W 585mm H 430mm thickness 50mm complete FAGOR		
<b>For models:</b>	FI-30, FI-30AR, FI-30AR+DD, FI-30B, FI-30B-BT-UK, FI-30-UK, FI-48, FI-48AR, FI-48B, FI-48B-BT-UK, FI-48C, FI-48D, FI-48HY-CLINIC, FI-48W, FI-64, FI-64AR, FI-64B, FI-64B-BT-UK, FI-64C, FI-64D, FI-64HY-CLINIC, FI-64W		



Зип Общепит

vsezip.ru

+7(812)987-08-81



<b>GEV No.</b>	691912	<b>Ref. No.</b>	12015781 Z420511
<b>description</b>	inner door W 405mm H 340mm thickness 18mm FAGOR suitable for LVC / LVR		
<b>For models:</b>	LVC-21, LVC-21B, LVC-21D, LVC-21W, LVR-20, LVR-20B, LVR-20D, MF-21		

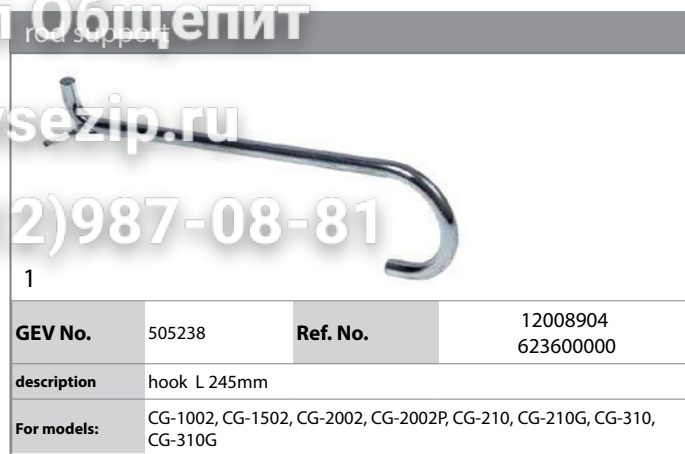

<b>GEV No.</b>	505238	<b>Ref. No.</b>	12008904 623600000
<b>description</b>	hook L 245mm		
<b>For models:</b>	CG-1002, CG-1502, CG-2002, CG-2002P, CG-210, CG-210G, CG-310, CG-310G		

door guides



<b>GEV No.</b>	517826	<b>Ref. No.</b>	12024682 Z270336 Z270336000
<b>description</b>	door guides L 620mm W 37mm H 13mm mounting pos. right		
<b>For models:</b>	ECO-160, ECO-160D, ECO-160I, ECO-200, ECO-200D, ECO-200H, ECO-200HD, ECO-200HI, ECO-200I, ECO-280D, ECO-280I, ECO-370D, ECO-370I, ECO-460D, ECO-460I, ECO-550D, ECO-550I, FI-160, FI-160AR, FI-160D, FI-160I, FI-200, FI-200AR, FI-200D, FI-200H, FI-200HD, FI-200HI, FI-200I, FI-200W, FI-200WL, FI-200WR, FI-280D, FI-280I, FI-370D, FI-370I, FI-460D, FI-460I, FI-550D, FI-550I		

door bumpers

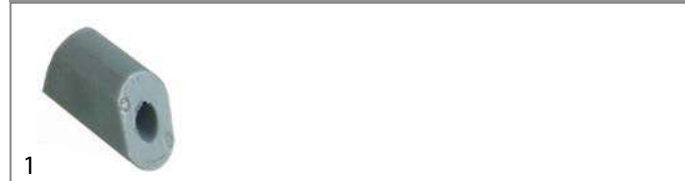

<b>GEV No.</b>	505149	<b>Ref. No.</b>	12024299 Z200522
<b>description</b>	door bumper door bumper		
<b>For models:</b>	AD-20C-UK, AD-21, AD-21B, AD-21BDD, AD-21C, AD-21D, AD-21DD, AD-21W, AD-45BBT, AD-48, AD-48B, AD-48BDD, AD-48C, AD-48D, AD-48DD, AD-48HY, AD-48W, AD-64, AD-64B, AD-64BBT, AD-64BDD, AD-64BTDD, AD-64C, AD-64CW, AD-64D, AD-64DD, AD-64HY, AD-72, AD-72W, EASY-500, EASY-500B, EASY-500DD, EASY-500HP, EASY-500HPWBDD, FI-30, FI-30AR, FI-30AR+DD, FI-30B, FI-30B-BT-UK, FI-30-UK, FI-48, FI-48AR, FI-48B, FI-48B-BT-UK, FI-48C, FI-48D, FI-48HY-CLINIC, FI-48W, FI-50, FI-60DD...(Other models you can see in the webshop)		

door frames



<b>GEV No.</b>	504239	<b>Ref. No.</b>	12024295 Z200524
<b>description</b>	door frame L 360mm W 15mm H 14mm plastic L-shape mounting distance 150mm		
<b>For models:</b>	AD-45BBT, AD-48, AD-48B, AD-48BDD, AD-48C, AD-48D, AD-48DD, AD-48HY, AD-48W, AD-64, AD-64B, AD-64BBT, AD-64BDD, AD-64BTDD, AD-64C, AD-64CW, AD-64D, AD-64DD, AD-64HY, EASY-500, EASY-500B, EASY-500DD, EASY-500HP, EASY-500HPWBDD, FI-30, FI-30AR, FI-30AR+DD, FI-30B, FI-30B-BT-UK, FI-30-UK, FI-48, FI-48AR, FI-48B, FI-48B-BT-UK, FI-48C, FI-48D, FI-48HY-CLINIC, FI-48W, FI-50, FI-60DD, FI-64, FI-64AR, FI-64B, FI-64B-BT-UK, FI-64C, FI-64D, FI-64HY-CLINIC, FI-64W, MF-48, MF-64		



<b>GEV No.</b>	506266	<b>Ref. No.</b>	12016638 Z105042
<b>description</b>	door bumper H 28mm L 66mm W 7.5mm mounting pos. door plastic		
<b>For models:</b>	ECO-1600, ECO-2300, ECO-3000, FI-1600, FI-2300, FI-3000		

locks



<b>GEV No.</b>	505196	<b>Ref. No.</b>	12024235 Z200601
<b>description</b>	door catch		
<b>For models:</b>	AD-15, AD-15D, AD-20C-UK, AD-21, AD-21B, AD-21BDD, AD-21C, AD-21D, AD-21DD, AD-21W, AD-45BBT, AD-48, AD-48B, AD-48BDD, AD-48C, AD-48D, AD-48DD, AD-48HY, AD-48W, AD-64, AD-64B, AD-64BBT, AD-64BDD, AD-64BTDD, AD-64C, AD-64CW, AD-64D, AD-64DD, AD-64HY, AD-72, AD-72W, EASY-500, EASY-500B, EASY-500DD, EASY-500HP, EASY-500HPWBDD, ECO-2700D, ECO-2700I, ECO-4000D, ECO-4000I, ECO-6000D, ECO-6000I, FI-2700D, FI-2700I, FI-30, FI-30AR, FI-30AR+DD, FI-30B, FI-30B-BT-UK, FI-30-UK...(Other models you can see in the webshop)		

mechanical components, equipment accessories

Зип Общепит

vsezip.ru

+7(812)987-08-81



1

<b>GEV No.</b>	505007	<b>Ref. No.</b>	12003212 12003363 12Z2006070
<b>description</b>	door catch door locking catch		
<b>For models:</b>	AD-15, AD-15D, AD-20C-UK, AD-21, AD-21B, AD-21BDD, AD-21C, AD-21D, AD-21DD, AD-21W, AD-45BBT, AD-48, AD-48B, AD-48BDD, AD-48C, AD-48D, AD-48DD, AD-48HY, AD-48W, AD-64, AD-64B, AD-64BBT, AD-64BDD, AD-64BTDD, AD-64C, AD-64CW, AD-64D, AD-64DD, AD-64HY, AD-72, AD-72W, EASY-500, EASY-500B, EASY-500DD, EASY-500HP, EASY-500HPWBDD, ECO-2700D, ECO-2700I, ECO-4000D, ECO-4000I, ECO-6000D, ECO-6000I, FI-2700D, FI-2700I, FI-30, FI-30AR, FI-30AR+DD, FI-30B, FI-30B-BT-UK, FI-30-UK...(Other models you can see in the webshop)		

## miscellaneous



1

<b>GEV No.</b>	505010	<b>Ref. No.</b>	12023624 Z710544
<b>description</b>	screw screw		
<b>For models:</b>	AD-120, AD-120B, AD-120BBTDD-UK, AD-90, AD-90BA, AD-90BBT, AD-90BDD, AD-90DD, ADE-120, ADE-120B, ECO-120, ECO-120B, FI-100, FI-100AR, FI-100B, FI-100BBT-UK, FI-120, FI-120AR+DD, FI-120B, FI-120C, FI-120HY-CLINIC, FI-120W, FI-80, FI-80AR, FI-80BBT-UK, FI-80W, FI-E-100, LABP-1000, LABP-1200, LABP-800, MF-120		



1

<b>GEV No.</b>	505008	<b>Ref. No.</b>	12025166 Z710529
<b>description</b>	spring compressor spring compressor		
<b>For models:</b>	AD-120, AD-120B, AD-120BBTDD-UK, AD-90, AD-90BA, AD-90BBT, AD-90BDD, AD-90DD, ADE-120, ADE-120B, ECO-120, ECO-120B, FI-100, FI-100AR, FI-100B, FI-100BBT-UK, FI-120, FI-120AR+DD, FI-120B, FI-120C, FI-120HY-CLINIC, FI-120W, FI-80, FI-80AR, FI-80BBT-UK, FI-80W, FI-E-100, LABP-1000, LABP-1200, LABP-800, MF-120		



1

<b>GEV No.</b>	508396	<b>Ref. No.</b>	12021923 Z710543
<b>description</b>	spring rod straight stainless steel L 140mm W 24mm		
<b>For models:</b>	AD-120, AD-120B, AD-120BBTDD-UK, AD-90, AD-90BA, AD-90BBT, AD-90BDD, AD-90DD, ADE-120, ADE-120B, ECO-120, ECO-120B, FI-100, FI-100AR, FI-100B, FI-100BBT-UK, FI-120, FI-120AR+DD, FI-120B, FI-120C, FI-120HY-CLINIC, FI-120W, FI-80, FI-80AR, FI-80BBT-UK, FI-80W, FI-E-100, LABP-1000, LABP-1200, LABP-800, MF-120		

## screw connections



1

<b>GEV No.</b>	505163	<b>Ref. No.</b>	12025276 Z602102
<b>description</b>	nut thread 1 1/2"		
<b>For models:</b>	ECO-1200, ECO-1600, ECO-2300, ECO-2700D, ECO-2700I, ECO-280D, ECO-280I, ECO-3000, ECO-370D, ECO-370I, ECO-4000D, ECO-4000I, ECO-460D, ECO-460I, ECO-550D, ECO-550I, ECO-6000D, ECO-6000I, FI-1200, FI-1600, FI-2300, FI-2700D, FI-2700I, FI-280D, FI-280I, FI-3000, FI-300B, FI-300R, FI-370D, FI-370I, FI-4000D, FI-4000I, FI-460D, FI-460I, FI-550D, FI-550I, FI-6000D, FI-6000I, FI-650R, FI-900		



1

<b>GEV No.</b>	504369	<b>Ref. No.</b>	12007871 Q223023
<b>description</b>	nut thread 5/8" pipe (22.7mm) H 7.3mm WS 32 brass Qty 1 pcs		
<b>For models:</b>	AD-120, AD-120B, AD-120BBTDD-UK, AD-120C, AD-120CW, AD-120HY, AD-90, AD-90BA, AD-90BBT, AD-90BDD, AD-90DD, ADE-120, ADE-120B, CO-142W, CO-142WDD, COP-174W, COP-174WHRS, ECO-120, ECO-1200, ECO-120B, ECO-160, ECO-1600, ECO-160D, ECO-160I, ECO-200, ECO-200D, ECO-200H, ECO-200HD, ECO-200HI, ECO-200I, ECO-2300, ECO-2700D, ECO-2700I, ECO-280D, ECO-280I, ECO-3000, ECO-370D, ECO-370I, ECO-4000D, ECO-4000I, ECO-460D, ECO-460I, ECO-550D, ECO-550I, ECO-6000D, ECO-6000I, FI-100, FI-100AR, FI-100B, FI-100BBT-UK...(Other models you can see in the webshop)		



Зип Общежит  
washing and rinsing systems

vsezip.ru

+7(812)987-08-81

curtains

curtains



<b>GEV No.</b>	533002	<b>Ref. No.</b>	12039834 Z106405
<b>description</b>	curtain W 615mm H 400mm rubber thickness 2.7mm		
<b>For models:</b>	ECO-1600, ECO-2300, ECO-3000, FI-1600, FI-2300, FI-3000		



<b>GEV No.</b>	533015	<b>Ref. No.</b>	12003701 12006760 12012962 12Z2764290 Z276410
<b>description</b>	curtain W 620mm H 410mm thickness 1.6mm warewashing		
<b>For models:</b>	ECO-160, ECO-160D, ECO-160I, ECO-200, ECO-200D, ECO-200H, ECO-200HD, ECO-200HI, ECO-200I, ECO-2700D, ECO-2700I, ECO-280D, ECO-280I, ECO-370D, ECO-370I, ECO-4000D, ECO-4000I, ECO-460D, ECO-460I, ECO-550D, ECO-550I, ECO-6000D, ECO-6000I, FI-160, FI-160AR, FI-160D, FI-160I, FI-200, FI-200AR, FI-200D, FI-200H, FI-200HD, FI-200HI, FI-200I, FI-200W, FI-200WL, FI-200WR, FI-2700D, FI-2700I, FI-280D, FI-280I, FI-370D, FI-370I, FI-4000D, FI-4000I, FI-460D, FI-460I, FI-550D, FI-550I, FI-6000D... (Other models you can see in the webshop)		



<b>GEV No.</b>	533014	<b>Ref. No.</b>	12006850 12012916 12Z2764190 Z276401
<b>description</b>	curtain W 620mm H 500mm thickness 1.4mm warewashing		
<b>For models:</b>	ECO-160, ECO-160D, ECO-160I, ECO-200, ECO-200D, ECO-200H, ECO-200HD, ECO-200HI, ECO-200I, ECO-2700D, ECO-2700I, ECO-280D, ECO-280I, ECO-370D, ECO-370I, ECO-4000D, ECO-4000I, ECO-460D, ECO-460I, ECO-550D, ECO-550I, ECO-6000D, ECO-6000I, FI-160, FI-160AR, FI-160D, FI-160I, FI-200, FI-200AR, FI-200D, FI-200H, FI-200HD, FI-200HI, FI-200I, FI-200W, FI-2700D, FI-2700I, FI-280D, FI-280I, FI-370D, FI-370I, FI-4000D, FI-4000I, FI-460D, FI-460I, FI-550D, FI-550I, FI-6000D, FI-6000I		

<b>GEV No.</b>	505040	<b>Ref. No.</b>	12023726 12110631 Z650704
<b>description</b>	bush for wash arm		
<b>For models:</b>	AD-45BBT, AD-48, AD-48B, AD-48BDD, AD-48C, AD-48D, AD-48DD, AD-48HY, AD-48W, AD-505, AD-505-SOFT, AD-64, AD-64B, AD-64BBT, AD-64BDD, AD-64BTDD, AD-64C, AD-64CW, AD-64D, AD-64DD, AD-64HY, AD-72, AD-72W, AD-90, AD-90BA, AD-90BBT, AD-90BDD, AD-90DD, CO-110, CO-110B, CO-110BDD, CO-110DD, CO-112, CO-112B, CO-112BDD, CO-112DD, CO-500, CO-500B, CO-500BDD, CO-500DD, CO-501, CO-501B, CO-501BDD, CO-501DD, CO-501-SOFT, CO-502B, CO-502BDD, CO-502DD, CO-502W, COP-503... (Other models you can see in the webshop)		

<b>GEV No.</b>	505041	<b>Ref. No.</b>	12025116 Z710712
<b>description</b>	bush for wash arm		
<b>For models:</b>	AD-120, AD-120B, AD-120BBTDD-UK, AD-120C, AD-120CW, AD-120HY, AD-125, AD-125HRS, AD-125-SOFT, ADE-120, ADE-120B, CO-142W, CO-142WDD, CO-170, CO-170B, CO-170BDD, CO-170DD, CO-170HRS, CO-170HRSDD, CO-170HRS-SOFT, CO-170-SOFT, CO-172, CO-172B, CO-172BDD, CO-172DD, COP-173, COP-173B, COP-173BDD, COP-173DD, COP-173HRS, COP-173HRSDD, COP-173-SOFT, COP-174, COP-174B, COP-174BDD, COP-174DD, COP-174HRS, COP-174HRSDD, COP-174W, COP-174WHRS, ECO-120, ECO-120B, FI-100, FI-100AR, FI-100B, FI-100BBT-UK, FI-120, FI-120AR+DD, FI-120B, FI-120C... (Other models you can see in the webshop)		

<b>GEV No.</b>	507425	<b>Ref. No.</b>	12018740 Z710707
<b>description</b>	duct D1 ø 38mm D2 ø 45mm L 72mm int. ø 1 31mm int. ø 2 39mm		
<b>For models:</b>	ECO-120, ECO-120B, ECO-160D, ECO-160I, ECO-200D, ECO-200I, FI-100, FI-100AR, FI-100B, FI-120, FI-120AR+DD, FI-120B, FI-120C, FI-120HY-CLINIC, FI-120W, FI-160D, FI-160I, FI-200D, FI-200I, FI-E-100, MF-120		
<b>spare parts for</b>	507425		
<b>GEV No.</b>	518080	<b>Ref. No.</b>	12023537 Z710708
<b>description</b>	nut thread 1½" WS 50 duct thickness 15mm		

mechanical components, equipment accessories

Зип Общепит

vsezip.ru

+7(812)987-08-81



1

<b>GEV No.</b>	505260	<b>Ref. No.</b>	12024287 Z310721
<b>description</b>	end cap for wash arm $\phi$ 32mm L 33mm suitable for FAGOR		
<b>For models:</b>	ECO-2700D, ECO-2700I, ECO-280D, ECO-280I, ECO-370D, ECO-370I, ECO-4000D, ECO-4000I, ECO-460D, ECO-460I, ECO-550D, ECO-550I, ECO-6000D, ECO-6000I, FI-2700D, FI-2700I, FI-280D, FI-280I, FI-370D, FI-370I, FI-4000D, FI-4000I, FI-460D, FI-460I, FI-550D, FI-550I, FI-6000D, FI-6000I		
<b>accessories for</b>	505260		
	<b>GEV No.</b>	502036	<b>Ref. No.</b> —
	O-ring EPDM thickness 2.62mm ID $\phi$ 28.25mm Qty 1 pcs		



1

<b>GEV No.</b>	505168	<b>Ref. No.</b>	12017869 Z400708
<b>description</b>	nut		
<b>For models:</b>	LVR-10, LVR-14, LVR-14D, LVR-20, LVR-20B, LVR-20D		



1

<b>GEV No.</b>	518080	<b>Ref. No.</b>	12023537 Z710708
<b>description</b>	nut thread 1 1/2" WS 50 duct thickness 15mm		
<b>For models:</b>	AD-120, AD-120B, AD-120BBTDD-UK, AD-120C, AD-120CW, AD-120HY, AD-90, AD-90BA, AD-90BBT, AD-90BDD, AD-90DD, ADE-120, ADE-120B, ECO-120, ECO-120B, ECO-160, ECO-160D, ECO-160I, ECO-200, ECO-200D, ECO-200H, ECO-200HD, ECO-200HI, ECO-200I, ECO-370D, ECO-370I, ECO-550D, ECO-550I, FI-100, FI-100AR, FI-100B, FI-100BBT-UK, FI-120, FI-120AR+DD, FI-120B, FI-120C, FI-120HY-CLINIC, FI-120W, FI-160, FI-160AR, FI-160D, FI-160I, FI-200, FI-200AR, FI-200D, FI-200H, FI-200HD, FI-200HI, FI-200I, FI-200W...(Other models you can see in the webshop)		
<b>spare parts for</b>	518080		
	<b>GEV No.</b>	507425	<b>Ref. No.</b> 12018740 Z710707
	duct D1 $\phi$ 38mm D2 $\phi$ 45mm L 72mm int. $\phi$ 1 31mm int. $\phi$ 2 39mm		



1

<b>GEV No.</b>	505184	<b>Ref. No.</b>	12024222 Z203013
<b>description</b>	eye bolt		
<b>For models:</b>	AD-120, AD-120B, AD-120BBTDD-UK, AD-120C, AD-120CW, AD-120HY, AD-15, AD-15D, AD-20C-UK, AD-21, AD-21B, AD-21BDD, AD-21C, AD-21D, AD-21DD, AD-21W, AD-45BBT, AD-48, AD-48B, AD-48BDD, AD-48C, AD-48D, AD-48DD, AD-48HY, AD-48W, AD-64, AD-64B, AD-64BBT, AD-64BDD, AD-64BTDD, AD-64C, AD-64CW, AD-64D, AD-64DD, AD-64HY, AD-72, AD-72W, AD-90, AD-90BA, AD-90BBT, AD-90BDD, AD-90DD, ADE-120, ADE-120B, EASY-500, EASY-500B, EASY-500DD, EASY-500HP, EASY-500HPWBDD, ECO-120...(Other models you can see in the webshop)		



1

<b>GEV No.</b>	505227	<b>Ref. No.</b>	12019816 Z270731
<b>description</b>	gasket for wash arm $\phi$ 55mm ID $\phi$ 39mm thickness 10mm		
<b>For models:</b>	ECO-160, ECO-160D, ECO-160I, ECO-200, ECO-200D, ECO-200H, ECO-200HD, ECO-200HI, ECO-200I, FI-160, FI-160D, FI-160I, FI-200, FI-200D, FI-200H, FI-200HD, FI-200HI, FI-200I, FI-200W		



1

<b>GEV No.</b>	505171	<b>Ref. No.</b>	12017466 12020831 12024375 Z200705
<b>description</b>	knurled nut thread M14x1 $\phi$ 35mm H 5mm SS		
<b>For models:</b>	AD-45BBT, AD-48, AD-48B, AD-48BDD, AD-48C, AD-48D, AD-48DD, AD-48HY, AD-48W, AD-64, AD-64B, AD-64BBT, AD-64BDD, AD-64BTDD, AD-64C, AD-64CW, AD-64D, AD-64DD, AD-64HY, AD-72, AD-72W, AD-90, AD-90BA, AD-90BBT, AD-90BDD, AD-90DD, EASY-500, EASY-500B, EASY-500DD, EASY-500HP, EASY-500HPWBDD, FI-30, FI-30AR, FI-30AR+DD, FI-30B, FI-30B-BT-UK, FI-30-UK, FI-48, FI-48AR, FI-48B, FI-48B-BT-UK, FI-48C, FI-48D, FI-48HY-CLINIC, FI-48W, FI-50, FI-60DD, FI-64, FI-64AR, FI-64B...(Other models you can see in the webshop)		



1

<b>GEV No.</b>	505089	<b>Ref. No.</b>	12017331 Z401913
<b>description</b>	rinse arm support mounting pos. upper		
<b>For models:</b>	LVR-10, LVR-14, LVR-20, LVR-20B		



1

<b>GEV No.</b>	505134	<b>Ref. No.</b>	12023115 12038952 Z821910
<b>description</b>	rinse arm support thread M23x1.75 L 61mm WS 32 hose $\phi$ 10mm		
<b>For models:</b>	ECO-1200, ECO-1600, ECO-2300, ECO-2700D, ECO-2700I, ECO-280D, ECO-280I, ECO-3000, ECO-370D, ECO-370I, ECO-4000D, ECO-4000I, ECO-460D, ECO-460I, ECO-550D, ECO-550I, ECO-6000D, ECO-6000I, FI-1200, FI-1600, FI-2300, FI-2700D, FI-2700I, FI-280D, FI-280I, FI-3000, FI-370D, FI-370I, FI-4000D, FI-4000I, FI-460D, FI-460I, FI-550D, FI-550I, FI-6000D, FI-6000I, FI-900		



Зип Общепит

vsezip.ru

+7(812)987-08-81

 <p>1</p>			
<b>GEV No.</b>	505034	<b>Ref. No.</b>	12009829 Q152016
<b>description</b>	Thumb screw thread M5 thread L 7mm ø 20mm H 3mm SS		
<b>For models:</b>	AD-120, AD-120B, AD-120BBTDD-UK, AD-120C, AD-120CW, AD-120HY, AD-15, AD-15D, AD-20C-UK, AD-21, AD-21B, AD-21BDD, AD-21C, AD-21D, AD-21DD, AD-21W, AD-45BBT, AD-48, AD-48B, AD-48BDD, AD-48C, AD-48D, AD-48DD, AD-48HY, AD-48W, AD-64, AD-64B, AD-64BBT, AD-64BDD, AD-64BTDD, AD-64C, AD-64CW, AD-64D, AD-64DD, AD-64HY, AD-72, AD-72W, AD-90, AD-90BA, AD-90BBT, AD-90BDD, AD-90DD, ADE-120, ADE-120B, CO-110, CO-110B, CO-110BDD, CO-110DD, CO-112, CO-112B...(Other models you can see in the webshop)		

 <p>1</p>			
<b>GEV No.</b>	501483	<b>Ref. No.</b>	12024859 Z310753
<b>description</b>	wash distributor 4-fold for dishwasher H 29mm ø 45mm ID ø 30mm hole ø 18mm thread L 20mm		
<b>For models:</b>	ECO-2700D, ECO-2700I, ECO-280D, ECO-280I, ECO-370D, ECO-370I, ECO-4000D, ECO-4000I, ECO-460D, ECO-460I, ECO-550D, ECO-550I, ECO-6000D, ECO-6000I, FI-2700D, FI-2700I, FI-280D, FI-280I, FI-370D, FI-370I, FI-4000D, FI-4000I, FI-460D, FI-460I, FI-550D, FI-550I, FI-6000D, FI-6000I		

 <p>1</p>			
<b>GEV No.</b>	505243	<b>Ref. No.</b>	12009769 Q223108
<b>description</b>	union nut ø 14mm thread M24x2.5		
<b>For models:</b>	ECO-160, ECO-160D, ECO-160I, ECO-200, ECO-200D, ECO-200H, ECO-200HD, ECO-200HI, ECO-200I, ECO-2700D, ECO-2700I, ECO-280D, ECO-280I, ECO-370D, ECO-370I, ECO-4000D, ECO-4000I, ECO-460D, ECO-460I, ECO-550D, ECO-550I, ECO-6000D, ECO-6000I, FI-160, FI-160AR, FI-160D, FI-160I, FI-200, FI-200AR, FI-200D, FI-200H, FI-200HD, FI-200HI, FI-200I, FI-200WL, FI-200WR, FI-2700D, FI-2700I, FI-280D, FI-280I, FI-370D, FI-370I, FI-4000D, FI-4000I, FI-460D, FI-460I, FI-550D, FI-550I, FI-6000D...(Other models you can see in the webshop)		

 <p>1</p>			
<b>GEV No.</b>	505181	<b>Ref. No.</b>	12024059 Z410711
<b>description</b>	wash pipe L 530mm		
<b>For models:</b>	AD-15, AD-15D, CO-350, CO-350-B, CO-350-B-DD, CO-350-COLD, CO-350-COLD-B, CO-350-COLD-B-DD, CO-350-COLD-DD, CO-350-DD, CO-352-COLD, CO-352-COLD-B, CO-352-COLD-B-DD, CO-352-COLD-DD, LVC-12, LVC-15, LVC-15D		

 <p>1</p>			
<b>GEV No.</b>	501546	<b>Ref. No.</b>	12048173
<b>description</b>	wash arm support mounting pos. upper ø 42mm H 78mm L1 340mm		
<b>For models:</b>	AD-125, AD-125HRS, AD-125-SOFT, CO-110, CO-110B, CO-110BDD, CO-110DD, CO-112, CO-112B, CO-112BDD, CO-112DD, CO-170, CO-170B, CO-170BDD, CO-170DD, CO-170HRS, CO-170HRSDD, CO-170HRS-SOFT, CO-170-SOFT, CO-172, CO-172B, CO-172BDD, CO-172DD, COP-173, COP-173B, COP-173BDD, COP-173DD, COP-173HRS, COP-173HRSDD, COP-173-SOFT, COP-174, COP-174B, COP-174BDD, COP-174DD, COP-174HRS, COP-174HRSDD		
<b>accessories for</b>	501546		
	<b>GEV No.</b>	<b>Ref. No.</b>	12049214
	O-ring EPDM thickness 3.53mm ID ø 13.87mm Qty 10 pcs		
	<b>GEV No.</b>	<b>Ref. No.</b>	12048366
	gasket L 118mm W 73mm H 9mm thickness 9mm		

 <p>1</p>			
<b>GEV No.</b>	505182	<b>Ref. No.</b>	12025154 Z440711
<b>description</b>	wash pipe L 605mm		
<b>For models:</b>	AD-20C-UK, AD-21, AD-21B, AD-21BDD, AD-21C, AD-21D, AD-21DD, AD-21W, CO-400, CO-400-B, CO-400-B-DD, CO-400-COLD, CO-400-COLD-B, CO-400-COLD-B-DD, CO-400-COLD-DD, CO-400-DD, CO-400-SOFT, CO-402-COLD, CO-402-COLD-B, CO-402-COLD-B-DD, CO-402-COLD-DD, CO-402W, LVC-21, LVC-21B, LVC-21C, LVC-21D, LVC-21W, MF-21		

 <p>1</p>			
<b>GEV No.</b>	505169	<b>Ref. No.</b>	12023699 Z200706
<b>description</b>	wash pipe L 681mm		
<b>For models:</b>	AD-45BBT, AD-48, AD-48B, AD-48BDD, AD-48C, AD-48D, AD-48DD, AD-48HY, AD-48W, AD-64, AD-64B, AD-64BBT, AD-64BDD, AD-64BTDD, AD-64C, AD-64CW, AD-64D, AD-64DD, AD-64HY, EASY-500, EASY-500B, EASY-500DD, EASY-500HP, EASY-500HPWBDD, FI-30, FI-30AR, FI-30AR+DD, FI-30B, FI-30B-BT-UK, FI-30-UK, FI-48, FI-48AR, FI-48B, FI-48B-BT-UK, FI-48C, FI-48D, FI-48HY-CLINIC, FI-48W, FI-50, FI-60DD, FI-64, FI-64AR, FI-64B, FI-64B-BT-UK, FI-64C, FI-64D, FI-64HY-CLINIC, FI-64W, MF-48, MF-64		

 <p>1</p>			
<b>GEV No.</b>	505188	<b>Ref. No.</b>	12024606 Z260701
<b>description</b>	wash pipe L 790mm		
<b>For models:</b>	AD-72, AD-72W, FI-72, FI-72AR, FI-72W		

Зип Общепит

vsezip.ru

8 (812) 987-08-81



1

<b>GEV No.</b>	505320	<b>Ref. No.</b>	12010593 12Z3107010
<b>description</b>	wash pipe mounting pos. lower ø 53mm L 40mm suitable for FAGOR		
<b>For models:</b>	ECO-280D, ECO-280I, ECO-370D, ECO-370I, ECO-460D, ECO-460I, ECO-550D, ECO-550I, FI-280D, FI-280I, FI-370D, FI-370I, FI-460D, FI-460I, FI-550D, FI-550I		



1

<b>GEV No.</b>	511991	<b>Ref. No.</b>	12006587 12Z7107090
<b>description</b>	wash pipe ø 38mm L 730mm SS		
<b>For models:</b>	AD-120, AD-120B, AD-120BBTDD-UK, AD-120C, AD-120CW, AD-120HY, AD-90, AD-90BA, AD-90BBT, AD-90BDD, AD-90DD, ADE-120, ADE-120B, ECO-120, ECO-120B, FI-100, FI-100AR, FI-100B, FI-100BBT-UK, FI-120, FI-120AR+DD, FI-120B, FI-120C, FI-120HY-CLINIC, FI-120W, FI-80, FI-80AR, FI-80BBT-UK, FI-80W, FI-E-100, LABP-1000, LABP-1200, LABP-800, MF-120		

## washing and rinsing systems (sorted by producer)

FAGOR



1

<b>GEV No.</b>	505038	<b>Ref. No.</b>	12011257 12025122 Z650716
<b>description</b>	wash arm L 490mm nozzles 9 mounting ø 32mm mounting pos. upper/lower		
<b>For models:</b>	AD-45BBT, AD-48, AD-48B, AD-48BDD, AD-48C, AD-48D, AD-48DD, AD-48HY, AD-48W, AD-505, AD-505-SOFT, AD-64, AD-64B, AD-64BBT, AD-64BDD, AD-64BTDD, AD-64C, AD-64CW, AD-64D, AD-64DD, AD-64HY, AD-72, AD-72W, AD-90, AD-90BA, AD-90BBT, AD-90BDD, AD-90DD, CO-110, CO-110B, CO-110BDD, CO-110DD, CO-112, CO-112B, CO-112BDD, CO-112DD, CO-500, CO-500B, CO-500BDD, CO-500DD, CO-501, CO-501B, CO-501BDD, CO-501DD, CO-501-SOFT, CO-502B, CO-502BDD, CO-502DD, CO-502W, COP-503...(Other models you can see in the webshop)		



<b>GEV No.</b>	505039	<b>Ref. No.</b>	12003421 12038375 12Z7107010
<b>description</b>	wash arm L 525mm nozzles 14 mounting ø 50mm mounting pos. upper/lower		
<b>For models:</b>	AD-120, AD-120B, AD-120BBTDD-UK, AD-120C, AD-120CW, AD-120HY, AD-125, AD-125HRS, AD-125-SOFT, ADE-120, ADE-120B, CO-142W, CO-142WDD, CO-170, CO-170B, CO-170BDD, CO-170DD, CO-170HRS, CO-170HRSDD, CO-170HRS-SOFT, CO-170-SOFT, CO-172, CO-172B, CO-172BDD, CO-172DD, COP-173, COP-173B, COP-173BDD, COP-173DD, COP-173HRS, COP-173HRSDD, COP-173-SOFT, COP-174, COP-174B, COP-174BDD, COP-174DD, COP-174HRS, COP-174HRSDD, COP-174W, COP-174WHRS, ECO-120, ECO-120B, FI-100, FI-100AR, FI-100B, FI-100BBT-UK, FI-120, FI-120AR+DD, FI-120B, FI-120C...(Other models you can see in the webshop)		



1

<b>GEV No.</b>	505031	<b>Ref. No.</b>	12023710 Z400711
<b>description</b>	opposite support		
<b>For models:</b>	AD-15, AD-15D, AD-20C-UK, AD-21, AD-21B, AD-21BDD, AD-21C, AD-21D, AD-21DD, AD-21W, CO-350, CO-350-B, CO-350-B-DD, CO-350-COLD, CO-350-COLD-B, CO-350-COLD-B-DD, CO-350-COLD-DD, CO-350-DD, CO-352-COLD, CO-352-COLD-B, CO-352-COLD-B-DD, CO-352-COLD-DD, CO-400, CO-400-B, CO-400-B-DD, CO-400-COLD, CO-400-COLD-B, CO-400-COLD-B-DD, CO-400-COLD-DD, CO-400-DD, CO-400-SOFT, CO-402-COLD, CO-402-COLD-B, CO-402-COLD-B-DD, CO-402-COLD-DD, CO-402W, ECO-2700D, ECO-2700I, ECO-280D, ECO-280I, ECO-370D, ECO-370I, ECO-4000D, ECO-4000I, ECO-460D, ECO-460I, ECO-550D, ECO-550I, ECO-6000D, ECO-6000I...(Other models you can see in the webshop)		



1

<b>GEV No.</b>	505046	<b>Ref. No.</b>	12024006 Z201906
<b>description</b>	opposite support rinse jet		
<b>For models:</b>	AD-15, AD-15D, AD-90, AD-90BA, AD-90BDD, AD-90DD, FI-30, FI-30AR, FI-30AR+DD, FI-30B, FI-30B-BT-UK, FI-30-UK, FI-48, FI-48AR, FI-48B, FI-48B-BT-UK, FI-48C, FI-48D, FI-48HY-CLINIC, FI-48W, FI-60DD, FI-80, FI-80AR, FI-80W, FI-E-100, LABP-800, LVC-12, LVC-15, LVC-15D, LVC-21, LVC-21B, LVC-21C, LVC-21D, LVC-21W, LVR-10, LVR-14, LVR-20, LVR-20B, MF-21		



1

<b>GEV No.</b>	505045	<b>Ref. No.</b>	12009912 Q307036
<b>description</b>	O-ring EPDM thickness 1.78mm ID ø 5.28mm Qty 1 pcs		
<b>For models:</b>	AD-15, AD-15D, AD-90, AD-90BA, AD-90BDD, AD-90DD, COG-202, EASY-500, EASY-500B, EASY-500DD, EASY-500HP, EASY-500HPWBDD, FI-30, FI-30AR, FI-30AR+DD, FI-30B, FI-30B-BT-UK, FI-30-UK, FI-48, FI-48AR, FI-48B, FI-48B-BT-UK, FI-48C, FI-48D, FI-48HY-CLINIC, FI-48W, FI-60DD, FI-80, FI-80AR, FI-80W, FI-E-100, HGC-20-21, HGP-10-21, HGP-20-21, HGV-20-21, LABP-800, LF-13MPP, LF-18MPP, LF-25MPP, LF-8MPP, LVC-12, LVC-15, LVC-15D, LVC-21, LVC-21B, LVC-21D, LVC-21W, LVR-10, LVR-14, LVR-20...(Other models you can see in the webshop)		







Зип Общепит  
vsezip.ru  
+7(812)987-08-81

			
1			
<b>GEV No.</b>	505065	<b>Ref. No.</b>	12020476 Z411902
<b>description</b>	rinse arm		
<b>For models:</b>	CO-350, CO-350-B, CO-350-B-DD, CO-350-COLD, CO-350-COLD-B, CO-350-COLD-B-DD, CO-350-COLD-DD, CO-350-DD, CO-352-COLD, CO-352-COLD-B, CO-352-COLD-B-DD, CO-352-COLD-DD, LVC-12, LVC-15, LVC-15D		

			
1			
<b>GEV No.</b>	505064	<b>Ref. No.</b>	12022710 Z441902
<b>description</b>	rinse arm L 166mm nozzles 3 mounting ø 11.5mm mounting pos. „B”		
<b>For models:</b>	AD-20C-UK, AD-21, AD-21B, AD-21BDD, AD-21C, AD-21D, AD-21DD, AD-21W, CO-400, CO-400-B, CO-400-B-DD, CO-400-COLD, CO-400-COLD-B, CO-400-COLD-B-DD, CO-400-COLD-DD, CO-400-DD, CO-400-SOFT, CO-402-COLD, CO-402-COLD-B, CO-402-COLD-B-DD, CO-402-COLD-DD, CO-402W, LVC-15D, LVC-21, LVC-21B, LVC-21C, LVC-21D, LVC-21W, MF-21		

			
1			
<b>GEV No.</b>	505042	<b>Ref. No.</b>	12025253 Z461902
<b>description</b>	rinse arm L 144mm nozzles 2 mounting ø 11.7mm mounting pos. „A”		
<b>For models:</b>	AD-15, AD-15D, LVC-12, LVC-15, LVC-15D		

			
1			
<b>GEV No.</b>	505044	<b>Ref. No.</b>	12024077 Z201905
<b>description</b>	rinse jet		
<b>For models:</b>	AD-15, AD-15D, AD-90, AD-90BA, AD-90BBT, AD-90BDD, AD-90DD, EASY-500, EASY-500B, EASY-500DD, EASY-500HP, EASY-500HPWBDD, FI-30, FI-30AR, FI-30AR+DD, FI-30B, FI-30B-BT-UK, FI-30-UK, FI-48, FI-48AR, FI-48B, FI-48B-BT-UK, FI-48C, FI-48D, FI-48HY-CLINIC, FI-48W, FI-60DD, FI-80, FI-80AR, FI-80BBT-UK, FI-80W, FI-E-100, LABP-800, LVC-12, LVC-15, LVC-15D, LVC-21, LVC-21B, LVC-21C, LVC-21D, LVC-21W, LVR-10, LVR-14, LVR-20, LVR-20B, MF-21		
<b>accessories for</b>	505044		

			
1			
<b>GEV No.</b>	505063	<b>Ref. No.</b>	12024137 Z461901
<b>description</b>	rinse arm L 144mm nozzles 2 mounting ø 7mm mounting pos. „B”		
<b>For models:</b>	AD-15, AD-15D, LVC-12, LVC-15, LVC-15D		

<b>GEV No.</b>	505045	<b>Ref. No.</b>	12009912 Q307036
<b>description</b>	O-ring EPDM thickness 1.78mm ID ø 5.28mm Qty 1 pcs		
<b>GEV No.</b>	505046	<b>Ref. No.</b>	12024006 Z201906
<b>description</b>	opposite support rinse jet		

			
1			
<b>GEV No.</b>	505066	<b>Ref. No.</b>	12020475 Z411901
<b>description</b>	rinse arm L 145mm		
<b>For models:</b>	CO-350, CO-350-B, CO-350-B-DD, CO-350-COLD, CO-350-COLD-B, CO-350-COLD-B-DD, CO-350-COLD-DD, CO-350-DD, CO-352-COLD, CO-352-COLD-B, CO-352-COLD-B-DD, CO-352-COLD-DD, LVC-12, LVC-15, LVC-15D		

			
1			
<b>GEV No.</b>	505103	<b>Ref. No.</b>	12024252 Z211903
<b>description</b>	rinse jet		
<b>For models:</b>	AD-120, AD-120B, AD-120BBTDD-UK, AD-120C, AD-120CW, AD-120HY, AD-20C-UK, AD-21, AD-21B, AD-21BDD, AD-21C, AD-21D, AD-21DD, AD-21W, AD-45BBT, AD-48, AD-48B, AD-48BDD, AD-48C, AD-48D, AD-48DD, AD-48HY, AD-48W, AD-64, AD-64B, AD-64BBT, AD-64BDD, AD-64BTDD, AD-64C, AD-64CW, AD-64D, AD-64DD, AD-64HY, AD-72, AD-72W, AD-90, AD-90BA, AD-90BDD, AD-90DD, ADE-120, ADE-120B, CO-110, CO-110B, CO-110BDD, CO-110DD, CO-112, CO-112B, CO-112BDD, CO-112DD, CO-142W...(Other models you can see in the webshop)		

			
1			
<b>GEV No.</b>	505043	<b>Ref. No.</b>	12022613 Z441901
<b>description</b>	rinse arm L 166mm nozzles 2 mounting ø 11.5mm mounting pos. „A”		
<b>For models:</b>	AD-20C-UK, AD-21, AD-21B, AD-21BDD, AD-21C, AD-21D, AD-21DD, AD-21W, CO-400, CO-400-B, CO-400-B-DD, CO-400-COLD, CO-400-COLD-B, CO-400-COLD-B-DD, CO-400-COLD-DD, CO-400-DD, CO-400-SOFT, CO-402-COLD, CO-402-COLD-B, CO-402-COLD-B-DD, CO-402-COLD-DD, CO-402W, LVC-15D, LVC-21, LVC-21B, LVC-21C, LVC-21D, LVC-21W, MF-21		

			
1			
<b>GEV No.</b>	505147	<b>Ref. No.</b>	12019827 Z410706
<b>description</b>	wash arm		
<b>For models:</b>	CO-350, CO-350-B, CO-350-B-DD, CO-350-COLD, CO-350-COLD-B, CO-350-COLD-B-DD, CO-350-COLD-DD, CO-350-DD, CO-352-COLD, CO-352-COLD-B, CO-352-COLD-B-DD, CO-352-COLD-DD, LVC-12, LVC-15, LVC-15D		

mechanical components, equipment accessories

Зип Общепит

vsezip.ru

+7(812)987-08-81



1

<b>GEV No.</b>	505054	<b>Ref. No.</b>	12025251 Z460701
<b>description</b>	wash arm L 140mm nozzles 2 mounting ø 21.5mm mounting pos. „B“		
<b>For models:</b>	AD-15, AD-15D, LVC-12, LVC-15, LVC-15D		



1

<b>GEV No.</b>	505036	<b>Ref. No.</b>	12024138 Z460702
<b>description</b>	wash arm L 140mm nozzles 3 mounting ø 21.5mm mounting pos. „A“		
<b>For models:</b>	AD-15, AD-15D, LVC-12, LVC-15, LVC-15D		



1

<b>GEV No.</b>	505037	<b>Ref. No.</b>	12022381 Z440706
<b>description</b>	wash arm L 163mm nozzles 3 mounting ø 18mm mounting pos. „A“		
<b>For models:</b>	AD-20C-UK, AD-21, AD-21B, AD-21BDD, AD-21C, AD-21D, AD-21DD, AD-21W, CO-400, CO-400-B, CO-400-B-DD, CO-400-COLD, CO-400-COLD-B, CO-400-COLD-B-DD, CO-400-COLD-DD, CO-400-DD, CO-400-SOFT, CO-402-COLD, CO-402-COLD-B, CO-402-COLD-B-DD, CO-402-COLD-DD, CO-402W, LVC-21, LVC-21B, LVC-21C, LVC-21D, LVC-21W, MF-21		



1

<b>GEV No.</b>	505055	<b>Ref. No.</b>	12022382 Z440707
<b>description</b>	wash arm L 163mm nozzles 3 mounting ø 18mm mounting pos. „B“		
<b>For models:</b>	AD-20C-UK, AD-21, AD-21B, AD-21BDD, AD-21C, AD-21D, AD-21DD, AD-21W, CO-400, CO-400-B, CO-400-B-DD, CO-400-COLD, CO-400-COLD-B, CO-400-COLD-B-DD, CO-400-COLD-DD, CO-400-DD, CO-400-SOFT, CO-402-COLD, CO-402-COLD-B, CO-402-COLD-B-DD, CO-402-COLD-DD, CO-402W, LVC-21, LVC-21B, LVC-21C, LVC-21D, LVC-21W, MF-21		



1

<b>GEV No.</b>	505068	<b>Ref. No.</b>	12025216 Z410704
<b>description</b>	wash arm boss		

**For models:** AD-15, AD-15D, AD-20C-UK, AD-21, AD-21B, AD-21BDD, AD-21C, AD-21D, AD-21DD, AD-21W, CO-350, CO-350-B, CO-350-B-DD, CO-350-COLD, CO-350-COLD-B, CO-350-COLD-B-DD, CO-350-COLD-DD, CO-350-DD, CO-352-COLD, CO-352-COLD-B, CO-352-COLD-B-DD, CO-352-COLD-DD, CO-400, CO-400-B, CO-400-B-DD, CO-400-COLD, CO-400-COLD-B, CO-400-COLD-B-DD, CO-400-COLD-DD, CO-400-DD, CO-400-SOFT, CO-402-COLD, CO-402-COLD-B, CO-402-COLD-B-DD, CO-402-COLD-DD, CO-402W, LVC-12, LVC-15, LVC-15D, LVC-21, LVC-21B, LVC-21C, LVC-21D, LVC-21W, MF-21

**accessories for** 505068



<b>GEV No.</b>	505035	<b>Ref. No.</b>	12024086 Z410705
bushing			



1

<b>GEV No.</b>	505033	<b>Ref. No.</b>	12023732 Z400709
<b>description</b>	wash jet		

**For models:** AD-15, AD-15D, AD-20C-UK, AD-21, AD-21B, AD-21BDD, AD-21C, AD-21D, AD-21DD, AD-21W, CO-350, CO-350-B, CO-350-B-DD, CO-350-COLD, CO-350-COLD-B, CO-350-COLD-B-DD, CO-350-COLD-DD, CO-350-DD, CO-352-COLD, CO-352-COLD-B, CO-352-COLD-B-DD, CO-352-COLD-DD, CO-400, CO-400-B, CO-400-B-DD, CO-400-COLD, CO-400-COLD-B, CO-400-COLD-B-DD, CO-400-COLD-DD, CO-400-DD, CO-400-SOFT, CO-402-COLD, CO-402-COLD-B, CO-402-COLD-B-DD, CO-402-COLD-DD, CO-402W, LVC-12, LVC-15, LVC-15D, LVC-21, LVC-21B, LVC-21C, LVC-21D, LVC-21W, LVR-10, LVR-14, LVR-14D, LVR-20, LVR-20B, LVR-20D...(Other models you can see in the webshop)

**accessories for** 505033



<b>GEV No.</b>	505031	<b>Ref. No.</b>	12023710 Z400711
opposite support			



1

<b>GEV No.</b>	505046	<b>Ref. No.</b>	12024006 Z201906
<b>description</b>	opposite support rinse jet		

**For models:** AD-15, AD-15D, AD-90, AD-90BA, AD-90BDD, AD-90DD, FI-30, FI-30AR, FI-30AR+DD, FI-30B, FI-30B-BT-UK, FI-30-UK, FI-48, FI-48AR, FI-48B, FI-48B-BT-UK, FI-48C, FI-48D, FI-48HY-CLINIC, FI-48W, FI-60DD, FI-80, FI-80AR, FI-80W, FI-E-100, LABP-800, LVC-12, LVC-15, LVC-15D, LVC-21, LVC-21B, LVC-21C, LVC-21D, LVC-21W, LVR-10, LVR-14, LVR-20, LVR-20B, MF-21



Зип Общепит



vsezip.ru

2)987-08-81

1 			
<b>GEV No.</b>	505045	<b>Ref. No.</b>	12009912 Q307036
<b>description</b>	O-ring EPDM thickness 1.78mm ID ø 5.28mm Qty 1 pcs		
<b>For models:</b>	AD-15, AD-15D, AD-90, AD-90BA, AD-90BDD, AD-90DD, CO-120, EASY-500, EASY-500B, EASY-500DD, EASY-500HP, EASY-500HPWBDD, FI-30, FI-30AR, FI-30AR+DD, FI-30B, FI-30B-BT-UK, FI-30-UK, FI-48, FI-48AR, FI-48B, FI-48B-BT-UK, FI-48C, FI-48D, FI-48HY-CLINIC, FI-48W, FI-60DD, FI-80, FI-80AR, FI-80W, FI-E-100, HGC-20-21, HGP-10-21, HGP-20-21, HGV-20-21, LABP-800, LF-13MPP, LF-18MPP, LF-25MPP, LF-8MPP, LVC-12, LVC-15, LVC-15D, LVC-21, LVC-21B, LVC-21D, LVC-21W, LVR-10, LVR-14, LVR-20...(Other models you can see in the webshop)		

2 			
<b>GEV No.</b>	505069	<b>Ref. No.</b>	12024470 Z201903
<b>description</b>	rinse arm, loss mounting pos. upper/lower ø 12mm H 22mm L 59mm		
<b>For models:</b>	AD-120, AD-120B, AD-120BBTDD-UK, AD-120C, AD-120CW, AD-120HY, AD-45BBT, AD-48, AD-48B, AD-48BDD, AD-48C, AD-48D, AD-48DD, AD-48HY, AD-48W, AD-64, AD-64B, AD-64BBT, AD-64BDD, AD-64BTDD, AD-64C, AD-64CW, AD-64D, AD-64DD, AD-64HY, AD-72, AD-72W, AD-90, AD-90BA, AD-90BBT, AD-90BDD, AD-90DD, ADE-120, ADE-120B, CO-110, CO-110B, CO-110BDD, CO-110DD, CO-112, CO-112B, CO-112BDD, CO-112DD, CO-142W, CO-142WDD, CO-170, CO-170B, CO-170BDD, CO-170DD, CO-170HRS, CO-170HRSDD...(Other models you can see in the webshop)		
<b>accessories for</b>	505069		
	<b>GEV No.</b>	560076	<b>Ref. No.</b>
			12009852 12010293 Q152024
countersunk screw thread M4 L 10mm SS DIN 963/ISO 2009 Qty 20 pcs intake slotted head ø 7.5mm			

2 			
<b>GEV No.</b>	505061	<b>Ref. No.</b>	12022442 12113596 Z201902
<b>description</b>	rinse arm L 220mm nozzles 3 mounting ø 11.7mm mounting pos. left		
<b>For models:</b>	AD-120, AD-120B, AD-120BBTDD-UK, AD-120C, AD-120CW, AD-120HY, AD-45BBT, AD-48, AD-48B, AD-48BDD, AD-48C, AD-48D, AD-48DD, AD-48HY, AD-48W, AD-64, AD-64B, AD-64BBT, AD-64BDD, AD-64BTDD, AD-64C, AD-64CW, AD-64D, AD-64DD, AD-64HY, AD-72, AD-72W, AD-90, AD-90BA, AD-90BBT, AD-90BDD, AD-90DD, ADE-120, ADE-120B, CO-110, CO-110B, CO-110BDD, CO-110DD, CO-112, CO-112B, CO-112BDD, CO-112DD, CO-142W, CO-142WDD, CO-170, CO-170B, CO-170BDD, CO-170DD, CO-170HRS, CO-170HRSDD...(Other models you can see in the webshop)		

1 			
<b>GEV No.</b>	505044	<b>Ref. No.</b>	12024077 Z201905
<b>description</b>	rinse jet		
<b>For models:</b>	AD-15, AD-15D, AD-90, AD-90BA, AD-90BBT, AD-90BDD, AD-90DD, EASY-500, EASY-500B, EASY-500DD, EASY-500HP, EASY-500HPWBDD, FI-30, FI-30AR, FI-30AR+DD, FI-30B, FI-30B-BT-UK, FI-30-UK, FI-48, FI-48AR, FI-48B, FI-48B-BT-UK, FI-48C, FI-48D, FI-48HY-CLINIC, FI-48W, FI-60DD, FI-80, FI-80AR, FI-80BBT-UK, FI-80W, FI-E-100, LABP-800, LVC-12, LVC-15, LVC-15D, LVC-21, LVC-21B, LVC-21C, LVC-21D, LVC-21W, LVR-10, LVR-14, LVR-20, LVR-20B, MF-21		
<b>accessories for</b>	505044		
	<b>GEV No.</b>	505045	<b>Ref. No.</b>
			12009912 Q307036
O-ring EPDM thickness 1.78mm ID ø 5.28mm Qty 1 pcs			
	<b>GEV No.</b>	505046	<b>Ref. No.</b>
			12024006 Z201906
opposite support rinse jet			

1 			
<b>GEV No.</b>	505062	<b>Ref. No.</b>	12022441 12113595 Z201901
<b>description</b>	rinse arm L 220mm nozzles 3 mounting ø 12mm mounting pos. right		
<b>For models:</b>	AD-120, AD-120B, AD-120BBTDD-UK, AD-120C, AD-120CW, AD-120HY, AD-45BBT, AD-48, AD-48B, AD-48BDD, AD-48C, AD-48D, AD-48DD, AD-48HY, AD-48W, AD-64, AD-64B, AD-64BBT, AD-64BDD, AD-64BTDD, AD-64C, AD-64CW, AD-64D, AD-64DD, AD-64HY, AD-72, AD-72W, AD-90, AD-90BA, AD-90BBT, AD-90BDD, AD-90DD, ADE-120, ADE-120B, CO-110, CO-110B, CO-110BDD, CO-110DD, CO-112, CO-112B, CO-112BDD, CO-112DD, CO-142W, CO-142WDD, CO-170, CO-170B, CO-170BDD, CO-170DD, CO-170HRS, CO-170HRSDD...(Other models you can see in the webshop)		

1 			
<b>GEV No.</b>	505136	<b>Ref. No.</b>	12018104 Z680742
<b>description</b>	wash arm L 225mm nozzles 4 ø 25mm		
<b>For models:</b>	ECO-1200, FI-1200, FI-900		

1 			
<b>GEV No.</b>	505217	<b>Ref. No.</b>	12018636 Z680741
<b>description</b>	wash arm L 225mm nozzles 4 ø 25mm		
<b>For models:</b>	ECO-1200, FI-1200, FI-900		

mechanical components, equipment accessories

Зип Общепит

vsezip.ru

+7(812)987-08-81



1

<b>GEV No.</b>	505216	<b>Ref. No.</b>	12039835 Z680745
<b>description</b>	wash arm boss L 90mm W 90mm H 38mm		
<b>For models:</b>	ECO-1200, FI-1200, FI-900		



1

<b>GEV No.</b>	505267	<b>Ref. No.</b>	12017814 Z600705
<b>description</b>	wash jet for pipe ø 25mm		
<b>For models:</b>	ECO-1200, FI-1200, FI-900		



1

<b>GEV No.</b>	505046	<b>Ref. No.</b>	12024006 Z201906
<b>description</b>	opposite support rinse jet		
<b>For models:</b>	AD-15, AD-15D, AD-90, AD-90BA, AD-90BDD, AD-90DD, FI-30, FI-30AR, FI-30AR+DD, FI-30B, FI-30B-BT-UK, FI-30-UK, FI-48, FI-48AR, FI-48B, FI-48B-BT-UK, FI-48C, FI-48D, FI-48HY-CLINIC, FI-48W, FI-60DD, FI-80, FI-80AR, FI-80W, FI-E-100, LABP-800, LVC-12, LVC-15, LVC-15D, LVC-21, LVC-21B, LVC-21C, LVC-21D, LVC-21W, LVR-10, LVR-14, LVR-20, LVR-20B, MF-21		



1

<b>GEV No.</b>	505045	<b>Ref. No.</b>	12009912 Q307036
<b>description</b>	O-ring EPDM thickness 1.78mm ID ø 5.28mm Qty 1 pcs		
<b>For models:</b>	AD-15, AD-15D, AD-90, AD-90BA, AD-90BDD, AD-90DD, COG-202, EASY-500, EASY-500B, EASY-500DD, EASY-500HP, EASY-500HPWBDD, FI-30, FI-30AR, FI-30AR+DD, FI-30B, FI-30B-BT-UK, FI-30-UK, FI-48, FI-48AR, FI-48B, FI-48B-BT-UK, FI-48C, FI-48D, FI-48HY-CLINIC, FI-48W, FI-60DD, FI-80, FI-80AR, FI-80W, FI-E-100, HGC-20-21, HGP-10-21, HGP-20-21, HGV-20-21, LABP-800, LF-13MPP, LF-18MPP, LF-25MPP, LF-8MPP, LVC-12, LVC-15, LVC-15D, LVC-21, LVC-21B, LVC-21D, LVC-21W, LVR-10, LVR-14, LVR-20...(Other models you can see in the webshop)		



1

<b>GEV No.</b>	505067	<b>Ref. No.</b>	12017301 Z401915
<b>description</b>	rinse arm mounting pos. upper/lower L 157mm mounting ø 11.5mm nozzles 4		
<b>For models:</b>	LVR-10, LVR-14		



1

<b>GEV No.</b>	505090	<b>Ref. No.</b>	12040402 Z421904
<b>description</b>	rinse arm mounting pos. upper/lower L 175mm mounting ø 10mm nozzles 5		
<b>For models:</b>	LVR-20, LVR-20B		



1

<b>GEV No.</b>	505044	<b>Ref. No.</b>	12024077 Z201905
<b>description</b>	rinse jet		
<b>For models:</b>	AD-15, AD-15D, AD-90, AD-90BA, AD-90BBT, AD-90BDD, AD-90DD, EASY-500, EASY-500B, EASY-500DD, EASY-500HP, EASY-500HPWBDD, FI-30, FI-30AR, FI-30AR+DD, FI-30B, FI-30B-BT-UK, FI-30-UK, FI-48, FI-48AR, FI-48B, FI-48B-BT-UK, FI-48C, FI-48D, FI-48HY-CLINIC, FI-48W, FI-60DD, FI-80, FI-80AR, FI-80BBT-UK, FI-80W, FI-E-100, LABP-800, LVC-12, LVC-15, LVC-15D, LVC-21, LVC-21B, LVC-21C, LVC-21D, LVC-21W, LVR-10, LVR-14, LVR-20, LVR-20B, MF-21		

<b>accessories for</b>	505044	<b>GEV No.</b>	505045	<b>Ref. No.</b>	12009912 Q307036
O-ring EPDM thickness 1.78mm ID ø 5.28mm Qty 1 pcs					
		<b>GEV No.</b>	505046	<b>Ref. No.</b>	12024006 Z201906
opposite support rinse jet					



1

<b>GEV No.</b>	505046	<b>Ref. No.</b>	12024006 Z201906
<b>description</b>	opposite support rinse jet		
<b>For models:</b>	AD-15, AD-15D, AD-90, AD-90BA, AD-90BDD, AD-90DD, FI-30, FI-30AR, FI-30AR+DD, FI-30B, FI-30B-BT-UK, FI-30-UK, FI-48, FI-48AR, FI-48B, FI-48B-BT-UK, FI-48C, FI-48D, FI-48HY-CLINIC, FI-48W, FI-60DD, FI-80, FI-80AR, FI-80W, FI-E-100, LABP-800, LVC-12, LVC-15, LVC-15D, LVC-21, LVC-21B, LVC-21C, LVC-21D, LVC-21W, LVR-10, LVR-14, LVR-20, LVR-20B, MF-21		



1

<b>GEV No.</b>	505045	<b>Ref. No.</b>	12009912 Q307036
<b>description</b>	O-ring EPDM thickness 1.78mm ID ø 5.28mm Qty 1 pcs		
<b>For models:</b>	AD-15, AD-15D, AD-90, AD-90BA, AD-90BDD, AD-90DD, COG-202, EASY-500, EASY-500B, EASY-500DD, EASY-500HP, EASY-500HPWBDD, FI-30, FI-30AR, FI-30AR+DD, FI-30B, FI-30B-BT-UK, FI-30-UK, FI-48, FI-48AR, FI-48B, FI-48B-BT-UK, FI-48C, FI-48D, FI-48HY-CLINIC, FI-48W, FI-60DD, FI-80, FI-80AR, FI-80W, FI-E-100, HGC-20-21, HGP-10-21, HGP-20-21, HGV-20-21, LABP-800, LF-13MPP, LF-18MPP, LF-25MPP, LF-8MPP, LVC-12, LVC-15, LVC-15D, LVC-21, LVC-21B, LVC-21D, LVC-21W, LVR-10, LVR-14, LVR-20...(Other models you can see in the webshop)		





Зип Общепит



vsezip.ru

+7(812)987-08-81

			
1			
<b>GEV No.</b>	505265	<b>Ref. No.</b>	12023524 Z208712
<b>description</b>	rinse arm L 230mm nozzles 3		
<b>For models:</b>	AD-90, AD-90BA, AD-90BBT, AD-90BDD, AD-90DD, EASY-500, EASY-500B, EASY-500DD, EASY-500HP, EASY-500HPWBDD, FI-30, FI-30AR, FI-30AR+DD, FI-30B, FI-30B-BT-UK, FI-30-UK, FI-48, FI-48AR, FI-48B, FI-48B-BT-UK, FI-48C, FI-48D, FI-48HY-CLINIC, FI-48W, FI-60DD, FI-80, FI-80AR, FI-80W, FI-E-100, LABP-800		

			
1			
<b>GEV No.</b>	505266	<b>Ref. No.</b>	12023527 Z208713
<b>description</b>	rinse arm L 230mm nozzles 3 right		
<b>For models:</b>	AD-90, AD-90BA, AD-90BBT, AD-90BDD, AD-90DD, EASY-500, EASY-500B, EASY-500DD, EASY-500HP, EASY-500HPWBDD, FI-30, FI-30AR, FI-30AR+DD, FI-30B, FI-30B-BT-UK, FI-30-UK, FI-48, FI-48AR, FI-48B, FI-48B-BT-UK, FI-48C, FI-48D, FI-48HY-CLINIC, FI-48W, FI-60DD, FI-80, FI-80AR, FI-80W, FI-E-100, LABP-800		

			
1			
<b>GEV No.</b>	505069	<b>Ref. No.</b>	12024470 Z201903
<b>description</b>	rinse arm boss mounting pos. upper/lower ø 12mm H 22mm L 59mm		
<b>For models:</b>	AD-120, AD-120B, AD-120BBTDD-UK, AD-120C, AD-120CW, AD-120HY, AD-45BBT, AD-48, AD-48B, AD-48BDD, AD-48C, AD-48D, AD-48DD, AD-48HY, AD-48W, AD-64, AD-64B, AD-64BBT, AD-64BDD, AD-64BTDD, AD-64C, AD-64CW, AD-64D, AD-64DD, AD-64HY, AD-72, AD-72W, AD-90, AD-90BA, AD-90BBT, AD-90BDD, AD-90DD, ADE-120, ADE-120B, CO-110, CO-110B, CO-110BDD, CO-110DD, CO-112, CO-112B, CO-112BDD, CO-112DD, CO-142W, CO-142WDD, CO-170, CO-170B, CO-170BDD, CO-170DD, CO-170HRS, CO-170HRSDD...(Other models you can see in the webshop)		
<b>accessories for</b>	505069		
	<b>GEV No.</b>	560076	<b>Ref. No.</b>
			12009852 12010293 Q152024
	countersunk screw thread M4 L 10mm SS DIN 963/ISO 2009 Qty 20 pcs intake slotted head ø 7.5mm		

			
1			
<b>GEV No.</b>	505044	<b>Ref. No.</b>	12024077 Z201905
<b>description</b>	rinse jet		
<b>For models:</b>	AD-15, AD-15D, AD-90, AD-90BA, AD-90BBT, AD-90BDD, AD-90DD, EASY-500, EASY-500B, EASY-500DD, EASY-500HP, EASY-500HPWBDD, FI-30, FI-30AR, FI-30AR+DD, FI-30B, FI-30B-BT-UK, FI-30-UK, FI-48, FI-48AR, FI-48B, FI-48B-BT-UK, FI-48C, FI-48D, FI-48HY-CLINIC, FI-48W, FI-60DD, FI-80, FI-80AR, FI-80BBT-UK, FI-80W, FI-E-100, LABP-800, LVC-12, LVC-15, LVC-15D, LVC-21, LVC-21B, LVC-21C, LVC-21D, LVC-21W, LVR-10, LVR-14, LVR-20, LVR-20B, MF-21		
<b>accessories for</b>	505044		
	<b>GEV No.</b>	505045	<b>Ref. No.</b>
			12009912 Q307036
	O-ring EPDM thickness 1.78mm ID ø 5.28mm Qty 1 pcs		

			
<b>GEV No.</b>	505046	<b>Ref. No.</b>	12024006 Z201906
<b>description</b>	opposite support rinse jet		

			
1			
<b>GEV No.</b>	507537	<b>Ref. No.</b>	12007166 12Z3119100
<b>description</b>	rinse arm W 630mm H 645mm nozzles 12		
<b>For models:</b>	ECO-280D, ECO-280I, ECO-370D, ECO-370I, ECO-460D, ECO-460I, ECO-550D, ECO-550I, FI-280D, FI-280I, FI-370D, FI-370I, FI-460D, FI-460I, FI-550D, FI-550I		

			
1			
<b>GEV No.</b>	505031	<b>Ref. No.</b>	12023710 Z400711
<b>description</b>	opposite support		
<b>For models:</b>	AD-15, AD-15D, AD-20C-UK, AD-21, AD-21B, AD-21BDD, AD-21C, AD-21D, AD-21DD, AD-21W, CO-350, CO-350-B, CO-350-B-DD, CO-350-COLD, CO-350-COLD-B, CO-350-COLD-B-DD, CO-350-COLD-DD, CO-350-DD, CO-352-COLD, CO-352-COLD-B, CO-352-COLD-B-DD, CO-352-COLD-DD, CO-400, CO-400-B, CO-400-B-DD, CO-400-COLD, CO-400-COLD-B, CO-400-COLD-B-DD, CO-400-COLD-DD, CO-400-DD, CO-400-SOFT, CO-402-COLD, CO-402-COLD-B, CO-402-COLD-B-DD, CO-402-COLD-DD, CO-402W, ECO-2700D, ECO-2700I, ECO-280D, ECO-280I, ECO-370D, ECO-370I, ECO-4000D, ECO-4000I, ECO-460D, ECO-460I, ECO-550D, ECO-550I, ECO-6000D, ECO-6000I...(Other models you can see in the webshop)		

			
1			
<b>GEV No.</b>	505231	<b>Ref. No.</b>	12021106 Z791931
<b>description</b>	rinse jet ø 14mm H 22mm thread M10x0.9		
<b>For models:</b>	ECO-1600, ECO-2300, ECO-3000, FI-1600, FI-2300, FI-3000		

			
1			
<b>GEV No.</b>	505258	<b>Ref. No.</b>	12023568 Z311831
<b>description</b>	wash jet		
<b>For models:</b>	ECO-2700D, ECO-2700I, ECO-280D, ECO-280I, ECO-370D, ECO-370I, ECO-4000D, ECO-4000I, ECO-460D, ECO-460I, ECO-550D, ECO-550I, ECO-6000D, ECO-6000I, FI-2700D, FI-2700I, FI-280D, FI-280I, FI-370D, FI-370I, FI-4000D, FI-4000I, FI-460D, FI-460I, FI-550D, FI-550I, FI-6000D, FI-6000I		

			
1			
<b>GEV No.</b>	505324	<b>Ref. No.</b>	12017004 Z100707
<b>description</b>	end cap for wash arm screw mounting H 13mm WS 42		
<b>For models:</b>	ECO-1600, ECO-2300, ECO-3000, FI-1600, FI-2300, FI-3000		

mechanical components, equipment accessories

Зип Общепит

vsezip.ru

+7(812)987-08-81



1

<b>GEV No.</b>	505233	<b>Ref. No.</b>	12020338 Z100700
<b>description</b>	wash arm with flange L 180mm		
<b>For models:</b>	ECO-1600, ECO-2300, ECO-3000, FI-1600, FI-2300, FI-3000		



1

<b>GEV No.</b>	505319	<b>Ref. No.</b>	12020529 Z100705
<b>description</b>	wash arm with flange L 255mm nozzles 3		
<b>For models:</b>	ECO-1600, ECO-2300, ECO-3000, FI-1600, FI-2300, FI-3000		

**accessories for** 505319



<b>GEV No.</b>	505324	<b>Ref. No.</b>	12017004 Z100707
----------------	--------	-----------------	---------------------

end cap for wash arm screw mounting H 13mm WS 42



<b>GEV No.</b>	510116	<b>Ref. No.</b>	12017168 Z100709
----------------	--------	-----------------	---------------------

wash jet mounting pos. upper H 37mm type B hose ø 37mm



1

<b>GEV No.</b>	510116	<b>Ref. No.</b>	12017168 Z100709
<b>description</b>	wash jet mounting pos. upper H 37mm type B hose ø 37mm		
<b>For models:</b>	ECO-1600, ECO-2300, ECO-3000, FI-1600, FI-2300, FI-3000		

## miscellaneous



1

<b>GEV No.</b>	505334	<b>Ref. No.</b>	12024302 Z270721
<b>description</b>	end cap for wash arm ø 27mm L 33mm suitable for FAGOR		
<b>For models:</b>	ECO-160, ECO-160D, ECO-160I, ECO-200, ECO-200D, ECO-200H, ECO-200HD, ECO-200HI, ECO-200I, FI-160, FI-160AR, FI-160D, FI-160I, FI-200, FI-200AR, FI-200D, FI-200H, FI-200HD, FI-200HI, FI-200I, FI-200W, FI-200WL, FI-200WR		

**accessories for** 505334



<b>GEV No.</b>	532499	<b>Ref. No.</b>	12010230 Q307062
----------------	--------	-----------------	---------------------

O-ring EPDM thickness 2.62mm ID ø 23.47mm Qty 1 pcs



1

<b>GEV No.</b>	505215	<b>Ref. No.</b>	12017837 Z600704
<b>description</b>	wash jet		

## wash arm supports



1

<b>GEV No.</b>	505020	<b>Ref. No.</b>	12016686 Z400702
<b>description</b>	opposite support mounting pos. lower		
<b>For models:</b>	LVR-10, LVR-14, LVR-14D, LVR-20, LVR-20B, LVR-20D		



1

<b>GEV No.</b>	505021	<b>Ref. No.</b>	12024312 Z710706
<b>description</b>	opposite support mounting pos. lower		
<b>For models:</b>	AD-120, AD-120B, AD-120BBTDD-UK, AD-120C, AD-120CW, AD-120HY, AD-90, AD-90BA, AD-90BBT, AD-90BDD, AD-90DD, ADE-120, ADE-120B, ECO-120, ECO-120B, FI-100, FI-100AR, FI-100B, FI-100BBT-UK, FI-120, FI-120AR+DD, FI-120B, FI-120C, FI-120HY-CLINIC, FI-120W, FI-80, FI-80AR, FI-80BBT-UK, FI-80W, FI-E-100, LABP-1000, LABP-1200, LABP-800, MF-120		



1

<b>GEV No.</b>	505053	<b>Ref. No.</b>	12024703 Z410702
<b>description</b>	opposite support mounting pos. lower		
<b>For models:</b>	AD-15, AD-15D, AD-20C-UK, AD-21, AD-21B, AD-21BDD, AD-21C, AD-21D, AD-21DD, AD-21W, CO-350, CO-350-B, CO-350-B-DD, CO-350-COLD, CO-350-COLD-B, CO-350-COLD-B-DD, CO-350-COLD-DD, CO-350-DD, CO-352-COLD, CO-352-COLD-B, CO-352-COLD-B-DD, CO-352-COLD-DD, CO-400, CO-400-B, CO-400-B-DD, CO-400-COLD, CO-400-COLD-B, CO-400-COLD-B-DD, CO-400-COLD-DD, CO-400-DD, CO-400-SOFT, CO-402-COLD, CO-402-COLD-B, CO-402-COLD-B-DD, CO-402-COLD-DD, CO-402W, LVC-12, LVC-15, LVC-15D, LVC-21, LVC-21B, LVC-21C, LVC-21D, LVC-21W, MF-21		





Зип Общепит  
vsezip.ru  
+7(812)987-08-81

			
1			
<b>GEV No.</b>	505051	<b>Ref. No.</b>	12023613 Z200703
<b>description</b>	opposite support mounting pos. lower for wash arm support		
<b>For models:</b>	AD-45BBT, AD-48, AD-48B, AD-48BDD, AD-48C, AD-48D, AD-48DD, AD-48HY, AD-48W, AD-64, AD-64B, AD-64BBT, AD-64BDD, AD-64BTDD, AD-64C, AD-64CW, AD-64D, AD-64DD, AD-64HY, AD-72, AD-72W, EASY-500, EASY-500B, EASY-500DD, EASY-500HP, EASY-500HPWBDD, FI-30, FI-30AR, FI-30AR+DD, FI-30B, FI-30B-BT-UK, FI-30-UK, FI-48, FI-48AR, FI-48B, FI-48B-BT-UK, FI-48C, FI-48D, FI-48HY-CLINIC, FI-48W, FI-50, FI-60DD, FI-64, FI-64AR, FI-64B, FI-64B-BT-UK, FI-64C, FI-64D, FI-64HY-CLINIC, FI-64W...(Other models you can see in the webshop)		

			
1			
<b>GEV No.</b>	505022	<b>Ref. No.</b>	12023652 Z710704
<b>description</b>	wash arm support mounting pos. lower		
<b>For models:</b>	AD-120, AD-120B, AD-120BBTDD-UK, AD-120C, AD-120CW, AD-120HY, ADE-120, ADE-120B, ECO-120, ECO-120B, FI-100, FI-100AR, FI-100B, FI-120, FI-120AR+DD, FI-120B, FI-120C, FI-120HY-CLINIC, FI-120W, FI-E-100, LABP-1200, MF-120		

			
2			
<b>GEV No.</b>	505017	<b>Ref. No.</b>	12020347 Z400701
<b>description</b>	wash arm support mounting pos. lower		
<b>For models:</b>	LVR-10, LVR-14, LVR-14D, LVR-20, LVR-20B, LVR-20D		

			
1			
<b>GEV No.</b>	505275	<b>Ref. No.</b>	12024478 Z710719
<b>description</b>	wash arm support mounting pos. lower D1 ø 47mm H 91mm L1 86mm		
<b>For models:</b>	FI-100, FI-100AR, FI-100B, FI-100BBT-UK, LABP-1000		

			
1			
<b>GEV No.</b>	505018	<b>Ref. No.</b>	12024480 Z200701 Z210701
<b>description</b>	wash arm support mounting pos. lower		
<b>For models:</b>	AD-45BBT, AD-48, AD-48B, AD-48BDD, AD-48C, AD-48D, AD-48DD, AD-48HY, AD-48W, AD-64, AD-64B, AD-64BBT, AD-64BDD, AD-64BTDD, AD-64C, AD-64CW, AD-64D, AD-64DD, AD-64HY, AD-72, AD-72W, EASY-500, EASY-500B, EASY-500DD, EASY-500HP, EASY-500HPWBDD, FI-30, FI-30AR, FI-30AR+DD, FI-30B, FI-30B-BT-UK, FI-30-UK, FI-48, FI-48AR, FI-48B, FI-48B-BT-UK, FI-48C, FI-48D, FI-48HY-CLINIC, FI-48W, FI-50, FI-60DD, FI-64, FI-64AR, FI-64B, FI-64B-BT-UK, FI-64C, FI-64D, FI-64HY-CLINIC, FI-64W...(Other models you can see in the webshop)		

			
1			
<b>GEV No.</b>	505050	<b>Ref. No.</b>	12025133 Z410701
<b>description</b>	wash arm support mounting pos. lower H 102mm D1 ø 40mm D2 ø 48mm D3 ø 68mm		
<b>For models:</b>	AD-15, AD-15D, AD-20C-UK, AD-21, AD-21B, AD-21BDD, AD-21C, AD-21D, AD-21DD, AD-21W, LVC-12, LVC-15, LVC-15D, LVC-21, LVC-21B, LVC-21C, LVC-21D, LVC-21W, MF-21		

			
1			
<b>GEV No.</b>	505019	<b>Ref. No.</b>	12020989 12025170 Z740702 Z740705
<b>description</b>	wash arm support mounting pos. lower		
<b>For models:</b>	AD-90, AD-90BA, AD-90BBT, AD-90BDD, AD-90DD, FI-80, FI-80AR, FI-80BBT-UK, FI-80W, FI-E-100, LABP-800		

			
1			
<b>GEV No.</b>	505056	<b>Ref. No.</b>	12023590 Z410703
<b>description</b>	wash arm support mounting pos. upper		
<b>For models:</b>	AD-15, AD-15D, AD-20C-UK, AD-21, AD-21B, AD-21BDD, AD-21C, AD-21D, AD-21DD, AD-21W, LVC-12, LVC-15, LVC-15D, LVC-21, LVC-21B, LVC-21C, LVC-21D, LVC-21W, MF-21		

mechanical components, equipment accessories

Зип-Общепит

rinse arm shaft

vsezip.ru

+7(812)987-08-81

			
1			
<b>GEV No.</b>	505057	<b>Ref. No.</b>	12024471 Z200707
<b>description</b>	wash arm support mounting pos. upper		
<b>For models:</b>	AD-45BBT, AD-48, AD-48B, AD-48BDD, AD-48C, AD-48D, AD-48DD, AD-48HY, AD-48W, AD-64, AD-64B, AD-64BBT, AD-64BDD, AD-64BTDD, AD-64C, AD-64CW, AD-64D, AD-64DD, AD-64HY, AD-72, AD-72W, EASY-500, EASY-500B, EASY-500DD, EASY-500HP, EASY-500HPWBDD, FI-30, FI-30AR, FI-30AR+DD, FI-30B, FI-30B-BT-UK, FI-30-UK, FI-48, FI-48AR, FI-48B, FI-48B-BT-UK, FI-48C, FI-48D, FI-48HY-CLINIC, FI-48W, FI-50, FI-60DD, FI-64, FI-64AR, FI-64B, FI-64B-BT-UK, FI-64C, FI-64D, FI-64HY-CLINIC, FI-64W...(Other models you can see in the webshop)		



			
1			
<b>GEV No.</b>	505047	<b>Ref. no.</b>	12025114 Z410708
<b>description</b>	rinse arm shaft		
<b>For models:</b>	AD-15, AD-15D, AD-20C-UK, AD-21, AD-21B, AD-21BDD, AD-21C, AD-21D, AD-21DD, AD-21W, CO-350, CO-350-B, CO-350-B-DD, CO-350-COLD, CO-350-COLD-B, CO-350-COLD-B-DD, CO-350-COLD-DD, CO-350-DD, CO-352-COLD, CO-352-COLD-B, CO-352-COLD-B-DD, CO-352-COLD-DD, CO-400, CO-400-B, CO-400-B-DD, CO-400-COLD, CO-400-COLD-B, CO-400-COLD-B-DD, CO-400-COLD-DD, CO-400-SD, CO-400-SOFT, CO-402-COLD, CO-402-COLD-B, CO-402-COLD-B-DD, CO-402-COLD-DD, CO-402W, LVC-12, LVC-15, LVC-15D, LVC-21, LVC-21B, LVC-21C, LVC-21D, LVC-21W, MF-21		

			
2			
<b>GEV No.</b>	505059	<b>Ref. No.</b>	12024927 Z740703
<b>description</b>	wash arm support mounting pos. upper		
<b>For models:</b>	AD-120BBTDD-UK, AD-90, AD-90BA, AD-90BBT, AD-90BDD, AD-90DD, FI-80, FI-80AR, FI-80BBT-UK, FI-80W, FI-E-100, LABP-800		

			
1			
<b>GEV No.</b>	505048	<b>Ref. No.</b>	12023844 Z200704
<b>description</b>	rinse arm shaft		
<b>For models:</b>	AD-45BBT, AD-48, AD-48B, AD-48BDD, AD-48C, AD-48D, AD-48DD, AD-48HY, AD-48W, AD-64, AD-64B, AD-64BBT, AD-64BDD, AD-64BTDD, AD-64C, AD-64CW, AD-64D, AD-64DD, AD-64HY, AD-72, AD-72W, AD-90, AD-90BA, AD-90BBT, AD-90BDD, AD-90DD, EASY-500, EASY-500B, EASY-500DD, EASY-500HP, EASY-500HPWBDD, FI-30, FI-30AR, FI-30AR+DD, FI-30B, FI-30B-BT-UK, FI-30-UK, FI-48, FI-48AR, FI-48B, FI-48B-BT-UK, FI-48C, FI-48D, FI-48HY-CLINIC, FI-48W, FI-50, FI-60DD, FI-64, FI-64AR, FI-64B...(Other models you can see in the webshop)		

			
1			
<b>GEV No.</b>	505060	<b>Ref. No.</b>	12024934 Z710705
<b>description</b>	wash arm support mounting pos. upper		
<b>For models:</b>	AD-120, AD-120B, AD-120BBTDD-UK, AD-120C, AD-120CW, AD-120HY, AD-90, AD-90BA, AD-90BDD, AD-90DD, ADE-120, ADE-120B, CO-142W, CO-142WDD, COP-174W, COP-174WHR, ECO-120, ECO-120B, FI-100, FI-100AR, FI-100B, FI-100BBT-UK, FI-120, FI-120AR+DD, FI-120B, FI-120C, FI-120HY-CLINIC, FI-120W, FI-E-100, LABP-1000, LABP-1200, LABP-800, MF-120		

			
1			
<b>GEV No.</b>	505049	<b>Ref. No.</b>	12023601 Z710711
<b>description</b>	rinse arm shaft		
<b>For models:</b>	AD-120, AD-120B, AD-120BBTDD-UK, AD-120C, AD-120CW, AD-120HY, ADE-120, ADE-120B, ECO-120, ECO-120B, FI-100, FI-100AR, FI-100B, FI-100BBT-UK, FI-120, FI-120AR+DD, FI-120B, FI-120C, FI-120HY-CLINIC, FI-120W, FI-E-100, LABP-1000, LABP-1200, MF-120		

			
1			
<b>GEV No.</b>	501546	<b>Ref. No.</b>	12048173
<b>description</b>	wash arm support mounting pos. upper ø 42mm H 78mm L1 340mm		
<b>For models:</b>	AD-125, AD-125HRS, AD-125-SOFT, CO-110, CO-110B, CO-110BDD, CO-110DD, CO-112, CO-112B, CO-112BDD, CO-112DD, CO-170, CO-170B, CO-170BDD, CO-170DD, CO-170HRS, CO-170HRSDD, CO-170HRS-SOFT, CO-170-SOFT, CO-172, CO-172B, CO-172BDD, CO-172DD, COP-173, COP-173B, COP-173BDD, COP-173DD, COP-173HRS, COP-173HRSDD, COP-173-SOFT, COP-174, COP-174B, COP-174BDD, COP-174DD, COP-174HRS, COP-174HRSDD		
<b>accessories for</b>	501546		
	<b>GEV No.</b>	532103	<b>Ref. No.</b> 12049214
	O-ring EPDM thickness 3.53mm ID ø 13.87mm Qty 10 pcs		
	<b>GEV No.</b>	699343	<b>Ref. No.</b> 12048366
	gasket L 118mm W 73mm H 9mm thickness 9mm		

			
1			
<b>GEV No.</b>	513122	<b>Ref. No.</b>	12029990 EU926130
<b>description</b>	rinse arm shaft		

			
1			
<b>GEV No.</b>	505251	<b>Ref. No.</b>	12018232 Z680748
<b>description</b>	rinse arm shaft H 85mm		
<b>For models:</b>	ECO-1200, FI-1200, FI-900		







Зип Общепит

vsezip.ru

812)987-08-81

1 			
<b>GEV No.</b>	505052	<b>Ref. No.</b>	12023801 Z410712
<b>description</b>	rinse arm shaft L1 102mm L2 84mm L3 26mm		
<b>For models:</b>	AD-15, AD-15D, AD-20C-UK, AD-21, AD-21B, AD-21BDD, AD-21C, AD-21D, AD-21DD, AD-21W, CO-350, CO-350-B, CO-350-B-DD, CO-350-COLD, CO-350-COLD-B, CO-350-COLD-B-DD, CO-350-COLD-DD, CO-350-DD, CO-352-COLD, CO-352-COLD-B, CO-352-COLD-B-DD, CO-352-COLD-DD, CO-400, CO-400-B, CO-400-B-DD, CO-400-COLD, CO-400-COLD-B, CO-400-COLD-B-DD, CO-400-COLD-DD, CO-400-DD, CO-400-SOFT, CO-402-COLD, CO-402-COLD-B, CO-402-COLD-B-DD, CO-402-COLD-DD, CO-402W, LVC-12, LVC-15, LVC-15D, LVC-21, LVC-21B, LVC-21C, LVC-21D, LVC-21W, MF-21		

1 			
<b>GEV No.</b>	112296	<b>Ref. No.</b>	12024309 Z214902
<b>description</b>	knob switch zero mark ø 39mm shaft ø 6x4.6mm shaft flat lower black shaft L 19mm		
<b>For models:</b>	ECO-120, ECO-120B, FI-100, FI-100AR, FI-100B, FI-120, FI-120B, FI-120W, FI-30, FI-30AR, FI-30AR+DD, FI-30B, FI-30B-BT-UK, FI-30-UK, FI-48, FI-48AR, FI-48B, FI-48B-BT-UK, FI-48C, FI-48D, FI-48HY-CLINIC, FI-48W, FI-64, FI-64AR, FI-64B, FI-64B-BT-UK, FI-64C, FI-64D, FI-64HY-CLINIC, FI-64W, FI-80, FI-80AR, FI-80BBT-UK, LABP-1000, LABP-1200, LABP-800, LVC-12, LVC-15, LVC-15D, LVC-21, LVC-21B, LVC-21C, LVC-21D, LVC-21W, MF-120, MF-48, MF-64		

for washing machine

1 			
<b>GEV No.</b>	698504	<b>Ref. No.</b>	12026769 DO00V21001
<b>description</b>	rack FAGOR center piece for washing machine		

1 			
<b>GEV No.</b>	113003	<b>Ref. No.</b>	12040072 R343043
<b>description</b>	knob zero mark ø 39mm shaft ø 6x4.6mm shaft flat lower		
<b>For models:</b>	FE-18, FE-25, FE-4, FE-6, FE-8, FI-300B, HCV-10-11, HCV-10-21, HCV-2-10-21, HCV-5-11, HE-10-11, HE-10-21, HE-2-10-11, HE-5-11, HE-6-11, HG-10-11, HG-10-21, HG-2-10-11		

knobs

producer-specific knobs

FAGOR			
1 			
<b>GEV No.</b>	112293	<b>Ref. No.</b>	12024300 Z203069
<b>description</b>	knob switch zero mark ø 39mm shaft ø 6x4.6mm shaft flat lower black		
<b>For models:</b>	ECO-160D, ECO-160I, ECO-200D, ECO-200HD, ECO-200HI, ECO-200I, ECO-280D, ECO-280I, ECO-370D, ECO-370I, ECO-460D, ECO-460I, ECO-550D, ECO-550I, FI-160AR, FI-160D, FI-160I, FI-200AR, FI-200D, FI-200HD, FI-200HI, FI-200I, FI-200WL, FI-200WR, FI-280D, FI-280I, FI-30, FI-30AR, FI-30AR+DD, FI-30B, FI-30B-BT-UK, FI-30-UK, FI-370D, FI-370I, FI-460D, FI-460I, FI-48, FI-48AR, FI-48B, FI-48B-BT-UK, FI-48C, FI-48D, FI-48HY-CLINIC, FI-48W, FI-550D, FI-550I, FI-60DD, FI-64, FI-64AR, FI-64B...(Other models you can see in the webshop)		

1 			
<b>GEV No.</b>	113042	<b>Ref. No.</b>	12009885 Z513024000
<b>description</b>	knob zero mark t.max.°C ø 50mm shaft ø 6x4.6mm shaft flat lower black		
<b>For models:</b>	ECO-160D, ECO-160I, ECO-200D, ECO-200HD, ECO-200HI, ECO-200I, ECO-2700D, ECO-2700I, ECO-280D, ECO-280I, ECO-370D, ECO-370I, ECO-4000D, ECO-4000I, ECO-460D, ECO-460I, ECO-550D, ECO-550I, ECO-6000D, ECO-6000I, FI-160AR, FI-160D, FI-160I, FI-200AR, FI-200D, FI-200HD, FI-200HI, FI-200I, FI-200WL, FI-200WR, FI-2700D, FI-2700I, FI-280D, FI-280I, FI-370D, FI-370I, FI-4000D, FI-4000I, FI-460D, FI-460I, FI-550D, FI-550I, FI-6000D, FI-6000I		

1 			
<b>GEV No.</b>	550438	<b>Ref. No.</b>	12039850 Z603052
<b>description</b>	indicator for knob		
<b>For models:</b>	FE-18, FE-25, FE-4, FE-6, FE-8, FI-300B, FI-300R, FI-650R, HCV-10-11, HCV-10-21, HCV-2-10-21, HCV-5-11, HE-10-11, HE-10-21, HE-2-10-11, HE-5-11, HE-6-11, HG-10-11, HG-10-21, HG-2-10-11, LC-10, LC-14, LC-7, LC-7A		

mechanical components, equipment accessories



Зип Общепит

vsezip.ru

+7(812)987-08-81

accessories

gaskets



<b>GEV No.</b>	691074	<b>Ref. No.</b>	12024516 R663046
<b>description</b>	gasket switch shaft		
<b>For models:</b>	CO-350, CO-350-B, CO-350-B-DD, CO-350-COLD, CO-350-COLD-B, CO-350-COLD-B-DD, CO-350-COLD-DD, CO-350-DD, CO-400, CO-400-B, CO-400-B-DD, CO-400-COLD, CO-400-COLD-B, CO-400-COLD-B-DD, CO-400-COLD-DD, CO-400-DD, CO-400-SOFT, CO-500, CO-500B, CO-500BDD, CO-500DD, CO-501, CO-501B, CO-501BDD, CO-501DD, CO-501-SOFT, COP-503, COP-503B, COP-503BDD, COP-503DD, COP-503-SOFT, COP-504, COP-504B, COP-504BDD, COP-504DD, ECO-2700D, ECO-2700I, ECO-4000D, ECO-4000I, ECO-6000D, ECO-6000I, FI-200W, FI-2700D, FI-2700I, FI-4000D, FI-4000I, FI-6000D, FI-6000I, HCG-10-11, HCG-10-21...(Other models you can see in the webshop)		

<b>GEV No.</b>	691681	<b>Ref. No.</b>	12024991 Z400540
<b>description</b>	pull handle L 205mm mounting distance 170mm ø 30mm handle M5		
<b>For models:</b>	CG9-51L, CG9-51LC, CG9-51R, CG9-51RC, CG9-61, CGP9-11, CPG9-05, CPG9-05NC, CPG9-05S, CPG9-05SNC, ECO-2700D, ECO-2700I, ECO-280D, ECO-280I, ECO-370D, ECO-370I, ECO-4000D, ECO-4000I, ECO-460D, ECO-460I, ECO-550D, ECO-550I, ECO-6000D, ECO-6000I, EN9-05C, EN9-10C, FE9-05, FE9-05S, FE9-05USMC, FE9-10, FG9-05, FG9-05S, FG9-10, FI-2700D, FI-2700I, FI-280D, FI-280I, FI-370D, FI-370I, FI-4000D, FI-4000I, FI-460D, FI-460I, FI-550D, FI-550I, FI-6000D, FI-6000I, MB9-05-PUERTA-DCHA, MB9-05-PUERTA-IZDA, MB9-10-PUERTA-DOBLE...(Other models you can see in the webshop)		

handles and hand wheels

cone handles



<b>GEV No.</b>	111464	<b>Ref. No.</b>	12021169 Z102105
<b>description</b>	cone handle thread M10 ø 26mm L 42mm plastic black		
<b>For models:</b>	ECO-1600, ECO-2300, ECO-3000, FI-1600, FI-2300, FI-3000		

<b>GEV No.</b>	505316	<b>Ref. No.</b>	12024005 Z200550
<b>description</b>	pull handle L 293mm H 65mm mounting distance 260mm thread M6 W 36mm		
<b>For models:</b>	ECO-160, ECO-160D, ECO-160I, ECO-200, ECO-200D, ECO-200H, ECO-200HD, ECO-200HI, ECO-200I, ECO-2700D, ECO-2700I, ECO-280D, ECO-280I, ECO-370D, ECO-370I, ECO-4000D, ECO-4000I, ECO-460D, ECO-460I, ECO-550D, ECO-550I, ECO-6000D, ECO-6000I, FI-100, FI-100AR, FI-100B, FI-100BBT-UK, FI-160, FI-160AR, FI-160D, FI-160I, FI-200, FI-200AR, FI-200D, FI-200H, FI-200HD, FI-200HI, FI-200I, FI-200W, FI-200WL, FI-200WR, FI-2700D, FI-2700I, FI-280D, FI-280I, FI-370D, FI-370I, FI-4000D, FI-4000I, FI-460D...(Other models you can see in the webshop)		

handle rails

FAGOR



<b>GEV No.</b>	507538	<b>Ref. No.</b>	12009630 12019260 Z450502
<b>description</b>	handle rail L 505mm W 29mm H 35mm hole distance 277mm Qty 1 pcs		
<b>For models:</b>	AD-20C-UK, AD-21C		

<b>GEV No.</b>	691679	<b>Ref. No.</b>	12024557 Z400542
<b>description</b>	pull handle L 310mm H 32mm mounting distance 260mm dishwasher since 2007 handle M6		
<b>For models:</b>	ATM-031ECO, CE6-41, CG-310, CG-310G, CG6-41, CGE6-41, FI-100, FI-100AR, FI-100B, FI-100BBT-UK, FI-80, FI-80AR, FI-80BBT-UK, FI-80W, FI-E-100, LVC-12, LVC-15, LVC-15D, LVC-21, LVC-21B, LVC-21C, LVC-21D, LVC-21W		

bracket handles



<b>GEV No.</b>	505001	<b>Ref. No.</b>	12016135 U580521
<b>description</b>	pull handle L 182mm H 42mm mounting distance 170mm thread M6 W 36mm		
<b>For models:</b>	CG-310, CG-310G, CG7-61, CG9-51L, CG9-51LC, CG9-51R, CG9-51RC, CG9-61, CGB7-61, CPG7-05, ECO-280D, ECO-280I, ECO-370D, ECO-370I, ECO-460D, ECO-460I, ECO-550D, ECO-550I, EN9-05C, EN9-10C, FE-710, FE-720, FE9-05, FE9-05S, FE9-10, FE-920, FG-710, FG-720, FG9-05, FG9-05S, FG9-10, FG-920, FG-940, FI-280D, FI-280I, FI-370D, FI-370I, FI-460D, FI-460I, FI-550D, FI-550I, LVC-12, LVC-15, LVC-15D, LVC-21, LVC-21B, LVC-21D, LVC-21W, LVR-10, LVR-14...(Other models you can see in the webshop)		

mechanical components, equipment accessories



locks

electromagnetic closer

			
<b>GEV No.</b>	692613	<b>Ref. No.</b>	12003922 12038364 12038446 12127838 12154822 13P6205160
<b>description</b>	electromagnetic closer L 220mm W 100mm H 50mm		
<b>For models:</b>	LA-25M, LA-AC-10M, LA-AC-10MA, LA-AC-10MP, LA-AC-13M, LA-AC-13MA, LA-AC-13MP, LA-AC-18M, LA-AC-18MA, LA-AC-18MP, LA-AC-25M, LA-AC-25MA, LA-AC-25MP, LA-E-10M, LA-E-10MA, LA-E-10MP, LA-E-13M, LA-E-13MA, LA-E-13MP, LA-E-18M, LA-E-18MA, LA-E-18MP, LA-E-25M, LA-E-25MA, LA-E-25MP, LA-V-10M, LA-V-10MP, LA-V-13M, LA-V-13MP, LA-V-18M, LA-V-18MP, LA-V-25M, LA-V-25MP, LB-AC-10M, LB-E-10M, LB-V-10M, LF-13MPP, LF-18MPP, LF-8MPP, LR-AC-10M, LR-AC-10MA, LR-AC-10MP, LR-AC-13M, LR-AC-13MA, LR-AC-13MP, LR-AC-18M, LR-AC-18MA, LR-AC-18MP, LR-AC-25M, LR-AC-25MA...(Other models you can see in the webshop)		

espagnolette locks

producer-specific

FAGOR

group 2

			
<b>GEV No.</b>	560068	<b>Ref. No.</b>	12010213 Q032032
<b>description</b>	flat-headed bolt thread M5 thread L 16mm SS DIN 7985/ISO 7045 Qty 20 pcs intake Phillips head ø 10mm head thickness 2mm		
<b>For models:</b>	ACE-201, ACE-202, ACG-201, ACG-202, AD-120B, AD-120BTTDD-UK, AD-120C, AD-120HY, AD-15, AD-15D, AD-20C-UK, AD-21, AD-21B, AD-21BDD, AD-21C, AD-21D, AD-21DD, AD-21W, AD-90BA, AD-90BBT, AD-90BDD, ADE-120B, AE-201, AE-202, AG-201, AG-202, APE-201, APE-202, APG-201, APG-202, COE-201, COE-202, COG-201, COG-202, ECO-120B, FI-100B, FI-100BTT-UK, FI-120B, FI-120C, FI-120HY-CLINIC, FI-80BBT-UK, GA-20, GA-20D, GA-40, GA-40D, HCG-10-11, HCG-10-21, HCG-20-11, HCG-20-21, HCG-2-10-11...(Other models you can see in the webshop)		

			
<b>GEV No.</b>	560132	<b>Ref. No.</b>	12010194 12010284 Q162030 Q163030
<b>description</b>	hexagonal nut thread M5 H 4mm WS 8 SS DIN/ISO DIN 934 / ISO 4032/8673 Qty 20 pcs		
<b>For models:</b>	ACE-061, ACE-101, ACE-102, ACE-201, ACE-202, ACG-061, ACG-101, ACG-102, ACG-201, ACG-202, AD-120, AD-120B, AD-120BTTDD-UK, AD-120C, AD-120CW, AD-120HY, AD-15, AD-15D, AD-20C-UK, AD-21, AD-21B, AD-21BDD, AD-21C, AD-21D, AD-21DD, AD-21W, AD-45BBT, AD-48, AD-48B, AD-48BDD, AD-48C, AD-48D, AD-48DD, AD-48HY, AD-48W, AD-64, AD-64B, AD-64BBT, AD-64BDD, AD-64C, AD-64CW, AD-64D, AD-64DD, AD-64HY, AD-72, AD-72W, AD-90, AD-90BA, AD-90BBT...(Other models you can see in the webshop)		

Zip Общепит

vsezip.ru

+7(812)987-08-81

			
<b>GEV No.</b>	511212	<b>Ref. No.</b>	12010255 Q162040 Q16314000
<b>description</b>	hexagonal nut thread M6 H 5mm WS 10 SS DIN/ISO DIN 934 / ISO 4032/8673 Qty 1 pcs		
<b>For models:</b>	ACE-061, ACE-101, ACE-102, ACE-201, ACE-202, ACG-061, ACG-101, ACG-102, ACG-201, ACG-202, AD-120, AD-120B, AD-120BTTDD-UK, AD-120C, AD-120CW, AD-120HY, AD-15, AD-15D, AD-20C-UK, AD-21, AD-21B, AD-21BDD, AD-21C, AD-21D, AD-21DD, AD-21W, AD-45BBT, AD-48, AD-48B, AD-48BDD, AD-48C, AD-48D, AD-48DD, AD-48HY, AD-48W, AD-64, AD-64B, AD-64BBT, AD-64BDD, AD-64C, AD-64CW, AD-64D, AD-64DD, AD-64HY, AD-72, AD-72W, AD-90, AD-90BA, AD-90BBT...(Other models you can see in the webshop)		

			
<b>GEV No.</b>	560123	<b>Ref. No.</b>	12009872 Q262040
<b>description</b>	lock washer ID ø 6.3mm ED ø 11mm SS DIN127 Qty 20 pcs for thread M6		
<b>For models:</b>	ACE-061, ACE-101, ACE-102, ACE-201, ACE-202, AD-120, AD-120B, AD-120BTTDD-UK, AD-120C, AD-120CW, AD-120HY, AD-15, AD-15D, AD-20C-UK, AD-21, AD-21B, AD-21BDD, AD-21C, AD-21D, AD-21DD, AD-21W, AD-45BBT, AD-48, AD-48B, AD-48BDD, AD-48C, AD-48D, AD-48DD, AD-48HY, AD-48W, AD-64, AD-64B, AD-64BBT, AD-64BDD, AD-64C, AD-64CW, AD-64D, AD-64DD, AD-64HY, AD-72, AD-72W, AD-90, AD-90BA, AD-90BBT, AD-90BDD, AD-90DD, ADE-120, ADE-120B, AE-061...(Other models you can see in the webshop)		

			
<b>GEV No.</b>	516198	<b>Ref. No.</b>	12010285 Q271033 Q301033
<b>description</b>	retaining ring E D1 ø 6mm D2 ø 12mm SS DIN 6799 thickness 0.7mm for shaft ø 7-9mm		
<b>For models:</b>	COE-201, COE-202, COG-201, COG-202, FE-710, FE-720, FE9-05, FE9-05S, FE9-05USMC, FE9-10, FE-920, HCG-10-11, HCG-10-21, HCG-20-11, HCG-20-21, HCG-2-10-11, HCG-2-20-11, HCG-6-11, HCV-10-11, HCV-10-21, HCV-2-10-21, HCV-6-11, HE-10-11, HE-10-21, HE-2-10-11, HE-6-11, HEI-10-21, HEI-20-21, HEM-10-21, HEM-20-21, HEP-10-21, HEP-20-21, HG-10-21, HG-2-10-11, HGC-10-21, HGC-20-21, HGP-10-21, HGP-20-21, HGV-10-11, HGV-10-21, HGV-20-11, HGV-20-21, HME-10-11, HME-10-21, HME-20-11, HME-20-21, HME-2-10-11, HME-2-20-11, HME-6-11, HMG-10-11...(Other models you can see in the webshop)		

			
<b>GEV No.</b>	560126	<b>Ref. No.</b>	12009890 Q242030
<b>description</b>	tooth lock washer ID ø 5.2mm ED ø 10mm SS DIN/ISO DIN 6798A Qty 20 pcs for thread M5		
<b>For models:</b>	ACE-061, ACE-101, ACE-102, ACE-201, ACE-202, ACG-061, ACG-101, ACG-102, ACG-201, ACG-202, AD-120, AD-120B, AD-120BTTDD-UK, AD-120C, AD-120CW, AD-120HY, AD-15, AD-15D, AD-20C-UK, AD-21, AD-21B, AD-21BDD, AD-21C, AD-21D, AD-21DD, AD-21W, AD-45BBT, AD-48, AD-48B, AD-48BDD, AD-48C, AD-48D, AD-48DD, AD-48HY, AD-48W, AD-64, AD-64B, AD-64BBT, AD-64BDD, AD-64C, AD-64CW, AD-64D, AD-64DD, AD-64HY, AD-72, AD-72W, AD-90, AD-90BA, AD-90BBT, AD-90BDD...(Other models you can see in the webshop)		

mechanical components, equipment accessories

Зип Общепит equipment feet and end caps

equipment feet  
with fixing plate

+7(812)987-08-81



<b>GEV No.</b>	701100	<b>Ref. No.</b>	12009104 12033566 6007050017 X260151
<b>description</b>	equipment foot tube ø 64mm plate size 82x82mm hole distance 65x65mm H 135-200mm SS size 2 1/2" Qty 1 pcs		
<b>For models:</b>	AC-120, AC-180, ACE-061, ACE-101, ACE-102, ACG-061, ACG-101, ACG-102, AD-120, AD-120B, AD-120BTTDD-UK, AD-120C, AD-120CW, AD-120HY, AD-125, AD-125HRS, AD-125-SOFT, AD-72, AD-72W, AD-90, AD-90BA, AD-90BBT, AD-90BDD, AD-90DD, ADAEP-1602, ADAEP-801, ADAFN-1602, ADAFN-801, ADAFP-1602, ADAFP-801, ADE-120, ADE-120B, ADMCN-135, ADMCN-180, ADMCN-225, ADMCP-135, ADMCP-180, ADMCP-225, ADMFN-135, ADMFN-180, ADMFN-225, ADMFP-135, ADMFP-135-GR, ADMFP-135HD, ADMFP-135HH, ADMFP-135PC, ADMFP-180, ADMFP-180-GR, ADMFP-180HDD, ADMFP-180HHD...(Other models you can see in the webshop)		

bullet feet

plastic/SS



<b>GEV No.</b>	700110	<b>Ref. No.</b>	12024301 R675610
<b>description</b>	equipment foot pipe type 40x40 thickness 1-1.2mm H 23-60mm plastic/SS Qty 1 pcs		
<b>For models:</b>	ECO-120, ECO-120B, ECO-160, ECO-1600, ECO-160D, ECO-160I, ECO-200, ECO-200D, ECO-200H, ECO-200HD, ECO-200HI, ECO-200I, ECO-2300, ECO-280D, ECO-280I, ECO-3000, ECO-370D, ECO-370I, ECO-460D, ECO-460I, ECO-550D, ECO-550I, FI-100, FI-100AR, FI-100B, FI-120, FI-120B, FI-120W, FI-160, FI-1600, FI-160D, FI-160I, FI-200, FI-200D, FI-200H, FI-200HD, FI-200HI, FI-200I, FI-200W, FI-2300, FI-280D, FI-280I, FI-3000, FI-370D, FI-370I, FI-460D, FI-460I, FI-550D, FI-550I, FI-80...(Other models you can see in the webshop)		

hinges

accessories

shafts



<b>GEV No.</b>	700818	<b>Ref. No.</b>	12024071 Z400516
<b>description</b>	hinge bolt L 32mm stainless steel D1 ø 7.8mm D2 ø 12mm		
<b>For models:</b>	AD-15, AD-15D, AD-20C-UK, AD-21, AD-21B, AD-21BDD, AD-21C, AD-21D, AD-21DD, AD-21W, AD-45BBT, AD-48, AD-48B, AD-48BDD, AD-48C, AD-48D, AD-48DD, AD-48HY, AD-48W, AD-64, AD-64B, AD-64BBT, AD-64BDD, AD-64BTDD, AD-64C, AD-64CW, AD-64D, AD-64DD, AD-64HY, AD-72, AD-72W, EASY-500, EASY-500B, EASY-500DD, EASY-500HP, EASY-500HPWBDD, FI-30, FI-30AR, FI-30AR+DD, FI-30B, FI-30B-BT-UK, FI-30-UK, FI-48, FI-48AR, FI-48B, FI-48B-BT-UK, FI-48C, FI-48D, FI-48HY-CLINIC, FI-48W...(Other models you can see in the webshop)		
<b>spare parts for</b>	700818		
<b>GEV No.</b>	505005	<b>Ref. No.</b>	12022324 Z400514
<b>description</b>	door hinge hinge left mounting pos. left		

pullouts

rollers

rollers



<b>GEV No.</b>	501343	<b>Ref. No.</b>	12034280 12038133 GQ500214 SPQ510708P
<b>description</b>	roller rollerø 75mm B1 12mm overall width 25mm A 75mm B 12mm C 25mm plastic tread rubber		
<b>For models:</b>	SE-7		

accessories



<b>GEV No.</b>	505252	<b>Ref. No.</b>	12037139 12038096 SPQ56461 SPQ56461P
<b>description</b>	shaft for roller		



Zip Общепит

vsezip.ru

+7(812)987-08-81

screw-in feet

			
1			
<b>GEV No.</b>	510115	<b>Ref. No.</b>	12024163 6003010275 Z200107
<b>description</b>	equipment foot thread M10 thread L 40mm ø 30mm H 10mm Qty 1 pcs		
<b>For models:</b>	AD-15, AD-15D, AD-20C-UK, AD-21, AD-21B, AD-21BDD, AD-21C, AD-21D, AD-21DD, AD-21W, AD-45BBT, AD-48, AD-48B, AD-48BDD, AD-48C, AD-48D, AD-48DD, AD-48HY, AD-48W, AD-505, AD-505-SOFT, AD-64, AD-64B, AD-64BBT, AD-64BDD, AD-64BTDD, AD-64C, AD-64CW, AD-64D, AD-64DD, AD-64HY, BG6-05I, BG7-05, BG7-05I, BG7-10, BG7-10I, BG9-05, BG9-05AD, BG9-05I, BG9-05PF, BG9-05PI, BG9-05PLUS-I, BG9-10, BG9-10AD, BG9-10I, BG9-10PF, BG9-10PI, BG9-10PLUS-I, BME6-05, BME7-05...(Other models you can see in the webshop)		

cutlery inserts

			
1			
<b>GEV No.</b>	976010	<b>Ref. No.</b>	12025242
<b>description</b>	cutlery insert Lmm Wmm ø 95mm H 105mm plastic		
<b>For models:</b>	AD-15, AD-15D, AD-20C-UK, AD-21, AD-21B, AD-21BDD, AD-21C, AD-21D, AD-21DD, AD-21W, CO-350, CO-350-B, CO-350-B-DD, CO-350-COLD, CO-350-COLD-B, CO-350-COLD-B-DD, CO-350-COLD-DD, CO-350-DD, CO-352-COLD, CO-352-COLD-B, CO-352-COLD-B-DD, CO-352-COLD-DD, CO-400, CO-400-B, CO-400-B-DD, CO-400-COLD, CO-400-COLD-B, CO-400-COLD-B-DD, CO-400-COLD-DD, CO-400-DD, CO-400-SOFT, CO-402-COLD, CO-402-COLD-B, CO-402-COLD-B-DD, CO-402-COLD-DD, CO-402W, LVC-12, LVC-15, LVC-15D, LVC-21, LVC-21B, LVC-21C, LVC-21D, LVC-21W		

baskets

warewashing baskets

plastic baskets round

			
1			
<b>GEV No.</b>	970648	<b>Ref. No.</b>	12020206 Z605304
<b>description</b>	mix basket ED ø 350mm H 120mm seat ø 280mm mesh type wide-meshed		
<b>For models:</b>	LVR-10, LVR-14, LVR-14D		

plastic baskets octagonal

mix baskets

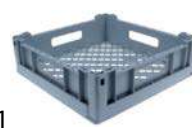
			
1			
<b>GEV No.</b>	971136	<b>Ref. No.</b>	12024550 Z415320
<b>description</b>	mix basket L 352mm W 352mm H 105mm		
<b>For models:</b>	AD-15, AD-15D, CO-350, CO-350-B, CO-350-B-DD, CO-350-COLD, CO-350-COLD-B, CO-350-COLD-B-DD, CO-350-COLD-DD, CO-350-DD, CO-352-COLD, CO-352-COLD-B, CO-352-COLD-B-DD, CO-352-COLD-DD, LVC-12, LVC-15, LVC-15D		

			
1			
<b>GEV No.</b>	976000	<b>Ref. No.</b>	12025069 Z44532
<b>description</b>	mix basket L 395mm W 395mm H 145mm		
<b>For models:</b>	AD-20C-UK, AD-21, AD-21B, AD-21BDD, AD-21C, AD-21D, AD-21DD, AD-21W, CO-400, CO-400-B, CO-400-B-DD, CO-400-COLD, CO-400-COLD-B, CO-400-COLD-B-DD, CO-400-COLD-DD, CO-400-DD, CO-400-SOFT, CO-402-COLD, CO-402-COLD-B, CO-402-COLD-B-DD, CO-402-COLD-DD, CO-402W, LVC-21, LVC-21B, LVC-21C, LVC-21D, LVC-21W		

sliding corners

			
1			
<b>GEV No.</b>	970001	<b>Ref. No.</b>	12039794 Z855303
<b>description</b>	sliding corner wire gauge ø 5mm L 120mm W 120mm H 12mm L-shape		
<b>For models:</b>	FI-300B, LVC-12, LVC-15		

basket holders



			
1			
<b>GEV No.</b>	691910	<b>Ref. No.</b>	12000014 12000235 12012770 12038455 12Z7103250 12Z7103770 Z710311
<b>description</b>	basket support L 540mm W 630mm suitable for FI 80 - 120 stainless steel		
<b>For models:</b>	ECO-120, ECO-120B, FI-100, FI-100AR, FI-100B, FI-100BBT-UK, FI-120, FI-120AR+DD, FI-120B, FI-120C, FI-120HY-CLINIC, FI-120W, FI-80, FI-80AR, FI-80BBT-UK, FI-80W, FI-E-100, MF-120		

plate inserts

			
1			
<b>GEV No.</b>	976005	<b>Ref. No.</b>	12024286 Z605302
<b>description</b>	plate insert L 335mm W 195mm H 105mm plates 10 plastic-coated		
<b>For models:</b>	AD-15, AD-15D, CO-350, CO-350-B, CO-350-B-DD, CO-350-COLD, CO-350-COLD-B, CO-350-COLD-B-DD, CO-350-COLD-DD, CO-350-DD, CO-352-COLD, CO-352-COLD-B, CO-352-COLD-B-DD, CO-352-COLD-DD, LVC-12, LVC-15, LVC-15D, LVR-14, LVR-14D		

mechanical components, equipment accessories

Зип Общепит

vsezip.ru

+7(812)987-08-81



<b>GEV No.</b>	976014	<b>Ref. No.</b>	12025030 Z625302
<b>description</b>	plate insert L 370mm W 195mm H 105mm plates 11 plastic-coated		
<b>For models:</b>	AD-20C-UK, AD-21, AD-21B, AD-21BDD, AD-21C, AD-21D, AD-21DD, AD-21W, CO-400, CO-400-B, CO-400-B-DD, CO-400-COLD, CO-400-COLD-B, CO-400-COLD-B-DD, CO-400-COLD-DD, CO-400-DD, CO-400-SOFT, CO-402-COLD, CO-402-COLD-B, CO-402-COLD-B-DD, CO-402-COLD-DD, CO-402W, LVC-21, LVC-21B, LVC-21C, LVC-21D, LVC-21W, LVR-20, LVR-20B, LVR-20D, MF-21		

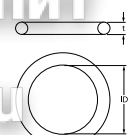

<b>GEV No.</b>	505045	<b>Ref. No.</b>	12009912 Q307036
<b>description</b>	O-ring EPDM thickness 1.78mm ID ø 5.28mm Qty 1 pcs		
<b>For models:</b>	AD-15, AD-15D, AD-90, AD-90BA, AD-90BDD, AD-90DD, COG-202, EASY-500, EASY-500B, EASY-500DD, EASY-500HP, EASY-500HPWBD, FI-30, FI-30AR, FI-30AR+DD, FI-30B, FI-30B-BT-UK, FI-30-UK, FI-48, FI-48AR, FI-48B, FI-48B-BT-UK, FI-48C, FI-48D, FI-48HY-CLINIC, FI-48W, FI-60DD, FI-80, FI-80AR, FI-80W, FI-E-100, HGC-20-21, HGP-10-21, HGP-20-21, HGV-20-21, LABP-800, LF-13MPP, LF-18MPP, LF-25MPP, LF-8MPP, LVC-12, LVC-15, LVC-15D, LVC-21, LVC-21B, LVC-21D, LVC-21W, LVR-10, LVR-14, LVR-20...(Other models you can see in the webshop)		

## shelves and shelf rails

### shelf rails and supports

#### producer-specific



<b>GEV No.</b>	691887	<b>Ref. No.</b>	12021988 Z712509
<b>description</b>	shelf support L 28mm W 20mm H 15mm SS		
<b>For models:</b>	ECO-120, ECO-120B, FI-100, FI-100AR, FI-100B, FI-120, FI-120B, FI-120W, FI-80, FI-80W, MF-120		

<b>ø2.62mm</b>			
<b>GEV No.</b>	529412	<b>Ref. No.</b>	12009873 Q307003
<b>description</b>	O-ring EPDM thickness 2.62mm ID ø 10.78mm Qty 1 pcs		
<b>For models:</b>	AD-120, AD-120B, AD-120BTTDD-UK, AD-120C, AD-120CW, AD-120HY, AD-15, AD-15D, AD-20C-UK, AD-21, AD-21B, AD-21BDD, AD-21C, AD-21D, AD-21DD, AD-21W, AD-45BBT, AD-48, AD-48B, AD-48BDD, AD-48C, AD-48D, AD-48DD, AD-48HY, AD-48W, AD-64, AD-64B, AD-64BBT, AD-64BDD, AD-64BTDD, AD-64C, AD-64CW, AD-64D, AD-64DD, AD-64HY, AD-72, AD-72W, AD-90, AD-90BA, AD-90BBT, AD-90BDD, AD-90DD, ADE-120, ADE-120B, CO-350, CO-350-B, CO-350-B-DD, CO-350-COLD, CO-350-COLD-B, CO-350-COLD-B-DD...(Other models you can see in the webshop)		

## gaskets

### O-rings

#### EPDM

#### ø1.78mm

<b>GEV No.</b>	529545	<b>Ref. No.</b>	12009911 Q307056
<b>description</b>	O-ring EPDM thickness 1.78mm ID ø 10.82mm Qty 1 pcs		
<b>For models:</b>	AD-15, AD-15D, AD-20C-UK, AD-21, AD-21B, AD-21BDD, AD-21C, AD-21D, AD-21DD, AD-21W, CO-350, CO-350-B, CO-350-B-DD, CO-350-COLD, CO-350-COLD-B, CO-350-COLD-B-DD, CO-350-COLD-DD, CO-350-DD, CO-352-COLD, CO-352-COLD-B, CO-352-COLD-B-DD, CO-352-COLD-DD, CO-400, CO-400-B, CO-400-B-DD, CO-400-COLD, CO-400-COLD-B, CO-400-COLD-B-DD, CO-400-COLD-DD, CO-400-DD, CO-400-SOFT, CO-402-COLD, CO-402-COLD-B, CO-402-COLD-B-DD, CO-402-COLD-DD, CO-402W, LVC-12, LVC-15, LVC-15D, LVC-21, LVC-21B, LVC-21C, LVC-21D, LVC-21W, MF-21		

<b>GEV No.</b>	505073	<b>Ref. No.</b>	12010282 Q307041
<b>description</b>	O-ring EPDM thickness 2.62mm ID ø 20.63mm Qty 1 pcs		
<b>For models:</b>	AD-15, AD-15D, AD-20C-UK, AD-21, AD-21B, AD-21BDD, AD-21C, AD-21D, AD-21W, CG-1002, CG-1502, CG-2000, CG-2000-2P, CG-2002, CG-2002P, CG9-11, CG9-11AD, CG9-11PLUS, CG9-31PLUS-D, CG9-31PLUS-I, CG9-41, CG9-41AD, CG9-41AD-H, CG9-41H, CG9-41PLUS, CG9-41PLUS-H, CG9-51L, CG9-51LC, CG9-51R, CG9-51RC, CG9-61, CG9-61AD, CG9-61AD-H, CG9-61H, CG9-61OP, CG9-61PLUS, CG9-61PLUS-H, CG9-82, CG9-82AD, CG9-82PLUS, CGF9-121D, CGF9-121D-AD, CGF9-121I, CGF9-121PLUS-D, CGF9-121PLUS-I, FF-35, FI-5420, FI-7630, FTG9-11L, FTG9-11L+R...(Other models you can see in the webshop)		

mechanical components, equipment accessories



Зип Общепит

vsezip.ru

(812)987-08-81

<b>GEV No.</b>	532499	<b>Ref. No.</b>	12010230 Q307062
<b>description</b>	O-ring EPDM thickness 2.62mm ID $\varnothing$ 23.47mm Qty 1 pcs		
<b>For models:</b>	ECO-160, ECO-160D, ECO-160I, ECO-200, ECO-200D, ECO-200H, ECO-200HD, ECO-200HI, ECO-200I, FI-160, FI-160AR, FI-160D, FI-160I, FI-200, FI-200AR, FI-200D, FI-200H, FI-200HD, FI-200HI, FI-200I, FI-200W, FI-200WL, FI-200WR		

<b>GEV No.</b>	532494	<b>Ref. No.</b>	12010165 Q307051 Q307061
<b>description</b>	O-ring EPDM thickness 2.62mm ID $\varnothing$ 36.14mm Qty 1 pcs		
<b>For models:</b>	AD-120, AD-120B, AD-120BBTDD-UK, AD-120C, AD-120CW, AD-120HY, AD-45BBT, AD-48, AD-48B, AD-48BD, AD-48C, AD-48D, AD-48DD, AD-48HY, AD-48W, AD-64, AD-64B, AD-64BBT, AD-64BDD, AD-64BTDD, AD-64C, AD-64CW, AD-64D, AD-64DD, AD-64HY, AD-72, AD-72W, AD-90, AD-90BA, AD-90BBT, AD-90BDD, AD-90DD, ADE-120, ADE-120B, EASY-500, EASY-500B, EASY-500DD, EASY-500HP, ECO-120, ECO-120B, ECO-160, ECO-160D, ECO-160I, ECO-200, ECO-200D, ECO-200H, ECO-200HD, ECO-200HI, ECO-200I, ECO-2700D...(Other models you can see in the webshop)		

<b>GEV No.</b>	532546	<b>Ref. No.</b>	12010184 Q307064
<b>description</b>	O-ring EPDM thickness 2.62mm ID $\varnothing$ 52.07mm Qty 1 pcs		
<b>For models:</b>	ECO-280D, ECO-280I, ECO-370D, ECO-370I, ECO-460D, ECO-460I, ECO-550D, ECO-550I, FI-280D, FI-280I, FI-370D, FI-370I, FI-460D, FI-460I, FI-550D, FI-550I		

$\varnothing$ 3.00mm

<b>GEV No.</b>	532548	<b>Ref. No.</b>	12010176 Q307068
<b>description</b>	O-ring EPDM thickness 3mm ID $\varnothing$ 27mm Qty 1 pcs		
<b>For models:</b>	ECO-2700D, ECO-2700I, ECO-280D, ECO-280I, ECO-370D, ECO-370I, ECO-4000D, ECO-4000I, ECO-460D, ECO-460I, ECO-550D, ECO-550I, ECO-6000D, ECO-6000I, FI-2700D, FI-2700I, FI-280D, FI-280I, FI-370D, FI-370I, FI-4000D, FI-4000I, FI-460D, FI-460I, FI-550D, FI-550I, FI-6000D, FI-6000I		

<b>GEV No.</b>	532102	<b>Ref. No.</b>	12010234 Q307063
<b>description</b>	O-ring EPDM thickness 3.53mm ID $\varnothing$ 12.29mm Qty 10 pcs		
<b>For models:</b>	ECO-160, ECO-160D, ECO-160I, ECO-200, ECO-200D, ECO-200H, ECO-200HD, ECO-200HI, ECO-200I, ECO-2700D, ECO-2700I, ECO-280D, ECO-280I, ECO-370D, ECO-370I, ECO-4000D, ECO-4000I, ECO-460D, ECO-460I, ECO-550D, ECO-550I, ECO-6000D, ECO-6000I, FI-160, FI-160AR, FI-160D, FI-160I, FI-200, FI-200AR, FI-200D, FI-200H, FI-200HD, FI-200HI, FI-200I, FI-200W, FI-200WL, FI-200WR, FI-2700D, FI-2700I, FI-280D, FI-280I, FI-370D, FI-370I, FI-4000D, FI-4000I, FI-460D, FI-460I, FI-550D, FI-550I, FI-6000D...(Other models you can see in the webshop)		

<b>GEV No.</b>	532151	<b>Ref. No.</b>	12021011 Z201084
<b>description</b>	O-ring EPDM thickness 3.53mm ID $\varnothing$ 120.2mm Qty 10 pcs		
<b>For models:</b>	ECO-120, ECO-120B, FI-100, FI-100AR, FI-100B, FI-120, FI-120B, FI-120W, MF-120		

<b>GEV No.</b>	532103	<b>Ref. No.</b>	12049214
<b>description</b>	O-ring EPDM thickness 3.53mm ID $\varnothing$ 13.87mm Qty 10 pcs		
<b>For models:</b>	AD-125, AD-125HRS, AD-125-SOFT, CO-110, CO-110B, CO-110BDD, CO-110DD, CO-112, CO-112B, CO-112BDD, CO-112DD, CO-170, CO-170B, CO-170BDD, CO-170DD, CO-170HRS, CO-170HRSDD, CO-170HRS-SOFT, CO-170-SOFT, CO-172, CO-172B, CO-172BDD, CO-172DD, COP-173, COP-173B, COP-173BDD, COP-173DD, COP-173HRS, COP-173HRSDD, COP-173-SOFT, COP-174, COP-174B, COP-174BDD, COP-174DD, COP-174HRS, COP-174HRSDD		

<b>GEV No.</b>	505152	<b>Ref. No.</b>	12009666 Q307000
<b>description</b>	O-ring EPDM thickness 3.53mm ID $\varnothing$ 29mm Qty 1 pcs		
<b>For models:</b>	ECO-1200, ECO-1600, ECO-2300, ECO-3000, FE-18, FE-25, FI-1200, FI-1600, FI-2300, FI-3000, FI-300B, FI-300R, FI-650R, FI-900		

mechanical components, equipment accessories

Зип.Общепит

05.04.011

vsezip.ru

77(812)987-08-81

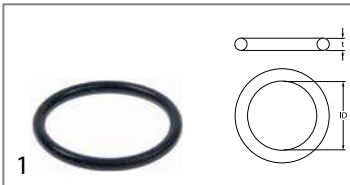

<b>GEV No.</b>	512511	<b>Ref. No.</b>	12115850
<b>description</b>	O-ring EPDM thickness 3.53mm ID ø 32mm Qty 10 pcs		
<b>For models:</b>	CO-500, CO-500B, CO-500BDD, CO-500DD, CO-501, CO-501B, CO-501BDD, CO-501DD, CO-501-SOFT, CO-502B, CO-502BDD, CO-502DD, CO-502W, COP-503, COP-503B, COP-503BDD, COP-503DD, COP-503-SOFT, COP-504, COP-504B, COP-504BDD, COP-504DD, COP-504W		

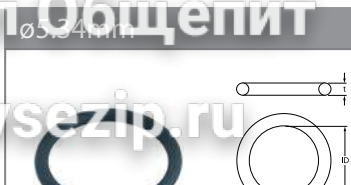

<b>GEV No.</b>	505092	<b>Ref. No.</b>	12010062 12016701 Q307053 S312113
<b>description</b>	O-ring EPDM thickness 5.34mm ID ø 43.82mm Qty 1 pcs		
<b>For models:</b>	AD-15, AD-15D, AD-20C-UK, AD-21, AD-21B, AD-21BDD, AD-21C, AD-21D, AD-21DD, AD-21W, LVC-12, LVC-15, LVC-15D, LVC-21, LVC-21B, LVC-21C, LVC-21D, LVC-21W, LVR-10, LVR-14, LVR-14D, LVR-20, LVR-20B, LVR-20D, MF-21		



<b>GEV No.</b>	506015	<b>Ref. No.</b>	12024031 Z471109
<b>description</b>	O-ring EPDM thickness 3.53mm ID ø 39.69mm Qty 1 pcs		
<b>For models:</b>	AD-15D, AD-21D, AD-48D, AD-64D, CO-400-SOFT, FI-48, FI-48AR, FI-48B, FI-48B-BT-UK, FI-48C, FI-48D, FI-48HY-CLINIC, FI-48W, FI-64, FI-64AR, FI-64B, FI-64B-BT-UK, FI-64C, FI-64D, FI-64HY-CLINIC, FI-64W, LVC-15D, LVC-21D		



<b>GEV No.</b>	510408	<b>Ref. No.</b>	12039760 eu456002 Q307020
<b>description</b>	O-ring EPDM thickness 5.34mm ID ø 47mm Qty 1 pcs		
<b>For models:</b>	ECO-1200, FI-1200, FI-300B, FI-300R, FI-650R, FI-900		

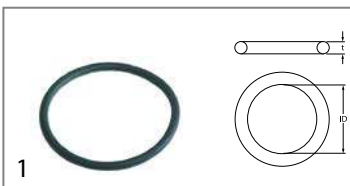

<b>GEV No.</b>	505180	<b>Ref. No.</b>	12010118 Q307057
<b>description</b>	O-ring EPDM thickness 3.53mm ID ø 47.22mm Qty 1 pcs		
<b>For models:</b>	AD-120, AD-120B, AD-120BBTDD-UK, AD-120C, AD-120CW, AD-120HY, AD-90, AD-90BA, AD-90BBT, AD-90BDD, AD-90DD, ADE-120, ADE-120B, ECO-120, ECO-120B, ECO-160, ECO-160D, ECO-160I, ECO-200, ECO-200D, ECO-200H, ECO-200HD, ECO-200HI, ECO-200I, ECO-280D, ECO-280I, ECO-370D, ECO-370I, ECO-460D, ECO-460I, ECO-550D, ECO-550I, FI-100, FI-100AR, FI-100B, FI-100BBT-UK, FI-120, FI-120AR+DD, FI-120B, FI-120C, FI-120HY-CLINIC, FI-120W, FI-160, FI-160D, FI-160I, FI-200, FI-200D, FI-200H, FI-200HD, FI-200HI...(Other models you can see in the webshop)		



<b>GEV No.</b>	505175	<b>Ref. No.</b>	12010079 Q307052
<b>description</b>	O-ring EPDM thickness 5.34mm ID ø 50.16mm Qty 1 pcs		
<b>For models:</b>	AD-15, AD-15D, AD-20C-UK, AD-21, AD-21B, AD-21BDD, AD-21C, AD-21D, AD-21DD, AD-21W, AD-45BBT, AD-48, AD-48B, AD-48BDD, AD-48C, AD-48D, AD-48DD, AD-48HY, AD-48W, AD-64, AD-64B, AD-64BBT, AD-64BDD, AD-64BTDD, AD-64C, AD-64CW, AD-64D, AD-64DD, AD-64HY, AD-72, AD-72W, CO-350, CO-350-B, CO-350-B-DD, CO-350-COLD, CO-350-COLD-B, CO-350-COLD-B-DD, CO-350-COLD-DD, CO-350-DD, CO-352-COLD, CO-352-COLD-B, CO-352-COLD-B-DD, CO-352-COLD-DD, CO-400, CO-400-B, CO-400-B-DD, CO-400-COLD, CO-400-COLD-B, CO-400-COLD-B-DD, CO-400-COLD-DD...(Other models you can see in the webshop)		

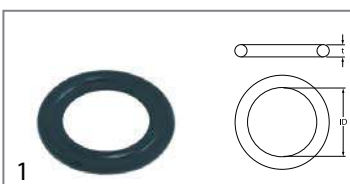

<b>GEV No.</b>	532498	<b>Ref. No.</b>	12010256 Q307048
<b>description</b>	O-ring EPDM thickness 3.53mm ID ø 9.12mm Qty 1 pcs		
<b>For models:</b>	AD-120, AD-120B, AD-120BBTDD-UK, AD-120C, AD-120CW, AD-120HY, AD-45BBT, AD-48, AD-48B, AD-48BDD, AD-48C, AD-48D, AD-48DD, AD-48HY, AD-48W, AD-64, AD-64B, AD-64BBT, AD-64BDD, AD-64BTDD, AD-64C, AD-64CW, AD-64D, AD-64DD, AD-64HY, AD-72, AD-72W, AD-90, AD-90BA, AD-90BBT, AD-90BDD, AD-90DD, ADE-120, ADE-120B, EASY-500, EASY-500B, EASY-500DD, EASY-500HP, EASY-500HPWBDD, ECO-120, ECO-120D, ECO-120B, ECO-160, ECO-160D, ECO-160I, ECO-200, ECO-200D, ECO-200H, ECO-200HD...(Other models you can see in the webshop)		

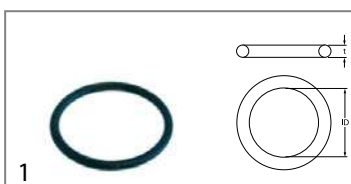

<b>GEV No.</b>	510409	<b>Ref. No.</b>	12010040 Q307044
<b>description</b>	O-ring EPDM thickness 5.34mm ID ø 56.52mm Qty 1 pcs		
<b>For models:</b>	ECO-160, ECO-160D, ECO-160I, ECO-200, ECO-200D, ECO-200H, ECO-200HD, ECO-200HI, ECO-200I, ECO-2300, ECO-2700D, ECO-2700I, ECO-280D, ECO-280I, ECO-3000, ECO-370D, ECO-370I, ECO-4000D, ECO-4000I, ECO-460D, ECO-460I, ECO-550D, ECO-550I, ECO-6000D, ECO-6000I, FI-160, FI-160D, FI-160AR, FI-160D, FI-160I, FI-200, FI-200AR, FI-200D, FI-200H, FI-200HD, FI-200HI, FI-200I, FI-200W, FI-200WL, FI-200WR, FI-2300, FI-2700D, FI-2700I, FI-280D, FI-280I, FI-3000, FI-370D, FI-370I, FI-4000D...(Other models you can see in the webshop)		





Зип Общепит

vsezip.ru

(812)987-08-81

<b>GEV No.</b>	691033	<b>Ref. No.</b>	12010051 Q307035
<b>description</b>	O-ring EPDM thickness 5.34mm ID ø 62.87mm Qty 1 pcs		
<b>For models:</b>	AD-120, AD-120B, AD-120BBTDD-UK, AD-120C, AD-120HY, AD-45BBT, AD-48, AD-48B, AD-48BDD, AD-48C, AD-48D, AD-48DD, AD-48HY, AD-48W, AD-64, AD-64B, AD-64BBT, AD-64BDD, AD-64BTDD, AD-64C, AD-64CW, AD-64D, AD-64DD, AD-64HY, AD-72, AD-72W, AD-90, AD-90BA, AD-90BBT, AD-90BDD, AD-90DD, CO-110, CO-110B, CO-110BDD, CO-110DD, CO-112, CO-112B, CO-112BDD, CO-112DD, CO-142W, CO-142WDD, CO-170, CO-170B, CO-170BDD, CO-170DD, CO-170HRS, CO-170HRSDD, CO-170HRS-SOFT, CO-170-SOFT, CO-172...(Other models you can see in the webshop)		

<b>GEV No.</b>	510153	<b>Ref. No.</b>	12010206 Q306050
<b>description</b>	flat gasket fibre ED ø 12mm ID ø 6.2mm thickness 1.5mm Qty 1 pcs		
<b>For models:</b>	AD-120, AD-120B, AD-120C, AD-120CW, AD-45BBT, AD-48, AD-48B, AD-48C, AD-48D, AD-48DD, AD-48HY, AD-48W, AD-64, AD-64B, AD-64BBT, AD-64BTDD, AD-64C, AD-64CW, AD-64D, AD-64DD, AD-64HY, AD-72, AD-72W, AD-90, AD-90BA, AD-90BBT, AD-90BDD, AD-90DD, ADE-120, ADE-120B, ECO-120, ECO-120B, ECO-160, ECO-160D, ECO-160I, ECO-200, ECO-200D, ECO-200H, ECO-200HD, ECO-200HI, ECO-200I, FI-100, FI-100AR, FI-100B, FI-100BBT-UK, FI-120, FI-120AR+DD, FI-120B, FI-120C, FI-120HY-CLINIC...(Other models you can see in the webshop)		

<b>GEV No.</b>	505178	<b>Ref. No.</b>	12009976 Q307049
<b>description</b>	O-ring EPDM thickness 5.34mm ID ø 85.09mm Qty 1 pcs		
<b>For models:</b>	AD-45BBT, AD-48, AD-48B, AD-48BDD, AD-48C, AD-48D, AD-48DD, AD-48HY, AD-48W, AD-64, AD-64B, AD-64BBT, AD-64BDD, AD-64BTDD, AD-64C, AD-64CW, AD-64D, AD-64DD, AD-64HY, AD-72, AD-72W, EASY-500, EASY-500B, EASY-500DD, EASY-500HP, EASY-500HPWBDD, FI-30, FI-30AR, FI-30AR+DD, FI-30B, FI-30B-BT-UK, FI-30-UK, FI-48, FI-48AR, FI-48B, FI-48B-BT-UK, FI-48C, FI-48D, FI-48HY-CLINIC, FI-48W, FI-50, FI-60DD, FI-64, FI-64AR, FI-64B, FI-64B-BT-UK, FI-64C, FI-64D, FI-64HY-CLINIC, FI-64W...(Other models you can see in the webshop)		

<b>GEV No.</b>	507332	<b>Ref. No.</b>	12010260 Q306024
<b>description</b>	flat gasket fibre ED ø 18mm ID ø 12mm thickness 2mm Qty 1 pcs		
<b>For models:</b>	AD-120, AD-120B, AD-120BBTDD-UK, AD-120C, AD-120CW, AD-120HY, AD-45BBT, AD-48, AD-48B, AD-48BDD, AD-48C, AD-48D, AD-48DD, AD-48HY, AD-48W, AD-64, AD-64B, AD-64BBT, AD-64BDD, AD-64BTDD, AD-64C, AD-64CW, AD-64D, AD-64DD, AD-64HY, AD-72, AD-72W, AD-90, AD-90BA, AD-90BBT, AD-90BDD, AD-90DD, ADE-120, ADE-120B, BME7-05, BME7-10, BME9-05, BME9-05AD, BME9-05PLUS, BME9-05V-T, BME9-10, BME9-10AD, BME9-10PLUS, BME9-10V-T, BMG7-10, BMG-9045, BMG9-05, BMG9-05V-T, BMG9-10, BMG9-10V-T...(Other models you can see in the webshop)		

<b>GEV No.</b>	532639	<b>Ref. No.</b>	12009995 Q307045
<b>description</b>	O-ring EPDM thickness 5.34mm ID ø 94.62mm Qty 1 pcs		
<b>For models:</b>	ECO-160, ECO-1600, ECO-160D, ECO-160I, ECO-200, ECO-200D, ECO-200H, ECO-200HD, ECO-200HI, ECO-200I, ECO-2300, ECO-280D, ECO-280I, ECO-3000, ECO-370D, ECO-370I, ECO-460D, ECO-460I, ECO-550D, ECO-550I, FI-160, FI-1600, FI-160AR, FI-160D, FI-160I, FI-200, FI-200AR, FI-200D, FI-200H, FI-200HD, FI-200HI, FI-200I, FI-200W, FI-200WL, FI-200WR, FI-2300, FI-280D, FI-280I, FI-3000, FI-370D, FI-370I, FI-460D, FI-460I, FI-550D, FI-550I		

<b>GEV No.</b>	510152	<b>Ref. No.</b>	12010203 Q306038
<b>description</b>	flat gasket fibre ED ø 31mm ID ø 21mm thickness 1.5mm Qty 1 pcs		
<b>For models:</b>	ADE-120, ADE-120B, BME7-05, BME7-10, BME9-05, BME9-10, BMG7-10, BMG-9045, BMG9-05, BMG9-10, CPE9-05, CPE9-05S, CPG7-05, CPG9-05, CPG9-05NC, CPG9-05S, CPG9-05SNC, ECO-120, ECO-1200, ECO-120B, ECO-160, ECO-1600, ECO-160D, ECO-160I, ECO-200, ECO-200D, ECO-200H, ECO-200HD, ECO-200HI, ECO-200I, ECO-2300, ECO-2700D, ECO-2700I, ECO-280D, ECO-280I, ECO-3000, ECO-370D, ECO-370I, ECO-4000D, ECO-4000I, ECO-460D, ECO-460I, ECO-550D, ECO-550I, ECO-6000D, ECO-6000I, GA-20, GA-20D, GA-40, GA-40D...(Other models you can see in the webshop)		

<p>sealing washers</p> <p>fibre gaskets</p>			
<b>GEV No.</b>	505246	<b>Ref. No.</b>	12016868 Z953097
<b>description</b>	flat gasket FIBER ED ø 17mm ID ø 13.5mm thickness 1.5mm Qty 1 pcs		
<b>For models:</b>	GA-20, GA-20D, GA-40, GA-40D		

<b>GEV No.</b>	510406	<b>Ref. No.</b>	12035981 ICR09387
<b>description</b>	flat gasket fibre ED ø 60mm ID ø 48mm thickness 3mm for thread 1½" Qty 1 pcs		

mechanical components, equipment accessories

## rubber gaskets



<b>GEV No.</b>	505245	<b>Ref. No.</b>	12039712 Q307038
<b>description</b>	flat gasket ED $\varnothing$ 77mm ID $\varnothing$ 48mm thickness 1.5mm Qty 1 pcs		
<b>For models:</b>	ECO-1200, FI-1200, FI-900		



<b>GEV No.</b>	505199	<b>Ref. No.</b>	12010191 Q307031
<b>description</b>	flat gasket rubber ED $\varnothing$ 24mm ID $\varnothing$ 14mm thickness 3mm Qty 1 pcs		
<b>For models:</b>	AD-45BBT, AD-48B, AD-48BDD, AD-48C, AD-48HY, AD-48W, AD-64B, AD-64BBT, AD-64BDD, AD-64C, AD-64CW, AD-64HY, BME7-05, BME7-10, BMG7-10, ECO-120, ECO-1200, FI-100, FI-100AR, FI-100B, FI-100BBT-UK, FI-120, FI-1200, FI-120B, FI-120W, FI-200W, FI-30, FI-300B, FI-300R, FI-30B, FI-30B-BT-UK, FI-48, FI-48AR, FI-48B, FI-48B-BT-UK, FI-48C, FI-48HY-CLINIC, FI-48W, FI-50, FI-64, FI-64AR, FI-64B, FI-64B-BT-UK, FI-64C, FI-64HY-CLINIC, FI-64W, FI-650R, FI-72, FI-80, FI-80BBT-UK... (Other models you can see in the webshop)		



<b>GEV No.</b>	900909	<b>Ref. No.</b>	12018710 Z401905
<b>description</b>	flat gasket rubber ED $\varnothing$ 31mm ID $\varnothing$ 18mm thickness 2mm Qty 1 pcs		
<b>For models:</b>	LVR-10, LVR-14, LVR-20, LVR-20B		



<b>GEV No.</b>	515018	<b>Ref. No.</b>	12009947 Q307032
<b>description</b>	flat gasket rubber ED $\varnothing$ 32mm ID $\varnothing$ 21mm thickness 3mm Qty 1 pcs		
<b>For models:</b>	AD-120, AD-120B, AD-120BBTDD-UK, AD-120C, AD-120CW, AD-120HY, AD-90, AD-90BA, AD-90BBT, AD-90BDD, AD-90DD, ADE-120, ADE-120B, BME7-05, BME7-10, BME9-05, BME9-05AD, BME9-05PLUS, BME9-05V-T, BME9-10, BME9-10AD, BME9-10PLUS, BME9-10V-T, BMG7-10, BMG9-05, BMG9-05V-T, BMG9-10, BMG9-10V-T, CO-142W, CO-142WDD, COP-174W, COP-174WHRS, ECO-120, ECO-1200, ECO-120B, ECO-160, ECO-1600, ECO-160D, ECO-160I, ECO-200, ECO-200D, ECO-200H, ECO-200HD, ECO-200HI, ECO-200I, ECO-2300, ECO-2700D, ECO-2700I, ECO-280D, ECO-280I... (Other models you can see in the webshop)		



<b>GEV No.</b>	510154	<b>Ref. No.</b>	12010053 Q307029
<b>description</b>	flat gasket rubber ED $\varnothing$ 33mm ID $\varnothing$ 26mm thickness 2mm Qty 1 pcs		
<b>For models:</b>	ECO-120, FE-18, FE-25, FG-1-40, FG-2-80, FI-100, FI-120, FI-120W, FI-30, FI-48, FI-48B, FI-48W, FI-50, FI-64, FI-64B, FI-64W, FI-72, LVC-21W, MF-21, MF-48, MF-64, MG-9150BM		

Зип Общепит

vsezip.ru

7(812)987-08-81



<b>GEV No.</b>	505161	<b>Ref. No.</b>	12010028 Q307027
<b>description</b>	flat gasket rubber ED $\varnothing$ 45mm ID $\varnothing$ 35mm thickness 2mm Qty 1 pcs		
<b>For models:</b>	BMG-9045, ECO-1200, ECO-1600, ECO-2300, ECO-2700D, ECO-2700I, ECO-280D, ECO-280I, ECO-3000, ECO-370D, ECO-370I, ECO-4000D, ECO-4000I, ECO-460D, ECO-460I, ECO-550D, ECO-550I, ECO-6000D, ECO-6000I, FI-1200, FI-1600, FI-2300, FI-2700D, FI-2700I, FI-280D, FI-280I, FI-3000, FI-300B, FI-300R, FI-370D, FI-370I, FI-4000D, FI-4000I, FI-460D, FI-460I, FI-550D, FI-550I, FI-6000D, FI-6000I, FI-650R, FI-900		



<b>GEV No.</b>	501302	<b>Ref. No.</b>	12023554 R675007
<b>description</b>	flat gasket rubber ED $\varnothing$ 57mm ID $\varnothing$ 30mm thickness 2mm Qty 1 pcs		
<b>For models:</b>	AD-45BBT, AD-48HY, AD-64BBT, AD-64BTDD, AD-64HY, EA-SY-500HPWBDD, FI-30B-BT-UK, FI-48B-BT-UK, FI-48HY-CLINIC, FI-64B-BT-UK, FI-64HY-CLINIC, HEI-10-11, HEI-20-11, HEI-6-11, HEM-10-11, HEM-20-11, HEM-6-11, HEP-10-11, HEP-20-11, HEP-6-11, HME-10-11, HME-20-11, HME-6-11, HMI-10-11, HMI-20-11, HMI-6-11, HMM-10-11, HMM-20-11, HMM-6-11, HMI-10-11UL, HMI-20-11UL, HMI-6-11UL, HMM-10-11UL, HMM-20-11UL, HMM-6-11UL, HMP-10-11, HMP-20-11... (Other models you can see in the webshop)		



<b>GEV No.</b>	505224	<b>Ref. No.</b>	12009960 Q307058
<b>description</b>	flat gasket rubber ED $\varnothing$ 60mm ID $\varnothing$ 44mm thickness 2mm Qty 1 pcs		
<b>For models:</b>	AD-120, AD-120B, AD-120BBTDD-UK, AD-120C, AD-120CW, AD-120HY, AD-90, AD-90BA, AD-90BBT, AD-90BDD, AD-90DD, ADE-120, ADE-120B, ECO-120, ECO-120B, ECO-160, ECO-160D, ECO-160I, ECO-200, ECO-200D, ECO-200H, ECO-200HD, ECO-200HI, ECO-200I, ECO-370D, ECO-370I, ECO-550D, ECO-550I, FI-100, FI-100AR, FI-100B, FI-100BBT-UK, FI-120, FI-120AR+DD, FI-120B, FI-120C, FI-120HY-CLINIC, FI-120W, FI-160, FI-160AR, FI-160D, FI-160I, FI-200, FI-200AR, FI-200D, FI-200H, FI-200HD, FI-200HI, FI-200I, FI-200W... (Other models you can see in the webshop)		



<b>GEV No.</b>	505223	<b>Ref. No.</b>	12009939 Q307009
<b>description</b>	flat gasket rubber ED $\varnothing$ 70mm ID $\varnothing$ 48mm thickness 1.5mm Qty 1 pcs		
<b>For models:</b>	BMG-9045, ECO-1200, ECO-1600, ECO-2300, ECO-2700D, ECO-2700I, ECO-280D, ECO-280I, ECO-3000, ECO-370D, ECO-370I, ECO-4000D, ECO-4000I, ECO-460D, ECO-460I, ECO-550D, ECO-550I, ECO-6000D, ECO-6000I, FI-1200, FI-1600, FI-2300, FI-2700D, FI-2700I, FI-280D, FI-280I, FI-3000, FI-300B, FI-300R, FI-370D, FI-370I, FI-4000D, FI-4000I, FI-460D, FI-460I, FI-550D, FI-550I, FI-6000D, FI-6000I, FI-650R, FI-900		





Зип Общепит

vsezip.ru

812)987-08-81

			
1			
<b>GEV No.</b>	505247	<b>Ref. No.</b>	12039795 Q307024
<b>description</b>	flat gasket rubber ED ø 72mm ID ø 54mm thickness 2mm Qty 1 pcs		
<b>For models:</b>	ECO-280D, ECO-280I, ECO-370D, ECO-370I, ECO-460D, ECO-460I, ECO-550D, ECO-550I, FI-280D, FI-280I, FI-300B, FI-300R, FI-370D, FI-370I, FI-460D, FI-460I, FI-550D, FI-550I, FI-650R		

			
1			
<b>GEV No.</b>	505194	<b>Ref. No.</b>	12009937 Q307059
<b>description</b>	flat gasket rubber ED ø 72mm ID ø 57mm thickness 2mm Qty 1 pcs		
<b>For models:</b>	AD-120, AD-120B, AD-120BBTDD-UK, AD-120C, AD-120CW, AD-120HY, AD-90, AD-90BA, AD-90BBT, AD-90BDD, AD-90DD, ADE-120, ADE-120B, ECO-120, ECO-120B, ECO-160, ECO-160D, ECO-160I, ECO-200, ECO-200D, ECO-200H, ECO-200HD, ECO-200HI, ECO-200I, ECO-2700D, ECO-2700I, ECO-280D, ECO-280I, ECO-370D, ECO-370I, ECO-4000D, ECO-4000I, ECO-460D, ECO-460I, ECO-550D, ECO-550I, ECO-6000D, ECO-6000I, FI-100, FI-100AR, FI-100B, FI-100BBT-UK, FI-120, FI-120AR+DD, FI-120B, FI-120C, FI-120HY-CLINIC, FI-120W, FI-160, FI-160AR...(Other models you can see in the webshop)		

			
1			
<b>GEV No.</b>	510832	<b>Ref. No.</b>	12023571 Z310902
<b>description</b>	flat gasket rubber ED ø 92mm ID ø 66mm thickness 2mm Qty 1 pcs equiv. no. 200906/33456		
<b>For models:</b>	ECO-2700D, ECO-2700I, ECO-280D, ECO-280I, ECO-370D, ECO-370I, ECO-4000D, ECO-4000I, ECO-460D, ECO-460I, ECO-550D, ECO-550I, ECO-6000D, ECO-6000I, FI-2700D, FI-2700I, FI-280D, FI-280I, FI-370D, FI-370I, FI-4000D, FI-4000I, FI-460D, FI-460I, FI-550D, FI-550I, FI-6000D, FI-6000I		

			
1			
<b>GEV No.</b>	505249	<b>Ref. No.</b>	12009936 Q307011
<b>description</b>	gasket ED ø 56mm ID ø 39mm thickness 1mm Qty 1 pcs		
<b>For models:</b>	ECO-1600, ECO-2300, ECO-280D, ECO-280I, ECO-3000, ECO-370D, ECO-370I, ECO-460D, ECO-460I, ECO-550D, ECO-550I, FI-1600, FI-2300, FI-280D, FI-280I, FI-3000, FI-370D, FI-370I, FI-460D, FI-460I, FI-550D, FI-550I		

<b>plastic gaskets</b>			
			
1			
<b>GEV No.</b>	510212	<b>Ref. No.</b>	12019069 Q308008
<b>description</b>	flat gasket plastic ED ø 12mm ID ø 7.3mm thickness 2mm Qty 1 pcs		
<b>For models:</b>	FI-300B, FI-300R, FI-650R		

<b>PTFE gaskets</b>			
			
1			
<b>GEV No.</b>	505226	<b>Ref. No.</b>	12018644 Q308009
<b>description</b>	slide ring PTFE ED ø 19mm ID ø 7.5mm thickness 2mm Qty 1 pcs		
<b>For models:</b>	FI-300B, FI-300R, FI-650R		

			
1			
<b>GEV No.</b>	505225	<b>Ref. No.</b>	12009922 Q308012
<b>description</b>	slide ring PTFE ED ø 30mm ID ø 10mm thickness 3mm for hood joint Qty 1 pcs		
<b>For models:</b>	AD-120, AD-120B, AD-120BBTDD-UK, AD-120C, AD-120CW, AD-120HY, AD-90, AD-90BA, AD-90BBT, AD-90BDD, AD-90DD, ADE-120, ADE-120B, ECO-120, ECO-120B, FI-100, FI-100AR, FI-100B, FI-100BBT-UK, FI-120, FI-120AR+DD, FI-120B, FI-120C, FI-120HY-CLINIC, FI-120W, FI-80, FI-80AR, FI-80BBT-UK, FI-80W, FI-E-100, LABP-1000, LABP-1200, LABP-800, MF-120		

<b>foam rubber gaskets</b>			
			
1			
<b>GEV No.</b>	505250	<b>Ref. No.</b>	12021459 Z680532
<b>description</b>	foam rubber gasket W 20mm thickness 5mm Qty 720mm		
<b>For models:</b>	ECO-1200, FI-1200, FI-900		

			
1			
<b>GEV No.</b>	505237	<b>Ref. No.</b>	12025277 Z400309
<b>description</b>	foam rubber gasket W 8mm thickness 2mm self-adhesive Qty 450mm		
<b>For models:</b>	AD-15, AD-15D, LVC-12, LVC-15, LVC-15D, LVR-10, LVR-14, LVR-14D		

mechanical components, equipment accessories



1

<b>GEV No.</b>	505264	<b>Ref. No.</b>	12024174 Z200313
<b>description</b>	foam rubber gasket W 9mm thickness 2.5mm self-adhesive Qty 625mm		
<b>For models:</b>	AD-45BBT, AD-48, AD-48B, AD-48BDD, AD-48C, AD-48D, AD-48DD, AD-48HY, AD-48W, AD-64, AD-64B, AD-64BBT, AD-64BDD, AD-64BTDD, AD-64C, AD-64CW, AD-64D, AD-64DD, AD-64HY, AD-72, AD-72W, EASY-500, EASY-500B, EASY-500DD, EASY-500HP, EASY-500HPWBDD, FI-30, FI-30AR, FI-30AR+DD, FI-30B, FI-30B-BT-UK, FI-30-UK, FI-48, FI-48AR, FI-48B, FI-48B-BT-UK, FI-48C, FI-48D, FI-48HY-CLINIC, FI-48W, FI-50, FI-60DD, FI-64, FI-64AR, FI-64B, FI-64B-BT-UK, FI-64C, FI-64D, FI-64HY-CLINIC, FI-64W...(Other models you can see in the webshop)		

Зип Общепит

vsezip.ru

+7(812)987-08-81



1

<b>GEV No.</b>	505250	<b>Ref. No.</b>	12021459 Z680532
<b>description</b>	foam rubber gasket W 20mm thickness 5mm Qty 720mm		
<b>For models:</b>	ECO-1200, FI-1200, FI-900		

## shaft gaskets

## shaft gaskets



1

<b>GEV No.</b>	698001	<b>Ref. No.</b>	12025169 Z105016
<b>description</b>	shaft seal ID ø 20mm ED ø 35mm thickness 7mm		
<b>For models:</b>	ECO-160, ECO-1600, ECO-160D, ECO-160I, ECO-200, ECO-200D, ECO-200H, ECO-200HD, ECO-200HI, ECO-200I, ECO-2300, ECO-280D, ECO-280I, ECO-3000, ECO-370D, ECO-370I, ECO-460D, ECO-460I, ECO-550D, ECO-550I, FI-160, FI-1600, FI-160AR, FI-160D, FI-160I, FI-200, FI-200AR, FI-200D, FI-200H, FI-200HD, FI-200HI, FI-200I, FI-200W, FI-200WL, FI-200WR, FI-2300, FI-280D, FI-280I, FI-3000, FI-370D, FI-370I, FI-460D, FI-460I, FI-550D, FI-550I		



1

<b>GEV No.</b>	505237	<b>Ref. No.</b>	12025277 Z400309
<b>description</b>	foam rubber gasket W 8mm thickness 2mm self-adhesive Qty 450mm		
<b>For models:</b>	AD-15, AD-15D, LVC-12, LVC-15, LVC-15D, LVR-10, LVR-14, LVR-14D		

## special gaskets

## door seals for dishwashers



1

<b>GEV No.</b>	518215	<b>Ref. No.</b>	12024374
<b>description</b>	door seal L 590mm W 26mm H 26mm silicone FAGOR suitable for dishwasher		
<b>For models:</b>	AD-45BBT, AD-48, AD-48B, AD-48BDD, AD-48C, AD-48D, AD-48DD, AD-48HY, AD-48W, AD-64, AD-64B, AD-64BBT, AD-64BDD, AD-64BTDD, AD-64C, AD-64CW, AD-64D, AD-64DD, AD-64HY, AD-72, AD-72W, EASY-500, EASY-500B, EASY-500DD, EASY-500HP, EASY-500HPWBDD, FI-30, FI-30AR, FI-30AR+DD, FI-30B, FI-30B-BT-UK, FI-30-UK, FI-48, FI-48AR, FI-48B, FI-48B-BT-UK, FI-48C, FI-48D, FI-48HY-CLINIC, FI-48W, FI-60DD, FI-64, FI-64AR, FI-64B, FI-64B-BT-UK, FI-64C, FI-64D, FI-64HY-CLINIC, FI-64W, FI-72...(Other models you can see in the webshop)		



1

<b>GEV No.</b>	505264	<b>Ref. No.</b>	12024174 Z200313
<b>description</b>	foam rubber gasket W 9mm thickness 2.5mm self-adhesive Qty 625mm		
<b>For models:</b>	AD-45BBT, AD-48, AD-48B, AD-48BDD, AD-48C, AD-48D, AD-48DD, AD-48HY, AD-48W, AD-64, AD-64B, AD-64BBT, AD-64BDD, AD-64BTDD, AD-64C, AD-64CW, AD-64D, AD-64DD, AD-64HY, AD-72, AD-72W, EASY-500, EASY-500B, EASY-500DD, EASY-500HP, EASY-500HPWBDD, FI-30, FI-30AR, FI-30AR+DD, FI-30B, FI-30B-BT-UK, FI-30-UK, FI-48, FI-48AR, FI-48B, FI-48B-BT-UK, FI-48C, FI-48D, FI-48HY-CLINIC, FI-48W, FI-50, FI-60DD, FI-64, FI-64AR, FI-64B, FI-64B-BT-UK, FI-64C, FI-64D, FI-64HY-CLINIC, FI-64W...(Other models you can see in the webshop)		



Зип Общежит

thermostat gaskets

vsezip.ru

+7(812)987-08-81

miscellaneous



<b>GEV No.</b>	505078	<b>Ref. No.</b>	12024556 Z200907
<b>description</b>	gasket external hight 23.5mm for sump ED ø 225mm ID ø 200mm		
<b>For models:</b>	AD-45BBT, AD-48, AD-48B, AD-48BDD, AD-48C, AD-48D, AD-48DD, AD-48HY, AD-48W, AD-64, AD-64B, AD-64BBT, AD-64BDD, AD-64BTDD, AD-64C, AD-64CW, AD-64D, AD-64DD, AD-64HY, AD-72, AD-72W, EASY-500, EASY-500B, EASY-500DD, EASY-500HP, FI-30, FI-30AR, FI-30AR+DD, FI-30B, FI-30B-BT-UK, FI-30-UK, FI-48, FI-48AR, FI-48B, FI-48B-BT-UK, FI-48C, FI-48D, FI-48HY-CLINIC, FI-48W, FI-50, FI-60DD, FI-64, FI-64AR, FI-64B, FI-64B-BT-UK, FI-64C, FI-64D, FI-64HY-CLINIC, FI-64W, FI-72...(Other models you can see in the webshop)		



<b>GEV No.</b>	505077	<b>Ref. No.</b>	12024113 Z400902
<b>description</b>	gasket external hight 23mm for sump		
<b>For models:</b>	AD-15, AD-15D, AD-20C-UK, AD-21, AD-21B, AD-21BDD, AD-21C, AD-21D, AD-21DD, AD-21W, CO-350, CO-350-B, CO-350-B-DD, CO-350-COLD, CO-350-COLD-B, CO-350-COLD-B-DD, CO-350-COLD-DD, CO-350-DD, CO-352-COLD, CO-352-COLD-B, CO-352-COLD-B-DD, CO-352-COLD-DD, CO-400, CO-400-B, CO-400-B-DD, CO-400-COLD, CO-400-COLD-B, CO-400-COLD-B-DD, CO-400-COLD-DD, CO-400-DD, CO-400-SOFT, CO-402-COLD, CO-402-COLD-B, CO-402-COLD-B-DD, CO-402-COLD-DD, CO-402W, LVC-12, LVC-15, LVC-15D, LVC-21, LVC-21B, LVC-21C, LVC-21D, LVC-21W, LVR-10, LVR-14, LVR-14D, LVR-20, LVR-20B, LVR-20D...(Other models you can see in the webshop)		



<b>GEV No.</b>	511992	<b>Ref. No.</b>	12023517 Z710547
<b>description</b>	gasket suitable for FAGOR for hood mechanics L 100mm W 86mm thickness 2mm hole distance 30/45mm		
<b>For models:</b>	AD-120, AD-120B, AD-120BBTDD-UK, AD-120C, AD-120CW, AD-120HY, AD-90, AD-90BA, AD-90BBT, AD-90BDD, AD-90DD, ADE-120, ADE-120B, ECO-120, ECO-120B, FI-100, FI-100AR, FI-100B, FI-100BBT-UK, FI-120, FI-120AR+DD, FI-120B, FI-120C, FI-120HY-CLINIC, FI-120W, FI-80, FI-80AR, FI-80BBT-UK, FI-80W, FI-E-100, LABP-1000, LABP-1200, LABP-800, MF-120		



<b>GEV No.</b>	505093	<b>Ref. No.</b>	12024049 N503017
<b>description</b>	gasket for thermostat ED ø 35mm ID ø 24mm thickness 7mm equiv. no. N503017		
<b>For models:</b>	AD-120, AD-120B, AD-120BBTDD-UK, AD-120C, AD-120CW, AD-120HY, AD-15, AD-15D, AD-20C-UK, AD-21, AD-21B, AD-21BDD, AD-21C, AD-21D, AD-21DD, AD-21W, AD-45BBT, AD-48, AD-48B, AD-48BDD, AD-48C, AD-48D, AD-48DD, AD-48HY, AD-48W, AD-64, AD-64B, AD-64BBT, AD-64BDD, AD-64BTDD, AD-64C, AD-64CW, AD-64D, AD-64DD, AD-64HY, AD-72, AD-72W, AD-90, AD-90BA, AD-90BBT, AD-90BDD, AD-90DD, ADE-120, ADE-120B, BME7-05, BME7-10, BME9-05, BME9-10, EASY-500, EASY-500B...(Other models you can see in the webshop)		

gaskets for wash arm support



<b>GEV No.</b>	505167	<b>Ref. No.</b>	12023533 Z400703
<b>description</b>	gasket D1 ø 68mm D2 ø 35mm thickness 3.5mm with 4 screw holes equiv. no. Z400703 suitable for FAGOR		
<b>For models:</b>	AD-15, AD-15D, AD-20C-UK, AD-21, AD-21B, AD-21BDD, AD-21C, AD-21D, AD-21DD, AD-21W, CO-350, CO-350-B, CO-350-B-DD, CO-350-COLD, CO-350-COLD-B, CO-350-COLD-B-DD, CO-350-COLD-DD, CO-350-DD, CO-352-COLD, CO-352-COLD-B, CO-352-COLD-B-DD, CO-352-COLD-DD, CO-400, CO-400-B, CO-400-B-DD, CO-400-COLD, CO-400-COLD-B, CO-400-COLD-B-DD, CO-400-COLD-DD, CO-400-DD, CO-400-SOFT, CO-402-COLD, CO-402-COLD-B, CO-402-COLD-B-DD, CO-402-COLD-DD, CO-402W, LVC-12, LVC-15, LVC-15D, LVC-21, LVC-21B, LVC-21C, LVC-21D, LVC-21W, LVR-10, LVR-14, LVR-14D, LVR-20, LVR-20B, LVR-20D...(Other models you can see in the webshop)		



<b>GEV No.</b>	505179	<b>Ref. No.</b>	12024227 Z710714
<b>description</b>	gasket D1 ø 82.5mm D2 ø 44mm thickness 2.5mm with 4 screw holes wash arm support equiv. no. Z710714 suitable for FAGOR		
<b>For models:</b>	AD-120, AD-120B, AD-120BBTDD-UK, AD-120C, AD-120CW, AD-120HY, AD-90, AD-90BA, AD-90BBT, AD-90BDD, AD-90DD, ADE-120, ADE-120B, ECO-120, ECO-120B, ECO-160, ECO-160D, ECO-160I, ECO-200, ECO-200D, ECO-200H, ECO-200HD, ECO-200HI, ECO-200I, FI-100, FI-100AR, FI-100B, FI-100BBT-UK, FI-120, FI-120AR+DD, FI-120B, FI-120C, FI-120HY-CLINIC, FI-120W, FI-160, FI-160D, FI-160I, FI-200, FI-200D, FI-200H, FI-200HD, FI-200HI, FI-200I, FI-200W, FI-80, FI-80AR, FI-80BBT-UK, FI-80W, FI-E-100, LABP-1000...(Other models you can see in the webshop)		

mechanical components, equipment accessories

transmission technology and ball bearings

Вип.Общепит

chains

vsezip.ru

+7(812)987-08-81

ball bearings

deep-groove ball bearings 2RS



<b>GEV No.</b>	523551	<b>Ref. No.</b>	12025150 Z105017
<b>description</b>	deep-groove ball bearing type 6003-2RS shaft ø 17mm ED ø 35mm W 10mm with sealing discs deep-groove ball bearing DIN 625-1		
<b>For models:</b>	ECO-160, ECO-1600, ECO-160D, ECO-160I, ECO-200, ECO-200D, ECO-200H, ECO-200HD, ECO-200HI, ECO-200I, ECO-2300, ECO-280D, ECO-280I, ECO-3000, ECO-370D, ECO-370I, ECO-460D, ECO-460I, ECO-550D, ECO-550I, FI-160, FI-1600, FI-160AR, FI-160D, FI-160I, FI-200, FI-200AR, FI-200D, FI-200H, FI-200HD, FI-200HI, FI-200I, FI-200W, FI-200WL, FI-200WR, FI-2300, FI-280D, FI-280I, FI-3000, FI-370D, FI-370I, FI-460D, FI-460I, FI-550D, FI-550I		



<b>GEV No.</b>	505011	<b>Ref. No.</b>	12024032 Z710541
<b>description</b>	deep-groove ball bearing type 6200-2RS shaft ø 10mm ED ø 30mm W 9mm DIN 625-1		
<b>For models:</b>	AD-120, AD-120B, AD-120BBTDD-UK, AD-120C, AD-120CW, AD-120HY, AD-90, AD-90BA, AD-90BBT, AD-90BDD, AD-90DD, ADE-120, ADE-120B, ECO-120, ECO-120B, FI-100, FI-100AR, FI-100B, FI-100BBT-UK, FI-120, FI-120AR+DD, FI-120B, FI-120C, FI-120HY-CLINIC, FI-120W, FI-80, FI-80AR, FI-80BBT-UK, FI-80W, FI-E-100, LABP-1000, LABP-1200, LABP-800, MF-120		

miscellaneous



<b>GEV No.</b>	523010	<b>Ref. No.</b>	12038332 1300000084
<b>description</b>	ball bearing set		
<b>For models:</b>	LA-AC-13M, LA-AC-13MA, LA-AC-13MP, LA-E-13M, LA-E-13MA, LA-E-13MP, LA-V-13M, LA-V-13MP, LF-13MPP, LR-AC-13M, LR-AC-13MA, LR-AC-13MP, LR-AC-18M, LR-AC-18MA, LR-AC-18MP, LR-E-13M, LR-E-13MA, LR-E-13MP, LR-E-18M, LR-E-18MA, LR-E-18MP, LR-V-13M, LR-V-13MP, LR-V-18M, LR-V-18MP		

roller chains 08B-1 single

<b>GEV No.</b>	505339	<b>Ref. No.</b>	12025097 Z275008
<b>description</b>	roller chain DIN/ISO 08 B-1 splitting 1/2" / 12.7mm links 28 internal width 7.75mm rollerø 8.51mm		
<b>For models:</b>	ECO-160, ECO-160D, ECO-160I, ECO-200, ECO-200D, ECO-200H, ECO-200HD, ECO-200HI, ECO-200I, ECO-2700D, ECO-2700I, ECO-280D, ECO-280I, ECO-370D, ECO-370I, ECO-4000D, ECO-4000I, ECO-460D, ECO-460I, ECO-550D, ECO-550I, ECO-6000D, ECO-6000I, FI-160, FI-160AR, FI-160D, FI-160I, FI-200, FI-200AR, FI-200D, FI-200H, FI-200HD, FI-200HI, FI-200I, FI-200W, FI-200WL, FI-200WR, FI-2700D, FI-2700I, FI-280D, FI-280I, FI-370D, FI-370I, FI-4000D, FI-4000I, FI-460D, FI-460I, FI-550D, FI-550I, FI-6000D...(Other models you can see in the webshop)		

connectors



<b>GEV No.</b>	693276	<b>Ref. No.</b>	12023767 Z105012
<b>description</b>	connector single DIN/ISO 08 B-1 splitting 1/2" links 1 L 23mm internal width 11.8mm rollerø 4.3mm metal		
<b>For models:</b>	ECO-160, ECO-1600, ECO-160D, ECO-160I, ECO-200, ECO-200D, ECO-200H, ECO-200HD, ECO-200HI, ECO-200I, ECO-2300, ECO-2700D, ECO-2700I, ECO-280D, ECO-280I, ECO-3000, ECO-370D, ECO-370I, ECO-4000D, ECO-4000I, ECO-460D, ECO-460I, ECO-550D, ECO-550I, ECO-6000D, ECO-6000I, FI-160, FI-1600, FI-160AR, FI-160D, FI-160I, FI-200, FI-200AR, FI-200D, FI-200H, FI-200HD, FI-200HI, FI-200I, FI-200W, FI-200WL, FI-200WR, FI-2300, FI-2700D, FI-2700I, FI-280D, FI-280I, FI-3000, FI-370D, FI-370I, FI-4000D...(Other models you can see in the webshop)		

springs

torsion springs



<b>GEV No.</b>	692159	<b>Ref. No.</b>	12024390 Z271203
<b>description</b>	torsion spring ø 10.3mm L2 20mm wire gauge ø 1.4mm L1 2mm L3 33mm Qty 1 pcs		
<b>For models:</b>	ECO-160, ECO-160D, ECO-160I, ECO-200, ECO-200D, ECO-200H, ECO-200HD, ECO-200HI, ECO-200I, ECO-280D, ECO-280I, ECO-370D, ECO-370I, ECO-460D, ECO-460I, ECO-550D, ECO-550I, FI-160, FI-160AR, FI-160D, FI-160I, FI-200, FI-200AR, FI-200D, FI-200H, FI-200HD, FI-200HI, FI-200I, FI-200W, FI-200WL, FI-200WR, FI-280D, FI-280I, FI-370D, FI-370I, FI-460D, FI-460I, FI-550D, FI-550I		

mechanical components, equipment accessories





Зип Общепит

vsezip.ru

+7(812)987-08-81

compression springs

			
<b>GEV No.</b>	505138	<b>Ref. No.</b>	12040429 Z600605
<b>description</b>	compression spring		
<b>For models:</b>	FI-300B, FI-300R, FI-650R, FTG7-05, FTG7-10, FTG9-05L, FTG9-05R, FTG9-10L, FTG9-10L+R, FTG9-10R, FTGC9-05, FTGC9-10, LC-10, LC-14, LC-7, LC-7A		

			
<b>GEV No.</b>	691008	<b>Ref. No.</b>	12025252 Z700603
<b>description</b>	compression spring $\phi$ 10mm L 28mm wire gauge $\phi$ 0.9mm		
<b>For models:</b>	BG9-05PLUS-I, BG9-10PLUS-I, CE-15, CE-9, FE-710, FE-720, FE9-05, FE9-05S, FE9-05USMC, FE9-10, FI-300B, FI-300R, FI-650R, FTG9-05PLUS-CL, FTG9-05PLUS-CR, FTG9-05PLUS-L, FTG9-05PLUS-LV, FTG9-05PLUS-RV, FTG9-05PLUS-RV, FTG9-10PLUS-CL, FTG9-10PLUS-CLR, FTG9-10PLUS-CR, FTG9-10PLUS-L, FTG9-10PLUS-LR, FTG9-10PLUS-LRV, FTG9-10PLUS-LV, FTG9-10PLUS-R, FTG9-10PLUS-RV, HCG-10-11, HCG-10-21, HCG-20-11, HCG-2-10-11, HCG-6-11, HME-10-11, HME-10-21, HME-20-11, HME-20-21, HME-2-10-11, HME-6-11, HMG-10-11, HMG-10-11UL, HMG-10-21, HMG-10-21UL, HMG-20-11, HMG-2-10-11, HMG-6-11, HMI-10-11, HMI-10-11UL, HMI-10-21, HMI-10-21UL...(Other models you can see in the webshop)		

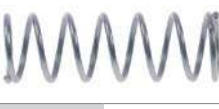
			
<b>GEV No.</b>	696553	<b>Ref. No.</b>	12017801 Z883001
<b>description</b>	compression spring $\phi$ 7.5mm L 23mm wire gauge $\phi$ 0.7mm		
<b>For models:</b>	ECO-280D, ECO-280I, ECO-370D, ECO-370I, ECO-460D, ECO-460I, ECO-550D, ECO-550I, FI-280D, FI-280I, FI-370D, FI-370I, FI-460D, FI-460I, FI-550D, FI-550I, HEI-10-11, HEI-20-11, HEI-6-11, HEM-10-11, HEM-20-11, HEM-6-11, HEP-10-11, HEP-20-11, HEP-6-11, HME-10-11, HME-10-21, HME-20-11, HME-20-21, HME-2-10-11, HME-2-20-11, HME-6-11, HMI-10-11, HMI-10-11UL, HMI-10-21, HMI-10-21UL, HMI-2-10-11, HMI-6-11, HMI-6-11UL, HMM-10-11, HMM-10-11UL, HMM-10-21, HMM-10-21UL, HMM-20-11, HMM-20-11UL, HMM-20-21, HMM-20-21UL, HMM-2-10-11, HMM-2-20-11, HMM-40-11-USMC...(Other models you can see in the webshop)		

roller springs

roller springs

			
<b>GEV No.</b>	501430	<b>Ref. No.</b>	12024877 Z310511
<b>description</b>	roller spring W 40mm ID $\phi$ 33mm lug length 49mm mounting distance 10mm		
<b>For models:</b>	ECO-280D, ECO-280I, ECO-370D, ECO-370I, ECO-460D, ECO-460I, ECO-550D, ECO-550I, FI-280D, FI-280I, FI-370D, FI-370I, FI-460D, FI-460I, FI-550D, FI-550I		

<b>GEV No.</b>	519451	<b>Ref. No.</b>	12024689 Z270513
<b>description</b>	roller spring W 40mm ID $\phi$ 35mm lug length 50mm		
<b>For models:</b>	ECO-160, ECO-160D, ECO-160I, ECO-200, ECO-200D, ECO-200H, ECO-200HD, ECO-200HI, ECO-200I, ECO-2700D, ECO-2700I, ECO-280D, ECO-280I, ECO-370D, ECO-370I, ECO-4000D, ECO-4000I, ECO-460D, ECO-460I, ECO-550D, ECO-550I, ECO-6000D, ECO-6000I, FI-160, FI-160AR, FI-160D, FI-160I, FI-200, FI-200AR, FI-200D, FI-200H, FI-200HD, FI-200HI, FI-200I, FI-200W, FI-200WL, FI-200WR, FI-2700D, FI-2700I, FI-280D, FI-280I, FI-370D, FI-370I, FI-4000D, FI-4000I, FI-460D, FI-460I, FI-550D, FI-550I, FI-6000D...(Other models you can see in the webshop)		

accessories

holders

			
<b>GEV No.</b>	517431	<b>Ref. No.</b>	12011392 Z270515
<b>description</b>	bracket for roller spring $\phi$ mm L 105mm W 44mm H 20mm		
<b>For models:</b>	ECO-160, ECO-160D, ECO-160I, ECO-200, ECO-200D, ECO-200H, ECO-200HD, ECO-200HI, ECO-200I, FI-160, FI-160AR, FI-160D, FI-160I, FI-200, FI-200AR, FI-200D, FI-200H, FI-200HD, FI-200HI, FI-200I, FI-200W, FI-200WL, FI-200WR		

miscellaneous

			
<b>GEV No.</b>	504387	<b>Ref. No.</b>	12024391 Z271204
<b>description</b>	spring right for transport system shaft diameter $\phi$ 10.5mm L 36mm Wmm Hmm wire gauge $\phi$ 1.4mm		
<b>For models:</b>	ECO-160, ECO-160D, ECO-160I, ECO-200, ECO-200D, ECO-200H, ECO-200HD, ECO-200HI, ECO-200I, ECO-280D, ECO-280I, ECO-370D, ECO-370I, ECO-460D, ECO-460I, ECO-550D, ECO-550I, FI-160, FI-160AR, FI-160D, FI-160I, FI-200, FI-200AR, FI-200D, FI-200H, FI-200HD, FI-200HI, FI-200I, FI-200W, FI-200WL, FI-200WR, FI-280D, FI-280I, FI-370D, FI-370I, FI-460D, FI-460I, FI-550D, FI-550I		

tension springs

			
<b>GEV No.</b>	505009	<b>Ref. No.</b>	12024948 Z710528
<b>description</b>	tension spring $\phi$ 35mm total length 420mm wire gauge $\phi$ 5mm		
<b>For models:</b>	AD-120, AD-120B, AD-120BBTDD-UK, AD-90, AD-90BA, AD-90BBT, AD-90BDD, AD-90DD, ADE-120, ADE-120B, ECO-120, ECO-120B, FI-100, FI-100AR, FI-100B, FI-100BBT-UK, FI-120, FI-120AR+DD, FI-120B, FI-120C, FI-120HY-CLINIC, FI-120W, FI-80, FI-80AR, FI-80BBT-UK, FI-80W, FI-E-100, LABP-1000, LABP-1200, LABP-800, MF-120		

mechanical components, equipment accessories

Зип-Общепит

spare parts for 361795			
GEV No.	361268	Ref. No.	12017199 12024224 Z209521 Z209530
dosing pump GERMAC frequency control 3l/h 230VAC detergent hose ø 4x6mm hose thermoplastic type G300 built-in version dimensions 67x72x101mm			
GEV No.	361467	Ref. No.	—
pump hose GERMAC detergent hose type thermoplastic hose ø 6x10mm for model G43/G45/G53/G54/G55/G300/G305			

1			
GEV No.	361268	Ref. No.	12017199 12024224 Z209521 Z209530
dosing pump GERMAC frequency control 3l/h 230VAC detergent hose ø 4x6mm hose thermoplastic type G300 built-in version dimensions 67x72x101mm			
<b>For models:</b> FI-30, FI-48, FI-48B, FI-48W, FI-50, FI-64, FI-64B, FI-64W, FI-72, MF-48, MF-64			
<b>spare parts for</b>		361268	
GEV No.	361467	Ref. No.	—
pump hose GERMAC detergent hose type thermoplastic hose ø 6x10mm for model G43/G45/G53/G54/G55/G300/G305			
GEV No.	361557	Ref. No.	—
control PCB type G300/G302/G305 GERMAC			
GEV No.	361589	Ref. No.	—
roller assembly GERMAC suitable for G42/43/45/53/54/55/300/302/305/705			
GEV No.	362032	Ref. No.	—
cover for GERMAC			
<b>accessories for</b>		361268	
GEV No.	361106	Ref. No.	—
container filter with weight and non-return valve SS hose ø 4x6mm ø 21mm L 51mm non return valve lip valve			
GEV No.	520090	Ref. No.	—
PVC hose ID ø 4mm ED ø 6mm L 2m thickness 1mm t.max. 60°C transparent			
GEV No.	520091	Ref. No.	—
nylon hose ID ø 4mm ED ø 6mm L 2m thickness 1mm operating p. 10bar burst p. 50bar t.max. 100°C transparent			

manometers

1			
GEV No.	541596	Ref. No.	12025146 Z102316
description manometer ø 52mm pressure range 0 up to 10bar connection dishwasher thread 1/4"			
<b>For models:</b> ECO-160, ECO-1600, ECO-200, ECO-200H, ECO-2300, ECO-3000, FI-160, FI-1600, FI-160AR, FI-160D, FI-160I, FI-200, FI-200AR, FI-200D, FI-200H, FI-200HD, FI-200HI, FI-200I, FI-2300, FI-2700D, FI-2700I, FI-280D, FI-280I, FI-3000, FI-370D, FI-370I, FI-4000D, FI-4000I, FI-460D, FI-460I, FI-550D, FI-550I, FI-6000D, FI-6000I			

1			
GEV No.	541793	Ref. No.	12019289 12024625 Z271125 Z718417
description manometer ø 52mm pressure range 0-4bar thread 1/4"			
<b>For models:</b> AD-120CW, CO-142W, CO-142WDD, FI-120W, FI-200W, FI-200WL, FI-200WR, FI-80W, MF-120			

dosing pumps

peristaltic dosing pumps

GERMAC

built-in version

with frequency control

1			
GEV No.	361795 <sup>1</sup>	Ref. No.	120000132 19022347
description dosing pump GERMAC frequency control 3l/h 230VAC detergent hose ø 4x6mm hose thermoplastic type G300 3.5W 230V code 82334968 installation kit inclusive			
<b>For models:</b> CO-110DD, CO-112DD, CO-142WDD, CO-170DD, CO-172DD, CO-350-COLD-DD, CO-350-DD, CO-400-COLD-DD, CO-400-DD, CO-402-COLD, CO-402-COLD-B, CO-402-COLD-B-DD, CO-402-COLD-DD, CO-402W, CO-500DD, CO-501DD, CO-502DD, CO-502W, COP-173DD, COP-174DD, COP-174W, COP-174WHR, COP-503DD, COP-504DD, COP-504W, FI-30, FI-30AR, FI-30AR+DD, FI-30-UK, FI-48, FI-48AR, FI-48B, FI-48B-BT-UK, FI-48C, FI-48D, FI-48HY-CLINIC, FI-48W, FI-64, FI-64AR, FI-64B, FI-64B-BT-UK, FI-64C, FI-64D, FI-64HY-CLINIC, FI-64W, FI-72, FI-72AR, FI-72W			
<b>spare parts for</b>		361795	
GEV No.	361142	Ref. No.	—
mounting set detergent hose type 4x6mm hose length 2m PVC 2x hose/container filter/tank intake transparent			

<sup>1</sup>with accessories

mechanical components, equipment accessories





membrane dosing pumps

Зип Общепит









various

self-priming

LANG





1

<b>GEV No.</b>	361221	<b>Ref. No.</b>	12024105 12039170 Z211109 Z651123
<b>description</b>	dosing pump type N6 rinse aid pressure connection ø 4x6mm suction connection ø 6x8mm LANG		
<b>For models:</b>	AD-120, AD-120B, AD-120C, AD-120CW, AD-15, AD-15D, AD-20C-UK, AD-21, AD-21B, AD-21BDD, AD-21C, AD-21D, AD-21DD, AD-21W, AD-48, AD-48B, AD-48BDD, AD-48C, AD-48D, AD-48DD, AD-48W, AD-64, AD-64B, AD-64BDD, AD-64C, AD-64CW, AD-64DD, AD-72, AD-72W, AD-90, AD-90A, AD-90B, AD-90BDD, AD-90DD, ADE-120, ADE-120B, ECO-120, ECO-1200, ECO-120B, FI-100, FI-100AR, FI-100B, FI-100BBT-UK, FI-120, FI-1200, FI-120AR+DD, FI-120B, FI-120C, FI-120HY-CLINIC, FI-120W...(Other models you can see in the webshop)		
<b>spare parts for</b>	361221		
	<b>GEV No.</b>	361079	<b>Ref. No.</b> —
	spring for type N5/N6 for ball		
	<b>GEV No.</b>	361080	<b>Ref. No.</b> —
	O-ring EPDM thickness 2mm ID ø 16mm Qty 1 pcs		
	<b>GEV No.</b>	361085	<b>Ref. No.</b> —
	O-ring EPDM thickness 2mm ID ø 8mm Qty 1 pcs		
	<b>GEV No.</b>	361309	<b>Ref. No.</b> —
	ball for type N5/N6		
	<b>GEV No.</b>	361310	<b>Ref. No.</b> —
	bracket for type N6 ball guide		
	<b>GEV No.</b>	361311	<b>Ref. No.</b> —
	O-ring EPDM thickness 2mm ID ø 6mm Qty 1 pcs for type N6		
	<b>GEV No.</b>	361314	<b>Ref. No.</b> —
	valve ring for type N6 holder for O-ring		
	<b>GEV No.</b>	361317	<b>Ref. No.</b> —
	sealing disc for type N6		
	<b>GEV No.</b>	361886	<b>Ref. No.</b> —
	non-return valve inletmm outletmm outlet ø 12.4mm L 12.7mm		
	<b>GEV No.</b>	505228	<b>Ref. No.</b> 12024067 Z203007
	spacer bush ID ø 4.5mm ED ø 10mm L 16mm for dosing pump		



1

<b>GEV No.</b>	361015	<b>Ref. No.</b>	12045206
<b>description</b>	dosing pump membrane dosing pump rinse aid inlet 6x8mm outlet 4x6mm pressure connection ø 4x6mm suction connection ø 6x8mm		
<b>For models:</b>	AD-120, AD-120B, AD-120C, AD-15, AD-15D, AD-20C-UK, AD-21, AD-21B, AD-21BDD, AD-21C, AD-21D, AD-21W, AD-48, AD-48B, AD-48BDD, AD-48C, AD-48D, AD-48DD, AD-48W, AD-64, AD-64B, AD-64BDD, AD-64C, AD-64CW, AD-64DD, AD-72, AD-72W, AD-90, AD-90A, AD-90B, AD-90BDD, AD-90DD, ADE-120, ADE-120B, CO-110, CO-110B, CO-110BDD, CO-110DD, CO-112, CO-112B, CO-112BDD, CO-112DD, CO-142W, CO-142WDD, CO-170, CO-170B, CO-170BDD, CO-170DD, CO-170HRS, CO-170HRSDD, CO-170HRS-SOFT...(Other models you can see in the webshop)		
<b>spare parts for</b>	361015		
	<b>GEV No.</b>	361132	<b>Ref. No.</b> —
	membrane dosing pump		
	<b>GEV No.</b>	510298	<b>Ref. No.</b> —
	lip valve dosing pump suitable for DB2/DS5		

accessories

container filters



1

<b>GEV No.</b>	361062	<b>Ref. No.</b>	12011355 Z601153
<b>description</b>	container filter hose ø 4mm		
<b>For models:</b>	AD-125, AD-125HRS, AD-125-SOFT, AD-505, CO-110DD, CO-112DD, CO-142WDD, CO-170DD, CO-172DD, COP-173, COP-173B, COP-173BDD, COP-173DD, COP-173HRS, COP-173HRSDD, COP-173-SOFT, COP-174, COP-174B, COP-174BDD, COP-174DD, COP-174HRS, COP-174HRSDD, COP-174W, COP-174WHRS, COP-503, COP-503B, COP-503BDD, COP-503DD, COP-503-SOFT, COP-504, COP-504B, COP-504BDD, COP-504DD, COP-504W, ECO-120, ECO-1200, ECO-120B, FI-100, FI-100AR, FI-100B, FI-120, FI-1200, FI-120B, FI-120W, FI-30, FI-300B, FI-300R, FI-48, FI-48B, FI-48W...(Other models you can see in the webshop)		

water and beverage technology



Зип.Общепит hoses

supply hoses  
vsezip.ru  
PVC supply hoses

+7(812)987-08-81

filter weights



1

<b>GEV No.</b>	505197	<b>Ref. No.</b>	12024353 old version Z701152
<b>description</b>	filter weight ID ø 8x9mm ext. ø 14 L 20mm 17g brass		
<b>For models:</b>	AD-120, AD-120B, AD-120C, AD-120CW, AD-120HY, AD-15, AD-15D, AD-20C-UK, AD-21, AD-21B, AD-21BDD, AD-21C, AD-21D, AD-21DD, AD-21W, AD-45BBT, AD-48, AD-48B, AD-48BDD, AD-48C, AD-48D, AD-48DD, AD-48HY, AD-48W, AD-64, AD-64B, AD-64BBT, AD-64BDD, AD-64C, AD-64CW, AD-64D, AD-64DD, AD-64HY, AD-72, AD-72W, AD-90, AD-90BA, AD-90BBT, AD-90BDD, AD-90DD, ADE-120, ADE-120B, ECO-120, ECO-1200, FI-100, FI-100AR, FI-100BBT-UK, FI-120, FI-1200, FI-120AR+DD...(Other models you can see in the webshop)		

hose couplings

plastic



1

<b>GEV No.</b>	361100	<b>Ref. No.</b>	12036489 RT20620351
<b>description</b>	hose connector plastic straight thread M10x1 hose ø 6mm Qty 1 pcs connection M10x1		

tank inlets



1

<b>GEV No.</b>	361105	<b>Ref. No.</b>	FAG1200026
<b>description</b>	tank inlet plastic M10 hose ø 4x6mm		



1

<b>GEV No.</b>	361656	<b>Ref. No.</b>	6000012
<b>description</b>	tank inlet stainless steel M10x1.5 hose ø 4mm		

miscellaneous



1

<b>GEV No.</b>	505228	<b>Ref. No.</b>	12024067 Z203007
<b>description</b>	spacer bush ID ø 4.5mm ED ø 10mm L 16mm for dosing pump		
<b>For models:</b>	ACE-201, ACE-202, ACG-201, ACG-202, AD-45BBT, AD-48, AD-48B, AD-48BDD, AD-48C, AD-48D, AD-48DD, AD-48HY, AD-48W, AD-64, AD-64B, AD-64BBT, AD-64BDD, AD-64BTDD, AD-64C, AD-64CW, AD-64D, AD-64DD, AD-64HY, AD-72, AD-72W, AE-201, AE-202, AG-201, AG-202, APE-201, APE-202, APG-201, APG-202, EASY-500, EASY-500B, EASY-500DD, EASY-500HP, EASY-500HPWBDD, FE-4, FE-6, FE-8, FI-30, FI-30AR, FI-30AR+DD, FI-30B, FI-30B-BT-UK, FI-30-UK, FI-48, FI-48AR, FI-48B...(Other models you can see in the webshop)		



1

<b>GEV No.</b>	520010	<b>Ref. No.</b>	12024115 Z602121	
<b>description</b>	supply hose PVC straight-curved DN13 connections 3/4" L 1500mm operating p. 10bar burst p. 32bar t.max. 90°C blue approval VDE flat seal			
<b>For models:</b>	AD-120, AD-120B, AD-120BBTDD-UK, AD-120C, AD-120CW, AD-120HY, AD-125, AD-125HRS, AD-125-SOFT, AD-15D, AD-21D, AD-45BBT, AD-48, AD-48B, AD-48BDD, AD-48C, AD-48D, AD-48DD, AD-48HY, AD-48W, AD-505, AD-64, AD-64B, AD-64BBT, AD-64BDD, AD-64BTDD, AD-64C, AD-64CW, AD-64D, AD-64DD, AD-64HY, AD-72, AD-72W, AD-90, AD-90BA, AD-90BBT, AD-90BDD, AD-90DD, ADE-120, ADE-120B, CO-110, CO-110B, CO-110BDD, CO-110DD, CO-112, CO-112B, CO-112BDD, CO-112DD, CO-142W, CO-142WDD...(Other models you can see in the webshop)			
<b>accessories for</b>	520010			
	<b>GEV No.</b>	520053	<b>Ref. No.</b>	12025278 Z701132
	screen connection 3/4" D1 ø 26mm D2 ø 15mm Qty 10 pcs rubber thickness 8mm			
	<b>GEV No.</b>	520054	<b>Ref. No.</b>	—
	flat gasket rubber ED ø 23.5mm ID ø 14mm thickness 2.3mm Qty 10 pcs			



1

<b>GEV No.</b>	520012	<b>Ref. No.</b>	12025198 Z601114
<b>description</b>	supply hose PVC straight-curved DN13 connections 3/4" L 2500mm operating p. 10bar burst p. 32bar t.max. 90°C approval VDE flat seal		
<b>For models:</b>	ACE-061, ACE-101, ACE-102, ACE-201, ACE-202, ACG-061, ACG-101, ACG-102, ACG-201, ACG-202, AD-15, AD-20C-UK, AD-21, AD-21B, AD-21BDD, AD-21C, AD-21DD, AE-061, AE-061W, AE-101, AE-101W, AE-102, AE-102W, AE-201, AE-202, AG-061, AG-061W, AG-101, AG-101W, AG-102, AG-102W, AG-201, AG-202, APE-061, APE-061W, APE-101, APE-101W, APE-102, APE-102W, APE-201, APE-202, APG-061, APG-061W, APG-101, APG-101W, APG-102, APG-102W, APG-201, APG-202, COG-061...(Other models you can see in the webshop)		

water and beverage technology



drain hoses

Зип Общепит

vsezip.ru

+7(812)987-08-81



<b>GEV No.</b>	505082	<b>Ref. No.</b>	12024473 Z200910
<b>description</b>	drain hose DN25 L 1500mm elbow ø inside 48mm elbow ext. ø 58mm outer hose ø 31mm		
<b>For models:</b>	AD-120, AD-120CW, AD-48, AD-48D, AD-48DD, AD-64, AD-64BTDD, AD-64D, AD-64DD, AD-72, AD-72W, AD-90, AD-90DD, ADE-120, APE-061, APE-101, APE-102, APE-201, APE-202, APG-061, APG-101, APG-102, APG-201, APG-202, CO-110, CO-110B, CO-110BDD, CO-110DD, CO-112DD, CO-142W, CO-142WDD, CO-170, CO-170B, CO-170BDD, CO-170DD, CO-170HRS, CO-170HRSDD, CO-170HRS-SOFT, CO-170-SOFT, CO-172DD, COP-173, COP-173B, COP-173BDD, COP-173DD, COP-173HRS, COP-173HRSDD, COP-173-SOFT, COP-174DD, COP-174W, COP-174WHRS...(Other models you can see in the webshop)		

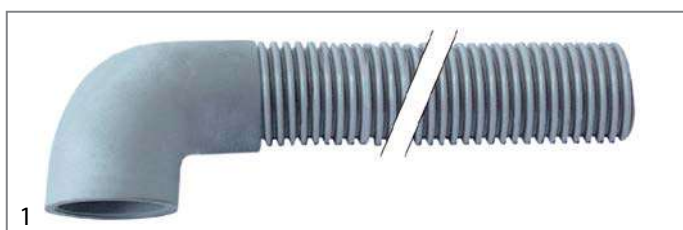

<b>GEV No.</b>	505081	<b>Ref. No.</b>	12024114 Z400908
<b>description</b>	drain hose DN25 L 1600mm elbow ø inside 31mm elbow ext. ø 40mm outer hose ø 30mm		
<b>For models:</b>	AD-15, AD-15D, AD-21, AD-21D, AD-21DD, ATM-051ECO, CO-350, CO-350-COLD, CO-350-COLD-DD, CO-350-DD, CO-352-COLD, CO-352-COLD-DD, CO-400, CO-400-COLD, CO-400-COLD-DD, CO-400-DD, CO-400-SOFT, CO-402-COLD, CO-402-COLD-DD, ECO-2700D, ECO-2700I, ECO-4000D, ECO-4000I, ECO-6000D, ECO-6000I, FI-2700D, FI-2700I, FI-4000D, FI-4000I, FI-6000D, FI-6000I, GA-20, GA-20D, GA-40, GA-40D, LVC-12, LVC-15, LVC-15D, LVC-21, LVC-21B, LVC-21C, LVC-21D, LVC-21W, LVR-10, LVR-14, LVR-14D, LVR-20, LVR-20D		

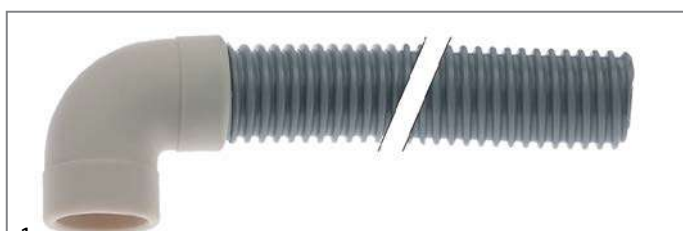

<b>GEV No.</b>	505402	<b>Ref. No.</b>	12115471
<b>description</b>	drain hose DN25 L 2000mm elbow ø inside 27mm elbow ext. ø 35mm inner hose ø 25mm outer hose ø 30mm plastic		
<b>For models:</b>	CO-500, CO-500DD, CO-501, CO-501DD, CO-501-SOFT, CO-502DD, COP-503, COP-503DD, COP-503-SOFT, COP-504, COP-504DD		



<b>GEV No.</b>	505084	<b>Ref. No.</b>	12023666 Z220903
<b>description</b>	drain hose DN19 L 2000mm straight ø inside 21mm straight ext. ø 26mm elbow ø inside 21mm elbow ext. ø 27mm outer hose ø 27mm		
<b>For models:</b>	AD-120B, AD-120BBTDD-UK, AD-120C, AD-120HY, AD-125, AD-125HRS, AD-125-SOFT, AD-20C-UK, AD-21B, AD-21BDD, AD-21C, AD-21W, AD-45BBT, AD-48B, AD-48BDD, AD-48C, AD-48HY, AD-48W, AD-64B, AD-64BBT, AD-64BDD, AD-64C, AD-64CW, AD-64HY, AD-90BA, AD-90BBT, AD-90BDD, ADE-120B, BME7-05, BME7-10, BMG7-10, CO-350-B, CO-350-B-DD, CO-350-COLD-B, CO-350-COLD-B-DD, CO-352-COLD-B, CO-352-COLD-B-DD, CO-400-B, CO-400-B-DD, CO-400-COLD-B, CO-400-COLD-B-DD, CO-402-COLD-B, CO-402-COLD-B-DD, CO-402W, CO-500B, CO-500BDD, CO-501B, CO-501BDD, CO-502B, CO-502BDD...(Other models you can see in the webshop)		

industrial hoses

Niplaflex hoses



<b>GEV No.</b>	530561	<b>Ref. No.</b>	11000083 S102121000
<b>description</b>	pressure hose ID ø 10mm ED ø 17mm L 5m thickness 3.5mm operating p. 10bar burst p. 30bar t.max. 110°C		
<b>For models:</b>	ACE-061, ACE-101, ACE-102, ACE-201, ACE-202, ACG-061, ACG-101, ACG-102, ACG-201, ACG-202, AD-120, AD-120B, AD-120BBTDD-UK, AD-120C, AD-120CW, AD-120HY, AD-125, AD-125HRS, AD-125-SOFT, AD-15, AD-15D, AD-20C-UK, AD-21, AD-21B, AD-21BDD, AD-21C, AD-21D, AD-21DD, AD-21W, AD-45BBT, AD-48, AD-48B, AD-48BDD, AD-48C, AD-48D, AD-48DD, AD-48HY, AD-48W, AD-505, AD-505-SOFT, AD-64, AD-64B, AD-64BBT, AD-64BDD, AD-64BTDD, AD-64C, AD-64CW, AD-64D, AD-64DD, AD-64HY...(Other models you can see in the webshop)		

pressure control hoses



<b>GEV No.</b>	530560	<b>Ref. No.</b>	11000066 3702400
<b>description</b>	pressure control hose ID ø 5mm ED ø 9mm L 5m operating p. 30bar burst p. 90bar temp.-resist. 60°C		
<b>For models:</b>	AD-120, AD-120B, AD-120BBTDD-UK, AD-120C, AD-120CW, AD-120HY, AD-125, AD-125HRS, AD-125-SOFT, AD-15, AD-15D, AD-20C-UK, AD-21, AD-21B, AD-21BDD, AD-21C, AD-21D, AD-21DD, AD-21W, AD-45BBT, AD-48, AD-48B, AD-48BDD, AD-48C, AD-48D, AD-48DD, AD-48HY, AD-48W, AD-505, AD-505-SOFT, AD-64, AD-64B, AD-64BBT, AD-64BDD, AD-64BTDD, AD-64C, AD-64CW, AD-64D, AD-64DD, AD-64HY, AD-72, AD-72W, AD-90, AD-90BA, AD-90BBT, AD-90BDD, AD-90DD, ADE-120, ADE-120B, CO-110...(Other models you can see in the webshop)		

water and beverage technology



formed hoses

Зип-Общепит

straight



1			
<b>GEV No.</b>	505026	<b>Ref. No.</b>	12023607 Z400906
<b>description</b>	formed hose dishwasher straight		
<b>For models:</b>	AD-15, AD-15D, AD-20C-UK, AD-21, AD-21B, AD-21BDD, AD-21C, AD-21D, AD-21DD, AD-21W, CO-350, CO-350-B, CO-350-B-DD, CO-350-COLD, CO-350-COLD-B, CO-350-COLD-B-DD, CO-350-COLD-DD, CO-350-DD, CO-352-COLD, CO-352-COLD-B, CO-352-COLD-B-DD, CO-352-COLD-DD, CO-400, CO-400-B, CO-400-B-DD, CO-400-COLD, CO-400-COLD-B, CO-400-COLD-B-DD, CO-400-COLD-DD, CO-400-DD, CO-400-SOFT, CO-402-COLD, CO-402-COLD-B, CO-402-COLD-B-DD, CO-402-COLD-DD, CO-402W, LVC-12, LVC-15, LVC-15D, LVC-21, LVC-21B, LVC-21C, LVC-21D, LVC-21W, LVR-10, LVR-14, LVR-14D, LVR-20, LVR-20B, LVR-20D...(Other models you can see in the webshop)		



1			
<b>GEV No.</b>	503150	<b>Ref. No.</b>	12000050 12023567 Z162301 Z740902
<b>description</b>	formed hose hose ext. ø 54mm hose int. ø 38mm L 55mm		
<b>For models:</b>	AD-120BBTDD-UK, AD-120HY, AD-90, AD-90BA, AD-90BBT, AD-90BDD, AD-90DD, ADE-120, ADE-120B, ECO-120, ECO-120B, ECO-160, ECO-160D, ECO-160H, ECO-160I, ECO-200, ECO-200H, ECO-200HD, ECO-200HI, ECO-200I, ECO-2300, ECO-2700D, ECO-2700I, ECO-280D, ECO-280I, ECO-3000, ECO-370D, ECO-370I, ECO-4000D, ECO-4000I, ECO-460D, ECO-460I, ECO-550D, ECO-550I, ECO-6000D, ECO-6000I, FI-100, FI-100AR, FI-100B, FI-100BBT-UK, FI-120HY-CLINIC, FI-2700D, FI-2700I, FI-280D, FI-280I, FI-370D, FI-370I, FI-4000D, FI-4000I...(Other models you can see in the webshop)		



1			
<b>GEV No.</b>	530880	<b>Ref. No.</b>	12024437
<b>description</b>	formed hose hose int. ø 30.5mm D1 ø 39mm D2 ø 44.5mm L 45mm Qty 1		
<b>For models:</b>	AD-64BTDD, EASY-500HPWBDD		



1			
<b>GEV No.</b>	505336	<b>Ref. No.</b>	12024143 Z310904
<b>description</b>	extraction hose ED ø 76mm L 220mm L-shape ID ø 60mm for FAGOR		
<b>For models:</b>	ECO-2700D, ECO-2700I, ECO-280D, ECO-280I, ECO-370D, ECO-370I, ECO-4000D, ECO-4000I, ECO-460D, ECO-460I, ECO-550D, ECO-550I, ECO-6000D, ECO-6000I, FI-2700D, FI-2700I, FI-280D, FI-280I, FI-370D, FI-370I, FI-4000D, FI-4000I, FI-460D, FI-460I, FI-550D, FI-550I, FI-6000D, FI-6000I		



1			
<b>GEV No.</b>	524028	<b>Ref. No.</b>	12023698 12Z7409010
<b>description</b>	formed hose 90° L2 120mm L1 190mm ID ø 38mm ED ø 54mm		
<b>For models:</b>	AD-120C, AD-120HY, AD-90, AD-90BA, AD-90BDD, AD-90DD, ECO-160D, ECO-160I, ECO-200D, ECO-200HD, ECO-200HI, ECO-200I, FI-160AR, FI-160D, FI-160I, FI-200AR, FI-200D, FI-200HD, FI-200HI, FI-200I, FI-200WL, FI-200WR, FI-80, FI-80AR, FI-80W, FI-E-100, LABP-800		



1			
<b>GEV No.</b>	505028	<b>Ref. No.</b>	12023689 Z200905
<b>description</b>	formed hose end piece A int. ø 50mm ø end piece B 38mm L 250mm warewashing L-shape equiv. no. Z200905		
<b>For models:</b>	AD-45BBT, AD-48, AD-48B, AD-48BDD, AD-48C, AD-48D, AD-48DD, AD-48HY, AD-48W, AD-64, AD-64B, AD-64BBT, AD-64BDD, AD-64BTDD, AD-64C, AD-64CW, AD-64D, AD-64DD, AD-64HY, AD-72, AD-72W, EASY-500, EASY-500B, EASY-500DD, EASY-500HP, EASY-500HPWBDD, FI-30, FI-30AR, FI-30AR+DD, FI-30B, FI-30B-BT-UK, FI-30-UK, FI-48, FI-48AR, FI-48B, FI-48B-BT-UK, FI-48C, FI-48D, FI-48HY-CLINIC, FI-48W, FI-50, FI-60DD, FI-64, FI-64AR, FI-64B, FI-64B-BT-UK, FI-64C, FI-64D, FI-64HY-CLINIC, FI-64W...(Other models you can see in the webshop)		

water and beverage technology



Зип Общепит

vsezip.ru

+7(812)987-08-81

			
<b>GEV No.</b>	505024	<b>Ref. No.</b>	12023683 Z200904
<b>description</b>	formed hose warewashing L-shape equiv. no. Z200904		
<b>For models:</b>	AD-45BBT, AD-48, AD-48B, AD-48BDD, AD-48C, AD-48D, AD-48DD, AD-48HY, AD-48W, AD-64, AD-64B, AD-64BBT, AD-64BDD, AD-64BTDD, AD-64C, AD-64CW, AD-64D, AD-64DD, AD-64HY, AD-72, AD-72W, EASY-500, EASY-500B, EASY-500DD, EASY-500HP, EASY-500HPWBDD, FI-30, FI-30AR, FI-30AR+DD, FI-30B, FI-30B-BT-UK, FI-30-UK, FI-48, FI-48AR, FI-48B, FI-48B-BT-UK, FI-48C, FI-48D, FI-48HY-CLINIC, FI-48W, FI-50, FI-60DD, FI-64, FI-64AR, FI-64B, FI-64B-BT-UK, FI-64C, FI-64D, FI-64HY-CLINIC, FI-64W...(Other models you can see in the webshop)		

			
<b>GEV No.</b>	505030	<b>Ref. No.</b>	12023519 Z710906
<b>description</b>	formed hose warewashing L-shape equiv. no. Z710906 mounting pos. upper		
<b>For models:</b>	AD-120, AD-120B, AD-120BBTDD-UK, AD-120C, AD-120CW, AD-120HY, AD-90BBT, ADE-120, ADE-120B, ECO-120, ECO-120B, ECO-160, ECO-160D, ECO-160I, ECO-200, ECO-200D, ECO-200H, ECO-200HD, ECO-200HI, ECO-200I, ECO-370D, ECO-370I, ECO-550D, ECO-550I, FI-100, FI-100AR, FI-100B, FI-100BBT-UK, FI-120, FI-120AR+DD, FI-120B, FI-120C, FI-120HY-CLINIC, FI-120W, FI-160, FI-160AR, FI-160D, FI-160I, FI-200, FI-200AR, FI-200D, FI-200H, FI-200HD, FI-200HI, FI-200I, FI-200W, FI-200WL, FI-200WR, FI-370D, FI-370I...(Other models you can see in the webshop)		

			
<b>GEV No.</b>	505023	<b>Ref. No.</b>	12023670 Z400905
<b>description</b>	formed hose warewashing L-shape equiv. no. Z400905		
<b>For models:</b>	AD-15, AD-15D, AD-20C-UK, AD-21, AD-21B, AD-21BDD, AD-21C, AD-21D, AD-21DD, AD-21W, CO-350, CO-350-B, CO-350-B-DD, CO-350-COLD, CO-350-COLD-B, CO-350-COLD-B-DD, CO-350-COLD-DD, CO-350-DD, CO-352-COLD, CO-352-COLD-B, CO-352-COLD-B-DD, CO-352-COLD-DD, CO-400, CO-400-B, CO-400-B-DD, CO-400-COLD, CO-400-COLD-B, CO-400-COLD-B-DD, CO-400-COLD-DD, CO-400-DD, CO-400-SOFT, CO-402-COLD, CO-402-COLD-B, CO-402-COLD-B-DD, CO-402-COLD-DD, CO-402W, LVC-12, LVC-15, LVC-15D, LVC-21, LVC-21B, LVC-21C, LVC-21D, LVC-21W, LVR-10, LVR-14, LVR-14D, LVR-20, LVR-20B, LVR-20D...(Other models you can see in the webshop)		

			
<b>GEV No.</b>	505027	<b>Ref. No.</b>	12023625 Z710904
<b>description</b>	formed hose warewashing L-shape equiv. no. Z740901		
<b>For models:</b>	AD-120, AD-120B, AD-120BBTDD-UK, AD-120C, AD-120CW, AD-120HY, AD-90, AD-90BA, AD-90BBT, AD-90BDD, AD-90DD, ADE-120, ADE-120B, ECO-120, ECO-120B, ECO-160, ECO-160D, ECO-160I, ECO-200, ECO-200D, ECO-200H, ECO-200HD, ECO-200HI, ECO-200I, ECO-370D, ECO-370I, ECO-550D, ECO-550I, FI-100, FI-100AR, FI-100B, FI-100BBT-UK, FI-120, FI-120AR+DD, FI-120B, FI-120C, FI-120HY-CLINIC, FI-120W, FI-160, FI-160AR, FI-160D, FI-160I, FI-200, FI-200AR, FI-200D, FI-200H, FI-200HD, FI-200HI, FI-200I, FI-200W...(Other models you can see in the webshop)		

			
<b>GEV No.</b>	505029	<b>Ref. No.</b>	12023741 Z710905
<b>description</b>	formed hose warewashing L-shape equiv. no. Z710905 mounting pos. lower		
<b>For models:</b>	AD-120, AD-120B, AD-120BBTDD-UK, AD-120C, AD-120CW, AD-120HY, AD-90BBT, ADE-120, ADE-120B, ECO-120, ECO-120B, ECO-160, ECO-160D, ECO-160I, ECO-200, ECO-200D, ECO-200H, ECO-200HD, ECO-200HI, ECO-200I, ECO-2700D, ECO-2700I, ECO-370D, ECO-370I, ECO-4000D, ECO-4000I, ECO-550D, ECO-550I, ECO-6000D, ECO-6000I, FI-100, FI-100AR, FI-100B, FI-100BBT-UK, FI-120, FI-120AR+DD, FI-120B, FI-120C, FI-120HY-CLINIC, FI-120W, FI-160, FI-160AR, FI-160D, FI-160I, FI-200, FI-200AR, FI-200D, FI-200H, FI-200HD, FI-200HI, FI-200I...(Other models you can see in the webshop)		

			
<b>GEV No.</b>	505032	<b>Ref. No.</b>	12023779 Z740903
<b>description</b>	formed hose warewashing L-shape equiv. no. Z740903 mounting pos. lower		
<b>For models:</b>	AD-90, AD-90BA, AD-90BDD, AD-90DD, FI-80, FI-80AR, FI-80W, FI-E-100, LABP-800		

water and beverage technology



Зип-Общепит accessories

for dishwashers

pressure hoses



<b>GEV No.</b>	513136	<b>Ref. No.</b>	11000070
<b>description</b>	pressure hose ext. $\phi$ 10 ID $\phi$ 4.5mm L 1000mm dosage black Qty 1 rinse aid		
<b>For models:</b>	AD-120, AD-120B, AD-120BBTDD-UK, AD-120C, AD-120CW, AD-120HY, AD-15, AD-15D, AD-20C-UK, AD-21, AD-21B, AD-21BDD, AD-21C, AD-21D, AD-21DD, AD-21W, AD-48, AD-48B, AD-48BDD, AD-48C, AD-48D, AD-48DD, AD-48W, AD-64, AD-64B, AD-64BDD, AD-64C, AD-64CW, AD-64D, AD-64DD, AD-72, AD-72W, AD-90, AD-90BA, AD-90BBT, AD-90BDD, AD-90DD, ADE-120, ADE-120B, CO-110, CO-110B, CO-110BDD, CO-110DD, CO-112, CO-112B, CO-112BDD, CO-112DD, CO-142W, CO-142WDD, CO-170...(Other models you can see in the webshop)		

miscellaneous



<b>GEV No.</b>	511557	<b>Ref. No.</b>	11000142 3715300
<b>description</b>	dosing hose ED $\phi$ 26mm ID $\phi$ 15mm L 1200mm burst p. 20bar		
<b>For models:</b>	ECO-160, ECO-160D, ECO-160I, ECO-200, ECO-200D, ECO-200H, ECO-200HD, ECO-200HI, ECO-200I, ECO-2700D, ECO-2700I, ECO-280D, ECO-280I, ECO-370D, ECO-370I, ECO-4000D, ECO-4000I, ECO-460D, ECO-460I, ECO-550D, ECO-550I, ECO-6000D, ECO-6000I, FI-2700D, FI-2700I, FI-280D, FI-280I, FI-30B-BT-UK, FI-370D, FI-370I, FI-4000D, FI-4000I, FI-460D, FI-460I, FI-48B-BT-UK, FI-48HY-CLINIC, FI-550D, FI-550I, FI-6000D, FI-6000I, FI-64B-BT-UK, FI-64HY-CLINIC		



<b>GEV No.</b>	105503	<b>Ref. No.</b>	12023858 Z951101
<b>description</b>	extraction hose ED $\phi$ 35mm IT 1" L 970mm SS		
<b>For models:</b>	ADE-120, ADE-120B, ECO-120, ECO-120B, ECO-160, ECO-160D, ECO-160I, ECO-200, ECO-200D, ECO-200H, ECO-200HD, ECO-200HI, ECO-200I, ECO-2300, ECO-2700D, ECO-2700I, ECO-280D, ECO-280I, ECO-3000, ECO-370D, ECO-370I, ECO-4000D, ECO-4000I, ECO-460D, ECO-460I, ECO-550D, ECO-550I, ECO-6000D, ECO-6000I, GA-20, GA-20D, GA-40, GA-40D		



<b>GEV No.</b>	505336	<b>Ref. No.</b>	12024143 Z310904
<b>description</b>	extraction hose ED $\phi$ 76mm L 220mm L-shape ID $\phi$ 60mm for FAGOR		
<b>For models:</b>	ECO-2700D, ECO-2700I, ECO-280D, ECO-280I, ECO-370D, ECO-370I, ECO-4000D, ECO-4000I, ECO-460D, ECO-460I, ECO-550D, ECO-550I, ECO-6000D, ECO-6000I, FI-2700D, FI-2700I, FI-280D, FI-280I, FI-370D, FI-370I, FI-4000D, FI-4000I, FI-460D, FI-460I, FI-550D, FI-550I, FI-6000D, FI-6000I		



<b>GEV No.</b>	520053	<b>Ref. No.</b>	12025278 Z701132
<b>description</b>	screen connection 3/4" D1 $\phi$ 26mm D2 $\phi$ 15mm Qty 10 pcs rubber thickness 8mm		
<b>For models:</b>	FI-100, FI-100AR, FI-100B, FI-120, FI-1200, FI-120B, FI-120W, FI-30, FI-300B, FI-300R, FI-48, FI-48B, FI-48W, FI-50, FI-64, FI-64B, FI-64W, FI-650R, FI-72, FI-80, FI-80W, FI-900, GA-20, GA-20D, GA-40, GA-40D, HCG-10-11, HCG-10-21, HCG-20-11, HCG-20-21, HCG-2-10-11, HCG-2-20-11, HCG-6-11, HCV-10-11, HCV-10-21, HCV-2-10-21, HCV-5-11, HCV-6-11, HE-10-11, HE-10-21, HE-2-10-11, HE-5-11, HE-6-11, HEI-10-11, HEI-10-21, HEI-20-21, HEI-6-11, HEM-10-11, HEM-10-21...(Other models you can see in the webshop)		

fittings, hose and pipe connectors

hose connectors

without screw connection



<b>GEV No.</b>	505088	<b>Ref. No.</b>	12023511 Z201106
<b>description</b>	Y-piece plastic hose $\phi$ 12-12-12mm L 75mm		
<b>For models:</b>	AD-120, AD-120B, AD-120C, AD-120CW, AD-125, AD-125HRS, AD-125-SOFT, AD-45BBT, AD-48, AD-48B, AD-48BDD, AD-48C, AD-48D, AD-48DD, AD-48HY, AD-48W, AD-64, AD-64B, AD-64BBT, AD-64BDD, AD-64BTDD, AD-64C, AD-64CW, AD-64D, AD-64DD, AD-64HY, AD-72, AD-72W, AD-90, AD-90BA, AD-90BDD, AD-90DD, ADE-120, ADE-120B, CO-110, CO-110B, CO-110BDD, CO-110DD, CO-112, CO-112B, CO-112BDD, CO-112DD, CO-142W, CO-142WDD, CO-170, CO-170B, CO-170BDD, CO-170DD, CO-170HRS, CO-170HRSDD...(Other models you can see in the webshop)		



Зип Общепит

vsezip.ru

+7(812)987-08-81

 <p>1</p>			
<b>GEV No.</b>	541109	<b>Ref. No.</b>	12023510 Z103077
<b>description</b>	Y-piece plastic hose ø 8-6-8mm for pressure switch		
<b>For models:</b>	AD-120B, AD-120BBTDD-UK, AD-120C, AD-120HY, AD-45BBT, AD-48B, AD-48BDD, AD-48C, AD-48HY, AD-48W, AD-64B, AD-64BBT, AD-64BDD, AD-64BTDD, AD-64C, AD-64CW, AD-64HY, AD-72W, AD-90BA, AD-90BBT, AD-90BDD, ADE-120B, CO-500, CO-500B, CO-500BDD, CO-500DD, CO-501, CO-501B, CO-501BDD, CO-501DD, CO-501-SOFT, CO-502B, CO-502BDD, CO-502DD, CO-502W, COP-503, COP-503B, COP-503BDD, COP-503DD, COP-503-SOFT, COP-504, COP-504B, COP-504BDD, COP-504DD, COP-504W, EASY-500B, EASY-500HPWBDD, ECO-120B, ECO-160, ECO-1600...(Other models you can see in the webshop)		

 <p>1</p>			
<b>GEV No.</b>	505323	<b>Ref. No.</b>	12023772 Z102309
<b>description</b>	hose connector brass straight thread 3/4" hose ø 10mm Qty 1 pcs		
<b>For models:</b>	ECO-1600, ECO-2300, ECO-280D, ECO-280I, ECO-3000, ECO-370D, ECO-370I, ECO-460D, ECO-460I, ECO-550D, ECO-550I, FI-1600, FI-200W, FI-200WL, FI-200WR, FI-2300, FI-280D, FI-280I, FI-3000, FI-370D, FI-370I, FI-460D, FI-460I, FI-550D, FI-550I		

<p><b> fittings </b></p> <p><b> double nipples </b></p>			
 <p>1</p>			
<b>GEV No.</b>	520169	<b>Ref. No.</b>	12023958 12024396 Z102301 Z209509
<b>description</b>	double nipple brass thread 3/4" - 3/4" Qty 1 pcs		
<b>For models:</b>	AD-120CW, BME7-05, BME7-10, BMG7-10, CO-142W, CO-142WDD, ECO-120, ECO-1200, ECO-120B, ECO-160, ECO-1600, ECO-200, ECO-200H, ECO-2300, ECO-3000, FI-100, FI-100AR, FI-100B, FI-120, FI-1200, FI-120B, FI-120W, FI-160, FI-1600, FI-160AR, FI-160D, FI-160I, FI-200, FI-200AR, FI-200D, FI-200H, FI-200HD, FI-200HI, FI-200I, FI-200W, FI-200WL, FI-200WR, FI-2300, FI-2700D, FI-2700I, FI-280D, FI-280I, FI-30, FI-3000, FI-30AR, FI-30AR+DD, FI-30-UK, FI-370D, FI-370I, FI-4000D...(Other models you can see in the webshop)		

<p><b> producer-specific </b></p>			
 <p>1</p>			
<b>GEV No.</b>	505262	<b>Ref. No.</b>	12018650 12019642 12024428 Z208914 Z230902 Z230905
<b>description</b>	duct thread M12x1.75 for hose ID 4mm SS		
<b>For models:</b>	AD-120C, AD-120HY, AD-20C-UK, AD-21B, AD-21BDD, AD-21C, AD-21DD, AD-21W, AD-45BBT, AD-48B, AD-48BDD, AD-48C, AD-48DD, AD-48HY, AD-48W, AD-64B, AD-64BBT, AD-64BDD, AD-64C, AD-64CW, AD-64DD, AD-64HY, AD-90BBT, AD-90BDD, AD-90DD, ECO-120, ECO-1200, FI-100, FI-100AR, FI-100BBT-UK, FI-120, FI-1200, FI-120AR+DD, FI-120C, FI-120HY-CLINIC, FI-120W, FI-30, FI-30AR, FI-30AR+DD, FI-30B, FI-30B-BT-UK, FI-30-UK, FI-48, FI-48AR, FI-48B, FI-48B-BT-UK, FI-48C, FI-48D, FI-48HY-CLINIC, FI-48W...(Other models you can see in the webshop)		

<p><b> hose connectors </b></p> <p><b> plastic </b></p>			
 <p>1</p>			
<b>GEV No.</b>	361100	<b>Ref. No.</b>	12036489 RT20620351
<b>description</b>	hose connector plastic straight thread M10x1 hose ø 6mm Qty 1 pcs connection M10x1		

 <p>1</p>			
<b>GEV No.</b>	505133	<b>Ref. No.</b>	12023967 Z701104
<b>description</b>	hose connector for hose ID 38-11mm brass		
<b>For models:</b>	AD-120BBTDD-UK, AD-120HY, AD-90BBT, ADE-120, ADE-120B, ECO-120, ECO-1200, ECO-120B, ECO-1600, ECO-2300, ECO-3000, FI-100, FI-100AR, FI-100B, FI-100BBT-UK, FI-120HY-CLINIC, FI-80BBT-UK		

water and beverage technology

Зип Общепит  
drain systems and wash basins

standpipes  
vsezip.ru  
producer-specific

FAGOR

(812) 987-08-81



1

<b>GEV No.</b>	505236	<b>Ref. No.</b>	12023983 Z281901J
<b>description</b>	hose connector grommet ø 13mm ID ø 11mm grommet length 18mm WS 32 total length 51mm thread L 17mm		
<b>For models:</b>	ECO-160D, ECO-160I, ECO-200D, ECO-200HD, ECO-200HI, ECO-200I, ECO-2700D, ECO-2700I, ECO-280D, ECO-280I, ECO-370D, ECO-370I, ECO-4000D, ECO-4000I, ECO-460D, ECO-460I, ECO-550D, ECO-550I, ECO-6000D, ECO-6000I, FI-2700D, FI-2700I, FI-280D, FI-280I, FI-370D, FI-370I, FI-4000D, FI-4000I, FI-460D, FI-460I, FI-550D, FI-550I, FI-6000D, FI-6000I		



2

<b>GEV No.</b>	361840	<b>Ref. No.</b>	12024395 Z711904
<b>description</b>	hose connector thread M20x2.5 5/8" pipe (22.7mm) grommet ø 11.5mm ID ø chrome-plated brassmm grommet length 20mm total length 52mm thread L 31mm T2: 5/8" pipe (22.7mm)		
<b>For models:</b>	AD-120, AD-120B, AD-120BBTDD-UK, AD-120C, AD-120CW, AD-120HY, AD-90, AD-90BA, AD-90BBT, AD-90BDD, AD-90DD, ADE-120, ADE-120B, ECO-120, ECO-120B, FI-100, FI-100AR, FI-100B, FI-100BBT-UK, FI-120, FI-120AR+DD, FI-120B, FI-120C, FI-120HY-CLINIC, FI-120W, FI-160AR, FI-200AR, FI-280D, FI-280I, FI-370D, FI-370I, FI-460D, FI-460I, FI-550D, FI-550I, FI-80, FI-80AR, FI-80BBT-UK, FI-80W, FI-E-100, LABP-1000, LABP-1200, LABP-800, MF-120		
<b>accessories for</b>	361840		
	<b>GEV No.</b>	<b>Ref. No.</b>	12009819 Q223107
	nut thread M20x2.5 WS 24 SS Qty 1 pcs H 13mm for pipe ø 12mm		



1

<b>GEV No.</b>	507534	<b>Ref. No.</b>	12009819 Q223107
<b>description</b>	nut thread M20x2.5 WS 24 SS Qty 1 pcs H 13mm for pipe ø 12mm		
<b>For models:</b>	AD-120, AD-120B, AD-120BBTDD-UK, AD-120C, AD-120CW, AD-120HY, AD-90, AD-90BA, AD-90BBT, AD-90BDD, AD-90DD, ADE-120, ADE-120B, ECO-120, ECO-120B, FI-100, FI-100AR, FI-100B, FI-100BBT-UK, FI-120, FI-120AR+DD, FI-120B, FI-120C, FI-120HY-CLINIC, FI-120W, FI-160AR, FI-200AR, FI-280D, FI-280I, FI-370D, FI-370I, FI-460D, FI-460I, FI-550D, FI-550I, FI-80, FI-80AR, FI-80BBT-UK, FI-80W, FI-E-100, LABP-1000, LABP-1200, LABP-800, MF-120		



1

<b>GEV No.</b>	691024	<b>Ref. No.</b>	12019791 R205018
<b>description</b>	overflow pipe L 165mm ø 20mm		
<b>For models:</b>	BME7-05, BME7-10, BME9-05, BME9-10, BMG7-10, BMG9-05, BMG9-10		

water cycle components

pressure reduction valves

pressure reduction valves

producer-specific



1

<b>GEV No.</b>	520558	<b>Ref. No.</b>	12024846 Z102307
<b>description</b>	pressure reduction valve RBM series RINOXDUE connection 3/4" default setting 3bar setting range 0.5-4bar p max 25bar t.max. 80°C nickel-plated brass ACS		
<b>For models:</b>	AD-120CW, CO-142W, CO-142WDD, ECO-160, ECO-1600, ECO-200, ECO-200H, ECO-2300, ECO-3000, FI-120W, FI-160, FI-1600, FI-160AR, FI-160D, FI-160I, FI-200, FI-200AR, FI-200D, FI-200H, FI-200HD, FI-200HI, FI-200I, FI-200W, FI-200WL, FI-200WR, FI-2300, FI-2700D, FI-2700I, FI-280D, FI-280I, FI-3000, FI-370D, FI-370I, FI-4000D, FI-4000I, FI-460D, FI-460I, FI-550D, FI-550I, FI-6000D, FI-6000I, FI-80W		





ancillary products

clamps

hose clamps

DIN 3017 - W2



1

<b>GEV No.</b>	520111	<b>Ref. No.</b>	12035874 RT20660205
----------------	--------	-----------------	------------------------

**description** hose clamp ø 10-16mm width 9mm Qty 10 pcs DIN 3017



1

<b>GEV No.</b>	520114	<b>Ref. No.</b>	12010023 12035505 Q881304 RT20660506
----------------	--------	-----------------	---

**description** hose clamp ø 20-32mm width 9mm Qty 10 pcs DIN 3017

**For models:** AD-120B, AD-120BTDD-UK, AD-120C, AD-120HY, AD-125, AD-125HRS, AD-125-SOFT, AD-505, AD-505-SOFT, AD-90BA, AD-90BBT, AD-90BDD, ADE-120B, APE-061, APE-061W, APE-101, APE-101W, APE-102, APE-102W, APE-201, APE-202, APG-061, APG-061W, APG-101, APG-101W, APG-102, APG-102W, APG-201, APG-202, BME9-05, BME9-10, BMG9-10, CO-110B, CO-110BDD, CO-112B, CO-112BDD, CO-170B, CO-170BDD, CO-172B, CO-172BDD, CO-500B, CO-500BDD, CO-501B, CO-501BDD, CO-502B, CO-502BDD, CO-502W, COP-173, COP-173B, COP-173BDD...(Other models you can see in the webshop)



1

<b>GEV No.</b>	520115	<b>Ref. No.</b>	12009997 Q881305
----------------	--------	-----------------	---------------------

**description** hose clamp ø 25-40mm width 9mm Qty 10 pcs DIN 3017

**For models:** AD-45BBT, AD-48, AD-48B, AD-48BDD, AD-48C, AD-48D, AD-48DD, AD-48HY, AD-48W, AD-505, AD-64, AD-64B, AD-64BBT, AD-64BDD, AD-64BTDD, AD-64C, AD-64CW, AD-64D, AD-64DD, AD-64HY, AD-72, AD-72W, AE-201, AE-202, AG-061, AG-061W, AG-101, AG-101W, AG-102, AG-102W, AG-201, AG-202, APE-061, APE-061W, APE-101, APE-101W, APE-102, APE-102W, APE-201, APE-202, APG-061, APG-061W, APG-101, APG-101W, APG-102, APG-102W, APG-201, APG-202, BME7-05, BME7-10...(Other models you can see in the webshop)

Зип Общепит

vsezip.ru

+7(812)987-08-81



1

<b>GEV No.</b>	520118	<b>Ref. No.</b>	12009933 12036496 Q881324 RT20660300
----------------	--------	-----------------	---

**description** hose clamp ø 50-70mm width 9mm Qty 5 pcs DIN 3017

**For models:** AD-45BBT, AD-48, AD-48B, AD-48BDD, AD-48C, AD-48D, AD-48DD, AD-48HY, AD-48W, AD-505, AD-505-SOFT, AD-64, AD-64B, AD-64BBT, AD-64BDD, AD-64BTDD, AD-64C, AD-64CW, AD-64D, AD-64DD, AD-64HY, AD-72, AD-72W, CO-500, CO-500B, CO-500BDD, CO-500DD, CO-501, CO-501B, CO-501BDD, CO-501DD, CO-501-SOFT, CO-502B, CO-502BDD, CO-502DD, CO-502W, COP-503, COP-503B, COP-503BDD, COP-503DD, COP-503-SOFT, COP-504, COP-504B, COP-504BDD, COP-504DD, COP-504W, EASY-500, EASY-500B, EASY-500DD, EASY-500HP...(Other models you can see in the webshop)



1

<b>GEV No.</b>	520119	<b>Ref. No.</b>	12036081 RT20660516
----------------	--------	-----------------	------------------------

**description** hose clamp ø 60-80mm width 9mm Qty 5 pcs DIN 3017



1

<b>GEV No.</b>	520454	<b>Ref. No.</b>	12009914 12036146 Q881326 RT20660505
----------------	--------	-----------------	---

**description** hose clamp ø 70-90mm width 9mm Qty 5 pcs DIN 3017

**For models:** ACE-202, ACG-202, AE-202, AG-202, APE-202, APG-202, COE-202, ECO-2700D, ECO-2700I, ECO-280D, ECO-280I, ECO-370D, ECO-370I, ECO-4000D, ECO-4000I, ECO-460D, ECO-460I, ECO-550D, ECO-550I, ECO-6000D, ECO-6000I, FI-2700D, FI-2700I, FI-280D, FI-280I, FI-370D, FI-370I, FI-4000D, FI-4000I, FI-460D, FI-460I, FI-550D, FI-550I, FI-6000D, FI-6000I, HMG-10-21-STACKING, LA-13M, LA-18MP, LA-25M, LAC-25, LAC-25MP, LAC-25MPP, LAC-55, LAC-55MP, LAC-55MPP, LB-AC-10M, LB-E-10M, LB-V-10M, LC-10, LC-14...(Other models you can see in the webshop)

water and beverage technology





Зип-Общепит double wire clamps

vsezip.ru

7(812)987-08-81

			
<b>1</b>			
<b>GEV No.</b>	520110	<b>Ref. No.</b>	12010047 12037543 GH51X003 Q881308
<b>description</b>	hose clamp ø 8-12mm width 9mm Qty 10 pcs DIN 3017		
<b>For models:</b>	AD-120, AD-120B, AD-120BBTDD-UK, AD-120C, AD-120CW, AD-120HY, AD-15, AD-15D, AD-20C-UK, AD-21, AD-21B, AD-21BDD, AD-21C, AD-21D, AD-21DD, AD-21W, AD-48, AD-48B, AD-48BDD, AD-48C, AD-48D, AD-48DD, AD-48W, AD-64, AD-64B, AD-64BDD, AD-64C, AD-64CW, AD-64D, AD-64DD, AD-72, AD-72W, AD-90, AD-90BA, AD-90BBT, AD-90BDD, AD-90DD, ADE-120, ADE-120B, CO-110, CO-110B, CO-110BDD, CO-110DD, CO-112, CO-112B, CO-112BDD, CO-112DD, CO-142W, CO-142WDD, CO-170...(Other models you can see in the webshop)		

			
<b>1</b>			
<b>GEV No.</b>	505190	<b>Ref. No.</b>	12009972 Q901307
<b>description</b>	hose clamp ø 36-42mm wire gauge ø 3mm zinc-coated steel Qty 1 pcs		
<b>For models:</b>	AD-15, AD-15D, AD-20C-UK, AD-21, AD-21B, AD-21BDD, AD-21C, AD-21D, AD-21DD, AD-21W, ECO-1200, FI-1200, FI-900, HEI-10-21, HEM-10-21, HGC-10-21, HGC-20-21, HGV-10-21, LVC-12, LVC-15, LVC-15D, LVC-21, LVC-21B, LVC-21C, LVC-21D, LVC-21W, LVR-10, LVR-14, LVR-14D, LVR-20, LVR-20B, LVR-20D, MF-21		

			
<b>2</b>			
<b>GEV No.</b>	520117	<b>Ref. No.</b>	12009962 12035446 Q881306000 Q881307 RT20660504
<b>description</b>	hose clamp stainless steel ø 40-60mm width 9mm Qty 5 pcs DIN 3017		
<b>For models:</b>	ACE-061, ACE-101, ACE-102, ACE-201, ACE-202, ACG-061, ACG-101, ACG-102, ACG-201, ACG-202, AD-120, AD-120B, AD-120BBTDD-UK, AD-120C, AD-120CW, AD-120HY, AD-125, AD-125HRS, AD-125-SOFT, AD-15, AD-15D, AD-20C-UK, AD-21, AD-21B, AD-21BDD, AD-21C, AD-21D, AD-21DD, AD-21W, AD-45BBT, AD-48, AD-48B, AD-48BDD, AD-48C, AD-48D, AD-48DD, AD-48HY, AD-48W, AD-505, AD-505-SOFT, AD-64, AD-64B, AD-64BBT, AD-64BDD, AD-64BTDD, AD-64C, AD-64CW, AD-64D, AD-64DD, AD-64HY...(Other models you can see in the webshop)		

			
<b>1</b>			
<b>GEV No.</b>	505191	<b>Ref. No.</b>	12007966 Q901308
<b>description</b>	hose clamp ø 52-59mm wire gauge ø 3.5mm Qty 1 pcs		
<b>For models:</b>	AD-45BBT, AD-48, AD-48B, AD-48BDD, AD-48C, AD-48D, AD-48DD, AD-48HY, AD-48W, AD-64, AD-64B, AD-64BBT, AD-64BDD, AD-64BTDD, AD-64C, AD-64CW, AD-64D, AD-64DD, AD-64HY, AD-72, AD-72W, EASY-500, EASY-500B, EASY-500DD, EASY-500HP, FI-30, FI-30AR, FI-30AR+DD, FI-30B, FI-30B-BT-UK, FI-30-UK, FI-48, FI-48AR, FI-48B, FI-48B-BT-UK, FI-48C, FI-48D, FI-48HY-CLINIC, FI-48W, FI-50, FI-60DD, FI-64, FI-64AR, FI-64B, FI-64B-BT-UK, FI-64C, FI-64D, FI-64HY-CLINIC, FI-64W, FI-72...(Other models you can see in the webshop)		

<b>DIN 3017 - W4</b>			
			
<b>1</b>			
<b>GEV No.</b>	520120	<b>Ref. No.</b>	12010036 Q881302
<b>description</b>	hose clamp SS W4 ø 12-20mm width 9mm Qty 1 pcs DIN 3017		
<b>For models:</b>	ACE-061, ACE-101, ACE-102, ACE-201, ACE-202, ACG-061, ACG-101, ACG-102, ACG-201, ACG-202, AD-120, AD-120B, AD-120BBTDD-UK, AD-120C, AD-120CW, AD-120HY, AD-125, AD-125HRS, AD-125-SOFT, AD-15, AD-15D, AD-20C-UK, AD-21, AD-21B, AD-21BDD, AD-21C, AD-21D, AD-21DD, AD-21W, AD-45BBT, AD-48, AD-48B, AD-48BDD, AD-48C, AD-48D, AD-48DD, AD-48HY, AD-48W, AD-505, AD-505-SOFT, AD-64, AD-64B, AD-64BBT, AD-64BDD, AD-64BTDD, AD-64C, AD-64CW, AD-64D, AD-64DD, AD-64HY...(Other models you can see in the webshop)		

<b>double wire clamps with screw</b>			
			
<b>1</b>			
<b>GEV No.</b>	505079	<b>Ref. No.</b>	12025195 Z400903
<b>description</b>	hose clamp ø 186-172mm Qty 1 pcs		
<b>For models:</b>	AD-15, AD-15D, AD-20C-UK, AD-21, AD-21B, AD-21BDD, AD-21C, AD-21D, AD-21DD, AD-21W, CO-350, CO-350-B, CO-350-B-DD, CO-350-COLD, CO-350-COLD-B, CO-350-COLD-B-DD, CO-350-COLD-DD, CO-350-DD, CO-352-COLD, CO-352-COLD-B, CO-352-COLD-B-DD, CO-352-COLD-DD, CO-400, CO-400-B, CO-400-B-DD, CO-400-COLD, CO-400-COLD-B, CO-400-COLD-B-DD, CO-400-COLD-DD, CO-400-DD, CO-400-SOFT, CO-402-COLD, CO-402-COLD-B, CO-402-COLD-B-DD, CO-402-COLD-DD, CO-402W, LVC-12, LVC-15, LVC-15D, LVC-21, LVC-21B, LVC-21C, LVC-21D, LVC-21W, LVR-10, LVR-14, LVR-14D, LVR-20, LVR-20B, LVR-20D...(Other models you can see in the webshop)		

water and beverage technology



Зип Общепит  
fastening material

rivets/rivet nuts

blind rivets DIN 7337 - aluminium

+7(812)987-08-81



1

<b>GEV No.</b>	505080	<b>Ref. No.</b>	12023841 Z200908
<b>description</b>	hose clamp ø 235-215mm Qty 1 pcs		
<b>For models:</b>	AD-45BBT, AD-48, AD-48B, AD-48BDD, AD-48C, AD-48D, AD-48DD, AD-48HY, AD-48W, AD-64, AD-64B, AD-64BBT, AD-64BDD, AD-64BTDD, AD-64C, AD-64CW, AD-64D, AD-64DD, AD-64HY, AD-72, AD-72W, EASY-500, EASY-500B, EASY-500DD, EASY-500HP, FI-30, FI-30AR, FI-30AR+DD, FI-30B, FI-30B-BT-UK, FI-30-UK, FI-48, FI-48AR, FI-48B, FI-48B-BT-UK, FI-48C, FI-48D, FI-48HY-CLINIC, FI-48W, FI-50, FI-60DD, FI-64, FI-64AR, FI-64B, FI-64B-BT-UK, FI-64C, FI-64D, FI-64HY-CLINIC, FI-64W, FI-72...(Other models you can see in the webshop)		



1

<b>GEV No.</b>	560048	<b>Ref. No.</b>	12010266 Q419005
<b>description</b>	blind rivet aluminium ø 4mm L 8mm Qty 1 pcs		
<b>For models:</b>	AD-120, AD-120B, AD-120BBTDD-UK, AD-120C, AD-120CW, AD-120HY, AD-15, AD-15D, AD-20C-UK, AD-21, AD-21B, AD-21BDD, AD-21C, AD-21D, AD-21DD, AD-21W, AD-64BTDD, AD-90, AD-90BA, AD-90BBT, AD-90BDD, AD-90DD, ADE-120, ADE-120B, BG6-05I, BG7-05, BG7-05I, BG7-10, BG7-10I, BG9-05, BG9-05AD, BG9-05I, BG9-05PF, BG9-05PI, BG9-05PLUS-I, BG9-10, BG9-10AD, BG9-10I, BG9-10PF, BG9-10PI, BG9-10PLUS-I, BME6-05, BME7-05, BME7-10, BME9-05, BME9-05AD, BME9-05PLUS, BME9-05V-T, BME9-10, BME9-10AD...(Other models you can see in the webshop)		

measuring equipment

thermometers

built-in thermometers



1

<b>GEV No.</b>	501492	<b>Ref. No.</b>	12023939 Z513023
<b>description</b>	thermometer mounting measurements 58x25.5mm +20 up to +120°C capillary pipe 3470mm probe ø 6mm probe L 35mm		
<b>For models:</b>	ECO-160D, ECO-160I, ECO-200D, ECO-200HD, ECO-200HI, ECO-200I, ECO-2700D, ECO-2700I, ECO-280D, ECO-280I, ECO-370D, ECO-370I, ECO-4000D, ECO-4000I, ECO-460D, ECO-460I, ECO-550D, ECO-550I, ECO-6000D, ECO-6000I, FI-160AR, FI-160D, FI-160I, FI-200AR, FI-200D, FI-200HD, FI-200HI, FI-200I, FI-2700D, FI-2700I, FI-280D, FI-280I, FI-370D, FI-370I, FI-4000D, FI-4000I, FI-460D, FI-460I, FI-550D, FI-550I, FI-6000D, FI-6000I		



1

<b>GEV No.</b>	560047	<b>Ref. No.</b>	12010117 Q411304
<b>description</b>	blind rivet steel ø 4.8mm L 11.3mm Qty 1 pcs		
<b>For models:</b>	AD-120, AD-120B, AD-120BBTDD-UK, AD-120C, AD-120CW, AD-120HY, AD-48BDD, AD-48C, AD-48DD, AD-48W, AD-64BDD, AD-64C, AD-64CW, AD-64DD, AD-72, AD-72W, AD-90, AD-90BA, AD-90BBT, AD-90BDD, AD-90DD, ADE-120, ADE-120B, BG9-05, BG9-10, BME7-05, BME7-10, BME9-05, BME9-05AD, BME9-05PLUS, BME9-05V-T, BME9-10, BME9-10AD, BME9-10PLUS, BME9-10V-T, BMG7-10, BMG9-05, BMG9-05V-T, BMG9-10, BMG9-10V-T, CE6-41, CE7-41, CE7-41Q, CE9-41, CE9-41AD, CE9-41PLUS, CG-1002, CG-1502, CG-2002, CG-2002P...(Other models you can see in the webshop)		



1

<b>GEV No.</b>	539003	<b>Ref. No.</b>	12049669
<b>description</b>	thermometer mounting measurements 62x11mm 0 up to +120°C capillary pipe 1700mm probe ø 6mm probe L 25mm		
<b>For models:</b>	COP-503, COP-503B, COP-503BDD, COP-503DD, COP-503-SOFT		



1

<b>GEV No.</b>	550777	<b>Ref. No.</b>	12010024 Q221345
<b>description</b>	rivet nut thread M10 DN 13mm L 22mm Qty 1 pcs		
<b>For models:</b>	BG6-05I, BG7-05, BG7-05I, BG7-10, BG7-10I, BG9-05, BG9-05AD, BG9-05I, BG9-05PF, BG9-05PI, BG9-05PLUS-I, BG9-10, BG9-10AD, BG9-10I, BG9-10PF, BG9-10PI, BG9-10PLUS-I, BME7-05, BME7-10, BME9-05, BME9-05AD, BME9-05PLUS, BME9-05V-T, BME9-10, BME9-10AD, BME9-10PLUS, BME9-10V-T, BMG7-10, BMG9-05, BMG9-05V-T, BMG9-10, BMG9-10V-T, CE7-20, CE7-20Q, CE7-40, CE7-40Q, CE9-20, CE9-20AD, CE9-20PLUS, CE9-40, CE9-40AD, CE9-40PLUS, CG-2005, CG-210, CG-210G, CG-300S, CG-310, CG-310G, CG7-10, CG7-20...(Other models you can see in the webshop)		

water and beverage technology

Зип-Общепит  
SCREWSsheet metal screws  
vsezip.ru

+7(812)987-08-81



1

<b>GEV No.</b>	696427	<b>Ref. No.</b>	12009970 Q222011
<b>description</b>	rivet nut thread M5 DN 4mm L 12mm SS Qty 1 pcs ø 7mm WS 6		
<b>For models:</b>	ACE-061, ACE-101, ACE-102, ACE-201, ACE-202, ACG-061, ACG-101, ACG-102, ACG-201, ACG-202, AD-45BBT, AD-48HY, AD-64BBT, AD-64BTDD, AD-64HY, AE-061, AE-061W, AE-101, AE-101W, AE-102, AE-102W, AE-201, AE-202, AG-061, AG-061W, AG-101, AG-101W, AG-102, AG-102W, AG-201, AG-202, APE-061, APE-061W, APE-101, APE-101W, APE-102, APE-102W, APE-201, APE-202, APG-061, APG-061W, APG-101, APG-101W, APG-102, APG-102W, APG-201, APG-202, CE9-40, CE9-41, CG-2000...(Other models you can see in the webshop)		



1

<b>GEV No.</b>	551034	<b>Ref. No.</b>	12010163 Q221342
<b>description</b>	rivet nut thread M5 DN 7mm L 12mm Qty 10 pcs		
<b>For models:</b>	ACE-061, ACE-101, ACE-102, ACE-201, ACE-202, ACG-061, ACG-101, ACG-102, ACG-201, ACG-202, AD-120, AD-120B, AD-120BBTDD-UK, AD-120C, AD-120CW, AD-120HY, AD-45BBT, AD-48HY, AD-64, AD-64B, AD-64BBT, AD-64BTDD, AD-64C, AD-64D, AD-64DD, AD-64HY, AD-72, AD-90, AD-90BA, AD-90BBT, AD-90BDD, AD-90DD, ADE-120, ADE-120B, AE-061, AE-061W, AE-101, AE-101W, AE-102, AE-102W, AE-201, AE-202, AG-061, AG-061W, AG-101, AG-101W, AG-102, AG-102W, AG-201, AG-202...(Other models you can see in the webshop)		



1

<b>GEV No.</b>	550776	<b>Ref. No.</b>	12010126 Q221343
<b>description</b>	rivet nut thread M6 DN 10mm L 15mm SS Qty 1 pcs		
<b>For models:</b>	ACE-061, ACE-101, ACE-102, ACE-201, ACE-202, ACG-061, ACG-101, ACG-102, ACG-201, ACG-202, ADE-120, ADE-120B, AE-061, AE-061W, AE-101, AE-101W, AE-102, AE-102W, AE-201, AE-202, AG-061, AG-061W, AG-101, AG-101W, AG-102, AG-102W, AG-201, AG-202, APE-061, APE-061W, APE-101, APE-101W, APE-102, APE-102W, APE-201, APE-202, APG-061, APG-061W, APG-101, APG-101W, APG-102, APG-102W, APG-201, APG-202, BG6-05I, BG7-05, BG7-05I, BG7-10, BG7-10I, BG9-05...(Other models you can see in the webshop)		



1

<b>GEV No.</b>	560098	<b>Ref. No.</b>	12010290 Q082032
<b>description</b>	sheet metal screws ø 3.5mm L 9.5mm SS Qty 20 pcs DIN 7981/ISO 7049 head ø 6.9mm oval head		
<b>For models:</b>	AD-120, AD-120B, AD-120BBTDD-UK, AD-120C, AD-120CW, AD-120HY, AD-15, AD-15D, AD-20C-UK, AD-21, AD-21B, AD-21BDD, AD-21C, AD-21D, AD-21DD, AD-21W, AD-45BBT, AD-48, AD-48B, AD-48BDD, AD-48C, AD-48D, AD-48DD, AD-48HY, AD-48W, AD-64, AD-64B, AD-64BBT, AD-64BDD, AD-64BTDD, AD-64C, AD-64CW, AD-64D, AD-64DD, AD-64HY, AD-72, AD-72W, AD-90, AD-90BA, AD-90BBT, AD-90BDD, AD-90DD, ADE-120, ADE-120B, EASY-500, EASY-500B, EASY-500DD, EASY-500HP, EASY-500HPWBDD, ECO-120...(Other models you can see in the webshop)		



1

<b>GEV No.</b>	560108	<b>Ref. No.</b>	12010257 Q082005
<b>description</b>	sheet metal screws ø 4.2mm L 13mm SS Qty 20 pcs DIN 7981/ISO 7049 head ø 8.2mm oval head		
<b>For models:</b>	CPG9-05AD, CPG9-05AD-S, CPG9-05PLUS, CPG9-05PLUS-S, CV9-20AD, CV9-20PLUS, CV9-40AD, CV9-40PLUS, ECO-160D, ECO-160I, ECO-200D, ECO-200HD, ECO-200HI, ECO-200I, ECO-280D, ECO-280I, ECO-370D, ECO-370I, ECO-460D, ECO-460I, ECO-550D, ECO-550I, FG7-05-1C, FG7-05-2C, FG7-10-2C, FG7-10-4C, FG9-05-1C, FG9-05-2C, FG9-05AD, FG9-05PLUS, FG9-05PLUS-S, FG9-05S-1C, FG9-05S-2C, FG9-05S-AD, FG9-10-2C, FG9-10-4C, FG9-10AD, FG9-10PLUS, FGCL9-05-1C, FGCL9-05-2C, FGCL9-05S-1C, FGCL9-05S-2C, FI-160AR, FI-160D, FI-160I, FI-200AR, FI-200D, FI-200HD, FI-200HI...(Other models you can see in the webshop)		

## countersunk screws





1

<b>GEV No.</b>	560076	<b>Ref. No.</b>	12009852 12010293 Q152024
<b>description</b>	countersunk screw thread M4 L 10mm SS DIN 963/ISO 2009 Qty 20 pcs intake slotted head ø 7.5mm		
<b>For models:</b>	AD-120, AD-120B, AD-120BBTDD-UK, AD-120C, AD-120CW, AD-120HY, AD-15, AD-15D, AD-20C-UK, AD-21, AD-21B, AD-21BDD, AD-21C, AD-21D, AD-21DD, AD-21W, AD-45BBT, AD-48, AD-48B, AD-48BDD, AD-48C, AD-48D, AD-48DD, AD-48HY, AD-48W, AD-64, AD-64B, AD-64BBT, AD-64BDD, AD-64BTDD, AD-64C, AD-64CW, AD-64D, AD-64DD, AD-64HY, AD-72, AD-72W, AD-90, AD-90BA, AD-90BBT, AD-90BDD, AD-90DD, ADE-120, ADE-120B, CGP9-11, EASY-500, EASY-500B, EASY-500DD, EASY-500HP, EASY-500HPWBDD...(Other models you can see in the webshop)		



Зип Общепит  
vsezip.ru  
8(812)987-08-81

			
1			
<b>GEV No.</b>	560211	<b>Ref. No.</b>	12010262 Q042022
<b>description</b>	countersunk screw thread M4 L 14mm SS DIN 963/ISO 2009 Qty 20 pcs intake slotted head ø 7.5mm		
<b>For models:</b>	ACE-061, ACE-101, ACE-102, ACE-201, ACE-202, ACG-061, ACG-101, ACG-102, ACG-201, ACG-202, AD-120, AD-120B, AD-120BBTDD-UK, AD-120C, AD-120CW, AD-120HY, AD-15, AD-15D, AD-20C-UK, AD-21, AD-21B, AD-21BDD, AD-21C, AD-21D, AD-21DD, AD-21W, AD-45BBT, AD-48, AD-48B, AD-48BDD, AD-48C, AD-48D, AD-48DD, AD-48HY, AD-64, AD-64B, AD-64BDD, AD-64BTDD, AD-64C, AD-64D, AD-64DD, AD-64HY, AD-72, AD-90, AD-90BA, AD-90BBT, AD-90BDD, AD-90DD, ADE-120, ADE-120B...(Other models you can see in the webshop)		

			
1			
<b>GEV No.</b>	560019	<b>Ref. No.</b>	12009838 Q152015 Q153112
<b>description</b>	flat-headed bolt thread M3 thread L 6mm SS DIN 7985/ISO 7045 Qty 20 pcs head ø 6mm head thickness 2mm Phillips		
<b>For models:</b>	AD-45BBT, AD-48, AD-48B, AD-48BDD, AD-48C, AD-48D, AD-48DD, AD-48HY, AD-48W, AD-64, AD-64B, AD-64BBT, AD-64BDD, AD-64BTDD, AD-64C, AD-64CW, AD-64D, AD-64DD, AD-64HY, AD-72, AD-72W, EASY-500, EASY-500B, EASY-500DD, EASY-500HP, EASY-500HPWBDD, FI-30, FI-300B, FI-300R, FI-30AR, FI-30AR+DD, FI-30B, FI-30B-BT-UK, FI-30-UK, FI-48, FI-48AR, FI-48B, FI-48B-BT-UK, FI-48C, FI-48D, FI-48HY-CLINIC, FI-48W, FI-50, FI-60DD, FI-64, FI-64AR, FI-64B, FI-64B-BT-UK, FI-64C, FI-64D...(Other models you can see in the webshop)		

			
1			
<b>GEV No.</b>	560263	<b>Ref. No.</b>	12010287 Q041324
<b>description</b>	countersunk screw thread M4 L 25mm SS DIN 963/ISO 2009 Qty 20 pcs intake slotted head ø 7.5mm		
<b>For models:</b>	AD-45BBT, AD-48, AD-48B, AD-48BDD, AD-48C, AD-48D, AD-48DD, AD-48HY, AD-48W, AD-64, AD-64B, AD-64BBT, AD-64BDD, AD-64BTDD, AD-64C, AD-64CW, AD-64D, AD-64DD, AD-64HY, AD-72, AD-72W, EASY-500, EASY-500B, EASY-500DD, EASY-500HP, EASY-500HPWBDD, ECO-120, ECO-120B, ECO-160, ECO-160D, ECO-160I, ECO-200, ECO-200D, ECO-200H, ECO-200HD, ECO-200HI, ECO-200I, ECO-2700D, ECO-2700I, ECO-280D, ECO-280I, ECO-370D, ECO-370I, ECO-4000D, ECO-4000I, ECO-460D, ECO-460I, ECO-550D, ECO-550I, ECO-6000D...(Other models you can see in the webshop)		

			
1			
<b>GEV No.</b>	560062	<b>Ref. No.</b>	12010278 Q032021
<b>description</b>	flat-headed bolt thread M4 thread L 10mm SS DIN 7985/ISO 7045 Qty 20 pcs intake Phillips head ø 8mm head thickness 2mm		
<b>For models:</b>	ACE-061, ACE-101, ACE-102, ACE-201, ACE-202, ACG-061, ACG-101, ACG-102, ACG-201, ACG-202, AD-15, AD-15D, AD-20C-UK, AD-21, AD-21B, AD-21BDD, AD-21C, AD-21D, AD-21DD, AD-21W, AE-061, AE-061W, AE-101, AE-101W, AE-102, AE-102W, AE-201, AE-202, AG-061, AG-101, AG-102, AG-201, AG-202, APE-061, APE-061W, APE-101, APE-101W, APE-102, APE-102W, APE-201, APE-202, APG-061, APG-101, APG-102, APG-201, APG-202, BMG7-10, CG-1002, CG-1502, CG-2002...(Other models you can see in the webshop)		

			
1			
<b>GEV No.</b>	560077	<b>Ref. No.</b>	12010265 Q042031
<b>description</b>	countersunk screw thread M5 L 10mm SS DIN 963/ISO 2009 Qty 20 pcs intake slotted head ø 9.2mm		
<b>For models:</b>	ECO-1200, FE-18, FE-25, FE-4, FE-6, FE-8, FE-9, FE-9-05, FE9-10, FF-35, FG9-05, FG9-05S, FG9-10, FI-1200, FI-900, HCG-10-11, HCG-10-21, HCG-20-11, HCG-20-21, HCG-2-10-11, HCG-2-20-11, HCG-6-11, HEI-20-11, HEM-20-11, HEP-20-11, HGP-10-21, HGP-20-21, HGV-10-11, HGV-10-21, HGV-20-11, HGV-20-21, HME-10-11, HME-10-21, HME-20-11, HME-20-21, HME-2-10-11, HME-2-20-11, HME-6-11, HMG-10-11, HMG-10-11UL, HMG-10-21, HMG-10-21UL, HMG-20-11, HMG-2-10-11, HMG-6-11, HMI-10-11, HMI-10-11UL, HMI-10-21, HMI-10-21UL, HMI-20-11...(Other models you can see in the webshop)		

			
1			
<b>GEV No.</b>	560061	<b>Ref. No.</b>	12009876 Q151320
<b>description</b>	flat-headed bolt thread M4 thread L 6mm SS DIN 7985/ISO 7045 Qty 20 pcs intake Phillips head ø 8mm head thickness 2mm		
<b>For models:</b>	ACE-061, ACE-101, ACE-102, ACE-201, ACE-202, ACG-061, ACG-101, ACG-102, ACG-201, ACG-202, AE-061, AE-061W, AE-101, AE-101W, AE-102, AE-102W, AE-201, AE-202, AG-061, AG-061W, AG-101, AG-101W, AG-102, AG-102W, AG-201, AG-202, APE-061, APE-061W, APE-101, APE-101W, APE-102, APE-102W, APE-201, APE-202, APG-061, APG-061W, APG-101, APG-101W, APG-102, APG-102W, APG-201, APG-202, BME6-05, BME7-05, BME7-10, BME9-05, BME9-05AD, BME9-05PLUS, BME9-05V-T, BME9-10...(Other models you can see in the webshop)		

<b>flat-headed bolts</b>			
			
1			
<b>GEV No.</b>	560021	<b>Ref. No.</b>	12010286 Q032011
<b>description</b>	flat-headed bolt thread M3 thread L 10mm SS DIN 7985/ISO 7045 Qty 20 pcs head ø 6mm head thickness 2mm Phillips		
<b>For models:</b>	AD-120, AD-120B, AD-120BBTDD-UK, AD-120C, AD-120CW, AD-120HY, AD-90, AD-90BA, AD-90BBT, AD-90BDD, AD-90DD, ADE-120, ADE-120B, ECO-120, ECO-120B, FI-100, FI-100AR, FI-100B, FI-100BBT-UK, FI-120, FI-120AR+DD, FI-120B, FI-120C, FI-120HY-CLINIC, FI-120W, FI-64, FI-64AR, FI-64B, FI-64B-BT-UK, FI-64C, FI-64D, FI-64HY-CLINIC, FI-64W, FI-E-100, HGC-10-21, HGV-10-21, LABP-1000, LABP-1200, LAC-10, LAC-10MP, LAC-10MPP, LAC-14, LAC-14MP, LAC-14MPP, LAC-7, LAC-7MP, LAC-7MPP, LC-AC-10, LC-AC-10A, LC-AC-14...(Other models you can see in the webshop)		

			
1			
<b>GEV No.</b>	560061	<b>Ref. No.</b>	12009876 Q151320
<b>description</b>	flat-headed bolt thread M4 thread L 6mm SS DIN 7985/ISO 7045 Qty 20 pcs intake Phillips head ø 8mm head thickness 2mm		
<b>For models:</b>	ACE-061, ACE-101, ACE-102, ACE-201, ACE-202, ACG-061, ACG-101, ACG-102, ACG-201, ACG-202, AE-061, AE-061W, AE-101, AE-101W, AE-102, AE-102W, AE-201, AE-202, AG-061, AG-061W, AG-101, AG-101W, AG-102, AG-102W, AG-201, AG-202, APE-061, APE-061W, APE-101, APE-101W, APE-102, APE-102W, APE-201, APE-202, APG-061, APG-061W, APG-101, APG-101W, APG-102, APG-102W, APG-201, APG-202, BME6-05, BME7-05, BME7-10, BME9-05, BME9-05AD, BME9-05PLUS, BME9-05V-T, BME9-10...(Other models you can see in the webshop)		

Зип.Общепит

vsezip.ru

+7(812)987-0881

			
1			
<b>GEV No.</b>	560068	<b>Ref. No.</b>	12010213 Q032032
<b>description</b>	flat-headed bolt thread M5 thread L 16mm SS DIN 7985/ISO 7045 Qty 20 pcs intake Phillips head ø 10mm head thickness 2mm		
<b>For models:</b>	ACE-201, ACE-202, ACG-201, ACG-202, AD-120B, AD-120BTTDD-UK, AD-120C, AD-120HY, AD-15, AD-15D, AD-20C-UK, AD-21, AD-21B, AD-21BDD, AD-21C, AD-21D, AD-21DD, AD-21W, AD-90BA, AD-90BBT, AD-90BDD, ADE-120B, AE-201, AE-202, AG-201, AG-202, APE-201, APE-202, APG-201, APG-202, COE-201, COE-202, COG-201, COG-202, ECO-120B, FI-100B, FI-100BBT-UK, FI-120B, FI-120C, FI-120HY-CLINIC, FI-80BBT-UK, GA-20, GA-20D, GA-40, GA-40D, HCG-10-11, HCG-10-21, HCG-20-11, HCG-20-21, HCG-2-10-11...(Other models you can see in the webshop)		

			
1			
<b>GEV No.</b>	560057	<b>Ref. No.</b>	12010242 Q152004
<b>description</b>	oval head screw thread M5 L 13mm stainless steel intake Phillips Qty 10 pcs		
<b>For models:</b>	ACE-061, ACE-101, ACE-102, ACE-201, ACE-202, ACG-061, ACG-101, ACG-102, ACG-201, ACG-202, AD-120, AD-120B, AD-120BTTDD-UK, AD-120C, AD-120CW, AD-120HY, AD-125, AD-125HRS, AD-125-SOFT, AD-15, AD-15D, AD-20C-UK, AD-21, AD-21B, AD-21BDD, AD-21C, AD-21D, AD-21DD, AD-21W, AD-45BBT, AD-48, AD-48B, AD-48BDD, AD-48C, AD-48D, AD-48DD, AD-48HY, AD-48W, AD-64, AD-64B, AD-64BBT, AD-64BDD, AD-64BTTDD, AD-64C, AD-64CW, AD-64D, AD-64DD, AD-64HY, AD-72, AD-72W...(Other models you can see in the webshop)		

			
2			
<b>GEV No.</b>	560071	<b>Ref. No.</b>	12010166 Q032035
<b>description</b>	flat-headed bolt thread M5 thread L 30mm SS DIN 7985/ISO 7045 Qty 20 pcs intake Phillips head ø 10mm head thickness 2mm		
<b>For models:</b>	AD-45BBT, AD-48HY, AD-64BBT, AD-64HY, CG-1002, CG-1502, FE-18, FE-25, FE-4, FE-6, FE-8, FI-30B-BT-UK, FI-48B-BT-UK, FI-48HY-CLINIC, FI-64B-BT-UK, FI-64HY-CLINIC, HCV-10-11, HCV-10-21, HCV-2-10-21, HCV-5-11, HCV-6-11, HE-10-11, HE-10-21, HE-2-10-11, HE-5-11, HE-6-11, HG-10-11, HG-10-21, HG-2-10-11, LAC-10, LAC-10MP, LAC-10MPP, LAC-14, LAC-14MP, LAC-14MPP, LAC-25, LAC-25MP, LAC-25MPP, LAC-55, LAC-55MP, LAC-55MPP, LAC-7, LAC-7MP, LAC-7MPP, LC-10, LC-14, LC-25, LC-7, LC-7A		

<b>hexagonal screws</b>			
			
1			
<b>GEV No.</b>	560311	<b>Ref. No.</b>	12010030 Q012063
<b>description</b>	hexagonal screw thread M10 thread L 20mm SS WS 17 Qty 1 pcs DIN 933 / ISO 4017		
<b>For models:</b>	ACE-061, ACE-101, ACE-102, ACE-201, ACE-202, ACG-061, ACG-101, ACG-102, ACG-201, ACG-202, AD-120, AD-120B, AD-120C, AD-120CW, AD-48, AD-48B, AD-48BDD, AD-48C, AD-48D, AD-48DD, AD-48W, AD-64, AD-64B, AD-64BDD, AD-64BTTDD, AD-64C, AD-64CW, AD-64D, AD-64DD, AD-72, AD-72W, AD-90, AD-90BA, AD-90BDD, AD-90DD, AE-061, AE-061W, AE-101, AE-101W, AE-102, AE-102W, AE-201, AE-202, AG-061, AG-061W, AG-101, AG-101W, AG-102, AG-102W, AG-201...(Other models you can see in the webshop)		

			
1			
<b>GEV No.</b>	560018	<b>Ref. No.</b>	12010157 Q032041
<b>description</b>	flat-headed bolt thread M6 thread L 10mm SS DIN 7985/ISO 7045 Qty 20 pcs head ø 12mm head thickness 5mm Phillips		
<b>For models:</b>	AD-120, AD-120B, AD-120BTTDD-UK, AD-120HY, AD-90, AD-90BA, AD-90BBT, AD-90BDD, AD-90DD, ADE-120, ADE-120B, EASY-500, EASY-500B, EASY-500DD, EASY-500HP, EASY-500HPWBDD, ECO-120, ECO-120B, FI-100, FI-100AR, FI-100B, FI-100BBT-UK, FI-120, FI-120AR+DD, FI-120B, FI-120C, FI-120HY-CLINIC, FI-120W, FI-30, FI-30AR, FI-30AR+DD, FI-30B, FI-30B-BT-UK, FI-30-UK, FI-48, FI-48AR, FI-48B, FI-48B-BT-UK, FI-48C, FI-48D, FI-48HY-CLINIC, FI-48W, FI-50, FI-60DD, FI-64, FI-64AR, FI-64B, FI-64B-BT-UK, FI-64C, FI-64D...(Other models you can see in the webshop)		

			
1			
<b>GEV No.</b>	560081	<b>Ref. No.</b>	12010249 Q012021
<b>description</b>	hexagonal screw thread M4 thread L 10mm SS WS 7 Qty 20 pcs DIN 933 / ISO 4017		
<b>For models:</b>	ACE-061, ACE-101, ACE-102, ACE-201, ACE-202, ACG-061, ACG-101, ACG-102, ACG-201, ACG-202, AE-061, AE-061W, AE-101, AE-101W, AE-102, AE-102W, AE-201, AE-202, AG-061, AG-061W, AG-101, AG-101W, AG-102, AG-102W, AG-201, AG-202, APE-061, APE-061W, APE-101, APE-101W, APE-102, APE-102W, APE-201, APE-202, APG-061, APG-061W, APG-101, APG-101W, APG-102, APG-102W, APG-201, APG-202, CG-2000, CG-2000-2P, CG-2005, CG-210, CG-210G, CG-300S, CG-310, CG-310G...(Other models you can see in the webshop)		

			
1			
<b>GEV No.</b>	560355	<b>Ref. No.</b>	Q062031
<b>description</b>	flat-headed bolt thread M5 thread L 10mm SS DIN 84/ISO 1207 Qty 1 pcs intake slotted head ø 8.3mm head thickness 3.2mm		
<b>For models:</b>	FI-1200, FI-300B, FI-300R, FI-650R, FI-900, HCV-10-11, HCV-10-21, HCV-2-10-21, HCV-5-11, HCV-6-11, HE-10-11, HE-10-21, HE-2-10-11, HE-5-11, HE-6-11, HME-10-11, HME-10-21, HME-20-11, HME-2-10-11, HME-6-11, HMI-10-11, HMI-10-11UL, HMI-10-21, HMI-10-21UL, HMI-2-10-11, HMI-6-11, HMI-6-11UL, HMM-10-11, HMM-10-11UL, HMM-10-21, HMM-10-21UL, HMM-20-11, HMM-20-11UL, HMM-2-10-11, HMM-6-11, HMM-6-11UL, HMP-10-11, HMP-10-21, HMP-20-11, HMP-2-10-11, HMP-6-11, LC-10, LC-14, LC-7, LC-7A, LF-AC-25, LF-AC-25MP, LF-AC-25MPP, LF-AC-55, LF-AC-55MP...(Other models you can see in the webshop)		





Зип Общепит

vsezip.ru

7(812)987-08-81

 <p>1</p>			
<b>GEV No.</b>	560083	<b>Ref. No.</b>	12010238 Q012031
<b>description</b>	hexagonal screw thread M5 thread L 10mm SS WS 8 Qty 20 pcs DIN 933 / ISO 4017		
<b>For models:</b>	ACE-061, ACE-101, ACE-102, ACE-201, ACE-202, ACG-061, ACG-101, ACG-102, ACG-201, ACG-202, AD-120, AD-120B, AD-120BBTDD-UK, AD-120C, AD-120CW, AD-120HY, AD-20C-UK, AD-21B, AD-21BDD, AD-21C, AD-21DD, AD-21W, AD-45BBT, AD-48, AD-48B, AD-48BDD, AD-48C, AD-48D, AD-48DD, AD-48HY, AD-48W, AD-64, AD-64B, AD-64BBT, AD-64BDD, AD-64BTDD, AD-64C, AD-64CW, AD-64D, AD-64DD, AD-64HY, AD-72, AD-72W, AD-90, AD-90BA, AD-90BBT, AD-90BDD, AD-90DD, ADE-120, ADE-120B...(Other models you can see in the webshop)		

 <p>1</p>			
<b>GEV No.</b>	560088	<b>Ref. No.</b>	12010180 Q012043
<b>description</b>	hexagonal screw thread M6 thread L 20mm SS WS 10 Qty 20 pcs DIN 933 / ISO 4017		
<b>For models:</b>	ACE-061, ACE-101, ACE-102, ACG-061, ACG-101, ACG-102, AE-061, AE-061W, AE-101, AE-101W, AE-102, AE-102W, AG-061, AG-061W, AG-101, AG-101W, AG-102, AG-102W, APE-061, APE-061W, APE-101, APE-101W, APE-102, APE-102W, APG-061, APG-061W, APG-101, APG-101W, APG-102, APG-102W, BME9-05, BME9-10, BMG9-05, BMG9-10, CE7-41, CE7-41Q, CE9-41, CG-1002, CG-1502, CG7-11, CG7-31D, CG7-31I, CG7-41, CG7-41H, CG7-51, CG7-61, CG7-61H, CG9-10, CG9-11, CG9-11AD...(Other models you can see in the webshop)		

 <p>2</p>			
<b>GEV No.</b>	560086	<b>Ref. No.</b>	12010202 Q012041
<b>description</b>	hexagonal screw thread M6 thread L 10mm SS WS 10 Qty 20 pcs DIN 933 / ISO 4017		
<b>For models:</b>	AD-120, AD-120B, AD-120BBTDD-UK, AD-120C, AD-120CW, AD-120HY, AD-45BBT, AD-48, AD-48B, AD-48BDD, AD-48C, AD-48D, AD-48DD, AD-48HY, AD-48W, AD-64, AD-64B, AD-64BBT, AD-64BDD, AD-64BTDD, AD-64C, AD-64CW, AD-64D, AD-64DD, AD-64HY, AD-72, AD-72W, AD-90, AD-90BA, AD-90BBT, AD-90BDD, AD-90DD, ADE-120, ADE-120B, BME9-05, BME9-10, BMG7-10, BMG9-05, BMG9-10, CE6-41, CE7-41, CE7-41Q, CE9-41, CE9-41AD, CE9-41PLUS, CG-1002, CG-1502, CG-2000, CG-2000-2P, CG-2002...(Other models you can see in the webshop)		

 <p>1</p>			
<b>GEV No.</b>	560089	<b>Ref. No.</b>	12010153 Q012044
<b>description</b>	hexagonal screw thread M6 thread L 25mm SS WS 10 Qty 20 pcs DIN 933 / ISO 4017		
<b>For models:</b>	AD-120, AD-120B, AD-120BBTDD-UK, AD-120C, AD-120CW, AD-120HY, AD-90, AD-90BA, AD-90BBT, AD-90BDD, AD-90DD, ADE-120, ADE-120B, CE9-41, CG-1002, CG-1502, CG-2000, CG-2000-2P, CG-2002, CG-2005, CG-210, CG-210G, CG-3005, CG-310, CG-310G, CG7-20, CG7-200, CG7-40, CG7-400, CG7-41, CG7-415, CG7-61, CG7-615, CG9-20, CG9-40, CG9-41, CG9-51L, CG9-51LC, CG9-51R, CG9-51RC, CG9-60, CG9-61, CG9-82, CGB7-61, CGE7-41, CGE9-41, COG-061, COG-101, ECO-120, ECO-120B...(Other models you can see in the webshop)		

 <p>1</p>			
<b>GEV No.</b>	560079	<b>Ref. No.</b>	12037772 RT10060761
<b>description</b>	hexagonal screw thread M6 thread L 12mm SS WS 10 Qty 20 pcs DIN 933 / ISO 4017		
<b>For models:</b>	AD-45BBT, AD-48, AD-48B, AD-48C, AD-48D, AD-48DD, AD-48HY, AD-48W, AD-64, AD-64B, AD-64BBT, AD-64BTDD, AD-64C, AD-64CW, AD-64D, AD-64DD, AD-64HY, AD-72, AD-72W, EASY-500, EASY-500B, EASY-500DD, EASY-500HP, EASY-500HPWBDD, ECO-160, ECO-1600, ECO-160D, ECO-160I, ECO-200, ECO-200D, ECO-200H, ECO-200HD, ECO-200HI, ECO-200I, ECO-2300, ECO-280D, ECO-280I, ECO-3000, ECO-370D, ECO-370I, ECO-460D, ECO-460I, ECO-550D, ECO-550I, FI-160, FI-1600, FI-160D, FI-160I, FI-200, FI-200D...(Other models you can see in the webshop)		

 <p>1</p>			
<b>GEV No.</b>	560252	<b>Ref. No.</b>	12010115 Q012046
<b>description</b>	hexagonal screw thread M6 thread L 40mm SS WS 10 Qty 20 pcs DIN 933 / ISO 4017		
<b>For models:</b>	AD-45BBT, AD-48, AD-48B, AD-48C, AD-48D, AD-48DD, AD-48HY, AD-48W, AD-64, AD-64B, AD-64BBT, AD-64BTDD, AD-64C, AD-64CW, AD-64D, AD-64DD, AD-64HY, AD-72, AD-72W, EASY-500, EASY-500B, EASY-500DD, EASY-500HP, EASY-500HPWBDD, ECO-160, ECO-1600, ECO-160D, ECO-160I, ECO-200, ECO-200D, ECO-200H, ECO-200HD, ECO-200HI, ECO-200I, ECO-2300, ECO-280D, ECO-280I, ECO-3000, ECO-370D, ECO-370I, ECO-460D, ECO-460I, ECO-550D, ECO-550I, FI-160, FI-1600, FI-160D, FI-160I, FI-200, FI-200D...(Other models you can see in the webshop)		

 <p>1</p>			
<b>GEV No.</b>	524118	<b>Ref. No.</b>	12010186 Q012042
<b>description</b>	hexagonal screw thread M6 thread L 16mm SS WS 10 Qty 1 pcs DIN 933 / ISO 4017		
<b>For models:</b>	ACE-061, ACE-101, ACE-102, ACE-201, ACE-202, ACG-061, ACG-101, ACG-102, ACG-201, ACG-202, AD-120, AD-120B, AD-120BBTDD-UK, AD-120C, AD-120CW, AD-120HY, AD-15, AD-15D, AD-20C-UK, AD-21, AD-21B, AD-21BDD, AD-21C, AD-21D, AD-21DD, AD-21W, AD-45BBT, AD-48, AD-48B, AD-48BDD, AD-48C, AD-48D, AD-48DD, AD-48HY, AD-48W, AD-64, AD-64B, AD-64BBT, AD-64BDD, AD-64BTDD, AD-64C, AD-64CW, AD-64D, AD-64DD, AD-64HY, AD-72, AD-72W, AD-90, AD-90BA, AD-90BBT...(Other models you can see in the webshop)		

 <p>1</p>			
<b>GEV No.</b>	550682	<b>Ref. No.</b>	12010076 Q012053
<b>description</b>	hexagonal screw thread M8 thread L 20mm SS WS 13 Qty 1 pcs DIN 933 / ISO 4017		
<b>For models:</b>	AD-120, AD-120B, AD-120BBTDD-UK, AD-120C, AD-120CW, AD-120HY, AD-90, AD-90BA, AD-90BBT, AD-90BDD, AD-90DD, ADE-120, ADE-120B, CE-410, CG-110, CG-9110, CGB7-61H, CGB7-61R, CGB7-61RH, ECO-120, ECO-120B, ECO-160, ECO-1600, ECO-160D, ECO-160I, ECO-200, ECO-200D, ECO-200H, ECO-200HD, ECO-200HI, ECO-200I, ECO-2300, ECO-2700D, ECO-2700I, ECO-280D, ECO-280I, ECO-3000, ECO-370D, ECO-370I, ECO-4000D, ECO-4000I, ECO-460D, ECO-460I, ECO-550D, ECO-550I, ECO-6000D, ECO-6000I, FI-100, FI-100AR, FI-100B...(Other models you can see in the webshop)		

Зип, Общепит

grub screws  
DIN 914/ISO 4027

1

<b>GEV No.</b>	506446	<b>Ref. No.</b>	12010056 Q012056
<b>description</b>	hexagonal screw thread M8 thread L 40mm SS WS 15 Qty 1 pcs DIN 933 / ISO 4017		
<b>For models:</b>	ACE-061, ACE-101, ACE-102, ACE-201, ACE-202, ACG-061, ACG-101, ACG-102, ACG-201, ACG-202, AE-061, AE-061W, AE-101, AE-101W, AE-102, AE-102W, AE-201, AE-202, AG-061, AG-061W, AG-101, AG-101W, AG-102, AG-102W, AG-201, AG-202, APE-061, APE-061W, APE-101, APE-101W, APE-102, APE-102W, APE-201, APE-202, APG-061, APG-061W, APG-101, APG-101W, APG-102, APG-102W, APG-201, APG-202, COE-102, COE-202, COG-102, COG-201, COG-202, ECO-1600, ECO-2300, ECO-3000...(Other models you can see in the webshop)		

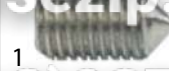

1

<b>GEV No.</b>	560175	<b>Ref. No.</b>	12010091 Q131504 Q131552
<b>description</b>	grub screw thread M8 L 16mm DIN 914/ISO 4027 intake internal hexagon WS 4 Qty 1 pcs		
<b>For models:</b>	SBE7-10, SBE9-10, SBE9-10I, SBE9-10I-AD, SBE9-10I-AD-S, SBE9-10IIM, SBE9-10IMS, SBE9-10IS, SBE9-10PLUS-I, SBE9-10PLUS-SI, SBE9-10S, SBE9-10USMC, SBG7-10, SBG-9040, SBG9-10, SBG9-10I, SBG9-10I-AD, SBG9-10I-AD-S, SBG9-10IS, SBG9-10PLUS-I, SBG9-10PLUS-SI, SBG9-10S		



1

<b>GEV No.</b>	550528	<b>Ref. No.</b>	12040516 RT10052000
<b>description</b>	safety screw thread M5 WS 8 Qty 10 pcs L 8mm head ø 11mm		



1

<b>GEV No.</b>	696737	<b>Ref. No.</b>	12024023 Z105051 Z105051000
<b>description</b>	grub screw thread M8 L 16mm DIN 914/ISO 4027 Qty 1 pcs		
<b>For models:</b>	ECO-160, ECO-1600, ECO-160D, ECO-160I, ECO-200, ECO-200D, ECO-200H, ECO-200HD, ECO-200HI, ECO-200I, ECO-2300, ECO-280D, ECO-280I, ECO-3000, ECO-370D, ECO-370I, ECO-460D, ECO-460I, ECO-550D, ECO-550I, FI-160, FI-1600, FI-160AR, FI-160D, FI-160I, FI-200, FI-200AR, FI-200D, FI-200H, FI-200HD, FI-200HI, FI-200I, FI-200W, FI-200WL, FI-200WR, FI-2300, FI-280D, FI-280I, FI-3000, FI-370D, FI-370I, FI-460D, FI-460I, FI-550D, FI-550I		

## cylinder head bolts

DIN 912/ISO 4762



1

<b>GEV No.</b>	560380	<b>Ref. No.</b>	12010084 12018750 Q052046 Q152033
<b>description</b>	cylinder head bolt thread M6 L 40mm thread L 25mm WS 5 SS Qty 1 pcs DIN 912/ISO 4762		
<b>For models:</b>	ACG-061, ACG-101, ACG-102, ACG-201, ACG-202, AG-061, AG-061W, AG-101, AG-101W, AG-102, AG-102W, AG-201, AG-202, APG-061, APG-061W, APG-101, APG-101W, APG-102, APG-102W, APG-201, APG-202, ECO-1200, FI-1200, FI-120W, FI-200W, FI-200WL, FI-200WR, FI-80W, FI-900, LAC-25, LAC-25MP, LAC-25MPP, LAC-55, LAC-55MP, LAC-55MPP, LC-25, LC-AC-25, LC-E-25, LC-V-25, LF-25MPP, LF-AC-25, LF-AC-25MP, LF-AC-25MPP, LF-AC-55, LF-AC-55MP, LF-AC-55MPP, LF-E-25, LF-E-25MP, LF-E-25MPP, LF-E-55...(Other models you can see in the webshop)		

## side bolts



1

<b>GEV No.</b>	560038	<b>Ref. No.</b>	12010148 Q152017
<b>description</b>	side bolts thread M6 L 13mm Qty 20 pcs intake Phillips head ø 15mm		
<b>For models:</b>	BME9-05, BME9-10, BMG9-05, BMG9-10, CE7-41, CE9-41, CG-1002, CG-1502, CG-2000, CG-2000-2P, CG-2002, CG-2002P, CG-2005, CG-210, CG-210G, CG-300S, CG-310, CG-310G, CG7-11, CG7-41, CG7-61, CG9-11, CG9-20, CG9-40, CG9-41, CG9-51L, CG9-51LC, CG9-51R, CG9-51RC, CG9-60, CG9-61, CG9-82, CGE7-198, CGE7-202, CGE7-41, CGE9-41, CGF9-121D, CGF9-121I, CGP9-11, ECO-120, ECO-120B, ECO-160, ECO-160D, ECO-160I, ECO-200, ECO-200D, ECO-200H, ECO-200HD, ECO-200HI, ECO-200I...(Other models you can see in the webshop)		

## knurled screws



1

<b>GEV No.</b>	505034	<b>Ref. No.</b>	12009829 Q152016
<b>description</b>	Thumb screw thread M5 thread L 7mm ø 20mm H 3mm SS		
<b>For models:</b>	AD-120, AD-120B, AD-120BTTDD-UK, AD-120C, AD-120CW, AD-120HY, AD-15, AD-15D, AD-20C-UK, AD-21, AD-21B, AD-21BDD, AD-21C, AD-21D, AD-21DD, AD-21W, AD-45BBT, AD-48, AD-48B, AD-48BDD, AD-48C, AD-48D, AD-48DD, AD-48HY, AD-48W, AD-64, AD-64B, AD-64BBT, AD-64BDD, AD-64BTDD, AD-64C, AD-64CW, AD-64D, AD-64DD, AD-64HY, AD-72, AD-72W, AD-90, AD-90BA, AD-90BBT, AD-90BDD, AD-90DD, ADE-120, ADE-120B, CO-110, CO-110B, CO-110BDD, CO-110DD, CO-112, CO-112B...(Other models you can see in the webshop)		

## miscellaneous



1

<b>GEV No.</b>	505140	<b>Ref. No.</b>	12016848 Z643015
<b>description</b>	screw SS		
<b>For models:</b>	FI-300B, FI-300R, FI-650R		





Зип Общепит

vsezip.ru

+7(812)987-08-81

nuts

plate nuts



1

<b>GEV No.</b>	560046	<b>Ref. No.</b>	12010134 Q221012
<b>description</b>	plate nut hole ø M5mm L 16mm W 10mm		
<b>For models:</b>	AD-15, AD-15D, AD-21, AD-21B, AD-21BDD, AD-21D, AD-21DD, AD-21W, AD-45BBT, AD-48, AD-48B, AD-48BDD, AD-48C, AD-48D, AD-48DD, AD-48HY, AD-48W, AD-64, AD-64B, AD-64BBT, AD-64BDD, AD-64C, AD-64CW, AD-64D, AD-64DD, AD-64HY, AD-72, AD-72W, EASY-500, EASY-500B, EASY-500DD, EASY-500HP, EASY-500HPWBDD, ECO-1200, FI-1200, FI-30, FI-300B, FI-300R, FI-30AR, FI-30AR+DD, FI-30B, FI-30B-BT-UK, FI-30-UK, FI-48, FI-48AR, FI-48B, FI-48B-BT-UK, FI-48C, FI-48D, FI-48HY-CLINIC...(Other models you can see in the webshop)		

1

<b>GEV No.</b>	560138	<b>Ref. No.</b>	12010094 Q212051
<b>description</b>	cap nuts thread M8 WS 13 SS Qty 20 pcs DIN/ISO DIN 1587		
<b>For models:</b>	FF-35, HCG-10-11, HCG-10-21, HCG-20-11, HCG-20-21, HCG-2-10-11, HCG-2-20-11, HCG-6-11, HEI-10-11, HEI-20-11, HEI-6-11, HEM-10-11, HEM-20-11, HEM-6-11, HEP-10-11, HEP-20-11, HEP-6-11, HGC-10-11, HGC-20-11, HGC-6-11, HGV-10-11, HGV-20-11, HME-10-11, HME-10-21, HME-20-11, HME-20-21, HME-2-10-11, HME-2-20-11, HME-6-11, HMI-10-11, HMI-10-11UL, HMI-10-21, HMI-10-21UL, HMI-2-10-11, HMI-6-11, HMI-6-11UL, HMM-10-11, HMM-10-11UL, HMM-10-21, HMM-10-21UL, HMM-20-11, HMM-20-11UL, HMM-20-21, HMM-20-21UL, HMM-2-10-11, HMM-2-20-11, HMM-40-11-USMC, HMM-6-11, HMM-6-11UL, HMP-10-11...(Other models you can see in the webshop)		

cap nuts



1

<b>GEV No.</b>	560136	<b>Ref. No.</b>	12010167 Q212031
<b>description</b>	cap nuts thread M5 WS 8 SS Qty 20 pcs DIN/ISO DIN 1587		
<b>For models:</b>	ECO-160, ECO-160D, ECO-160I, ECO-200, ECO-200D, ECO-200H, ECO-200HD, ECO-200HI, ECO-200I, ECO-2700D, ECO-2700I, ECO-280D, ECO-280I, ECO-370D, ECO-370I, ECO-4000D, ECO-4000I, ECO-460D, ECO-460I, ECO-550D, ECO-550I, ECO-6000D, ECO-6000I, FE9-05, FE9-05S, FE9-05USMC, FE9-10, FG9-05, FG9-05S, FG9-10, FI-160, FI-160AR, FI-160D, FI-160I, FI-200, FI-200AR, FI-200D, FI-200H, FI-200HD, FI-200HI, FI-200I, FI-200W, FI-200WL, FI-200WR, FI-2700D, FI-2700I, FI-280D, FI-280I, FI-370D, FI-370I...(Other models you can see in the webshop)		

knurled nuts



1

<b>GEV No.</b>	505171	<b>Ref. No.</b>	12017466 12020831 12024375 Z200705
<b>description</b>	knurled nut thread M14x1 ø 35mm H 5mm SS		
<b>For models:</b>	AD-45BBT, AD-48, AD-48B, AD-48BDD, AD-48C, AD-48D, AD-48DD, AD-48HY, AD-48W, AD-64, AD-64B, AD-64BBT, AD-64BDD, AD-64BTDD, AD-64C, AD-64CW, AD-64D, AD-64DD, AD-64HY, AD-72, AD-72W, AD-90, AD-90BA, AD-90BBT, AD-90BDD, AD-90DD, EASY-500, EASY-500B, EASY-500DD, EASY-500HP, EASY-500HPWBDD, FI-30, FI-30AR, FI-30AR+DD, FI-30B, FI-30B-BT-UK, FI-30-UK, FI-48, FI-48AR, FI-48B, FI-48B-BT-UK, FI-48C, FI-48D, FI-48HY-CLINIC, FI-48W, FI-50, FI-60DD, FI-64, FI-64AR, FI-64B...(Other models you can see in the webshop)		

hexagonal nuts

DIN 934 / ISO 4032/8673



1

<b>GEV No.</b>	560199	<b>Ref. No.</b>	12036825 RT11120110
<b>description</b>	hexagonal nut thread M10 H 8mm WS 17 SS DIN/ISO DIN 934 / ISO 4032/8673 Qty 10 pcs		

<b>GEV No.</b>	560137	<b>Ref. No.</b>	12010143 12034573 Q212040 RT11060360
<b>description</b>	cap nuts thread M6 WS 10 SS Qty 20 pcs DIN/ISO DIN 1587		
<b>For models:</b>	ECO-160, ECO-160D, ECO-160I, ECO-200, ECO-200D, ECO-200H, ECO-200HD, ECO-200HI, ECO-200I, ECO-2700D, ECO-2700I, ECO-280D, ECO-280I, ECO-370D, ECO-370I, ECO-4000D, ECO-4000I, ECO-460D, ECO-460I, ECO-550D, ECO-550I, ECO-6000D, ECO-6000I, FE-710, FE-720, FE-920, FF-35, FG-710, FG-720, FG-920, FI-160, FI-160AR, FI-160D, FI-160I, FI-200, FI-200AR, FI-200D, FI-200H, FI-200HD, FI-200HI, FI-200I, FI-200W, FI-200WL, FI-200WR, FI-2700D, FI-2700I, FI-280D, FI-280I, FI-370D, FI-370I...(Other models you can see in the webshop)		

Зип Общепит

vsezip.ru

7(812)987-08-81



1

<b>GEV No.</b>	560131	<b>Ref. No.</b>	12009839 Q162020
<b>description</b>	hexagonal nut thread M4 H 3.2mm WS 7 SS DIN/ISO DIN 934 / ISO 4032/8673 Qty 20 pcs		
<b>For models:</b>	ACE-201, ACE-202, AD-120, AD-120B, AD-120BBTDD-UK, AD-120C, AD-120CW, AD-120HY, AD-15, AD-15D, AD-20C-UK, AD-21, AD-21B, AD-21BDD, AD-21C, AD-21D, AD-21DD, AD-21W, AD-45BBT, AD-48, AD-48B, AD-48BDD, AD-48C, AD-48D, AD-48DD, AD-48HY, AD-48W, AD-64, AD-64B, AD-64BBT, AD-64BDD, AD-64C, AD-64CW, AD-64D, AD-64DD, AD-64HY, AD-72, AD-72W, AD-90, AD-90BA, AD-90BBT, AD-90BDD, AD-90DD, ADE-120, ADE-120B, AE-061, AE-061W, AE-101, AE-101W, AE-102...(Other models you can see in the webshop)		



2

<b>GEV No.</b>	560132	<b>Ref. No.</b>	12010194 12010284 Q162030 Q163030
<b>description</b>	hexagonal nut thread M5 H 4mm WS 8 SS DIN/ISO DIN 934 / ISO 4032/8673 Qty 20 pcs		
<b>For models:</b>	ACE-061, ACE-101, ACE-102, ACE-201, ACE-202, ACG-061, ACG-101, ACG-102, ACG-201, ACG-202, AD-120, AD-120B, AD-120BBTDD-UK, AD-120C, AD-120CW, AD-120HY, AD-15, AD-15D, AD-20C-UK, AD-21, AD-21B, AD-21BDD, AD-21C, AD-21D, AD-21DD, AD-21W, AD-45BBT, AD-48, AD-48B, AD-48BDD, AD-48C, AD-48D, AD-48DD, AD-48HY, AD-48W, AD-64, AD-64B, AD-64BBT, AD-64BDD, AD-64BTDD, AD-64C, AD-64CW, AD-64D, AD-64DD, AD-64HY, AD-72, AD-72W, AD-90, AD-90BA, AD-90BBT...(Other models you can see in the webshop)		



1

<b>GEV No.</b>	511212	<b>Ref. No.</b>	12010255 Q162040 Q163140000
<b>description</b>	hexagonal nut thread M6 H 5mm WS 10 SS DIN/ISO DIN 934 / ISO 4032/8673 Qty 1 pcs		
<b>For models:</b>	ACE-061, ACE-101, ACE-102, ACE-201, ACE-202, ACG-061, ACG-101, ACG-102, ACG-201, ACG-202, AD-120, AD-120B, AD-120BBTDD-UK, AD-120C, AD-120CW, AD-120HY, AD-15, AD-15D, AD-20C-UK, AD-21, AD-21B, AD-21BDD, AD-21C, AD-21D, AD-21DD, AD-21W, AD-45BBT, AD-48, AD-48B, AD-48BDD, AD-48C, AD-48D, AD-48DD, AD-48HY, AD-48W, AD-64, AD-64B, AD-64BBT, AD-64BDD, AD-64BTDD, AD-64C, AD-64CW, AD-64D, AD-64DD, AD-64HY, AD-72, AD-72W, AD-90, AD-90BA, AD-90BBT...(Other models you can see in the webshop)		



1

<b>GEV No.</b>	560134	<b>Ref. No.</b>	12010210 12037260 Q162050 RT11080260
<b>description</b>	hexagonal nut thread M8 H 6.5mm WS 13 SS DIN/ISO DIN 934 / ISO 4032/8673 Qty 20 pcs		
<b>For models:</b>	ACE-061, ACE-101, ACE-102, ACE-201, ACE-202, ACG-061, ACG-101, ACG-102, ACG-201, ACG-202, AD-120, AD-120B, AD-120BBTDD-UK, AD-120C, AD-120CW, AD-120HY, AD-45BBT, AD-48, AD-48B, AD-48BDD, AD-48C, AD-48D, AD-48DD, AD-48HY, AD-48W, AD-64, AD-64B, AD-64BBT, AD-64BDD, AD-64BTDD, AD-64C, AD-64CW, AD-64D, AD-64DD, AD-64HY, AD-72, AD-72W, AD-90, AD-90BA, AD-90BBT, AD-90BDD, AD-90DD, ADE-120, ADE-120B, AE-061, AE-061W, AE-101, AE-101W, AE-102, AE-102W...(Other models you can see in the webshop)		

## DIN 985



1

<b>GEV No.</b>	560140	<b>Ref. No.</b>	12009897
<b>description</b>	hexagonal nut thread M4 H 4.8mm SS WS 7 Qty 20 pcs DIN/ISO DIN 985 self-locking		
<b>For models:</b>	AD-64BTDD		



1

<b>GEV No.</b>	560142	<b>Ref. No.</b>	12010251 Q222012
<b>description</b>	hexagonal nut thread M6 H 6mm SS WS 10 Qty 20 pcs DIN/ISO DIN 985 self-locking		
<b>For models:</b>	AD-120, AD-120B, AD-120BBTDD-UK, AD-15, AD-15D, AD-20C-UK, AD-21, AD-21B, AD-21BDD, AD-21C, AD-21D, AD-21DD, AD-21W, AD-45BBT, AD-48, AD-48B, AD-48BDD, AD-48C, AD-48D, AD-48DD, AD-48HY, AD-48W, AD-64, AD-64B, AD-64BBT, AD-64BDD, AD-64BTDD, AD-64C, AD-64CW, AD-64D, AD-64DD, AD-64HY, AD-72, AD-72W, AD-90, AD-90BA, AD-90BBT, AD-90BDD, AD-90DD, ADE-120, ADE-120B, EASY-500, EASY-500B, EASY-500DD, EASY-500HP, EASY-500HPWBDD, ECO-120, ECO-120B, ECO-160, ECO-160D...(Other models you can see in the webshop)		

## DIN 439 / ISO 4035/8675



1

<b>GEV No.</b>	507533	<b>Ref. No.</b>	12009948 Q222016
<b>description</b>	nut thread M20 H 9.5mm SS WS 29.5 Qty 1 pcs DIN/ISO DIN 439		
<b>For models:</b>	AD-120, AD-120B, AD-120BBTDD-UK, AD-90, AD-90BA, AD-90BBT, AD-90BDD, AD-90DD, ADE-120, ADE-120B, ECO-120, ECO-120B, FI-100, FI-100AR, FI-100B, FI-100BBT-UK, FI-120, FI-120AR+DD, FI-120B, FI-120C, FI-120HY-CLINIC, FI-120W, FI-80, FI-80AR, FI-80BBT-UK, FI-80W, FI-E-100, LABP-1000, LABP-1200, LABP-800, MF-120		



Зип Общепит

vsezip.ru

+7(812)987-08-81

hexagonal nuts metric (without norm)



1

<b>GEV No.</b>	550261	<b>Ref. No.</b>	12016635 X163012 Z600603
<b>description</b>	nut thread M14x1 H 4mm WS 19 SS Qty 1 pcs		
<b>For models:</b>	BG9-05, BG9-05I, BG9-10, BG9-10I, FE-710, FE-720, FE-920, FG-710, FG-720, FG-920, FI-300B, FI-300R, FI-650R, LVC-15, LVC-21, LVR-14, LVR-20, LVR-20B		



1

<b>GEV No.</b>	101345	<b>Ref. No.</b>	12009877 Q223021
<b>description</b>	nut thread M15x1 H 3mm WS 19 brass Qty 1 pcs		
<b>For models:</b>	BME7-05, BME7-10, BME9-05, BME9-05AD, BME9-05PLUS, BME9-05V-T, BME9-10, BME9-10AD, BME9-10PLUS, BME9-10V-T, FG-1-40, FG-2-80, FG7-05-1C, FG7-05-2C, FG-710, FG7-10-2C, FG7-104C, FG7-10-4C, FG-71-15, FG-720, FG-72-30, FG9-05, FG9-05-1C, FG9-05-2C, FG9-05AD, FG9-05PLUS, FG9-05PLUS-S, FG9-05S, FG9-05S-1C, FG9-05S-2C, FG9-05S-AD, FG9-10, FG9-10-2C, FG9-10-4C, FG9-10AD, FG9-10PLUS, FG-91-20, FG-920, FG-92-40, FG-940, FI-300B, FI-300R, FI-650R		



1

<b>GEV No.</b>	691862	<b>Ref. No.</b>	12016713 Q223011
<b>description</b>	nut thread M18x1.5 H 5mm WS 22 SS Qty 1 pcs		
<b>For models:</b>	FI-300B, FI-300R, FI-650R, LVR-10, LVR-14, LVR-20, LVR-20B		



1

<b>GEV No.</b>	507536	<b>Ref. No.</b>	12018993 Q223022
<b>description</b>	nut thread M8x1 H 3mm WS 11 brass Qty 1 pcs		
<b>For models:</b>	CG-210G, CG-310G, CG-7200, CG-7400, CG-7415, CG-7615, CG-HP-20, ECO-1600, ECO-2300, ECO-3000, FE-710, FE-720, FG-1-40, FG-2-80, FG7-05-1C, FG7-05-2C, FG-710, FG7-10-2C, FG7-104C, FG7-10-4C, FG-71-15, FG-720, FG-72-30, FG-91-20, FG-92-40, FI-100, FI-120, FI-120W, FI-1600, FI-160D, FI-160I, FI-200D, FI-200I, FI-2300, FI-280D, FI-280I, FI-3000, FI-370D, FI-370I, FI-460D, FI-460I, FI-48, FI-48B, FI-48W, FI-50, FI-5420, FI-550D, FI-550I, FI-64, FI-64B...(Other models you can see in the webshop)		

hexagonal nuts in 1/4" thread



1

<b>GEV No.</b>	507532	<b>Ref. No.</b>	12009831 Q223014
<b>description</b>	nut thread 1" H 10mm WS 40 brass Qty 1 pcs		
<b>For models:</b>	AD-45BBT, AD-48HY, AD-64BBT, AD-64BTDD, AD-64HY, EA-SY-500HPWBDD, FE-18, FE-25, FE-710, FE-720, FE-91-20, FG-1-40, FG-2-80, FG-710, FG-720, FG-91-20, FG-920, FG-92-40, FG-940, FGCL9-05, FI-30B-BT-UK, FI-48B-BT-UK, FI-48HY-CLINIC, FI-64B-BT-UK, FI-64HY-CLINIC, HCG-10-11, HCG-10-21, HCG-20-11, HCG-20-21, HCG-2-10-11, HCG-2-20-11, HCG-6-11, HEI-10-11, HEI-20-11, HEI-6-11, HEM-10-11, HEM-20-11, HEM-6-11, HEP-10-11, HEP-20-11, HEP-6-11, HGC-10-11, HGC-20-11, HGC-6-11, HGV-10-11, HGV-20-11, HME-10-11, HME-20-11, HME-20-21...(Other models you can see in the webshop)		



1

<b>GEV No.</b>	507535	<b>Ref. No.</b>	12009899 Q221324
<b>description</b>	nut thread 3/4" H 7mm WS 30 SS Qty 1 pcs		
<b>For models:</b>	BG7-05, BG7-05I, BG7-10, BG7-10I, BG9-05, BG9-05I, BG9-05PF, BG9-05PI, BG9-10, BG9-10I, BG9-10PF, BG9-10PI, BMG7-10, BMG-9045, BMG9-05, BMG9-05V-T, BMG9-10, BMG9-10V-T, CE-410, CE9-41, CG-2000-2P, CG9-51L, CG9-51LC, CG9-51R, CG9-51RC, ECO-160, ECO-200, ECO-200H, ECO-2700D, ECO-2700I, ECO-280D, ECO-280I, ECO-370D, ECO-370I, ECO-4000D, ECO-4000I, ECO-460D, ECO-460I, ECO-550D, ECO-550I, ECO-6000D, ECO-6000I, FG-71-15, FG-72-30, FI-160, FI-160AR, FI-160D, FI-160I, FI-200, FI-200AR...(Other models you can see in the webshop)		



1

<b>GEV No.</b>	503042	<b>Ref. No.</b>	12007923 Q223019
<b>description</b>	nut thread 3/8" H 6mm brass WS 22 Qty 1 pcs		
<b>For models:</b>	BG6-05I, BG7-05, BG7-05I, BG7-10, BG7-10I, BG9-05, BG9-05AD, BG9-05I, BG9-05PF, BG9-05PI, BG9-05PLUS-I, BG9-10, BG9-10AD, BG9-10I, BG9-10PF, BG9-10PI, BG9-10PLUS-I, BMG7-10, BMG-9045, BMG9-05, BMG9-05V-T, BMG9-10, BMG9-10V-T, CG-1002, CG-1502, CG-2000, CG-2000-2P, CG-2002, CG-210, CG-210G, CG-310, CG-310G, CG6-41, CG7-10, CG7-11, CG-7115, CG-7200, CG7-31D, CG7-31I, CG-7400, CG7-41, CG-7415, CG7-41H, CG7-51, CG7-61, CG-7615, CG7-61H, CG9-10, CG9-10AD, CG9-10PLUS...(Other models you can see in the webshop)		

Зип Общепит

vsezip.ru

+7 (812) 987-08-81

## hexagonal nuts with PG thread



1

<b>GEV No.</b>	550578	<b>Ref. No.</b>	12009764 Q223016
<b>description</b>	nut thread PG21 H 4.6mm WS 32 nickel-plated brass Qty 1 pcs mounting ømm cable ømm		
<b>For models:</b>	ECO-120, ECO-120B, FI-100, FI-100AR, FI-100B, FI-120, FI-120B, FI-120W, FI-30, FI-48, FI-48B, FI-48W, FI-50, FI-64, FI-64B, FI-64W, FI-72, FI-80, FI-80W, LA-13M, LA-18MP, LA-AC-10M, LA-AC-10MA, LA-AC-10MP, LA-AC-13M, LA-AC-13MA, LA-AC-13MP, LA-AC-18M, LA-AC-18MA, LA-AC-18MP, LA-AC-25M, LA-AC-25MA, LA-AC-25MP, LA-E-10M, LA-E-10MA, LA-E-10MP, LA-E-13M, LA-E-13MA, LA-E-13MP, LA-E-18M, LA-E-18MA, LA-E-18MP, LA-E-25M, LA-E-25MA, LA-E-25MP, LA-V-10M, LA-V-10MP, LA-V-13M, LA-V-13MP, LA-V-18M...(Other models you can see in the webshop)		

## washers

## spring rings



1

<b>GEV No.</b>	560122	<b>Ref. No.</b>	12009924 Q262030
<b>description</b>	lock washer ID ø 5.2mm ED ø 9mm SS DIN127 Qty 20 pcs for thread M5		
<b>For models:</b>	AD-15, AD-15D, AD-20C-UK, AD-21, AD-21B, AD-21BDD, AD-21C, AD-21D, AD-21DD, AD-21W, AD-45BBT, AD-48, AD-48B, AD-48BDD, AD-48C, AD-48D, AD-48DD, AD-48HY, AD-48W, AD-64, AD-64B, AD-64BBT, AD-64BDD, AD-64BTDD, AD-64C, AD-64CW, AD-64D, AD-64DD, AD-64HY, AD-72, AD-72W, AD-90, AD-90DD, ADE-120, ADE-120B, BG9-05AD, BG9-05PLUS-I, BG9-10AD, BG9-10PLUS-I, BME9-05, BME9-05AD, BME9-05PLUS, BME9-05V-T, BME9-10, BME9-10AD, BME9-10PLUS, BME9-10V-T, BMG7-10, BMG9-05, BMG9-05V-T...(Other models you can see in the webshop)		



1

<b>GEV No.</b>	560123	<b>Ref. No.</b>	12009872 Q262040
<b>description</b>	lock washer ID ø 6.3mm ED ø 11mm SS DIN127 Qty 20 pcs for thread M6		
<b>For models:</b>	ACE-061, ACE-101, ACE-102, ACE-201, ACE-202, AD-120, AD-120B, AD-120BTTDD-UK, AD-120C, AD-120CW, AD-120HY, AD-15, AD-15D, AD-20C-UK, AD-21, AD-21B, AD-21BDD, AD-21C, AD-21D, AD-21DD, AD-21W, AD-45BBT, AD-48, AD-48B, AD-48BDD, AD-48C, AD-48D, AD-48DD, AD-48HY, AD-48W, AD-64, AD-64B, AD-64BBT, AD-64BDD, AD-64BTDD, AD-64C, AD-64CW, AD-64D, AD-64DD, AD-64HY, AD-72, AD-72W, AD-90, AD-90BA, AD-90BBT, AD-90BDD, AD-90DD, ADE-120, ADE-120B, AE-061...(Other models you can see in the webshop)		

## washers

## DIN 125A



1

<b>GEV No.</b>	560312	<b>Ref. No.</b>	12010235 Q232060
<b>description</b>	plain washer ID ø 10.5mm ED ø 20mm thickness 2mm SS Qty 1 pcs DIN 125A for thread M10		
<b>For models:</b>	CG-1002, CG-1502, CG-2000, CG-2000-2P, CG-2002, CG-2002P, ECO-280D, ECO-280I, ECO-370D, ECO-370I, ECO-460D, ECO-460I, ECO-550D, ECO-550I, FI-280D, FI-280I, FI-300B, FI-300R, FI-370D, FI-370I, FI-460D, FI-460I, FI-550D, FI-550I, FI-650R, FTEC9-05USMC, FTEC9-10USMC, HCG-10-11, HCG-10-21, HCG-20-11, HCG-20-21, HCG-2-10-11, HCG-6-11, HCV-10-11, HCV-10-21, HCV-2-10-21, HCV-5-11, HCV-6-11, HE-10-11, HE-10-21, HE-2-10-11, HE-5-11, HE-6-11, HG-10-11, HG-10-21, HG-2-10-11, HME-10-11, HME-10-21, HME-20-11, HME-20-21...(Other models you can see in the webshop)		



1

<b>GEV No.</b>	560111	<b>Ref. No.</b>	12009987 Q232020
<b>description</b>	plain washer ID ø 4.3mm ED ø 9mm thickness 0.8mm SS Qty 20 pcs DIN 125A for thread M4		
<b>For models:</b>	ACE-061, ACE-101, ACE-102, ACE-201, ACE-202, ACG-061, ACG-101, ACG-102, ACG-201, ACG-202, AD-120, AD-120B, AD-120BTTDD-UK, AD-120C, AD-120CW, AD-120HY, AD-15, AD-15D, AD-21, AD-21B, AD-21BDD, AD-21C, AD-21D, AD-21DD, AD-21W, AD-48, AD-48B, AD-48C, AD-48D, AD-48DD, AD-64, AD-64B, AD-64BTDD, AD-64C, AD-64D, AD-64DD, AD-72, AD-90, AD-90BA, AD-90BBT, AD-90BDD, AD-90DD, ADE-120, ADE-120B, AE-061, AE-061W, AE-101, AE-101W, AE-102, AE-102W...(Other models you can see in the webshop)		



Зип Общепит

DIN 9021

vsezip.ru

(812)987-08-81

			
1			
<b>GEV No.</b>	560112	<b>Ref. No.</b>	12009944 Q232030
<b>description</b>	plain washer ID ø 5.3mm ED ø 10mm thickness 1mm SS Qty 20 pcs DIN 125A for thread M5		
<b>For models:</b>	ACE-061, ACE-101, ACE-102, ACE-201, ACE-202, ACG-061, ACG-101, ACG-102, ACG-201, ACG-202, AD-120, AD-120B, AD-120BTDD-UK, AD-120C, AD-120CW, AD-120HY, AD-15, AD-15D, AD-20C-UK, AD-21, AD-21B, AD-21BDD, AD-21C, AD-21D, AD-21DD, AD-21W, AD-45BBT, AD-48, AD-48B, AD-48BDD, AD-48C, AD-48D, AD-48DD, AD-48HY, AD-48W, AD-64, AD-64B, AD-64BBT, AD-64BDD, AD-64BTDD, AD-64C, AD-64CW, AD-64D, AD-64DD, AD-64HY, AD-72, AD-72W, AD-90, AD-90BA, AD-90BBT...(Other models you can see in the webshop)		

			
1			
<b>GEV No.</b>	560117	<b>Ref. No.</b>	12010267 Q302022
<b>description</b>	plain washer ID ø 6.4mm ED ø 18mm thickness 1.5mm SS Qty 20 pcs DIN 9021 for thread M6		
<b>For models:</b>	ACE-061, ACE-101, ACE-102, ACE-201, ACE-202, ACG-061, ACG-101, ACG-102, ACG-201, ACG-202, AD-120, AD-120B, AD-120BTDD-UK, AD-120C, AD-120CW, AD-120HY, AD-15, AD-15D, AD-20C-UK, AD-21, AD-21B, AD-21BDD, AD-21C, AD-21D, AD-21DD, AD-21W, AD-45BBT, AD-48, AD-48B, AD-48BDD, AD-48C, AD-48D, AD-48DD, AD-48HY, AD-48W, AD-64, AD-64B, AD-64BBT, AD-64BDD, AD-64BTDD, AD-64C, AD-64CW, AD-64D, AD-64DD, AD-64HY, AD-72, AD-72W, AD-90, AD-90BA, AD-90BBT...(Other models you can see in the webshop)		

			
2			
<b>GEV No.</b>	560113	<b>Ref. No.</b>	12009868 12038251 Q232040 RT13060120
<b>description</b>	plain washer ID ø 6.4mm ED ø 12mm thickness 1.6mm SS Qty 20 pcs DIN 125A for thread M6		
<b>For models:</b>	ACE-061, ACE-101, ACE-102, ACE-201, ACE-202, ACG-061, ACG-101, ACG-102, ACG-201, ACG-202, AD-120, AD-120B, AD-120BTDD-UK, AD-120C, AD-120CW, AD-120HY, AD-15, AD-15D, AD-20C-UK, AD-21, AD-21B, AD-21BDD, AD-21C, AD-21D, AD-21DD, AD-21W, AD-45BBT, AD-48, AD-48B, AD-48BDD, AD-48C, AD-48D, AD-48DD, AD-48HY, AD-48W, AD-64, AD-64B, AD-64BBT, AD-64BDD, AD-64BTDD, AD-64C, AD-64CW, AD-64D, AD-64DD, AD-64HY, AD-72, AD-72W, AD-90, AD-90BA, AD-90BBT...(Other models you can see in the webshop)		

miscellaneous			
			
1			
<b>GEV No.</b>	506160	<b>Ref. No.</b>	Q231450000
<b>description</b>	plain washer ID ø 8.6mm ED ø 16mm thickness 1.5mm SS Qty 1 pcs		

			
1			
<b>GEV No.</b>	560114	<b>Ref. No.</b>	12010268 12037409 Q232050 RT13080160
<b>description</b>	plain washer ID ø 8.4mm ED ø 16mm thickness 1.6mm SS Qty 20 pcs DIN 125A for thread M8		
<b>For models:</b>	AD-120, AD-120B, AD-120BTDD-UK, AD-120C, AD-120CW, AD-120HY, AD-90, AD-90BA, AD-90BBT, AD-90BDD, AD-90DD, ADE-120, ADE-120B, CE7-20Q, CE7-40Q, CE7-41Q, CE9-20, CE9-20AD, CE9-20PLUS, CE9-40, CE9-40AD, CE9-40PLUS, CE9-41, CE9-41AD, CE9-41PLUS, CG7-51, CG7-61, CG7-61H, CGB7-61, CGP9-11, CPE7-05, CPE7-05NC, CPE9-05, CPE9-05AD, CPE9-05AD-S, CPE9-05NC, CPE9-05PLUS, CPE9-05PLUS-S, CPE9-05S, CPE9-05SNC, CPG7-05, CPG7-05NC, CPG9-05, CPG9-05AD, CPG9-05AD-S, CPG9-05NC, CPG9-05PLUS, CPG9-05PLUS-S, CPG9-05S, CPG9-05SNC...(Other models you can see in the webshop)		

tooth lock washers			
DIN 6798A			
			
1			
<b>GEV No.</b>	560036	<b>Ref. No.</b>	12009953 Q242010
<b>description</b>	tooth lock washer ID ø 3.1mm ED ø 5.7mm SS Qty 10 pcs		
<b>For models:</b>	AD-120, AD-120B, AD-120BTDD-UK, AD-120C, AD-120CW, AD-120HY, AD-15, AD-15D, AD-20C-UK, AD-21, AD-21B, AD-21BDD, AD-21C, AD-21D, AD-21DD, AD-21W, AD-45BBT, AD-48, AD-48B, AD-48BDD, AD-48C, AD-48D, AD-48DD, AD-48HY, AD-48W, AD-64, AD-64B, AD-64BBT, AD-64BDD, AD-64BTDD, AD-64C, AD-64CW, AD-64D, AD-64DD, AD-64HY, AD-72, AD-72W, AD-90, AD-90BA, AD-90BBT, AD-90BDD, AD-90DD, ADE-120, ADE-120B, CE-15, CE-9, EASY-500, EASY-500B, EASY-500DD, EASY-500HP...(Other models you can see in the webshop)		

			
1			
<b>GEV No.</b>	560125	<b>Ref. No.</b>	12009928 Q242020
<b>description</b>	tooth lock washer ID ø 4.2mm ED ø 8mm SS DIN/ISO DIN 6798A Qty 20 pcs for thread M4		
<b>For models:</b>	ACE-061, ACE-101, ACE-102, ACE-201, ACE-202, ACG-061, ACG-101, ACG-102, ACG-201, ACG-202, AD-120, AD-120B, AD-120BTDD-UK, AD-120C, AD-120CW, AD-120HY, AD-15, AD-15D, AD-20C-UK, AD-21, AD-21B, AD-21BDD, AD-21C, AD-21D, AD-21DD, AD-21W, AD-45BBT, AD-48, AD-48B, AD-48BDD, AD-48C, AD-48D, AD-48DD, AD-48HY, AD-48W, AD-64, AD-64B, AD-64BBT, AD-64BDD, AD-64BTDD, AD-64C, AD-64CW, AD-64D, AD-64DD, AD-64HY, AD-72, AD-72W, AD-90, AD-90BA, AD-90BBT, AD-90BDD...(Other models you can see in the webshop)		

## Зип-Общепит

clamps

hose clamps

vsezip.ru

+7(812)987-08-81

			
1			
<b>GEV No.</b>	560126	<b>Ref. No.</b>	12009890 Q242030
<b>description</b>	tooth lock washer ID $\varnothing$ 5.2mm ED $\varnothing$ 10mm SS DIN/ISO DIN 6798 A Qty 20 pcs for thread M5		
<b>For models:</b>	ACE-061, ACE-101, ACE-102, ACE-201, ACE-202, ACG-061, ACG-101, ACG-102, ACG-201, ACG-202, AD-120, AD-120B, AD-120BBTDD-UK, AD-120C, AD-120CW, AD-120HY, AD-15, AD-15D, AD-20C-UK, AD-21, AD-21B, AD-21BDD, AD-21C, AD-21D, AD-21DD, AD-21W, AD-45BBT, AD-48, AD-48B, AD-48BDD, AD-48C, AD-48D, AD-48DD, AD-48HY, AD-48W, AD-64, AD-64B, AD-64BBT, AD-64BDD, AD-64C, AD-64CW, AD-64D, AD-64DD, AD-64HY, AD-72, AD-72W, AD-90, AD-90BA, AD-90BBT, AD-90BDD...(Other models you can see in the webshop)		

			
1			
<b>GEV No.</b>	560342	<b>Ref. No.</b>	12009882 Q242040
<b>description</b>	tooth lock washer ID $\varnothing$ 6.5mm ED $\varnothing$ 11mm SS Qty 1 pcs for thread M6		
<b>For models:</b>	ACE-061, ACE-101, ACE-102, ACE-201, ACE-202, ACG-061, ACG-101, ACG-102, ACG-201, ACG-202, AD-120, AD-120B, AD-120BBTDD-UK, AD-120C, AD-120CW, AD-120HY, AD-64BTDD, AD-90, AD-90BA, AD-90BBT, AD-90BDD, AD-90DD, ADE-120, ADE-120B, AE-061, AE-061W, AE-101, AE-101W, AE-102, AE-102W, AE-201, AE-202, AG-061, AG-061W, AG-101, AG-101W, AG-102, AG-102W, AG-201, AG-202, APE-061, APE-061W, APE-101, APE-101W, APE-102, APE-102W, APE-201, APE-202, APG-061, APG-061W...(Other models you can see in the webshop)		

## fasteners

## slot nuts

			
1			
<b>GEV No.</b>	560286	<b>Ref. No.</b>	12023513 Z105014
<b>description</b>	slot nut W 6mm H 6mm L 25mm		
<b>For models:</b>	ECO-160, ECO-1600, ECO-160D, ECO-160I, ECO-200, ECO-200D, ECO-200H, ECO-200HD, ECO-200HI, ECO-200I, ECO-2300, ECO-2700D, ECO-2700I, ECO-280D, ECO-280I, ECO-3000, ECO-370D, ECO-370I, ECO-4000D, ECO-4000I, ECO-460D, ECO-460I, ECO-550D, ECO-550I, ECO-6000D, ECO-6000I, FI-160, FI-1600, FI-160AR, FI-160D, FI-160I, FI-200, FI-200AR, FI-200D, FI-200H, FI-200HD, FI-200HI, FI-200I, FI-200W, FI-200WL, FI-200WR, FI-2300, FI-2700D, FI-2700I, FI-280D, FI-280I, FI-3000, FI-370D, FI-370I, FI-4000D...(Other models you can see in the webshop)		

			
1			
<b>GEV No.</b>	520111	<b>Ref. No.</b>	12035874 RT20660205
<b>description</b>	hose clamp $\varnothing$ 10-16mm width 9mm Qty 10 pcs DIN 3017		

			
1			
<b>GEV No.</b>	520114	<b>Ref. No.</b>	12010023 12035505 Q881304 RT20660506
<b>description</b>	hose clamp $\varnothing$ 20-32mm width 9mm Qty 10 pcs DIN 3017		
<b>For models:</b>	AD-120B, AD-120BBTDD-UK, AD-120C, AD-120HY, AD-125, AD-125HRS, AD-125-SOFT, AD-505, AD-505-SOFT, AD-90BA, AD-90BBT, AD-90BDD, ADE-120B, APE-061, APE-061W, APE-101, APE-101W, APE-102, APE-102W, APE-201, APE-202, APG-061, APG-061W, APG-101, APG-101W, APG-102, APG-102W, APG-201, APG-202, BME9-05, BME9-10, BMG9-10, CO-110B, CO-110BDD, CO-112B, CO-112BDD, CO-170B, CO-170BDD, CO-172B, CO-172BDD, CO-500B, CO-500BDD, CO-501B, CO-501BDD, CO-502B, CO-502BDD, CO-502W, COP-173, COP-173B, COP-173BDD...(Other models you can see in the webshop)		

			
1			
<b>GEV No.</b>	520115	<b>Ref. No.</b>	12009997 Q881305
<b>description</b>	hose clamp $\varnothing$ 25-40mm width 9mm Qty 10 pcs DIN 3017		
<b>For models:</b>	AD-45BBT, AD-48, AD-48B, AD-48BDD, AD-48C, AD-48D, AD-48DD, AD-48HY, AD-48W, AD-505, AD-64, AD-64B, AD-64BBT, AD-64BDD, AD-64BTDD, AD-64C, AD-64CW, AD-64D, AD-64DD, AD-64HY, AD-72, AD-72W, AE-201, AE-202, AG-061, AG-061W, AG-101, AG-101W, AG-102, AG-102W, AG-201, AG-202, APE-061, APE-061W, APE-101, APE-101W, APE-102, APE-102W, APE-201, APE-202, APG-061, APG-061W, APG-101, APG-101W, APG-102, APG-102W, APG-201, APG-202, BME7-05, BME7-10...(Other models you can see in the webshop)		



Зип Общепит

vsezip.ru

(812)987-08-81

			
1			
<b>GEV No.</b>	520118	<b>Ref. No.</b>	12009933 12036496 Q881324 RT20660300
<b>description</b>	hose clamp ø 50-70mm width 9mm Qty 5 pcs DIN 3017		
<b>For models:</b>	AD-45BBT, AD-48, AD-48B, AD-48BDD, AD-48C, AD-48D, AD-48DD, AD-48HY, AD-48W, AD-505, AD-505-SOFT, AD-64, AD-64B, AD-64BBT, AD-64BDD, AD-64BTDD, AD-64C, AD-64CW, AD-64D, AD-64DD, AD-64HY, AD-72, AD-72W, CO-500, CO-500B, CO-500BDD, CO-500DD, CO-501, CO-501B, CO-501BDD, CO-501DD, CO-501-SOFT, CO-502B, CO-502BDD, CO-502DD, CO-502W, COP-503, COP-503B, COP-503BDD, COP-503DD, COP-503-SOFT, COP-504, COP-504B, COP-504BDD, COP-504DD, COP-504W, EASY-500, EASY-500B, EASY-500DD, EASY-500HP... (Other models you can see in the webshop)		

			
1			
<b>GEV No.</b>	520117	<b>Ref. No.</b>	12009962 12035446 Q881306000 Q881307 RT20660504
<b>description</b>	hose clamp stainless steel ø 40-60mm width 9mm Qty 5 pcs DIN 3017		
<b>For models:</b>	ACE-061, ACE-101, ACE-102, ACE-201, ACE-202, ACG-061, ACG-101, ACG-102, ACG-201, ACG-202, AD-120, AD-120B, AD-120BTTDD-UK, AD-120C, AD-120CW, AD-120HY, AD-125, AD-125HRS, AD-125-SOFT, AD-15, AD-15D, AD-20C-UK, AD-21, AD-21B, AD-21BDD, AD-21C, AD-21D, AD-21DD, AD-21W, AD-45BBT, AD-48, AD-48B, AD-48BDD, AD-48C, AD-48D, AD-48DD, AD-48HY, AD-48W, AD-505, AD-505-SOFT, AD-64, AD-64B, AD-64BBT, AD-64BDD, AD-64BTDD, AD-64C, AD-64CW, AD-64D, AD-64DD, AD-64HY... (Other models you can see in the webshop)		

			
2			
<b>GEV No.</b>	520119	<b>Ref. No.</b>	12036081 RT20660516
<b>description</b>	hose clamp ø 60-80mm width 9mm Qty 5 pcs DIN 3017		

<b>DIN 3017 - W4</b>			
			
1			
<b>GEV No.</b>	520120	<b>Ref. No.</b>	12010036 Q881302
<b>description</b>	hose clamp SS W4 ø 12-20mm width 9mm Qty 1 pcs DIN 3017		
<b>For models:</b>	ACE-061, ACE-101, ACE-102, ACE-201, ACE-202, ACG-061, ACG-101, ACG-102, ACG-201, ACG-202, AD-120, AD-120B, AD-120BTTDD-UK, AD-120C, AD-120CW, AD-120HY, AD-125, AD-125HRS, AD-125-SOFT, AD-15, AD-15D, AD-20C-UK, AD-21, AD-21B, AD-21BDD, AD-21C, AD-21D, AD-21DD, AD-21W, AD-45BBT, AD-48, AD-48B, AD-48BDD, AD-48C, AD-48D, AD-48DD, AD-48HY, AD-48W, AD-505, AD-505-SOFT, AD-64, AD-64B, AD-64BBT, AD-64BDD, AD-64BTDD, AD-64C, AD-64CW, AD-64D, AD-64DD, AD-64HY... (Other models you can see in the webshop)		

			
1			
<b>GEV No.</b>	520454	<b>Ref. No.</b>	12009914 12036146 Q881326 RT20660505
<b>description</b>	hose clamp ø 70-90mm width 9mm Qty 5 pcs DIN 3017		
<b>For models:</b>	ACE-202, ACG-202, AE-202, AG-202, APE-202, APG-202, COE-202, ECO-2700D, ECO-2700I, ECO-280D, ECO-280I, ECO-370D, ECO-370I, ECO-4000D, ECO-4000I, ECO-460D, ECO-460I, ECO-550D, ECO-550I, ECO-6000D, ECO-6000I, FI-2700D, FI-2700I, FI-280D, FI-280I, FI-370D, FI-370I, FI-4000D, FI-4000I, FI-460D, FI-460I, FI-550D, FI-550I, FI-6000D, FI-6000I, HMG-10-21-STACKING, LA-13M, LA-18MP, LA-25M, LAC-25, LAC-25MP, LAC-25MPP, LAC-55, LAC-55MP, LAC-55MPP, LB-AC-10M, LB-E-10M, LB-V-10M, LC-10, LC-14... (Other models you can see in the webshop)		

<b>double wire clamps</b>			
			
1			
<b>GEV No.</b>	505190	<b>Ref. No.</b>	12009972 Q901307
<b>description</b>	hose clamp ø 36-42mm wire gauge ø 3mm zinc-coated steel Qty 1 pcs		
<b>For models:</b>	AD-15, AD-15D, AD-20C-UK, AD-21, AD-21B, AD-21BDD, AD-21C, AD-21D, AD-21DD, AD-21W, ECO-1200, FI-1200, FI-900, HEI-10-21, HEM-10-21, HGC-10-21, HGC-20-21, HGV-10-21, LVC-12, LVC-15, LVC-15D, LVC-21, LVC-21B, LVC-21C, LVC-21D, LVC-21W, LVR-10, LVR-14, LVR-14D, LVR-20, LVR-20B, LVR-20D, MF-21		

			
1			
<b>GEV No.</b>	520110	<b>Ref. No.</b>	12010047 12037543 GH51X003 Q881308
<b>description</b>	hose clamp ø 8-12mm width 9mm Qty 10 pcs DIN 3017		
<b>For models:</b>	AD-120, AD-120B, AD-120BTTDD-UK, AD-120C, AD-120CW, AD-120HY, AD-15, AD-15D, AD-20C-UK, AD-21, AD-21B, AD-21BDD, AD-21C, AD-21D, AD-21DD, AD-21W, AD-48, AD-48B, AD-48BDD, AD-48C, AD-48D, AD-48DD, AD-48W, AD-64, AD-64B, AD-64BDD, AD-64C, AD-64CW, AD-64D, AD-64DD, AD-72, AD-72W, AD-90, AD-90BA, AD-90BBT, AD-90BDD, AD-90DD, ADE-120, ADE-120B, CO-110, CO-110B, CO-110BDD, CO-110DD, CO-112, CO-112B, CO-112BDD, CO-112DD, CO-142W, CO-142WDD, CO-170... (Other models you can see in the webshop)		

Зип-Общепит

retaining rings

vsezip.ru

+7(812)987-08-81

1

GEV No.	514030	Ref. No.	12010212 Q301020
<b>description</b>	retaining ring shaft $\varnothing$ 20mm thickness 1.3mm steel DIN 471		
<b>For models:</b>	SBE7-10, SBE9-10, SBE9-10I, SBE9-10I-AD, SBE9-10I-AD-S, SBE9-10IM, SBE9-10IM-AD, SBE9-10IM-AD-S, SBE9-10IMS, SBE9-10IS, SBE9-10M, SBE9-10MS, SBE9-10PLUS-I, SBE9-10PLUS-IM, SBE9-10PLUS-SI, SBE9-10PLUS-SIM, SBE9-10S, SBE9-10USMC, SBE9-15IM, SBE9-15IM-AD, SBE9-15IM-AD-S, SBE9-15IMS, SBE9-15PLUS-IM, SBE9-15PLUS-SIM, SBG7-10, SBG9-10, SBG9-10I, SBG9-10I-AD, SBG9-10I-AD-S, SBG9-10IM, SBG9-10IM-AD, SBG9-10IM-AD-S, SBG9-10IMS, SBG9-10IS, SBG9-10M, SBG9-10MS, SBG9-10PLUS-I, SBG9-10PLUS-IM, SBG9-10PLUS-SI, SBG9-10PLUS-SIM, SBG9-10S, SBG9-15IM, SBG9-15IM-AD, SBG9-15IM-AD-S, SBG9-15IMS, SBG9-15PLUS-IM, SBG9-15PLUS-SIM		



1

GEV No.	505191	Ref. No.	12007965 Q901308
<b>description</b>	hose clamp $\varnothing$ 52-59mm wire gauge $\varnothing$ 3.5mm Qty 1 pcs		
<b>For models:</b>	AD-45BBT, AD-48, AD-48B, AD-48BDD, AD-48C, AD-48D, AD-48DD, AD-48HY, AD-48W, AD-64, AD-64B, AD-64BBT, AD-64BDD, AD-64BTDD, AD-64C, AD-64CW, AD-64D, AD-64DD, AD-64HY, AD-72, AD-72W, EASY-500, EASY-500B, EASY-500DD, EASY-500HP, FI-30, FI-30AR, FI-30AR+DD, FI-30B, FI-30B-BT-UK, FI-30-UK, FI-48, FI-48AR, FI-48B, FI-48B-BT-UK, FI-48C, FI-48D, FI-48HY-CLINIC, FI-48W, FI-50, FI-60DD, FI-64, FI-64AR, FI-64B, FI-64B-BT-UK, FI-64C, FI-64D, FI-64HY-CLINIC, FI-64W, FI-72...(Other models you can see in the webshop)		

## double wire clamps with screw



1

GEV No.	505079	Ref. No.	12025195 Z400903
<b>description</b>	hose clamp $\varnothing$ 186-172mm Qty 1 pcs		
<b>For models:</b>	AD-15, AD-15D, AD-20C-UK, AD-21, AD-21B, AD-21BDD, AD-21C, AD-21D, AD-21DD, AD-21W, CO-350, CO-350-B, CO-350-B-DD, CO-350-COLD, CO-350-COLD-B, CO-350-COLD-B-DD, CO-350-COLD-DD, CO-350-DD, CO-352-COLD, CO-352-COLD-B, CO-352-COLD-B-DD, CO-352-COLD-DD, CO-400, CO-400-B, CO-400-B-DD, CO-400-COLD, CO-400-COLD-B, CO-400-COLD-B-DD, CO-400-COLD-DD, CO-400-DD, CO-400-SOFT, CO-402-COLD, CO-402-COLD-B, CO-402-COLD-B-DD, CO-402-COLD-DD, CO-402W, LVC-12, LVC-15, LVC-15D, LVC-21, LVC-21B, LVC-21C, LVC-21D, LVC-21W, LVR-10, LVR-14, LVR-14D, LVR-20, LVR-20B, LVR-20D...(Other models you can see in the webshop)		

## DIN 6799



1

GEV No.	516198	Ref. No.	12010285 Q271033 Q301033
<b>description</b>	retaining ring E D1 $\varnothing$ 6mm D2 $\varnothing$ 12mm SS DIN 6799 thickness 0.7mm for shaft $\varnothing$ 7-9mm		
<b>For models:</b>	COE-201, COE-202, COG-201, COG-202, FE-710, FE-720, FE9-05, FE9-05S, FE9-05USMC, FE9-10, FE-920, HCG-10-11, HCG-10-21, HCG-20-11, HCG-20-21, HCG-2-10-11, HCG-2-20-11, HCG-6-11, HCV-10-11, HCV-20-11, HCV-2-10-21, HCV-6-11, HE-10-11, HE-10-21, HE-2-10-11, HE-6-11, HEI-10-21, HEI-20-21, HEM-10-21, HEM-20-21, HEP-10-21, HEP-20-21, HG-10-21, HG-2-10-11, HGC-10-21, HGC-20-21, HGP-10-21, HGP-20-21, HGV-10-11, HGV-10-21, HGV-20-11, HGV-20-21, HME-10-11, HME-10-21, HME-20-11, HME-20-21, HME-2-10-11, HME-2-20-11, HME-6-11, HMG-10-11...(Other models you can see in the webshop)		



1

GEV No.	505080	Ref. No.	12023841 Z200908
<b>description</b>	hose clamp $\varnothing$ 235-215mm Qty 1 pcs		
<b>For models:</b>	AD-45BBT, AD-48, AD-48B, AD-48BDD, AD-48C, AD-48D, AD-48DD, AD-48HY, AD-48W, AD-64, AD-64B, AD-64BBT, AD-64BDD, AD-64BTDD, AD-64C, AD-64CW, AD-64D, AD-64DD, AD-64HY, AD-72, AD-72W, EASY-500, EASY-500B, EASY-500DD, EASY-500HP, FI-30, FI-30AR, FI-30AR+DD, FI-30B, FI-30B-BT-UK, FI-30-UK, FI-48, FI-48AR, FI-48B, FI-48B-BT-UK, FI-48C, FI-48D, FI-48HY-CLINIC, FI-48W, FI-50, FI-60DD, FI-64, FI-64AR, FI-64B, FI-64B-BT-UK, FI-64C, FI-64D, FI-64HY-CLINIC, FI-64W, FI-72...(Other models you can see in the webshop)		



1

GEV No.	691470	Ref. No.	12010014 Q271006
<b>description</b>	retaining ring E D1 $\varnothing$ 8mm D2 $\varnothing$ 16mm SS DIN 6799 thickness 1mm for shaft $\varnothing$ 9-12mm		
<b>For models:</b>	ACE-061, ACE-101, ACE-102, ACE-201, ACE-202, ACG-061, ACG-101, ACG-102, ACG-201, ACG-202, AD-120, AD-120B, AD-120BBTDD-UK, AD-120C, AD-120CW, AD-120HY, AD-90, AD-90BA, AD-90BBT, AD-90BDD, AD-90DD, ADE-120, ADE-120B, AE-061, AE-061W, AE-101, AE-101W, AE-102, AE-102W, AE-201, AE-202, AG-061, AG-061W, AG-101, AG-101W, AG-102, AG-102W, AG-201, AG-202, APE-061, APE-061W, APE-101, APE-101W, APE-102, APE-102W, APE-201, APE-202, APG-061, APG-061W, APG-101...(Other models you can see in the webshop)		





Зип-Общепит

vsezip.ru

+7(812)987-08-81

roll pins



1

<b>GEV No.</b>	504451	<b>Ref. No.</b>	12009828 12021015 Q362000 Z105026
<b>description</b>	roll pin ø 6.3mm L 50mm SS		
<b>For models:</b>	ECO-160, ECO-1600, ECO-160D, ECO-160I, ECO-200, ECO-200D, ECO-200H, ECO-200HD, ECO-200HI, ECO-200I, ECO-2300, ECO-280D, ECO-280I, ECO-3000, ECO-370D, ECO-370I, ECO-460D, ECO-460I, ECO-550D, ECO-550I, FI-160, FI-1600, FI-160AR, FI-160D, FI-160I, FI-200, FI-200AR, FI-200D, FI-200H, FI-200HD, FI-200HI, FI-200I, FI-200W, FI-200WL, FI-200WR, FI-2300, FI-280D, FI-280I, FI-3000, FI-370D, FI-370I, FI-460D, FI-460I, FI-550D, FI-550I		

cotter pins



1

<b>GEV No.</b>	551305	<b>Ref. No.</b>	12010292 Q352001
<b>description</b>	cotter pin ø 2mm L 23mm SS Qty 20 pcs		
<b>For models:</b>	ACE-201, ACE-202, ACG-201, ACG-202, AE-201, AE-202, AG-201, AG-202, APE-201, APE-202, APG-201, APG-202, COE-201, COE-202, COG-201, COG-202, ECO-120, ECO-120B, ECO-160, ECO-160D, ECO-160I, ECO-200, ECO-200D, ECO-200H, ECO-200HD, ECO-200HI, ECO-200I, ECO-2700D, ECO-2700I, ECO-280D, ECO-280I, ECO-370D, ECO-370I, ECO-4000D, ECO-4000I, ECO-460D, ECO-460I, ECO-550D, ECO-550I, ECO-6000D, ECO-6000I, FI-100, FI-100AR, FI-100B, FI-120, FI-120B, FI-120W, FI-160, FI-160AR, FI-160D...(Other models you can see in the webshop)		

consumables

sealants and adhesives

screw fixings



1

<b>GEV No.</b>	890137	<b>Ref. No.</b>	12030041 RT20010042
<b>description</b>	screw fixing LOCTITE 243 medium-strength bottle 5ml		
<b>description</b>	LOCTITE® 243™ - bottle 5ml Is a general purpose threadlocker of medium bond strength. This threadlocker secures and seal bolts, nuts and studs to prevent loosening due to vibration. The product works on all metals, including passive substrates such as stainless steel, aluminium and plated surfaces. It is proven to be tolerant of minor contamination due to industrial oils, e.g. engine oils, corrosion prevention oils and cutting fluids.		

fuses

fine fuses



1

<b>GEV No.</b>	358671	<b>Ref. No.</b>	12039844 R663101
<b>description</b>	fine fuse size ø5x20mm 1A fast-acting rated 250V Qty 10 pcs		
<b>For models:</b>	HME-10-11, HME-10-21, HME-20-11, HME-20-21, HME-2-10-11, HME-2-20-11, HME-6-11, HMP-10-11, HMP-10-21, HMP-20-11, HMP-20-21, HMP-2-10-11, HMP-6-11		



1

<b>GEV No.</b>	358677	<b>Ref. No.</b>	12024333 12035393 P184011 RT30190112
<b>description</b>	fine fuse size ø5x20mm 4A fast-acting rated 250V Qty 10 pcs		
<b>For models:</b>	CE-15, CE-9, ECO-160, ECO-1600, ECO-160D, ECO-160I, ECO-200, ECO-200D, ECO-200H, ECO-200HD, ECO-200HI, ECO-200I, ECO-2300, ECO-280D, ECO-280I, ECO-3000, ECO-370D, ECO-370I, ECO-460D, ECO-460I, ECO-550D, ECO-550I, FF-35, FI-160, FI-1600, FI-160AR, FI-160D, FI-160I, FI-200, FI-200AR, FI-200D, FI-200H, FI-200HD, FI-200HI, FI-200I, FI-200W, FI-2300, FI-280D, FI-280I, FI-3000, FI-370D, FI-370I, FI-460D, FI-460I, FI-550D, FI-550I, GA-20, GA-40, HCV-10-11, HCV-10-21... (Other models you can see in the webshop)		

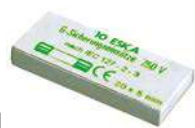

1

<b>GEV No.</b>	358603	<b>Ref. No.</b>	12034888 RT30190120
<b>description</b>	fine fuse size ø5x20mm 2A slow-acting rated 250V Qty 10 pcs		

ø6.3x32mm 250V



1

<b>GEV No.</b>	358792	<b>Ref. No.</b>	12035115 RT40010225
<b>description</b>	fine fuse size ø6.3x32mm 10A slow-acting rated 250V Qty 10 pcs		



1

<b>GEV No.</b>	358791	<b>Ref. No.</b>	12037374 RT40010224
<b>description</b>	fine fuse size ø6.3x32mm 6.3A slow-acting rated 250V Qty 10 pcs		



Зип-Общепит

vsezip.ru

+7(812)987-08-81

screw locks

D0-system (NEOZED)



1

<b>GEV No.</b>	358043	<b>Ref. No.</b>	12033846 RT30190401
<b>description</b>	fuse size D01 16A rated 250/400V E14 ø 11mm L 36mm Qty 10 pcs		



1

<b>GEV No.</b>	358047	<b>Ref. No.</b>	12032709 RT30190405
<b>description</b>	fuse size D02 63A rated 250/400V E18 ø 15mm L 36mm Qty 10 pcs		

gauge pieces (NEOZED)



1

<b>GEV No.</b>	358064	<b>Ref. No.</b>	12037278 RT40011238
<b>description</b>	gauge piece size D02 suitable for 16A		

## Зип Общепит

vsezip.ru

+7(812)987-08-81

<b>A</b>		<b>G</b>	
axial fans	30	gaskets for wash arm support	85
<b>B</b>		grub screws	104
bi-metal thermostats	8, 3	<b>H</b>	
booster pumps I	33	heating elements	2
booster pumps II	35	heating elements for convection	5
<b>C</b>		hexagonal nuts	105
cable glands	37, 37	hexagonal screws	102
cables	37	hose clamps	97, 110
cam switches	12	hose connectors	94, 95
cap nuts	105	hose couplings	90
clamps	97, 110	hoses	90
coil heating elements	2	<b>I</b>	
condensators & interference suppression filters	35	immersion heating elements	2
consumables	113	indicator lights	14
contactors	17	indicator lights (complete)	14
container filters	89	industrial hoses	91
control equipment	14	<b>K</b>	
control thermostats	8	knurled nuts	105
cotter pins	113	knurled screws	104
countersunk screws	100	<b>L</b>	
cylinder head bolts	104	lamps	14
<b>D</b>		light bulbs	15
DIN rails	40	<b>M</b>	
door seals for dishwashers	84	magnetic switches	13
dosing pumps	88	measuring equipment	99
double nipples	95	mechanical timers	17
double wire clamps	98, 111	microswitches	11
double wire clamps with screw	98, 112	miscellaneous	37
drain hoses	91	motors	30
drain pumps	33	<b>N</b>	
drain systems and wash basins	96	Niplaflex hoses	91
<b>E</b>		nuts	105
electric accessories	37	<b>O</b>	
electromagnetic closer	75	operating capacitors	35
espagnolette locks	75	O-rings	78
<b>F</b>		oval head screws	102
fans	30	<b>P</b>	
fasteners	110	plate nuts	105
fastening material	99	plunger sockets	9
filter weights	90	pressure control hoses	91
fine fuses	113	pressure hoses	94
fittings	95	pressure reduction valves	96, 96
flat-headed bolts	101	pressure switches	28
foam rubber gaskets	83		
formed hoses	92		
fuses	36, 113		

probes	20
programme timers	15
protection hoses	37
pumps	31
push/momentary push switches	10
PVC supply hoses	50

**R**

relays	19
retaining rings	112
ribbon cables	38
rivets/rivet nuts	99
rocker/momentary rocker switches	10
roll pins	113
rotary switches	12

**S**

safety bi-metal thermostats	8
screw fixings	113
screw locks	114
screws	100
sealants and adhesives	113
sealing washers	81
shaft gaskets	84
sheet metal screws	100
shelves and shelf rails	78
side bolts	104
slot nuts	110
solenoid valves	24
spring rings	108
standpipes	96
strain reliefs	38
supply hoses	90
switches and momentary switches	10
system switches (ROLD)	11

**T**

tank inlets	90
temperature probes	20
terminals	38
thermostat gaskets	85
thermostats	8
threaded cable glands	37
time relays	19
timers	15
tooth lock washers	109

**U**

universal probes	20
------------------	----

**W**

wash and rinse pumps	31
washers	108

Зип Общепит

water cycle components

96

vsezip.ru

+7(812)987-08-81