

Зип Общепит

vsezip.ru

+7(812)987-08-81



switches and momentary switches

5

rocker/momentary rocker switches.....	284
push/momentary push switches.....	290
accessories.....	299
toggle switches.....	299
microswitches.....	299
position switches.....	304
toggle switches.....	306
system switches (ROLD).....	306
system switches.....	313
float switches.....	315
door lock switches.....	317
operation switches.....	318
rotary switches.....	334
foot switches.....	341
touch sensitive light switches.....	342
magnetic switches.....	342



Вип.Общепит

switches and momentary switches

rocker/momentary rocker switches

19x13mm



fig.	GEV No.	description	function	volt. (V)	SC (A)	connection	diagram
1	345314	momentary switch	1NO	250	10	F4.8	T01
2	301066	switch	2NO	250	6	F4.8	S07
3	347978	switch	2NO	240	6	F4.8	S07

Diagrams may be found at the end of the chapter



fig.	GEV No.	description	function	volt. (V)	SC (A)	connection	diagram
1	301069 ¹	switch	2NO	250	13	F4.8	S10
2	301067 ¹	switch	2NO	250	13	F4.8	S10
3	301068 ¹	switch	2NO	250	13	F4.8	S10

¹illuminated

Diagrams may be found at the end of the chapter



fig.	GEV No.	description
1	346541	protective cover for rocker switch

19x22mm



fig.	GEV No.	description	function	volt. (V)	SC (A)	connection	diagram
1	346133 ¹	switch	2NO	250	10	F4.8	S10
2	346134 ¹	switch	2NO	250	10	F4.8	S10
3	346549	switch	2NO	250	10	F4.8	S07
4	346550 ¹	switch	2NO	250	10	F4.8	S10

¹illuminated

Diagrams may be found at the end of the chapter



fig.	GEV No.	description	function	volt. (V)	SC (A)	connection	diagram
1	346552	switch	1NO/NO	250	10	F4.8	S06, S06



fig.	GEV No.	description	function	volt. (V)	SC (A)	connection	diagram
1	301252	switch	2NO	250	16	F6.3	S10
2	347267	switch	2NO	250	16	F6.3	S10

Diagrams may be found at the end of the chapter

27.8x25mm



fig.	GEV No.	description	function	volt. (V)	SC (A)	connection	diagram
1	347119 ¹	momentary switch	2CO	250	16	F6.3	T13
1	347115 ¹	switch	2CO	250	16	F6.3	S13
2	345280 ¹	switch	2CO	250	16	F6.3	S13
3	347116 ¹	momentary switch	2CO	250	16	F6.3	T13
3	345282 ¹	switch	2CO	250	16	F6.3	S13
4	345281 ¹	switch	2CO	250	16	F6.3	S13

¹illuminated

Diagrams may be found at the end of the chapter



fig.	GEV No.	description	function	volt. (V)	SC (A)	connection	diagram
1	345278 ¹	switch	2NO	250	16	F6.3	S10
2	345013 ¹	switch	2NO	250	16	F6.3	S10
3	346448 ¹	switch	2NO	260	16	F6.3	S10
4	301245 ¹	switch	2NO	250	16	F6.3	S10
5	345277 ¹	switch	2NO	250	16	F6.3	S10

¹illuminated

Diagrams may be found at the end of the chapter



fig.	GEV No.	description	function	volt. (V)	SC (A)	connection	diagram
1	347868	momentary switch	1NO/1H	250	16	F6.3	T05
1	301108 ¹	momentary switch	2NO	250	16	F6.3	T10
2	347173 ¹	momentary switch	2NO	250	16	F6.3	T10

¹illuminated

Diagrams may be found at the end of the chapter



fig.	GEV No.	description	function	volt. (V)	SC (A)	connection	diagram
1	345002	switch	2CO	250	16	F6.3	S12
2	345191 ¹	momentary switch	2CO	250	16	F6.3	T13
3	345003 ¹	switch	2NO	250	16	F6.3	S10
4	347120 ¹	switch	2NO	250	16	F6.3	S10
5	347128 ¹	momentary switch	2CO	250	16	F6.3	T13

¹illuminated

Diagrams may be found at the end of the chapter



Zip Общепит
vsezip.ru
7(812)987-08-81

fig.	GEV No.	description	function	volt. (V)	SC (A)	connection	diagram
1	345076	momentary switch	2CO	250	16	F6.3	T12
2	345123	switch	2CO	250	16	F6.3	S12
3	345201 ¹	momentary switch	2CO	250	16	F6.3	T13
4	345843 ¹	momentary switch	2CO	24	16	F6.3	T13
5	345000 ¹	momentary switch	2CO	250	16	F6.3	T13

¹illuminated

fig.	GEV No.	description	function	volt. (V)	SC (A)	connection	diagram
6	345014 ¹	momentary switch	2CO	250	16	F6.3	T10
7	345030 ¹	momentary switch	2CO	250	16	F6.3	T13

¹illuminated

Diagrams may be found at the end of the chapter

fig.	GEV No.	description
1	510281	blank black 27,8x25mm

28x10mm

fig.	GEV No.	description	function	volt. (V)	SC (A)	connection	diagram
1	347804	switch	1NO	250	15	F6.3	S01

28x13.5mm

fig.	GEV No.	description	function	volt. (V)	SC (A)	connection	diagram
1	348099	switch	1CO	250	10	F6.3	S04
2	347873	momentary switch	1NO	250	16	F6.3	T01
3	347825	switch	1NO	250	10	F6.3	S01
4	347828	switch	1NO	250	10	F6.3	S01
5	347039	switch	2NO	250	16	F6.3	S10

fig.	GEV No.	description	function	volt. (V)	SC (A)	connection	diagram
6	346957	switch	1NO	250	6	F6.3	S06
7	346143	switch	1NO	250	10	F6.3	S01
8	347376	switch	1NO	250	16	F6.3	S01

Diagrams may be found at the end of the chapter

28x22mm

fig.	GEV No.	description	function	volt. (V)	SC (A)	connection	diagram
1	301305	switch	2NO	240	16	F6.3	S07
2	301253 ¹	switch	2NO	250	16	F6.3	S10
3	301301 ¹	switch	2NO	250	20	F6.3	S10
4	347827	switch	2NO	250	14	F6.3	S07
5	301025	switch	2NO	230	16	F6.3	S07

¹illuminated

Diagrams may be found at the end of the chapter

fig.	GEV No.	description	function	volt. (V)	SC (A)	connection	diagram
6	348115 ¹	switch	2NO	250	16	F6.3	S10

¹illuminated

30x11mm

fig.	GEV No.	description	function	volt. (V)	SC (A)	connection	diagram
1	301013	switch	1CO	250	16	F6.3	S03
2	345575	switch	1CO	250	16	F6.3	S04
3	347350	switch	1CO	250	16	F6.3	S01
4	301014	momentary switch	1NO	250	16	F6.3	T01
5	348107	momentary switch	1NO	250	16	F6.3	T01

fig.	GEV No.	description	function	volt. (V)	SC (A)	connection	diagram
6	345489	momentary switch	1NO	250	16	F6.3	T01
7	347185	switch	1CO	250	16	F6.3	S03

Diagrams may be found at the end of the chapter

fig.	GEV No.	description	function	volt. (V)	SC (A)	connection	diagram
1	301012	switch	1NO/1H	250	16	F6.3	S06
2	345381	switch	1NO/1H	24	16	F6.3	S06
3	301011	switch	1NO/1H	250	16	F6.3	S06
4	301010	switch	1NO/1H	250	16	F6.3	S05
5	301053	switch	1NO/1H	250	16	F6.3	S06



Зип Общепит

vsezip.ru

+7(812)987-08-81



fig.	GEV No.	description	function	volt. (V)	SC (A)	connection	diagram
6	345386	switch	1NO	250	16	F6.3	S06
7	345383	switch	1NO/1H	250	16	F6.3	S06
8	345384	switch	1NO/1H	250	16	F6.3	S06

Diagrams may be found at the end of the chapter



fig.	GEV No.	description	function	volt. (V)	SC (A)	connection	diagram
1	301038	switch	1NO/1H	250	16	F6.3	S06
2	301037	switch	1NO/1H	250	16	F6.3	S06
3	301039	switch	1NO/1H	250	16	F6.3	S06

Diagrams may be found at the end of the chapter

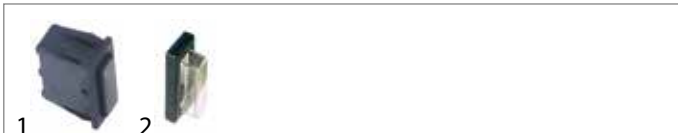

fig.	GEV No.	description
1	346787	dummy element external size 30x11mm black
2	301035	protective cover 30x11mm



fig.	GEV No.	description	function	volt. (V)	SC (A)	connection	diagram
1	301293	switch	1NO	230	16	F6.3	S06
2	301291	switch	1NO	230	16	F6.3	S06
3	301290	switch	1NO	230	16	F6.3	S06
4	301292	switch	1NO	230	16	F6.3	S06

Diagrams may be found at the end of the chapter

30x22mm



fig.	GEV No.	description	function	volt. (V)	SC (A)	connection	diagram
1	301145	momentary switch	2CO	250	16	F6.3	T13
1	301017	switch	2CO	250	16	F6.3	S13
1	301278	switch	2CO	24	6	F6.3	S13
2	345163	momentary switch	2CO	250	16	F6.3	S13
3	301016	switch	2CO	250	16	F6.3	S13
3	345491	momentary switch	2NO/1H	250	16	F6.3	T10
4	346568	momentary switch	1NC	230	16	F6.3	T06
4	301015	switch	2CO	250	16	F6.3	S13

Diagrams may be found at the end of the chapter



fig.	GEV No.	description	function	volt. (V)	SC (A)	connection	diagram
1	301000	switch	2NO	250	16	F6.3	S10
2	301019	momentary switch	2NO	250	16	F6.3	T10
2	301003	switch	2NO	250	16	F6.3	S10
2	346495	switch	2NO	250	16	screw	S10
3	301018	momentary switch	2NO	250	16	F6.3	T10
3	301135	momentary switch	2NO	24	16	F6.3	S10
3	301002	switch	2NO	250	16	F6.3	S10
3	345512	switch	2NO	250	16	F6.3	S10
4	301020	momentary switch	2NO	250	16	F6.3	T10
4	301001	switch	2NO	250	16	F6.3	S10
4	301091	switch	2NO	400	10	F6.3	S10
5	301085	momentary switch	2NO	250	16	F6.3	T10
5	301009	switch	2NO	250	16	F6.3	S10

Diagrams may be found at the end of the chapter



fig.	GEV No.	description	colour	function	volt. (V)	SC (A)	connection	diagram
1	301259	switch	blue	2NO	250	16	F6.3	S10
2	348040	switch	green	2CO	250	16	F6.3	S13
2	301062	switch	green	2NO	250	16	F6.3	S10
3	346689	momentary switch	orange	1NO/1H	230	16	F6.3	T01, X01
3	347813	switch	orange	2CO	250	16	F6.3	S13
3	301061	switch	orange	2NO	250	16	F6.3	S10
4	347704	momentary switch	red	2CO	250	16	F6.3	T13
4	301060	switch	red	2NO	250	16	F6.3	S10

Diagrams may be found at the end of the chapter



fig.	GEV No.	description	function	volt. (V)	SC (A)	connection	diagram
1	345645	switch	2NO	230	16	F6.3	S10
1	347791	switch	2NO	230	20	F6.3	S10
2	346899	switch	2NO	230	16	F6.3	S10
2	347973	switch	2NO	250	20	F6.3	S10
3	345641	switch	2NO	230	16	F6.3	S10
3	347974	switch	2NO	250	20	F6.3	S10
4	347394	switch	2NO	250	16	F6.3	S10
4	347207	switch	2NO	250	20	F6.3	S10
5	346896 ¹	switch	2NO	250	16	F6.3	S07
5	301202 ¹	switch	2NO	230	20	F6.3	S07

¹non-illuminated

Diagrams may be found at the end of the chapter



Зип Общепит
vsezip.ru
+7(812)937-08-81

fig.	GEV No.	description	function	volt. (V)	SC (A)	connection	diagram
1	347531	switch	2NO	250	20	F6.3	S10
1	345317	momentary switch	2NO	230	16	F6.3	T10
2	347774	switch	2NO	250	20	F6.3	S10
3	347775	switch	2NO	250	20	F6.3	S10
4	347956	switch	2NO	250	20	F6.3	S07

Diagrams may be found at the end of the chapter

fig.	GEV No.	description	function	volt. (V)	SC (A)	connection	diagram
5	347814 ¹	switch	2NO	250	20	F6.3	S07

¹non-illuminated

fig.	GEV No.	description	function	volt. (V)	SC (A)	connection	diagram
6	343301	switch	2CO	250	16	F6.3	S12
7	301314	switch	2NO	250	16	F6.3	S11
8	301272	switch	2NO/2NO	250	16	F6.3	S11

Diagrams may be found at the end of the chapter

fig.	GEV No.	description	function	volt. (V)	SC (A)	connection	diagram
1	345189	momentary switch	2NO	250	16	F6.3	T07
2	345423	momentary switch	2NO	230	16	F6.3	T04
3	347204	momentary switch	2NO	250	16	F6.3	T07
4	348090	switch	2CO	250	16	F6.3	T12
5	346081	switch	2NO	250	16	F6.3	S07

Diagrams may be found at the end of the chapter

accessories

fig.	GEV No.	description
1	301046	gasket internal size 30x22mm
2	346425	gasket internal size 30x22mm suitable for switch
3	301036	protective cover internal size 30x22mm

fig.	GEV No.	description	function	volt. (V)	SC (A)	connection	diagram
1	346978	momentary switch	2CO	250	16	F6.3	T12
1	301004	switch	2CO	250	16	F6.3	S12
2	345356	momentary switch	1CO	250	16	F6.3	T03
3	301718	momentary switch	1NO/1H	250	16	F6.3	T01, X01
4	301101	switch	2CO	250	16	F6.3	T12

Diagrams may be found at the end of the chapter

fig.	GEV No.	description	function	volt. (V)	SC (A)	connection	diagram
1	301140	switch	2CO	250	16	F6.3	S12
2	346852	switch	2CO	250	16	F6.3	S11
2	301188	switch	2NO/2NO	250	16	F6.3	S11
3	301078	momentary switch	2NO	250	6	F6.3	T07
3	346068	momentary switch	2NO	250	16	F6.3	T10
3	346377	switch	2NO	230	16	F6.3	S07
4	301249	switch	2CO	250	16	F6.3	S12
5	301717	momentary switch	1NO	250	16	F6.3	S01

fig.	GEV No.	description	function	volt. (V)	SC (A)	connection	diagram
1	345689 ¹	momentary switch	1NO	250	16	F6.3	T06
2	301136	momentary switch	2NO/1H	250	16	F6.3	T21
3	346017 ¹	switch	2NO	230	16	F6.3	S10
4	301081 ¹	switch	2CO	250	16	F6.3	S13

¹illuminated

Diagrams may be found at the end of the chapter

fig.	GEV No.	description	function	volt. (V)	SC (A)	connection	diagram
1	301716	switch	2NO	250	16	F6.3	S10

fig.	GEV No.	description	function	volt. (V)	SC (A)	connection	diagram
1	346157	momentary switch	2NO	250	16	F6.3	S10

fig.	GEV No.	description	function	volt. (V)	SC (A)	connection	diagram
1	347870	momentary switch	1NO/1H	250	16	F6.3	T05
2	301304	momentary switch	2CO	250	16	F6.3	T13
3	345124	momentary switch	2CO	250	16	F6.3	T13
4	346844	switch	2CO	230	16	F6.3	S13
5	301132	momentary switch	2NO	250	16	F6.3	T10



fig.	GEV No.	description	function	volt. (V)	SC (A)	connection	diagram
6	301251	switch	2NO	250	16	F6.3	S10
7	345714	switch	2NO	250	16	F6.3	S10
8	346930	switch	2NO	250	16	F6.3	S10
9	347112	switch	2NO	250	16	F6.3	S10
10	301133	momentary switch	2NO	250	16	F6.3	S10



fig.	GEV No.	description	function	volt. (V)	SC (A)	connection	diagram
11	346897	switch	2NO	230	16	F6.3	S10
12	346898	switch	2NO	230	16	F6.3	S10
13	347019	switch	2NO	250	16	F6.3	S10
14	301076	momentary switch	2NO	250	16	F6.3	T13
15	345188	switch	2NO	250	16	F6.3	S10



fig.	GEV No.	description	function	volt. (V)	SC (A)	connection	diagram
16	346047	switch	2NO	250	16	F6.3	S10
17	346049	switch	2NO	250	16	F6.3	S10
18	301021	momentary switch	2NO	250	16	F6.3	S10

Diagrams may be found at the end of the chapter



fig.	GEV No.	description	function	volt. (V)	SC (A)	connection	diagram
1	346981	switch	2NO	250	16	F6.3	S10
2	345056	switch	2NO	250	8	F6.3	S10
3	346108	switch	2NO	250	16	F6.3	S10
4	346109	switch	2NO	250	16	F6.3	S10
5	346110	switch	2NO	250	16	F6.3	S10

Diagrams may be found at the end of the chapter



fig.	GEV No.	description	function	volt. (V)	SC (A)	connection	diagram
6	346111	switch	2NO	250	16	F6.3	S10

blank



fig.	GEV No.	description	function	volt. (V)	SC (A)	connection	diagram
1	346564	switch	2CO	230	16	F6.3	S12

Зип-Общепит

vsezip.ru

+7(812)987-08-88



fig.	GEV No.	description	function	volt. (V)	SC (A)	symbol	connection diagram
1	301264	switch	2NO	250	16	cup warmer	F6.3 S10
2	301266	switch	2NO	250	16	heating	F6.3 S10
3	301267	switch	2NO	250	16	flash	F6.3 S10

Diagrams may be found at the end of the chapter

accessories

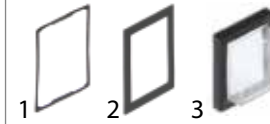

fig.	GEV No.	description
1	301046	gasket internal size 30x22mm
2	346425	gasket internal size 30x22mm suitable for switch
3	301036	protective cover internal size 30x22mm



fig.	GEV No.	description	function	volt. (V)	SC (A)	connection	diagram
1	301029	switch	1NO/NO	250	16	F6.3	S06, S06
2	301031	switch	1NO/NO	250	16	F6.3	S06, S06
3	301030	switch	1NO/NO	250	16	F6.3	S06, S06

Diagrams may be found at the end of the chapter



fig.	GEV No.	description	function	volt. (V)	SC (A)	connection	diagram
1	301261	switch	1NO/NO	250	16	F6.3	S06, S06
2	345599	switch	1NO/1NO/1H	250	16	F6.3	S06, S06
3	347412	switch	1NO/NO	250	16	F6.3	S06, S06

Diagrams may be found at the end of the chapter



fig.	GEV No.	description	function	volt. (V)	SC (A)	connection	diagram
1	301080	switch	1CO/1CO	250	16	F6.3	S03, S03
2	346985	switch	1NO/1CO	250	16	F6.3	S01, S03

Diagrams may be found at the end of the chapter



Зип-Общепит

vsezip.ru

+7(812)987-08-81



fig.	GEV No.	description	function	volt. (V)	SC (A)	connection	diagram
1	345646	switch	1NO/1H	250	16	F6.3	S01, X01
2	301034	switch	1NO/1H	250	16	F6.3	S01, X01
3	301102	switch	1CO/1H	250	16	F6.3	X01, S06
4	301077	switch	1NO/1H	250	16	F6.3	S06, X01
5	301032	switch	1NO/1H	250	16	F6.3	S01, X01

Diagrams may be found at the end of the chapter



fig.	GEV No.	description	function	volt. (V)	SC (A)	connection	diagram
6	345713	switch	1NO/NO	250	16	F6.3	S01, S06



fig.	GEV No.	description	function	volt. (V)	SC (A)	connection	diagram
1	346190	switch	1NO/NO	12	6	F6.3	S06, S06
2	347092	switch	1CO/1H	250	16	F6.3	S03, X01
3	348113	momentary switch	1NO/1NC	250	16	F6.3	T08, X01
4	301148	switch	1NO/NO	250	16	F6.3	S06, T01

Diagrams may be found at the end of the chapter

34.2x12.6mm



fig.	GEV No.	description	function	volt. (V)	SC (A)	connection	diagram
1	301139	switch	2CO	250	16	F6.3	S13
2	301130	momentary switch	2NO	250	16	F6.3	T10
3	301131	momentary switch	2NO	250	16	F6.3	S10

Diagrams may be found at the end of the chapter

34x15mm



fig.	GEV No.	description	function	volt. (V)	SC (A)	connection	diagram
1	345284	switch	11NO	230	16	F4.8	S01
2	345283	switch	1NO/1H	250	10	F6.3	S06

Diagrams may be found at the end of the chapter



fig.	GEV No.	description	function	volt. (V)	SC (A)	connection	diagram
1	348097 ¹	switch	1CO	250	10	F6.3	S04
2	348095	switch	1NO	250	20	F6.3	S01
3	348092 ²	switch	2CO	250	10	F6.3	S13
4	348093	switch	2CO	250	10	F6.3	S12
5	348096 ¹	switch	2CO	250	10	F6.3	S11

¹with neutral position ²illuminated



fig.	GEV No.	description	function	volt. (V)	SC (A)	connection	diagram
6	348098 ¹	switch	2CO	250	10	F6.3	S11
7	348094	momentary switch	2NO	250	10	F6.3	T07
8	347969	switch	2NO	250	10	F6.3	S07
9	347824	switch	2NO	250	10	F6.3	S07
10	347826 ²	switch	2NO	250	10	F6.3	S15

¹with neutral position ²illuminated



fig.	GEV No.	description	function	volt. (V)	SC (A)	connection	diagram
11	347970 ¹	switch	2NO	250	10	screw	S10
12	348059	switch	1CO	250	6	F6.3	S03
13	348062	switch	2NO	250	15	F6.3	S07

¹illuminated

Diagrams may be found at the end of the chapter

ø20mm



fig.	GEV No.	description	function	volt. (V)	SC (A)	connection	diagram
1	347242	switch	1NO	250	6	F4.8	S01
2	347278	switch	1NO	250	6	F4.8	S06, X01
3	347802	switch	1NO	250	6	F4.8	S26
4	347803	switch	1NO	250	16	F4.8	S01
5	347241	switch	1NO/1H	250	10	F4.8	S06

Diagrams may be found at the end of the chapter



fig.	GEV No.	description	function	volt. (V)	SC (A)	connection	diagram
6	357074	switch	2NO	250	10	F4.8	S07



push/momentary push switches

Зип Общепит

vsezip.ru

+7(812)987-08-81

17x13mm



fig.	GEV No.	description	function	volt. (V)	SC (A)	connection	diagram
1	345950	momentary switch	2CO	250	16	F6.3	T12

19x13mm



fig.	GEV No.	description	function	volt. (V)	SC (A)	connection	diagram
1	346537 ¹	switch	2NO	250	16	F4.8	S07
2	345690	momentary switch	1NO	250	16	F4.8	T01
3	346540	switch	2NO	250	16	F4.8	S07
3	347753	switch	2NO	250	16	F6.3	S07
4	301190	switch	2NO	250	16	F4.8	S07

¹illuminated

Diagrams may be found at the end of the chapter



fig.	GEV No.	description	function	volt. (V)	SC (A)	connection	diagram
5	301105	momentary switch	1NO	250	16	F6.3	T01



fig.	GEV No.	description	function	volt. (V)	SC (A)	connection	diagram
1	346538 ¹	switch	2NO	250	16	F4.8	S10
2	346871 ¹	switch	2NO	250	16	F4.8	S10
2	347755 ¹	switch	2NO	250	16	F6.3	S10
3	347754 ¹	switch	2NO	250	16	F6.3	S10
4	346542 ¹	switch	2NO	250	16	F4.8	S10
4	347605 ¹	switch	2NO	250	16	F6.3	S10

¹illuminated

Diagrams may be found at the end of the chapter



fig.	GEV No.	description	function	volt. (V)	SC (A)	connection	diagram
1	301713	switch	1NO	250	16	F6.3	T01
2	347691 ¹	switch	2NO	250	15	F4.8	S10
3	301099	momentary switch	1NO	250	16	F6.3	T01
4	301054	momentary switch	1NO	250	16	F6.3	T01

¹illuminated

Diagrams may be found at the end of the chapter

1

fig.	GEV No.	description
1	301004	protective cover for pressure switch



fig.	GEV No.	description	function	volt. (V)	SC (A)	connection	diagram
1	347106	momentary switch	1NO	250	16	F6.3	T01
2	347105	switch	1NO	250	16	F6.3	S01
3	347627	momentary switch	2NO	250	16	F6.3	T07
4	347079 ¹	switch	2NO	250	16	F6.3	S10

¹illuminated

fig.	GEV No.	description	function	volt. (V)	SC (A)	connection	diagram
5	347292 ¹	switch	2NO	250	16	F6.3	S10
6	359446 ¹	switch	2NO	250	16	F6.3	S15

¹illuminated

Diagrams may be found at the end of the chapter



fig.	GEV No.	description	function	volt. (V)	SC (A)	connection	diagram
1	347261	element holder	-	-	-	-	-
2	347260	switch	2NO	250	16	F6.3	S07
3	347257	switch	1NO	250	16	F6.3	S01

Diagrams may be found at the end of the chapter

20.6x16.4mm



fig.	GEV No.	description	function	volt. (V)	SC (A)	symbol	connection diagram
1	347885	momentary switch	1NO	250	16	pump	F6.3 T01
2	347806	momentary switch	1CO	250	16	STOP	F6.3 T03
3	346595	momentary switch	1NO	250	16	ignition	F6.3 S01
4	345667	switch	1NO	250	16	heating	F6.3 S01



Зип Общепит
vsezip.ru
+7(812)987-08-81



fig.	GEV No.	description	function	volt. (V)	SC (A)	symbol	connection diagram
5	348108	switch	1NO	250	16		F6.3
6	347886	momentary switch	1NO	250	16	-	F6.3 T01
7	345949	switch	2CO	250	16	-	F6.3 S12
8	347805	switch	2NO	250	16	ON-OFF	F6.3 S07



fig.	GEV No.	description	function	volt. (V)	SC (A)	connection diagram
1	345028	momentary switch	1NO	230	16	F6.3 T01
2	345452	momentary switch	1CO	250	16	F6.3 T03
3	345498	momentary switch	2NO	250	16	F6.3 T07
4	345497	switch	2CO	250	16	F6.3 S12



fig.	GEV No.	description	function	volt. (V)	SC (A)	symbol	connection diagram
9	301306	momentary switch	1NO	250	16	reset	F6.3 T01
10	346573	switch	2CO	250	16	-	F6.3 S12



fig.	GEV No.	description	function	volt. (V)	SC (A)	connection diagram
5	345565	switch	2NO	250	16	F6.3 S07
6	347724	switch	1CO	250	16	F6.3 S01
7	345179	momentary switch	1CO	250	16	F6.3 T03
8	345928	momentary switch	2NO	250	16	F6.3 T07

Diagrams may be found at the end of the chapter

27.2x22.2mm



fig.	GEV No.	description	function	volt. (V)	SC (A)	connection diagram
1	345093 ¹	momentary switch	2NO	250	16	F6.3 T10
1	345036 ¹	switch	2NO	250	16	F6.3 S10
1	345101	momentary switch	2NO/1H	250	16	F6.3 T15
1	345097	switch	2NO/1H	250	16	F6.3 S15
2	346598 ¹	switch	1NO	250	16	F6.3 S06
2	345092 ¹	momentary switch	2NO	250	16	F6.3 T10
2	345035 ¹	switch	2NO	250	16	F6.3 S10
2	345100	momentary switch	2NO/1H	250	16	F6.3 T15
2	345096	switch	2NO/1H	250	16	F6.3 S15
3	345090 ¹	momentary switch	2NO	250	16	F6.3 T10
3	345033 ¹	switch	2NO	250	16	F6.3 S10
3	345098	momentary switch	2NO/1H	250	16	F6.3 T15
3	345094	switch	2NO/1H	250	16	F6.3 S15
4	345091 ¹	momentary switch	2NO	250	16	F6.3 T10
4	345034 ¹	switch	2NO	250	16	F6.3 S10
4	345099	momentary switch	2NO/1H	250	16	F6.3 T15
4	345095	switch	2NO/1H	250	16	F6.3 S15

¹illuminated
Diagrams may be found at the end of the chapter



fig.	GEV No.	description	function	volt. (V)	SC (A)	connection diagram
9	345940	momentary switch	2CO	240	16	F6.3 T12
9	345942	switch	2CO	250	16	F6.3 S12
10	345499	switch	1CO/1NO	250	16	F6.3 S25
11	347206	switch	2NO	250	16	F6.3 S07
12	345227	switch	1CO	250	16	F6.3 S03



fig.	GEV No.	description	function	volt. (V)	SC (A)	connection diagram
13	347176	switch	2NO	250	16	F6.3 S07
14	346661	momentary switch	1NO	250	16	F6.3 T01
15	347982	momentary switch	1NO	250	16	F6.3 T01
16	346512	switch	2CO	250	16	F6.3 S12

Diagrams may be found at the end of the chapter

28.5x28.5mm



fig.	GEV No.	description	function	volt. (V)	SC (A)	connection diagram
1	345142	switch	2NO	250	16	F6.3 S07



fig.	GEV No.	description	function	volt. (V)	SC (A)	symbol	diagram
1	347855	momentary switch	2CO	250	16	drain pump	T12
2	345845	switch	2CO	250	16	ON-OFF	S12
3	347455	switch	2CO	250	16	main switch	S12
4	345846	momentary switch	2CO	250	16	start	T12

Зип Общепит

vsezip.ru

+7(812)987-08-81



fig.	GEV No.	description	function	volt. (V)	SC (A)	symbol	diagram
5	345941	momentary switch	2CO	250	16	drain pump	T12
6	347990	momentary switch	2CO	250	16	regeneration	T12

Diagrams may be found at the end of the chapter



fig.	GEV No.	description	function	volt. (V)	SC (A)	connection	diagram
1	347931	momentary switch	2NO	250	16	F6.3	T07
2	345973	momentary switch	1NO	250	16	F6.3	T01
3	345979	switch	2CO	250	16	F6.3	S12
4	345553	switch	2NO	250	16	F6.3	S07

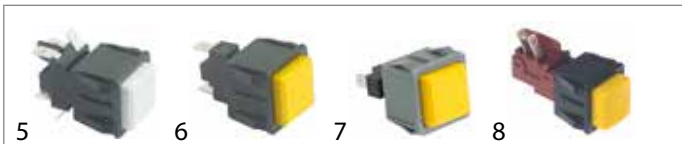

fig.	GEV No.	description	function	volt. (V)	SC (A)	connection	diagram
5	345551	switch	2CO	250	16	F6.3	S12
6	345550	momentary switch	1NO	250	16	F6.3	T01
7	345974	momentary switch	1NO	250	16	F6.3	T01
8	346866	momentary switch	2CO	250	16	F6.3	T12

Diagrams may be found at the end of the chapter



fig.	GEV No.	description	function	volt. (V)	SC (A)	connection	diagram
9	345589	switch	2CO	250	16	F6.3	S12



fig.	GEV No.	description	function	volt. (V)	SC (A)	connection	diagram
1	346491	switch	2NO	250	16	F6.3	S07
2	301179	switch	2CO	250	16	F6.3	S12
3	346502	switch	2NO	250	16	F6.3	S07

Diagrams may be found at the end of the chapter



fig.	GEV No.	description	function	volt. (V)	SC (A)	symbol	connection	diagram
1	347933	momentary switch	1NO	250	16	START	F6.3	T01
2	100160	momentary switch	1NO	250	12	ignition	F6.3	T01

Diagrams may be found at the end of the chapter



fig.	GEV No.	description	function	volt. (V)	SC (A)	symbol	diagram
1	301179	switch	2CO	250	16	-	S12
2	345925	switch	1CO	250	16	rinsing	S03
3	345977	momentary switch	2NO	250	16	outflow	T07
4	345143	switch	2CO	250	16	main switch	S12
4	345924	switch	1CO	250	16	main switch	S03



fig.	GEV No.	description	function	volt. (V)	SC (A)	symbol	diagram
5	345975	switch	2NO	250	16	main switch	S07
5	345976	switch	2CO	250	16	main switch	S12

Diagrams may be found at the end of the chapter

28.5x52.6mm



fig.	GEV No.	function	diagram	suitable for	Ref. No.
1	347780	1NO/1CO	S01, S02	Frigomat	E07.37511
2	345691	1NO/NO	S01, S01	Fiamma	4.0.000.0520
3	347852	2CO	S12	Teikos	844109



fig.	GEV No.	function	diagram	suitable for	Ref. No.
4	347851	2NO/1H	S07, X01	Teikos	844113
5	347441	1NO/1H	S15, X01	Teikos	844107
6	346076	2NO/1NO	S01, S07	Luxia	L7210



fig.	GEV No.	function	diagram	suitable for	Ref. No.
7	347853	1NO/1H	T01, X01	Teikos	844509
8	347440	2NO/1H	S07, X01	Teikos	844309
9	345874	1NO/1H	S05, X01	Dihir Kromo	DW15899/B DW15899/B



Зип Общепит
vsezip.ru
+7(812)987-08-81

10	11	12			
fig.	GEV No.	function	diagram	suitable for	Ref. No.
10	345875	1NO/1H	S05, X01	Dihl Kromo DW15899/C DW15899/C	
11	345876	1NO/1H	S05, X01	Dihl Kromo DW15899 DW15899	
12	347928	2CO	T12	Comenda 130495	

7	8	9			
fig.	GEV No.	function	diagram	suitable for	Ref. No.
7	347611	2CO/2NO/2NO	S12, S07, S07	Bonnet 5865E	
8	347574	2NO/1NO1NC/2CO	S07, S12, S08	Bonnet 5865E	
9	345558	2NO/1H/1H	S07, X01, X01	Fabar 13403	

13	14	15			
fig.	GEV No.	function	diagram	suitable for	Ref. No.
13	345463	2NO/1CO	S07, S03	ATA 4716	
14	345465	2CO/1H	S12, X01	ATA 7373	
15	346919	2NO/1H	S15, X01	VEMA XRPV1	

10	11	12			
fig.	GEV No.	function	diagram	suitable for	Ref. No.
10	346996	2NO/1NO/1NO	T07, T01, T01	Luxia L2034	
11	345871	1CO/1H	S22, X01	Dihl Kromo DW15796 DW15796	
12	345869	1NO/1H/1H	T01, X01, X01	Dihl Kromo Rosinox DW15894 DW15894 RX94808342	

16	17	18			
fig.	GEV No.	function	diagram	suitable for	Ref. No.
16	346227	1NO/NO	S01, S01	Krupps 103320	
17	346664	2CO/1NO	S12, S01	Modular 46102613	
18	346226	2NO/2NO	S07, S07	Krupps 103300	

13	14	15			
fig.	GEV No.	function	diagram	suitable for	Ref. No.
13	345867	2CO/1H/1NO	S12, X01, S01	Dihl Kromo Rosinox DW15891 DW15891 RX94808334	
13	345866	2NO/1NO/1H	S07, S01, X01	Dihl Kromo Multi Rosinox DW15888 DW15888 130825 RX94808359	
14	345868	2NO/1H	S07, X01	Dihl Kromo Multi Rosinox DW15893 DW15893 130827 RX94808367	
15	345870	2NO/1NO/1H	S07, S01, X01	Dihl Kromo Rosinox DW15892 DW15892 RX94810629	

28.5x77.5mm

1	2	3			
fig.	GEV No.	function	diagram	suitable for	Ref. No.
1	345692	1NO/1NO/1NO	S01, S01, S01	Fiamma 4.0.000.0523	
2	346363	2CO/2CO	S12, T12	Bertos Foinox 10043 10043	
3	346365	2CO/2CO	S12, T12	Bertos Foinox 25057800 10044	



16	17	18			
fig.	GEV No.	function	diagram	suitable for	Ref. No.
16	345872	2NO/1NO/1H	S23	Dihl Kromo DW15893/A DW15893/A	
17	347856	2NO/1H/2NO	T07, T07, X01	Dihl Kromo DW27315 DW27315	
18	347621	2CO/2NO/2NO	T12, T07, S07	Mach 500074600	
18	345556	2NO/1NO/1NO	S07, T01, T01	Mach 500017900	

4	5	6			
fig.	GEV No.	function	diagram	suitable for	Ref. No.
4	347779	2CO/2CO/1NO	S12, S12, S01	Frigomat E07.37980	
5	345622	2CO/2CO/2NO	S12, S12, S07	Colged DEP81	
6	345625	2CO/2NO/2NO	S07, S07, S13	Colged Elettrobar DEP61 926190	

Зип Общепит



vsezip.ru



+7(812)987-08-81

					
19	20	21			
fig.	GEV No.	function	diagram	suitable for	Ref. No.
19	346551	2NO/1NO/2NO	S07, T01, S07	Luxia	L2037
20	345434	2CO/1H/1H	S12, X01, X01	ATA	7208
21	345555	2NO/2CO/2CO	S07, S12, S12	Mach	500040900

					
31	32	33			
fig.	GEV No.	function	diagram	suitable for	Ref. No.
31	345027	2CO/2NO/1NO	S12, S07, S01	ATA	7205
32	345464	2NO/1NO/1NO	S07, S01, S01	ATA	7372
33	347957	2NO/1NO/1NO	S07, S07, S13	Mach	500083100



Diagrams may be found at the end of the chapter



					
22	23	24			
fig.	GEV No.	function	diagram	suitable for	Ref. No.
22	345554	2NO/2CO/1NO	S07, S12, S01	Mach	80001513
23	348018	2NO/2CO/1NO	S07, S12, S01	Mach	500005300
24	347731	2NO/2CO/1H	X01, S12, S07	Dihir Kromo	DW75090 DW75090

30x22mm						
						
1	2	3				
fig.	GEV No.	description	function	volt. (V)	SC (A)	connection diagram
1	345963	momentary switch	2NO	250	16	F6.3 T07
1	346536	switch	2NO	250	16	F6.3 S07
2	301050 ¹	momentary switch	2NO	250	16	F6.3 T10
2	301047 ¹	switch	2NO	250	16	F6.3 S10
2	301052	momentary switch	2NO/1H	250	16	F6.3/F4.8 T14, X01
2	301049	switch	2NO/1H	250	16	F6.3 S15, X01
3	301051 ¹	momentary switch	2NO	250	16	F6.3 T10
3	301048 ¹	switch	2NO	250	16	F6.3 S10

¹illuminated

Diagrams may be found at the end of the chapter



					
25	26	27			
fig.	GEV No.	function	diagram	suitable for	Ref. No.
25	345180	1CO/1CO/1CO	S12, S12, S12	Elframo Komel	28160023 28160023
26	345944	2CO	S12	Elframo Komel	28160028 28160028
27	345945	2CO/2CO/2CO	S12, S12, T12	Elframo Komel	28160029 28160029

						
1	2					
fig.	GEV No.	description	function	volt. (V)	SC (A)	connection diagram
1	301274	momentary switch	1NO	250	16	F6.3 T01
2	301275 ¹	switch	2NO	250	16	F6.3 S10

¹illuminated

Diagrams may be found at the end of the chapter

					
28	29	30			
fig.	GEV No.	function	diagram	suitable for	Ref. No.
28	345946	2CO/2CO/2CO	S12, S12, S12	Elframo Komel	28160036 28160036
29	345954	2CO/2CO/2CO	S12, S12, S12	Elframo Komel	28160274 28160274
30	345590	1NO/1H/1H	S01, X01, X01	Silanos	905327

						
1	2	3				
fig.	GEV No.	description	function	volt. (V)	SC (A)	connection diagram
1	301042 ¹	momentary switch	2NO	250	16	F6.3 S10
1	301040 ¹	switch	2NO	250	16	F6.3 S10
2	301043 ¹	momentary switch	2NO	250	16	F6.3 S10
2	301041 ¹	switch	2NO	250	16	F6.3 S10
3	345864 ²	switch	2NO	250	16	F6.3 S15

¹illuminated ²indicator light 24V

Diagrams may be found at the end of the chapter



Зип Общепит
vsezip.ru
+7(812)987-08-81



fig.	GEV No.	description	function	volt. (V)	SC (A)	connection	diagram
1	346048	momentary switch	1NO	250	16	F6.3	S01
2	347955	switch	1NO/1NC	250	12	F4.8	S08
3	345237 ¹	momentary switch	2NO	250	16	F6.3	T10
3	345235 ¹	switch	2NO	250	16	F6.3	S10
4	347024	momentary switch	1NO/1H	250	16	F6.3	T05, X01

¹illuminated



fig.	GEV No.	description	function	volt. (V)	SC (A)	connection	diagram
5	346041 ¹	switch	2NO	250	16	F6.3	S10
6	345238 ¹	momentary switch	2NO	250	16	F6.3	T10
6	345236 ¹	switch	2NO	250	16	F6.3	S10

¹illuminated

Diagrams may be found at the end of the chapter



fig.	GEV No.	description	function	volt. (V)	SC (A)	connection	diagram
1	345443 ¹	switch	2NO	250	16	F6.3	S10
2	345436	momentary switch	1NO/1H	250	16	F6.3	T05, X01
2	345441	switch	2NO/1H	250	16	F4.8/F6.3	T14, X01
3	345440	momentary switch	1NO/1H	250	16	F4.8/F6.3	T01, X01
3	345437 ¹	switch	2NO/1H	250	16	F4.8/F6.3	S15, X01
4	345442 ¹	switch	2NO/2NC/1H	250	16	F4.8/F6.3	S17

¹illuminated

Diagrams may be found at the end of the chapter



fig.	GEV No.	description	function	volt. (V)	SC (A)	connection	diagram
1	347916	momentary switch	1NC	250	16	F6.3	T02
2	347918	momentary switch	1NO	250	16	F6.3	T01
3	347917	momentary switch	1NO/1NC/1H	250	12	F4.8/F6.3	T09
4	347915 ¹	switch	2NO	250	16	F6.3	S14
5	347914	switch	2NO/2NC/1H	250	12	F4.8/F6.3	S17

¹illuminated

Diagrams may be found at the end of the chapter



fig.	GEV No.	description	function	volt. (V)	SC (A)	connection	diagram
1	301036	switch	2NO	250	12	F6.3	S07
2	346112	switch	2NO	250	16	F6.3	S10
3	346052	switch	2CO	250	16	F6.3	S12
4	301082	switch	2NO	250	12	F6.3	S10



fig.	GEV No.	description	function	volt. (V)	SC (A)	connection	diagram
5	301083	switch	2NO	250	12	F6.3	S10
6	301084	switch	2NO	250	12	F6.3	S10

Diagrams may be found at the end of the chapter



fig.	GEV No.	description	function	version	diagram
1	345712	switch	2CO	-	S12
1	345510	switch	2NO	latching	S07
2	347175	push button	1NO	-	S01

Diagrams may be found at the end of the chapter



fig.	GEV No.	description
1	301046	gasket internal size 30x22mm
2	346425	gasket internal size 30x22mm suitable for switch
3	301036	protective cover internal size 30x22mm

34.1x23.1mm



fig.	GEV No.	description	function	volt. (V)	SC (A)	connection	diagram
1	347489	switch	2NO	250	16	F6.3	S07
2	347312	switch	2NO	250	16	F6.3	S07
3	347311	momentary switch	1CO	250	16	F6.3	T03

Diagrams may be found at the end of the chapter

Зип.Общепит

vsezip.ru

+7(812)987-08-81

ø 9mm



fig.	GEV No.	description	suitable for	Part No.
1	346053	momentary switch connection cable 280mm with plug protection IP40	Thermoplan	104,503

ø11mm



fig.	GEV No.	description	function	volt. (V)	SC (A)	connection	diagram
1	347060	push button	1NO	250	16	F6.3	T01
2	300126	push button	2NO	250	16	F6.3	T07

Diagrams may be found at the end of the chapter

ø12mm



fig.	GEV No.	description	function	volt. (V)	SC (A)	connection	diagram
1	347745	momentary switch	1NO	250	2	F6.3	T01
2	346594	momentary switch	1NO	250	4	F6.3	T01
3	346703	momentary switch	1NO	250	4	F6.3	T01
4	346702	momentary switch	1NO	250	4	F6.3	T01

Diagrams may be found at the end of the chapter



fig.	GEV No.	description	function	volt. (V)	SC (A)	connection	diagram
5	347567	momentary switch	1NO	250	4	F6.3	T01

ø15.2mm



fig.	GEV No.	description	function	volt. (V)	SC (A)	connection	diagram
1	346154	momentary switch	1NO	250	0.7	screw	T01
2	346155	momentary switch	1NC	250	0.7	screw	T02

Diagrams may be found at the end of the chapter

ø16.2mm



fig.	GEV No.	description	function	volt. (V)	SC (A)	connection	diagram
1	346534	momentary switch	1NO	250	2	screw	T01

ø16mm



fig.	GEV No.	description	function	volt. (V)	SC (A)	connection	diagram
1	301172	momentary switch	1NO	250	16	F6.3	T01
1	301227	switch	1NO	250	16	F6.3	S01
2	301295	switch	1NO	250	16	F6.3	S01
3	301173	momentary switch	2CO	250	16	F6.3	T12
3	301175	switch	2CO	250	16	F6.3	S12
4	301174	switch	2NO	250	16	F6.3	S07



fig.	GEV No.	description	function	volt. (V)	SC (A)	connection	diagram
5	301310	switch	1NO	250	16	F6.3	S01
6	301309	switch	2NO	250	16	F6.3	S07
7	347906	momentary switch	1NO/1NC	250	16	F6.3	T08
8	345462	momentary switch	2NO	250	16	F6.3	T07



fig.	GEV No.	description	function	volt. (V)	SC (A)	connection	diagram
9	346287 ¹	momentary switch	1NO	250	3	F2.8	T06
10	346315	momentary switch	1NO/1H	250	3	F2.8	T06
11	346346	momentary switch	1NO/1H	250	3	F2.8	T05
12	101029	momentary switch	1NO	250	16	F6.3	T01

¹illuminated

Diagrams may be found at the end of the chapter



fig.	GEV No.	description	function	volt. (V)	SC (A)	connection	diagram
13	346895	momentary switch	1NO	250	16	F6.3	T01

ø18.2mm



fig.	GEV No.	description	function	volt. (V)	SC (A)	connection	diagram
1	346508	momentary switch	1NC/1NO	250	2	screw	T08



Зип Общепит
vsezip.ru
+7(812)987-08-81

ø19.2mm

1 2

fig.	GEV No.	description	function	volt. (V)	SC (A)	connection	diagram
1	346414	momentary switch	1NC/1NO	250	5	solder connection	T08
2	347650	momentary switch	1NO	24	0.05	F6.3	T01

Diagrams may be found at the end of the chapter

ø19mm

1

fig.	GEV No.	description	function	volt. (V)	SC (A)	connection	diagram
1	347534	switch	1NO	250	16	F6.3	S01

ø22.3mm

1 2

fig.	GEV No.	description	function	volt. (V)	SC (A)	connection	diagram
1	346401	switch	1NO	250	10	screw	S01
2	346402	momentary switch	1NC	250	10	screw	T02

Diagrams may be found at the end of the chapter

ø22mm

1

fig.	GEV No.	description	function	volt. (V)	SC (A)	connection	diagram
1	347107	momentary switch	2NO	250	16	screw	T07

1 2 3 4

fig.	GEV No.	description	function	volt. (V)	SC (A)	connection	diagram
1	699002	momentary switch	1NO/1NC/1H	230	6	screw	T01, T02, X01
2	403149	control PCB	-	230	10	F6.3	S15, S02
3	347111	momentary switch	1NO/1NC	250	10	screw	T08
4	403549	momentary switch	1NO/1NC	230	6	screw	T01, T02

5 6 7 8

fig.	GEV No.	description	function	volt. (V)	SC (A)	connection	diagram
5	347819	momentary switch	1NO/1NC/1H	240	10	screw	T09
6	401357	momentary switch	1NO/1NC/1H	400	4	screw	T01, T02, X01
7	401868	momentary switch	1NO/1NC/1H	230	6	screw	T09
8	403539	momentary switch	1NO/1NC/1H	230	6	F6.3	T09

Diagrams may be found at the end of the chapter

9

fig.	GEV No.	description	function	volt. (V)	SC (A)	connection	diagram
9	347789	momentary switch	1NO/1NC	250	4	screw	T08

1

fig.	GEV No.	description	function	volt. (V)	SC (A)	connection	diagram
1	347766	momentary switch	1NO/1NC/1NO	400	4	F6.3	T01, T01, T02

1 2 3 4

fig.	GEV No.	description
1	301058	protective cover internal size 30x55mm
1	401709	protective cover rubber external size 57x32mm
2	301127	protective cover internal size 30x55mm transparent
3	358007	protective cover external size 33x53mm
4	346181	push button mounting ø 21 mm external size 30x55mm

ø25mm

1 2

fig.	GEV No.	description	function	volt. (V)	SC (A)	connection	diagram
1	346039	switch	2NO	250	16	F6.3	S07
2	348109	switch	2NO	250	16	F6.3	

Diagrams may be found at the end of the chapter

1 2 3 4

fig.	GEV No.	description	function	volt. (V)	SC (A)	connection	diagram
1	345038	momentary switch	2NO	250	16	F6.3	T07
2	346316	switch	2NO	250	16	F6.3	S07
3	346554	switch	2NO	250	16	F6.3	S07
4	345037	switch	2NO	250	16	F6.3	S07

Diagrams may be found at the end of the chapter

Зип-Общепит

vsezip.ru

+7(812)987-08-81



fig.	GEV No.	description	function	volt. (V)	SC (A)	connection	diagram
1	346936	momentary switch	1NO/1H	250	16	F6.3	T05
1	345161 ¹	switch	2NO	250	16	F6.3	S10
2	345961	momentary switch	1NO/1H	250	16	F6.3	T05
2	345152 ¹	momentary switch	2NO	250	16	F6.3	T10
2	345151 ¹	switch	2NO	250	16	F6.3	S10
3	345160 ¹	switch	2NO	250	16	F6.3	S10
3	347294 ¹	switch	2NO	250	16	F6.3	S10
4	300161 ¹	switch	2NO	250	16	F6.3	S10
4	345212	switch	2NO/1H	250	16	F6.3	S07

¹illuminated

Diagrams may be found at the end of the chapter



fig.	GEV No.	description	function	volt. (V)	SC (A)	connection	diagram
5	345162 ¹	switch	2NO	250	16	F6.3	S10

¹illuminated



fig.	GEV No.	description	function	volt. (V)	SC (A)	connection	diagram
1	345642	switch	1NO/1H	250	16	F6.3	T05
2	346497	switch	2NO	250	16	F6.3	S10
3	347771	momentary switch	1NO/1H	250	16	F6.3	T05

Diagrams may be found at the end of the chapter



fig.	GEV No.	description	function	volt. (V)	SC (A)	connection	diagram
1	346094	switch	2NO/1H	250	16	F6.3	S10
2	346318	momentary switch	1NO	250	16	F6.3	T01
3	345039	protective cover					

Diagrams may be found at the end of the chapter

overload switches



fig.	GEV No.	type	volt. (V)	SC (A)	suitable for	Ref. No.
1	347067	KJD17	250	10	Fimar GAM Sirman	SL2919 RSTER30_26 19410152
2	347815	KJD17	250	10	Celme Thunderbird	60169 ARM0119
3	347837	KJD17	240	4.5	Rotor	296.61.13



fig.	GEV No.	description	diagram	suitable for	Ref. No.
1	347406	push switch green 2NO 250V 16A connection male faston 6,3mm	S07	Adler	20044



fig.	GEV No.	description	diagram	suitable for	Ref. No.
1	345028	switch combination double black/green 1CO/2NO 250V 16A connection male faston 6,3mm	S03, S07	Adler	20065



fig.	GEV No.	description	suitable for	Ref. No.
1	345136	switch combination triple green 240V 16A connection male faston 6,3mm	Krefftt Küppersbusch Rational	76-30161405 407319 3016.1405
2	345029	switch combination triple grey/black/green 1CO/1CO/2NO 250V 10A connection male faston 6,3mm	Adler	20064
3	345417	switch combination triple white/black/green 240V 16A connection male faston 6,3mm	Adler	20149



fig.	GEV No.	description	diagram	suitable for	Ref. No.
1	347840	switch combination 4-fold white/grey/grey/green 250V 16A connection male faston 6,3mm	T03, S25, T03, S07	Adler	20501

miscellaneous



fig.	GEV No.	description	function	version	diagram
1	347737	momentary switch	1CO	with protecting cover	T03
2	345951	momentary switch	2CO	without frame	T12

Diagrams may be found at the end of the chapter



3ип Общепит
vsezip.ru
+7(812)987-08-81

accessories

push buttons



fig.	GEV No.	description
1	347183	push button mounting ø 14,3mm chrome-plated

protective covers



fig.	GEV No.	description	fig.	GEV No.	description
1	346343	protective cover	2	346344	ring

toggle switches

M6



fig.	GEV No.	function	volt. (V)	SC (A)	application	connector	diagram
1	345680	1CO	125	6	ON-ON	solder connection	S03

M12x0.75



fig.	GEV No.	function	volt. (V)	SC (A)	application	connector	diagram
1	346518	1CO	250	15	ON-OFF-MOM	F6.3	S04
1	346517	1CO	250	15	ON-OFF-ON	F6.3	S04
1	346528	1CO	250	15	ON-ON	F6.3	S03
1	346516	1NO	250	15	ON-OFF	F6.3	S01
2	346526	1CO	250	15	ON-ON	F6.3	S03
3	346520	2CO	250	15	ON-OFF-ON	F6.3	S11
3	346527	2CO	250	15	ON-ON	F6.3	S12
3	346529	2CO	250	15	ON-ON	F6.3	S12
3	346519	2NO	250	15	ON-OFF	F6.3	S07
3	301230	2NO	250	15	ON-OFF	screw	S07
4	348055	2CO	250	15	ON-ON	screw	S12



fig.	GEV No.	function	volt. (V)	SC (A)	application	connector	diagram
5	348050	2NO	250	10	ON-OFF	F6.3	S07
6	346520	3CO	250	15	ON-OFF-ON	F6.3	S20
6	346523	3CO	250	15	ON-ON	F6.3	S18
6	346522	3NO	250	15	ON-OFF	F6.3	S16
7	348058	3CO	250	12	ON-OFF-ON	F6.3	S20

Diagrams may be found at the end of the chapter

2 hole fixing



fig.	GEV No.	function	volt. (V)	SC (A)	connection	HD (mm)	diagram
1	346531	2NO	250	16	screw	46	S07
2	345051	2NO	400	10	screw	34	S07
3	346532	3NO	250	16	screw	36	S16
3	346533 ¹	3NO	250	16	screw	36	S16
4	346162	3NO	400	10	screw	34	S16
4	346391	3NO	400	16	screw	46	S16

¹with jumped terminal
Diagrams may be found at the end of the chapter

accessories



fig.	GEV No.	description
1	347197	bezel ON/OFF for toggle switch M12
2	346525	protection cap L 23,5mm W 17,3mm protection cap

microswitches

universal



fig.	GEV No.	description	SC (A)	function	connection	act.F. (g)	diagram
1	348041	microswitch	16	1CO	F6.3	45	T03
1	348042	microswitch	16	1CO	F6.3	75	T03
1	348044	microswitch	16	1CO	F4.8	45	T03
1	348045	microswitch	16	1CO	F4.8	75	T03
1	348046	microswitch	16	1CO	F4.8	100	T03
1	348043	microswitch	16	1CO	F6.3	100	T03

Зип Общепит
vsezip.ru
+7(812)987-08-81



fig.	GEV No.	description	SC (A)	function	connection	act.F. (g)	diagram
2	345042	microswitch	16	1CO	F6.3	75	T03
2	347217	microswitch	16	1CO	F6.3	20	T03
3	345043	lever set					



fig.	GEV No.	description	SC (A)	function	connection	act.F. (g)	diagram
4	345214	microswitch	6	1CO	cable	180	T03
5	345229	lever set					

Diagrams may be found at the end of the chapter

lever actuated

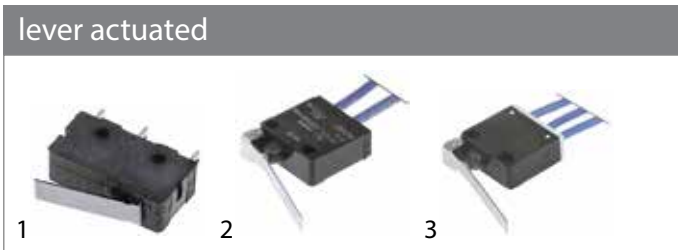

fig.	GEV No.	volt. (V)	SC (A)	function	connection	L (mm)	act.F. (g)	diagram
1	347021	250	5	1CO	solder connection	15	13	T03
2	347032	250	10	1NO	with cable	40	10	T01
3	347033	250	10	1CO	with cable	38	60	T03



fig.	GEV No.	volt. (V)	SC (A)	function	connection	L (mm)	act.F. (g)	diagram
4	347034	30	1	1NO	with cable	18	100	T01
4	347035	30	1	1CO	with cable	25	80	T03
5	347758	250	5	1CO	with cable	35	160	T03

Diagrams may be found at the end of the chapter

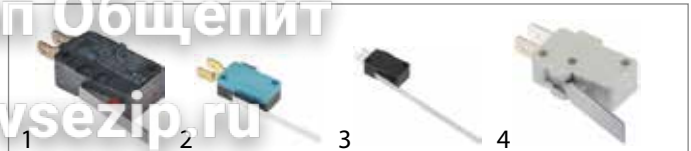

fig.	GEV No.	SC (A)	function	connection	L (mm)	act.F. (g)	diagram
1	347010	15	1CO	F4.8	36	50	T03
1	347201	16	1CO	F4.8	37	70	T03
2	580078	16	1CO	F4.8	68	30	T03
3	345107	16	1CO	F6.3	28	30	T03
4	345178	16	1CO	F6.3	28	220	T03



fig.	GEV No.	SC (A)	function	connection	L (mm)	act.F. (g)	diagram
5	345254	16	1CO	F6.3	29	60	T03
6	345255	16	1CO	F6.3	28	136	T03
6	345256	16	1CO	F6.3	29	150	T03
6	345257	16	1CO	F6.3	29	130	T03
7	345279	6	1CO	F6.3	27	12	T03
8	345345	16	1CO	F6.3	78	40	T03
8	345742	16	1CO	F6.3	55	75	T03

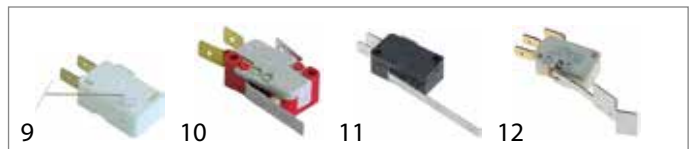

fig.	GEV No.	SC (A)	function	connection	L (mm)	act.F. (g)	diagram
9	345367	6	1CO	F6.3	113	40	T03
10	345702	6	1CO	F6.3	35	60	T03
11	345773	10.1	1CO	F6.3	60	65	T03
12	346314	16	1CO	F6.3	56	50	T03

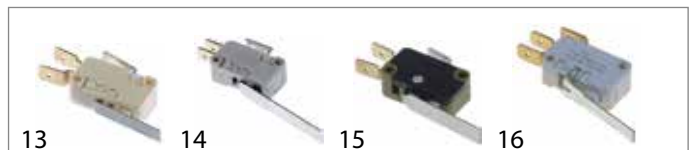

fig.	GEV No.	SC (A)	function	connection	L (mm)	act.F. (g)	diagram
13	346456	0.1	1CO	F6.3	36	25	T03
14	346872	0.1	1CO	F6.3	50	6	T03
15	347443	16	1CO	F6.3	40	120	T03
16	347596	12	1CO	F6.3	42	35	T03

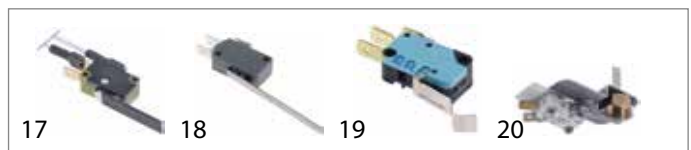

fig.	GEV No.	SC (A)	function	connection	L (mm)	act.F. (g)	diagram
17	347622	12	1CO	F6.3	51	40	T03
18	348000	22	1CO	F6.3	70	120	T03
19	530480	16	1CO	F6.3	42	20	T03
20	346237	16	1NO	F6.3	46.5	80	T01



Зип Общепит
vsezip.ru
+7(812)987-08-81



fig.	GEV No.	SC (A)	function	connection	L (mm)	act.F. (g)	diagram
21	346969	16	1NO	F6.3	59	50	T01
22	347997	3	1NO	F6.3	77	160	T01
23	345183	16	2CO	F6.3	50	290	T12
24	346838	16	2CO	F6.3	40	160	T12

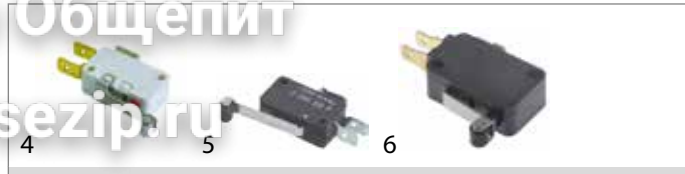

fig.	GEV No.	volt. (V)	SC (A)	function	connection	L1 (mm)	diagram
4	345253	250	16	1CO	F6.3	37	T03
5	345276	250	16	1CO	F6.3	28	T03
6	347767	250	16	1CO	F4.8	16	T03



fig.	GEV No.	SC (A)	function	connection	L (mm)	act.F. (g)	diagram
25	346861	16	2CO	F6.3	82	80	T12
26	346927	10	2CO	F6.3	-	220	T12



fig.	GEV No.	volt. (V)	SC (A)	function	connection	L1 (mm)	diagram
7	347839	250	10	1CO	F6.3	21	T03
8	347949	250	16	1NC	F6.3	12	T02

Diagrams may be found at the end of the chapter

Diagrams may be found at the end of the chapter



fig.	GEV No.	volt. (V)	SC (A)	function	connection	L1 (mm)	act.F. (g)	diagram
1	345044	250	16	1CO	F6.3	70	25	T03
1	345125	250	16	1CO	F6.3	60	25	T03
1	345269	250	16	1CO	F6.3	54	70	T03
2	345074	250	16	1CO	F6.3	145	25	T03
3	345271	250	16	1CO	F6.3	150	23	T03

Diagrams may be found at the end of the chapter

heavy duty version



fig.	GEV No.	volt. (V)	SC (A)	function	connection	L1 (mm)	act.F. (g)	diagram
1	345045	250	16	1CO	solder connection	55	95	T03
2	345266	250	16	1CO	solder connection	39	125	T03
3	345485	250	20	1CO	screw	49	75	T03



fig.	GEV No.	volt. (V)	SC (A)	function	connection	L (mm)	act.F. (g)	diagram
1	300158	250	8	1CO	cable	31	300	T03
2	346232	250	16	1CO	F6.3	38	30	T03
3	347160	250	16	1CO	F6.3	59.5	35	T03
4	347764	250	5	1NO/1NC	F6.3	35	100	T08

Diagrams may be found at the end of the chapter



fig.	GEV No.	volt. (V)	SC (A)	function	connection	L1 (mm)	act.F. (g)	diagram
4	346874	250	16	1CO	screw	49	120	T03
5	347718	250	16	1CO	screw	39	50	T03

Diagrams may be found at the end of the chapter

roller-lever actuated microswitches

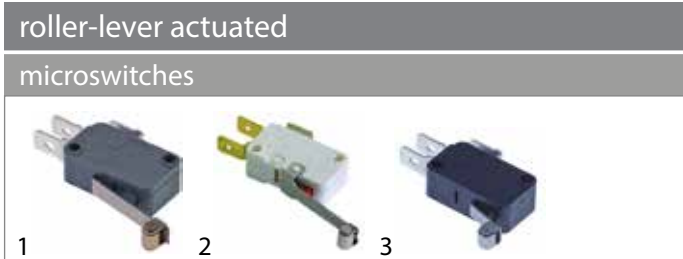



fig.	GEV No.	volt. (V)	SC (A)	function	connection	L1 (mm)	diagram
1	345250	250	16	1CO	F6.3	36	T03
2	345251	250	16	1CO	F6.3	42	T03
3	345252	250	16	1CO	F6.3	19	T03

with mounting components



technical data:
voltage 250V

fig.	GEV No.	SC (A)	function	connection	L1 (mm)	act.F. (g)	diagram
1	346876	16	1CO	male faston	28	86	T03
2	347528	10	1CO	F6.3		120	T03

Diagrams may be found at the end of the chapter

Зип-Общепит

vsezip.ru

+7(812)987-08-31

non-standard



fig.	GEV No.	volt. (V)	SC (A)	function	connection	L1 (mm)	act.F. (g)	diagram
1	347026	250	5	1CO	solder connection	20	55	T03

fig.	GEV No.	volt. (V)	SC (A)	function	connection	act.F. (g)	diagram
9	347785	250	15	1CO	F4.8	190	T03
9	347795	250	15	1CO	F4.8	180	T03

Diagrams may be found at the end of the chapter

pin-plunger actuated



fig.	GEV No.	volt. (V)	SC (A)	function	connection	act.F. (g)	diagram
1	300092	400	16	2NO	F6.3	150	T07
2	345247	250	6	2NO	F6.3	350	T07
3	345285	400	16	2NO	F6.3	400	T07
4	305004	250	16	1NO/1NC	F6.3	500	T08
4	345326	250	16	1NO	F6.3	350	T01

M10



fig.	GEV No.	TL (mm)	SC (A)	function	stroke (mm)	act.F. (g)	diagram
1	346864	6	10	1NO	3	200	T01
2	347288	10	16	1NO	6	160	T01
3	347603	10	16	1CO	5	170	T03
4	347772	12	16	1CO	2.5	460	T03



fig.	GEV No.	volt. (V)	SC (A)	function	connection	act.F. (g)	diagram
5	345060	250	16	1NO	F6.3	350	T01
5	345061	250	16	1NC	F6.3	350	T02
5	345062	250	16	1NO/1NC	F6.3	350	T08

Diagrams may be found at the end of the chapter



fig.	GEV No.	TL (mm)	SC (A)	function	stroke (mm)	act.F. (g)	diagram
5	347945 ¹	13	5	1CO	6	340	T03
6	346347	14	6	2NO	4	100	T07
7	347216	14	10	1CO	7.5	260	T03
8	347482	14	16	1CO	3	250	T03

¹protection class IP65



fig.	GEV No.	volt. (V)	SC (A)	function	connection	act.F. (g)	diagram
1	345105	250	10	1CO	F6.3	280	T03
1	347411	250	10	1CO	F6.3	46	T03
2	346158	250	5	1CO	F4.8	120	T03
3	347043	250	16	1NC	F4.8	140	T02
3	348015	250	16	1NO	F4.8	120	T01
3	348114	250	16	1NO	F4.8	230	T01
4	347757	250	16	1CO	F4.8	120	T03



fig.	GEV No.	TL (mm)	SC (A)	function	stroke (mm)	act.F. (g)	diagram
9	347762	14	16	2NO	4	650	T07
10	345678	16	16	1NO	2.5	290	T01
11	347862	18	10	1CO	4	240	T03
12	348013	20	6	1NO	5.8	360	T01



fig.	GEV No.	volt. (V)	SC (A)	function	connection	act.F. (g)	diagram
5	345042	250	16	1CO	F6.3	75	T03
5	347217	250	16	1CO	F6.3	20	T03
6	347793	250	16	1NO	F6.3	280	T01
7	344000	250	15	1CO	F6.3	340	T03
7	347847	250	4	1CO	F6.3	240	T03
8	347785	250	15	1NO	F4.8	195	T01
8	347798	250	15	1NO	F4.8	200	T01



fig.	GEV No.	TL (mm)	SC (A)	function	stroke (mm)	act.F. (g)	diagram
13	346369	27	16	1CO	14	150	T03
14	345032	12	16	1CO	7	180	T03
15	345156	13	16	1CO	6	340	T03
16	347004	16	10	1NO	8	160	T01

Diagrams may be found at the end of the chapter



Зип Общепит

vsezip.ru

+7(812)987-08-81



17

fig.	GEV No.	TL (mm)	SC (A)	function	stroke (mm)	act.F. (g)	diagram
17	347341	16	10	1NO	5	130	TU1

M12



fig.	GEV No.	TL (mm)	volt. (V)	SC (A)	function	connection	stroke (mm)	act.F. (g)	diagram
1	348014	12	240	1	1CO	F6.3	7	200	T03
2	345810	14	230	12	1CO	F6.3	2	2000	T03
3	347865	14	250	12	1CO	F6.3	2	500	T03
4	345350	16	250	16	1CO	F6.3	4	66	T03



fig.	GEV No.	TL (mm)	volt. (V)	SC (A)	function	connection	stroke (mm)	act.F. (g)	diagram
5	345679	9	250	5	1CO	F6.3	5	680	T03
6	345138	12	250	20	1CO	screw	7	250	T03
7	345258	14	250	16	1CO	F6.3	6	330	T03
8	345694	14	250	16	1CO	screw	4	350	T03



fig.	GEV No.	TL (mm)	volt. (V)	SC (A)	function	connection	stroke (mm)	act.F. (g)	diagram
9	348061	14	250	10	1CO	screw	10	560	T03
10	347586	66	400	20	1CO	screw	8	500	T03

Diagrams may be found at the end of the chapter

M16



technical data:
voltage 250V
switching capacity 5A

fig.	GEV No.	TL (mm)	function	connection	stroke (mm)	act.F. (g)	diagram
1	345046	25	1NC/1NO	F6.3	6	400	T28
2	345047	27	1NO	cable	5	400	T01

Diagrams may be found at the end of the chapter



fig.	GEV No.	TL (mm)	volt. (V)	SC (A)	function	connection	act.F. (g)	diagram
1	345425	15	250	16	1CO	F6.3	500	T03
2	345811	14	250	12	2CO	F6.3	1800	T12
3	346289	14	250	4	1CO	cable	250	T03

Diagrams may be found at the end of the chapter

non-standard



fig.	GEV No.	volt. (V)	SC (A)	function	connection	act.F. (g)	diagram
1	344001	250	15	1CO	screw	390	T03
2	345460	250	15	1NO	F6.3	850	T01
3	347189	250	0.1	1CO	F2.8	25	T03

Diagrams may be found at the end of the chapter

with push button

gas ignition



technical data:
voltage 250V
connection male faston 6.3mm

fig.	GEV No.	SC (A)	function	type	act.F. (g)	diagram
1	100038	16	1CO	KW3-OZ	350	T03
2	347250	12	1NO	VRSR03AA1	200	T01

Diagrams may be found at the end of the chapter

switches with snap-fit



fig.	GEV No.	volt. (V)	SC (A)	function	connection	act.F. (g)	diagram
1	345249	250	0.25	1NO	F6.3	500	T01
2	346166	250	4	1NO	F6.3	150	T01
3	346569	250	0.1	1NC	F6.3	146	T02
4	346724	250	0.25	1NO	F4.8	900	T01



fig.	GEV No.	volt. (V)	SC (A)	function	connection	act.F. (g)	diagram
5	346772	250	5	1CO	F4.8	160	T03
6	347018	250	1	1CO	F2.8	60	T03
7	347027	250	1	1CO	F2.8	50	T03
8	347057	250	2.5	1CO	F4.8	300	T03

Зип.Общепит

vsezip.ru

+7(812)987-08-81



fig.	GEV No.	volt. (V)	SC (A)	function	connection	act.F. (g)	diagram
9	347163	250	1	1NO	F6.3	250	T01
10	347393	250	3	1CO	F6.3	200	T03
11	347587	250	1	1CO	F2.8	50	T03
12	347801	250	0.5	1NC	F4.8	150	T02

Diagrams may be found at the end of the chapter



fig.	GEV No.	volt. (V)	SC (A)	function	connection	act.F. (g)	diagram
13	348008	250	2.5	1NO/1NC	F2.8/F6.3	180	T08

roller actuated

roller 0°



fig.	GEV No.	function	connection	TL (mm)	TS	act.F. (g)	diagram
1	345639	1CO	solder/screw	14	M10	300	T03
2	346370	1CO	screw	14	M10	300	T03

Diagrams may be found at the end of the chapter



fig.	GF / No.	SC (A)	connection	TL (mm)	TS	act.F. (g)	diagram
1	345104	16	F6.3	12	M10x0.75	280	T03
2	347096	20	screw	14.5	M12x1	370	T03

Diagrams may be found at the end of the chapter

non-standard



fig.	GEV No.	MD (mm)	SC (A)	function	connection	diagram
1	301207	24	0.5	NO	F4.8	T01
2	346888	97	16	3CO	F6.3	T18

Diagrams may be found at the end of the chapter



fig.	GEV No.	MD (mm)	SC (A)	function	connection	diagram
3	346962	22	16	2CO	F6.3	T12

position switches

BERNSTEIN



fig.	GEV No.	version	function	volt. (V)	SC (A)	L (mm)	W (mm)	H (mm)	protection	act.F. (g)	screw connection	MD (mm)	diagram
1	345921	with roller	1NO/1NC	500	10	108	36	33	IP65	1280	M20	25	T08
2	345922	with knee switch	1NO/1NC	240	3	51	26	21	IP30	580	-	15	T08
3	347965	with handle with a switch	1NO/1NC	500	10	108	36	33	IP65	1000	M20	25	T08

Diagrams may be found at the end of the chapter

BREMAS



fig.	GEV No.	version	function	volt. (V)	SC (A)	L (mm)	W (mm)	H (mm)	protection	act.F. (g)	screw connection	MD (mm)	diagram
1	346405	plastic	1NO/1NC	230	6	89	31	33	IP66	950	M19	20	T08



Зип Общепит

vsezip.ru

+7(812)987-08781

LOVATO



fig.	GEV No.	version	function	volt. (V)	SC (A)	L (mm)	W (mm)	H (mm)	protection	act.F. (g)	screw connection	MD (mm)	diagram
1	347579	plastic	1NO/1NC	400	3	110	30	44	IP66/67	380	M16	22	T08
2	347908	plastic	1NO/1NC	400	3	110	30	44	IP66/67	380	M16	22	T08

Diagrams may be found at the end of the chapter

PIZZATO

FA series



fig.	GEV No.	version	function	volt. (V)	SC (A)	L (mm)	W (mm)	H (mm)	protection	act.F. (g)	MD (mm)	diagram
1	300137		1NO/1NC	400	3	49	30	16	IP67	1000	20	T08
2	345696		1NO/1NC	400	3	86	30	16	IP67	1000	20	T08

Diagrams may be found at the end of the chapter

FB series



fig.	GEV No.	version	function	volt. (V)	SC (A)	L (mm)	W (mm)	H (mm)	protection	act.F. (g)	MD (mm)	diagram
1	346175		1NO/1NC	400	3	52	39	16	IP67	1000	25	T08

FD series



fig.	GEV No.	version	function	volt. (V)	SC (A)	L (mm)	W (mm)	H (mm)	protection	act.F. (g)	screw connection	MD (mm)	diagram
1	345057		1NO/1NC	400	3	98	40	35	IP67	450	PG13.5	30x60	T08
2	345058		1NC/1NO	400	3	92	40	35	IP67	900	PG13.5	30x60	T08
3	345075		1NO/1NC	400	3	141	40	35	IP67	300	PG13.5	30x60	T08
4	345862		1NO/1NC	400	3	118	40	35	IP67	500	PG13.5	30x60	T08

Diagrams may be found at the end of the chapter

FR series



fig.	GEV No.	version	function	volt. (V)	SC (A)	L (mm)	W (mm)	H (mm)	protection	act.F. (g)	screw connection	MD (mm)	diagram
1	345144	plastic	1NC/1NO	400	3	92	31	31	IP67	360	PG13.5	22	T08
2	345181	plastic	1NC/1NO	400	3	92	31	31	IP67	450	PG13.5	22	T08
3	345209	plastic	1NO/1NC	400	3	104	31	31	IP67	350	M20	22	T08
4	345337	plastic	1NO/1NC	400	3	83	31	31	IP67	900	PG11	20	T08
5	345338	plastic	1NO/1NC	400	3	85	31	31	IP67	790	PG11	22	T08
6	345389	plastic	1NC/1NO	400	3	92	31	31	IP67	300	PG13.5	22	T08
7	345488	plastic	1NC/1NO	400	3	92	31	31	IP67	750	PG13.5	22	T08



Зип Общепит

vsezip.ru

+7(812)987-08-81



fig.	GEV No.	version	function	volt. (V)	SC (A)	L (mm)	W (mm)	H (mm)	protection	act.F. (g)	screw connection	MD (mm)	diagram
8	345509	plastic	1NO/1NC	400	3	80	31	31	IP67	250	PG13.5	20	T08
9	345513	plastic	1NO/1NC	400	3	74	31	31	IP67	75	PG13.5	22	T08
10	347052	plastic	1NC/1NO	400	3	92	31	31	IP67	300	PG13.5	22	T08
11	347958	plastic	2NO	400	3	75	31	31	IP67	350	PG13.5	22	T07
12	347985	plastic	1NO/1NC	400	3	80	31	31	IP67	500	PG13.5	22	T08
13	348101	plastic	1NC/1NO	400	3	85	31	31	IP67	760	PG11	22	T08

Diagrams may be found at the end of the chapter

TELEMECANIQUE (EFA)



fig.	GEV No.	version	function	volt. (V)	SC (A)	L (mm)	W (mm)	H (mm)	protection	act.F. (g)	screw connection	MD (mm)	diagram
1	346807	plastic	1NO/1NC	400	3	116.7	40	36	IP67	1800	M19	30x60	T08
2	347579	plastic	1NO/1NC	400	3	110	30	44	IP66/67	380	M16	22	T08
3	347636	plastic	1NC/1NO	400	6	50	30	16	IP65	560	-	20	T08
4	347903	plastic	1NO/1NC	400	3	110	30	44	IP66/67	380	M16	22	T08

Diagrams may be found at the end of the chapter

toggle switches



fig.	GEV No.	description
1	301198	swing switch 2NO/2NC 10A L 85mm

system switches (ROLD)

D13 series

19.3x12.9mm

element holders



fig.	GEV No.	colour	for push buttons
1	345577	black	11x15.8

indicator light lenses



fig.	GEV No.	size (mm)	colour	symbol
1	346617	11x15.8	green	-

D16 series

ø16mm

element holders



fig.	GEV No.	version	colour	fig.	GEV No.	version	colour
1	347308	arched	black	3	359241	flat	grey
2	345536	flat	black	4	347276	flat	silver

push buttons

flat



fig.	GEV No.	colour	fig.	GEV No.	colour	fig.	GEV No.	colour
1	345538	black	3	346202	green	5	346204	red
2	346205	blue	4	359243	grey	6	346203	yellow



Зип Общепит
vsezip.ru
7(812)987-08-81

curved

fig.	GEV No.	colour	symbol
1	347309	black	coffee
2	347310	black	cup warmer
3	347315	black	light
4	347282	chrome-plated	0-1
5	347680	chrome-plated	1-2
6	347466	gold	-

fig.	GEV No.	size (mm)	colour	symbol	symbol colour
6	345545	17x13	grey	drain pump	white
7	347810	17x13	grey	start	white
8	346035	17x13	silver	-	-
9	347751	17x13	silver	0-I	gold
10	347752	17x13	silver	crossed out flame	gold

blanks

fig.	GEV No.	description	colour
1	359244	blank ø 12,2mm grey (RAL7001)	grey (RAL7001)
2	359249	blank ø 12,2mm grey (RAL7015)	grey (RAL7015)

fig.	GEV No.	size (mm)	colour	symbol	symbol colour
11	348032	17x13	silver	fan speed	black
12	347750	17x13	silver	steam	gold
13	346572	17x13	yellow	-	-

indicator light lenses

fig.	GEV No.	ø (mm)	colour	fig.	GEV No.	ø (mm)	colour
1	346808	12.2	blue	4	359245	12.2	red
2	346228	12.2	clear	5	359246	12.2	yellow
3	359247	12.2	green				

indicator light lenses

fig.	GEV No.	size (mm)	colour	symbol	symbol colour
1	346814	17x13	blue	-	-
2	357223	17x13	blue	Sinus	gold
3	357226	17x13	blue	thermometer	gold
4	346813	17x13	clear	-	-
5	346811	17x13	green	-	-

20.6x16.4mm element holders

fig.	GEV No.	colour	fig.	GEV No.	colour
1	345627	black	3	347182	chrome-plated
2	346846	blue	4	357225	gold

fig.	GEV No.	size (mm)	colour	symbol	symbol colour
6	347749	17x13	green	crossed out flame	gold
7	347748	17x13	green	Sinus	gold
8	347747	17x13	green	steam	gold
9	347746	17x13	green	thermometer	gold
10	346815	17x13	grey	dummy cap	-

fig.	GEV No.	colour	fig.	GEV No.	colour
5	345537	grey	6	357224	silver

fig.	GEV No.	size (mm)	colour	symbol	symbol colour
11	346812	17x13	orange	-	-
12	346823	17x13	red	-	-

push buttons

fig.	GEV No.	size (mm)	colour	symbol	symbol colour
1	345621	17x13	black	-	-
2	346810	17x13	blue	-	-
3	347181	13x17mm	chrome-plated	-	-
4	346809	17x13	green	-	-
5	345539	17x13	grey	-	-

23.6x14.6mm element holders

fig.	GEV No.	MM (mm)	colour	version
1	347150	23.6x14.6	grey	arched
2	347151	23.6x14.6	white	arched

Зип Общепит

vsezip.ru

+7(812)987-08-81

push buttons



fig.	GEV No.	size (mm)	colour	fig.	GEV No.	size (mm)	colour
1	347152	11x21	blue	2	347922	11x21	silver

D25 series

element holders



fig.	GEV No.	ø (mm)	colour
1	346848		grey
2	347400		light blue
3	347256	25	chrome-plated

push buttons



fig.	GEV No.	ø (mm)	colour	symbol	version
1	347469	21	blue	regeneration	-
2	347099	21	blue	START	-
3	347255	21	chrome-plated	-	-
4	347850	21	dark blue	-	-
5	347399	21	dark blue	ON-OFF	-
6	347470	21	grey	-	with lens



fig.	GEV No.	ø (mm)	colour	symbol	version
7	347842	21	grey	-	-
8	347517	21	silver	-	-
9	347705	21	silver	-	with lens

Domino ST series

element holders



fig.	GEV No.	MM (mm)	colour	version
1	346498	28.5x28.5	black	single element holder
2	345131	28.5x28.5	grey	single element holder
3	346499	28.5x52.6	black	twofold element holder



fig.	GEV No.	MM (mm)	colour	version
4	346200	28.5x52.6	grey	twofold element holder
5	346500	28.5x77.5	black	threefold element holder
6	346201	28.5x77.5	grey	threefold element holder

push buttons



fig.	GEV No.	ø (mm)	colour	symbol	version
1	346816	23	black	-	-
2	346501	23	black	-	with lens
3	346626	23	black	arrow	-
4	346820	23	black	cup	with lens
5	346032	23	black	flash	with lens
6	347872	23	black	programme	-

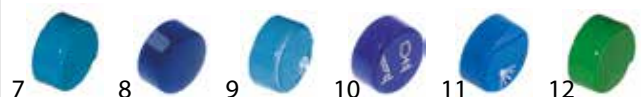

fig.	GEV No.	ø (mm)	colour	symbol	version
7	346818	23	blue	-	-
8	553001	23	blue	-	-
9	346822	23	blue	-	with lens
10	347145	23	blue	programme	-
11	345848	23	blue	rinsing	-
12	345132	23	green	-	-



fig.	GEV No.	ø (mm)	colour	symbol	version
13	346210	23	green	-	with lens
14	346212	23	green	main switch	with lens
15	347871	23	green	main switch	with lens
16	345852	23	green	outflow	-
17	345847	23	green	start	-
18	345133	23	grey	-	-



fig.	GEV No.	ø (mm)	colour	symbol	version
19	346211	23	grey	-	with lens
20	346258	23	grey	arrow	-
21	346256	23	grey	clock	no lens
22	346259	23	grey	double arrow	-

Table continues overleaf



Зип Общепит
vsezip.ru
+7(812)987-08-81



fig.	GEV No.	ø (mm)	colour	symbol	version
23	346255	23	grey	drain pump	-
24	346253	23	grey	main switch	-
25	347686	23	grey	outflow	-
26	345523	23	grey	programme	-
27	346254	23	grey	programme	-
28	345849	23	grey	regeneration	-



fig.	GEV No.	ø (mm)	colour	symbol
6	346268	23.3	green	water
7	346242	23.3	red	-
8	346241	23.3	yellow	-



fig.	GEV No.	ø (mm)	colour	symbol	version
29	345850	23	grey	rinsing	-
30	346257	23	grey	rinsing	-
31	345851	23	grey	start	-
32	346265	23	grey	start	-
33	346819	23	red	-	-
34	345524	23	red	ON-OFF	-

blanks



fig.	GEV No.	ø (mm)	colour	symbol	version
1	346233	23.3	grey	-	-



fig.	GEV No.	ø (mm)	colour	symbol	version
35	346817	23	white	-	-
36	553000	23	white	-	-
37	346821	23	white	-	with lens
38	347475	23	white	main switch	-
39	347929	23	white	programme	-
40	347930	23	white	regeneration	-

Domino SQ series

element holders



fig.	GEV No.	version	MM (mm)	colour
1	345604	single	28.5x28.5	black
2	347592	single	28.5x28.5	grey
3	345602	double	28.5x52.6	black



fig.	GEV No.	ø (mm)	colour	symbol	version
41	346570	23	yellow	-	-
42	347439	23	yellow	-	-
43	346663	23	yellow	-	with lens

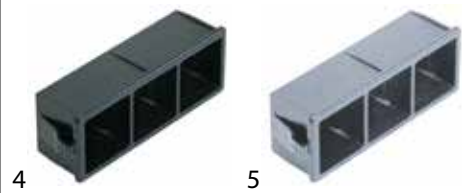

fig.	GEV No.	version	MM (mm)	colour
4	345603	triple	28.5x77.5	black
5	347620	triple	28.5x77.5	grey

indicator light lenses



fig.	GEV No.	ø (mm)	colour	symbol
1	346244	23.3	blue	-
2	346243	23.3	clear	-
3	346240	23.3	green	-
4	346269	23.3	green	boiler
5	346267	23.3	green	thermometer

push buttons



fig.	GEV No.	size (mm)	colour	symbol	version
1	345727	23x23	black	0-1	with lens
2	346494	23x23	black	-	-
3	346492	23x23	black	-	with lens
4	345618	23x23	black	cold rinsing	-
5	345613	23x23	black	drain pump	-
6	345660	23x23	black	flash	with lens



fig.	GEV No.	size (mm)	colour	symbol	version
7	345726	23x23	black	light	with lens
8	345607	23x23	black	main switch	with lens
9	345725	23x23	black	moisture	with lens
10	345615	23x23	black	programme	-
11	345611	23x23	black	rinsing	-
12	346230	23x23	black	Sinus	with lens



fig.	GEV No.	size (mm)	colour	symbol	version
37	345213	23x23	grey	-	with lens
38	34 875	23x23	grey	-	with lens
39	346215	23x23	white	-	-
40	346219	23x23	white	-	with lens
41	346214	23x23	yellow	-	-
42	347889	23x23	yellow	drain pump	-



fig.	GEV No.	size (mm)	colour	symbol	version
13	345609	23x23	black	start	-
14	346261	23x23	black	start	-
15	345661	23x23	black	timer	-
16	346231	23x23	black	timer	with lens
17	345745	23x23	black	ventilation	with lens
18	346216	23x23	blue	-	-



fig.	GEV No.	size (mm)	colour	symbol	version
43	347484	23x23	yellow	ON-OFF	with lens
44	347765	23x23	yellow	programme	-
45	347890	23x23	yellow	regeneration	-
46	347888	23x23	yellow	START	-



fig.	GEV No.	size (mm)	colour	symbol	version
19	347895	23x23	blue	-	-
20	346220	23x23	blue	-	with lens
21	347892	23x23	blue	drain pump	-
22	346260	23x23	blue	drying	with lens
23	347893	23x23	blue	ON-OFF	with lens
24	347701	23x23	blue	programme	-

indicator lights accessories



fig.	GEV No.	size (mm)	colour	symbol
1	346248	23x23	blue	-
2	346247	23x23	clear	-
3	346245	23x23	green	-
4	346264	23x23	green	programme
5	346249	23x23	green	temperature

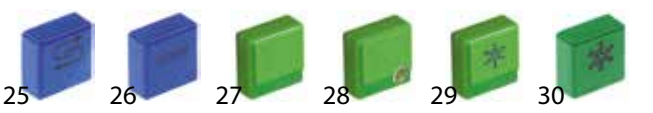

fig.	GEV No.	size (mm)	colour	symbol	version
25	347891	23x23	blue	regeneration	-
26	347894	23x23	blue	START	-
27	346213	23x23	green	-	-
28	346217	23x23	green	-	with lens
29	346225	23x23	green	cold rinsing	-
30	347896	23x23	green	cold rinsing	-



fig.	GEV No.	size (mm)	colour	symbol
6	346250	23x23	green	washing cycle
7	346246	23x23	yellow	-
8	346263	23x23	yellow	temperature



fig.	GEV No.	size (mm)	colour	symbol	version
31	347590	23x23	green	drain pump	-
32	346223	23x23	green	drain pump	with lens
33	346221	23x23	green	ON-OFF	with lens
34	346224	23x23	green	regeneration	-
35	346222	23x23	green	start	-
36	346493	23x23	grey	-	-

blanks



fig.	GEV No.	size (mm)	colour	symbol
1	345612	23x23	black	-
2	345724	23x23	black	MIN/MED/MAX
3	346229	23x23	grey	-



Зип Общепит

vsezip.ru

+7(812)987-08-81

Domino SR series

indicator light lenses



fig.	GEV No.	colour	symbol
1	345733	yellow	defrosting

push buttons



fig.	GEV No.	L (mm)	W (mm)	colour	symbol
1	345732	25	19.5	black	ventilation
2	345737	25	19.5	black	0-1
3	345738	25	19.5	black	moisture
4	345739	25	19.5	black	-
5	345740	25	19.5	black	light
6	345746	25	19.5	black	light
7	346952	25	19.5	black	-

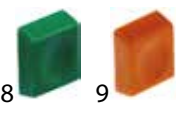

fig.	GEV No.	L (mm)	W (mm)	colour	symbol
8	346950	25	19.5	green	-
9	346951	25	19.5	orange	-

indicator lamps



fig.	GEV No.	volt. (V)	colour	ø (mm)	diagram
1	345428	230	red	-	X01
2	345601	-	-	11	
3	345734	230	green	-	X01
4	359350	230	blue	11	
5	360598	250	white	11	

Diagrams may be found at the end of the chapter

miscellaneous



fig.	GEV No.	description
1	345723	adjusting screw
2	345741	bezel for thermostat black MIN/MED/MAX

D85 SB series

push buttons



fig.	GEV No.	ø (mm)	colour	symbol
1	346830	23	black	-
2	347136	23	blue	-
3	347137	23	blue	heating
4	347863	23	green	-
5	346949	23	green	ON-OFF
6	347133	23	green	rinsing warm/cold



fig.	GEV No.	ø (mm)	colour	symbol
7	345833	23	grey	-
8	347141	23	grey	-
9	347139	23	grey	cycle
10	347144	23	grey	drain pump
11	347142	23	grey	heating
12	347138	23	grey	ON-OFF



fig.	GEV No.	ø (mm)	colour	symbol
13	347148	23	grey	programme
14	347143	23	grey	regeneration
15	347140	23	grey	rinsing warm/cold
16	346947	23	orange	cycle
17	346948	23	orange	drain pump
18	347845	23	orange	NORMAL/HEAVY



fig.	GEV No.	ø (mm)	colour	symbol
19	347146	23	orange	programme
20	347132	23	orange	regeneration
21	346829	23	white	-
22	345834	23	yellow	-

D83 SB series

element holders



fig.	GEV No.	MM (mm)	colour
1	346828	27.8x27.8	black

Зип-Общепит

vsezip.ru

+7(812)987-08-81

push buttons



fig.	GEV No.	ø (mm)	colour	symbol
1	346832	23	green	start
2	346833	23	grey	cooling
3	345829	23	grey	drain pump
4	346831	23	grey	I, II
5	346827	23	grey	regeneration
6	345827	23	grey	Sinus



fig.	GEV No.	ø (mm)	colour	symbol
7	345828	23	yellow	start / I
8	347989	23	yellow	start / II

switches

D13-D16/Domino SQ-ST-SR series



fig.	GEV No.	description	function	volt. (V)	SC (A)	connection	diagram
1	347676	switch	1NO	250	16	F6.3	T01
2	345130	momentary switch unit	1NO	250	16	F6.3	T01
2	345722	switch	1NO	250	16	F6.3	S01
3	345980	momentary switch unit	2NO	250	16	F6.3	T07
3	345720	switch	2NO	250	16	F6.3	S07
4	345546	momentary switch unit	1CO	250	16	F6.3	T03
4	345719	switch	1CO	250	16	F6.3	T03



fig.	GEV No.	description	function	volt. (V)	SC (A)	connection	diagram
5	345605	switch	2CO	250	16	F6.3	S12
5	347098	switch	2CO	250	16	F6.3	S12
5	345606	momentary switch unit	2CO	250	16	F6.3	T12
6	347678	switch	2NO	250	16	F6.3	S07
7	345651	switch	2CO	250	16	F6.3	S12
7	345650	momentary switch unit	2CO	250	16	F6.3	T12

Diagrams may be found at the end of the chapter

D25 series



fig.	GEV No.	description	function	volt. (V)	SC (A)	connection	diagram
1	347841	switch	1CO/1NO	250	16	F6.3	S25

D83 SB series



fig.	GEV No.	description	function	volt. (V)	SC (A)	connection	diagram
1	345832	momentary switch unit	1CO	250	16	F6.3	S03
2	347193	momentary switch unit	1NO	250	16	F6.3	T01
3	347277	momentary switch unit	1NO	250	16	F6.3	T01



fig.	GEV No.	description	function	volt. (V)	SC (A)	connection	diagram
4	345831	switch	2CO	250	16	F6.3	S12
5	346851	switch	2CO	250	16	F6.3	S12
6	345141	switch	2NO	250	16	F6.3	S07



fig.	GEV No.	description	function	volt. (V)	SC (A)	connection	diagram
7	345720	switch	2NO	250	16	F6.3	S07
8	347192	switch	2NO	250	16	F6.3	S07
9	347547	switch	2NO	250	16	F6.3	T07

Diagrams may be found at the end of the chapter

D83 SB series



fig.	GEV No.	description	function	volt. (V)	SC (A)	connection	diagram
1	345825	momentary switch unit	1NO	250	16	F6.3	T01
2	346913	switch	1NO	250	16	F6.3	S01
3	345826	switch	2CO	250	16	F6.3	T12

Diagrams may be found at the end of the chapter



fig.	GEV No.	description	function	volt. (V)	SC (A)	connection	diagram
4	345824	switch	2NO	250	16	F6.3	S07



Зип Общежит

vsezip.ru

+7(812)987-08-81

rotating discs

D25 series



1

technical data:
disc diameter 19,7mm

fig.	GEV No.	colour
1	346847	green/black

Domino SR series



1

technical data:
disc diameter 16,9mm

fig.	GEV No.	colour
1	345731	red/black

Domino SQ-ST series



1 2 3

technical data:
disc diameter 20,6mm

fig.	GEV No.	colour	fig.	GEV No.	colour
1	345608	green/black	3	346251	orange/green
2	346665	green/grey			



4 5 6

technical data:
disc diameter 20,6mm

fig.	GEV No.	colour	fig.	GEV No.	colour
4	346824	red/black	6	346364	red/white
5	346262	red/grey			

indicator lamps



1 2 3

fig.	GEV No.	volt. (V)	colour	ø (mm)	fig.	GEV No.	volt. (V)	colour	ø (mm)
1	345601	-	-	11	3	360598	250	white	11
2	359350	230	blue	11					

blank holders



1

fig.	GEV No.	description
1	345721	blank cap holder

CARIMALI

push buttons



1

fig.	GEV No.	Ref. No.
1	347181	95.01735

switches



1

fig.	GEV No.	description	diagram	Ref. No.
1	345720	switch 2NO 250 V 16 A connection male faston 6.3mm	S07	96.00786

DIHR / KROMO

oval

element holders

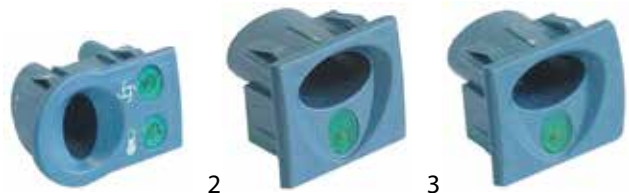

1 2 3

fig.	GEV No.	description	Ref. No.
1	345906	element holder blue-grey mounting pos. left temperature / pump illuminable	DW89301
2	345897	element holder blue-grey mounting pos. centre illuminable	DW89302
3	345898	element holder blue-grey mounting pos. right illuminable	DW89304



4 5

fig.	GEV No.	description	Ref. No.
4	345895	element holder blue-grey shape oval illuminable	DW89300
5	345899	blank housing blue-grey	DW89303

push buttons



1 2 3 4

fig.	GEV No.	colour	symbol	Ref. No.
1	345888	black	START	DW89341
2	345894	blue-grey	-	DW89348
3	345891	blue-grey	cold rinsing	DW89344
4	345890	blue-grey	drain pump	DW89343



fig.	GEV No.	colour	symbol	Ref. No.
5	345887	blue-grey	ON-OFF	DW89340
6	345893	blue-grey	ON-OFF	DW89346
7	345889	blue-grey	programme	DW89342
8	345892	blue-grey	regeneration	DW89345
9	345907	blue-grey	START	DW89347



fig.	GEV No.	symbol	Ref. No.
5	345879	point	DW560526/A
6	345886	point	DW560538
7	345883	programme	DW560530/A
8	345884	regeneration	DW560531/A

switches



fig.	GEV No.	description	diagram	Ref. No.
1	345546	momentary switch unit 1CO 250V 16A connection male faston 6,3mm	T03	DW15813
2	345606	momentary switch unit 2CO 250V 16A connection male faston 6,3mm	T12	DW15811/A
2	345605	switch 2CO 250 V 16 A connection male faston 6.3mm	S12	DW15811
3	345980	momentary switch unit 2NO 250V 16A connection male faston 6,3mm	T07	DW15800
3	345720	switch 2NO 250 V 16 A connection male faston 6.3mm	S07	DW15812



fig.	GEV No.	symbol	Ref. No.
9	345882	START	DW560514

Diagrams may be found at the end of the chapter

accessories

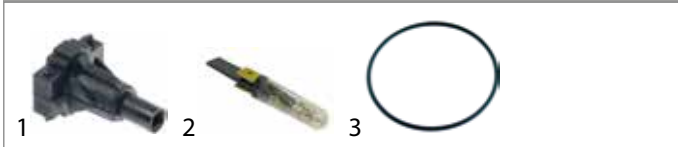

fig.	GEV No.	description	Ref. No.
1	345721	blank cap holder	DW15844
2	359132	indicator lamp green illuminant 250V connection male faston 6,3mm	DW15826
3	345896	O-ring EPDM thickness 1,5mm ID ø 37mm Qty 1 pcs	DW89332

switches



fig.	GEV No.	description	diagram	Ref. No.
1	345546	momentary switch unit 1CO 250V 16A connection male faston 6,3mm	T03	DW15813
2	345606	momentary switch unit 2CO 250V 16A connection male faston 6,3mm	T12	DW15811/A
2	345605	switch 2CO 250 V 16 A connection male faston 6.3mm	S12	DW15811
3	345980	momentary switch unit 2NO 250V 16A connection male faston 6,3mm	T07	DW15800
3	345720	switch 2NO 250 V 16 A connection male faston 6.3mm	S07	DW15812

Diagrams may be found at the end of the chapter

round

push buttons



fig.	GEV No.	symbol	Ref. No.
1	345885	cold rinsing	DW560534/A
2	345881	drain pump	DW560528/A
3	345880	ON-OFF	DW560512
4	345878	point	DW560523/A

accessories



fig.	GEV No.	description	Ref. No.
1	345721	blank cap holder	DW15844

rectangular



fig.	GEV No.	description	diagram	Ref. No.
1	347589	push button size 11x15,5mm green START		DW15835
2	347591	element holder 13x20mm green shape rectangular		DW15834
3	345546	momentary switch unit 1CO 250V 16A connection male faston 6,3mm	T03	DW15813
4	347193	momentary switch unit 1NO 250V 16A connection male faston 6,3mm	T01	DW15813

Diagrams may be found at the end of the chapter



Зип Общежит

vsezip.ru

+7(812)987-08-81

ELETTROBAR

fascias

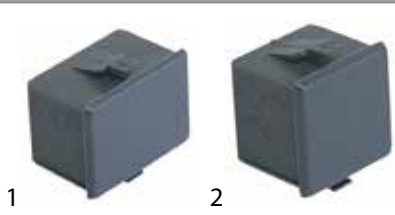

fig.	GEV No.	description
1	345655	blank grey shape rectangular
2	345652	blank grey shape square

push buttons



fig.	GEV No.	description
1	345658	push button
2	345659	push button
3	347523	push button ø 12mm black H 7mm
4	347522	push button ø 20mm green H 11mm



fig.	GEV No.	description
5	347922	push button size 11x21mm silver

fig.	GEV No.	description
1	345653	element holder grey shape square suitable for

IME-OMNIWASH

push buttons



fig.	GEV No.	Ref. No.	fig.	GEV No.	Ref. No.
1	347983	CETPCBSIM	2	347726	CETPCSIM

RST-FIAMMA

switches



fig.	GEV No.	description	diagram	Ref. No.
1	345722	switch 1NO 250 V 16 A connection male faston 6.3mm	S01	—

float switches



fig.	GEV No.	TS	ø (mm)	L (mm)	mounting ø (mm)	volt. (V)	SC (A)	CL (mm)	suitable for
1	347381	10.8	20	40	10.8	250	0.5	170	Bonamat
1	347328	M10x1.5	25	50	11	250	0.5	300	Animo
1	347418	M10x1.5	26/27	52	10	250	0.5	260	Marco
1	347672	M12	30	74	12	250	0.5	500	ITV
2	401442	1/4"	28	70	1/4"	250	0.5	2100	Scholl
3	403494	1/4" NPT	52	90	14	240	0.4	910	Pitco
3	347959	1/4" NPT	53	90	14	250	0.4	600	Meiko
4	348087	1/8"	30	110	10	300	0.5	1600	Cookmax Henkelman
4	401986	1/8"	28	116	10	220	0.5	330	Cookmax Olis
4	402061	9.7	26	130	10	230	0.5	500	Cookmax Hatco
5	400023	3/8"	30	170	3/8"	250	0.5	2000	Küppersbusch Rational

Зип Общепит

vsezip.ru

+7(812)987-08-81

fig.	GEV No.	TS	ø (mm)	L (mm)	mounting ø (mm)	volt. (V)	SC (A)	CL (mm)	suitable for
1	347654	M16x2	17	70	16	-	-	500	Charvet
2	347494	M16x1.5	17	88	16	250	1	520	Nayati

fig.	GEV No.	TS	ø (mm)	L (mm)	mounting ø (mm)	volt. (V)	SC (A)	CL (mm)	suitable for
3	347348	M16x2	18	88.5	16	240	1	1000	Sammic
4	347020	M16x2	16	88.5	16	250	1	800	Cookmax Mafrol
4	345484	M16x1.5	17.5	92	16	250	1	2000	ATA Electrolux Meiko Therma Zanussi
4	345822	M16x1.5	17.4	98	16	250	0.5	2000	Electrolux Hoonved Zanussi
4	345446	M14x2	17.5	114	15	250	0.13	230	Winterhalter

fig.	GEV No.	TS	ø (mm)	L (mm)	mounting ø (mm)	volt. (V)	SC (A)	CL (mm)	suitable for
5	345447	M16x1.5	17.5	96	19	250	0.5	-	—

fig.	GEV No.	function	volt. (V)	SC (A)	suitable for	fig.	GEV No.	function	volt. (V)	SC (A)	suitable for	fig.	GEV No.	function	volt. (V)	SC (A)	suitable for
1	400429	1CO	240	16	—	3	345365	1CO	250	16	Icematic Scotsman Simag	3	347088	1CO	250	16	Icematic Scotsman SF-Maschinen Simag
2	345324	1CO	250	6	ITV												

Table continues overleaf







Зип Общепит

vsezip.ru





+7(812)987-08781

																	
4	5	6	7														
fig.	GEV No.	function	volt. (V)	SC (A)	suitable for	fig.	GEV No.	function	volt. (V)	SC (A)	suitable for	fig.	GEV No.	function	volt. (V)	SC (A)	suitable for
4	345371	1CO	250	16	Brice Italia Eurfrigor Geofrigor Kastel NuovaSimonelli	4	345372	1CO	250	6	Eurfrigor Geofrigor Kastel	6	403479	1CO	250	4	Migel
						5	379653	1CO	250	3	Staff Ice System	7	403551	1CO	250	4	Icematic

									
1	2	3							
fig.	GEV No.	function	ø (mm)	mounting ø (mm)	volt. (V)	SC (A)	connector	CL (mm)	suitable for
1	348026	1CO	25	12	250	10	F6.3	1380	Staff Ice System
2	346208	1NC	85	-	240	16	F6.3	-	Meiko
3	403292	1NO	12	8	24	0.2	plug	880	Angelo-Po

										
1										
fig.	GEV No.	TS	function	ø (mm)	L (mm)	mounting ø (mm)	volt. (V)	SC (A)	CL (mm)	suitable for
1	403081	1/4"	1CO	12	65	16	24	0.5	100	Hobart

door lock switches

				
1	2	3	4	
fig.	GEV No.	description	suitable for	Ref. No.
1	347991	switch kit for microwave	ACP Amana	53002030 53001600
2	347992	switch kit for microwave	ACP	54127052
3	347999	switch kit for microwave	ACP	14090023
4	348001	switch kit for microwave	ACP Amana	59114167 59002060

Зип Общепит

vsezip.ru

+7(812)987-08-81



5 6

fig.	GEV No.	description	suitable for	Ref. No.
5	348002	switch kit for microwave	ACP	56002052
6	348003	switch kit for microwave	ACP	R0000277
7	348009	switch kit for microwave	ACP	12002647
8	348010	switch kit for microwave	ACP	12002636



9 10 11

fig.	GEV No.	description	suitable for	Ref. No.
9	348011	switch kit for microwave	ACP	12002862
10	348012	switch kit for microwave	ACP	59114157
11	347998	switch kit with relay and fuse F1 for microwave	ACP	14119060

operation switches

on/off



1 2 3 4

fig.	GEV No.	type	function	sequence	SC (A)	shaft ø (mm)	shaft L (mm)	connection	diagram	suitable for	Ref. No.
1	301087	2 operating positions	2NO	0-1	10	6x4.6	23	F6.3	NS020401	Electrolux Zanussi	047498 047498
1	300044	2 operating positions	4NO	0-1	16	6x4.6	23	F6.3	NS020401	Eloma	ELE320006
2	345686	2 operating positions	2NO	0-1	10	6x4.6	23	F6.3	NS020202	Fagor	12020265
3	300129	2 operating positions	2NO	0-1	16	6x4.6	23	F6.3	NS020202	Anitec Ascobloc Coven EGO EGO Gierre Giorik Imperial-Germany Lincar Miele Silanos Star10	073016 09/1324 EMIG1600 49.22015.520 49.22015.700 COM123 6030007 08016200 40001025 8016200 901727 073016
4	301115	2 operating positions	2NO	0-1	16	6x4.6	23	F6.3	NS020203	Angelo-Po EGO Falcon Lincat Star10	3168540 42.02900.000 732910481 SW58 073015.46

Table continues overleaf



Зип Общепит

vsezip.ru

+7(812)987-08-81

fig.	GEV No.	type	function	sequence	LC (A)	shaft ø (mm)	shaft L (mm)	connection	diagram	suitable for	Ref. No.
5	300151	2 operating positions	2NO	0-1	16	6x4.6	23	screw	NS020202	CPE EGO Forved GIGA MBM-Italia Star10 Whirlpool	49.22015.705 49.22015.705 03227/B X51300 RTCU700212 X51300 483286009387
5	300020	4 operating positions	2NO	0-1-0-1	16	6x4.6	23	screw	NS040201	Angelo-Po Capito Chergui EGO Electrolux Küppersbusch MKN Nayati Olis Öztiryakiler Palux Rosinox Stahl Zanussi	32W0490 63870 03EDCO0010 49.22015.000 028390 182861 203563 PD2247 BN6A049300 6254.00005.03 291757 RX94805256 A67100 028390
6	301281	2 operating positions	2NO	0-1	25	6x4.6	23	F6.3	NS020201	EGO Jemi	42.04400.026 2004051
7	300074	4 operating positions	2NO	0-1-0-1	16	6x4.6	23	F6.3	NS040201	Alpeninox EGO Electrolux Emmepi Franke FriFri Haka Küppersbusch Lohberger Roka Salvis Silko Thielmann Valentine Zanussi	0A2162 49.22015.500 0A2162 806286 178843 1G960702 9020 540856 51450150 8900301 178843 SIR0101380 144696 2693-01 0A2162
8	347953	4 operating positions	2NO	0-1-0-1	16	6x4.6	23	F6.3	NS040201	EGO MKN	42.04900.012 203958
9	300088	2 operating positions	4NO	0-1	16	6x4.6	23	F6.3	NS020401	Angelo-Po EGO Rosinox Silko	32W3830 49.42915.707 RX94805363 SIR0108007
9	300176	2 operating positions	4NO	0-1	16	6x4.6	23	screw	NS020401	Dühr EGO Fornitalia Forved Kromo Star10	DW9564 49.42915.704 40/60Z18 03227/A DW9564 073005

Table continues overleaf

Зип Общепит

vsezip.ru

+7(812)987-08-81

fig.	GEV No.	type	function	sequence	IC (A)	shaft D (mm)	shaft L (mm)	connection	Diagram	table for	Ref. No.
10	345665	2 operating positions	4NO	0-1	16	6x4.6	23	screw	NS020401	Bertos EGO GIGA Silko Star10	22051600 49.41015.700 X40700 SIR0109058 X40700
10	300021	4 operating positions	4NO	0-1-0-1	16	6x4.6	23	screw	NS040401	Baron Capic Capito Charvet Cookmax EGO Electrolux HORO Inoksan King Lincat Mareno MKN Olis Palux Roka Silko Valentine	BN41826630290 E052505 63869 ELE0083 1230100 49.42015.000 0K9771 — 10010304 0K9771 SW42 MA1230100 203563 6A046700 290343 8900302 MA1230100 0719
11	300017	4 operating positions	4NO	0-1-0-1	16	6x4.6	23	F6.3	NS040401	Alpeninox EGO Electrolux Emmepi Haka Juno Tecno MCM Zanussi	0A2241 49.42015.500 0A2241 C00690 9021 0A2241 030138E 0A2241
11	300102	4 operating positions	4NO	0-1-0-1	32	6x4.6	23	screw	NS040401	Capito EGO Electrolux Gico Juno Mareno MKN Palux Rosinox Valentine Zanussi	63868 43.42032.000 050857 539502 050857 MA1475900 203564 291722 RX94014842 0718 050857
12	300218	2 operating positions	6NO	0-1	16	6x4.6	23	F6.3	NS020401	Electrolux Therma Zanussi	0E5222 0E5222 0E5222

Diagrams may be found at the end of the chapter



4-position

Зип Общепит

vsezip.ru

+7(812)987-08-81



fig.	GEV No.	type	function	sequence	SC (A)	shaft ø (mm)	shaft L (mm)	connection	diagram	suitable for	Ref. No.
1	300007	4 operating positions	1NO/2CO	0-1-2-3	16	6x4.6	23	F6.3	NS040404	Bertos Cooking-Systems EGO Electrolux GIGA Haka Juno King Star10 Therma Whirlpool	22050100 3218 49.24215.520 0H6602 X44000 9022 0H6602 0H6602 X44000 0H6602 483286009309
1	300016	4 operating positions	1NO/2CO	0-1-2-3	16	6x4.6	23	F6.3	NS040404	EGO Eloma Palux	49.24215.520.MOD E0185 104248
2	300023	4 operating positions	1NO/2CO	0-1-2-3	16	6x4.6	23	screw	NS040404	Ambach Blumauer Chergui EGO EGO KSF Küppersbusch Polydor Wiesheu-Wiwa	5060902384 180510 03EDCO0020 49.24215.000 49.24215.500 4.013.02.03 183205 202170 421053
2	300094	4 operating positions	1NO/2CO	0-1-2-3	16	6x4.6	15	screw	NS040404	EGO Roller Grill	49.24215.001 A01001
3	300103	4 operating positions	1NO/2CO	0-1-2-3	32	6x4.6	23	screw	NS040404	Ambach Capic Charvet EGO EGO EGO Electrolux Foem Gico Imperial-Germany Juno Küppersbusch Malag Mareno Palux Rosinox Solymac	5060902396 E052520 02093A 43.24032.000 43.24232.000 43.34032.000 0H6598 05010049940 52002432 5931 0H6598 183105 106062 MA501400 226491 RX273349196 P86C

Table continues overleaf

Зип Общепит

vsezip.ru

+7(812)987-08-81



fig.	GEV No.	type	function	sequence	SC (A)	shaft ø (mm)	shaft L (mm)	connection	diagram	suitable for	Ref. No.
4	300022	4 operating positions	2CO	0-1-2-3	16	6x4.6	23	screw	NS040301	EGO Falcon Hatco Inoksan North	49.24015.000 537850020 X02.19.174.00 10010303 DE00027
5	300174	4 operating positions	2NO/2CO	0-1-2-3	32	6x4.6	23	screw	NS040507	Ambach EGO	5060908251 43.24432.000
5	300104	4 operating positions	3NO/1CO	0-1-2-3	32	6x4.6	23	screw	NS040504	Ambach Capic EGO Electrolux Eloma Gico GIGA Juno Küppersbusch Mareno MBM-Italia Olis Palux Roller Grill Rosinox Silko Thielmann Ubert	5060909122 E052530 43.34232.000 0H6683 EL0532215 52003432 X44000 0H6683 540431 MA790700 RTCP900036 BN6A038300 126608 A01002 RX27334937 SIR0101400 141188 341134
6	300194	4 operating positions	4NO	0-1-2-3	16	6x4.6	23	screw	NS040506	EGO Electrolux Juno MKN	43.24216.000 0K2034 0K2034 203223
6	300110	4 operating positions	5NO	0-1-2-3	16	6x4.6	23	screw	NS040506	EGO	43.24216.020

Diagrams may be found at the end of the chapter

5-position



fig.	GEV No.	type	function	sequence	SC (A)	shaft ø (mm)	shaft L (mm)	connection	diagram	suitable for	Ref. No.
1	300172	5 operating positions	1NO/2CO	0-1-2-3-4	16	6x4.6	23	F6.3	NS050401	Ascobloc EGO Palux	9173302 49.25215.520 193224
2	300147	5 operating positions	1NO/2CO	0-1-2-3-4	16	6x4.6	23	screw	NS050401	Angelo-Po EGO Electrolux MBM-Italia	32W0510 49.25215.000 052749 RTCU900068
3	300075	5 operating positions	2NO/2CO	0-1-2-3-4	32	6x4.6	23	screw	NS050501	Angelo-Po EGO Electrolux Zanussi	32W0520 43.25232.020 025300 025300
3	300149	5 operating positions	2NO/2CO	0-1-2-3-4	32	6x4.6	23	screw	NS050503	Angelo-Po EGO	32W1050 43.25432.000
3	300105	5 operating positions	3NO/1CO	0-1-2-3-4	32	6x4.6	23	screw	NS050504	Angelo-Po EGO Heidebrenner Valentine	32W3260 43.35232.000 94202 3770

Diagrams may be found at the end of the chapter



7-position

Зип Общепит



fig.	GEV No.	type	function	sequence	SC (A)	shaft Ø (mm)	shaft L (mm)	connection	diagram	suitable for	Ref. No.
1	301250	7 operating positions	1NO/2CO	0-1-2-3-4-5-6	10	6x4.6	23	F6.3	NS070501	EGO GIGA	46.27266.817 AEC004ZR10
2	300004	7 operating positions	1NO/2CO	0-1-2-3-4-5-6	16	6x4.6	23	F6.3	NS070502	Anitec Ascobloc Bertos Cookmax EGO EGO Electrolux GIGA Haka Juno King Küppersbusch Palux Potis Star10 Tecnoinox Therma Whirlpool Zanussi	X54100 9295403 22049900 PT0178 49.27215.520 49.27215.717 49.27215.747 0K6627 X54100 9023 0K6627 0K6627 183206 010170 PT0178 X54100 RC00291000 0K6627 483286009633 0K6627
3	300031	7 operating positions	1NO/2CO	0-1-2-3-4-5-6	16	6x4.6	23	F6.3	NS070503	Ambassade Bartscher EGO Fagor Heidebrenner Lincat RSI	6553435 A030008088 46.27266.500 12024405 94214 SW14 30008088
4	300025	7 operating positions	1NO/2CO	0-1-2-3-4-5-6	16	6x4.6	23	screw	NS070503	Alpeninox Ambach Angelo-Po Anitec Baron Blumauer Capito Cookmax EGO EGO EGO Electrolux Emmepi Falcon Foem Franke Gico Hobart Ilsa Inoksan Küppersbusch Lotus Malag Mareno MBM-Italia MKN Modular Morice Offcar Olis Palux Potis Roka Rosinox Salvis Silko Star10 Ubert Zanussi	0A2021 5060904034 32W0760 073007 BN41826630070 180511 63873 1616100 49.27215.000 49.27215.020 49.27215.746 0A2021 C00213 539110400 05000083150 178851 52002715 MRTCU700078 843751 10010302 182774 537000300 106070 1037033100 RTCU700078 203224 66100200 DE0781 843751 6A045500 290335 PT0177 8900220 RX94015013 178851 MA1616100 073007 341133 0A2021

Table continues overleaf



Зип Общепит

vsezip.ru

+7(812)987-08-81

fig.	GEV No.	type	function	sequence	SC (A)	shaft ø (mm)	shaft L (mm)	connection	diagram	suitable for	Ref. No.
5	300106	7 operating positions	1NO/2CO	0-1-2-3-4-5-6	32	6x4.6	23	screw	NS070401	Alpeninox Ambach Angelo-Po Bonnet Capito EGO Electrolux Foem Giorik Juno Küppersbusch Lincar Lotus Malag Mareno MBM-Italia MKN Modular Morice Rosinox Silko Therma Thielmann Zanussi	0A2022 5060904041 32W2920 300010 63872 43.27032.000 43.27232.000 0A2022 05010076150 6030001 0A2022 183104 40001005 537027700 106072 MA1937800 RTC800151 203560 96100000 DE0785 RX94015021 MA1937800 0A2022 141187 0A2022
6	300026	7 operating positions	2CO	0-1-2-3-4-5-6	16	6x4.6	27	screw	NS070402	EGO Inoksan	49.27016.200 10010302
7	301223	7 operating positions	3NO	0-1-2-3-4-5-6	16	6x4.6	35	F6.3	NS070302	EGO MBM-Italia	42.07400.004 RIC0004532
8	300177	7 operating positions	6NO	0-1-2-3-4-5-6	16	6x4.6	23	F6.3	NS070601	EGO Electrolux Forved Zanussi	46.27266.813 059238 SNACKCOMMUT 059238
9	301289	7 operating positions	7NO	0-1-2-3-4-5-6	16	6x4.6	34	F6.3		EGO Smeg	41.55710.004 811730316

Diagrams may be found at the end of the chapter

2 operating positions

fig.	GEV No.	type	function	sequence	SC (A)	shaft ø (mm)	shaft L (mm)	connection	diagram	suitable for	Ref. No.
1	301715	2 operating positions		0-1	16	6x4.6	23	F6.3		Cookmax EGO RM-Gastro	401505000 42.04400.027 401505000
2	300112		1NO	0-1	10	6x4.6	23	screw	NS020101	EGO GMG Küppersbusch	49.10906.000 KL-007 183232
3	301316	2 operating positions	2NO	0-1	16	6x4.6	23	F6.3	NS020207	Fagor	12024465
4	300216	2 operating positions	2NO	1-2	10	6x4.6	23	F6.3	NS020204	EGO Sogeco	49.24815.840 03-CMM-001

Diagrams may be found at the end of the chapter



Зип ОбщеПТ

3 operating positions



fig.	GEV No.	type	function	sequence	SC (A)	shaft ø (mm)	shaft L (mm)	connection	diagram	suitable for	Ref. No.
1	345684	3 operating positions	10NO	1-2-3	16	6x4.6	34	F6.3		Fagor	12019182
2	345687	3 operating positions	-	1-0-2	16	6x4.6	23	F6.3		Fagor	12019852
3	345670	3 operating positions	1CO	1-0-2	16	6x4.6	23	F6.3	NS030201	Bertos EGO Elettrobar	30051600 49.14915.705 923011
4	300116	3 operating positions	2NO	1-0-2	16	6x4.6	23	screw	NS030402	Cuppone EGO	91310066 49.34915.704
5	300167	3 operating positions	2NO/1CO	0-1-2	16	6x4.6	23	screw	NS030501	Bertos EGO Firex GIGA Lincar Offcar Olis Whirlpool	35050100 49.27215.802 40100004 E11000 40001026 FX40100004 BN6A001412 483286009427
6	347996	3 operating positions	2NO/1CO	0-1-2	32	6x4.6	23	F6.3	NS030401	EGO Electrolux	49.26915.780 0L3145

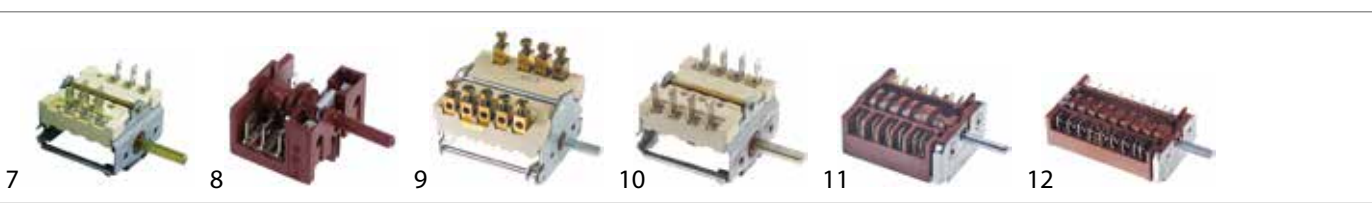

fig.	GEV No.	type	function	sequence	SC (A)	shaft ø (mm)	shaft L (mm)	connection	diagram	suitable for	Ref. No.
7	345171	3 operating positions	3NO	0-1-2	16	6x4.6	26	F6.3	NS030301	Angelo-Po EGO Electrolux Zanussi	3041660 49.26915.769 048271 048271
8	345492	3 operating positions	3NO	1-0-2	16	6x4.6	23	F6.3	NS030302	Fagor	12025105
9	346469	3 operating positions	3NO/1CO	0-1-2	32	6x4.6	23	screw	NS030502	EGO Electrolux Valentine	43.34832.003 0H9806 6317-51
10	301315	3 operating positions	4NO	1-0-2	16	6x4.6	23	F6.3		EGO Gierre	49.44915.712 COM140
11	347854	3 operating positions	6NO	1-0-2	16	6x4.6	23	F6.3	NS030601	EGO Rancilio	46.26966.506 65205011
12	347157	3 operating positions	8NO	0-1-2	16	6x4.6	23	F6.3	NS040801	EGO Valentine	42.04000.021 6316-52

Diagrams may be found at the end of the chapter

4 operating positions

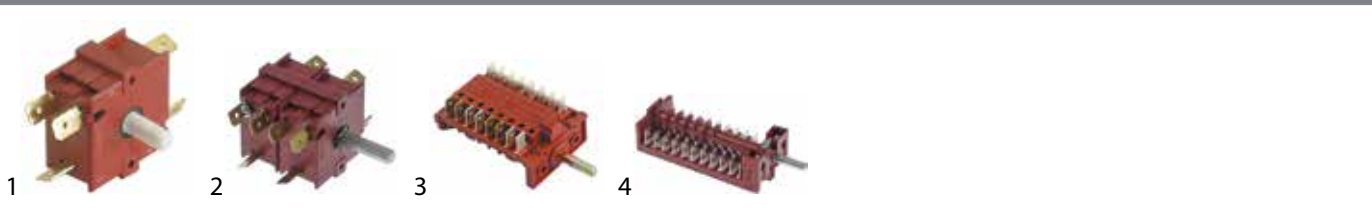

fig.	GEV No.	type	function	sequence	SC (A)	shaft ø (mm)	shaft L (mm)	connection	diagram	suitable for	Ref. No.
1	300143	4 operating positions	-	0-1-2-3	13	6x4.6	13	F6.3		Roller Grill	A01014
1	300250	4 operating positions	-	0-1-2-3	13	6x4.6	25	F6.3		—	—
1	347366	4 operating positions	2NO	0-1-2-3	16	6x4.6	23	F6.3		Bartscher	A040081
2	347778	4 operating positions	-	0-1-2-3	13	6x4.6	23	F6.3		963foodtech	3000002
3	345494	4 operating positions	-	1-0-2-3	16	6x4.6	23	F6.3		Fagor	12024972
4	347883	4 operating positions	11NO	0-1-2-3	16	6x4.6	23	F6.3		Electrolux	0C9725

Table continues overleaf

Зип Общепит

vsezip.ru

+7(812)987-08-81

fig.	GEV No.	type	function	sequence	SC (A)	shaft ø (mm)	shaft L (mm)	connection	diagram	suitable for	Ref. No.
5	347101	4 operating positions	1NO/1CO	0-1-2-3	13	6x4.6	23	F6.3	NS040302	Roller Grill	A01017
6	301313	4 operating positions	2CO/1NO	0-1-2-3	16	6.9x4.3	21.5	screw	NS040414	EGO Garland	49.249115.221 4523164
7	300185	4 operating positions	2NO	1-2-1-2	16	6x4.6	23	F6.3	NS040202	EGO Küppersbusch	49.22915.500 182728
8	347756	4 operating positions	2NO/1CO	0-1-2-3	32	6x6	23	screw	NS040510	Capic EGO	E052525 43.24832.120
8	300360	4 operating positions	3NO/1CO	0-1-2-3	32	6x4.6	23	screw	NS030503	Bonnet EGO Morice Thirode	300051 43.24832.060 DE0205 300051
9	300010	4 operating positions	2NO/2CO	0-1-2-3	16	6x4.6	23	F6.3	NS040603	Bertos EGO Electrolux Foinox Gico Inoxtrend Lainox Zanussi	23050900 49.24915.705 057934 0281 620044924 C2214-00 LAR65080010 057934
10	300170	4 operating positions	3NO	0-1-2-3	16	6x4.6	23	F6.3	NS040407	EGO MKN	42.04400.002 203414

fig.	GEV No.	type	function	sequence	SC (A)	shaft ø (mm)	shaft L (mm)	connection	diagram	suitable for	Ref. No.
11	301199	4 operating positions	3NO	0-1-2-3	16	6x4.6	15	F6.3	NS040304	Stahl	167105
12	300076	4 operating positions	3NO/1CO	0-1-2-3	32	6x4.6	23	screw	NS040508	EGO GIGA	43.42032.703 X40600
12	300113	4 operating positions	4NO	0-1-0-2	32	6x4.6	23	screw	NS040410	Ascobloc EGO Küppersbusch	9296002 43.44032.020 183011
12	300210	4 operating positions	4NO	0-1-2-3	16	6x4.6	23	screw	NS040409	Descobloc EGO Ilsa Modular	60773 49.44015.712 60773 66103700
12	300145	4 operating positions	4NO	0-1-2-3	32	6x4.6	23	screw	NS040509	EGO Modular Offcar	43.34232.800 66106200 898973
13	300081	4 operating positions	3NO/2CO	0-1-2-3	16	6x4.6	23	screw	NS040701	Anitec Baron Bertos Cookmax EGO GIGA Giorik Mareno Olis Rosinox Silko Star10	X44100 BN6A046750 22049800 6A046750 49.34615.701 X44100 6030036 MA1309000 6A046750 RX94806478 SIR0101397 X44100

Table continues overleaf



Зип Общепит

vsezip.ru

+7(812)987-08-81

fig.	GEV No.	type	function	sequence	SC (A)	shaft ø (mm)	shaft L (mm)	connection	diagram	suitable for	Ref. No.
14	300229	4 operating positions	4NO	0-1-0-2	16	6x4.6	23	F6.3	NS040406	EGO MBM-Italia Piron	42.04400.003 RTFOC00694 COM30001
14	300239	4 operating positions	4NO	0-1-2-3	16	6x4.6	23	F6.3	NS040412	Baron EGO GIGA Giorik Lainox Mareno Silko	CR0581810 42.04400.025 776-024-00 6030040 CR0581810 CR0581810 CR0581810
14	345320	4 operating positions	4NO	0-1-2-3	16	6x4.6	23	F6.3	NS040408	EGO Roller Grill	42.04400.001 A01009
15	300033	4 operating positions	4NO	0-1-2-3	16	6x4.6	23	F6.3	NS040411	Eloma Palux	ELE320005 103680
16	300037	4 operating positions	4NO	0-1-2-3	16	6x4.6	23	F6.3	NS040411	Electrolux Juno	0H6387 0H6387
17	300179	4 operating positions	4NO/1CO	0-1-0-2	32	6x4.6	23	screw	NS040501	Ascobloc EGO Küppersbusch	9295405 43.24932.040 183156
18	300019	4 operating positions	4NO/1CO	1-2-1-2	16	6x4.6	23	F6.3	NS040607	EGO Küppersbusch	49.54915.510 182746
19	300046	4 operating positions	5NO	0-1-2-3	16	6x4.6	27	F6.3	NS050505	Krefftt Rational	76-30161631 3016.1631

fig.	GEV No.	type	function	sequence	SC (A)	shaft ø (mm)	shaft L (mm)	connection	diagram	suitable for	Ref. No.
20	300077	4 operating positions	5NO	0-1-2-3	16	6x4.6	23	F6.3		Bourgeois EGO Hobart	COMU004 42.04000.003 845259
21	301216	4 operating positions	5NO	0-1-2-3	16	6x4.6	23	F6.3	NS040602	EGO Electrolux Zanussi	46.24866.803 059544 059544
22	300057	4 operating positions	6NO	0-1-2-3	16	6x4.6	23	F6.3	NS040605	Eloma Palux	EL0292664 292664
23	300195	4 operating positions	6NO	0-1-2-3	16	6x4.6	23	F6.3	NS040601	EGO MKN	46.24966.501 203156
24	301144	4 operating positions	6NO	0-1-2-3	16	6x4.6	23	F6.3	NS040604	Angelo-Po EGO	3162280 42.04000.023
25	347386	4 operating positions	6NO	0-1-2-3	16	6x4.6	23	F6.3	NS040606	Fagor	12024733

fig.	GEV No.	type	function	sequence	SC (A)	shaft ø (mm)	shaft L (mm)	connection	diagram	suitable for	Ref. No.
26	347638	4 operating positions	6NO	0-1-2-3	16	6x4.6	23	F6.3		Fagor	12023800
27	301186	4 operating positions	7NO	1-0-2-3	16	6x4.6	23	F6.3	NS041201	Electrolux Zanussi	049144 049144
28	345168	4 operating positions	7NO	2-0-1-momentary	16	6x4.6	23	F6.3	NS031201	Electrolux Zanussi	048828 048828
29	300211	4 operating positions	8NO	0-1-0-2	16	6x4.6	18	F6.3	NS040802	EGO Küppersbusch	42.04000.010 545500
30	300045	4 operating positions	8NO	0-1-2-3	16	6x4.6	23	F6.3	NS040807	Krefftt Rational Rosinox	76-30161610 3016.1610 RX27338151

Table continues overleaf

Зип Общепит
vsezip.ru
+7(812)987-08-81

fig.	GEV No.	type	function	sequence	SC (%)	shaft ø (mm)	shaft L (mm)	connection	diagram	suitable for	Ref. No.
31	300049	4 operating positions	8NO	0-1-2-3	16	6x4.6	17	F6.3		Rational Rosinox	3016.1640 RX27338144
32	345409	4 operating positions	8NO	0-1-2-3	16	6x4.6	23	F6.3	NS040806	Fagor	12023918
33	345765	4 operating positions	8NO	0-1-2-3	16	6x4.6	23	F6.3	NS040803	EGO Tecnoinox	42.04000.020 RC01071000
34	347483	4 operating positions	8NO	0-1-2-3	16	6x4.6	17	F6.3	NS040804	Alpeninox Electrolux	053866 0C7965
35	347817	4 operating positions	8NO	1-0-2-3	16	6x4.6	23	F6.3	NS040805	Fagor	12024445

Diagrams may be found at the end of the chapter

5 operating positions

fig.	GEV No.	type	function	sequence	SC (A)	shaft ø (mm)	shaft L (mm)	connection	diagram	suitable for	Ref. No.
1	301297	5 operating positions	1-0-2-3-4	8NO	16	6x4.6	23	F6.3	NS050803	Inoxtrend	C8160-00
2	345199	5 operating positions	2NO/1CO	0-1-2-3-4	16	6x4.6	23	F6.3	NS050301	EGO Eloma Franke Palux Salvis	49.25215.530 ELE320034 279800 720534 10279800
3	301221	5 operating positions	2NO/1CO	0-4-3-2-1	16	6x4.6	23	F6.3		Capic EGO MBM-Italia	E052535 49.25815.703 RTFOC00143
4	300114	5 operating positions	5NO	0-1-2-3-4	16	6x4.6	23	F6.3	NS040608	EGO Indesit Modular	46.25866.824 C00055060 66107400
5	347652	5 operating positions	5NO/2CO	0-1-2-3-4	16	6x4.6	23	F6.3	NS051001	—	—
6	346352	5 operating positions	5NO/2CO	1-0-2-3-4	16	6x4.6	23	F6.3	NS050901	Baron EGO Olis	0A046015 49.26915.792 BN6A046015

fig.	GEV No.	type	function	sequence	SC (A)	shaft ø (mm)	shaft L (mm)	connection	diagram	suitable for	Ref. No.
7	301296	5 operating positions	6NO/1CO	0-1-2-3-4	16	6x4.6	24	F6.3	NS050802	Electrolux	0C9080
7	301277	5 operating positions	7NO	0-1-2-3-4	16	6x4.6	19	F6.3	NS050801	Convotherm EGO	5003023 42.08000.047
8	300070	5 operating positions	9NO	0-1-2-3-4	16	6x4.6	23	F6.3	NS101101	Rational	3016.1613
9	347191	5 operating positions	9NO	1-0-2-3-4	16	6x4.6	23	F6.3	NS050904	Lainox	LAR65080020

Diagrams may be found at the end of the chapter



Зип ОбщеПИТ

vsezip.ru

+7(812)987-08-81

6 operating positions



fig.	GEV No.	type	function	sequence	SC (A)	shaft ø (mm)	shaft L (mm)	connection	diagram	suitable for	Ref. No.
1	345688	6 operating positions	-	0-1-2-3-4-5	16	6x4.6	23	F6.3		Fagor	12019026
2	347091	6 operating positions	-	0-1-2-3-4-5	16	6x4.6	23	F6.3		Fagor	12018564
3	345170	6 operating positions	1CO	0-1-2-3-4-5	16	6x4.6	23	F6.3	NS060301	EGO Electrolux Zanussi	49.26915.775 048270 048270
4	300051	6 operating positions	2NO	1-0-2-3-4-5	6	6x4.6	33	F6.3		Kreff Rational Rosinox	76-30161631 3016.1631 RX27338136
5	345683	6 operating positions	7NO	0-1-2-3-4-5	16	6x4.6	23	F6.3		Fagor	12019003
6	347578	6 operating positions	7NO	0-1-2-3-4-5	16	6x4.6	23	F6.3	NS060701	Fagor	12024290

Diagrams may be found at the end of the chapter

7 operating positions



fig.	GEV No.	type	function	sequence	SC (A)	shaft ø (mm)	shaft L (mm)	connection	diagram	suitable for	Ref. No.
1	301298	7 operating positions	12NO	0-1-2-3-4-5-6	16	6x4.6	23	F6.3	NS071201	Fagor	12024932
2	301312	7 operating positions	2CO/1NO	0-1-2-3-4-5-6	16	6x4.6	23	F6.3	NS070504	EGO Garland	49.27215.505 4523166
3	301210	7 operating positions	7NO	0-1-2-3-4-5-6	16	6x4.6	23	F6.3	NS070701	EGO Electrolux Zanussi	42.07000.025 004741 004741

Diagrams may be found at the end of the chapter

8 operating positions



fig.	GEV No.	type	function	sequence	SC (A)	shaft ø (mm)	shaft L (mm)	connection	diagram	suitable for	Ref. No.
1	347924	8 operating positions	13NO	0-1-2-3-4-5-6-7	16	6x4.6	19	F6.3		Hobart	231960-5
2	301094	8 operating positions	7NO	0-1-2-3-4-5-6-7	16	6x4.6	23	F6.3	NS080501	EGO Electrolux Whirlpool Zanussi	49.28915.751 055017 155017 055017

Diagrams may be found at the end of the chapter

10 operating positions

Зип Общепит

vsezip.ru

+7(812)987-08-81



fig.	GEV No.	type	function	sequence	SC (A)	shaft ø (mm)	shaft L (mm)	connection	diagram	suitable for	Ref. No.
1	300135	10 operating positions	10NO	0-1-2-3-4-5-6-7-8-9	16	6x4.6	23	F6.3	NS101101	Indesit Lotus	C00052299 537019200
2	347848	10 operating positions	2NO	0-1-2-3-4-5-6-7-8-9	16	6x4.6	23	F6.3	NS020203	Franke Salvis	1G960711 1G960000
3	301205	10 operating positions	5NO/1CO	0-1-2-3-4-5-6-7-8-9	16	6x4.6	23	F6.3	NS100701	EGO Foinox Tecnoeka	49.29815.733 10027 01200040
4	345666	10 operating positions	6NO/1CO	0-1-2-3-4-5-6-7-8-9	8	6x4.6	23	F6.3	NS100801	Anitec Bertos EGO GIGA Mareno Star10	073034 22049700 42.00000.015 X68204 MA1037103800 073034
4	347770	10 operating positions	8NO	0-1-2-3-4-5-6-7-8-9	18	6x4.6	23	F6.3	NS100802	EGO Garbin	42.00001.001 COM000

Diagrams may be found at the end of the chapter

with potentiometer

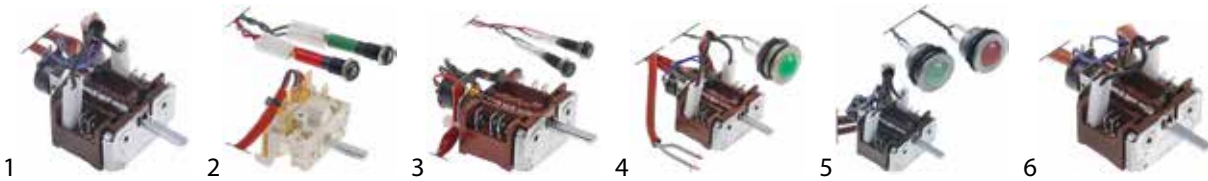

fig.	GEV No.	type	function	sequence	SC (A)	shaft ø (mm)	shaft L (mm)	connection	CL (mm)	resistance (Ohm)	suitable for	Ref. No.
1	345331	2 operating positions	1NO	0-1	16	6x4.6	23	coded plug	2400	0.1-10K	EGO Electrolux	78.94032.507 0G3299
2	348104	10 operating positions	1NO	0-1-2-3-4-5-6-7-8-9	16	6x4.6	23	coded plug	45	0.1-10K	Electrolux	0C0084
3	300252	2 operating positions	2NO	0-1	16	6x4.6	23	coded plug	1420	10k	Baron EGO Mareno	CR0737320 78.94031.523 CR0737320
4	346441	2 operating positions	2NO	0-1	16	6x4.6	23	coded plug	1600	10k	Lotus	537023400
5	347436	2 operating positions	2NO	0-1	16	6x4.6	23	coded plug	2400	0.1-10K	Ambach EGO	5003518422 78.94032.009
6	347514	2 operating positions	2NO	0-1	16	6x4.6	23	coded plug	2400	0.1-10K	EGO Electrolux	78.94032.506 0G3298

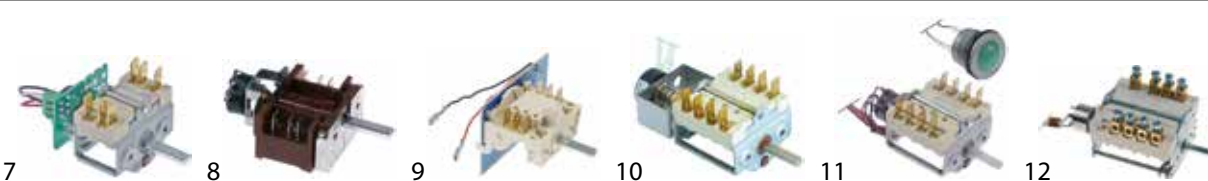

fig.	GEV No.	type	function	sequence	SC (A)	shaft ø (mm)	shaft L (mm)	connection	CL (mm)	resistance (Ohm)	suitable for	Ref. No.
7	300249	2 operating positions	2NO	0-1	16	6x4.6	23	screw	-	10k	Berner	LP1-100108
8	345119	2 operating positions	2NO	0-1	16	6x4.6	23	solder connection	-	10k	EGO Gico Rosinox Scholl	78.94010.000 — RX94814321 94010000
9	347952	16 operating positions	3NO	0-16	16	6x4.6	23	F2.8	-	coded	MKN	203894
10	345636	2 operating positions	4NO	0-1	16	6x4.6	23	cable 560mm	-	0.1-10K	Tecnoinox	RC01028000
11	347599	2 operating positions	4NO	0-1	16	6x4.6	23	coded plug	-	0.1-10K	Bertos EGO EGO	38151200 78.94031.519 78.94031.520
12	346984	2 operating positions	4NO	0-1	32	6x4.6	23	cable 2400mm	2400	50k	Electrolux Therma	0K5063 0K5063



operation switches

Зип Общепит

vsezip.ru

+7(812)987-08-81



fig.	GEV No.	type	function	sequence	SC (A)	shaft ø (mm)	shaft L (mm)	connection	diagram	suitable for	Ref. No.
1	300200	2 operating positions	2NO	0-1	16	6x4.6	23	F6.3	NS020205	Alpeninox Ambassade Anitec Ascobloc Baron Bonnet Capic Cookmax EGO Electrolux Emmepi FriFri Gemini Forni Gico Juno Küppersbusch Mareno Olis Rieber Rosinox Star10 Tecnoinox Therma Thielmann Zanussi	0A2036 6528979 073015 09/3460 MA1037313200 905108 E052584 6A046000 49.21015.610 49.21015.705 054375 C00217 400372 233117 52002115 054375 540461 MA1037313200 6A046000 33351201 RX94015070 073015 RC00037000 054375 142752 054375
2	301153	2 operating positions	2NO	0-1	16	6x4.6	23	F6.3	NS020206	Angelo-Po EGO	32W2550 49.21915.731
3	300091	2 operating positions	2NO	0-1	16	6x4.6	23	screw	NS020205	Ambach Bertos Bonnet Cookmax EGO EGO EGO EGO Emainox Emmepi GIGA Küppersbusch Lotus Mareno MBM-Italia Morice RM-Gastro Silko Thirode	5060904057 22050400 300175 401506000 49.21015.000 49.21015.300 49.21015.320 49.21015.724 3700003 C00217 Y16200 182825 537000400 MA1037035700 RTCU900110 DE0197 401506000 SIR0109057 300175
4	345322	4 operating positions	2NO/1CO	0-1-2-3	16	6x4.6	23	screw	NS040511	EGO	49.23815.787
5	300073	6 operating positions	2NO/1CO	0-1-2-3-4-5	16	6x4.6	23	screw	NS060501	EGO EGO MBM-Italia	49.23815.000 49.23815.050 RTCU700079
6	300027	2 operating positions	3NO	0-1	16	6x4.6	23	screw/F6.3	NS020301	EGO Palux	49.31015.020 086312

Зип Общепит

vsezip.ru

+7(812)387-08-81

fig.	GEV No.	type	function	sequence	SC (A)	shaft ø (mm)	shaft L (mm)	connection	diagram	suitable for	Ref. No.
7	300178	3 operating positions	3NO/2CO	0-1-2	16	6x4.6	23	F6.3	NS030702	EGO Electrolux Juno	49.53915.500 0H6284 0H6284
8	300002	2 operating positions	4NO	0-1	16	6x4.6	23	F6.3	NS020402	Alpeninox Baron Bertos Casta Cookmax EGO Electrolux Emmepi FriFri Giorik Haka Juno King Lincar Mareno Olis Öztiryakiler Rosinox Silko Star10 Techninox Therma Zanussi	0A2134 41826630150 22050300 09/85900009 6A046001 49.41015.500 0A2134 C00690 400371 6030019 9021h 0A2134 0A2134 40001010 MA710300 BN6A046001 6254.00005.04 RX94806098 BN6A046001 X40900 RC00070000 0A2134 0A2134
9	300166	2 operating positions	4NO	0-1	16	6x4.6	23	F6.3	NS020402	Baron EGO Giorik Lincar MBM-Italia Offcar Rosinox Silko	BN4185326030019 49.41015.705 6030019 40001024 RTBF900083 862317 RX94805405 SIR0108026
10	301109	2 operating positions	4NO	0-1	16	6x4.6	23	F6.3	NS020403	EGO Fagor	42.03400.009 12024459
11	300067	3 operating positions	4NO	0-1-2	16	6x4.6	23	F6.3	NS030405	EGO Heidebrenner	42.02400.001 94215
12	300173	3 operating positions	4NO	0-1-2	16	6x4.6	232	F6.3		EGO Palux	42.02400.003 685380

fig.	GEV No.	type	function	sequence	SC (A)	shaft ø (mm)	shaft L (mm)	connection	diagram	suitable for	Ref. No.
13	300361	3 operating positions	4NO	0-1-2	16	6x4.6	23	screw	NS030404	Ambach EGO	5060910023 49.41915.707
14	301286	4 operating positions	4NO	0-1-2-3	16	6x4.6	23	F6.3	NS040413	Eloma	ELE320007
15	345321	4 operating positions	5NO	0-1-2-3	16	6x4.6	23	F6.3	NS040609	CB EGO EKU Eloma Palux	07040014 46.23866.580 15-CB-86 ELE320004 647967
16	300183	5 operating positions	5NO	0-1-2-3-4	16	6x4.6	23	F6.3	NS050601	EGO Tecnoeka	46.23866.802 01950337400
17	300119	6 operating positions	5NO	0-1-2-3-4-5	16	6x4.6	23	F6.3	NS060601	EGO Indesit Lotus Star-Manufacturing	46.23866.500 C00055060 537005700 10013000860
18	347655	3 operating positions	8NO	0-1-2	16	6x4.6	33	F6.3	NS030801	Smeg	811730383



Зип Общепит

vsezip.ru

+7(812)987-08-81

fig.	GEV No.	type	function	sequence	SC (A)	shaft ø (mm)	shaft L (mm)	connection	diagram	suitable for	Ref. No.
19	301214	2 operating positions	operation switch	0-1	16	6x4.6	33	F6.3		Cuppone EGO Electrolux Gastrofrit Juno	91310095 42.02900.003 0K1004 306040.030 0K1004
20	300080	2 operating positions	operation switch	0-1	16	6x4.6	23	screw	NS020405	Ambach Anitec Baron Cookmax EGO Electrolux FriFri Gico GIGA Hobart Juno Küppersbusch Lincar Lotus Mareno MBM-Italia Modular Offcar Olis Rosinox Silko Star10 Therma Whirlpool Zanussi	5060904036 X49700 MA710300 710300 49.41015.300 026945 21558010 52004115 X49700 491175 026945 183110 40001018 537000200 MA710300 RTBF900007 66100000 FX40100006 6A044800 RX94805892 MA710300 X49700 026945 483286009371 026945
21	300107	2 operating positions	operation switch	0-1	32	6x4.6	23	screw	NS020406	EGO EGO Silko	43.41832.000 43.41832.020 SIR0108074
22	300180	2 operating positions	operation switch	0-1	32	6x4.6	23	screw	NS020402	Baron EGO Electrolux Mareno Silko Zanussi	CR0686110 43.41832.030 006649 CR0686110 CR0686110 006649
23	300153	3 operating positions	operation switch	0-1-2	16	6x4.6	23	F6.3	NS030602	Bertos EGO Foinox MBM-Italia	23050600 46.23966.950 0038 RTCU700454
24	301095	4 operating positions	operation switch	0-1-2-3		6x4.6		male faston		EGO Electrolux Nayati Zanussi	46.23966.845 054324 PD2455 054324

Diagrams may be found at the end of the chapter

fig.	GEV No.	type	function	sequence	SC (A)	shaft ø (mm)	shaft L (mm)	connection	diagram	suitable for	Ref. No.
25	300209	5 operating positions	operation switch	0-1-2-3-4	16	6x4.6	23	male faston	NS050506	Ambassade Bartscher EGO	6552194 06552194 49.23815.560

miscellaneous

Зип Общепит

vsezip.ru

+7(812)987-08-81



fig.	GEV No.	type	function	sequence	SC (A)	shaft ø (mm)	shaft L (mm)	connection	diagram	suitable for	Ref. No.
1	300219	3 operating positions	3NO	0-1 momentary switch	16	6x4.6	23	F6.3	NS030303	Electrolux Therma Zanussi	0E5132 0E5132 0E5132
2	300221	2 operating positions	4NO	1-2	16	6x4.6	23	F6.3	NS020404	Electrolux Therma Zanussi	0E5131 0E5131 0E5131
3	301299	8 operating positions	5NO	0-1-2-3-4-5-6-7	16	6x4.6	23	F6.3	NS080502	Alpeninox Electrolux Zanussi	0C6245 0C6245 0C6245

Diagrams may be found at the end of the chapter

rotary switches

BREMAS

A1200 series



fig.	GEV No.	sets of contacts	operating positions	function	type	volt. (V)	SC (A)	shaft ø (mm)	shaft L (mm)	connection	diagram	suitable for	Ref. No.
1	345547	1	2	0-1	CA0120001	380	12	5x5	23	screw	010201	Angelo-Po Elettrobar GGF	32W1060 213001 unbekannt
1	345019	2	2	0-1	CA0120002	380	12	5x5	23	screw	020201	Comenda Dihl Fiorenzato-M.C Hoonved Kromo Mareno Rosinox	120712 DW30009001 600000002 H120712 DW30009001 120712 RX94809944
2	345675	3	2	0-1	CA0120003	380	12	5x5	23	screw	030201	Pizza-Group	A87AZ69004
2	345274	4	2	0-1	CA0120004	380	12	5x5	23	screw	040201	Elettrobar Pizza-Group	213003 A87AZ69004
3	347187	3	3	0-1 momentary switch	CS0128293	400	12	5x5	18	screw	030301	Fiorenzato-M.C	600000003
4	345913	4	4	1-2-3-4	CS012M014	400	12	5x5	23	screw	040401	Dihl Kromo Rosinox	DW10300207 DW10300207 RX94807120
5	347857	6	4	0-1-2-3	CS0127042	600	12	5x5	25	screw	060401	Dihl Kromo	DW3002031 DW3002031
6	345628	6	4	0-1-2-3	CS0128445	400	16	5x5	15	screw	050401	Colged Elettrobar	DEC49 926186

Diagrams may be found at the end of the chapter



Зип Общепит

vsezip.ru

+7(812)987-08-81

A1600 series



fig.	GEV No.	sets of contacts	operating positions	function	type	volt. (V)	SC (A)	shaft ø (mm)	shaft L (mm)	connection	diagram	suitable for	Ref. No.
1	345676	3	2	0-1	CA0160003	400	20	5x5	23	screw	030201	Pizza-Group	A87AZ69005
2	345677 ¹	4	2	0-1	CA0160004V	400	16	5x5	23	screw	040202	Comenda	120714
2	300222	4	3	0-1-2	CS0167133	400	16	5x5	24	screw	040302	Comenda Hoonved	120715 H120715
2	347097	4	5	0-1-2-3-4	CS0169615	400	16	5x5	25	screw	040501	Comenda	120751
3	345915	4	5	0-1-2-3-4-5	CS0168485	400	16	5x5	23	screw		Dihl Kromo Rosinox	DW80410 DW80410 RX94809936
4	345009	6	3	0-1-2	CS0168378	600	16	5x5	23	screw	060306	Comenda	120722
5	345315 ²	6	3	1-0-2	CA160007	400	16	5x5	23	screw	060304	Comenda Cuppone Electrolux Tornati	110801 ME0000310 004156 304023
5	345762	6	3	1-0-2	CS0167085	400	16	5x5	23	screw	060301	OEM	EH00900
5	345842	6	5	0-1-2-3-4	CS0168359	400	16	5x5	23	screw	060501	Comenda Mareno	120716 120716
6	347401	8	4	0-1-momentary switch	CS0077762	600	16	5x5	22	screw		Elettobar	205004
7	345012	8	5	0-1-2-3-4	CS0167898	400	16	5x5	25	screw	080501	Comenda	120728
7	345024	8	6	0-1-2-3-4-5	CS0168339	400	16	5x5	25	screw	080601	Comenda Mareno	120729 120729

¹incl. knob and dial plate ²incl. knob
Diagrams may be found at the end of the chapter

A1700 series



fig.	GEV No.	sets of contacts	operating positions	function	type	volt. (V)	SC (A)	shaft ø (mm)	shaft L (mm)	connection	diagram	suitable for	Ref. No.
1	347085	2	2	0-1	CA0170002	400	20	5x5	18	screw	020202	Elektra Mazzer NuovaSimonelli	00056035 5000INA09/QQQ 04200015
2	346104	3	2	0-1	CA0170003	400	20	5x5	21	screw	030202	Astoria Expobar La Marzocco Mazzer WEGA	18201 60900002 E.2.002 5000INA04/AQQ W10734
2	347198 ¹	4	2	0-1	CA0200004V	400	20	5x5	19	screw	040205	BFC Elektra Expobar Royal	5005105 02019035 60900010 5005105
2	346148	4	3	0-1 momentary switch	CS0178377	400	20	5x5	18	screw	040307	Mazzer	5000INA10/AQQ
2	347487 ²	4	3	1-0-2	CA0200006P2	400	25	5x5	24	screw	040310	Gaggia	—
2	347879	4	4	0-1-2-3	CS0176874	400	16	5x5	21	screw		La Cimbali	532005800
3	346397	6	3	0-1-2	CK0208334	400	20	5x5	23	screw	060314	Brasilia Fiamma	17213.2.00.08 5.0.000.0061
4	345007	6	4	0-1-2-3	CS0178766	400	20	5x5	25	screw	050402	Comenda Hoonved Rosinox	120713 H120713 RX94813779
5	346100	8	3	1-0-2	CS0177412	400	20	5x5	21	screw	080302	Astoria BFC Royal WEGA	8318104R 5005035 5005035 WY18104

¹incl. rubber protective sleeve ²incl. knob and dial plate
Diagrams may be found at the end of the chapter



Зип Общепит

vsezip.ru

+7(812)937-08-81

A2000 series



fig.	GEV No.	sets of contacts	operating positions	function	type	volt. (V)	SC (A)	shaft ø (mm)	shaft L (mm)	connection	diagram	suitable for	Ref. No.
1	345574	8	3	1-0-2	CS0204083	400	25	5x5	30	screw	080303	Eloma Palux	ELE320033 368873

A2500 series



fig.	GEV No.	sets of contacts	operating positions	function	type	volt. (V)	SC (A)	shaft ø (mm)	shaft L (mm)	connection	diagram	suitable for	Ref. No.
1	347688	2	2	0-1	120701	600	32	5x5	19	screw	020201	Comenda	120701
2	346105	3	2	0-1	CA0250003	690	32	5x5	23	screw	030203	Astoria OEM	18207 EH00600
3	345026 ¹	6	3	1-0-2	CS0257088	600	32	5x5	23	screw	060304	Cuppone	91310061
3	347251	6	4	0-1-2-3	CS0258542	600	32	5x5	27	screw	060403	Gaggia	WGADM1944

¹incl. knob and dial plate
Diagrams may be found at the end of the chapter

A3200 series



fig.	GEV No.	sets of contacts	operating positions	function	type	volt. (V)	SC (A)	shaft ø (mm)	shaft L (mm)	connection	diagram	suitable for	Ref. No.
1	345817	4	2	0-1	CS0327690	600	32	5x5	26	screw	040204	Lincar MBM-Italia Offcar Silko	40001021 RTBF800161 862325 SIR0108008
2	346023	6	3	1-0-2	CS0327419	600	40	5x5	23	screw	050301	Rancilio	34030025

Diagrams may be found at the end of the chapter

CQ016R series



fig.	GEV No.	sets of contacts	operating positions	function	volt. (V)	SC (A)	shaft ø (mm)	shaft L (mm)	connection	diagram	suitable for	Ref. No.
1	346592	2	2	0-1	400	20	5x5	16	screw	020203	Sirman	19410160

Зип Общепит

vsezip.ru

+7(812)987-08-81

accessories



fig.	GEV No.	ø (mm)	shaft ø (mm)	colour	H (mm)	L (mm)	suitable for	Ref. No.	fig.	GEV No.	ø (mm)	shaft ø (mm)	colour	H (mm)	L (mm)	suitable for	Ref. No.
1	111012	34/60	5x5	black	22	50	CB Gaggia La-Spaziale	07110149 12000822 2421	1	111420	34/60	5x5	red	22	50	Electrolux	004147
1	111369	28/48	5x5	black	22	40	La Marzocco SV-Italia	L400/K SVTMM023	2	346399	50	-	transparent	-	-	Brasilia	17234.2.00.08
									3	347398	-	-	black	-	52	—	—

BRETER

rotary switches



fig.	GEV No.	sets of contacts	operating positions	function	type	volt. (V)	SC (A)	shaft ø (mm)	shaft L (mm)	connection	diagram
1	347884	3	3	0-1-2 (momentary)	LE2-16	690	16	5x5	15	screw	030304
1	347909	4	3	1-0-2	LE2-12-3252	600	12	9x8	20	screw	040318
2	347156	8	3	1-0-2	LE2-16-7293	690	16	8x9	20	screw	080307

Diagrams may be found at the end of the chapter

accessories



fig.	GEV No.	description	version	function	dimensions (mm)	shaft ø (mm)
1	347910	knob dimensions 22mm shaft ø 9x7mm	-	-	22	9x7
2	111294	knob shaft 5x5 black	-	-		
3	347619	knob with bezel 0-1	with bezel	0-1		

ENTRELEC



fig.	GEV No.	sets of contacts	operating positions	function	type	volt. (V)	SC (A)	shaft ø (mm)	shaft L (mm)	connection	suitable for	Ref. No.
1	305001	10	4	0-1-2-3	-	400	18	6x6	23	screw	Bonnet	311243



GIOVENZANA

Зип Общепит

rotary switches

vsezip.ru

+7(812)987-08-81



technical data:
connection screw

fig.	GEV No.	sets of contacts	operating positions	function	volt. (V)	SC (A)	shaft ø (mm)	shaft L (mm)	diagram	suitable for	Ref. No.
1	347503	2	2	0-1	690	20	6x4.6	28	020203	Bezzera	7633334
2	347975	3	3	0-1-2	690	20	5x5	15	030309	—	—
2	346565 ¹	4	2	0-1-2	600	16	5x5	15	040312	CB	07040031
3	348053	4	2	0-1	600	32	5x5	26		Giorik	6030003
4	347634	4	2	0-1	690	20	8x8	15	040206	Pizza-Group	A87AZ69004
5	345239	4	2	0-1	690	40	6x4.6	15	040207	Pizza-Group	A87AZ69009

¹incl. knob and dial plate



technical data:
connection screw

fig.	GEV No.	sets of contacts	operating positions	function	volt. (V)	SC (A)	shaft ø (mm)	shaft L (mm)	diagram	suitable for	Ref. No.
6	348091	6	2	0-1	690	20	6x4.6	24		Bezzera	7633337
7	347658	6	3	0-1-2	690	20	5x5	38		Brasilia	04990.2.00.08

Diagrams may be found at the end of the chapter

accessories



fig.	GEV No.	description	version	ø (mm)	shaft (mm)	shaft diameter (mm)	application
1	347651	knob with bezel dimensions 48x48mm display 0-I	with bezel	-	-	-	for rotary switch
2	111344	knob zero mark ø 40mm shaft diameter 5x5mm	zero mark	40	-	5x5	-

GOTTAK



fig.	GEV No.	sets of contacts	operating positions	function	type	volt. (V)	SC (A)	shaft ø (mm)	shaft L (mm)	connection	suitable for	Ref. No.
1	347356 ¹	2	2	0-1	4RH	400	16	6x4.6	18	F6.3	Sammic	2309182
1	347471 ¹	4	4	0-1-2-3	4RH	400	16	6x4.6	18	F6.3	Sammic	2309869
2	347723	5	3	1-2-3	46RCTH	400	16	6x4.6	23	F6.3	Electrolux	0K8614
3	347874	10	5	0-1-2-3-4	46RCTH	400	16	6x4.6	23	F6.3	Fagor	12023965

¹incl. knob

KRAUS & NAIMER

Зип Общепит

rotary switches



vsezip.ru

+7(812)987-08-81

fig.	GEV No.	sets of contacts	operating positions	function	type	volt. (V)	SC (A)	shaft ø (mm)	shaft L (mm)	connection	diagram	suitable for	Ref. No.
1	345474	3	3	0-1-2	CH6-A230	400	20	6x4.6	21	screw	030303	Meiko	0123273
2	345431	4	2	0-1	9A003PL-2V	400	2	6	17	screw	030204	Pizza-Group	A96ZN00037
3	347807	4	3	momentary switch-1-2	CA10-AT13F623	400	20	6x4.6	21	screw	040314	Kreff	151205

Diagrams may be found at the end of the chapter

accessories

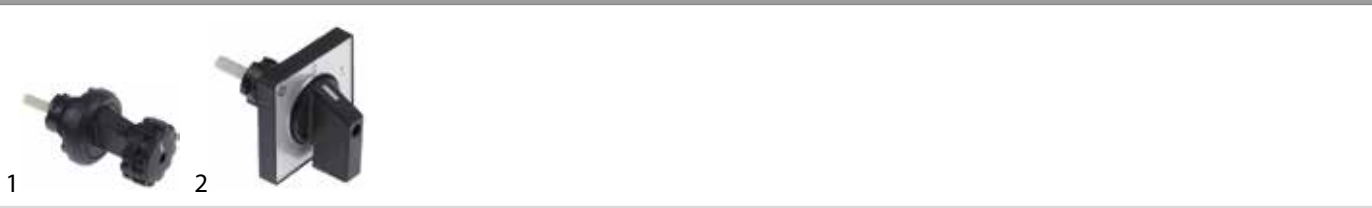

fig.	GEV No.	description	operating positions	shaft ø (mm)	shaft L (mm)
1	347214	knob shaft ø 6mm shaft length 20mm complete		6	20
2	347215	knob complete 2 shaft ø 6mm shaft length 20mm	2	6	20

LOVATO



fig.	GEV No.	sets of contacts	operating positions	function	type	volt. (V)	SC (A)	shaft ø (mm)	shaft L (mm)	connection	diagram	suitable for	Ref. No.
1	346234	2	2	0-1	GN20 9480 U	690	20	6x6	23.5	screw	020203	ATA	7950
1	346178	2	2	0-1	GN209479U	690	20	6x6	23.5	screw	020203	ATA	7606
1	347976 ¹	2	2	0-1	GN209775U20	690	20	6x6	15	screw	020203	Lamber	0301020
2	346902	4	3	1-2-start	GN209482U	690	20	6x6	23.5	screw	040319	ATA	4277
3	346179	5	3	1-0-2	GN209538U	690	20	6x6	23.5	screw	050304	ATA	7951
3	346235	6	5	0-1-2-3-4	GN209478U	690	20	6x6	23.5	screw	060502	ATA	9804
4	345799	7	4	1-2-3-4	GN20 9779 U20	690	20	6x6	13.5	screw	070402	Lamber	0301025
4	347984	8	6	1-0-2-3-4-5	GN209537U	400	20	5x5	16.28	screw	080602	ATA	4970

¹incl. knob and dial plate

Diagrams may be found at the end of the chapter

MOELLER/EATON

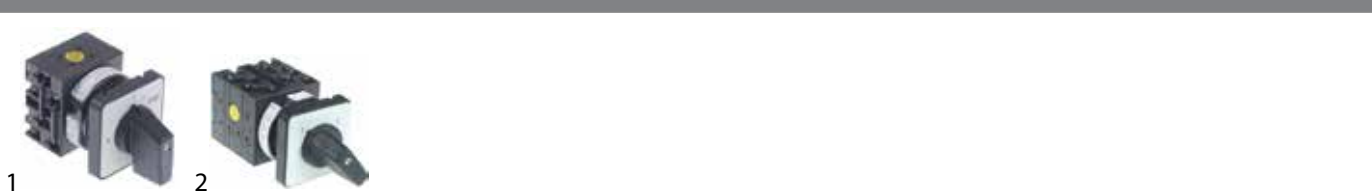

fig.	GEV No.	sets of contacts	operating positions	function	type	volt. (V)	SC (A)	shaft ø (mm)	shaft L (mm)	connection	diagram	suitable for	Ref. No.
1	347954	4	3	0-1-2	T0-2-15512	400	16	5.8x6.9	27	screw	040315	MKN	203969
2	346588	8	2	1-2	T0-4-969I/E	400	16	5.8x6.9	26.8	screw	080201	Fimar	SL2743

Diagrams may be found at the end of the chapter



SONTHEIMER

Зип Общепит

vsezip.ru

+7(812)987-08-81



1

fig.	GEV No.	operating positions	function	sets of contacts	volt. (V)	SC (A)	shaft ø (mm)	shaft L (mm)	type	connection	diagram	suitable for	Ref. No.
1	345388	2	0-1	2	600	16	6x6	24	A2/12E/Z3/BG/X70S	screw	020203	KSF Rancilio	4.013.02.01 34030026

TECNOMATIC



fig.	GEV No.	sets of contacts	operating positions	function	type	volt. (V)	SC (A)	shaft ø (mm)	shaft L (mm)	connection	diagram	suitable for	Ref. No.
1	345016	1	2	0-1	HD1201R000	600	12	5x5	23	screw	010202	Elframo Repagas	25100001 8700027
2	347055	2	2	0-1	HD1602R000	600	16	5x5	23	screw	020203	Elframo	25100102
3	300331	2	2	0-1	HD1602R000	600	16	4x6	17	screw	020203	Marels Modular	461.030.00 461.030.00
4	345994	4	5	0-1-2-3-4	HD16G014F112	600	16	5x5	23	screw	040503	Fimar Sirman	CO1045 IB5806800
5	346239	5	3	1-0-2 momentary	HD1237R921-L5	600	12	6	22	F6.3	050305	Cookmax Sirman	MF2365 MF2365
5	346238	6	3	1-0-2 momentary	HD1249R922	600	12	5x5	23	screw	060310	Cookmax Sirman	MF2364 MF2364
6	347993	6	5	0-1-2-3-4	HD12X167R000	600	12	6x4.6	21	F6.3		Inoxtrend	C3652-12
7	347875	6	5	0-1-2-3-4	HD16G014F112	600	16	5x5	23	screw		Sirman	IB5806820

Diagrams may be found at the end of the chapter



8

fig.	GEV No.	sets of contacts	operating positions	function	type	volt. (V)	SC (A)	shaft ø (mm)	shaft L (mm)	connection	diagram	suitable for	Ref. No.
8	345503	16	5	2-1-0-1-2	HD16X370R000	600	16	5x4	17	screw clamp	160501	—	—

TELERGON



1

fig.	GEV No.	sets of contacts	operating positions	function	type	volt. (V)	SC (A)	shaft ø (mm)	shaft L (mm)	connection	suitable for	Ref. No.
1	347693	1	2	0-1	T-0002000011E1N1	300	20	5x5	15	screw clamp	Repagas	27800010



Зип Общепит

producer-specific rotary switches

DIHR / KROMO

vsezip.ru

+7(812)987-08-81

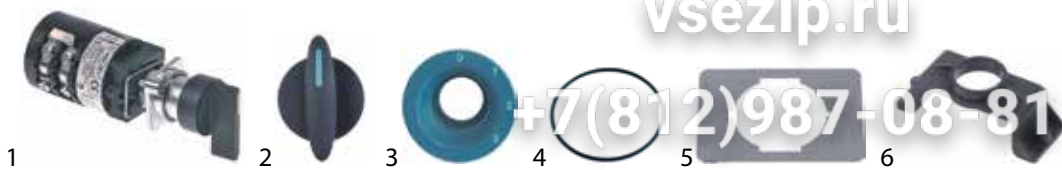

fig.	GEV No.	description	Ref. No.
1	345913	rotary switch 4 1-2-3-4 4 type CS012M014 400V 12A shaft \varnothing 5x5mm shaft length 23mm shaft square	DW10300207
2	110731	knob switch zero mark \varnothing 29mm black shaft special	DW89321
3	345911	element holder blue-grey shape round 0-3	DW89349
4	345896	O-ring EPDM thickness 1,5mm ID \varnothing 37mm Qty 1 pcs	DW89332
5	697910	fixing plate for rotary switch L 80mm W 60mm thickness 1mm	DW89323
6	697909	fastening angle for rotary switch plastic L 76mm W 31mm	DW89322

miscellaneous



fig.	GEV No.	sets of contacts	operating positions	function	type	volt. (V)	SC (A)	shaft \varnothing (mm)	shaft L (mm)	connection	diagram	suitable for	Ref. No.
1	348100	2	0-1	3NO	4G10N-10-R03	600	20	6x6	20	screw	030204	—	—
2	347734	2	2	0-1	CA20A201	690	25	5.8	27	screw	020203	GMG	PI-B101
3	348036	2	2	0-1	CH	400	16	6x4.6	22	F6.3		Saro	122-2018
4	347689	2	2	0-1	CS20-00063	690	25	5x5	22	F6.3	020201	Colged Elettrobar Faema	REB213002 213002 3761119055
5	347040	3	2	0-1 momentary	-	400	32	5x5	-	screw	030204	Cookmax Henkelman	0220060 0220060

Diagrams may be found at the end of the chapter

accessories

levers



fig.	GEV No.	description
1	347041	knob 2 0-1 for rotary switch
2	347866	lever ON/OFF lever length 115mm L 90mm W 90mm shaft 8x8mm mounting distance 68mm

knobs



fig.	GEV No.	description
1	112613	knob \varnothing 42mm H 22mm black shaft diameter 5x5mm
2	112615	knob with indicator \varnothing 35mm H 22mm shaft diameter 8x7mm black

symbol labels

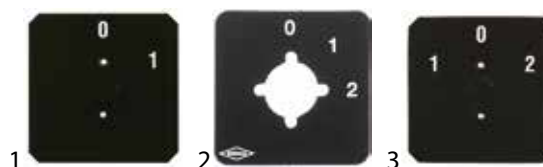

fig.	GEV No.	description
1	345793	symbol label 0 up to 1 L 58,5mm W 58,5mm bore \varnothing 10mm mounting distance 20mm
2	347773	symbol label 0-1-2 L 49mm W 49mm bore \varnothing 17mm
3	345794	symbol label 1-0-2 L 58,5mm W 58,5mm bore \varnothing 10mm mounting distance 20mm

foot switches



fig.	GEV No.	description	fig.	GEV No.	description
1	347735	foot switch	2	346841	foot switch 1CO



Зип-Общепит

vsezip.ru

+7(812)987-08-81

touch sensitive light switches



fig.	GEV No.	description	suitable for	Ref. No.
1	402043	light barrier L 180 mm W 35 mm H 46 mm	Electrolux Icematic Scotsman Simag	0KM709 CF65067402 65067402 65067402
1	402009	light barrier L 310mm W 35mm H 47mm	Electrolux GIGA Icematic Scotsman	086475 I78316701 33580175/0 65067400
2	403481	light barrier receiver for ice maker	Migel	1LT066
2	403480	light barrier transmitter for ice maker	Migel	1LT065



fig.	GEV No.	description	suitable for	Ref. No.
3	346388	switch 1NO for combi-steamer L 47 mm W 20 mm	Ambach Lainox	R65260750 LAR65260750

magnetic switches

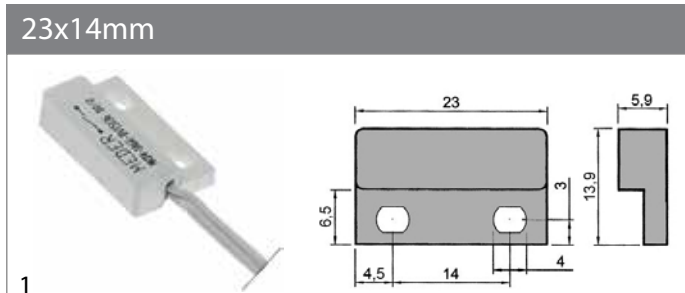

fig.	GEV No.	function	volt. (V)	SC (A)	P max. (W)	CL (mm)	suitable for
1	347995	1NO	180	0.5	10	500	Retigo
1	347994	1NO	180	0.5	10	700	Retigo
1	346106	1NO	90	0.5	10	500	Astoria WEGA



fig.	GEV No.	function	volt. (V)	SC (A)	P max. (W)	CL (mm)	suitable for
1	348110 ¹	1NO	300	0.5	10	1500	Icematic

¹with coded connector

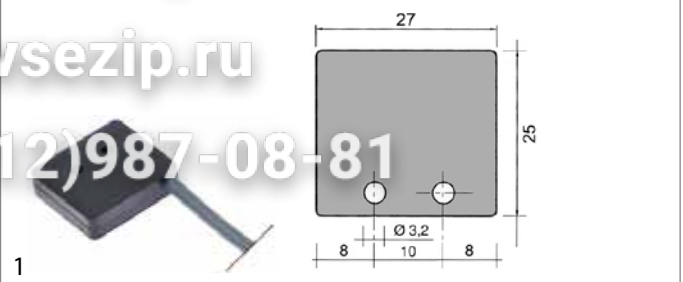

fig.	GEV No.	function	volt. (V)	SC (A)	P max. (W)	CL (mm)	suitable for
1	347760	1NO	24	0.4	9.6	300	Falcon

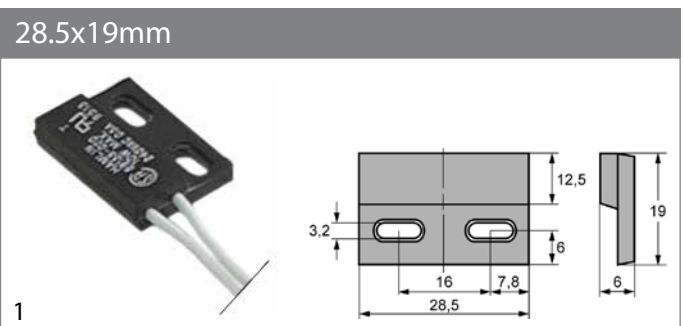

fig.	GEV No.	function	volt. (V)	SC (A)	P max. (W)	CL (mm)	suitable for
1	345219	1NO	230	0.5	10	800	MKN

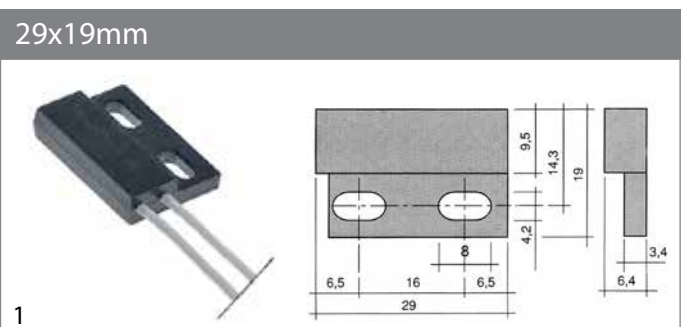

fig.	GEV No.	function	volt. (V)	SC (A)	P max. (W)	CL (mm)	suitable for
1	347966	1CO	12	0.05	0.6	5000	Meiko
1	345808	1CO	150	0.5	10	1000	FriFri Meiko MKN
1	347960	1NO	12	0.05	0.6	290	Meiko
1	345248	1NO	24	0.01	0.24	300	Meiko
1	345217	1NO	125	0.5	10	2000	Convotherm FriFri Krefft Rational
1	347030 ¹	1NO	250			360	Cookmax N&W
1	345117	1NO	250	0.04	10	1000	Convotherm EKU Electrolux Hobart MKN Zanussi
1	347025	1NO	250	0.04	10	1000	Jemi
1	347495	1NO	250	0.3	10	2000	Convotherm
1	348050 ¹	1NO	250	0.5	10	290	Pitco
1	348051	1NO	250	0.5	10	290	Pitco
1	347405	1NO	250	1.5	50	500	Melitta
1	348049	1NO	250	1.5	50	600	Pitco

¹with coded connector



Зип Общепит

vsezip.ru

+7(812)987-08-81

32x15mm

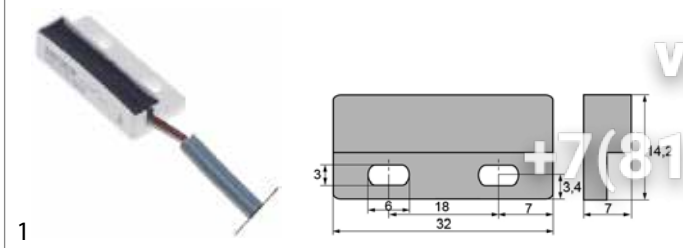

1

fig.	GEV No.	function	volt. (V)	SC (A)	P max. (W)	CL (mm)	suitable for
1	347186	1NO	175	0.25	3	1350	Winterhalter
1	345109	1NO	250	1	40	2000	Fagor Krefft Morice Rational

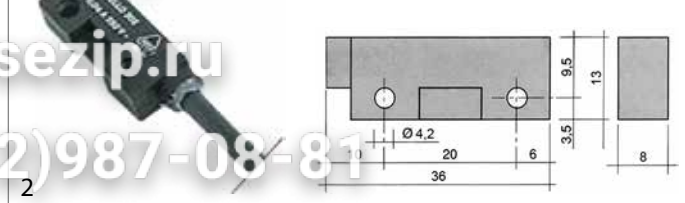

2

fig.	GEV No.	function	volt. (V)	SC (A)	P max. (W)	CL (mm)	suitable for
2	345792 ¹	1NO	250	0.04	10	2500	Lasa
2	345820 ¹	1NO	250	1	50	290	Electrolux Zanussi

¹with coded connector

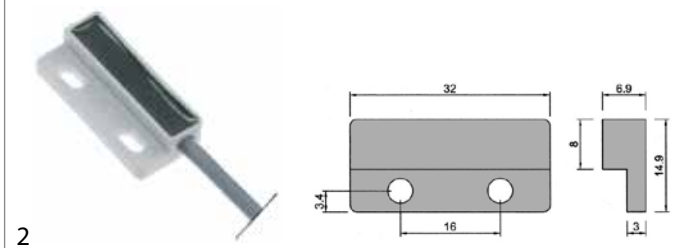

2

fig.	GEV No.	function	volt. (V)	SC (A)	P max. (W)	CL (mm)	suitable for
2	346515 ¹	1NO	250	0.5	50	1750	Rational
2	345968	1NO	250	1	100	1000	Winterhalter

¹with coded connector

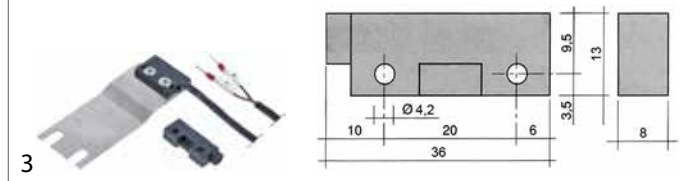

3

fig.	GEV No.	function	volt. (V)	SC (A)	P max. (W)	CL (mm)	suitable for
3	347867	1NO	250	0.4	100	1000	Jemi

36x13mm

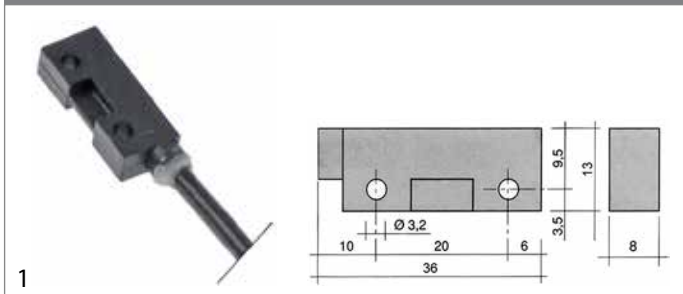

1

fig.	GEV No.	function	volt. (V)	SC (A)	P max. (W)	CL (mm)	suitable for
1	345335	1NO	250	0.04	10	960	Comenda Cookmax Friulinox Hoonved LineaBlanca Mareno Polaris Rosinox Sirman
1	345118 ¹	1NO	250	1	50	980	Colged Cookmax Elettrobar GIGA Hobart Icematic Krefft Nayati Palux Rancilio SF-Maschinen

¹with coded connector

36x26mm

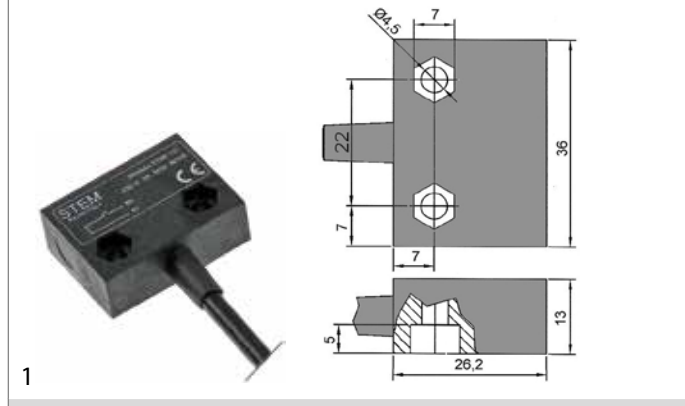

1

fig.	GEV No.	function	volt. (V)	SC (A)	P max. (W)	CL (mm)	suitable for
1	346999	1NC	230	3	60	2000	Electrolux Zanussi
1	346998	1NO	230	3	60	2000	Electrolux Therma Zanussi
1	347000	1NO	230	3	60	5500	Electrolux Therma Zanussi



Зип-Общепит

65x20mm

vsezip.ru

+7(812)987-08-81

37x16mm

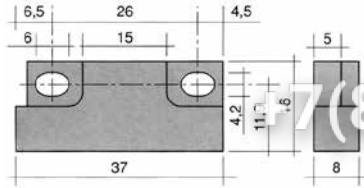

fig.	GEV No.	function	volt. (V)	SC (A)	P max. (W)	CL (mm)	suitable for
1	347540	1NO	250	0.04	10	370	Silanos
1	345341	1NO	250	0.04	10	1960	Silanos
1	347936 ¹	1NO	250	0.04	10	360/540	Silanos Whirlpool
1	345600	1NO	250	0.2	50	960	Angelo-Po Inoxtrend Silanos

40x13mm

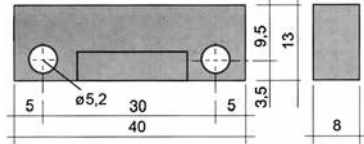

fig.	GEV No.	function	volt. (V)	SC (A)	P max. (W)	CL (mm)	suitable for
1	346351	1NO	250	0.04	10	650	Baron Olis
1	345358	1NO	250	0.04	10	900	Comenda
1	345504	1NO	250	0.04	10	1000	Lamber Sammic
1	345990	1NO	250	0.04	10	2000	Dihr Kromo Rosinox

50x19mm

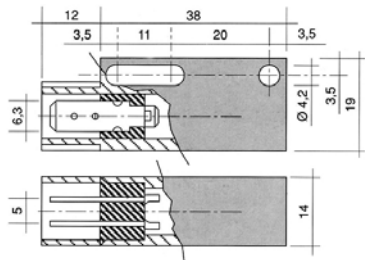

fig.	GEV No.	function	volt. (V)	SC (A)	P max. (W)	suitable for
1	345821	1NO	250	1	50	Electrolux Hobart Zanussi
1	347450 ¹	1NO	250	1	50	Electrolux

¹incl. bracket

fig.	GEV No.	function	volt. (V)	SC (A)	P max. (W)	CL (mm)	suitable for
1	347876	1NC	24	4	100	1940	Colged Elettrobar
1	347911	1NO	24	3	72	2000	ATA
1	345122 ¹	1NO	24	8	192	344	Comenda Hoonved Mareno Rosinox
1	344998 ¹	1NO	250	0.4	25	2000	Afinox
1	345116	1NO	250	0.4	100	3000	ATA Colged Comenda Dihr Elettrobar Elframo Fagor Frigomat Hoonved Ilsa Komel Kromo Lamber Lohberger Lotus Mach Mareno NuovaSimonelli Omnivash Polaris Rosinox

¹with coded connector

fig.	GEV No.	function	volt. (V)	SC (A)	P max. (W)	CL (mm)	suitable for
2	346030 ¹	1NO	250	0.04	100	80	—
2	346058	1NO	250	0.04	100	80	—

¹incl. bracket



Зип Общепит

vsezip.ru

+7(812)987-08-81

79x21mm

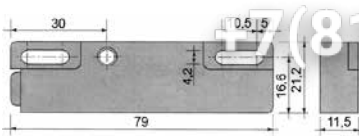



fig.	GEV No.	function	volt. (V)	SC (A)	P max. (W)	CL (mm)	suitable for
1	345783	1NO	250	1	50	580	—





fig.	GEV No.	function	volt. (V)	SC (A)	P max. (W)	CL (mm)	suitable for
1	348102	1NO	250		10	1500	La Minerva

80x20mm

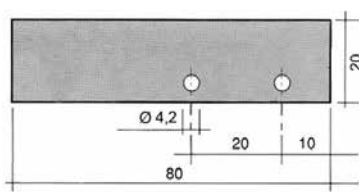



fig.	GEV No.	function	volt. (V)	SC (A)	P max. (W)	CL (mm)	suitable for
1	347912	1NO	250	1	100	7000	Winterhalter
1	347644	1NO	180-265	0.5	10	550	Winterhalter

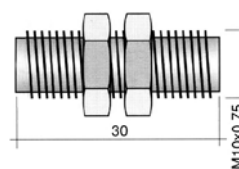



fig.	GEV No.	function	volt. (V)	SC (A)	P max. (W)	CL (mm)	suitable for
2	347937	1NO	250	0.04	10	430	Sammic

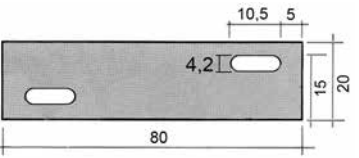



fig.	GEV No.	function	volt. (V)	SC (A)	P max. (W)	CL (mm)	suitable for
2	345801	1NO	250	3	100	5000	Meiko





fig.	GEV No.	function	volt. (V)	SC (A)	P max. (W)	CL (mm)	suitable for
3	345632	1NO	250	0.5	50	2000	Angelo-Po Celme Convotherm Fimar GAM Hemerson Icematic Saro Silanos Sirman Whirlpool

80x30mm

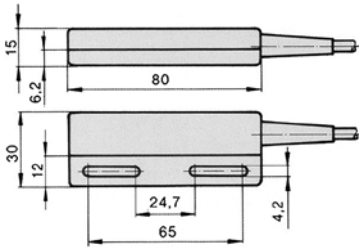



fig.	GEV No.	function	volt. (V)	SC (A)	P max. (W)	connection	CL (mm)
1	345806	1CO	250	1	80	cable	7500
1	347925	1NO	250	0.2	100	cable	1300
1	345918	1NO	250	0.2	100	cable	4500

M10x1

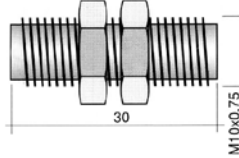



fig.	GEV No.	function	volt. (V)	SC (A)	P max. (W)	CL (mm)	suitable for
1	347829	1NO	230	0.2	46	1300	Nisbets



Зип.Общепит

Ø 5.2mm

vsezip.ru

+7(812)987-08-81

M12x1

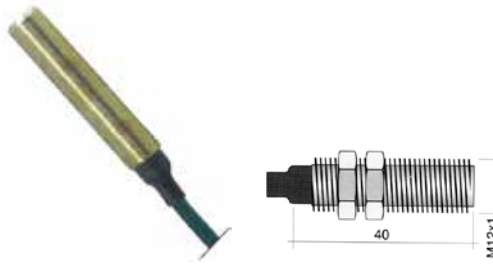

1

fig.	GEV No.	function	volt. (V)	SC (A)	P max. (W)	CL (mm)	suitable for
1	345430	1NO	250	1	50	2000	—
1	345135	1NO	250	3	100	2000	Eloma Falcon



1

fig.	GEV No.	volt. (V)	SC (A)	P max. (W)	probe L (mm)	CL (mm)	suitable for
1	347011	250	0.04	10	26	1000	Eloma

2

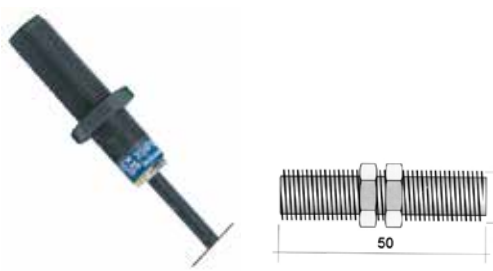
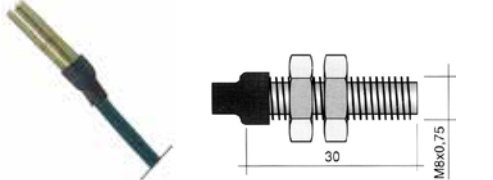

fig.	GEV No.	function	volt. (V)	SC (A)	P max. (W)	CL (mm)	suitable for
2	345900	1NO	24-240V AC/DC	0.2	5-50	2000	Bourgeois Telemecanique

M8x0.75



1

fig.	GEV No.	function	volt. (V)	SC (A)	P max. (W)	CL (mm)	suitable for
1	345631	1NO	250	1	50	2000	Colged Cookmax Rosinox Sirman

Ø 4mm



1 2

fig.	GEV No.	volt. (V)	SC (A)	P max. (W)	probe L (mm)	CL (mm)	suitable for
1	381268				57	800	Hounö
2	347049	24	0.5	12	20		Omas

Ø 6mm



1 2

fig.	GEV No.	volt. (V)	SC (A)	P max. (W)	probe L (mm)	CL (mm)	suitable for
1	347461	28	0.5	15	26	280	Ecomax Hobart
1	347835	150	1	10	29	1700	Hobart
1	345630	250	0.04	10	29	350	Elettrobar
1	345202	250	0.04	10	29	1400	Colged Elettrobar Eloma Rosinox
1	345146	250	1	50	29	460	Electrolux Elettrobar Fagor Zanussi
1	345967	250	1	50	29	3000	Cookmax Sirman
2	347044 ¹	200	0.1	10	26	490	Thermoplan

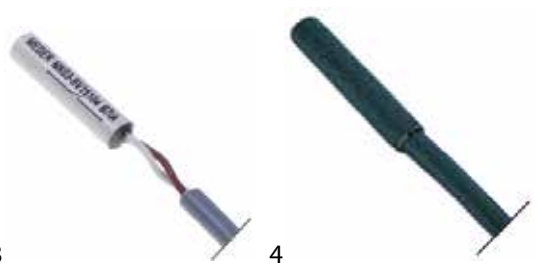
¹with coded connector

3 4

fig.	GEV No.	volt. (V)	SC (A)	P max. (W)	probe L (mm)	CL (mm)	suitable for
3	347584 ¹	200	0.5	100	26	700	Winterhalter
4	347685 ¹	250	0.04	10	29	650	Sammic
4	345819 ¹	250	1	50	29	300	Electrolux Zanussi
4	347972	100	0.5	20	29	5	Meiko

¹with coded connector



Зип Общепит

vsezip.ru

+7(812)987-08-81

ø 7mm

1 2

fig.	GEV No.	description	volt. (V)	SC (A)	P max. (W)	probe L (mm)	CL (mm)	suitable for
1	347330 ¹	magnetic switch	28	0.2	5	26	400	Animo
2	347818	magnetic switch	100	0.5	20	31	700	—

¹with coded connector

3

fig.	GEV No.	volt. (V)	SC (A)	P max. (W)	probe L (mm)	CL (mm)	suitable for
3	348024	250	1	10	33	1500	Sagi

ø 8mm

1 2

fig.	GEV No.	volt. (V)	SC (A)	P max. (W)	probe L (mm)	CL (mm)	suitable for
1	347430	12	1	10	50	2500	Winterhalter
2	346511	230	0.2	50	60	2500	Fagor Rational

miscellaneous

1 2

fig.	GEV No.	volt. (V)	SC (A)	P max. (W)	function	L (mm)	suitable for
1	348039				1NO	65	Hounö
2	347921	12	0.07	1	1NO	32	Winterhalter

ø 9mm

1

fig.	GEV No.	volt. (V)	SC (A)	P max. (W)	probe L (mm)	CL (mm)	suitable for
1	347190	150	0.5	10	30	1500	Electrolux Zanussi
1	345991	250	0.04	10	30	2000	Dihl Kromo Rosinox

3 4

fig.	GEV No.	volt. (V)	SC (A)	P max. (W)	function	L (mm)	suitable for
3	347457	12	0.5	6	1CO	55	Saro
4	347203	12	0.5	6	1NO	35	Robot-Coupe

ø 10mm

1 2

fig.	GEV No.	volt. (V)	SC (A)	P max. (W)	probe L (mm)	CL (mm)	suitable for
1	347899	12	1	10	26	1500	Electrolux
2	347409	165	0.75	120	39	800	Bonamat

5 6

fig.	GEV No.	volt. (V)	SC (A)	P max. (W)	function	L (mm)	suitable for
5	344999	24	0.1	2.5	1NO	60	Nilma
6	347812	100	0.01	1	1NC	48	Ascobloc



Зип Общепит

vsezip.ru

+7(812)987-08-81

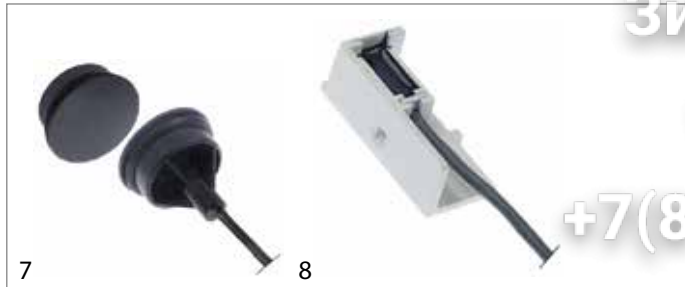

fig.	GEV No.	volt. (V)	SC (A)	P max. (W)	function	L (mm)	suitable for
7	347629	250			1NO	800	Foster
8	347697	250	1	250	1NO	61	Manitowoc



fig.	GEV No.	volt. (V)	SC (A)	P max. (W)	function	L (mm)	suitable for
9	347961	250	3	750	1NO	12	Öztiryakiler

Unable to find the right part?



www.gev-online.com
www.gev-online.co.uk

You will find even more catering spare parts in the GEV Webshop



010201

	R/U
0	
1	X

010202

	1/2
0	
1	X

020201

	R/U	S/V
0		
1	X	X

020202

	UT1/RL1	VT2/SL2
0		
1	X	X

020203

	1/2	3/4
0		
1	X	X

030201

	R/U	S/V	T/W
0			
1	X	X	X

030202

	UT1/RL1	SL2/VT2	TL3/WT3
0			
1	X	X	X

030203

	R/U	S/V	T/W
0			
1	X	X	X

030204

	1/2	3/4	5/6
0			
1	X	X	X

030301

	A/A	L1/T1	L2/T2
0			
1	X	X	X
2	X	X	X

030303

	1/2	3/4	5/6
0			
1	X		
2		X	
4			X

030304

	1/2	3/4	5/6
0			
1	X	X	
2	X	X	X

030309

	1/2	5/6	7/8
0			
1	X	X	
2			X

040201

	R/U	S/V	T/W	N/N
0				
1	X	X	X	X

040202

	L1/T1	L2/T2	L3/T3	N/N
0				
1	X	X	X	X

040204

	R/U	S/V	T/W	O/O
0				
1	X	X	X	X

040205

	L1/T1	L2/T2	L3/T3	N/N
0				
1	X	X	X	X

040206

	1/2	3/4	5/6	7/8
0				
1	X	X	X	X

040207

	1/2	3/4	5/6	N/N
0				
1	X	X	X	X

040302

	1/1	2/2	3/3	4/4
0				
1	X	X		
2	X	X	X	X

040307

	A/A	UT1/RL1	SL2/VT2	TL3/WT3
0				
1		X	X	X
Taster	X	X	X	X

040310

	L1/T1	L2/T2	L1/U1	L2/V1
1	X	X		
0				
2			X	X

040312

	1/S	1/R	2/S	2/R
0				
1	X	X		
2	X	X	X	X

040314

	1/2	3/4	5/6	7/8
Taster	X	X	X	
1				X
2	X	X		X

040315

	1/2	3/4	5/6	7/8
0				
1	X	X		
2			X	X

040318

	1/2	3/4	5/6	7/8
0				
1		X		X
2	X		X	

040319

	1/2	3/4	5/6	7/8
1				X
2	X	X		
Start	X	X	X	

040401

	1/R	2/R	3/R	4/R
0	R	R	R	R
1	X			
2		X		
3			X	
4				X

040501

	1/1	2/2	3/3	4/4
0				
1	X	X		X
2	X	X	X	
3	X	X	X	X
4	X	X		

040503

	1/2	3/4	5/6	7/8
0				
1	X			
2	X	X		
3	X	X	X	
4	X	X	X	X

050301

	R/1	S/2	T/3	T/4	N/5
1				X	X
0					
2	X	X	X	X	X

050304

	1/2	3/4	5/6	7/8	9/10
1	X	X	X	X	
0					
2	X	X			X

050305

	1/2	3/4	5/6	7/8	9/10
0					
1	X			X	X
0					
Taster		X	X		X

050401

	2/3	4/3	6/3	8/7	10/9
0					
1	X				X
2		X			X
3			X		X
4				X	

050402

	1/1	2/2	3/3	4/4	5/5
0					
1	X	X			X
2	X	X		X	
3	X	X	X		

060301

	R/U	R/U1	S/V	S/V1	T/W	T/W1
0	R	R				
1			S	S		
2					T	T
3			U	V	W	
1	X		X		X	
0						
2		X		X		X

060304

	R/U	R/U1	S/V	S/V1	T/W	T/W1
1	X		X		X	
0						
2		X		X		X

060306

	1/1	2/2	3/3	4/4	5/5	6/6
0						
1	X	X	X	X	X	
2	X	X	X	X		X

Зип Общепит

vsezip.ru

7(812)987-08-81

060310

	1/2	3/4	5/6	7/8	9/10	11/12
	1		5			9
	3		7			11
1	X	X	X			X
0						
Taster	X	X		X	X	

060314

	1/2	3/4	1/6	7/8	1/10	7/12
	1		5			9
	3		7			11
0						
1					X	X
2	X	X	X	X	X	X

060401

	1/1	2/2	3/3	4/4	5/5	6/6
0						
1	X	X				
2	X	X	X	X		X
3	X	X	X	X	X	

060403

	1/L1	N/2	3/L2	4/4	5/5	6/L3
0						
1	X	X				
2	X	X	X	X	X	
3	X	X	X	X	X	X

060501

	1/1	2/2	3/3	4/4	5/5	6/6
0						
1	X	X				X
2	X	X			X	
3	X	X		X		
4	X	X	X			

060502

	1/2	3/4	5/6	7/8	9/10	11/12
0						
1	X	X				
2	X	X	X	X		
3	X	X	X		X	
4	X	X	X			X

070402

	1/2	3/4	5/6	7/8	9/10	11/12	13/14
	1		5				
			9			13	
	4		8				
1	X	X					
2			X	X	X		
3			X	X		X	
4			X	X			X

080201

	1/2	3/4	5/6	7/8	9/10	11/12	13/14	15/16
	2		4					
			8			10		12
						14		16
						11		15
	5		9					
	3		7					
1		X			X			X
2	X			X	X		X	X

080302

	1/2	3/4	5/6	7/8	9/10	11/12	13/14	15/16
1		X		X	X	X		X
0					X	X		
2	X	X	X	X		X	X	X

080303

	R/U	R/Z	S/V	Y/Z	S/X	Y/X	T/W	Y/W
1	X		X	X		X	X	
0								
2	X	X	X		X		X	X

080307

	1/2	3/4	5/6	7/8	9/10	11/12	13/14	15/16	
	3		5		7				
			11			15			
			9			13			
1		X			X	X			
0									
2	X		X	X			X	X	

080501

	1/1	2/2	3/3	4/4	5/5	6/6	7/7	8/8
0								
1	X	X	X	X				X
2	X	X	X					X
3	X	X			X		X	X
4	X	X				X	X	X

080601

	1/1	2/2	3/3	4/4	5/5	6/6	7/7	8/8
0								
1	X	X	X		X			
2	X	X	X	X				
3	X	X	X					
4	X	X				X		X
5	X	X					X	X

080602

	1/2	3/4	5/6	7/8	9/10	11/12	13/14	15/16
1	X	X					X	
0								
2	X	X						X
3	X	X	X	X				X
4	X	X	X		X			X
5	X	X	X			X		X

160501

	1/2	3/4	5/6	7/8	9/10	11/12	13/14	15/16	17/18	19/20	21/22	23/24	25/26	27/28	29/30	31/32
2	X	X	X	X				X	X	X	X		X			
1	X	X	X	X				X	X		X		X			
0																
1	X		X				X			X		X		X		
2	X		X	X	X		X				X		X		X	



NS020101

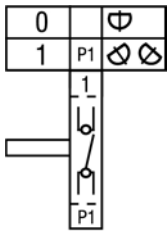

NS020201

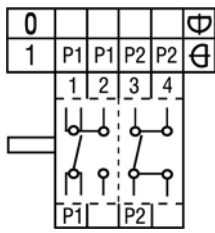

NS020202

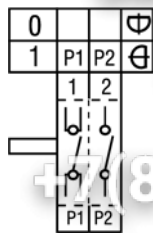

NS020203

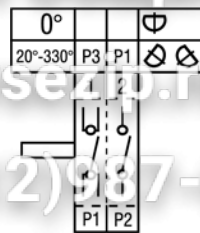

NS020204

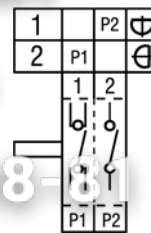

NS020205

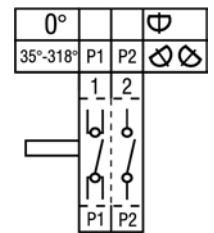

NS020206

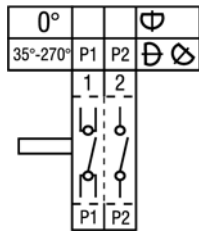

NS020207

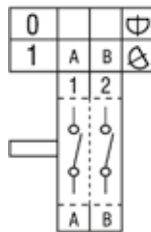

NS020301

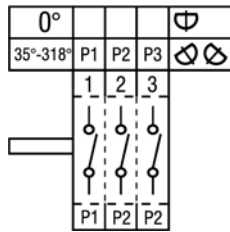

NS020401

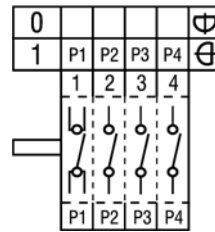

NS020402

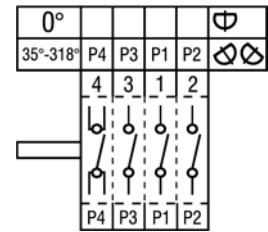

NS020403

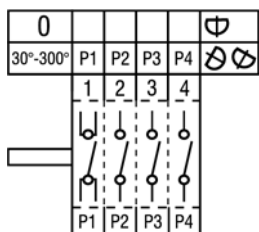

NS020404

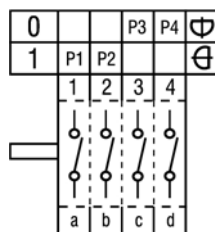

NS020405

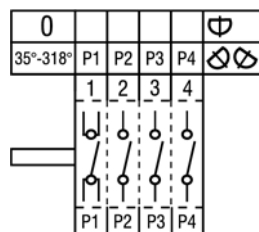

NS020406

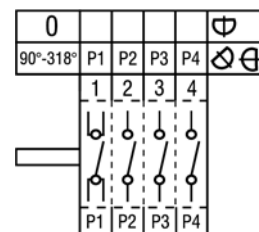

NS030201

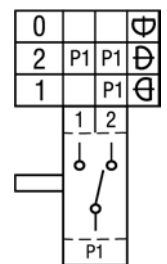

NS030301

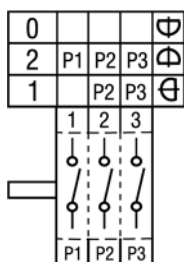

NS030302

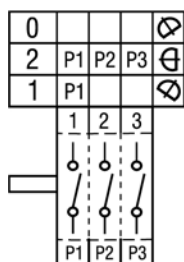

NS030303

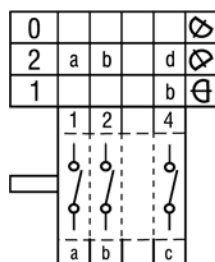

NS030401

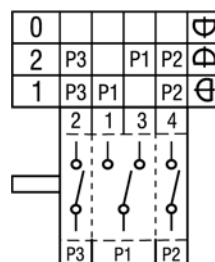

NS030402

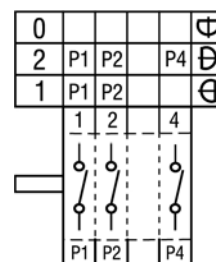

NS030404

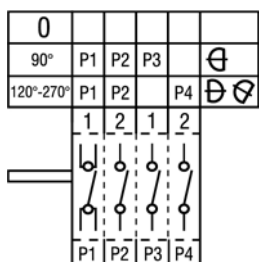

NS030405

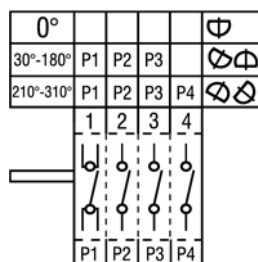

NS030501

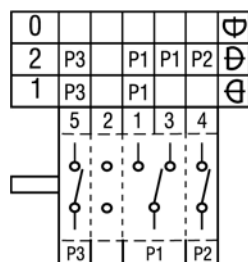

NS030502

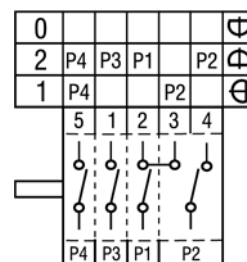

NS030503

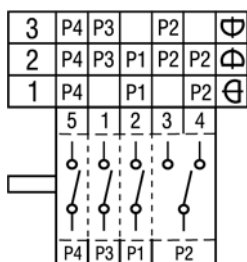

NS030601

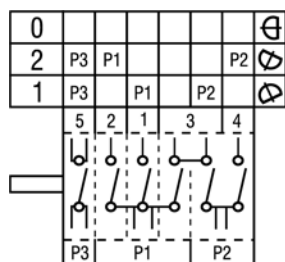

NS030602

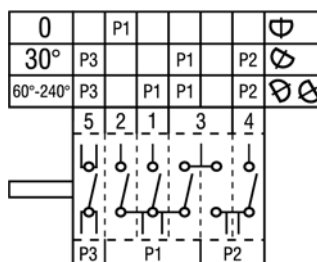

Зип Общент

NS030702

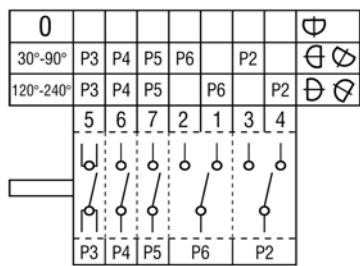

NS030801

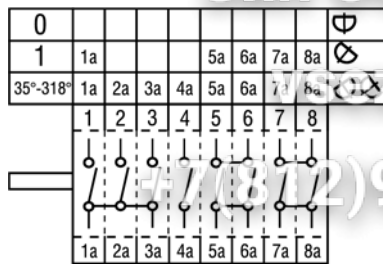

NS031201

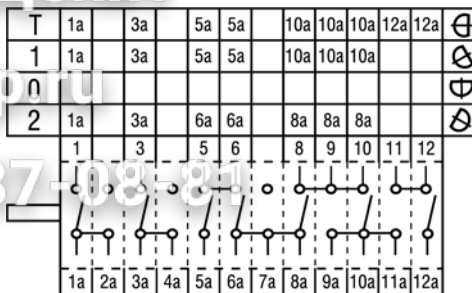

NS040201

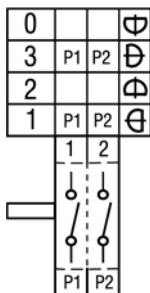

NS040202

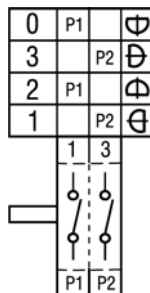

NS040301

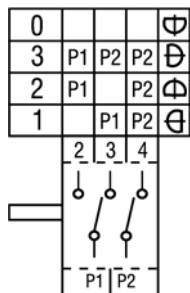

NS040302

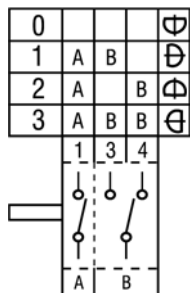

NS040304

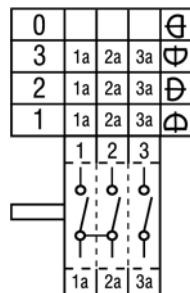

NS040401

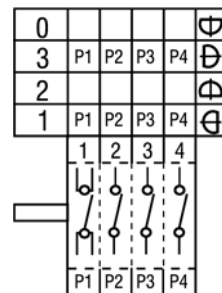

NS040404

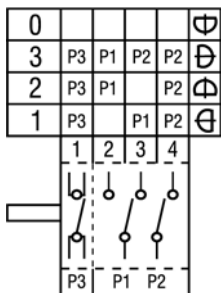

NS040406

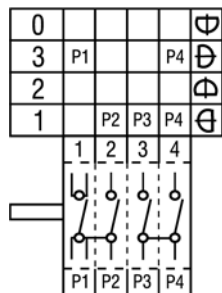

NS040407

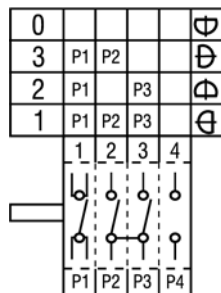

NS040408

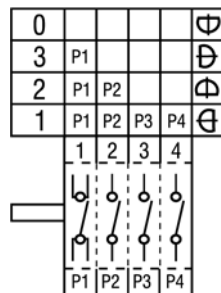

NS040409

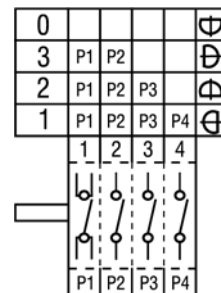

NS040410

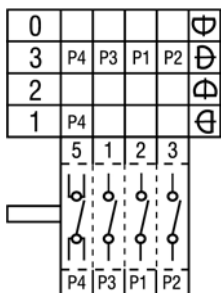

NS040411

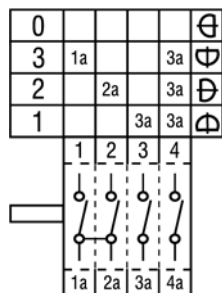

NS040412

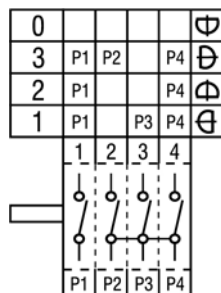

NS040413

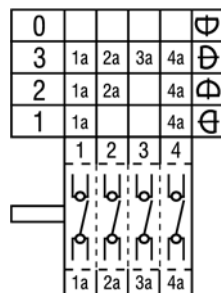

NS040414

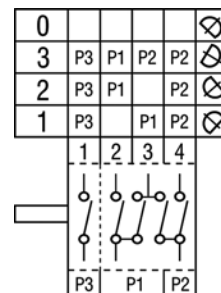

NS040501

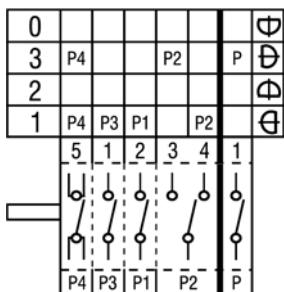

NS040504

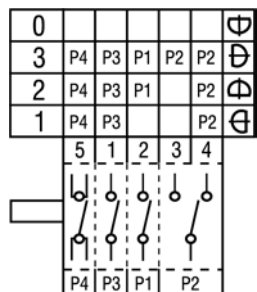

NS040506

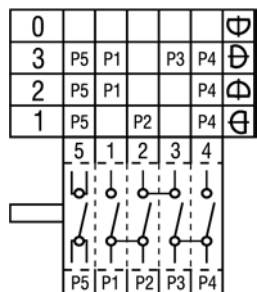

NS040507

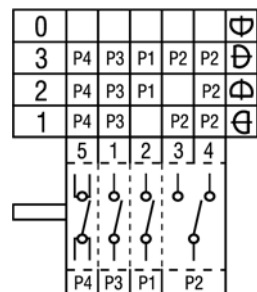



NS040508

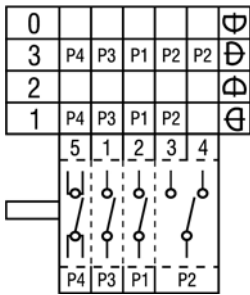

NS040509

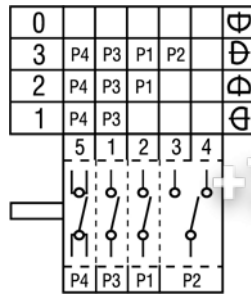

NS040510

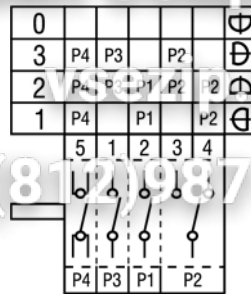

NS040511

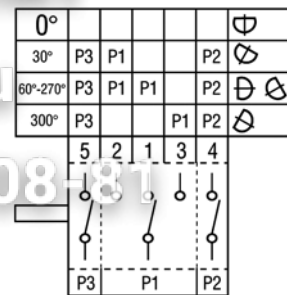

NS040601

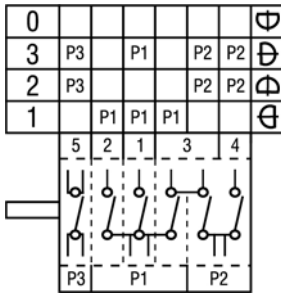

NS040602

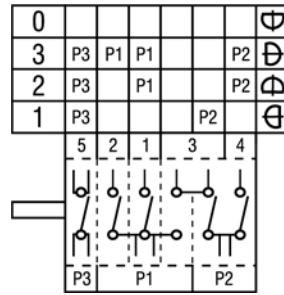

NS040603

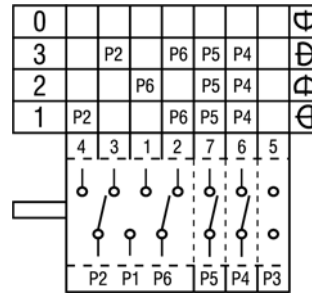

NS040604

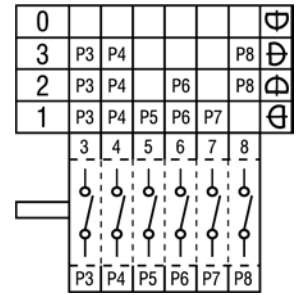

NS040605

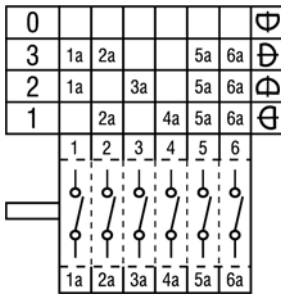

NS040606

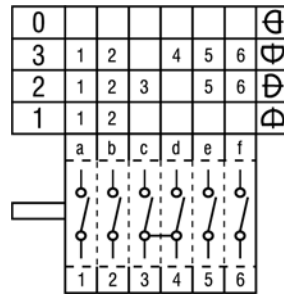

NS040607

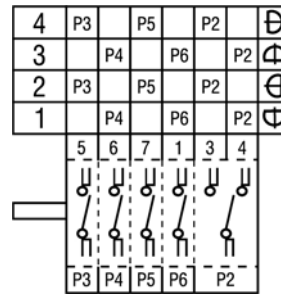

NS040608

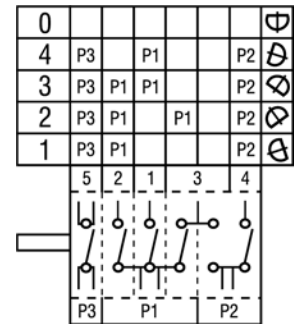

NS040609

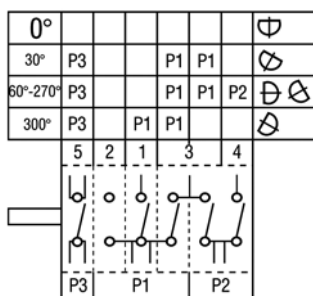

NS040701

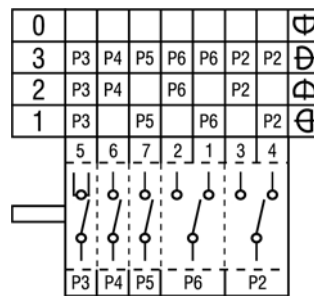

NS040801

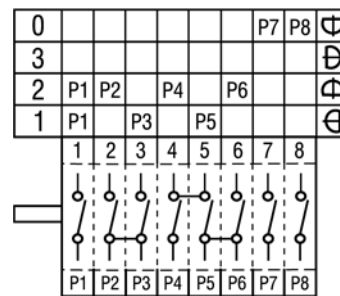

NS040802

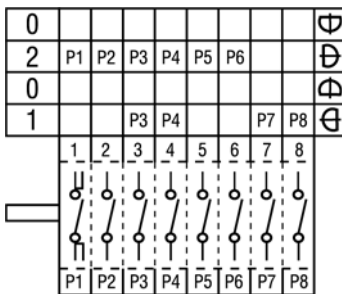

NS040803

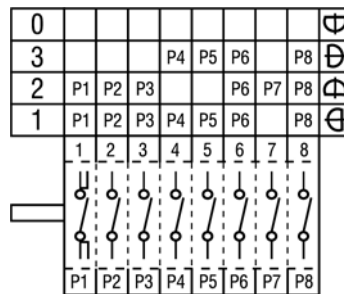

NS040804

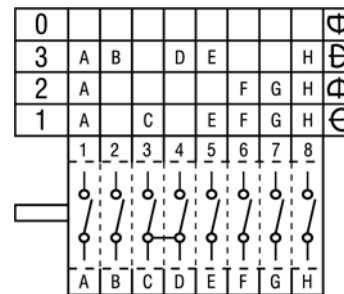

Зип Общепит

NS040805

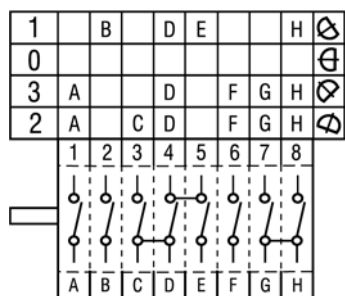

NS040806

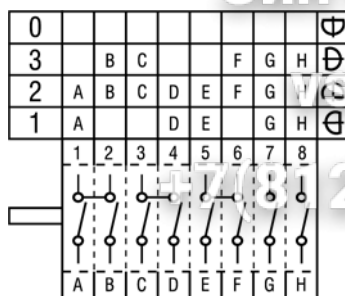

NS040807

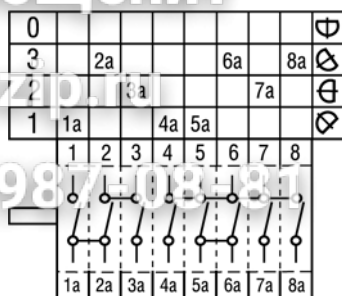

NS041201

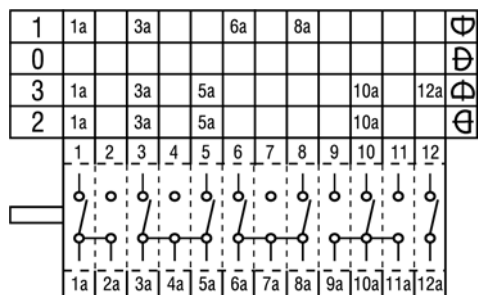

NS050301

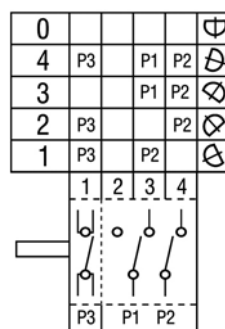

NS050401

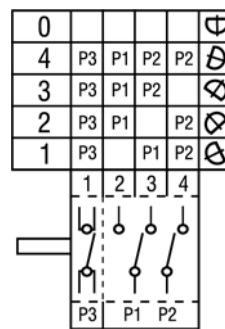

NS050501

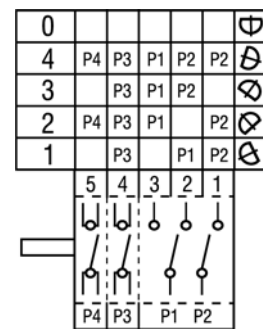

NS050503

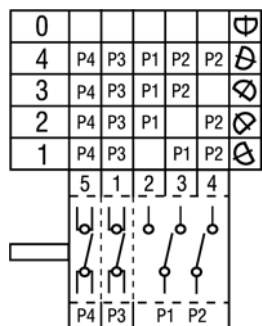

NS050504

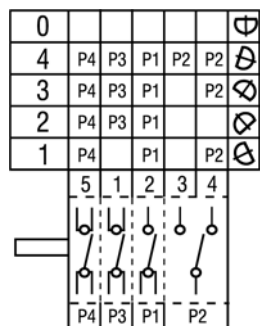

NS050505

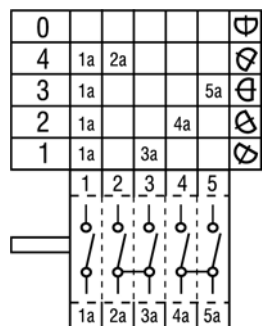

NS050506

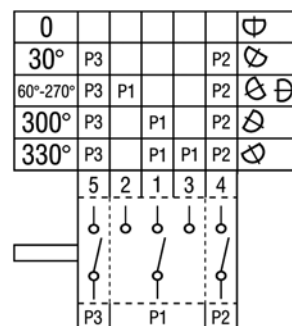

NS050601

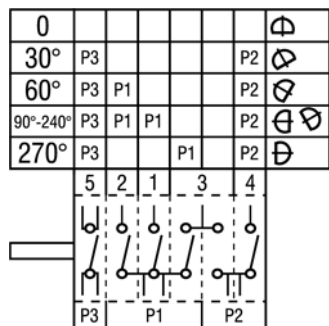

NS050801

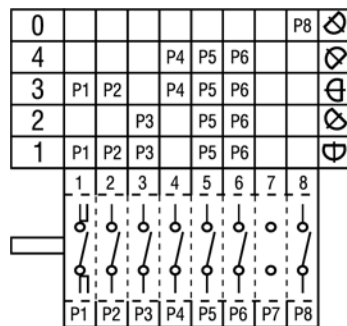

NS050802

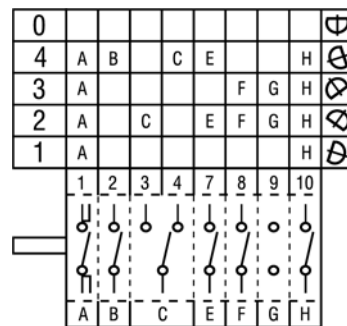

NS050803

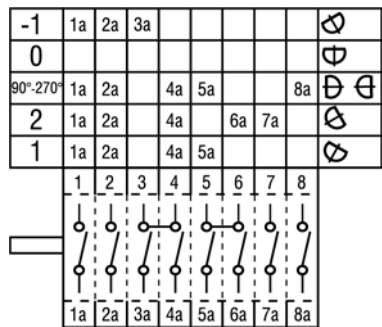

NS050901

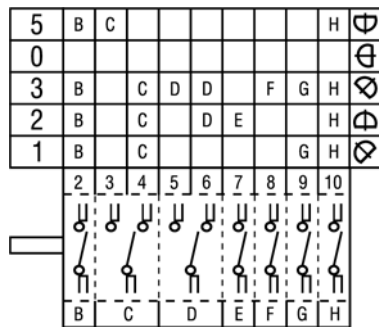

NS050904

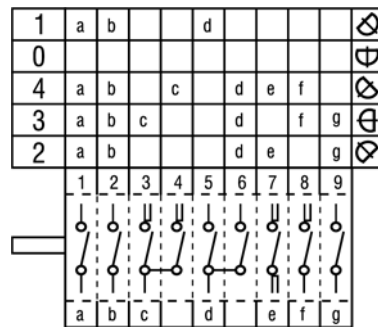



NS051001

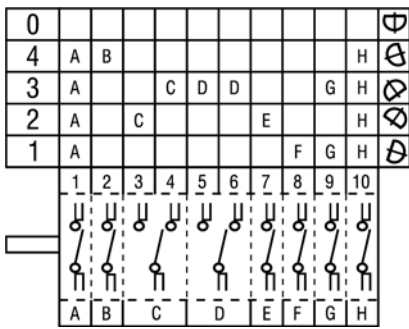

NS060301



NS060501

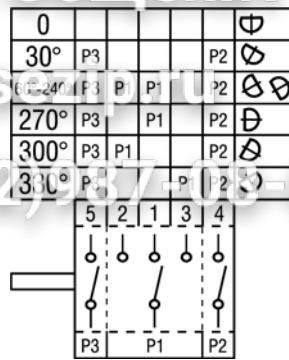

NS060601

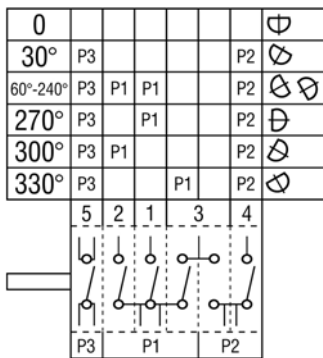

NS060701

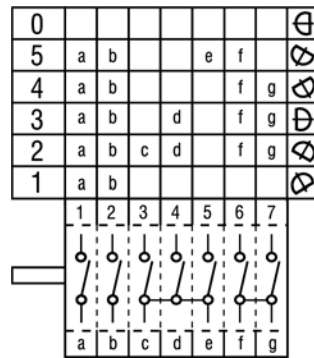

NS070302

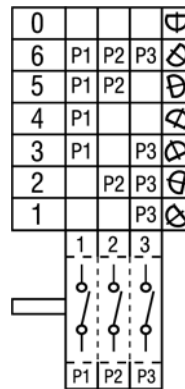

NS070401

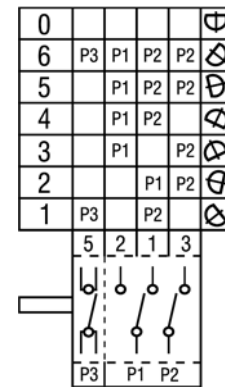

NS070402

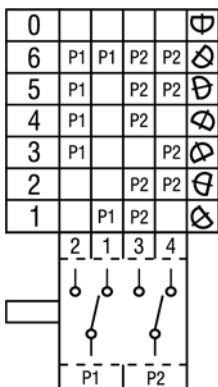

NS070501

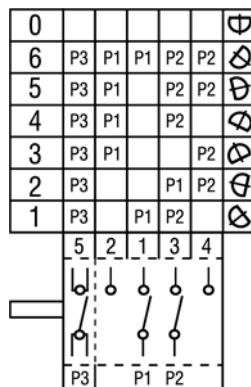

NS070502

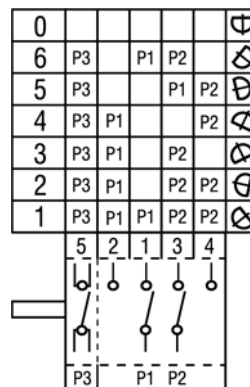

NS070503

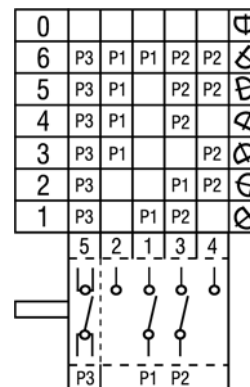

NS070504

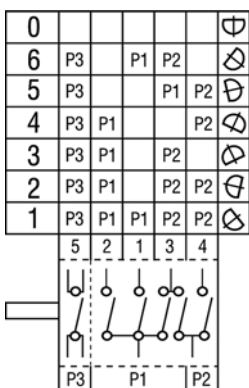

NS070601

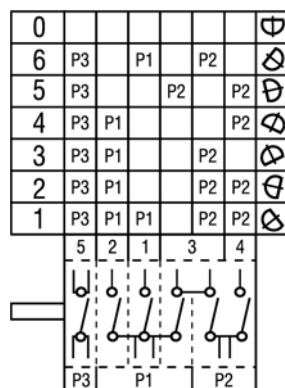

NS070701

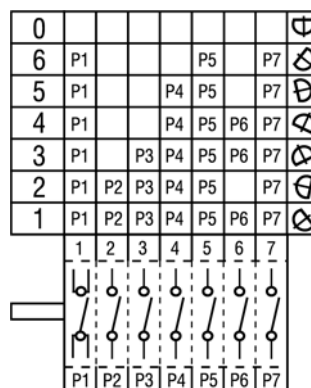

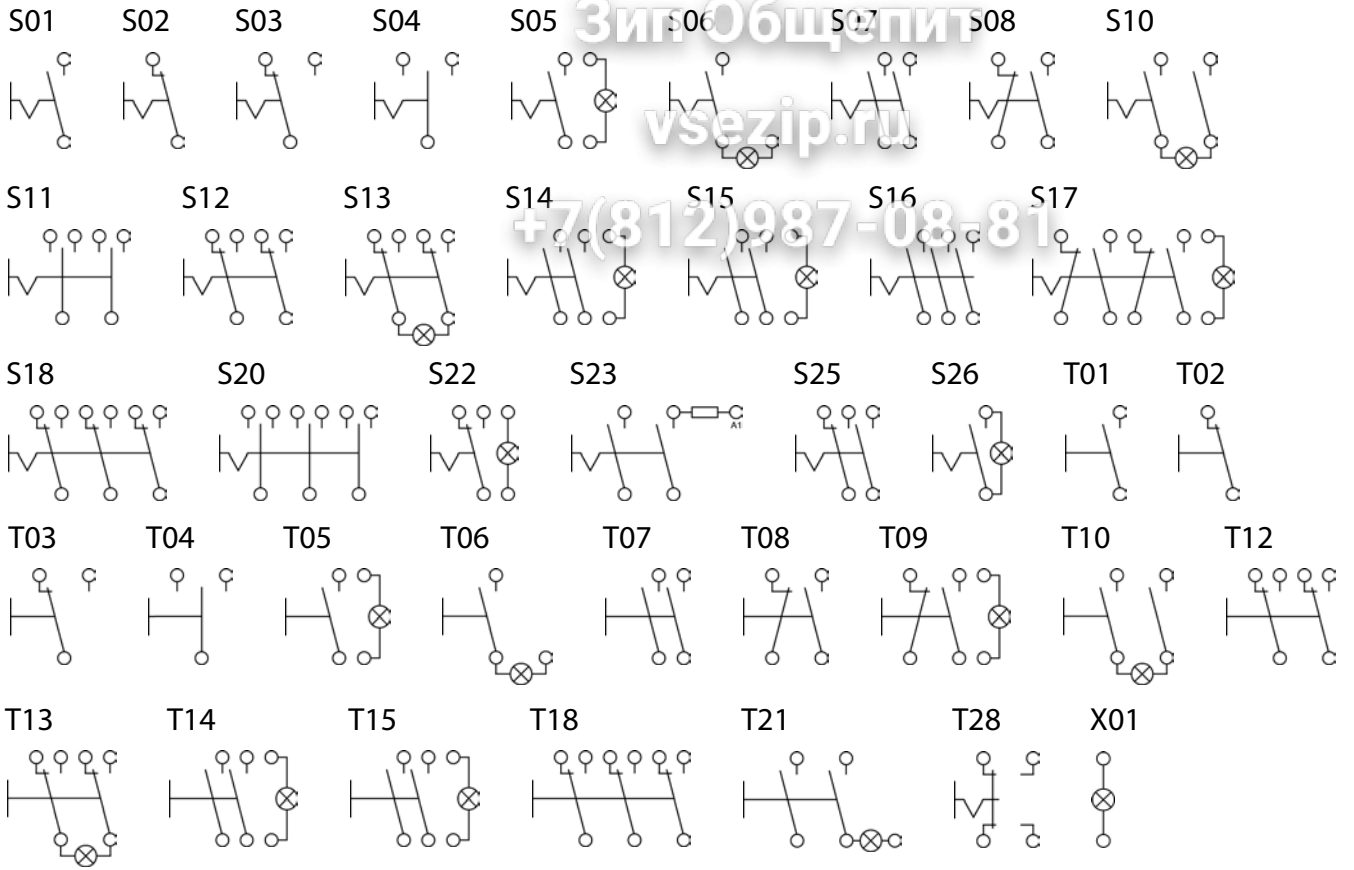

Зип Общепит

vsezip.ru

+7(812)987-08-81