







Зип Общепит

XFT133/0.D06

vsezip.ru

+7(812)987-08-81

Assembly code	Assembly description	Assembly image
ASM0025C/0.D00	Door	
ASM2019C/0.D00	Cooking chamber	
ASM2020D/0.D02	External cover	
ASM2021D/0.D00	Electrical system	



Зип Общепит
vsezip.ru

SPARE PART LIST

ASM0025C/0.D00 Door

+7(812)987-08-81

ASM0025C/0.D00 - Door

FRONT

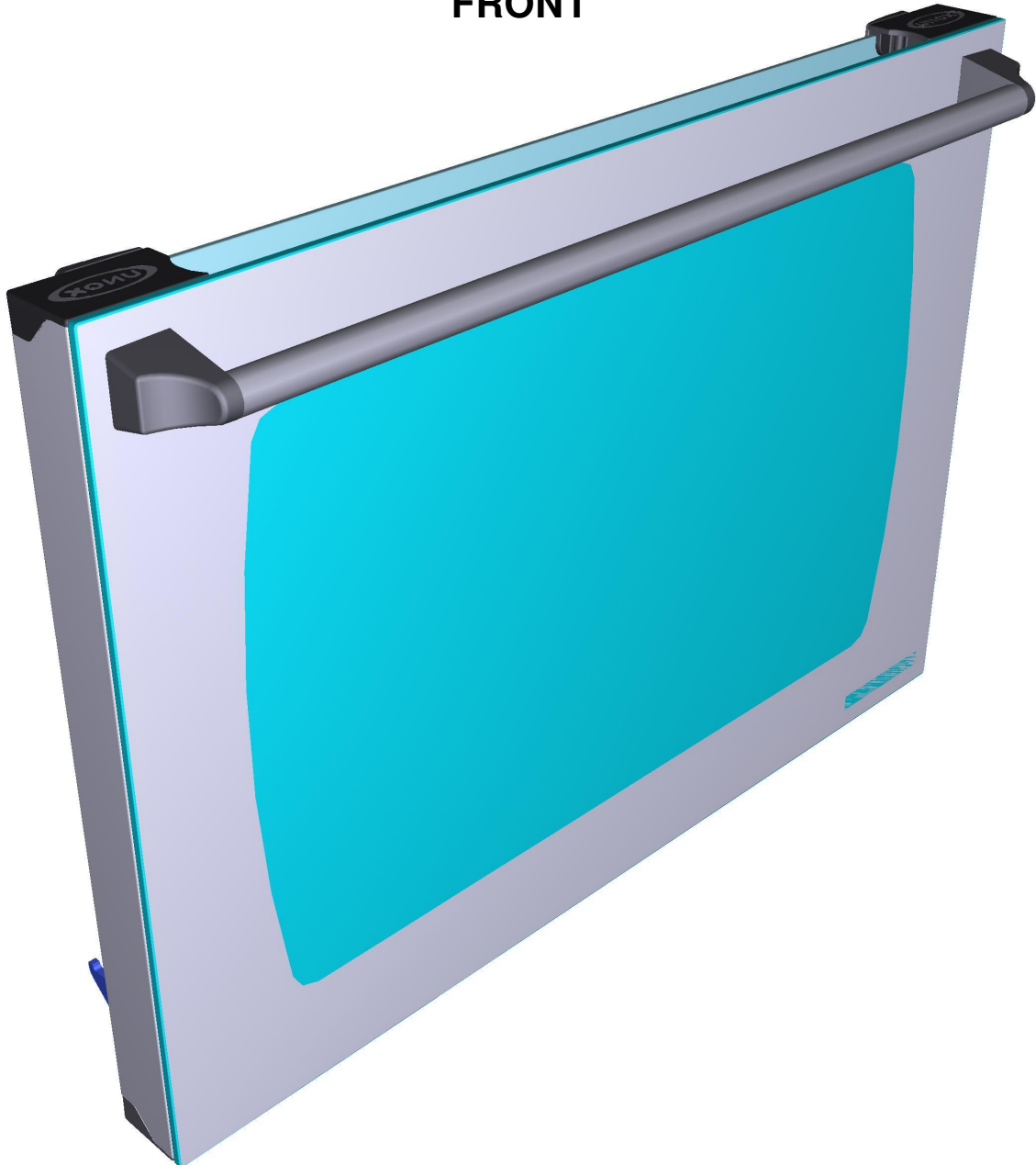



Зип Общепит

ASM0025C/0.D00 Door

vsezip.ru

+7(812)987-08-81

ASM0025C/0.D00 - Door

REAR

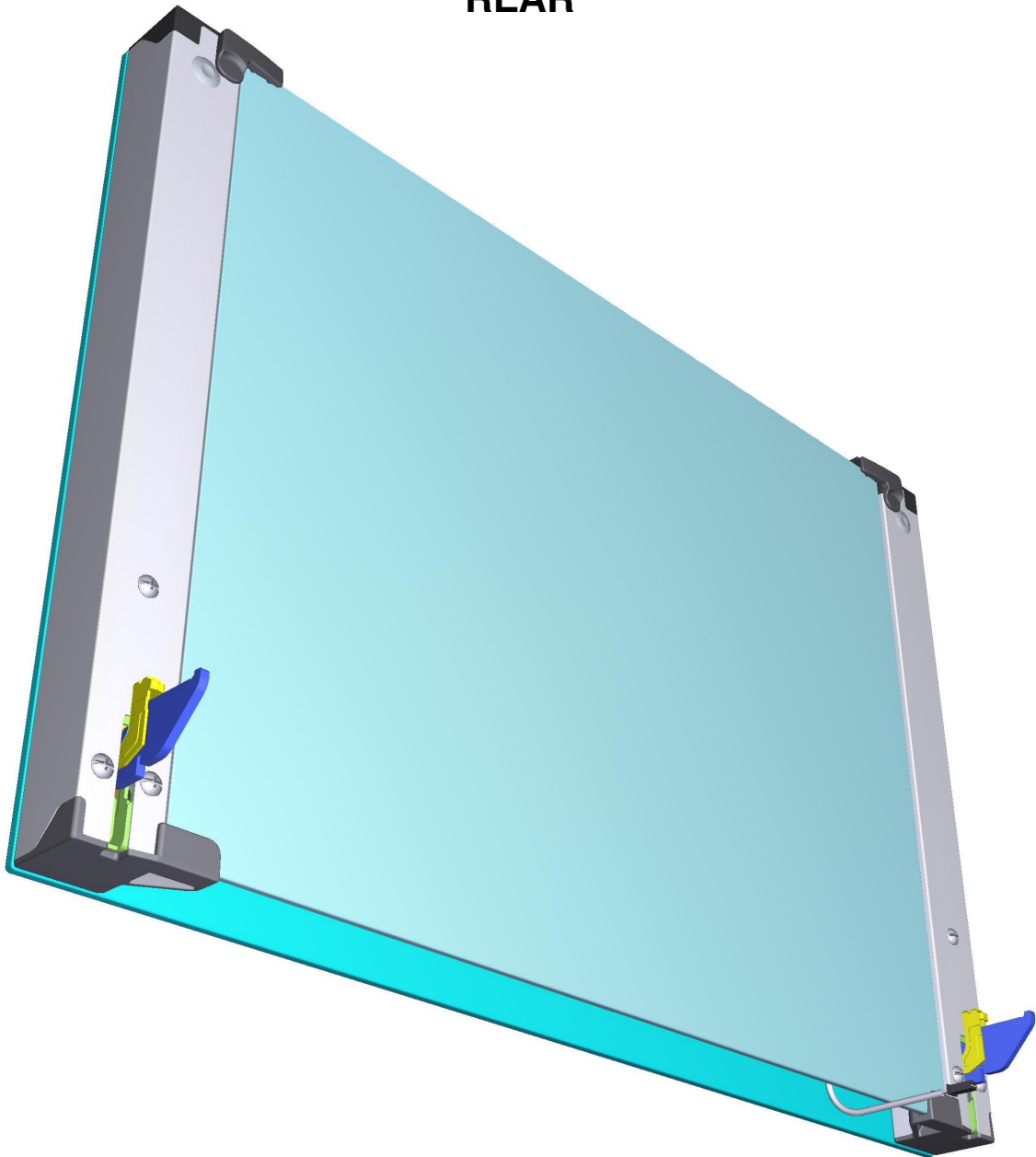

+7(812)987-08-81

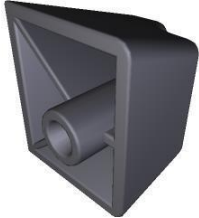
COMPONENT			SPARE PART																										
Code	Description	Image	Code	Description	Kit components																								
0H1925B	ST.STEEL HANDLE TUBE Ext.D=18 Th=1 L=518		K0H1925B	LMISS 600 COMPLETE HANDLE KIT	<table border="1"> <thead> <tr> <th>Code</th> <th>Description</th> <th>Qty</th> <th>UOM</th> </tr> </thead> <tbody> <tr> <td>0H1925B0</td> <td>ST.STEEL HANDLE TUBE Ext.D=18 Th=1 L=518</td> <td>1.000</td> <td>PC</td> </tr> <tr> <td>MG1015B0</td> <td>L.MISS/L.MICR O/CHEFTOP HANDLE END</td> <td>2.000</td> <td>PC</td> </tr> <tr> <td>VI1855A0</td> <td>5X25 SELF-TAPPING G SCREW</td> <td>2.000</td> <td>PC</td> </tr> <tr> <td>VM1794A0</td> <td>250x4.8 PA66 BLACK CLAMP</td> <td>2.000</td> <td>PC</td> </tr> <tr> <td>VM2103A0</td> <td>CLAMP LOCK</td> <td>2.000</td> <td>PC</td> </tr> </tbody> </table>	Code	Description	Qty	UOM	0H1925B0	ST.STEEL HANDLE TUBE Ext.D=18 Th=1 L=518	1.000	PC	MG1015B0	L.MISS/L.MICR O/CHEFTOP HANDLE END	2.000	PC	VI1855A0	5X25 SELF-TAPPING G SCREW	2.000	PC	VM1794A0	250x4.8 PA66 BLACK CLAMP	2.000	PC	VM2103A0	CLAMP LOCK	2.000	PC
					Code	Description	Qty	UOM																					
					0H1925B0	ST.STEEL HANDLE TUBE Ext.D=18 Th=1 L=518	1.000	PC																					
					MG1015B0	L.MISS/L.MICR O/CHEFTOP HANDLE END	2.000	PC																					
					VI1855A0	5X25 SELF-TAPPING G SCREW	2.000	PC																					
VM1794A0	250x4.8 PA66 BLACK CLAMP	2.000	PC																										
VM2103A0	CLAMP LOCK	2.000	PC																										
CR1015A	LineMiss ARIANNA DOOR HINGE		KCR1015A	LINEMISS ARIANNA HINGES KIT	<table border="1"> <thead> <tr> <th>Code</th> <th>Description</th> <th>Qty</th> <th>UOM</th> </tr> </thead> <tbody> <tr> <td>CR1015A0</td> <td>LineMiss ARIANNA DOOR HINGE</td> <td>2.000</td> <td>PC</td> </tr> <tr> <td>VI1875A0</td> <td>SCREW M5X10 TC1/2T INOX</td> <td>6.000</td> <td>PC</td> </tr> </tbody> </table>	Code	Description	Qty	UOM	CR1015A0	LineMiss ARIANNA DOOR HINGE	2.000	PC	VI1875A0	SCREW M5X10 TC1/2T INOX	6.000	PC												
					Code	Description	Qty	UOM																					
CR1015A0	LineMiss ARIANNA DOOR HINGE	2.000	PC																										
VI1875A0	SCREW M5X10 TC1/2T INOX	6.000	PC																										
MG1015B	L.MISS/L.MICRO/CH EFTOP HANDLE END		KMG1015B	2 PCS. HANDLE END KIT	<table border="1"> <thead> <tr> <th>Code</th> <th>Description</th> <th>Qty</th> <th>UOM</th> </tr> </thead> <tbody> <tr> <td>MG1015B0</td> <td>L.MISS/L.MICR O/CHEFTOP HANDLE END</td> <td>2.000</td> <td>PC</td> </tr> <tr> <td>VI1855A0</td> <td>5X25 SELF-TAPPING G SCREW</td> <td>2.000</td> <td>PC</td> </tr> <tr> <td>VI1870A0</td> <td>50x50 SELF-THREADING SCREW FOR PLASTIC</td> <td>2.000</td> <td>PC</td> </tr> <tr> <td>VM1025A0</td> <td>Ø16 GREY NYLON LID</td> <td>2.000</td> <td>PC</td> </tr> </tbody> </table>	Code	Description	Qty	UOM	MG1015B0	L.MISS/L.MICR O/CHEFTOP HANDLE END	2.000	PC	VI1855A0	5X25 SELF-TAPPING G SCREW	2.000	PC	VI1870A0	50x50 SELF-THREADING SCREW FOR PLASTIC	2.000	PC	VM1025A0	Ø16 GREY NYLON LID	2.000	PC				
					Code	Description	Qty	UOM																					
					MG1015B0	L.MISS/L.MICR O/CHEFTOP HANDLE END	2.000	PC																					
					VI1855A0	5X25 SELF-TAPPING G SCREW	2.000	PC																					
VI1870A0	50x50 SELF-THREADING SCREW FOR PLASTIC	2.000	PC																										
VM1025A0	Ø16 GREY NYLON LID	2.000	PC																										
VI1855A	5X25 SELF-TAPPING SCREW		KVI1855A	5x25 SELF-TAPPING SCREW 20 PCS.	<table border="1"> <thead> <tr> <th>Code</th> <th>Description</th> <th>Qty</th> <th>UOM</th> </tr> </thead> <tbody> <tr> <td>VI1855A0</td> <td>5X25 SELF-TAPPING G SCREW</td> <td>20.000</td> <td>PC</td> </tr> </tbody> </table>	Code	Description	Qty	UOM	VI1855A0	5X25 SELF-TAPPING G SCREW	20.000	PC																
Code	Description	Qty	UOM																										
VI1855A0	5X25 SELF-TAPPING G SCREW	20.000	PC																										



+7(812)987-08-81

COMPONENT			SPARE PART																																						
Code	Description	Image	Code	Description	Kit components																																				
VM1025A	Ø16 GREY NYLON LI		KVM1025A	GREY NYLON CAPS 20 PCS KIT	<table border="1"> <thead> <tr> <th>Code</th> <th>Description</th> <th>Qty</th> <th>UOM</th> </tr> </thead> <tbody> <tr> <td>VM1025A0</td> <td>Ø16 GREY NYLON LID</td> <td>20.000</td> <td>PC</td> </tr> </tbody> </table>	Code	Description	Qty	UOM	VM1025A0	Ø16 GREY NYLON LID	20.000	PC																												
Code	Description	Qty	UOM																																						
VM1025A0	Ø16 GREY NYLON LID	20.000	PC																																						
VM1920A	INTERNAL GLASS CLOSING RIGHT PLATE		KVM1920A	LM INNER GLASS STOPPER 2PCS KIT	<table border="1"> <thead> <tr> <th>Code</th> <th>Description</th> <th>Qty</th> <th>UOM</th> </tr> </thead> <tbody> <tr> <td>RC1200A0</td> <td>ED=4 WIRE D.=0.5 COMPRESSIO N SPRING</td> <td>2.000</td> <td>PC</td> </tr> <tr> <td>VM1695A0</td> <td>HANDLE POSITION PIN</td> <td>2.000</td> <td>PC</td> </tr> <tr> <td>VM1920A0</td> <td>INTERNAL GLASS CLOSING RIGHT PLATE</td> <td>1.000</td> <td>PC</td> </tr> <tr> <td>VM1921A0</td> <td>INTERNAL GLASS CLOSING LEFT PLATE</td> <td>1.000</td> <td>PC</td> </tr> </tbody> </table>	Code	Description	Qty	UOM	RC1200A0	ED=4 WIRE D.=0.5 COMPRESSIO N SPRING	2.000	PC	VM1695A0	HANDLE POSITION PIN	2.000	PC	VM1920A0	INTERNAL GLASS CLOSING RIGHT PLATE	1.000	PC	VM1921A0	INTERNAL GLASS CLOSING LEFT PLATE	1.000	PC																
Code	Description	Qty	UOM																																						
RC1200A0	ED=4 WIRE D.=0.5 COMPRESSIO N SPRING	2.000	PC																																						
VM1695A0	HANDLE POSITION PIN	2.000	PC																																						
VM1920A0	INTERNAL GLASS CLOSING RIGHT PLATE	1.000	PC																																						
VM1921A0	INTERNAL GLASS CLOSING LEFT PLATE	1.000	PC																																						
VM2062A	L.Miss 46x33 RIGHT UPPER DOOR COLUMN CAP		KVT1252A	XF135-EG- VT1252A EXTERNAL GLASS KIT	<table border="1"> <thead> <tr> <th>Code</th> <th>Description</th> <th>Qty</th> <th>UOM</th> </tr> </thead> <tbody> <tr> <td>RC1200A0</td> <td>ED=4 WIRE D.=0.5 COMPRESSIO N SPRING</td> <td>2.000</td> <td>PC</td> </tr> <tr> <td>SL1050A1</td> <td>3M TRANSFER ADHESIVE TAPE</td> <td>0.820</td> <td>M</td> </tr> <tr> <td>TB2301A0</td> <td>RIGHT COLUMN XVC105E 40x40x1</td> <td>1.000</td> <td>PC</td> </tr> <tr> <td>TB3081A0</td> <td>LMISS ARIANNA/ROS SELLA DOOR LEFT COLUMN</td> <td>1.000</td> <td>PC</td> </tr> <tr> <td>VM1025A0</td> <td>Ø16 GREY NYLON LID</td> <td>2.000</td> <td>PC</td> </tr> <tr> <td>VM1695A0</td> <td>HANDLE POSITION PIN</td> <td>2.000</td> <td>PC</td> </tr> <tr> <td>VM1920A0</td> <td>INTERNAL GLASS CLOSING RIGHT PLATE</td> <td>1.000</td> <td>PC</td> </tr> <tr> <td>VM1921A0</td> <td>INTERNAL GLASS CLOSING LEFT PLATE</td> <td>1.000</td> <td>PC</td> </tr> </tbody> </table>	Code	Description	Qty	UOM	RC1200A0	ED=4 WIRE D.=0.5 COMPRESSIO N SPRING	2.000	PC	SL1050A1	3M TRANSFER ADHESIVE TAPE	0.820	M	TB2301A0	RIGHT COLUMN XVC105E 40x40x1	1.000	PC	TB3081A0	LMISS ARIANNA/ROS SELLA DOOR LEFT COLUMN	1.000	PC	VM1025A0	Ø16 GREY NYLON LID	2.000	PC	VM1695A0	HANDLE POSITION PIN	2.000	PC	VM1920A0	INTERNAL GLASS CLOSING RIGHT PLATE	1.000	PC	VM1921A0	INTERNAL GLASS CLOSING LEFT PLATE	1.000	PC
Code	Description	Qty	UOM																																						
RC1200A0	ED=4 WIRE D.=0.5 COMPRESSIO N SPRING	2.000	PC																																						
SL1050A1	3M TRANSFER ADHESIVE TAPE	0.820	M																																						
TB2301A0	RIGHT COLUMN XVC105E 40x40x1	1.000	PC																																						
TB3081A0	LMISS ARIANNA/ROS SELLA DOOR LEFT COLUMN	1.000	PC																																						
VM1025A0	Ø16 GREY NYLON LID	2.000	PC																																						
VM1695A0	HANDLE POSITION PIN	2.000	PC																																						
VM1920A0	INTERNAL GLASS CLOSING RIGHT PLATE	1.000	PC																																						
VM1921A0	INTERNAL GLASS CLOSING LEFT PLATE	1.000	PC																																						



+7(812)987-08-81

COMPONENT			SPARE PART																																											
Code	Description	Image	Code	Description	Kit components																																									
VM2062A	L.Miss 46x33 RIGHT UPPER DOOR COLUMN CAP		KVT1252A	XF135-EG- VT1252A EXTERNAL GLASS KIT	<table border="1"> <thead> <tr> <th>Code</th> <th>Description</th> <th>Qty</th> <th>UOM</th> </tr> </thead> <tbody> <tr> <td>VM2062A0</td> <td>L.Miss 46x33 RIGHT UPPER DOOR COLUMN CAP</td> <td>1.000</td> <td>PC</td> </tr> <tr> <td>VM2063A0</td> <td>L.Miss 46x33 LEFT UPPER DOOR COLUMN CAP</td> <td>1.000</td> <td>PC</td> </tr> <tr> <td>VM2064A0</td> <td>L.Miss 46x33 RIGHT LOWER DOOR COLUMN CAP</td> <td>1.000</td> <td>PC</td> </tr> <tr> <td>VM2065A0</td> <td>L.Miss 46x33 LEFT LOWER DOOR COLUMN CAP</td> <td>1.000</td> <td>PC</td> </tr> <tr> <td>VT1252A0</td> <td>XFT135 DOOR EXT. BLACK GLASS - ENGEFOOD</td> <td>1.000</td> <td>PC</td> </tr> </tbody> </table>	Code	Description	Qty	UOM	VM2062A0	L.Miss 46x33 RIGHT UPPER DOOR COLUMN CAP	1.000	PC	VM2063A0	L.Miss 46x33 LEFT UPPER DOOR COLUMN CAP	1.000	PC	VM2064A0	L.Miss 46x33 RIGHT LOWER DOOR COLUMN CAP	1.000	PC	VM2065A0	L.Miss 46x33 LEFT LOWER DOOR COLUMN CAP	1.000	PC	VT1252A0	XFT135 DOOR EXT. BLACK GLASS - ENGEFOOD	1.000	PC																	
			Code	Description	Qty	UOM																																								
VM2062A0	L.Miss 46x33 RIGHT UPPER DOOR COLUMN CAP	1.000	PC																																											
VM2063A0	L.Miss 46x33 LEFT UPPER DOOR COLUMN CAP	1.000	PC																																											
VM2064A0	L.Miss 46x33 RIGHT LOWER DOOR COLUMN CAP	1.000	PC																																											
VM2065A0	L.Miss 46x33 LEFT LOWER DOOR COLUMN CAP	1.000	PC																																											
VT1252A0	XFT135 DOOR EXT. BLACK GLASS - ENGEFOOD	1.000	PC																																											
KVT1063A	L.MISS ARIANNA FORNETTI EXT. GLASS KIT	<table border="1"> <thead> <tr> <th>Code</th> <th>Description</th> <th>Qty</th> <th>UOM</th> </tr> </thead> <tbody> <tr> <td>MS1009A0</td> <td>FORNETTI LOGO LABEL</td> <td>1.000</td> <td>PC</td> </tr> <tr> <td>RC1200A0</td> <td>ED=4 WIRE D.=0.5 COMPRESSIO N SPRING</td> <td>2.000</td> <td>PC</td> </tr> <tr> <td>SL1050A1</td> <td>3M TRANSFER ADHESIVE TAPE</td> <td>0.820</td> <td>M</td> </tr> <tr> <td>TB2301A0</td> <td>RIGHT COLUMN XVC105E 40x40x1</td> <td>1.000</td> <td>PC</td> </tr> <tr> <td>TB3081A0</td> <td>LMISS ARIANNA/ROS SELLA DOOR LEFT COLUMN</td> <td>1.000</td> <td>PC</td> </tr> <tr> <td>VM1025A0</td> <td>Ø16 GREY NYLON LID</td> <td>2.000</td> <td>PC</td> </tr> <tr> <td>VM1695A0</td> <td>HANDLE POSITION PIN</td> <td>2.000</td> <td>PC</td> </tr> <tr> <td>VM1920A0</td> <td>INTERNAL GLASS CLOSING RIGHT PLATE</td> <td>1.000</td> <td>PC</td> </tr> <tr> <td>VM1921A0</td> <td>INTERNAL GLASS CLOSING LEFT PLATE</td> <td>1.000</td> <td>PC</td> </tr> <tr> <td>VM2062A0</td> <td>L.Miss 46x33 RIGHT UPPER DOOR COLUMN CAP</td> <td>1.000</td> <td>PC</td> </tr> </tbody> </table>	Code	Description	Qty	UOM	MS1009A0	FORNETTI LOGO LABEL	1.000	PC	RC1200A0	ED=4 WIRE D.=0.5 COMPRESSIO N SPRING	2.000	PC	SL1050A1	3M TRANSFER ADHESIVE TAPE	0.820	M	TB2301A0	RIGHT COLUMN XVC105E 40x40x1	1.000	PC	TB3081A0	LMISS ARIANNA/ROS SELLA DOOR LEFT COLUMN	1.000	PC	VM1025A0	Ø16 GREY NYLON LID	2.000	PC	VM1695A0	HANDLE POSITION PIN	2.000	PC	VM1920A0	INTERNAL GLASS CLOSING RIGHT PLATE	1.000	PC	VM1921A0	INTERNAL GLASS CLOSING LEFT PLATE	1.000	PC	VM2062A0	L.Miss 46x33 RIGHT UPPER DOOR COLUMN CAP	1.000	PC
Code	Description	Qty	UOM																																											
MS1009A0	FORNETTI LOGO LABEL	1.000	PC																																											
RC1200A0	ED=4 WIRE D.=0.5 COMPRESSIO N SPRING	2.000	PC																																											
SL1050A1	3M TRANSFER ADHESIVE TAPE	0.820	M																																											
TB2301A0	RIGHT COLUMN XVC105E 40x40x1	1.000	PC																																											
TB3081A0	LMISS ARIANNA/ROS SELLA DOOR LEFT COLUMN	1.000	PC																																											
VM1025A0	Ø16 GREY NYLON LID	2.000	PC																																											
VM1695A0	HANDLE POSITION PIN	2.000	PC																																											
VM1920A0	INTERNAL GLASS CLOSING RIGHT PLATE	1.000	PC																																											
VM1921A0	INTERNAL GLASS CLOSING LEFT PLATE	1.000	PC																																											
VM2062A0	L.Miss 46x33 RIGHT UPPER DOOR COLUMN CAP	1.000	PC																																											



+7(812)987-08-81

COMPONENT			SPARE PART																																																		
Code	Description	Image	Code	Description	Kit components																																																
VM2062A	L.Miss 46x33 RIGHT UPPER DOOR COLUMN CAP		KVT1063A	L.MISS ARIANNA FORNETTI EXT. GLASS KIT	<table border="1"> <thead> <tr> <th>Code</th> <th>Description</th> <th>Qty</th> <th>UOM</th> </tr> </thead> <tbody> <tr> <td>VM2063A0</td> <td>L.Miss 46x33 LEFT UPPER DOOR COLUMN CAP</td> <td>1.000</td> <td>PC</td> </tr> <tr> <td>VM2064A0</td> <td>L.Miss 46x33 RIGHT LOWER DOOR COLUMN CAP</td> <td>1.000</td> <td>PC</td> </tr> <tr> <td>VM2065A0</td> <td>L.Miss 46x33 LEFT LOWER DOOR COLUMN CAP</td> <td>1.000</td> <td>PC</td> </tr> <tr> <td>VT1063A0</td> <td>XF135F EXTERNAL GLASS 598x42</td> <td>1.000</td> <td>PC</td> </tr> </tbody> </table>	Code	Description	Qty	UOM	VM2063A0	L.Miss 46x33 LEFT UPPER DOOR COLUMN CAP	1.000	PC	VM2064A0	L.Miss 46x33 RIGHT LOWER DOOR COLUMN CAP	1.000	PC	VM2065A0	L.Miss 46x33 LEFT LOWER DOOR COLUMN CAP	1.000	PC	VT1063A0	XF135F EXTERNAL GLASS 598x42	1.000	PC																												
Code	Description	Qty	UOM																																																		
VM2063A0	L.Miss 46x33 LEFT UPPER DOOR COLUMN CAP	1.000	PC																																																		
VM2064A0	L.Miss 46x33 RIGHT LOWER DOOR COLUMN CAP	1.000	PC																																																		
VM2065A0	L.Miss 46x33 LEFT LOWER DOOR COLUMN CAP	1.000	PC																																																		
VT1063A0	XF135F EXTERNAL GLASS 598x42	1.000	PC																																																		
			KVT1062A	L.M. ARIANNA BLACK EXTERNAL GLASS KIT	<table border="1"> <thead> <tr> <th>Code</th> <th>Description</th> <th>Qty</th> <th>UOM</th> </tr> </thead> <tbody> <tr> <td>RC1200A0</td> <td>ED=4 WIRE D.=0.5 COMPRESSIO N SPRING</td> <td>2.000</td> <td>PC</td> </tr> <tr> <td>SL1050A1</td> <td>3M TRANSFER ADHESIVE TAPE</td> <td>0.820</td> <td>M</td> </tr> <tr> <td>TB2301A0</td> <td>RIGHT COLUMN XVC105E 40x40x1</td> <td>1.000</td> <td>PC</td> </tr> <tr> <td>TB3081A0</td> <td>LMISS ARIANNA/ROS SELLA DOOR LEFT COLUMN</td> <td>1.000</td> <td>PC</td> </tr> <tr> <td>VM1025A0</td> <td>Ø16 GREY NYLON LID</td> <td>2.000</td> <td>PC</td> </tr> <tr> <td>VM1695A0</td> <td>HANDLE POSITION PIN</td> <td>2.000</td> <td>PC</td> </tr> <tr> <td>VM1920A0</td> <td>INTERNAL GLASS CLOSING RIGHT PLATE</td> <td>1.000</td> <td>PC</td> </tr> <tr> <td>VM1921A0</td> <td>INTERNAL GLASS CLOSING LEFT PLATE</td> <td>1.000</td> <td>PC</td> </tr> <tr> <td>VM2062A0</td> <td>L.Miss 46x33 RIGHT UPPER DOOR COLUMN CAP</td> <td>1.000</td> <td>PC</td> </tr> <tr> <td>VM2063A0</td> <td>L.Miss 46x33 LEFT UPPER DOOR COLUMN CAP</td> <td>1.000</td> <td>PC</td> </tr> <tr> <td>VM2064A0</td> <td>L.Miss 46x33 RIGHT LOWER DOOR COLUMN CAP</td> <td>1.000</td> <td>PC</td> </tr> </tbody> </table>	Code	Description	Qty	UOM	RC1200A0	ED=4 WIRE D.=0.5 COMPRESSIO N SPRING	2.000	PC	SL1050A1	3M TRANSFER ADHESIVE TAPE	0.820	M	TB2301A0	RIGHT COLUMN XVC105E 40x40x1	1.000	PC	TB3081A0	LMISS ARIANNA/ROS SELLA DOOR LEFT COLUMN	1.000	PC	VM1025A0	Ø16 GREY NYLON LID	2.000	PC	VM1695A0	HANDLE POSITION PIN	2.000	PC	VM1920A0	INTERNAL GLASS CLOSING RIGHT PLATE	1.000	PC	VM1921A0	INTERNAL GLASS CLOSING LEFT PLATE	1.000	PC	VM2062A0	L.Miss 46x33 RIGHT UPPER DOOR COLUMN CAP	1.000	PC	VM2063A0	L.Miss 46x33 LEFT UPPER DOOR COLUMN CAP	1.000	PC	VM2064A0	L.Miss 46x33 RIGHT LOWER DOOR COLUMN CAP	1.000	PC
Code	Description	Qty	UOM																																																		
RC1200A0	ED=4 WIRE D.=0.5 COMPRESSIO N SPRING	2.000	PC																																																		
SL1050A1	3M TRANSFER ADHESIVE TAPE	0.820	M																																																		
TB2301A0	RIGHT COLUMN XVC105E 40x40x1	1.000	PC																																																		
TB3081A0	LMISS ARIANNA/ROS SELLA DOOR LEFT COLUMN	1.000	PC																																																		
VM1025A0	Ø16 GREY NYLON LID	2.000	PC																																																		
VM1695A0	HANDLE POSITION PIN	2.000	PC																																																		
VM1920A0	INTERNAL GLASS CLOSING RIGHT PLATE	1.000	PC																																																		
VM1921A0	INTERNAL GLASS CLOSING LEFT PLATE	1.000	PC																																																		
VM2062A0	L.Miss 46x33 RIGHT UPPER DOOR COLUMN CAP	1.000	PC																																																		
VM2063A0	L.Miss 46x33 LEFT UPPER DOOR COLUMN CAP	1.000	PC																																																		
VM2064A0	L.Miss 46x33 RIGHT LOWER DOOR COLUMN CAP	1.000	PC																																																		



Зип Общепит
vsezip.ru

SPARE PART LIST

ASM0025C/0.D00 Door

+7(812)987-08-81

COMPONENT			SPARE PART																																																					
Code	Description	Image	Code	Description	Kit components																																																			
VM2062A	L.Miss 46x33 RIGHT UPPER DOOR COLUMN CAP		KVT1062A	L.M. ARIANNA BLACK EXTERNAL GLASS KIT	<table border="1"> <thead> <tr> <th>Code</th> <th>Description</th> <th>Qty</th> <th>UOM</th> </tr> </thead> <tbody> <tr> <td>VM2065A0</td> <td>L.Miss 46x33 LEFT LOWER DOOR COLUMN CAP</td> <td>1.000</td> <td>PC</td> </tr> <tr> <td>VT1062A0</td> <td>LineMiss ARIANNA GREY EXTERNAL GLASS</td> <td>1.000</td> <td>PC</td> </tr> </tbody> </table>	Code	Description	Qty	UOM	VM2065A0	L.Miss 46x33 LEFT LOWER DOOR COLUMN CAP	1.000	PC	VT1062A0	LineMiss ARIANNA GREY EXTERNAL GLASS	1.000	PC																																							
			Code	Description	Qty	UOM																																																		
VM2065A0	L.Miss 46x33 LEFT LOWER DOOR COLUMN CAP	1.000	PC																																																					
VT1062A0	LineMiss ARIANNA GREY EXTERNAL GLASS	1.000	PC																																																					
KVT1061A	LM ARIANNA EXTERNAL YELLOW GLASS KIT	<table border="1"> <thead> <tr> <th>Code</th> <th>Description</th> <th>Qty</th> <th>UOM</th> </tr> </thead> <tbody> <tr> <td>RC1200A0</td> <td>ED=4 WIRE D.=0.5 COMPRESSIO N SPRING</td> <td>2.000</td> <td>PC</td> </tr> <tr> <td>SL1050A1</td> <td>3M TRANSFER ADHESIVE TAPE</td> <td>0.820</td> <td>M</td> </tr> <tr> <td>TB2301A0</td> <td>RIGHT COLUMN XVC105E 40x40x1</td> <td>2.000</td> <td>PC</td> </tr> <tr> <td>VM1025A0</td> <td>Ø16 GREY NYLON LID</td> <td>2.000</td> <td>PC</td> </tr> <tr> <td>VM1695A0</td> <td>HANDLE POSITION PIN</td> <td>2.000</td> <td>PC</td> </tr> <tr> <td>VM1920A0</td> <td>INTERNAL GLASS CLOSING RIGHT PLATE</td> <td>1.000</td> <td>PC</td> </tr> <tr> <td>VM1921A0</td> <td>INTERNAL GLASS CLOSING LEFT PLATE</td> <td>1.000</td> <td>PC</td> </tr> <tr> <td>VM2062A0</td> <td>L.Miss 46x33 RIGHT UPPER DOOR COLUMN CAP</td> <td>1.000</td> <td>PC</td> </tr> <tr> <td>VM2063A0</td> <td>L.Miss 46x33 LEFT UPPER DOOR COLUMN CAP</td> <td>1.000</td> <td>PC</td> </tr> <tr> <td>VM2064A0</td> <td>L.Miss 46x33 RIGHT LOWER DOOR COLUMN CAP</td> <td>1.000</td> <td>PC</td> </tr> <tr> <td>VM2065A0</td> <td>L.Miss 46x33 LEFT LOWER DOOR COLUMN CAP</td> <td>1.000</td> <td>PC</td> </tr> <tr> <td></td> <td></td> <td></td> <td>VT1061A2</td> <td>EXTERNAL YELLOW GLASS 598x424x5</td> <td>1.000 PC</td> </tr> </tbody> </table>	Code	Description	Qty	UOM	RC1200A0	ED=4 WIRE D.=0.5 COMPRESSIO N SPRING	2.000	PC	SL1050A1	3M TRANSFER ADHESIVE TAPE	0.820	M	TB2301A0	RIGHT COLUMN XVC105E 40x40x1	2.000	PC	VM1025A0	Ø16 GREY NYLON LID	2.000	PC	VM1695A0	HANDLE POSITION PIN	2.000	PC	VM1920A0	INTERNAL GLASS CLOSING RIGHT PLATE	1.000	PC	VM1921A0	INTERNAL GLASS CLOSING LEFT PLATE	1.000	PC	VM2062A0	L.Miss 46x33 RIGHT UPPER DOOR COLUMN CAP	1.000	PC	VM2063A0	L.Miss 46x33 LEFT UPPER DOOR COLUMN CAP	1.000	PC	VM2064A0	L.Miss 46x33 RIGHT LOWER DOOR COLUMN CAP	1.000	PC	VM2065A0	L.Miss 46x33 LEFT LOWER DOOR COLUMN CAP	1.000	PC				VT1061A2	EXTERNAL YELLOW GLASS 598x424x5	1.000 PC
Code	Description	Qty	UOM																																																					
RC1200A0	ED=4 WIRE D.=0.5 COMPRESSIO N SPRING	2.000	PC																																																					
SL1050A1	3M TRANSFER ADHESIVE TAPE	0.820	M																																																					
TB2301A0	RIGHT COLUMN XVC105E 40x40x1	2.000	PC																																																					
VM1025A0	Ø16 GREY NYLON LID	2.000	PC																																																					
VM1695A0	HANDLE POSITION PIN	2.000	PC																																																					
VM1920A0	INTERNAL GLASS CLOSING RIGHT PLATE	1.000	PC																																																					
VM1921A0	INTERNAL GLASS CLOSING LEFT PLATE	1.000	PC																																																					
VM2062A0	L.Miss 46x33 RIGHT UPPER DOOR COLUMN CAP	1.000	PC																																																					
VM2063A0	L.Miss 46x33 LEFT UPPER DOOR COLUMN CAP	1.000	PC																																																					
VM2064A0	L.Miss 46x33 RIGHT LOWER DOOR COLUMN CAP	1.000	PC																																																					
VM2065A0	L.Miss 46x33 LEFT LOWER DOOR COLUMN CAP	1.000	PC																																																					
			VT1061A2	EXTERNAL YELLOW GLASS 598x424x5	1.000 PC																																																			



Зип Общепит
vsezip.ru

+7(812)987-08-81

COMPONENT			SPARE PART																																																																					
Code	Description	Image	Code	Description	Kit components																																																																			
VM2062A	L.Miss 46x33 RIGHT UPPER DOOR COLUMN CAP		KVT1057A	LM STEFANIA BLACK EXTERNAL GLASS KIT	<table border="1"> <thead> <tr> <th>Code</th> <th>Description</th> <th>Qty</th> <th>UOM</th> </tr> </thead> <tbody> <tr> <td>RC1200A0</td> <td>ED=4 WIRE D.=0.5 COMPRESSIO N SPRING</td> <td>2.000</td> <td>PC</td> </tr> <tr> <td>SL1050A1</td> <td>3M TRANSFER ADHESIVE TAPE</td> <td>0.660</td> <td>M</td> </tr> <tr> <td>TB2306A0</td> <td>L.Miss Stefania/Elena DOOR RIGHT COLUMN</td> <td>1.000</td> <td>PC</td> </tr> <tr> <td>TB3080A0</td> <td>L.MISS STEFANIA/ELE NA DOOR LEFT COLUMN</td> <td>1.000</td> <td>PC</td> </tr> <tr> <td>VM1025A0</td> <td>Ø16 GREY NYLON LID</td> <td>2.000</td> <td>PC</td> </tr> <tr> <td>VM1695A0</td> <td>HANDLE POSITION PIN</td> <td>2.000</td> <td>PC</td> </tr> <tr> <td>VM1920A0</td> <td>INTERNAL GLASS CLOSING RIGHT PLATE</td> <td>1.000</td> <td>PC</td> </tr> <tr> <td>VM1921A0</td> <td>INTERNAL GLASS CLOSING LEFT PLATE</td> <td>1.000</td> <td>PC</td> </tr> <tr> <td>VM2062A0</td> <td>L.Miss 46x33 RIGHT UPPER DOOR COLUMN CAP</td> <td>1.000</td> <td>PC</td> </tr> <tr> <td>VM2063A0</td> <td>L.Miss 46x33 LEFT UPPER DOOR COLUMN CAP</td> <td>1.000</td> <td>PC</td> </tr> <tr> <td>VM2064A0</td> <td>L.Miss 46x33 RIGHT LOWER DOOR COLUMN CAP</td> <td>1.000</td> <td>PC</td> </tr> <tr> <td>VM2065A0</td> <td>L.Miss 46x33 LEFT LOWER DOOR COLUMN CAP</td> <td>1.000</td> <td>PC</td> </tr> <tr> <td>VT1057A0</td> <td>L.MISS STEFANIA EXTERNAL GLASS 598x344x5</td> <td>1.000</td> <td>PC</td> </tr> </tbody> </table>	Code	Description	Qty	UOM	RC1200A0	ED=4 WIRE D.=0.5 COMPRESSIO N SPRING	2.000	PC	SL1050A1	3M TRANSFER ADHESIVE TAPE	0.660	M	TB2306A0	L.Miss Stefania/Elena DOOR RIGHT COLUMN	1.000	PC	TB3080A0	L.MISS STEFANIA/ELE NA DOOR LEFT COLUMN	1.000	PC	VM1025A0	Ø16 GREY NYLON LID	2.000	PC	VM1695A0	HANDLE POSITION PIN	2.000	PC	VM1920A0	INTERNAL GLASS CLOSING RIGHT PLATE	1.000	PC	VM1921A0	INTERNAL GLASS CLOSING LEFT PLATE	1.000	PC	VM2062A0	L.Miss 46x33 RIGHT UPPER DOOR COLUMN CAP	1.000	PC	VM2063A0	L.Miss 46x33 LEFT UPPER DOOR COLUMN CAP	1.000	PC	VM2064A0	L.Miss 46x33 RIGHT LOWER DOOR COLUMN CAP	1.000	PC	VM2065A0	L.Miss 46x33 LEFT LOWER DOOR COLUMN CAP	1.000	PC	VT1057A0	L.MISS STEFANIA EXTERNAL GLASS 598x344x5	1.000	PC	KVT1056A	LM STEFANIA YELLOW EXTERNAL GLASS KIT	<table border="1"> <thead> <tr> <th>Code</th> <th>Description</th> <th>Qty</th> <th>UOM</th> </tr> </thead> <tbody> <tr> <td>RC1200A0</td> <td>ED=4 WIRE D.=0.5 COMPRESSIO N SPRING</td> <td>2.000</td> <td>PC</td> </tr> </tbody> </table>	Code	Description	Qty	UOM	RC1200A0	ED=4 WIRE D.=0.5 COMPRESSIO N SPRING	2.000	PC
			Code	Description	Qty	UOM																																																																		
RC1200A0	ED=4 WIRE D.=0.5 COMPRESSIO N SPRING	2.000	PC																																																																					
SL1050A1	3M TRANSFER ADHESIVE TAPE	0.660	M																																																																					
TB2306A0	L.Miss Stefania/Elena DOOR RIGHT COLUMN	1.000	PC																																																																					
TB3080A0	L.MISS STEFANIA/ELE NA DOOR LEFT COLUMN	1.000	PC																																																																					
VM1025A0	Ø16 GREY NYLON LID	2.000	PC																																																																					
VM1695A0	HANDLE POSITION PIN	2.000	PC																																																																					
VM1920A0	INTERNAL GLASS CLOSING RIGHT PLATE	1.000	PC																																																																					
VM1921A0	INTERNAL GLASS CLOSING LEFT PLATE	1.000	PC																																																																					
VM2062A0	L.Miss 46x33 RIGHT UPPER DOOR COLUMN CAP	1.000	PC																																																																					
VM2063A0	L.Miss 46x33 LEFT UPPER DOOR COLUMN CAP	1.000	PC																																																																					
VM2064A0	L.Miss 46x33 RIGHT LOWER DOOR COLUMN CAP	1.000	PC																																																																					
VM2065A0	L.Miss 46x33 LEFT LOWER DOOR COLUMN CAP	1.000	PC																																																																					
VT1057A0	L.MISS STEFANIA EXTERNAL GLASS 598x344x5	1.000	PC																																																																					
Code	Description	Qty	UOM																																																																					
RC1200A0	ED=4 WIRE D.=0.5 COMPRESSIO N SPRING	2.000	PC																																																																					



Зип Общепит
vsezip.ru

+7(812)987-08-81

COMPONENT			SPARE PART																																																		
Code	Description	Image	Code	Description	Kit components																																																
VM2062A	L.Miss 46x33 RIGHT UPPER DOOR COLUMN CAP		KVT1056A	LM STEFANIA YELLOW EXTERNAL GLASS KIT	<table border="1"> <thead> <tr> <th>Code</th> <th>Description</th> <th>Qty</th> <th>UOM</th> </tr> </thead> <tbody> <tr> <td>SL1050A1</td> <td>3M TRANSFER ADHESIVE TAPE</td> <td>0.660</td> <td>M</td> </tr> <tr> <td>TB2306A0</td> <td>L.Miss Stefania/Elena DOOR RIGHT COLUMN</td> <td>2.000</td> <td>PC</td> </tr> <tr> <td>VM1025A0</td> <td>Ø16 GREY NYLON LID</td> <td>2.000</td> <td>PC</td> </tr> <tr> <td>VM1695A0</td> <td>HANDLE POSITION PIN</td> <td>2.000</td> <td>PC</td> </tr> <tr> <td>VM1920A0</td> <td>INTERNAL GLASS CLOSING RIGHT PLATE</td> <td>1.000</td> <td>PC</td> </tr> <tr> <td>VM1921A0</td> <td>INTERNAL GLASS CLOSING LEFT PLATE</td> <td>1.000</td> <td>PC</td> </tr> <tr> <td>VM2062A0</td> <td>L.Miss 46x33 RIGHT UPPER DOOR COLUMN CAP</td> <td>1.000</td> <td>PC</td> </tr> <tr> <td>VM2063A0</td> <td>L.Miss 46x33 LEFT UPPER DOOR COLUMN CAP</td> <td>1.000</td> <td>PC</td> </tr> <tr> <td>VM2064A0</td> <td>L.Miss 46x33 RIGHT LOWER DOOR COLUMN CAP</td> <td>1.000</td> <td>PC</td> </tr> <tr> <td>VM2065A0</td> <td>L.Miss 46x33 LEFT LOWER DOOR COLUMN CAP</td> <td>1.000</td> <td>PC</td> </tr> <tr> <td>VT1056A2</td> <td>YELLOW SER GLASS 598X344X5</td> <td>1.000</td> <td>PC</td> </tr> </tbody> </table>	Code	Description	Qty	UOM	SL1050A1	3M TRANSFER ADHESIVE TAPE	0.660	M	TB2306A0	L.Miss Stefania/Elena DOOR RIGHT COLUMN	2.000	PC	VM1025A0	Ø16 GREY NYLON LID	2.000	PC	VM1695A0	HANDLE POSITION PIN	2.000	PC	VM1920A0	INTERNAL GLASS CLOSING RIGHT PLATE	1.000	PC	VM1921A0	INTERNAL GLASS CLOSING LEFT PLATE	1.000	PC	VM2062A0	L.Miss 46x33 RIGHT UPPER DOOR COLUMN CAP	1.000	PC	VM2063A0	L.Miss 46x33 LEFT UPPER DOOR COLUMN CAP	1.000	PC	VM2064A0	L.Miss 46x33 RIGHT LOWER DOOR COLUMN CAP	1.000	PC	VM2065A0	L.Miss 46x33 LEFT LOWER DOOR COLUMN CAP	1.000	PC	VT1056A2	YELLOW SER GLASS 598X344X5	1.000	PC
			Code	Description	Qty	UOM																																															
SL1050A1	3M TRANSFER ADHESIVE TAPE	0.660	M																																																		
TB2306A0	L.Miss Stefania/Elena DOOR RIGHT COLUMN	2.000	PC																																																		
VM1025A0	Ø16 GREY NYLON LID	2.000	PC																																																		
VM1695A0	HANDLE POSITION PIN	2.000	PC																																																		
VM1920A0	INTERNAL GLASS CLOSING RIGHT PLATE	1.000	PC																																																		
VM1921A0	INTERNAL GLASS CLOSING LEFT PLATE	1.000	PC																																																		
VM2062A0	L.Miss 46x33 RIGHT UPPER DOOR COLUMN CAP	1.000	PC																																																		
VM2063A0	L.Miss 46x33 LEFT UPPER DOOR COLUMN CAP	1.000	PC																																																		
VM2064A0	L.Miss 46x33 RIGHT LOWER DOOR COLUMN CAP	1.000	PC																																																		
VM2065A0	L.Miss 46x33 LEFT LOWER DOOR COLUMN CAP	1.000	PC																																																		
VT1056A2	YELLOW SER GLASS 598X344X5	1.000	PC																																																		
KVT1052A	LM CRISTINA BLACK EXTERNAL GLASS KIT	<table border="1"> <thead> <tr> <th>Code</th> <th>Description</th> <th>Qty</th> <th>UOM</th> </tr> </thead> <tbody> <tr> <td>RC1200A0</td> <td>ED=4 WIRE D.=0.5 COMPRESSIO N SPRING</td> <td>2.000</td> <td>PC</td> </tr> <tr> <td>SL1050A1</td> <td>3M TRANSFER ADHESIVE TAPE</td> <td>0.660</td> <td>M</td> </tr> <tr> <td>TB2306A0</td> <td>L.Miss Stefania/Elena DOOR RIGHT COLUMN</td> <td>2.000</td> <td>PC</td> </tr> <tr> <td>VM1025A0</td> <td>Ø16 GREY NYLON LID</td> <td>2.000</td> <td>PC</td> </tr> <tr> <td>VM1695A0</td> <td>HANDLE POSITION PIN</td> <td>2.000</td> <td>PC</td> </tr> </tbody> </table>	Code	Description	Qty	UOM	RC1200A0	ED=4 WIRE D.=0.5 COMPRESSIO N SPRING	2.000	PC	SL1050A1	3M TRANSFER ADHESIVE TAPE	0.660	M	TB2306A0	L.Miss Stefania/Elena DOOR RIGHT COLUMN	2.000	PC	VM1025A0	Ø16 GREY NYLON LID	2.000	PC	VM1695A0	HANDLE POSITION PIN	2.000	PC																											
Code	Description	Qty	UOM																																																		
RC1200A0	ED=4 WIRE D.=0.5 COMPRESSIO N SPRING	2.000	PC																																																		
SL1050A1	3M TRANSFER ADHESIVE TAPE	0.660	M																																																		
TB2306A0	L.Miss Stefania/Elena DOOR RIGHT COLUMN	2.000	PC																																																		
VM1025A0	Ø16 GREY NYLON LID	2.000	PC																																																		
VM1695A0	HANDLE POSITION PIN	2.000	PC																																																		



Зип Общепит
vsezip.ru



+7(812)987-08-81

COMPONENT			SPARE PART																																		
Code	Description	Image	Code	Description	Kit components																																
VM2062A	L.Miss 46x33 RIGHT UPPER DOOR COLUMN CAP		KVT1052A	LM CRISTINA BLACK EXTERNAL GLASS KIT	<table border="1"> <thead> <tr> <th>Code</th> <th>Description</th> <th>Qty</th> <th>UOM</th> </tr> </thead> <tbody> <tr> <td>VM1920A0</td> <td>INTERNAL GLASS CLOSING RIGHT PLATE</td> <td>1.000</td> <td>PC</td> </tr> <tr> <td>VM1921A0</td> <td>INTERNAL GLASS CLOSING LEFT PLATE</td> <td>1.000</td> <td>PC</td> </tr> <tr> <td>VM2062A0</td> <td>L.Miss 46x33 RIGHT UPPER DOOR COLUMN CAP</td> <td>1.000</td> <td>PC</td> </tr> <tr> <td>VM2063A0</td> <td>L.Miss 46x33 LEFT UPPER DOOR COLUMN CAP</td> <td>1.000</td> <td>PC</td> </tr> <tr> <td>VM2064A0</td> <td>L.Miss 46x33 RIGHT LOWER DOOR COLUMN CAP</td> <td>1.000</td> <td>PC</td> </tr> <tr> <td>VM2065A0</td> <td>L.Miss 46x33 LEFT LOWER DOOR COLUMN CAP</td> <td>1.000</td> <td>PC</td> </tr> <tr> <td>VT1052A0</td> <td>478X344X5 EXTERNAL GLASS</td> <td>1.000</td> <td>PC</td> </tr> </tbody> </table>	Code	Description	Qty	UOM	VM1920A0	INTERNAL GLASS CLOSING RIGHT PLATE	1.000	PC	VM1921A0	INTERNAL GLASS CLOSING LEFT PLATE	1.000	PC	VM2062A0	L.Miss 46x33 RIGHT UPPER DOOR COLUMN CAP	1.000	PC	VM2063A0	L.Miss 46x33 LEFT UPPER DOOR COLUMN CAP	1.000	PC	VM2064A0	L.Miss 46x33 RIGHT LOWER DOOR COLUMN CAP	1.000	PC	VM2065A0	L.Miss 46x33 LEFT LOWER DOOR COLUMN CAP	1.000	PC	VT1052A0	478X344X5 EXTERNAL GLASS	1.000	PC
			Code	Description	Qty	UOM																															
VM1920A0	INTERNAL GLASS CLOSING RIGHT PLATE	1.000	PC																																		
VM1921A0	INTERNAL GLASS CLOSING LEFT PLATE	1.000	PC																																		
VM2062A0	L.Miss 46x33 RIGHT UPPER DOOR COLUMN CAP	1.000	PC																																		
VM2063A0	L.Miss 46x33 LEFT UPPER DOOR COLUMN CAP	1.000	PC																																		
VM2064A0	L.Miss 46x33 RIGHT LOWER DOOR COLUMN CAP	1.000	PC																																		
VM2065A0	L.Miss 46x33 LEFT LOWER DOOR COLUMN CAP	1.000	PC																																		
VT1052A0	478X344X5 EXTERNAL GLASS	1.000	PC																																		
KVT1051A	LM CRISTINA YELLOW EXTERNAL GLASS KIT	<table border="1"> <thead> <tr> <th>Code</th> <th>Description</th> <th>Qty</th> <th>UOM</th> </tr> </thead> <tbody> <tr> <td>RC1200A0</td> <td>ED=4 WIRE D.=0.5 COMPRESSIO N SPRING</td> <td>2.000</td> <td>PC</td> </tr> <tr> <td>SL1050A1</td> <td>3M TRANSFER ADHESIVE TAPE</td> <td>0.660</td> <td>M</td> </tr> <tr> <td>TB2306A0</td> <td>L.Miss Stefania/Elena DOOR RIGHT COLUMN</td> <td>2.000</td> <td>PC</td> </tr> <tr> <td>VM1025A0</td> <td>Ø16 GREY NYLON LID</td> <td>2.000</td> <td>PC</td> </tr> <tr> <td>VM1695A0</td> <td>HANDLE POSITION PIN</td> <td>2.000</td> <td>PC</td> </tr> <tr> <td>VM1920A0</td> <td>INTERNAL GLASS CLOSING RIGHT PLATE</td> <td>1.000</td> <td>PC</td> </tr> <tr> <td>VM1921A0</td> <td>INTERNAL GLASS CLOSING LEFT PLATE</td> <td>1.000</td> <td>PC</td> </tr> </tbody> </table>	Code	Description	Qty	UOM	RC1200A0	ED=4 WIRE D.=0.5 COMPRESSIO N SPRING	2.000	PC	SL1050A1	3M TRANSFER ADHESIVE TAPE	0.660	M	TB2306A0	L.Miss Stefania/Elena DOOR RIGHT COLUMN	2.000	PC	VM1025A0	Ø16 GREY NYLON LID	2.000	PC	VM1695A0	HANDLE POSITION PIN	2.000	PC	VM1920A0	INTERNAL GLASS CLOSING RIGHT PLATE	1.000	PC	VM1921A0	INTERNAL GLASS CLOSING LEFT PLATE	1.000	PC			
Code	Description	Qty	UOM																																		
RC1200A0	ED=4 WIRE D.=0.5 COMPRESSIO N SPRING	2.000	PC																																		
SL1050A1	3M TRANSFER ADHESIVE TAPE	0.660	M																																		
TB2306A0	L.Miss Stefania/Elena DOOR RIGHT COLUMN	2.000	PC																																		
VM1025A0	Ø16 GREY NYLON LID	2.000	PC																																		
VM1695A0	HANDLE POSITION PIN	2.000	PC																																		
VM1920A0	INTERNAL GLASS CLOSING RIGHT PLATE	1.000	PC																																		
VM1921A0	INTERNAL GLASS CLOSING LEFT PLATE	1.000	PC																																		



Зип Общепит
vsezip.ru

+7(812)987-08-81

COMPONENT			SPARE PART																																														
Code	Description	Image	Code	Description	Kit components																																												
VM2062A	L.Miss 46x33 RIGHT UPPER DOOR COLUMN CAP		KVT1051A	LM CRISTINA YELLOW EXTERNAL GLASS KIT	<table border="1"> <thead> <tr> <th>Code</th> <th>Description</th> <th>Qty</th> <th>UOM</th> </tr> </thead> <tbody> <tr> <td>VM2062A0</td> <td>L.Miss 46x33 RIGHT UPPER DOOR COLUMN CAP</td> <td>1.000</td> <td>PC</td> </tr> <tr> <td>VM2063A0</td> <td>L.Miss 46x33 LEFT UPPER DOOR COLUMN CAP</td> <td>1.000</td> <td>PC</td> </tr> <tr> <td>VM2064A0</td> <td>L.Miss 46x33 RIGHT LOWER DOOR COLUMN CAP</td> <td>1.000</td> <td>PC</td> </tr> <tr> <td>VM2065A0</td> <td>L.Miss 46x33 LEFT LOWER DOOR COLUMN CAP</td> <td>1.000</td> <td>PC</td> </tr> <tr> <td>VT1051A2</td> <td>YELLOW SER GLASS 478X344X5</td> <td>1.000</td> <td>PC</td> </tr> </tbody> </table>	Code	Description	Qty	UOM	VM2062A0	L.Miss 46x33 RIGHT UPPER DOOR COLUMN CAP	1.000	PC	VM2063A0	L.Miss 46x33 LEFT UPPER DOOR COLUMN CAP	1.000	PC	VM2064A0	L.Miss 46x33 RIGHT LOWER DOOR COLUMN CAP	1.000	PC	VM2065A0	L.Miss 46x33 LEFT LOWER DOOR COLUMN CAP	1.000	PC	VT1051A2	YELLOW SER GLASS 478X344X5	1.000	PC																				
Code	Description	Qty	UOM																																														
VM2062A0	L.Miss 46x33 RIGHT UPPER DOOR COLUMN CAP	1.000	PC																																														
VM2063A0	L.Miss 46x33 LEFT UPPER DOOR COLUMN CAP	1.000	PC																																														
VM2064A0	L.Miss 46x33 RIGHT LOWER DOOR COLUMN CAP	1.000	PC																																														
VM2065A0	L.Miss 46x33 LEFT LOWER DOOR COLUMN CAP	1.000	PC																																														
VT1051A2	YELLOW SER GLASS 478X344X5	1.000	PC																																														
VM2063A	L.Miss 46x33 LEFT UPPER DOOR COLUMN CAP		KVT1252A	XF135-EG- VT1252A EXTERNAL GLASS KIT	<table border="1"> <thead> <tr> <th>Code</th> <th>Description</th> <th>Qty</th> <th>UOM</th> </tr> </thead> <tbody> <tr> <td>RC1200A0</td> <td>ED=4 WIRE D.=0.5 COMPRESSIO N SPRING</td> <td>2.000</td> <td>PC</td> </tr> <tr> <td>SL1050A1</td> <td>3M TRANSFER ADHESIVE TAPE</td> <td>0.820</td> <td>M</td> </tr> <tr> <td>TB2301A0</td> <td>RIGHT COLUMN XVC105E 40x40x1</td> <td>1.000</td> <td>PC</td> </tr> <tr> <td>TB3081A0</td> <td>LMISS ARIANNA/ROS SELLA DOOR LEFT COLUMN</td> <td>1.000</td> <td>PC</td> </tr> <tr> <td>VM1025A0</td> <td>Ø16 GREY NYLON LID</td> <td>2.000</td> <td>PC</td> </tr> <tr> <td>VM1695A0</td> <td>HANDLE POSITION PIN</td> <td>2.000</td> <td>PC</td> </tr> <tr> <td>VM1920A0</td> <td>INTERNAL GLASS CLOSING RIGHT PLATE</td> <td>1.000</td> <td>PC</td> </tr> <tr> <td>VM1921A0</td> <td>INTERNAL GLASS CLOSING LEFT PLATE</td> <td>1.000</td> <td>PC</td> </tr> <tr> <td>VM2062A0</td> <td>L.Miss 46x33 RIGHT UPPER DOOR COLUMN CAP</td> <td>1.000</td> <td>PC</td> </tr> <tr> <td>VM2063A0</td> <td>L.Miss 46x33 LEFT UPPER DOOR COLUMN CAP</td> <td>1.000</td> <td>PC</td> </tr> </tbody> </table>	Code	Description	Qty	UOM	RC1200A0	ED=4 WIRE D.=0.5 COMPRESSIO N SPRING	2.000	PC	SL1050A1	3M TRANSFER ADHESIVE TAPE	0.820	M	TB2301A0	RIGHT COLUMN XVC105E 40x40x1	1.000	PC	TB3081A0	LMISS ARIANNA/ROS SELLA DOOR LEFT COLUMN	1.000	PC	VM1025A0	Ø16 GREY NYLON LID	2.000	PC	VM1695A0	HANDLE POSITION PIN	2.000	PC	VM1920A0	INTERNAL GLASS CLOSING RIGHT PLATE	1.000	PC	VM1921A0	INTERNAL GLASS CLOSING LEFT PLATE	1.000	PC	VM2062A0	L.Miss 46x33 RIGHT UPPER DOOR COLUMN CAP	1.000	PC	VM2063A0	L.Miss 46x33 LEFT UPPER DOOR COLUMN CAP	1.000	PC
Code	Description	Qty	UOM																																														
RC1200A0	ED=4 WIRE D.=0.5 COMPRESSIO N SPRING	2.000	PC																																														
SL1050A1	3M TRANSFER ADHESIVE TAPE	0.820	M																																														
TB2301A0	RIGHT COLUMN XVC105E 40x40x1	1.000	PC																																														
TB3081A0	LMISS ARIANNA/ROS SELLA DOOR LEFT COLUMN	1.000	PC																																														
VM1025A0	Ø16 GREY NYLON LID	2.000	PC																																														
VM1695A0	HANDLE POSITION PIN	2.000	PC																																														
VM1920A0	INTERNAL GLASS CLOSING RIGHT PLATE	1.000	PC																																														
VM1921A0	INTERNAL GLASS CLOSING LEFT PLATE	1.000	PC																																														
VM2062A0	L.Miss 46x33 RIGHT UPPER DOOR COLUMN CAP	1.000	PC																																														
VM2063A0	L.Miss 46x33 LEFT UPPER DOOR COLUMN CAP	1.000	PC																																														



Зип Общепит
vsezip.ru

+7(812)987-08-81

COMPONENT			SPARE PART																																																			
Code	Description	Image	Code	Description	Kit components																																																	
VM2063A	L.Miss 46x33 LEFT UPPER DOOR COLUMN CAP		KVT1252A	XF135-EG- VT1252A EXTERNAL GLASS KIT	<table border="1"> <thead> <tr> <th>Code</th> <th>Description</th> <th>Qty</th> <th>UOM</th> </tr> </thead> <tbody> <tr> <td>VM2064A0</td> <td>L.Miss 46x33 RIGHT LOWER DOOR COLUMN CAP</td> <td>1.000</td> <td>PC</td> </tr> <tr> <td>VM2065A0</td> <td>L.Miss 46x33 LEFT LOWER DOOR COLUMN CAP</td> <td>1.000</td> <td>PC</td> </tr> <tr> <td>VT1252A0</td> <td>XFT135 DOOR EXT. BLACK GLASS - ENGEFOOD</td> <td>1.000</td> <td>PC</td> </tr> </tbody> </table>	Code	Description	Qty	UOM	VM2064A0	L.Miss 46x33 RIGHT LOWER DOOR COLUMN CAP	1.000	PC	VM2065A0	L.Miss 46x33 LEFT LOWER DOOR COLUMN CAP	1.000	PC	VT1252A0	XFT135 DOOR EXT. BLACK GLASS - ENGEFOOD	1.000	PC																																	
			Code	Description	Qty	UOM																																																
VM2064A0	L.Miss 46x33 RIGHT LOWER DOOR COLUMN CAP	1.000	PC																																																			
VM2065A0	L.Miss 46x33 LEFT LOWER DOOR COLUMN CAP	1.000	PC																																																			
VT1252A0	XFT135 DOOR EXT. BLACK GLASS - ENGEFOOD	1.000	PC																																																			
KVT1063A	L.MISS ARIANNA FORNETTI EXT. GLASS KIT	<table border="1"> <thead> <tr> <th>Code</th> <th>Description</th> <th>Qty</th> <th>UOM</th> </tr> </thead> <tbody> <tr> <td>MS1009A0</td> <td>FORNETTI LOGO LABEL</td> <td>1.000</td> <td>PC</td> </tr> <tr> <td>RC1200A0</td> <td>ED=4 WIRE D.=0.5 COMPRESSIO N SPRING</td> <td>2.000</td> <td>PC</td> </tr> <tr> <td>SL1050A1</td> <td>3M TRANSFER ADHESIVE TAPE</td> <td>0.820</td> <td>M</td> </tr> <tr> <td>TB2301A0</td> <td>RIGHT COLUMN XVC105E 40x40x1</td> <td>1.000</td> <td>PC</td> </tr> <tr> <td>TB3081A0</td> <td>LMISS ARIANNA/ROS SELLA DOOR LEFT COLUMN</td> <td>1.000</td> <td>PC</td> </tr> <tr> <td>VM1025A0</td> <td>Ø16 GREY NYLON LID</td> <td>2.000</td> <td>PC</td> </tr> <tr> <td>VM1695A0</td> <td>HANDLE POSITION PIN</td> <td>2.000</td> <td>PC</td> </tr> <tr> <td>VM1920A0</td> <td>INTERNAL GLASS CLOSING RIGHT PLATE</td> <td>1.000</td> <td>PC</td> </tr> <tr> <td>VM1921A0</td> <td>INTERNAL GLASS CLOSING LEFT PLATE</td> <td>1.000</td> <td>PC</td> </tr> <tr> <td>VM2062A0</td> <td>L.Miss 46x33 RIGHT UPPER DOOR COLUMN CAP</td> <td>1.000</td> <td>PC</td> </tr> <tr> <td>VM2063A0</td> <td>L.Miss 46x33 LEFT UPPER DOOR COLUMN CAP</td> <td>1.000</td> <td>PC</td> </tr> <tr> <td>VM2064A0</td> <td>L.Miss 46x33 RIGHT LOWER DOOR COLUMN CAP</td> <td>1.000</td> <td>PC</td> </tr> </tbody> </table>	Code	Description	Qty	UOM	MS1009A0	FORNETTI LOGO LABEL	1.000	PC	RC1200A0	ED=4 WIRE D.=0.5 COMPRESSIO N SPRING	2.000	PC	SL1050A1	3M TRANSFER ADHESIVE TAPE	0.820	M	TB2301A0	RIGHT COLUMN XVC105E 40x40x1	1.000	PC	TB3081A0	LMISS ARIANNA/ROS SELLA DOOR LEFT COLUMN	1.000	PC	VM1025A0	Ø16 GREY NYLON LID	2.000	PC	VM1695A0	HANDLE POSITION PIN	2.000	PC	VM1920A0	INTERNAL GLASS CLOSING RIGHT PLATE	1.000	PC	VM1921A0	INTERNAL GLASS CLOSING LEFT PLATE	1.000	PC	VM2062A0	L.Miss 46x33 RIGHT UPPER DOOR COLUMN CAP	1.000	PC	VM2063A0	L.Miss 46x33 LEFT UPPER DOOR COLUMN CAP	1.000	PC	VM2064A0	L.Miss 46x33 RIGHT LOWER DOOR COLUMN CAP	1.000	PC
Code	Description	Qty	UOM																																																			
MS1009A0	FORNETTI LOGO LABEL	1.000	PC																																																			
RC1200A0	ED=4 WIRE D.=0.5 COMPRESSIO N SPRING	2.000	PC																																																			
SL1050A1	3M TRANSFER ADHESIVE TAPE	0.820	M																																																			
TB2301A0	RIGHT COLUMN XVC105E 40x40x1	1.000	PC																																																			
TB3081A0	LMISS ARIANNA/ROS SELLA DOOR LEFT COLUMN	1.000	PC																																																			
VM1025A0	Ø16 GREY NYLON LID	2.000	PC																																																			
VM1695A0	HANDLE POSITION PIN	2.000	PC																																																			
VM1920A0	INTERNAL GLASS CLOSING RIGHT PLATE	1.000	PC																																																			
VM1921A0	INTERNAL GLASS CLOSING LEFT PLATE	1.000	PC																																																			
VM2062A0	L.Miss 46x33 RIGHT UPPER DOOR COLUMN CAP	1.000	PC																																																			
VM2063A0	L.Miss 46x33 LEFT UPPER DOOR COLUMN CAP	1.000	PC																																																			
VM2064A0	L.Miss 46x33 RIGHT LOWER DOOR COLUMN CAP	1.000	PC																																																			



Зип Общепит
vsezip.ru

+7(812)987-08-81

COMPONENT			SPARE PART																																																										
Code	Description	Image	Code	Description	Kit components																																																								
VM2063A	L.Miss 46x33 LEFT UPPER DOOR COLUMN CAP		KVT1063A	L.MISS ARIANNA FORNETTI EXT. GLASS KIT	<table border="1"> <thead> <tr> <th>Code</th> <th>Description</th> <th>Qty</th> <th>UOM</th> </tr> </thead> <tbody> <tr> <td>VM2065A0</td> <td>L.Miss 46x33 LEFT LOWER DOOR COLUMN CAP</td> <td>1.000</td> <td>PC</td> </tr> <tr> <td>VT1063A0</td> <td>XF135F EXTERNAL GLASS 598x42</td> <td>1.000</td> <td>PC</td> </tr> </tbody> </table>	Code	Description	Qty	UOM	VM2065A0	L.Miss 46x33 LEFT LOWER DOOR COLUMN CAP	1.000	PC	VT1063A0	XF135F EXTERNAL GLASS 598x42	1.000	PC																																												
Code	Description	Qty	UOM																																																										
VM2065A0	L.Miss 46x33 LEFT LOWER DOOR COLUMN CAP	1.000	PC																																																										
VT1063A0	XF135F EXTERNAL GLASS 598x42	1.000	PC																																																										
			KVT1062A	L.M. ARIANNA BLACK EXTERNAL GLASS KIT	<table border="1"> <thead> <tr> <th>Code</th> <th>Description</th> <th>Qty</th> <th>UOM</th> </tr> </thead> <tbody> <tr> <td>RC1200A0</td> <td>ED=4 WIRE D.=0.5 COMPRESSIO N SPRING</td> <td>2.000</td> <td>PC</td> </tr> <tr> <td>SL1050A1</td> <td>3M TRANSFER ADHESIVE TAPE</td> <td>0.820</td> <td>M</td> </tr> <tr> <td>TB2301A0</td> <td>RIGHT COLUMN XVC105E 40x40x1</td> <td>1.000</td> <td>PC</td> </tr> <tr> <td>TB3081A0</td> <td>LMISS ARIANNA/ROS SELLA DOOR LEFT COLUMN</td> <td>1.000</td> <td>PC</td> </tr> <tr> <td>VM1025A0</td> <td>Ø16 GREY NYLON LID</td> <td>2.000</td> <td>PC</td> </tr> <tr> <td>VM1695A0</td> <td>HANDLE POSITION PIN</td> <td>2.000</td> <td>PC</td> </tr> <tr> <td>VM1920A0</td> <td>INTERNAL GLASS CLOSING RIGHT PLATE</td> <td>1.000</td> <td>PC</td> </tr> <tr> <td>VM1921A0</td> <td>INTERNAL GLASS CLOSING LEFT PLATE</td> <td>1.000</td> <td>PC</td> </tr> <tr> <td>VM2062A0</td> <td>L.Miss 46x33 RIGHT UPPER DOOR COLUMN CAP</td> <td>1.000</td> <td>PC</td> </tr> <tr> <td>VM2063A0</td> <td>L.Miss 46x33 LEFT UPPER DOOR COLUMN CAP</td> <td>1.000</td> <td>PC</td> </tr> <tr> <td>VM2064A0</td> <td>L.Miss 46x33 RIGHT LOWER DOOR COLUMN CAP</td> <td>1.000</td> <td>PC</td> </tr> <tr> <td>VM2065A0</td> <td>L.Miss 46x33 LEFT LOWER DOOR COLUMN CAP</td> <td>1.000</td> <td>PC</td> </tr> <tr> <td>VT1062A0</td> <td>LineMiss ARIANNA GREY EXTERNAL GLASS</td> <td>1.000</td> <td>PC</td> </tr> </tbody> </table>	Code	Description	Qty	UOM	RC1200A0	ED=4 WIRE D.=0.5 COMPRESSIO N SPRING	2.000	PC	SL1050A1	3M TRANSFER ADHESIVE TAPE	0.820	M	TB2301A0	RIGHT COLUMN XVC105E 40x40x1	1.000	PC	TB3081A0	LMISS ARIANNA/ROS SELLA DOOR LEFT COLUMN	1.000	PC	VM1025A0	Ø16 GREY NYLON LID	2.000	PC	VM1695A0	HANDLE POSITION PIN	2.000	PC	VM1920A0	INTERNAL GLASS CLOSING RIGHT PLATE	1.000	PC	VM1921A0	INTERNAL GLASS CLOSING LEFT PLATE	1.000	PC	VM2062A0	L.Miss 46x33 RIGHT UPPER DOOR COLUMN CAP	1.000	PC	VM2063A0	L.Miss 46x33 LEFT UPPER DOOR COLUMN CAP	1.000	PC	VM2064A0	L.Miss 46x33 RIGHT LOWER DOOR COLUMN CAP	1.000	PC	VM2065A0	L.Miss 46x33 LEFT LOWER DOOR COLUMN CAP	1.000	PC	VT1062A0	LineMiss ARIANNA GREY EXTERNAL GLASS	1.000	PC
Code	Description	Qty	UOM																																																										
RC1200A0	ED=4 WIRE D.=0.5 COMPRESSIO N SPRING	2.000	PC																																																										
SL1050A1	3M TRANSFER ADHESIVE TAPE	0.820	M																																																										
TB2301A0	RIGHT COLUMN XVC105E 40x40x1	1.000	PC																																																										
TB3081A0	LMISS ARIANNA/ROS SELLA DOOR LEFT COLUMN	1.000	PC																																																										
VM1025A0	Ø16 GREY NYLON LID	2.000	PC																																																										
VM1695A0	HANDLE POSITION PIN	2.000	PC																																																										
VM1920A0	INTERNAL GLASS CLOSING RIGHT PLATE	1.000	PC																																																										
VM1921A0	INTERNAL GLASS CLOSING LEFT PLATE	1.000	PC																																																										
VM2062A0	L.Miss 46x33 RIGHT UPPER DOOR COLUMN CAP	1.000	PC																																																										
VM2063A0	L.Miss 46x33 LEFT UPPER DOOR COLUMN CAP	1.000	PC																																																										
VM2064A0	L.Miss 46x33 RIGHT LOWER DOOR COLUMN CAP	1.000	PC																																																										
VM2065A0	L.Miss 46x33 LEFT LOWER DOOR COLUMN CAP	1.000	PC																																																										
VT1062A0	LineMiss ARIANNA GREY EXTERNAL GLASS	1.000	PC																																																										



Зип Общепит
vsezip.ru

+7(812)987-08-81

COMPONENT			SPARE PART																																																																																		
Code	Description	Image	Code	Description	Kit components																																																																																
VM2063A	L.Miss 46x33 LEFT UPPER DOOR COLUMN CAP		KVT1061A	LM ARIANNA EXTERNAL YELLOW GLASS KIT	<table border="1"> <thead> <tr> <th>Code</th> <th>Description</th> <th>Qty</th> <th>UOM</th> </tr> </thead> <tbody> <tr> <td>RC1200A0</td> <td>ED=4 WIRE D.=0.5 COMPRESSIO N SPRING</td> <td>2.000</td> <td>PC</td> </tr> <tr> <td>SL1050A1</td> <td>3M TRANSFER ADHESIVE TAPE</td> <td>0.820</td> <td>M</td> </tr> <tr> <td>TB2301A0</td> <td>RIGHT COLUMN XVC105E 40x40x1</td> <td>2.000</td> <td>PC</td> </tr> <tr> <td>VM1025A0</td> <td>Ø16 GREY NYLON LID</td> <td>2.000</td> <td>PC</td> </tr> <tr> <td>VM1695A0</td> <td>HANDLE POSITION PIN</td> <td>2.000</td> <td>PC</td> </tr> <tr> <td>VM1920A0</td> <td>INTERNAL GLASS CLOSING RIGHT PLATE</td> <td>1.000</td> <td>PC</td> </tr> <tr> <td>VM1921A0</td> <td>INTERNAL GLASS CLOSING LEFT PLATE</td> <td>1.000</td> <td>PC</td> </tr> <tr> <td>VM2062A0</td> <td>L.Miss 46x33 RIGHT UPPER DOOR COLUMN CAP</td> <td>1.000</td> <td>PC</td> </tr> <tr> <td>VM2063A0</td> <td>L.Miss 46x33 LEFT UPPER DOOR COLUMN CAP</td> <td>1.000</td> <td>PC</td> </tr> <tr> <td>VM2064A0</td> <td>L.Miss 46x33 RIGHT LOWER DOOR COLUMN CAP</td> <td>1.000</td> <td>PC</td> </tr> <tr> <td>VM2065A0</td> <td>L.Miss 46x33 LEFT LOWER DOOR COLUMN CAP</td> <td>1.000</td> <td>PC</td> </tr> <tr> <td></td> <td></td> <td></td> <td></td> <td></td> <td> <table border="1"> <thead> <tr> <th>Code</th> <th>Description</th> <th>Qty</th> <th>UOM</th> </tr> </thead> <tbody> <tr> <td>VT1061A2</td> <td>EXTERNAL YELLOW GLASS 598x424x5</td> <td>1.000</td> <td>PC</td> </tr> </tbody> </table> </td> </tr> <tr> <td></td> <td></td> <td></td> <td>KVT1057A</td> <td>LM STEFANIA BLACK EXTERNAL GLASS KIT</td> <td> <table border="1"> <thead> <tr> <th>Code</th> <th>Description</th> <th>Qty</th> <th>UOM</th> </tr> </thead> <tbody> <tr> <td>RC1200A0</td> <td>ED=4 WIRE D.=0.5 COMPRESSIO N SPRING</td> <td>2.000</td> <td>PC</td> </tr> <tr> <td>SL1050A1</td> <td>3M TRANSFER ADHESIVE TAPE</td> <td>0.660</td> <td>M</td> </tr> </tbody> </table> </td> </tr> </tbody> </table>	Code	Description	Qty	UOM	RC1200A0	ED=4 WIRE D.=0.5 COMPRESSIO N SPRING	2.000	PC	SL1050A1	3M TRANSFER ADHESIVE TAPE	0.820	M	TB2301A0	RIGHT COLUMN XVC105E 40x40x1	2.000	PC	VM1025A0	Ø16 GREY NYLON LID	2.000	PC	VM1695A0	HANDLE POSITION PIN	2.000	PC	VM1920A0	INTERNAL GLASS CLOSING RIGHT PLATE	1.000	PC	VM1921A0	INTERNAL GLASS CLOSING LEFT PLATE	1.000	PC	VM2062A0	L.Miss 46x33 RIGHT UPPER DOOR COLUMN CAP	1.000	PC	VM2063A0	L.Miss 46x33 LEFT UPPER DOOR COLUMN CAP	1.000	PC	VM2064A0	L.Miss 46x33 RIGHT LOWER DOOR COLUMN CAP	1.000	PC	VM2065A0	L.Miss 46x33 LEFT LOWER DOOR COLUMN CAP	1.000	PC						<table border="1"> <thead> <tr> <th>Code</th> <th>Description</th> <th>Qty</th> <th>UOM</th> </tr> </thead> <tbody> <tr> <td>VT1061A2</td> <td>EXTERNAL YELLOW GLASS 598x424x5</td> <td>1.000</td> <td>PC</td> </tr> </tbody> </table>	Code	Description	Qty	UOM	VT1061A2	EXTERNAL YELLOW GLASS 598x424x5	1.000	PC				KVT1057A	LM STEFANIA BLACK EXTERNAL GLASS KIT	<table border="1"> <thead> <tr> <th>Code</th> <th>Description</th> <th>Qty</th> <th>UOM</th> </tr> </thead> <tbody> <tr> <td>RC1200A0</td> <td>ED=4 WIRE D.=0.5 COMPRESSIO N SPRING</td> <td>2.000</td> <td>PC</td> </tr> <tr> <td>SL1050A1</td> <td>3M TRANSFER ADHESIVE TAPE</td> <td>0.660</td> <td>M</td> </tr> </tbody> </table>	Code	Description	Qty	UOM	RC1200A0	ED=4 WIRE D.=0.5 COMPRESSIO N SPRING	2.000	PC	SL1050A1	3M TRANSFER ADHESIVE TAPE	0.660	M
			Code	Description	Qty	UOM																																																																															
RC1200A0	ED=4 WIRE D.=0.5 COMPRESSIO N SPRING	2.000	PC																																																																																		
SL1050A1	3M TRANSFER ADHESIVE TAPE	0.820	M																																																																																		
TB2301A0	RIGHT COLUMN XVC105E 40x40x1	2.000	PC																																																																																		
VM1025A0	Ø16 GREY NYLON LID	2.000	PC																																																																																		
VM1695A0	HANDLE POSITION PIN	2.000	PC																																																																																		
VM1920A0	INTERNAL GLASS CLOSING RIGHT PLATE	1.000	PC																																																																																		
VM1921A0	INTERNAL GLASS CLOSING LEFT PLATE	1.000	PC																																																																																		
VM2062A0	L.Miss 46x33 RIGHT UPPER DOOR COLUMN CAP	1.000	PC																																																																																		
VM2063A0	L.Miss 46x33 LEFT UPPER DOOR COLUMN CAP	1.000	PC																																																																																		
VM2064A0	L.Miss 46x33 RIGHT LOWER DOOR COLUMN CAP	1.000	PC																																																																																		
VM2065A0	L.Miss 46x33 LEFT LOWER DOOR COLUMN CAP	1.000	PC																																																																																		
					<table border="1"> <thead> <tr> <th>Code</th> <th>Description</th> <th>Qty</th> <th>UOM</th> </tr> </thead> <tbody> <tr> <td>VT1061A2</td> <td>EXTERNAL YELLOW GLASS 598x424x5</td> <td>1.000</td> <td>PC</td> </tr> </tbody> </table>	Code	Description	Qty	UOM	VT1061A2	EXTERNAL YELLOW GLASS 598x424x5	1.000	PC																																																																								
Code	Description	Qty	UOM																																																																																		
VT1061A2	EXTERNAL YELLOW GLASS 598x424x5	1.000	PC																																																																																		
			KVT1057A	LM STEFANIA BLACK EXTERNAL GLASS KIT	<table border="1"> <thead> <tr> <th>Code</th> <th>Description</th> <th>Qty</th> <th>UOM</th> </tr> </thead> <tbody> <tr> <td>RC1200A0</td> <td>ED=4 WIRE D.=0.5 COMPRESSIO N SPRING</td> <td>2.000</td> <td>PC</td> </tr> <tr> <td>SL1050A1</td> <td>3M TRANSFER ADHESIVE TAPE</td> <td>0.660</td> <td>M</td> </tr> </tbody> </table>	Code	Description	Qty	UOM	RC1200A0	ED=4 WIRE D.=0.5 COMPRESSIO N SPRING	2.000	PC	SL1050A1	3M TRANSFER ADHESIVE TAPE	0.660	M																																																																				
Code	Description	Qty	UOM																																																																																		
RC1200A0	ED=4 WIRE D.=0.5 COMPRESSIO N SPRING	2.000	PC																																																																																		
SL1050A1	3M TRANSFER ADHESIVE TAPE	0.660	M																																																																																		



Зип Общепит
vsezip.ru

+7(812)987-08-81

COMPONENT			SPARE PART																																																		
Code	Description	Image	Code	Description	Kit components																																																
VM2063A	L.Miss 46x33 LEFT UPPER DOOR COLUMN CAP		KVT1057A	LM STEFANIA BLACK EXTERNAL GLASS KIT	<table border="1"> <thead> <tr> <th>Code</th> <th>Description</th> <th>Qty</th> <th>UOM</th> </tr> </thead> <tbody> <tr> <td>TB2306A0</td> <td>L.Miss Stefania/Elena DOOR RIGHT COLUMN</td> <td>1.000</td> <td>PC</td> </tr> <tr> <td>TB3080A0</td> <td>LMISS STEFANIA/ELE NA DOOR LEFT COLUMN</td> <td>1.000</td> <td>PC</td> </tr> <tr> <td>VM1025A0</td> <td>Ø16 GREY NYLON LID</td> <td>2.000</td> <td>PC</td> </tr> <tr> <td>VM1695A0</td> <td>HANDLE POSITION PIN</td> <td>2.000</td> <td>PC</td> </tr> <tr> <td>VM1920A0</td> <td>INTERNAL GLASS CLOSING RIGHT PLATE</td> <td>1.000</td> <td>PC</td> </tr> <tr> <td>VM1921A0</td> <td>INTERNAL GLASS CLOSING LEFT PLATE</td> <td>1.000</td> <td>PC</td> </tr> <tr> <td>VM2062A0</td> <td>L.Miss 46x33 RIGHT UPPER DOOR COLUMN CAP</td> <td>1.000</td> <td>PC</td> </tr> <tr> <td>VM2063A0</td> <td>L.Miss 46x33 LEFT UPPER DOOR COLUMN CAP</td> <td>1.000</td> <td>PC</td> </tr> <tr> <td>VM2064A0</td> <td>L.Miss 46x33 RIGHT LOWER DOOR COLUMN CAP</td> <td>1.000</td> <td>PC</td> </tr> <tr> <td>VM2065A0</td> <td>L.Miss 46x33 LEFT LOWER DOOR COLUMN CAP</td> <td>1.000</td> <td>PC</td> </tr> <tr> <td>VT1057A0</td> <td>L.MISS STEFANIA EXTERNAL GLASS 598x344x5</td> <td>1.000</td> <td>PC</td> </tr> </tbody> </table>	Code	Description	Qty	UOM	TB2306A0	L.Miss Stefania/Elena DOOR RIGHT COLUMN	1.000	PC	TB3080A0	LMISS STEFANIA/ELE NA DOOR LEFT COLUMN	1.000	PC	VM1025A0	Ø16 GREY NYLON LID	2.000	PC	VM1695A0	HANDLE POSITION PIN	2.000	PC	VM1920A0	INTERNAL GLASS CLOSING RIGHT PLATE	1.000	PC	VM1921A0	INTERNAL GLASS CLOSING LEFT PLATE	1.000	PC	VM2062A0	L.Miss 46x33 RIGHT UPPER DOOR COLUMN CAP	1.000	PC	VM2063A0	L.Miss 46x33 LEFT UPPER DOOR COLUMN CAP	1.000	PC	VM2064A0	L.Miss 46x33 RIGHT LOWER DOOR COLUMN CAP	1.000	PC	VM2065A0	L.Miss 46x33 LEFT LOWER DOOR COLUMN CAP	1.000	PC	VT1057A0	L.MISS STEFANIA EXTERNAL GLASS 598x344x5	1.000	PC
Code	Description	Qty	UOM																																																		
TB2306A0	L.Miss Stefania/Elena DOOR RIGHT COLUMN	1.000	PC																																																		
TB3080A0	LMISS STEFANIA/ELE NA DOOR LEFT COLUMN	1.000	PC																																																		
VM1025A0	Ø16 GREY NYLON LID	2.000	PC																																																		
VM1695A0	HANDLE POSITION PIN	2.000	PC																																																		
VM1920A0	INTERNAL GLASS CLOSING RIGHT PLATE	1.000	PC																																																		
VM1921A0	INTERNAL GLASS CLOSING LEFT PLATE	1.000	PC																																																		
VM2062A0	L.Miss 46x33 RIGHT UPPER DOOR COLUMN CAP	1.000	PC																																																		
VM2063A0	L.Miss 46x33 LEFT UPPER DOOR COLUMN CAP	1.000	PC																																																		
VM2064A0	L.Miss 46x33 RIGHT LOWER DOOR COLUMN CAP	1.000	PC																																																		
VM2065A0	L.Miss 46x33 LEFT LOWER DOOR COLUMN CAP	1.000	PC																																																		
VT1057A0	L.MISS STEFANIA EXTERNAL GLASS 598x344x5	1.000	PC																																																		
			KVT1056A	LM STEFANIA YELLOW EXTERNAL GLASS KIT	<table border="1"> <thead> <tr> <th>Code</th> <th>Description</th> <th>Qty</th> <th>UOM</th> </tr> </thead> <tbody> <tr> <td>RC1200A0</td> <td>ED=4 WIRE D.=0.5 COMPRESSIO N SPRING</td> <td>2.000</td> <td>PC</td> </tr> <tr> <td>SL1050A1</td> <td>3M TRANSFER ADHESIVE TAPE</td> <td>0.660</td> <td>M</td> </tr> <tr> <td>TB2306A0</td> <td>L.Miss Stefania/Elena DOOR RIGHT COLUMN</td> <td>2.000</td> <td>PC</td> </tr> </tbody> </table>	Code	Description	Qty	UOM	RC1200A0	ED=4 WIRE D.=0.5 COMPRESSIO N SPRING	2.000	PC	SL1050A1	3M TRANSFER ADHESIVE TAPE	0.660	M	TB2306A0	L.Miss Stefania/Elena DOOR RIGHT COLUMN	2.000	PC																																
Code	Description	Qty	UOM																																																		
RC1200A0	ED=4 WIRE D.=0.5 COMPRESSIO N SPRING	2.000	PC																																																		
SL1050A1	3M TRANSFER ADHESIVE TAPE	0.660	M																																																		
TB2306A0	L.Miss Stefania/Elena DOOR RIGHT COLUMN	2.000	PC																																																		



Зип Общепит
vsezip.ru

+7(812)987-08-81

COMPONENT			SPARE PART																																										
Code	Description	Image	Code	Description	Kit components																																								
VM2063A	L.Miss 46x33 LEFT UPPER DOOR COLUMN CAP		KVT1056A	LM STEFANIA YELLOW EXTERNAL GLASS KIT	<table border="1"> <thead> <tr> <th>Code</th> <th>Description</th> <th>Qty</th> <th>UOM</th> </tr> </thead> <tbody> <tr> <td>VM1025A0</td> <td>Ø16 GREY NYLON LID</td> <td>2.000</td> <td>PC</td> </tr> <tr> <td>VM1695A0</td> <td>HANDLE POSITION PIN</td> <td>2.000</td> <td>PC</td> </tr> <tr> <td>VM1920A0</td> <td>INTERNAL GLASS CLOSING RIGHT PLATE</td> <td>1.000</td> <td>PC</td> </tr> <tr> <td>VM1921A0</td> <td>INTERNAL GLASS CLOSING LEFT PLATE</td> <td>1.000</td> <td>PC</td> </tr> <tr> <td>VM2062A0</td> <td>L.Miss 46x33 RIGHT UPPER DOOR COLUMN CAP</td> <td>1.000</td> <td>PC</td> </tr> <tr> <td>VM2063A0</td> <td>L.Miss 46x33 LEFT UPPER DOOR COLUMN CAP</td> <td>1.000</td> <td>PC</td> </tr> <tr> <td>VM2064A0</td> <td>L.Miss 46x33 RIGHT LOWER DOOR COLUMN CAP</td> <td>1.000</td> <td>PC</td> </tr> <tr> <td>VM2065A0</td> <td>L.Miss 46x33 LEFT LOWER DOOR COLUMN CAP</td> <td>1.000</td> <td>PC</td> </tr> <tr> <td>VT1056A2</td> <td>YELLOW SER GLASS 598X344X5</td> <td>1.000</td> <td>PC</td> </tr> </tbody> </table>	Code	Description	Qty	UOM	VM1025A0	Ø16 GREY NYLON LID	2.000	PC	VM1695A0	HANDLE POSITION PIN	2.000	PC	VM1920A0	INTERNAL GLASS CLOSING RIGHT PLATE	1.000	PC	VM1921A0	INTERNAL GLASS CLOSING LEFT PLATE	1.000	PC	VM2062A0	L.Miss 46x33 RIGHT UPPER DOOR COLUMN CAP	1.000	PC	VM2063A0	L.Miss 46x33 LEFT UPPER DOOR COLUMN CAP	1.000	PC	VM2064A0	L.Miss 46x33 RIGHT LOWER DOOR COLUMN CAP	1.000	PC	VM2065A0	L.Miss 46x33 LEFT LOWER DOOR COLUMN CAP	1.000	PC	VT1056A2	YELLOW SER GLASS 598X344X5	1.000	PC
			Code	Description	Qty	UOM																																							
VM1025A0	Ø16 GREY NYLON LID	2.000	PC																																										
VM1695A0	HANDLE POSITION PIN	2.000	PC																																										
VM1920A0	INTERNAL GLASS CLOSING RIGHT PLATE	1.000	PC																																										
VM1921A0	INTERNAL GLASS CLOSING LEFT PLATE	1.000	PC																																										
VM2062A0	L.Miss 46x33 RIGHT UPPER DOOR COLUMN CAP	1.000	PC																																										
VM2063A0	L.Miss 46x33 LEFT UPPER DOOR COLUMN CAP	1.000	PC																																										
VM2064A0	L.Miss 46x33 RIGHT LOWER DOOR COLUMN CAP	1.000	PC																																										
VM2065A0	L.Miss 46x33 LEFT LOWER DOOR COLUMN CAP	1.000	PC																																										
VT1056A2	YELLOW SER GLASS 598X344X5	1.000	PC																																										
KVT1052A	LM CRISTINA BLACK EXTERNAL GLASS KIT	<table border="1"> <thead> <tr> <th>Code</th> <th>Description</th> <th>Qty</th> <th>UOM</th> </tr> </thead> <tbody> <tr> <td>RC1200A0</td> <td>ED=4 WIRE D.=0.5 COMPRESSIO N SPRING</td> <td>2.000</td> <td>PC</td> </tr> <tr> <td>SL1050A1</td> <td>3M TRANSFER ADHESIVE TAPE</td> <td>0.660</td> <td>M</td> </tr> <tr> <td>TB2306A0</td> <td>L.Miss Stefania/Elena DOOR RIGHT COLUMN</td> <td>2.000</td> <td>PC</td> </tr> <tr> <td>VM1025A0</td> <td>Ø16 GREY NYLON LID</td> <td>2.000</td> <td>PC</td> </tr> <tr> <td>VM1695A0</td> <td>HANDLE POSITION PIN</td> <td>2.000</td> <td>PC</td> </tr> <tr> <td>VM1920A0</td> <td>INTERNAL GLASS CLOSING RIGHT PLATE</td> <td>1.000</td> <td>PC</td> </tr> </tbody> </table>	Code	Description	Qty	UOM	RC1200A0	ED=4 WIRE D.=0.5 COMPRESSIO N SPRING	2.000	PC	SL1050A1	3M TRANSFER ADHESIVE TAPE	0.660	M	TB2306A0	L.Miss Stefania/Elena DOOR RIGHT COLUMN	2.000	PC	VM1025A0	Ø16 GREY NYLON LID	2.000	PC	VM1695A0	HANDLE POSITION PIN	2.000	PC	VM1920A0	INTERNAL GLASS CLOSING RIGHT PLATE	1.000	PC															
Code	Description	Qty	UOM																																										
RC1200A0	ED=4 WIRE D.=0.5 COMPRESSIO N SPRING	2.000	PC																																										
SL1050A1	3M TRANSFER ADHESIVE TAPE	0.660	M																																										
TB2306A0	L.Miss Stefania/Elena DOOR RIGHT COLUMN	2.000	PC																																										
VM1025A0	Ø16 GREY NYLON LID	2.000	PC																																										
VM1695A0	HANDLE POSITION PIN	2.000	PC																																										
VM1920A0	INTERNAL GLASS CLOSING RIGHT PLATE	1.000	PC																																										



Зип Общепит
vsezip.ru



+7(812)987-08-81

COMPONENT			SPARE PART																																			
Code	Description	Image	Code	Description	Kit components																																	
VM2063A	L.Miss 46x33 LEFT UPPER DOOR COLUMN CAP		KVT1052A	LM CRISTINA BLACK EXTERNAL GLASS KIT	<table border="1"> <thead> <tr> <th>Code</th> <th>Description</th> <th>Qty</th> <th>UOM</th> </tr> </thead> <tbody> <tr> <td>VM1921A0</td> <td>INTERNAL GLASS CLOSING LEFT PLATE</td> <td>1.000</td> <td>PC</td> </tr> <tr> <td>VM2062A0</td> <td>L.Miss 46x33 RIGHT UPPER DOOR COLUMN CAP</td> <td>1.000</td> <td>PC</td> </tr> <tr> <td>VM2063A0</td> <td>L.Miss 46x33 LEFT UPPER DOOR COLUMN CAP</td> <td>1.000</td> <td>PC</td> </tr> <tr> <td>VM2064A0</td> <td>L.Miss 46x33 RIGHT LOWER DOOR COLUMN CAP</td> <td>1.000</td> <td>PC</td> </tr> <tr> <td>VM2065A0</td> <td>L.Miss 46x33 LEFT LOWER DOOR COLUMN CAP</td> <td>1.000</td> <td>PC</td> </tr> <tr> <td>VT1052A0</td> <td>478X344X5 EXTERNAL GLASS</td> <td>1.000</td> <td>PC</td> </tr> </tbody> </table>	Code	Description	Qty	UOM	VM1921A0	INTERNAL GLASS CLOSING LEFT PLATE	1.000	PC	VM2062A0	L.Miss 46x33 RIGHT UPPER DOOR COLUMN CAP	1.000	PC	VM2063A0	L.Miss 46x33 LEFT UPPER DOOR COLUMN CAP	1.000	PC	VM2064A0	L.Miss 46x33 RIGHT LOWER DOOR COLUMN CAP	1.000	PC	VM2065A0	L.Miss 46x33 LEFT LOWER DOOR COLUMN CAP	1.000	PC	VT1052A0	478X344X5 EXTERNAL GLASS	1.000	PC					
			Code	Description	Qty	UOM																																
VM1921A0	INTERNAL GLASS CLOSING LEFT PLATE	1.000	PC																																			
VM2062A0	L.Miss 46x33 RIGHT UPPER DOOR COLUMN CAP	1.000	PC																																			
VM2063A0	L.Miss 46x33 LEFT UPPER DOOR COLUMN CAP	1.000	PC																																			
VM2064A0	L.Miss 46x33 RIGHT LOWER DOOR COLUMN CAP	1.000	PC																																			
VM2065A0	L.Miss 46x33 LEFT LOWER DOOR COLUMN CAP	1.000	PC																																			
VT1052A0	478X344X5 EXTERNAL GLASS	1.000	PC																																			
KVT1051A	LM CRISTINA YELLOW EXTERNAL GLASS KIT	<table border="1"> <thead> <tr> <th>Code</th> <th>Description</th> <th>Qty</th> <th>UOM</th> </tr> </thead> <tbody> <tr> <td>RC1200A0</td> <td>ED=4 WIRE D.=0.5 COMPRESSIO N SPRING</td> <td>2.000</td> <td>PC</td> </tr> <tr> <td>SL1050A1</td> <td>3M TRANSFER ADHESIVE TAPE</td> <td>0.660</td> <td>M</td> </tr> <tr> <td>TB2306A0</td> <td>L.Miss Stefania/Elena DOOR RIGHT COLUMN</td> <td>2.000</td> <td>PC</td> </tr> <tr> <td>VM1025A0</td> <td>Ø16 GREY NYLON LID</td> <td>2.000</td> <td>PC</td> </tr> <tr> <td>VM1695A0</td> <td>HANDLE POSITION PIN</td> <td>2.000</td> <td>PC</td> </tr> <tr> <td>VM1920A0</td> <td>INTERNAL GLASS CLOSING RIGHT PLATE</td> <td>1.000</td> <td>PC</td> </tr> <tr> <td>VM1921A0</td> <td>INTERNAL GLASS CLOSING LEFT PLATE</td> <td>1.000</td> <td>PC</td> </tr> <tr> <td>VM2062A0</td> <td>L.Miss 46x33 RIGHT UPPER DOOR COLUMN CAP</td> <td>1.000</td> <td>PC</td> </tr> </tbody> </table>	Code	Description	Qty	UOM	RC1200A0	ED=4 WIRE D.=0.5 COMPRESSIO N SPRING	2.000	PC	SL1050A1	3M TRANSFER ADHESIVE TAPE	0.660	M	TB2306A0	L.Miss Stefania/Elena DOOR RIGHT COLUMN	2.000	PC	VM1025A0	Ø16 GREY NYLON LID	2.000	PC	VM1695A0	HANDLE POSITION PIN	2.000	PC	VM1920A0	INTERNAL GLASS CLOSING RIGHT PLATE	1.000	PC	VM1921A0	INTERNAL GLASS CLOSING LEFT PLATE	1.000	PC	VM2062A0	L.Miss 46x33 RIGHT UPPER DOOR COLUMN CAP	1.000	PC
Code	Description	Qty	UOM																																			
RC1200A0	ED=4 WIRE D.=0.5 COMPRESSIO N SPRING	2.000	PC																																			
SL1050A1	3M TRANSFER ADHESIVE TAPE	0.660	M																																			
TB2306A0	L.Miss Stefania/Elena DOOR RIGHT COLUMN	2.000	PC																																			
VM1025A0	Ø16 GREY NYLON LID	2.000	PC																																			
VM1695A0	HANDLE POSITION PIN	2.000	PC																																			
VM1920A0	INTERNAL GLASS CLOSING RIGHT PLATE	1.000	PC																																			
VM1921A0	INTERNAL GLASS CLOSING LEFT PLATE	1.000	PC																																			
VM2062A0	L.Miss 46x33 RIGHT UPPER DOOR COLUMN CAP	1.000	PC																																			



Зип Общепит
vsezip.ru

+7(812)987-08-81

COMPONENT			SPARE PART																																						
Code	Description	Image	Code	Description	Kit components																																				
VM2063A	L.Miss 46x33 LEFT UPPER DOOR COLUMN CAP		KVT1051A	LM CRISTINA YELLOW EXTERNAL GLASS KIT	<table border="1"> <thead> <tr> <th>Code</th> <th>Description</th> <th>Qty</th> <th>UOM</th> </tr> </thead> <tbody> <tr> <td>VM2063A0</td> <td>L.Miss 46x33 LEFT UPPER DOOR COLUMN CAP</td> <td>1.000</td> <td>PC</td> </tr> <tr> <td>VM2064A0</td> <td>L.Miss 46x33 RIGHT LOWER DOOR COLUMN CAP</td> <td>1.000</td> <td>PC</td> </tr> <tr> <td>VM2065A0</td> <td>L.Miss 46x33 LEFT LOWER DOOR COLUMN CAP</td> <td>1.000</td> <td>PC</td> </tr> <tr> <td>VT1051A2</td> <td>YELLOW SER GLASS 478X344X5</td> <td>1.000</td> <td>PC</td> </tr> </tbody> </table>	Code	Description	Qty	UOM	VM2063A0	L.Miss 46x33 LEFT UPPER DOOR COLUMN CAP	1.000	PC	VM2064A0	L.Miss 46x33 RIGHT LOWER DOOR COLUMN CAP	1.000	PC	VM2065A0	L.Miss 46x33 LEFT LOWER DOOR COLUMN CAP	1.000	PC	VT1051A2	YELLOW SER GLASS 478X344X5	1.000	PC																
					Code	Description	Qty	UOM																																	
					VM2063A0	L.Miss 46x33 LEFT UPPER DOOR COLUMN CAP	1.000	PC																																	
					VM2064A0	L.Miss 46x33 RIGHT LOWER DOOR COLUMN CAP	1.000	PC																																	
VM2065A0	L.Miss 46x33 LEFT LOWER DOOR COLUMN CAP	1.000	PC																																						
VT1051A2	YELLOW SER GLASS 478X344X5	1.000	PC																																						
LP1036A	LineMiss L=100 LED BAR		KLP1036A	LMISS L200 LED BAR KIT	<table border="1"> <thead> <tr> <th>Code</th> <th>Description</th> <th>Qty</th> <th>UOM</th> </tr> </thead> <tbody> <tr> <td>LP1036A2</td> <td>L200 E200 LM LUX COMPLETE LED BAR</td> <td>1.000</td> <td>PC</td> </tr> </tbody> </table>	Code	Description	Qty	UOM	LP1036A2	L200 E200 LM LUX COMPLETE LED BAR	1.000	PC																												
					Code	Description	Qty	UOM																																	
LP1036A2	L200 E200 LM LUX COMPLETE LED BAR	1.000	PC																																						
VM2064A	L.Miss 46x33 RIGHT LOWER DOOR COLUMN CAP		KVT1252A	XF135-EG- VT1252A EXTERNAL GLASS KIT	<table border="1"> <thead> <tr> <th>Code</th> <th>Description</th> <th>Qty</th> <th>UOM</th> </tr> </thead> <tbody> <tr> <td>RC1200A0</td> <td>ED=4 WIRE D.=0.5 COMPRESSIO N SPRING</td> <td>2.000</td> <td>PC</td> </tr> <tr> <td>SL1050A1</td> <td>3M TRANSFER ADHESIVE TAPE</td> <td>0.820</td> <td>M</td> </tr> <tr> <td>TB2301A0</td> <td>RIGHT COLUMN XVC105E 40x40x1</td> <td>1.000</td> <td>PC</td> </tr> <tr> <td>TB3081A0</td> <td>LMISS ARIANNA/ROS SELLA DOOR LEFT COLUMN</td> <td>1.000</td> <td>PC</td> </tr> <tr> <td>VM1025A0</td> <td>Ø16 GREY NYLON LID</td> <td>2.000</td> <td>PC</td> </tr> <tr> <td>VM1695A0</td> <td>HANDLE POSITION PIN</td> <td>2.000</td> <td>PC</td> </tr> <tr> <td>VM1920A0</td> <td>INTERNAL GLASS CLOSING RIGHT PLATE</td> <td>1.000</td> <td>PC</td> </tr> <tr> <td>VM1921A0</td> <td>INTERNAL GLASS CLOSING LEFT PLATE</td> <td>1.000</td> <td>PC</td> </tr> </tbody> </table>	Code	Description	Qty	UOM	RC1200A0	ED=4 WIRE D.=0.5 COMPRESSIO N SPRING	2.000	PC	SL1050A1	3M TRANSFER ADHESIVE TAPE	0.820	M	TB2301A0	RIGHT COLUMN XVC105E 40x40x1	1.000	PC	TB3081A0	LMISS ARIANNA/ROS SELLA DOOR LEFT COLUMN	1.000	PC	VM1025A0	Ø16 GREY NYLON LID	2.000	PC	VM1695A0	HANDLE POSITION PIN	2.000	PC	VM1920A0	INTERNAL GLASS CLOSING RIGHT PLATE	1.000	PC	VM1921A0	INTERNAL GLASS CLOSING LEFT PLATE	1.000	PC
					Code	Description	Qty	UOM																																	
					RC1200A0	ED=4 WIRE D.=0.5 COMPRESSIO N SPRING	2.000	PC																																	
					SL1050A1	3M TRANSFER ADHESIVE TAPE	0.820	M																																	
					TB2301A0	RIGHT COLUMN XVC105E 40x40x1	1.000	PC																																	
					TB3081A0	LMISS ARIANNA/ROS SELLA DOOR LEFT COLUMN	1.000	PC																																	
					VM1025A0	Ø16 GREY NYLON LID	2.000	PC																																	
					VM1695A0	HANDLE POSITION PIN	2.000	PC																																	
					VM1920A0	INTERNAL GLASS CLOSING RIGHT PLATE	1.000	PC																																	
					VM1921A0	INTERNAL GLASS CLOSING LEFT PLATE	1.000	PC																																	



Зип Общепит
vsezip.ru

+7(812)987-08-81

COMPONENT			SPARE PART																																														
Code	Description	Image	Code	Description	Kit components																																												
VM2064A	L.Miss 46x33 RIGHT LOWER DOOR COLUMN CAP		KVT1252A	XF135-EG- VT1252A EXTERNAL GLASS KIT	<table border="1"> <thead> <tr> <th>Code</th> <th>Description</th> <th>Qty</th> <th>UOM</th> </tr> </thead> <tbody> <tr> <td>VM2062A0</td> <td>L.Miss 46x33 RIGHT UPPER DOOR COLUMN CAP</td> <td>1.000</td> <td>PC</td> </tr> <tr> <td>VM2063A0</td> <td>L.Miss 46x33 LEFT UPPER DOOR COLUMN CAP</td> <td>1.000</td> <td>PC</td> </tr> <tr> <td>VM2064A0</td> <td>L.Miss 46x33 RIGHT LOWER DOOR COLUMN CAP</td> <td>1.000</td> <td>PC</td> </tr> <tr> <td>VM2065A0</td> <td>L.Miss 46x33 LEFT LOWER DOOR COLUMN CAP</td> <td>1.000</td> <td>PC</td> </tr> <tr> <td>VT1252A0</td> <td>XFT135 DOOR EXT. BLACK GLASS - ENGEFOOD</td> <td>1.000</td> <td>PC</td> </tr> </tbody> </table>	Code	Description	Qty	UOM	VM2062A0	L.Miss 46x33 RIGHT UPPER DOOR COLUMN CAP	1.000	PC	VM2063A0	L.Miss 46x33 LEFT UPPER DOOR COLUMN CAP	1.000	PC	VM2064A0	L.Miss 46x33 RIGHT LOWER DOOR COLUMN CAP	1.000	PC	VM2065A0	L.Miss 46x33 LEFT LOWER DOOR COLUMN CAP	1.000	PC	VT1252A0	XFT135 DOOR EXT. BLACK GLASS - ENGEFOOD	1.000	PC																				
Code	Description	Qty	UOM																																														
VM2062A0	L.Miss 46x33 RIGHT UPPER DOOR COLUMN CAP	1.000	PC																																														
VM2063A0	L.Miss 46x33 LEFT UPPER DOOR COLUMN CAP	1.000	PC																																														
VM2064A0	L.Miss 46x33 RIGHT LOWER DOOR COLUMN CAP	1.000	PC																																														
VM2065A0	L.Miss 46x33 LEFT LOWER DOOR COLUMN CAP	1.000	PC																																														
VT1252A0	XFT135 DOOR EXT. BLACK GLASS - ENGEFOOD	1.000	PC																																														
			KVT1063A	L.MISS ARIANNA FORNETTI EXT. GLASS KIT	<table border="1"> <thead> <tr> <th>Code</th> <th>Description</th> <th>Qty</th> <th>UOM</th> </tr> </thead> <tbody> <tr> <td>MS1009A0</td> <td>FORNETTI LOGO LABEL</td> <td>1.000</td> <td>PC</td> </tr> <tr> <td>RC1200A0</td> <td>ED=4 WIRE D.=0.5 COMPRESSIO N SPRING</td> <td>2.000</td> <td>PC</td> </tr> <tr> <td>SL1050A1</td> <td>3M TRANSFER ADHESIVE TAPE</td> <td>0.820</td> <td>M</td> </tr> <tr> <td>TB2301A0</td> <td>RIGHT COLUMN XVC105E 40x40x1</td> <td>1.000</td> <td>PC</td> </tr> <tr> <td>TB3081A0</td> <td>LMISS ARIANNA/ROS SELLA DOOR LEFT COLUMN</td> <td>1.000</td> <td>PC</td> </tr> <tr> <td>VM1025A0</td> <td>Ø16 GREY NYLON LID</td> <td>2.000</td> <td>PC</td> </tr> <tr> <td>VM1695A0</td> <td>HANDLE POSITION PIN</td> <td>2.000</td> <td>PC</td> </tr> <tr> <td>VM1920A0</td> <td>INTERNAL GLASS CLOSING RIGHT PLATE</td> <td>1.000</td> <td>PC</td> </tr> <tr> <td>VM1921A0</td> <td>INTERNAL GLASS CLOSING LEFT PLATE</td> <td>1.000</td> <td>PC</td> </tr> <tr> <td>VM2062A0</td> <td>L.Miss 46x33 RIGHT UPPER DOOR COLUMN CAP</td> <td>1.000</td> <td>PC</td> </tr> </tbody> </table>	Code	Description	Qty	UOM	MS1009A0	FORNETTI LOGO LABEL	1.000	PC	RC1200A0	ED=4 WIRE D.=0.5 COMPRESSIO N SPRING	2.000	PC	SL1050A1	3M TRANSFER ADHESIVE TAPE	0.820	M	TB2301A0	RIGHT COLUMN XVC105E 40x40x1	1.000	PC	TB3081A0	LMISS ARIANNA/ROS SELLA DOOR LEFT COLUMN	1.000	PC	VM1025A0	Ø16 GREY NYLON LID	2.000	PC	VM1695A0	HANDLE POSITION PIN	2.000	PC	VM1920A0	INTERNAL GLASS CLOSING RIGHT PLATE	1.000	PC	VM1921A0	INTERNAL GLASS CLOSING LEFT PLATE	1.000	PC	VM2062A0	L.Miss 46x33 RIGHT UPPER DOOR COLUMN CAP	1.000	PC
Code	Description	Qty	UOM																																														
MS1009A0	FORNETTI LOGO LABEL	1.000	PC																																														
RC1200A0	ED=4 WIRE D.=0.5 COMPRESSIO N SPRING	2.000	PC																																														
SL1050A1	3M TRANSFER ADHESIVE TAPE	0.820	M																																														
TB2301A0	RIGHT COLUMN XVC105E 40x40x1	1.000	PC																																														
TB3081A0	LMISS ARIANNA/ROS SELLA DOOR LEFT COLUMN	1.000	PC																																														
VM1025A0	Ø16 GREY NYLON LID	2.000	PC																																														
VM1695A0	HANDLE POSITION PIN	2.000	PC																																														
VM1920A0	INTERNAL GLASS CLOSING RIGHT PLATE	1.000	PC																																														
VM1921A0	INTERNAL GLASS CLOSING LEFT PLATE	1.000	PC																																														
VM2062A0	L.Miss 46x33 RIGHT UPPER DOOR COLUMN CAP	1.000	PC																																														



+7(812)987-08-81

COMPONENT			SPARE PART																																																		
Code	Description	Image	Code	Description	Kit components																																																
VM2064A	L.Miss 46x33 RIGHT LOWER DOOR COLUMN CAP		KVT1063A	L.MISS ARIANNA FORNETTI EXT. GLASS KIT	<table border="1"> <thead> <tr> <th>Code</th> <th>Description</th> <th>Qty</th> <th>UOM</th> </tr> </thead> <tbody> <tr> <td>VM2063A0</td> <td>L.Miss 46x33 LEFT UPPER DOOR COLUMN CAP</td> <td>1.000</td> <td>PC</td> </tr> <tr> <td>VM2064A0</td> <td>L.Miss 46x33 RIGHT LOWER DOOR COLUMN CAP</td> <td>1.000</td> <td>PC</td> </tr> <tr> <td>VM2065A0</td> <td>L.Miss 46x33 LEFT LOWER DOOR COLUMN CAP</td> <td>1.000</td> <td>PC</td> </tr> <tr> <td>VT1063A0</td> <td>XF135F EXTERNAL GLASS 598x42</td> <td>1.000</td> <td>PC</td> </tr> </tbody> </table>	Code	Description	Qty	UOM	VM2063A0	L.Miss 46x33 LEFT UPPER DOOR COLUMN CAP	1.000	PC	VM2064A0	L.Miss 46x33 RIGHT LOWER DOOR COLUMN CAP	1.000	PC	VM2065A0	L.Miss 46x33 LEFT LOWER DOOR COLUMN CAP	1.000	PC	VT1063A0	XF135F EXTERNAL GLASS 598x42	1.000	PC																												
Code	Description	Qty	UOM																																																		
VM2063A0	L.Miss 46x33 LEFT UPPER DOOR COLUMN CAP	1.000	PC																																																		
VM2064A0	L.Miss 46x33 RIGHT LOWER DOOR COLUMN CAP	1.000	PC																																																		
VM2065A0	L.Miss 46x33 LEFT LOWER DOOR COLUMN CAP	1.000	PC																																																		
VT1063A0	XF135F EXTERNAL GLASS 598x42	1.000	PC																																																		
			KVT1062A	L.M. ARIANNA BLACK EXTERNAL GLASS KIT	<table border="1"> <thead> <tr> <th>Code</th> <th>Description</th> <th>Qty</th> <th>UOM</th> </tr> </thead> <tbody> <tr> <td>RC1200A0</td> <td>ED=4 WIRE D.=0.5 COMPRESSIO N SPRING</td> <td>2.000</td> <td>PC</td> </tr> <tr> <td>SL1050A1</td> <td>3M TRANSFER ADHESIVE TAPE</td> <td>0.820</td> <td>M</td> </tr> <tr> <td>TB2301A0</td> <td>RIGHT COLUMN XVC105E 40x40x1</td> <td>1.000</td> <td>PC</td> </tr> <tr> <td>TB3081A0</td> <td>LMISS ARIANNA/ROS SELLA DOOR LEFT COLUMN</td> <td>1.000</td> <td>PC</td> </tr> <tr> <td>VM1025A0</td> <td>Ø16 GREY NYLON LID</td> <td>2.000</td> <td>PC</td> </tr> <tr> <td>VM1695A0</td> <td>HANDLE POSITION PIN</td> <td>2.000</td> <td>PC</td> </tr> <tr> <td>VM1920A0</td> <td>INTERNAL GLASS CLOSING RIGHT PLATE</td> <td>1.000</td> <td>PC</td> </tr> <tr> <td>VM1921A0</td> <td>INTERNAL GLASS CLOSING LEFT PLATE</td> <td>1.000</td> <td>PC</td> </tr> <tr> <td>VM2062A0</td> <td>L.Miss 46x33 RIGHT UPPER DOOR COLUMN CAP</td> <td>1.000</td> <td>PC</td> </tr> <tr> <td>VM2063A0</td> <td>L.Miss 46x33 LEFT UPPER DOOR COLUMN CAP</td> <td>1.000</td> <td>PC</td> </tr> <tr> <td>VM2064A0</td> <td>L.Miss 46x33 RIGHT LOWER DOOR COLUMN CAP</td> <td>1.000</td> <td>PC</td> </tr> </tbody> </table>	Code	Description	Qty	UOM	RC1200A0	ED=4 WIRE D.=0.5 COMPRESSIO N SPRING	2.000	PC	SL1050A1	3M TRANSFER ADHESIVE TAPE	0.820	M	TB2301A0	RIGHT COLUMN XVC105E 40x40x1	1.000	PC	TB3081A0	LMISS ARIANNA/ROS SELLA DOOR LEFT COLUMN	1.000	PC	VM1025A0	Ø16 GREY NYLON LID	2.000	PC	VM1695A0	HANDLE POSITION PIN	2.000	PC	VM1920A0	INTERNAL GLASS CLOSING RIGHT PLATE	1.000	PC	VM1921A0	INTERNAL GLASS CLOSING LEFT PLATE	1.000	PC	VM2062A0	L.Miss 46x33 RIGHT UPPER DOOR COLUMN CAP	1.000	PC	VM2063A0	L.Miss 46x33 LEFT UPPER DOOR COLUMN CAP	1.000	PC	VM2064A0	L.Miss 46x33 RIGHT LOWER DOOR COLUMN CAP	1.000	PC
Code	Description	Qty	UOM																																																		
RC1200A0	ED=4 WIRE D.=0.5 COMPRESSIO N SPRING	2.000	PC																																																		
SL1050A1	3M TRANSFER ADHESIVE TAPE	0.820	M																																																		
TB2301A0	RIGHT COLUMN XVC105E 40x40x1	1.000	PC																																																		
TB3081A0	LMISS ARIANNA/ROS SELLA DOOR LEFT COLUMN	1.000	PC																																																		
VM1025A0	Ø16 GREY NYLON LID	2.000	PC																																																		
VM1695A0	HANDLE POSITION PIN	2.000	PC																																																		
VM1920A0	INTERNAL GLASS CLOSING RIGHT PLATE	1.000	PC																																																		
VM1921A0	INTERNAL GLASS CLOSING LEFT PLATE	1.000	PC																																																		
VM2062A0	L.Miss 46x33 RIGHT UPPER DOOR COLUMN CAP	1.000	PC																																																		
VM2063A0	L.Miss 46x33 LEFT UPPER DOOR COLUMN CAP	1.000	PC																																																		
VM2064A0	L.Miss 46x33 RIGHT LOWER DOOR COLUMN CAP	1.000	PC																																																		



Зип Общепит
vsezip.ru

+7(812)987-08-81

COMPONENT			SPARE PART																																																			
Code	Description	Image	Code	Description	Kit components																																																	
VM2064A	L.Miss 46x33 RIGHT LOWER DOOR COLUMN CAP		KVT1062A	L.M. ARIANNA BLACK EXTERNAL GLASS KIT	<table border="1"> <thead> <tr> <th>Code</th> <th>Description</th> <th>Qty</th> <th>UOM</th> </tr> </thead> <tbody> <tr> <td>VM2065A0</td> <td>L.Miss 46x33 LEFT LOWER DOOR COLUMN CAP</td> <td>1.000</td> <td>PC</td> </tr> <tr> <td>VT1062A0</td> <td>LineMiss ARIANNA GREY EXTERNAL GLASS</td> <td>1.000</td> <td>PC</td> </tr> </tbody> </table>	Code	Description	Qty	UOM	VM2065A0	L.Miss 46x33 LEFT LOWER DOOR COLUMN CAP	1.000	PC	VT1062A0	LineMiss ARIANNA GREY EXTERNAL GLASS	1.000	PC																																					
			Code	Description	Qty	UOM																																																
VM2065A0	L.Miss 46x33 LEFT LOWER DOOR COLUMN CAP	1.000	PC																																																			
VT1062A0	LineMiss ARIANNA GREY EXTERNAL GLASS	1.000	PC																																																			
KVT1061A	LM ARIANNA EXTERNAL YELLOW GLASS KIT	<table border="1"> <thead> <tr> <th>Code</th> <th>Description</th> <th>Qty</th> <th>UOM</th> </tr> </thead> <tbody> <tr> <td>RC1200A0</td> <td>ED=4 WIRE D.=0.5 COMPRESSIO N SPRING</td> <td>2.000</td> <td>PC</td> </tr> <tr> <td>SL1050A1</td> <td>3M TRANSFER ADHESIVE TAPE</td> <td>0.820</td> <td>M</td> </tr> <tr> <td>TB2301A0</td> <td>RIGHT COLUMN XVC105E 40x40x1</td> <td>2.000</td> <td>PC</td> </tr> <tr> <td>VM1025A0</td> <td>Ø16 GREY NYLON LID</td> <td>2.000</td> <td>PC</td> </tr> <tr> <td>VM1695A0</td> <td>HANDLE POSITION PIN</td> <td>2.000</td> <td>PC</td> </tr> <tr> <td>VM1920A0</td> <td>INTERNAL GLASS CLOSING RIGHT PLATE</td> <td>1.000</td> <td>PC</td> </tr> <tr> <td>VM1921A0</td> <td>INTERNAL GLASS CLOSING LEFT PLATE</td> <td>1.000</td> <td>PC</td> </tr> <tr> <td>VM2062A0</td> <td>L.Miss 46x33 RIGHT UPPER DOOR COLUMN CAP</td> <td>1.000</td> <td>PC</td> </tr> <tr> <td>VM2063A0</td> <td>L.Miss 46x33 LEFT UPPER DOOR COLUMN CAP</td> <td>1.000</td> <td>PC</td> </tr> <tr> <td>VM2064A0</td> <td>L.Miss 46x33 RIGHT LOWER DOOR COLUMN CAP</td> <td>1.000</td> <td>PC</td> </tr> <tr> <td>VM2065A0</td> <td>L.Miss 46x33 LEFT LOWER DOOR COLUMN CAP</td> <td>1.000</td> <td>PC</td> </tr> <tr> <td>VT1061A2</td> <td>EXTERNAL YELLOW GLASS 598x424x5</td> <td>1.000</td> <td>PC</td> </tr> </tbody> </table>	Code	Description	Qty	UOM	RC1200A0	ED=4 WIRE D.=0.5 COMPRESSIO N SPRING	2.000	PC	SL1050A1	3M TRANSFER ADHESIVE TAPE	0.820	M	TB2301A0	RIGHT COLUMN XVC105E 40x40x1	2.000	PC	VM1025A0	Ø16 GREY NYLON LID	2.000	PC	VM1695A0	HANDLE POSITION PIN	2.000	PC	VM1920A0	INTERNAL GLASS CLOSING RIGHT PLATE	1.000	PC	VM1921A0	INTERNAL GLASS CLOSING LEFT PLATE	1.000	PC	VM2062A0	L.Miss 46x33 RIGHT UPPER DOOR COLUMN CAP	1.000	PC	VM2063A0	L.Miss 46x33 LEFT UPPER DOOR COLUMN CAP	1.000	PC	VM2064A0	L.Miss 46x33 RIGHT LOWER DOOR COLUMN CAP	1.000	PC	VM2065A0	L.Miss 46x33 LEFT LOWER DOOR COLUMN CAP	1.000	PC	VT1061A2	EXTERNAL YELLOW GLASS 598x424x5	1.000	PC
Code	Description	Qty	UOM																																																			
RC1200A0	ED=4 WIRE D.=0.5 COMPRESSIO N SPRING	2.000	PC																																																			
SL1050A1	3M TRANSFER ADHESIVE TAPE	0.820	M																																																			
TB2301A0	RIGHT COLUMN XVC105E 40x40x1	2.000	PC																																																			
VM1025A0	Ø16 GREY NYLON LID	2.000	PC																																																			
VM1695A0	HANDLE POSITION PIN	2.000	PC																																																			
VM1920A0	INTERNAL GLASS CLOSING RIGHT PLATE	1.000	PC																																																			
VM1921A0	INTERNAL GLASS CLOSING LEFT PLATE	1.000	PC																																																			
VM2062A0	L.Miss 46x33 RIGHT UPPER DOOR COLUMN CAP	1.000	PC																																																			
VM2063A0	L.Miss 46x33 LEFT UPPER DOOR COLUMN CAP	1.000	PC																																																			
VM2064A0	L.Miss 46x33 RIGHT LOWER DOOR COLUMN CAP	1.000	PC																																																			
VM2065A0	L.Miss 46x33 LEFT LOWER DOOR COLUMN CAP	1.000	PC																																																			
VT1061A2	EXTERNAL YELLOW GLASS 598x424x5	1.000	PC																																																			



Зип Общепит
vsezip.ru

+7(812)987-08-81

COMPONENT			SPARE PART																																																																					
Code	Description	Image	Code	Description	Kit components																																																																			
VM2064A	L.Miss 46x33 RIGHT LOWER DOOR COLUMN CAP		KVT1057A	LM STEFANIA BLACK EXTERNAL GLASS KIT	<table border="1"> <thead> <tr> <th>Code</th> <th>Description</th> <th>Qty</th> <th>UOM</th> </tr> </thead> <tbody> <tr> <td>RC1200A0</td> <td>ED=4 WIRE D.=0.5 COMPRESSIO N SPRING</td> <td>2.000</td> <td>PC</td> </tr> <tr> <td>SL1050A1</td> <td>3M TRANSFER ADHESIVE TAPE</td> <td>0.660</td> <td>M</td> </tr> <tr> <td>TB2306A0</td> <td>L.Miss Stefania/Elena DOOR RIGHT COLUMN</td> <td>1.000</td> <td>PC</td> </tr> <tr> <td>TB3080A0</td> <td>L.MISS STEFANIA/ELE NA DOOR LEFT COLUMN</td> <td>1.000</td> <td>PC</td> </tr> <tr> <td>VM1025A0</td> <td>Ø16 GREY NYLON LID</td> <td>2.000</td> <td>PC</td> </tr> <tr> <td>VM1695A0</td> <td>HANDLE POSITION PIN</td> <td>2.000</td> <td>PC</td> </tr> <tr> <td>VM1920A0</td> <td>INTERNAL GLASS CLOSING RIGHT PLATE</td> <td>1.000</td> <td>PC</td> </tr> <tr> <td>VM1921A0</td> <td>INTERNAL GLASS CLOSING LEFT PLATE</td> <td>1.000</td> <td>PC</td> </tr> <tr> <td>VM2062A0</td> <td>L.Miss 46x33 RIGHT UPPER DOOR COLUMN CAP</td> <td>1.000</td> <td>PC</td> </tr> <tr> <td>VM2063A0</td> <td>L.Miss 46x33 LEFT UPPER DOOR COLUMN CAP</td> <td>1.000</td> <td>PC</td> </tr> <tr> <td>VM2064A0</td> <td>L.Miss 46x33 RIGHT LOWER DOOR COLUMN CAP</td> <td>1.000</td> <td>PC</td> </tr> <tr> <td>VM2065A0</td> <td>L.Miss 46x33 LEFT LOWER DOOR COLUMN CAP</td> <td>1.000</td> <td>PC</td> </tr> <tr> <td>VT1057A0</td> <td>L.MISS STEFANIA EXTERNAL GLASS 598x344x5</td> <td>1.000</td> <td>PC</td> </tr> </tbody> </table>	Code	Description	Qty	UOM	RC1200A0	ED=4 WIRE D.=0.5 COMPRESSIO N SPRING	2.000	PC	SL1050A1	3M TRANSFER ADHESIVE TAPE	0.660	M	TB2306A0	L.Miss Stefania/Elena DOOR RIGHT COLUMN	1.000	PC	TB3080A0	L.MISS STEFANIA/ELE NA DOOR LEFT COLUMN	1.000	PC	VM1025A0	Ø16 GREY NYLON LID	2.000	PC	VM1695A0	HANDLE POSITION PIN	2.000	PC	VM1920A0	INTERNAL GLASS CLOSING RIGHT PLATE	1.000	PC	VM1921A0	INTERNAL GLASS CLOSING LEFT PLATE	1.000	PC	VM2062A0	L.Miss 46x33 RIGHT UPPER DOOR COLUMN CAP	1.000	PC	VM2063A0	L.Miss 46x33 LEFT UPPER DOOR COLUMN CAP	1.000	PC	VM2064A0	L.Miss 46x33 RIGHT LOWER DOOR COLUMN CAP	1.000	PC	VM2065A0	L.Miss 46x33 LEFT LOWER DOOR COLUMN CAP	1.000	PC	VT1057A0	L.MISS STEFANIA EXTERNAL GLASS 598x344x5	1.000	PC	KVT1056A	LM STEFANIA YELLOW EXTERNAL GLASS KIT	<table border="1"> <thead> <tr> <th>Code</th> <th>Description</th> <th>Qty</th> <th>UOM</th> </tr> </thead> <tbody> <tr> <td>RC1200A0</td> <td>ED=4 WIRE D.=0.5 COMPRESSIO N SPRING</td> <td>2.000</td> <td>PC</td> </tr> </tbody> </table>	Code	Description	Qty	UOM	RC1200A0	ED=4 WIRE D.=0.5 COMPRESSIO N SPRING	2.000	PC
			Code	Description	Qty	UOM																																																																		
RC1200A0	ED=4 WIRE D.=0.5 COMPRESSIO N SPRING	2.000	PC																																																																					
SL1050A1	3M TRANSFER ADHESIVE TAPE	0.660	M																																																																					
TB2306A0	L.Miss Stefania/Elena DOOR RIGHT COLUMN	1.000	PC																																																																					
TB3080A0	L.MISS STEFANIA/ELE NA DOOR LEFT COLUMN	1.000	PC																																																																					
VM1025A0	Ø16 GREY NYLON LID	2.000	PC																																																																					
VM1695A0	HANDLE POSITION PIN	2.000	PC																																																																					
VM1920A0	INTERNAL GLASS CLOSING RIGHT PLATE	1.000	PC																																																																					
VM1921A0	INTERNAL GLASS CLOSING LEFT PLATE	1.000	PC																																																																					
VM2062A0	L.Miss 46x33 RIGHT UPPER DOOR COLUMN CAP	1.000	PC																																																																					
VM2063A0	L.Miss 46x33 LEFT UPPER DOOR COLUMN CAP	1.000	PC																																																																					
VM2064A0	L.Miss 46x33 RIGHT LOWER DOOR COLUMN CAP	1.000	PC																																																																					
VM2065A0	L.Miss 46x33 LEFT LOWER DOOR COLUMN CAP	1.000	PC																																																																					
VT1057A0	L.MISS STEFANIA EXTERNAL GLASS 598x344x5	1.000	PC																																																																					
Code	Description	Qty	UOM																																																																					
RC1200A0	ED=4 WIRE D.=0.5 COMPRESSIO N SPRING	2.000	PC																																																																					



Зип Общепит
vsezip.ru

+7(812)987-08-81

COMPONENT			SPARE PART																																																																													
Code	Description	Image	Code	Description	Kit components																																																																											
VM2064A	L.Miss 46x33 RIGHT LOWER DOOR COLUMN CAP		KVT1056A	LM STEFANIA YELLOW EXTERNAL GLASS KIT	<table border="1"> <thead> <tr> <th>Code</th> <th>Description</th> <th>Qty</th> <th>UOM</th> </tr> </thead> <tbody> <tr> <td>SL1050A1</td> <td>3M TRANSFER ADHESIVE TAPE</td> <td>0.660</td> <td>M</td> </tr> <tr> <td>TB2306A0</td> <td>L.Miss Stefania/Elena DOOR RIGHT COLUMN</td> <td>2.000</td> <td>PC</td> </tr> <tr> <td>VM1025A0</td> <td>Ø16 GREY NYLON LID</td> <td>2.000</td> <td>PC</td> </tr> <tr> <td>VM1695A0</td> <td>HANDLE POSITION PIN</td> <td>2.000</td> <td>PC</td> </tr> <tr> <td>VM1920A0</td> <td>INTERNAL GLASS CLOSING RIGHT PLATE</td> <td>1.000</td> <td>PC</td> </tr> <tr> <td>VM1921A0</td> <td>INTERNAL GLASS CLOSING LEFT PLATE</td> <td>1.000</td> <td>PC</td> </tr> <tr> <td>VM2062A0</td> <td>L.Miss 46x33 RIGHT UPPER DOOR COLUMN CAP</td> <td>1.000</td> <td>PC</td> </tr> <tr> <td>VM2063A0</td> <td>L.Miss 46x33 LEFT UPPER DOOR COLUMN CAP</td> <td>1.000</td> <td>PC</td> </tr> <tr> <td>VM2064A0</td> <td>L.Miss 46x33 RIGHT LOWER DOOR COLUMN CAP</td> <td>1.000</td> <td>PC</td> </tr> <tr> <td>VM2065A0</td> <td>L.Miss 46x33 LEFT LOWER DOOR COLUMN CAP</td> <td>1.000</td> <td>PC</td> </tr> <tr> <td>VT1056A2</td> <td>YELLOW SER GLASS 598X344X5</td> <td>1.000</td> <td>PC</td> </tr> </tbody> </table>	Code	Description	Qty	UOM	SL1050A1	3M TRANSFER ADHESIVE TAPE	0.660	M	TB2306A0	L.Miss Stefania/Elena DOOR RIGHT COLUMN	2.000	PC	VM1025A0	Ø16 GREY NYLON LID	2.000	PC	VM1695A0	HANDLE POSITION PIN	2.000	PC	VM1920A0	INTERNAL GLASS CLOSING RIGHT PLATE	1.000	PC	VM1921A0	INTERNAL GLASS CLOSING LEFT PLATE	1.000	PC	VM2062A0	L.Miss 46x33 RIGHT UPPER DOOR COLUMN CAP	1.000	PC	VM2063A0	L.Miss 46x33 LEFT UPPER DOOR COLUMN CAP	1.000	PC	VM2064A0	L.Miss 46x33 RIGHT LOWER DOOR COLUMN CAP	1.000	PC	VM2065A0	L.Miss 46x33 LEFT LOWER DOOR COLUMN CAP	1.000	PC	VT1056A2	YELLOW SER GLASS 598X344X5	1.000	PC	KVT1052A	LM CRISTINA BLACK EXTERNAL GLASS KIT	<table border="1"> <thead> <tr> <th>Code</th> <th>Description</th> <th>Qty</th> <th>UOM</th> </tr> </thead> <tbody> <tr> <td>RC1200A0</td> <td>ED=4 WIRE D.=0.5 COMPRESSIO N SPRING</td> <td>2.000</td> <td>PC</td> </tr> <tr> <td>SL1050A1</td> <td>3M TRANSFER ADHESIVE TAPE</td> <td>0.660</td> <td>M</td> </tr> <tr> <td>TB2306A0</td> <td>L.Miss Stefania/Elena DOOR RIGHT COLUMN</td> <td>2.000</td> <td>PC</td> </tr> <tr> <td>VM1025A0</td> <td>Ø16 GREY NYLON LID</td> <td>2.000</td> <td>PC</td> </tr> <tr> <td>VM1695A0</td> <td>HANDLE POSITION PIN</td> <td>2.000</td> <td>PC</td> </tr> </tbody> </table>	Code	Description	Qty	UOM	RC1200A0	ED=4 WIRE D.=0.5 COMPRESSIO N SPRING	2.000	PC	SL1050A1	3M TRANSFER ADHESIVE TAPE	0.660	M	TB2306A0	L.Miss Stefania/Elena DOOR RIGHT COLUMN	2.000	PC	VM1025A0	Ø16 GREY NYLON LID	2.000	PC	VM1695A0	HANDLE POSITION PIN	2.000	PC
			Code	Description	Qty	UOM																																																																										
SL1050A1	3M TRANSFER ADHESIVE TAPE	0.660	M																																																																													
TB2306A0	L.Miss Stefania/Elena DOOR RIGHT COLUMN	2.000	PC																																																																													
VM1025A0	Ø16 GREY NYLON LID	2.000	PC																																																																													
VM1695A0	HANDLE POSITION PIN	2.000	PC																																																																													
VM1920A0	INTERNAL GLASS CLOSING RIGHT PLATE	1.000	PC																																																																													
VM1921A0	INTERNAL GLASS CLOSING LEFT PLATE	1.000	PC																																																																													
VM2062A0	L.Miss 46x33 RIGHT UPPER DOOR COLUMN CAP	1.000	PC																																																																													
VM2063A0	L.Miss 46x33 LEFT UPPER DOOR COLUMN CAP	1.000	PC																																																																													
VM2064A0	L.Miss 46x33 RIGHT LOWER DOOR COLUMN CAP	1.000	PC																																																																													
VM2065A0	L.Miss 46x33 LEFT LOWER DOOR COLUMN CAP	1.000	PC																																																																													
VT1056A2	YELLOW SER GLASS 598X344X5	1.000	PC																																																																													
Code	Description	Qty	UOM																																																																													
RC1200A0	ED=4 WIRE D.=0.5 COMPRESSIO N SPRING	2.000	PC																																																																													
SL1050A1	3M TRANSFER ADHESIVE TAPE	0.660	M																																																																													
TB2306A0	L.Miss Stefania/Elena DOOR RIGHT COLUMN	2.000	PC																																																																													
VM1025A0	Ø16 GREY NYLON LID	2.000	PC																																																																													
VM1695A0	HANDLE POSITION PIN	2.000	PC																																																																													



Зип Общепит
vsezip.ru



+7(812)987-08-81

COMPONENT			SPARE PART																																		
Code	Description	Image	Code	Description	Kit components																																
VM2064A	L.Miss 46x33 RIGHT LOWER DOOR COLUMN CAP		KVT1052A	LM CRISTINA BLACK EXTERNAL GLASS KIT	<table border="1"> <thead> <tr> <th>Code</th> <th>Description</th> <th>Qty</th> <th>UOM</th> </tr> </thead> <tbody> <tr> <td>VM1920A0</td> <td>INTERNAL GLASS CLOSING RIGHT PLATE</td> <td>1.000</td> <td>PC</td> </tr> <tr> <td>VM1921A0</td> <td>INTERNAL GLASS CLOSING LEFT PLATE</td> <td>1.000</td> <td>PC</td> </tr> <tr> <td>VM2062A0</td> <td>L.Miss 46x33 RIGHT UPPER DOOR COLUMN CAP</td> <td>1.000</td> <td>PC</td> </tr> <tr> <td>VM2063A0</td> <td>L.Miss 46x33 LEFT UPPER DOOR COLUMN CAP</td> <td>1.000</td> <td>PC</td> </tr> <tr> <td>VM2064A0</td> <td>L.Miss 46x33 RIGHT LOWER DOOR COLUMN CAP</td> <td>1.000</td> <td>PC</td> </tr> <tr> <td>VM2065A0</td> <td>L.Miss 46x33 LEFT LOWER DOOR COLUMN CAP</td> <td>1.000</td> <td>PC</td> </tr> <tr> <td>VT1052A0</td> <td>478X344X5 EXTERNAL GLASS</td> <td>1.000</td> <td>PC</td> </tr> </tbody> </table>	Code	Description	Qty	UOM	VM1920A0	INTERNAL GLASS CLOSING RIGHT PLATE	1.000	PC	VM1921A0	INTERNAL GLASS CLOSING LEFT PLATE	1.000	PC	VM2062A0	L.Miss 46x33 RIGHT UPPER DOOR COLUMN CAP	1.000	PC	VM2063A0	L.Miss 46x33 LEFT UPPER DOOR COLUMN CAP	1.000	PC	VM2064A0	L.Miss 46x33 RIGHT LOWER DOOR COLUMN CAP	1.000	PC	VM2065A0	L.Miss 46x33 LEFT LOWER DOOR COLUMN CAP	1.000	PC	VT1052A0	478X344X5 EXTERNAL GLASS	1.000	PC
			Code	Description	Qty	UOM																															
VM1920A0	INTERNAL GLASS CLOSING RIGHT PLATE	1.000	PC																																		
VM1921A0	INTERNAL GLASS CLOSING LEFT PLATE	1.000	PC																																		
VM2062A0	L.Miss 46x33 RIGHT UPPER DOOR COLUMN CAP	1.000	PC																																		
VM2063A0	L.Miss 46x33 LEFT UPPER DOOR COLUMN CAP	1.000	PC																																		
VM2064A0	L.Miss 46x33 RIGHT LOWER DOOR COLUMN CAP	1.000	PC																																		
VM2065A0	L.Miss 46x33 LEFT LOWER DOOR COLUMN CAP	1.000	PC																																		
VT1052A0	478X344X5 EXTERNAL GLASS	1.000	PC																																		
KVT1051A	LM CRISTINA YELLOW EXTERNAL GLASS KIT	<table border="1"> <thead> <tr> <th>Code</th> <th>Description</th> <th>Qty</th> <th>UOM</th> </tr> </thead> <tbody> <tr> <td>RC1200A0</td> <td>ED=4 WIRE D.=0.5 COMPRESSIO N SPRING</td> <td>2.000</td> <td>PC</td> </tr> <tr> <td>SL1050A1</td> <td>3M TRANSFER ADHESIVE TAPE</td> <td>0.660</td> <td>M</td> </tr> <tr> <td>TB2306A0</td> <td>L.Miss Stefania/Elena DOOR RIGHT COLUMN</td> <td>2.000</td> <td>PC</td> </tr> <tr> <td>VM1025A0</td> <td>Ø16 GREY NYLON LID</td> <td>2.000</td> <td>PC</td> </tr> <tr> <td>VM1695A0</td> <td>HANDLE POSITION PIN</td> <td>2.000</td> <td>PC</td> </tr> <tr> <td>VM1920A0</td> <td>INTERNAL GLASS CLOSING RIGHT PLATE</td> <td>1.000</td> <td>PC</td> </tr> <tr> <td>VM1921A0</td> <td>INTERNAL GLASS CLOSING LEFT PLATE</td> <td>1.000</td> <td>PC</td> </tr> </tbody> </table>	Code	Description	Qty	UOM	RC1200A0	ED=4 WIRE D.=0.5 COMPRESSIO N SPRING	2.000	PC	SL1050A1	3M TRANSFER ADHESIVE TAPE	0.660	M	TB2306A0	L.Miss Stefania/Elena DOOR RIGHT COLUMN	2.000	PC	VM1025A0	Ø16 GREY NYLON LID	2.000	PC	VM1695A0	HANDLE POSITION PIN	2.000	PC	VM1920A0	INTERNAL GLASS CLOSING RIGHT PLATE	1.000	PC	VM1921A0	INTERNAL GLASS CLOSING LEFT PLATE	1.000	PC			
Code	Description	Qty	UOM																																		
RC1200A0	ED=4 WIRE D.=0.5 COMPRESSIO N SPRING	2.000	PC																																		
SL1050A1	3M TRANSFER ADHESIVE TAPE	0.660	M																																		
TB2306A0	L.Miss Stefania/Elena DOOR RIGHT COLUMN	2.000	PC																																		
VM1025A0	Ø16 GREY NYLON LID	2.000	PC																																		
VM1695A0	HANDLE POSITION PIN	2.000	PC																																		
VM1920A0	INTERNAL GLASS CLOSING RIGHT PLATE	1.000	PC																																		
VM1921A0	INTERNAL GLASS CLOSING LEFT PLATE	1.000	PC																																		



Зип Общепит
vsezip.ru

+7(812)987-08-81

COMPONENT			SPARE PART																																														
Code	Description	Image	Code	Description	Kit components																																												
VM2064A	L.Miss 46x33 RIGHT LOWER DOOR COLUMN CAP		KVT1051A	LM CRISTINA YELLOW EXTERNAL GLASS KIT	<table border="1"> <thead> <tr> <th>Code</th> <th>Description</th> <th>Qty</th> <th>UOM</th> </tr> </thead> <tbody> <tr> <td>VM2062A0</td> <td>L.Miss 46x33 RIGHT UPPER DOOR COLUMN CAP</td> <td>1.000</td> <td>PC</td> </tr> <tr> <td>VM2063A0</td> <td>L.Miss 46x33 LEFT UPPER DOOR COLUMN CAP</td> <td>1.000</td> <td>PC</td> </tr> <tr> <td>VM2064A0</td> <td>L.Miss 46x33 RIGHT LOWER DOOR COLUMN CAP</td> <td>1.000</td> <td>PC</td> </tr> <tr> <td>VM2065A0</td> <td>L.Miss 46x33 LEFT LOWER DOOR COLUMN CAP</td> <td>1.000</td> <td>PC</td> </tr> <tr> <td>VT1051A2</td> <td>YELLOW SER GLASS 478X344X5</td> <td>1.000</td> <td>PC</td> </tr> </tbody> </table>	Code	Description	Qty	UOM	VM2062A0	L.Miss 46x33 RIGHT UPPER DOOR COLUMN CAP	1.000	PC	VM2063A0	L.Miss 46x33 LEFT UPPER DOOR COLUMN CAP	1.000	PC	VM2064A0	L.Miss 46x33 RIGHT LOWER DOOR COLUMN CAP	1.000	PC	VM2065A0	L.Miss 46x33 LEFT LOWER DOOR COLUMN CAP	1.000	PC	VT1051A2	YELLOW SER GLASS 478X344X5	1.000	PC																				
					Code	Description	Qty	UOM																																									
VM2062A0	L.Miss 46x33 RIGHT UPPER DOOR COLUMN CAP	1.000	PC																																														
VM2063A0	L.Miss 46x33 LEFT UPPER DOOR COLUMN CAP	1.000	PC																																														
VM2064A0	L.Miss 46x33 RIGHT LOWER DOOR COLUMN CAP	1.000	PC																																														
VM2065A0	L.Miss 46x33 LEFT LOWER DOOR COLUMN CAP	1.000	PC																																														
VT1051A2	YELLOW SER GLASS 478X344X5	1.000	PC																																														
VM2065A	L.Miss 46x33 LEFT LOWER DOOR COLUMN CAP		KVT1252A	XF135-EG- VT1252A EXTERNAL GLASS KIT	<table border="1"> <thead> <tr> <th>Code</th> <th>Description</th> <th>Qty</th> <th>UOM</th> </tr> </thead> <tbody> <tr> <td>RC1200A0</td> <td>ED=4 WIRE D.=0.5 COMPRESSIO N SPRING</td> <td>2.000</td> <td>PC</td> </tr> <tr> <td>SL1050A1</td> <td>3M TRANSFER ADHESIVE TAPE</td> <td>0.820</td> <td>M</td> </tr> <tr> <td>TB2301A0</td> <td>RIGHT COLUMN XVC105E 40x40x1</td> <td>1.000</td> <td>PC</td> </tr> <tr> <td>TB3081A0</td> <td>LMISS ARIANNA/ROS SELLA DOOR LEFT COLUMN</td> <td>1.000</td> <td>PC</td> </tr> <tr> <td>VM1025A0</td> <td>Ø16 GREY NYLON LID</td> <td>2.000</td> <td>PC</td> </tr> <tr> <td>VM1695A0</td> <td>HANDLE POSITION PIN</td> <td>2.000</td> <td>PC</td> </tr> <tr> <td>VM1920A0</td> <td>INTERNAL GLASS CLOSING RIGHT PLATE</td> <td>1.000</td> <td>PC</td> </tr> <tr> <td>VM1921A0</td> <td>INTERNAL GLASS CLOSING LEFT PLATE</td> <td>1.000</td> <td>PC</td> </tr> <tr> <td>VM2062A0</td> <td>L.Miss 46x33 RIGHT UPPER DOOR COLUMN CAP</td> <td>1.000</td> <td>PC</td> </tr> <tr> <td>VM2063A0</td> <td>L.Miss 46x33 LEFT UPPER DOOR COLUMN CAP</td> <td>1.000</td> <td>PC</td> </tr> </tbody> </table>	Code	Description	Qty	UOM	RC1200A0	ED=4 WIRE D.=0.5 COMPRESSIO N SPRING	2.000	PC	SL1050A1	3M TRANSFER ADHESIVE TAPE	0.820	M	TB2301A0	RIGHT COLUMN XVC105E 40x40x1	1.000	PC	TB3081A0	LMISS ARIANNA/ROS SELLA DOOR LEFT COLUMN	1.000	PC	VM1025A0	Ø16 GREY NYLON LID	2.000	PC	VM1695A0	HANDLE POSITION PIN	2.000	PC	VM1920A0	INTERNAL GLASS CLOSING RIGHT PLATE	1.000	PC	VM1921A0	INTERNAL GLASS CLOSING LEFT PLATE	1.000	PC	VM2062A0	L.Miss 46x33 RIGHT UPPER DOOR COLUMN CAP	1.000	PC	VM2063A0	L.Miss 46x33 LEFT UPPER DOOR COLUMN CAP	1.000	PC
					Code	Description	Qty	UOM																																									
					RC1200A0	ED=4 WIRE D.=0.5 COMPRESSIO N SPRING	2.000	PC																																									
					SL1050A1	3M TRANSFER ADHESIVE TAPE	0.820	M																																									
					TB2301A0	RIGHT COLUMN XVC105E 40x40x1	1.000	PC																																									
					TB3081A0	LMISS ARIANNA/ROS SELLA DOOR LEFT COLUMN	1.000	PC																																									
					VM1025A0	Ø16 GREY NYLON LID	2.000	PC																																									
					VM1695A0	HANDLE POSITION PIN	2.000	PC																																									
					VM1920A0	INTERNAL GLASS CLOSING RIGHT PLATE	1.000	PC																																									
					VM1921A0	INTERNAL GLASS CLOSING LEFT PLATE	1.000	PC																																									
					VM2062A0	L.Miss 46x33 RIGHT UPPER DOOR COLUMN CAP	1.000	PC																																									
					VM2063A0	L.Miss 46x33 LEFT UPPER DOOR COLUMN CAP	1.000	PC																																									



+7(812)987-08-81

COMPONENT			SPARE PART																																																						
Code	Description	Image	Code	Description	Kit components																																																				
VM2065A	L.Miss 46x33 LEFT LOWER DOOR COLUMN CAP		KVT1252A	XF135-EG- VT1252A EXTERNAL GLASS KIT	<table border="1"> <thead> <tr> <th>Code</th> <th>Description</th> <th>Qty</th> <th>UOM</th> </tr> </thead> <tbody> <tr> <td>VM2064A0</td> <td>L.Miss 46x33 RIGHT LOWER DOOR COLUMN CAP</td> <td>1.000</td> <td>PC</td> </tr> <tr> <td>VM2065A0</td> <td>L.Miss 46x33 LEFT LOWER DOOR COLUMN CAP</td> <td>1.000</td> <td>PC</td> </tr> <tr> <td>VT1252A0</td> <td>XFT135 DOOR EXT. BLACK GLASS - ENGEFOOD</td> <td>1.000</td> <td>PC</td> </tr> </tbody> </table>	Code	Description	Qty	UOM	VM2064A0	L.Miss 46x33 RIGHT LOWER DOOR COLUMN CAP	1.000	PC	VM2065A0	L.Miss 46x33 LEFT LOWER DOOR COLUMN CAP	1.000	PC	VT1252A0	XFT135 DOOR EXT. BLACK GLASS - ENGEFOOD	1.000	PC																																				
Code	Description	Qty	UOM																																																						
VM2064A0	L.Miss 46x33 RIGHT LOWER DOOR COLUMN CAP	1.000	PC																																																						
VM2065A0	L.Miss 46x33 LEFT LOWER DOOR COLUMN CAP	1.000	PC																																																						
VT1252A0	XFT135 DOOR EXT. BLACK GLASS - ENGEFOOD	1.000	PC																																																						
			KVT1063A	L.MISS ARIANNA FORNETTI EXT. GLASS KIT	<table border="1"> <thead> <tr> <th>Code</th> <th>Description</th> <th>Qty</th> <th>UOM</th> </tr> </thead> <tbody> <tr> <td>MS1009A0</td> <td>FORNETTI LOGO LABEL</td> <td>1.000</td> <td>PC</td> </tr> <tr> <td>RC1200A0</td> <td>ED=4 WIRE D.=0.5 COMPRESSIO N SPRING</td> <td>2.000</td> <td>PC</td> </tr> <tr> <td>SL1050A1</td> <td>3M TRANSFER ADHESIVE TAPE</td> <td>0.820</td> <td>M</td> </tr> <tr> <td>TB2301A0</td> <td>RIGHT COLUMN XVC105E 40x40x1</td> <td>1.000</td> <td>PC</td> </tr> <tr> <td>TB3081A0</td> <td>LMISS ARIANNA/ROS SELLA DOOR LEFT COLUMN</td> <td>1.000</td> <td>PC</td> </tr> <tr> <td>VM1025A0</td> <td>Ø16 GREY NYLON LID</td> <td>2.000</td> <td>PC</td> </tr> <tr> <td>VM1695A0</td> <td>HANDLE POSITION PIN</td> <td>2.000</td> <td>PC</td> </tr> <tr> <td>VM1920A0</td> <td>INTERNAL GLASS CLOSING RIGHT PLATE</td> <td>1.000</td> <td>PC</td> </tr> <tr> <td>VM1921A0</td> <td>INTERNAL GLASS CLOSING LEFT PLATE</td> <td>1.000</td> <td>PC</td> </tr> <tr> <td>VM2062A0</td> <td>L.Miss 46x33 RIGHT UPPER DOOR COLUMN CAP</td> <td>1.000</td> <td>PC</td> </tr> <tr> <td>VM2063A0</td> <td>L.Miss 46x33 LEFT UPPER DOOR COLUMN CAP</td> <td>1.000</td> <td>PC</td> </tr> <tr> <td>VM2064A0</td> <td>L.Miss 46x33 RIGHT LOWER DOOR COLUMN CAP</td> <td>1.000</td> <td>PC</td> </tr> </tbody> </table>	Code	Description	Qty	UOM	MS1009A0	FORNETTI LOGO LABEL	1.000	PC	RC1200A0	ED=4 WIRE D.=0.5 COMPRESSIO N SPRING	2.000	PC	SL1050A1	3M TRANSFER ADHESIVE TAPE	0.820	M	TB2301A0	RIGHT COLUMN XVC105E 40x40x1	1.000	PC	TB3081A0	LMISS ARIANNA/ROS SELLA DOOR LEFT COLUMN	1.000	PC	VM1025A0	Ø16 GREY NYLON LID	2.000	PC	VM1695A0	HANDLE POSITION PIN	2.000	PC	VM1920A0	INTERNAL GLASS CLOSING RIGHT PLATE	1.000	PC	VM1921A0	INTERNAL GLASS CLOSING LEFT PLATE	1.000	PC	VM2062A0	L.Miss 46x33 RIGHT UPPER DOOR COLUMN CAP	1.000	PC	VM2063A0	L.Miss 46x33 LEFT UPPER DOOR COLUMN CAP	1.000	PC	VM2064A0	L.Miss 46x33 RIGHT LOWER DOOR COLUMN CAP	1.000	PC
Code	Description	Qty	UOM																																																						
MS1009A0	FORNETTI LOGO LABEL	1.000	PC																																																						
RC1200A0	ED=4 WIRE D.=0.5 COMPRESSIO N SPRING	2.000	PC																																																						
SL1050A1	3M TRANSFER ADHESIVE TAPE	0.820	M																																																						
TB2301A0	RIGHT COLUMN XVC105E 40x40x1	1.000	PC																																																						
TB3081A0	LMISS ARIANNA/ROS SELLA DOOR LEFT COLUMN	1.000	PC																																																						
VM1025A0	Ø16 GREY NYLON LID	2.000	PC																																																						
VM1695A0	HANDLE POSITION PIN	2.000	PC																																																						
VM1920A0	INTERNAL GLASS CLOSING RIGHT PLATE	1.000	PC																																																						
VM1921A0	INTERNAL GLASS CLOSING LEFT PLATE	1.000	PC																																																						
VM2062A0	L.Miss 46x33 RIGHT UPPER DOOR COLUMN CAP	1.000	PC																																																						
VM2063A0	L.Miss 46x33 LEFT UPPER DOOR COLUMN CAP	1.000	PC																																																						
VM2064A0	L.Miss 46x33 RIGHT LOWER DOOR COLUMN CAP	1.000	PC																																																						



Зип Общепит
vsezip.ru

+7(812)987-08-81

COMPONENT			SPARE PART																																																							
Code	Description	Image	Code	Description	Kit components																																																					
VM2065A	L.Miss 46x33 LEFT LOWER DOOR COLUMN CAP		KVT1063A	L.MISS ARIANNA FORNETTI EXT. GLASS KIT	<table border="1"> <thead> <tr> <th>Code</th> <th>Description</th> <th>Qty</th> <th>UOM</th> </tr> </thead> <tbody> <tr> <td>VM2065A0</td> <td>L.Miss 46x33 LEFT LOWER DOOR COLUMN CAP</td> <td>1.000</td> <td>PC</td> </tr> <tr> <td>VT1063A0</td> <td>XF135F EXTERNAL GLASS 598x42</td> <td>1.000</td> <td>PC</td> </tr> </tbody> </table>	Code	Description	Qty	UOM	VM2065A0	L.Miss 46x33 LEFT LOWER DOOR COLUMN CAP	1.000	PC	VT1063A0	XF135F EXTERNAL GLASS 598x42	1.000	PC																																									
			Code	Description	Qty	UOM																																																				
VM2065A0	L.Miss 46x33 LEFT LOWER DOOR COLUMN CAP	1.000	PC																																																							
VT1063A0	XF135F EXTERNAL GLASS 598x42	1.000	PC																																																							
KVT1062A	L.M. ARIANNA BLACK EXTERNAL GLASS KIT	<table border="1"> <thead> <tr> <th>Code</th> <th>Description</th> <th>Qty</th> <th>UOM</th> </tr> </thead> <tbody> <tr> <td>RC1200A0</td> <td>ED=4 WIRE D.=0.5 COMPRESSIO N SPRING</td> <td>2.000</td> <td>PC</td> </tr> <tr> <td>SL1050A1</td> <td>3M TRANSFER ADHESIVE TAPE</td> <td>0.820</td> <td>M</td> </tr> <tr> <td>TB2301A0</td> <td>RIGHT COLUMN XVC105E 40x40x1</td> <td>1.000</td> <td>PC</td> </tr> <tr> <td>TB3081A0</td> <td>LMISS ARIANNA/ROS SELLA DOOR LEFT COLUMN</td> <td>1.000</td> <td>PC</td> </tr> <tr> <td>VM1025A0</td> <td>Ø16 GREY NYLON LID</td> <td>2.000</td> <td>PC</td> </tr> <tr> <td>VM1695A0</td> <td>HANDLE POSITION PIN</td> <td>2.000</td> <td>PC</td> </tr> <tr> <td>VM1920A0</td> <td>INTERNAL GLASS CLOSING RIGHT PLATE</td> <td>1.000</td> <td>PC</td> </tr> <tr> <td>VM1921A0</td> <td>INTERNAL GLASS CLOSING LEFT PLATE</td> <td>1.000</td> <td>PC</td> </tr> <tr> <td>VM2062A0</td> <td>L.Miss 46x33 RIGHT UPPER DOOR COLUMN CAP</td> <td>1.000</td> <td>PC</td> </tr> <tr> <td>VM2063A0</td> <td>L.Miss 46x33 LEFT UPPER DOOR COLUMN CAP</td> <td>1.000</td> <td>PC</td> </tr> <tr> <td>VM2064A0</td> <td>L.Miss 46x33 RIGHT LOWER DOOR COLUMN CAP</td> <td>1.000</td> <td>PC</td> </tr> <tr> <td>VM2065A0</td> <td>L.Miss 46x33 LEFT LOWER DOOR COLUMN CAP</td> <td>1.000</td> <td>PC</td> </tr> <tr> <td>VT1062A0</td> <td>LineMiss ARIANNA GREY EXTERNAL GLASS</td> <td>1.000</td> <td>PC</td> </tr> </tbody> </table>	Code	Description	Qty	UOM	RC1200A0	ED=4 WIRE D.=0.5 COMPRESSIO N SPRING	2.000	PC	SL1050A1	3M TRANSFER ADHESIVE TAPE	0.820	M	TB2301A0	RIGHT COLUMN XVC105E 40x40x1	1.000	PC	TB3081A0	LMISS ARIANNA/ROS SELLA DOOR LEFT COLUMN	1.000	PC	VM1025A0	Ø16 GREY NYLON LID	2.000	PC	VM1695A0	HANDLE POSITION PIN	2.000	PC	VM1920A0	INTERNAL GLASS CLOSING RIGHT PLATE	1.000	PC	VM1921A0	INTERNAL GLASS CLOSING LEFT PLATE	1.000	PC	VM2062A0	L.Miss 46x33 RIGHT UPPER DOOR COLUMN CAP	1.000	PC	VM2063A0	L.Miss 46x33 LEFT UPPER DOOR COLUMN CAP	1.000	PC	VM2064A0	L.Miss 46x33 RIGHT LOWER DOOR COLUMN CAP	1.000	PC	VM2065A0	L.Miss 46x33 LEFT LOWER DOOR COLUMN CAP	1.000	PC	VT1062A0	LineMiss ARIANNA GREY EXTERNAL GLASS	1.000	PC
Code	Description	Qty	UOM																																																							
RC1200A0	ED=4 WIRE D.=0.5 COMPRESSIO N SPRING	2.000	PC																																																							
SL1050A1	3M TRANSFER ADHESIVE TAPE	0.820	M																																																							
TB2301A0	RIGHT COLUMN XVC105E 40x40x1	1.000	PC																																																							
TB3081A0	LMISS ARIANNA/ROS SELLA DOOR LEFT COLUMN	1.000	PC																																																							
VM1025A0	Ø16 GREY NYLON LID	2.000	PC																																																							
VM1695A0	HANDLE POSITION PIN	2.000	PC																																																							
VM1920A0	INTERNAL GLASS CLOSING RIGHT PLATE	1.000	PC																																																							
VM1921A0	INTERNAL GLASS CLOSING LEFT PLATE	1.000	PC																																																							
VM2062A0	L.Miss 46x33 RIGHT UPPER DOOR COLUMN CAP	1.000	PC																																																							
VM2063A0	L.Miss 46x33 LEFT UPPER DOOR COLUMN CAP	1.000	PC																																																							
VM2064A0	L.Miss 46x33 RIGHT LOWER DOOR COLUMN CAP	1.000	PC																																																							
VM2065A0	L.Miss 46x33 LEFT LOWER DOOR COLUMN CAP	1.000	PC																																																							
VT1062A0	LineMiss ARIANNA GREY EXTERNAL GLASS	1.000	PC																																																							



Зип Общепит
vsezip.ru

+7(812)987-08-81

COMPONENT			SPARE PART																																																																					
Code	Description	Image	Code	Description	Kit components																																																																			
VM2065A	L.Miss 46x33 LEFT LOWER DOOR COLUMN CAP		KVT1061A	LM ARIANNA EXTERNAL YELLOW GLASS KIT	<table border="1"> <thead> <tr> <th>Code</th> <th>Description</th> <th>Qty</th> <th>UOM</th> </tr> </thead> <tbody> <tr> <td>RC1200A0</td> <td>ED=4 WIRE D.=0.5 COMPRESSIO N SPRING</td> <td>2.000</td> <td>PC</td> </tr> <tr> <td>SL1050A1</td> <td>3M TRANSFER ADHESIVE TAPE</td> <td>0.820</td> <td>M</td> </tr> <tr> <td>TB2301A0</td> <td>RIGHT COLUMN XVC105E 40x40x1</td> <td>2.000</td> <td>PC</td> </tr> <tr> <td>VM1025A0</td> <td>Ø16 GREY NYLON LID</td> <td>2.000</td> <td>PC</td> </tr> <tr> <td>VM1695A0</td> <td>HANDLE POSITION PIN</td> <td>2.000</td> <td>PC</td> </tr> <tr> <td>VM1920A0</td> <td>INTERNAL GLASS CLOSING RIGHT PLATE</td> <td>1.000</td> <td>PC</td> </tr> <tr> <td>VM1921A0</td> <td>INTERNAL GLASS CLOSING LEFT PLATE</td> <td>1.000</td> <td>PC</td> </tr> <tr> <td>VM2062A0</td> <td>L.Miss 46x33 RIGHT UPPER DOOR COLUMN CAP</td> <td>1.000</td> <td>PC</td> </tr> <tr> <td>VM2063A0</td> <td>L.Miss 46x33 LEFT UPPER DOOR COLUMN CAP</td> <td>1.000</td> <td>PC</td> </tr> <tr> <td>VM2064A0</td> <td>L.Miss 46x33 RIGHT LOWER DOOR COLUMN CAP</td> <td>1.000</td> <td>PC</td> </tr> <tr> <td>VM2065A0</td> <td>L.Miss 46x33 LEFT LOWER DOOR COLUMN CAP</td> <td>1.000</td> <td>PC</td> </tr> <tr> <td>VT1061A2</td> <td>EXTERNAL YELLOW GLASS 598x424x5</td> <td>1.000</td> <td>PC</td> </tr> </tbody> </table>	Code	Description	Qty	UOM	RC1200A0	ED=4 WIRE D.=0.5 COMPRESSIO N SPRING	2.000	PC	SL1050A1	3M TRANSFER ADHESIVE TAPE	0.820	M	TB2301A0	RIGHT COLUMN XVC105E 40x40x1	2.000	PC	VM1025A0	Ø16 GREY NYLON LID	2.000	PC	VM1695A0	HANDLE POSITION PIN	2.000	PC	VM1920A0	INTERNAL GLASS CLOSING RIGHT PLATE	1.000	PC	VM1921A0	INTERNAL GLASS CLOSING LEFT PLATE	1.000	PC	VM2062A0	L.Miss 46x33 RIGHT UPPER DOOR COLUMN CAP	1.000	PC	VM2063A0	L.Miss 46x33 LEFT UPPER DOOR COLUMN CAP	1.000	PC	VM2064A0	L.Miss 46x33 RIGHT LOWER DOOR COLUMN CAP	1.000	PC	VM2065A0	L.Miss 46x33 LEFT LOWER DOOR COLUMN CAP	1.000	PC	VT1061A2	EXTERNAL YELLOW GLASS 598x424x5	1.000	PC	KVT1057A	LM STEFANIA BLACK EXTERNAL GLASS KIT	<table border="1"> <thead> <tr> <th>Code</th> <th>Description</th> <th>Qty</th> <th>UOM</th> </tr> </thead> <tbody> <tr> <td>RC1200A0</td> <td>ED=4 WIRE D.=0.5 COMPRESSIO N SPRING</td> <td>2.000</td> <td>PC</td> </tr> <tr> <td>SL1050A1</td> <td>3M TRANSFER ADHESIVE TAPE</td> <td>0.660</td> <td>M</td> </tr> </tbody> </table>	Code	Description	Qty	UOM	RC1200A0	ED=4 WIRE D.=0.5 COMPRESSIO N SPRING	2.000	PC	SL1050A1	3M TRANSFER ADHESIVE TAPE	0.660	M
			Code	Description	Qty	UOM																																																																		
RC1200A0	ED=4 WIRE D.=0.5 COMPRESSIO N SPRING	2.000	PC																																																																					
SL1050A1	3M TRANSFER ADHESIVE TAPE	0.820	M																																																																					
TB2301A0	RIGHT COLUMN XVC105E 40x40x1	2.000	PC																																																																					
VM1025A0	Ø16 GREY NYLON LID	2.000	PC																																																																					
VM1695A0	HANDLE POSITION PIN	2.000	PC																																																																					
VM1920A0	INTERNAL GLASS CLOSING RIGHT PLATE	1.000	PC																																																																					
VM1921A0	INTERNAL GLASS CLOSING LEFT PLATE	1.000	PC																																																																					
VM2062A0	L.Miss 46x33 RIGHT UPPER DOOR COLUMN CAP	1.000	PC																																																																					
VM2063A0	L.Miss 46x33 LEFT UPPER DOOR COLUMN CAP	1.000	PC																																																																					
VM2064A0	L.Miss 46x33 RIGHT LOWER DOOR COLUMN CAP	1.000	PC																																																																					
VM2065A0	L.Miss 46x33 LEFT LOWER DOOR COLUMN CAP	1.000	PC																																																																					
VT1061A2	EXTERNAL YELLOW GLASS 598x424x5	1.000	PC																																																																					
Code	Description	Qty	UOM																																																																					
RC1200A0	ED=4 WIRE D.=0.5 COMPRESSIO N SPRING	2.000	PC																																																																					
SL1050A1	3M TRANSFER ADHESIVE TAPE	0.660	M																																																																					



Зип Общепит
vsezip.ru

+7(812)987-08-81

COMPONENT			SPARE PART																																																																					
Code	Description	Image	Code	Description	Kit components																																																																			
VM2065A	L.Miss 46x33 LEFT LOWER DOOR COLUMN CAP		KVT1057A	LM STEFANIA BLACK EXTERNAL GLASS KIT	<table border="1"> <thead> <tr> <th>Code</th> <th>Description</th> <th>Qty</th> <th>UOM</th> </tr> </thead> <tbody> <tr> <td>TB2306A0</td> <td>L.Miss Stefania/Elena DOOR RIGHT COLUMN</td> <td>1.000</td> <td>PC</td> </tr> <tr> <td>TB3080A0</td> <td>LMISS STEFANIA/ELE NA DOOR LEFT COLUMN</td> <td>1.000</td> <td>PC</td> </tr> <tr> <td>VM1025A0</td> <td>Ø16 GREY NYLON LID</td> <td>2.000</td> <td>PC</td> </tr> <tr> <td>VM1695A0</td> <td>HANDLE POSITION PIN</td> <td>2.000</td> <td>PC</td> </tr> <tr> <td>VM1920A0</td> <td>INTERNAL GLASS CLOSING RIGHT PLATE</td> <td>1.000</td> <td>PC</td> </tr> <tr> <td>VM1921A0</td> <td>INTERNAL GLASS CLOSING LEFT PLATE</td> <td>1.000</td> <td>PC</td> </tr> <tr> <td>VM2062A0</td> <td>L.Miss 46x33 RIGHT UPPER DOOR COLUMN CAP</td> <td>1.000</td> <td>PC</td> </tr> <tr> <td>VM2063A0</td> <td>L.Miss 46x33 LEFT UPPER DOOR COLUMN CAP</td> <td>1.000</td> <td>PC</td> </tr> <tr> <td>VM2064A0</td> <td>L.Miss 46x33 RIGHT LOWER DOOR COLUMN CAP</td> <td>1.000</td> <td>PC</td> </tr> <tr> <td>VM2065A0</td> <td>L.Miss 46x33 LEFT LOWER DOOR COLUMN CAP</td> <td>1.000</td> <td>PC</td> </tr> <tr> <td>VT1057A0</td> <td>L.MISS STEFANIA EXTERNAL GLASS 598x344x5</td> <td>1.000</td> <td>PC</td> </tr> </tbody> </table>	Code	Description	Qty	UOM	TB2306A0	L.Miss Stefania/Elena DOOR RIGHT COLUMN	1.000	PC	TB3080A0	LMISS STEFANIA/ELE NA DOOR LEFT COLUMN	1.000	PC	VM1025A0	Ø16 GREY NYLON LID	2.000	PC	VM1695A0	HANDLE POSITION PIN	2.000	PC	VM1920A0	INTERNAL GLASS CLOSING RIGHT PLATE	1.000	PC	VM1921A0	INTERNAL GLASS CLOSING LEFT PLATE	1.000	PC	VM2062A0	L.Miss 46x33 RIGHT UPPER DOOR COLUMN CAP	1.000	PC	VM2063A0	L.Miss 46x33 LEFT UPPER DOOR COLUMN CAP	1.000	PC	VM2064A0	L.Miss 46x33 RIGHT LOWER DOOR COLUMN CAP	1.000	PC	VM2065A0	L.Miss 46x33 LEFT LOWER DOOR COLUMN CAP	1.000	PC	VT1057A0	L.MISS STEFANIA EXTERNAL GLASS 598x344x5	1.000	PC	KVT1056A	LM STEFANIA YELLOW EXTERNAL GLASS KIT	<table border="1"> <thead> <tr> <th>Code</th> <th>Description</th> <th>Qty</th> <th>UOM</th> </tr> </thead> <tbody> <tr> <td>RC1200A0</td> <td>ED=4 WIRE D.=0.5 COMPRESSIO N SPRING</td> <td>2.000</td> <td>PC</td> </tr> <tr> <td>SL1050A1</td> <td>3M TRANSFER ADHESIVE TAPE</td> <td>0.660</td> <td>M</td> </tr> <tr> <td>TB2306A0</td> <td>L.Miss Stefania/Elena DOOR RIGHT COLUMN</td> <td>2.000</td> <td>PC</td> </tr> </tbody> </table>	Code	Description	Qty	UOM	RC1200A0	ED=4 WIRE D.=0.5 COMPRESSIO N SPRING	2.000	PC	SL1050A1	3M TRANSFER ADHESIVE TAPE	0.660	M	TB2306A0	L.Miss Stefania/Elena DOOR RIGHT COLUMN	2.000	PC
			Code	Description	Qty	UOM																																																																		
TB2306A0	L.Miss Stefania/Elena DOOR RIGHT COLUMN	1.000	PC																																																																					
TB3080A0	LMISS STEFANIA/ELE NA DOOR LEFT COLUMN	1.000	PC																																																																					
VM1025A0	Ø16 GREY NYLON LID	2.000	PC																																																																					
VM1695A0	HANDLE POSITION PIN	2.000	PC																																																																					
VM1920A0	INTERNAL GLASS CLOSING RIGHT PLATE	1.000	PC																																																																					
VM1921A0	INTERNAL GLASS CLOSING LEFT PLATE	1.000	PC																																																																					
VM2062A0	L.Miss 46x33 RIGHT UPPER DOOR COLUMN CAP	1.000	PC																																																																					
VM2063A0	L.Miss 46x33 LEFT UPPER DOOR COLUMN CAP	1.000	PC																																																																					
VM2064A0	L.Miss 46x33 RIGHT LOWER DOOR COLUMN CAP	1.000	PC																																																																					
VM2065A0	L.Miss 46x33 LEFT LOWER DOOR COLUMN CAP	1.000	PC																																																																					
VT1057A0	L.MISS STEFANIA EXTERNAL GLASS 598x344x5	1.000	PC																																																																					
Code	Description	Qty	UOM																																																																					
RC1200A0	ED=4 WIRE D.=0.5 COMPRESSIO N SPRING	2.000	PC																																																																					
SL1050A1	3M TRANSFER ADHESIVE TAPE	0.660	M																																																																					
TB2306A0	L.Miss Stefania/Elena DOOR RIGHT COLUMN	2.000	PC																																																																					



Зип Общепит
vsezip.ru

+7(812)987-08-81

COMPONENT			SPARE PART																																										
Code	Description	Image	Code	Description	Kit components																																								
VM2065A	L.Miss 46x33 LEFT LOWER DOOR COLUMN CAP		KVT1056A	LM STEFANIA YELLOW EXTERNAL GLASS KIT	<table border="1"> <thead> <tr> <th>Code</th> <th>Description</th> <th>Qty</th> <th>UOM</th> </tr> </thead> <tbody> <tr> <td>VM1025A0</td> <td>Ø16 GREY NYLON LID</td> <td>2.000</td> <td>PC</td> </tr> <tr> <td>VM1695A0</td> <td>HANDLE POSITION PIN</td> <td>2.000</td> <td>PC</td> </tr> <tr> <td>VM1920A0</td> <td>INTERNAL GLASS CLOSING RIGHT PLATE</td> <td>1.000</td> <td>PC</td> </tr> <tr> <td>VM1921A0</td> <td>INTERNAL GLASS CLOSING LEFT PLATE</td> <td>1.000</td> <td>PC</td> </tr> <tr> <td>VM2062A0</td> <td>L.Miss 46x33 RIGHT UPPER DOOR COLUMN CAP</td> <td>1.000</td> <td>PC</td> </tr> <tr> <td>VM2063A0</td> <td>L.Miss 46x33 LEFT UPPER DOOR COLUMN CAP</td> <td>1.000</td> <td>PC</td> </tr> <tr> <td>VM2064A0</td> <td>L.Miss 46x33 RIGHT LOWER DOOR COLUMN CAP</td> <td>1.000</td> <td>PC</td> </tr> <tr> <td>VM2065A0</td> <td>L.Miss 46x33 LEFT LOWER DOOR COLUMN CAP</td> <td>1.000</td> <td>PC</td> </tr> <tr> <td>VT1056A2</td> <td>YELLOW SER GLASS 598X344X5</td> <td>1.000</td> <td>PC</td> </tr> </tbody> </table>	Code	Description	Qty	UOM	VM1025A0	Ø16 GREY NYLON LID	2.000	PC	VM1695A0	HANDLE POSITION PIN	2.000	PC	VM1920A0	INTERNAL GLASS CLOSING RIGHT PLATE	1.000	PC	VM1921A0	INTERNAL GLASS CLOSING LEFT PLATE	1.000	PC	VM2062A0	L.Miss 46x33 RIGHT UPPER DOOR COLUMN CAP	1.000	PC	VM2063A0	L.Miss 46x33 LEFT UPPER DOOR COLUMN CAP	1.000	PC	VM2064A0	L.Miss 46x33 RIGHT LOWER DOOR COLUMN CAP	1.000	PC	VM2065A0	L.Miss 46x33 LEFT LOWER DOOR COLUMN CAP	1.000	PC	VT1056A2	YELLOW SER GLASS 598X344X5	1.000	PC
			Code	Description	Qty	UOM																																							
VM1025A0	Ø16 GREY NYLON LID	2.000	PC																																										
VM1695A0	HANDLE POSITION PIN	2.000	PC																																										
VM1920A0	INTERNAL GLASS CLOSING RIGHT PLATE	1.000	PC																																										
VM1921A0	INTERNAL GLASS CLOSING LEFT PLATE	1.000	PC																																										
VM2062A0	L.Miss 46x33 RIGHT UPPER DOOR COLUMN CAP	1.000	PC																																										
VM2063A0	L.Miss 46x33 LEFT UPPER DOOR COLUMN CAP	1.000	PC																																										
VM2064A0	L.Miss 46x33 RIGHT LOWER DOOR COLUMN CAP	1.000	PC																																										
VM2065A0	L.Miss 46x33 LEFT LOWER DOOR COLUMN CAP	1.000	PC																																										
VT1056A2	YELLOW SER GLASS 598X344X5	1.000	PC																																										
KVT1052A	LM CRISTINA BLACK EXTERNAL GLASS KIT	<table border="1"> <thead> <tr> <th>Code</th> <th>Description</th> <th>Qty</th> <th>UOM</th> </tr> </thead> <tbody> <tr> <td>RC1200A0</td> <td>ED=4 WIRE D.=0.5 COMPRESSIO N SPRING</td> <td>2.000</td> <td>PC</td> </tr> <tr> <td>SL1050A1</td> <td>3M TRANSFER ADHESIVE TAPE</td> <td>0.660</td> <td>M</td> </tr> <tr> <td>TB2306A0</td> <td>L.Miss Stefania/Elena DOOR RIGHT COLUMN</td> <td>2.000</td> <td>PC</td> </tr> <tr> <td>VM1025A0</td> <td>Ø16 GREY NYLON LID</td> <td>2.000</td> <td>PC</td> </tr> <tr> <td>VM1695A0</td> <td>HANDLE POSITION PIN</td> <td>2.000</td> <td>PC</td> </tr> <tr> <td>VM1920A0</td> <td>INTERNAL GLASS CLOSING RIGHT PLATE</td> <td>1.000</td> <td>PC</td> </tr> </tbody> </table>	Code	Description	Qty	UOM	RC1200A0	ED=4 WIRE D.=0.5 COMPRESSIO N SPRING	2.000	PC	SL1050A1	3M TRANSFER ADHESIVE TAPE	0.660	M	TB2306A0	L.Miss Stefania/Elena DOOR RIGHT COLUMN	2.000	PC	VM1025A0	Ø16 GREY NYLON LID	2.000	PC	VM1695A0	HANDLE POSITION PIN	2.000	PC	VM1920A0	INTERNAL GLASS CLOSING RIGHT PLATE	1.000	PC															
Code	Description	Qty	UOM																																										
RC1200A0	ED=4 WIRE D.=0.5 COMPRESSIO N SPRING	2.000	PC																																										
SL1050A1	3M TRANSFER ADHESIVE TAPE	0.660	M																																										
TB2306A0	L.Miss Stefania/Elena DOOR RIGHT COLUMN	2.000	PC																																										
VM1025A0	Ø16 GREY NYLON LID	2.000	PC																																										
VM1695A0	HANDLE POSITION PIN	2.000	PC																																										
VM1920A0	INTERNAL GLASS CLOSING RIGHT PLATE	1.000	PC																																										

+7(812)987-08-81

COMPONENT			SPARE PART																																			
Code	Description	Image	Code	Description	Kit components																																	
VM2065A	L.Miss 46x33 LEFT LOWER DOOR COLUMN CAP		KVT1052A	LM CRISTINA BLACK EXTERNAL GLASS KIT	<table border="1"> <thead> <tr> <th>Code</th> <th>Description</th> <th>Qty</th> <th>UOM</th> </tr> </thead> <tbody> <tr> <td>VM1921A0</td> <td>INTERNAL GLASS CLOSING LEFT PLATE</td> <td>1.000</td> <td>PC</td> </tr> <tr> <td>VM2062A0</td> <td>L.Miss 46x33 RIGHT UPPER DOOR COLUMN CAP</td> <td>1.000</td> <td>PC</td> </tr> <tr> <td>VM2063A0</td> <td>L.Miss 46x33 LEFT UPPER DOOR COLUMN CAP</td> <td>1.000</td> <td>PC</td> </tr> <tr> <td>VM2064A0</td> <td>L.Miss 46x33 RIGHT LOWER DOOR COLUMN CAP</td> <td>1.000</td> <td>PC</td> </tr> <tr> <td>VM2065A0</td> <td>L.Miss 46x33 LEFT LOWER DOOR COLUMN CAP</td> <td>1.000</td> <td>PC</td> </tr> <tr> <td>VT1052A0</td> <td>478X344X5 EXTERNAL GLASS</td> <td>1.000</td> <td>PC</td> </tr> </tbody> </table>	Code	Description	Qty	UOM	VM1921A0	INTERNAL GLASS CLOSING LEFT PLATE	1.000	PC	VM2062A0	L.Miss 46x33 RIGHT UPPER DOOR COLUMN CAP	1.000	PC	VM2063A0	L.Miss 46x33 LEFT UPPER DOOR COLUMN CAP	1.000	PC	VM2064A0	L.Miss 46x33 RIGHT LOWER DOOR COLUMN CAP	1.000	PC	VM2065A0	L.Miss 46x33 LEFT LOWER DOOR COLUMN CAP	1.000	PC	VT1052A0	478X344X5 EXTERNAL GLASS	1.000	PC					
			Code	Description	Qty	UOM																																
VM1921A0	INTERNAL GLASS CLOSING LEFT PLATE	1.000	PC																																			
VM2062A0	L.Miss 46x33 RIGHT UPPER DOOR COLUMN CAP	1.000	PC																																			
VM2063A0	L.Miss 46x33 LEFT UPPER DOOR COLUMN CAP	1.000	PC																																			
VM2064A0	L.Miss 46x33 RIGHT LOWER DOOR COLUMN CAP	1.000	PC																																			
VM2065A0	L.Miss 46x33 LEFT LOWER DOOR COLUMN CAP	1.000	PC																																			
VT1052A0	478X344X5 EXTERNAL GLASS	1.000	PC																																			
KVT1051A	LM CRISTINA YELLOW EXTERNAL GLASS KIT	<table border="1"> <thead> <tr> <th>Code</th> <th>Description</th> <th>Qty</th> <th>UOM</th> </tr> </thead> <tbody> <tr> <td>RC1200A0</td> <td>ED=4 WIRE D.=0.5 COMPRESSIO N SPRING</td> <td>2.000</td> <td>PC</td> </tr> <tr> <td>SL1050A1</td> <td>3M TRANSFER ADHESIVE TAPE</td> <td>0.660</td> <td>M</td> </tr> <tr> <td>TB2306A0</td> <td>L.Miss Stefania/Elena DOOR RIGHT COLUMN</td> <td>2.000</td> <td>PC</td> </tr> <tr> <td>VM1025A0</td> <td>Ø16 GREY NYLON LID</td> <td>2.000</td> <td>PC</td> </tr> <tr> <td>VM1695A0</td> <td>HANDLE POSITION PIN</td> <td>2.000</td> <td>PC</td> </tr> <tr> <td>VM1920A0</td> <td>INTERNAL GLASS CLOSING RIGHT PLATE</td> <td>1.000</td> <td>PC</td> </tr> <tr> <td>VM1921A0</td> <td>INTERNAL GLASS CLOSING LEFT PLATE</td> <td>1.000</td> <td>PC</td> </tr> <tr> <td>VM2062A0</td> <td>L.Miss 46x33 RIGHT UPPER DOOR COLUMN CAP</td> <td>1.000</td> <td>PC</td> </tr> </tbody> </table>	Code	Description	Qty	UOM	RC1200A0	ED=4 WIRE D.=0.5 COMPRESSIO N SPRING	2.000	PC	SL1050A1	3M TRANSFER ADHESIVE TAPE	0.660	M	TB2306A0	L.Miss Stefania/Elena DOOR RIGHT COLUMN	2.000	PC	VM1025A0	Ø16 GREY NYLON LID	2.000	PC	VM1695A0	HANDLE POSITION PIN	2.000	PC	VM1920A0	INTERNAL GLASS CLOSING RIGHT PLATE	1.000	PC	VM1921A0	INTERNAL GLASS CLOSING LEFT PLATE	1.000	PC	VM2062A0	L.Miss 46x33 RIGHT UPPER DOOR COLUMN CAP	1.000	PC
Code	Description	Qty	UOM																																			
RC1200A0	ED=4 WIRE D.=0.5 COMPRESSIO N SPRING	2.000	PC																																			
SL1050A1	3M TRANSFER ADHESIVE TAPE	0.660	M																																			
TB2306A0	L.Miss Stefania/Elena DOOR RIGHT COLUMN	2.000	PC																																			
VM1025A0	Ø16 GREY NYLON LID	2.000	PC																																			
VM1695A0	HANDLE POSITION PIN	2.000	PC																																			
VM1920A0	INTERNAL GLASS CLOSING RIGHT PLATE	1.000	PC																																			
VM1921A0	INTERNAL GLASS CLOSING LEFT PLATE	1.000	PC																																			
VM2062A0	L.Miss 46x33 RIGHT UPPER DOOR COLUMN CAP	1.000	PC																																			

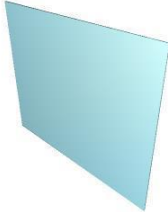

+7(812)987-08-81

COMPONENT			SPARE PART																																						
Code	Description	Image	Code	Description	Kit components																																				
VM2065A	L.Miss 46x33 LEFT LOWER DOOR COLUMN CAP		KVT1051A	LM CRISTINA YELLOW EXTERNAL GLASS KIT	<table border="1"> <thead> <tr> <th>Code</th> <th>Description</th> <th>Qty</th> <th>UOM</th> </tr> </thead> <tbody> <tr> <td>VM2063A0</td> <td>L.Miss 46x33 LEFT UPPER DOOR COLUMN CAP</td> <td>1.000</td> <td>PC</td> </tr> <tr> <td>VM2064A0</td> <td>L.Miss 46x33 RIGHT LOWER DOOR COLUMN CAP</td> <td>1.000</td> <td>PC</td> </tr> <tr> <td>VM2065A0</td> <td>L.Miss 46x33 LEFT LOWER DOOR COLUMN CAP</td> <td>1.000</td> <td>PC</td> </tr> <tr> <td>VT1051A2</td> <td>YELLOW SER GLASS 478X344X5</td> <td>1.000</td> <td>PC</td> </tr> </tbody> </table>	Code	Description	Qty	UOM	VM2063A0	L.Miss 46x33 LEFT UPPER DOOR COLUMN CAP	1.000	PC	VM2064A0	L.Miss 46x33 RIGHT LOWER DOOR COLUMN CAP	1.000	PC	VM2065A0	L.Miss 46x33 LEFT LOWER DOOR COLUMN CAP	1.000	PC	VT1051A2	YELLOW SER GLASS 478X344X5	1.000	PC																
Code	Description	Qty	UOM																																						
VM2063A0	L.Miss 46x33 LEFT UPPER DOOR COLUMN CAP	1.000	PC																																						
VM2064A0	L.Miss 46x33 RIGHT LOWER DOOR COLUMN CAP	1.000	PC																																						
VM2065A0	L.Miss 46x33 LEFT LOWER DOOR COLUMN CAP	1.000	PC																																						
VT1051A2	YELLOW SER GLASS 478X344X5	1.000	PC																																						
VT1060A	INTERNAL GLASS 515x414x4 L.Miss ARIANNA		KVT1060A	LM ARIANNA INTERNAL GLASS KI	<table border="1"> <thead> <tr> <th>Code</th> <th>Description</th> <th>Qty</th> <th>UOM</th> </tr> </thead> <tbody> <tr> <td>GN1130A0</td> <td>LINE MISS INTERNAL GLASS L=23mm SEAL</td> <td>4.000</td> <td>PC</td> </tr> <tr> <td>VT1060A0</td> <td>INTERNAL GLASS 515x414x4 L.Miss ARIANN</td> <td>1.000</td> <td>PC</td> </tr> </tbody> </table>	Code	Description	Qty	UOM	GN1130A0	LINE MISS INTERNAL GLASS L=23mm SEAL	4.000	PC	VT1060A0	INTERNAL GLASS 515x414x4 L.Miss ARIANN	1.000	PC																								
Code	Description	Qty	UOM																																						
GN1130A0	LINE MISS INTERNAL GLASS L=23mm SEAL	4.000	PC																																						
VT1060A0	INTERNAL GLASS 515x414x4 L.Miss ARIANN	1.000	PC																																						
			KDR1062A	L.M. ARIANNA BLACK COMPLETE DOOR	<table border="1"> <thead> <tr> <th>Code</th> <th>Description</th> <th>Qty</th> <th>UOM</th> </tr> </thead> <tbody> <tr> <td>0H1925B0</td> <td>ST.STEEL HANDLE TUBE Ext.D=18 Th=1 L=518</td> <td>1.000</td> <td>PC</td> </tr> <tr> <td>CR1015A0</td> <td>LineMiss ARIANNA DOOR HINGE</td> <td>2.000</td> <td>PC</td> </tr> <tr> <td>MG1015B0</td> <td>L.MISS/L.MICR O/CHEFTOP HANDLE END</td> <td>2.000</td> <td>PC</td> </tr> <tr> <td>RC1200A0</td> <td>ED=4 WIRE D=0.5 COMPRESSIO N SPRING</td> <td>2.000</td> <td>PC</td> </tr> <tr> <td>SL1050A1</td> <td>3M TRANSFER ADHESIVE TAPE</td> <td>0.820</td> <td>M</td> </tr> <tr> <td>TB2301A0</td> <td>RIGHT COLUMN XVC105E 40x40x1</td> <td>1.000</td> <td>PC</td> </tr> <tr> <td>TB3081A0</td> <td>LMISS ARIANNA/ROS SELLA DOOR LEFT COLUMN</td> <td>1.000</td> <td>PC</td> </tr> <tr> <td>VI1855A0</td> <td>5X25 SELF-TAPPIN G SCREW</td> <td>2.000</td> <td>PC</td> </tr> </tbody> </table>	Code	Description	Qty	UOM	0H1925B0	ST.STEEL HANDLE TUBE Ext.D=18 Th=1 L=518	1.000	PC	CR1015A0	LineMiss ARIANNA DOOR HINGE	2.000	PC	MG1015B0	L.MISS/L.MICR O/CHEFTOP HANDLE END	2.000	PC	RC1200A0	ED=4 WIRE D=0.5 COMPRESSIO N SPRING	2.000	PC	SL1050A1	3M TRANSFER ADHESIVE TAPE	0.820	M	TB2301A0	RIGHT COLUMN XVC105E 40x40x1	1.000	PC	TB3081A0	LMISS ARIANNA/ROS SELLA DOOR LEFT COLUMN	1.000	PC	VI1855A0	5X25 SELF-TAPPIN G SCREW	2.000	PC
Code	Description	Qty	UOM																																						
0H1925B0	ST.STEEL HANDLE TUBE Ext.D=18 Th=1 L=518	1.000	PC																																						
CR1015A0	LineMiss ARIANNA DOOR HINGE	2.000	PC																																						
MG1015B0	L.MISS/L.MICR O/CHEFTOP HANDLE END	2.000	PC																																						
RC1200A0	ED=4 WIRE D=0.5 COMPRESSIO N SPRING	2.000	PC																																						
SL1050A1	3M TRANSFER ADHESIVE TAPE	0.820	M																																						
TB2301A0	RIGHT COLUMN XVC105E 40x40x1	1.000	PC																																						
TB3081A0	LMISS ARIANNA/ROS SELLA DOOR LEFT COLUMN	1.000	PC																																						
VI1855A0	5X25 SELF-TAPPIN G SCREW	2.000	PC																																						

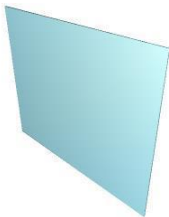

Зип Общепит
vsezip.ru

+7(812)987-08-81

COMPONENT			SPARE PART																																																		
Code	Description	Image	Code	Description	Kit components																																																
VT1060A	INTERNAL GLASS 515x414x4 LMiss ARIANNA		KDR1062A	L.M. ARIANNA BLACK COMPLETE DOOR	<table border="1"> <thead> <tr> <th>Code</th> <th>Description</th> <th>Qty</th> <th>UOM</th> </tr> </thead> <tbody> <tr> <td>VI1875A0</td> <td>SCREW M5X10 TC1/2T INOX</td> <td>6.000</td> <td>PC</td> </tr> <tr> <td>VM1025A0</td> <td>Ø16 GREY NYLON LID</td> <td>2.000</td> <td>PC</td> </tr> <tr> <td>VM1695A0</td> <td>HANDLE POSITION PIN</td> <td>2.000</td> <td>PC</td> </tr> <tr> <td>VM1920A0</td> <td>INTERNAL GLASS CLOSING RIGHT PLATE</td> <td>1.000</td> <td>PC</td> </tr> <tr> <td>VM1921A0</td> <td>INTERNAL GLASS CLOSING LEFT PLATE</td> <td>1.000</td> <td>PC</td> </tr> <tr> <td>VM2062A0</td> <td>L.Miss 46x33 RIGHT UPPER DOOR COLUMN CAP</td> <td>1.000</td> <td>PC</td> </tr> <tr> <td>VM2063A0</td> <td>L.Miss 46x33 LEFT UPPER DOOR COLUMN CAP</td> <td>1.000</td> <td>PC</td> </tr> <tr> <td>VM2064A0</td> <td>L.Miss 46x33 RIGHT LOWER DOOR COLUMN CAP</td> <td>1.000</td> <td>PC</td> </tr> <tr> <td>VM2065A0</td> <td>L.Miss 46x33 LEFT LOWER DOOR COLUMN CAP</td> <td>1.000</td> <td>PC</td> </tr> <tr> <td>VT1060A0</td> <td>INTERNAL GLASS 515x414x4 LMiss ARIANN</td> <td>1.000</td> <td>PC</td> </tr> <tr> <td>VT1062A0</td> <td>LineMiss ARIANNA GREY EXTERNAL GLASS</td> <td>1.000</td> <td>PC</td> </tr> </tbody> </table>	Code	Description	Qty	UOM	VI1875A0	SCREW M5X10 TC1/2T INOX	6.000	PC	VM1025A0	Ø16 GREY NYLON LID	2.000	PC	VM1695A0	HANDLE POSITION PIN	2.000	PC	VM1920A0	INTERNAL GLASS CLOSING RIGHT PLATE	1.000	PC	VM1921A0	INTERNAL GLASS CLOSING LEFT PLATE	1.000	PC	VM2062A0	L.Miss 46x33 RIGHT UPPER DOOR COLUMN CAP	1.000	PC	VM2063A0	L.Miss 46x33 LEFT UPPER DOOR COLUMN CAP	1.000	PC	VM2064A0	L.Miss 46x33 RIGHT LOWER DOOR COLUMN CAP	1.000	PC	VM2065A0	L.Miss 46x33 LEFT LOWER DOOR COLUMN CAP	1.000	PC	VT1060A0	INTERNAL GLASS 515x414x4 LMiss ARIANN	1.000	PC	VT1062A0	LineMiss ARIANNA GREY EXTERNAL GLASS	1.000	PC
					Code	Description	Qty	UOM																																													
					VI1875A0	SCREW M5X10 TC1/2T INOX	6.000	PC																																													
					VM1025A0	Ø16 GREY NYLON LID	2.000	PC																																													
					VM1695A0	HANDLE POSITION PIN	2.000	PC																																													
					VM1920A0	INTERNAL GLASS CLOSING RIGHT PLATE	1.000	PC																																													
					VM1921A0	INTERNAL GLASS CLOSING LEFT PLATE	1.000	PC																																													
					VM2062A0	L.Miss 46x33 RIGHT UPPER DOOR COLUMN CAP	1.000	PC																																													
					VM2063A0	L.Miss 46x33 LEFT UPPER DOOR COLUMN CAP	1.000	PC																																													
					VM2064A0	L.Miss 46x33 RIGHT LOWER DOOR COLUMN CAP	1.000	PC																																													
					VM2065A0	L.Miss 46x33 LEFT LOWER DOOR COLUMN CAP	1.000	PC																																													
					VT1060A0	INTERNAL GLASS 515x414x4 LMiss ARIANN	1.000	PC																																													
					VT1062A0	LineMiss ARIANNA GREY EXTERNAL GLASS	1.000	PC																																													
VT1062A	LineMiss ARIANNA GREY EXTERNAL GLASS		KVT1062A	L.M. ARIANNA BLACK EXTERNAL GLASS KIT	<table border="1"> <thead> <tr> <th>Code</th> <th>Description</th> <th>Qty</th> <th>UOM</th> </tr> </thead> <tbody> <tr> <td>RC1200A0</td> <td>ED=4 WIRE D.=0.5 COMPRESSION N SPRING</td> <td>2.000</td> <td>PC</td> </tr> <tr> <td>SL1050A1</td> <td>3M TRANSFER ADHESIVE TAPE</td> <td>0.820</td> <td>M</td> </tr> <tr> <td>TB2301A0</td> <td>RIGHT COLUMN XVC105E 40x40x1</td> <td>1.000</td> <td>PC</td> </tr> </tbody> </table>	Code	Description	Qty	UOM	RC1200A0	ED=4 WIRE D.=0.5 COMPRESSION N SPRING	2.000	PC	SL1050A1	3M TRANSFER ADHESIVE TAPE	0.820	M	TB2301A0	RIGHT COLUMN XVC105E 40x40x1	1.000	PC																																
					Code	Description	Qty	UOM																																													
					RC1200A0	ED=4 WIRE D.=0.5 COMPRESSION N SPRING	2.000	PC																																													
SL1050A1	3M TRANSFER ADHESIVE TAPE	0.820	M																																																		
TB2301A0	RIGHT COLUMN XVC105E 40x40x1	1.000	PC																																																		



+7(812)987-08-81

COMPONENT			SPARE PART																																																
Code	Description	Image	Code	Description	Kit components																																														
VT1062A	LineMiss ARIANNA GREY EXTERNAL GLASS		KVT1062A	L.M. ARIANNA BLACK EXTERNAL GLASS KIT	<table border="1"> <thead> <tr> <th>Code</th> <th>Description</th> <th>Qty</th> <th>UOM</th> </tr> </thead> <tbody> <tr> <td>TB3081A0</td> <td>LMISS ARIANNA/ROS SELLA DOOR LEFT COLUMN</td> <td>1.000</td> <td>PC</td> </tr> <tr> <td>VM1025A0</td> <td>Ø16 GREY NYLON LID</td> <td>2.000</td> <td>PC</td> </tr> <tr> <td>VM1695A0</td> <td>HANDLE POSITION PIN</td> <td>2.000</td> <td>PC</td> </tr> <tr> <td>VM1920A0</td> <td>INTERNAL GLASS CLOSING RIGHT PLATE</td> <td>1.000</td> <td>PC</td> </tr> <tr> <td>VM1921A0</td> <td>INTERNAL GLASS CLOSING LEFT PLATE</td> <td>1.000</td> <td>PC</td> </tr> <tr> <td>VM2062A0</td> <td>L.Miss 46x33 RIGHT UPPER DOOR COLUMN CAP</td> <td>1.000</td> <td>PC</td> </tr> <tr> <td>VM2063A0</td> <td>L.Miss 46x33 LEFT UPPER DOOR COLUMN CAP</td> <td>1.000</td> <td>PC</td> </tr> <tr> <td>VM2064A0</td> <td>L.Miss 46x33 RIGHT LOWER DOOR COLUMN CAP</td> <td>1.000</td> <td>PC</td> </tr> <tr> <td>VM2065A0</td> <td>L.Miss 46x33 LEFT LOWER DOOR COLUMN CAP</td> <td>1.000</td> <td>PC</td> </tr> <tr> <td>VT1062A0</td> <td>LineMiss ARIANNA GREY EXTERNAL GLASS</td> <td></td> <td></td> <td>1.000</td> <td>PC</td> </tr> </tbody> </table>	Code	Description	Qty	UOM	TB3081A0	LMISS ARIANNA/ROS SELLA DOOR LEFT COLUMN	1.000	PC	VM1025A0	Ø16 GREY NYLON LID	2.000	PC	VM1695A0	HANDLE POSITION PIN	2.000	PC	VM1920A0	INTERNAL GLASS CLOSING RIGHT PLATE	1.000	PC	VM1921A0	INTERNAL GLASS CLOSING LEFT PLATE	1.000	PC	VM2062A0	L.Miss 46x33 RIGHT UPPER DOOR COLUMN CAP	1.000	PC	VM2063A0	L.Miss 46x33 LEFT UPPER DOOR COLUMN CAP	1.000	PC	VM2064A0	L.Miss 46x33 RIGHT LOWER DOOR COLUMN CAP	1.000	PC	VM2065A0	L.Miss 46x33 LEFT LOWER DOOR COLUMN CAP	1.000	PC	VT1062A0	LineMiss ARIANNA GREY EXTERNAL GLASS			1.000	PC
			Code	Description	Qty	UOM																																													
TB3081A0	LMISS ARIANNA/ROS SELLA DOOR LEFT COLUMN	1.000	PC																																																
VM1025A0	Ø16 GREY NYLON LID	2.000	PC																																																
VM1695A0	HANDLE POSITION PIN	2.000	PC																																																
VM1920A0	INTERNAL GLASS CLOSING RIGHT PLATE	1.000	PC																																																
VM1921A0	INTERNAL GLASS CLOSING LEFT PLATE	1.000	PC																																																
VM2062A0	L.Miss 46x33 RIGHT UPPER DOOR COLUMN CAP	1.000	PC																																																
VM2063A0	L.Miss 46x33 LEFT UPPER DOOR COLUMN CAP	1.000	PC																																																
VM2064A0	L.Miss 46x33 RIGHT LOWER DOOR COLUMN CAP	1.000	PC																																																
VM2065A0	L.Miss 46x33 LEFT LOWER DOOR COLUMN CAP	1.000	PC																																																
VT1062A0	LineMiss ARIANNA GREY EXTERNAL GLASS			1.000	PC																																														
KDR1062A	L.M. ARIANNA BLACK COMPLETE DOOR	<table border="1"> <thead> <tr> <th>Code</th> <th>Description</th> <th>Qty</th> <th>UOM</th> </tr> </thead> <tbody> <tr> <td>0H1925B0</td> <td>ST.STEEL HANDLE TUBE Ext.D=18 Th=1 L=518</td> <td>1.000</td> <td>PC</td> </tr> <tr> <td>CR1015A0</td> <td>LineMiss ARIANNA DOOR HINGE</td> <td>2.000</td> <td>PC</td> </tr> <tr> <td>MG1015B0</td> <td>L.MISS/L.MICR O/CHEFTOP HANDLE END</td> <td>2.000</td> <td>PC</td> </tr> <tr> <td>RC1200A0</td> <td>ED=4 WIRE D.=0.5 COMPRESSIO N SPRING</td> <td>2.000</td> <td>PC</td> </tr> </tbody> </table>	Code	Description	Qty	UOM	0H1925B0	ST.STEEL HANDLE TUBE Ext.D=18 Th=1 L=518	1.000	PC	CR1015A0	LineMiss ARIANNA DOOR HINGE	2.000	PC	MG1015B0	L.MISS/L.MICR O/CHEFTOP HANDLE END	2.000	PC	RC1200A0	ED=4 WIRE D.=0.5 COMPRESSIO N SPRING	2.000	PC																													
Code	Description	Qty	UOM																																																
0H1925B0	ST.STEEL HANDLE TUBE Ext.D=18 Th=1 L=518	1.000	PC																																																
CR1015A0	LineMiss ARIANNA DOOR HINGE	2.000	PC																																																
MG1015B0	L.MISS/L.MICR O/CHEFTOP HANDLE END	2.000	PC																																																
RC1200A0	ED=4 WIRE D.=0.5 COMPRESSIO N SPRING	2.000	PC																																																



+7(812)987-08-81

COMPONENT			SPARE PART																																																																		
Code	Description	Image	Code	Description	Kit components																																																																
VT1062A	LineMiss ARIANNA GREY EXTERNAL GLASS		KDR1062A	L.M. ARIANNA BLACK COMPLETE DOOR	<table border="1"> <thead> <tr> <th>Code</th> <th>Description</th> <th>Qty</th> <th>UOM</th> </tr> </thead> <tbody> <tr> <td>SL1050A1</td> <td>3M TRANSFER ADHESIVE TAPE</td> <td>0.820</td> <td>M</td> </tr> <tr> <td>TB2301A0</td> <td>RIGHT COLUMN XVC105E 40x40x1</td> <td>1.000</td> <td>PC</td> </tr> <tr> <td>TB3081A0</td> <td>LMISS ARIANNA/ROS SELLA DOOR LEFT COLUMN</td> <td>1.000</td> <td>PC</td> </tr> <tr> <td>VI1855A0</td> <td>5X25 SELF-TAPPIN G SCREW</td> <td>2.000</td> <td>PC</td> </tr> <tr> <td>VI1875A0</td> <td>SCREW M5X10 TC1/2T INOX</td> <td>6.000</td> <td>PC</td> </tr> <tr> <td>VM1025A0</td> <td>Ø16 GREY NYLON LID</td> <td>2.000</td> <td>PC</td> </tr> <tr> <td>VM1695A0</td> <td>HANDLE POSITION PIN</td> <td>2.000</td> <td>PC</td> </tr> <tr> <td>VM1920A0</td> <td>INTERNAL GLASS CLOSING RIGHT PLATE</td> <td>1.000</td> <td>PC</td> </tr> <tr> <td>VM1921A0</td> <td>INTERNAL GLASS CLOSING LEFT PLATE</td> <td>1.000</td> <td>PC</td> </tr> <tr> <td>VM2062A0</td> <td>L.Miss 46x33 RIGHT UPPER DOOR COLUMN CAP</td> <td>1.000</td> <td>PC</td> </tr> <tr> <td>VM2063A0</td> <td>L.Miss 46x33 LEFT UPPER DOOR COLUMN CAP</td> <td>1.000</td> <td>PC</td> </tr> <tr> <td>VM2064A0</td> <td>L.Miss 46x33 RIGHT LOWER DOOR COLUMN CAP</td> <td>1.000</td> <td>PC</td> </tr> <tr> <td>VM2065A0</td> <td>L.Miss 46x33 LEFT LOWER DOOR COLUMN CAP</td> <td>1.000</td> <td>PC</td> </tr> <tr> <td>VT1060A0</td> <td>INTERNAL GLASS 515x414x4 L.Miss ARIANN</td> <td>1.000</td> <td>PC</td> </tr> <tr> <td>VT1062A0</td> <td>LineMiss ARIANNA GREY EXTERNAL GLASS</td> <td>1.000</td> <td>PC</td> </tr> </tbody> </table>	Code	Description	Qty	UOM	SL1050A1	3M TRANSFER ADHESIVE TAPE	0.820	M	TB2301A0	RIGHT COLUMN XVC105E 40x40x1	1.000	PC	TB3081A0	LMISS ARIANNA/ROS SELLA DOOR LEFT COLUMN	1.000	PC	VI1855A0	5X25 SELF-TAPPIN G SCREW	2.000	PC	VI1875A0	SCREW M5X10 TC1/2T INOX	6.000	PC	VM1025A0	Ø16 GREY NYLON LID	2.000	PC	VM1695A0	HANDLE POSITION PIN	2.000	PC	VM1920A0	INTERNAL GLASS CLOSING RIGHT PLATE	1.000	PC	VM1921A0	INTERNAL GLASS CLOSING LEFT PLATE	1.000	PC	VM2062A0	L.Miss 46x33 RIGHT UPPER DOOR COLUMN CAP	1.000	PC	VM2063A0	L.Miss 46x33 LEFT UPPER DOOR COLUMN CAP	1.000	PC	VM2064A0	L.Miss 46x33 RIGHT LOWER DOOR COLUMN CAP	1.000	PC	VM2065A0	L.Miss 46x33 LEFT LOWER DOOR COLUMN CAP	1.000	PC	VT1060A0	INTERNAL GLASS 515x414x4 L.Miss ARIANN	1.000	PC	VT1062A0	LineMiss ARIANNA GREY EXTERNAL GLASS	1.000	PC
Code	Description	Qty	UOM																																																																		
SL1050A1	3M TRANSFER ADHESIVE TAPE	0.820	M																																																																		
TB2301A0	RIGHT COLUMN XVC105E 40x40x1	1.000	PC																																																																		
TB3081A0	LMISS ARIANNA/ROS SELLA DOOR LEFT COLUMN	1.000	PC																																																																		
VI1855A0	5X25 SELF-TAPPIN G SCREW	2.000	PC																																																																		
VI1875A0	SCREW M5X10 TC1/2T INOX	6.000	PC																																																																		
VM1025A0	Ø16 GREY NYLON LID	2.000	PC																																																																		
VM1695A0	HANDLE POSITION PIN	2.000	PC																																																																		
VM1920A0	INTERNAL GLASS CLOSING RIGHT PLATE	1.000	PC																																																																		
VM1921A0	INTERNAL GLASS CLOSING LEFT PLATE	1.000	PC																																																																		
VM2062A0	L.Miss 46x33 RIGHT UPPER DOOR COLUMN CAP	1.000	PC																																																																		
VM2063A0	L.Miss 46x33 LEFT UPPER DOOR COLUMN CAP	1.000	PC																																																																		
VM2064A0	L.Miss 46x33 RIGHT LOWER DOOR COLUMN CAP	1.000	PC																																																																		
VM2065A0	L.Miss 46x33 LEFT LOWER DOOR COLUMN CAP	1.000	PC																																																																		
VT1060A0	INTERNAL GLASS 515x414x4 L.Miss ARIANN	1.000	PC																																																																		
VT1062A0	LineMiss ARIANNA GREY EXTERNAL GLASS	1.000	PC																																																																		



Зип Общепит

ASM2019C/0.D00 Cooking chamber

vsezip.ru

+7(812)987-08-81

ASM2019C/0.D00 - Cooking chamber

FRONT

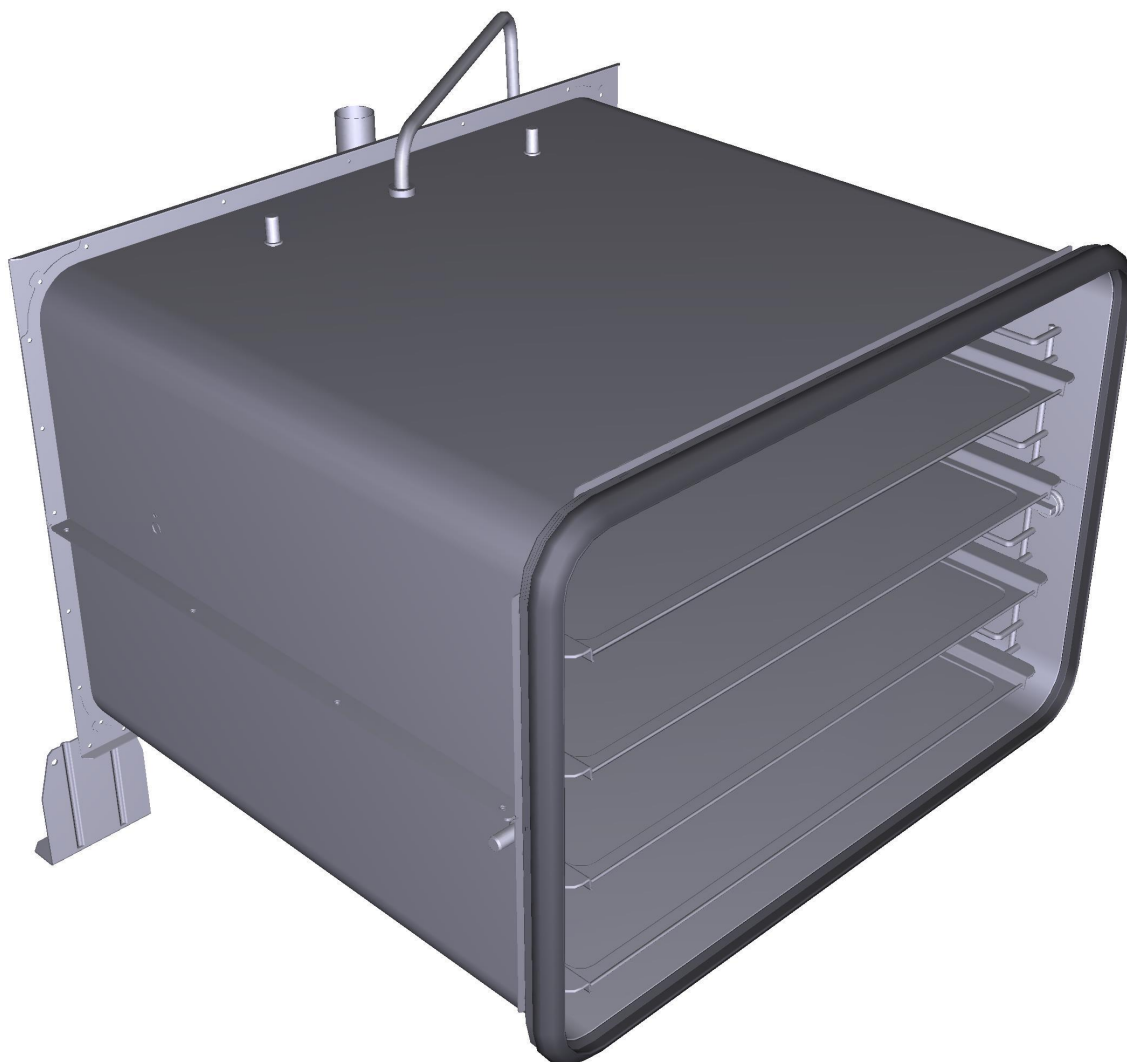



Зип Общепит

ASM2019C/0.D00 Cooking chamber

vsezip.ru

+7(812)987-08-81

ASM2019C/0.D00 - Cooking chamber

REAR

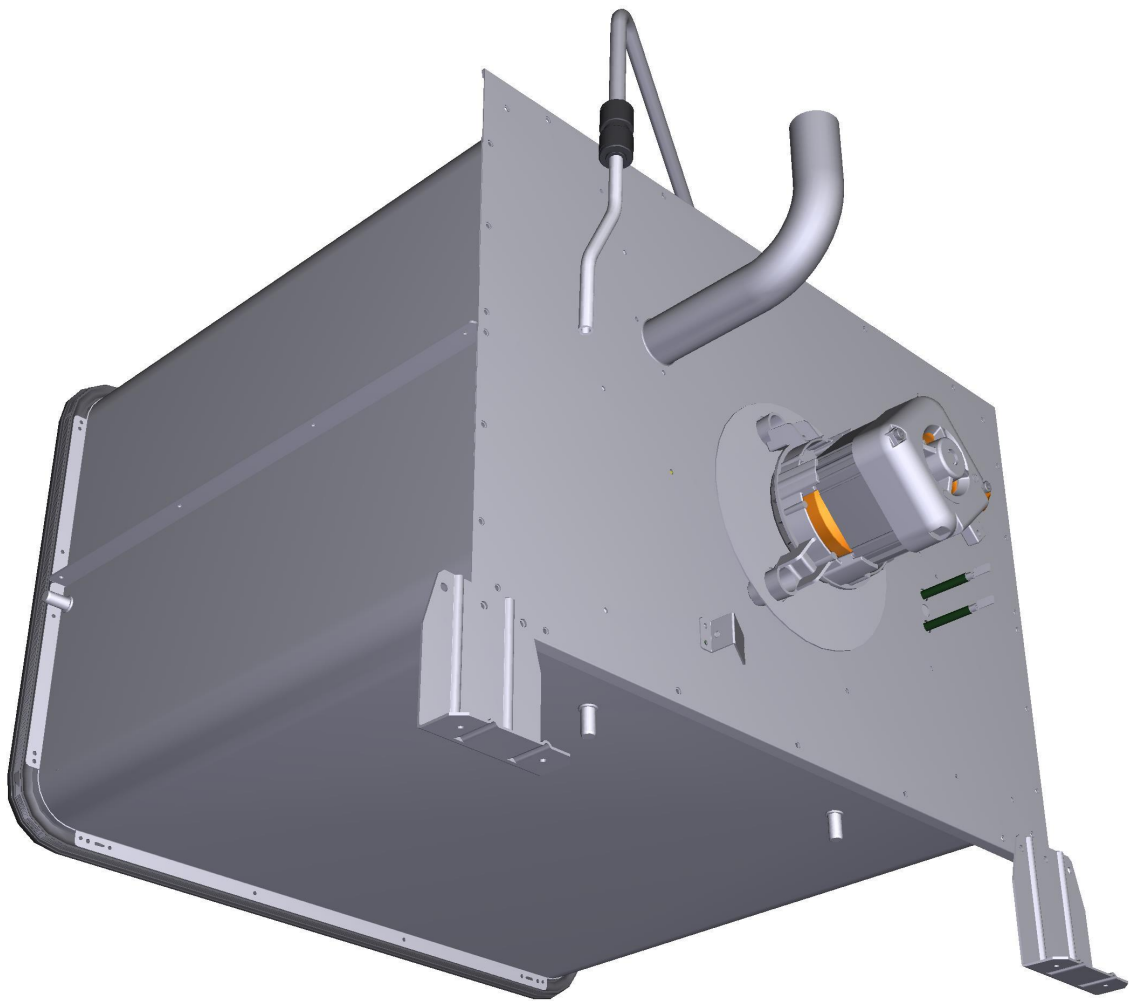







Зип Общепит

ASM2019C/0.D00 Cooking chamber

vsezip.ru

+7(812)987-08-81

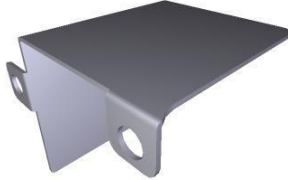
COMPONENT			SPARE PART		
Code	Description	Image	Code	Description	Kit components
0C1079A	EDELSTAHL ECKHALTERUNG INNERE RÜCKWAND		0C1079A1	EDELSTAHL ECKHALTERUNG INNERE RÜCKWAND	
0G1112C	ARIANNA MANUAL FAN GUARD		0G1112C1	ARIANNA MANUAL FAN GUARD	
0G1145A	ARIANNA FAN GUARD SPACER		OUTOFPRODUCTIO	ITEM OUT OF PRODUCTION	
0H1455A	MUFFLE SUPPORT BRACKET		0H1455A2	MUFFLE SUPPORT BRACKET	
0H2090B	ELENA PLATE FOR CHIMNEY FUMES EXIT		0H2090B0	ELENA PLATE FOR CHIMNEY FUMES EXIT	







Зип Общепит

ASM2019C/0.D00 Cooking chamber

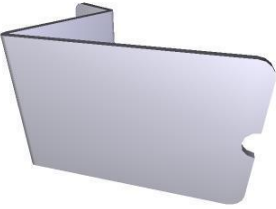
vsezip.ru

+7(812)987-08-81

COMPONENT			SPARE PART										
Code	Description	Image	Code	Description	Kit components								
0H3590A	SAFETY THERMOSTAT BULB FASTENER		0H3590A1	SAFETY THERMOSTAT BULB FASTENER									
0H4820A	BULB HOLDING BRACKET		0H4820A1	BULB HOLDING BRACKET									
0H3020A	MOTOR SHAFT SEALING DISC		0H3020A1	MOTOR SHAFT SEALING DISC									
0H3585A	ZINCED MOTOR GUARD PLATE L.M.		0H3585A0	ZINCED MOTOR GUARD PLATE L.M.									
GN1546A	SHAFT GASKET D8		KG1546A	D=8 MOTOR SHAFT GASKET KIT	<table border="1"> <thead> <tr> <th>Code</th> <th>Description</th> <th>Qty</th> <th>UOM</th> </tr> </thead> <tbody> <tr> <td>GN1546A0</td> <td>SHAFT GASKET D8</td> <td>1.000</td> <td>PC</td> </tr> </tbody> </table>	Code	Description	Qty	UOM	GN1546A0	SHAFT GASKET D8	1.000	PC
Code	Description	Qty	UOM										
GN1546A0	SHAFT GASKET D8	1.000	PC										



Зип Общепит

ASM2019C/0.D00 Cooking chamber

vsezip.ru

+7(812)987-08-81

COMPONENT

SPARE PART

Code	Description	Image	Code	Description	Kit components																												
VI1785A	CHROMIUM PLATED BRASS SCREW M6x12		KVI1785A	M6x12 SCREW 20 PCS. KIT	<table border="1"> <thead> <tr> <th>Code</th> <th>Description</th> <th>Qty</th> <th>UOM</th> </tr> </thead> <tbody> <tr> <td>VI1300A0</td> <td>SCREW M6X12 T1/2T+INOX</td> <td>20.000</td> <td>PC</td> </tr> </tbody> </table>	Code	Description	Qty	UOM	VI1300A0	SCREW M6X12 T1/2T+INOX	20.000	PC																				
Code	Description	Qty	UOM																														
VI1300A0	SCREW M6X12 T1/2T+INOX	20.000	PC																														
VN1035B	LINE MISS 230 VAC MOTOR		KVN1035B	LINEMISS / LINEMICRO MOTOR KIT	<table border="1"> <thead> <tr> <th>Code</th> <th>Description</th> <th>Qty</th> <th>UOM</th> </tr> </thead> <tbody> <tr> <td>GN1270A0</td> <td>13x5.5x0.8 FLAT WASHER</td> <td>3.000</td> <td>PC</td> </tr> <tr> <td>GN1546A0</td> <td>SHAFT GASKET D8</td> <td>1.000</td> <td>PC</td> </tr> <tr> <td>VI1695A0</td> <td>M6x16 H6 CH10 STAINLESS STEEL NUT</td> <td>1.000</td> <td>PC</td> </tr> <tr> <td>VI1700A0</td> <td>18x6.4x1.5 STAINLESS STEEL FLAT WASHER</td> <td>1.000</td> <td>PC</td> </tr> <tr> <td>VI1836A0</td> <td>M6x12 OT63 ROTOR SCRE</td> <td>3.000</td> <td>PC</td> </tr> <tr> <td>VN1035B1</td> <td>LINE MISS 230 VAC MOTOR</td> <td>1.000</td> <td>PC</td> </tr> </tbody> </table>	Code	Description	Qty	UOM	GN1270A0	13x5.5x0.8 FLAT WASHER	3.000	PC	GN1546A0	SHAFT GASKET D8	1.000	PC	VI1695A0	M6x16 H6 CH10 STAINLESS STEEL NUT	1.000	PC	VI1700A0	18x6.4x1.5 STAINLESS STEEL FLAT WASHER	1.000	PC	VI1836A0	M6x12 OT63 ROTOR SCRE	3.000	PC	VN1035B1	LINE MISS 230 VAC MOTOR	1.000	PC
Code	Description	Qty	UOM																														
GN1270A0	13x5.5x0.8 FLAT WASHER	3.000	PC																														
GN1546A0	SHAFT GASKET D8	1.000	PC																														
VI1695A0	M6x16 H6 CH10 STAINLESS STEEL NUT	1.000	PC																														
VI1700A0	18x6.4x1.5 STAINLESS STEEL FLAT WASHER	1.000	PC																														
VI1836A0	M6x12 OT63 ROTOR SCRE	3.000	PC																														
VN1035B1	LINE MISS 230 VAC MOTOR	1.000	PC																														
VN1050A	D=196 H=32 38 BLADES STAINLESS STEEL FAN		KVN1050A	D196 H32 FAN KIT	<table border="1"> <thead> <tr> <th>Code</th> <th>Description</th> <th>Qty</th> <th>UOM</th> </tr> </thead> <tbody> <tr> <td>VI1695A0</td> <td>M6x16 H6 CH10 STAINLESS STEEL NUT</td> <td>1.000</td> <td>PC</td> </tr> <tr> <td>VI1700A0</td> <td>18x6.4x1.5 STAINLESS STEEL FLAT WASHER</td> <td>1.000</td> <td>PC</td> </tr> <tr> <td>VN1050A2</td> <td>D=196 H=32 38 BLADES STAINLESS STEEL FAN</td> <td>1.000</td> <td>PC</td> </tr> </tbody> </table>	Code	Description	Qty	UOM	VI1695A0	M6x16 H6 CH10 STAINLESS STEEL NUT	1.000	PC	VI1700A0	18x6.4x1.5 STAINLESS STEEL FLAT WASHER	1.000	PC	VN1050A2	D=196 H=32 38 BLADES STAINLESS STEEL FAN	1.000	PC												
Code	Description	Qty	UOM																														
VI1695A0	M6x16 H6 CH10 STAINLESS STEEL NUT	1.000	PC																														
VI1700A0	18x6.4x1.5 STAINLESS STEEL FLAT WASHER	1.000	PC																														
VN1050A2	D=196 H=32 38 BLADES STAINLESS STEEL FAN	1.000	PC																														
RS1130A	D=230 3 TURNS 2900W HEATING ELEMENT		KRS1130A	2,9 Kw HEATING ELEMENT KIT	<table border="1"> <thead> <tr> <th>Code</th> <th>Description</th> <th>Qty</th> <th>UOM</th> </tr> </thead> <tbody> <tr> <td>GN1327A0</td> <td>HEATING ELEMENT GASKET</td> <td>1.000</td> <td>PC</td> </tr> <tr> <td>RS1130A0</td> <td>D=230 3 TURNS 2900W HEATING ELEMENT</td> <td>1.000</td> <td>PC</td> </tr> <tr> <td>SL1045A0</td> <td>S57 BLACK SILICONE - 80ml CARTRIDGE</td> <td>1.000</td> <td>PC</td> </tr> </tbody> </table>	Code	Description	Qty	UOM	GN1327A0	HEATING ELEMENT GASKET	1.000	PC	RS1130A0	D=230 3 TURNS 2900W HEATING ELEMENT	1.000	PC	SL1045A0	S57 BLACK SILICONE - 80ml CARTRIDGE	1.000	PC												
Code	Description	Qty	UOM																														
GN1327A0	HEATING ELEMENT GASKET	1.000	PC																														
RS1130A0	D=230 3 TURNS 2900W HEATING ELEMENT	1.000	PC																														
SL1045A0	S57 BLACK SILICONE - 80ml CARTRIDGE	1.000	PC																														



Зип Общепит





ASM2019C/0.D00 Cooking chamber

vsezip.ru

+7(812)987-08-81

COMPONENT

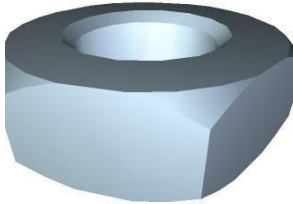
SPARE PART

Code	Description	Image	Code	Description	Kit components																
RS1130A	D=230 3 TURNS 2900W HEATING ELEMENT		KRS1130A	2,9 Kw HEATING ELEMENT KIT	<table border="1"> <thead> <tr> <th>Code</th> <th>Description</th> <th>Qty</th> <th>UOM</th> </tr> </thead> <tbody> <tr> <td>VI1220A1</td> <td>4,2x12 TCB SELF-TAPPIN G SCREW</td> <td>5.000</td> <td>PC</td> </tr> <tr> <td>VM1794A0</td> <td>250x4.8 PA66 BLACK CLAMP</td> <td>2.000</td> <td>PC</td> </tr> <tr> <td>VM2103A0</td> <td>CLAMP LOCK</td> <td>2.000</td> <td>PC</td> </tr> </tbody> </table>	Code	Description	Qty	UOM	VI1220A1	4,2x12 TCB SELF-TAPPIN G SCREW	5.000	PC	VM1794A0	250x4.8 PA66 BLACK CLAMP	2.000	PC	VM2103A0	CLAMP LOCK	2.000	PC
Code	Description	Qty	UOM																		
VI1220A1	4,2x12 TCB SELF-TAPPIN G SCREW	5.000	PC																		
VM1794A0	250x4.8 PA66 BLACK CLAMP	2.000	PC																		
VM2103A0	CLAMP LOCK	2.000	PC																		
0H1990A	EXTERNAL WATER PIPE + RC1165A0		K0H1990A	WATER PIPE + JOINT RC1165A KIT	<table border="1"> <thead> <tr> <th>Code</th> <th>Description</th> <th>Qty</th> <th>UOM</th> </tr> </thead> <tbody> <tr> <td>0H1990A1</td> <td>EXTERNAL WATER PIPE + RC1165A0</td> <td>1.000</td> <td>PC</td> </tr> </tbody> </table>	Code	Description	Qty	UOM	0H1990A1	EXTERNAL WATER PIPE + RC1165A0	1.000	PC								
Code	Description	Qty	UOM																		
0H1990A1	EXTERNAL WATER PIPE + RC1165A0	1.000	PC																		
EL1055A	Ø10 - Ø8 INT. REDUCTION - USE PM201008E		KEL1055A	Ø10-Ø8 JG REDUCTION 10 PCS KIT	<table border="1"> <thead> <tr> <th>Code</th> <th>Description</th> <th>Qty</th> <th>UOM</th> </tr> </thead> <tbody> <tr> <td>EL1055A0</td> <td>Ø10 - Ø8 INT. REDUCTION - USE PM201008</td> <td>10.000</td> <td>PC</td> </tr> </tbody> </table>	Code	Description	Qty	UOM	EL1055A0	Ø10 - Ø8 INT. REDUCTION - USE PM201008	10.000	PC								
Code	Description	Qty	UOM																		
EL1055A0	Ø10 - Ø8 INT. REDUCTION - USE PM201008	10.000	PC																		
RC1170A	M14 H=7 CH=22 STAINLESS STEEL NUT		KRC1170A	M14 H8 CH22 NUT - 10 PCS. KIT	<table border="1"> <thead> <tr> <th>Code</th> <th>Description</th> <th>Qty</th> <th>UOM</th> </tr> </thead> <tbody> <tr> <td>RC1170A1</td> <td>M14 H=7 CH=22 STAINLESS STEEL NUT</td> <td>10.000</td> <td>PC</td> </tr> </tbody> </table>	Code	Description	Qty	UOM	RC1170A1	M14 H=7 CH=22 STAINLESS STEEL NUT	10.000	PC								
Code	Description	Qty	UOM																		
RC1170A1	M14 H=7 CH=22 STAINLESS STEEL NUT	10.000	PC																		
TB2034A	L.MISS WATER SYSTEM - TB1815A		KTB2597A	Ø8 TRANSPARENT WATER PIPE 150 M KIT	<table border="1"> <thead> <tr> <th>Code</th> <th>Description</th> <th>Qty</th> <th>UOM</th> </tr> </thead> <tbody> <tr> <td>TB1815A0</td> <td>7,93x4,75 PE TRANSP. PIPE (JG #PE08100N)</td> <td>150.000</td> <td>M</td> </tr> </tbody> </table>	Code	Description	Qty	UOM	TB1815A0	7,93x4,75 PE TRANSP. PIPE (JG #PE08100N)	150.000	M								
Code	Description	Qty	UOM																		
TB1815A0	7,93x4,75 PE TRANSP. PIPE (JG #PE08100N)	150.000	M																		
			KTB2529A	Ø8 TRANSPARENT HUMIDITY PIPE 2 M KIT	<table border="1"> <thead> <tr> <th>Code</th> <th>Description</th> <th>Qty</th> <th>UOM</th> </tr> </thead> <tbody> <tr> <td>TB1815A0</td> <td>7,93x4,75 PE TRANSP. PIPE (JG #PE08100N)</td> <td>2.000</td> <td>M</td> </tr> </tbody> </table>	Code	Description	Qty	UOM	TB1815A0	7,93x4,75 PE TRANSP. PIPE (JG #PE08100N)	2.000	M								
Code	Description	Qty	UOM																		
TB1815A0	7,93x4,75 PE TRANSP. PIPE (JG #PE08100N)	2.000	M																		







Зип Общепит

ASM2019C/0.D00 Cooking chamber

vsezip.ru

+7(812)987-08-81

COMPONENT			SPARE PART										
Code	Description	Image	Code	Description	Kit components								
TB2034A	L.MISS WATER SYSTEM - TB1815A		KTB1959A	Ø8 TB1815 TRANSPARENT PIPE 5M KIT	<table border="1"> <thead> <tr> <th>Code</th> <th>Description</th> <th>Qty</th> <th>UOM</th> </tr> </thead> <tbody> <tr> <td>TB1815A0</td> <td>7,93x4,75 PE TRANSP. PIPE (JG #PE08100N)</td> <td>5.000</td> <td>M</td> </tr> </tbody> </table>	Code	Description	Qty	UOM	TB1815A0	7,93x4,75 PE TRANSP. PIPE (JG #PE08100N)	5.000	M
Code	Description	Qty	UOM										
TB1815A0	7,93x4,75 PE TRANSP. PIPE (JG #PE08100N)	5.000	M										
TB1062A	ARIANNA INTERNAL HUMIDITY PIPE D16X1		TB1062A0	ARIANNA INTERNAL HUMIDITY PIPE D16X1									
GN1352A	L.M. TOUCH ARIANNA DOOR GASKET - GN1110A		KG1352A	LM ARIANNA/BT CABINET DOOR GASKET KIT	<table border="1"> <thead> <tr> <th>Code</th> <th>Description</th> <th>Qty</th> <th>UOM</th> </tr> </thead> <tbody> <tr> <td>GN1110A2</td> <td>Line Miss/XVC105-0 55/XK/XL DOOR GASKE</td> <td>1.630</td> <td>M</td> </tr> </tbody> </table>	Code	Description	Qty	UOM	GN1110A2	Line Miss/XVC105-0 55/XK/XL DOOR GASKE	1.630	M
Code	Description	Qty	UOM										
GN1110A2	Line Miss/XVC105-0 55/XK/XL DOOR GASKE	1.630	M										
GRL1010A	Arianna LineMiss RIGHT/LEFT LATERAL GRID		KGRL1010A	R/L CHROM. PLATED LATERAL SUPP KIT	<table border="1"> <thead> <tr> <th>Code</th> <th>Description</th> <th>Qty</th> <th>UOM</th> </tr> </thead> <tbody> <tr> <td>GRL1010A2</td> <td>Arianna LineMiss RIGHT/LEFT LATERAL GRID</td> <td>2.000</td> <td>PC</td> </tr> </tbody> </table>	Code	Description	Qty	UOM	GRL1010A2	Arianna LineMiss RIGHT/LEFT LATERAL GRID	2.000	PC
Code	Description	Qty	UOM										
GRL1010A2	Arianna LineMiss RIGHT/LEFT LATERAL GRID	2.000	PC										
TB2120B	LINE MISS 600 EXHAUST CHIMNEY Ø30X1		TB2120B0	LINE MISS 600 EXHAUST CHIMNEY Ø30X1									



Зип Общепит

ASM2019C/0.D00 Cooking chamber

vsezip.ru

+7(812)987-08-81

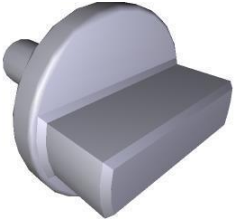
COMPONENT			SPARE PART										
Code	Description	Image	Code	Description	Kit components								
VM1815A	LATERAL SUPPORTS FIXING BOLT		KVM1815A	MISS/MICRO/S4/S3 THUMB SCREW 10 PCS KIT	<table border="1"> <thead> <tr> <th>Code</th> <th>Description</th> <th>Qty</th> <th>UOM</th> </tr> </thead> <tbody> <tr> <td>VM1815A0</td> <td>LATERAL SUPPORTS FIXING BOLT</td> <td>10.000</td> <td>PC</td> </tr> </tbody> </table>	Code	Description	Qty	UOM	VM1815A0	LATERAL SUPPORTS FIXING BOLT	10.000	PC
Code	Description	Qty	UOM										
VM1815A0	LATERAL SUPPORTS FIXING BOLT	10.000	PC										



Зип Общепит **ASM2020D/0.D02 External cover**

vsezip.ru

+7(812)987-08-81

ASM2020D/0.D02 - External cover

FRONT

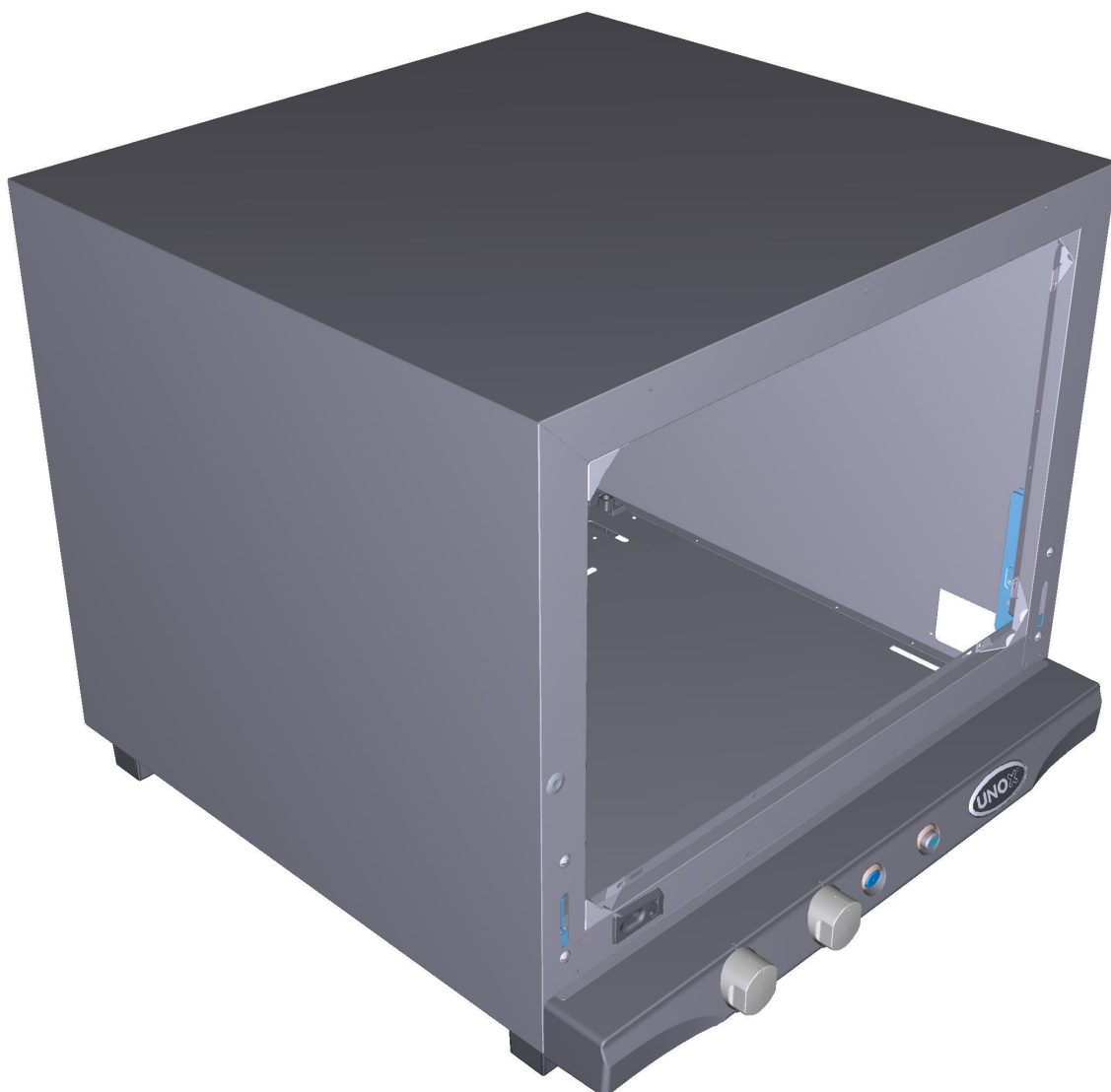



Зип Общепит **ASM2020D/0.D02 External cover**

vsezip.ru

+7(812)987-08-81



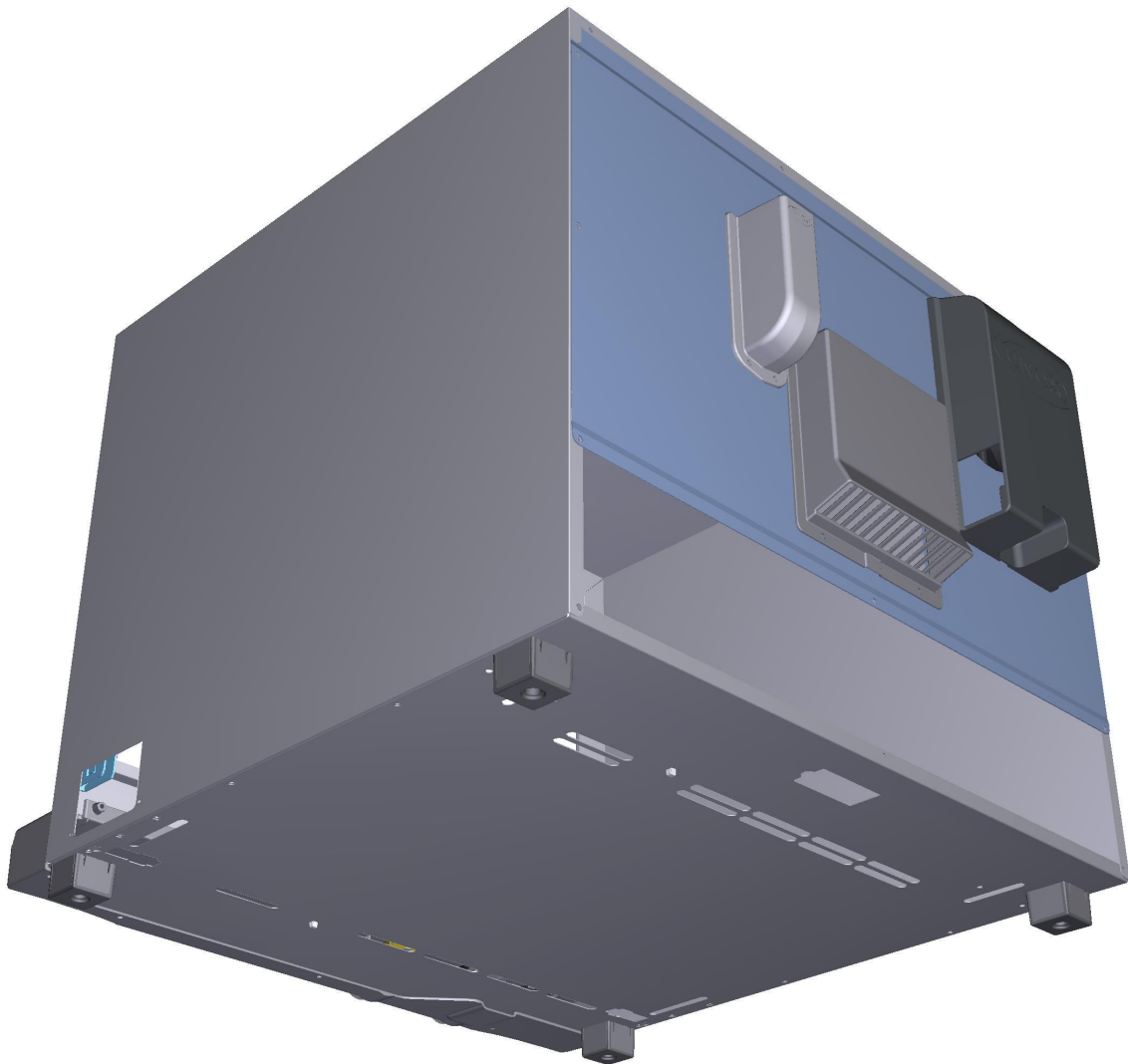

ASM2020D/0.D02 - External cover

REAR



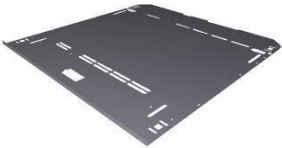

+7(812)987-08-81



COMPONENT			SPARE PART		
Code	Description	Image	Code	Description	Kit components
0D1275C	LM ARIANNA EXTERNAL CASING		0D1275C0	LM ARIANNA EXTERNAL CASING	
0D1295B	LM 600 FRONT LOWER PROFILE		0D1295B0	LM 600 FRONT LOWER PROFILE	
0E1075E	LM 600 EXTERNAL BOTTOM PANEL		0E1075E0	LM 600 EXTERNAL BOTTOM PANEL	
0F1085C	L.MISS ARIANNA BACK PANEL		0F1085C0	L.MISS ARIANNA BACK PANEL	
0H1450A	XB-XV-XG ST. STEEL MUFFLE FRONT CORNER		OUTOFPRODUCTIO	ITEM OUT OF PRODUCTION	



Зип Общепит ASM2020D/0.D02 External cover



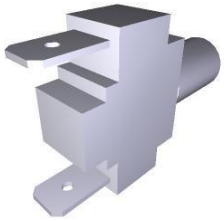
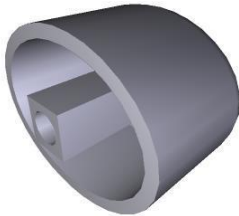

vsezip.ru

+7(812)987-08-81

COMPONENT			SPARE PART																		
Code	Description	Image	Code	Description	Kit components																
VE1562A	UNIPOLAR NA PUSH BUTTON		KVE0107A	SILVER CLOUD KEY KIT	<table border="1"> <thead> <tr> <th>Code</th> <th>Description</th> <th>Qty</th> <th>UOM</th> </tr> </thead> <tbody> <tr> <td>VE1170A0</td> <td>D16 OPAQUE NICKEL ELLIPTICAL SUPPORT</td> <td>2.000</td> <td>PC</td> </tr> <tr> <td>VE1562A0</td> <td>UNIPOLAR NA PUSH BUTTO</td> <td>1.000</td> <td>PC</td> </tr> <tr> <td>VM1775A0</td> <td>OPAQUE SILVER KEY WITH GOLD CLOUD</td> <td>1.000</td> <td>PC</td> </tr> </tbody> </table>	Code	Description	Qty	UOM	VE1170A0	D16 OPAQUE NICKEL ELLIPTICAL SUPPORT	2.000	PC	VE1562A0	UNIPOLAR NA PUSH BUTTO	1.000	PC	VM1775A0	OPAQUE SILVER KEY WITH GOLD CLOUD	1.000	PC
					Code	Description	Qty	UOM													
VE1170A0	D16 OPAQUE NICKEL ELLIPTICAL SUPPORT	2.000	PC																		
VE1562A0	UNIPOLAR NA PUSH BUTTO	1.000	PC																		
VM1775A0	OPAQUE SILVER KEY WITH GOLD CLOUD	1.000	PC																		
<table border="1"> <thead> <tr> <th>Code</th> <th>Description</th> <th>Qty</th> <th>UOM</th> </tr> </thead> <tbody> <tr> <td>VE1170A0</td> <td>D16 OPAQUE NICKEL ELLIPTICAL SUPPORT</td> <td>1.000</td> <td>PC</td> </tr> <tr> <td>VE1562A0</td> <td>UNIPOLAR NA PUSH BUTTO</td> <td>1.000</td> <td>PC</td> </tr> <tr> <td>VM1774A0</td> <td>SILVER OPAQUE KEY W/ GOLD FLAME</td> <td>1.000</td> <td>PC</td> </tr> </tbody> </table>	Code	Description	Qty	UOM	VE1170A0	D16 OPAQUE NICKEL ELLIPTICAL SUPPORT	1.000	PC	VE1562A0	UNIPOLAR NA PUSH BUTTO	1.000	PC	VM1774A0	SILVER OPAQUE KEY W/ GOLD FLAME	1.000	PC					
Code	Description	Qty	UOM																		
VE1170A0	D16 OPAQUE NICKEL ELLIPTICAL SUPPORT	1.000	PC																		
VE1562A0	UNIPOLAR NA PUSH BUTTO	1.000	PC																		
VM1774A0	SILVER OPAQUE KEY W/ GOLD FLAME	1.000	PC																		
VM1775A	OPAQUE SILVER KEY WITH GOLD CLOUD		KVE0107A	SILVER CLOUD KEY KIT	<table border="1"> <thead> <tr> <th>Code</th> <th>Description</th> <th>Qty</th> <th>UOM</th> </tr> </thead> <tbody> <tr> <td>VE1170A0</td> <td>D16 OPAQUE NICKEL ELLIPTICAL SUPPORT</td> <td>2.000</td> <td>PC</td> </tr> <tr> <td>VE1562A0</td> <td>UNIPOLAR NA PUSH BUTTO</td> <td>1.000</td> <td>PC</td> </tr> <tr> <td>VM1775A0</td> <td>OPAQUE SILVER KEY WITH GOLD CLOUD</td> <td>1.000</td> <td>PC</td> </tr> </tbody> </table>	Code	Description	Qty	UOM	VE1170A0	D16 OPAQUE NICKEL ELLIPTICAL SUPPORT	2.000	PC	VE1562A0	UNIPOLAR NA PUSH BUTTO	1.000	PC	VM1775A0	OPAQUE SILVER KEY WITH GOLD CLOUD	1.000	PC
					Code	Description	Qty	UOM													
VE1170A0	D16 OPAQUE NICKEL ELLIPTICAL SUPPORT	2.000	PC																		
VE1562A0	UNIPOLAR NA PUSH BUTTO	1.000	PC																		
VM1775A0	OPAQUE SILVER KEY WITH GOLD CLOUD	1.000	PC																		
<table border="1"> <thead> <tr> <th>Code</th> <th>Description</th> <th>Qty</th> <th>UOM</th> </tr> </thead> <tbody> <tr> <td>MN1090B1</td> <td>0-60 MIN TIMER KNOB</td> <td>1.000</td> <td>PC</td> </tr> </tbody> </table>	Code	Description	Qty	UOM	MN1090B1	0-60 MIN TIMER KNOB	1.000	PC													
Code	Description	Qty	UOM																		
MN1090B1	0-60 MIN TIMER KNOB	1.000	PC																		
MN1090B	0-60 MIN TIMER KNOB		KMN1090B	LINEMISS 0-60MIN TIMER KNOB KIT	<table border="1"> <thead> <tr> <th>Code</th> <th>Description</th> <th>Qty</th> <th>UOM</th> </tr> </thead> <tbody> <tr> <td>MN1090B1</td> <td>0-60 MIN TIMER KNOB</td> <td>1.000</td> <td>PC</td> </tr> </tbody> </table>	Code	Description	Qty	UOM	MN1090B1	0-60 MIN TIMER KNOB	1.000	PC								
Code	Description	Qty	UOM																		
MN1090B1	0-60 MIN TIMER KNOB	1.000	PC																		

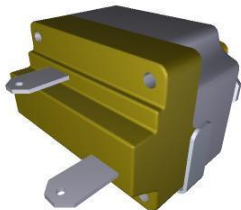
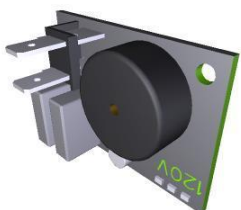

+7(812)987-08-81



COMPONENT			SPARE PART																						
Code	Description	Image	Code	Description	Kit components																				
TM1005A	MI2 60 MIN 250V 16A TIMER		KTM1005A	60 MIN TIMER KIT	<table border="1"> <thead> <tr> <th>Code</th> <th>Description</th> <th>Qty</th> <th>UOM</th> </tr> </thead> <tbody> <tr> <td>TM1005A0</td> <td>MI2 60 MIN 250V 16A TIME</td> <td>1.000</td> <td>PC</td> </tr> <tr> <td>VI1850A0</td> <td>TCB M4x6 SCREW</td> <td>2.000</td> <td>PC</td> </tr> </tbody> </table>	Code	Description	Qty	UOM	TM1005A0	MI2 60 MIN 250V 16A TIME	1.000	PC	VI1850A0	TCB M4x6 SCREW	2.000	PC								
					Code	Description	Qty	UOM																	
TM1005A0	MI2 60 MIN 250V 16A TIME	1.000	PC																						
VI1850A0	TCB M4x6 SCREW	2.000	PC																						
<table border="1"> <thead> <tr> <th>Code</th> <th>Description</th> <th>Qty</th> <th>UOM</th> </tr> </thead> <tbody> <tr> <td>MN1091B1</td> <td>80-260 °C THERMOSTAT KNOB</td> <td>1.000</td> <td>PC</td> </tr> </tbody> </table>	Code	Description	Qty	UOM	MN1091B1	80-260 °C THERMOSTAT KNOB	1.000	PC																	
Code	Description	Qty	UOM																						
MN1091B1	80-260 °C THERMOSTAT KNOB	1.000	PC																						
MN1091B	80-260 °C THERMOSTAT KNO		KMN1091B	THERMOSTAT 80-260 °C KNOB KIT	<table border="1"> <thead> <tr> <th>Code</th> <th>Description</th> <th>Qty</th> <th>UOM</th> </tr> </thead> <tbody> <tr> <td>MN1091B1</td> <td>80-260 °C THERMOSTAT KNOB</td> <td>1.000</td> <td>PC</td> </tr> </tbody> </table>	Code	Description	Qty	UOM	MN1091B1	80-260 °C THERMOSTAT KNOB	1.000	PC												
					Code	Description	Qty	UOM																	
MN1091B1	80-260 °C THERMOSTAT KNOB	1.000	PC																						
<table border="1"> <thead> <tr> <th>Code</th> <th>Description</th> <th>Qty</th> <th>UOM</th> </tr> </thead> <tbody> <tr> <td>TR1100A0</td> <td>269 °C 55.19052.80 ADJUSTABLE THERMOSTAT</td> <td>1.000</td> <td>PC</td> </tr> <tr> <td>VI1850A0</td> <td>TCB M4x6 SCREW</td> <td>2.000</td> <td>PC</td> </tr> </tbody> </table>	Code	Description	Qty	UOM	TR1100A0	269 °C 55.19052.80 ADJUSTABLE THERMOSTAT	1.000	PC	VI1850A0	TCB M4x6 SCREW	2.000	PC													
Code	Description	Qty	UOM																						
TR1100A0	269 °C 55.19052.80 ADJUSTABLE THERMOSTAT	1.000	PC																						
VI1850A0	TCB M4x6 SCREW	2.000	PC																						
TR1100A	269 °C 55.19052.80 ADJUSTABLE THERMOSTAT		KTR1100A	269 °C THERMOSTAT KIT	<table border="1"> <thead> <tr> <th>Code</th> <th>Description</th> <th>Qty</th> <th>UOM</th> </tr> </thead> <tbody> <tr> <td>TR1100A0</td> <td>269 °C 55.19052.80 ADJUSTABLE THERMOSTAT</td> <td>1.000</td> <td>PC</td> </tr> <tr> <td>VI1850A0</td> <td>TCB M4x6 SCREW</td> <td>2.000</td> <td>PC</td> </tr> </tbody> </table>	Code	Description	Qty	UOM	TR1100A0	269 °C 55.19052.80 ADJUSTABLE THERMOSTAT	1.000	PC	VI1850A0	TCB M4x6 SCREW	2.000	PC								
					Code	Description	Qty	UOM																	
TR1100A0	269 °C 55.19052.80 ADJUSTABLE THERMOSTAT	1.000	PC																						
VI1850A0	TCB M4x6 SCREW	2.000	PC																						
<table border="1"> <thead> <tr> <th>Code</th> <th>Description</th> <th>Qty</th> <th>UOM</th> </tr> </thead> <tbody> <tr> <td>TM1001C3</td> <td>15 SEC 120/240V BUZZER KIT</td> <td>1.000</td> <td>PC</td> </tr> <tr> <td>VI1220A1</td> <td>4,2x12 TCB SELF-TAPPIN G SCREW</td> <td>3.000</td> <td>PC</td> </tr> <tr> <td>VI1850A0</td> <td>TCB M4x6 SCREW</td> <td>3.000</td> <td>PC</td> </tr> <tr> <td>VM1745A0</td> <td>CARD SUPPORT</td> <td>3.000</td> <td>PC</td> </tr> </tbody> </table>	Code	Description	Qty	UOM	TM1001C3	15 SEC 120/240V BUZZER KIT	1.000	PC	VI1220A1	4,2x12 TCB SELF-TAPPIN G SCREW	3.000	PC	VI1850A0	TCB M4x6 SCREW	3.000	PC	VM1745A0	CARD SUPPORT	3.000	PC					
Code	Description	Qty	UOM																						
TM1001C3	15 SEC 120/240V BUZZER KIT	1.000	PC																						
VI1220A1	4,2x12 TCB SELF-TAPPIN G SCREW	3.000	PC																						
VI1850A0	TCB M4x6 SCREW	3.000	PC																						
VM1745A0	CARD SUPPORT	3.000	PC																						
TM1001C	15 SEC 120V ELECTRONIC BUZZE		KTM1001C	15 SEC BUZZER KIT	<table border="1"> <thead> <tr> <th>Code</th> <th>Description</th> <th>Qty</th> <th>UOM</th> </tr> </thead> <tbody> <tr> <td>TM1001C3</td> <td>15 SEC 120/240V BUZZER KIT</td> <td>1.000</td> <td>PC</td> </tr> <tr> <td>VI1220A1</td> <td>4,2x12 TCB SELF-TAPPIN G SCREW</td> <td>3.000</td> <td>PC</td> </tr> <tr> <td>VI1850A0</td> <td>TCB M4x6 SCREW</td> <td>3.000</td> <td>PC</td> </tr> <tr> <td>VM1745A0</td> <td>CARD SUPPORT</td> <td>3.000</td> <td>PC</td> </tr> </tbody> </table>	Code	Description	Qty	UOM	TM1001C3	15 SEC 120/240V BUZZER KIT	1.000	PC	VI1220A1	4,2x12 TCB SELF-TAPPIN G SCREW	3.000	PC	VI1850A0	TCB M4x6 SCREW	3.000	PC	VM1745A0	CARD SUPPORT	3.000	PC
					Code	Description	Qty	UOM																	
TM1001C3	15 SEC 120/240V BUZZER KIT	1.000	PC																						
VI1220A1	4,2x12 TCB SELF-TAPPIN G SCREW	3.000	PC																						
VI1850A0	TCB M4x6 SCREW	3.000	PC																						
VM1745A0	CARD SUPPORT	3.000	PC																						
<table border="1"> <thead> <tr> <th>Code</th> <th>Description</th> <th>Qty</th> <th>UOM</th> </tr> </thead> <tbody> <tr> <td>ED1070A</td> <td>78x33 UNOX LOGO STICKER</td> <td>10</td> <td>PCS. KI</td> </tr> </tbody> </table>	Code	Description	Qty	UOM	ED1070A	78x33 UNOX LOGO STICKER	10	PCS. KI																	
Code	Description	Qty	UOM																						
ED1070A	78x33 UNOX LOGO STICKER	10	PCS. KI																						
ED1070A	78x33 UNOX LOGO STICKER		KED1070A	UNOX LOGO STICKER 10 PCS. KI																					



Зип Общепит ASM2020D/0.D02 External cover

vsezip.ru

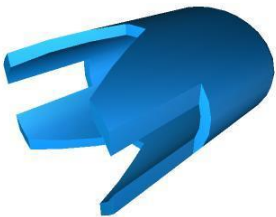
+7(812)987-08-81

COMPONENT			SPARE PART																										
Code	Description	Image	Code	Description	Kit components																								
VE1530A	GOLD THERMOMETER BLUE LIGHT COVER		KLP1012A	GOLDEN THERMOMETER BLUE LIGHT KIT	<table border="1"> <thead> <tr> <th>Code</th> <th>Description</th> <th>Qty</th> <th>UOM</th> </tr> </thead> <tbody> <tr> <td>VE1170A0</td> <td>D16 OPAQUE NICKEL ELLIPTICAL SUPPORT</td> <td>1.000</td> <td>PC</td> </tr> <tr> <td>VE1530A0</td> <td>GOLD THERMOMETE R BLUE LIGHT COVER</td> <td>1.000</td> <td>PC</td> </tr> <tr> <td>VE1535A1</td> <td>230V WHITE LED</td> <td>1.000</td> <td>PC</td> </tr> <tr> <td>VM1762A0</td> <td>INNER LAMP SUPPORT</td> <td>1.000</td> <td>PC</td> </tr> <tr> <td>VM2009A0</td> <td>D16 SILVER ELLIPTICAL SUPPORT</td> <td>1.000</td> <td>PC</td> </tr> </tbody> </table>	Code	Description	Qty	UOM	VE1170A0	D16 OPAQUE NICKEL ELLIPTICAL SUPPORT	1.000	PC	VE1530A0	GOLD THERMOMETE R BLUE LIGHT COVER	1.000	PC	VE1535A1	230V WHITE LED	1.000	PC	VM1762A0	INNER LAMP SUPPORT	1.000	PC	VM2009A0	D16 SILVER ELLIPTICAL SUPPORT	1.000	PC
Code	Description	Qty	UOM																										
VE1170A0	D16 OPAQUE NICKEL ELLIPTICAL SUPPORT	1.000	PC																										
VE1530A0	GOLD THERMOMETE R BLUE LIGHT COVER	1.000	PC																										
VE1535A1	230V WHITE LED	1.000	PC																										
VM1762A0	INNER LAMP SUPPORT	1.000	PC																										
VM2009A0	D16 SILVER ELLIPTICAL SUPPORT	1.000	PC																										
VE1535A	230V WHITE LED		KVE1535A	LED LIGHT 1 PC KIT	<table border="1"> <thead> <tr> <th>Code</th> <th>Description</th> <th>Qty</th> <th>UOM</th> </tr> </thead> <tbody> <tr> <td>VE1535A1</td> <td>230V WHITE LED</td> <td>1.000</td> <td>PC</td> </tr> </tbody> </table>	Code	Description	Qty	UOM	VE1535A1	230V WHITE LED	1.000	PC																
Code	Description	Qty	UOM																										
VE1535A1	230V WHITE LED	1.000	PC																										
			KVE0105A	CLOUD LED LIGHT+COVER+SUP PORT KIT	<table border="1"> <thead> <tr> <th>Code</th> <th>Description</th> <th>Qty</th> <th>UOM</th> </tr> </thead> <tbody> <tr> <td>VE1170A0</td> <td>D16 OPAQUE NICKEL ELLIPTICAL SUPPORT</td> <td>1.000</td> <td>PC</td> </tr> <tr> <td>VE1535A1</td> <td>230V WHITE LED</td> <td>1.000</td> <td>PC</td> </tr> <tr> <td>VM1762A0</td> <td>INNER LAMP SUPPORT</td> <td>1.000</td> <td>PC</td> </tr> <tr> <td>VM1903A0</td> <td>GREEN PILOT WITH GOLD "CLOUD"</td> <td>1.000</td> <td>PC</td> </tr> </tbody> </table>	Code	Description	Qty	UOM	VE1170A0	D16 OPAQUE NICKEL ELLIPTICAL SUPPORT	1.000	PC	VE1535A1	230V WHITE LED	1.000	PC	VM1762A0	INNER LAMP SUPPORT	1.000	PC	VM1903A0	GREEN PILOT WITH GOLD "CLOUD"	1.000	PC				
Code	Description	Qty	UOM																										
VE1170A0	D16 OPAQUE NICKEL ELLIPTICAL SUPPORT	1.000	PC																										
VE1535A1	230V WHITE LED	1.000	PC																										
VM1762A0	INNER LAMP SUPPORT	1.000	PC																										
VM1903A0	GREEN PILOT WITH GOLD "CLOUD"	1.000	PC																										
			KVE0104A	NEUTRAL GREEN LIGHT KIT	<table border="1"> <thead> <tr> <th>Code</th> <th>Description</th> <th>Qty</th> <th>UOM</th> </tr> </thead> <tbody> <tr> <td>VE1170A0</td> <td>D16 OPAQUE NICKEL ELLIPTICAL SUPPORT</td> <td>1.000</td> <td>PC</td> </tr> <tr> <td>VE1535A1</td> <td>230V WHITE LED</td> <td>1.000</td> <td>PC</td> </tr> <tr> <td>VM1762A0</td> <td>INNER LAMP SUPPORT</td> <td>1.000</td> <td>PC</td> </tr> <tr> <td>VM1902A0</td> <td>NEUTRAL GREEN PLASTIC COVER FOR</td> <td>1.000</td> <td>PC</td> </tr> </tbody> </table>	Code	Description	Qty	UOM	VE1170A0	D16 OPAQUE NICKEL ELLIPTICAL SUPPORT	1.000	PC	VE1535A1	230V WHITE LED	1.000	PC	VM1762A0	INNER LAMP SUPPORT	1.000	PC	VM1902A0	NEUTRAL GREEN PLASTIC COVER FOR	1.000	PC				
Code	Description	Qty	UOM																										
VE1170A0	D16 OPAQUE NICKEL ELLIPTICAL SUPPORT	1.000	PC																										
VE1535A1	230V WHITE LED	1.000	PC																										
VM1762A0	INNER LAMP SUPPORT	1.000	PC																										
VM1902A0	NEUTRAL GREEN PLASTIC COVER FOR	1.000	PC																										
			KVE0102A	GOLDEN FLAME LIGHT COVER KIT	<table border="1"> <thead> <tr> <th>Code</th> <th>Description</th> <th>Qty</th> <th>UOM</th> </tr> </thead> <tbody> <tr> <td>VE1170A0</td> <td>D16 OPAQUE NICKEL ELLIPTICAL SUPPORT</td> <td>1.000</td> <td>PC</td> </tr> </tbody> </table>	Code	Description	Qty	UOM	VE1170A0	D16 OPAQUE NICKEL ELLIPTICAL SUPPORT	1.000	PC																
Code	Description	Qty	UOM																										
VE1170A0	D16 OPAQUE NICKEL ELLIPTICAL SUPPORT	1.000	PC																										



Зип Общепит ASM2020D/0.D02 External cover

vsezip.ru

+7(812)987-08-81

COMPONENT

SPARE PART

Code	Description	Image	Code	Description	Kit components																									
VE1535A	230V WHITE LED		KVE0102A	GOLDEN FLAME LIGHT COVER KIT	<table border="1"> <thead> <tr> <th>Code</th> <th>Description</th> <th>Qty</th> <th>UOM</th> </tr> </thead> <tbody> <tr> <td>VE1535A1</td> <td>230V WHITE LED</td> <td>1.000</td> <td>PC</td> </tr> <tr> <td>VM1762A0</td> <td>INNER LAMP SUPPORT</td> <td>1.000</td> <td>PC</td> </tr> <tr> <td>VM1767A0</td> <td>GREEN PILOT LIGHT W/ GOLD FLAME</td> <td>1.000</td> <td>PC</td> </tr> </tbody> </table>	Code	Description	Qty	UOM	VE1535A1	230V WHITE LED	1.000	PC	VM1762A0	INNER LAMP SUPPORT	1.000	PC	VM1767A0	GREEN PILOT LIGHT W/ GOLD FLAME	1.000	PC									
					Code	Description	Qty	UOM																						
					VE1535A1	230V WHITE LED	1.000	PC																						
			VM1762A0	INNER LAMP SUPPORT	1.000	PC																								
			VM1767A0	GREEN PILOT LIGHT W/ GOLD FLAME	1.000	PC																								
			KVE0101A	SINUSOID LIGHT GREEN COVER KIT	<table border="1"> <thead> <tr> <th>Code</th> <th>Description</th> <th>Qty</th> <th>UOM</th> </tr> </thead> <tbody> <tr> <td>VE1170A0</td> <td>D16 OPAQUE NICKEL ELLIPTICAL SUPPORT</td> <td>1.000</td> <td>PC</td> </tr> <tr> <td>VE1535A1</td> <td>230V WHITE LED</td> <td>1.000</td> <td>PC</td> </tr> <tr> <td>VM1762A0</td> <td>INNER LAMP SUPPORT</td> <td>1.000</td> <td>PC</td> </tr> <tr> <td>VM1765A0</td> <td>GREEN PILOT WITH GOLD SINUSOIDE</td> <td>1.000</td> <td>PC</td> </tr> </tbody> </table>	Code	Description	Qty	UOM	VE1170A0	D16 OPAQUE NICKEL ELLIPTICAL SUPPORT	1.000	PC	VE1535A1	230V WHITE LED	1.000	PC	VM1762A0	INNER LAMP SUPPORT	1.000	PC	VM1765A0	GREEN PILOT WITH GOLD SINUSOIDE	1.000	PC					
					Code	Description	Qty	UOM																						
					VE1170A0	D16 OPAQUE NICKEL ELLIPTICAL SUPPORT	1.000	PC																						
					VE1535A1	230V WHITE LED	1.000	PC																						
			VM1762A0	INNER LAMP SUPPORT	1.000	PC																								
			VM1765A0	GREEN PILOT WITH GOLD SINUSOIDE	1.000	PC																								
			KVE0100A	THERMOMETER LIGHT COVER KIT	<table border="1"> <thead> <tr> <th>Code</th> <th>Description</th> <th>Qty</th> <th>UOM</th> </tr> </thead> <tbody> <tr> <td>VE1530A0</td> <td>GOLD THERMOMETE R BLUE LIGHT COVER</td> <td>1.000</td> <td>PC</td> </tr> <tr> <td>VE1535A1</td> <td>230V WHITE LED</td> <td>1.000</td> <td>PC</td> </tr> <tr> <td>VM1761A0</td> <td>D16 BLACK ELLIPTICAL SUPPORT</td> <td>1.000</td> <td>PC</td> </tr> <tr> <td>VM1762A0</td> <td>INNER LAMP SUPPORT</td> <td>1.000</td> <td>PC</td> </tr> </tbody> </table>	Code	Description	Qty	UOM	VE1530A0	GOLD THERMOMETE R BLUE LIGHT COVER	1.000	PC	VE1535A1	230V WHITE LED	1.000	PC	VM1761A0	D16 BLACK ELLIPTICAL SUPPORT	1.000	PC	VM1762A0	INNER LAMP SUPPORT	1.000	PC					
Code	Description	Qty			UOM																									
VE1530A0	GOLD THERMOMETE R BLUE LIGHT COVER	1.000			PC																									
VE1535A1	230V WHITE LED	1.000			PC																									
VM1761A0	D16 BLACK ELLIPTICAL SUPPORT	1.000			PC																									
VM1762A0	INNER LAMP SUPPORT	1.000	PC																											
KVE0011A	SP KNOBS AND LIGHTS KIT	<table border="1"> <thead> <tr> <th>Code</th> <th>Description</th> <th>Qty</th> <th>UOM</th> </tr> </thead> <tbody> <tr> <td>MN1105A0</td> <td>120-400C XP THERMOSTAT KNOB</td> <td>1.000</td> <td>PC</td> </tr> <tr> <td>MN1110A0</td> <td>XP NEUTRAL INDEX DIAL</td> <td>1.000</td> <td>PC</td> </tr> <tr> <td>VE1530A0</td> <td>GOLD THERMOMETE R BLUE LIGHT COVER</td> <td>1.000</td> <td>PC</td> </tr> <tr> <td>VE1535A1</td> <td>230V WHITE LED</td> <td>1.000</td> <td>PC</td> </tr> <tr> <td>VE1561A0</td> <td>NA/NA BIPOLAR SWITCH</td> <td>1.000</td> <td>PC</td> </tr> <tr> <td>VM1761A0</td> <td>D16 BLACK ELLIPTICAL SUPPORT</td> <td>2.000</td> <td>PC</td> </tr> </tbody> </table>	Code	Description	Qty	UOM	MN1105A0	120-400C XP THERMOSTAT KNOB	1.000	PC	MN1110A0	XP NEUTRAL INDEX DIAL	1.000	PC	VE1530A0	GOLD THERMOMETE R BLUE LIGHT COVER	1.000	PC	VE1535A1	230V WHITE LED	1.000	PC	VE1561A0	NA/NA BIPOLAR SWITCH	1.000	PC	VM1761A0	D16 BLACK ELLIPTICAL SUPPORT	2.000	PC
		Code	Description	Qty	UOM																									
		MN1105A0	120-400C XP THERMOSTAT KNOB	1.000	PC																									
		MN1110A0	XP NEUTRAL INDEX DIAL	1.000	PC																									
		VE1530A0	GOLD THERMOMETE R BLUE LIGHT COVER	1.000	PC																									
		VE1535A1	230V WHITE LED	1.000	PC																									
		VE1561A0	NA/NA BIPOLAR SWITCH	1.000	PC																									
VM1761A0	D16 BLACK ELLIPTICAL SUPPORT	2.000	PC																											
<table border="1"> <thead> <tr> <th>Code</th> <th>Description</th> <th>Qty</th> <th>UOM</th> </tr> </thead> <tbody> <tr> <td>VM1762A0</td> <td>INNER LAMP SUPPORT</td> <td>1.000</td> <td>PC</td> </tr> <tr> <td>VM1776A0</td> <td>"GOLD "0-1" MATT SILVER KEY"</td> <td>1.000</td> <td>PC</td> </tr> </tbody> </table>	Code	Description	Qty	UOM	VM1762A0	INNER LAMP SUPPORT	1.000	PC	VM1776A0	"GOLD "0-1" MATT SILVER KEY"	1.000	PC																		
Code	Description	Qty	UOM																											
VM1762A0	INNER LAMP SUPPORT	1.000	PC																											
VM1776A0	"GOLD "0-1" MATT SILVER KEY"	1.000	PC																											



Зип Общепит ASM2020D/0.D02 External cover

vsezip.ru

+7(812)987-08-81

COMPONENT

SPARE PART

Code	Description	Image	Code	Description	Kit components																																								
VE1535A	230V WHITE LED		KVE0008A	XL PILOT BLUE LIGHTS KIT	<table border="1"> <thead> <tr> <th>Code</th> <th>Description</th> <th>Qty</th> <th>UOM</th> </tr> </thead> <tbody> <tr> <td>VE1170A0</td> <td>D16 OPAQUE NICKEL ELLIPTICAL SUPPORT</td> <td>3.000</td> <td>PC</td> </tr> <tr> <td>VE1530A0</td> <td>GOLD THERMOMETE R BLUE LIGHT COVER</td> <td>1.000</td> <td>PC</td> </tr> <tr> <td>VE1535A1</td> <td>230V WHITE LED</td> <td>1.000</td> <td>PC</td> </tr> <tr> <td>VE1561A0</td> <td>NA/NA BIPOLAR SWITCH</td> <td>1.000</td> <td>PC</td> </tr> <tr> <td>VE1562A0</td> <td>UNIPOLAR NA PUSH BUTTO</td> <td>1.000</td> <td>PC</td> </tr> <tr> <td>VM1762A0</td> <td>INNER LAMP SUPPORT</td> <td>1.000</td> <td>PC</td> </tr> <tr> <td>VM1775A0</td> <td>OPAQUE SILVER KEY WITH GOLD CLOUD</td> <td>1.000</td> <td>PC</td> </tr> <tr> <td>VM1776A0</td> <td>"GOLD "0-1" MATT SILVER KEY"</td> <td>1.000</td> <td>PC</td> </tr> </tbody> </table>	Code	Description	Qty	UOM	VE1170A0	D16 OPAQUE NICKEL ELLIPTICAL SUPPORT	3.000	PC	VE1530A0	GOLD THERMOMETE R BLUE LIGHT COVER	1.000	PC	VE1535A1	230V WHITE LED	1.000	PC	VE1561A0	NA/NA BIPOLAR SWITCH	1.000	PC	VE1562A0	UNIPOLAR NA PUSH BUTTO	1.000	PC	VM1762A0	INNER LAMP SUPPORT	1.000	PC	VM1775A0	OPAQUE SILVER KEY WITH GOLD CLOUD	1.000	PC	VM1776A0	"GOLD "0-1" MATT SILVER KEY"	1.000	PC				
Code	Description	Qty	UOM																																										
VE1170A0	D16 OPAQUE NICKEL ELLIPTICAL SUPPORT	3.000	PC																																										
VE1530A0	GOLD THERMOMETE R BLUE LIGHT COVER	1.000	PC																																										
VE1535A1	230V WHITE LED	1.000	PC																																										
VE1561A0	NA/NA BIPOLAR SWITCH	1.000	PC																																										
VE1562A0	UNIPOLAR NA PUSH BUTTO	1.000	PC																																										
VM1762A0	INNER LAMP SUPPORT	1.000	PC																																										
VM1775A0	OPAQUE SILVER KEY WITH GOLD CLOUD	1.000	PC																																										
VM1776A0	"GOLD "0-1" MATT SILVER KEY"	1.000	PC																																										
			KVE0007A	XF-XG LED AND LED COVERS KIT	<table border="1"> <thead> <tr> <th>Code</th> <th>Description</th> <th>Qty</th> <th>UOM</th> </tr> </thead> <tbody> <tr> <td>VE1170A0</td> <td>D16 OPAQUE NICKEL ELLIPTICAL SUPPORT</td> <td>5.000</td> <td>PC</td> </tr> <tr> <td>VE1530A0</td> <td>GOLD THERMOMETE R BLUE LIGHT COVER</td> <td>1.000</td> <td>PC</td> </tr> <tr> <td>VE1535A1</td> <td>230V WHITE LED</td> <td>1.000</td> <td>PC</td> </tr> <tr> <td>VE1562A0</td> <td>UNIPOLAR NA PUSH BUTTO</td> <td>1.000</td> <td>PC</td> </tr> <tr> <td>VE1585A0</td> <td>BLUE LIGHT COVER GOLD SINUSOID</td> <td>1.000</td> <td>PC</td> </tr> <tr> <td>VM1762A0</td> <td>INNER LAMP SUPPORT</td> <td>4.000</td> <td>PC</td> </tr> <tr> <td>VM1767A0</td> <td>GREEN PILOT LIGHT W/ GOLD FLAME</td> <td>1.000</td> <td>PC</td> </tr> <tr> <td>VM1774A0</td> <td>SILVER OPAQUE KEY W/ GOLD FLAME</td> <td>1.000</td> <td>PC</td> </tr> <tr> <td>VM1775A0</td> <td>OPAQUE SILVER KEY WITH GOLD CLOUD</td> <td>1.000</td> <td>PC</td> </tr> </tbody> </table>	Code	Description	Qty	UOM	VE1170A0	D16 OPAQUE NICKEL ELLIPTICAL SUPPORT	5.000	PC	VE1530A0	GOLD THERMOMETE R BLUE LIGHT COVER	1.000	PC	VE1535A1	230V WHITE LED	1.000	PC	VE1562A0	UNIPOLAR NA PUSH BUTTO	1.000	PC	VE1585A0	BLUE LIGHT COVER GOLD SINUSOID	1.000	PC	VM1762A0	INNER LAMP SUPPORT	4.000	PC	VM1767A0	GREEN PILOT LIGHT W/ GOLD FLAME	1.000	PC	VM1774A0	SILVER OPAQUE KEY W/ GOLD FLAME	1.000	PC	VM1775A0	OPAQUE SILVER KEY WITH GOLD CLOUD	1.000	PC
Code	Description	Qty	UOM																																										
VE1170A0	D16 OPAQUE NICKEL ELLIPTICAL SUPPORT	5.000	PC																																										
VE1530A0	GOLD THERMOMETE R BLUE LIGHT COVER	1.000	PC																																										
VE1535A1	230V WHITE LED	1.000	PC																																										
VE1562A0	UNIPOLAR NA PUSH BUTTO	1.000	PC																																										
VE1585A0	BLUE LIGHT COVER GOLD SINUSOID	1.000	PC																																										
VM1762A0	INNER LAMP SUPPORT	4.000	PC																																										
VM1767A0	GREEN PILOT LIGHT W/ GOLD FLAME	1.000	PC																																										
VM1774A0	SILVER OPAQUE KEY W/ GOLD FLAME	1.000	PC																																										
VM1775A0	OPAQUE SILVER KEY WITH GOLD CLOUD	1.000	PC																																										



Зип Общепит ASM2020D/0.D02 External cover

vsezip.ru



+7(812)987-08-81

COMPONENT			SPARE PART																										
Code	Description	Image	Code	Description	Kit components																								
VE1535A	230V WHITE LED		KVE0007A	XF-XG LED AND LED COVERS KIT	<table border="1"> <thead> <tr> <th>Code</th> <th>Description</th> <th>Qty</th> <th>UOM</th> </tr> </thead> <tbody> <tr> <td>VM1902A0</td> <td>NEUTRAL GREEN PLASTIC COVER FOR</td> <td>1.000</td> <td>PC</td> </tr> <tr> <td>VM1903A0</td> <td>GREEN PILOT WITH GOLD "CLOUD"</td> <td>1.000</td> <td>PC</td> </tr> </tbody> </table>	Code	Description	Qty	UOM	VM1902A0	NEUTRAL GREEN PLASTIC COVER FOR	1.000	PC	VM1903A0	GREEN PILOT WITH GOLD "CLOUD"	1.000	PC												
			Code	Description	Qty	UOM																							
			VM1902A0	NEUTRAL GREEN PLASTIC COVER FOR	1.000	PC																							
			VM1903A0	GREEN PILOT WITH GOLD "CLOUD"	1.000	PC																							
			KLP1014A	SINUSOID LED LIGHT+COVER+SUPPORT KIT	<table border="1"> <thead> <tr> <th>Code</th> <th>Description</th> <th>Qty</th> <th>UOM</th> </tr> </thead> <tbody> <tr> <td>VE1170A0</td> <td>D16 OPAQUE NICKEL ELLIPTICAL SUPPORT</td> <td>2.000</td> <td>PC</td> </tr> <tr> <td>VE1535A1</td> <td>230V WHITE LED</td> <td>2.000</td> <td>PC</td> </tr> <tr> <td>VE1585A0</td> <td>BLUE LIGHT COVER GOLD SINUSOID</td> <td>2.000</td> <td>PC</td> </tr> <tr> <td>VM1762A0</td> <td>INNER LAMP SUPPORT</td> <td>2.000</td> <td>PC</td> </tr> <tr> <td>VM2009A0</td> <td>D16 SILVER ELLIPTICAL SUPPORT</td> <td>1.000</td> <td>PC</td> </tr> </tbody> </table>	Code	Description	Qty	UOM	VE1170A0	D16 OPAQUE NICKEL ELLIPTICAL SUPPORT	2.000	PC	VE1535A1	230V WHITE LED	2.000	PC	VE1585A0	BLUE LIGHT COVER GOLD SINUSOID	2.000	PC	VM1762A0	INNER LAMP SUPPORT	2.000	PC	VM2009A0	D16 SILVER ELLIPTICAL SUPPORT	1.000	PC
			Code	Description	Qty	UOM																							
			VE1170A0	D16 OPAQUE NICKEL ELLIPTICAL SUPPORT	2.000	PC																							
			VE1535A1	230V WHITE LED	2.000	PC																							
			VE1585A0	BLUE LIGHT COVER GOLD SINUSOID	2.000	PC																							
			VM1762A0	INNER LAMP SUPPORT	2.000	PC																							
			VM2009A0	D16 SILVER ELLIPTICAL SUPPORT	1.000	PC																							
			KLP1012A	GOLDEN THERMOMETER BLUE LIGHT KIT	<table border="1"> <thead> <tr> <th>Code</th> <th>Description</th> <th>Qty</th> <th>UOM</th> </tr> </thead> <tbody> <tr> <td>VE1170A0</td> <td>D16 OPAQUE NICKEL ELLIPTICAL SUPPORT</td> <td>1.000</td> <td>PC</td> </tr> <tr> <td>VE1530A0</td> <td>GOLD THERMOMETE R BLUE LIGHT COVER</td> <td>1.000</td> <td>PC</td> </tr> <tr> <td>VE1535A1</td> <td>230V WHITE LED</td> <td>1.000</td> <td>PC</td> </tr> <tr> <td>VM1762A0</td> <td>INNER LAMP SUPPORT</td> <td>1.000</td> <td>PC</td> </tr> <tr> <td>VM2009A0</td> <td>D16 SILVER ELLIPTICAL SUPPORT</td> <td>1.000</td> <td>PC</td> </tr> </tbody> </table>	Code	Description	Qty	UOM	VE1170A0	D16 OPAQUE NICKEL ELLIPTICAL SUPPORT	1.000	PC	VE1530A0	GOLD THERMOMETE R BLUE LIGHT COVER	1.000	PC	VE1535A1	230V WHITE LED	1.000	PC	VM1762A0	INNER LAMP SUPPORT	1.000	PC	VM2009A0	D16 SILVER ELLIPTICAL SUPPORT	1.000	PC
Code	Description	Qty	UOM																										
VE1170A0	D16 OPAQUE NICKEL ELLIPTICAL SUPPORT	1.000	PC																										
VE1530A0	GOLD THERMOMETE R BLUE LIGHT COVER	1.000	PC																										
VE1535A1	230V WHITE LED	1.000	PC																										
VM1762A0	INNER LAMP SUPPORT	1.000	PC																										
VM2009A0	D16 SILVER ELLIPTICAL SUPPORT	1.000	PC																										
KLP1010A	THERMOSTAT GREEN LIGHT KIT	<table border="1"> <thead> <tr> <th>Code</th> <th>Description</th> <th>Qty</th> <th>UOM</th> </tr> </thead> <tbody> <tr> <td>VE1170A0</td> <td>D16 OPAQUE NICKEL ELLIPTICAL SUPPORT</td> <td>1.000</td> <td>PC</td> </tr> <tr> <td>VE1535A1</td> <td>230V WHITE LED</td> <td>1.000</td> <td>PC</td> </tr> <tr> <td>VM1762A0</td> <td>INNER LAMP SUPPORT</td> <td>1.000</td> <td>PC</td> </tr> <tr> <td>VM1764A0</td> <td>GREEN PILOT WITH GOLD THERMOMETE</td> <td>1.000</td> <td>PC</td> </tr> </tbody> </table>	Code	Description	Qty	UOM	VE1170A0	D16 OPAQUE NICKEL ELLIPTICAL SUPPORT	1.000	PC	VE1535A1	230V WHITE LED	1.000	PC	VM1762A0	INNER LAMP SUPPORT	1.000	PC	VM1764A0	GREEN PILOT WITH GOLD THERMOMETE	1.000	PC							
Code	Description	Qty	UOM																										
VE1170A0	D16 OPAQUE NICKEL ELLIPTICAL SUPPORT	1.000	PC																										
VE1535A1	230V WHITE LED	1.000	PC																										
VM1762A0	INNER LAMP SUPPORT	1.000	PC																										
VM1764A0	GREEN PILOT WITH GOLD THERMOMETE	1.000	PC																										

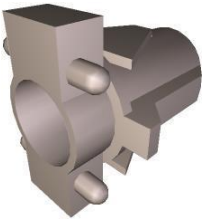

Зип Общепит ASM2020D/0.D02 External cover
vsezip.ru

+7(812)987-08-81

COMPONENT			SPARE PART																																										
Code	Description	Image	Code	Description	Kit components																																								
VM1762A	INNER LAMP SUPPORT		KVM1762A	LAMP INTERNAL SUPPORT KIT	<table border="1"> <thead> <tr> <th>Code</th> <th>Description</th> <th>Qty</th> <th>UOM</th> </tr> </thead> <tbody> <tr> <td>VM1762A0</td> <td>INNER LAMP SUPPORT</td> <td>1.000</td> <td>PC</td> </tr> </tbody> </table>	Code	Description	Qty	UOM	VM1762A0	INNER LAMP SUPPORT	1.000	PC																																
Code	Description	Qty	UOM																																										
VM1762A0	INNER LAMP SUPPORT	1.000	PC																																										
VM2018A	L.MISS TOUCH MANUAL 46x33 CONTROL BOARD		KVM2018A	XFT MANUAL 460X330 CONTROL BOARD KIT	<table border="1"> <thead> <tr> <th>Code</th> <th>Description</th> <th>Qty</th> <th>UOM</th> </tr> </thead> <tbody> <tr> <td>VE1170A0</td> <td>D16 OPAQUE NICKEL ELLIPTICAL SUPPORT</td> <td>2.000</td> <td>PC</td> </tr> <tr> <td>VE1530A0</td> <td>GOLD THERMOMETE R BLUE LIGHT COVER</td> <td>1.000</td> <td>PC</td> </tr> <tr> <td>VE1535A1</td> <td>230V WHITE LED</td> <td>1.000</td> <td>PC</td> </tr> <tr> <td>VE1562A0</td> <td>UNIPOLAR NA PUSH BUTTO</td> <td>1.000</td> <td>PC</td> </tr> <tr> <td>VM1762A0</td> <td>INNER LAMP SUPPORT</td> <td>1.000</td> <td>PC</td> </tr> <tr> <td>VM1775A0</td> <td>OPAQUE SILVER KEY WITH GOLD CLOUD</td> <td>1.000</td> <td>PC</td> </tr> <tr> <td>VM1794A0</td> <td>250x4.8 PA66 BLACK CLAMP</td> <td>2.000</td> <td>PC</td> </tr> <tr> <td>VM2018A1</td> <td>L.MISS TOUCH MANUAL 46x33 CONTROL BOARD</td> <td>1.000</td> <td>PC</td> </tr> <tr> <td>VM2103A0</td> <td>CLAMP LOCK</td> <td>2.000</td> <td>PC</td> </tr> </tbody> </table>	Code	Description	Qty	UOM	VE1170A0	D16 OPAQUE NICKEL ELLIPTICAL SUPPORT	2.000	PC	VE1530A0	GOLD THERMOMETE R BLUE LIGHT COVER	1.000	PC	VE1535A1	230V WHITE LED	1.000	PC	VE1562A0	UNIPOLAR NA PUSH BUTTO	1.000	PC	VM1762A0	INNER LAMP SUPPORT	1.000	PC	VM1775A0	OPAQUE SILVER KEY WITH GOLD CLOUD	1.000	PC	VM1794A0	250x4.8 PA66 BLACK CLAMP	2.000	PC	VM2018A1	L.MISS TOUCH MANUAL 46x33 CONTROL BOARD	1.000	PC	VM2103A0	CLAMP LOCK	2.000	PC
Code	Description	Qty	UOM																																										
VE1170A0	D16 OPAQUE NICKEL ELLIPTICAL SUPPORT	2.000	PC																																										
VE1530A0	GOLD THERMOMETE R BLUE LIGHT COVER	1.000	PC																																										
VE1535A1	230V WHITE LED	1.000	PC																																										
VE1562A0	UNIPOLAR NA PUSH BUTTO	1.000	PC																																										
VM1762A0	INNER LAMP SUPPORT	1.000	PC																																										
VM1775A0	OPAQUE SILVER KEY WITH GOLD CLOUD	1.000	PC																																										
VM1794A0	250x4.8 PA66 BLACK CLAMP	2.000	PC																																										
VM2018A1	L.MISS TOUCH MANUAL 46x33 CONTROL BOARD	1.000	PC																																										
VM2103A0	CLAMP LOCK	2.000	PC																																										
CR1000A	HINGE LATCH L.M.		KCR1000A	LM HINGES LATCH KIT	<table border="1"> <thead> <tr> <th>Code</th> <th>Description</th> <th>Qty</th> <th>UOM</th> </tr> </thead> <tbody> <tr> <td>CR1000A0</td> <td>HINGE LATCH L.M.</td> <td>1.000</td> <td>PC</td> </tr> <tr> <td>V11875A0</td> <td>SCREW M5X10 TC1/2T INOX</td> <td>2.000</td> <td>PC</td> </tr> </tbody> </table>	Code	Description	Qty	UOM	CR1000A0	HINGE LATCH L.M.	1.000	PC	V11875A0	SCREW M5X10 TC1/2T INOX	2.000	PC																												
Code	Description	Qty	UOM																																										
CR1000A0	HINGE LATCH L.M.	1.000	PC																																										
V11875A0	SCREW M5X10 TC1/2T INOX	2.000	PC																																										



+7(812)987-08-81



COMPONENT			SPARE PART										
Code	Description	Image	Code	Description	Kit components								
VM1556A	XBC-XVC COOLING FAN GUARD		KVM1556A	XBC-XVC COOLING FAN GUARD KIT	<table border="1"> <thead> <tr> <th>Code</th> <th>Description</th> <th>Qty</th> <th>UOM</th> </tr> </thead> <tbody> <tr> <td>VM1556A0</td> <td>XBC-XVC COOLING FAN GUARD</td> <td>1.000</td> <td>PC</td> </tr> </tbody> </table>	Code	Description	Qty	UOM	VM1556A0	XBC-XVC COOLING FAN GUARD	1.000	PC
Code	Description	Qty	UOM										
VM1556A0	XBC-XVC COOLING FAN GUARD	1.000	PC										
VN1175A	230V 50/60Hz 120x120 COOLING DOWN FAN		KVN1175A	120x120 230V 50/60Hz COOLING FAN KIT	<table border="1"> <thead> <tr> <th>Code</th> <th>Description</th> <th>Qty</th> <th>UOM</th> </tr> </thead> <tbody> <tr> <td>VN1175A0</td> <td>230V 50/60Hz 120x120 COOLING DOWN FAN</td> <td>1.000</td> <td>PC</td> </tr> </tbody> </table>	Code	Description	Qty	UOM	VN1175A0	230V 50/60Hz 120x120 COOLING DOWN FAN	1.000	PC
Code	Description	Qty	UOM										
VN1175A0	230V 50/60Hz 120x120 COOLING DOWN FAN	1.000	PC										
PD1001A	35x35 H26 GREY PLASTIC+RUBBER FOOT		KPD1001A	35x35 H26 FEET 4 PCS KIT	<table border="1"> <thead> <tr> <th>Code</th> <th>Description</th> <th>Qty</th> <th>UOM</th> </tr> </thead> <tbody> <tr> <td>PD1001A0</td> <td>35x35 H26 GREY PLASTIC+RUBBER FOOT</td> <td>4.000</td> <td>PC</td> </tr> </tbody> </table>	Code	Description	Qty	UOM	PD1001A0	35x35 H26 GREY PLASTIC+RUBBER FOOT	4.000	PC
Code	Description	Qty	UOM										
PD1001A0	35x35 H26 GREY PLASTIC+RUBBER FOOT	4.000	PC										
VM1025A	Ø16 GREY NYLON LI		KVM1025A	GREY NYLON CAPS 20 PCS KIT	<table border="1"> <thead> <tr> <th>Code</th> <th>Description</th> <th>Qty</th> <th>UOM</th> </tr> </thead> <tbody> <tr> <td>VM1025A0</td> <td>Ø16 GREY NYLON LID</td> <td>20.000</td> <td>PC</td> </tr> </tbody> </table>	Code	Description	Qty	UOM	VM1025A0	Ø16 GREY NYLON LID	20.000	PC
Code	Description	Qty	UOM										
VM1025A0	Ø16 GREY NYLON LID	20.000	PC										
VM1225A	PLATE WITH HOLES FOR ELECTRONIC		VM1225A1	PLATE WITH HOLES FOR ELECTRONIC									



Зип Общепит ASM2020D/0.D02 External cover

vsezip.ru

+7(812)987-08-81

COMPONENT			SPARE PART														
Code	Description	Image	Code	Description	Kit components												
VM1951A	IP CHIMNEY COVER		KVM1951A	EXHAUST CHIMNEY COVER KIT	<table border="1"> <thead> <tr> <th>Code</th> <th>Description</th> <th>Qty</th> <th>UOM</th> </tr> </thead> <tbody> <tr> <td>VI1220A1</td> <td>4,2x12 TCB SELF-TAPPIN G SCREW</td> <td>2.000</td> <td>PC</td> </tr> <tr> <td>VM1951A1</td> <td>CHIMNEY COVER</td> <td>1.000</td> <td>PC</td> </tr> </tbody> </table>	Code	Description	Qty	UOM	VI1220A1	4,2x12 TCB SELF-TAPPIN G SCREW	2.000	PC	VM1951A1	CHIMNEY COVER	1.000	PC
Code	Description	Qty	UOM														
VI1220A1	4,2x12 TCB SELF-TAPPIN G SCREW	2.000	PC														
VM1951A1	CHIMNEY COVER	1.000	PC														
VM1952A	IP MOTOR COVER		KVM1952A	XF/XFT/XAF/XAFT MOTOR COVER KIT	<table border="1"> <thead> <tr> <th>Code</th> <th>Description</th> <th>Qty</th> <th>UOM</th> </tr> </thead> <tbody> <tr> <td>VI1220A1</td> <td>4,2x12 TCB SELF-TAPPIN G SCREW</td> <td>2.000</td> <td>PC</td> </tr> <tr> <td>VM1952A1</td> <td>IP MOTOR COVER KIT</td> <td>1.000</td> <td>PC</td> </tr> </tbody> </table>	Code	Description	Qty	UOM	VI1220A1	4,2x12 TCB SELF-TAPPIN G SCREW	2.000	PC	VM1952A1	IP MOTOR COVER KIT	1.000	PC
Code	Description	Qty	UOM														
VI1220A1	4,2x12 TCB SELF-TAPPIN G SCREW	2.000	PC														
VM1952A1	IP MOTOR COVER KIT	1.000	PC														



Зип Общепит

ASM2021D/0.D00 Electrical system

vsezip.ru

+7(812)987-08-81

ASM2021D/0.D00 - Electrical system

FRONT

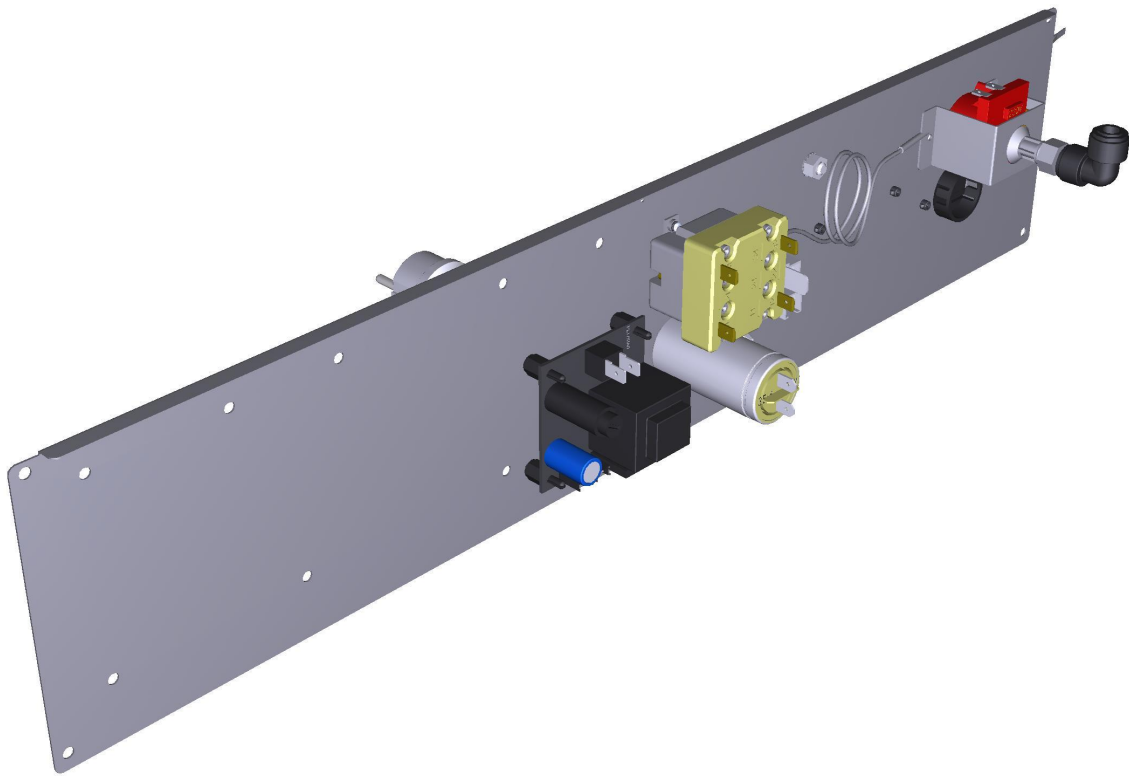



Зип Общепит

ASM2021D/0.D00 Electrical system

vsezip.ru

+7(812)987-08-81

ASM2021D/0.D00 - Electrical system

REAR

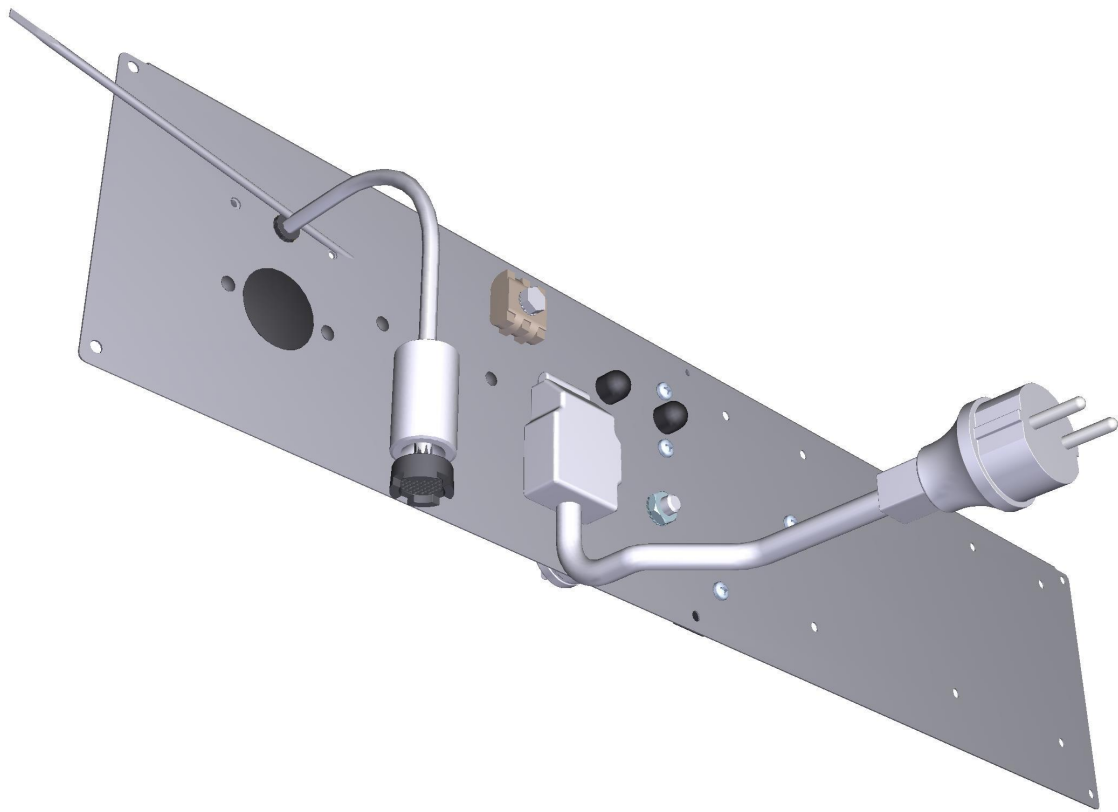



Зип Общепит

ASM2021D/0.D00 Electrical system

vsezip.ru

+7(812)987-08-81

COMPONENT			SPARE PART														
Code	Description	Image	Code	Description	Kit components												
0H6222D	LMiss600 Dynamic-Manual PARTS HOLDIN BOX		0H6222D0	LMiss600 Dynamic-Manual PARTS HOLDIN BOX													
VM1750A	BRASS COMB CLAM		KVM1750A	COMB TERMINAL BLOCK KIT	<table border="1"> <thead> <tr> <th>Code</th> <th>Description</th> <th>Qty</th> <th>UOM</th> </tr> </thead> <tbody> <tr> <td>VH1040A0</td> <td>INDENTED INTERNAL WASHER D=6 ZN</td> <td>2.000</td> <td>PC</td> </tr> <tr> <td>VM1750A0</td> <td>BRASS COMB CLAMP</td> <td>1.000</td> <td>PC</td> </tr> </tbody> </table>	Code	Description	Qty	UOM	VH1040A0	INDENTED INTERNAL WASHER D=6 ZN	2.000	PC	VM1750A0	BRASS COMB CLAMP	1.000	PC
Code	Description	Qty	UOM														
VH1040A0	INDENTED INTERNAL WASHER D=6 ZN	2.000	PC														
VM1750A0	BRASS COMB CLAMP	1.000	PC														
TR1140A	350°C SAFETY THERMOSTAT MANUAL RESET		KTR1140A	350°C 12 POLES MANUAL SAFETY THERM. KIT	<table border="1"> <thead> <tr> <th>Code</th> <th>Description</th> <th>Qty</th> <th>UOM</th> </tr> </thead> <tbody> <tr> <td>TR1140A0</td> <td>350°C SAFETY THERMOSTAT MANUAL RESE</td> <td>1.000</td> <td>PC</td> </tr> </tbody> </table>	Code	Description	Qty	UOM	TR1140A0	350°C SAFETY THERMOSTAT MANUAL RESE	1.000	PC				
Code	Description	Qty	UOM														
TR1140A0	350°C SAFETY THERMOSTAT MANUAL RESE	1.000	PC														
0H3743A	PUMP EL070 SUPPORT		0H3743A0	PUMP EL070 SUPPORT													
EL1185A	Ø8F - Ø8F ELBOW CONNECTION		KEL1185A	D8F-D8F JG ELBOW FITTING 10 PCS KIT	<table border="1"> <thead> <tr> <th>Code</th> <th>Description</th> <th>Qty</th> <th>UOM</th> </tr> </thead> <tbody> <tr> <td>EL1185A0</td> <td>Ø8F - Ø8F ELBOW CONNECTION</td> <td>10.000</td> <td>PC</td> </tr> </tbody> </table>	Code	Description	Qty	UOM	EL1185A0	Ø8F - Ø8F ELBOW CONNECTION	10.000	PC				
Code	Description	Qty	UOM														
EL1185A0	Ø8F - Ø8F ELBOW CONNECTION	10.000	PC														



Зип Общепит

ASM2021D/0.D00 Electrical system

vsezip.ru

+7(812)987-08-81

COMPONENT

SPARE PART

Code	Description	Image	Code	Description	Kit components																																																																				
PM1000A	PUMP NME1C+ATT SUP PUMP M10 09.02.060/B		XC665	PUMP KIT	<table border="1"> <thead> <tr> <th>Code</th> <th>Description</th> <th>Qty</th> <th>UOM</th> </tr> </thead> <tbody> <tr> <td>0H3743A0</td> <td>PUMP EL070 SUPPORT</td> <td>1.000</td> <td>PC</td> </tr> <tr> <td>CE1155A0</td> <td>6,3x0,81 - 2,5 ALPACA FEMALE FASTON</td> <td>2.000</td> <td>PC</td> </tr> <tr> <td>CE1205A0</td> <td>FEMALE INAR-LOCK END CONNECTOR</td> <td>2.000</td> <td>PC</td> </tr> <tr> <td>CE1235A0</td> <td>ø0,75 mmq UNIPOlar WHITE WIRE</td> <td>0.500</td> <td>M</td> </tr> <tr> <td>CE1325A0</td> <td>2 WAYS MALE INAR-LOCK CONNECTOR</td> <td>1.000</td> <td>PC</td> </tr> <tr> <td>CE1330A0</td> <td>3 WAYS MALE INAR-LOCK CONNECTOR</td> <td>1.000</td> <td>PC</td> </tr> <tr> <td>CE1450A0</td> <td>FASTON PIGGY BACK 6,3 X 0,8</td> <td>2.000</td> <td>PC</td> </tr> <tr> <td>CE1570A0</td> <td>WHITE UNIP AWG18 ST.3135 WIRE</td> <td>1.300</td> <td>M</td> </tr> <tr> <td>CE1660A0</td> <td>6,3x0,8 FEMALE FASTON COVE</td> <td>2.000</td> <td>PC</td> </tr> <tr> <td>CE1797A0</td> <td>4,8X0,8 FEMALE FASTON</td> <td>2.000</td> <td>PC</td> </tr> <tr> <td>CE1798A0</td> <td>4,8X0,8 FEMALE FASTON COVE</td> <td>2.000</td> <td>PC</td> </tr> <tr> <td>EL1185A0</td> <td>Ø8F - Ø8F ELBOW CONNECTION</td> <td>1.000</td> <td>PC</td> </tr> <tr> <td>EL1220A0</td> <td>JG STRAIGHT CONNECTION Ø8F-Ø8F</td> <td>1.000</td> <td>PC</td> </tr> <tr> <td>EL1345A0</td> <td>CLIP TO FIX Ø8 mm CONNECTION JOINT</td> <td>1.000</td> <td>PC</td> </tr> <tr> <td>GN1324A0</td> <td>RUBBER O-RING NBR70/75SH R=4</td> <td>1.000</td> <td>PC</td> </tr> <tr> <td>PM1000A0</td> <td>PUMP NME1C+ATT SUP PUMP M10 09.02.060/</td> <td>1.000</td> <td>PC</td> </tr> </tbody> </table>	Code	Description	Qty	UOM	0H3743A0	PUMP EL070 SUPPORT	1.000	PC	CE1155A0	6,3x0,81 - 2,5 ALPACA FEMALE FASTON	2.000	PC	CE1205A0	FEMALE INAR-LOCK END CONNECTOR	2.000	PC	CE1235A0	ø0,75 mmq UNIPOlar WHITE WIRE	0.500	M	CE1325A0	2 WAYS MALE INAR-LOCK CONNECTOR	1.000	PC	CE1330A0	3 WAYS MALE INAR-LOCK CONNECTOR	1.000	PC	CE1450A0	FASTON PIGGY BACK 6,3 X 0,8	2.000	PC	CE1570A0	WHITE UNIP AWG18 ST.3135 WIRE	1.300	M	CE1660A0	6,3x0,8 FEMALE FASTON COVE	2.000	PC	CE1797A0	4,8X0,8 FEMALE FASTON	2.000	PC	CE1798A0	4,8X0,8 FEMALE FASTON COVE	2.000	PC	EL1185A0	Ø8F - Ø8F ELBOW CONNECTION	1.000	PC	EL1220A0	JG STRAIGHT CONNECTION Ø8F-Ø8F	1.000	PC	EL1345A0	CLIP TO FIX Ø8 mm CONNECTION JOINT	1.000	PC	GN1324A0	RUBBER O-RING NBR70/75SH R=4	1.000	PC	PM1000A0	PUMP NME1C+ATT SUP PUMP M10 09.02.060/	1.000	PC
Code	Description	Qty	UOM																																																																						
0H3743A0	PUMP EL070 SUPPORT	1.000	PC																																																																						
CE1155A0	6,3x0,81 - 2,5 ALPACA FEMALE FASTON	2.000	PC																																																																						
CE1205A0	FEMALE INAR-LOCK END CONNECTOR	2.000	PC																																																																						
CE1235A0	ø0,75 mmq UNIPOlar WHITE WIRE	0.500	M																																																																						
CE1325A0	2 WAYS MALE INAR-LOCK CONNECTOR	1.000	PC																																																																						
CE1330A0	3 WAYS MALE INAR-LOCK CONNECTOR	1.000	PC																																																																						
CE1450A0	FASTON PIGGY BACK 6,3 X 0,8	2.000	PC																																																																						
CE1570A0	WHITE UNIP AWG18 ST.3135 WIRE	1.300	M																																																																						
CE1660A0	6,3x0,8 FEMALE FASTON COVE	2.000	PC																																																																						
CE1797A0	4,8X0,8 FEMALE FASTON	2.000	PC																																																																						
CE1798A0	4,8X0,8 FEMALE FASTON COVE	2.000	PC																																																																						
EL1185A0	Ø8F - Ø8F ELBOW CONNECTION	1.000	PC																																																																						
EL1220A0	JG STRAIGHT CONNECTION Ø8F-Ø8F	1.000	PC																																																																						
EL1345A0	CLIP TO FIX Ø8 mm CONNECTION JOINT	1.000	PC																																																																						
GN1324A0	RUBBER O-RING NBR70/75SH R=4	1.000	PC																																																																						
PM1000A0	PUMP NME1C+ATT SUP PUMP M10 09.02.060/	1.000	PC																																																																						



Зип Общепит



ASM2021D/0.D00 Electrical system

vsezip.ru

+7(812)987-08-81

COMPONENT

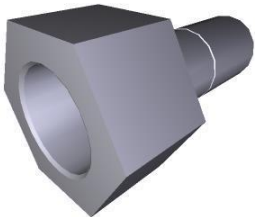
SPARE PART

Code	Description	Image	Code	Description	Kit components																				
PM1000A	PUMP NME1C+ATT SUP PUMP M10 09.02.060/B		XC665	PUMP KIT	<table border="1"> <thead> <tr> <th>Code</th> <th>Description</th> <th>Qty</th> <th>UOM</th> </tr> </thead> <tbody> <tr> <td>RC1180A3</td> <td>M10x1 Ø8-FEMALE REDUCING FITTING</td> <td>1.000</td> <td>PC</td> </tr> <tr> <td>TB1816A0</td> <td>CLEAR POLYPROPYL ENE PIPE 6x4m</td> <td>1.600</td> <td>M</td> </tr> <tr> <td>VI1220A1</td> <td>4,2x12 TCB SELF-TAPPIN G SCREW</td> <td>2.000</td> <td>PC</td> </tr> <tr> <td>VL1010A0</td> <td>L. MISS/S.4/5 HOLD DOWN WEIGHT + FILTER</td> <td>1.000</td> <td>PC</td> </tr> </tbody> </table>	Code	Description	Qty	UOM	RC1180A3	M10x1 Ø8-FEMALE REDUCING FITTING	1.000	PC	TB1816A0	CLEAR POLYPROPYL ENE PIPE 6x4m	1.600	M	VI1220A1	4,2x12 TCB SELF-TAPPIN G SCREW	2.000	PC	VL1010A0	L. MISS/S.4/5 HOLD DOWN WEIGHT + FILTER	1.000	PC
			Code	Description	Qty	UOM																			
RC1180A3	M10x1 Ø8-FEMALE REDUCING FITTING	1.000	PC																						
TB1816A0	CLEAR POLYPROPYL ENE PIPE 6x4m	1.600	M																						
VI1220A1	4,2x12 TCB SELF-TAPPIN G SCREW	2.000	PC																						
VL1010A0	L. MISS/S.4/5 HOLD DOWN WEIGHT + FILTER	1.000	PC																						
KPM1000A	ULKA PUMP KIT 230	<table border="1"> <thead> <tr> <th>Code</th> <th>Description</th> <th>Qty</th> <th>UOM</th> </tr> </thead> <tbody> <tr> <td>GN1324A0</td> <td>RUBBER O-RING NBR70/75SH R=4</td> <td>1.000</td> <td>PC</td> </tr> <tr> <td>PM1000A0</td> <td>PUMP NME1C+ATT SUP PUMP M10 09.02.060/</td> <td>1.000</td> <td>PC</td> </tr> <tr> <td>VI1220A1</td> <td>4,2x12 TCB SELF-TAPPIN G SCREW</td> <td>2.000</td> <td>PC</td> </tr> </tbody> </table>	Code	Description	Qty	UOM	GN1324A0	RUBBER O-RING NBR70/75SH R=4	1.000	PC	PM1000A0	PUMP NME1C+ATT SUP PUMP M10 09.02.060/	1.000	PC	VI1220A1	4,2x12 TCB SELF-TAPPIN G SCREW	2.000	PC							
Code	Description	Qty	UOM																						
GN1324A0	RUBBER O-RING NBR70/75SH R=4	1.000	PC																						
PM1000A0	PUMP NME1C+ATT SUP PUMP M10 09.02.060/	1.000	PC																						
VI1220A1	4,2x12 TCB SELF-TAPPIN G SCREW	2.000	PC																						
RC1180A	M10x1 Ø8-FEMALE REDUCING FITTING		KRC1180A	M10X1 FEMALE-D8 REDUCING KIT	<table border="1"> <thead> <tr> <th>Code</th> <th>Description</th> <th>Qty</th> <th>UOM</th> </tr> </thead> <tbody> <tr> <td>GN1324A0</td> <td>RUBBER O-RING NBR70/75SH R=4</td> <td>1.000</td> <td>PC</td> </tr> <tr> <td>RC1180A3</td> <td>M10x1 Ø8-FEMALE REDUCING FITTING</td> <td>1.000</td> <td>PC</td> </tr> </tbody> </table>	Code	Description	Qty	UOM	GN1324A0	RUBBER O-RING NBR70/75SH R=4	1.000	PC	RC1180A3	M10x1 Ø8-FEMALE REDUCING FITTING	1.000	PC								
Code	Description	Qty	UOM																						
GN1324A0	RUBBER O-RING NBR70/75SH R=4	1.000	PC																						
RC1180A3	M10x1 Ø8-FEMALE REDUCING FITTING	1.000	PC																						
TB1856A	ULKA PUMP PIPE - TB1816A		KTB1288A	CLEAR POLYPROPYLENE PIPE 3M KIT	<table border="1"> <thead> <tr> <th>Code</th> <th>Description</th> <th>Qty</th> <th>UOM</th> </tr> </thead> <tbody> <tr> <td>TB1816A0</td> <td>CLEAR POLYPROPYL ENE PIPE 6x4m</td> <td>3.000</td> <td>M</td> </tr> </tbody> </table>	Code	Description	Qty	UOM	TB1816A0	CLEAR POLYPROPYL ENE PIPE 6x4m	3.000	M												
Code	Description	Qty	UOM																						
TB1816A0	CLEAR POLYPROPYL ENE PIPE 6x4m	3.000	M																						







Зип Общепит

ASM2021D/0.D00 Electrical system

vsezip.ru

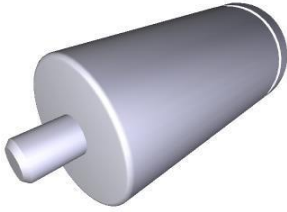
+7(812)987-08-81

COMPONENT			SPARE PART																		
Code	Description	Image	Code	Description	Kit components																
VL1010A	L. MISS/S.4/5 HOLD DOWN WEIGHT + FILTER		KVL1010A	L. MISS/S.4/5 HOLD DOWN WEIGHT + FILTER	<table border="1"> <thead> <tr> <th>Code</th> <th>Description</th> <th>Qty</th> <th>UOM</th> </tr> </thead> <tbody> <tr> <td>VL1010A0</td> <td>L. MISS/S.4/5 HOLD DOWN WEIGHT + FILTER</td> <td>1.000</td> <td>PC</td> </tr> </tbody> </table>	Code	Description	Qty	UOM	VL1010A0	L. MISS/S.4/5 HOLD DOWN WEIGHT + FILTER	1.000	PC								
Code	Description	Qty	UOM																		
VL1010A0	L. MISS/S.4/5 HOLD DOWN WEIGHT + FILTER	1.000	PC																		
PE1781A	200-240Vac 12Vcc 1,5VA POWER SUPPLY		KPE1781A	240Vac 12Vcc 1.5VA POWER SUPPLY KIT	<table border="1"> <thead> <tr> <th>Code</th> <th>Description</th> <th>Qty</th> <th>UOM</th> </tr> </thead> <tbody> <tr> <td>PE1781A0</td> <td>200-240Vac 12Vcc 1,5VA POWER SUPPLY</td> <td>1.000</td> <td>PC</td> </tr> <tr> <td>VM1745A0</td> <td>CARD SUPPORT</td> <td>4.000</td> <td>PC</td> </tr> </tbody> </table>	Code	Description	Qty	UOM	PE1781A0	200-240Vac 12Vcc 1,5VA POWER SUPPLY	1.000	PC	VM1745A0	CARD SUPPORT	4.000	PC				
Code	Description	Qty	UOM																		
PE1781A0	200-240Vac 12Vcc 1,5VA POWER SUPPLY	1.000	PC																		
VM1745A0	CARD SUPPORT	4.000	PC																		
VM1745A	CARD SUPPORT		KVM1745A	BOARD SUPPORT 10 PCS KIT	<table border="1"> <thead> <tr> <th>Code</th> <th>Description</th> <th>Qty</th> <th>UOM</th> </tr> </thead> <tbody> <tr> <td>VM1745A0</td> <td>CARD SUPPORT</td> <td>10.000</td> <td>PC</td> </tr> </tbody> </table>	Code	Description	Qty	UOM	VM1745A0	CARD SUPPORT	10.000	PC								
Code	Description	Qty	UOM																		
VM1745A0	CARD SUPPORT	10.000	PC																		
CN1010A	MOTOR CAPACITOR 3,5µF 450V,CE/UL,P CLASS		KCN1010A	3.5UF MOTOR CAPACITOR KIT	<table border="1"> <thead> <tr> <th>Code</th> <th>Description</th> <th>Qty</th> <th>UOM</th> </tr> </thead> <tbody> <tr> <td>CN1010A0</td> <td>MOTOR CAPACITOR 3,5µF 450V,CE/UL,P CLASS</td> <td>1.000</td> <td>PC</td> </tr> <tr> <td>V1931A0</td> <td>M8x1.65 H4 CH13 ZINC PLATED NUT</td> <td>1.000</td> <td>PC</td> </tr> <tr> <td>V1932A0</td> <td>D8 INDENTED ZINC PLATED WASHER</td> <td>1.000</td> <td>PC</td> </tr> </tbody> </table>	Code	Description	Qty	UOM	CN1010A0	MOTOR CAPACITOR 3,5µF 450V,CE/UL,P CLASS	1.000	PC	V1931A0	M8x1.65 H4 CH13 ZINC PLATED NUT	1.000	PC	V1932A0	D8 INDENTED ZINC PLATED WASHER	1.000	PC
Code	Description	Qty	UOM																		
CN1010A0	MOTOR CAPACITOR 3,5µF 450V,CE/UL,P CLASS	1.000	PC																		
V1931A0	M8x1.65 H4 CH13 ZINC PLATED NUT	1.000	PC																		
V1932A0	D8 INDENTED ZINC PLATED WASHER	1.000	PC																		
MR1000A	CABLE 3x1,5 H07RN-F MT1,5+K2/3+SCHUK		KMR1000A	KIT CABLE 3X1,5 H07RN-F +K2/3+SCHUKO	<table border="1"> <thead> <tr> <th>Code</th> <th>Description</th> <th>Qty</th> <th>UOM</th> </tr> </thead> <tbody> <tr> <td>MR1000A0</td> <td>CABLE 3x1,5 H07RN-F MT1,5+K2/3+SCHUKO</td> <td>1.000</td> <td>PC</td> </tr> </tbody> </table>	Code	Description	Qty	UOM	MR1000A0	CABLE 3x1,5 H07RN-F MT1,5+K2/3+SCHUKO	1.000	PC								
Code	Description	Qty	UOM																		
MR1000A0	CABLE 3x1,5 H07RN-F MT1,5+K2/3+SCHUKO	1.000	PC																		



Зип Общепит

ASM2021D/0.D00 Electrical system

vsezip.ru

+7(812)987-08-81

COMPONENT			SPARE PART										
Code	Description	Image	Code	Description	Kit components								
VM1968A	SOLENOID INLET CA		KVM1968A	SOLENOID INLET CAP 10PCS KIT	<table border="1"> <thead> <tr> <th>Code</th> <th>Description</th> <th>Qty</th> <th>UOM</th> </tr> </thead> <tbody> <tr> <td>VM1968A0</td> <td>SOLENOID INLET CAP</td> <td>10.000</td> <td>PC</td> </tr> </tbody> </table>	Code	Description	Qty	UOM	VM1968A0	SOLENOID INLET CAP	10.000	PC
Code	Description	Qty	UOM										
VM1968A0	SOLENOID INLET CAP	10.000	PC										