





Зип Общедит

ХЕБFC-08EU-C/0.D02 8 600X400 PROVER

vsezip.ru

+7(812)987-08-81

Assembly code	Assembly revision	Assembly image
ASM3045A/0.D00	External cover	
ASM3047A/0.D00	General overview	
ASM3046B/0.D00	General overview	



Зип Общепит **ASM3045A/0.D00 External cover**

vsezip.ru

+7(812)987-08-81

ASM3045A/0.D00 - External cover

FRONT





Зип Общепит **ASM3045A/0.D00 External cover**

vsezip.ru

+7(812)987-08-81

ASM3045A/0.D00 - External cover

REAR

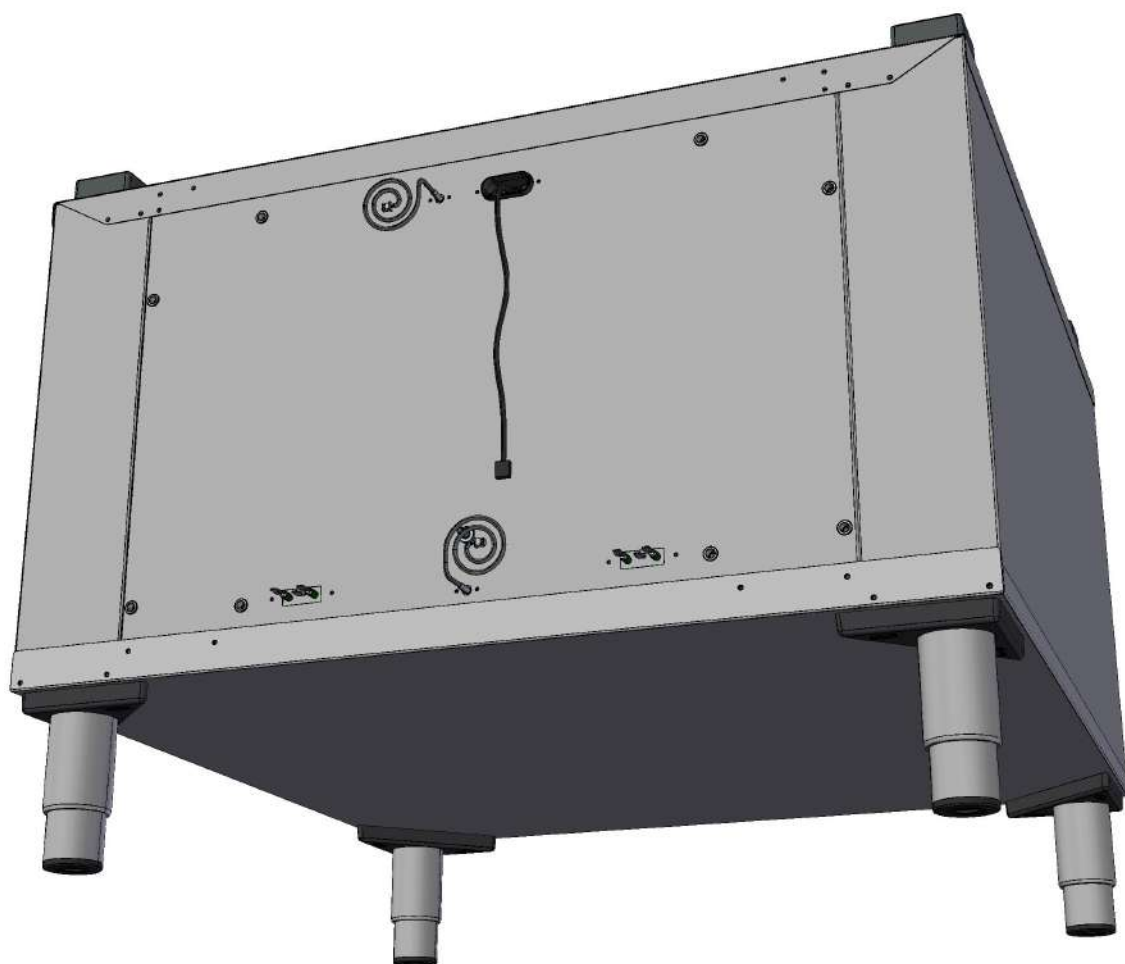



Зип Общепит **ASM3045A/0.D00 External cover**

vsezip.ru

+7(812)987-08-81

COMPONENT			SPARE PART														
Code	Description	Image	Code	Description	Components list												
VM1820A	LATERAL SUPPORTS M6 FIXING BOLT		KVM1820A	THUMB SCREW 10PCS KIT	<table border="1"> <thead> <tr> <th>Code</th> <th>Description</th> <th>Qty</th> <th>UOM</th> </tr> </thead> <tbody> <tr> <td>VM1820A0</td> <td>LATERAL SUPPORTS M6 FIXING BOLT</td> <td>10</td> <td>PZ</td> </tr> </tbody> </table>	Code	Description	Qty	UOM	VM1820A0	LATERAL SUPPORTS M6 FIXING BOLT	10	PZ				
Code	Description	Qty	UOM														
VM1820A0	LATERAL SUPPORTS M6 FIXING BOLT	10	PZ														
PD1075A	FOOT LOCKING BRACKET		KPD1075A	OVEN FOOT STOPPING BRACKET KIT	<table border="1"> <thead> <tr> <th>Code</th> <th>Description</th> <th>Qty</th> <th>UOM</th> </tr> </thead> <tbody> <tr> <td>PD1075A0</td> <td>FOOT LOCKING BRACKET</td> <td>4</td> <td>PZ</td> </tr> <tr> <td>V11950A0</td> <td>ST. STEEL 4,2X13 TCB SELF-DRILLING SCREW</td> <td>8</td> <td>PZ</td> </tr> </tbody> </table>	Code	Description	Qty	UOM	PD1075A0	FOOT LOCKING BRACKET	4	PZ	V11950A0	ST. STEEL 4,2X13 TCB SELF-DRILLING SCREW	8	PZ
Code	Description	Qty	UOM														
PD1075A0	FOOT LOCKING BRACKET	4	PZ														
V11950A0	ST. STEEL 4,2X13 TCB SELF-DRILLING SCREW	8	PZ														
0D2283A	EU VERSION ELECTRONIC PROOFER EXT.COVER		0D2283A0	EU VERSION ELECTRONIC PROOFER EXT.COVER													
PD1064A	100-150MM ADJUSTABLE FOOT		XR608	E SERIES 150 MM FEET KIT	<table border="1"> <thead> <tr> <th>Code</th> <th>Description</th> <th>Qty</th> <th>UOM</th> </tr> </thead> <tbody> <tr> <td>PD1064A0</td> <td>100-150MM ADJUSTABLE FOOT</td> <td>4</td> <td>PZ</td> </tr> </tbody> </table>	Code	Description	Qty	UOM	PD1064A0	100-150MM ADJUSTABLE FOOT	4	PZ				
Code	Description	Qty	UOM														
PD1064A0	100-150MM ADJUSTABLE FOOT	4	PZ														
0H7389A	EUROPEAN PROOFER HORIZ GASKET GUIDE		0H7389A0	EUROPEAN PROOFER HORIZ GASKET GUIDE													



+7(812)987-08-81



COMPONENT			SPARE PART														
Code	Description	Image	Code	Description	Components list												
VM1645A	XL405 PROOFER CORNER GASKET																
0H7206A	EUROPEAN PROOFER FRONT BARRIER		0H7206A0	EUROPEAN PROOFER FRONT BARRIER													
VE1607A	RUBBER MAGNETIC SUCTION CUP		KVE1607A	MAGNETIC SUCTION CUP	<table border="1"> <thead> <tr> <th>Code</th> <th>Description</th> <th>Qty</th> <th>UOM</th> </tr> </thead> <tbody> <tr> <td>VE1607A1</td> <td>RUBBER MAGNETIC SUCTION CUP</td> <td>4</td> <td>PZ</td> </tr> <tr> <td>VI1700A0</td> <td>18X6.4X1.5 STAINLESS STEEL FLAT WASHER</td> <td>4</td> <td>PZ</td> </tr> </tbody> </table>	Code	Description	Qty	UOM	VE1607A1	RUBBER MAGNETIC SUCTION CUP	4	PZ	VI1700A0	18X6.4X1.5 STAINLESS STEEL FLAT WASHER	4	PZ
Code	Description	Qty	UOM														
VE1607A1	RUBBER MAGNETIC SUCTION CUP	4	PZ														
VI1700A0	18X6.4X1.5 STAINLESS STEEL FLAT WASHER	4	PZ														
VM1022B	PROOFER DOOR UPPER BRACKET		KVM1022B	PROOFER DOOR UPPER BRACKET	<table border="1"> <thead> <tr> <th>Code</th> <th>Description</th> <th>Qty</th> <th>UOM</th> </tr> </thead> <tbody> <tr> <td>VM1022B0</td> <td>PROOFER DOOR UPPER BRACKET</td> <td>1</td> <td>PZ</td> </tr> </tbody> </table>	Code	Description	Qty	UOM	VM1022B0	PROOFER DOOR UPPER BRACKET	1	PZ				
Code	Description	Qty	UOM														
VM1022B0	PROOFER DOOR UPPER BRACKET	1	PZ														
VM1024B	PROOFER DOOR LEFT LOWER BRACKET		KVM1024B	PROOFER DOOR LEFT+RIGHT LOWER BRACKET KI	<table border="1"> <thead> <tr> <th>Code</th> <th>Description</th> <th>Qty</th> <th>UOM</th> </tr> </thead> <tbody> <tr> <td>VM1023B0</td> <td>PROOFER DOOR RIGHT LOWER BRACKET</td> <td>1</td> <td>PZ</td> </tr> <tr> <td>VM1024B0</td> <td>PROOFER DOOR LEFT LOWER BRACKET</td> <td>1</td> <td>PZ</td> </tr> </tbody> </table>	Code	Description	Qty	UOM	VM1023B0	PROOFER DOOR RIGHT LOWER BRACKET	1	PZ	VM1024B0	PROOFER DOOR LEFT LOWER BRACKET	1	PZ
Code	Description	Qty	UOM														
VM1023B0	PROOFER DOOR RIGHT LOWER BRACKET	1	PZ														
VM1024B0	PROOFER DOOR LEFT LOWER BRACKET	1	PZ														



Зип Общепит ASM3045A/0.D00 External cover

vsezip.ru

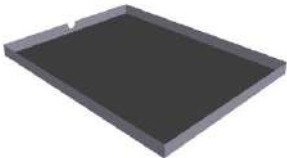
+7(812)987-08-81

COMPONENT			SPARE PART																																		
Code	Description	Image	Code	Description	Components list																																
VM1023B	PROOFER DOOR RIGHT LOWER BRACKET		KVM1024A	PROOFER LF/RG DOOR LOWER BRACKET KIT	<table border="1"> <thead> <tr> <th>Code</th> <th>Description</th> <th>Qty</th> <th>UOM</th> </tr> </thead> <tbody> <tr> <td>VM1023A0</td> <td>PROOFER DOOR RIGHT LOWER BRACKET</td> <td>1</td> <td>PZ</td> </tr> <tr> <td>VM1024A0</td> <td>PROOFER DOOR LEFT LOWER BRACKET</td> <td>1</td> <td>PZ</td> </tr> </tbody> </table>	Code	Description	Qty	UOM	VM1023A0	PROOFER DOOR RIGHT LOWER BRACKET	1	PZ	VM1024A0	PROOFER DOOR LEFT LOWER BRACKET	1	PZ																				
Code	Description	Qty	UOM																																		
VM1023A0	PROOFER DOOR RIGHT LOWER BRACKET	1	PZ																																		
VM1024A0	PROOFER DOOR LEFT LOWER BRACKET	1	PZ																																		
0H7211A	EUROPEAN PROOFER WATER TRAY		0H7211A0	EUROPEAN PROOFER WATER TRAY																																	
RS1095A	HEATING ELEMENT 1200W 230V		KRS1095A	1.2KW HEATING ELEMENT KIT	<table border="1"> <thead> <tr> <th>Code</th> <th>Description</th> <th>Qty</th> <th>UOM</th> </tr> </thead> <tbody> <tr> <td>GN1326A1</td> <td>ELEMENT SEALING</td> <td>1</td> <td>PZ</td> </tr> <tr> <td>IP1385A0</td> <td></td> <td>1.200</td> <td>PZ</td> </tr> <tr> <td>IP1385A1</td> <td>CORNER POLYSTYREN E PACKING 110X80X2000</td> <td>0.500</td> <td>M</td> </tr> <tr> <td>RS1095A1</td> <td>HEATING ELEMENT 1200W 230V</td> <td>1</td> <td>PZ</td> </tr> <tr> <td>SL1045A0</td> <td>S53 BLACK SILICONE - 80ML CARTRIDGE</td> <td>1</td> <td>PZ</td> </tr> <tr> <td>VI1220A1</td> <td>4,2X12 TCB SELF-TAPPIN G SCREW</td> <td>2</td> <td>PZ</td> </tr> <tr> <td>VM1059A1</td> <td>HEAT SHRINK FILM H800</td> <td>1.200</td> <td>M</td> </tr> </tbody> </table>	Code	Description	Qty	UOM	GN1326A1	ELEMENT SEALING	1	PZ	IP1385A0		1.200	PZ	IP1385A1	CORNER POLYSTYREN E PACKING 110X80X2000	0.500	M	RS1095A1	HEATING ELEMENT 1200W 230V	1	PZ	SL1045A0	S53 BLACK SILICONE - 80ML CARTRIDGE	1	PZ	VI1220A1	4,2X12 TCB SELF-TAPPIN G SCREW	2	PZ	VM1059A1	HEAT SHRINK FILM H800	1.200	M
Code	Description	Qty	UOM																																		
GN1326A1	ELEMENT SEALING	1	PZ																																		
IP1385A0		1.200	PZ																																		
IP1385A1	CORNER POLYSTYREN E PACKING 110X80X2000	0.500	M																																		
RS1095A1	HEATING ELEMENT 1200W 230V	1	PZ																																		
SL1045A0	S53 BLACK SILICONE - 80ML CARTRIDGE	1	PZ																																		
VI1220A1	4,2X12 TCB SELF-TAPPIN G SCREW	2	PZ																																		
VM1059A1	HEAT SHRINK FILM H800	1.200	M																																		
0D2317A	8 600X400 PROOFER EXTERNAL SIDE PANEL		0D2317A0	8 600X400 PROOFER EXTERNAL SIDE PANEL																																	







COMPONENT			SPARE PART																															
Code	Description	Image	Code	Description	Components list																													
GN1285A	NTC TEMPERATURE PROBE SEALING		KTR1106A	5-5E S. L2000 CHAMBER TEMP. PROBE KIT	<table border="1"> <thead> <tr> <th>Code</th> <th>Description</th> <th>Qty</th> <th>UOM</th> </tr> </thead> <tbody> <tr> <td>GN1285A0</td> <td>NTC TEMPERATUR E PROBE SEALING</td> <td>1</td> <td>PZ</td> </tr> <tr> <td>SL1045A0</td> <td>S53 BLACK SILICONE - 80ML CARTRIDGE</td> <td>1</td> <td>PZ</td> </tr> <tr> <td>TR1106A3</td> <td>PT100 L=2000 TEMPERATUR E PROBE</td> <td>1</td> <td>PZ</td> </tr> <tr> <td>VI1220A1</td> <td>4,2X12 TCB SELF-TAPPIN G SCREW</td> <td>2</td> <td>PZ</td> </tr> <tr> <td>VM1465A0</td> <td>CHEFTOP TEMPERATUR E PROBE COVER</td> <td>1</td> <td>PZ</td> </tr> </tbody> </table>	Code	Description	Qty	UOM	GN1285A0	NTC TEMPERATUR E PROBE SEALING	1	PZ	SL1045A0	S53 BLACK SILICONE - 80ML CARTRIDGE	1	PZ	TR1106A3	PT100 L=2000 TEMPERATUR E PROBE	1	PZ	VI1220A1	4,2X12 TCB SELF-TAPPIN G SCREW	2	PZ	VM1465A0	CHEFTOP TEMPERATUR E PROBE COVER	1	PZ					
			Code	Description	Qty	UOM																												
			GN1285A0	NTC TEMPERATUR E PROBE SEALING	1	PZ																												
SL1045A0	S53 BLACK SILICONE - 80ML CARTRIDGE	1	PZ																															
TR1106A3	PT100 L=2000 TEMPERATUR E PROBE	1	PZ																															
VI1220A1	4,2X12 TCB SELF-TAPPIN G SCREW	2	PZ																															
VM1465A0	CHEFTOP TEMPERATUR E PROBE COVER	1	PZ																															
KTR1105A	PT100 L1000 TEMPERATURE PROBE KIT	<table border="1"> <thead> <tr> <th>Code</th> <th>Description</th> <th>Qty</th> <th>UOM</th> </tr> </thead> <tbody> <tr> <td>GN1120A0</td> <td>TEMPERATUR E PROBE NTC SEAL</td> <td>1</td> <td>PZ</td> </tr> <tr> <td>GN1285A0</td> <td>NTC TEMPERATUR E PROBE SEALING</td> <td>1</td> <td>PZ</td> </tr> <tr> <td>SL1045A0</td> <td>S53 BLACK SILICONE - 80ML CARTRIDGE</td> <td>1</td> <td>PZ</td> </tr> <tr> <td>TR1105A3</td> <td>L=1000 PT1000 TEMPERATUR E PROBE</td> <td>1</td> <td>PZ</td> </tr> <tr> <td>TR1105A4</td> <td></td> <td>1</td> <td>PZ</td> </tr> <tr> <td>VI1220A1</td> <td>4,2X12 TCB SELF-TAPPIN G SCREW</td> <td>2</td> <td>PZ</td> </tr> <tr> <td>VM1465A0</td> <td>CHEFTOP TEMPERATUR E PROBE COVER</td> <td>1</td> <td>PZ</td> </tr> </tbody> </table>	Code	Description	Qty	UOM	GN1120A0	TEMPERATUR E PROBE NTC SEAL	1	PZ	GN1285A0	NTC TEMPERATUR E PROBE SEALING	1	PZ	SL1045A0	S53 BLACK SILICONE - 80ML CARTRIDGE	1	PZ	TR1105A3	L=1000 PT1000 TEMPERATUR E PROBE	1	PZ	TR1105A4		1	PZ	VI1220A1	4,2X12 TCB SELF-TAPPIN G SCREW	2	PZ	VM1465A0	CHEFTOP TEMPERATUR E PROBE COVER	1	PZ
Code	Description	Qty	UOM																															
GN1120A0	TEMPERATUR E PROBE NTC SEAL	1	PZ																															
GN1285A0	NTC TEMPERATUR E PROBE SEALING	1	PZ																															
SL1045A0	S53 BLACK SILICONE - 80ML CARTRIDGE	1	PZ																															
TR1105A3	L=1000 PT1000 TEMPERATUR E PROBE	1	PZ																															
TR1105A4		1	PZ																															
VI1220A1	4,2X12 TCB SELF-TAPPIN G SCREW	2	PZ																															
VM1465A0	CHEFTOP TEMPERATUR E PROBE COVER	1	PZ																															
KTR1096A	NTC 150 L=1500 TEMPERATURE PROBE KIT	<table border="1"> <thead> <tr> <th>Code</th> <th>Description</th> <th>Qty</th> <th>UOM</th> </tr> </thead> <tbody> <tr> <td>GN1120A0</td> <td>TEMPERATUR E PROBE NTC SEAL</td> <td>1</td> <td>PZ</td> </tr> <tr> <td>GN1285A0</td> <td>NTC TEMPERATUR E PROBE SEALING</td> <td>2</td> <td>PZ</td> </tr> <tr> <td>SL1045A0</td> <td>S53 BLACK SILICONE - 80ML CARTRIDGE</td> <td>1</td> <td>PZ</td> </tr> </tbody> </table>	Code	Description	Qty	UOM	GN1120A0	TEMPERATUR E PROBE NTC SEAL	1	PZ	GN1285A0	NTC TEMPERATUR E PROBE SEALING	2	PZ	SL1045A0	S53 BLACK SILICONE - 80ML CARTRIDGE	1	PZ																
Code	Description	Qty	UOM																															
GN1120A0	TEMPERATUR E PROBE NTC SEAL	1	PZ																															
GN1285A0	NTC TEMPERATUR E PROBE SEALING	2	PZ																															
SL1045A0	S53 BLACK SILICONE - 80ML CARTRIDGE	1	PZ																															



COMPONENT			SPARE PART																											
Code	Description	Image	Code	Description	Components list																									
GN1285A	NTC TEMPERATURE PROBE SEALING		KTR1096A	NTC 150 L=1500 TEMPERATURE PROBE KIT	<table border="1"> <thead> <tr> <th>Code</th> <th>Description</th> <th>Qty</th> <th>UOM</th> </tr> </thead> <tbody> <tr> <td>TR1096A0</td> <td>TEMPERATUR E PROBE NTC 150 L=1500</td> <td>1</td> <td>PZ</td> </tr> <tr> <td>VI1220A1</td> <td>4,2X12 TCB SELF-TAPPIN G SCREW</td> <td>2</td> <td>PZ</td> </tr> <tr> <td>VM1465A0</td> <td>CHEFTOP TEMPERATUR E PROBE COVER</td> <td>1</td> <td>PZ</td> </tr> </tbody> </table>	Code	Description	Qty	UOM	TR1096A0	TEMPERATUR E PROBE NTC 150 L=1500	1	PZ	VI1220A1	4,2X12 TCB SELF-TAPPIN G SCREW	2	PZ	VM1465A0	CHEFTOP TEMPERATUR E PROBE COVER	1	PZ									
			Code	Description	Qty	UOM																								
			TR1096A0	TEMPERATUR E PROBE NTC 150 L=1500	1	PZ																								
VI1220A1	4,2X12 TCB SELF-TAPPIN G SCREW	2	PZ																											
VM1465A0	CHEFTOP TEMPERATUR E PROBE COVER	1	PZ																											
KTR1095A	NTC 150 L=1050 TEMPERATURE PROBE KIT	<table border="1"> <thead> <tr> <th>Code</th> <th>Description</th> <th>Qty</th> <th>UOM</th> </tr> </thead> <tbody> <tr> <td>GN1120A0</td> <td>TEMPERATUR E PROBE NTC SEAL</td> <td>1</td> <td>PZ</td> </tr> <tr> <td>GN1285A0</td> <td>NTC TEMPERATUR E PROBE SEALING</td> <td>1</td> <td>PZ</td> </tr> <tr> <td>SL1045A0</td> <td>S53 BLACK SILICONE - 80ML CARTRIDGE</td> <td>1</td> <td>PZ</td> </tr> <tr> <td>TR1095A0</td> <td>TEMPERATUR E PROBE NTC 150 L=1050</td> <td>1</td> <td>PZ</td> </tr> <tr> <td>VI1220A1</td> <td>4,2X12 TCB SELF-TAPPIN G SCREW</td> <td>2</td> <td>PZ</td> </tr> <tr> <td>VM1465A0</td> <td>CHEFTOP TEMPERATUR E PROBE COVER</td> <td>1</td> <td>PZ</td> </tr> </tbody> </table>	Code	Description	Qty	UOM	GN1120A0	TEMPERATUR E PROBE NTC SEAL	1	PZ	GN1285A0	NTC TEMPERATUR E PROBE SEALING	1	PZ	SL1045A0	S53 BLACK SILICONE - 80ML CARTRIDGE	1	PZ	TR1095A0	TEMPERATUR E PROBE NTC 150 L=1050	1	PZ	VI1220A1	4,2X12 TCB SELF-TAPPIN G SCREW	2	PZ	VM1465A0	CHEFTOP TEMPERATUR E PROBE COVER	1	PZ
Code	Description	Qty	UOM																											
GN1120A0	TEMPERATUR E PROBE NTC SEAL	1	PZ																											
GN1285A0	NTC TEMPERATUR E PROBE SEALING	1	PZ																											
SL1045A0	S53 BLACK SILICONE - 80ML CARTRIDGE	1	PZ																											
TR1095A0	TEMPERATUR E PROBE NTC 150 L=1050	1	PZ																											
VI1220A1	4,2X12 TCB SELF-TAPPIN G SCREW	2	PZ																											
VM1465A0	CHEFTOP TEMPERATUR E PROBE COVER	1	PZ																											
KTR1002A	PT100 L1000 UL TEMPERATURE PROBE KIT	<table border="1"> <thead> <tr> <th>Code</th> <th>Description</th> <th>Qty</th> <th>UOM</th> </tr> </thead> <tbody> <tr> <td>GN1285A0</td> <td>NTC TEMPERATUR E PROBE SEALING</td> <td>2</td> <td>PZ</td> </tr> <tr> <td>SL1045A0</td> <td>S53 BLACK SILICONE - 80ML CARTRIDGE</td> <td>1</td> <td>PZ</td> </tr> <tr> <td>TR1002A0</td> <td>TEMPERATUR E PROBE UL PT100 L1000</td> <td>1</td> <td>PZ</td> </tr> <tr> <td>TR1002A1</td> <td></td> <td>1</td> <td>PZ</td> </tr> <tr> <td>VI1220A1</td> <td>4,2X12 TCB SELF-TAPPIN G SCREW</td> <td>2</td> <td>PZ</td> </tr> <tr> <td>VM1465A0</td> <td>CHEFTOP TEMPERATUR E PROBE COVER</td> <td>1</td> <td>PZ</td> </tr> </tbody> </table>	Code	Description	Qty	UOM	GN1285A0	NTC TEMPERATUR E PROBE SEALING	2	PZ	SL1045A0	S53 BLACK SILICONE - 80ML CARTRIDGE	1	PZ	TR1002A0	TEMPERATUR E PROBE UL PT100 L1000	1	PZ	TR1002A1		1	PZ	VI1220A1	4,2X12 TCB SELF-TAPPIN G SCREW	2	PZ	VM1465A0	CHEFTOP TEMPERATUR E PROBE COVER	1	PZ
Code	Description	Qty	UOM																											
GN1285A0	NTC TEMPERATUR E PROBE SEALING	2	PZ																											
SL1045A0	S53 BLACK SILICONE - 80ML CARTRIDGE	1	PZ																											
TR1002A0	TEMPERATUR E PROBE UL PT100 L1000	1	PZ																											
TR1002A1		1	PZ																											
VI1220A1	4,2X12 TCB SELF-TAPPIN G SCREW	2	PZ																											
VM1465A0	CHEFTOP TEMPERATUR E PROBE COVER	1	PZ																											



+7(812)987-08-81





COMPONENT			SPARE PART																																		
Code	Description	Image	Code	Description	Components list																																
VM1465A	CHEFTOP TEMPERATURE PROBE COVER		VM1465A0	CHEFTOP TEMPERATURE PROBE COVER																																	
TR1105A	L=1000 PT1000 TEMPERATURE PROBE		KTR1105A	PT100 L1000 TEMPERATURE PROBE KIT	<table border="1"> <thead> <tr> <th>Code</th> <th>Description</th> <th>Qty</th> <th>UOM</th> </tr> </thead> <tbody> <tr> <td>GN1120A0</td> <td>TEMPERATUR E PROBE NTC SEAL</td> <td>1</td> <td>PZ</td> </tr> <tr> <td>GN1285A0</td> <td>NTC TEMPERATUR E PROBE SEALING</td> <td>1</td> <td>PZ</td> </tr> <tr> <td>SL1045A0</td> <td>S53 BLACK SILICONE - 80ML CARTRIDGE</td> <td>1</td> <td>PZ</td> </tr> <tr> <td>TR1105A3</td> <td>L=1000 PT1000 TEMPERATUR E PROBE</td> <td>1</td> <td>PZ</td> </tr> <tr> <td>TR1105A4</td> <td></td> <td>1</td> <td>PZ</td> </tr> <tr> <td>VI1220A1</td> <td>4,2X12 TCB SELF-TAPPIN G SCREW</td> <td>2</td> <td>PZ</td> </tr> <tr> <td>VM1465A0</td> <td>CHEFTOP TEMPERATUR E PROBE COVER</td> <td>1</td> <td>PZ</td> </tr> </tbody> </table>	Code	Description	Qty	UOM	GN1120A0	TEMPERATUR E PROBE NTC SEAL	1	PZ	GN1285A0	NTC TEMPERATUR E PROBE SEALING	1	PZ	SL1045A0	S53 BLACK SILICONE - 80ML CARTRIDGE	1	PZ	TR1105A3	L=1000 PT1000 TEMPERATUR E PROBE	1	PZ	TR1105A4		1	PZ	VI1220A1	4,2X12 TCB SELF-TAPPIN G SCREW	2	PZ	VM1465A0	CHEFTOP TEMPERATUR E PROBE COVER	1	PZ
Code	Description	Qty	UOM																																		
GN1120A0	TEMPERATUR E PROBE NTC SEAL	1	PZ																																		
GN1285A0	NTC TEMPERATUR E PROBE SEALING	1	PZ																																		
SL1045A0	S53 BLACK SILICONE - 80ML CARTRIDGE	1	PZ																																		
TR1105A3	L=1000 PT1000 TEMPERATUR E PROBE	1	PZ																																		
TR1105A4		1	PZ																																		
VI1220A1	4,2X12 TCB SELF-TAPPIN G SCREW	2	PZ																																		
VM1465A0	CHEFTOP TEMPERATUR E PROBE COVER	1	PZ																																		
UG1004A	XC415-515-625 1/8" WATER NOZZLE		KUG1004A	XC415-515-625 1/8" WATER NOZZLE KIT	<table border="1"> <thead> <tr> <th>Code</th> <th>Description</th> <th>Qty</th> <th>UOM</th> </tr> </thead> <tbody> <tr> <td>UG1004A0</td> <td>XC415-515-625 1/8\" WATER NOZZLE</td> <td>1</td> <td>PZ</td> </tr> </tbody> </table>	Code	Description	Qty	UOM	UG1004A0	XC415-515-625 1/8\" WATER NOZZLE	1	PZ																								
Code	Description	Qty	UOM																																		
UG1004A0	XC415-515-625 1/8\" WATER NOZZLE	1	PZ																																		
VM1690A	HUMIDITY PROBE SUPPORT XL405		KVM1690A	HUMIDITY SENSOR SUPPORT KIT	<table border="1"> <thead> <tr> <th>Code</th> <th>Description</th> <th>Qty</th> <th>UOM</th> </tr> </thead> <tbody> <tr> <td>VM1690A0</td> <td>HUMIDITY PROBE SUPPORT XL405</td> <td>1</td> <td>PZ</td> </tr> </tbody> </table>	Code	Description	Qty	UOM	VM1690A0	HUMIDITY PROBE SUPPORT XL405	1	PZ																								
Code	Description	Qty	UOM																																		
VM1690A0	HUMIDITY PROBE SUPPORT XL405	1	PZ																																		



Зип Общепит ASM3045A/0.D00 External cover

vsezip.ru

+7(812)987-08-81





COMPONENT			SPARE PART																						
Code	Description	Image	Code	Description	Components list																				
VM2160A	HUMIDITY SENSOR EXTENSION		VM2160A0	HUMIDITY SENSOR EXTENSION																					
0F1508A	8 600X400 EL.PROOFER EXTERNAL BACK PANEL		0F1508A0	8 600X400 EL.PROOFER EXTERNAL BACK PANEL																					
TR1120A	HUMIDITY SENSOR		KTR1120A	HUMIDITY PROBE KI	<table border="1"> <thead> <tr> <th>Code</th> <th>Description</th> <th>Qty</th> <th>UOM</th> </tr> </thead> <tbody> <tr> <td>SL1045A0</td> <td>S53 BLACK SILICONE - 80ML CARTRIDGE</td> <td>1</td> <td>PZ</td> </tr> <tr> <td>TR1120A0</td> <td>HUMIDITY SENSOR</td> <td>1</td> <td>PZ</td> </tr> <tr> <td>VI1220A1</td> <td>4,2X12 TCB SELF-TAPPIN G SCREW</td> <td>2</td> <td>PZ</td> </tr> <tr> <td>VM1690A0</td> <td>HUMIDITY PROBE SUPPORT XL405</td> <td>1</td> <td>PZ</td> </tr> </tbody> </table>	Code	Description	Qty	UOM	SL1045A0	S53 BLACK SILICONE - 80ML CARTRIDGE	1	PZ	TR1120A0	HUMIDITY SENSOR	1	PZ	VI1220A1	4,2X12 TCB SELF-TAPPIN G SCREW	2	PZ	VM1690A0	HUMIDITY PROBE SUPPORT XL405	1	PZ
Code	Description	Qty	UOM																						
SL1045A0	S53 BLACK SILICONE - 80ML CARTRIDGE	1	PZ																						
TR1120A0	HUMIDITY SENSOR	1	PZ																						
VI1220A1	4,2X12 TCB SELF-TAPPIN G SCREW	2	PZ																						
VM1690A0	HUMIDITY PROBE SUPPORT XL405	1	PZ																						
RC1400A	PROOFER TURNED FITTING		RC1400A1	PROOFER TURNED FITTING																					
0H7329A	8TRAY PROOFER LATERAL GASKET PLACE		0H7329A0	8TRAY PROOFER LATERAL GASKET PLACE																					



Зип Общепит **ASM3045A/0.D00 External cover**

vsezip.ru

+7(812)987-08-81

COMPONENT			SPARE PART		
Code	Description	Image	Code	Description	Components list
GN1557A	8TRAY PROOFER DOOR GASKET - GN1110A		GN1557A0	8TRAY PROOFER DOOR GASKET - GN1110A	
GRL1401A	8 600X400 PROOFER LEFT LATERAL SUPPORT		GRL1401A0	8 600X400 PROOFER LEFT LATERAL SUPPORT	
GRL1402A	8 600X400 PROOFER RIGHT LATERAL SUPPORT		GRL1402A0	8 600X400 PROOFER RIGHT LATERAL SUPPORT	
0H7213A	EUROPEAN PROOFER COVER TRAY		0H7213A0	EUROPEAN PROOFER COVER TRAY	
0E1347A	EU VERSION PROOFER EXT.BOTTOM PANE		0E1347A1	EU VERSION PROOFER EXT.BOTTOM PANE	



Зип Общепит **ASM3045A/0.D00 External cover**

vsezip.ru

+7(812)987-08-81

COMPONENT			SPARE PART		
<i>Code</i>	<i>Description</i>	<i>Image</i>	<i>Code</i>	<i>Description</i>	<i>Components list</i>
VM1281A	TRIANGULAR SUPPORT FOOT-WHEEL				



Зип Общепит

ASM3047A/0.D00 General overview

vsezip.ru

+7(812)987-08-81

ASM3047A/0.D00 - General overview

FRONT

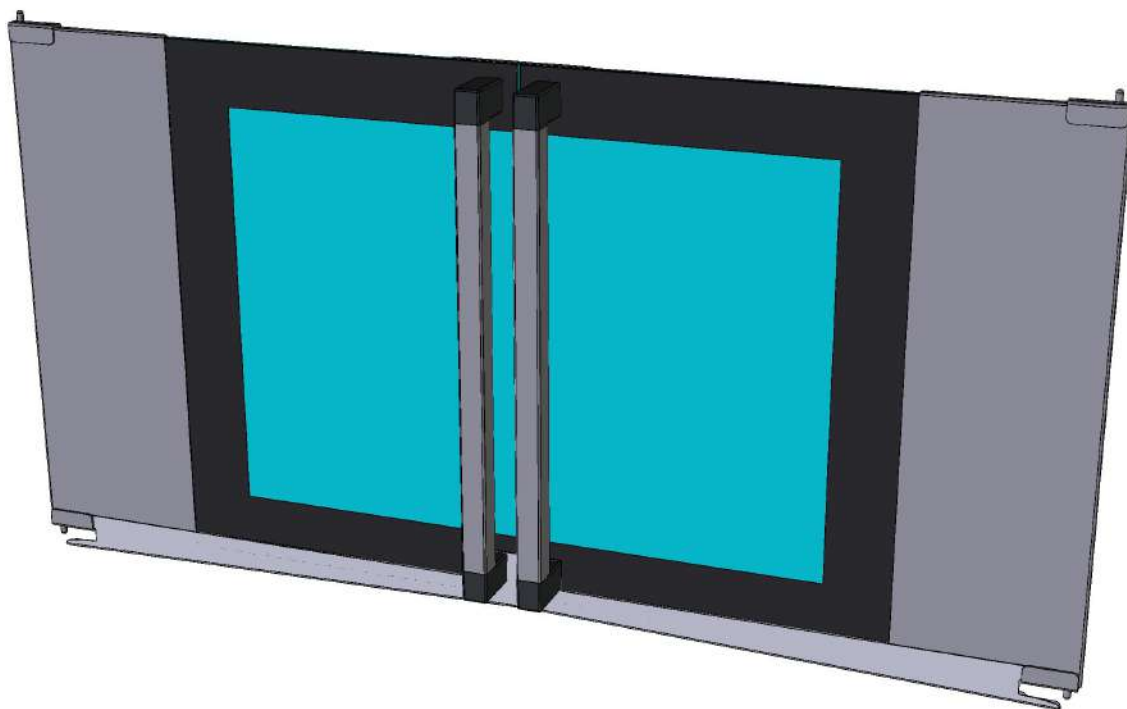



Зип Общепит

ASM3047A/0.D00 General overview

vsezip.ru

+7(812)987-08-81

ASM3047A/0.D00 - General overview

REAR

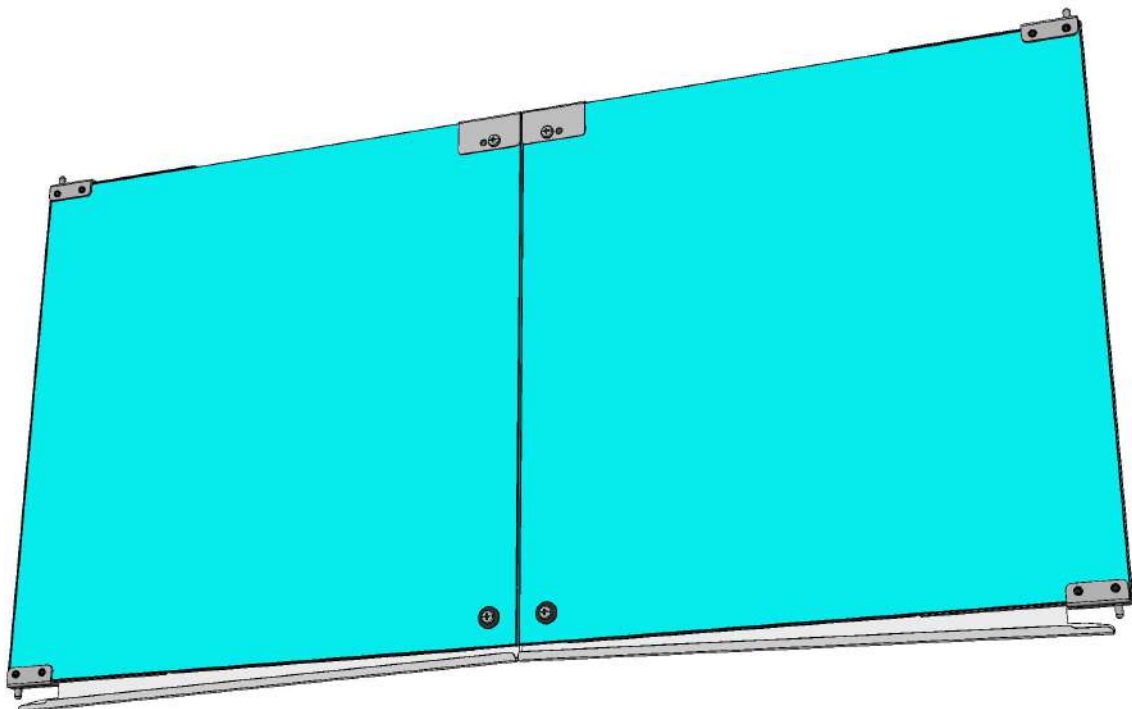





Зип Общепит

ASM3047A/0.D00 General overview

vsezip.ru

+7(812)987-08-81

COMPONENT			SPARE PART																																																						
Code	Description	Image	Code	Description	Components list																																																				
0H4540A	DOOR PLATES MAGNET XL405		0H4540A0	DOOR PLATES MAGNET XL405																																																					
VM1720A	XL405 DOOR WASKER		VM1720A0	XL405 DOOR WASKER																																																					
GN1330A	FERRITIC PLATE GASKET XL405		KVT1086BR	XLT195/XLT193 RIGHT COMPLETE DOOR KIT	<table border="1"> <thead> <tr> <th>Code</th> <th>Description</th> <th>Qty</th> <th>UOM</th> </tr> </thead> <tbody> <tr> <td>0H4540A0</td> <td>DOOR PLATES MAGNET XL40</td> <td>1</td> <td>PZ</td> </tr> <tr> <td>CR1080A0</td> <td>XV-XL-XB ST. STEEL RIGHT HINGE</td> <td>1</td> <td>PZ</td> </tr> <tr> <td>CR1081A0</td> <td>XV-XL-XB ST. STEEL LEFT HINGE</td> <td>1</td> <td>PZ</td> </tr> <tr> <td>GN1320A0</td> <td>DOOR GLASS HINGE GASKE</td> <td>2</td> <td>PZ</td> </tr> <tr> <td>GN1320A1</td> <td>DOOR GLASS GASKET</td> <td>2</td> <td>PZ</td> </tr> <tr> <td>GN1330A0</td> <td>FERRITIC PLATE GASKET XL40</td> <td>1</td> <td>PZ</td> </tr> <tr> <td>MG1015B0</td> <td>L.MISS/L.MICR O/CHEFTOP HANDLE END</td> <td>2</td> <td>PZ</td> </tr> <tr> <td>TB1077A0</td> <td>XLT135/XLT19 5 Ø18X1 HANDLE TUBE</td> <td>1</td> <td>PZ</td> </tr> <tr> <td>VI1685A0</td> <td>M6X6 STAINLESS STEEL SCREW</td> <td>4</td> <td>PZ</td> </tr> <tr> <td>VI1930A0</td> <td>5X25 ST. STEEL SCREW CHIP</td> <td>2</td> <td>PZ</td> </tr> <tr> <td>VM1720A0</td> <td>XL405 DOOR WASKER</td> <td>1</td> <td>PZ</td> </tr> <tr> <td>VT1086B0</td> <td>XLT195/XLT19 3 DOOR BLACK GLASS 399X661</td> <td>1</td> <td>PZ</td> </tr> </tbody> </table>	Code	Description	Qty	UOM	0H4540A0	DOOR PLATES MAGNET XL40	1	PZ	CR1080A0	XV-XL-XB ST. STEEL RIGHT HINGE	1	PZ	CR1081A0	XV-XL-XB ST. STEEL LEFT HINGE	1	PZ	GN1320A0	DOOR GLASS HINGE GASKE	2	PZ	GN1320A1	DOOR GLASS GASKET	2	PZ	GN1330A0	FERRITIC PLATE GASKET XL40	1	PZ	MG1015B0	L.MISS/L.MICR O/CHEFTOP HANDLE END	2	PZ	TB1077A0	XLT135/XLT19 5 Ø18X1 HANDLE TUBE	1	PZ	VI1685A0	M6X6 STAINLESS STEEL SCREW	4	PZ	VI1930A0	5X25 ST. STEEL SCREW CHIP	2	PZ	VM1720A0	XL405 DOOR WASKER	1	PZ	VT1086B0	XLT195/XLT19 3 DOOR BLACK GLASS 399X661	1	PZ
Code	Description	Qty	UOM																																																						
0H4540A0	DOOR PLATES MAGNET XL40	1	PZ																																																						
CR1080A0	XV-XL-XB ST. STEEL RIGHT HINGE	1	PZ																																																						
CR1081A0	XV-XL-XB ST. STEEL LEFT HINGE	1	PZ																																																						
GN1320A0	DOOR GLASS HINGE GASKE	2	PZ																																																						
GN1320A1	DOOR GLASS GASKET	2	PZ																																																						
GN1330A0	FERRITIC PLATE GASKET XL40	1	PZ																																																						
MG1015B0	L.MISS/L.MICR O/CHEFTOP HANDLE END	2	PZ																																																						
TB1077A0	XLT135/XLT19 5 Ø18X1 HANDLE TUBE	1	PZ																																																						
VI1685A0	M6X6 STAINLESS STEEL SCREW	4	PZ																																																						
VI1930A0	5X25 ST. STEEL SCREW CHIP	2	PZ																																																						
VM1720A0	XL405 DOOR WASKER	1	PZ																																																						
VT1086B0	XLT195/XLT19 3 DOOR BLACK GLASS 399X661	1	PZ																																																						



COMPONENT			SPARE PART																																																																																													
Code	Description	Image	Code	Description	Components list																																																																																											
GN1330A	FERRITIC PLATE GASKET XL405		KVT1086BL	XLT195/XLT193 LEFT COMPLETE DOOR KIT	<table border="1"> <thead> <tr> <th>Code</th> <th>Description</th> <th>Qty</th> <th>UOM</th> </tr> </thead> <tbody> <tr> <td>0H4540A0</td> <td>DOOR PLATES MAGNET XL40</td> <td>1</td> <td>PZ</td> </tr> <tr> <td>CR1080A0</td> <td>XV-XL-XB ST. STEEL RIGHT HINGE</td> <td>1</td> <td>PZ</td> </tr> <tr> <td>CR1081A0</td> <td>XV-XL-XB ST. STEEL LEFT HINGE</td> <td>1</td> <td>PZ</td> </tr> <tr> <td>GN1320A0</td> <td>DOOR GLASS HINGE GASKE</td> <td>2</td> <td>PZ</td> </tr> <tr> <td>GN1320A1</td> <td>DOOR GLASS GASKET</td> <td>2</td> <td>PZ</td> </tr> <tr> <td>GN1330A0</td> <td>FERRITIC PLATE GASKET XL40</td> <td>1</td> <td>PZ</td> </tr> <tr> <td>MG1015B0</td> <td>L.MISS/L.MICR O/CHEFTOP HANDLE END</td> <td>2</td> <td>PZ</td> </tr> <tr> <td>TB1077A0</td> <td>XLT135/XLT19 5 Ø18X1 HANDLE TUBE</td> <td>1</td> <td>PZ</td> </tr> <tr> <td>VI1685A0</td> <td>M6X6 STAINLESS STEEL SCREW</td> <td>4</td> <td>PZ</td> </tr> <tr> <td>VI1930A0</td> <td>5X25 ST. STEEL SCREW CHIP</td> <td>2</td> <td>PZ</td> </tr> <tr> <td>VM1720A0</td> <td>XL405 DOOR WASKER</td> <td>1</td> <td>PZ</td> </tr> <tr> <td>VT1086B0</td> <td>XLT195/XLT19 3 DOOR BLACK GLASS 399X661</td> <td>1</td> <td>PZ</td> </tr> </tbody> </table>	Code	Description	Qty	UOM	0H4540A0	DOOR PLATES MAGNET XL40	1	PZ	CR1080A0	XV-XL-XB ST. STEEL RIGHT HINGE	1	PZ	CR1081A0	XV-XL-XB ST. STEEL LEFT HINGE	1	PZ	GN1320A0	DOOR GLASS HINGE GASKE	2	PZ	GN1320A1	DOOR GLASS GASKET	2	PZ	GN1330A0	FERRITIC PLATE GASKET XL40	1	PZ	MG1015B0	L.MISS/L.MICR O/CHEFTOP HANDLE END	2	PZ	TB1077A0	XLT135/XLT19 5 Ø18X1 HANDLE TUBE	1	PZ	VI1685A0	M6X6 STAINLESS STEEL SCREW	4	PZ	VI1930A0	5X25 ST. STEEL SCREW CHIP	2	PZ	VM1720A0	XL405 DOOR WASKER	1	PZ	VT1086B0	XLT195/XLT19 3 DOOR BLACK GLASS 399X661	1	PZ	KVT1076BR	XLT135/XLT133 RIGHT COMPLETE DOOR KIT	<table border="1"> <thead> <tr> <th>Code</th> <th>Description</th> <th>Qty</th> <th>UOM</th> </tr> </thead> <tbody> <tr> <td>0H4540A0</td> <td>DOOR PLATES MAGNET XL40</td> <td>1</td> <td>PZ</td> </tr> <tr> <td>CR1080A0</td> <td>XV-XL-XB ST. STEEL RIGHT HINGE</td> <td>1</td> <td>PZ</td> </tr> <tr> <td>CR1081A0</td> <td>XV-XL-XB ST. STEEL LEFT HINGE</td> <td>1</td> <td>PZ</td> </tr> <tr> <td>GN1320A0</td> <td>DOOR GLASS HINGE GASKE</td> <td>2</td> <td>PZ</td> </tr> <tr> <td>GN1320A1</td> <td>DOOR GLASS GASKET</td> <td>2</td> <td>PZ</td> </tr> <tr> <td>GN1330A0</td> <td>FERRITIC PLATE GASKET XL40</td> <td>1</td> <td>PZ</td> </tr> <tr> <td>IP1385A1</td> <td>CORNER POLYSTYREN E PACKING 110X80X2000</td> <td>1.400</td> <td>M</td> </tr> <tr> <td>IP1508A0</td> <td></td> <td>0.300</td> <td>PZ</td> </tr> </tbody> </table>	Code	Description	Qty	UOM	0H4540A0	DOOR PLATES MAGNET XL40	1	PZ	CR1080A0	XV-XL-XB ST. STEEL RIGHT HINGE	1	PZ	CR1081A0	XV-XL-XB ST. STEEL LEFT HINGE	1	PZ	GN1320A0	DOOR GLASS HINGE GASKE	2	PZ	GN1320A1	DOOR GLASS GASKET	2	PZ	GN1330A0	FERRITIC PLATE GASKET XL40	1	PZ	IP1385A1	CORNER POLYSTYREN E PACKING 110X80X2000	1.400	M	IP1508A0		0.300	PZ
			Code	Description	Qty	UOM																																																																																										
0H4540A0	DOOR PLATES MAGNET XL40	1	PZ																																																																																													
CR1080A0	XV-XL-XB ST. STEEL RIGHT HINGE	1	PZ																																																																																													
CR1081A0	XV-XL-XB ST. STEEL LEFT HINGE	1	PZ																																																																																													
GN1320A0	DOOR GLASS HINGE GASKE	2	PZ																																																																																													
GN1320A1	DOOR GLASS GASKET	2	PZ																																																																																													
GN1330A0	FERRITIC PLATE GASKET XL40	1	PZ																																																																																													
MG1015B0	L.MISS/L.MICR O/CHEFTOP HANDLE END	2	PZ																																																																																													
TB1077A0	XLT135/XLT19 5 Ø18X1 HANDLE TUBE	1	PZ																																																																																													
VI1685A0	M6X6 STAINLESS STEEL SCREW	4	PZ																																																																																													
VI1930A0	5X25 ST. STEEL SCREW CHIP	2	PZ																																																																																													
VM1720A0	XL405 DOOR WASKER	1	PZ																																																																																													
VT1086B0	XLT195/XLT19 3 DOOR BLACK GLASS 399X661	1	PZ																																																																																													
Code	Description	Qty	UOM																																																																																													
0H4540A0	DOOR PLATES MAGNET XL40	1	PZ																																																																																													
CR1080A0	XV-XL-XB ST. STEEL RIGHT HINGE	1	PZ																																																																																													
CR1081A0	XV-XL-XB ST. STEEL LEFT HINGE	1	PZ																																																																																													
GN1320A0	DOOR GLASS HINGE GASKE	2	PZ																																																																																													
GN1320A1	DOOR GLASS GASKET	2	PZ																																																																																													
GN1330A0	FERRITIC PLATE GASKET XL40	1	PZ																																																																																													
IP1385A1	CORNER POLYSTYREN E PACKING 110X80X2000	1.400	M																																																																																													
IP1508A0		0.300	PZ																																																																																													



Зип Общепит

ASM3047A/0.D00 General overview

vsezip.ru

+7(812)987-08-81

COMPONENT			SPARE PART																																											
Code	Description	Image	Code	Description	Components list																																									
GN1330A	FERRITIC PLATE GASKET XL405		KVT1076BR	XLT135/XLT133 RIGHT COMPLETE DOOR KIT	<table border="1"> <thead> <tr> <th>Code</th> <th>Description</th> <th>Qty</th> <th>UOM</th> </tr> </thead> <tbody> <tr> <td>IP1508A1</td> <td>POLYSTYREN E U SHAPED PROFILE 2000X60X60</td> <td>2</td> <td>M</td> </tr> <tr> <td>MG1015B0</td> <td>L.MISS/L.MICR O/CHEFTOP HANDLE END</td> <td>2</td> <td>PZ</td> </tr> <tr> <td>TB1077A0</td> <td>XLT135/XLT19 5 Ø18X1 HANDLE TUBE</td> <td>1</td> <td>PZ</td> </tr> <tr> <td>VI1685A0</td> <td>M6X6 STAINLESS STEEL SCREW</td> <td>4</td> <td>PZ</td> </tr> <tr> <td>VI1930A0</td> <td>5X25 ST. STEEL SCREW CHIP</td> <td>2</td> <td>PZ</td> </tr> <tr> <td>VM1059A1</td> <td>HEAT SHRINK FILM H800</td> <td>1.500</td> <td>M</td> </tr> <tr> <td>VM1720A0</td> <td>XL405 DOOR WASKER</td> <td>1</td> <td>PZ</td> </tr> <tr> <td>VT1076B0</td> <td>XLT135/XLT13 3 BLACK DOOR GLASS 299X661</td> <td>1</td> <td>PZ</td> </tr> </tbody> </table>	Code	Description	Qty	UOM	IP1508A1	POLYSTYREN E U SHAPED PROFILE 2000X60X60	2	M	MG1015B0	L.MISS/L.MICR O/CHEFTOP HANDLE END	2	PZ	TB1077A0	XLT135/XLT19 5 Ø18X1 HANDLE TUBE	1	PZ	VI1685A0	M6X6 STAINLESS STEEL SCREW	4	PZ	VI1930A0	5X25 ST. STEEL SCREW CHIP	2	PZ	VM1059A1	HEAT SHRINK FILM H800	1.500	M	VM1720A0	XL405 DOOR WASKER	1	PZ	VT1076B0	XLT135/XLT13 3 BLACK DOOR GLASS 299X661	1	PZ					
			Code	Description	Qty	UOM																																								
IP1508A1	POLYSTYREN E U SHAPED PROFILE 2000X60X60	2	M																																											
MG1015B0	L.MISS/L.MICR O/CHEFTOP HANDLE END	2	PZ																																											
TB1077A0	XLT135/XLT19 5 Ø18X1 HANDLE TUBE	1	PZ																																											
VI1685A0	M6X6 STAINLESS STEEL SCREW	4	PZ																																											
VI1930A0	5X25 ST. STEEL SCREW CHIP	2	PZ																																											
VM1059A1	HEAT SHRINK FILM H800	1.500	M																																											
VM1720A0	XL405 DOOR WASKER	1	PZ																																											
VT1076B0	XLT135/XLT13 3 BLACK DOOR GLASS 299X661	1	PZ																																											
KVT1076BL	XLT135/XLT133 LEFT COMPLETE DOOR KIT	<table border="1"> <thead> <tr> <th>Code</th> <th>Description</th> <th>Qty</th> <th>UOM</th> </tr> </thead> <tbody> <tr> <td>0H4540A0</td> <td>DOOR PLATES MAGNET XL40</td> <td>1</td> <td>PZ</td> </tr> <tr> <td>CR1080A0</td> <td>XV-XL-XB ST. STEEL RIGHT HINGE</td> <td>1</td> <td>PZ</td> </tr> <tr> <td>CR1081A0</td> <td>XV-XL-XB ST. STEEL LEFT HINGE</td> <td>1</td> <td>PZ</td> </tr> <tr> <td>GN1320A0</td> <td>DOOR GLASS HINGE GASKE</td> <td>2</td> <td>PZ</td> </tr> <tr> <td>GN1320A1</td> <td>DOOR GLASS GASKET</td> <td>2</td> <td>PZ</td> </tr> <tr> <td>GN1330A0</td> <td>FERRITIC PLATE GASKET XL40</td> <td>1</td> <td>PZ</td> </tr> <tr> <td>IP1385A1</td> <td>CORNER POLYSTYREN E PACKING 110X80X2000</td> <td>1.400</td> <td>M</td> </tr> <tr> <td>IP1508A1</td> <td>POLYSTYREN E U SHAPED PROFILE 2000X60X60</td> <td>0.300</td> <td>M</td> </tr> <tr> <td>MG1015B0</td> <td>L.MISS/L.MICR O/CHEFTOP HANDLE END</td> <td>2</td> <td>PZ</td> </tr> <tr> <td>TB1077A0</td> <td>XLT135/XLT19 5 Ø18X1 HANDLE TUBE</td> <td>1</td> <td>PZ</td> </tr> </tbody> </table>	Code	Description	Qty	UOM	0H4540A0	DOOR PLATES MAGNET XL40	1	PZ	CR1080A0	XV-XL-XB ST. STEEL RIGHT HINGE	1	PZ	CR1081A0	XV-XL-XB ST. STEEL LEFT HINGE	1	PZ	GN1320A0	DOOR GLASS HINGE GASKE	2	PZ	GN1320A1	DOOR GLASS GASKET	2	PZ	GN1330A0	FERRITIC PLATE GASKET XL40	1	PZ	IP1385A1	CORNER POLYSTYREN E PACKING 110X80X2000	1.400	M	IP1508A1	POLYSTYREN E U SHAPED PROFILE 2000X60X60	0.300	M	MG1015B0	L.MISS/L.MICR O/CHEFTOP HANDLE END	2	PZ	TB1077A0	XLT135/XLT19 5 Ø18X1 HANDLE TUBE	1	PZ
Code	Description	Qty	UOM																																											
0H4540A0	DOOR PLATES MAGNET XL40	1	PZ																																											
CR1080A0	XV-XL-XB ST. STEEL RIGHT HINGE	1	PZ																																											
CR1081A0	XV-XL-XB ST. STEEL LEFT HINGE	1	PZ																																											
GN1320A0	DOOR GLASS HINGE GASKE	2	PZ																																											
GN1320A1	DOOR GLASS GASKET	2	PZ																																											
GN1330A0	FERRITIC PLATE GASKET XL40	1	PZ																																											
IP1385A1	CORNER POLYSTYREN E PACKING 110X80X2000	1.400	M																																											
IP1508A1	POLYSTYREN E U SHAPED PROFILE 2000X60X60	0.300	M																																											
MG1015B0	L.MISS/L.MICR O/CHEFTOP HANDLE END	2	PZ																																											
TB1077A0	XLT135/XLT19 5 Ø18X1 HANDLE TUBE	1	PZ																																											



COMPONENT			SPARE PART																																																															
Code	Description	Image	Code	Description	Components list																																																													
GN1330A	FERRITIC PLATE GASKET XL405		KVT1076BL	XLT135/XLT133 LEFT COMPLETE DOOR KIT	<table border="1"> <thead> <tr> <th>Code</th> <th>Description</th> <th>Qty</th> <th>UOM</th> </tr> </thead> <tbody> <tr> <td>VI1685A0</td> <td>M6X6 STAINLESS STEEL SCREW</td> <td>4</td> <td>PZ</td> </tr> <tr> <td>VI1930A0</td> <td>5X25 ST. STEEL SCREW CHIP</td> <td>2</td> <td>PZ</td> </tr> <tr> <td>VM1059A1</td> <td>HEAT SHRINK FILM H800</td> <td>1.500</td> <td>M</td> </tr> <tr> <td>VM1720A0</td> <td>XL405 DOOR WASKER</td> <td>1</td> <td>PZ</td> </tr> <tr> <td>VT1076B0</td> <td>XLT135/XLT13 3 BLACK DOOR GLASS 299X661</td> <td>1</td> <td>PZ</td> </tr> </tbody> </table>	Code	Description	Qty	UOM	VI1685A0	M6X6 STAINLESS STEEL SCREW	4	PZ	VI1930A0	5X25 ST. STEEL SCREW CHIP	2	PZ	VM1059A1	HEAT SHRINK FILM H800	1.500	M	VM1720A0	XL405 DOOR WASKER	1	PZ	VT1076B0	XLT135/XLT13 3 BLACK DOOR GLASS 299X661	1	PZ																																					
			Code	Description	Qty	UOM																																																												
VI1685A0	M6X6 STAINLESS STEEL SCREW	4	PZ																																																															
VI1930A0	5X25 ST. STEEL SCREW CHIP	2	PZ																																																															
VM1059A1	HEAT SHRINK FILM H800	1.500	M																																																															
VM1720A0	XL405 DOOR WASKER	1	PZ																																																															
VT1076B0	XLT135/XLT13 3 BLACK DOOR GLASS 299X661	1	PZ																																																															
KDR1210AR	XL405 COMPLETE RIGHT DOOR	<table border="1"> <thead> <tr> <th>Code</th> <th>Description</th> <th>Qty</th> <th>UOM</th> </tr> </thead> <tbody> <tr> <td>0H4530C0</td> <td>RIGHT DOOR DRIPPING TRAY XL415</td> <td>1</td> <td>PZ</td> </tr> <tr> <td>0H4540A0</td> <td>DOOR PLATES MAGNET XL40</td> <td>1</td> <td>PZ</td> </tr> <tr> <td>CR1080A0</td> <td>XV-XL-XB ST. STEEL RIGHT HINGE</td> <td>1</td> <td>PZ</td> </tr> <tr> <td>CR1081A0</td> <td>XV-XL-XB ST. STEEL LEFT HINGE</td> <td>1</td> <td>PZ</td> </tr> <tr> <td>GN1320A0</td> <td>DOOR GLASS HINGE GASKE</td> <td>2</td> <td>PZ</td> </tr> <tr> <td>GN1320A1</td> <td>DOOR GLASS GASKET</td> <td>2</td> <td>PZ</td> </tr> <tr> <td>GN1330A0</td> <td>FERRITIC PLATE GASKET XL40</td> <td>1</td> <td>PZ</td> </tr> <tr> <td>IP1385A1</td> <td>CORNER POLYSTYREN E PACKING 110X80X2000</td> <td>1.300</td> <td>M</td> </tr> <tr> <td>IP1508A0</td> <td></td> <td>0.570</td> <td>PZ</td> </tr> <tr> <td>IP1508A1</td> <td>POLYSTYREN E U SHAPED PROFILE 2000X60X60</td> <td>2</td> <td>M</td> </tr> <tr> <td>MG1015B0</td> <td>L.MISS/L.MICR O/CHEFTOP HANDLE END</td> <td>2</td> <td>PZ</td> </tr> <tr> <td>TB1730A0</td> <td>XL405-413-415 HANDLE TUBE</td> <td>1</td> <td>PZ</td> </tr> <tr> <td>VI1685A0</td> <td>M6X6 STAINLESS STEEL SCREW</td> <td>4</td> <td>PZ</td> </tr> <tr> <td>VI1930A0</td> <td>5X25 ST. STEEL SCREW CHIP</td> <td>2</td> <td>PZ</td> </tr> <tr> <td>VM1059A1</td> <td>HEAT SHRINK FILM H800</td> <td>1.300</td> <td>M</td> </tr> </tbody> </table>	Code	Description	Qty	UOM	0H4530C0	RIGHT DOOR DRIPPING TRAY XL415	1	PZ	0H4540A0	DOOR PLATES MAGNET XL40	1	PZ	CR1080A0	XV-XL-XB ST. STEEL RIGHT HINGE	1	PZ	CR1081A0	XV-XL-XB ST. STEEL LEFT HINGE	1	PZ	GN1320A0	DOOR GLASS HINGE GASKE	2	PZ	GN1320A1	DOOR GLASS GASKET	2	PZ	GN1330A0	FERRITIC PLATE GASKET XL40	1	PZ	IP1385A1	CORNER POLYSTYREN E PACKING 110X80X2000	1.300	M	IP1508A0		0.570	PZ	IP1508A1	POLYSTYREN E U SHAPED PROFILE 2000X60X60	2	M	MG1015B0	L.MISS/L.MICR O/CHEFTOP HANDLE END	2	PZ	TB1730A0	XL405-413-415 HANDLE TUBE	1	PZ	VI1685A0	M6X6 STAINLESS STEEL SCREW	4	PZ	VI1930A0	5X25 ST. STEEL SCREW CHIP	2	PZ	VM1059A1	HEAT SHRINK FILM H800	1.300	M
Code	Description	Qty	UOM																																																															
0H4530C0	RIGHT DOOR DRIPPING TRAY XL415	1	PZ																																																															
0H4540A0	DOOR PLATES MAGNET XL40	1	PZ																																																															
CR1080A0	XV-XL-XB ST. STEEL RIGHT HINGE	1	PZ																																																															
CR1081A0	XV-XL-XB ST. STEEL LEFT HINGE	1	PZ																																																															
GN1320A0	DOOR GLASS HINGE GASKE	2	PZ																																																															
GN1320A1	DOOR GLASS GASKET	2	PZ																																																															
GN1330A0	FERRITIC PLATE GASKET XL40	1	PZ																																																															
IP1385A1	CORNER POLYSTYREN E PACKING 110X80X2000	1.300	M																																																															
IP1508A0		0.570	PZ																																																															
IP1508A1	POLYSTYREN E U SHAPED PROFILE 2000X60X60	2	M																																																															
MG1015B0	L.MISS/L.MICR O/CHEFTOP HANDLE END	2	PZ																																																															
TB1730A0	XL405-413-415 HANDLE TUBE	1	PZ																																																															
VI1685A0	M6X6 STAINLESS STEEL SCREW	4	PZ																																																															
VI1930A0	5X25 ST. STEEL SCREW CHIP	2	PZ																																																															
VM1059A1	HEAT SHRINK FILM H800	1.300	M																																																															



COMPONENT			SPARE PART																																																																											
Code	Description	Image	Code	Description	Components list																																																																									
GN1330A	FERRITIC PLATE GASKET XL405		KDR1210AR	XL405 COMPLETE RIGHT DOOR	<table border="1"> <thead> <tr> <th>Code</th> <th>Description</th> <th>Qty</th> <th>UOM</th> </tr> </thead> <tbody> <tr> <td>VM1720A0</td> <td>XL405 DOOR WASKER</td> <td>1</td> <td>PZ</td> </tr> <tr> <td>VM1790A0</td> <td>HINGE BUSH 12X6.5 DI5.3</td> <td>2</td> <td>PZ</td> </tr> <tr> <td>VT1210A0</td> <td>XL405-413-415 DOOR GLASS</td> <td>1</td> <td>PZ</td> </tr> </tbody> </table>	Code	Description	Qty	UOM	VM1720A0	XL405 DOOR WASKER	1	PZ	VM1790A0	HINGE BUSH 12X6.5 DI5.3	2	PZ	VT1210A0	XL405-413-415 DOOR GLASS	1	PZ																																																									
			Code	Description	Qty	UOM																																																																								
VM1720A0	XL405 DOOR WASKER	1	PZ																																																																											
VM1790A0	HINGE BUSH 12X6.5 DI5.3	2	PZ																																																																											
VT1210A0	XL405-413-415 DOOR GLASS	1	PZ																																																																											
KDR1210AL	XL405 COMPLETE LEFT DOOR	<table border="1"> <thead> <tr> <th>Code</th> <th>Description</th> <th>Qty</th> <th>UOM</th> </tr> </thead> <tbody> <tr> <td>0H4535C0</td> <td>LEFT DOOR DRIPPING TRAY XL415</td> <td>1</td> <td>PZ</td> </tr> <tr> <td>0H4540A0</td> <td>DOOR PLATES MAGNET XL40</td> <td>1</td> <td>PZ</td> </tr> <tr> <td>CR1080A0</td> <td>XV-XL-XB ST. STEEL RIGHT HINGE</td> <td>1</td> <td>PZ</td> </tr> <tr> <td>CR1081A0</td> <td>XV-XL-XB ST. STEEL LEFT HINGE</td> <td>1</td> <td>PZ</td> </tr> <tr> <td>GN1320A0</td> <td>DOOR GLASS HINGE GASKE</td> <td>2</td> <td>PZ</td> </tr> <tr> <td>GN1320A1</td> <td>DOOR GLASS GASKET</td> <td>2</td> <td>PZ</td> </tr> <tr> <td>GN1330A0</td> <td>FERRITIC PLATE GASKET XL40</td> <td>1</td> <td>PZ</td> </tr> <tr> <td>IP1385A1</td> <td>CORNER POLYSTYREN E PACKING 110X80X2000</td> <td>1.300</td> <td>M</td> </tr> <tr> <td>IP1508A0</td> <td></td> <td>0.570</td> <td>PZ</td> </tr> <tr> <td>IP1508A1</td> <td>POLYSTYREN E U SHAPED PROFILE 2000X60X60</td> <td>2</td> <td>M</td> </tr> <tr> <td>MG1015B0</td> <td>L.MISS/L.MICR O/CHEFTOP HANDLE END</td> <td>2</td> <td>PZ</td> </tr> <tr> <td>TB1730A0</td> <td>XL405-413-415 HANDLE TUBE</td> <td>1</td> <td>PZ</td> </tr> <tr> <td>VI1685A0</td> <td>M6X6 STAINLESS STEEL SCREW</td> <td>4</td> <td>PZ</td> </tr> <tr> <td>VI1930A0</td> <td>5X25 ST. STEEL SCREW CHIP</td> <td>2</td> <td>PZ</td> </tr> <tr> <td>VM1059A1</td> <td>HEAT SHRINK FILM H800</td> <td>1.300</td> <td>M</td> </tr> <tr> <td>VM1720A0</td> <td>XL405 DOOR WASKER</td> <td>1</td> <td>PZ</td> </tr> <tr> <td>VM1790A0</td> <td>HINGE BUSH 12X6.5 DI5.3</td> <td>2</td> <td>PZ</td> </tr> <tr> <td>VT1210A0</td> <td>XL405-413-415 DOOR GLASS</td> <td>1</td> <td>PZ</td> </tr> </tbody> </table>	Code	Description	Qty	UOM	0H4535C0	LEFT DOOR DRIPPING TRAY XL415	1	PZ	0H4540A0	DOOR PLATES MAGNET XL40	1	PZ	CR1080A0	XV-XL-XB ST. STEEL RIGHT HINGE	1	PZ	CR1081A0	XV-XL-XB ST. STEEL LEFT HINGE	1	PZ	GN1320A0	DOOR GLASS HINGE GASKE	2	PZ	GN1320A1	DOOR GLASS GASKET	2	PZ	GN1330A0	FERRITIC PLATE GASKET XL40	1	PZ	IP1385A1	CORNER POLYSTYREN E PACKING 110X80X2000	1.300	M	IP1508A0		0.570	PZ	IP1508A1	POLYSTYREN E U SHAPED PROFILE 2000X60X60	2	M	MG1015B0	L.MISS/L.MICR O/CHEFTOP HANDLE END	2	PZ	TB1730A0	XL405-413-415 HANDLE TUBE	1	PZ	VI1685A0	M6X6 STAINLESS STEEL SCREW	4	PZ	VI1930A0	5X25 ST. STEEL SCREW CHIP	2	PZ	VM1059A1	HEAT SHRINK FILM H800	1.300	M	VM1720A0	XL405 DOOR WASKER	1	PZ	VM1790A0	HINGE BUSH 12X6.5 DI5.3	2	PZ	VT1210A0	XL405-413-415 DOOR GLASS	1	PZ
Code	Description	Qty	UOM																																																																											
0H4535C0	LEFT DOOR DRIPPING TRAY XL415	1	PZ																																																																											
0H4540A0	DOOR PLATES MAGNET XL40	1	PZ																																																																											
CR1080A0	XV-XL-XB ST. STEEL RIGHT HINGE	1	PZ																																																																											
CR1081A0	XV-XL-XB ST. STEEL LEFT HINGE	1	PZ																																																																											
GN1320A0	DOOR GLASS HINGE GASKE	2	PZ																																																																											
GN1320A1	DOOR GLASS GASKET	2	PZ																																																																											
GN1330A0	FERRITIC PLATE GASKET XL40	1	PZ																																																																											
IP1385A1	CORNER POLYSTYREN E PACKING 110X80X2000	1.300	M																																																																											
IP1508A0		0.570	PZ																																																																											
IP1508A1	POLYSTYREN E U SHAPED PROFILE 2000X60X60	2	M																																																																											
MG1015B0	L.MISS/L.MICR O/CHEFTOP HANDLE END	2	PZ																																																																											
TB1730A0	XL405-413-415 HANDLE TUBE	1	PZ																																																																											
VI1685A0	M6X6 STAINLESS STEEL SCREW	4	PZ																																																																											
VI1930A0	5X25 ST. STEEL SCREW CHIP	2	PZ																																																																											
VM1059A1	HEAT SHRINK FILM H800	1.300	M																																																																											
VM1720A0	XL405 DOOR WASKER	1	PZ																																																																											
VM1790A0	HINGE BUSH 12X6.5 DI5.3	2	PZ																																																																											
VT1210A0	XL405-413-415 DOOR GLASS	1	PZ																																																																											





Зип Общепит

ASM3047A/0.D00 General overview

vsezip.ru

+7(812)987-08-81

COMPONENT			SPARE PART																														
Code	Description	Image	Code	Description	Components list																												
CR1081A	XV-XL-XB ST. STEEL LEFT HINGE		KCR1080A	RIGHT/LEFT HINGES KIT CR1080A+CR1081A	<table border="1"> <thead> <tr> <th>Code</th> <th>Description</th> <th>Qty</th> <th>UOM</th> </tr> </thead> <tbody> <tr> <td>CR1080A0</td> <td>XV-XL-XB ST. STEEL RIGHT HINGE</td> <td>1</td> <td>PZ</td> </tr> <tr> <td>CR1081A0</td> <td>XV-XL-XB ST. STEEL LEFT HINGE</td> <td>1</td> <td>PZ</td> </tr> <tr> <td>GN1320A0</td> <td>DOOR GLASS HINGE GASKE</td> <td>2</td> <td>PZ</td> </tr> <tr> <td>GN1320A1</td> <td>DOOR GLASS GASKET</td> <td>2</td> <td>PZ</td> </tr> <tr> <td>VI1685A0</td> <td>M6X6 STAINLESS STEEL SCREW</td> <td>4</td> <td>PZ</td> </tr> <tr> <td>VM1790A0</td> <td>HINGE BUSH 12X6.5 DI5.3</td> <td>2</td> <td>PZ</td> </tr> </tbody> </table>	Code	Description	Qty	UOM	CR1080A0	XV-XL-XB ST. STEEL RIGHT HINGE	1	PZ	CR1081A0	XV-XL-XB ST. STEEL LEFT HINGE	1	PZ	GN1320A0	DOOR GLASS HINGE GASKE	2	PZ	GN1320A1	DOOR GLASS GASKET	2	PZ	VI1685A0	M6X6 STAINLESS STEEL SCREW	4	PZ	VM1790A0	HINGE BUSH 12X6.5 DI5.3	2	PZ
Code	Description	Qty	UOM																														
CR1080A0	XV-XL-XB ST. STEEL RIGHT HINGE	1	PZ																														
CR1081A0	XV-XL-XB ST. STEEL LEFT HINGE	1	PZ																														
GN1320A0	DOOR GLASS HINGE GASKE	2	PZ																														
GN1320A1	DOOR GLASS GASKET	2	PZ																														
VI1685A0	M6X6 STAINLESS STEEL SCREW	4	PZ																														
VM1790A0	HINGE BUSH 12X6.5 DI5.3	2	PZ																														
CR1080A	XV-XL-XB ST. STEEL RIGHT HINGE		KCR1080A	RIGHT/LEFT HINGES KIT CR1080A+CR1081A	<table border="1"> <thead> <tr> <th>Code</th> <th>Description</th> <th>Qty</th> <th>UOM</th> </tr> </thead> <tbody> <tr> <td>CR1080A0</td> <td>XV-XL-XB ST. STEEL RIGHT HINGE</td> <td>1</td> <td>PZ</td> </tr> <tr> <td>CR1081A0</td> <td>XV-XL-XB ST. STEEL LEFT HINGE</td> <td>1</td> <td>PZ</td> </tr> <tr> <td>GN1320A0</td> <td>DOOR GLASS HINGE GASKE</td> <td>2</td> <td>PZ</td> </tr> <tr> <td>GN1320A1</td> <td>DOOR GLASS GASKET</td> <td>2</td> <td>PZ</td> </tr> <tr> <td>VI1685A0</td> <td>M6X6 STAINLESS STEEL SCREW</td> <td>4</td> <td>PZ</td> </tr> <tr> <td>VM1790A0</td> <td>HINGE BUSH 12X6.5 DI5.3</td> <td>2</td> <td>PZ</td> </tr> </tbody> </table>	Code	Description	Qty	UOM	CR1080A0	XV-XL-XB ST. STEEL RIGHT HINGE	1	PZ	CR1081A0	XV-XL-XB ST. STEEL LEFT HINGE	1	PZ	GN1320A0	DOOR GLASS HINGE GASKE	2	PZ	GN1320A1	DOOR GLASS GASKET	2	PZ	VI1685A0	M6X6 STAINLESS STEEL SCREW	4	PZ	VM1790A0	HINGE BUSH 12X6.5 DI5.3	2	PZ
Code	Description	Qty	UOM																														
CR1080A0	XV-XL-XB ST. STEEL RIGHT HINGE	1	PZ																														
CR1081A0	XV-XL-XB ST. STEEL LEFT HINGE	1	PZ																														
GN1320A0	DOOR GLASS HINGE GASKE	2	PZ																														
GN1320A1	DOOR GLASS GASKET	2	PZ																														
VI1685A0	M6X6 STAINLESS STEEL SCREW	4	PZ																														
VM1790A0	HINGE BUSH 12X6.5 DI5.3	2	PZ																														
0H7216A	BAKERTOP PROOFER LEFT DRIP TRAY		0H7216A0	BAKERTOP PROOFER LEFT DRIP TRAY																													
MG1082A	HANDLE END PROFILE 20X20		MG1082A0	HANDLE END PROFILE 20X20																													







Зип Общепит

ASM3047A/0.D00 General overview

vsezip.ru

+7(812)987-08-81

COMPONENT			SPARE PART																																						
Code	Description	Image	Code	Description	Components list																																				
GN1554A	PROOFER HANDLE GASKET		GN1554A0	PROOFER HANDLE GASKET																																					
0H7325A	600X400 8TRAY PROOFER DOOR BAND		0H7325A0	600X400 8TRAY PROOFER DOOR BAND																																					
TB2969A	8TRAY PROOFER HANDLE PROFILE 20X20		TB2969A0	8TRAY PROOFER HANDLE PROFILE 20X20																																					
VT1308A	LOW PROVER DOOR GLASS		KVT1308AR	8 TRAYS PROVER RIGHT DOOR GLASS KIT	<table border="1"> <thead> <tr> <th>Code</th> <th>Description</th> <th>Qty</th> <th>UOM</th> </tr> </thead> <tbody> <tr> <td>0H4540A0</td> <td>DOOR PLATES MAGNET XL40</td> <td>1</td> <td>PZ</td> </tr> <tr> <td>0H7217A0</td> <td>BAKERTOP PROOFER RIGHT DRIP TRAY</td> <td>1</td> <td>PZ</td> </tr> <tr> <td>0H7325A0</td> <td>600X400 8TRAY PROOFER DOOR BAND</td> <td>1</td> <td>PZ</td> </tr> <tr> <td>CR1080A0</td> <td>XV-XL-XB ST. STEEL RIGHT HINGE</td> <td>1</td> <td>PZ</td> </tr> <tr> <td>CR1081A0</td> <td>XV-XL-XB ST. STEEL LEFT HINGE</td> <td>1</td> <td>PZ</td> </tr> <tr> <td>GN1330A0</td> <td>FERRITIC PLATE GASKET XL40</td> <td>1</td> <td>PZ</td> </tr> <tr> <td>GN1554A0</td> <td>PROOFER HANDLE GASKET</td> <td>1</td> <td>PZ</td> </tr> <tr> <td>GN1577A1</td> <td>PROOFER HINGE GASKE</td> <td>2</td> <td>PZ</td> </tr> </tbody> </table>	Code	Description	Qty	UOM	0H4540A0	DOOR PLATES MAGNET XL40	1	PZ	0H7217A0	BAKERTOP PROOFER RIGHT DRIP TRAY	1	PZ	0H7325A0	600X400 8TRAY PROOFER DOOR BAND	1	PZ	CR1080A0	XV-XL-XB ST. STEEL RIGHT HINGE	1	PZ	CR1081A0	XV-XL-XB ST. STEEL LEFT HINGE	1	PZ	GN1330A0	FERRITIC PLATE GASKET XL40	1	PZ	GN1554A0	PROOFER HANDLE GASKET	1	PZ	GN1577A1	PROOFER HINGE GASKE	2	PZ
Code	Description	Qty	UOM																																						
0H4540A0	DOOR PLATES MAGNET XL40	1	PZ																																						
0H7217A0	BAKERTOP PROOFER RIGHT DRIP TRAY	1	PZ																																						
0H7325A0	600X400 8TRAY PROOFER DOOR BAND	1	PZ																																						
CR1080A0	XV-XL-XB ST. STEEL RIGHT HINGE	1	PZ																																						
CR1081A0	XV-XL-XB ST. STEEL LEFT HINGE	1	PZ																																						
GN1330A0	FERRITIC PLATE GASKET XL40	1	PZ																																						
GN1554A0	PROOFER HANDLE GASKET	1	PZ																																						
GN1577A1	PROOFER HINGE GASKE	2	PZ																																						



COMPONENT			SPARE PART																																											
Code	Description	Image	Code	Description	Components list																																									
VT1308A	LOW PROVER DOOR GLASS		KVT1308AR	8 TRAYS PROVER RIGHT DOOR GLASS KIT	<table border="1"> <thead> <tr> <th>Code</th> <th>Description</th> <th>Qty</th> <th>UOM</th> </tr> </thead> <tbody> <tr> <td>IP1508A1</td> <td>POLYSTYREN E U SHAPED PROFILE 2000X60X60</td> <td>1.500</td> <td>M</td> </tr> <tr> <td>MG1082A0</td> <td>HANDLE END PROFILE 20X2</td> <td>2</td> <td>PZ</td> </tr> <tr> <td>TB2969A0</td> <td>8TRAY PROOFER HANDLE PROFILE 20X2</td> <td>1</td> <td>PZ</td> </tr> <tr> <td>VI1685A0</td> <td>M6X6 STAINLESS STEEL SCREW</td> <td>4</td> <td>PZ</td> </tr> <tr> <td>VI1930A0</td> <td>5X25 ST. STEEL SCREW CHIP</td> <td>2</td> <td>PZ</td> </tr> <tr> <td>VM1059A1</td> <td>HEAT SHRINK FILM H800</td> <td>1</td> <td>M</td> </tr> <tr> <td>VM1720A0</td> <td>XL405 DOOR WASKER</td> <td>1</td> <td>PZ</td> </tr> <tr> <td>VM2000A0</td> <td>M4 SOCKET HEAD SCREW COVER</td> <td>4</td> <td>PZ</td> </tr> <tr> <td>VT1308A0</td> <td>LOW PROVER DOOR GLASS</td> <td></td> <td>1</td> <td>PZ</td> </tr> </tbody> </table>	Code	Description	Qty	UOM	IP1508A1	POLYSTYREN E U SHAPED PROFILE 2000X60X60	1.500	M	MG1082A0	HANDLE END PROFILE 20X2	2	PZ	TB2969A0	8TRAY PROOFER HANDLE PROFILE 20X2	1	PZ	VI1685A0	M6X6 STAINLESS STEEL SCREW	4	PZ	VI1930A0	5X25 ST. STEEL SCREW CHIP	2	PZ	VM1059A1	HEAT SHRINK FILM H800	1	M	VM1720A0	XL405 DOOR WASKER	1	PZ	VM2000A0	M4 SOCKET HEAD SCREW COVER	4	PZ	VT1308A0	LOW PROVER DOOR GLASS		1	PZ
			Code	Description	Qty	UOM																																								
IP1508A1	POLYSTYREN E U SHAPED PROFILE 2000X60X60	1.500	M																																											
MG1082A0	HANDLE END PROFILE 20X2	2	PZ																																											
TB2969A0	8TRAY PROOFER HANDLE PROFILE 20X2	1	PZ																																											
VI1685A0	M6X6 STAINLESS STEEL SCREW	4	PZ																																											
VI1930A0	5X25 ST. STEEL SCREW CHIP	2	PZ																																											
VM1059A1	HEAT SHRINK FILM H800	1	M																																											
VM1720A0	XL405 DOOR WASKER	1	PZ																																											
VM2000A0	M4 SOCKET HEAD SCREW COVER	4	PZ																																											
VT1308A0	LOW PROVER DOOR GLASS		1	PZ																																										
KVT1308AL	8 TRAYS PROVER LEFT DOOR GLASS KIT	<table border="1"> <thead> <tr> <th>Code</th> <th>Description</th> <th>Qty</th> <th>UOM</th> </tr> </thead> <tbody> <tr> <td>0H4540A0</td> <td>DOOR PLATES MAGNET XL40</td> <td>1</td> <td>PZ</td> </tr> <tr> <td>0H7216A0</td> <td>BAKERTOP PROOFER LEFT DRIP TRAY</td> <td>1</td> <td>PZ</td> </tr> <tr> <td>0H7325A0</td> <td>600X400 8TRAY PROOFER DOOR BAND</td> <td>1</td> <td>PZ</td> </tr> <tr> <td>CR1080A0</td> <td>XV-XL-XB ST. STEEL RIGHT HINGE</td> <td>1</td> <td>PZ</td> </tr> <tr> <td>CR1081A0</td> <td>XV-XL-XB ST. STEEL LEFT HINGE</td> <td>1</td> <td>PZ</td> </tr> <tr> <td>GN1330A0</td> <td>FERRITIC PLATE GASKET XL40</td> <td>1</td> <td>PZ</td> </tr> <tr> <td>GN1554A0</td> <td>PROOFER HANDLE GASKET</td> <td>1</td> <td>PZ</td> </tr> <tr> <td>GN1577A1</td> <td>PROOFER HINGE GASKE</td> <td>2</td> <td>PZ</td> </tr> <tr> <td>IP1508A1</td> <td>POLYSTYREN E U SHAPED PROFILE 2000X60X60</td> <td>1.500</td> <td>M</td> </tr> </tbody> </table>	Code	Description	Qty	UOM	0H4540A0	DOOR PLATES MAGNET XL40	1	PZ	0H7216A0	BAKERTOP PROOFER LEFT DRIP TRAY	1	PZ	0H7325A0	600X400 8TRAY PROOFER DOOR BAND	1	PZ	CR1080A0	XV-XL-XB ST. STEEL RIGHT HINGE	1	PZ	CR1081A0	XV-XL-XB ST. STEEL LEFT HINGE	1	PZ	GN1330A0	FERRITIC PLATE GASKET XL40	1	PZ	GN1554A0	PROOFER HANDLE GASKET	1	PZ	GN1577A1	PROOFER HINGE GASKE	2	PZ	IP1508A1	POLYSTYREN E U SHAPED PROFILE 2000X60X60	1.500	M				
Code	Description	Qty	UOM																																											
0H4540A0	DOOR PLATES MAGNET XL40	1	PZ																																											
0H7216A0	BAKERTOP PROOFER LEFT DRIP TRAY	1	PZ																																											
0H7325A0	600X400 8TRAY PROOFER DOOR BAND	1	PZ																																											
CR1080A0	XV-XL-XB ST. STEEL RIGHT HINGE	1	PZ																																											
CR1081A0	XV-XL-XB ST. STEEL LEFT HINGE	1	PZ																																											
GN1330A0	FERRITIC PLATE GASKET XL40	1	PZ																																											
GN1554A0	PROOFER HANDLE GASKET	1	PZ																																											
GN1577A1	PROOFER HINGE GASKE	2	PZ																																											
IP1508A1	POLYSTYREN E U SHAPED PROFILE 2000X60X60	1.500	M																																											



Зип Общепит



ASM3047A/0.D00 General overview

vsezip.ru

+7(812)987-08-81

COMPONENT

SPARE PART

Code	Description	Image	Code	Description	Components list																																				
VT1308A	LOW PROVER DOOR GLASS		KVT1308AL	8 TRAYS PROVER LEFT DOOR GLASS KIT	<table border="1"> <thead> <tr> <th>Code</th> <th>Description</th> <th>Qty</th> <th>UOM</th> </tr> </thead> <tbody> <tr> <td>MG1082A0</td> <td>HANDLE END PROFILE 20X2</td> <td>2</td> <td>PZ</td> </tr> <tr> <td>TB2969A0</td> <td>8TRAY PROOFER HANDLE PROFILE 20X2</td> <td>1</td> <td>PZ</td> </tr> <tr> <td>VI1685A0</td> <td>M6X6 STAINLESS STEEL SCREW</td> <td>4</td> <td>PZ</td> </tr> <tr> <td>VI1930A0</td> <td>5X25 ST. STEEL SCREW CHIP</td> <td>2</td> <td>PZ</td> </tr> <tr> <td>VM1059A1</td> <td>HEAT SHRINK FILM H800</td> <td>1</td> <td>M</td> </tr> <tr> <td>VM1720A0</td> <td>XL405 DOOR WASKER</td> <td>1</td> <td>PZ</td> </tr> <tr> <td>VM2000A0</td> <td>M4 SOCKET HEAD SCREW COVER</td> <td>4</td> <td>PZ</td> </tr> <tr> <td>VT1308A0</td> <td>LOW PROVER DOOR GLASS</td> <td>1</td> <td>PZ</td> </tr> </tbody> </table>	Code	Description	Qty	UOM	MG1082A0	HANDLE END PROFILE 20X2	2	PZ	TB2969A0	8TRAY PROOFER HANDLE PROFILE 20X2	1	PZ	VI1685A0	M6X6 STAINLESS STEEL SCREW	4	PZ	VI1930A0	5X25 ST. STEEL SCREW CHIP	2	PZ	VM1059A1	HEAT SHRINK FILM H800	1	M	VM1720A0	XL405 DOOR WASKER	1	PZ	VM2000A0	M4 SOCKET HEAD SCREW COVER	4	PZ	VT1308A0	LOW PROVER DOOR GLASS	1	PZ
					Code	Description	Qty	UOM																																	
MG1082A0	HANDLE END PROFILE 20X2	2	PZ																																						
TB2969A0	8TRAY PROOFER HANDLE PROFILE 20X2	1	PZ																																						
VI1685A0	M6X6 STAINLESS STEEL SCREW	4	PZ																																						
VI1930A0	5X25 ST. STEEL SCREW CHIP	2	PZ																																						
VM1059A1	HEAT SHRINK FILM H800	1	M																																						
VM1720A0	XL405 DOOR WASKER	1	PZ																																						
VM2000A0	M4 SOCKET HEAD SCREW COVER	4	PZ																																						
VT1308A0	LOW PROVER DOOR GLASS	1	PZ																																						
KVT1308A	XEBPC-08EU-C- 1PC GLASS KIT	<table border="1"> <thead> <tr> <th>Code</th> <th>Description</th> <th>Qty</th> <th>UOM</th> </tr> </thead> <tbody> <tr> <td>IP1508A1</td> <td>POLYSTYREN E U SHAPED PROFILE 2000X60X60</td> <td>2</td> <td>M</td> </tr> <tr> <td>VM1059A1</td> <td>HEAT SHRINK FILM H800</td> <td>1.800</td> <td>M</td> </tr> <tr> <td>VT1308A0</td> <td>LOW PROVER DOOR GLASS</td> <td>1</td> <td>PZ</td> </tr> </tbody> </table>	Code	Description	Qty	UOM	IP1508A1	POLYSTYREN E U SHAPED PROFILE 2000X60X60	2	M	VM1059A1	HEAT SHRINK FILM H800	1.800	M	VT1308A0	LOW PROVER DOOR GLASS	1	PZ																							
Code	Description	Qty	UOM																																						
IP1508A1	POLYSTYREN E U SHAPED PROFILE 2000X60X60	2	M																																						
VM1059A1	HEAT SHRINK FILM H800	1.800	M																																						
VT1308A0	LOW PROVER DOOR GLASS	1	PZ																																						
GN1577A	PROOFER HINGE GASKET		GN1577A1	PROOFER HINGE GASKET																																					
0H4540A	DOOR PLATES MAGNET XL405		0H4540A0	DOOR PLATES MAGNET XL405																																					



Зип Общепит

ASM3047A/0.D00 General overview

vsezip.ru

+7(812)987-08-81

COMPONENT			SPARE PART																																																						
Code	Description	Image	Code	Description	Components list																																																				
VM1720A	XL405 DOOR WASKER		VM1720A0	XL405 DOOR WASKER																																																					
GN1330A	FERRITIC PLATE GASKET XL405		KVT1086BR	XLT195/XLT193 RIGHT COMPLETE DOOR KIT	<table border="1"> <thead> <tr> <th>Code</th> <th>Description</th> <th>Qty</th> <th>UOM</th> </tr> </thead> <tbody> <tr> <td>0H4540A0</td> <td>DOOR PLATES MAGNET XL40</td> <td>1</td> <td>PZ</td> </tr> <tr> <td>CR1080A0</td> <td>XV-XL-XB ST. STEEL RIGHT HINGE</td> <td>1</td> <td>PZ</td> </tr> <tr> <td>CR1081A0</td> <td>XV-XL-XB ST. STEEL LEFT HINGE</td> <td>1</td> <td>PZ</td> </tr> <tr> <td>GN1320A0</td> <td>DOOR GLASS HINGE GASKE</td> <td>2</td> <td>PZ</td> </tr> <tr> <td>GN1320A1</td> <td>DOOR GLASS GASKET</td> <td>2</td> <td>PZ</td> </tr> <tr> <td>GN1330A0</td> <td>FERRITIC PLATE GASKET XL40</td> <td>1</td> <td>PZ</td> </tr> <tr> <td>MG1015B0</td> <td>L.MISS/L.MICR O/CHEFTOP HANDLE END</td> <td>2</td> <td>PZ</td> </tr> <tr> <td>TB1077A0</td> <td>XLT135/XLT19 5 Ø18X1 HANDLE TUBE</td> <td>1</td> <td>PZ</td> </tr> <tr> <td>VI1685A0</td> <td>M6X6 STAINLESS STEEL SCREW</td> <td>4</td> <td>PZ</td> </tr> <tr> <td>VI1930A0</td> <td>5X25 ST. STEEL SCREW CHIP</td> <td>2</td> <td>PZ</td> </tr> <tr> <td>VM1720A0</td> <td>XL405 DOOR WASKER</td> <td>1</td> <td>PZ</td> </tr> <tr> <td>VT1086B0</td> <td>XLT195/XLT19 3 DOOR BLACK GLASS 399X661</td> <td>1</td> <td>PZ</td> </tr> </tbody> </table>	Code	Description	Qty	UOM	0H4540A0	DOOR PLATES MAGNET XL40	1	PZ	CR1080A0	XV-XL-XB ST. STEEL RIGHT HINGE	1	PZ	CR1081A0	XV-XL-XB ST. STEEL LEFT HINGE	1	PZ	GN1320A0	DOOR GLASS HINGE GASKE	2	PZ	GN1320A1	DOOR GLASS GASKET	2	PZ	GN1330A0	FERRITIC PLATE GASKET XL40	1	PZ	MG1015B0	L.MISS/L.MICR O/CHEFTOP HANDLE END	2	PZ	TB1077A0	XLT135/XLT19 5 Ø18X1 HANDLE TUBE	1	PZ	VI1685A0	M6X6 STAINLESS STEEL SCREW	4	PZ	VI1930A0	5X25 ST. STEEL SCREW CHIP	2	PZ	VM1720A0	XL405 DOOR WASKER	1	PZ	VT1086B0	XLT195/XLT19 3 DOOR BLACK GLASS 399X661	1	PZ
Code	Description	Qty	UOM																																																						
0H4540A0	DOOR PLATES MAGNET XL40	1	PZ																																																						
CR1080A0	XV-XL-XB ST. STEEL RIGHT HINGE	1	PZ																																																						
CR1081A0	XV-XL-XB ST. STEEL LEFT HINGE	1	PZ																																																						
GN1320A0	DOOR GLASS HINGE GASKE	2	PZ																																																						
GN1320A1	DOOR GLASS GASKET	2	PZ																																																						
GN1330A0	FERRITIC PLATE GASKET XL40	1	PZ																																																						
MG1015B0	L.MISS/L.MICR O/CHEFTOP HANDLE END	2	PZ																																																						
TB1077A0	XLT135/XLT19 5 Ø18X1 HANDLE TUBE	1	PZ																																																						
VI1685A0	M6X6 STAINLESS STEEL SCREW	4	PZ																																																						
VI1930A0	5X25 ST. STEEL SCREW CHIP	2	PZ																																																						
VM1720A0	XL405 DOOR WASKER	1	PZ																																																						
VT1086B0	XLT195/XLT19 3 DOOR BLACK GLASS 399X661	1	PZ																																																						
			KVT1086BL	XLT195/XLT193 LEFT COMPLETE DOOR KIT	<table border="1"> <thead> <tr> <th>Code</th> <th>Description</th> <th>Qty</th> <th>UOM</th> </tr> </thead> <tbody> <tr> <td>0H4540A0</td> <td>DOOR PLATES MAGNET XL40</td> <td>1</td> <td>PZ</td> </tr> <tr> <td>CR1080A0</td> <td>XV-XL-XB ST. STEEL RIGHT HINGE</td> <td>1</td> <td>PZ</td> </tr> <tr> <td>CR1081A0</td> <td>XV-XL-XB ST. STEEL LEFT HINGE</td> <td>1</td> <td>PZ</td> </tr> <tr> <td>GN1320A0</td> <td>DOOR GLASS HINGE GASKE</td> <td>2</td> <td>PZ</td> </tr> </tbody> </table>	Code	Description	Qty	UOM	0H4540A0	DOOR PLATES MAGNET XL40	1	PZ	CR1080A0	XV-XL-XB ST. STEEL RIGHT HINGE	1	PZ	CR1081A0	XV-XL-XB ST. STEEL LEFT HINGE	1	PZ	GN1320A0	DOOR GLASS HINGE GASKE	2	PZ																																
Code	Description	Qty	UOM																																																						
0H4540A0	DOOR PLATES MAGNET XL40	1	PZ																																																						
CR1080A0	XV-XL-XB ST. STEEL RIGHT HINGE	1	PZ																																																						
CR1081A0	XV-XL-XB ST. STEEL LEFT HINGE	1	PZ																																																						
GN1320A0	DOOR GLASS HINGE GASKE	2	PZ																																																						



COMPONENT			SPARE PART																																															
Code	Description	Image	Code	Description	Components list																																													
GN1330A	FERRITIC PLATE GASKET XL405		KVT1086BL	XLT195/XLT193 LEFT COMPLETE DOOR KIT	<table border="1"> <thead> <tr> <th>Code</th> <th>Description</th> <th>Qty</th> <th>UOM</th> </tr> </thead> <tbody> <tr> <td>GN1320A1</td> <td>DOOR GLASS GASKET</td> <td>2</td> <td>PZ</td> </tr> <tr> <td>GN1330A0</td> <td>FERRITIC PLATE GASKET XL40</td> <td>1</td> <td>PZ</td> </tr> <tr> <td>MG1015B0</td> <td>L.MISS/L.MICR O/CHEFTOP HANDLE END</td> <td>2</td> <td>PZ</td> </tr> <tr> <td>TB1077A0</td> <td>XLT135/XLT19 5 Ø18X1 HANDLE TUBE</td> <td>1</td> <td>PZ</td> </tr> <tr> <td>VI1685A0</td> <td>M6X6 STAINLESS STEEL SCREW</td> <td>4</td> <td>PZ</td> </tr> <tr> <td>VI1930A0</td> <td>5X25 ST. STEEL SCREW CHIP</td> <td>2</td> <td>PZ</td> </tr> <tr> <td>VM1720A0</td> <td>XL405 DOOR WASKER</td> <td>1</td> <td>PZ</td> </tr> <tr> <td>VT1086B0</td> <td>XLT195/XLT19 3 DOOR BLACK GLASS 399X661</td> <td>1</td> <td>PZ</td> </tr> </tbody> </table>	Code	Description	Qty	UOM	GN1320A1	DOOR GLASS GASKET	2	PZ	GN1330A0	FERRITIC PLATE GASKET XL40	1	PZ	MG1015B0	L.MISS/L.MICR O/CHEFTOP HANDLE END	2	PZ	TB1077A0	XLT135/XLT19 5 Ø18X1 HANDLE TUBE	1	PZ	VI1685A0	M6X6 STAINLESS STEEL SCREW	4	PZ	VI1930A0	5X25 ST. STEEL SCREW CHIP	2	PZ	VM1720A0	XL405 DOOR WASKER	1	PZ	VT1086B0	XLT195/XLT19 3 DOOR BLACK GLASS 399X661	1	PZ									
			Code	Description	Qty	UOM																																												
GN1320A1	DOOR GLASS GASKET	2	PZ																																															
GN1330A0	FERRITIC PLATE GASKET XL40	1	PZ																																															
MG1015B0	L.MISS/L.MICR O/CHEFTOP HANDLE END	2	PZ																																															
TB1077A0	XLT135/XLT19 5 Ø18X1 HANDLE TUBE	1	PZ																																															
VI1685A0	M6X6 STAINLESS STEEL SCREW	4	PZ																																															
VI1930A0	5X25 ST. STEEL SCREW CHIP	2	PZ																																															
VM1720A0	XL405 DOOR WASKER	1	PZ																																															
VT1086B0	XLT195/XLT19 3 DOOR BLACK GLASS 399X661	1	PZ																																															
KVT1076BR	XLT135/XLT133 RIGHT COMPLETE DOOR KIT	<table border="1"> <thead> <tr> <th>Code</th> <th>Description</th> <th>Qty</th> <th>UOM</th> </tr> </thead> <tbody> <tr> <td>OH4540A0</td> <td>DOOR PLATES MAGNET XL40</td> <td>1</td> <td>PZ</td> </tr> <tr> <td>CR1080A0</td> <td>XV-XL-XB ST. STEEL RIGHT HINGE</td> <td>1</td> <td>PZ</td> </tr> <tr> <td>CR1081A0</td> <td>XV-XL-XB ST. STEEL LEFT HINGE</td> <td>1</td> <td>PZ</td> </tr> <tr> <td>GN1320A0</td> <td>DOOR GLASS HINGE GASKE</td> <td>2</td> <td>PZ</td> </tr> <tr> <td>GN1320A1</td> <td>DOOR GLASS GASKET</td> <td>2</td> <td>PZ</td> </tr> <tr> <td>GN1330A0</td> <td>FERRITIC PLATE GASKET XL40</td> <td>1</td> <td>PZ</td> </tr> <tr> <td>IP1385A1</td> <td>CORNER POLYSTYREN E PACKING 110X80X2000</td> <td>1.400</td> <td>M</td> </tr> <tr> <td>IP1508A0</td> <td></td> <td>0.300</td> <td>PZ</td> </tr> <tr> <td>IP1508A1</td> <td>POLYSTYREN E U SHAPED PROFILE 2000X60X60</td> <td>2</td> <td>M</td> </tr> <tr> <td>MG1015B0</td> <td>L.MISS/L.MICR O/CHEFTOP HANDLE END</td> <td>2</td> <td>PZ</td> </tr> <tr> <td>TB1077A0</td> <td>XLT135/XLT19 5 Ø18X1 HANDLE TUBE</td> <td>1</td> <td>PZ</td> </tr> </tbody> </table>	Code	Description	Qty	UOM	OH4540A0	DOOR PLATES MAGNET XL40	1	PZ	CR1080A0	XV-XL-XB ST. STEEL RIGHT HINGE	1	PZ	CR1081A0	XV-XL-XB ST. STEEL LEFT HINGE	1	PZ	GN1320A0	DOOR GLASS HINGE GASKE	2	PZ	GN1320A1	DOOR GLASS GASKET	2	PZ	GN1330A0	FERRITIC PLATE GASKET XL40	1	PZ	IP1385A1	CORNER POLYSTYREN E PACKING 110X80X2000	1.400	M	IP1508A0		0.300	PZ	IP1508A1	POLYSTYREN E U SHAPED PROFILE 2000X60X60	2	M	MG1015B0	L.MISS/L.MICR O/CHEFTOP HANDLE END	2	PZ	TB1077A0	XLT135/XLT19 5 Ø18X1 HANDLE TUBE	1	PZ
Code	Description	Qty	UOM																																															
OH4540A0	DOOR PLATES MAGNET XL40	1	PZ																																															
CR1080A0	XV-XL-XB ST. STEEL RIGHT HINGE	1	PZ																																															
CR1081A0	XV-XL-XB ST. STEEL LEFT HINGE	1	PZ																																															
GN1320A0	DOOR GLASS HINGE GASKE	2	PZ																																															
GN1320A1	DOOR GLASS GASKET	2	PZ																																															
GN1330A0	FERRITIC PLATE GASKET XL40	1	PZ																																															
IP1385A1	CORNER POLYSTYREN E PACKING 110X80X2000	1.400	M																																															
IP1508A0		0.300	PZ																																															
IP1508A1	POLYSTYREN E U SHAPED PROFILE 2000X60X60	2	M																																															
MG1015B0	L.MISS/L.MICR O/CHEFTOP HANDLE END	2	PZ																																															
TB1077A0	XLT135/XLT19 5 Ø18X1 HANDLE TUBE	1	PZ																																															



COMPONENT			SPARE PART																																																															
Code	Description	Image	Code	Description	Components list																																																													
GN1330A	FERRITIC PLATE GASKET XL405		KVT1076BR	XLT135/XLT133 RIGHT COMPLETE DOOR KIT	<table border="1"> <thead> <tr> <th>Code</th> <th>Description</th> <th>Qty</th> <th>UOM</th> </tr> </thead> <tbody> <tr> <td>VI1685A0</td> <td>M6X6 STAINLESS STEEL SCREW</td> <td>4</td> <td>PZ</td> </tr> <tr> <td>VI1930A0</td> <td>5X25 ST. STEEL SCREW CHIP</td> <td>2</td> <td>PZ</td> </tr> <tr> <td>VM1059A1</td> <td>HEAT SHRINK FILM H800</td> <td>1.500</td> <td>M</td> </tr> <tr> <td>VM1720A0</td> <td>XL405 DOOR WASKER</td> <td>1</td> <td>PZ</td> </tr> <tr> <td>VT1076B0</td> <td>XLT135/XLT13 3 BLACK DOOR GLASS 299X661</td> <td>1</td> <td>PZ</td> </tr> </tbody> </table>	Code	Description	Qty	UOM	VI1685A0	M6X6 STAINLESS STEEL SCREW	4	PZ	VI1930A0	5X25 ST. STEEL SCREW CHIP	2	PZ	VM1059A1	HEAT SHRINK FILM H800	1.500	M	VM1720A0	XL405 DOOR WASKER	1	PZ	VT1076B0	XLT135/XLT13 3 BLACK DOOR GLASS 299X661	1	PZ																																					
			Code	Description	Qty	UOM																																																												
VI1685A0	M6X6 STAINLESS STEEL SCREW	4	PZ																																																															
VI1930A0	5X25 ST. STEEL SCREW CHIP	2	PZ																																																															
VM1059A1	HEAT SHRINK FILM H800	1.500	M																																																															
VM1720A0	XL405 DOOR WASKER	1	PZ																																																															
VT1076B0	XLT135/XLT13 3 BLACK DOOR GLASS 299X661	1	PZ																																																															
KVT1076BL	XLT135/XLT133 LEFT COMPLETE DOOR KIT	<table border="1"> <thead> <tr> <th>Code</th> <th>Description</th> <th>Qty</th> <th>UOM</th> </tr> </thead> <tbody> <tr> <td>OH4540A0</td> <td>DOOR PLATES MAGNET XL40</td> <td>1</td> <td>PZ</td> </tr> <tr> <td>CR1080A0</td> <td>XV-XL-XB ST. STEEL RIGHT HINGE</td> <td>1</td> <td>PZ</td> </tr> <tr> <td>CR1081A0</td> <td>XV-XL-XB ST. STEEL LEFT HINGE</td> <td>1</td> <td>PZ</td> </tr> <tr> <td>GN1320A0</td> <td>DOOR GLASS HINGE GASKE</td> <td>2</td> <td>PZ</td> </tr> <tr> <td>GN1320A1</td> <td>DOOR GLASS GASKET</td> <td>2</td> <td>PZ</td> </tr> <tr> <td>GN1330A0</td> <td>FERRITIC PLATE GASKET XL40</td> <td>1</td> <td>PZ</td> </tr> <tr> <td>IP1385A1</td> <td>CORNER POLYSTYREN E PACKING 110X80X2000</td> <td>1.400</td> <td>M</td> </tr> <tr> <td>IP1508A1</td> <td>POLYSTYREN E U SHAPED PROFILE 2000X60X60</td> <td>0.300</td> <td>M</td> </tr> <tr> <td>MG1015B0</td> <td>L.MISS/L.MICR O/CHEFTOP HANDLE END</td> <td>2</td> <td>PZ</td> </tr> <tr> <td>TB1077A0</td> <td>XLT135/XLT19 5 Ø18X1 HANDLE TUBE</td> <td>1</td> <td>PZ</td> </tr> <tr> <td>VI1685A0</td> <td>M6X6 STAINLESS STEEL SCREW</td> <td>4</td> <td>PZ</td> </tr> <tr> <td>VI1930A0</td> <td>5X25 ST. STEEL SCREW CHIP</td> <td>2</td> <td>PZ</td> </tr> <tr> <td>VM1059A1</td> <td>HEAT SHRINK FILM H800</td> <td>1.500</td> <td>M</td> </tr> <tr> <td>VM1720A0</td> <td>XL405 DOOR WASKER</td> <td>1</td> <td>PZ</td> </tr> <tr> <td>VT1076B0</td> <td>XLT135/XLT13 3 BLACK DOOR GLASS 299X661</td> <td>1</td> <td>PZ</td> </tr> </tbody> </table>	Code	Description	Qty	UOM	OH4540A0	DOOR PLATES MAGNET XL40	1	PZ	CR1080A0	XV-XL-XB ST. STEEL RIGHT HINGE	1	PZ	CR1081A0	XV-XL-XB ST. STEEL LEFT HINGE	1	PZ	GN1320A0	DOOR GLASS HINGE GASKE	2	PZ	GN1320A1	DOOR GLASS GASKET	2	PZ	GN1330A0	FERRITIC PLATE GASKET XL40	1	PZ	IP1385A1	CORNER POLYSTYREN E PACKING 110X80X2000	1.400	M	IP1508A1	POLYSTYREN E U SHAPED PROFILE 2000X60X60	0.300	M	MG1015B0	L.MISS/L.MICR O/CHEFTOP HANDLE END	2	PZ	TB1077A0	XLT135/XLT19 5 Ø18X1 HANDLE TUBE	1	PZ	VI1685A0	M6X6 STAINLESS STEEL SCREW	4	PZ	VI1930A0	5X25 ST. STEEL SCREW CHIP	2	PZ	VM1059A1	HEAT SHRINK FILM H800	1.500	M	VM1720A0	XL405 DOOR WASKER	1	PZ	VT1076B0	XLT135/XLT13 3 BLACK DOOR GLASS 299X661	1	PZ
Code	Description	Qty	UOM																																																															
OH4540A0	DOOR PLATES MAGNET XL40	1	PZ																																																															
CR1080A0	XV-XL-XB ST. STEEL RIGHT HINGE	1	PZ																																																															
CR1081A0	XV-XL-XB ST. STEEL LEFT HINGE	1	PZ																																																															
GN1320A0	DOOR GLASS HINGE GASKE	2	PZ																																																															
GN1320A1	DOOR GLASS GASKET	2	PZ																																																															
GN1330A0	FERRITIC PLATE GASKET XL40	1	PZ																																																															
IP1385A1	CORNER POLYSTYREN E PACKING 110X80X2000	1.400	M																																																															
IP1508A1	POLYSTYREN E U SHAPED PROFILE 2000X60X60	0.300	M																																																															
MG1015B0	L.MISS/L.MICR O/CHEFTOP HANDLE END	2	PZ																																																															
TB1077A0	XLT135/XLT19 5 Ø18X1 HANDLE TUBE	1	PZ																																																															
VI1685A0	M6X6 STAINLESS STEEL SCREW	4	PZ																																																															
VI1930A0	5X25 ST. STEEL SCREW CHIP	2	PZ																																																															
VM1059A1	HEAT SHRINK FILM H800	1.500	M																																																															
VM1720A0	XL405 DOOR WASKER	1	PZ																																																															
VT1076B0	XLT135/XLT13 3 BLACK DOOR GLASS 299X661	1	PZ																																																															



Зип Общепит

ASM3047A/0.D00 General overview

vsezip.ru

+7(812)987-08-81

COMPONENT

SPARE PART

Code	Description	Image	Code	Description	Components list																																																																																											
GN1330A	FERRITIC PLATE GASKET XL405		KDR1210AR	XL405 COMPLETE RIGHT DOOR	<table border="1"> <thead> <tr> <th>Code</th> <th>Description</th> <th>Qty</th> <th>UOM</th> </tr> </thead> <tbody> <tr> <td>0H4530C0</td> <td>RIGHT DOOR DRIPPING TRAY XL415</td> <td>1</td> <td>PZ</td> </tr> <tr> <td>0H4540A0</td> <td>DOOR PLATES MAGNET XL40</td> <td>1</td> <td>PZ</td> </tr> <tr> <td>CR1080A0</td> <td>XV-XL-XB ST. STEEL RIGHT HINGE</td> <td>1</td> <td>PZ</td> </tr> <tr> <td>CR1081A0</td> <td>XV-XL-XB ST. STEEL LEFT HINGE</td> <td>1</td> <td>PZ</td> </tr> <tr> <td>GN1320A0</td> <td>DOOR GLASS HINGE GASKE</td> <td>2</td> <td>PZ</td> </tr> <tr> <td>GN1320A1</td> <td>DOOR GLASS GASKET</td> <td>2</td> <td>PZ</td> </tr> <tr> <td>GN1330A0</td> <td>FERRITIC PLATE GASKET XL40</td> <td>1</td> <td>PZ</td> </tr> <tr> <td>IP1385A1</td> <td>CORNER POLYSTYREN E PACKING 110X80X2000</td> <td>1.300</td> <td>M</td> </tr> <tr> <td>IP1508A0</td> <td></td> <td>0.570</td> <td>PZ</td> </tr> <tr> <td>IP1508A1</td> <td>POLYSTYREN E U SHAPED PROFILE 2000X60X60</td> <td>2</td> <td>M</td> </tr> <tr> <td>MG1015B0</td> <td>L.MISS/L.MICR O/CHEFTOP HANDLE END</td> <td>2</td> <td>PZ</td> </tr> <tr> <td>TB1730A0</td> <td>XL405-413-415 HANDLE TUBE</td> <td>1</td> <td>PZ</td> </tr> <tr> <td>VI1685A0</td> <td>M6X6 STAINLESS STEEL SCREW</td> <td>4</td> <td>PZ</td> </tr> <tr> <td>VI1930A0</td> <td>5X25 ST. STEEL SCREW CHIP</td> <td>2</td> <td>PZ</td> </tr> <tr> <td>VM1059A1</td> <td>HEAT SHRINK FILM H800</td> <td>1.300</td> <td>M</td> </tr> <tr> <td>VM1720A0</td> <td>XL405 DOOR WASKER</td> <td>1</td> <td>PZ</td> </tr> <tr> <td>VM1790A0</td> <td>HINGE BUSH 12X6.5 DI5.3</td> <td>2</td> <td>PZ</td> </tr> <tr> <td>VT1210A0</td> <td>XL405-413-415 DOOR GLASS</td> <td>1</td> <td>PZ</td> </tr> </tbody> </table>	Code	Description	Qty	UOM	0H4530C0	RIGHT DOOR DRIPPING TRAY XL415	1	PZ	0H4540A0	DOOR PLATES MAGNET XL40	1	PZ	CR1080A0	XV-XL-XB ST. STEEL RIGHT HINGE	1	PZ	CR1081A0	XV-XL-XB ST. STEEL LEFT HINGE	1	PZ	GN1320A0	DOOR GLASS HINGE GASKE	2	PZ	GN1320A1	DOOR GLASS GASKET	2	PZ	GN1330A0	FERRITIC PLATE GASKET XL40	1	PZ	IP1385A1	CORNER POLYSTYREN E PACKING 110X80X2000	1.300	M	IP1508A0		0.570	PZ	IP1508A1	POLYSTYREN E U SHAPED PROFILE 2000X60X60	2	M	MG1015B0	L.MISS/L.MICR O/CHEFTOP HANDLE END	2	PZ	TB1730A0	XL405-413-415 HANDLE TUBE	1	PZ	VI1685A0	M6X6 STAINLESS STEEL SCREW	4	PZ	VI1930A0	5X25 ST. STEEL SCREW CHIP	2	PZ	VM1059A1	HEAT SHRINK FILM H800	1.300	M	VM1720A0	XL405 DOOR WASKER	1	PZ	VM1790A0	HINGE BUSH 12X6.5 DI5.3	2	PZ	VT1210A0	XL405-413-415 DOOR GLASS	1	PZ	KDR1210AL	XL405 COMPLETE LEFT DOOR	<table border="1"> <thead> <tr> <th>Code</th> <th>Description</th> <th>Qty</th> <th>UOM</th> </tr> </thead> <tbody> <tr> <td>0H4535C0</td> <td>LEFT DOOR DRIPPING TRAY XL415</td> <td>1</td> <td>PZ</td> </tr> <tr> <td>0H4540A0</td> <td>DOOR PLATES MAGNET XL40</td> <td>1</td> <td>PZ</td> </tr> </tbody> </table>	Code	Description	Qty	UOM	0H4535C0	LEFT DOOR DRIPPING TRAY XL415	1	PZ	0H4540A0	DOOR PLATES MAGNET XL40	1	PZ
			Code	Description	Qty	UOM																																																																																										
0H4530C0	RIGHT DOOR DRIPPING TRAY XL415	1	PZ																																																																																													
0H4540A0	DOOR PLATES MAGNET XL40	1	PZ																																																																																													
CR1080A0	XV-XL-XB ST. STEEL RIGHT HINGE	1	PZ																																																																																													
CR1081A0	XV-XL-XB ST. STEEL LEFT HINGE	1	PZ																																																																																													
GN1320A0	DOOR GLASS HINGE GASKE	2	PZ																																																																																													
GN1320A1	DOOR GLASS GASKET	2	PZ																																																																																													
GN1330A0	FERRITIC PLATE GASKET XL40	1	PZ																																																																																													
IP1385A1	CORNER POLYSTYREN E PACKING 110X80X2000	1.300	M																																																																																													
IP1508A0		0.570	PZ																																																																																													
IP1508A1	POLYSTYREN E U SHAPED PROFILE 2000X60X60	2	M																																																																																													
MG1015B0	L.MISS/L.MICR O/CHEFTOP HANDLE END	2	PZ																																																																																													
TB1730A0	XL405-413-415 HANDLE TUBE	1	PZ																																																																																													
VI1685A0	M6X6 STAINLESS STEEL SCREW	4	PZ																																																																																													
VI1930A0	5X25 ST. STEEL SCREW CHIP	2	PZ																																																																																													
VM1059A1	HEAT SHRINK FILM H800	1.300	M																																																																																													
VM1720A0	XL405 DOOR WASKER	1	PZ																																																																																													
VM1790A0	HINGE BUSH 12X6.5 DI5.3	2	PZ																																																																																													
VT1210A0	XL405-413-415 DOOR GLASS	1	PZ																																																																																													
Code	Description	Qty	UOM																																																																																													
0H4535C0	LEFT DOOR DRIPPING TRAY XL415	1	PZ																																																																																													
0H4540A0	DOOR PLATES MAGNET XL40	1	PZ																																																																																													



Зип Общепит

ASM3047A/0.D00 General overview

vsezip.ru

+7(812)987-08-81

COMPONENT

SPARE PART

Code	Description	Image	Code	Description	Components list																																																																				
GN1330A	FERRITIC PLATE GASKET XL405		KDR1210AL	XL405 COMPLETE LEFT DOOR	<table border="1"> <thead> <tr> <th>Code</th> <th>Description</th> <th>Qty</th> <th>UOM</th> </tr> </thead> <tbody> <tr> <td>CR1080A0</td> <td>XV-XL-XB ST. STEEL RIGHT HINGE</td> <td>1</td> <td>PZ</td> </tr> <tr> <td>CR1081A0</td> <td>XV-XL-XB ST. STEEL LEFT HINGE</td> <td>1</td> <td>PZ</td> </tr> <tr> <td>GN1320A0</td> <td>DOOR GLASS HINGE GASKE</td> <td>2</td> <td>PZ</td> </tr> <tr> <td>GN1320A1</td> <td>DOOR GLASS GASKET</td> <td>2</td> <td>PZ</td> </tr> <tr> <td>GN1330A0</td> <td>FERRITIC PLATE GASKET XL40</td> <td>1</td> <td>PZ</td> </tr> <tr> <td>IP1385A1</td> <td>CORNER POLYSTYREN E PACKING 110X80X2000</td> <td>1.300</td> <td>M</td> </tr> <tr> <td>IP1508A0</td> <td></td> <td>0.570</td> <td>PZ</td> </tr> <tr> <td>IP1508A1</td> <td>POLYSTYREN E U SHAPED PROFILE 2000X60X60</td> <td>2</td> <td>M</td> </tr> <tr> <td>MG1015B0</td> <td>L.MISS/L.MICR O/CHEFTOP HANDLE END</td> <td>2</td> <td>PZ</td> </tr> <tr> <td>TB1730A0</td> <td>XL405-413-415 HANDLE TUBE</td> <td>1</td> <td>PZ</td> </tr> <tr> <td>VI1685A0</td> <td>M6X6 STAINLESS STEEL SCREW</td> <td>4</td> <td>PZ</td> </tr> <tr> <td>VI1930A0</td> <td>5X25 ST. STEEL SCREW CHIP</td> <td>2</td> <td>PZ</td> </tr> <tr> <td>VM1059A1</td> <td>HEAT SHRINK FILM H800</td> <td>1.300</td> <td>M</td> </tr> <tr> <td>VM1720A0</td> <td>XL405 DOOR WASKER</td> <td>1</td> <td>PZ</td> </tr> <tr> <td>VM1790A0</td> <td>HINGE BUSH 12X6.5 DI5.3</td> <td>2</td> <td>PZ</td> </tr> <tr> <td>VT1210A0</td> <td>XL405-413-415 DOOR GLASS</td> <td>1</td> <td>PZ</td> </tr> </tbody> </table>	Code	Description	Qty	UOM	CR1080A0	XV-XL-XB ST. STEEL RIGHT HINGE	1	PZ	CR1081A0	XV-XL-XB ST. STEEL LEFT HINGE	1	PZ	GN1320A0	DOOR GLASS HINGE GASKE	2	PZ	GN1320A1	DOOR GLASS GASKET	2	PZ	GN1330A0	FERRITIC PLATE GASKET XL40	1	PZ	IP1385A1	CORNER POLYSTYREN E PACKING 110X80X2000	1.300	M	IP1508A0		0.570	PZ	IP1508A1	POLYSTYREN E U SHAPED PROFILE 2000X60X60	2	M	MG1015B0	L.MISS/L.MICR O/CHEFTOP HANDLE END	2	PZ	TB1730A0	XL405-413-415 HANDLE TUBE	1	PZ	VI1685A0	M6X6 STAINLESS STEEL SCREW	4	PZ	VI1930A0	5X25 ST. STEEL SCREW CHIP	2	PZ	VM1059A1	HEAT SHRINK FILM H800	1.300	M	VM1720A0	XL405 DOOR WASKER	1	PZ	VM1790A0	HINGE BUSH 12X6.5 DI5.3	2	PZ	VT1210A0	XL405-413-415 DOOR GLASS	1	PZ
Code	Description	Qty	UOM																																																																						
CR1080A0	XV-XL-XB ST. STEEL RIGHT HINGE	1	PZ																																																																						
CR1081A0	XV-XL-XB ST. STEEL LEFT HINGE	1	PZ																																																																						
GN1320A0	DOOR GLASS HINGE GASKE	2	PZ																																																																						
GN1320A1	DOOR GLASS GASKET	2	PZ																																																																						
GN1330A0	FERRITIC PLATE GASKET XL40	1	PZ																																																																						
IP1385A1	CORNER POLYSTYREN E PACKING 110X80X2000	1.300	M																																																																						
IP1508A0		0.570	PZ																																																																						
IP1508A1	POLYSTYREN E U SHAPED PROFILE 2000X60X60	2	M																																																																						
MG1015B0	L.MISS/L.MICR O/CHEFTOP HANDLE END	2	PZ																																																																						
TB1730A0	XL405-413-415 HANDLE TUBE	1	PZ																																																																						
VI1685A0	M6X6 STAINLESS STEEL SCREW	4	PZ																																																																						
VI1930A0	5X25 ST. STEEL SCREW CHIP	2	PZ																																																																						
VM1059A1	HEAT SHRINK FILM H800	1.300	M																																																																						
VM1720A0	XL405 DOOR WASKER	1	PZ																																																																						
VM1790A0	HINGE BUSH 12X6.5 DI5.3	2	PZ																																																																						
VT1210A0	XL405-413-415 DOOR GLASS	1	PZ																																																																						
CR1081A	XV-XL-XB ST. STEEL LEFT HINGE		KCR1080A	RIGHT/LEFT HINGES KIT CR1080A+CR1081A	<table border="1"> <thead> <tr> <th>Code</th> <th>Description</th> <th>Qty</th> <th>UOM</th> </tr> </thead> <tbody> <tr> <td>CR1080A0</td> <td>XV-XL-XB ST. STEEL RIGHT HINGE</td> <td>1</td> <td>PZ</td> </tr> <tr> <td>CR1081A0</td> <td>XV-XL-XB ST. STEEL LEFT HINGE</td> <td>1</td> <td>PZ</td> </tr> <tr> <td>GN1320A0</td> <td>DOOR GLASS HINGE GASKE</td> <td>2</td> <td>PZ</td> </tr> <tr> <td>GN1320A1</td> <td>DOOR GLASS GASKET</td> <td>2</td> <td>PZ</td> </tr> </tbody> </table>	Code	Description	Qty	UOM	CR1080A0	XV-XL-XB ST. STEEL RIGHT HINGE	1	PZ	CR1081A0	XV-XL-XB ST. STEEL LEFT HINGE	1	PZ	GN1320A0	DOOR GLASS HINGE GASKE	2	PZ	GN1320A1	DOOR GLASS GASKET	2	PZ																																																
Code	Description	Qty	UOM																																																																						
CR1080A0	XV-XL-XB ST. STEEL RIGHT HINGE	1	PZ																																																																						
CR1081A0	XV-XL-XB ST. STEEL LEFT HINGE	1	PZ																																																																						
GN1320A0	DOOR GLASS HINGE GASKE	2	PZ																																																																						
GN1320A1	DOOR GLASS GASKET	2	PZ																																																																						



Зип Общепит

ASM3047A/0.D00 General overview

vsezip.ru

+7(812)987-08-81

COMPONENT			SPARE PART																														
Code	Description	Image	Code	Description	Components list																												
CR1081A	XV-XL-XB ST. STEEL LEFT HINGE		KCR1080A	RIGHT/LEFT HINGES KIT CR1080A+CR1081A	<table border="1"> <thead> <tr> <th>Code</th> <th>Description</th> <th>Qty</th> <th>UOM</th> </tr> </thead> <tbody> <tr> <td>VI1685A0</td> <td>M6X6 STAINLESS STEEL SCREW</td> <td>4</td> <td>PZ</td> </tr> <tr> <td>VM1790A0</td> <td>HINGE BUSH 12X6.5 DI5.3</td> <td>2</td> <td>PZ</td> </tr> </tbody> </table>	Code	Description	Qty	UOM	VI1685A0	M6X6 STAINLESS STEEL SCREW	4	PZ	VM1790A0	HINGE BUSH 12X6.5 DI5.3	2	PZ																
Code	Description	Qty	UOM																														
VI1685A0	M6X6 STAINLESS STEEL SCREW	4	PZ																														
VM1790A0	HINGE BUSH 12X6.5 DI5.3	2	PZ																														
CR1080A	XV-XL-XB ST. STEEL RIGHT HINGE		KCR1080A	RIGHT/LEFT HINGES KIT CR1080A+CR1081A	<table border="1"> <thead> <tr> <th>Code</th> <th>Description</th> <th>Qty</th> <th>UOM</th> </tr> </thead> <tbody> <tr> <td>CR1080A0</td> <td>XV-XL-XB ST. STEEL RIGHT HINGE</td> <td>1</td> <td>PZ</td> </tr> <tr> <td>CR1081A0</td> <td>XV-XL-XB ST. STEEL LEFT HINGE</td> <td>1</td> <td>PZ</td> </tr> <tr> <td>GN1320A0</td> <td>DOOR GLASS HINGE GASKE</td> <td>2</td> <td>PZ</td> </tr> <tr> <td>GN1320A1</td> <td>DOOR GLASS GASKET</td> <td>2</td> <td>PZ</td> </tr> <tr> <td>VI1685A0</td> <td>M6X6 STAINLESS STEEL SCREW</td> <td>4</td> <td>PZ</td> </tr> <tr> <td>VM1790A0</td> <td>HINGE BUSH 12X6.5 DI5.3</td> <td>2</td> <td>PZ</td> </tr> </tbody> </table>	Code	Description	Qty	UOM	CR1080A0	XV-XL-XB ST. STEEL RIGHT HINGE	1	PZ	CR1081A0	XV-XL-XB ST. STEEL LEFT HINGE	1	PZ	GN1320A0	DOOR GLASS HINGE GASKE	2	PZ	GN1320A1	DOOR GLASS GASKET	2	PZ	VI1685A0	M6X6 STAINLESS STEEL SCREW	4	PZ	VM1790A0	HINGE BUSH 12X6.5 DI5.3	2	PZ
Code	Description	Qty	UOM																														
CR1080A0	XV-XL-XB ST. STEEL RIGHT HINGE	1	PZ																														
CR1081A0	XV-XL-XB ST. STEEL LEFT HINGE	1	PZ																														
GN1320A0	DOOR GLASS HINGE GASKE	2	PZ																														
GN1320A1	DOOR GLASS GASKET	2	PZ																														
VI1685A0	M6X6 STAINLESS STEEL SCREW	4	PZ																														
VM1790A0	HINGE BUSH 12X6.5 DI5.3	2	PZ																														
MG1082A	HANDLE END PROFILE 20X20		MG1082A0	HANDLE END PROFILE 20X20																													
GN1554A	PROOFER HANDLE GASKET		GN1554A0	PROOFER HANDLE GASKET																													







Зип Общепит

ASM3047A/0.D00 General overview

vsezip.ru

+7(812)987-08-81

COMPONENT			SPARE PART																																						
Code	Description	Image	Code	Description	Components list																																				
0H7217A	BAKERTOP PROOFER RIGHT DRIP TRAY		0H7217A0	BAKERTOP PROOFER RIGHT DRIP TRAY																																					
0H7325A	600X400 8TRAY PROOFER DOOR BAND		0H7325A0	600X400 8TRAY PROOFER DOOR BAND																																					
TB2969A	8TRAY PROOFER HANDLE PROFILE 20X20		TB2969A0	8TRAY PROOFER HANDLE PROFILE 20X20																																					
VT1308A	LOW PROVER DOOR GLASS		KVT1308AR	8 TRAYS PROVER RIGHT DOOR GLASS KIT	<table border="1"> <thead> <tr> <th>Code</th> <th>Description</th> <th>Qty</th> <th>UOM</th> </tr> </thead> <tbody> <tr> <td>0H4540A0</td> <td>DOOR PLATES MAGNET XL40</td> <td>1</td> <td>PZ</td> </tr> <tr> <td>0H7217A0</td> <td>BAKERTOP PROOFER RIGHT DRIP TRAY</td> <td>1</td> <td>PZ</td> </tr> <tr> <td>0H7325A0</td> <td>600X400 8TRAY PROOFER DOOR BAND</td> <td>1</td> <td>PZ</td> </tr> <tr> <td>CR1080A0</td> <td>XV-XL-XB ST. STEEL RIGHT HINGE</td> <td>1</td> <td>PZ</td> </tr> <tr> <td>CR1081A0</td> <td>XV-XL-XB ST. STEEL LEFT HINGE</td> <td>1</td> <td>PZ</td> </tr> <tr> <td>GN1330A0</td> <td>FERRITIC PLATE GASKET XL40</td> <td>1</td> <td>PZ</td> </tr> <tr> <td>GN1554A0</td> <td>PROOFER HANDLE GASKET</td> <td>1</td> <td>PZ</td> </tr> <tr> <td>GN1577A1</td> <td>PROOFER HINGE GASKE</td> <td>2</td> <td>PZ</td> </tr> </tbody> </table>	Code	Description	Qty	UOM	0H4540A0	DOOR PLATES MAGNET XL40	1	PZ	0H7217A0	BAKERTOP PROOFER RIGHT DRIP TRAY	1	PZ	0H7325A0	600X400 8TRAY PROOFER DOOR BAND	1	PZ	CR1080A0	XV-XL-XB ST. STEEL RIGHT HINGE	1	PZ	CR1081A0	XV-XL-XB ST. STEEL LEFT HINGE	1	PZ	GN1330A0	FERRITIC PLATE GASKET XL40	1	PZ	GN1554A0	PROOFER HANDLE GASKET	1	PZ	GN1577A1	PROOFER HINGE GASKE	2	PZ
Code	Description	Qty	UOM																																						
0H4540A0	DOOR PLATES MAGNET XL40	1	PZ																																						
0H7217A0	BAKERTOP PROOFER RIGHT DRIP TRAY	1	PZ																																						
0H7325A0	600X400 8TRAY PROOFER DOOR BAND	1	PZ																																						
CR1080A0	XV-XL-XB ST. STEEL RIGHT HINGE	1	PZ																																						
CR1081A0	XV-XL-XB ST. STEEL LEFT HINGE	1	PZ																																						
GN1330A0	FERRITIC PLATE GASKET XL40	1	PZ																																						
GN1554A0	PROOFER HANDLE GASKET	1	PZ																																						
GN1577A1	PROOFER HINGE GASKE	2	PZ																																						



COMPONENT			SPARE PART																																											
Code	Description	Image	Code	Description	Components list																																									
VT1308A	LOW PROVER DOOR GLASS		KVT1308AR	8 TRAYS PROVER RIGHT DOOR GLASS KIT	<table border="1"> <thead> <tr> <th>Code</th> <th>Description</th> <th>Qty</th> <th>UOM</th> </tr> </thead> <tbody> <tr> <td>IP1508A1</td> <td>POLYSTYREN E U SHAPED PROFILE 2000X60X60</td> <td>1.500</td> <td>M</td> </tr> <tr> <td>MG1082A0</td> <td>HANDLE END PROFILE 20X2</td> <td>2</td> <td>PZ</td> </tr> <tr> <td>TB2969A0</td> <td>8TRAY PROOFER HANDLE PROFILE 20X2</td> <td>1</td> <td>PZ</td> </tr> <tr> <td>VI1685A0</td> <td>M6X6 STAINLESS STEEL SCREW</td> <td>4</td> <td>PZ</td> </tr> <tr> <td>VI1930A0</td> <td>5X25 ST. STEEL SCREW CHIP</td> <td>2</td> <td>PZ</td> </tr> <tr> <td>VM1059A1</td> <td>HEAT SHRINK FILM H800</td> <td>1</td> <td>M</td> </tr> <tr> <td>VM1720A0</td> <td>XL405 DOOR WASKER</td> <td>1</td> <td>PZ</td> </tr> <tr> <td>VM2000A0</td> <td>M4 SOCKET HEAD SCREW COVER</td> <td>4</td> <td>PZ</td> </tr> <tr> <td>VT1308A0</td> <td>LOW PROVER DOOR GLASS</td> <td></td> <td>1</td> <td>PZ</td> </tr> </tbody> </table>	Code	Description	Qty	UOM	IP1508A1	POLYSTYREN E U SHAPED PROFILE 2000X60X60	1.500	M	MG1082A0	HANDLE END PROFILE 20X2	2	PZ	TB2969A0	8TRAY PROOFER HANDLE PROFILE 20X2	1	PZ	VI1685A0	M6X6 STAINLESS STEEL SCREW	4	PZ	VI1930A0	5X25 ST. STEEL SCREW CHIP	2	PZ	VM1059A1	HEAT SHRINK FILM H800	1	M	VM1720A0	XL405 DOOR WASKER	1	PZ	VM2000A0	M4 SOCKET HEAD SCREW COVER	4	PZ	VT1308A0	LOW PROVER DOOR GLASS		1	PZ
			Code	Description	Qty	UOM																																								
IP1508A1	POLYSTYREN E U SHAPED PROFILE 2000X60X60	1.500	M																																											
MG1082A0	HANDLE END PROFILE 20X2	2	PZ																																											
TB2969A0	8TRAY PROOFER HANDLE PROFILE 20X2	1	PZ																																											
VI1685A0	M6X6 STAINLESS STEEL SCREW	4	PZ																																											
VI1930A0	5X25 ST. STEEL SCREW CHIP	2	PZ																																											
VM1059A1	HEAT SHRINK FILM H800	1	M																																											
VM1720A0	XL405 DOOR WASKER	1	PZ																																											
VM2000A0	M4 SOCKET HEAD SCREW COVER	4	PZ																																											
VT1308A0	LOW PROVER DOOR GLASS		1	PZ																																										
KVT1308AL	8 TRAYS PROVER LEFT DOOR GLASS KIT	<table border="1"> <thead> <tr> <th>Code</th> <th>Description</th> <th>Qty</th> <th>UOM</th> </tr> </thead> <tbody> <tr> <td>0H4540A0</td> <td>DOOR PLATES MAGNET XL40</td> <td>1</td> <td>PZ</td> </tr> <tr> <td>0H7216A0</td> <td>BAKERTOP PROOFER LEFT DRIP TRAY</td> <td>1</td> <td>PZ</td> </tr> <tr> <td>0H7325A0</td> <td>600X400 8TRAY PROOFER DOOR BAND</td> <td>1</td> <td>PZ</td> </tr> <tr> <td>CR1080A0</td> <td>XV-XL-XB ST. STEEL RIGHT HINGE</td> <td>1</td> <td>PZ</td> </tr> <tr> <td>CR1081A0</td> <td>XV-XL-XB ST. STEEL LEFT HINGE</td> <td>1</td> <td>PZ</td> </tr> <tr> <td>GN1330A0</td> <td>FERRITIC PLATE GASKET XL40</td> <td>1</td> <td>PZ</td> </tr> <tr> <td>GN1554A0</td> <td>PROOFER HANDLE GASKET</td> <td>1</td> <td>PZ</td> </tr> <tr> <td>GN1577A1</td> <td>PROOFER HINGE GASKE</td> <td>2</td> <td>PZ</td> </tr> <tr> <td>IP1508A1</td> <td>POLYSTYREN E U SHAPED PROFILE 2000X60X60</td> <td>1.500</td> <td>M</td> </tr> </tbody> </table>	Code	Description	Qty	UOM	0H4540A0	DOOR PLATES MAGNET XL40	1	PZ	0H7216A0	BAKERTOP PROOFER LEFT DRIP TRAY	1	PZ	0H7325A0	600X400 8TRAY PROOFER DOOR BAND	1	PZ	CR1080A0	XV-XL-XB ST. STEEL RIGHT HINGE	1	PZ	CR1081A0	XV-XL-XB ST. STEEL LEFT HINGE	1	PZ	GN1330A0	FERRITIC PLATE GASKET XL40	1	PZ	GN1554A0	PROOFER HANDLE GASKET	1	PZ	GN1577A1	PROOFER HINGE GASKE	2	PZ	IP1508A1	POLYSTYREN E U SHAPED PROFILE 2000X60X60	1.500	M				
Code	Description	Qty	UOM																																											
0H4540A0	DOOR PLATES MAGNET XL40	1	PZ																																											
0H7216A0	BAKERTOP PROOFER LEFT DRIP TRAY	1	PZ																																											
0H7325A0	600X400 8TRAY PROOFER DOOR BAND	1	PZ																																											
CR1080A0	XV-XL-XB ST. STEEL RIGHT HINGE	1	PZ																																											
CR1081A0	XV-XL-XB ST. STEEL LEFT HINGE	1	PZ																																											
GN1330A0	FERRITIC PLATE GASKET XL40	1	PZ																																											
GN1554A0	PROOFER HANDLE GASKET	1	PZ																																											
GN1577A1	PROOFER HINGE GASKE	2	PZ																																											
IP1508A1	POLYSTYREN E U SHAPED PROFILE 2000X60X60	1.500	M																																											





Зип Общепит

ASM3047A/0.D00 General overview

vsezip.ru

+7(812)987-08-81

COMPONENT			SPARE PART																																						
Code	Description	Image	Code	Description	Components list																																				
VT1308A	LOW PROVER DOOR GLASS		KVT1308AL	8 TRAYS PROVER LEFT DOOR GLASS KIT	<table border="1"> <thead> <tr> <th>Code</th> <th>Description</th> <th>Qty</th> <th>UOM</th> </tr> </thead> <tbody> <tr> <td>MG1082A0</td> <td>HANDLE END PROFILE 20X2</td> <td>2</td> <td>PZ</td> </tr> <tr> <td>TB2969A0</td> <td>8TRAY PROOFER HANDLE PROFILE 20X2</td> <td>1</td> <td>PZ</td> </tr> <tr> <td>VI1685A0</td> <td>M6X6 STAINLESS STEEL SCREW</td> <td>4</td> <td>PZ</td> </tr> <tr> <td>VI1930A0</td> <td>5X25 ST. STEEL SCREW CHIP</td> <td>2</td> <td>PZ</td> </tr> <tr> <td>VM1059A1</td> <td>HEAT SHRINK FILM H800</td> <td>1</td> <td>M</td> </tr> <tr> <td>VM1720A0</td> <td>XL405 DOOR WASKER</td> <td>1</td> <td>PZ</td> </tr> <tr> <td>VM2000A0</td> <td>M4 SOCKET HEAD SCREW COVER</td> <td>4</td> <td>PZ</td> </tr> <tr> <td>VT1308A0</td> <td>LOW PROVER DOOR GLASS</td> <td>1</td> <td>PZ</td> </tr> </tbody> </table>	Code	Description	Qty	UOM	MG1082A0	HANDLE END PROFILE 20X2	2	PZ	TB2969A0	8TRAY PROOFER HANDLE PROFILE 20X2	1	PZ	VI1685A0	M6X6 STAINLESS STEEL SCREW	4	PZ	VI1930A0	5X25 ST. STEEL SCREW CHIP	2	PZ	VM1059A1	HEAT SHRINK FILM H800	1	M	VM1720A0	XL405 DOOR WASKER	1	PZ	VM2000A0	M4 SOCKET HEAD SCREW COVER	4	PZ	VT1308A0	LOW PROVER DOOR GLASS	1	PZ
			Code	Description	Qty	UOM																																			
MG1082A0	HANDLE END PROFILE 20X2	2	PZ																																						
TB2969A0	8TRAY PROOFER HANDLE PROFILE 20X2	1	PZ																																						
VI1685A0	M6X6 STAINLESS STEEL SCREW	4	PZ																																						
VI1930A0	5X25 ST. STEEL SCREW CHIP	2	PZ																																						
VM1059A1	HEAT SHRINK FILM H800	1	M																																						
VM1720A0	XL405 DOOR WASKER	1	PZ																																						
VM2000A0	M4 SOCKET HEAD SCREW COVER	4	PZ																																						
VT1308A0	LOW PROVER DOOR GLASS	1	PZ																																						
KVT1308A	XEBPC-08EU-C- 1PC GLASS KIT	<table border="1"> <thead> <tr> <th>Code</th> <th>Description</th> <th>Qty</th> <th>UOM</th> </tr> </thead> <tbody> <tr> <td>IP1508A1</td> <td>POLYSTYREN E U SHAPED PROFILE 2000X60X60</td> <td>2</td> <td>M</td> </tr> <tr> <td>VM1059A1</td> <td>HEAT SHRINK FILM H800</td> <td>1.800</td> <td>M</td> </tr> <tr> <td>VT1308A0</td> <td>LOW PROVER DOOR GLASS</td> <td>1</td> <td>PZ</td> </tr> </tbody> </table>	Code	Description	Qty	UOM	IP1508A1	POLYSTYREN E U SHAPED PROFILE 2000X60X60	2	M	VM1059A1	HEAT SHRINK FILM H800	1.800	M	VT1308A0	LOW PROVER DOOR GLASS	1	PZ																							
Code	Description	Qty	UOM																																						
IP1508A1	POLYSTYREN E U SHAPED PROFILE 2000X60X60	2	M																																						
VM1059A1	HEAT SHRINK FILM H800	1.800	M																																						
VT1308A0	LOW PROVER DOOR GLASS	1	PZ																																						
GN1577A	PROOFER HINGE GASKET		GN1577A1	PROOFER HINGE GASKET																																					



Зип Общепит

ASM3046B/0.D00 General overview

vsezip.ru

+7(812)987-08-81

ASM3046B/0.D00 - General overview

FRONT

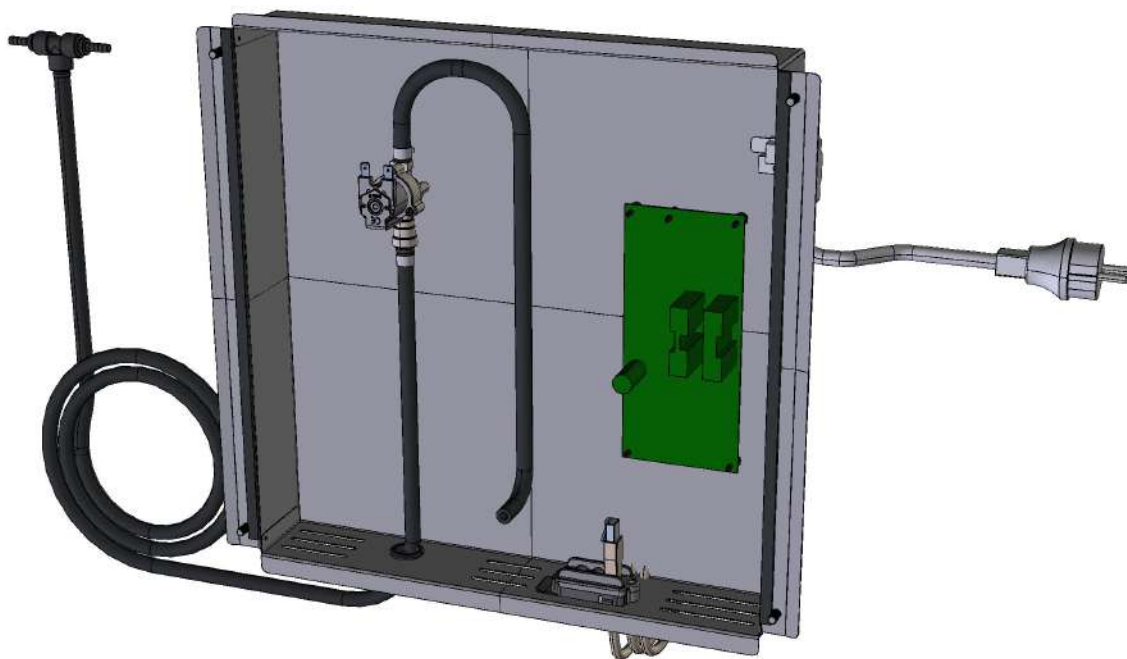



Зип Общепит

ASM3046B/0.D00 General overview

vsezip.ru

+7(812)987-08-81

ASM3046B/0.D00 - General overview

REAR

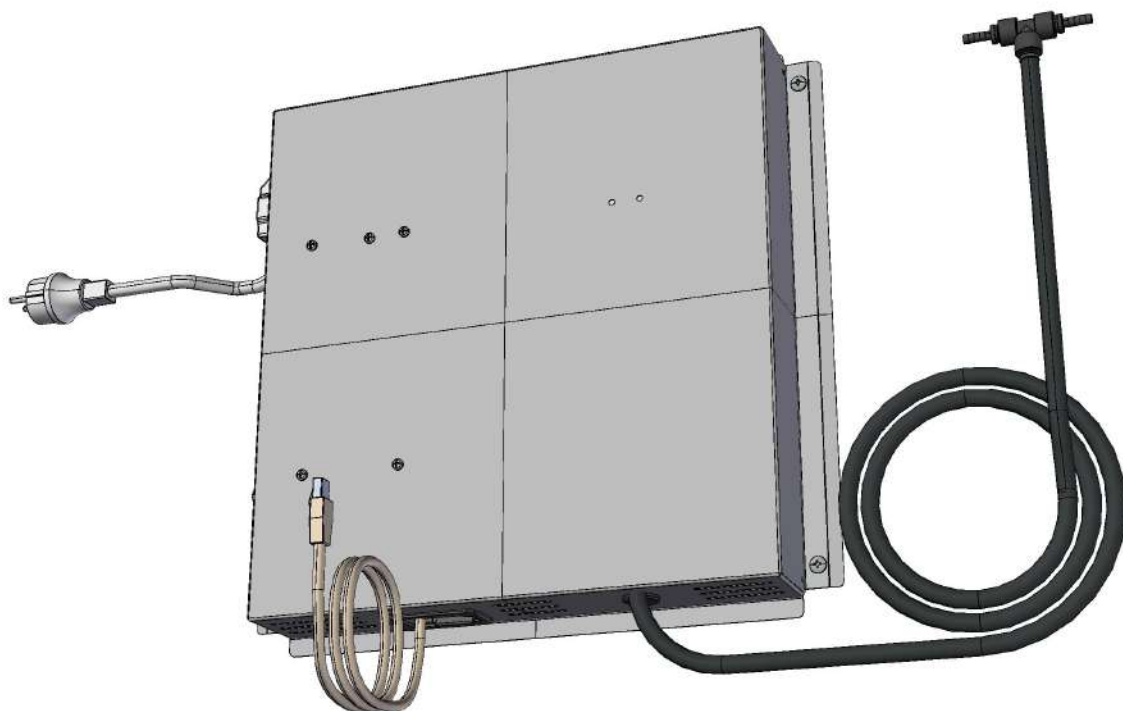







Зип Общепит

ASM3046B/0.D00 General overview

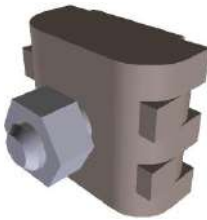
vsezip.ru

+7(812)987-08-81

COMPONENT			SPARE PART																		
Code	Description	Image	Code	Description	Components list																
VM1750A	BRASS COMB CLAM		KVM1750A	COMB TERMINAL BLOCK KIT	<table border="1"> <thead> <tr> <th>Code</th> <th>Description</th> <th>Qty</th> <th>UOM</th> </tr> </thead> <tbody> <tr> <td>VM1750A0</td> <td>BRASS COMB CLAMP</td> <td>1</td> <td>PZ</td> </tr> </tbody> </table>	Code	Description	Qty	UOM	VM1750A0	BRASS COMB CLAMP	1	PZ								
Code	Description	Qty	UOM																		
VM1750A0	BRASS COMB CLAMP	1	PZ																		
CE1305A	L=2MT RJ45 - RJ45 CABLE		KCE1305A	RJ45 - RJ45 L=2MT CABLE KIT	<table border="1"> <thead> <tr> <th>Code</th> <th>Description</th> <th>Qty</th> <th>UOM</th> </tr> </thead> <tbody> <tr> <td>CE1305A0</td> <td>L=2MT RJ45 - RJ45 CABLE</td> <td>1</td> <td>PZ</td> </tr> </tbody> </table>	Code	Description	Qty	UOM	CE1305A0	L=2MT RJ45 - RJ45 CABLE	1	PZ								
Code	Description	Qty	UOM																		
CE1305A0	L=2MT RJ45 - RJ45 CABLE	1	PZ																		
MR1000A	CABLE 3X1,5 H07RN-F MT1,5+K2/3+SCHUK		KMR1000A	KIT CABLE 3X1,5 H07RN-F +K2/3+SCHUKO	<table border="1"> <thead> <tr> <th>Code</th> <th>Description</th> <th>Qty</th> <th>UOM</th> </tr> </thead> <tbody> <tr> <td>MR1000A0</td> <td>CABLE 3X1,5 H07RN-F MT1,5+K2/3+SCHUKO</td> <td>1</td> <td>PZ</td> </tr> </tbody> </table>	Code	Description	Qty	UOM	MR1000A0	CABLE 3X1,5 H07RN-F MT1,5+K2/3+SCHUKO	1	PZ								
Code	Description	Qty	UOM																		
MR1000A0	CABLE 3X1,5 H07RN-F MT1,5+K2/3+SCHUKO	1	PZ																		
VL1047A	D6 PIPE HOLDER - D8 J.G. TERMINAL		KVL1047A	Ø6 PIPE HOLDER+Ø8 JG TERMINAL 10 PCS KIT	<table border="1"> <thead> <tr> <th>Code</th> <th>Description</th> <th>Qty</th> <th>UOM</th> </tr> </thead> <tbody> <tr> <td>VL1047A1</td> <td>D6 PIPE HOLDER - D8 J.G. TERMINAL</td> <td>10</td> <td>PZ</td> </tr> </tbody> </table>	Code	Description	Qty	UOM	VL1047A1	D6 PIPE HOLDER - D8 J.G. TERMINAL	10	PZ								
Code	Description	Qty	UOM																		
VL1047A1	D6 PIPE HOLDER - D8 J.G. TERMINAL	10	PZ																		
			KVL0016A	BRITA ADAPTOR KIT FOR MM CLEANING SYSTEM	<table border="1"> <thead> <tr> <th>Code</th> <th>Description</th> <th>Qty</th> <th>UOM</th> </tr> </thead> <tbody> <tr> <td>EL1185A0</td> <td>Ø8F - Ø8F ELBOW CONNECTION</td> <td>1</td> <td>PZ</td> </tr> <tr> <td>RC1018A0</td> <td>ZINC PLATED D12 ELASTIC CLAMP</td> <td>2</td> <td>PZ</td> </tr> <tr> <td>VL1047A1</td> <td>D6 PIPE HOLDER - D8 J.G. TERMINAL</td> <td>2</td> <td>PZ</td> </tr> </tbody> </table>	Code	Description	Qty	UOM	EL1185A0	Ø8F - Ø8F ELBOW CONNECTION	1	PZ	RC1018A0	ZINC PLATED D12 ELASTIC CLAMP	2	PZ	VL1047A1	D6 PIPE HOLDER - D8 J.G. TERMINAL	2	PZ
Code	Description	Qty	UOM																		
EL1185A0	Ø8F - Ø8F ELBOW CONNECTION	1	PZ																		
RC1018A0	ZINC PLATED D12 ELASTIC CLAMP	2	PZ																		
VL1047A1	D6 PIPE HOLDER - D8 J.G. TERMINAL	2	PZ																		



COMPONENT			SPARE PART																										
Code	Description	Image	Code	Description	Components list																								
EL1424A	H2O UL SOLENOID JG D8-PIPE HOLDER		KEL1426A	WATER SOLENOID VALVE KIT JG D8	<table border="1"> <thead> <tr> <th>Code</th> <th>Description</th> <th>Qty</th> <th>UOM</th> </tr> </thead> <tbody> <tr> <td>EL1426A0</td> <td>H2O UL SOLENOID JG D8-PIPE HOLDER</td> <td>1</td> <td>PZ</td> </tr> </tbody> </table>	Code	Description	Qty	UOM	EL1426A0	H2O UL SOLENOID JG D8-PIPE HOLDER	1	PZ																
Code	Description	Qty	UOM																										
EL1426A0	H2O UL SOLENOID JG D8-PIPE HOLDER	1	PZ																										
EL1020A	D8 INTERMEDIATE T-SHAPED FITTING		KEL1020A	Ø8 T-SHAPED FITTING 10 PCS. KIT	<table border="1"> <thead> <tr> <th>Code</th> <th>Description</th> <th>Qty</th> <th>UOM</th> </tr> </thead> <tbody> <tr> <td>EL1020A0</td> <td>Ø8 INTERMEDIAT E "T" CONN. (NEW #PM0208E)</td> <td>10</td> <td>PZ</td> </tr> <tr> <td>EL1020A1</td> <td>D8 INTERMEDIAT E T-SHAPED FITTING</td> <td>10</td> <td>PZ</td> </tr> </tbody> </table>	Code	Description	Qty	UOM	EL1020A0	Ø8 INTERMEDIAT E "T" CONN. (NEW #PM0208E)	10	PZ	EL1020A1	D8 INTERMEDIAT E T-SHAPED FITTING	10	PZ												
Code	Description	Qty	UOM																										
EL1020A0	Ø8 INTERMEDIAT E "T" CONN. (NEW #PM0208E)	10	PZ																										
EL1020A1	D8 INTERMEDIAT E T-SHAPED FITTING	10	PZ																										
VM1505A	WALL PASSING WITH DIAPHRAGM		KVM1505A	THROUGH-WALL CONNECTION+DIAPHRAGM KIT	<table border="1"> <thead> <tr> <th>Code</th> <th>Description</th> <th>Qty</th> <th>UOM</th> </tr> </thead> <tbody> <tr> <td>VI1220A1</td> <td>4,2X12 TCB SELF-TAPPIN G SCREW</td> <td>1</td> <td>PZ</td> </tr> <tr> <td>VM1505A0</td> <td>WALL PASSING WITH DIAPHRAGM</td> <td>3</td> <td>PZ</td> </tr> <tr> <td>VM2055A0</td> <td>UPPER THROUGH-WA LL CONNECTION</td> <td>1</td> <td>PZ</td> </tr> <tr> <td>VM2056A0</td> <td>LOWER THROUGH-WA LL CONNECTION</td> <td>1</td> <td>PZ</td> </tr> <tr> <td>VM2061A0</td> <td>ACCESSORIES CABLES WALL PASSING</td> <td>1</td> <td>PZ</td> </tr> </tbody> </table>	Code	Description	Qty	UOM	VI1220A1	4,2X12 TCB SELF-TAPPIN G SCREW	1	PZ	VM1505A0	WALL PASSING WITH DIAPHRAGM	3	PZ	VM2055A0	UPPER THROUGH-WA LL CONNECTION	1	PZ	VM2056A0	LOWER THROUGH-WA LL CONNECTION	1	PZ	VM2061A0	ACCESSORIES CABLES WALL PASSING	1	PZ
Code	Description	Qty	UOM																										
VI1220A1	4,2X12 TCB SELF-TAPPIN G SCREW	1	PZ																										
VM1505A0	WALL PASSING WITH DIAPHRAGM	3	PZ																										
VM2055A0	UPPER THROUGH-WA LL CONNECTION	1	PZ																										
VM2056A0	LOWER THROUGH-WA LL CONNECTION	1	PZ																										
VM2061A0	ACCESSORIES CABLES WALL PASSING	1	PZ																										
PE1969A	BAKERTOP PROVER POWER CARD		KPE1969A	BT PROOFER POWER BOARD KIT	<table border="1"> <thead> <tr> <th>Code</th> <th>Description</th> <th>Qty</th> <th>UOM</th> </tr> </thead> <tbody> <tr> <td>PE1969A0</td> <td>BAKERTOP PROVER POWER CARD</td> <td>1</td> <td>PZ</td> </tr> <tr> <td>VI1850A0</td> <td>M4X6 NICKEL PLATED FIXING SCRE</td> <td>5</td> <td>PZ</td> </tr> <tr> <td>VM1745A0</td> <td>CARD SUPPORT</td> <td>4</td> <td>PZ</td> </tr> <tr> <td>VM2147A0</td> <td>ESD SPONGE PINK SMOOTH 410X343X15 M</td> <td>1</td> <td>PZ</td> </tr> </tbody> </table>	Code	Description	Qty	UOM	PE1969A0	BAKERTOP PROVER POWER CARD	1	PZ	VI1850A0	M4X6 NICKEL PLATED FIXING SCRE	5	PZ	VM1745A0	CARD SUPPORT	4	PZ	VM2147A0	ESD SPONGE PINK SMOOTH 410X343X15 M	1	PZ				
Code	Description	Qty	UOM																										
PE1969A0	BAKERTOP PROVER POWER CARD	1	PZ																										
VI1850A0	M4X6 NICKEL PLATED FIXING SCRE	5	PZ																										
VM1745A0	CARD SUPPORT	4	PZ																										
VM2147A0	ESD SPONGE PINK SMOOTH 410X343X15 M	1	PZ																										







Зип Общепит

ASM3046B/0.D00 General overview

vsezip.ru

+7(812)987-08-81

COMPONENT			SPARE PART																										
Code	Description	Image	Code	Description	Components list																								
EL1426A	H2O UL SOLENOID JG D8-PIPE HOLDER		KEL1426A	WATER SOLENOID VALVE KIT JG D8	<table border="1"> <thead> <tr> <th>Code</th> <th>Description</th> <th>Qty</th> <th>UOM</th> </tr> </thead> <tbody> <tr> <td>EL1426A0</td> <td>H2O UL SOLENOID JG D8-PIPE HOLDER</td> <td>1</td> <td>PZ</td> </tr> </tbody> </table>	Code	Description	Qty	UOM	EL1426A0	H2O UL SOLENOID JG D8-PIPE HOLDER	1	PZ																
Code	Description	Qty	UOM																										
EL1426A0	H2O UL SOLENOID JG D8-PIPE HOLDER	1	PZ																										
VM2061A	ACCESSORIES CABLES WALL PASSING		KVM1505A	THROUGH-WALL CONNECTION+DIAPHRAGM KIT	<table border="1"> <thead> <tr> <th>Code</th> <th>Description</th> <th>Qty</th> <th>UOM</th> </tr> </thead> <tbody> <tr> <td>V11220A1</td> <td>4,2X12 TCB SELF-TAPPIN G SCREW</td> <td>1</td> <td>PZ</td> </tr> <tr> <td>VM1505A0</td> <td>WALL PASSING WITH DIAPHRAGM</td> <td>3</td> <td>PZ</td> </tr> <tr> <td>VM2055A0</td> <td>UPPER THROUGH-WA LL CONNECTION</td> <td>1</td> <td>PZ</td> </tr> <tr> <td>VM2056A0</td> <td>LOWER THROUGH-WA LL CONNECTION</td> <td>1</td> <td>PZ</td> </tr> <tr> <td>VM2061A0</td> <td>ACCESSORIES CABLES WALL PASSING</td> <td>1</td> <td>PZ</td> </tr> </tbody> </table>	Code	Description	Qty	UOM	V11220A1	4,2X12 TCB SELF-TAPPIN G SCREW	1	PZ	VM1505A0	WALL PASSING WITH DIAPHRAGM	3	PZ	VM2055A0	UPPER THROUGH-WA LL CONNECTION	1	PZ	VM2056A0	LOWER THROUGH-WA LL CONNECTION	1	PZ	VM2061A0	ACCESSORIES CABLES WALL PASSING	1	PZ
Code	Description	Qty	UOM																										
V11220A1	4,2X12 TCB SELF-TAPPIN G SCREW	1	PZ																										
VM1505A0	WALL PASSING WITH DIAPHRAGM	3	PZ																										
VM2055A0	UPPER THROUGH-WA LL CONNECTION	1	PZ																										
VM2056A0	LOWER THROUGH-WA LL CONNECTION	1	PZ																										
VM2061A0	ACCESSORIES CABLES WALL PASSING	1	PZ																										
0H7326B	EUROPEAN ELECT 8TRAY PROOFER COMP HOLDER		0H7326B0	EUROPEAN ELECT 8TRAY PROOFER COMP HOLDER																									
GN0032A			GN0032A0																										



Зип Общепит

ASM3046B/0.D00 General overview

vsezip.ru

+7(812)987-08-81

COMPONENT			SPARE PART		
<i>Code</i>	<i>Description</i>	<i>Image</i>	<i>Code</i>	<i>Description</i>	<i>Components list</i>
TB3250A	PROOFER CONNECTING WHITE-BLACK EPDM PIPE		TB3250A0	PROOFER CONNECTING WHITE-BLACK EPDM PIPE	