



# ***SPARE PARTS CATALOGUE 1/2019***

## ***THERMAL EQUIPMENT KOGAST 700 & 900***

COMMON PARTS AND ACCESORIES

HOBS

OVENS

GRIDDLE PLATES

FRYERS

BAINS-MARIE

PASTA COOKERS

BOILING PANS

COOKING PANS

*KOGAST GROSUPLJE d.d.*

*Adamičeva cesta 36*

*SI-1290 Grosuplje*

*Phone: ++386 (0)1/78-66-300; Fax: ++386 (0)1/78-66-320*

*e-mail: sales@kogast.si; www.kogast.si*

**Зип Общепит**

**vsezip.ru**

**+7(812)987-08-81**

Зип Общепит



*Pictures and photos are informative. Specifications are subject to change due to technical improvements.*

1. Spare parts catalogue is valid from October 1<sup>st</sup>, 2019.
2. Our spare parts are tested on safe and reliable operating and certified according to EN or IEC norms:



**General conditions of sale**

**Зип Общепит**

**vsezip.ru**

**+7(812)987-08-81**

**THERMAL EQUIPMENT KOGAST 700 and 900  
COMMON PARTS AND ACCESSORIES**



Всёобщепит

vsezip.ru

+7(812)987-08-81

Code	Type	Drawing
------	------	---------

Spare parts	Code No.	Description	Ref.	Remark
-------------	----------	-------------	------	--------



52240 WRENCH FOR KNOB BED REMOVAL

55963 KEY FOR DRAIN VALVE 2"



65530 SPANNER FOR ADJUSTABLE LEGS  
for old and new legs

since 26th of  
November 2018



**ARCHIVE OF CHANGES**

52408 SPANNER FOR ADJUSTABLE LEGS

26th of November  
2018 replaced with  
code 65530



Accessories for electric and gas appliances

# THERMAL EQUIPMENT KOGAST 700 and 900 COMMON PARTS AND ACCESSORIES



Common spare parts for electric and gas appliances

Всёобщепит

vsezip.ru

+7(812)987-08-81

Spare parts	Code No.	Description	Ref.	Remark
	76568	<b>CONTROL LIGHT, RED</b> WITH GASKET AND NUT		since 6th of June 2017
	76569	<b>CONTROL LIGHT, GREEN</b> WITH GASKET AND NUT		since 6th of June 2017
	76573	<b>CONTROL LIGHT, ORANGE</b> WITH GASKET AND NUT		since 6th of June 2017
	83353	<b>BUTTON FOR EL. SWITCH</b> colour: dark blue		
	47582	<b>SPRING FOR ELECTRIC BUTTON</b> dim.: 15x7 mm		
	83330	<b>KNOB BED</b> for electric appliances		
	83332	<b>KNOB BED</b> for gas appliances		
	83329	<b>POSITION MARK FOR KNOB</b>		



**THERMAL EQUIPMENT KOGAST 700 and 900  
COMMON PARTS AND ACCESSORIES**



Всёобщепит

vsezip.ru

+7(812)987-08-81

Spare parts	Code No.	Description	Ref.	Remark
	83333	BLUE COVER FOR JOINT BETWEEN APPLIANCES - DOUBLE		
	83334	BLUE COVER FOR JOINT BETWEEN APPLIANCES - SINGLE		
	55978	ADJUSTABLE LEG WITH FLANGE dim.: 70x70x100-160/T mm		

**ARCHIVE OF CHANGES**

	76575	CONTROL LIGHT voltage: 250V		discontinued on 6th of June 2017
	76577	LENS FOR CONTROL LIGHT colour: yellow		6th of June 2017 replaced with code 76573
	76578	LENS FOR CONTROL LIGHT colour: green		6th of June 2017 replaced with code 76569

Common spare parts for electric and gas appliances

# THERMAL EQUIPMENT KOGAST 700 and 900 HOBS



Зип Общепит

vsezip.ru

+7(812)987-08-81

Code	Type	Drawing
------	------	---------

- 55822 ES-T27/P
- 55824 ES-T47/P
- 55833 ES-T67/P
- 56482 ES-T49/P
- 55889 ES-T69/P
- 55827 ES-T47/1
- 55830 ES-T47/1K
- 55834 ES-T67/1-O
- 55835 ES-T67/1K-0
- 56483 ES-T49/1
- 56484 ES-T49/1K
- 55890 ES-T69/1-0
- 56485 ES-T69/1K-0

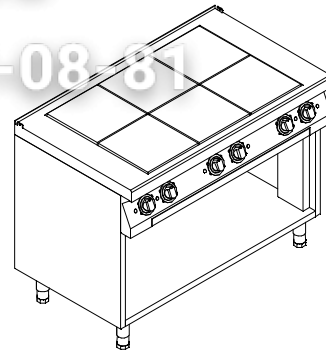

Spare parts	Code No.	Description	Ref.	Remark
-------------	----------	-------------	------	--------

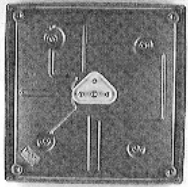

**72385**     **HOT PLATE WITH PROTECTOR**  
 power: 2500W  
 voltage: 230V  
 dim.: 300x300 mm

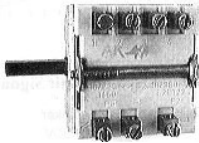

**73449**     **SWITCH**  
 el. load: 16A/250V-10A/380V  
 poles: 4



**46200**     **SCALE PLATE FOR KNOB**

Electric hobs ES



# THERMAL EQUIPMENT KOGAST 700 and 900 HOBS



Зип Общепит

vsezip.ru

+7(812)987-0811

Code	Type	Drawing
------	------	---------

- 55823 ESK-T27/P
- 55825 ESK-T47/P
- 55881 ESK-T29/P
- 55882 ESK-T49/P
- 55828 ESK-T47/1
- 55831 ESK-T47/1K
- 55884 ESK-T49/1
- 55886 ESK-T49/1K
- 55887 ESK-T69/1-O
- 55842 KS-T(2+2)7/P
- 55843 KS-T(2+2)7/1
- 55844 KS-T(2+2)7/1K
- 55902 KS-T(2+2)9/1
- 55901 KS-T(2+2)9/P
- 55903 KS-T(2+2)9/1K

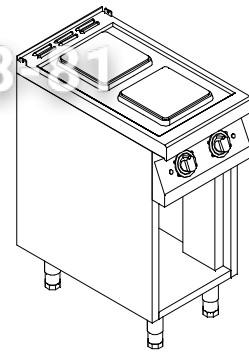

Spare parts	Code No.	Description	Ref.	Remark
-------------	----------	-------------	------	--------



**72400 SEALED HOT PLATE WITH PROTECTOR**  
power: 2 kW  
voltage: 230V  
dim.: 220x220 mm

- ESK-T27/P
- ESK-T47/P
- ESK-T47/1
- ESK-T47/1K
- KS-T(2+2)7/P
- KS-T(2+2)7/1
- KS-T(2+2)7/1K



**72395 SEALED HOT PLATE WITH PROTECTOR**  
power: 2500W  
dim.: 300x300 mm

- ESK-T29/P
- ESK-T49/P
- ESK-T49/1
- ESK-T49/1K
- KS-T(2+2)9/1
- KS-T(2+2)9/P
- KS-T(2+2)9/1K



**72380 SEALED HOT PLATE WITH PROTECTOR**  
power: 4000W  
dim.: 300x300 mm

- ESK-T29/P
- ESK-T49/P
- ESK-T49/1
- ESK-T49/1K
- ESK-T69/1-O

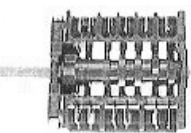

**73448 SWITCH**  
el. load: 250V/16A-400V/10A  
positions: 7

- ESK-T27/P
- ESK-T47/P
- ESK-T47/1
- ESK-T47/1K
- KS-T(2+2)7/P
- KS-T(2+2)7/1
- KS-T(2+2)7/1K

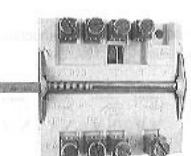

**73447 SWITCH**  
el. load: 250V/32A-400V

- ESK-T29/P
- ESK-T49/P
- ESK-T49/1
- ESK-T49/1K
- ESK-T69/1-O
- KS-T(2+2)9/1
- KS-T(2+2)9/P
- KS-T(2+2)9/1K

Electric hobs ESK-

**THERMAL EQUIPMENT KOGAST 700 and 900  
HOBS**



Зип Общепит

vsezip.ru

+7(812)987-08-81

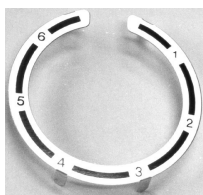
Spare parts	Code No.	Description	Ref.	Remark
	46204	SCALE PLATE FOR SWITCH KNOB		

Electric hobs ESK-

# THERMAL EQUIPMENT KOGAST 700 and 900 HOBS



Зип Общепит

vsezip.ru

+7(812)987-08-81

Code	Type	Drawing
------	------	---------

- 55826 ESC-T47/P
- 55829 ESC-T47/1
- 55832 ESC-T47/1K
- 55883 ESC-T49/P
- 55885 ESC-T49/1
- 55888 ESC-T49/1K

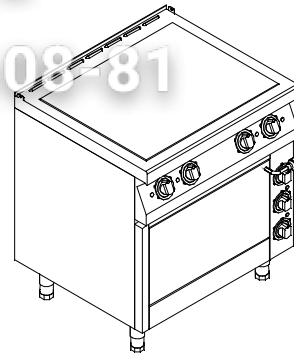

Spare parts	Code No.	Description	Ref.	Remark
-------------	----------	-------------	------	--------

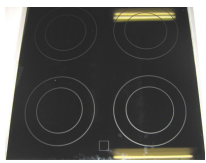

**83554 GLASS**  
with frame and fixing supports  
dim. of glass: 700x560 mm

ESC-T47/P  
ESC-T47/1  
ESC-T47/1K

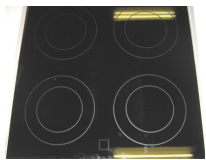

**83551 GLASS**  
with frame and fixing supports  
dim. of glass: 720x720 mm

ESC-T49/P  
ESC-T49/1  
ESC-T49/1K



**83549 HEATING ZONE - DOUBLE**  
power: 2,5 kW  
volatge: 230V

ESC-T47/P  
ESC-T47/1  
ESC-T47/1K



**83544 HEATING ZONE**  
power: 3400W

ESC-T49/P  
ESC-T49/1  
ESC-T49/1K

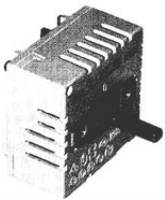

**73625 ENERGY REGULATOR**  
el. load: 240V-13A/400V-7A

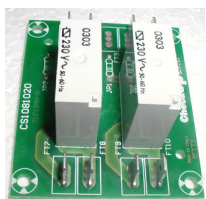

**73383 PCB WITH RELAYS**

ESC-T49/P  
ESC-T49/1  
ESC-T49/1K

Glass ceran hobs

**THERMAL EQUIPMENT KOGAST 700 and 900  
HOBS**



Зип Общепит

vsezip.ru

+7(812)987-08-81

Spare parts	Code No.	Description	Ref.	Remark
	46214	SCALE LABEL FOR BUTTON		

**Glass ceran hobs**

# THERMAL EQUIPMENT KOGAST 700 and 900 HOBS



Зип Общепит

vsezip.ru

+7(812)987-08-81

Code	Type	Drawing
------	------	---------

50966 ESI-T27/PB  
50967 ESI-T47/PB  
50968 ESI-T29/PB  
50969 ESI-T49/PB

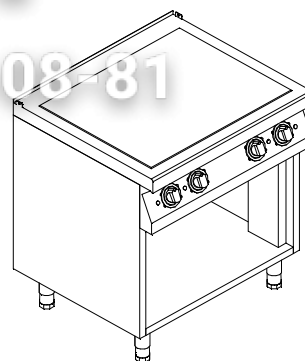

Spare parts	Code No.	Description	Ref.	Remark
-------------	----------	-------------	------	--------



77045 INDUCTION GENERATOR BERNER



77026 POTENTIOMETER FOR INDUCTION  
PLATES BERNER

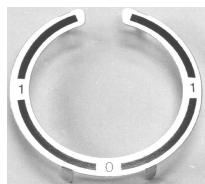

46201 SCALE LABEL FOR MAIN SWITCH BUTTON



46481 SCALE PLATE

Induction hobs

# THERMAL EQUIPMENT KOGAST 700 and 900 HOBS



Зип Общепит

vsezip.ru

+7(812)987-08449

Code	Type	Drawing
------	------	---------

- 55836 PS-T27/P
- 55750 PS-T47/P
- 55838 PS-T67/P
- 55837 PS-T47/1
- 55839 PS-T67/1-0
- 55840 KS-T47/1
- 55841 KS-T47/1K
- 55842 KS-T(2+2)7/P
- 55843 KS-T(2+2)7/1
- 55844 KS-T(2+2)7/1K
- 55845 KS-T67/1-0
- 55846 KS-T67/1K-0
- 55891 PS-T29/P
- 55892 PS-T49/P
- 52139 PS-T49/PM
- 55893 PS-T69/P
- 52141 PS-T69/PM
- 55894 PS-T49/1
- 52140 PS-T49/1M
- 55895 PS-T69/1-O
- 52142 PS-T69/1-OM
- 55896 PS-T69/1A
- 52361 PS-T69/1AM
- 55898 PS-T2+1/1-0
- 55902 KS-T(2+2)9/1
- 55900 KS-T49/1
- 55899 KS-T49/1K
- 55901 KS-T(2+2)9/P
- 55903 KS-T(2+2)9/1K
- 52135 KS-T49/1M
- 52137 KS-T49/1KM
- 55904 KS-T69/1-0
- 52136 KS-T69/1-OM
- 55905 KS-T69/1K-0
- 52138 KS-T69/1K-OM

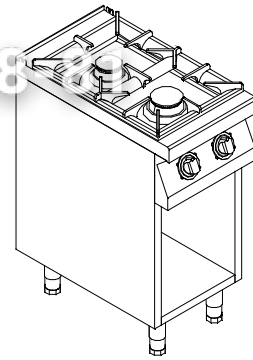

Open gas burners

Spare parts	Code No.	Description	Ref.	Remark
-------------	----------	-------------	------	--------



42142 **GAS VALVE 21 S/B**  
thread for thermocouple: M9x1



20030 **BURNER COVER 3,5 kW**  
dim.: fi80 mm

# THERMAL EQUIPMENT KOGAST 700 and 900 HOBS



Зип Общепит

vsezip.ru

+7(812)987-08-81

Spare parts	Code No.	Description	Ref.	Remark
	20031	<b>BURNER COVER 5,5 kW</b> dim.: fi100 mm		
	40847	<b>BURNER COVER 7 kW</b> dim.: fi128 mm		
	13247	<b>COVER SUPPORT 3,5 kW</b> dim.: fi80 mm		
	16337	<b>COVER SUPPORT 5,5 kW</b> dim.: fi100 mm		
	40848	<b>COVER SUPPORT 7 kW</b> dim.: fi152 mm		
	52685	<b>VENTURI TUBE 3,5 kW</b>		
	52686	<b>VENTURI TUBE 5,5 kW</b> dim.: fi100 mm		
	40849	<b>VENTURI TUBE 7 kW</b>		

Open gas burners

# THERMAL EQUIPMENT KOGAST 700 and 900 HOBS



Зип Общепит

vsezip.ru

+7(812)987-08-81

Spare parts	Code No.	Description	Ref.	Remark
	50374	PRIMARY AIR REGULATOR FOR BURNER 3,5 kW		
	50375	PRIMARY AIR REGULATOR FOR BURNER 5,5 kW		
	40850	PRIMARY AIR REGULATOR FOR BURNER 7 kW		
	13233	PILOT FLAME BURNER		
	46239	PILOT FLAME BURNER		for 7 kW burner
	47030	THERMOELEMENT L= 600 mm thread: M9x1		for burners 3,5 kW and 5,5, kW
	47031	THERMOELEMENT L= 850 mm thread: M9x1		for burners 3,5 kW and 5,5, kW
	47033	THERMOELEMENT L= 600 mm without thread		for burner 7,0 kW

Open gas burners



# THERMAL EQUIPMENT KOGAST 700 and 900 HOBS



Зип Общепит

vsezip.ru

+7(812)987-08-81

Spare parts	Code No.	Description	Ref.	Remark
	47032	<b>THERMOELEMENT</b> L= 1200 mm without thread		for burner 7,0 kW
	52166	<b>CAST IRON BURNER GRID</b> dim.: 390x576x48 mm	PS-T27/P PS-T47/P PS-T67/P PS-T47/1 PS-T67/1-0 KS-T47/1 KS-T47/1K KS-T(2+2)7/P KS-T(2+2)7/1 KS-T(2+2)7/1K KS-T67/1-0 KS-T67/1K-0	
	52167	<b>CAST IRON BURNER GRID</b> dim.: 395x388x48 mm	PS-T29/P PS-T49/P PS-T49/PM PS-T69/P PS-T69/PM PS-T49/1 PS-T49/1M PS-T69/1-0 PS-T69/1-OM PS-T69/1A PS-T69/1AM PS-T2+1/1-0 KS-T(2+2)9/1 KS-T49/1 KS-T49/1K KS-T(2+2)9/P KS-T(2+2)9/1K KS-T49/1M KS-T49/1KM KS-T69/1-0 KS-T69/1-OM KS-T69/1K-0 KS-T69/1K-OM	
	83354	<b>BUTTON FOR GAS VALVE</b> colour: dark blue		
	46203	<b>SCALE LABEL FOR BUTTON</b>		
	20034	<b>INJECTOR 90</b> thread: M1 1x1 G30/G31 - burner: 3,5 kW		for burner 3,5 kW; G30/G31, 30 mbar (LPG)

Open gas burners





# THERMAL EQUIPMENT KOGAST 700 and 900 HOBS



Зип Общепит

vsezip.ru

+7(812)987-08-81

Spare parts	Code No.	Description	Ref.	Remark
	20044	<b>INJECTOR 120</b> thread: M1 1x1		f or burner 5,5 kW; G30/G31, 30 mbar (LPG)
	20039	<b>INJECTOR 130 - G30/31</b> thread: M1 1x1		f or burner 7,0 kW; G30/G31, 30 mbar (LPG)
	25416	<b>INJECTOR 135</b> thread: M1 1x1 G20 - burner: 3,5 kW		f or burner 3,5 kW; G20, 20 mbar (natural gas)
	24961	<b>INJECTOR 170</b> thread: M1 1x1		f or burner 5,5 kW; G20, 20 mbar (natural gas)
	37921	<b>INJECTOR 195</b> thread: M1 1x1		f or burner 7,0 kW; G20, 20 mbar (natural gas)

Open gas burners

# THERMAL EQUIPMENT KOGAST 700 and 900 HOBS



Зип Общепит

vsezip.ru

+7(812)987-08-81

Code	Type	Drawing
------	------	---------

55897 PS-T1/1  
55898 PS-T2+1/1-0

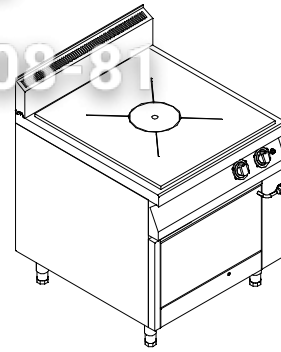

Spare parts	Code No.	Description	Ref.	Remark
-------------	----------	-------------	------	--------



42140 **GAS VALVE 22S/O-B**  
thread for thermocouple: M9x1

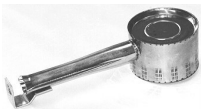

44410 **BURNER**  
power: 12kW



46328 **PIEZO IGNITER**



44820 **PILOT FLAME SPARK PLUG**



47477 **CABLE FOR PIEZO SPARKING DEVICE**  
L= 1000 mm



53086 **PIEZO IGNITER PROTECTION**

Closed gas burners (burner below plate)

**THERMAL EQUIPMENT KOGAST 700 and 900  
HOBS**



Зип Общепит

vsezip.ru

+7(812)987-08-81

Closed gas burners (burner below plate)

Spare parts	Code No.	Description	Ref.	Remark
	46241	PILOT FLAME BURNER		
	47033	THERMOELEMENT L= 600 mm without thread		
	83355	BUTTON FOR GAS VALVE colour: dark blue		
	46203	SCALE LABEL FOR BUTTON		
	20050	INJECTOR 250 thread: M1 1 x1		G20, 20 mbar (natural gas)
	24961	INJECTOR 170 thread: M1 1 x1		G30/G31, 30 mbar (LPG)

# THERMAL EQUIPMENT KOGAST 700 and 900 OVENS



Зип Овщепит

vsezip.ru

+7(812)987-08-81

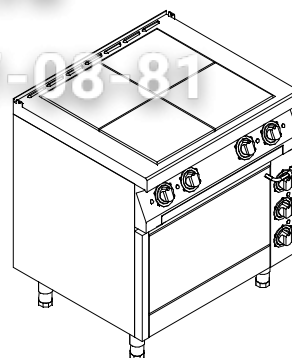

Code	Type	Drawing
55827	ES-T47/1	
55834	ES-T67/1-O	
55828	ESK-T47/1	
55829	ESC-T47/1	
55840	KS-T47/1	
55843	KS-T(2+2)7/1	
55845	KS-T67/1-0	
56483	ES-T49/1	
55884	ESK-T49/1	
55885	ESC-T49/1	
55890	ES-T69/1-0	
55887	ESK-T69/1-O	
55902	KS-T(2+2)9/1	
55900	KS-T49/1	
52135	KS-T49/1M	
55904	KS-T69/1-0	
52136	KS-T69/1-OM	
51997	KSP-T1	
55949	KSP-T2	
55950	KSP-T3	

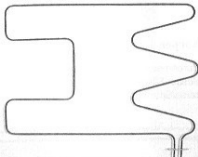
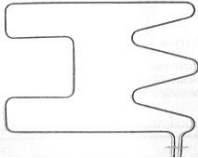
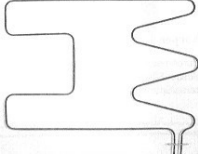
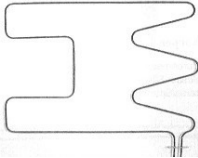
Spare parts	Code No.	Description	Ref.	Remark
	72263	<b>HEATING ELEMENT 700 - lower</b> power: 3000W dim.: 500x400 mm	ES-T47/1 ES-T67/1-O ESK-T47/1 ESC-T47/1 KS-T47/1 KS-T(2+2)7/1 KS-T67/1-0	
	72264	<b>HEATING ELEMENT 700 - upper</b> power: 1500W dim.: 500x400 mm	ES-T47/1 ES-T67/1-O ESK-T47/1 ESC-T47/1 KS-T47/1 KS-T(2+2)7/1 KS-T67/1-0	
	72151	<b>HEATING ELEMENT 900 - lower</b> power: 3400W dim.: 605x504 mm	ES-T49/1 ESK-T49/1 ESC-T49/1 ES-T69/1-0 ESK-T69/1-O KS-T(2+2)9/1 KS-T49/1 KS-T49/1M KS-T69/1-0 KS-T69/1-OM	
	72150	<b>HEATING ELEMENT 900 - upper</b> power: 2500W dim.: 605x504 mm	ES-T49/1 ESK-T49/1 ESC-T49/1 ES-T69/1-0 ESK-T69/1-O KS-T(2+2)9/1 KS-T49/1 KS-T49/1M KS-T69/1-0 KS-T69/1-OM	

Electric classic ovens

# THERMAL EQUIPMENT KOGAST 700 and 900 OVENS



Зип Общепит

vsezip.ru

87(812)987-08-81

Spare parts	Code No.	Description	Ref.	Remark
	72487	<b>THERMOSTAT</b> operating temp.: 50-290°C el. load: 16 (2,5)A/380V pole: 1; capillary: L=830 mm		
	72583	<b>SAFETY-THERMOSTAT</b> operating temp.: 368°C el. load: 20 (4)A/380 V poles: 3; capillary: L= 1490 mm		
	73440	<b>MAIN SWITCH ON-OFF</b> el. load: 16A/250V-10A/380V poles: 4		
	83716	<b>HANDLE M10</b> oven door		
	46201	<b>SCALE LABEL FOR MAIN SWITCH BUTTON</b>		
	46205	<b>SCALE LABEL FOR BUTTON</b>		
	47069	<b>OVEN DOOR HINGE - LEFT</b>		
	47068	<b>OVEN DOOR HINGE - RIGHT</b>		

Electric classic ovens

**THERMAL EQUIPMENT KOGAST 700 and 900  
OVENS**



Зип Общепит

vsezip.ru

+7(812)987-08-81

Spare parts	Code No.	Description	Ref.	Remark
-------------	----------	-------------	------	--------

47064 HINGE SUPPORT



**Electric classic ovens**

# THERMAL EQUIPMENT KOGAST 700 and 900 OVENS



Зип Общепит

vsezip.ru

+7(812)987-08-81

Code	Type	Drawing
55830	ES-T47/1K	
55835	ES-T67/1K-0	
55831	ESK-T47/1K	
55832	ESC-T47/1K	
55841	KS-T47/1K	
55844	KS-T(2+2)7/1K	
55846	KS-T67/1K-0	
56484	ES-T49/1K	
55888	ESC-T49/1K	
55886	ESK-T49/1K	
56485	ES-T69/1K-0	
55899	KS-T49/1K	
55903	KS-T(2+2)9/1K	
52137	KS-T49/1KM	
55905	KS-T69/1K-0	
52138	KS-T69/1K-OM	
52673	KSP-T1K	
52437	KSP-T2K	
52438	KSP-T3K	

Spare parts	Code No.	Description	Ref.	Remark
	72082	<b>HEATING ELEMENT - rare</b> power: 2200W dim.: 249,5x198 mm	ES-T47/1K ES-T67/1K-0 ESK-T47/1K ESC-T47/1K KS-T47/1K KS-T(2+2)7/1K KS-T67/1K-0 ES-T49/1K ESC-T49/1K ESK-T49/1K ES-T69/1K-0 KS-T49/1K KS-T(2+2)9/1K KS-T49/1KM KS-T69/1K-0 KS-T69/1K-OM	
	72263	<b>HEATING ELEMENT 700 - lower</b> power: 3000W dim.: 500x400 mm	ES-T47/1K ES-T67/1K-0 ESK-T47/1K ESC-T47/1K KS-T47/1K KS-T(2+2)7/1K KS-T67/1K-0	
	72264	<b>HEATING ELEMENT 700 - upper</b> power: 1500W dim.: 500x400 mm	ES-T47/1K ES-T67/1K-0 ESK-T47/1K ESC-T47/1K KS-T47/1K KS-T(2+2)7/1K KS-T67/1K-0	

Electric convection ovens





# THERMAL EQUIPMENT KOGAST 700 and 900 OVENS



Зип Общепит

vsezip.ru

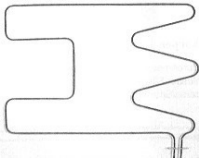
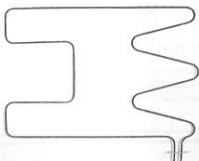
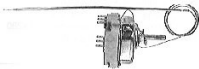
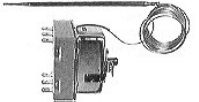
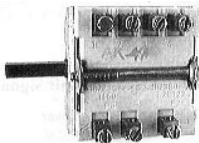
+7(812)987-08-81

Spare parts	Code No.	Description	Ref.	Remark
	72151	<b>HEATING ELEMENT 900 - lower</b> power: 3400W dim.: 605x504 mm	ES-T49/1K ESC-T49/1K ECC-T49/1K FSC-T49/1K ESK-T49/1K ES-T69/1K-0 KS-T49/1K KS-T49/1K KS-T(2+2)9/1K KS-T49/1KM KS-T69/1K-0 KS-T69/1K-OM	
	72152	<b>HEATING ELEMENT 900 - upper</b> power: 1000W dim.: 605x504 mm	ES-T49/1K ESC-T49/1K ESK-T49/1K ES-T69/1K-0 KS-T49/1K KS-T(2+2)9/1K KS-T49/1KM KS-T69/1K-0 KS-T69/1K-OM	
	72519	<b>THERMOSTAT</b> operating temp.: 50-300°C el. load: 16 (4)A/380V poles: 3; capillary: 1590 mm		
	72583	<b>SAFETY-THERMOSTAT</b> operating temp.: 368°C el. load: 20 (4)A/380 V poles: 3; capillary: L= 1490 mm		
	73449	<b>SWITCH</b> el. load: 16A/250V-10A/380V poles: 4		
	73112	<b>CONTACTOR DIL M7-10</b> voltage: 230V AC		
	54893	<b>MOTOR WITH FAN</b>		since January 2012

Electric convection ovens

# THERMAL EQUIPMENT KOGAST 700 and 900 OVENS



Зип Общепит

vsezip.ru

+7(812)987-08-81

Spare parts	Code No.	Description	Ref.	Remark
-------------	----------	-------------	------	--------



83716 HANDLE M10 oven door

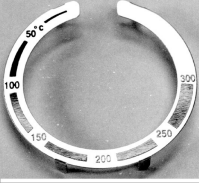

46205 SCALE LABEL FOR BUTTON

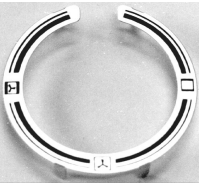

46202 SCALE PLATE FOR SELECTION KNOB



47069 OVEN DOOR HINGE - LEFT



47068 OVEN DOOR HINGE - RIGHT



47064 HINGE SUPPORT

## ARCHIVE OF CHANGES



36990 MOTOR WITH FAN

replaced with motor with fan 54893 since January 2012

Electric convection ovens

# THERMAL EQUIPMENT KOGAST 700 and 900 OVENS



Зип Общепит

vsezip.ru

+7(812)987-08289

Code	Type	Drawing
------	------	---------

- 55837 PS-T47/1
- 55839 PS-T67/1-0
- 55894 PS-T49/1
- 55895 PS-T69/1-O
- 52140 PS-T49/1M
- 52142 PS-T69/1-OM
- 52361 PS-T69/1AM
- 55896 PS-T69/1A
- 55897 PS-T1/1
- 55898 PS-T2+1/1-0
- 52810 PS-T67/1-OM

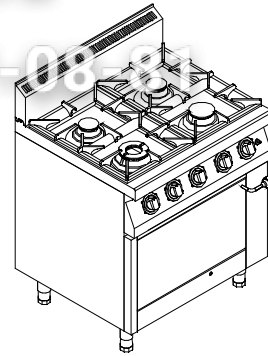



Spare parts	Code No.	Description	Ref.	Remark
-------------	----------	-------------	------	--------

	44431	<b>BURNER</b> power: 6,5kW	PS-T47/1 PS-T67/1-0 PS-T67/1-OM	
---	-------	-------------------------------	---------------------------------------	--

	53660	<b>BURNER</b> power: 9 kW	PS-T49/1 PS-T69/1-O PS-T49/1M PS-T69/1-OM PS-T1/1 PS-T2+1/1-0	44431 until September 2014: 53660 since September 2014
--	-------	------------------------------	--	---

	44404	<b>BURNER</b> power: 10kW	PS-T69/1AM PS-T69/1A	
---	-------	------------------------------	-------------------------	--

	46328	<b>PIEZO IGNITER</b>		
---	-------	----------------------	--	--

	44820	<b>PILOT FLAME SPARK PLUG</b>		
---	-------	-------------------------------	--	--

	47477	<b>CABLE FOR PIEZO SPARKING DEVICE</b> L= 1000 mm		
---	-------	--	--	--

Gas ovens







# THERMAL EQUIPMENT KOGAST 700 and 900 OVENS

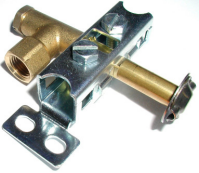

Зип Общепит

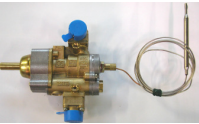
vsezip.ru

+7(812)987-08-81

Spare parts	Code No.	Description	Ref.	Remark
	53086	PIEZO IGNITER PROTECTION		
	46241	PILOT FLAME BURNER		
	47032	THERMOELEMENT L= 1200 mm without thread		
	42122	<b>GAS VALVE - SET</b> 42104 gas valve - SET 42105 gas valve screw 42016 ring for gas valve 42107 nut for gas valve 42108 ring for gas valve		
	42104	<b>GAS VALVE 24STS</b>		
	42105	<b>GAS VALVE SCREW FOR PILOT FLAME BURNER</b> dim.: fi 6 mm		
	42106	<b>RING FOR GAS VALVE</b> dim.: fi 6 mm		
	42107	<b>NUT FOR GAS VALVE</b> M20x1,5 / fi 12 mm		

Gas ovens

# THERMAL EQUIPMENT KOGAST 700 and 900 OVENS



Зип Общепит

vsezip.ru

+7(812)987-08-81

Spare parts	Code No.	Description	Ref.	Remark
	42108	<b>RING FOR GAS VALVE</b> dim.: fi 12 mm		
	83716	<b>HANDLE M10</b> oven door		
	83355	<b>BUTTON FOR GAS VALVE</b> colour: dark blue		
	46218	<b>SCALE LABEL FOR BUTTON</b> PL 1-8		
	25416	<b>INJECTOR 135</b> thread: M1 1x1 G20 - burner: 3,5 kW	PS-T47/1 PS-T67/1-0	G20; 20 mbar (natural gas)
	20041	<b>INJECTOR 180 - G20</b> thread: M1 1x1	PS-T47/1 PS-T67/1-0	G20; 20 mbar (natural gas)
	20046	<b>INJECTOR 150</b> thread: M1 1x1	PS-T49/1 PS-T69/1-O PS-T49/1M PS-T69/1-OM	G30/G31; 30 mbar (LPG)
	20042	<b>INJECTOR 210</b> thread: M1 1x1	PS-T49/1 PS-T69/1-O PS-T49/1M PS-T69/1-OM	G20; 20 mbar (natural gas)

Gas ovens

# THERMAL EQUIPMENT KOGAST 700 and 900 OVENS



Зип Общепит

vsezip.ru

87(812)987-08-81

Spare parts	Code No.	Description	Ref.	Remark
	25415	<b>INJECTOR 165</b> thread: M1 1x1 G20 - burner: 5,5 kW	PS-T69/1AM PS-T69/1A	G30/G31; 30 mbar (LPG)
	20047	<b>INJECTOR 230</b> thread: M1 1x1	PS-T69/1AM PS-T69/1A	G20; 20 mbar (natural gas)
	47069	<b>OVEN DOOR HINGE - LEFT</b>		
	47068	<b>OVEN DOOR HINGE - RIGHT</b>		
	47064	<b>HINGE SUPPORT</b>		

Gas ovens

# THERMAL EQUIPMENT KOGAST 700 and 900 GRIDDLE PLATES



Зип Общепит

vsezip.ru

+7(812)987-08-81

Code	Type	Drawing
------	------	---------

- 55848 EZ-T47/P-K
- 55849 EZ-T47/P-J
- 55847 EZ-T47/P-L
- 58169 EZ-T47/P-KR
- 55851 EZ-T87/P-K
- 55853 EZ-T87/P-KR
- 55852 EZ-T87/P-J
- 55850 EZ-T87/P-L
- 55908 EZ-T49/P-K
- 52130 EZ-T49/P-J
- 55906 EZ-T49/P-L
- 58171 EZ-T49/P-KR
- 55910 EZ-T89/P-K
- 55911 EZ-T89/P-KR
- 52131 EZ-T89/P-J
- 55909 EZ-T89/P-L

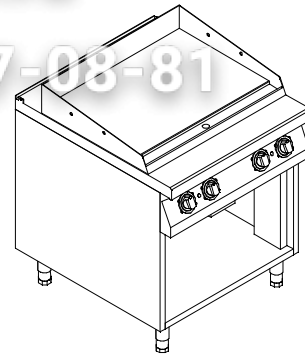

Spare parts	Code No.	Description	Ref.	Remark
-------------	----------	-------------	------	--------

	72062	<b>HEATING ELEMENT</b> power: 2 kW		
--	-------	---------------------------------------	--	--

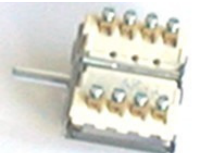
	73440	<b>MAIN SWITCH ON-OFF</b> el. load: 16A/250V-10A/380V poles: 4		
---	-------	--	--	--

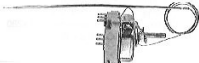
	72519	<b>THERMOSTAT</b> operating temp.: 50-300°C el. load: 16 (4)A/380V poles: 3; capillary: 1590 mm		
---	-------	--	--	--

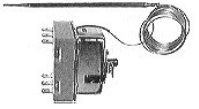
	72583	<b>SAFETY-THERMOSTAT</b> operating temp.: 368°C el. load: 20 (4)A/380 V poles: 3; capillary: L= 1490 mm		
---	-------	--	--	--

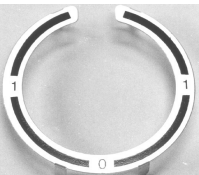
	46201	<b>SCALE LABEL FOR MAIN SWITCH BUTTON</b>		
---	-------	---	--	--

Electric griddle plates

**THERMAL EQUIPMENT KOGAST 700 and 900  
GRIDDLE PLATES**



Зип Общепит

vsezip.ru

+7(812)987-08-81

Spare parts	Code No.	Description	Ref.	Remark
	46205	SCALE LABEL FOR BUTTON		
	51763	<b>GRIDDLE PLATE</b> flat - cast iron plate cutting-out dim.: 395x610 mm useful dim.: 390x522 mm	EZ-T47/P-L EZ-T49/P-L	
	51779	<b>GRIDDLE PLATE</b> 1/2 flat + 1/2 ribbed - cast iron plate cutting-out dim.: 795x610 mm useful dim.: 790x522 mm	EZ-T87/P-L EZ-T89/P-L	

Electric griddle plates



# THERMAL EQUIPMENT KOGAST 700 and 900 GRIDDLE PLATES



Зип Общепит

vsezip.ru

+7(812)987-08-81

Code	Type	Drawing
55855	PZ-T47/P-K	
55856	PZ-T47/P-J	
55854	PZ-T47/P-L	
57240	PZ-T47/P-KR	
55858	PZ-T87/P-K	
55860	PZ-T87/P-KR	
55859	PZ-T87/P-J	
55857	PZ-T87/P-L	
55913	PZ-T49/P-K	
52132	PZ-T49/P-J	
55912	PZ-T49/P-L	
58172	PZ-T49/P-KR	
55915	PZ-T89/P-K	
55916	PZ-T89/P-KR	
52133	PZ-T89/P-J	
55914	PZ-T89/P-L	

Spare parts	Code No.	Description	Ref.	Remark
	44430	<b>BURNER</b> power: 6,5 kW	PZ-T47/P-K PZ-T47/P-J PZ-T47/P-L PZ-T47/P-KR PZ-T87/P-K PZ-T87/P-KR PZ-T87/P-J PZ-T87/P-L PZ-T49/P-L PZ-T89/P-L	
	44437	<b>BURNER</b> power: 9 kW	PZ-T49/P-K PZ-T89/P-K PZ-T89/P-KR PZ-T49/P-J PZ-T89/P-J PZ-T49/P-KR	since March 2013
	46328	<b>PIEZO IGNITER</b>		
	44820	<b>PILOT FLAME SPARK PLUG</b>		
	47474	<b>CABLE FOR PIEZO SPARKING DEVICE</b> L= 500 mm		

Gas griddle plates







# THERMAL EQUIPMENT KOGAST 700 and 900 GRIDDLE PLATES

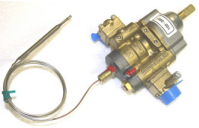

Зип Общепит

vsezip.ru

+7(812)987-08-81

Spare parts	Code No.	Description	Ref.	Remark
	53086	PIEZO IGNITER PROTECTION		
	46241	PILOT FLAME BURNER		
	42122	<b>GAS VALVE - SET</b> 42104 gas valve 24STS 42105 gas valve screw for pilot burner 42106 ring for gas valve 42107 nut for gas valve 42108 ring for gas valve		
	42104	<b>GAS VALVE 24STS</b>		
	42105	<b>GAS VALVE SCREW FOR PILOT FLAME BURNER</b> dim.: fi 6 mm		
	42106	<b>RING FOR GAS VALVE</b> dim.: fi 6 mm		
	42107	<b>NUT FOR GAS VALVE</b> M20x1,5 / fi 12 mm		
	42108	<b>RING FOR GAS VALVE</b> dim.: fi 12 mm		

Gas griddle plates

# THERMAL EQUIPMENT KOGAST 700 and 900 GRIDDLE PLATES



Зип Общепит

vsezip.ru

+7(812)987-08-81

Spare parts	Code No.	Description	Ref.	Remark
	47033	<b>THERMOELEMENT</b> L= 600 mm without thread		
	20039	<b>INJECTOR 130 - G30/31</b> thread: M1 1x1	PZ-T47/P-K PZ-T47/P-J PZ-T47/P-L PZ-T47/P-KR PZ-T87/P-K PZ-T87/P-KR PZ-T87/P-J PZ-T87/P-L PZ-T49/P-L PZ-T89/P-L	G30/G31; 30 mbar (LPG)
	20041	<b>INJECTOR 180 - G20</b> thread: M1 1x1	PZ-T47/P-K PZ-T47/P-J PZ-T47/P-L PZ-T47/P-KR PZ-T87/P-K PZ-T87/P-KR PZ-T87/P-J PZ-T87/P-L PZ-T49/P-L PZ-T89/P-L	G20; 20 mbar (natural gas)
	20046	<b>INJECTOR 150</b> thread: M1 1x1	PZ-T49/P-K PZ-T89/P-K PZ-T89/P-KR PZ-T49/P-J PZ-T89/P-J PZ-T49/P-KR	G30/G31; 30 mbar (LPG)
	20042	<b>INJECTOR 210</b> thread: M1 1x1	PZ-T49/P-K PZ-T89/P-K PZ-T89/P-KR PZ-T49/P-J PZ-T89/P-J PZ-T49/P-KR	G20; 20 mbar (natural gas)
	83354	<b>BUTTON FOR GAS VALVE</b> colour: dark blue		
	46218	<b>SCALE LABEL FOR BUTTON</b> PL 1-8		

Gas griddle plates

# THERMAL EQUIPMENT KOGAST 700 and 900 GRIDDLE PLATES



Зип Общепит

vsezip.ru

+7(812)987-08-81

Spare parts	Code No.	Description	Ref.	Remark
	44412	GLASS FOR MAIN AND PILOT FLAME		
	51882	<b>GRIDDLE PLATE</b> flat - cast iron plate cutting-out dim.: 395x610 mm useful dim.: 390x522 mm	PZ-T47/P-L	
	56478	<b>GRIDDLE PLATE</b> 1/2 flat + 1/2 ribbed - cast iron plate cutting-out dim.: 795x610 mm useful dim.: 790x522 mm	PZ-T87/P-L	
	51938	<b>GRIDDLE PLATE</b> flat - cast iron plate cutting-out dim.: 395x610 mm useful dim.: 390x522 mm	PZ-T49/P-L	
	56532	<b>GRIDDLE PLATE</b> 1/2 flat + 1/2 ribbed - cast iron plate cutting-out dim.: 795x610 mm useful dim.: 790x522 mm	PZ-T89/P-L	

Gas griddle plates

# THERMAL EQUIPMENT KOGAST 700 and 900 GRIDDLE PLATES



Зип Общепит

vsezip.ru

+7(812)987-01-81

Code	Type	Drawing
------	------	---------

53370 EZ-T47/VZ

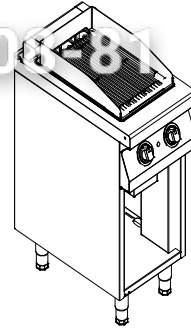

Spare parts	Code No.	Description	Ref.	Remark
-------------	----------	-------------	------	--------



72233 HEATING ELEMENT  
power: 1360W

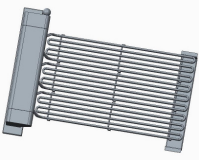

72234 HEATER  
with electric box for el. grill with wat  
power: 4100W

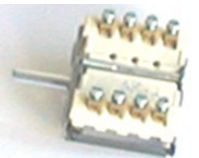

73440 MAIN SWITCH ON-OFF  
el. load: 16A/250V-10A/380V  
poles: 4



73622 ENERGY REGULATOR  
el. load: 12A/230V



73108 CONTACTOR DIL EM-10  
voltage: 230V

73479 LIMIT SWITCH  
el. load: 250V-16A

Electric grill with water drip pan



**THERMAL EQUIPMENT KOGAST 700 and 900  
GRIDDLE PLATES**



Зип Общепит

vsezip.ru

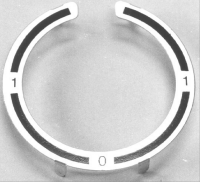
+7(812)987-08-81

Spare parts	Code No.	Description	Ref.	Remark
	46201	SCALE LABEL FOR MAIN SWITCH BUTTON		
	46481	SCALE PLATE		

**Electric grill with water drip pan**

# THERMAL EQUIPMENT KOGAST 700 and 900 GRIDDLE PLATES



Зип Общепит

vsezip.ru

+7(812)987-08-81

Code	Type	Drawing
------	------	---------

53310 PZ-T47/LG  
55861 PZ-T87/LG  
53526 PZ-T49/LG  
55917 PZ-T89/LG

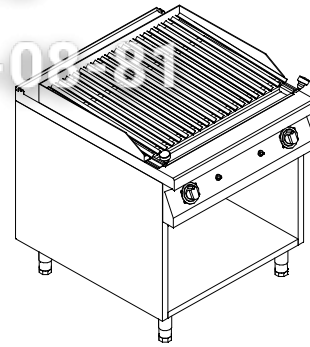

Spare parts	Code No.	Description	Ref.	Remark
-------------	----------	-------------	------	--------



49186 **BURNER**  
power: 9,5 kW

PZ-T47/LG  
PZ-T87/LG



49187 **BURNER**  
power: 11kW

PZ-T49/LG  
PZ-T89/LG



46328 **PIEZO IGNITER**



44820 **PILOT FLAME SPARK PLUG**



47474 **CABLE FOR PIEZO SPARKING DEVICE**  
L= 500 mm



53086 **PIEZO IGNITER PROTECTION**

Gas lava stone grills

# THERMAL EQUIPMENT KOGAST 700 and 900 GRIDDLE PLATES



Зип Общепит

vsezip.ru

+7(812)987-08-81

Spare parts	Code No.	Description	Ref.	Remark
	46241	<b>PILOT FLAME BURNER</b>		
	42142	<b>GAS VALVE 21 S/B</b> thread for thermocouple: M9x1		
	47033	<b>THERMOELEMENT</b> L= 600 mm without thread	PZ-T47/LG PZ-T87/LG	
	47032	<b>THERMOELEMENT</b> L= 1200 mm without thread	PZ-T49/LG PZ-T89/LG	
	20046	<b>INJECTOR 150</b> thread: M1 1x1	PZ-T47/LG PZ-T87/LG	G30/G31; 30 mbar (LPG)
	20042	<b>INJECTOR 210</b> thread: M1 1x1	PZ-T47/LG PZ-T87/LG	G20; 20 mbar (natural gas)
	24414	<b>INJECTOR 160</b> thread: M1 1x1	PZ-T49/LG PZ-T89/LG	G30/G31; 30 mbar (LPG)
	20047	<b>INJECTOR 230</b> thread: M1 1x1	PZ-T49/LG PZ-T89/LG	G20; 20 mbar (natural gas)

Gas lava stone grills







# THERMAL EQUIPMENT KOGAST 700 and 900 GRIDDLE PLATES



Зип Общепит

vsezip.ru

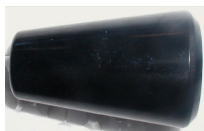
+7(812)987-08-81

Spare parts	Code No.	Description	Ref.	Remark
	83354	<b>BUTTON FOR GAS VALVE</b> colour: dark blue		
	46203	<b>SCALE LABEL FOR BUTTON</b>		
	50557	<b>GRIDDLE HANDLE</b> conical		
	44412	<b>GLASS FOR MAIN AND PILOT FLAME</b>		

Gas lava stone grills

**THERMAL EQUIPMENT KOGAST 700 and 900  
GRIDDLE PLATES**



Зип Общепит

vsezip.ru

+7(812)987-08-81

Code	Type	Drawing
------	------	---------

53881 EZ-CG

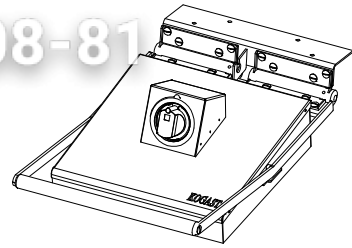

Spare parts	Code No.	Description	Ref.	Remark
-------------	----------	-------------	------	--------

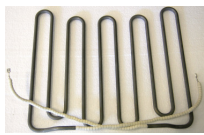

72245 **HEATING ELEMENT**  
power: 1,5 kW



46481 **SCALE PLATE**



73622 **ENERGY REGULATOR**  
el. load: 12A/230V



76396 **CONNECTION CABLE**  
dim.: 5 x 2,5mm<sup>2</sup> x 2000mm  
with plug

54896 **HINGE FOR EZ-CG -P**

Electric clamshell grill

# THERMAL EQUIPMENT KOGAST 700 and 900 FRYERS



Зип Общепит

vsezip.ru

+7(812)987-03-81

Code	Type	Drawing
------	------	---------

55862 EF-T7/14  
55863 EF-T7/28  
55918 EF-T9/14  
55919 EF-T9/28  
57534 EF-T7/2x5

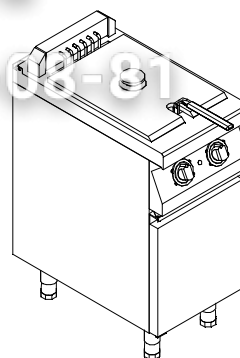

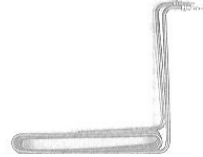

Spare parts	Code No.	Description	Ref.	Remark
-------------	----------	-------------	------	--------

	72068	<b>HEATING ELEMENT</b> power: 3,5 kW	EF-T7/2x5	
---	-------	---	-----------	--

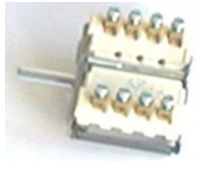
	72076	<b>HEATING ELEMENT</b> power: 3,7 kW voltage: 230V	EF-T7/14 EF-T7/28 EF-T9/14 EF-T9/28	
--	-------	--	--	--

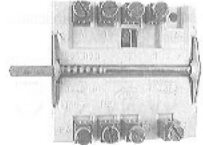
	73440	<b>MAIN SWITCH ON-OFF</b> el. load: 16A/250V-10A/380V poles: 4	EF-T7/2x5	
---	-------	--	-----------	--

	73458	<b>MAIN SWITCH ON-OFF</b> el. load: 32A/250V-25A/400V poles: 4	EF-T7/14 EF-T7/28 EF-T9/14 EF-T9/28	
---	-------	--	--	--

	72553	<b>THERMOSTAT</b> operating temp.: 40-180°C el. load: 16 (4)A/380V pole: 1; capillary: L=1580 mm		
---	-------	---	--	--

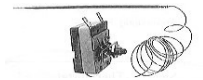
	72580	<b>SAFETY-THERMOSTAT</b> temperature limit: 220°C el. load: 16 (2,6)A/380V pole: 1; capillary: L=1540 mm	EF-T7/2x5	
---	-------	---	-----------	--

Electric fryers



# THERMAL EQUIPMENT KOGAST 700 and 900 FRYERS



Зип Общепит

vsezip.ru

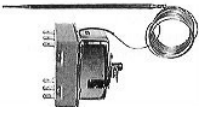
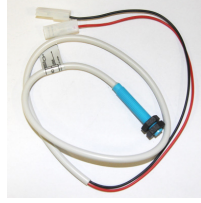
87(812)987-08-37

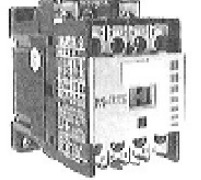
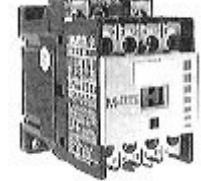
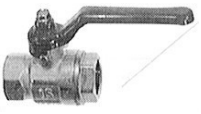
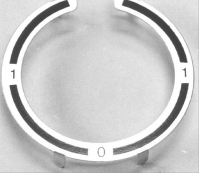
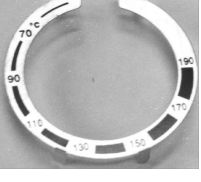
Spare parts	Code No.	Description	Ref.	Remark
	72577	<b>SAFETY-THERMOSTAT</b> temperature limit: 228°C el. load: 20 (4) A/380 V poles: 3; capillary: L=1580 mm	EF-T7/14 EF-T7/28 EF-T9/14 EF-T9/28	
	72439	<b>LIMIT SWITCH - MAGNETIC</b> el. current: 100 mA power: 100W, U=1000V type: RP 86 85 700 EF		
	56371	<b>MAGNET WITH SCREW, ASSEMBLY</b>		
	73112	<b>CONTACTOR DIL M7-10</b> voltage: 230V AC	EF-T7/14 EF-T7/28 EF-T9/14 EF-T9/28	
	73113	<b>CONTACTOR DIL MP20</b> voltage: 230V AC	EF-T7/2x5	
	42340	<b>DRAIN VALVE</b> dim.: 3/4"		
	46201	<b>SCALE LABEL FOR MAIN SWITCH BUTTON</b>		
	46208	<b>SCALE LABEL FOR BUTTON</b>		

Electric fryers

# THERMAL EQUIPMENT KOGAST 700 and 900 FRYERS



Зип Общепит

vsezip.ru

+7(812)987-08-81

Spare parts	Code No.	Description	Ref.	Remark
-------------	----------	-------------	------	--------



45613

**MAGNET**

dim.: fi 22 mm

thread: M5

Electric fryers

# THERMAL EQUIPMENT KOGAST 700 and 900 FRYERS



Зип Общепит

vsezip.ru

+7(812)987-08-81

Code	Type	Drawing
------	------	---------

55864 PF-T7/14  
55865 PF-T7/28  
55920 PF-T9/14  
55921 PF-T9/28

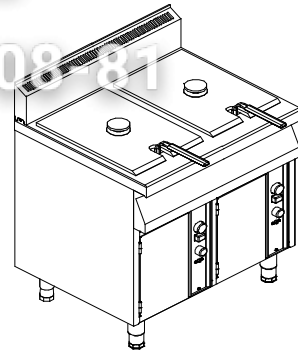

Spare parts	Code No.	Description	Ref.	Remark
-------------	----------	-------------	------	--------

15352 BURNER  
power: 5,6kW



02392 PILOT FLAME BURNER



46240 SUPPORT FOR CAPILLARY & PIEZO PLUG

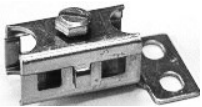

46328 PIEZO IGNITER



44820 PILOT FLAME SPARK PLUG



47474 CABLE FOR PIEZO SPARKING DEVICE  
L= 500 mm



Gas fryers

# THERMAL EQUIPMENT KOGAST 700 and 900 FRYERS



Зип Общепит

vsezip.ru

+7(812)987-08-81

Spare parts	Code No.	Description	Ref.	Remark
	46432	<b>THERMOREGULATOR - MINISIT</b> operating temp.: 110-190°C		Enclose the gasket 82819
	53086	<b>PIEZO IGNITER PROTECTION</b>		
	72582	<b>SAFETY-THERMOSTAT</b> temperature limit: 225°C el. load: 0,5A/12V pole: 1; capillary: L=900 mm		Enclose the gasket 63295
	47033	<b>THERMOELEMENT</b> L= 600 mm without thread		
	42350	<b>BALL VALVE</b> dim.: 1"		
	26362	<b>DRAIN TUBE-SET</b> dim.: R1"/fi22,3		
	20044	<b>INJECTOR 120</b> thread: M1 1x1		G30/G31, 30 mbar (LPG)
	22387	<b>INJECTOR 200</b> thread: M1 1x1		G20, 20 mbar (natural gas)

Gas fryers

**THERMAL EQUIPMENT KOGAST 700 and 900  
FRYERS**



Зип Общепит

vsezip.ru

+7(812)987-08-81

Spare parts	Code No.	Description	Ref.	Remark
	45613	<b>MAGNET</b> dim.: fi 22 mm thread: M5		

**Gas fryers**



# THERMAL EQUIPMENT KOGAST 700 and 900 BAINS-MARIE



Зип Общепит

vsezip.ru

+7(812)987-08-81

Code	Type	Drawing
------	------	---------

- 55868 EVK-T47/P
- 55869 EVK-T87/P
- 55922 EVK-T49/P
- 55923 EVK-T89/P

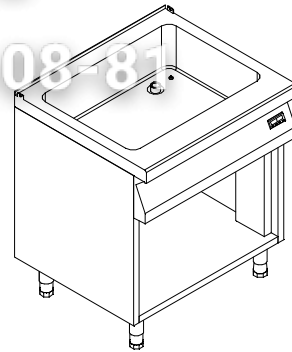

Spare parts	Code No.	Description	Ref.	Remark
-------------	----------	-------------	------	--------

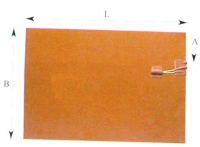

**72095**     **ADHESIVE HEATER**  
power: 1 kW  
dim.: 400x290 mm



**77130**     **TEMPERATURE CONTROLLER**  
type: AT1-5BS2E-BG

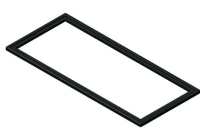

**77470**     **CONTROLLER GASKET**  
dim.: 76,5x34x1,5 mm

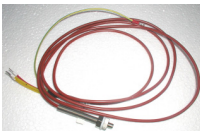

**77212**     **TEMPERATURE CONTROLLER PROBE**  
dim.: fi6x6 M10x1 mm  
dol.: 2000 mm

**Electric Bains-Marie**

# THERMAL EQUIPMENT KOGAST 700 and 900 PASTA COOKERS



Зип Общепит

vsezip.ru

+7(812)987-08-81

Code	Type	Drawing
------	------	---------

55870 EKT-T47/V  
55924 EKT-T49/V

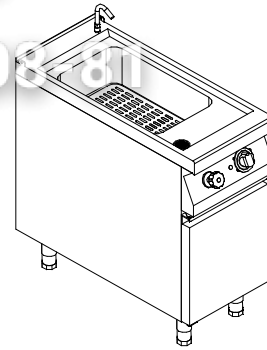

Electric pasta cookers with water inlet

Spare parts	Code No.	Description	Ref.	Remark
-------------	----------	-------------	------	--------



72244 **HEATING ELEMENT**  
power: 1500 W



77899 **SWITCH**  
el. load: 16A/250V-10A/400V

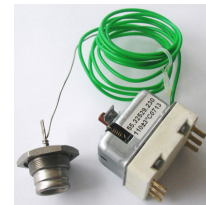

77900 **SAFETY-THERMOSTAT**  
temperature limit: 110°C  
poles: 3  
capillary: L= 1580 mm



42250 **WATER INLET VALVE**  
thread: G1/2

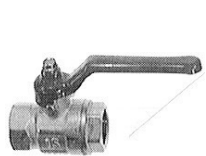

42360 **DRAIN VALVE**  
dim.: 5/4"



43417 **BRAIDED HOSE**  
thread: G1/2  
L= 900 mm

**THERMAL EQUIPMENT KOGAST 700 and 900  
PASTA COOKERS**



Зип Общепит

vsezip.ru

+7(812)987-08-81

Spare parts	Code No.	Description	Ref.	Remark
-------------	----------	-------------	------	--------



45613  
**MAGNET**  
dim.: fi 22 mm  
thread: M5



46483  
**SCALE PLATE FOR KNOB**



95089  
**ARMOURED HOSE**  
fi40/50

**Electric pasta cookers with water inlet**

# THERMAL EQUIPMENT KOGAST 700 and 900 PASTA COOKERS



Зип Общепит

vsezip.ru

+7(812)987-08-81

Electric pasta cookers with thermostatic regulation

Code	Type	Drawing
------	------	---------

52129 EKT-T47/V-T  
52134 EKT-T49/V-T

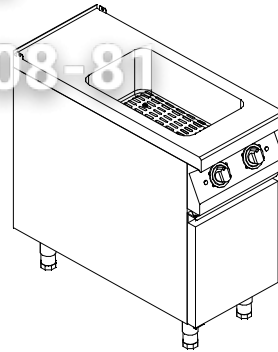

Spare parts	Code No.	Description	Ref.	Remark
-------------	----------	-------------	------	--------



72244 **HEATING ELEMENT**  
power: 1500 W

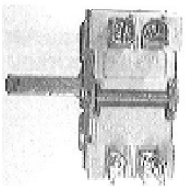

73457 **MAIN SWITCH ON-OFF**  
el. load: 16A/250V-10A/400V  
poles: 2

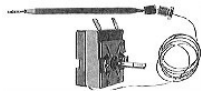

72555 **THERMOSTAT**  
temperature limit: 30-110°C  
el. load: 16 (4)A/380V  
pole: 1; capillary: L=850 mm

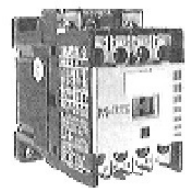

73112 **CONTACTOR DIL M7-10**  
voltage: 230V AC



42340 **DRAIN VALVE**  
dim.: 3/4"

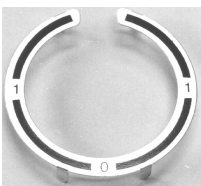

46201 **SCALE LABEL FOR MAIN SWITCH BUTTON**

**THERMAL EQUIPMENT KOGAST 700 and 900  
PASTA COOKERS**



Зип Общепит

vsezip.ru

+7(812)987-08-81

Spare parts	Code No.	Description	Ref.	Remark
-------------	----------	-------------	------	--------

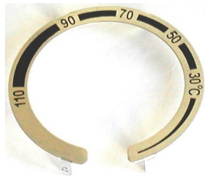

46213 SCALE PLATE FOR THERMOSTAT KNOB

**Electric pasta cookers with thermostatic regulation**

# THERMAL EQUIPMENT KOGAST 700 and 900 BOILING PANS



Зип Общепит

vsezip.ru

+7(812)987-08 81

Code	Type	Drawing
------	------	---------

- 55871 EK-T7/80-P
- 55872 EK-T7/80-O
- 55925 EK-T9/100-P
- 55929 EK-T9/100-O
- 55926 EK-T9/150-P
- 55930 EK-T9/150-O
- 55927 EK-T9/200-P
- 55928 EK-T9/300-P

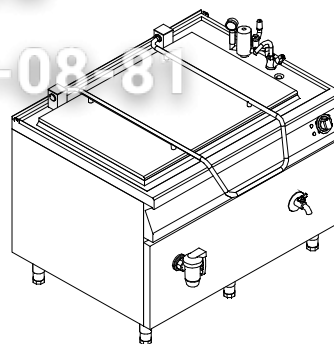

Spare parts	Code No.	Description	Ref.	Remark
-------------	----------	-------------	------	--------

	72241	<b>HEATING ELEMENT EK-T7/80</b> power: 3x 2250W	EK-T7/80-P EK-T7/80-O	
--	-------	--	--------------------------	--



	72239	<b>HEATING ELEMENT EK-T9/100</b> power: 3x 2400W	EK-T9/100-P EK-T9/100-O	
--	-------	---	----------------------------	--



	72243	<b>HEATING ELEMENT EK-T9/150</b> power: 3x 3000W	EK-T9/150-P EK-T9/150-O EK-T9/200-P EK-T9/300-P	
--	-------	---	--	--



	72077	<b>CONTROL HEATING ELEMENT</b> power: 600W		
--	-------	---	--	--



	82890	<b>SILICONE WASHER FOR HEATING ELEMENT</b> dim.: fi58xfi6		
--	-------	--	--	--



	73113	<b>CONTACTOR DIL MP20</b> voltage: 230V AC		
--	-------	---	--	--



Electric boiling pans





# THERMAL EQUIPMENT KOGAST 700 and 900 BOILING PANS

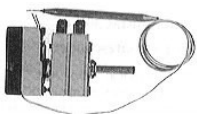
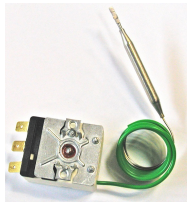
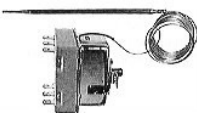

Зип Общепит

vsezip.ru

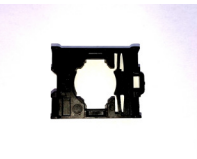
(812)987-08-81

Spare parts	Code No.	Description	Ref.	Remark
	72550	<b>THERMOSTAT WITH SWITCH</b> operating temp.: 60-120°C el. load: 16 (4)A/380V poles: 3		
	72565	<b>THERMOSTAT FOR CONTROL HEATING ELEMENT</b> temperature limit: 125°C el. load: 16(2,6)A/250V		
	72576	<b>SAFETY-THERMOSTAT</b> temperature limit: 135°C el. load: 16(4)A 400V poles: 3		
	76576	<b>LENS FOR CONTROL LIGHT - RED</b>		
	73501	<b>BUTTON WITH LIGHT, RED</b>		since 15th of February 2018 parts for "FULL POWER" switch
	73582	<b>SUPPORT FOR BUTTON WITH LIGHT M22-A</b>		since 15th of February 2018 parts for "FULL POWER" switch
	73584	<b>CONTACT ELEMENT NO M22-K10</b>		parts for "FULL POWER" switch since 15th of February 2018
	73500	<b>CONTACT ELEMENT FOR RED LED</b>		since 15th of February 2018 parts for "FULL POWER" switch

Electric boiling pans

# THERMAL EQUIPMENT KOGAST 700 and 900 BOILING PANS



Зип Общепит

vsezip.ru

+7(812)987-08-81

Spare parts	Code No.	Description	Ref.	Remark
	42234	<b>CONTROL DRAIN VALVE</b> dim.: 1/2"		
	42271	<b>MIXING WATER PIPE</b>		
	42272	<b>WATER OUTLET</b> L= 100 mm		
	46206	<b>SCALE PLATE</b>		
	83716	<b>HANDLE M10</b> oven door	EK-T7/80-O EK-T9/100-O EK-T9/150-O	
	42257	<b>SAFETY ARMATURE 3/4"</b>		
	49703	<b>MANOMETER FOR SAFETY ARMATURE</b> measuring range: 0-1 bar		
	87896	<b>CABLE FOR SEALING JOINTS</b> Loctite 55; Loctite code: 32560		

Electric boiling pans



# THERMAL EQUIPMENT KOGAST 700 and 900 BOILING PANS



Зип Ощепит

vsezip.ru

7(812)987-08-81

Spare parts	Code No.	Description	Ref.	Remark
	42096	<b>VENTIL IZPUSTN 1 1/2 KONIČNI - SESTAV</b> 42098 drain valve 1 1/2" 87002 washer for drain valve 1 1/2" 92014 lubricating grease for drain valve 1 1/2" 42116 gasket for ferrule 1 1/2" 42103 hex key no. 3 and threaded pins M5x5 (2 pcs.) 42101 threaded pin M5x5 for fixing ferrule 1 1/2"	EK-T7/80-O	since 1st March 2017
	42098	<b>DRAIN VALVE 1 1/2"</b>	EK-T7/80-O	since 1st March 2017
	87002	<b>WASHER FOR DRAIN VALVE 1 1/2"</b> dim.: fi46xfi38,5x2	EK-T7/80-O	
	42095	<b>VENTIL IZPUSTN 2" KONIČNI - SESTAV</b> 42097 drain valve 2" 92014 lubricating grease for drain valve 2" 42115 gasket for ferrule 2" 42103 hex key no. 3 and threaded pins M5x5 (2 pcs.) 42101 threaded pin M5x5 for fixing ferrule 2" 87001 washer for drain valve 2"	EK-T7/80-P EK-T9/100-P EK-T9/100-O EK-T9/150-P EK-T9/150-O EK-T9/200-P EK-T9/300-P	since 26th January 2018
	42097	<b>DRAIN VALVE 2"</b>	EK-T7/80-P EK-T9/100-P EK-T9/100-O EK-T9/150-P EK-T9/150-O EK-T9/200-P EK-T9/300-P	since 26th January 2018
	87001	<b>WASHER FOR DRAIN VALVE 2"</b> dim.: fi60xfi49,5x2	EK-T7/80-P EK-T9/100-P EK-T9/150-P EK-T9/150-O EK-T9/200-P EK-T9/300-P	
	92014	<b>LUBRICATING GREASE FOR DRAIN VALVE 100g</b>		

Electric boiling pans





# THERMAL EQUIPMENT KOGAST 700 and 900 BOILING PANS





Зип Общепит

vsezip.ru

+7(812)987-08-31

Spare parts	Code No.	Description	Ref.	Remark
	53254	<b>HINGE SPRING FOR COVER - LEFT</b> dim.: Ć 3,5	EK-T7/80-P EK-T7/80-O EK-T9/100-O EK-T9/150-O	
	53257	<b>HINGE SPRING FOR COVER - RIGHT</b> dim.: Ć 3,5	EK-T7/80-P EK-T7/80-O EK-T9/100-O EK-T9/150-O	
	53256	<b>HINGE SPRING FOR COVER - RIGHT</b> dim.: fi4,2	EK-T9/100-P EK-T9/150-P EK-T9/200-P EK-T9/300-P	
	53253	<b>HINGE SPRING FOR COVER - LEFT</b> dim.: Ć 4,2	EK-T9/100-P EK-T9/150-P EK-T9/200-P EK-T9/300-P	

## ARCHIVE OF CHANGES

	42007	<b>DRAIN VALVE 1 1/2" - SET</b>	EK-T7/80-O	1st of March 2017 replaced with code 42096
	42005	<b>DRAIN VALVE 1 1/2"</b>	EK-T7/80-O	1st of March 2017 replaced with code 42098
	42006	<b>DRAIN VALVE 2" - SET</b>	EK-T7/80-P EK-T9/100-P EK-T9/100-O EK-T9/150-P EK-T9/150-O EK-T9/200-P EK-T9/300-P	26th of January 2018 replaced with code 42095

Electric boiling pans

**THERMAL EQUIPMENT KOGAST 700 and 900  
BOILING PANS**



Зип Общепит

vsezip.ru

+7(812)987-08-88

Spare parts	Code No.	Description	Ref.	Remark
	42004	DRAIN VALVE 2"	EK-T7/80-P	26th of January 2018 replaced with code 42097
			EK-T9/100-P	
			EK-T9/100-O	
			EK-T9/150-P	
			EK-T9/150-O	
			EK-T9/200-P	
			EK-T9/300-P	

**Electric boiling pans**

# THERMAL EQUIPMENT KOGAST 700 and 900 BOILING PANS



Зип Общепит

vsezip.ru

+7(812)987-08-81

Code	Type	Drawing
------	------	---------

- 55873 PK-T7/80-P
- 55931 PK-T9/100-P
- 55933 PK-T9/150-P
- 55935 PK-T9/200-P
- 55936 PK-T9/300-P

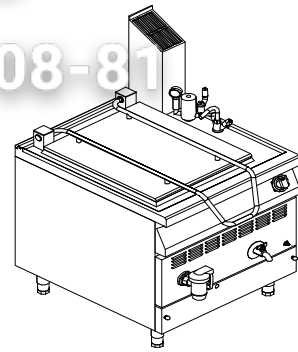

Gas boiling pans with rectangular vessel

Spare parts	Code No.	Description	Ref.	Remark
-------------	----------	-------------	------	--------

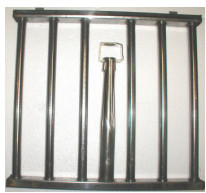

44407 BURNER  
power: 20kW

PK-T7/80-P



44416 BURNER  
power: 22kW

PK-T9/100-P  
PK-T9/150-P

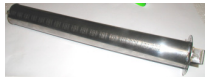

44411 BURNER  
power: 7kW

PK-T9/200-P  
PK-T9/300-P



46328 PIEZO IGNITER



42259 PILOT FLAME SPARK PLUG

PK-T7/80-P  
PK-T9/100-P  
PK-T9/150-P



44820 PILOT FLAME SPARK PLUG

PK-T9/200-P  
PK-T9/300-P

# THERMAL EQUIPMENT KOGAST 700 and 900 BOILING PANS



Зип Общепит

vsezip.ru

+7(812)987-08-81

Spare parts	Code No.	Description	Ref.	Remark
	47477	CABLE FOR PIEZO SPARKING DEVICE L= 1000 mm		
	53086	PIEZO IGNITER PROTECTION		
	42260	PILOT FLAME BURNER	PK-T7/80-P PK-T9/100-P PK-T9/150-P	
	46228	PILOT FLAME BURNER	PK-T9/200-P PK-T9/300-P	since July 2013
	42143	GAS VALVE 23S/0-B3 thread for thermoelement: M9x1		
	47032	THERMOELEMENT L= 1200 mm without thread		
	42271	MIXING WATER PIPE		
	42272	WATER OUTLET L= 100 mm		

Gas boiling pans with rectangular vessel

# THERMAL EQUIPMENT KOGAST 700 and 900 BOILING PANS



Зип Общепит

vsezip.ru

+7(812)987-08-81

Gas boiling pans with rectangular vessel

Spare parts	Code No.	Description	Ref.	Remark
	20047	<b>INJECTOR 230</b> thread: M1 1x1	PK-T7/80-P	G30/G31; 30 mbar (LPG)
	38845	<b>INJECTOR 340</b> thread: M1 1x1	PK-T7/80-P	G20; 20 mbar (natural gas)
	29008	<b>INJECTOR 240; G30/G31 (LPG)</b> thread: M1 1x1	PK-T9/100-P	G30/G31; 30 mbar (LPG)
	40128	<b>INJECTOR 350</b> thread: M1 1x1	PK-T9/100-P	G20; 20 mbar (natural gas)
	20050	<b>INJECTOR 250</b> thread: M1 1x1	PK-T9/150-P	G30/G31; 30 mbar (LPG)
	40129	<b>INJECTOR 360</b> thread: M1 1x1	PK-T9/150-P	G20; 20 mbar (natural gas)
	50745	<b>INJECTOR 135</b> thread: M6x0,75	PK-T9/200-P PK-T9/300-P	G30/G31; 30 mbar (LPG)
	46870	<b>INJECTOR FOR PILOT FLAME BURNER 027</b> G30/G31	PK-T9/200-P PK-T9/300-P	

# THERMAL EQUIPMENT KOGAST 700 and 900 BOILING PANS



Зип Общепит

vsezip.ru

+7(812)987-08-81

Spare parts	Code No.	Description	Ref.	Remark
	50747	<b>INJECTOR 205</b> thread: M6x0,75	PK-T9/200-P PK-T9/300-P	G20; 20 mbar (natural gas)
	42264	<b>INJECTOR FOR PILOT FLAME BURNER</b> MARK 19; G30/G31 (LPG)	PK-T7/80-P PK-T9/100-P PK-T9/150-P	
	42263	<b>INJECTOR FOR PILOT FLAME BURNER</b> MARK 27; G20 (natural gas)	PK-T7/80-P PK-T9/100-P PK-T9/150-P	
	46882	<b>«BY PASS» INJECTOR FOR GAS VALVE</b> 23S/0-B3; G20		
	46885	<b>«BY PASS» INJECTOR FOR GAS VALVE</b> 23S/0-B3; G30/G31 (LPG)	PK-T7/80-P PK-T9/100-P PK-T9/150-P	
	42234	<b>CONTROL DRAIN VALVE</b> dim.: 1/2"		
	42257	<b>SAFETY ARMATURE 3/4"</b>		
	49703	<b>MANOMETER FOR SAFETY ARMATURE</b> measuring range: 0-1 bar		

Gas boiling pans with rectangular vessel

# THERMAL EQUIPMENT KOGAST 700 and 900 BOILING PANS



Зип Общепит

vsezip.ru

7(812)987-08-81

Gas boiling pans with rectangular vessel

Spare parts	Code No.	Description	Ref.	Remark
	87896	<b>CABLE FOR SEALING JOINTS</b> Loctite 55; Loctite code: 02560		
	42095	<b>VENTIL IZPUSTN 2" KONIČNI - SESTAV</b> 42097 drain valve 2" 87001 washer for drain valve 2" 92014 lubricating grease for drain valve 2" 42115 gasket for ferrule 2" 42103 hex key no. 3 and threaded pins M5x5 (2 pcs.) 42101 threaded pin M5x5 for fixing ferrule 2"		since 26th of January 2018
	42097	<b>DRAIN VALVE 2"</b>		since 26th of January 2018
	87001	<b>WASHER FOR DRAIN VALVE 2"</b> dim.: fi60xfi49,5x2		
	92014	<b>LUBRICATING GREASE FOR DRAIN VALVE 100g</b>		
	83355	<b>BUTTON FOR GAS VALVE</b> colour: dark blue		
	46203	<b>SCALE LABEL FOR BUTTON</b>		
	44412	<b>GLASS FOR MAIN AND PILOT FLAME</b>	PK-T7/80-P PK-T9/100-P PK-T9/150-P	







# THERMAL EQUIPMENT KOGAST 700 and 900 BOILING PANS





Зип Общепит

vsezip.ru

+7(812)987-08-81

Spare parts	Code No.	Description	Ref.	Remark
	53254	HINGE SPRING FOR COVER - LEFT dim.: Ć 3,5	PK-T7/80-P	
	53257	HINGE SPRING FOR COVER - RIGHT dim.: Ć 3,5	PK-T7/80-P	
	53253	HINGE SPRING FOR COVER - LEFT dim.: Ć 4,2	PK-T9/100-P PK-T9/150-P PK-T9/200-P PK-T9/300-P	
	53256	HINGE SPRING FOR COVER - RIGHT dim.: fi4,2	PK-T9/100-P PK-T9/150-P PK-T9/200-P PK-T9/300-P	

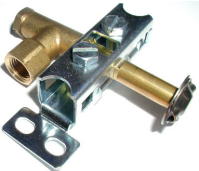
## ARCHIVE OF CHANGES

	46241	PILOT FLAME BURNER	PK-T9/200-P PK-T9/300-P	replaced with pilot flame burner 46228 with new support 57289 since July 2013
	42006	DRAIN VALVE 2" - SET		26th of January 2018 replaced with code 42095
	42004	DRAIN VALVE 2"		26th of January 2018 replaced with code 42097

Gas boiling pans with rectangular vessel

# THERMAL EQUIPMENT KOGAST 700 and 900 BOILING PANS



Зип Общепит

vsezip.ru

+7(812)987-08 81

Code	Type	Drawing
------	------	---------

55874 PK-T7/60-O  
55932 PK-T9/100-O  
55934 PK-T9/150-O

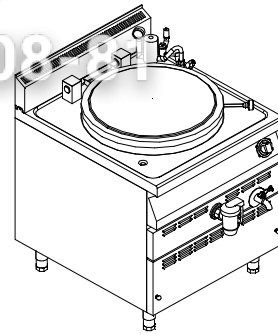

Gas boiling pans with round vessel

Spare parts	Code No.	Description	Ref.	Remark
-------------	----------	-------------	------	--------

50920 BURNER  
power: 4kW  
PK-T7/60-O



44411 BURNER  
power: 7kW  
PK-T9/100-O  
PK-T9/150-O



46328 PIEZO IGNITER



44820 PILOT FLAME SPARK PLUG



47477 CABLE FOR PIEZO SPARKING DEVICE  
L= 1000 mm

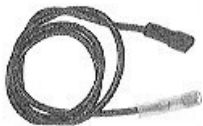

53086 PIEZO IGNITER PROTECTION



# THERMAL EQUIPMENT KOGAST 700 and 900 BOILING PANS



Зип Общепит

vsezip.ru

+7(812)987-08-81

Spare parts	Code No.	Description	Ref.	Remark
	46241	PILOT FLAME BURNER	PK-T7/60-O	
	46228	PILOT FLAME BURNER	PK-T9/100-O PK-T9/150-O	since July 2013; before July 2013 46241 with support 57289
	42143	GAS VALVE 23S/0-B3 thread for thermoelement: M9x1		
	47032	THERMOELEMENT L= 1200 mm without thread		
	42271	MIXING WATER PIPE		
	42272	WATER OUTLET L= 100 mm		
	50999	INJECTOR 110 navoj: M6x0,75	PK-T7/60-O	G30/G31, 30 mbar (LPG)
	50998	INJECTOR 175 thread: M6x0,75	PK-T7/60-O	G20, 20 mbar (natural gas)

Gas boiling pans with round vessel

# THERMAL EQUIPMENT KOGAST 700 and 900 BOILING PANS



Зип Общепит

vsezip.ru

+7(812)987-08-81

Gas boiling pans with round vessel

Spare parts	Code No.	Description	Ref.	Remark
	54247	<b>INJECTOR 130</b> thread M6x0,75	PK-T9/100-O	G30/G31, 30 mbar (LPG)
	54248	<b>INJECTOR 195</b> thread M6x0,75	PK-T9/100-O	G20, 20 mbar (natural gas)
	50745	<b>INJECTOR 135</b> thread: M6x0,75	PK-T9/100-O PK-T9/150-O	G30/G31, 30 mbar (LPG)
	50747	<b>INJECTOR 205</b> thread: M6x0,75	PK-T9/100-O PK-T9/150-O	G20, 20 mbar (natural gas)
	46870	<b>INJECTOR FOR PILOT FLAME BURNER 027</b> G30/G31	PK-T9/100-O PK-T9/150-O	
	46882	<b>«BY PASS» INJECTOR FOR GAS VALVE</b> 23S/0-B3; G20		
	42234	<b>CONTROL DRAIN VALVE</b> dim.: 1/2"		
	42257	<b>SAFETY ARMATURE 3/4"</b>		





# THERMAL EQUIPMENT KOGAST 700 and 900 BOILING PANS



Зип Общепит

vsezip.ru

+7(812)987-08-81

Spare parts	Code No.	Description	Ref.	Remark
	49703	<b>MANOMETER FOR SAFETY ARMATURE</b> measuring range: 0-1 bar		
	87896	<b>CABLE FOR SEALING JOINTS</b> Loctite 55; Loctite code: 32560		
	42096	<b>VENTIL IZPUSTN 1 1/2 KONIČNI - SESTAV</b> 42098 drain valve 1 1/2" 87002 washer for drain valve 1 1/2" 92014 lubricating grease for drain valve 1 1/2" 42116 gasket for ferrule 1 1/2" 42103 hex key no. 3 and threaded pins M5x5 (2 pcs.) 42101 threaded pin M5x5 for fixing ferrule 1 1/2"	PK-T7/60-O	since 1st of March 2017
	42098	<b>DRAIN VALVE 1 1/2"</b>	PK-T7/60-O	since 1st of March 2017
	87002	<b>WASHER FOR DRAIN VALVE 1 1/2"</b> dim.: fi46xfi38,5x2	PK-T7/60-O	
	42095	<b>VENTIL IZPUSTN 2" KONIČNI - SESTAV</b> 42101 threaded pin M5x5 for fixing ferrule 2" 42097 drain valve 2" 87001 washer for drain valve 2" 92014 lubricating grease for drain valve 2" 42115 gasket for ferrule 2" 42103 hex key no. 3 and threaded pins M5x5 (2 pcs.)	PK-T9/100-O PK-T9/150-O	since 26th of January 2018
	42097	<b>DRAIN VALVE 2"</b>	PK-T9/100-O PK-T9/150-O	since 26th of January 2018

Gas boiling pans with round vessel

# THERMAL EQUIPMENT KOGAST 700 and 900 BOILING PANS



Зип Общепит

vsezip.ru

+7(812)987-08-81

Gas boiling pans with round vessel

Spare parts	Code No.	Description	Ref.	Remark
	87001	<b>WASHER FOR DRAIN VALVE 2"</b> dim.: fi60xfi49,5x2	PK-T9/100-O PK-T9/150-O	
	92014	<b>LUBRICATING GREASE FOR DRAIN VALVE</b> 100g		
	83355	<b>BUTTON FOR GAS VALVE</b> colour: dark blue		
	46203	<b>SCALE LABEL FOR BUTTON</b>		
	83716	<b>HANDLE M10</b> oven door		
	53255	<b>HINGE SPRING FOR COVER - LEFT</b> dim.: fi3,2	PK-T7/60-O	
	53258	<b>HINGE SPRING FOR COVER - RIGHT</b> dim.: fi3,2	PK-T7/60-O	
	53254	<b>HINGE SPRING FOR COVER - LEFT</b> dim.: C 3,5	PK-T9/100-O PK-T9/150-O	

# THERMAL EQUIPMENT KOGAST 700 and 900 BOILING PANS



Зип Общепит

vsezip.ru

+7(812)987-08-81

Spare parts	Code No.	Description	Ref.	Remark
-------------	----------	-------------	------	--------



53257

**HINGE SPRING FOR COVER - RIGHT**  
dim.: Ć 3,5

PK-T9/100-O  
PK-T9/150-O

## ARCHIVE OF CHANGES



42007

**DRAIN VALVE 1 1/2" - SET**

PK-T7/60-O

1st of March 2017  
replaced with code  
42096



42005

**DRAIN VALVE 1 1/2"**

PK-T7/60-O

1st of March 2017  
replaced with code  
42098



42006

**DRAIN VALVE 2" - SET**

PK-T9/100-O  
PK-T9/150-O

26th of January 2018  
replaced with code  
42095



42004

**DRAIN VALVE 2"**

PK-T9/100-O  
PK-T9/150-O

26th of January 2018  
replaced with code  
42097

Gas boiling pans with round vessel

# THERMAL EQUIPMENT KOGAST 700 and 900 COOKING PANS



Зип Общепит

vsezip.ru

+7(812)987-08-81

Code	Type	Drawing
------	------	---------

55875 EB-T47/P  
55876 EB-T87/P  
55941 EB-T49/P  
55942 EB-T89/P

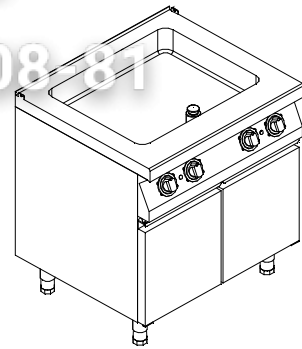

Spare parts	Code No.	Description	Ref.	Remark
-------------	----------	-------------	------	--------

72062 HEATING ELEMENT  
power: 2 kW



72083 HEATING ELEMENT  
power: 1kW



73440 MAIN SWITCH ON-OFF  
el. load: 16A/250V-10A/380V  
poles: 4

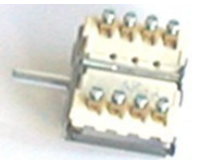

72519 THERMOSTAT  
operating temp.: 50-300°C  
el. load: 16 (4)A/380V  
poles: 3; capillary: 1590 mm

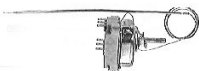

72583 SAFETY-THERMOSTAT  
operating temp.: 368°C  
el. load: 20 (4)A/380 V  
poles: 3; capillary: L= 1490 mm

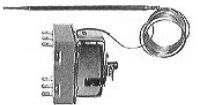

46201 SCALE LABEL FOR MAIN SWITCH BUTTON

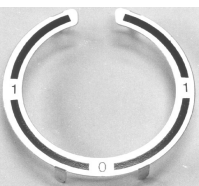

Electric multipurpose cooking pans



**THERMAL EQUIPMENT KOGAST 700 and 900  
COOKING PANS**



Зип Общепит

vsezip.ru

+7(812)987-08-81

Spare parts	Code No.	Description	Ref.	Remark
-------------	----------	-------------	------	--------

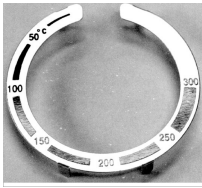

46205 SCALE LABEL FOR BUTTON



45613 **MAGNET**  
dim.: fi 22 mm  
thread: M5

Electric multipurpose cooking pans

# THERMAL EQUIPMENT KOGAST 700 and 900 COOKING PANS



Зип Общепит

vsezip.ru

+7(812)987-08-81

Code	Type	Drawing
------	------	---------

55878 EKP-T7/40SL  
55877 EKP-T7/60  
55943 EKP-T9/80  
55944 EKP-T9/100  
55945 EKP-T9/120

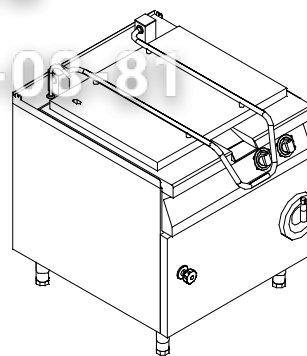

Spare parts	Code No.	Description	Ref.	Remark
-------------	----------	-------------	------	--------



72061 **HEATING ELEMENT**  
power: 2500W  
ceramic insulator colour: white

EKP-T7/40SL



72063 **HEATING ELEMENT**  
power: 1500W  
ceramic insulator colour: red

EKP-T7/40SL



72238 **HEATING ELEMENT**  
power: 1000W

EKP-T7/60



72237 **HEATING ELEMENT EKP-T900**  
power: 1500W

EKP-T9/80  
EKP-T9/100  
EKP-T9/120

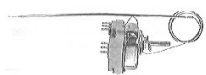

72487 **THERMOSTAT**  
operating temp.: 50-290°C  
el. load: 16 (2,6)A/380V  
pole: 1; capillary: L=830 mm

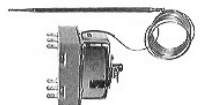

72583 **SAFETY-THERMOSTAT**  
operating temp.: 368°C  
el. load: 20 (4)A/380 V  
poles: 3; capillary: L= 1490 mm

Electric tilting pans







# THERMAL EQUIPMENT KOGAST 700 and 900 COOKING PANS

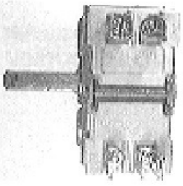
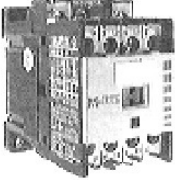
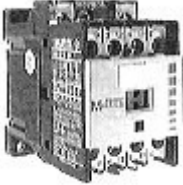

Зип Общепит

vsezip.ru

+7(812)987-08-81

Spare parts	Code No.	Description	Ref.	Remark
	73457	<b>MAIN SWITCH ON-OFF</b> el. load: 16A/250V-10A/400V poles: 2		
	73112	<b>CONTACTOR DIL M7-10</b> voltage: 230V AC	EKP-T7/40SL EKP-T7/60 EKP-T9/80 EKP-T9/100	
	73114	<b>CONTACTOR KNL30-00</b> voltage: 230V AC	EKP-T9/120	73112 until July 2009; 73114 since July 2009
	72439	<b>LIMIT SWITCH - MAGNETIC</b> el. current: 100 mA power: 100W, U=1000V type: RP 86 85 700 EF		
	42250	<b>WATER INLET VALVE</b> thread: G1/2		
	43408	<b>BRAIDED HOSE</b> between valve and outlet G1/2"-G1/2"X1200		
	82814	<b>"O" RING ON WATER OUTLET</b> dim.: fi30/fi24x3 mm material: rubber		
	43413	<b>BRAIDED HOSE</b> water connection G1/2-G1/2"x500		since July 2009

Electric tilting pans

# THERMAL EQUIPMENT KOGAST 700 and 900 COOKING PANS



Зип Общепит

vsezip.ru

+7(812)987-08-81

Spare parts	Code No.	Description	Ref.	Remark
	56249	TILTING MECHANISM		
	53232	HANDWHEEL WITH FLEXIBLE HANDLE dim.: fi200 mm		
	36738	FLEXIBLE HANDLE FOR HANDWHEEL dim.: fi200 mm		
	56264	THREADED SPINDLE 700	EKP-T7/40SL EKP-T7/60	
	56297	THREADED SPINDLE 900	EKP-T9/80 EKP-T9/100 EKP-T9/120	
	56185	NUT FOR THREADED SPINDLE 700 AND 900		cooking pans 900 since September 2009
	45613	MAGNET dim.: fi 22 mm thread: M5		
	47572	COIL SPRING FOR LIFTING MECHANISM dim.: fi5,5 x fi 53x220 mm		

Electric tilting pans



# THERMAL EQUIPMENT KOGAST 700 and 900 COOKING PANS



Зип Общепит

vsezip.ru

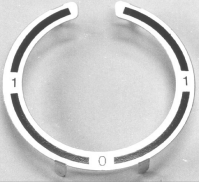
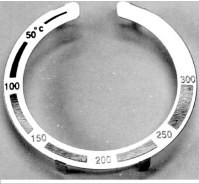
+7(812)987-08-81

Spare parts	Code No.	Description	Ref.	Remark
	46201	SCALE LABEL FOR MAIN SWITCH BUTTON		
	46205	SCALE LABEL FOR BUTTON		
	53253	HINGE SPRING FOR COVER - LEFT dim.: Ć 4,2	EKP-T7/40SL EKP-T7/60 EKP-T9/80 EKP-T9/100 EKP-T9/120	
	53256	HINGE SPRING FOR COVER - RIGHT dim.: fi4,2	EKP-T7/40SL EKP-T7/60 EKP-T9/80 EKP-T9/100 EKP-T9/120	

## ARCHIVE OF CHANGES

56289 SPINDLE NUT

replaced with nut  
56185 (cooking pans  
900) since  
September 2009

Electric tilting pans

# THERMAL EQUIPMENT KOGAST 700 and 900 COOKING PANS



Зип Общепит

vsezip.ru

+7(812)987-08781

Code	Type	Drawing
------	------	---------

55880 PKP-T7/40SL  
55879 PKP-T7/60  
55946 PKP-T9/80  
55947 PKP-T9/100  
55948 PKP-T9/120

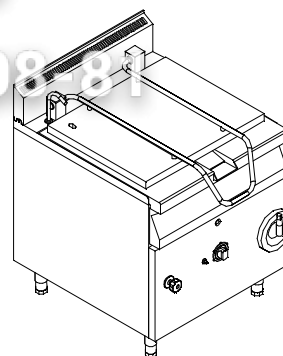

Spare parts	Code No.	Description	Ref.	Remark
-------------	----------	-------------	------	--------



56219 **BURNER**  
power: 10,5kW

PKP-T7/40SL  
PKP-T7/60



50225 **BURNER**  
power: 15,6kW

PKP-T9/80



50249 **BURNER**  
power: 20kW

PKP-T9/100



50768 **BURNER**  
power: 25kW

PKP-T9/120



46328 **PIEZO IGNITER**



44820 **PILOT FLAME SPARK PLUG**

Gas tilting pans

# THERMAL EQUIPMENT KOGAST 700 and 900 COOKING PANS



Зип Общепит

vsezip.ru

+7(812)987-08-81

Spare parts	Code No.	Description	Ref.	Remark
	47474	<b>CABLE FOR PIEZO SPARKING DEVICE</b> L= 500 mm		
	53086	<b>PIEZO IGNITER PROTECTION</b>		
	42122	<b>GAS VALVE - SET</b> 42104 gas valve 24STS 42105 gas valva screw 42106 ring for gas valve 42107 ring for gas valve 42108 nut for gas valve		
	46228	<b>PILOT FLAME BURNER</b>		since July 2013
	42104	<b>GAS VALVE 24STS</b>		
	42105	<b>GAS VALVE SCREW FOR PILOT FLAME BURNER</b> dim.: fi 6 mm		
	42106	<b>RING FOR GAS VALVE</b> dim.: fi 6 mm		
	42107	<b>NUT FOR GAS VALVE</b> M20x1,5 / fi 12 mm		

Gas tilting pans

# THERMAL EQUIPMENT KOGAST 700 and 900 COOKING PANS



Зип Общепит

vsezip.ru

+7(812)987-08-81

Spare parts	Code No.	Description	Ref.	Remark
	42108	<b>RING FOR GAS VALVE</b> dim.: fi 12 mm		
	47033	<b>THERMOELEMENT</b> L= 600 mm without thread	PKP-T7/40SL PKP-T7/60 PKP-T9/80 PKP-T9/100	
	47032	<b>THERMOELEMENT</b> L= 1200 mm without thread	PKP-T9/120	
	24414	<b>INJECTOR 160</b> thread: M1 1 x1	PKP-T7/40SL PKP-T7/60	G30/G31; 30 mbar (LPG)
	20051	<b>INJECTOR 280</b> thread: M1 1 x1	PKP-T7/40SL PKP-T7/60	G20; 20 mbar (natural gas)
	22387	<b>INJECTOR 200</b> thread: M1 1 x1	PKP-T9/80	G30/G31; 30 mbar (LPG)
	46870	<b>INJECTOR FOR PILOT FLAME BURNER 027</b> G30/G31		since July 2013
	29007	<b>INJECTOR 320</b> thread: M1 1 x1	PKP-T9/80	G20; 20 mbar (natural gas)

Gas tilting pans



# THERMAL EQUIPMENT KOGAST 700 and 900 COOKING PANS



Зип Общепит

vsezip.ru

+7(812)987-08-81

Spare parts	Code No.	Description	Ref.	Remark
	38846	<b>INJECTOR 220; G30/G31</b> thread: M1 1x1	PKP-T9/100	G30/G31; 30 mbar (LPG)
	38845	<b>INJECTOR 340</b> thread: M1 1x1	PKP-T9/100	G20; 20 mbar (natural gas)
	20050	<b>INJECTOR 250</b> thread: M1 1x1	PKP-T9/120	G30/G31; 30 mbar (LPG)
	40129	<b>INJECTOR 360</b> thread: M1 1x1	PKP-T9/120	G20; 20 mbar (natural gas)
	42250	<b>WATER INLET VALVE</b> thread: G1/2		
	43408	<b>BRAIDED HOSE</b> between valve and outlet G1/2"-G1/2"X1200		
	82814	<b>"O" RING ON WATER OUTLET</b> dim.: fi30/fi24x3 mm material: rubber		
	43413	<b>BRAIDED HOSE</b> water connection G1/2-G1/2"x500		

Gas tilting pans

# THERMAL EQUIPMENT KOGAST 700 and 900 COOKING PANS



Зип Общепит

vsezip.ru

+7(812)987-08-81

Spare parts	Code No.	Description	Ref.	Remark
	53232	<b>HANDWHEEL WITH FLEXIBLE HANDLE</b> dim.: fi200 mm		
	56249	<b>TILTING MECHANISM</b>		
	36738	<b>FLEXIBLE HANDLE FOR HANDWHEEL</b> dim.: fi200 mm		
	47572	<b>COIL SPRING FOR LIFTING MECHANISM</b> dim.: fi5,5 x fi 53x220 mm		
	56264	<b>THREADED SPINDLE 700</b>	PKP-T7/40SL PKP-T7/60	
	56297	<b>THREADED SPINDLE 900</b>	PKP-T9/80 PKP-T9/100 PKP-T9/120	
	56185	<b>NUT FOR THREADED SPINDLE 700 AND 900</b>		cooking pans 900 since September 2009
	83356	<b>BUTTON FOR GAS VALVE</b>		

Gas tilting pans

# THERMAL EQUIPMENT KOGAST 700 and 900 COOKING PANS



Зип Общепит

vsezip.ru

+7(812)987-08-81

Spare parts	Code No.	Description	Ref.	Remark
-------------	----------	-------------	------	--------



46218 SCALE LABEL FOR BUTTON  
PL 1-8



44412 GLASS FOR MAIN AND PILOT FLAME



53253 HINGE SPRING FOR COVER - LEFT  
dim.: Ć 4,2



53256 HINGE SPRING FOR COVER - RIGHT  
dim.: fi4,2

## ARCHIVE OF CHANGES

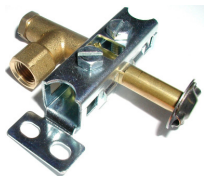

46241 PILOT FLAME BURNER

replaced with pilot flame burner 46228 with new support 57289 since July 2013

56289 SPINDLE NUT

replaced with spindle nut 56185 (cooking pans 900) since September 2009

Gas tilting pans