

	Modifica	  Codice	 Descrizione	 Cons.	Qtà Data validità
		1 3289330	TUBO ALIM. ACQUA		1 01/04/2016-
		2 3162191	RUBINETTO 3/8"	X	1 01/04/2016-
		3 3162210	MANOPOLA ANELLO BLU		1 01/04/2016-10/10/2019
		3 3162211	MANOPOLA RUBINETTO ACQUA BLU	X	1 11/10/2019-31/08/2021
		4 3289310	TUBO ALIM. ACQUA		1 01/04/2016-05/04/2021
		5 3003441	EROGATORE ACQUA	X	1 01/04/2016-
		6 36E3040	TAPPO M"1"	X	1 01/04/2016-
		7 3067420	RACCORDO "T" 1"	X	1 01/04/2016-
		8 33D1980	VALVOLA SFERA MF 1"	X	1 01/04/2016-
		9 3230210	TUBO SCARICO AD "Y"		1 01/04/2016-
		10 3230200	CAPPUCCIO DI MANOVRA VALVOLA	X	1 01/04/2016-
		11 3266970	ASTA MANIGLIA	X	1 01/04/2016-
		12 3235620	DISCO CHIUSURA PER ASTA		1 01/04/2016-
		13 3231990	LEVA COMANDO VALVOLA	X	1 01/04/2016-
		14 3266990	FILTRO COMP. CP	X	1 01/04/2016-

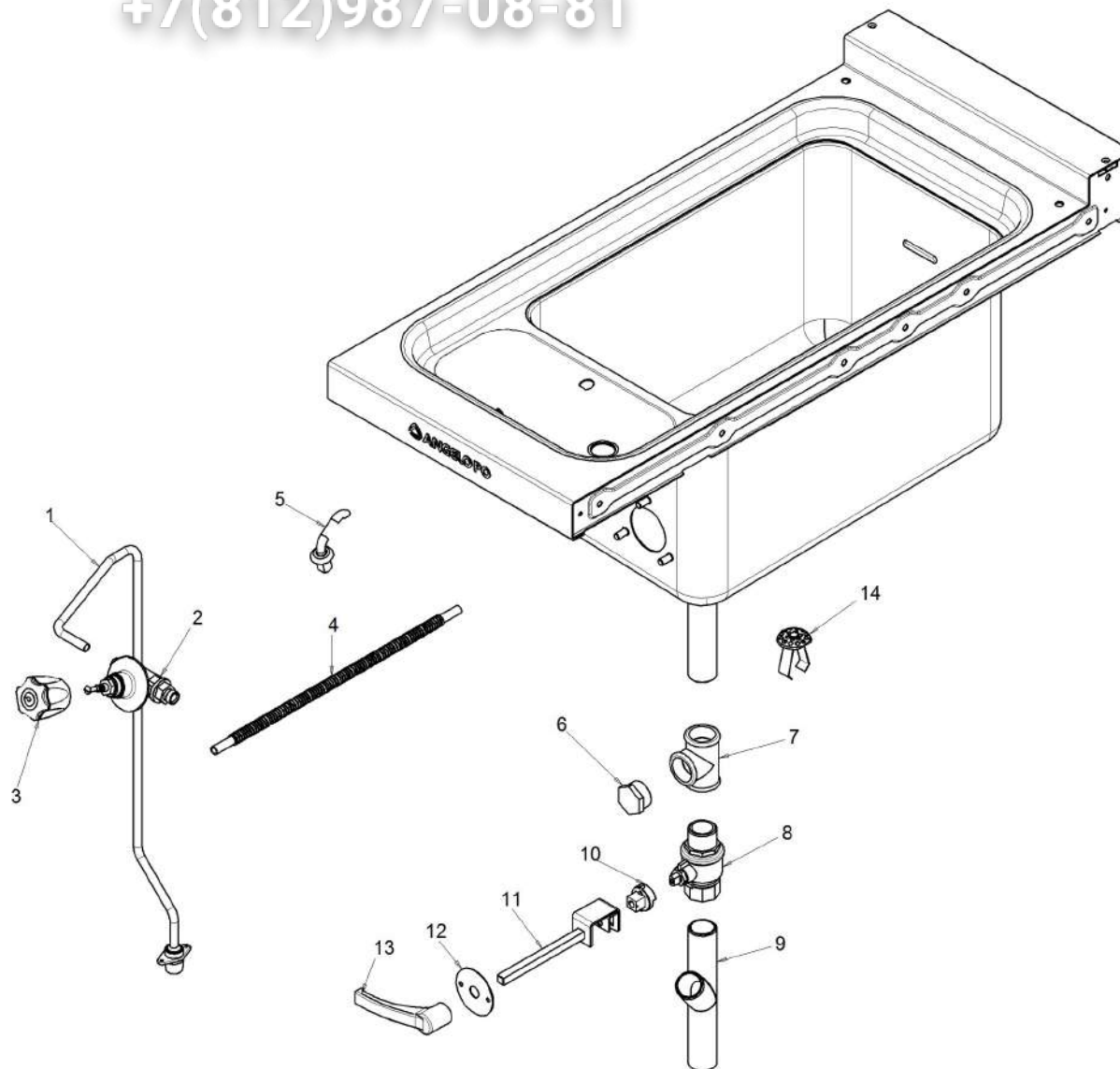

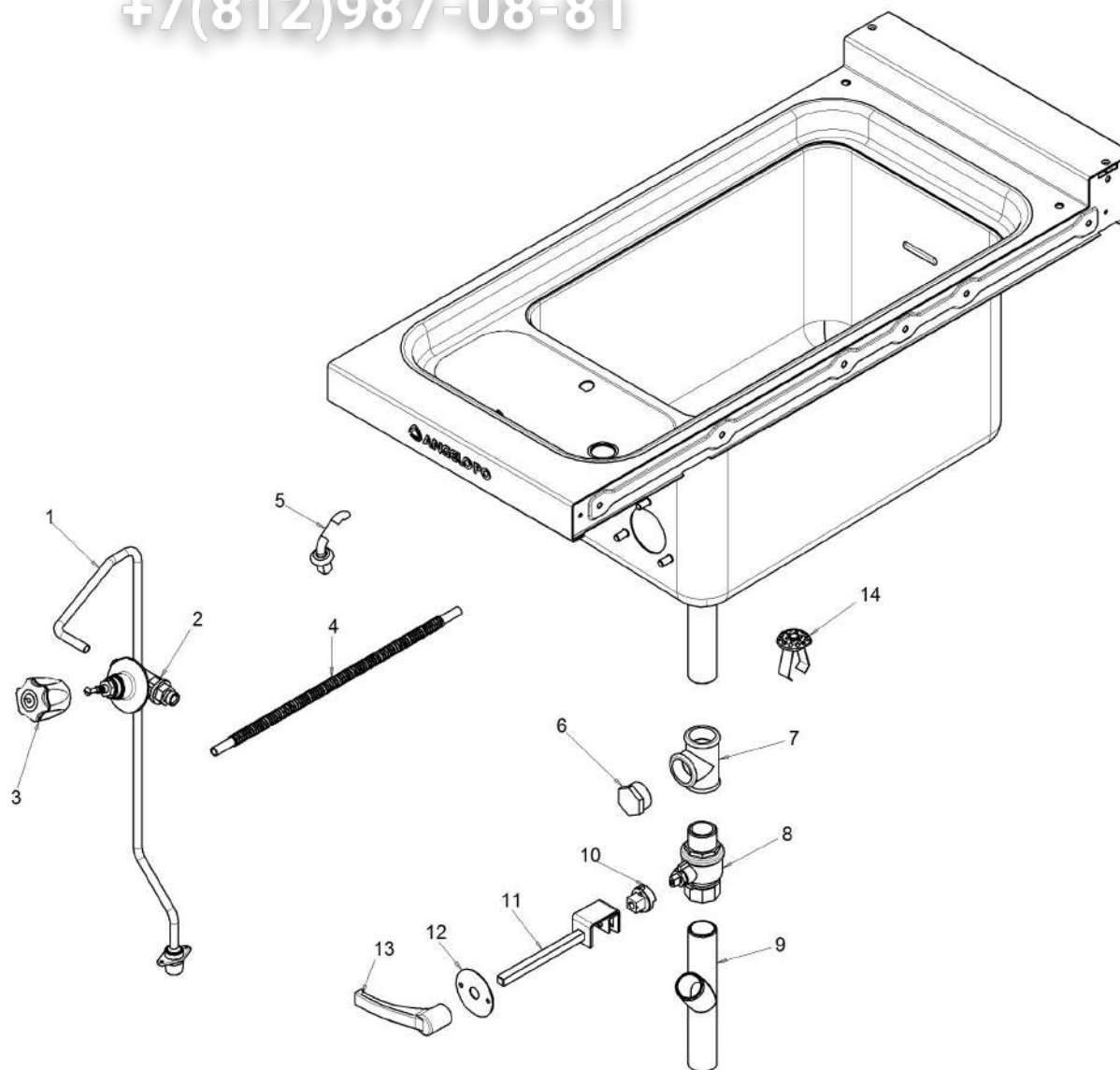





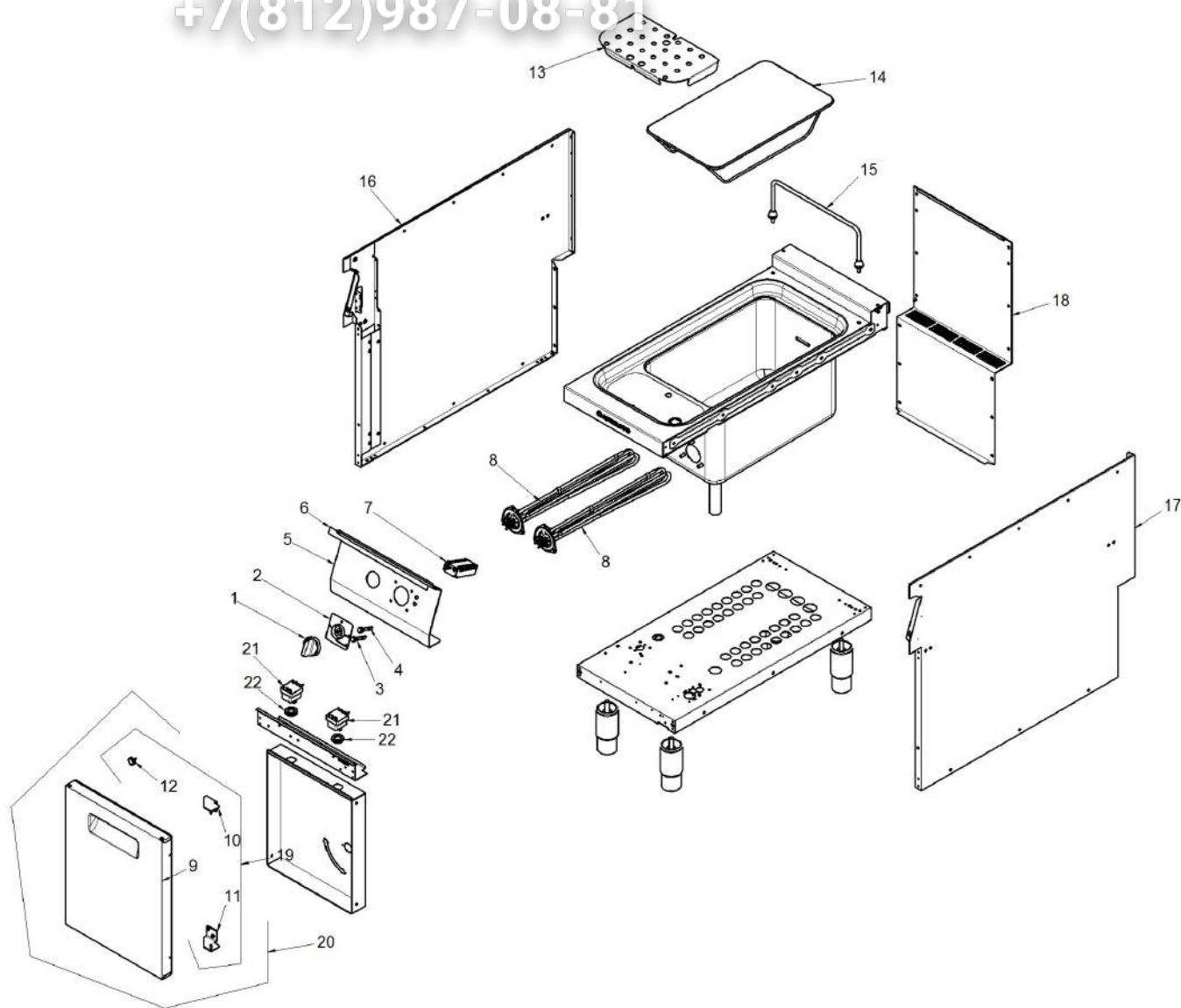





















	Modifica	  Codice	 Descrizione	 Cons.	Qtà Data validità
		1 3289330	TUBO ALIM. ACQUA		1 01/04/2016-
		2 3162191	RUBINETTO 3/8"	X	1 01/04/2016-
		3 3162211	MANOPOLA RUBINETTO ACQUA BLU	X	1 11/10/2019-31/08/2021
		3 3162201	MANOPOLA ANELLO ROSSO	X	1 01/09/2021-
		4 3014320	TUBO PIEGHEVOLE DN10 L=400	X	1 06/04/2021-29/09/2022
		4 3014321	TUBO PIEGHEVOLE DN10 L=400	X	1 30/09/2022-
		5 3003441	EROGATORE ACQUA	X	1 01/04/2016-
		6 36E3040	TAPPO M"1"	X	1 01/04/2016-
		7 3067420	RACCORDO "T" 1"	X	1 01/04/2016-
		8 33D1980	VALVOLA SFERA MF 1"	X	1 01/04/2016-
		9 3230210	TUBO SCARICO AD "Y"		1 01/04/2016-
		10 3230200	CAPPUCCIO DI MANOVRA VALVOLA	X	1 01/04/2016-
		11 3266970	ASTA MANIGLIA	X	1 01/04/2016-
		12 3235620	DISCO CHIUSURA PER ASTA		1 01/04/2016-
		13 3231990	LEVA COMANDO VALVOLA	X	1 01/04/2016-
		14 3266990	FILTRO COMP. CP	X	1 01/04/2016-



	Modifica	  Codice	 Descrizione	 Cons.	Qtà Data validità
		1 3289330	TUBO ALIM. ACQUA		1 01/04/2016-
		2 3162191	RUBINETTO 3/8"	X	1 01/04/2016-
		3 3162211	MANOPOLA RUBINETTO ACQUA BLU	X	1 11/10/2019-31/08/2021
		3 3162201	MANOPOLA ANELLO ROSSO	X	1 01/09/2021-
		4 3014320	TUBO PIEGHEVOLE DN10 L=400	X	1 06/04/2021-29/09/2022
		4 3014321	TUBO PIEGHEVOLE DN10 L=400	X	1 30/09/2022-
		5 3003441	EROGATORE ACQUA	X	1 01/04/2016-
		6 36E3040	TAPPO M"1"	X	1 01/04/2016-
		7 3067420	RACCORDO "T" 1"	X	1 01/04/2016-
		8 33D1980	VALVOLA SFERA MF 1"	X	1 01/04/2016-
		9 3230210	TUBO SCARICO AD "Y"		1 01/04/2016-
		10 3230200	CAPPUCCIO DI MANOVRA VALVOLA	X	1 01/04/2016-
		11 3266970	ASTA MANIGLIA	X	1 01/04/2016-
		12 3235620	DISCO CHIUSURA PER ASTA		1 01/04/2016-
		13 3231990	LEVA COMANDO VALVOLA	X	1 01/04/2016-
		14 3266990	FILTRO COMP. CP	X	1 01/04/2016-



	Modifica	   	Codice	 	Descrizione	 	Cons.	Qtà	Data validità
			1 3316250		MANOPOLA PERNO §6				1 01/04/2016-24/07/2020
			1 3389300		MANOPOLA PERNO §6		X		1 25/07/2020-
			2 3277820		BASE MANOPOLA				1 01/04/2016-
			3 3106710		LAMPADA VERDE 230V		X		1 01/04/2016-
			4 3106720		LAMPADA ROSSA 230V		X		1 01/04/2016-
			5 3300640		CRUSCOTTO				1 01/04/2016-05/04/2021
			5 3300641		CRUSCOTTO				1 06/04/2021-
			6 3311680		STRISCIA ROSSA		X		1 01/04/2016-
			7 3161840		COMMUTATORE 4 POS.		X		1 01/04/2016-20/11/2022
			7 3448360		COMMUTATORE 4 POS.		X		1 21/11/2022-
			8 32G2310		RESISTENZA 6000W. 400V		X		2 01/04/2016-
			9 6054570		GR. PORTA DX		X		1 01/04/2016-
			10 3253550		CERNIERA SUPERIORE DX				1 01/04/2016-
			11 3253560		CERNIERA INFERIORE DX				1 01/04/2016-
			12 3020990		MAGNETE		X		1 01/04/2016-
			13 35M9431		F/FONDO		X		1 01/04/2016-
			14 36A4642		RETE FONDO COMP.		X		1 01/04/2016-
			15 3289280		AGGANCIO PER CESTELLO				1 01/04/2016-
			16 3310870		FIANCO SX				1 01/04/2016-24/09/2017
			16 3361700		FIANCO SX				1 25/09/2017-25/11/2021

	Modifica	    Codice	  Descrizione	  Cons.	Qtà Data validità
		16 3361701	FIANCO SX		126/11/2021-
		17 3310880	FIANCO DX		101/04/2016-24/09/2017
		17 3361710	FIANCO DX		125/09/2017-25/11/2021
		17 3361711	FIANCO DX		126/11/2021-
		18 3202030	RETRO		101/04/2016-24/09/2017
		18 3361830	RETRO		125/09/2017-
		19 6045171	GR.CERNIERA PORTA DX	X	101/04/2016-
		20 M070610	MODULO PORTA DX		101/04/2016-
		21 3014261	TERMOSTATO SICUREZZA STB	X	201/04/2016-
		22 32X0120	PASSACAVO	X	201/04/2016-