

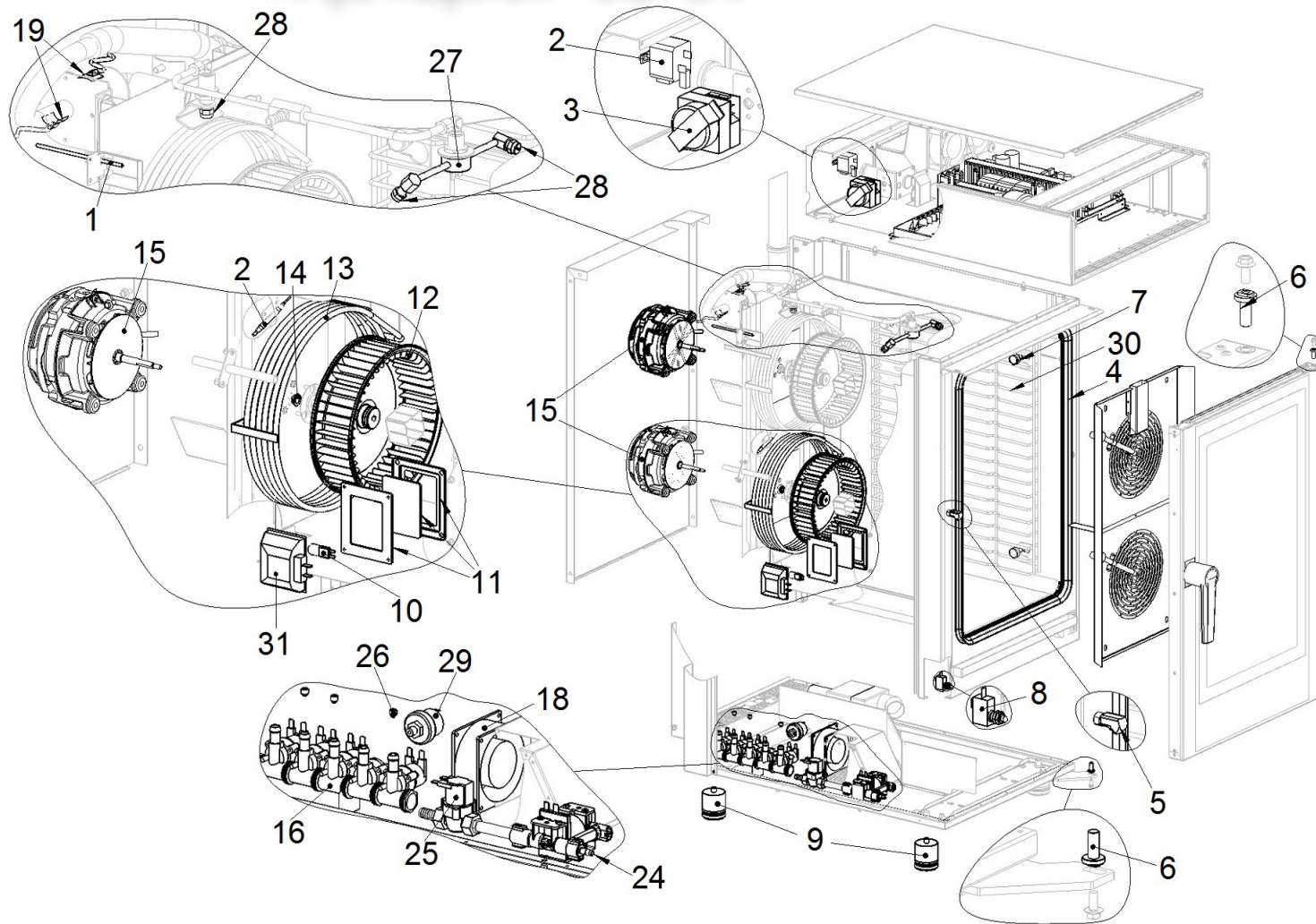































+7(812)987-08-81



	Modification	   Code	  Description	  Rec.	Price  	Qty Validity date
		1 3336850	Temperature probe	X	116,42	1 23/04/2016-
		2 3336860	Safety thermostat	X	104,90	1 23/04/2016-
		3 3336870	Motor for valve	X	109,88	1 23/04/2016-
		4 3336990	Black oven seal (2 meters for door)	X	45,51	2 23/04/2016-
		5 3336880	Locking dog		52,15	1 23/04/2016-
		6 3380630	spindle for door		26,95	2 23/04/2016-
		7 3376310	Bearing pin for grids rack		15,82	1 23/04/2016-
		8 3336890	Door microswitch	X	23,95	1 23/04/2016-
		9 3336900	Adjustable foot		0,00	4 23/04/2016-
		10 3336910	Halogen bulb 25w 220V	X	17,05	1 23/04/2016-
		11 3336920	Kit lamp socket gasket	X	52,77	1 23/04/2016-
		12 3336930	Oven fan 200x61	X	184,72	2 23/04/2016-12/06/2019
		12 3408220	Oven fan 200x61	X	206,50	2 13/06/2019-
		13 3336940	Heating element 6600 W 230V	X	354,74	2 23/04/2016-
		14 3336950	Motor shaft seal	X	9,34	2 23/04/2016-12/06/2019
		14 3408230	Motor shaft seal	X	14,43	2 13/06/2019-
		15 3336960	Motor 3ph	X	584,39	2 23/04/2016-12/06/2019
		15 3407960	MOTOR 230V-50/60Hz/3F	X	614,71	2 13/06/2019-
		16 3337150	Solenoid valve for water	X	326,61	1 23/04/2016-
		17 3336970	Nozzle for humidifying pipe	X	6,90	1 23/04/2016-

+7(812)987-08-81

	Modification	  Code	 Description	 Rec.	Price 	Qty Validity date
	18	3379330	Fan	X	236,99	223/04/2016-
	19	3401410	Umidity probe	X	152,64	123/04/2016-
	24	3337130	Detergent pump	X	165,74	123/04/2016-
	25	3337120	1-way solenoid valve for detergent	X	82,97	123/04/2016-
	26	3336980	Nozzle for washing system	X	14,14	123/04/2016-
	27	3337110	Diffuser washing system		297,15	123/04/2016-
	28	3337100	Nozzle for washing system		66,57	123/04/2016-
	29	3337180	Water pressure valve	X	83,00	123/04/2016-
	30	3376430	GRID SUPPORT		327,08	223/04/2016-
	31	3424150	LAMP.HOLDER		31,09	123/04/2016-