

Зип Общепит

vsezip.ru

Fino al / until 2004  
ordinare assieme  
order together  
ref. 37+34

+7(812)987-08-81

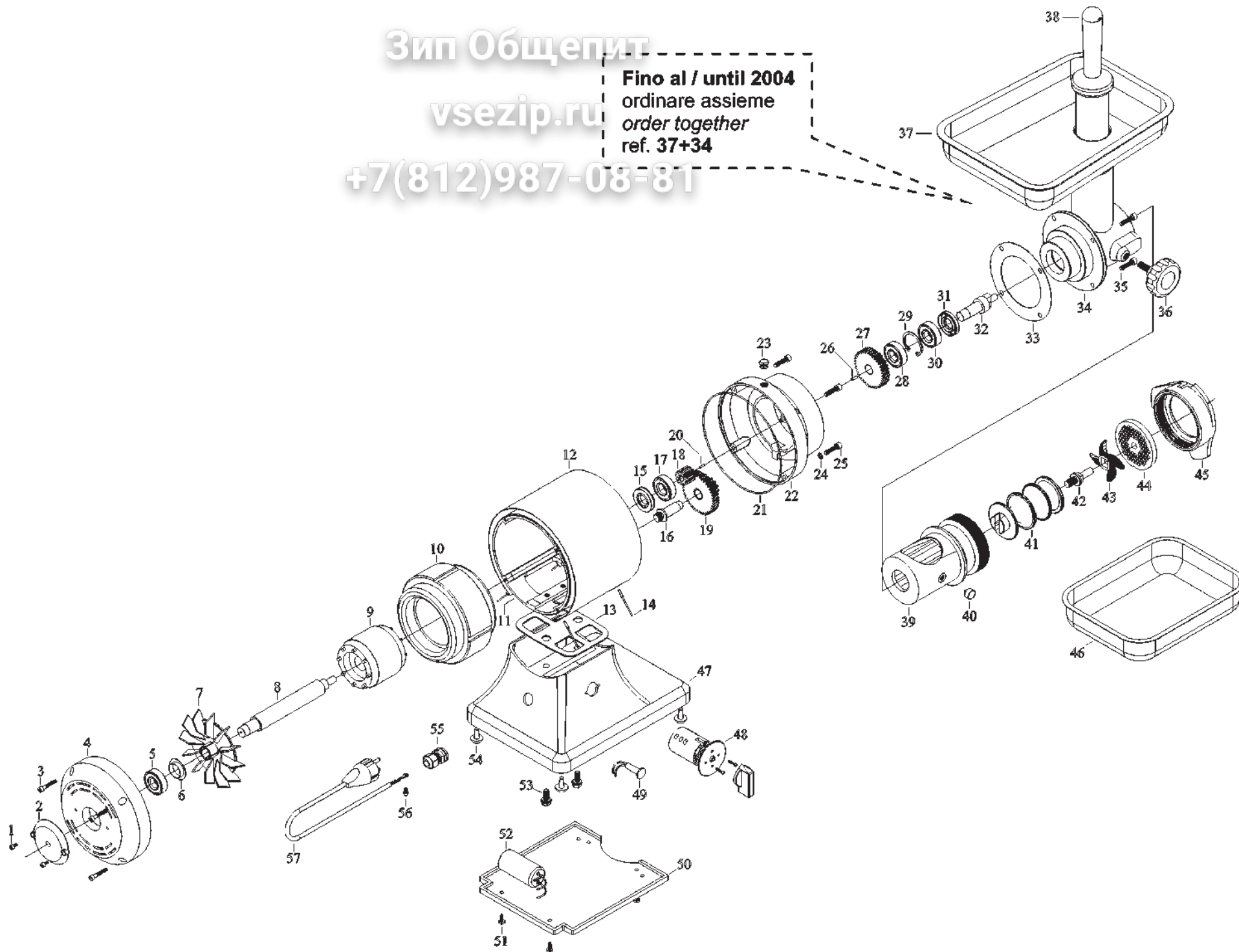

# Zip Общепит

TC 22 E - from 2004 TAV. UNICA

Riferiment	Nome prodotto	Codice	Q
	2 DISCO DI CHIUSURA TC/TCG/GF	MF2002	1
	4 CALOTTA VENTILATA GF-TC12-22E	MF2087	1
	5 CUSC.IX.FLAN.PLD ING.Y14 6203 2RS	19320203X	1
	6 ANELLO FISSAGGIO GF-TC12-22E	MF2145	1
	7 VENTOLA GF-TC12-22E	MF2146	1
	8 ALBERO MOTORE 230V. TC 22E	MF2200	1
	8 ALBERO MOTORE 400V. TC 22E	MF2201	1
08+09	ASS. ROTORE+ALBERO Y04 MN TC 22	MF0TC02202	1
08+09	ASS. ROTORE+ALBERO Y04 TF TC 22	MF0TC02203	1
	10 STATORE 230V/50 MN TC 22E	MF2203	1
	10 STATORE 400V/50 TF TC 22E	MF2204	1
	11 CARCASSA VENT. TC/TCG12-22E	MF2148	1
	12 FASCIA INOX TC/TCG12-22E	MF2100	1
	13 GUARNIZIONE BASE TC12E	MF2353	1
	15 PARAOLIO 40X25X7 TC/TCG12-22E	MF2101	1
	16 PERNO PORTA-INGRANAGGIO TC22E	MF2205	1
	17 CUSC.IX.FLAN.PLD ING.Y14 6203 2RS	19320203X	1
	18 INGRANAGGIO ELICA TC/TCG12-22E	MF2104	1
	19 INGRANAGGIO DOPPIO TC/TCG12-22E	MF2106	1
	20 CHIAVETTA 3X15	MF2606	1
	21 ANELLO OR 164,5X2 TC/TCG12-22E	MF2351	1
	22 CALOTTA CON MOZZO TC22E	MF2184	1
	23 TAPPO OLIO IN GOMMA TC/TCG	MF2112	1
	24 RONDELLA DI TENUTA TC/TCG	MF2352	1
	26 CHIAVETTA 4X12	MF2607	1
	27 INGRANAGGIO GRANDE TC/TCG12-22E	MF2107	1
	28 CUSC.IX.FLAN.PLD ING.Y14 6203 2RS	19320203X	1
	29 SEEGER DA 40 TC12-22E	MF2108	1
	30 CUSC.IX.FLAN.PLD ING.Y14 6203 2RS	19320203X	1
	31 PARAOLIO 40X25X7 TC/TCG12-22E	MF2101	1
	32 PERNO TRASCINATORE TC/TCG	MF2109	1
	33 GUARNIZIONE IN GOMMA TC22E	MF2206	1
	34 BOCCHETTONE TC22E	MF2209	1
	36 POMELLO FERMA BOCCA TC/TCG	MF2115	1
	37 TRAMOGGIA TC/TCG22E	MF2207	1
	38 PEDESTALLO TC/TCG 12E	MF2114	1

)

# Зип Общепит

45 VOLANTINO INOX TC/TCG22E	MF2221	1
46 CONTENITORE CARNE TC/TCG22E	MF2222	1
47 BASE TC12E	MF2137	1
48 INVERTITORE BIPOLARE TC12E	MF2364	1
48 INVERTITORE TRIPOLARE TC12E	MF2335	1
49 SPIA LUMINOSA ON/OFF TC/TCG	MF2192	1
50 FONDINO ABS GF-TC/TCG12E	MF2142	1
52 CONDENSATORE 25 MF TC/TCG 22E	MF2223	1
53 VITE TE DIN 933 M 8X25 T.F.	IX2933008025	10
54 PIEDINI IN GOMMA TC/TCG	MF2031	1
55 PRESSACAVO PG 11	19410805	5
57 CAVO ALIM.COMP. MN SUKO UNIFI	19410502	1
57 CAVO ALIM.COMP. TF ITALIA UNI	19410506	1

zip.ru

812987-08-81