



## heating elements

## immersion heating elements

3 hole flange ø47.5mm



<b>Part No.</b>	415931	<b>Ref. No.</b>	5007076 5007076K
<b>description</b>	heating element 12000W 220V mounting ø 47.5mm heating circuits 3 L 585mm W 28mm H 28mm number of thermostat sleeves 1 thermostat sleeves ø 6.5mm length thermostat sleeves 170mm thermostat sleeve clinging tube ø 6.3mm hole distance 63mm hole ø 8mm cable length 950mm 3 hole flange immersion heater		
<b>For models:</b>	OD20.20, OS20.20, OSC20.20, OSP20.20		
<b>accessories for</b>	415931		
	<b>Part No.</b>	510408	<b>Ref. No.</b> 6005015
	O-ring EPDM thickness 5.34mm ID ø 47mm Qty 1 pcs		
	<b>Part No.</b>	510562	<b>Ref. No.</b> —
	O-ring silicone thickness 5.34mm ID ø 47mm Qty 1 pcs		



<b>Part No.</b>	415803	<b>Ref. No.</b>	5007062 5007062K
<b>description</b>	heating element 6000W 230V mounting ø 47.5mm heating circuits 3 L 325mm W 26mm H 38mm number of thermostat sleeves 1 thermostat sleeves ø 6mm length thermostat sleeves 160mm thermostat sleeve clinging tube ø 6.3mm hole distance 62mm hole ø 8mm cable length 790mm connection cable 3 hole flange immersion heater		
<b>For models:</b>	OD10.10, OD10.20, OS10.10, OS10.20, OSC10.10, OSC10.20, OSP10.10, OSP10.20		
<b>spare parts for</b>	415803		
	<b>Part No.</b>	510408	<b>Ref. No.</b> 6005015
	O-ring EPDM thickness 5.34mm ID ø 47mm Qty 1 pcs		
<b>accessories for</b>	415803		
	<b>Part No.</b>	510562	<b>Ref. No.</b> —
	O-ring silicone thickness 5.34mm ID ø 47mm Qty 1 pcs		

Зип Ощепит

vsezip.ru

+7(812)987-08-81

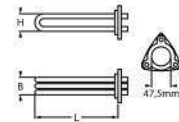

<b>Part No.</b>	415802	<b>Ref. No.</b>	5007071 5007071K 5030632
<b>description</b>	heating element 9000W 230V mounting ø 47.5mm heating circuits 3 L 385mm W 35mm H 46mm number of thermostat sleeves 1 thermostat sleeves ø 6mm length thermostat sleeves 160mm thermostat sleeve clinging tube ø 8.5mm hole distance 62mm hole ø 8mm cable length 800mm 3 hole flange immersion heater		
<b>For models:</b>	OD10.10, OD10.20, OD12.20, OD20.10, OD20.20, OD6.10, OS10.10, OS10.20, OS12.20, OS20.10, OS6.10, OSC10.10, OSC10.20, OSC12.20, OSC20.10, OSC6.10, OSP10.10, OSP10.20, OSP12.20, OSP20.10, OSP6.10		
<b>accessories for</b>	415802		
	<b>Part No.</b>	510562	<b>Ref. No.</b> —
	O-ring silicone thickness 5.34mm ID ø 47mm Qty 1 pcs		

## miscellaneous



<b>Part No.</b>	420042	<b>Ref. No.</b>	2619180 5017003
<b>description</b>	heating element 13200W 230V heating circuits 3 L 545mm W 65mm H 33mm number of thermostat sleeves 1 thermostat sleeves ø 8mm length thermostat sleeves 160mm tube ø 8.5mm hole distance 71mm hole ø 7mm cable length 1000mm flange connection immersion heater flange width 57mm flange length 88mm		
<b>For models:</b>	OEB20.20, OES20.20		



<b>Part No.</b>	417733	<b>Ref. No.</b>	5056321
<b>description</b>	heating element 13300W 230V heating circuits 3 L 275mm W 35mm H 70mm number of thermostat sleeves 2 thermostat sleeves ø 3.5/8mm length thermostat sleeves 120/140mm thermostat sleeve eccentric, clinging tube ø 8.5mm hole distance 67mm hole ø 8mm combi-steamer flange width 82mm flange length 82mm with gasket and nut		





<b>Part No.</b>	420043	<b>Ref. No.</b>	2619178 5017001
<b>description</b>	heating element 6600W 230V heating circuits 3 L 275mm W 65mm H 37mm number of thermostat sleeves 1 thermostat sleeves ø 7.8mm length thermostat sleeves 150mm tube ø 8.5mm hole distance 71mm hole ø 7mm cable length 1050mm flange connection immersion heater flange width 57mm flange length 88mm		
<b>For models:</b>	OEB10.10, OEB10.20, OEB6.20, OES10.10, OES10.20, OES6.20		
<b>accessories for</b>	420043		
	<b>Part No.</b>	550992	<b>Ref. No.</b> 6015023
	gasket L 87mm W 57mm hole ø 6mm hole distance 70/40mm 4 holes thickness 3mm suitable for CONVOTHERM		





Зип Общепит

vsezip.ru







7(812)987-08-81



			
1			
<b>Part No.</b>	417601	<b>Ref. No.</b>	2619187 5017012
<b>description</b>	heating element 6600W 230V heating circuits 3 L 275mm W 70mm H 25mm hole distance 40x70mm hole ø 6.5mm cable length 1010mm tube ø 8.5mm flange length 87mm flange width 56mm thermostat sleeves ø 6mm number of thermostat sleeves 1 length thermostat sleeves 170mm		
<b>For models:</b>	OEB10.10, OEB10.20, OEB6.20, OES10.10, OES10.20, OES6.20		
<b>accessories for</b>	417601		
	<b>Part No.</b>	550992	<b>Ref. No.</b> 6015023
	gasket L 87mm W 57mm hole ø 6mm hole distance 70/40mm 4 holes thickness 3mm suitable for CONVOTHERM		

			
1			
<b>Part No.</b>	417734	<b>Ref. No.</b>	5056320
<b>description</b>	heating element 9000W 230V heating circuits 3 L 210mm W 40mm H 70mm number of thermostat sleeves 2 thermostat sleeves ø 3.5/8mm length thermostat sleeves 119/139mm thermostat sleeve eccentric, clinging tube ø 8.5mm hole distance 67mm hole ø 8mm flange combi-steamer flange width 82mm flange length 82mm		

			
1			
<b>Part No.</b>	417719	<b>Ref. No.</b>	2619188 5017013
<b>description</b>	heating element 9900W 230V heating circuits 3 L 415mm W 52mm H 37mm number of thermostat sleeves 1 thermostat sleeves ø 7.5mm length thermostat sleeves 160mm thermostat sleeve eccentric, clinging tube ø 8.5mm hole distance 71mm hole ø 7mm 4 hole flange immersion heater flange width 57mm flange length 88mm		
<b>For models:</b>	OEB10.10, OEB10.20, OEB12.20, OEB20.10, OEB20.20, OEB6.10, OEB6.20, OES10.10, OES10.20, OES12.20, OES20.10, OES6.10, OES6.20		
<b>accessories for</b>	417719		
	<b>Part No.</b>	550992	<b>Ref. No.</b> 6015023
	gasket L 87mm W 57mm hole ø 6mm hole distance 70/40mm 4 holes thickness 3mm suitable for CONVOTHERM		

			
1			
<b>Part No.</b>	418685	<b>Ref. No.</b>	2619179 5017002
<b>description</b>	heating element 9900W 230V heating circuits 3 L 415mm W 65mm H 37mm number of thermostat sleeves 1 thermostat sleeves ø 6.5mm length thermostat sleeves 160mm tube ø 8.5mm hole distance 72mm hole ø 7mm flange width 58mm flange length 88mm		
<b>For models:</b>	OEB10.10, OEB10.20, OEB12.20, OEB20.10, OEB6.10, OEB6.20, OES10.10, OES10.20, OES12.20, OES20.10, OES6.10, OES6.20		
<b>accessories for</b>	418685		
	<b>Part No.</b>	550992	<b>Ref. No.</b> 6015023
	gasket L 87mm W 57mm hole ø 6mm hole distance 70/40mm 4 holes thickness 3mm suitable for CONVOTHERM		

			
1			
<b>Part No.</b>	415874	<b>Ref. No.</b>	5007067 5007068 5007068K 5030631
<b>description</b>	heating element 12000/14300W 220/240V heating circuits 3 thread 1½" L 585mm W 40mm H 30mm thermostat sleeves ø 6.5mm length thermostat sleeves 160mm thermostat sleeve eccentric, clinging tube ø 6.3mm cable length 750mm connection cable immersion heater flange with thread hole distance 63mm mounting ø 47.5mm hole ø 8/10mm number of thermostat sleeves 1		
<b>For models:</b>	HUD20.20		
<b>spare parts for</b>	415874		
	<b>Part No.</b>	510406	<b>Ref. No.</b> 6005065
	flat gasket fibre ED ø 60mm ID ø 48mm thickness 3mm for thread 1½" Qty 1 pcs		
<b>accessories for</b>	415874		
	<b>Part No.</b>	510424	<b>Ref. No.</b> —
	gasket copper ED ø 55mm ID ø 48mm thickness 2.2mm Centellen for thread 1½"		
	<b>Part No.</b>	520211	<b>Ref. No.</b> —
	reducer thread 2" ET - 1½" IT brass		
	<b>Part No.</b>	520212	<b>Ref. No.</b> —
	hexagonal nut thread 1½" brass WS 60 H 8mm		
	<b>Part No.</b>	550361	<b>Ref. No.</b> —
	blind flange ø 58mm thread 1½"		





			
1			
<b>Part No.</b>	415500	<b>Ref. No.</b>	5007061 5007061K 5007063 5007063K 5030629
<b>description</b>	heating element 7500W 220V heating circuits 3 thread 1½" L 435mm W 33mm H 25mm tube ø 6.3mm cable length 780mm immersion heater flange with thread		
<b>For models:</b>	HUD10.10		
<b>accessories for</b>	415500		
	<b>Part No.</b>	510406	<b>Ref. No.</b> 6005065
	flat gasket fibre ED ø 60mm ID ø 48mm thickness 3mm for thread 1½" Qty 1 pcs		
	<b>Part No.</b>	510424	<b>Ref. No.</b> —
	gasket copper ED ø 55mm ID ø 48mm thickness 2.2mm Centellen for thread 1½"		
	<b>Part No.</b>	520211	<b>Ref. No.</b> —
	reducer thread 2" ET - 1½" IT brass		
	<b>Part No.</b>	520212	<b>Ref. No.</b> —
	hexagonal nut thread 1½" brass WS 60 H 8mm		
	<b>Part No.</b>	550361	<b>Ref. No.</b> —
	blind flange ø 58mm thread 1½"		



Зип Общежит

vsezip.ru

+7(812)987-08-81

			
1			
<b>Part No.</b>	415501	<b>Ref. No.</b>	5007066 5007066K 5030630
<b>description</b>	heating element 9000W 230V heating circuits 3 thread 1 1/2" L 450mm W 32mm H 26mm tube ø 6.3mm cable length 820mm connection cable immersion heater flange with thread		
<b>For models:</b>	HUD10.10, HUD12.20, HUD20.10, HUD6.10, OD10.10, OD10.20, OD12.20, OD20.10, OD20.20, OD6.10		
<b>accessories for</b>	415501		
	<b>Part No.</b>	510406	<b>Ref. No.</b> 6005065
	flat gasket fibre ED ø 60mm ID ø 48mm thickness 3mm for thread 1 1/2" Qty 1 pcs		
	<b>Part No.</b>	510424	<b>Ref. No.</b> —
	gasket copper ED ø 55mm ID ø 48mm thickness 2.2mm Centellen for thread 1 1/2"		
	<b>Part No.</b>	520211	<b>Ref. No.</b> —
	reducer thread 2" ET - 1 1/2" IT brass		
	<b>Part No.</b>	520212	<b>Ref. No.</b> —
	hexagonal nut thread 1 1/2" brass WS 60 H 8mm		
	<b>Part No.</b>	550361	<b>Ref. No.</b> —
	blind flange ø 58mm thread 1 1/2"		

## heating elements for convection

			
1			
<b>Part No.</b>	420524	<b>Ref. No.</b>	2625104K 2630606
<b>description</b>	heating element 10200W 230V heating circuits 3 ID ø 250mm ED ø 320mm L 350mm H 58mm L1 70mm H1 8mm H2 58mm flange length 90mm flange width 70mm tube ø 8.5mm threaded		
<b>spare parts for</b>	420524		
	<b>Part No.</b>	521013	<b>Ref. No.</b> 2623226 6015025
	gasket set suitable for CONVOTHERM for heating element L 90mm W 71mm Qty 1m graphite hole distance 54/74mm		

			
1			
<b>Part No.</b>	420558	<b>Ref. No.</b>	5056330
<b>description</b>	heating element 10500W 230V heating circuits 3 ID ø 400mm ED ø 417mm L 472mm H 100mm H1 15mm H2 83mm flange length 90mm flange width 70mm hole distance 55mm connection M5 tube ø 8.5mm cable length 180mm convection heating element flange for combi-steamer series CONVOTHERM 4		

			
1			
<b>Part No.</b>	418684	<b>Ref. No.</b>	2619192 5017005
<b>description</b>	heating element 10500W 230V heating circuits 3 ID ø 402mm ED ø 420mm L 475mm H 100mm L1 55mm W1 29mm H1 25mm H2 75mm flange length 90mm flange width 70mm hole distance 74mm connection M5 tube ø 8.5mm convection heating element mounting thread M5 rectangular flange with bolt		
<b>For models:</b>	OEB6.10, OES6.10		

			
1			
<b>Part No.</b>	417718	<b>Ref. No.</b>	5007035 5007035K 5030625
<b>description</b>	heating element 12000W 220V heating circuits 3 ID ø 387mm ED ø 400mm L 430mm H 90mm H1 23mm H2 67mm thread M14 3 hole fixing connection male faston tube ø 6.5mm mounting pos. outer for combi-steamer		
<b>For models:</b>	AR100, AR108, AR28, AR30, AR40, AR50, AR54, HUD10.10, HUD20.10, OD6.10, OSC6.10, OSP10.10, OSP6.10, UG6.10		

			
1			
<b>Part No.</b>	415385	<b>Ref. No.</b>	5007036 5007036K 5030626
<b>description</b>	heating element 15000W 220V heating circuits 3 ID ø 390mm ED ø 405mm L 435mm H 110mm L1 22mm W1 300mm H1 22mm H2 84mm thread M14x1.5 6 hole fixing connection M5 tube ø 8.5mm convection heating element		
<b>For models:</b>	OD10.10, OD20.10, OS10.10, OS20.10, OSC10.10, OSC20.10, OSP10.10, OSP20.10		
<b>accessories for</b>	415385		
	<b>Part No.</b>	361182	<b>Ref. No.</b> —
	nut thread 1/4" H 5mm nickel-plated brass WS 17 Qty 1 pcs		
	<b>Part No.</b>	510417	<b>Ref. No.</b> —
	flat gasket fibre ED ø 20mm ID ø 14mm thickness 2mm Qty 1 pcs		
	<b>Part No.</b>	520228	<b>Ref. No.</b> —
	tooth lock washer ID ø 15.3mm ED ø 24mm steel Qty 1 pcs for thread M14		

Table continues overleaf



Зип Общепит

vsezip.ru

+7(812)987-08-81

accessories for	415385		
	Part No.	550262	Ref. No.
			—
	flat gasket copper ED ø 20mm ID ø 14mm thickness 2mm		

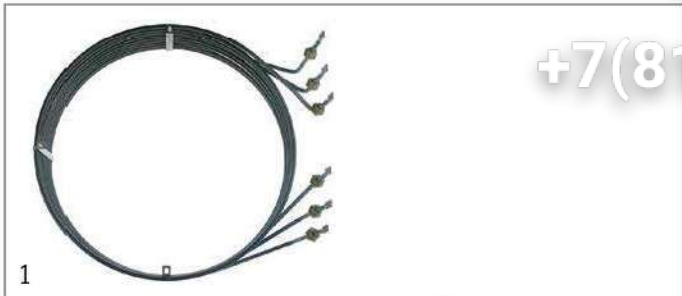

Part No.	418886	Ref. No.	5007038 5007038K 5007042K
description	heating element 18000W 380V heating circuits 3 ID ø 380mm ED ø 393mm L 435mm H 120mm L1 50mm H1 15mm thread M14x1.5 screw mounting tube ø 6.5mm convection heating element		
For models:	AR72, HUD10.10, HUD20.10, UG10.10, UG20.10		



Part No.	418768	Ref. No.	2619181 5017004
description	heating element 18900W 230V heating circuits 3 ID ø 467mm ED ø 484mm L 545mm H 99mm L1 6mm W1 28mm H1 14mm H2 85mm flange length 90mm flange width 70mm connection M4 connection length 112mm tube ø 8.5mm convection heating element with counterflange and cable		
For models:	OEB10.10, OEB20.10, OEB6.20, OES10.10, OES20.10, OES6.20		

spare parts for	418768		
	Part No.	521013	Ref. No.
			2623226 6015025
	gasket set suitable for CONVOTHERM for heating element L 90mm W 71mm Qty 1m graphite hole distance 54/74mm		
	Part No.	692931	Ref. No.
			2623218
	connection set with fixing kit suitable for CONVOTHERM for heating element		



Part No.	418876	Ref. No.	2619190 5017016
description	heating element 18900W 230V heating circuits 3 ID ø 470mm ED ø 486mm L 540mm H 100mm L1 48mm H1 27mm H2 73mm flange length 90mm flange width 70mm hole distance 55mm connection M5 connection length 115mm tube ø 8.5mm convection heating element		
For models:	OEB10.10, OEB20.10, OEB6.20, OES10.10, OES20.10, OES6.20		



Part No.	420557	Ref. No.	5056331
description	heating element 18900W 230V heating circuits 3 ID ø 470mm ED ø 487mm L 540mm H 100mm H1 16mm H2 83mm flange length 90mm flange width 70mm hole distance 55mm connection M5 tube ø 8.5mm cable length 1300mm convection heating element flange connection for combi-steamer series CONVOTHERM 4		



Part No.	420559	Ref. No.	5056332
description	heating element 2x16500W 230V heating circuits 6 ID ø 485mm ED ø 570mm L 590mm H 134mm H1 22mm H2 108mm flange length 175mm flange width 105mm hole distance 80mm connection length M5mm tube ø 8.5mm cable length 1500mm convection heating element flange for combi-steamer series CONVOTHERM		



Part No.	419102	Ref. No.	2619177 5017000
description	heating element 33000W 230/400V heating circuits 6 ID ø 480mm ED ø 570mm L 590mm H 140mm flange length 175mm flange width 105mm		
For models:	OEB10.20, OEB12.20, OEB20.20, OES10.20, OES12.20, OES20.20		





Part No.	419233	Ref. No.	2618805
description	heating element 5400W 230V heating circuits 2 ID ø 252mm ED ø 269mm L 297mm H 62mm L1 11mm W1 65mm H1 12mm H2 50mm flange length 100mm flange width 22mm hole distance 87mm connection 6.3x0.8 tube ø 8.5mm for combi-steamer mounting thread M5 with mounting accessories OES6.06 Mini P3		
For models:	OES6.06		









Зип Общепит

vsezip.ru

+7(812)987-08-81

			
1			
<b>Part No.</b>	420156	<b>Ref. No.</b>	2123634 2625181 5017084
<b>description</b>	heating element 6800W 230V heating circuits 2 ID $\varnothing$ 250mm ED $\varnothing$ 265mm L 300mm H 65mm L1 38mm H1 7mm H2 56mm flange length 90mm flange width 70mm connection male faston 6.3mm connection length 77mm tube $\varnothing$ 8.5mm convection heating element flange connection		
<b>spare parts for</b>	420156		
	<b>Part No.</b>	521013	<b>Ref. No.</b> 2623226 6015025
	gasket set suitable for CONVOTHERM for heating element L 90mm W 71mm Qty 1m graphite hole distance 54/74mm		

			
1			
<b>Part No.</b>	415384	<b>Ref. No.</b>	5007033 5007033K
<b>description</b>	heating element 9000W 230V heating circuits 3 ID $\varnothing$ 390mm ED $\varnothing$ 403mm L 440mm H 88mm L1 30mm W1 300mm H1 18mm H2 70mm thread M14x1.5 6 hole fixing connection M5 convection heating element		
<b>For models:</b>	AR28, AR40, OD10.10, OD10.20, OD6.10, OS6.10, OSC6.10, OSP6.10		
<b>spare parts for</b>	415384		
	<b>Part No.</b>	510417	<b>Ref. No.</b> —
	flat gasket fibre ED $\varnothing$ 20mm ID $\varnothing$ 14mm thickness 2mm Qty 1 pcs		
<b>accessories for</b>	415384		
	<b>Part No.</b>	520228	<b>Ref. No.</b> —
	tooth lock washer ID $\varnothing$ 15.3mm ED $\varnothing$ 24mm steel Qty 1 pcs for thread M14		
	<b>Part No.</b>	520230	<b>Ref. No.</b> —
	nut thread M14x1.5 H 5mm WS 19 zinc-coated steel Qty 1 pcs		
	<b>Part No.</b>	521101	<b>Ref. No.</b> —
	nut thread M14x1.5 H 5mm WS 19 SS Qty 1 pcs		
	<b>Part No.</b>	550262	<b>Ref. No.</b> —
	flat gasket copper ED $\varnothing$ 20mm ID $\varnothing$ 14mm thickness 2mm		

<b>Part No.</b>	420075	<b>Ref. No.</b>	5007022
<b>description</b>	mounting set suitable for convection heating element		
<b>For models:</b>	AR100, AR108, AR28, AR30, AR40, AR50, AR54, AR72, HUD10.10, HUD20.10, HUD6.10, OD10.10, OD20.10, OD6.10, OS10.10, OS6.10, OSC10.10, OSC6.10, OSP10.10, OSP6.10, UG10.10, UG20.10, UG6.10		

			
1			
<b>Part No.</b>	692737	<b>Ref. No.</b>	2623227 6015024
<b>description</b>	mounting set suitable for combi-steamer L 175mm W 105mm mounting pos. CONVOTHERM		
<b>For models:</b>	OEB10.20, OEB12.20, OEB20.20, OES10.20, OES12.20, OES20.20		

## accessories

## sealing washers

## fibre gaskets

			
1			
<b>Part No.</b>	510416	<b>Ref. No.</b>	6005016
<b>description</b>	flat gasket fibre ED $\varnothing$ 19mm ID $\varnothing$ 10.5mm thickness 1.5mm for thread M10 Qty 1 pcs		
<b>For models:</b>	OD10.10, OD10.20, OD12.20, OD20.10, OD20.20, OD6.10, OEB10.10, OEB10.20, OEB12.20, OEB20.10, OEB20.20, OEB6.10, OEB6.20, OES10.10, OES10.20, OES12.20, OES20.10, OES20.20, OES6.10, OES6.20, OGB10.10, OGB10.20, OGB12.20, OGB20.10, OGB20.20, OGB6.10, OGB6.20, OGS10.10, OGS10.20, OGS12.20, OGS20.10, OGS20.20, OGS6.10, OGS6.20, OS10.10, OS10.20, OS12.20, OS20.10, OS20.20, OS6.10, OSP10.10, OSP10.20, OSP12.20, OSP20.10, OSP20.20, OSP6.10		

			
1			
<b>Part No.</b>	510406	<b>Ref. No.</b>	6005065
<b>description</b>	flat gasket fibre ED $\varnothing$ 60mm ID $\varnothing$ 48mm thickness 3mm for thread 1 1/2" Qty 1 pcs		
<b>For models:</b>	HUD10.10, HUD12.20, HUD20.10, HUD20.20, HUD6.10, OD10.10, OD10.20, OD12.20, OD20.10, OD20.20, OD6.10		



Зип Общежит  
control and safety thermostats

vsezip.ru  
control thermostats

+7(812)987-08-81

O-rings

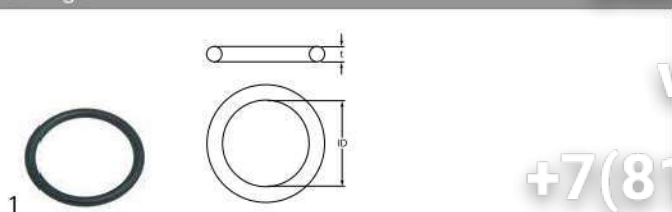

<b>Part No.</b>	510408	<b>Ref. No.</b>	6005015
<b>description</b>	O-ring EPDM thickness 5.34mm ID ø 47mm Qty 1 pcs		
<b>For models:</b>	OD10.10, OD10.20, OD12.20, OD20.10, OD20.20, OD6.10, OS10.10, OS10.20, OS12.20, OS20.10, OS20.20, OS6.10, OSC10.10, OSC10.20, OSC12.20, OSC20.10, OSC20.20, OSC6.10, OSP10.10, OSP10.20, OSP12.20, OSP20.10, OSP20.20, OSP6.10		

flange gaskets



<b>Part No.</b>	550992	<b>Ref. No.</b>	6015023
<b>description</b>	gasket L 87mm W 57mm hole ø 6mm hole distance 70/40mm 4 holes thickness 3mm suitable for CONVOTHERM		
<b>For models:</b>	OEB10.10, OEB10.20, OEB12.20, OEB20.10, OEB20.20, OEB6.10, OEB6.20, OES10.10, OES10.20, OES12.20, OES20.10, OES20.20, OES6.10, OES6.20, OGB10.10, OGB10.20, OGB12.20, OGB20.10, OGB20.20, OGB6.10, OGB6.20, OGS10.10, OGS10.20, OGS12.20, OGS20.10, OGS20.20, OGS6.10, OGS6.20		

thermostats

bi-metal thermostats

bi-metal thermostats



<b>Part No.</b>	391049	<b>Ref. No.</b>	5056372
<b>description</b>	bi-metal thermostat hole distance 24mm switch-off temp. 80°C 1NC 1-pole 10A 250V connection F6.3x0.8 suitable for CONVOTHERM		



EGO  
control thermostats  
55.10/19 series

<b>Part No.</b>	375631	<b>Ref. No.</b>	5001032
<b>description</b>	thermostat t.max. 249°C temperature range 55-249°C 1-pole 1NO 16A probe ø 3.1mm probe L 226mm capillary pipe 1270mm capillary pipe isolated 850mm gland nut 3/8"-M8x1 shaft ø ø6x4.6mm shaft L 23mm shaft position upper rotation 318°		
<b>For models:</b>	OD10.20, OD12.20		



EGO

<b>Part No.</b>	375632	<b>Ref. No.</b>	5001020
<b>description</b>	thermostat t.max. 90°C temperature range 30-90°C 1-pole 1CO 16A probe ø 6mm probe L 130mm capillary pipe 1300mm capillary pipe isolated 850mm gland nut M10x1 shaft ø ø6x4.6mm shaft L 23mm shaft position upper rotation 270°		
<b>For models:</b>	OD10.20, OD12.20		

55.13\_ series



EGO

<b>Part No.</b>	375116	<b>Ref. No.</b>	5001021 5001021K 5001040
<b>description</b>	thermostat t.max. 258°C temperature range 58-258°C 1-pole 1NC 16A probe ø 3.1mm probe L 201mm capillary pipe 1130mm capillary pipe isolatedmm gland nut shaft ø ø6x4.6mm shaft L 23mm shaft position upper rotation 270°		
<b>For models:</b>	AR100, AR108, AR12, AR16, AR18, AR28, AR30, AR40, AR50, AR54, AR72, AR8, HUD10.10, HUD12.20, HUD20.10, HUD20.20, HUD6.10, UG10.10, UG10.20, UG20.10, UG20.20, UG4.05, UG6.05, UG6.10		



Зип Общепит

vsezip.ru

+7(812)987-08-81

## safety thermostats

## 55.13\_ series



<b>Part No.</b>	375245	<b>Ref. No.</b>	5019002 5019004
<b>description</b>	safety thermostat switch-off temp. 135°C 1-pole 16A probe $\varnothing$ 6mm probe L 77mm capillary pipe 480mm capillary pipe isolatedmm gland nut probe SS		
<b>For models:</b>	OGB10.10, OGB10.20, OGB12.20, OGB20.10, OGB20.20, OGB6.10, OGB6.20, OGS10.10, OGS10.20, OGS12.20, OGS20.10, OGS20.20, OGS6.10, OGS6.20		



<b>Part No.</b>	375731	<b>Ref. No.</b>	5001026 5001026+6005081 5001026K
<b>description</b>	safety thermostat switch-off temp. 135°C 1-pole 16A probe $\varnothing$ 6mm probe L 77mm capillary pipe 520mm capillary pipe isolatedmm gland nut probe SS		
<b>For models:</b>	OD10.10, OD10.20, OD12.20, OD20.10, OD20.20, OD6.10		



<b>Part No.</b>	375117	<b>Ref. No.</b>	5001030 5001030K 51021
<b>description</b>	safety thermostat switch-off temp. 325°C 1-pole 16A probe $\varnothing$ 4mm probe L 91mm capillary pipe 390mm capillary pipe isolatedmm gland nut probe SS		
<b>For models:</b>	OD10.10, OD10.20, OD6.10		



<b>Part No.</b>	390126	<b>Ref. No.</b>	5001029 5001029K
<b>description</b>	safety thermostat switch-off temp. 340°C 1-pole 1NC 16A probe $\varnothing$ 3.1mm probe L 201mm capillary pipe 1170mm capillary pipe isolatedmm gland nut probe SS		
<b>For models:</b>	AR108, AR72, OD10.10, OD10.20, OD12.20, OD20.10, OD20.20, OD6.10, OS10.10, OS10.20, OS12.20, OS20.10, OS20.20, OS6.10, OSC10.10, OSC10.20, OSC12.20, OSC20.10, OSC20.20, OSC6.10, OSP10.10, OSP10.20, OSP12.20, OSP20.10, OSP20.20, OSP6.10		

## 55.32\_ series



<b>Part No.</b>	375392	<b>Ref. No.</b>	5001039
<b>description</b>	safety thermostat switch-off temp. 360°C 3-pole 1CO/2NC 20A probe $\varnothing$ 4mm probe L 120mm capillary pipe 1490mm capillary pipe isolated 1450mm gland nut probe SS		
<b>For models:</b>	AR12, AR18, AR28, AR40, AR54, AR8, OES6.06		



<b>Part No.</b>	375017	<b>Ref. No.</b>	2618787
<b>description</b>	safety thermostat switch-off temp. 360°C 3-pole 20A probe $\varnothing$ 4mm probe L 122mm capillary pipe 1490mm capillary pipe isolatedmm probe		
<b>For models:</b>	OES6.06		



Зип Общепит

vsezip.ru

+7(812)987-08-81



<b>Part No.</b>	375474	<b>Ref. No.</b>	5001031
<b>description</b>	safety thermostat t.max. 340°C switch-off temp. 340°C 2-pole 1NC/1CO 1x20/1x0.5A probe ø 4mm probe L 120mm capillary pipe 1300mm capillary pipe isolated 900mm gland nut probe		
<b>For models:</b>	OD10.10, OD10.20, OD12.20, OD20.20, OD6.10, OSG10.10, OSG12.20, OSG20.20		



<b>Part No.</b>	376061	<b>Ref. No.</b>	5056329
<b>description</b>	safety thermostat switch-off temp. 340°C 1-pole 16A probe ø 3mm probe L 160mm capillary pipe 1200mm capillary pipe isolated 1140mm		

56\_ series



<b>Part No.</b>	381480	<b>Ref. No.</b>	5056319
<b>description</b>	safety thermostat switch-off temp. 170°C temperature range 14-170°C 1-pole 16A probe ø 6mm probe L 65mm capillary pipe 1460mm capillary pipe isolated 1400mm probe material SS 230V		



<b>Part No.</b>	375870	<b>Ref. No.</b>	5001041
<b>description</b>	safety thermostat switch-off temp. 340°C 1-pole 16A probe ø 3mm probe L 160mm capillary pipe 1150mm capillary pipe isolated 1080mm gland nut probe		
<b>For models:</b>	OEB10.10, OEB10.20, OEB12.20, OEB20.10, OEB20.20, OEB6.10, OEB6.20, OES10.10, OES10.20, OES12.20, OES20.10, OES20.20, OES6.10, OES6.20, OGB10.10, OGB10.20, OGB12.20, OGB20.10, OGB20.20, OGB6.10, OGB6.20, OGS10.10, OGS10.20, OGS12.20, OGS20.10, OGS20.20, OGS6.10, OGS6.20, OSC10.10, OSC10.20, OSC12.20, OSC20.10, OSC20.20, OSC6.10, OSG10.10, OSG12.20, OSG20.20, OSG6.10		

accessories

fitting parts



<b>Part No.</b>	550389	<b>Ref. No.</b>	4006041
<b>description</b>	bracket for contact thermostat		
<b>For models:</b>	HUD12.20, HUD20.20		



<b>Part No.</b>	550388	<b>Ref. No.</b>	4006031
<b>description</b>	bracket for contact thermostat mounting distance 24.5mm mounting ø 3.8		
<b>For models:</b>	HUD10.10, HUD20.10, HUD20.20, OD10.20, OD12.20		

gland nut accessories

ducts



<b>Part No.</b>	550148	<b>Ref. No.</b>	6005080
<b>description</b>	gland duct ET M12x0.75 IT M9x1 probe ø max. 6.5mm WS 17 silicone		
<b>For models:</b>	HUD10.10, HUD12.20, HUD20.10, HUD20.20, HUD6.10, OD10.10, OD10.20, OD12.20, OD20.10, OD20.20, OD6.10, OS12.20, OS20.10, OS20.20, OSC12.20, OSC20.10, OSC20.20, OSP12.20, OSP20.10, OSP20.20		

gaskets



<b>Part No.</b>	699830	<b>Ref. No.</b>	6015026
<b>description</b>	gasket silicone ø 10mm L 8mm		
<b>For models:</b>	OEB10.10, OEB10.20, OEB12.20, OEB20.10, OEB20.20, OEB6.10, OEB6.20, OES10.10, OES10.20, OES12.20, OES20.10, OES20.20, OES6.10, OES6.20, OGB10.10, OGB10.20, OGB12.20, OGB20.10, OGB20.20, OGB6.10, OGB6.20, OGS10.10, OGS10.20, OGS12.20, OGS20.10, OGS20.20, OGS6.10, OGS6.20		

1 electric components





## switches and momentary switches

ЗипОбщепит

## cam switches

on/off



1

<b>Part No.</b>	301282	<b>Ref. No.</b>	5003022
<b>description</b>	cam switch sequence 0-1 shaft $\varnothing$ 6x4.6mm shaft L 19.5mm 4-pole rotation 45°		
<b>For models:</b>	OD10.10, OD10.20, OD12.20, OD20.10, OD20.20, OD6.10		

## 5 operating positions



1

<b>Part No.</b>	301277	<b>Ref. No.</b>	5003023
<b>description</b>	cam switch 5 operating positions 7NO sequence 0-1-2-3-4 16A shaft $\varnothing$ 6x4.6mm shaft L 19mm connection male faston 6.3mm plastic		
<b>For models:</b>	OD10.10, OD10.20, OD12.20, OD20.10, OD20.20, OD6.10		

## magnetic switches

28.5x19mm



1

<b>Part No.</b>	348210	<b>Ref. No.</b>	5056328
<b>description</b>	magnetic switch L 28.5mm W 19mm cable length 450mm PIC MS-328/980A 5214 suitable for CONVOTHERM		

vsezip.ru

+7(812)987-08-81

1

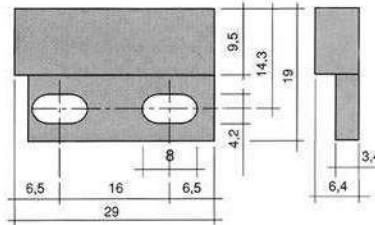

<b>Part No.</b>	345117	<b>Ref. No.</b>	5003075 5013070
<b>description</b>	magnetic switch L 28.5mm W 19mm 1NO 250V 0.04A P max. 10W connection cable cable length 1000mm		
<b>For models:</b>	OD10.10, OD10.20, OD12.20, OD20.10, OD20.20, OD6.10, OEB10.10, OEB10.20, OEB12.20, OEB20.10, OEB20.20, OEB6.10, OEB6.20, OES10.10, OES10.20, OES12.20, OES20.10, OES20.20, OES6.06, OES6.10, OES6.20, OGB10.10, OGB10.20, OGB12.20, OGB20.10, OGB20.20, OGB6.10, OGB6.20, OGS10.10, OGS10.20, OGS12.20, OGS20.10, OGS20.20, OGS6.10, OGS6.20, OS10.10, OS10.20, OS12.20, OS20.10, OS20.20, OS6.10, OSC10.10, OSC10.20, OSC12.20, OSC20.10, OSC20.20, OSC6.10, OSP10.10, OSP10.20, OSP12.20...(Other models you can see in the webshop)		

1

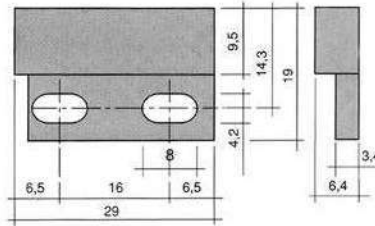

<b>Part No.</b>	345217	<b>Ref. No.</b>	5003082
<b>description</b>	magnetic switch L 29mm W 19mm 1NO 125V 0.5A P max. 10W connection cable cable length 2000mm		



Зип Общепит  
control equipment

vsezip.ru  
Lumitostat series

+7(812)987-08-81



1

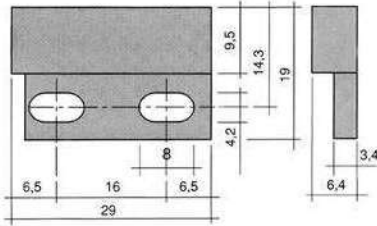

<b>Part No.</b>	347495	<b>Ref. No.</b>	2518798
<b>description</b>	magnetic switch L 29mm W 19mm 1NO 250V 0.3A P max. 10W connection cable cable length 2000mm PIC		
<b>For models:</b>	OES6.06		

M10x0.75

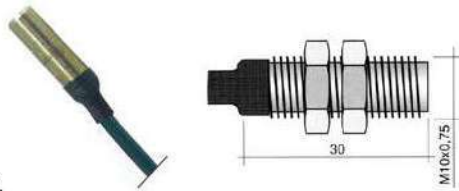

1

<b>Part No.</b>	345632	<b>Ref. No.</b>	5003079
<b>description</b>	magnetic switch thread M10x0.75 1NO 250V 0.5A P max. 50W connection cable cable length 2000mm type 102		
<b>For models:</b>	OD10.20, OD12.20, OD20.20, OSG10.10, OSG12.20, OSG20.20, OSG6.10		
<b>accessories for</b>	345632		
	<b>Part No.</b>	<b>Ref. No.</b>	—
	100779		
	nut thread M10x0.75 H 3mm WS 14 SS Qty 2 pcs		

accessories

magnets

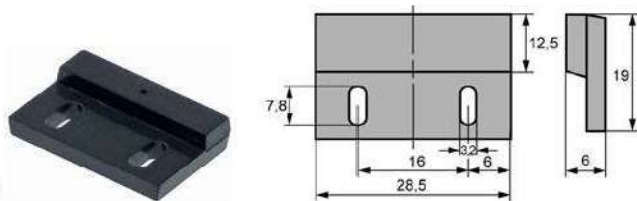

1

<b>Part No.</b>	345700	<b>Ref. No.</b>	5003076
<b>description</b>	magnet ømm L 29mm H 6.5mm W 19mm hole distance 16mm M3 hole ø 3.5mm		
<b>For models:</b>	OD10.10, OD10.20, OD12.20, OD20.10, OD20.20, OD6.10, OSP6.10		

RAFI Lumitostat series

fascias



1

<b>Part No.</b>	345140	<b>Ref. No.</b>	5003054
<b>description</b>	bezel clear		
<b>For models:</b>	HUD10.10, HUD12.20, HUD20.10, HUD20.20, HUD6.10		

momentary push switches



1

<b>Part No.</b>	345139	<b>Ref. No.</b>	5003053
<b>description</b>	momentary push switch mounting measurements ø16mm 230V 1NC/1NO		
<b>For models:</b>	HUD10.10, HUD12.20, HUD20.10, HUD20.20, HUD6.10		

**accessories for** 345139

	<b>Part No.</b>	345140	<b>Ref. No.</b>	5003054
				bezel clear
	<b>Part No.</b>	346719	<b>Ref. No.</b>	—
				bezel yellow
	<b>Part No.</b>	346720	<b>Ref. No.</b>	—
				bezel rectangular green
	<b>Part No.</b>	346721	<b>Ref. No.</b>	—
				bezel rectangular red
	<b>Part No.</b>	359590	<b>Ref. No.</b>	—
				light bulb socket T5.5K 24V 3W ø 5.5mm L 22mm clear
	<b>Part No.</b>	359591	<b>Ref. No.</b>	—
				light bulb socket T5.5K 48V 3W ø 5.5mm L 22mm clear
	<b>Part No.</b>	359592	<b>Ref. No.</b>	—
				light bulb socket T5.5K 12V 3W ø 5.5mm L 22mm clear
	<b>Part No.</b>	359593	<b>Ref. No.</b>	—
				light bulb socket T5.5K 60V 0.02A



## TELEMECANIQUE (EFA)

XB4 series

rotary switches



1

<b>Part No.</b>	347383	<b>Ref. No.</b>	5003031 5003031K 5003035
<b>description</b>	switch mounting measurements ø22mm 2NO 0-1 latching		
<b>For models:</b>	HUD10.10, HUD12.20, HUD20.10, HUD20.20, HUD6.10		

## encoders and potentiometers



1

<b>Part No.</b>	300268	<b>Ref. No.</b>	5056359
<b>description</b>	encoder rotation 360° 0.01A shaft ø 6x5.5mm shaft L 17mm connection for ribbon cable for combi-steamer thread M10x0.75 5V CONVOTHERM 4 0.10hm CESI 32/LS EBE		



1

<b>Part No.</b>	300098	<b>Ref. No.</b>	5009095
<b>description</b>	potentiometer		
<b>For models:</b>	OD10.10, OD10.20, OD12.20, OD20.10, OD20.20, OD6.10		

## lamps

indicator lights

indicator lights 3-piece (housing, lens and bulb)

lamps

light bulbs



1

<b>Part No.</b>	359055	<b>Ref. No.</b>	5003046
<b>description</b>	light bulb socket T1 1/2 12VW 0.08A ø 4.9mm L 13mm		
<b>For models:</b>	OD10.10, OD10.20, OD12.20, OD20.10, OD20.20, OD6.10		

Зип-Общепит

indicator lights (complete)

ø16mm

vsezip.ru

+7(812)987-08-81



<b>Part No.</b>	362003	<b>Ref. No.</b>	5004026
<b>description</b>	indicator light ø 16mm yellow connection F6.3 temp.-resist. 120°C		
<b>For models:</b>	AR100, AR108, AR12, AR16, AR18, AR28, AR30, AR40, AR50, AR54, AR72, AR8, UG10.10, UG10.20, UG20.10, UG20.20, UG4.05, UG6.05, UG6.10		

screw-on/push-on fit

light bulbs

for ovens



1

<b>Part No.</b>	359458	<b>Ref. No.</b>	2618779
<b>description</b>	light bulb socket E14 15W 230V with gasket		
<b>For models:</b>	OEB10.10, OEB10.20, OEB12.20, OEB20.10, OEB20.20, OEB6.10, OEB6.20, OES10.10, OES10.20, OES12.20, OES20.10, OES20.20, OES6.06, OES6.10, OES6.20, OGB10.10, OGB10.20, OGB12.20, OGB20.10, OGB20.20, OGB6.10, OGB6.20, OGS10.10, OGS10.20, OGS12.20, OGS20.10, OGS20.20, OGS6.10, OGS6.20		



1

<b>Part No.</b>	359610	<b>Ref. No.</b>	5005040 5005040K
<b>description</b>	light bulb t.max. 300°C socket E14 15W 230V ø 22mm L 47mm lens L 20mm for oven lamp type Philips		
<b>For models:</b>	HUD10.10, HUD12.20, HUD20.10, HUD20.20, HUD6.10, OD10.10, OD10.20, OD12.20, OD20.10, OD20.20, OD6.10, UG10.10, UG10.20, UG20.10, UG20.20, UG4.05, UG6.05, UG6.10		



1

<b>Part No.</b>	359612	<b>Ref. No.</b>	5005045
<b>description</b>	light bulb t.max. 300°C socket E14 25W 230V ø 25mm L 56mm lens L 30mm for oven lamp type Philips		

for indicator lights



1

<b>Part No.</b>	359055	<b>Ref. No.</b>	5003046
<b>description</b>	light bulb socket T1 1/2 12VW 0.08A ø 4.9mm L 13mm		
<b>For models:</b>	OD10.10, OD10.20, OD12.20, OD20.10, OD20.20, OD6.10		



oven lamps

Зип Общепит

vsezip.ru

+7(812)987-08-81





universal oven lamps

mounting diameter 35.5mm



<b>Part No.</b>	359720	<b>Ref. No.</b>	5005012
<b>description</b>	oven lamp mounting ø 35.5mm 230V 15W socket E14 temp.-resist. 300°C connection male faston 6.3mm hard glas		
<b>For models:</b>	HUD10.10, HUD12.20, HUD20.10, HUD20.20, HUD6.10, OD10.10, OD10.20, OD12.20, OD20.10, OD20.20, OD6.10, UG10.10, UG10.20, UG20.10, UG20.20, UG4.05, UG6.05, UG6.10		
<b>spare parts for</b>	359720		
	<b>Part No.</b>	359701	<b>Ref. No.</b> 5005016
	lamp socket socket E14 220-230V mounting ø 35.5mm connection male faston 6.3mm 15W		
	<b>Part No.</b>	359705	<b>Ref. No.</b> 5005017 5005017K 5030620
	oven lamp glass thr.ø 33.5mm ø 52mm hard glas temp.-resist. 350°C		
	<b>Part No.</b>	359721	<b>Ref. No.</b> 5005025
	gasket silicone ED ø 48mm ID ø 39.5mm thickness 5mm Qty 1 pcs		
	<b>Part No.</b>	359740	<b>Ref. No.</b> —
	light bulb t.max. 300°C socket E14 15W 230V ø 22mm L 48mm lens L 20mm for oven lamp IMPORT		





<b>Part No.</b>	359701	<b>Ref. No.</b>	5005016
<b>description</b>	lamp socket socket E14 220-230V mounting ø 35.5mm connection male faston 6.3mm 15W		
<b>For models:</b>	OD10.10, OD10.20, OD12.20, OD20.10, OD20.20, OD6.10, OS10.10, OS10.20, OS12.20, OS20.10, OS20.20, OS6.10, OSC10.10, OSC10.20, OSC12.20, OSC20.10, OSC20.20, OSC6.10, OSG10.10, OSG12.20, OSG20.20, OSG6.10, OSP10.10, OSP10.20, OSP12.20, OSP20.10, OSP20.20, OSP6.10		
<b>accessories for</b>	359701		
	<b>Part No.</b>	359705	<b>Ref. No.</b> 5005017 5005017K 5030620
	oven lamp glass thr.ø 33.5mm ø 52mm hard glas temp.-resist. 350°C		
	<b>Part No.</b>	359709	<b>Ref. No.</b> —
	oven lamp glass thr.ø 33.5mm ø 42mm hard glas temp.-resist. 350°C		
	<b>Part No.</b>	359721	<b>Ref. No.</b> 5005025
	gasket silicone ED ø 48mm ID ø 39.5mm thickness 5mm Qty 1 pcs		
	<b>Part No.</b>	359942	<b>Ref. No.</b> —
	oven lamp glass thr.ø 33.5mm ø 41mm hard glas temp.-resist. 350°C		

<b>Part No.</b>	359705	<b>Ref. No.</b>	5005017 5005017K 5030620
<b>description</b>	oven lamp glass thr.ø 33.5mm ø 52mm hard glas temp.-resist. 350°C		
<b>For models:</b>	HUD10.10, HUD12.20, HUD20.10, HUD20.20, HUD6.10, OD10.10, OD10.20, OD12.20, OD20.10, OD20.20, OD6.10, UG10.10, UG10.20, UG20.10, UG20.20, UG4.05, UG6.05, UG6.10		
<b>accessories for</b>	359705		
	<b>Part No.</b>	359610	<b>Ref. No.</b> 5005040 5005040K
	light bulb t.max. 300°C socket E14 15W 230V ø 22mm L 47mm lens L 20mm for oven lamp type Philips		
	<b>Part No.</b>	359700	<b>Ref. No.</b> —
	gasket for pizza oven fibre glass ID ø 32.5mm ED ø 55mm thickness 5mm		
	<b>Part No.</b>	359721	<b>Ref. No.</b> 5005025
	gasket silicone ED ø 48mm ID ø 39.5mm thickness 5mm Qty 1 pcs		
	<b>Part No.</b>	359837	<b>Ref. No.</b> —
	gasket ID ø 33mm ED ø 46mm thickness 1mm graphite		
	<b>Part No.</b>	359838	<b>Ref. No.</b> —
	gasket ID ø 33mm ED ø 45mm		

<b>Part No.</b>	359721	<b>Ref. No.</b>	5005025
<b>description</b>	gasket silicone ED ø 48mm ID ø 39.5mm thickness 5mm Qty 1 pcs		
<b>For models:</b>	HUD10.10, HUD12.20, HUD20.10, HUD20.20, HUD6.10, OD10.10, OD10.20, OD12.20, OD20.10, OD20.20, OD6.10, UG10.10, UG10.20, UG20.10, UG20.20, UG4.05, UG6.05, UG6.10		

55x70mm



<b>Part No.</b>	360730	<b>Ref. No.</b>	5056316
<b>description</b>	gasket		
<b>accessories for</b>	360730		
	<b>Part No.</b>	359596	<b>Ref. No.</b> 5056314
	halogen lamp socket G4 12V 10W temp.-resist. 500°C		
	<b>Part No.</b>	360728	<b>Ref. No.</b> 5056317
	lamp cover complete L 99.5mm W 84.5mm H 8.5mm mounting distance 68/83mm		
	<b>Part No.</b>	360729	<b>Ref. No.</b> 5056315
	lamp socket socket G4 with cable		

1 electric components

Зип-Общепит  
products based oven lamps



CONVOTHERM

vsezip.ru

+7(812)987-08-81



1

<b>Part No.</b>	360728	<b>Ref. No.</b>	5056317
<b>description</b>	lamp cover complete L 99.5mm W 84.5mm H 8.5mm mounting distance 68/83mm		
<b>accessories for</b>	360728		
	<b>Part No.</b>	359596	<b>Ref. No.</b> 5056314
<b>description</b>	halogen lamp socket G4 12V 10W temp.-resist. 500°C		
	<b>Part No.</b>	360729	<b>Ref. No.</b> 5056315
<b>description</b>	lamp socket socket G4 with cable		
	<b>Part No.</b>	360730	<b>Ref. No.</b> 5056316
<b>description</b>	gasket		



1

<b>Part No.</b>	359297	<b>Ref. No.</b>	5015003 5015006
<b>description</b>	frame L 95mm W 81mm mounting distance 68/83mm thickness 6mm		
<b>For models:</b>	OEB10.10, OEB10.20, OEB12.20, OEB20.10, OEB20.20, OEB6.10, OEB6.20, OES10.10, OES10.20, OES12.20, OES20.10, OES20.20, OES6.06, OES6.10, OES6.20, OGB10.10, OGB10.20, OGB12.20, OGB20.10, OGB20.20, OGB6.10, OGB6.20, OGS10.10, OGS10.20, OGS12.20, OGS20.10, OGS20.20, OGS6.10, OGS6.20		
<b>accessories for</b>	359297		
	<b>Part No.</b>	359299	<b>Ref. No.</b> —
<b>description</b>	gasket L 91mm W 77mm hole ø 3mm for oven lamp		

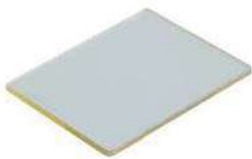

1

<b>Part No.</b>	359296	<b>Ref. No.</b>	5015002
<b>description</b>	lamp glass L 74mm W 58mm thickness 3mm		
<b>For models:</b>	OEB10.10, OEB10.20, OEB12.20, OEB20.10, OEB20.20, OEB6.10, OEB6.20, OES10.10, OES10.20, OES12.20, OES20.10, OES20.20, OES6.06, OES6.10, OES6.20, OGB10.10, OGB10.20, OGB12.20, OGB20.10, OGB20.20, OGB6.10, OGB6.20, OGS10.10, OGS10.20, OGS12.20, OGS20.10, OGS20.20, OGS6.10, OGS6.20		

products based oven lamps

CONVOTHERM

vsezip.ru

+7(812)987-08-81



1

<b>Part No.</b>	360641	<b>Ref. No.</b>	6015018 6015020 N/A
<b>description</b>	gasket L 86mm W 71mm PTFE thickness 0.5mm for oven lamp		
<b>For models:</b>	OEB10.10, OEB10.20, OEB12.20, OEB20.10, OEB20.20, OEB6.10, OEB6.20, OES10.10, OES10.20, OES12.20, OES20.10, OES20.20, OES6.06, OES6.10, OES6.20, OGB10.10, OGB10.20, OGB12.20, OGB20.10, OGB20.20, OGB6.10, OGB6.20, OGS10.10, OGS10.20, OGS12.20, OGS20.10, OGS20.20, OGS6.10, OGS6.20		

1

<b>Part No.</b>	358180	<b>Ref. No.</b>	6015018 6015020
<b>description</b>	gasket L 94mm W 78mm PTFE thickness 3mm for oven lamp		

1

<b>Part No.</b>	360728	<b>Ref. No.</b>	5056317
<b>description</b>	lamp cover complete L 99.5mm W 84.5mm H 8.5mm mounting distance 68/83mm		
<b>accessories for</b>	360728		
	<b>Part No.</b>	359596	<b>Ref. No.</b> 5056314
<b>description</b>	halogen lamp socket G4 12V 10W temp.-resist. 500°C		
	<b>Part No.</b>	360729	<b>Ref. No.</b> 5056315
<b>description</b>	lamp socket socket G4 with cable		
	<b>Part No.</b>	360730	<b>Ref. No.</b> 5056316
<b>description</b>	gasket		

1

<b>Part No.</b>	694335	<b>Ref. No.</b>	5015005
<b>description</b>	lamp glass L 87mm W 72mm thickness 3mm		



Зип Общепит

vsezip.ru

+7(812)987-08-81

1 

<b>Part No.</b>	359488	<b>Ref. No.</b>	261878
<b>description</b>	oven lamp complete mounting measurements 55x70mm 230V 15W socket E14 rectangular connection male faston 6.3mm L 87mm W 70mm		
<b>For models:</b>	OEB10.10, OEB10.20, OEB12.20, OEB20.10, OEB20.20, OEB6.10, OEB6.20, OES10.10, OES10.20, OES12.20, OES20.10, OES20.20, OES6.06, OES6.10, OES6.20, OGB10.10, OGB10.20, OGB12.20, OGB20.10, OGB20.20, OGB6.10, OGB6.20, OGS10.10, OGS10.20, OGS12.20, OGS20.10, OGS20.20, OGS6.10, OGS6.20		
<b>spare parts for</b>	359488		
	<b>Part No.</b>	358180	<b>Ref. No.</b> 6015018 6015020
	gasket L 94mm W 78mm PTFE thickness 3mm for oven lamp		
	<b>Part No.</b>	359297	<b>Ref. No.</b> 5015003 5015006
	frame L 95mm W 81mm mounting distance 68/83mm thickness 6mm		
	<b>Part No.</b>	359299	<b>Ref. No.</b> —
	gasket L 91mm W 77mm hole ø 3mm for oven lamp		
	<b>Part No.</b>	694335	<b>Ref. No.</b> 5015005
	lamp glass L 87mm W 72mm thickness 3mm		

1 

<b>Part No.</b>	359701	<b>Ref. No.</b>	5005016
<b>description</b>	lamp socket socket E14 220-230V mounting ø 35.5mm connection male faston 6.3mm 15W		
<b>For models:</b>	OD10.10, OD10.20, OD12.20, OD20.10, OD20.20, OD6.10, OS10.10, OS10.20, OS12.20, OS20.10, OS20.20, OS6.10, OSC10.10, OSC10.20, OSC12.20, OSC20.10, OSC20.20, OSC6.10, OSG10.10, OSG12.20, OSG20.20, OSG6.10, OSP10.10, OSP10.20, OSP12.20, OSP20.10, OSP20.20, OSP6.10		
<b>accessories for</b>	359701		
	<b>Part No.</b>	359705	<b>Ref. No.</b> 5005017 5005017K 5030620
	oven lamp glass thr.ø 33.5mm ø 52mm hard glas temp.-resist. 350°C		
	<b>Part No.</b>	359709	<b>Ref. No.</b> —
	oven lamp glass thr.ø 33.5mm ø 42mm hard glas temp.-resist. 350°C		
	<b>Part No.</b>	359721	<b>Ref. No.</b> 5005025
	gasket silicone ED ø 48mm ID ø 39.5mm thickness 5mm Qty 1 pcs		
	<b>Part No.</b>	359942	<b>Ref. No.</b> —
	oven lamp glass thr.ø 33.5mm ø 41mm hard glas temp.-resist. 350°C		

1 

<b>Part No.</b>	692171	<b>Ref. No.</b>	5005020
<b>description</b>	frame for lamp lenses bore ø 6.3mm D1 ø 72mm D2 ø 56mm L 83mm W 83mm thickness 1mm		
<b>For models:</b>	OD10.10, OD10.20, OD12.20, OD20.10, OD20.20, OD6.10, OS10.10, OS10.20, OS12.20, OS20.10, OS20.20, OS6.10, OSC10.10, OSC10.20, OSC12.20, OSC20.10, OSC20.20, OSC6.10, OSP10.10, OSP10.20, OSP12.20, OSP20.10, OSP20.20, OSP6.10		

1 

<b>Part No.</b>	360629	<b>Ref. No.</b>	2628501
<b>description</b>	oven lamp incl. gasket mounting ø 10mm 12V 10W socket G4 CONVOTHERM temp.-resist. 300°C		
<b>spare parts for</b>	360629		
	<b>Part No.</b>	359596	<b>Ref. No.</b> 5056314
	halogen lamp socket G4 12V 10W temp.-resist. 500°C		

1 

<b>Part No.</b>	359643	<b>Ref. No.</b>	5005022
<b>description</b>	lamp glass ø 69mm thickness 4mm		
<b>For models:</b>	OD10.10, OD10.20, OD12.20, OD20.10, OD20.20, OD6.10, OS10.10, OS10.20, OS12.20, OS20.10, OS20.20, OS6.10, OSC10.10, OSC10.20, OSC12.20, OSC20.10, OSC20.20, OSC6.10, OSP10.10, OSP10.20, OSP12.20, OSP20.10, OSP20.20, OSP6.10		

1 

<b>Part No.</b>	360680	<b>Ref. No.</b>	2628500
<b>description</b>	oven lamp incl. gasket mounting ø 10mm 12V 10W socket G4 CONVOTHERM temp.-resist. 300°C		
<b>spare parts for</b>	360680		
	<b>Part No.</b>	359596	<b>Ref. No.</b> 5056314
	halogen lamp socket G4 12V 10W temp.-resist. 500°C		



Зип-Общепит

timers

vsezip.ru

+7(812)987-08-81

## lamps

## light bulbs

PHILIPS



1

<b>Part No.</b>	359610	<b>Ref. No.</b>	5005040 5005040K
<b>description</b>	light bulb t.max. 300°C socket E14 15W 230V ø 22mm L 47mm lens L 20mm for oven lamp type Philips		
<b>For models:</b>	HUD10.10, HUD12.20, HUD20.10, HUD20.20, HUD6.10, OD10.10, OD10.20, OD12.20, OD20.10, OD20.20, OD6.10, UG10.10, UG10.20, UG20.10, UG20.20, UG4.05, UG6.05, UG6.10		

PHILIPS



1

<b>Part No.</b>	359612	<b>Ref. No.</b>	5005045
<b>description</b>	light bulb t.max. 300°C socket E14 25W 230V ø 25mm L 56mm lens L 30mm for oven lamp type Philips		

## sockets

## G4 / G5,3 / G6,35



1

<b>Part No.</b>	360729	<b>Ref. No.</b>	5056315
<b>description</b>	lamp socket socket G4 with cable		
<b>accessories for</b>	360729		

	<b>Part No.</b>	359596	<b>Ref. No.</b>	5056314
	<b>description</b>	halogen lamp socket G4 12V 10W temp.-resist. 500°C		

	<b>Part No.</b>	360728	<b>Ref. No.</b>	5056317
	<b>description</b>	lamp cover complete L 99.5mm W 84.5mm H 8.5mm mounting distance 68/83mm		

	<b>Part No.</b>	360730	<b>Ref. No.</b>	5056316
	<b>description</b>	gasket		

## mechanical timers



1

<b>Part No.</b>	350023	<b>Ref. No.</b>	5001003 5001003K	
<b>description</b>	timer M2 2-pole operation time 90min impulse mechanical 2CO at 250V 16A permanent position no shaft ø 6x4.6mm shaft 6x4.6mm shaft L 23mm mounting distance 28mm connection lateral			
<b>For models:</b>	HUD10.10, HUD12.20, HUD20.10, HUD20.20, HUD6.10, UG10.10, UG10.20, UG20.10, UG20.20, UG4.05, UG6.05, UG6.10			
<b>accessories for</b>	350023			
	<b>Part No.</b>	110366	<b>Ref. No.</b>	—
	<b>description</b>	knob switch zero mark t.max.°C ø 44mm shaft ø 6x4.6mm shaft flat upper black		



1

<b>Part No.</b>	350112	<b>Ref. No.</b>	5001001 5001001K
<b>description</b>	timer M2 2-pole operation time 90min impulse mechanical 2NO at 250V 16A permanent position no shaft ø 6x4.6mm shaft 6x4.6mm shaft L 23mm mounting distance 28mm connection rear		
<b>For models:</b>	AR100, AR108, AR12, AR16, AR18, AR28, AR30, AR40, AR50, AR54, AR72, AR8, UG10.10, UG10.20, UG20.10, UG20.20, UG4.05, UG6.05, UG6.10		

## alarm devices

## buzzers



1

<b>Part No.</b>	350053	<b>Ref. No.</b>	4003050
<b>description</b>	buzzer 12VAC connection male faston 3.2mm screw mounting buzzer		
<b>For models:</b>	HUD10.10, HUD12.20, HUD20.10, HUD20.20, HUD6.10, OD10.10, OD10.20, OD12.20, OD20.10, OD20.20, OD6.10, UG10.10, UG10.20, UG20.10, UG20.20, UG4.05, UG6.05, UG6.10		



Зип Общепит

auxiliary contacts

vsezip.ru

77(812)987-08-81



1

<b>Part No.</b>	350050	<b>Ref. No.</b>	5003050
<b>description</b>	buzzer 230VAC connection male faston 6.3mm screw mounting thread M4 60dB		

contactors

BENEDIKT & JÄGER

power contactors



1

<b>Part No.</b>	381476	<b>Ref. No.</b>	5056963
<b>description</b>	power contactor resistive load 130A 230 (AC3/400V) 37kW main contacts 3NO connection screw type K3-74A00		



1

<b>Part No.</b>	380774	<b>Ref. No.</b>	5056373A
<b>description</b>	power contactor resistive load 32A 230VAC (AC3/400V) 18A/7.5kW main contacts 3NO auxiliary contacts 1NO connection screw connection type K3-18ND10		



1

<b>Part No.</b>	380775	<b>Ref. No.</b>	5056962
<b>description</b>	power contactor resistive load 65A 230VAC (AC3/400V) 32A/15kW main contacts 3NO auxiliary contacts connection screw connection type K3-32A00230		



1

<b>Part No.</b>	381456	<b>Ref. No.</b>	5056966
<b>description</b>	auxiliary contact contacts 1NC/1NO AC15 3A connection screw type HKA11		



1

<b>Part No.</b>	380678	<b>Ref. No.</b>	5056965
<b>description</b>	auxiliary contact contacts 1NO AC15 10A for contactors K2/K3 connection screw type HN10 AC1 25A		

GENERAL ELECTRIC (AEG)

power contactors



1

<b>Part No.</b>	380247	<b>Ref. No.</b>	4001020 4001020K 4001027 4011000
<b>description</b>	power contactor resistive load 25A 400VAC (AC3/400V) 9A/4kW main contacts 3NO auxiliary contacts 1NC connection screw connection type AEG LS4K 01A type GE CL00A 301		
<b>For models:</b>	AR108, AR28, HUD10.10, OD10.10, OD10.20, OD12.20, OD20.10, OD20.20, OD6.10, OEB10.10, OEB10.20, OEB12.20, OEB20.10, OEB20.20, OEB6.10, OEB6.20, OES10.10, OES10.20, OES12.20, OES20.10, OES20.20, OES6.06, OES6.10, OES6.20, OGB10.10, OGB10.20, OGB12.20, OGB20.10, OGB20.20, OGB6.10, OGB6.20, OGS10.10, OGS10.20, OGS12.20, OGS20.10, OGS20.20, OGS6.10, OGS6.20, OSC10.10, OSC10.20, OSC12.20, OSC20.10, OSC20.20, OSC6.10, OSG10.10, OSG12.20, OSG20.20, OSG6.10, OSP10.10, OSP10.20...(Other models you can see in the webshop)		





Зип Общепит

vsezip.ru

+7(812)987-08-81

1

<b>Part No.</b>	381342	<b>Ref. No.</b>	4011001 4011001K 4030609
<b>description</b>	power contactor resistive load 25A 230VAC (AC3/400V) 18A/7.5kW main contacts 3NO auxiliary contacts 1NO/1NC connection elastic terminals type LC1D183P7		
<b>For models:</b>	OEB10.10, OEB10.20, OEB12.20, OEB20.10, OEB20.20, OEB6.10, OEB6.20, OES10.10, OES10.20, OES12.20, OES20.10, OES20.20, OES6.10, OES6.20		

1

<b>Part No.</b>	380265	<b>Ref. No.</b>	4001041 4011013K
<b>description</b>	power contactor resistive load 60A 230VAC (AC3/400V) 32A/16kW main contacts 3NO auxiliary contacts 1NO connection screw connection type AEG LS15K 00A type GE CL04A 310 H 98mm L 87mm W 55mm		
<b>For models:</b>	AR108, OD10.10, OD10.20, OD12.20, OD20.10, OD20.20, OD6.10, OSC10.10, OSC10.20, OSC12.20, OSC20.10, OSC20.20, OSP10.10, OSP10.20, OSP12.20, OSP20.10, OSP20.20, OSP6.10		

## auxiliary contacts



1

<b>Part No.</b>	380269	<b>Ref. No.</b>	4001072
<b>description</b>	auxiliary contact contacts 1NC AC15 6A for contactors CL+LS_K connection screw AC-12 10A type AEG HS07K 01 type GE BCLF 01		
<b>For models:</b>	HUD10.10, OD10.10, OD10.20, OD12.20, OD20.10, OD20.20, OD6.10		



1

<b>Part No.</b>	380268	<b>Ref. No.</b>	4001070
<b>description</b>	auxiliary contact contacts 1NO for contactors CL+LS_K connection screw AC-12 10A type AEG HS07K 10 type GE BCLF 10		
<b>For models:</b>	HUD20.20		



1

<b>Part No.</b>	380952	<b>Ref. No.</b>	4001015 4001030 4001030K 4030607
<b>description</b>	power contactor resistive load 40A 230VAC (AC3/400V) 25A/11kW main contacts 4NO auxiliary contacts 1NO/1NC connection screw connection type LC1DT40P7		
<b>For models:</b>	AR100, AR108, AR12, AR16, AR18, AR28, AR30, AR40, AR50, AR54, AR72, HUD10.10, HUD12.20, HUD20.10, HUD20.20, HUD6.10, OD10.10, OD10.20, OD12.20, OD20.10, OD20.20, OD6.10, OSC10.10, OSC10.20, OSC12.20, OSC20.10, OSC20.20, OSC6.10, OSP10.10, OSP10.20, OSP12.20, OSP20.10, OSP20.20, OSP6.10, UG10.10, UG20.10, UG6.05		

## TELEMECANIQUE (Schneider Electric)

## power contactors



1

<b>Part No.</b>	381204	<b>Ref. No.</b>	4011000K
<b>description</b>	power contactor resistive load 20A 230VAC (AC3/400V) 9A/4kW main contacts 3NO auxiliary contacts 1NO/1NC connection spring terminal type LC1D093P7 with RC circuit LAD4RCU		

## ABL SURSUM

## motor protection circuit breakers



1

<b>Part No.</b>	380300	<b>Ref. No.</b>	4002034
<b>description</b>	motor protection circuit breaker type Mbs25-016 setting range 1-1.6A (AC3/400V) 0.55kW		
<b>For models:</b>	HUD10.10, HUD20.10, HUD6.10, OD10.10, OD10.20, OD12.20, OD6.10, UG10.20, UG20.20		
<b>accessories for</b>	380300		



<b>Part No.</b>	380305	<b>Ref. No.</b>	4002039
-----------------	--------	-----------------	---------

auxiliary contact contacts 1NO/1NC HMS11



Зип Общепит

accessories

vsezip.ru

+7(812)987-08-81



1

<b>Part No.</b>	380301	<b>Ref. No.</b>	4002035
<b>description</b>	motor protection circuit breaker type Mbs25-025 setting range 1.6-2.5A (AC3/400V) 1.1kW		
<b>For models:</b>	AR18, AR28, AR40, AR54, OD10.10, OD10.20, OD12.20, OD20.10, OD20.20, OD6.10, OSG10.10, OSG12.20, OSG20.20, OSG6.10		



1

<b>Part No.</b>	380302	<b>Ref. No.</b>	4002036
<b>description</b>	motor protection circuit breaker type Mbs25-040 setting range 2.5-4A (AC3/400V) 1.5kW		
<b>For models:</b>	OD10.10, OD10.20, OD12.20, OD20.20, OD6.10, OSG10.10, OSG12.20, OSG20.20, OSG6.10		



1

<b>Part No.</b>	380322	<b>Ref. No.</b>	4002032
<b>description</b>	motor protection circuit breaker type SFK0E setting range 0.63-1A (AC3/400V) 0.5kW GENERAL ELECTRIC		
<b>For models:</b>	AR108, AR28, AR40, AR54, AR72, HUD10.10, HUD12.20, HUD20.10, HUD20.20, HUD6.10, OD10.10, OD10.20, OD12.20, OD20.10, OD20.20, OD6.10, UG10.10, UG20.10, UG6.10		



1

<b>Part No.</b>	380305	<b>Ref. No.</b>	4002039
<b>description</b>	auxiliary contact contacts 1NO/1NC HMS11		
<b>For models:</b>	HUD12.20, HUD20.20, OD10.10, OD10.20, OD12.20, OD20.10, OD20.20, OD6.10		

## solid state relays

### CRYDOM



1

<b>Part No.</b>	403868	<b>Ref. No.</b>	5056381
<b>description</b>	solid state relay CRYDOM 1 phase 90A 480V 4-32VDC L 58mm W 4mm screw type CWD4890P		

## relays

### power relays

#### with flange mounting



1

<b>Part No.</b>	380131	<b>Ref. No.</b>	4000017
<b>description</b>	power relays Italiana Relè 230VAC 16A 3CO connection male faston 6.3mm screw mounting manuf. no. B2-3-230AC		



## Зип Общепит

with male contacts

female contact 2.0mm

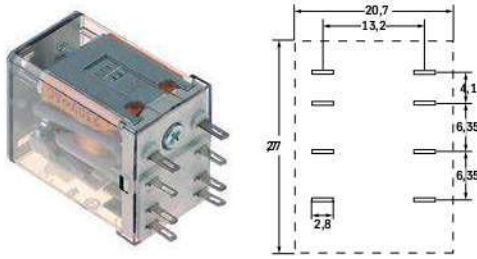

1

<b>Part No.</b>	380377	<b>Ref. No.</b>	4000022
<b>description</b>	power relays FINDER 220-240VAC 10A 2CO connection F2 plug-in connection manuf. no. 55.32.8.230.0000 94.92.3 250V		
<b>For models:</b>	OD10.20, OD12.20		
<b>accessories for</b>	380377		
	<b>Part No.</b>	380341	<b>Ref. No.</b> —
	relay socket 4-pole contacts 12 300V voltage AC 6A Italiana Relè manuf. no. ZMD4		
	<b>Part No.</b>	380378	<b>Ref. No.</b> —
	relay socket 2-pole 55/85 dimensions 70.5x30x27mm 250V voltage AC 10A FINDER manuf. no. 94.72		
	<b>Part No.</b>	380384	<b>Ref. No.</b> —
	relay socket 2-pole contacts male faston 2.8mm 250V voltage AC 10A W 23mm for		
	<b>Part No.</b>	380399	<b>Ref. No.</b> —
	relay socket 4-pole dimensions 76.2x27x86.1mm 250V voltage AC 1A FINDER manuf. no. 94.94.3		

## plug-in/print relays



1

<b>Part No.</b>	381090	<b>Ref. No.</b>	4000012
<b>description</b>	print relay 12VDC at 250V 10A with relay socket		
<b>spare parts for</b>	381090		
	<b>Part No.</b>	380500	<b>Ref. No.</b> —
	print relay 12VDC 2CO at 250V 8A connection pins raster size 5mm REIPOL		

vsezip.ru

+7(812)987-08-81



1

<b>Part No.</b>	381091	<b>Ref. No.</b>	4000013
<b>description</b>	print relay 230V voltage AC at 250V 10A with relay socket		
<b>For models:</b>	OD10.10, OD12.20, OD20.20, OD6.10, OSG10.10, OSG12.20, OSG20.20, OSG6.10		

## transformers

## power supplies



1

<b>Part No.</b>	402981	<b>Ref. No.</b>	2618809 5056385
<b>description</b>	power supply primary 100-240VAC secondary 12VDC 60VA secondary 5A H.38mm L.99mm W.155mm connection screw 50/60Hz type ABL1REM12050 combi-steamer P3-devices		
<b>For models:</b>	OES6.06		

## probes

## producer-specific probes

## probes



1

<b>Part No.</b>	400024	<b>Ref. No.</b>	5009050
<b>description</b>	temperature probe NTC 100kOhm cable PVC probe -40 up to +125°C cable -10 up to 100°C connection plug thread M10 probe ø6x120mm cable length 0.1m		
<b>For models:</b>	HUD10.10, HUD12.20, HUD20.10, HUD20.20, HUD6.10		



1

<b>Part No.</b>	379409	<b>Ref. No.</b>	5001035
<b>description</b>	temperature probe Pt100 cable PVC probe -100 up to 450°C cable -10 up to 100°C connection 2-wire thread M10 probe ø3x60mm cable length 0.7m		
<b>For models:</b>	OD10.10, OD10.20, OD12.20, OD20.20, OD6.10		



1



<b>Part No.</b>	379726	<b>Ref. No.</b>	5009053
<b>description</b>	temperature probe Pt100 cable silicone probe -100 up to 450°C cable -50 up to +180°C connection 3-wire thread M10x1 probe ø3x130mm cable length 1.5m		
<b>For models:</b>	OD10.10, OD10.20, OD12.20, OD20.20, OD6.10		





Зип Общепит

vsezip.ru



+7(812)987-08-81

			
<b>Part No.</b>	379104	<b>Ref. No.</b>	5009052
<b>description</b>	temperature probe Pt100 cable silicone probe -50 up to +300°C cable -50 up to +200°C connection 2-wire thread M10 probe ø4.5x-20mm cable length 3m		
<b>For models:</b>	OD10.10, OD10.20, OD12.20, OD20.10, OD20.20, OD6.10, OSP10.20, OSP12.20		
<b>accessories for</b>	379104		
	<b>Part No.</b>	510416	<b>Ref. No.</b> 6005016
flat gasket fibre ED ø 19mm ID ø 10.5mm thickness 1.5mm for thread M10 Qty 1 pcs			

			
<b>Part No.</b>	379105	<b>Ref. No.</b>	5001022 5001023
<b>description</b>	temperature probe Pt100 cable silicone probe -50 up to +600°C cable -50 up to +180°C connection 2-wire thread M14x1.5 probe ø3x350mm cable length 2.4m		
<b>For models:</b>	OD10.10, OD10.20, OD12.20, OD20.10, OD20.20, OD6.10		

			
<b>Part No.</b>	379410	<b>Ref. No.</b>	5001015
<b>description</b>	temperature probe thermocouple K (NiCr-Ni) cable silicone probe -50 up to 1150°C cable -50 up to +180°C connection 2-wire thread M10 probe ø3x125mm cable length 1.5m		
<b>For models:</b>	OSG10.10, OSG12.20, OSG20.20, OSG6.10		

			
<b>Part No.</b>	379420	<b>Ref. No.</b>	5001016
<b>description</b>	temperature probe thermocouple K (NiCr-Ni) cable silicone probe -50 up to 1150°C cable -50 up to +180°C connection 2-wire thread M10 probe ø3x70mm cable length 0.7m		
<b>For models:</b>	OSG10.10, OSG12.20, OSG20.20, OSG6.10		

			
<b>Part No.</b>	379800	<b>Ref. No.</b>	5002100 5002100K 5002101 5016014K 5030618
<b>description</b>	temperature probe thermocouple K (NiCr-Ni) cable silicone probe -50 up to 1150°C cable -50 up to +180°C connection 2-wire thread M5 probe ø4x20mm cable length 3m		
<b>For models:</b>	OEB10.10, OEB10.20, OEB12.20, OEB20.10, OEB20.20, OEB6.10, OEB6.20, OES10.10, OES10.20, OES12.20, OES20.10, OES20.20, OES6.06, OES6.10, OES6.20, OGB10.10, OGB10.20, OGB12.20, OGB20.10, OGB20.20, OGB6.10, OGB6.20, OGS10.10, OGS10.20, OGS12.20, OGS20.10, OGS20.20, OGS6.10, OGS6.20, OS10.10, OS10.20, OS12.20, OS20.10, OS20.20, OS6.10, OSC10.10, OSC10.20, OSC12.20, OSC20.10, OSC20.20, OSC6.10, OSG20.20, OSP10.10, OSP10.20, OSP12.20, OSP20.10, OSP20.20, OSP6.10		
<b>accessories for</b>	379800		
	<b>Part No.</b>	521012	<b>Ref. No.</b> 6005260
gasket graphite ED ø 15mm ID ø 5mm thickness 1.2mm Qty 1 pcs			

			
<b>Part No.</b>	402164	<b>Ref. No.</b>	5002102 5002102K 5030619
<b>description</b>	temperature probe thermocouple K (NiCr-Ni) cable silicone probe -50 up to 1150°C cable -50 up to +180°C connection 2-wire thread M8 probe ø3x130/230mm cable length 2.1m		
<b>For models:</b>	OS10.10, OS10.20, OS12.20, OS20.10, OS20.20, OS6.10, OSC10.10, OSC10.20, OSC12.20, OSC20.10, OSC20.20, OSC6.10, OSP10.10, OSP10.20, OSP12.20, OSP20.10, OSP20.20, OSP6.10		

			
<b>Part No.</b>	379536	<b>Ref. No.</b>	5016003
<b>description</b>	temperature probe thermocouple K (NiCr-Ni) cable silicone probe -50 up to 1150°C cable -50 up to +180°C connection 2-wire thread probe ø1.5x230mm cable length 2m		
<b>For models:</b>	OEB20.20, OGB10.10, OGB10.20, OGB12.20, OGB20.10, OGB20.20, OGB6.10, OGB6.20, OGS10.10, OGS10.20, OGS12.20, OGS20.10, OGS20.20, OGS6.10, OGS6.20		

			
<b>Part No.</b>	379440	<b>Ref. No.</b>	5002103 5016017
<b>description</b>	temperature probe thermocouple K (NiCr-Ni) cable silicone probe -50 up to 1150°C cable -50 up to +180°C connection 2-wire thread probe ø1.5x35mm cable length 1.6m		
<b>For models:</b>	OS10.20, OS6.10, OSC10.10, OSC10.20, OSC12.20, OSC20.10, OSC20.20, OSC6.10, OSP10.10, OSP10.20, OSP12.20, OSP20.10, OSP20.20, OSP6.10		

			
<b>Part No.</b>	379751	<b>Ref. No.</b>	5002104
<b>description</b>	temperature probe thermocouple K (NiCr-Ni) cable silicone probe -50 up to 1150°C cable -50 up to +180°C connection 2-wire thread probe ø1.5x35mm cable length 2.8m		
<b>For models:</b>	OEB10.10, OEB10.20, OEB12.20, OEB20.10, OEB20.20, OEB6.10, OEB6.20, OES10.10, OES10.20, OES12.20, OES20.10, OES20.20, OES6.10, OES6.20, OGB10.10, OGB10.20, OGB12.20, OGB20.10, OGB20.20, OGB6.10, OGB6.20, OS10.10, OS12.20, OS20.10, OS20.20, OSC10.10, OSC12.20, OSC20.10, OSC20.20, OSP10.10, OSP12.20, OSP20.10, OSP20.20		

			
<b>Part No.</b>	379751	<b>Ref. No.</b>	5002104
<b>description</b>	temperature probe thermocouple K (NiCr-Ni) cable silicone probe -50 up to 1150°C cable -50 up to +180°C connection 2-wire thread probe ø1.5x35mm cable length 2.8m		
<b>For models:</b>	OEB10.10, OEB10.20, OEB12.20, OEB20.10, OEB20.20, OEB6.10, OEB6.20, OES10.10, OES10.20, OES12.20, OES20.10, OES20.20, OES6.10, OES6.20, OGB10.10, OGB10.20, OGB12.20, OGB20.10, OGB20.20, OGB6.10, OGB6.20, OS10.10, OS12.20, OS20.10, OS20.20, OSC10.10, OSC12.20, OSC20.10, OSC20.20, OSP10.10, OSP12.20, OSP20.10, OSP20.20		