



Зип Общепит

vsezip.ru

+7(812)987-08-81



GAS COMPONENTS



ELECTRIC COMPONENTS



WATER TECHNOLOGY



MECHANICAL COMPONENTS



TOOLS

Spare parts suitable for

DEXION

Find the complete and up-to-date range of products in our GEV Webshop

Зип Общепит

vsezip.ru

+7(812)987-08-81

Manufacturer catalogue

The most important spare parts and accessories arranged clearly for every manufacturer



Complete product range and all appliance data always up to date in the GEV Webshop







Alphabetical Index at the end of the catalogue

GEV Webshop

www.gev-online.co.uk

www.gev-online.com



-  Add to Favourites
-  Sign In with email address and usual password
-  Easy-order – place several items in your basket at the same time
-  Quick item search – no login needed



heating elements

heating elements for ovens

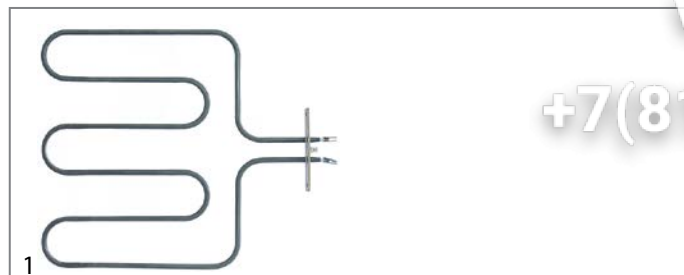

GEV No.	416541	Ref. No.	RIC0002548
description	heating element 1500W 230V heating circuits 1 L 350mm W 510mm L1 40mm L2 305mm W1 233mm W2 30mm flange length 100mm flange width 22mm hole distance 86mm hole ø 5mm tube ø 6.6mm connection male faston 6.3mm windings 3 rectangular flange dry heating element oven grill setin		
For models:	ME103-03-013XL, ME106-03-010XL, MG106-03-010, MG106-03-010XL		

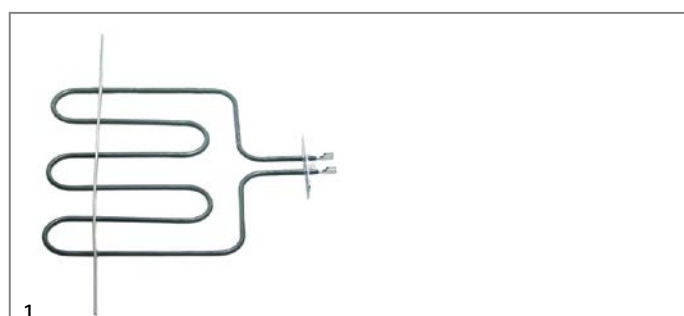

GEV No.	418495	Ref. No.	9303350400 RIC0001836
description	heating element 1800W 230V heating circuits 1 L 320mm W 287mm L1 78mm L2 242mm W1 127mm W2 30mm flange length 100mm flange width 22mm hole distance 86mm bridge length 480mm hole ø 5mm tube ø 6.3mm connection male faston 6.3mm connection length 35mm windings 3 rectangular flange dry heating element oven grill setin		
For models:	ME066-03-010, ME066-03-013, ME106-03-013, MG066-03-010		

heating elements for bain maries

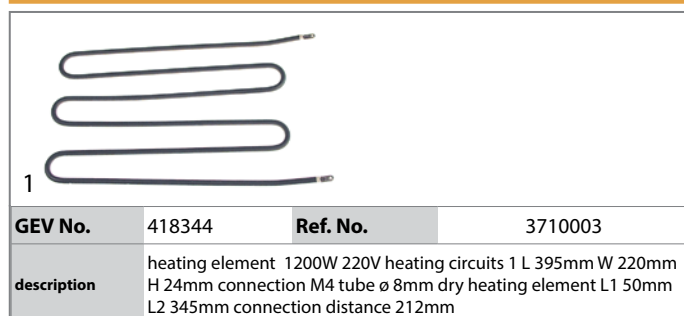

GEV No.	418344	Ref. No.	3710003
description	heating element 1200W 220V heating circuits 1 L 395mm W 220mm H 24mm connection M4 tube ø 8mm dry heating element L1 50mm L2 345mm connection distance 212mm		

GEV No.	416554	Ref. No.	RTCU700280
description	heating element 1500W 230V heating circuits 1 L 355mm W 203mm flange length 70mm flange width 22mm hole distance 56mm connection M4 tube ø 8.5mm rectangular flange hole ø 5mm dry heating element L1 40mm L2 315mm W1 85mm W2 33mm		
For models:	ME046-03-003, ME066-03-006		

Зип Общепит

vsezip.ru

+7(812)987-08-81

GEV No.	416032	Ref. No.	013448-00 013448-00R
description	heating element 850W 230V heating circuits 1 L 430mm L1 30mm W 145mm connection M4 connection distance 140mm tube ø 6.5mm dry heating element bain marie L2 400mm H 16mm		

heating elements for frying pans

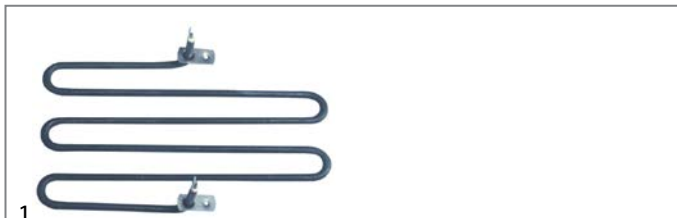

GEV No.	416550	Ref. No.	RTCU600125
description	heating element 1500W 230V heating circuits 1 L 350mm W 155mm hole distance 141mm connection length 23mm connection M4 tube ø 8.6mm bracket mounting hole ø M5mm dry heating element L1 148mm L2 158mm H 30mm lug length 40mm lug width 18mm		
For models:	ME066-03-015		

heating elements for fryers

off-center connection

with retaining rings

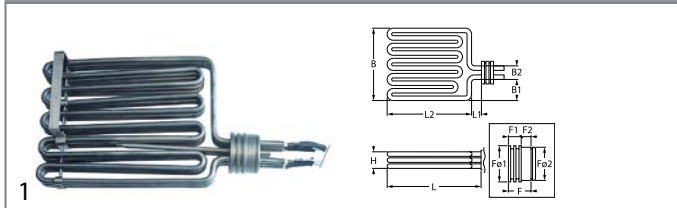

GEV No.	416557	Ref. No.	RTCU600122
description	heating element 9000W 230V heating circuits 3 mounting pos. right L 290mm W 202mm H 35mm thermostat sleeves ø M10mm number of thermostat sleeves 2 windings 5 L1 18mm L2 272mm W1 32mm W2 35mm tube ø 8.5mm cable length 375mm rotation flange immersion heater connection length 65mm		
For models:	ME046-03-004, ME066-03-007		

accessories for	416557			
	GEV No.	510243	Ref. No.	RTCU700565
		O-ring Viton thickness 3.53mm ID ø 55.56mm Qty 1 pcs		
	GEV No.	510244	Ref. No.	RTMIN00283
		retaining ring shaft ø 60mm thickness 2mm steel DIN 471		
	GEV No.	551117	Ref. No.	—
		plug conical ø 6.2/8mm L 37.5mm for probe rubber		



Зип Общепит heating elements for refrigeration

2 hole fixing

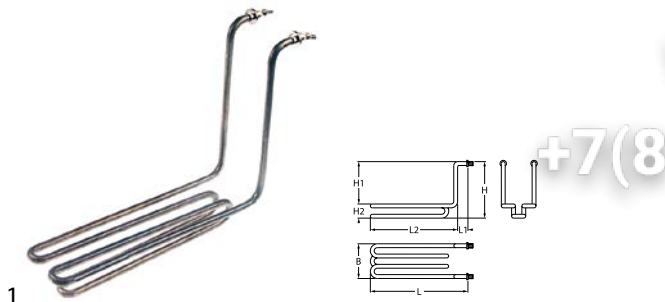

GEV No.	416889	Ref. No.	180588
description	heating element 2000W 230V heating circuits 1 L 310mm W 73mm H 225mm L1 40mm L2 270mm H1 190mm H2 36mm thread 1/4" mounting distance 65mm tube ø 8.5mm 2 hole fixing connection M5 fryer heaters windings 3		
accessories for	416889		
	GEV No.	361182	Ref. No. —
	nut thread 1/4" H 5mm nickel-plated brass WS 17 Qty 1 pcs		
	GEV No.	510417	Ref. No. —
	flat gasket fibre ED ø 20mm ID ø 14mm thickness 2mm Qty 1 pcs		
	GEV No.	520228	Ref. No. —
	tooth lock washer ID ø 15.3mm ED ø 24mm steel Qty 1 pcs for thread M14		
	GEV No.	550262	Ref. No. —
	flat gasket copper ED ø 20mm ID ø 14mm thickness 2mm		
	GEV No.	560112	Ref. No. —
	plain washer ID ø 5.3mm ED ø 10mm thickness 1mm SS Qty 20 pcs DIN 125A for thread M5		
	GEV No.	560132	Ref. No. —
	hexagonal nut thread M5 H 4mm WS 8 SS DIN/ISO DIN 934 / ISO 4032/8673 Qty 20 pcs		

heating elements for griddles

	GEV No.	416544	Ref. No.	RTCU600183
description	heating element 1250W 240V heating circuits 1 L 416mm W 70mm H 65mm tube ø 8.5mm connection M4 connection distance 53mm dry heating element			
For models:	ME046-03-001, ME046-03-002, ME046-13-001, ME046-13-002, ME066-03-003, ME066-03-004, ME066-13-003, ME106-13-003			

heating elements for defrosting

	GEV No.	416313	Ref. No.	01152700R
description	heating element 1100W 230V L 277mm W 630mm L1 54mm L2 223mm W1 40mm W2 590mm cable length 1500mm tube ø 6.3mm dry heating element defrosting			

	GEV No.	416312	Ref. No.	011526-00 011526-00R 011526-01 011526-01R
description	heating element 550W 230V L 420mm W 210mm L1 26mm L2 394mm W1 45mm W2 165mm cable length 1500mm tube ø 6.3mm immersion heater defrosting connection cable suitable for DEXION			

	GEV No.	416418	Ref. No.	01447401R 022258-01R
description	heating element 550W 230V L 440mm W 160mm H 60mm W1 85mm W2 42mm cable length 1500mm tube ø 6.3mm connection length 40mm immersion heater defrosting			

	GEV No.	420338	Ref. No.	022258-02R
description	heating element 550W 230V L 440mm W 180mm H 80mm W1 60mm W2 60mm connection Faston 6.3mm cable length 1500mm tube ø 6.25mm immersion heater with thermal fuse switch-off temp. 72°C			

heating elements for condensate evaporation

	GEV No.	416374	Ref. No.	019430-02R
description	heating element 135W 230V L 480mm W 115mm Hmm cable length 2200mm tube ø 6.25mm			



Зип Общежит
heating cables

vsezip.ru
connection on both sides
with wire end ferrules

+7(812)987-08-81

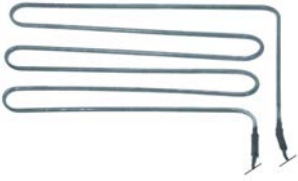

1

GEV No.	420393	Ref. No.	019014-00R
description	heating element 750W 230V L 425mm W 350mm for blast chiller suitable for DEXION		





1

GEV No.	416310	Ref. No.	00-556093 011524-00 011524-00R
description	heating cable 20W 230V L 6190mm L1 (unheated) 800mm L2 (heated) 4590mm silicone ø 3mm		

heating elements for pasta cookers



1

GEV No.	416552	Ref. No.	RTCU700283	
description	heating element 1850W 230V L 284mm W 48mm H 28mm 2 hole fixing connection M4 thread M16x1.5 tube ø 8.5mm L1 40mm L2 248mm mounting distance 40mm connection length 26mm pasta cooker immersion heater			
For models:	LX7EC4			
spare parts for	416552			
	GEV No.	521137	Ref. No.	—
accessories for	flat gasket fibre ED ø 20mm ID ø 18mm thickness 1.5mm for thread 3/8" Qty 1 pcs			
	GEV No.	361183	Ref. No.	—
accessories for	nut thread 3/8" H 6mm nickel-plated brass WS 20 Qty 1 pcs			



1



GEV No.	416311	Ref. No.	011525-00 011525-00R
description	heating cable 46W 230V 50Hz L 7560mm L1 (unheated) 800mm L2 (heated) 5960mm silicone door frame heating ø 3mm connection terminal		

ceramic heaters

245x60mm



1

GEV No.	415104	Ref. No.	RTCU600117	
description	ceramic emitter 1000W 230V cable beaded cord L 245mm W 60mm H 35mm			
For models:	ME046-03-005			
spare parts for	415104			
	GEV No.	415109	Ref. No.	—
accessories for	spring clip			
	GEV No.	415110	Ref. No.	—
accessories for	reflector L 245mm W 95mm H 31mm thickness 0.75mm hole ø 15x40mm			

heating elements for heated cabinets



1

GEV No.	418344	Ref. No.	3710003
description	heating element 1200W 220V heating circuits 1 L 395mm W 220mm H 24mm connection M4 tube ø 8mm dry heating element L1 50mm L2 345mm connection distance 212mm		

electric components



immersion heating elements

3 hole flange ø47.5mm

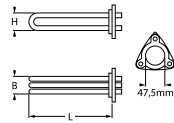

GEV No.	417440	Ref. No.	230111
description	heating element 4900W 230V mounting ø 47.5mm heating circuits 3 L 330mm W 32mm H 34mm number of thermostat sleeves 1 thermostat sleeves ø 7mm length thermostat sleeves 177mm thermostat sleeve not clinging tube ø 6.5mm hole distance 62mm hole ø 8mm connection M4 3 hole flange immersion heater		

For models: D501LS

accessories for 417440



GEV No.	510408	Ref. No.	456002 REB456002
----------------	--------	-----------------	---------------------

O-ring EPDM thickness 5.34mm ID ø 47mm Qty 1 pcs



GEV No.	510562	Ref. No.	—
----------------	--------	-----------------	---

O-ring silicone thickness 5.34mm ID ø 47mm Qty 1 pcs

with round flange ø47.5mm



GEV No.	420057	Ref. No.	230116
description	heating element 3000W 230V heating circuits 1 mounting ø 47.5mm L 330mm W 33mm H 19mm tube ø 8.4mm thermostat sleeves ø 7.4mm number of thermostat sleeves 1 length thermostat sleeves 170mm		

For models: D500LS, D501LS

spare parts for 420057



GEV No.	510408	Ref. No.	456002 REB456002
----------------	--------	-----------------	---------------------

O-ring EPDM thickness 5.34mm ID ø 47mm Qty 1 pcs



GEV No.	415665	Ref. No.	230086
description	heating element 2750/3250W 220/240V heating circuits 1 L 380mm W 110mm H 30mm thread M10x1 mounting distance 75mm tube ø 6.5mm connection M4 immersion heater 2 hole fixing		

For models: D500LS, D501LS

spare parts for 415665



GEV No.	510893	Ref. No.	456015
----------------	--------	-----------------	--------

O-ring EPDM thickness 2.62mm ID ø 9.92mm Qty 1 pcs

accessories for 415665



GEV No.	510416	Ref. No.	—
description	flat gasket fibre ED ø 19mm ID ø 10.5mm thickness 1.5mm for thread M10 Qty 1 pcs		







GEV No.	520231	Ref. No.	—
----------------	--------	-----------------	---

nut thread M10x1 H 6mm WS 14 zinc-coated steel Qty 1 pcs

Зип-Общепит

vsezip.ru

+7(812)987-08-81

	GEV No.	521103	Ref. No.	—
description	nut thread M4 H 3mm WS 7 brass Qty 20 pcs			
	GEV No.	521104	Ref. No.	—
description	washer ID ø 4.3mm ED ø 8mm thickness 0.5mm brass Qty 20 pcs for thread M4			
	GEV No.	521129	Ref. No.	—
description	nut thread M10 H 6mm SS WS 17 Qty 1 pcs DIN/ISO DIN 439			
	GEV No.	560111	Ref. No.	—
description	plain washer ID ø 4.3mm ED ø 9mm thickness 0.8mm SS Qty 20 pcs DIN 125A for thread M4			
	GEV No.	560131	Ref. No.	—
description	hexagonal nut thread M4 H 3.2mm WS 7 SS DIN/ISO DIN 934 / ISO 4032/8673 Qty 20 pcs			

heating elements for convection



GEV No.	418345	Ref. No.	3710004
description	heating element 1600W 230V heating circuits 1 ID ø 178mm ED ø 191mm L 250mm H 40mm L1 50mm W1 32mm H1 16mm H2 24mm flange length 70mm flange width 22mm hole distance 56mm connection male faston 6.3mm tube ø 6.3mm convection heating element hole ø 5mm rectangular flange		

accessories for 418345



GEV No.	510368	Ref. No.	—
description	gasket L 70mm W 23.5mm hole ø 5mm hole distance 56mm FIBER thickness 2mm for heating element		



GEV No.	416030	Ref. No.	011482-01 011482-01R 019522-00 019522-00R
----------------	--------	-----------------	--

description	heating element 1900W 230V heating circuits 1 ID ø 175mm ED ø 192mm L 255mm H 42mm L1 47mm W1 30mm H1 16mm H2 26mm flange length 70mm flange width 22mm hole distance 56mm connection male faston 6.3mm tube ø 6.5mm convection heating element mounting thread M4 rectangular flange with thread bolt		
--------------------	--	--	--

spare parts for 416030





GEV No.	510368	Ref. No.	—
description	gasket L 70mm W 23.5mm hole ø 5mm hole distance 56mm FIBER thickness 2mm for heating element		



Зип Общепит

vsezip.ru

+7(812)987-08-81

 <p>1</p>			
GEV No.	415966	Ref. No.	RIC0001835
description	heating element 2500W 230V heating circuits 1 ID ø 176mm ED ø 188mm L 210mm H 28mm L1 22mm W1 30mm H1 3mm H2 25mm flange length 70mm flange width 22mm hole distance 56mm connection male faston 6.3mm tube ø 6.3mm convection heating element hole ø 5mm rectangular flange		
For models:	ME066-03-010, ME066-03-013, ME103-03-013XL, ME106-03-010XL, ME106-03-013		
spare parts for	415966		
	GEV No.	510368	Ref. No. —
accessories for	415966		
	GEV No.	510368	Ref. No. —
	gasket L 70mm W 23.5mm hole ø 5mm hole distance 56mm FIBER thickness 2mm for heating element		

 <p>1</p>			
GEV No.	419014	Ref. No.	011482-00-R
description	heating element 2700W 230V heating circuits 1 ID ø 179mm ED ø 192mm L 247mm H 34mm L1 50mm W1 30mm H1 8mm H2 25mm flange length 70mm flange width 23mm hole distance 56mm tube ø 6.3mm mounting thread M4 mounting distance 56mm		

radiation heaters

1-circuit

 <p>1</p>			
GEV No.	490113	Ref. No.	RIC0001295
description	radiation heater ø 200mm 1800W 230V heating circuits 1 energy regulation with temperature signalization with ribbon heater connections 2+2 connection type male faston 6.3mm CERAMASPEED		
For models:	ME046-03-000V, ME066-03-000V		

 <p>2-circuit</p>			
GEV No.	490139	Ref. No.	RIC0001294
description	radiation heater ø 250mm 2500W 230V heating circuits 2 energy regulation with temperature signalization partial power 1000W with ribbon heater connections 3+2 connection type male faston 6.3mm EGO		
For models:	ME046-03-000V, ME066-03-000V		

foil heating elements

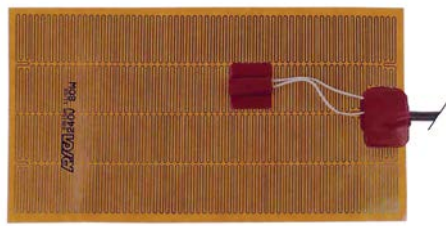
 <p>1</p>			
GEV No.	416416	Ref. No.	01233602R
description	foil heating element L 240mm W 130mm 80W 230V with temperature limiter 80°C t.max.°C plastic cable length 1270mm thickness 0.5mm connection cable		

 <p>1</p>			
GEV No.	416315	Ref. No.	01233501R 0123500R
description	heater mat L 470mm W 65mm 87W 230V with temperature limiter t.max. 80°C plastic cable length 3500mm		

 <p>1</p>			
GEV No.	416314	Ref. No.	01943001R
description	heating element 110W 230V cable length 2500mm		

accessories

retaining rings

 <p>1</p>			
GEV No.	510244	Ref. No.	RTMIN00283
description	retaining ring shaft ø 60mm thickness 2mm steel DIN 471		
For models:	ME046-03-004, ME066-03-007		



Зип.Общепит

vsezip.ru
With radused edge

for domestic and commercial kitchens

+7(812)987-08-81

sealing washers

O-rings

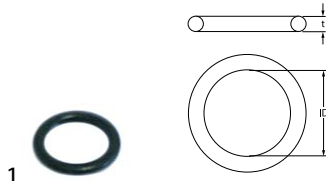

1

GEV No.	510893	Ref. No.	456015
description	O-ring EPDM thickness 2.62mm ID \varnothing 9.92mm Qty 1 pcs		
For models:	D500LS, D501LS		

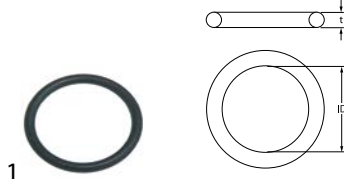

1

GEV No.	510408	Ref. No.	456002 REB456002
description	O-ring EPDM thickness 5.34mm ID \varnothing 47mm Qty 1 pcs		
For models:	D500LS, D501LS, LB03100000, LB03300000, LP05500010		

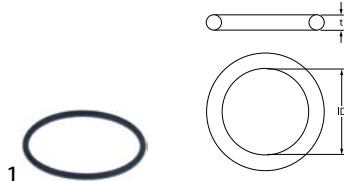

1

GEV No.	510243	Ref. No.	RTCU700565
description	O-ring Viton thickness 3.53mm ID \varnothing 55.56mm Qty 1 pcs		
For models:	ME046-03-004, ME066-03-007		

protection caps



1

GEV No.	510093	Ref. No.	69870
description	protection cap		
For models:	D500LS, D501LS		



1

GEV No.	520876	Ref. No.	463007
description	protection cap for heating element \varnothing 11.5mm H 32mm W 25mm plastic		
For models:	D500LS, D501LS		

round

With radused edge

for domestic and commercial kitchens



1

GEV No.	490012	Ref. No.	RTCU700087
description	hot plate \varnothing 145mm 1500W 230V connection 4 screw clamps with 8mm spill ring		
For models:	ME046-03-000, ME066-03-000, ME066-03-013, ME103-03-013XL, ME106-03-000, ME106-03-013		



1

GEV No.	490020	Ref. No.	RTCU700086
description	hot plate \varnothing 220mm 2600W 230V connection 4 screw clamps with 8mm spill ring		
For models:	ME046-03-000, ME066-03-000, ME066-03-013, ME103-03-013XL, ME106-03-000, ME106-03-013		

accessories for 490020

GEV No.	550796	Ref. No.	—
fixing plate for hot plate \varnothing 220mm			

accessories

miscellaneous

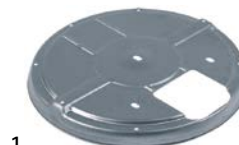

1

GEV No.	490111	Ref. No.	RTCU700083
description	cover for hot plate \varnothing 237mm		
For models:	ME046-03-000, ME066-03-000, ME066-03-013, ME103-03-013XL, ME106-03-000, ME106-03-013		



energy regulators

EGO

1-circuit



GEV No.	380015	Ref. No.	RTCU800066
description	energy regulator 230V 13A single-circuit turn direction right shaft \varnothing 6x4.6mm shaft L 23mm mounting thread M4 power release 6-100% no. 50.57021.010		
For models:	ME046-03-005		



GEV No.	380019	Ref. No.	RIC0001299
description	energy regulator 240V 13A single-circuit turn direction right shaft \varnothing 6x4.6mm shaft L 23mm mounting thread M4 power release 6-100% no. 50.57071.010		
For models:	ME046-03-000V, ME066-03-000V		

2-circuit



GEV No.	380024	Ref. No.	RIC0001010
description	energy regulator 240V 13A turn direction right shaft \varnothing 6x4.6mm shaft L 36mm mounting thread M4 no. 50.67079.601 with operation switch 1-pole		
For models:	ME046-03-000V, ME066-03-000V		

thermostats

bi-metal thermostats

safety bi-metal thermostats



GEV No.	390233	Ref. No.	236039
description	bi-metal safety thermostat hole distance 24mm switch-off temp. 110°C 1NC 1-pole 16A connection F6.3 2 hole fixing without holder		
For models:	D501LS		
accessories for	390233		
GEV No.	504736	Ref. No.	—



bracket for contact thermostat

accessories for	390233	GEV No.	550388	Ref. No.	—
description	bracket for contact thermostat mounting distance 24.5mm mounting \varnothing 3.3				



GEV No.	390526	Ref. No.	012728-00 01272800R
description	bi-metal safety thermostat hole distance mm switch-off temp. 25°C 1NO 1-pole AV connection F6.3		



GEV No.	390959	Ref. No.	2LT135
description	bi-metal safety thermostat switch-off temp. 60°C 1-pole connection F6.3		
For models:	KL030-10-000W		



GEV No.	390318	Ref. No.	236047
description	bi-metal safety thermostat switch-off temp. 95°C 1-pole 2 hole fixing		
For models:	D500LS, D501LS		

control and safety thermostats

EGO

control thermostats

51_ series



GEV No.	375347	Ref. No.	RTCU700609
description	thermostat t.max. 175°C temperature range 95-175°C 1-pole capillary pipe isolated mm gland nut shaft \varnothing 6x4.6mm		
For models:	ME046-03-004, ME066-03-007		

Зип-Общепит

vsezip.ru

+7(812)987-08-81



1

GEV No.	375334	Ref. No.	RTBF800152
description	thermostat t.max. 85°C temperature range 30-85°C 1-pole 1NO 16A probe ø 6mm probe L 130mm capillary pipe 900mm capillary pipe isolated 900mm gland nut shaft ø 6x4.6mm shaft L 23mm shaft position upper rotation 270°		
For models:	ME046-03-003		



1

GEV No.	375385	Ref. No.	53401031820
description	thermostat t.max. 180°C temperature range 100-180°C 3-pole 3NO 16A probe ø 6mm probe L 131mm capillary pipe 2000mm capillary pipe isolated 1800mm gland nut shaft ø 6x4.6mm shaft L 23mm shaft position upper rotation 270°		

55.10/19_series



1

GEV No.	375354	Ref. No.	RTCU600186
description	thermostat t.max. 270°C temperature range 50-270°C 1-pole 1NO 16A probe ø 3mm probe L 219mm capillary pipe 900mm capillary pipe isolated 900mm gland nut shaft ø 6x4.6mm shaft L 23mm shaft position upper rotation 270°		
For models:	ME066-03-010, ME066-03-013, ME103-03-013XL, ME106-03-010XL, ME106-03-013		



1

GEV No.	375355	Ref. No.	RTCU600067
description	thermostat t.max. 300°C temperature range 50-300°C 3-pole 3NO 16A probe ø 3mm probe L 219mm capillary pipe 900mm capillary pipe isolated 900mm gland nut shaft ø 6x4.6mm shaft L 23mm shaft position upper rotation 270°		
For models:	ME046-03-001, ME046-03-002, ME046-13-001, ME046-13-002, ME066-03-003, ME066-03-004, ME066-03-015, ME066-13-003, ME106-13-003		

safety thermostats

55.10/19_series

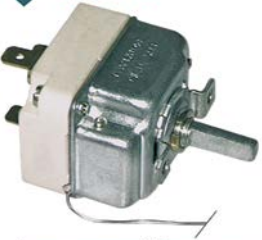

1

GEV No.	375232	Ref. No.	RTCU700085
description	thermostat t.max. 320°C temperature range 55-320°C 1-pole capillary pipe isolatedmm gland nut		
For models:	MG099-03-012, MG099-03-012M, MG099-13-012I, MG099-13-012IM		



1

GEV No.	375339	Ref. No.	RTBF900094
description	safety thermostat switch-off temp. 225°C 1-pole 0.5A probe ø 6mm probe L 133mm capillary pipe 870mm capillary pipe isolatedmm gland nut M10x1 probe		
For models:	MG046-03-004, MG066-03-007		

accessories for	375339			
	GEV No.	551083	Ref. No.	—
	cap for safety thermostat thread M8x1			



Зип Общепит

vsezip.ru

+7(812)987-08-81



GEV No.	375656	Ref. No.	RTBF800076
description	safety thermostat switch-off temp. 360°C 1-pole 0.5A probe ø 3.1mm probe L 201mm capillary pipe 900mm capillary pipe isolated 870mm gland nut probe SS		
For models:	MG099-03-012, MG099-03-012M, MG099-13-012I, MG099-13-012IM		



GEV No.	375228	Ref. No.	RTCU800152
description	safety thermostat switch-off temp. 350°C 3-pole 20A probe ø 3mm probe L 188mm capillary pipe 900mm capillary pipe isolated 900mm gland nut probe SS		
For models:	ME066-03-006		

55.32_series



GEV No.	375333	Ref. No.	RTCP900074
description	safety thermostat switch-off temp. 135°C 3-pole 20A probe ø 3.1mm probe L 225mm capillary pipe 890mm capillary pipe isolated 890mm gland nut probe SS		
For models:	LX7EC4, ME066-03-008		



GEV No.	375258	Ref. No.	RTBF800164
description	safety thermostat switch-off temp. 232°C 3-pole 20A probe ø 6mm probe L 94mm capillary pipe 900mm capillary pipe isolated 670mm gland nut M10x1 probe SS		
For models:	ME046-03-004, ME066-03-007		



IMIT / TEMPOMATIC / ARTHERMO

control thermostats



GEV No.	390008	Ref. No.	019310-00 01931000R
description	thermostat t.max. 210°C temperature range 64-210°C 1-pole 1CO 16A probe ø 5mm probe L 100mm capillary pipe 1000mm capillary pipe isolatedmm gland nut shaft L 19mm rotation 270° probe material copper		
accessories for	390008		
	GEV No.	110102	Ref. No. —
	knob thermostat t.max. 210°C 40-210°C ø 42mm shaft ø 6x4.6mm shaft flat -135° black		



GEV No.	390006	Ref. No.	014688-00 01468800R
description	thermostat t.max. 86°C temperature range 0-86°C 1-pole 1CO 16A probe ø 6.5mm probe L 95mm capillary pipe 1500mm capillary pipe isolatedmm gland nut shaft ø 6x4.6mm shaft L 19mm rotation 270°		
accessories for	390006		
	GEV No.	110100	Ref. No. —
	knob thermostat t.max. 90°C 0-90°C ø 42mm shaft ø 6x4.6mm shaft flat -135° black		
	GEV No.	110105	Ref. No. —
	rosette knob ø 42mm ø 56mm zero mark		

Зип-Общепит
refrigeration thermostatsuniversal without housing
vsezip.ru



+7(812)987-08-81

CAEM

control thermostats



1

GEV No.	390672	Ref. No.	236042
description	thermostat t.max. 53°C temperature range fixed 53°C 1-pole 1CO 16A probe ø 9.5mm probe L 30mm capillary pipe 600mm capillary pipe isolated 540mm gland nut shaft Lmm screw-in probe probe thread M14x1		
For models:	D500LS, D501LS		
spare parts for	390672		
	GEV No.	510417	Ref. No. —
	flat gasket fibre ED ø 20mm ID ø 14mm thickness 2mm Qty 1 pcs		
	GEV No.	550261	Ref. No. —
	nut thread M14x1 H 4mm WS 19 SS Qty 1 pcs		



1

GEV No.	390686	Ref. No.	236043
description	thermostat t.max. 83°C temperature range°C 1-pole 1CO 20A probe ø 6mm probe L 90mm capillary pipe 630mm capillary pipe isolated 550mm gland nut shaft ømm shaft Lmm shaft position rotation 270° probe material copper		
For models:	D500LS, D501LS		

PRODIGY / FIRT

control thermostats



1

GEV No.	390723	Ref. No.	012727-00
description	thermostat PRODIGY temperature range -35 up to +35°C probe ø 6mm probe L 110mm capillary pipe 1500mm type TR/711-N		
accessories for	390723		
	GEV No.	110305	Ref. No. —
	knob thermostat t.max. 35°C temperature range -35 up to +35°C ø 45mm shaft ø 6x4.6mm shaft flat inclined rotation 270° white		

universal without housing



1

GEV No.	390534	Ref. No.	012727-00 01272700R
description	thermostat temperature range -35 up to +35°C probe ø6x110mm capillary pipe 1800mm PRODIGY		
accessories for	390534		
	GEV No.	110305	Ref. No. —
	knob thermostat t.max. 35°C temperature range -35 up to +35°C ø 45mm shaft ø 6x4.6mm shaft flat inclined rotation 270° white		

RANCO

K22 series

RANCO



1

GEV No.	390207	Ref. No.	1LT020
description	thermostat RANCO type K22L2030 probe ø 2mm probe Lmm capillary pipe 2000mm temperature range -13 up to -4°C		
For models:	KL030-10-000A		

K50 series

RANCO



1

GEV No.	390271	Ref. No.	013475-00 01347500R
description	thermostat RANCO type K50L3078 probe ømm probe Lmm capillary pipe 2000mm temperature range -7 up to -3°C		





Зип Общепит
vsezip.ru

+7(812)987-08-81

			
GEV No.	390272	Ref. No.	013477-00 013477-00R
description	thermostat RANCO type K50P1117 probe ømm probe Lmm capillary pipe 2000mm temperature range -32 up to -12°C		

			
GEV No.	390273	Ref. No.	013471-00 01347100R
description	thermostat RANCO type K50L3194 capillary pipe 1870mm temperature range +1 up to +3°C probe ø10x40mm		

			
GEV No.	345386	Ref. No.	018153-00 01815300R
description	rocker switch mounting measurements 30x11mm yellow 1NO 250V 16A time/main switch connection male faston 6.3mm ambient temperature max. 90°C protection IP40		

			
GEV No.	345384	Ref. No.	013519-00 01351900R
description	rocker switch mounting measurements 30x11mm yellow 1NO/indicator light 250V 16A 0-lighting connection male faston 6.3mm ambient temperature max. 90°C protection IP40		

			
GEV No.	345383	Ref. No.	013474-00 01347400R
description	rocker switch mounting measurements 30x11mm yellow 1NO/indicator light 250V 16A fan connection male faston 6.3mm ambient temperature max. 90°C protection IP40		

accessories

connecting bows

			
GEV No.	550060	Ref. No.	RTBF900037
description	connecting bow long for thermostat Qty 1 pcs		
For models:	ME066-03-015		

switches and momentary switches

rocker/momentary rocker switches

<p>30x11mm</p> 			
GEV No.	345381	Ref. No.	017462-00 01746200R
description	rocker switch mounting measurements 30x11mm green 1NO/indicator light 24V 16A connection male faston 6.3mm		

			
GEV No.	345382	Ref. No.	013473-00 01347300R
description	rocker switch mounting measurements 30x11mm green 1NO/indicator light 250V 16A 0-I connection male faston 6.3mm ambient temperature max. 85°C protection IP40		

30x22mm

			
GEV No.	301003	Ref. No.	01273100R
description	rocker switch mounting measurements 30x22mm green 2NO 250V 16A illuminated 0-I connection male faston 6.3mm ambient temperature max. 125/55°C protection IP65		
accessories for	301003		
GEV No.	301036	Ref. No.	—
description	protective cover internal size 30x22mm for rocker switch mounting measurementsmm		

push/momentary push switches

<p>20.6x16.4mm</p> 			
GEV No.	346595	Ref. No.	RTCU600189
description	momentary push switch mounting ø 20.6x16.4mm black 1NO 250V 16A ignition connection male faston 6.3mm ambient temperature max. 150/75°C protection IP40		
For models:	ME066-03-010, ME106-03-010XL, MG066-03-010, MG106-03-010, MG106-03-010XL		



Зип.Общепит

vsezip.ru

+7(812)987-08-81

			
1			
GEV No.	345663	Ref. No.	RTCU600187
description	push switch mounting measurements 20.6x16.4mm black 1NO 250V 16A lamp connection male faston 6.3mm ambient temperature max. 150°C protection IP40		
For models:	ME106-03-010XL, MG066-03-010, MG106-03-010, MG106-03-010XL		

			
1			
GEV No.	345667	Ref. No.	RTCU600188
description	push switch mounting ø 20.6x16.4mm black 1NO 250V 16A heating connection male faston 6.3mm ambient temperature max. 150°C protection IP40		
For models:	ME106-03-010XL, MG066-03-010, MG106-03-010, MG106-03-010XL		

microswitches

lever actuated

			
Image not available			
1			
GEV No.	345376	Ref. No.	01273000R
description	microswitch		

			
1			
GEV No.	346182	Ref. No.	9353445500
description	microswitch with lever 250V 10A 1CO connection male faston ambient temperature max. 85°C		
For models:	MG066-03-010, MG106-03-010, MG106-03-010XL		

			
1			
GEV No.	345742	Ref. No.	RTBF900277
description	microswitch with lever 250V 16A 1CO connection male faston 6.3mm L 55mm ambient temperature max. 120°C mounting distance 22mm actuating force: 75g lever length 46mm		
For models:	ME046-03-004, ME066-03-007		

			
roller lever actuated			
microswitches			
1			
GEV No.	348144	Ref. No.	25001301 25001311
description	microswitch 250V 8A 1CO connection F6.3 actuating force: 300g		

roller actuated

			
roller 0°			
1			
GEV No.	346370	Ref. No.	RTBF800113
description	microswitch with roller plunger 230V 16A 1CO connection screw L1 49mm ambient temperature max. 125°C thread L 14mm thread M10 mounting distance 25mm actuating force: 300g type MV15-2		
For models:	MG099-03-012, MG099-03-012M, MG099-13-012I, MG099-13-012IM		

system switches (ROLD)

			
1			
GEV No.	345606	Ref. No.	226071
description	momentary switch unit 2CO 250V 16A connection male faston 6.3mm		
For models:	D500LS, D501LS		

			
1			
GEV No.	347517	Ref. No.	227060
description	push button ø 21mm silver edition		
For models:	D500LS, D501LS		

			
1			
GEV No.	345605	Ref. No.	208010
description	switch 2CO 250V 16A connection male faston 6.3mm		
For models:	D500LS, D501LS		



cam switches

on/off

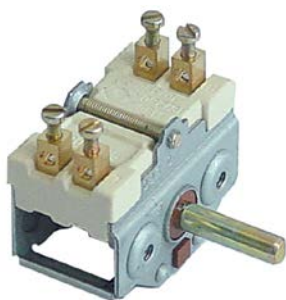

1

GEV No.	300151	Ref. No.	RTCU700212
description	cam switch 2 operating positions 2NO sequence 0-1 16A shaft ø 6x4.6mm shaft L 23mm connection screw ceramic		
For models:	ME046-03-003, ME066-03-006, MG099-03-012, MG099-03-012M, MG099-13-012I, MG099-13-012IM		

4-position





1

GEV No.	300104	Ref. No.	RTCP900036
description	cam switch 4 operating positions 3NO/1CO sequence 0-1-2-3 32A shaft ø 6x4.6mm shaft L 23mm connection screw ceramic		
For models:	LX7EC4, ME066-03-008		

7-position



1

GEV No.	300025	Ref. No.	RTCU700078
description	cam switch 7 operating positions 1NO/2CO sequence 0-1-2-3-4-5-6 16A shaft ø 6x4.6mm shaft L 23mm connection screw 7-position ceramic		
For models:	ME046-03-000, ME066-03-000, ME066-03-013, ME103-03-013XL, ME106-03-000, ME106-03-013		
accessories for	300025		
	GEV No.	112172	Ref. No. —
	knob universal ø 70mm black without adaptor/dial plate		
	GEV No.	112213	Ref. No. —
	knob dial plate silver switch 7-position t.max.°C ED ø 63mm ID ø 45.5mm		
	GEV No.	112311	Ref. No. —
	knob adapter shaft ø 6x4.6mm L 0mm with spring		

Зип Общежит

vsezip.ru

+7(812)987-08-81



1

GEV No.	300106	Ref. No.	RTCU800051
description	cam switch 7 operating positions 1NO/2CO sequence 0-1-2-3-4-5-6 32A shaft ø 6x4.6mm shaft L 23mm connection screw 7-position shaft flat upper		

operation switches



1

GEV No.	300080	Ref. No.	RTBF900007
description	cam switch 2 operating positions 4NO 16A sequence 0-1 shaft ø 6x4.6mm shaft L 23mm connection screw operation switch ceramic ambient temperature max. 150°C		
For models:	ME046-03-001, ME046-03-002, ME046-13-001, ME046-13-002, ME066-03-003, ME066-03-004, ME066-03-015, ME066-13-003, ME106-13-003		

accessories for	300080		
	GEV No.	551456	Ref. No. —
	gasket for switch ED ø 14mm ID ø 2.5mm thickness 3.5mm white		

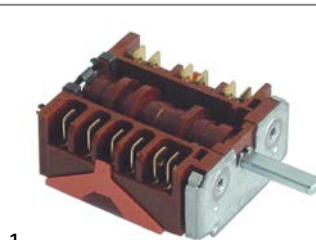

1

GEV No.	300157	Ref. No.	RTCU600185
description	cam switch 4 operating positions operation switch sequence 0-1-2-3 shaft ø 6x4.6mm connection male faston 3-pole ambient temperature max. 300°C		
For models:	ME066-03-010, ME066-03-013, ME103-03-013XL, ME106-03-010XL, ME106-03-013		



E-G-O



1

GEV No.	300091	Ref. No.	RTCU900110
description	operation switch EGO 2 operating positions 2NO 16A sequence 0-1 shaft \varnothing 6x4.6mm shaft L 23mm connection screw ceramic		
For models:	ME046-03-004		

magnetic switches

36x13mm



1

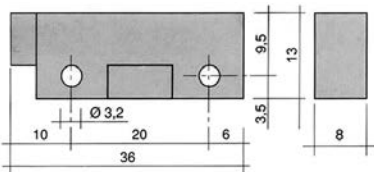

GEV No.	345118 ¹	Ref. No.	80871	
description	magnetic switch L 36mm W 13mm 1NO 250V 1A P max. 50W connection cable length 980mm			
For models:	D500LS, D501LS			
accessories for	345118			
	GEV No.	345399	Ref. No.	—
	magnet \varnothing 3.3mm L 40mm H 8mm W 13mm hole distance 30mm M3			

¹with coded connector

accessories

magnets



1

GEV No.	346953	Ref. No.	999108
description	magnet \varnothing 6mm L 23mm H 17mm W 18mm M6 hole \varnothing 6.5mm		
For models:	D500LS, D501LS		

Зип.Общепит
control equipment



TELEMECANIQUE (EFA)

vsezip.ru
XB2 series

+7(812)987-08-81



1

GEV No.	345412	Ref. No.	RTBF800125	
description	contact block with holder 1NO			
For models:	MG099-03-012, MG099-13-012I			
spare parts for	345412			
	GEV No.	345220	Ref. No.	—
	contact block EFA ZB2BE101 1NO max 230V 10(6)A black			
	GEV No.	345221	Ref. No.	—
	contact block EFA ZB2BE102 1NC max 230V 10(6)A black			
	GEV No.	347526	Ref. No.	—
	contact block holder for XB2			

lamps

indicator lights

indicator lights (complete)

 \varnothing 6mm

1

GEV No.	359005	Ref. No.	216025
description	indicator light \varnothing 6mm 230V yellow cable length 400mm		
For models:	D500LS, D501LS		

 \varnothing 10mm

with plug-in socket



1

GEV No.	359140	Ref. No.	216018
description	indicator light \varnothing 10mm yellow 230V connection male faston 6.3mm Qty 1 pcs		







Зип-Общепит



vsezip.ru

+7(812)987-08-81

ø12mm			
with screw socket			
			
1			
GEV No.	359291	Ref. No.	011486-00 01148600R
description	indicator light ø 12mm 400V green connection male faston 6.3mm		

30x11mm			
			
1			
GEV No.	359058	Ref. No.	013472-00 01347200R RIC0002907
description	indicator light mounting measurements 30x11mm 230V green		

ø13mm			
with screw socket			
			
1			
GEV No.	359145	Ref. No.	166465
description	indicator light ø 13mm 230V green t.max. 120°C		
For models:	LX7EC4		
accessories for	359145		
	GEV No.	510302	Ref. No. —
	O-ring EPDM ID ø 12.42mm thickness 1.78mm Qty 1 pcs		
	GEV No.	511505	Ref. No. —
	O-ring EPDM thickness 1.78mm ID ø 12.42mm Qty 10 pcs		

30x22mm			
			
1			
GEV No.	359157	Ref. No.	012732-00 01273200R
description	indicator light mounting measurements 30x22mm 230V green connection male faston 6.3mm temp.-resist. 125/55°C type RL2		
accessories for	359157		
	GEV No.	301036	Ref. No. —
	protective cover internal size 30x22mm for rocker switch mounting measurementsmm		

with plug-in socket			
			
1			
GEV No.	359142	Ref. No.	RTC900290
description	indicator light ø 13mm green 230V connection male faston 6.3mm temp.-resist. 120°C Qty 1 pcs		
For models:	ME046-03-000, ME046-03-000V, ME046-03-001, ME046-03-002, ME046-03-003, ME046-03-004, ME046-03-005, ME046-13-001, ME046-13-002, ME066-03-000, ME066-03-000V, ME066-03-003, ME066-03-004, ME066-03-006, ME066-03-007, ME066-03-008, ME066-03-010, ME066-03-013, ME066-03-015, ME066-13-003, ME103-03-013XL, ME106-03-000, ME106-03-010XL, ME106-03-013, ME106-13-003, MG066-03-010, MG099-03-012, MG099-03-012M, MG099-13-012I, MG099-13-012IM, MG106-03-010, MG106-03-010XL		

screw-on/push-on fit

light bulbs			
for ovens			
			
1			
GEV No.	359610	Ref. No.	9303310100 RIC0002592
description	light bulb t.max. 300°C socket E14 15W 230V ø 22mm L 47mm lens L 20mm for oven lamp type Philips		
For models:	ME066-03-010, ME066-03-013, ME103-03-013XL, ME106-03-010XL, ME106-03-013, MG066-03-010, MG106-03-010, MG106-03-010XL		

			
1			
GEV No.	359143	Ref. No.	RTC900072
description	indicator light ø 13mm yellow 230V connection male faston 6.3mm temp.-resist. 120°C Qty 1 pcs		
For models:	ME046-03-001, ME046-03-002, ME046-03-003, ME046-03-004, ME046-13-001, ME046-13-002, ME066-03-003, ME066-03-004, ME066-03-006, ME066-03-007, ME066-03-010, ME066-03-013, ME066-03-015, ME066-13-003, ME103-03-013XL, ME106-03-010XL, ME106-03-013, ME106-13-003, MG099-03-012, MG099-03-012M, MG099-13-012I, MG099-13-012IM		

electric components



Зип.Общепит

defrost timers



oven lamps

universal oven lamps

mounting diameter 35.5mm



1

GEV No.	359718	Ref. No.	9303310000 RIC0002549
description	oven lamp mounting ϕ 35.5mm 230V 15W socket E14 temp.-resist. 300°C connection male faston 6.3mm hard glas		
For models:	ME066-03-010, ME066-03-013, ME103-03-013XL, ME106-03-010XL, ME106-03-013, MG066-03-010, MG106-03-010, MG106-03-010XL		
spare parts for	359718		
	GEV No.	359701	Ref. No. —
	lamp socket socket E14 220-230V mounting ϕ 35.5mm connection male faston 6.3mm 15W		
	GEV No.	359740	Ref. No. —
	light bulb t.max. 300°C socket E14 15W 230V ϕ 22mm L 48mm lens L 20mm for oven lamp IMPORT		

lamps

light bulbs



1

GEV No.	359610	Ref. No.	9303310100 RIC0002592
description	light bulb t.max. 300°C socket E14 15W 230V ϕ 22mm L 47mm lens L 20mm for oven lamp type Philips		
For models:	ME066-03-010, ME066-03-013, ME103-03-013XL, ME106-03-010XL, ME106-03-013, MG066-03-010, MG106-03-010, MG106-03-010XL		

timers

programme timers

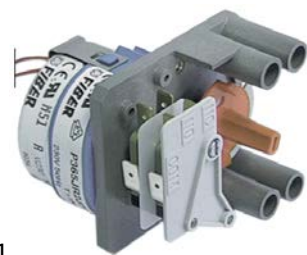

1

GEV No.	360051	Ref. No.	1LT017
description	timer FIBER P36 engines 1 chambers 2 operation time 15min 230V shaft ϕ 6mm shaft Lmm manuf. no. P365JR2J717 motor type M51B-J0R6400		
spare parts for	360051		
	GEV No.	360673	Ref. No. —
	motor kit pinion ϕ 6.8mm teeth 15 230V voltage AC 50/60Hz turn direction clockwise motor ϕ 48mm H 18.5mm motor type UDS-40NE1RNZ165 cable length 150mm with holder		

BIGATTI
vsezip.ru

1

GEV No.	360053	Ref. No.	013467-00 01346700R
description	defrost timer BIGATTI type D94.44 defrosting interval 4x per 24h defrosting time 10min fan delaymin 230V defr. funct. every 12h for 20 min.		



1

GEV No.	360058	Ref. No.	012720-01 01272001R
description	defrost timer type SB3.82 defrosting interval 1-12x in 24h defrosting time 2-54min fan delay 0-15min 230V defr. funct. 1-12x per 24h		

CDC



1

GEV No.	360521	Ref. No.	013467-00
description	defrost timer CDC type 11901F defrosting interval 4x per 24h defrosting time 12min fan delaymin 230V 50-60Hz defr. funct. every 6h		



contactors

ISKRA (FANAL)

power contactors



1

GEV No.	380213	Ref. No.	019033-00 01903300R
description	power contactor resistive load 20A 230VAC (AC3/400V) 8.5A/5.5kW main contacts 3NO auxiliary contacts 1NO connection screw connection type Fanal DSL7 10 type ISKRA K07M 10		

LOVATO

power contactors



1

GEV No.	380888	Ref. No.	RTFOC00465
description	power contactor resistive load 20A 230VAC (AC3/400V) 12A/5.7kW main contacts 3NO auxiliary contacts 1NC connection screw connection type 11BG1201A230		
For models:	ME046-03-004, ME066-03-007		

relays

power relays

with bracket mounting



1

GEV No.	380312	Ref. No.	019032-00 01903200R
description	power relays FINDER 230VAC 10A 3CO connection male faston 4.8mm bracket mounting dimensions 52x32.2x36.5mm manuf. no. 60.63.8.230.0000		
For models:	LB03100000, LB03300000, LP05500010		

Зип Общепит

vsezip.ru

+7(812)987-08-81



1

GEV No.	380702	Ref. No.	229039 229040
description	power relays FINDER 230VAC 16A 3NO connection male faston 6.3mm flange dimensions 36x38x68mm manuf. no. 62.83.8.230.0300 230V		
For models:	D500LS, D501LS		

relay sockets

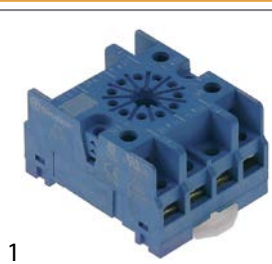

1

GEV No.	380667	Ref. No.	022031-00	
description	relay socket 11-pole dimensions 56x43x31mm 250V voltage AC 10A FINDER manuf. no. 90.27			
accessories for	380667			
	GEV No.	380805	Ref. No.	—
				support bracket

time relays

time relays



1

GEV No.	360172	Ref. No.	019028-00 01902800R	
description	time relay 2CO connection plug-in connection 100-240V 11-pole voltage AC 0.1s - 100h at 250V 5A			
accessories for	360172			
	GEV No.	360345	Ref. No.	—
				mounting frame for time relay for PM4H/LT4H
	GEV No.	380136	Ref. No.	—
				relay socket 11-pole connection plug-in connection round 11-pole dimensions 65x28x40mm 250V voltage AC 10A Italiana Relè manuf. no. ZVE11
	GEV No.	380667	Ref. No.	022031-00
				relay socket 11-pole dimensions 56x43x31mm 250V voltage AC 10A FINDER manuf. no. 90.27



+7(812)987-08-81

1 electric components

transformers

encapsulated transformers

with screw connection



1			
GEV No.	402016	Ref. No.	014687-00 01468700R
description	transformer 65VA		

PMA



1			
GEV No.	379054	Ref. No.	014675-00 01467500R
description	transformer primary 230VAC secondary 12VAC 3VA secondary 0.25A H 40mm L 45mm W 50mm connection screw 50/60Hz type 153/M		

electronic controllers

EKTRON

refrigeration controllers

built-in version



1			
GEV No.	402020	Ref. No.	014673-00 01467300R 014673-01 01467301R
description	electronic controller EKTRON type REK33-0020 mounting measurements 71x29mm 12V voltage AC/DC PTC relay outputs 3 NO-8A(4) NO-8A(4) NO-8A(4) PTC PTC built-in depth 71mm -50 up to +95°C display 3 digits		

refrigeration controllers



1			
GEV No.	402017	Ref. No.	019045-00 01904500R 019046-00 01904600R 019047-00 01904700R
description	electronic controller ELIWELL type EWPC974 mounting measurements 71x29mm		



1			
GEV No.	379645	Ref. No.	019497-00 024169-00
description	electronic controller ELIWELL type ID961 mounting measurements 71x29mm 230V voltage AC NTC/PTC relay outputs 1 relay -55 up to +150°C display 3½ digits compressor relay 15A		
For models:	SA100-00-000E		
accessories for	379645		
	GEV No.	379053	Ref. No. —
	temperature probe PTC 1kOhm cable PVC probe -50 up to +150°C cable -10 up to 100°C probe ø6x30mm cable length 3m without screw connection 2-wire		
	GEV No.	379064	Ref. No. 014674-00 01467400R 014674-01 01467401R
	temperature probe PTC 1kOhm cable silicone probe -50 up to +150°C cable -50 up to +180°C probe ø6x40mm cable length 3m without screw connection 2-wire		
	GEV No.	379161	Ref. No. —
	temperature probe NTC 10kOhm cable thermoplastic probe -40 up to +110°C cable -40 up to +110°C probe ø6x14mm cable length 3m without screw connection 2-wire		
	GEV No.	379782	Ref. No. —
	temperature probe PTC 1kOhm cable thermoplastic probe -50 up to +150°C cable -40 up to +110°C probe ø6x14mm cable length 3m 2-wire resistor 1kOhm		



LAE

refrigeration controllers

built-in version



1

GEV No.	378300	Ref. No.	025057-00R
description	electronic controller LAE mounting measurements 71x29mm 230V voltage AC NTC/PTC relay outputs 3 -50 to +120°C display 3 digits fan relay 7A 7A compressor relay 16A		



1

GEV No.	378420	Ref. No.	020518-01
description	electronic controller LAE type AT1-5AS2E-G mounting measurements 71x29mm 230V voltage AC NTC/PTC relay outputs 2 NO-16A(4) NO-7A(2) NTC/PTC front measurements 77x35mm built-in depth 70mm protection IP55 yes -50 to +120°C display 3 digits		
accessories for	378420		
	GEV No.	Ref. No.	025461-00
	temperature probe NTC 10kOhm cable TPE probe -40 up to +110°C cable -40 up to +110°C probe ø6x28mm cable length 2m cable colours grey 2-wire		



1

GEV No.	378184	Ref. No.	021226-00
description	electronic controller LAE type LCD32Q4E-C mounting measurements 149x30mm 230V voltage AC NTC relay outputs 4 NO-20A(6) NO-12A(4) NO-8A(3) CO-8A(3) NTC NTC DI DI front measurements 169x38mm built-in depth 78mm protection IP55 yes yes -30 up to +30°C display 3 digits		
accessories for	378184		
	GEV No.	Ref. No.	02128300 021283-00R
	temperature probe NTC 2kOhm cable thermoplastic probe -40 up to +110°C cable -40 up to +110°C probe ø6x35mm cable length 2m without screw connection 2-wire resistor 2kOhm		

Зип Общепит

vsezip.ru

+7(812)987-08-81



GEV No.	378260	Ref. No.	023382-00
description	electronic controller LAE type LD2-15B4E mounting measurements 71x29mm 230V voltage AC NTC relay outputs 3 relays yes yes -50 up to +80°C display 3 digits RoomTempIN yes DEF Relay 7A fan relay 7A compressor relay 16A		
accessories for	378260		
	GEV No.	Ref. No.	020519-00 020519-00R
	temperature probe NTC 10kOhm cable thermoplastic probe -40 up to +110°C cable -40 up to +110°C probe ø6x35mm cable length 3m without screw connection 2-wire		
	GEV No.	Ref. No.	02128300 021283-00R
	temperature probe NTC 2kOhm cable thermoplastic probe -40 up to +110°C cable -40 up to +110°C probe ø6x35mm cable length 2m without screw connection 2-wire resistor 2kOhm		

built-in version 2-piece



1

GEV No.	403413	Ref. No.	00-556225
description	power PCB LAE type LF28B253E-1FS mounting measurements 104x91mm 230V voltage AC NTC relay outputs 3 NO-20A(6) NO-12A(4) NO-7A(2) NTC NTC DI DI front measurements 105x63mm built-in depth 45mm protection IP2x -50 up to +80°C display		
accessories for	403413		
	GEV No.	Ref. No.	—
	keypad unit LAE type LCD5-5 mounting measurements 71x29mmV voltage relay outputs front measurements 77x35x20mm built-in depth 20mm protection IP55°C display 3 digits		
	GEV No.	Ref. No.	02128300 021283-00R
	temperature probe NTC 2kOhm cable thermoplastic probe -40 up to +110°C cable -40 up to +110°C probe ø6x35mm cable length 2m without screw connection 2-wire resistor 2kOhm		
	GEV No.	Ref. No.	—
	connection cable LAE type FC06-20M01		



SHANGFANG

accessories



1			
GEV No.	379054	Ref. No.	014675-00 01467500R
description	transformer primary 230VAC secondary 12VAC 3VA secondary 0.25A H 40mm L 45mm W 50mm connection screw 50/60Hz type 153/M		

miscellaneous

electronic thermometers



1			
GEV No.	379022	Ref. No.	527601R
description	thermometer mounting measurements 28.5x70.5mm -55 up to +99°C type EWTM 101		

probes

universal probes

temperature probes

1			
GEV No.	379784	Ref. No.	02128300 021283-00R
description	temperature probe NTC 2kOhm cable thermoplastic probe -40 up to +110°C cable -40 up to +110°C probe ø6x35mm cable length 2m without screw connection 2-wire resistor 2kOhm		

1			
GEV No.	378261	Ref. No.	020519-00 020519-00R
description	temperature probe NTC 10kOhm cable thermoplastic probe -40 up to +110°C cable -40 up to +110°C probe ø6x35mm cable length 3m without screw connection 2-wire		

1			
GEV No.	379805	Ref. No.	025461-00
description	temperature probe NTC 10kOhm cable TPE probe -40 up to +110°C cable -40 up to +110°C probe ø6x28mm cable length 2m cable colours grey 2-wire		

1			
GEV No.	379064	Ref. No.	014674-00 01467400R 014674-01 01467401R
description	temperature probe PTC 1kOhm cable silicone probe -50 up to +150°C cable -50 up to +180°C probe ø6x40mm cable length 3m without screw connection 2-wire		

Зип-Общепит

core probes

1			
GEV No.	379640	Ref. No.	N/A
description	core temperature probe PTC 1kOhm cable silicone probe -50 up to +150°C cable -50 up to +180°C probe ø6x110mm cable length 2.4m handle ø9mm handle length 80mm 2-wire		

producer-specific probes

core probes

1			
GEV No.	378408	Ref. No.	019064-00 019064-00R
description	core temperature probe PTC cable silicone probe -40 up to +120°C cable -50 up to +180°C connection 2-wire probe ø4-6x105mm cable length 3.5m handle ø13mm handle length 120mm		

electronics

PCBs

1			
GEV No.	401936	Ref. No.	24000001
description	keypad PCB with control		



Зип Общежит

membrane keypads

vsezip.ru

+7(812)987-08-81



1

GEV No.	401900	Ref. No.	215029
description	PCB L 120mm W 80mm		
For models:	D500LS, D501LS		

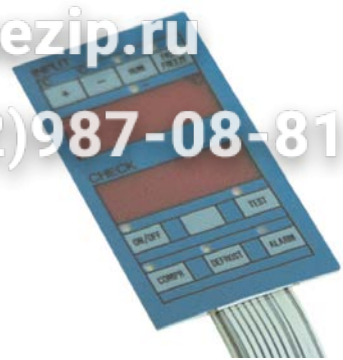

1

GEV No.	402023	Ref. No.	01086805R
description	membrane keypad		



1

GEV No.	402015	Ref. No.	016369-00R
description	PCB refrigerated counter Skin		

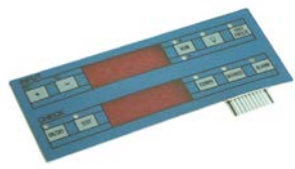

1

GEV No.	402024	Ref. No.	01087005R
description	membrane keypad		

keypads

front foils



1

GEV No.	402030	Ref. No.	01271301R
description	front foil		



1

GEV No.	402031	Ref. No.	01345001R
description	front foil		



1

GEV No.	402032	Ref. No.	01654900R
description	front foil		

solenoïd valves

solenoïd valves (water)

ELBI

straight



1

GEV No.	373017	Ref. No.	240016	
description	solenoïd valve single straight 230VAC inlet 3/4" outlet 11.5mm DN10 ELBI			
For models:	D500LS, D501LS			
spare parts for	373017			
	GEV No.	370467	Ref. No.	—
solenoïd valve filter suitable for ELBI				













ELTEK



1

GEV No.	370779	Ref. No.	2DR025
description	solenoïd valve single straight 230VAC inlet 3/4 outlet 11.5mm input 7l/min output 1.2l/min DN10 ELTEK		
For models:	KL030-10-000A		

RPE			
solenoid valves with reducers			
2-fold			
			
1			
GEV No.	370835	Ref. No.	2DR026
description	solenoid valve double straight 230VAC inlet 3/4" outlet 10.5mm input 7l/min output 2x1.2l/min DN10 t.max. 90°C RPE		
For models:	KL030-10-000W		

TP			
			
1			
GEV No.	370017	Ref. No.	240011
description	solenoid valve single straight 230VAC inlet 3/4" outlet 11.5mm DN10 TP p max 10bar		
For models:	D500LS, D501LS		
spare parts for	370017		
	GEV No.	371013	Ref. No. —
solenoid coil TP 230VAC 50/60Hz			
accessories for	370017		
	GEV No.	371220	Ref. No. —
reducer TP flow rate 3l/min red tolerance $\pm 15\%$			
	GEV No.	371221	Ref. No. —
reducer TP flow rate 5.5l/min yellow tolerance $\pm 15\%$			
	GEV No.	371222	Ref. No. —
reducer TP flow rate 6l/min grey tolerance $\pm 15\%$			
	GEV No.	371223	Ref. No. —
reducer TP flow rate 10l/min white tolerance $\pm 15\%$			
	GEV No.	371224	Ref. No. —
reducer TP flow rate 12l/min bronze tolerance $\pm 15\%$			
	GEV No.	371225	Ref. No. —
reducer TP flow rate 16l/min light brown tolerance $\pm 15\%$			
	GEV No.	371226	Ref. No. —
reducer TP flow rate 20l/min red tolerance $\pm 15\%$			
	GEV No.	371230	Ref. No. —
reducer TP flow rate 0.25l/min red tolerance $\pm 25\%$			
	GEV No.	371231	Ref. No. —
reducer TP flow rate 0.35l/min violet tolerance $\pm 25\%$			
	GEV No.	371232	Ref. No. —
reducer TP flow rate 0.5l/min orange tolerance $\pm 25\%$			

Зип-Общепит

vsezip.ru

+7(812)987-08-81

accessories for 370017			
	GEV No.	371233	Ref. No. —
reducer TP flow rate 0.8l/min white tolerance $\pm 25\%$			
	GEV No.	371234	Ref. No. —
reducer TP flow rate 1l/min light blue tolerance $\pm 25\%$			
	GEV No.	371235	Ref. No. —
reducer TP flow rate 1.2l/min brown tolerance $\pm 25\%$			
	GEV No.	371236	Ref. No. —
reducer TP flow rate 1.5l/min light brown tolerance $\pm 25\%$			
	GEV No.	371237	Ref. No. —
reducer TP flow rate 2.5l/min yellow tolerance $\pm 25\%$			
	GEV No.	371238	Ref. No. —
reducer TP flow rate 3.4l/min dark green tolerance $\pm 25\%$			
	GEV No.	371239	Ref. No. —
reducer TP flow rate 5l/min black tolerance $\pm 25\%$			
	GEV No.	371240	Ref. No. —
reducer TP flow rate 8l/min blue tolerance $\pm 20\%$			









tp			
			
1			
GEV No.	370015	Ref. No.	015552-00 01555200R
description	solenoid valve single angled 230VAC inlet 3/4" outlet 11.5mm DN10 TP		
accessories for	370015		
	GEV No.	371220	Ref. No. —
reducer TP flow rate 3l/min red tolerance $\pm 15\%$			
	GEV No.	371221	Ref. No. —
reducer TP flow rate 5.5l/min yellow tolerance $\pm 15\%$			
	GEV No.	371222	Ref. No. —
reducer TP flow rate 6l/min grey tolerance $\pm 15\%$			
	GEV No.	371223	Ref. No. —
reducer TP flow rate 10l/min white tolerance $\pm 15\%$			
	GEV No.	371224	Ref. No. —
reducer TP flow rate 12l/min bronze tolerance $\pm 15\%$			
	GEV No.	371225	Ref. No. —
reducer TP flow rate 16l/min light brown tolerance $\pm 15\%$			
	GEV No.	371226	Ref. No. —
reducer TP flow rate 20l/min red tolerance $\pm 15\%$			



Table continues overleaf



Зип Общедит
solenoid valves (refrigeration)

vsezip.ru
valve bodies

+7(812)987-08-81

accessories for		370015	
GEV No.	371230	Ref. No.	—
	reducer TP flow rate 0.25l/min red tolerance ±25%		
	reducer TP flow rate 0.35l/min violet tolerance ±25%		
	reducer TP flow rate 0.5l/min orange tolerance ±25%		
	reducer TP flow rate 0.8l/min white tolerance ±25%		
	reducer TP flow rate 1l/min light blue tolerance ±25%		
	reducer TP flow rate 1.2l/min brown tolerance ±25%		
	reducer TP flow rate 1.5l/min light brown tolerance ±25%		
	reducer TP flow rate 2.5l/min yellow tolerance ±25%		
	reducer TP flow rate 3.4l/min dark green tolerance ±25%		
	reducer TP flow rate 5l/min black tolerance ±25%		
	reducer TP flow rate 8l/min blue tolerance ±20%		

DANFOSS
valve bodies



1

GEV No.	370160	Ref. No.	012719-00 01271900R
description	solenoid valve body NC type EVR 3 p max 45.2bar DN 3.2mm connection 6mm soldering connection -40° up to 105°C refrigeration straight DANFOSS		
accessories for	370160		
	GEV No.	371046	Ref. No. —
	console for solenoid valve for EVR2,3,6,10		

various



1

GEV No.	370726	Ref. No.	999288
description	solenoid valve double straight 220-240VAC inlet 11mm outlet 11mm MILANO plastic output B red		
For models:	D500LS, D501LS		

PARKER
valves



1

GEV No.	370782	Ref. No.	1RF123
description	solenoid valve 230V connection 16mm soldering connection PARKER refrigeration straight		
For models:	KL030-10-000A, KL030-10-000W		
spare parts for	370782		
	GEV No.	371033	Ref. No. —
	solenoid coil PARKER 230VAC 9VA coil type YB09 with cable seat ø 14mm		

pressure switches
for warewashing

ø 58mm with male faston 6.3mm
with connection horizontal



1

GEV No.	541011	Ref. No.	224010
description	pressure control pressure range 110/70mbar connection 6mm ø 58mm pressure connection horizontal warewashing		
For models:	D500LS, D501LS		

→ electric components



ЗипОбщепит

vsezip.ru

7(812)987-08-81



1

GEV No.	541003	Ref. No.	224003
description	pressure control pressure range 55/35mbar connection 6mm ø 58mm pressure connection horizontal warewashing pressure connection ø 6mm		
For models:	D500LS, D501LS		

accessories



1

GEV No.	541109	Ref. No.	035031
description	Y-piece plastic hose ø 8-6-8mm for pressure switch		
For models:	D500LS, D501LS		

compressors

ACC/ZEL

R134A
HMBP monophase

High/Medium evaporation temperature above -20/-15 °C



1

GEV No.	605009	Ref. No.	022260-00
description	compressor coolant R134a type GL90TB 220-240V 50Hz HMBP fully hermetic 10.8kg 1/4HP power input 293W cylinder capacity 8.8cm ³ CSIR H 175.5mmW 143W 194W 259W 339W 432W 539W 661W 796W test method ASHRAE		

SELECT DANFOSS

R134A
HMBP monophase

High/Medium evaporation temperature above -20/-15 °C



1

GEV No.	605091	Ref. No.	014614-00
description	compressor coolant R134a type FR8.5G 220-240V 50Hz HMBP 10.6kg 1/4HP power input 261W cylinder capacity 7.95cm ³ RSIR/CSIR H 196mm 85W 123W 171W 228W 298W 381W 478W 592W 722WW		
spare parts for	605091		
	GEV No.	380484	Ref. No. —
	start relay DANFOSS 117U6015/F394 HST		

R404a/R507

LBP monophase

Lower evaporation temperature below -20°C



1

GEV No.	605057	Ref. No.	015132-00
description	compressor coolant R404a/R507 type SC12CL 220-240V 50Hz LBP fully hermetic 12.5kg 3/8HP cylinder capacity 12.87cm ³ CSIR H 209mm 410W 568W 754W 971W 1220W 1505WWWW test method ASHRAE		
spare parts for	605057		
	GEV No.	380078	Ref. No. —
	start relay DANFOSS 117U6005 HST		



fans

axial fans

ebm-papst

Зип Общепит

vsezip.ru

+7(812)987-08-81



1

GEV No.	601089 ¹	Ref. No.	01348001R
description	axial fan L 119mm W 119mm H 38mm 230VAC 50/60Hz 19W bearing slide bearing manuf. no. 4650N metal connection male faston 2.8mm ebm-papst fan wheel ø 110mm temp.-resist. 55°C		
accessories for	601089		
	GEV No.	550898	Ref. No. —
	connecting cable cable length 2000mm connection F 2.8 connection distance 7.9mm for axial flow fan		
	GEV No.	691104	Ref. No. —
	guard ø 115mm mounting distance 105mm for axial fan 119mm		

¹with slide bearings

ebmpapst



1

GEV No.	601082 ¹	Ref. No.	01468000R 01979700R
description	axial fan L 92mm W 92mm H 25mm 230VAC 50/60Hz 9/11W bearing ball bearing manuf. no. 3956 metal connection male faston 2.8mm ebm-papst fan wheel ø 85mm temp.-resist. 80°C		
accessories for	601082		
	GEV No.	691103	Ref. No. —
	guard ø 90mm mounting distance 83mm for axial fan 92mm		

¹with ball bearings



1

GEV No.	601074 ¹	Ref. No.	01904100R
description	axial fan L 92mm W 92mm H 25mm 24VDC 2.3W bearing ball bearing manuf. no. 3414N connection cable 300mm ebm-papst fan wheel ø 85mm temp.-resist. 70°C		
accessories for	601074		
	GEV No.	691103	Ref. No. —
	guard ø 90mm mounting distance 83mm for axial fan 92mm		

¹with ball bearings



1

GEV No.	601632 ¹	Ref. No.	01904100
description	axial fan L 92mm W 92mm H 25mm 24VDC 2.3W bearing slide bearing manuf. no. 3414NG connection cable 310mm ebm-papst		
accessories for	601632		
	GEV No.	691103	Ref. No. —
	guard ø 90mm mounting distance 83mm for axial fan 92mm		

¹with slide bearings

ebmpapst



1

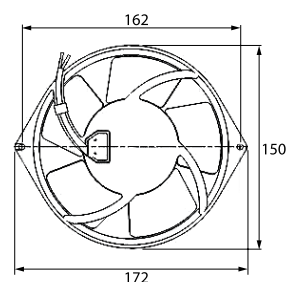

GEV No.	601088 ¹	Ref. No.	01468500R
description	axial fan L 172mm W 150mm H 55mm 230VAC 50/60Hz 39/45W bearing ball bearing connection cable 350mm manuf. no. 7855ES metal ebm-papst fan wheel ø 140mm temp.-resist. 50°C		

¹with ball bearings

→ electric components



Зип-Общепит

vsezip.ru

+7(812)987-08-81

import



GEV No.	601055 ¹	Ref. No.	01468000
description	axial fan L 92mm W 92mm H 25mm 230VAC 50/60Hz 14.5/14W bearing ball bearing connection male faston 2.8mm metal ADDA fan wheel ø 85mm temp.-resist. 70°C		
accessories for	601055		
	GEV No.	550898	Ref. No. —
	connecting cable cable length 2000mm connection F 2.8 connection distance 7.9mm for axial flow fan		
	GEV No.	691103	Ref. No. —
	guard ø 90mm mounting distance 83mm for axial fan 92mm		

¹with ball bearings

refrigeration fans

refrigeration motors universal

IMPORT

multi fit fan motors



GEV No.	601022	Ref. No.	01272500R
description	fan motor 10W 230V 50-60Hz L1 44mm L2 54mm L3 85mm W 84mm cable length 500mm 1300rpm YZF10-20-18/26 5 mounting options bearing slide bearing		

accessories

fan wheels

sucking

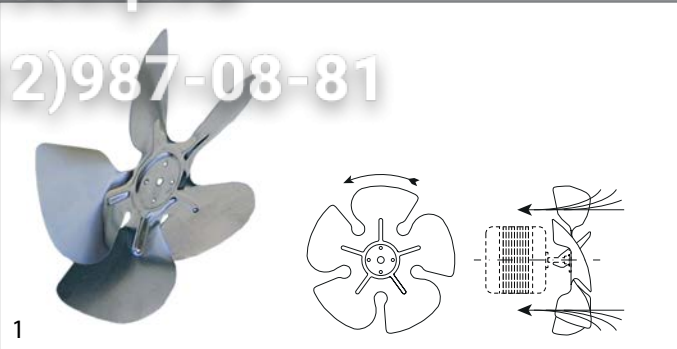

GEV No.	601071	Ref. No.	013479-00
description	fan wheel sucking ø 230mm fan wheel mounting 25.4mm blade angle 25° W 37mm aluminium		

cold air circulating fans (complete)

ebm-papst

A2E series

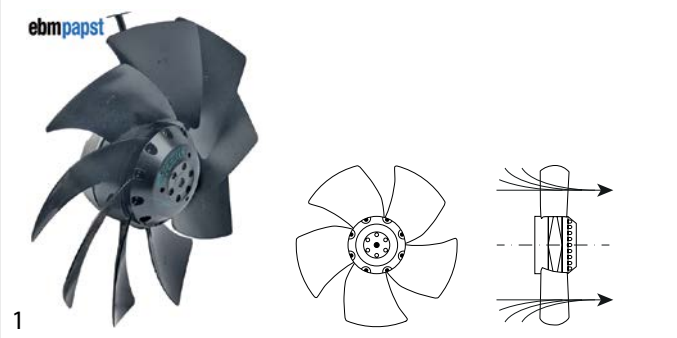

GEV No.	601962	Ref. No.	019055-00
description	fan A2E250AM06-01 fan wheel ø 250mm blades 9 230V 50Hz 120/160W 2450rpm cable length 400mm ebm-papst blowing suitable capacitor 3µF		
spare parts for	601962		
	GEV No.	365137	Ref. No. —
	capacitor capacity 3µF 450V tolerance 5% 50/60Hz ambient temperature max. -25 to +85°C ø 25mm L 56mm M8 plastic connection cable 250mm 416.17.77GF protection		



Зип Общепит

cross flow fans

COPREL
with moulded coils

+7(812)987-08-81

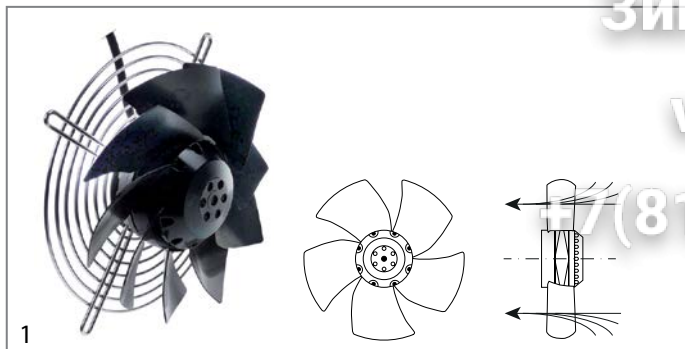

GEV No.	601663 ¹	Ref. No.	019027-00
description	fan A2E200-AI38-10 fan wheel ø 200mm blades 9 230V 50/60Hz 64W 2600rpm cable length 450mm ebm-papst sucking suitable capacitor 1.5µF with protective grid		
spare parts for	601663		
	GEV No.	365171	Ref. No. 019051-00
	capacitor capacity 1.5µF 400V tolerance 5% 50/60Hz ambient temperature max. -40 up to +85°C ø 25mm L 50mm M8 plastic connection cable 250mm MLR25PRL		
	GEV No.	601958	Ref. No. —
	guard ø 210mm for fan hole distance 258mm		

¹incl. capacitor and guard

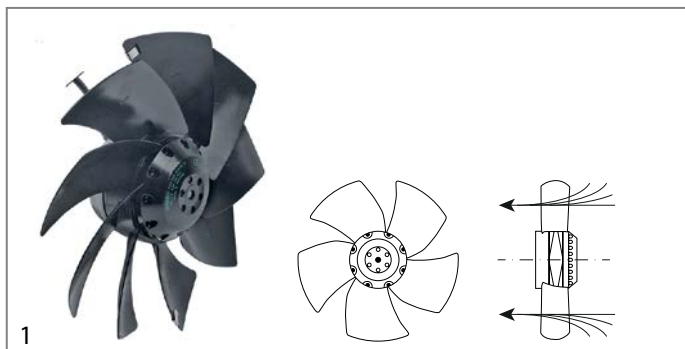

GEV No.	601964	Ref. No.	GF650/2 GF651
description	fan A2E250AM06-12 fan wheel ø 250mm blades 9 230V 50/60Hz 115/150W ø 250mm 2450rpm cable length 1400mm sucking suitable capacitor 3µF		
spare parts for	601964		
	GEV No.	365137	Ref. No. —
	capacitor capacity 3µF 450V tolerance 5% 50/60Hz ambient temperature max. -25 to +85°C ø 25mm L 56mm M8 plastic connection cable 250mm 416.17.77GF protection		

1



GEV No.	601456	Ref. No.	01272600R
description	cross flow fan roller ø 45mm roller length 180mm laminated core thickness 15mm motor position right 230V/50Hz 26W universal bearing silicone connection male faston 6.3mm -30 up to +100°C 230V 50/60Hz		

hot air fans
miscellaneous

1

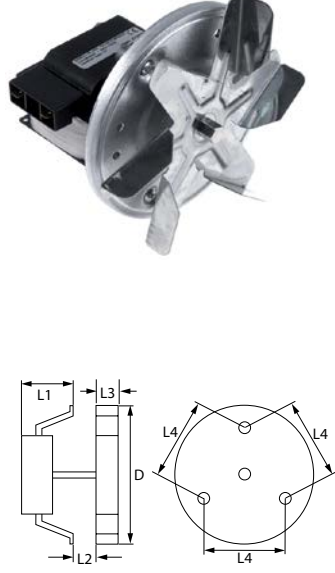

GEV No.	601094	Ref. No.	01154900R+01155000R
description	fan motor 240V 36W 50Hz L1 85mm L2 15mm L3 20mm L4 87mm fan wheel ø 150mm Emmevi type 260305X		

Зип.Общепит pumps

wash and rinse pumps vsezip.ru

+7(812)987-08-81

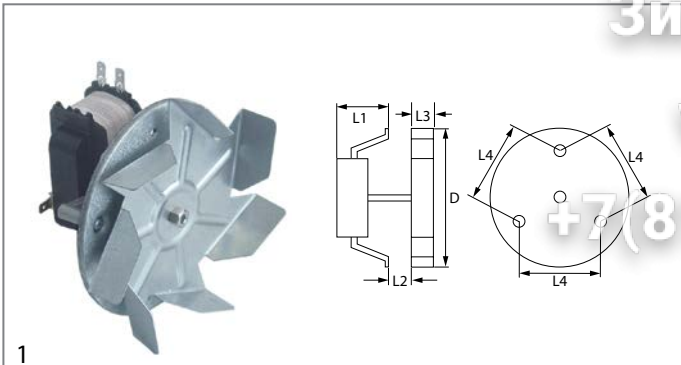

GEV No.	601124	Ref. No.	9343420000 RIC0002339
description	hot air fan 220-240V 30W L1 60mm L2 12mm L3 25mm L4 84mm fan wheel ø 150mm IMS type VRB150H2028		
For models:	ME066-03-010, ME066-03-013, ME103-03-013XL, ME106-03-010XL, ME106-03-013		



GEV No.	601531	Ref. No.	3740035
description	hot air fan 220V 30W 50Hz L1 70mm L2 12mm L3 30mm L4 87mm fan wheel ø 155mm FIME type C30R0407		

motors

motors

for tilting bratt pans



GEV No.	500813	Ref. No.	RTBF900122
description	motor 120W 230V 50Hz 1 phase shaft ø 9mm shaft length 20mm 2750rpm type M TUBO 56 ø 100mm H 155mm capacitor 6.3µF AMI 0.12kW		
For models:	MG099-03-012, MG099-13-012I		



GEV No.	500156	Ref. No.	130109
description	pump inlet ø 50mm outlet ø 50mm type ZF400SX 230V 50Hz 1 phase 0.6kW 0.8HP L 210mm rotation direction right capacitor 16µF LGB		
For models:	D500LS, D501LS		
spare parts for	500156		
	GEV No.	509020	Ref. No. 124031
	impellor ø 104mm H 25mm M8L		
	GEV No.	510703	Ref. No. 141007
	mechanical shaft seal for shaft ø 13mm slide ring H 13mm height counter ring 5.5mm ED ø 26mm		
	GEV No.	521548	Ref. No. 116019
	pump cover LGB inlet ø 50mm outlet ø 50mm		
	GEV No.	521734	Ref. No. 315022
	pump cover bottom part		
	GEV No.	523509	Ref. No. 314001
	deep-groove ball bearing type 6201-2RS shaft ø 12mm ED ø 32mm W 10mm with sealing discs deep-groove ball bearing DIN 625-1		
	GEV No.	532623	Ref. No. —
	O-ring EPDM thickness 2.62mm ID ø 120.32mm Qty 1 pcs		
accessories for	500156		
	GEV No.	365021	Ref. No. 206004
	operating capacitor capacity 16µF 425V tolerance 5% 50/60Hz ambient temperature max. -25 to +85°C ø 35mm L 73mm single M8 plastic connection male faston 6.3mm 416.10.99 protection		



drain pumps

ASKOLL



1

GEV No.	500214	Ref. No.	130105
description	drain pump inlet ø 30mm outlet ø 22mm 230/240V 30W 50Hz ASKOLL type R113		
For models:	D500LS, D501LS		

pumps for ice machines



1

GEV No.	499341	Ref. No.	2DR100
description	pump MIGEL 100W 230V 50Hz inlet ø 23mm outlet ø 25mm L 170mm rotation direction right ice maker		
For models:	KL030-10-000A, KL030-10-000W		



1

GEV No.	499003	Ref. No.	1DR037 2DR093
description	pump MIGEL type 100W 230V 50Hz inlet ø 25mm outlet ø 23mm L 170mm rotation direction right for ice maker		

condensators & interference suppression filters

starting capacitors

starting capacitors



1

GEV No.	365061	Ref. No.	020551-00
description	starting capacitor 220/300V 50Hz DANFOSS duty cycle 1.7/0.10% capacity 80µF for FR/NL		

operating capacitors

plastic



1

GEV No.	365171	Ref. No.	019051-00
description	capacitor capacity 1.5µF 400V tolerance 5% 50/60Hz ambient temperature max. -40 up to +85°C ø 25mm L 50mm M8 plastic connection cable 250mm MLR25PRL		



1

GEV No.	365021	Ref. No.	206004
description	operating capacitor capacity 16µF 425V tolerance 5% 50/60Hz ambient temperature max. -25 to +85°C ø 35mm L 73mm single M8 plastic connection male faston 6.3mm 416.10.99 protection		
For models:	D500LS, D501LS		

fuses

fine fuses



1

GEV No.	358677	Ref. No.	228010
description	fine fuse size ø5x20mm 4A fast-acting rated 250V Qty 10 pcs		
For models:	D500LS, D501LS		

1 electric components

fine fuse holders



GEV No.	551234	Ref. No.	210010
description	fuse holder suitable fuse $\varnothing 5 \times 20 \text{mm}$ 1-pole 6.3A rated 600V L 52mm W 8mm H 51mm connection screw clamp cross section 4mm^2		
For models:	D500LS, D501LS		

electric accessories

terminals

terminal blocks



GEV No.	550239	Ref. No.	RTBF900045
description	lustre terminal 12-pole cross section 16mm^2 max. 75A max 500V temp.-resist. 150°C		
For models:	ME046-03-000, ME046-03-000V, ME046-03-001, ME046-03-002, ME046-03-003, ME046-03-004, ME046-03-005, ME046-13-001, ME046-13-002, ME066-03-000, ME066-03-000V, ME066-03-003, ME066-03-004, ME066-03-006, ME066-03-007, ME066-03-008, ME066-03-010, ME066-03-013, ME066-03-015, ME066-13-003, ME103-03-013XL, ME106-03-000, ME106-03-010XL, ME106-03-013, ME106-13-003, MG066-03-010, MG099-03-012, MG099-03-012M, MG099-13-012L, MG099-13-012IM, MG106-03-010, MG106-03-010XL		

connection terminals with screw/faston connections



GEV No.	550411	Ref. No.	220011
description	power terminal block 6-pole max. 40A max 450V connection $\varnothing 6 \text{mm}^2$ / F6.3 temp.-resist. 150°C cross section 6mm^2		
For models:	D500LS, D501LS		

rail-mounted terminals

miscellaneous



GEV No.	551234	Ref. No.	210010
description	fuse holder suitable fuse $\varnothing 5 \times 20 \text{mm}$ 1-pole 6.3A rated 600V L 52mm W 8mm H 51mm connection screw clamp cross section 4mm^2		
For models:	D500LS, D501LS		

gas taps

PEL

vsezip.ru

215 series



GEV No.	101397	Ref. No.	RTCU700259
description	gas tap PEL type 215 gas inlet M16x1.5 (tube $\varnothing 10 \text{mm}$) bypass nozzle $\varnothing 0.35 \text{mm}$ gas outlet M16x1.5 (tube $\varnothing 10/8 \text{mm}$) thermocouple connection M9x1 pilot connection M10x1 shaft $\varnothing 8 \times 6.5 \text{mm}$ shaft L 22/15mm shaft flat lower		
For models:	MG066-03-008, MG086-13-014P		
spare parts for	101397		
	GEV No.	100408	Ref. No. —
	bypass nozzle type PEL20/21 bore $\varnothing 0.35 \text{mm}$ thread M5x0.5		
	GEV No.	101060	Ref. No. —
	magnet unit standard L 39mm D1 $\varnothing 15.4 \text{mm}$ D2 $\varnothing 11 \text{mm}$ suitable for PEL20-21/JUNKERS/EGA		
	GEV No.	101206	Ref. No. —
	gas tap front part shaft $\varnothing 8 \times 6.5 \text{mm}$ shaft L 22/15mm shaft flat upper/lower suitable for PEL21		
	GEV No.	101231	Ref. No. —
	thermocouple nut T1: M9x1 T2: M18x1		
accessories for	101397		
	GEV No.	100908	Ref. No. RTCU900133
	union screw thread M10x1 for pipe $\varnothing 4 \text{mm}$ Qty 1 pcs		
	GEV No.	100909	Ref. No. RTCP800038 RTCU900019
	union screw thread M10x1 for pipe $\varnothing 6 \text{mm}$ Qty 1 pcs		
	GEV No.	101246	Ref. No. —
	olive for pipe $\varnothing 4 \text{mm}$ Qty 1 pcs		
	GEV No.	101278	Ref. No. RTCU900012
	olive for pipe $\varnothing 10 \text{mm}$ Qty 1 pcs		
	GEV No.	101286	Ref. No. RTCU900018
	olive ID $\varnothing 6 \text{mm}$ Qty 1 pcs		
	GEV No.	101300	Ref. No. RTCU700297
	union nut thread M16x1.5 tube $\varnothing 10 \text{mm}$		
	GEV No.	101450	Ref. No. —
	olive for pipe $\varnothing 8 \text{mm}$ L 12.7mm Qty 1 pcs ED $\varnothing 10 \text{mm}$		
	GEV No.	101451	Ref. No. —
	union nut thread M16x1.5 tube $\varnothing 8 \text{mm}$		
	GEV No.	110081	Ref. No. —
	knob $\varnothing 70 \text{mm}$ shaft $\varnothing 8 \times 6.5 \text{mm}$ shaft flat universal		
	GEV No.	112206	Ref. No. —
	knob dial plate silver gas tap PEL21/22/23 t.max. $^\circ\text{C}$ ED $\varnothing 63 \text{mm}$ ID $\varnothing 45.5 \text{mm}$		









SABAF

Зип Общепит

vsezip.ru



+7(812)987-08-81

			
1			
GEV No.	101890	Ref. No.	RTCU600016
description	gas tap SABAF type 10 gas inlet pipe flange ø16mm bypass nozzle ø 0mm gas outlet 1/4" (tube ø 8mm) front fixing thermocouple connection plug-in connection shaft ø 8x6.5mm shaft L 26/12mm shaft flat upper		
For models:	ME066-03-010, ME106-03-010XL, MG046-03-000, MG066-03-000, MG066-03-010, MG106-03-000, MG106-03-010, MG106-03-010XL		
spare parts for	101890		
	GEV No.	101376	Ref. No. —
	gasket ID ø 8mm ED ø 12mm H 3/5mm		
	GEV No.	106723	Ref. No. —
	magnet unit L 29mm D1 ø 12.5mm D2 ø 8.5mm suitable for SABAF		
accessories for	101890		
	GEV No.	101277	Ref. No. —
	olive ID ø 8mm Qty 1 pcs		
	GEV No.	101751	Ref. No. RTCU600054
	bracket		
	GEV No.	520656	Ref. No. —
	union nut thread 1/4" tube ø 6/8mm		
	GEV No.	560082	Ref. No. —
	hexagonal screw thread M4 thread L 16mm SS WS 7 Qty 20 pcs DIN 933 / ISO 4017		

gas thermostats

SIT

710 Minisit series

			
1			
GEV No.	101135	Ref. No.	RTCU700574
description	gas thermostat SIT type MINISIT 710 t.max. 190°C 110-190°C gas inlet 1/2" gas outlet 3/8" thermocouple connection M9x1 pilot connection M10x1 probe ø 6mm probe L 102mm capillary pipe 1050mm probe type type A3 pressure controller no pressure regulator bar gland nut		
For models:	MG046-03-004, MG066-03-007		
spare parts for	101135		
	GEV No.	101053	Ref. No. —
	magnet unit T1: M9x1 T2: M24x1 L 45mm ø 17mm suitable for Minisit		













spare parts for	101135		
GEV No.	102118	Ref. No.	—
	probe 110-190°C probe ø 6mm probe L 102mm capillary pipe 1050mm t. max. 190°C fryer probe type type A3 suitable for MINISIT 710		
accessories for	101135		
	GEV No.	100800	Ref. No. —
	O-ring EPDM thickness 2mm ID ø 21mm Qty 1 pcs		
	GEV No.	100820	Ref. No. —
	gland duct ET M14x1.5 IT M10x0.75 probe ø max. 6.5mm WS 22		
	GEV No.	100904	Ref. No. —
	locking screw M10x1 for pipe ø 4mm Qty 1 pcs		
	GEV No.	100905	Ref. No. —
	locking screw M10x1 for pipe ø 6mm Qty 1 pcs		
	GEV No.	101054	Ref. No. —
	magnet unit T1: M10x1 T2: M24x1 L 45mm ø 17mm suitable for Minisit		
	GEV No.	101136	Ref. No. —
	piezoelectric igniter suitable for Minisit with cover cap ømm connection F6.3x0.8		
	GEV No.	101137	Ref. No. —
	cover cap without piezoelectric igniter		
	GEV No.	101267	Ref. No. —
	reducer IT 3/8" ET 1/2" L 21mm		
	GEV No.	101268	Ref. No. —
	gas connection thread 3/8" angled with O-ring MINISIT 710		
	GEV No.	101269	Ref. No. —
	gas connection thread 1/2" angled with O-ring MINISIT 710		
	GEV No.	101270	Ref. No. —
	screw connection IT 3/8" ET 3/8" L 28mm		
	GEV No.	101272	Ref. No. —
	screw connection IT 1/2" ET 3/8" L 57mm		
	GEV No.	101273	Ref. No. —
	olive for pipe ø 12mm L 9.5mm brass Qty 1 pcs suitable for universal		
	GEV No.	101274	Ref. No. —
	olive for pipe ø 16mm Qty 1 pcs		
	GEV No.	101275	Ref. No. —
	union screw thread 1/2" for pipe ø 16mm Qty 1 pcs		
	GEV No.	101276	Ref. No. —
	union screw thread 3/8" tube ø 12mm Qty 1 pcs		
	GEV No.	110068	Ref. No. RTCU900222
	knob suitable for Minisit ø 37mm		

1 gas components

PEL

25ST series



GEV No.	101172	Ref. No.	RTCU700289
description	gas thermostat PEL type 25ST 100-300°C gas inlet M16x1.5 (tube ø 10mm) bypass nozzle ø 0.35mm gas outlet M16x1.5 (tube ø 10/8mm) thermocouple connection M9x1 pilot connection M10x1 capillary pipe 1200mm probe ø 6mm probe L 100mm shaft ø 8x6.5mm shaft L 21/15mm shaft flat upper		
For models:	MG046-03-001, MG046-03-002, MG046-13-001, MG046-13-002, MG066-03-003, MG066-03-004, MG066-03-005, MG066-03-015, MG066-13-003, MG066-13-004, MG066-13-005, MG106-03-003, MG106-03-004, MG106-13-003, MG106-13-004		
spare parts for	101172		
	GEV No.	100259	Ref. No. —
	bypass nozzle type PEL22 bore ø 0.35mm thread M6x0.5		
	GEV No.	101060	Ref. No. —
	magnet unit standard L 39mm D1 ø 15.4mm D2 ø 11mm suitable for PEL20-21/JUNKERS/EGA		
	GEV No.	106200	Ref. No. —
	nut thread M9x1 suitable for PEL 24/25S		
accessories for	101172		
	GEV No.	100908	Ref. No. RTCU900133
	union screw thread M10x1 for pipe ø 4mm Qty 1 pcs		
	GEV No.	100909	Ref. No. RTCP800038 RTCU900019
	union screw thread M10x1 for pipe ø 6mm Qty 1 pcs		
	GEV No.	101246	Ref. No. —
	olive for pipe ø 4mm Qty 1 pcs		
	GEV No.	101278	Ref. No. RTCU900012
	olive for pipe ø 10mm Qty 1 pcs		
	GEV No.	101286	Ref. No. RTCU900018
	olive ID ø 6mm Qty 1 pcs		
	GEV No.	101300	Ref. No. RTCU700297
	union nut thread M16x1.5 tube ø 10mm		
	GEV No.	101450	Ref. No. —
	olive for pipe ø 8mm L 12.7mm Qty 1 pcs ED ø 10mm		
	GEV No.	101451	Ref. No. —
	union nut thread M16x1.5 tube ø 8mm		
	GEV No.	110079	Ref. No. —
	knob dial plate gas thermostat 1-8 silver		
	GEV No.	110081	Ref. No. —
	knob ø 70mm shaft ø 8x6.5mm shaft flat universal		

Зип Общепит

vsezip.ru

+7(812)9877777

GEV No.	101441	Ref. No.	RTCU700363
description	gas thermostat PEL type 25ST 30-90°C gas inlet M16x1.5 (tube ø 10mm) bypass nozzle ø 0.35mm gas outlet M16x1.5 (tube ø 10/8mm) thermocouple connection M9x1 pilot connection M10x1 capillary pipe 1200mm probe ø 6mm probe L 160mm shaft ø 8x6.5mm shaft L 21/15mm shaft flat upper		
For models:	MG046-03-003, MG066-03-006		
spare parts for	101441		
	GEV No.	100259	Ref. No. —
	bypass nozzle type PEL22 bore ø 0.35mm thread M6x0.5		
	GEV No.	101060	Ref. No. —
	magnet unit standard L 39mm D1 ø 15.4mm D2 ø 11mm suitable for PEL20-21/JUNKERS/EGA		
	GEV No.	106200	Ref. No. —
	nut thread M9x1 suitable for PEL 24/25S		
accessories for	101441		
	GEV No.	100908	Ref. No. RTCU900133
	union screw thread M10x1 for pipe ø 4mm Qty 1 pcs		
	GEV No.	100909	Ref. No. RTCP800038 RTCU900019
	union screw thread M10x1 for pipe ø 6mm Qty 1 pcs		
	GEV No.	101246	Ref. No. —
	olive for pipe ø 4mm Qty 1 pcs		
	GEV No.	101278	Ref. No. RTCU900012
	olive for pipe ø 10mm Qty 1 pcs		
	GEV No.	101286	Ref. No. RTCU900018
	olive ID ø 6mm Qty 1 pcs		
	GEV No.	101300	Ref. No. RTCU700297
	union nut thread M16x1.5 tube ø 10mm		
	GEV No.	101450	Ref. No. —
	olive for pipe ø 8mm L 12.7mm Qty 1 pcs ED ø 10mm		
	GEV No.	101451	Ref. No. —
	union nut thread M16x1.5 tube ø 8mm		



SABAF



GEV No.	101886	Ref. No.	RTCU600179 RTCU600180
description	gas thermostat SABAF t.max. 300°C gas inlet pipe flange ø16mm bypass nozzle ø 0.37mm gas outlet M13x1 IT (tube ø 8mm) gas outlet 2 thermocouple connection M8x1 pilot connection capillary pipe 850mm probe ø 4mm probe L 140mm shaft ø 8x6.5mm shaft L 17/12mm shaft flat upper		
For models:	MG066-03-010, MG106-03-010, MG106-03-010XL		
spare parts for	101886		
	GEV No.	101060	Ref. No. —
	magnet unit standard L 39mm D1 ø 15.4mm D2 ø 11mm suitable for PEL20-21/JUNKERS/EGA		
accessories for	101886		
	GEV No.	101277	Ref. No. —
	olive ID ø 8mm Qty 1 pcs		
	GEV No.	101477	Ref. No. —
	union screw thread M13x1 tube ø 8mm Qty 1 pcs		
	GEV No.	101751	Ref. No. RTCU600054
	bracket		



gas valves and ignition boxes

gas control valves

SIT

ELETTROSIT



GEV No.	101126	Ref. No.	RTBF800077
description	gas valve SIT type ELETTROSIT 230V gas inlet 1/2" gas outlet 1/2" thermocouple connection M9x1 pilot connection M10x1 bottom equiv. no. 0.810.136		
For models:	MG099-03-012, MG099-03-012M, MG099-13-012I, MG099-13-012IM		
spare parts for	101126		
	GEV No.	101312	Ref. No. —
	microswitch		
	GEV No.	101352	Ref. No. —
	solenoid coil 230V 50Hz suitable for ELETTROSIT		

accessories for 101126

	GEV No.	100006	Ref. No. —
	piezoelectric igniter suitable for ELETTROSIT body plastic blowing connection ø2.4mm ø 14mm		
	GEV No.	100904	Ref. No. —
	locking screw M10x1 for pipe ø 4mm Qty 1 pcs		
	GEV No.	100905	Ref. No. —
	locking screw M10x1 for pipe ø 6mm Qty 1 pcs		
	GEV No.	101301	Ref. No. —
	gas connection thread 1/2" straight ELETTROSIT screw with O-ring		
	GEV No.	101303	Ref. No. —
	gas connection straight thread 3/4" ELETTROSIT		
	GEV No.	101309	Ref. No. —
	extension		

ignition parts

pilot burners

SIT

100 series











GEV No.	107141	Ref. No.	RTCU700372
description	pilot burner SIT type 100 series 1 flame nozzle ø 0.35mm gas connection 6mm		
For models:	MG117-03-110XL		
spare parts for	107141		
	GEV No.	100885	Ref. No. —
	air mixing sleeve for pilot burner Qty 1 pcs		
	GEV No.	100905	Ref. No. —
	locking screw M10x1 for pipe ø 6mm Qty 1 pcs		
	GEV No.	107160	Ref. No. —
	pilot burner cap SIT 1 flame Hmm Lmm Qty 1 pcs		
	GEV No.	107166	Ref. No. —
	pilot burner head SIT 1 flame Hmm Lmm Qty 1 pcs		
accessories for	107141		
	GEV No.	100904	Ref. No. —
	locking screw M10x1 for pipe ø 4mm Qty 1 pcs		
	GEV No.	106733	Ref. No. 172882
	pilot burner bracket suitable for MBM		
	GEV No.	107167	Ref. No. —
	pilot burner nozzle SIT LPG code 21 bore ø 0.21mm Qty 1 pcs		

Table continues overleaf

Зиг-Общепит

vsezip.ru







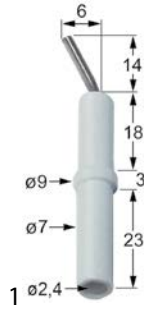





+7(812)987-08-81

accessories for	107141		
	GEV No.	107168	Ref. No.
			—
	pilot burner nozzle SIT natural gas bore \varnothing 0.35mm Qty 1 pcs thread M4x0.75 WS 5		

accessories			
pilot burner nozzles			
			
GEV No.	100245	Ref. No.	4370001
description	pilot burner nozzle LPG code 20 bore \varnothing 0.2mm Qty 1 pcs thread M8x0.75		

ignition electrodes			
			
GEV No.	100707	Ref. No.	RTCP800033
description	ignition electrode D1 \varnothing 7mm D2 \varnothing 9mm connection \varnothing 2.4mm L1 14mm L2 6mm BL1 18mm BL2 3mm BL3 23mm to clip Qty 1 pcs		
For models:	MG046-03-001, MG046-03-002, MG046-03-003, MG046-13-001, MG046-13-002, MG066-03-003, MG066-03-004, MG066-03-005, MG066-03-006, MG066-03-015, MG066-13-003, MG066-13-004, MG066-13-005, MG077-03-003, MG077-03-004, MG077-03-005, MG077-13-003, MG077-13-004, MG077-13-005, MG086-13-014P, MG099-03-012, MG099-03-012M, MG099-13-012I, MG099-13-012IM, MG106-03-003, MG106-03-004, MG106-13-003, MG106-13-004, MG117-03-110XL		

140 - 145 - 150 series			
			
GEV No.	107133	Ref. No.	RTCP800034
description	pilot burner SIT type 140 series 1 flame nozzle \varnothing mm gas connectionmm		
For models:	MG046-03-001, MG046-03-002, MG046-03-003, MG046-13-001, MG046-13-002, MG066-03-003, MG066-03-004, MG066-03-005, MG066-03-006, MG066-03-015, MG066-13-003, MG066-13-004, MG066-13-005, MG077-03-003, MG077-03-004, MG077-03-005, MG077-13-003, MG077-13-004, MG077-13-005, MG086-13-014P, MG099-03-012, MG099-03-012M, MG099-13-012I, MG099-13-012IM, MG106-03-003, MG106-03-004, MG106-13-003, MG106-13-004, MG117-03-110XL		
accessories for	107133		
	GEV No.	100204	Ref. No.
			—
	pilot burner nozzle SIT LPG code 14 bore \varnothing 0.18/0.20mm Qty 1 pcs suitable for 140 series		
	GEV No.	100205	Ref. No.
			RTCP800041
	pilot burner nozzle SIT LPG code 19 bore \varnothing 0.23/0.26mm Qty 1 pcs suitable for SIT 150 series		

accessories for	107133		
	GEV No.	100206	Ref. No.
			RTCP800040
	pilot burner nozzle SIT natural gas code 36 bore \varnothing 0.60/0.55mm Qty 1 pcs suitable for SIT 150 series		
	GEV No.	100207	Ref. No.
			RTCP800059
	pilot burner nozzle SIT natural gas code 27 bore \varnothing 0.40/0.38mm suitable for SIT 150 series		
	GEV No.	100216	Ref. No.
			—
	pilot burner nozzle SIT natural gas code 38 bore \varnothing 0.45mm Qty 1 pcs suitable for SIT 150 series		
	GEV No.	100701	Ref. No.
			RTCU900010
	ignition electrode connection M4 Qty 1 pcs		
	GEV No.	100897	Ref. No.
			—
	olive for pipe \varnothing 4mm Qty 1 pcs for pilot burner		
	GEV No.	100898	Ref. No.
			RTCU800183
	olive for pipe \varnothing 6mm Qty 1 pcs for pilot burner		
	GEV No.	100906	Ref. No.
			—
	screw connection thread M10x1 for ignition electrode brass Qty 1 pcs WS 10		
	GEV No.	100907	Ref. No.
			—
	screw connection thread M10x1 Qty 1 pcs type SEF 1 \varnothing mm for thermocouple		
	GEV No.	100908	Ref. No.
			RTCU900133
	union screw thread M10x1 for pipe \varnothing 4mm Qty 1 pcs		
	GEV No.	100909	Ref. No.
			RTCP800038 RTCU900019
	union screw thread M10x1 for pipe \varnothing 6mm Qty 1 pcs		
	GEV No.	102110	Ref. No.
			—
	pilot tube copper pipe \varnothing 4mm thickness 1mm L 3000mm		
	GEV No.	102111	Ref. No.
			—
	pilot tube copper pipe \varnothing 6mm thickness 1mm L 3000mm		



160 series			
			
GEV No.	100056	Ref. No.	RTCU700464
description	pilot burner SIT type 160 series 3 flames nozzle \varnothing mm gas connectionmm		
For models:	MG046-03-004, MG066-03-007, MG066-03-008		
spare parts for	100056		
	GEV No.	100907	Ref. No.
			—
	screw connection thread M10x1 Qty 1 pcs type SEF 1 \varnothing mm for thermocouple		
accessories for	100056		
	GEV No.	100202	Ref. No.
			—
	pilot burner nozzle natural gas code 41 Qty 1 pcs nozzle \varnothing 0.41mm		
	GEV No.	100203	Ref. No.
			—
	pilot burner nozzle LPG code 25 Qty 1 pcs nozzle \varnothing 0.25mm		

Table continues overleaf



Зип-Общепит

electrodes

vsezip.ru

+7(812)987-08-81

accessories for		100056	
	GEV No.	100701	Ref. No. RTCU900010
ignition electrode connection M4 Qty 1 pcs			
	GEV No.	100801	Ref. No. —
gasket for pilot burner Qty 1 pcs			
	GEV No.	100869	Ref. No. —
pilot burner nozzle natural gas code 51 Qty 1 pcs suitable for 160 series nozzle \varnothing 0.51 mm			
	GEV No.	100870	Ref. No. RTCU900134
olive for pipe \varnothing 4mm Qty 1 pcs suitable for 160 series for pilot burner			
	GEV No.	100906	Ref. No. —
screw connection thread M10x1 for ignition electrode brass Qty 1 pcs WS 10			
	GEV No.	100908	Ref. No. RTCU900133
union screw thread M10x1 for pipe \varnothing 4mm Qty 1 pcs			
	GEV No.	100909	Ref. No. RTCP800038 RTCU900019
union screw thread M10x1 for pipe \varnothing 6mm Qty 1 pcs			
	GEV No.	101287	Ref. No. —
olive for pipe \varnothing 6mm Qty 1 pcs			
	GEV No.	102110	Ref. No. —
pilot tube copper pipe \varnothing 4mm thickness 1mm L 3000mm			
	GEV No.	102111	Ref. No. —
pilot tube copper pipe \varnothing 6mm thickness 1mm L 3000mm			
	GEV No.	107650	Ref. No. —
pilot burner nozzle SIT LPG code 30 Qty 1 pcs			



GEV No.	100701	Ref. No.	RTCU900010
description	ignition electrode connection M4 Qty 1 pcs		
For models:	MG046-03-004, MG066-03-007, MG066-03-008		
accessories for	100701		
	GEV No.	100906	Ref. No. —
screw connection thread M10x1 for ignition electrode brass Qty 1 pcs WS 10			

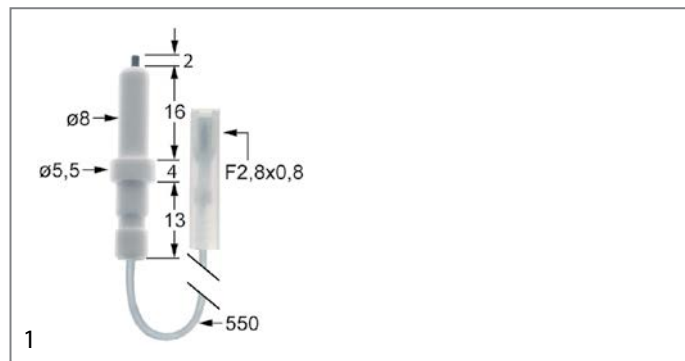

GEV No.	100808	Ref. No.	RTCU600045
description	ignition electrode D1 \varnothing 5.5mm cable length 550mm connection F 2.8x0.8mm D2 \varnothing 8mm L1 2mm BL1 16mm BL2 4mm BL3 13mm		
For models:	ME066-03-010, ME106-03-010XL, MG046-03-000, MG066-03-000, MG066-03-010, MG106-03-000, MG106-03-010, MG106-03-010XL		

accessories universal

pilot burner brackets



GEV No.	690798	Ref. No.	PACU701022
description	pilot burner bracket		
For models:	MG099-03-012, MG099-03-012M, MG099-13-012I, MG099-13-012IM		

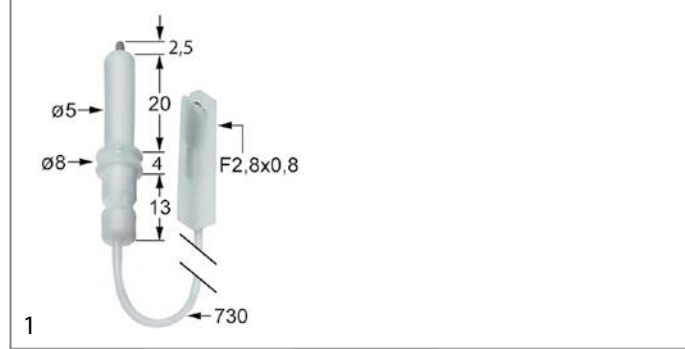

GEV No.	100826	Ref. No.	RTCU600046
description	ignition electrode D1 \varnothing 5mm cable length 730mm connection F 2.8x0.8mm D2 \varnothing 8mm L1 2.5mm BL1 20mm BL2 4mm BL3 13mm		
For models:	ME066-03-010, ME106-03-010XL, MG046-03-000, MG066-03-000, MG066-03-010, MG106-03-000, MG106-03-010, MG106-03-010XL		

Зип-Общепит

ignition cables

pre-assembled cables

vsezip.ru

+7(812)98708881

GEV No.	100707	Ref. No.	RTCP800033
description	ignition electrode D1 ø 7mm D2 ø 9mm connection ø2.4mm L1 14mm L2 6mm BL1 18mm BL2 3mm BL3 23mm to clip Qty 1 pcs		
For models:	MG046-03-001, MG046-03-002, MG046-03-003, MG046-13-001, MG046-13-002, MG066-03-003, MG066-03-004, MG066-03-005, MG066-03-006, MG066-03-015, MG066-13-003, MG066-13-004, MG066-13-005, MG077-03-003, MG077-03-004, MG077-03-005, MG077-13-003, MG077-13-004, MG077-13-005, MG086-13-014P, MG099-03-012, MG099-03-012M, MG099-13-012I, MG099-13-012IM, MG106-03-003, MG106-03-004, MG106-13-003, MG106-13-004, MG117-03-110XL		

GEV No.	100818	Ref. No.	9353457100 RIC0002551
description	ignition electrode flange length 23mm flange width 15mm D1 ø 7mm L1 18mm BL1 12mm BL2 41mm connection F 2.8x0.8mm fixing dimensions ø5x4mm with flange		
For models:	MG066-03-010, MG106-03-010, MG106-03-010XL		

GEV No.	106068	Ref. No.	RTCU600047
description	spring clip for igniter		
For models:	ME066-03-010, ME106-03-010XL, MG066-03-010, MG106-03-010, MG106-03-010XL		

GEV No.	106797	Ref. No.	RTCU900215
description	union screw thread M10x1 WS 10 bore ø 7.3mm		
For models:	MG099-03-012, MG099-03-012M, MG099-13-012I, MG099-13-012IM, MG117-03-110XL		

GEV No.	100026	Ref. No.	RTCU900384
description	ignition cable cable length 1000mm connection ø4mm / F6.3mm		
For models:	MG046-03-003, MG066-03-006		

GEV No.	100174	Ref. No.	9363490000 RIC0002554
description	ignition cable cable length 1500mm connection F2.8mm / F2.8mm		
For models:	MG066-03-010, MG106-03-010, MG106-03-010XL		

GEV No.	102163	Ref. No.	RTCU700005
description	ignition cable cable length 1500mm connection F2.8mm / ø2.4mm		
For models:	MG099-03-012, MG099-03-012M, MG099-13-012I, MG099-13-012IM		

GEV No.	100014	Ref. No.	RTCU700361
description	ignition cable cable length 300mm connection ø2.4mm / ø2.4mm		
For models:	MG046-03-001, MG046-03-002, MG046-13-001, MG046-13-002, MG066-03-003, MG066-03-004, MG066-03-005, MG066-03-015, MG066-13-003, MG066-13-004, MG066-13-005, MG077-03-003, MG077-03-004, MG077-03-005, MG077-13-003, MG077-13-004, MG077-13-005, MG086-13-014P, MG106-03-003, MG106-03-004, MG106-13-003, MG106-13-004		

GEV No.	100178	Ref. No.	RTBF700023
description	ignition cable cable length 900mm connection F2.8mm / ø2.4mm		
For models:	MG046-03-004, MG066-03-007, MG066-03-008		

piezoelectric igniters

mounting diameter 22mm

GEV No.	100005	Ref. No.	RTCU700020
description	piezoelectric igniter body plastic blowing mounting ø 22mm connection ø2.4mm cable lengthmm SIT		
For models:	MG046-03-000, MG046-03-001, MG046-03-002, MG046-03-003, MG046-03-004, MG046-13-001, MG046-13-002, MG066-03-000, MG066-03-003, MG066-03-004, MG066-03-005, MG066-03-006, MG066-03-007, MG066-03-008, MG066-03-015, MG066-13-003, MG066-13-004, MG066-13-005, MG077-03-003, MG077-03-004, MG077-03-005, MG077-13-003, MG077-13-004, MG077-13-005, MG086-13-014P, MG106-03-000, MG106-03-003, MG106-03-004, MG106-13-003, MG106-13-004, MG117-03-110XL		



ignition units

Зип Общепит

vsezip.ru

+7(812)987-08-81



1

GEV No.	102485	Ref. No.	RTBF800129
description	ignition unit outputs 2 220-240VAC 0.6VA 50-60Hz		
For models:	ME106-03-010XL, MG066-03-010, MG099-03-012, MG099-03-012M, MG099-13-012I, MG099-13-012IM, MG106-03-010, MG106-03-010XL		



1

GEV No.	102922	Ref. No.	RTCU600190
description	ignition unit outputs 4		
For models:	ME066-03-010, MG066-03-010		

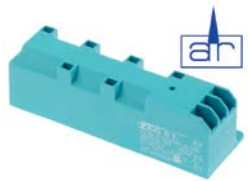

1

GEV No.	101024	Ref. No.	RTCU600191
description	ignition unit outputs 6 230VAC dimensions 112x22x34mm mounting distance 98mm inlet F6.3x0.8 outlet F2.8x0.8 type ZAG6 0.3VA 50/60Hz t.max. -20 up to +125°C		
For models:	ME106-03-010XL, MG106-03-010, MG106-03-010XL		

with barrel socket ø6(6.5)mm

thermocouples SIT

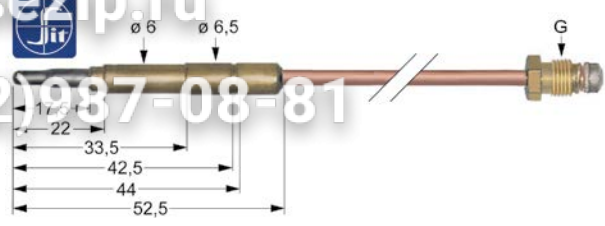

1

GEV No.	107613	Ref. No.	RTCU900061
description	thermocouple SIT M9x1 L 1200mm plug connection ø6.0(6.5)mm		
For models:	MG117-03-110XL		

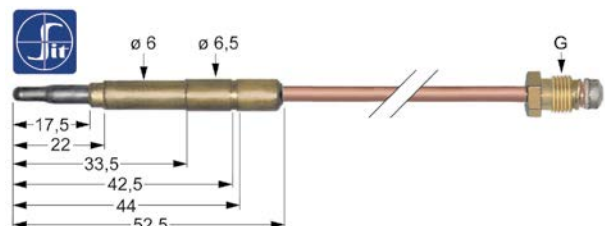

1

GEV No.	107608	Ref. No.	RTCU700148 RTCU900477
description	thermocouple SIT M9x1 L 500mm plug connection ø6.0(6.5)mm		
For models:	MG066-03-008, MG086-13-014P		

plug-in thermocouples with interruption

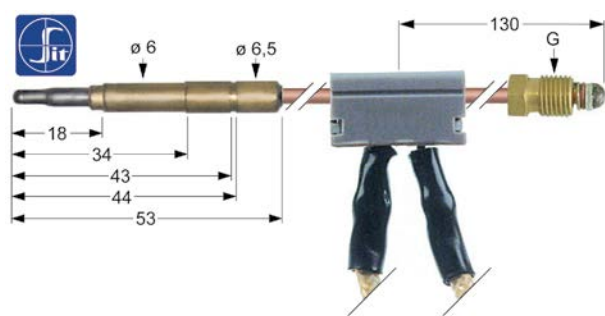

1

GEV No.	107863	Ref. No.	RTCU700651
description	thermocouple SIT with interrupter M9x1 L 1000mm plug connection ø6.0(6.5)mm cable 820mm		
For models:	MG046-03-004, MG066-03-007		

thermocouples

plug-in thermocouples

plug-in thermocouples standard

with barrel socket ø6mm

SIT

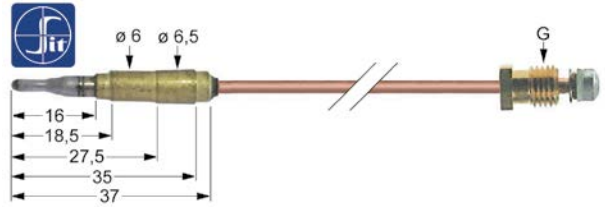

1

GEV No.	102923	Ref. No.	RTCU700296
description	thermocouple M9x1 L 750mm plug connection ø6.0mm		
For models:	MG046-03-001, MG046-03-002, MG046-03-003, MG046-13-001, MG046-13-002, MG066-03-003, MG066-03-004, MG066-03-005, MG066-03-006, MG066-03-015, MG066-13-003, MG066-13-004, MG066-13-005, MG077-03-003, MG077-03-004, MG077-03-005, MG077-13-003, MG077-13-004, MG077-13-005, MG106-03-003, MG106-03-004, MG106-13-003, MG106-13-004		

Зип-Общепит

vsezip.ru

+7(812)987-08-81

threaded thermocouples

threaded thermocouples standard

with socket with thread M8x1

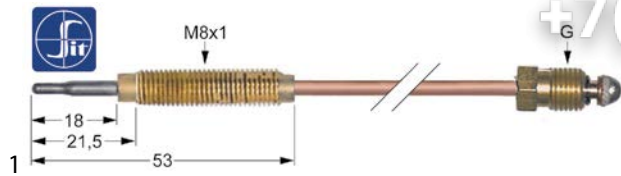

SIT

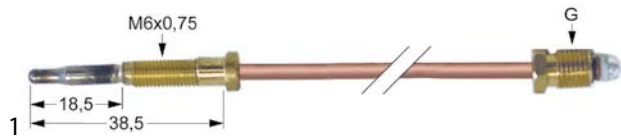

GEV No.	107633	Ref. No.	9606014100 RIC0002552
description	thermocouple SIT M8x1 L 1200mm M8x1		
For models:	MG066-03-010, MG106-03-010, MG106-03-010XL		
accessories for	107633		
	GEV No.	102067	Ref. No. 9404701700
	nut thread M8x1 H 3mm brass Qty 1 pcs type SEF 1		

threaded thermocouples (miscellaneous)



GEV No.	102138	Ref. No.	RTCU700373
description	thermocouple M9x1 L 300mm M6x0.75		
For models:	MG117-03-110XL		
accessories for	102138		
	GEV No.	102143	Ref. No. RTCU700391
	thermocouple nut thread M6x0.75 H 12mm WS 8 brass Qty 1 pcs		
	GEV No.	102680	Ref. No. RTCU600052
	nut thread M6x0.75 H 2.6mm WS 8 brass Qty 1 pcs type SEF 2		



GEV No.	102139	Ref. No.	RTCU700374
description	thermocouple M9x1 L 500mm M6x0.75		
For models:	MG117-03-110XL		
accessories for	102139		
	GEV No.	102143	Ref. No. RTCU700391
	thermocouple nut thread M6x0.75 H 12mm WS 8 brass Qty 1 pcs		

threaded thermocouples with cable link

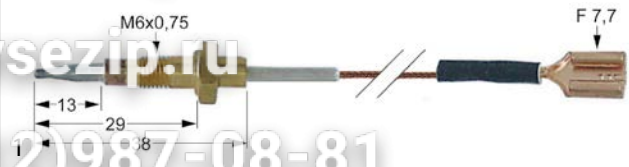

GEV No.	102243	Ref. No.	RTCU600021
description	thermocouple L 600mm		
For models:	ME066-03-010, ME106-03-010XL, MG046-03-000, MG066-03-000, MG066-03-010, MG106-03-000, MG106-03-010, MG106-03-010XL		



GEV No.	102924	Ref. No.	RTCU600039
description	thermocouple with two-conductors L 750mm M6x0.75 F 7.7mm M4		
For models:	ME066-03-010, ME106-03-010XL, MG046-03-000, MG066-03-000, MG066-03-010, MG106-03-000, MG106-03-010, MG106-03-010XL		

accessories

nuts



GEV No.	102067	Ref. No.	9404701700
description	nut thread M8x1 H 3mm brass Qty 1 pcs type SEF 1		
For models:	MG066-03-010, MG106-03-010, MG106-03-010XL		



GEV No.	102143	Ref. No.	RTCU700391
description	thermocouple nut thread M6x0.75 H 12mm WS 8 brass Qty 1 pcs		
For models:	MG117-03-110XL		





gas burners





hob burners



universal hob burners

SABAF



2 series - standard

 <p>1</p>			
GEV No.	105054	Ref. No.	RTCU600044
description	burner cap 3kW ø 100mm H 3.5mm bright finish		
For models:	ME066-03-010, ME106-03-010XL, MG046-03-000, MG066-03-000, MG066-03-010, MG106-03-000, MG106-03-010, MG106-03-010XL		
accessories for	105054		
	GEV No.	105058	Ref. No. RTCU600043
burner head 3kW for igniter ø 6mm for burner cap ø 100mm			
	GEV No.	105059	Ref. No. RTCU600017
burner lower part 3kW for igniter ø 6mm for thermocouple ø 6mm without nozzle for burner cap ø 100mm			

 <p>1</p>			
GEV No.	105058	Ref. No.	RTCU600043
description	burner head 3kW for igniter ø 6mm for burner cap ø 100mm		
For models:	ME066-03-010, ME106-03-010XL, MG046-03-000, MG066-03-000, MG066-03-010, MG106-03-000, MG106-03-010, MG106-03-010XL		
accessories for	105058		
	GEV No.	105054	Ref. No. RTCU600044
burner cap 3kW ø 100mm H 3.5mm bright finish			
	GEV No.	105059	Ref. No. RTCU600017
burner lower part 3kW for igniter ø 6mm for thermocouple ø 6mm without nozzle for burner cap ø 100mm			
	GEV No.	107374	Ref. No. —
burner cap 3kW ø 100mm H 3.5mm matt finish			

 <p>1</p>			
GEV No.	105059	Ref. No.	RTCU600017
description	burner lower part 3kW for igniter ø 6mm for thermocouple ø 6mm without nozzle for burner cap ø 100mm		
For models:	ME066-03-010, ME106-03-010XL, MG046-03-000, MG066-03-000, MG066-03-010, MG106-03-000, MG106-03-010, MG106-03-010XL		
accessories for	105059		
	GEV No.	105054	Ref. No. RTCU600044
burner cap 3kW ø 100mm H 3.5mm bright finish			
	GEV No.	105058	Ref. No. RTCU600043
burner head 3kW for igniter ø 6mm for burner cap ø 100mm			

accessories for	105059		
GEV No.	107374	Ref. No.	—
burner cap 3kW ø 100mm H 3.5mm matt finish			

2 series - flat skirt version			
 <p>1</p>			
GEV No.	105054	Ref. No.	RTCU600044
description	burner cap 3kW ø 100mm H 3.5mm bright finish		
For models:	ME066-03-010, ME106-03-010XL, MG046-03-000, MG066-03-000, MG066-03-010, MG106-03-000, MG106-03-010, MG106-03-010XL		
accessories for	105054		
	GEV No.	105058	Ref. No. RTCU600043
burner head 3kW for igniter ø 6mm for burner cap ø 100mm			
	GEV No.	105059	Ref. No. RTCU600017
burner lower part 3kW for igniter ø 6mm for thermocouple ø 6mm without nozzle for burner cap ø 100mm			

 <p>1</p>			
GEV No.	105059	Ref. No.	RTCU600017
description	burner lower part 3kW for igniter ø 6mm for thermocouple ø 6mm without nozzle for burner cap ø 100mm		
For models:	ME066-03-010, ME106-03-010XL, MG046-03-000, MG066-03-000, MG066-03-010, MG106-03-000, MG106-03-010, MG106-03-010XL		
accessories for	105059		
	GEV No.	105054	Ref. No. RTCU600044
burner cap 3kW ø 100mm H 3.5mm bright finish			
	GEV No.	105058	Ref. No. RTCU600043
burner head 3kW for igniter ø 6mm for burner cap ø 100mm			
	GEV No.	107374	Ref. No. —
burner cap 3kW ø 100mm H 3.5mm matt finish			



triple ring burner series - standard version			
 <p>1</p>			
GEV No.	105063	Ref. No.	RTCU600040
description	burner cap 3.6kW ø 131mm H 4mm mounting pos. outer		
For models:	ME066-03-010, ME106-03-010XL, MG046-03-000, MG066-03-000, MG066-03-010, MG106-03-000, MG106-03-010, MG106-03-010XL		
accessories for	105063		
	GEV No.	105064	Ref. No. RTCU600041
burner cap 3.6kW ø 61mm H 6.5mm mounting pos. inner bright finish			
	GEV No.	105065	Ref. No. RTCU600042
burner head 3.6kW for burner cap ø 61/131mm			



Table continues overleaf

1 gas components





Зип Общепит





vsezip.ru

7(812)987-08381

accessories for	105063		
	GEV No.	105717	Ref. No. —
	burner lower part 3.6kW for igniter ø 6mm for thermocouple ø 6mm with nozzle ø1.35mm ID ø 64mm for burner cap ø 61/131mm		
	GEV No.	105922	Ref. No. —
	burner lower part 3.6kW for igniter ø 6mm for thermocouple ø 6mm with nozzle ø1.35mm ID ø 75mm for burner cap ø 61/131mm		

	GEV No.	105064	Ref. No.	RTCU600041
description	burner cap 3.6kW ø 61mm H 6.5mm mounting pos. inner bright finish			
For models:	ME066-03-010, ME106-03-010XL, MG046-03-000, MG066-03-000, MG066-03-010, MG106-03-000, MG106-03-010, MG106-03-010XL			
accessories for	105064			
	GEV No.	105063	Ref. No.	RTCU600040
	burner cap 3.6kW ø 131mm H 4mm mounting pos. outer			
	GEV No.	105065	Ref. No.	RTCU600042
	burner head 3.6kW for burner cap ø 61/131mm			
	GEV No.	105717	Ref. No.	—
	burner lower part 3.6kW for igniter ø 6mm for thermocouple ø 6mm with nozzle ø1.35mm ID ø 64mm for burner cap ø 61/131mm			
	GEV No.	105922	Ref. No.	—
	burner lower part 3.6kW for igniter ø 6mm for thermocouple ø 6mm with nozzle ø1.35mm ID ø 75mm for burner cap ø 61/131mm			

	GEV No.	105065	Ref. No.	RTCU600042
description	burner head 3.6kW for burner cap ø 61/131mm			
For models:	ME066-03-010, ME106-03-010XL, MG046-03-000, MG066-03-000, MG066-03-010, MG106-03-000, MG106-03-010, MG106-03-010XL			
accessories for	105065			
	GEV No.	105063	Ref. No.	RTCU600040
	burner cap 3.6kW ø 131mm H 4mm mounting pos. outer			
	GEV No.	105064	Ref. No.	RTCU600041
	burner cap 3.6kW ø 61mm H 6.5mm mounting pos. inner bright finish			
	GEV No.	105717	Ref. No.	—
	burner lower part 3.6kW for igniter ø 6mm for thermocouple ø 6mm with nozzle ø1.35mm ID ø 64mm for burner cap ø 61/131mm			

	GEV No.	105123	Ref. No.	RTCU600018
description	burner lower part 3.6kW for igniter ø 7mm for thermocouple ø 6mm with nozzle ø1.35mm ID ø 75mm for burner cap ø 61/131mm			
For models:	ME066-03-010, ME106-03-010XL, MG046-03-000, MG066-03-000, MG066-03-010, MG106-03-000, MG106-03-010, MG106-03-010XL			
accessories for	105123			
	GEV No.	105124	Ref. No.	—
	burner head 3.6kW for burner cap ø 61/131mm			
	GEV No.	105125	Ref. No.	—
	burner cap 3.6kW ø 131mm H 7mm mounting pos. outer			
	GEV No.	105126	Ref. No.	—
	burner cap 3.6kW ø 61mm H 9mm mounting pos. inner matt finish			

triple ring burner series - flat skirt version				
	GEV No.	105063	Ref. No.	RTCU600040
description	burner cap 3.6kW ø 131mm H 4mm mounting pos. outer			
For models:	ME066-03-010, ME106-03-010XL, MG046-03-000, MG066-03-000, MG066-03-010, MG106-03-000, MG106-03-010, MG106-03-010XL			
accessories for	105063			
	GEV No.	105064	Ref. No.	RTCU600041
	burner cap 3.6kW ø 61mm H 6.5mm mounting pos. inner bright finish			
	GEV No.	105065	Ref. No.	RTCU600042
	burner head 3.6kW for burner cap ø 61/131mm			
	GEV No.	105717	Ref. No.	—
	burner lower part 3.6kW for igniter ø 6mm for thermocouple ø 6mm with nozzle ø1.35mm ID ø 64mm for burner cap ø 61/131mm			
	GEV No.	105922	Ref. No.	—
	burner lower part 3.6kW for igniter ø 6mm for thermocouple ø 6mm with nozzle ø1.35mm ID ø 75mm for burner cap ø 61/131mm			





	GEV No.	105064	Ref. No.	RTCU600041
description	burner cap 3.6kW ø 61mm H 6.5mm mounting pos. inner bright finish			
For models:	ME066-03-010, ME106-03-010XL, MG046-03-000, MG066-03-000, MG066-03-010, MG106-03-000, MG106-03-010, MG106-03-010XL			
accessories for	105064			
	GEV No.	105063	Ref. No.	RTCU600040
	burner cap 3.6kW ø 131mm H 4mm mounting pos. outer			
	GEV No.	105065	Ref. No.	RTCU600042
	burner head 3.6kW for burner cap ø 61/131mm			

Table continues overleaf





Зип Общепит
vsezip.ru
7(812)987-08-81

accessories for	105064		
	GEV No.	105717	Ref. No. —
	burner lower part 3.6kW for igniter ø 6mm for thermocouple ø 6mm with nozzle ø1.35mm ID ø 64mm for burner cap ø 61/131mm		
	GEV No.	105922	Ref. No. —
	burner lower part 3.6kW for igniter ø 6mm for thermocouple ø 6mm with nozzle ø1.35mm ID ø 75mm for burner cap ø 61/131mm		



GEV No.	105123	Ref. No.	RTCU600018
description	burner lower part 3.6kW for igniter ø 7mm for thermocouple ø 6mm with nozzle ø1.35mm ID ø 75mm for burner cap ø 61/131mm		
For models:	ME066-03-010, ME106-03-010XL, MG046-03-000, MG066-03-000, MG066-03-010, MG106-03-000, MG106-03-010, MG106-03-010XL		

accessories for	105123		
	GEV No.	105124	Ref. No. —
	burner head 3.6kW for burner cap ø 61/131mm		
	GEV No.	105125	Ref. No. —
	burner cap 3.6kW ø 131mm H 7mm mounting pos. outer		
	GEV No.	105126	Ref. No. —
	burner cap 3.6kW ø 61mm H 9mm mounting pos. inner matt finish		

accessories
reducers for pan supports



GEV No.	210050	Ref. No.	RTCU700028
description	reducer for pan support L 260mm W 260mm chrome-plated steel suitable for universal		
For models:	MG117-03-110XL		

pan supports



GEV No.	210174	Ref. No.	RTCU600019
description	pan support W 285mm L 505mm		
For models:	ME066-03-010, ME106-03-010XL, MG066-03-000, MG066-03-010, MG106-03-000, MG106-03-010, MG106-03-010XL		



GEV No.	210242	Ref. No.	RTCU600020
description	pan support W 340mm L 515mm		
For models:	ME106-03-010XL, MG046-03-000, MG106-03-000, MG106-03-010, MG106-03-010XL		

bar burners

bar burners



GEV No.	105194	Ref. No.	RIC0002462
description	bar burner		
For models:	MG066-03-010		



GEV No.	105211	Ref. No.	RTCU600070
description	bar burner 2 row L 470mm W 200mm ømm H 45mm chargrill		
For models:	MG086-13-014P		



GEV No.	105208	Ref. No.	RTCU700279
description	bar burner 2 row L 488mm W 250mm ømm H 170mm griddle		
For models:	MG077-03-003, MG077-03-004, MG077-03-005, MG077-13-003, MG077-13-004, MG077-13-005		



GEV No.	105706	Ref. No.	RTBF900098
description	bar burner 6 row L 518mm W 630mm ømm H 305mm tilting bratt pan		
For models:	MG099-03-012, MG099-03-012M, MG099-13-012L, MG099-13-012IM		





Зип Общепит

vsezip.ru

+7(812)9870881

			
1			
GEV No.	105219	Ref. No.	RTCU700320
description	bar burner ø 40mm Wmm Hmm L 192mm flange ø 61mm bain marie		
For models:	MG046-03-003		

			
1			
GEV No.	105220	Ref. No.	RTCU700321
description	bar burner ø 40mm Wmm Hmm L 310mm flange ø 61mm bain marie		
For models:	MG066-03-006		

			
1			
GEV No.	105213	Ref. No.	RTCU600150
description	bar burner ø 40mm Wmm Hmm L 310mm flange ø 61mm frying pan		
For models:	MG066-03-015		

			
1			
GEV No.	105207	Ref. No.	RTCU600003
description	bar burner ø 40mm Wmm Hmm L 405mm flange ø 61mm griddle		
For models:	MG046-03-001, MG046-03-002, MG046-13-001, MG046-13-002, MG066-03-003, MG066-03-004, MG066-03-005, MG066-13-003, MG066-13-004, MG066-13-005, MG106-03-003, MG106-03-004, MG106-13-003, MG106-13-004		

			
1			
GEV No.	210243	Ref. No.	RTCU600466
description	chargrill grid L 440mm W 355mm fish		
For models:	MG086-13-014P		

			
1			
GEV No.	210239	Ref. No.	A660000330
description	chargrill grid L 460mm W 350mm meat		
For models:	MG086-13-014P		

chargrill grids			
			
1			
GEV No.	210243	Ref. No.	RTCU600466
description	chargrill grid L 440mm W 355mm fish		
For models:	MG086-13-014P		

			
1			
GEV No.	210239	Ref. No.	A660000330
description	chargrill grid L 460mm W 350mm meat		
For models:	MG086-13-014P		

tube burners

			
1			
GEV No.	105214	Ref. No.	RTCU700465
description	tubular burner ø 74mm L 185mm H 60mm round for pasta cooker		
For models:	MG046-03-004, MG066-03-007, MG066-03-008		

accessories

nozzle holders			
			
1			
GEV No.	105184	Ref. No.	173320
description	nozzle holder		
For models:	MG117-03-110XL		



Зип Общепит
pilot burner nozzles

vsezip.ru
100 series

7(812)987-08-81

			
1			
GEV No.	106065	Ref. No.	RTCU900337
description	nozzle holder		
For models:	MG046-03-003, MG066-03-006, MG077-03-003, MG077-03-004, MG077-03-005, MG077-13-003, MG077-13-004, MG077-13-005, MG086-13-014P		

			
pilot burner nozzles SIT			
GEV No.	100245	Ref. No.	4370001
description	pilot burner nozzle LPG code 20 bore \varnothing 0.2mm Qty 1 pcs thread M8x0.75		

gas nozzles

main nozzles

gas nozzles M6x0.75

			
1			
GEV No.	106731	Ref. No.	RTCU600093
description	gas injector thread M6x0.75 WS 7 bore \varnothing 0.73mm		
For models:	ME066-03-010, ME106-03-010XL, MG066-03-010, MG106-03-010, MG106-03-010XL		

			
1			
GEV No.	106732	Ref. No.	RTCU600102
description	gas injector thread M6x0.75 WS 7 bore \varnothing 0.74mm		
For models:	ME066-03-010, ME106-03-010XL, MG066-03-010, MG106-03-010, MG106-03-010XL		

gas nozzles M10x1

			
1			
GEV No.	100661	Ref. No.	290201850-R
description	gas injector thread M10x1 WS 12 bore \varnothing 1.65mm		

gas nozzles M12x1

			
1			
GEV No.	100290	Ref. No.	RTCU900243
description	gas injector thread M12x1 WS 14 bore \varnothing 1.90mm		
For models:	MG077-03-003, MG077-03-004, MG077-03-005, MG077-13-003, MG077-13-004, MG077-13-005		

140/150 series

			
1			
GEV No.	100205	Ref. No.	RTCP800041
description	pilot burner nozzle SIT LPG code 19 bore \varnothing 0.23/0.26mm Qty 1 pcs suitable for SIT 150 series		
For models:	MG099-03-012, MG099-03-012M, MG099-13-012I, MG099-13-012IM		

			
1			
GEV No.	100207	Ref. No.	RTCP800059
description	pilot burner nozzle SIT natural gas code 27 bore \varnothing 0.40/0.38mm suitable for SIT 140 series		
For models:	MG077-03-003, MG077-03-004, MG077-03-005, MG077-13-003, MG077-13-004, MG077-13-005		

			
1			
GEV No.	100206	Ref. No.	RTCP800040
description	pilot burner nozzle SIT natural gas code 36 bore \varnothing 0.60/0.55mm Qty 1 pcs suitable for SIT 150 series		
For models:	MG099-03-012, MG099-03-012M, MG099-13-012I, MG099-13-012IM		

bypass nozzles

bypass nozzles PEL20/21

			
1			
GEV No.	100394	Ref. No.	4399247-R
description	bypass nozzle type PEL20/21 bore \varnothing 1.25mm thread M5x0.5		

			
1			
GEV No.	100534	Ref. No.	4399238-R
description	bypass nozzle type PEL20/21 bore \varnothing 1.4mm thread M5x0.5		

			
1			
GEV No.	100529	Ref. No.	RTCU700338
description	bypass nozzle type PEL20/21 bore \varnothing 1mm thread M5x0.5		



bypass nozzles PEL22



1

GEV No.	100428	Ref. No.	RTCU800175
description	bypass nozzle type PEL22 bore \varnothing 0.65mm thread M6x0.5		
For models:	MG077-03-003, MG077-03-004, MG077-03-005, MG077-13-003, MG077-13-004, MG077-13-005		

auxiliary gas parts

screw connections

olives



1

GEV No.	101278	Ref. No.	RTCU900012
description	olive for pipe \varnothing 10mm Qty 1 pcs		
For models:	MG046-03-003, MG046-03-004, MG066-03-006, MG066-03-007, MG066-03-008, MG077-03-003, MG077-03-004, MG077-03-005, MG077-13-003, MG077-13-004, MG077-13-005, MG099-03-012, MG099-03-012M, MG099-13-012I, MG099-13-012IM, MG117-03-110XL		

accessories for	101278	GEV No.	100943	Ref. No.	—
------------------------	--------	----------------	--------	-----------------	---

union nut thread M17x1 tube \varnothing 10mm

GEV No.	101300	Ref. No.	RTCU700297
----------------	--------	-----------------	------------

union nut thread M16x1.5 tube \varnothing 10mm

GEV No.	101478	Ref. No.	RTCU900013
----------------	--------	-----------------	------------

union nut thread 3/8" for pipe \varnothing 10mm

1

GEV No.	106798	Ref. No.	RTCP900088
description	olive for pipe \varnothing 14mm L 7mm brass Qty 1 pcs ED \varnothing 16mm		
For models:	MG099-03-012, MG099-03-012M, MG099-13-012I, MG099-13-012IM		



1

GEV No.	100870	Ref. No.	RTCU900134
description	olive for pipe \varnothing 4mm Qty 1 pcs suitable for 160 series for pilot burner		
For models:	MG099-03-012, MG099-03-012M, MG099-13-012I, MG099-13-012IM		



1

GEV No.	100898	Ref. No.	RTCU800183
description	olive for pipe \varnothing 6mm Qty 1 pcs for pilot burner		
For models:	MG086-13-014P, MG117-03-110XL		

accessories for	100898	GEV No.	100909	Ref. No.	RTCP800038 RTCU900019
					
union screw thread M10x1 for pipe \varnothing 6mm Qty 1 pcs					

Зип Общепит

vsezip.ru

7(812)987-08-81

GEV No.	101286	Ref. No.	RTCU900018
description	olive ID \varnothing 6mm Qty 1 pcs		
For models:	MG077-03-003, MG077-03-004, MG077-03-005, MG077-13-003, MG077-13-004, MG077-13-005, MG117-03-110XL		

accessories for	101286	GEV No.	100909	Ref. No.	RTCP800038 RTCU900019
					
union screw thread M10x1 for pipe \varnothing 6mm Qty 1 pcs					

GEV No.	101464	Ref. No.	—
			
union nut thread M12x1 for pipe \varnothing 6mm			



1

GEV No.	106799	Ref. No.	RTBF800137
description	olive L 6.5mm brass Qty 1 pcs ID \varnothing 14.3mm ED \varnothing 16.5mm		
For models:	MG099-03-012, MG099-03-012M, MG099-13-012I, MG099-13-012IM		

union nuts



1

GEV No.	102960	Ref. No.	RTBF800015
description	union nut thread 1/2" WS 24 brass for pipe \varnothing 14mm		
For models:	MG099-03-012, MG099-03-012M, MG099-13-012I, MG099-13-012IM		

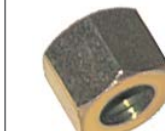

1

GEV No.	101478	Ref. No.	RTCU900013
description	union nut thread 3/8" for pipe \varnothing 10mm		
For models:	MG046-03-003, MG046-03-004, MG066-03-007, MG066-03-008, MG077-03-003, MG077-03-004, MG077-03-005, MG077-13-003, MG077-13-004, MG077-13-005		



1

GEV No.	101300	Ref. No.	RTCU700297
description	union nut thread M16x1.5 tube \varnothing 10mm		
For models:	MG066-03-008, MG077-03-003, MG077-03-004, MG077-03-005, MG077-13-003, MG077-13-004, MG077-13-005, MG117-03-110XL		

accessories for	101300	GEV No.	101278	Ref. No.	RTCU900012
					
olive for pipe \varnothing 10mm Qty 1 pcs					













Зип Общежит
consumables

vsezip.ru

+7(812)987-08-81

union screws

			
1			
GEV No.	100908	Ref. No.	RTCU900133
description	union screw thread M10x1 for pipe ø 4mm Qty 1 pcs		
For models:	MG099-03-012, MG099-03-012M, MG099-13-012I, MG099-13-012IM		
accessories for	100908		
	GEV No.	100897	Ref. No. —
olive for pipe ø 4mm Qty 1 pcs for pilot burner			
	GEV No.	101246	Ref. No. —
olive for pipe ø 4mm Qty 1 pcs			
	GEV No.	101280	Ref. No. —
olive for pipe ø 4mm Qty 1 pcs			
	GEV No.	101282	Ref. No. —
olive for pipe ø 4mm L 7.4mm Qty 1 pcs			

			
1			
GEV No.	100909	Ref. No.	RTCP800038 RTCU900019
description	union screw thread M10x1 for pipe ø 6mm Qty 1 pcs		
For models:	MG077-03-003, MG077-03-004, MG077-03-005, MG077-13-003, MG077-13-004, MG077-13-005, MG099-03-012, MG099-03-012M, MG099-13-012I, MG099-13-012IM, MG117-03-110XL		
accessories for	100909		
	GEV No.	100898	Ref. No. RTCU800183
olive for pipe ø 6mm Qty 1 pcs for pilot burner			
	GEV No.	101286	Ref. No. RTCU900018
olive ID ø 6mm Qty 1 pcs			
	GEV No.	101287	Ref. No. —
olive for pipe ø 6mm Qty 1 pcs			
	GEV No.	101288	Ref. No. —
olive for pipe ø 6mm L 6mm aluminium Qty 1 pcs ED ø 8.5mm			

lava rocks / ceramic briquettes

			
1			
GEV No.	211001	Ref. No.	A800001170
description	lava rocks Qty package content 9kg		
For models:	MG086-13-014P		

equipment-specific units

for ice-cube maker

spray systems

miscellaneous

spray arms

			
1			
GEV No.	694669	Ref. No.	2LV017
description	spray arm L 330mm nozzles 8		
For models:	KL030-10-000A, KL030-10-000W		

for espresso machines

steam/water taps

steam/water pipes

accessories

gaskets

			
1			
GEV No.	510893	Ref. No.	456015
description	O-ring EPDM thickness 2.62mm ID ø 9.92mm Qty 1 pcs		
For models:	D500LS, D501LS		

pipes

union nuts

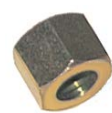
			
1			
GEV No.	101478	Ref. No.	RTCU900013
description	union nut thread 3/8" for pipe ø 10mm		
For models:	MG046-03-003, MG046-03-004, MG066-03-007, MG066-03-008, MG077-03-003, MG077-03-004, MG077-03-005, MG077-13-003, MG077-13-004, MG077-13-005		

for coffee grinders

			
1			
GEV No.	345742	Ref. No.	RTBF900277
description	microswitch with lever 250V 16A 1CO connection male faston 6.3mm L 55mm ambient temperature max. 120°C mounting distance 22mm actuating force: 75g lever length 46mm		
For models:	ME046-03-004, ME066-03-007		

for tilting bratt pans

gearboxes

			
1			
GEV No.	693642	Ref. No.	RTBF900109
description	gearbox motor shaft \varnothing 19mm flange \varnothing 118mm transmission I=1/60 drive shaft \varnothing 30mm flange \varnothing 180mm fixing dimensions 105mm type VU-70		
For models:	MG099-03-012, MG099-03-012M, MG099-13-012I, MG099-13-012IM		

for sliding doors

stand-offs

			
1			
GEV No.	690468	Ref. No.	011359-00-R
description	distance washer		

Зип-Общепит

for dishwashers

containers

vsezip.ru

salt tanks

+7(812)987-08-81

			
1			
GEV No.	524177	Ref. No.	480005
description	lid \varnothing 69mm H 20mm for salt tank ID \varnothing 50mm		
For models:	D500LS, D501LS		
accessories for	524177		
	GEV No.	524148	Ref. No. —
	O-ring EPDM thickness 3.53mm ID \varnothing 40.86mm Qty 1 pcs		

			
1			
GEV No.	510018	Ref. No.	429011
description	nut \varnothing 92mm H 10.5mm for salt tank ID \varnothing 64mm		
For models:	D500LS, D501LS		

			
1			
GEV No.	510032	Ref. No.	406998
description	salt tank without gasket new model		
For models:	D500LS, D501LS		
spare parts for	510032		
	GEV No.	506015	Ref. No. 456052
	O-ring EPDM thickness 3.53mm ID \varnothing 39.69mm Qty 1 pcs		
	GEV No.	510018	Ref. No. 429011
	nut \varnothing 92mm H 10.5mm for salt tank ID \varnothing 64mm		
	GEV No.	510071	Ref. No. 437034
	flat gasket rubber ED \varnothing 81mm ID \varnothing 68mm thickness 3mm for salt tank Qty 1 pcs		

Table continues overleaf





Зип Общепит

vsezip.ru

+7(812)987-08-81

spare parts for 510032			
	GEV No.	524177	Ref. No. 480005
lid ø 69mm H 20mm for salt tank ID ø 50mm			

accessories			
			
1			
GEV No.	510071	Ref. No.	437034
description	flat gasket rubber ED ø 81mm ID ø 68mm thickness 3mm for salt tank Qty 1 pcs		
For models:	D500LS, D501LS		

boilers			
boilers for dishwashers			
			
1			
GEV No.	518235	Ref. No.	104060
description	boiler ø 145mm L 405mm flange 3 hole flange		
For models:	D500LS, D501LS		

softener cartridges			
softening columns			
			
1			
GEV No.	530395	Ref. No.	117007
description	softener 4-fold L 380mm W 180mm		
For models:	D500LS, D501LS		

spare parts and accessories			
			
1			
GEV No.	692041	Ref. No.	023415-00
description	mounting clip		

housing and bezels			
miscellaneous			
			
1			
GEV No.	513000	Ref. No.	480057
description	lid rubber ED ø 27mm		
For models:	D500LS, D501LS		

			
1			
GEV No.	513708	Ref. No.	480058
description	lid rubber ø 17mm mounting ø 17mm		
For models:	D500LS, D501LS		

air traps			
air traps			
			
1			
GEV No.	518488	Ref. No.	107005
description	air trap		
For models:	D500LS, D501LS		
accessories for	518488		
	GEV No.	504618	Ref. No. —
O-ring EPDM thickness 2.62mm ID ø 15.54mm Qty 1 pcs			
	GEV No.	510075	Ref. No. 437019
flat gasket rubber ED ø 22mm ID ø 13mm thickness 1.5mm Qty 1 pcs			
	GEV No.	510106	Ref. No. 468029
hose connector for air trap			

			
1			
GEV No.	518200	Ref. No.	984005
description	air trap ø 34mm H 78mm hose ø 6mm plastic		
For models:	D500LS, D501LS		
spare parts for	518200		
	GEV No.	504618	Ref. No. —
O-ring EPDM thickness 2.62mm ID ø 15.54mm Qty 1 pcs			
	GEV No.	510075	Ref. No. 437019
flat gasket rubber ED ø 22mm ID ø 13mm thickness 1.5mm Qty 1 pcs			
	GEV No.	510106	Ref. No. 468029
hose connector for air trap			

air trap accessories



1

GEV No.	510075	Ref. No.	437019
description	flat gasket rubber ED ø 22mm ID ø 13mm thickness 1.5mm Qty: 1 pcs		
For models:	D500LS, D501LS		



1

GEV No.	510106	Ref. No.	468029
description	hose connector for air trap		
For models:	D500LS, D501LS		

pulleys



1

GEV No.	693828	Ref. No.	RTBF900124
description	round belt pulley disc ø 212mm single shaft intake ø 19mm groove depth 11mm disc width 16mm groove width 10mm overall width 26mm shaft ø 48mm		
For models:	MG099-03-012, MG099-13-012I		

backflow preventers

backflow preventers



1

GEV No.	518297	Ref. No.	144011
description	backflow preventer		
For models:	D500LS, D501LS		

door mechanics

linkage



1

GEV No.	518355	Ref. No.	304021
description	door pin step rod		
For models:	D500LS, D501LS		

sliding plates



1

GEV No.	518356	Ref. No.	307003
description	sliding plate sliding plate		
For models:	D500LS, D501LS		

hinges



1

GEV No.	518301	Ref. No.	311019
description	door hinge mounting pos. left/right		
For models:	D500LS, D501LS		

hinge pins



1

GEV No.	518267	Ref. No.	325036
description	hinge pin hinge pin		
For models:	D500LS, D501LS		

door bumpers



1

GEV No.	518066	Ref. No.	417041
description	door bumper end stop		
For models:	D500LS, D501LS		

Зип.Общепит

vsezip.ru

+7(812)987-08-81



Зип Общепит

vsezip.ru

+7(812)987-08-81

locks



1

GEV No.	513138	Ref. No.	994012
description	door catch with nut door locking catch		
For models:	D500LS, D501LS		



1

GEV No.	518298	Ref. No.	325066
description	spigot door catch		
For models:	D500LS, D501LS		

washing and rinsing systems



1

GEV No.	518461	Ref. No.	303029
description	flange for wash arm support		
For models:	D500LS, D501LS		



1

GEV No.	517444	Ref. No.	80697
description	knurled nut thread M10x1 ø 25mm H 4mm SS		
For models:	D500LS, D501LS		



1

GEV No.	517454	Ref. No.	308031
description	nut for wash arm ED ø 35mm thickness 11mm plastic		
For models:	D500LS, D501LS		



1

GEV No.	518125	Ref. No.	143240
description	rinse hose ø 17.5mm		
For models:	D500LS, D501LS		



1

GEV No.	518003	Ref. No.	447128
description	screw cap		
For models:	D500LS, D501LS		



1

GEV No.	517443	Ref. No.	80623
description	slide ring for rinse arm mounting pos. upper/lower PTFE ED ø 22mm ID ø 9.5mm thickness 1mm		
For models:	D500LS, D501LS		



1

GEV No.	510112	Ref. No.	454002
description	Thumb screw thread M10 thread L 10mm ø 22mm H 4.5mm SS		
For models:	D500LS, D501LS		

knobs

universal knobs



1

GEV No.	110253	Ref. No.	8335612010-R
description	knob switch zero mark t.max.°C ø 50mm shaft ø 6x4.6mm shaft flat upper black		

producer-specific knobs

DEXION



1

GEV No.	110861	Ref. No.	020778-00 020778-00R 8335602010-R
description	knob thermostat t.max. 110°C 30-110°C ø 49mm shaft ø 6x4.6mm shaft flat upper black temperature range 30-110°C		

Зип Общежит

cone handles

miscellaneous



1			
GEV No.	112068	Ref. No.	168846
description	knob hot water ø 70mm shaft ø 10x8mm shaft flat upper		
For models:	LX7EC4		



1			
GEV No.	698790	Ref. No.	25007038
description	knob ø 44mm shaft ø 5x7mm shaft flat right and left black Qty 1 pcs		

accessories

gaskets



1			
GEV No.	112078	Ref. No.	RTCU800185
description	gasket knob		
For models:	ME066-03-010, ME066-03-013, ME103-03-013XL, ME106-03-010XL, ME106-03-013		

handles and hand wheels

hand wheels

hand wheels



1			
GEV No.	690555	Ref. No.	RTBF800093
description	hand wheel ø 200mm D1 ø 50mm bore ø 20mm thread M6 hole distance 7mm groove width 6mm L1 40mm L2 43mm handle length 85mm with folding handle		
For models:	MG099-03-012M, MG099-13-012IM		



1			
GEV No.	110704	Ref. No.	RTCU700413
description	cone handle thread M6 ø 16mm L 25mm plastic black		
For models:	ME046-03-003, ME046-03-004, ME066-03-006, ME066-03-007, ME066-03-008, MG046-03-003, MG046-03-004, MG066-03-006, MG066-03-007, MG066-03-008		

bracket handles



1			
GEV No.	693810	Ref. No.	9636273200 RICO002479
description	pull handle		
For models:	ME066-03-010, ME066-03-013, ME103-03-013XL, ME106-03-010XL, ME106-03-013, MG066-03-010, MG106-03-010, MG106-03-010XL		

lever handles



1			
GEV No.	540871	Ref. No.	RTCU900492
description	lever handle cold water suitable for intake tap		
For models:	ME066-03-008, MG066-03-008		

locks

locking devices

producer-specific

DEXION



1			
GEV No.	690462	Ref. No.	01349400R
description	key cylinder ø 23mm thread M19x1 mounting measurements 16.5x19mm hub 38-45mm shaft ø 11mm thread L 12mm		
spare parts for	690462		
	GEV No.	691589	Ref. No.
			—
	spare keys for key cylinder 690462 key number 9233		



Зип Общепит
walk-in fridge catches

INTERKLIMAT
1800 series

+7(812)987-08-81



1 			
GEV No.	690461	Ref. No.	01348600R
description	key cylinder straight thread M19x1 rotation 90° cam length 5 mm cam width 16mm		

edgemoount latches

handle latches

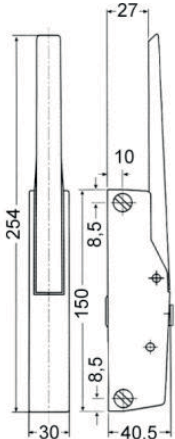
CAFF/FERMOD

1 			
			
GEV No.	690413	Ref. No.	795CRR
description	handle latch L 150mm mounting distance 133mm lockable refrigeration units G 795		
accessories for	690413		

	GEV No.	690418	Ref. No.	—
door catch L 36mm W 19mm H 29mm mounting distance 12mm zinc-coated steel for refrigeration units				
	GEV No.	690419	Ref. No.	—
door catch L 52mm W 20mm H 30mm mounting distance 26-37mm zamak for refrigeration units				
	GEV No.	700435	Ref. No.	—
door catch L 58mm W 20mm H 35mm mounting distance 42mm zamak for refrigeration units				

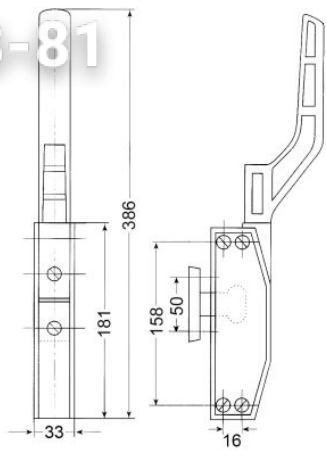
1 			
			
GEV No.	690457	Ref. No.	1825R
description	handle latch mounting distance 158mm L 181mm refrigeration units external lock type 1825 suitable for 1850		

GEV No.	690457	Ref. No.	1825R
description	handle latch mounting distance 158mm L 181mm refrigeration units external lock type 1825 suitable for 1850		

hinges

edgemoount hinges

CAFF/FERMOD

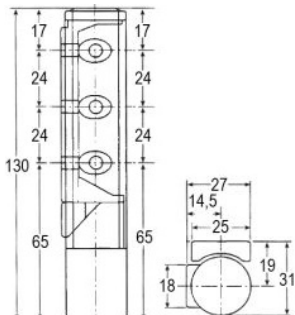
1 			
			
GEV No.	690436	Ref. No.	430CRR
description	edgemoount hinge L 130mm W 27mm mounting distance 48mm hinging left/right with gradient chrome-plated refrigeration units series G 430 centre of rotation 19mm		
accessories for	690436		

	GEV No.	690395	Ref. No.	—
base plate for type 300/303 thickness 5mm L 100mm				

Зип Общежит
spring assisted hinges

universal
vsezip.ru
INTERKLIMAT

hinges
+7(812)987-08-81

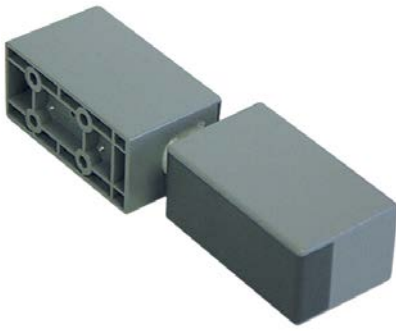

1

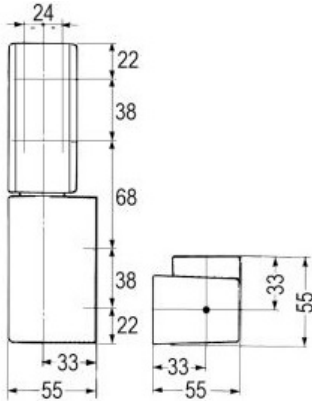

GEV No.	690458	Ref. No.	910R
description	edgmount hinge L 188mm mounting distance 38mm hinging left/right with gradient series G 915		
accessories for	690458		
	GEV No.	691642	Ref. No. —
	base plate thickness 5mm plastic L 98mm W 49mm		



1

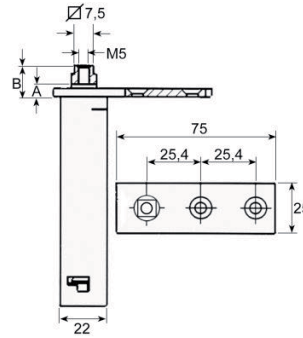

GEV No.	690714	Ref. No.	022104-00
description	spring assisted hinge series 28XC mounting pos. left/right L 75mm W 25mm H 103mm A 8mm B 11mm intake 7.5x7.5 refrigeration units mounting distance 25mm		

oven hinges

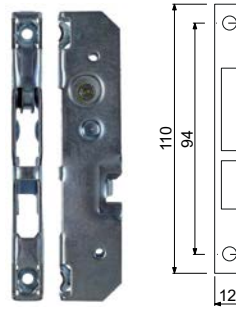

1

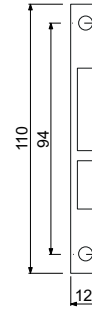

GEV No.	700003	Ref. No.	9626105200 RIC0002448
description	opposite support L 110mm W 12mm mounting distance 94mm		
For models:	ME066-03-010, ME066-03-013, ME106-03-013, MG066-03-010		



Зип Общепит

vsezip.ru

+7(812)987-08-81

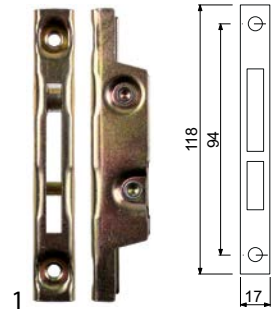

GEV No.	700001	Ref. No.	RTC900004
description	opposite support L 118mm W 17mm mounting distance 94mm		
For models:	MG117-03-110XL		

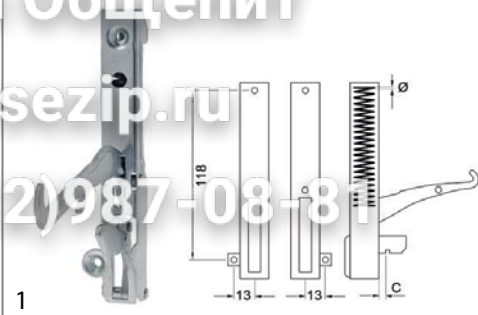



GEV No.	700013	Ref. No.	9626105100 RIC0002134	
description	oven hinge mounting distance 118mm lug mounting 13mm lever length 119mm groove distance 13mm spring thickness 3.5mm mounting ear position left spring length 60mm L 154mm			
For models:	ME066-03-010, ME066-03-013, ME106-03-013, MG066-03-010			
accessories for	700013			
	GEV No.	700003	Ref. No.	9626105200 RIC0002448
	opposite support L 110mm W 12mm mounting distance 94mm			



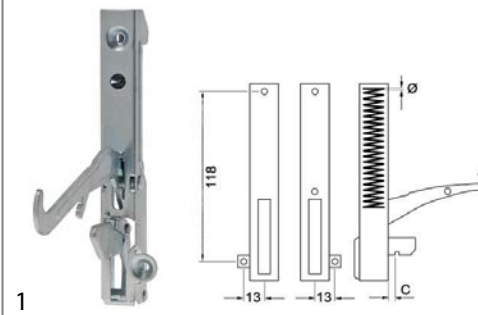

GEV No.	700396	Ref. No.	9626107200
description	opposite support oven hinge		
For models:	ME103-03-013XL, ME106-03-010XL, MG106-03-010, MG106-03-010XL		



GEV No.	700014	Ref. No.	9626105000 RIC0002133	
description	oven hinge mounting distance 118mm mounting distance 2mm lug mounting 13mm lever length 119mm groove distance 13mm spring thickness 3.5mm mounting ear position right spring length 60mm L 154mm			
For models:	ME066-03-010, ME066-03-013, ME106-03-013, MG066-03-010			
accessories for	700014			
	GEV No.	700003	Ref. No.	9626105200 RIC0002448
	opposite support L 110mm W 12mm mounting distance 94mm			



GEV No.	690498	Ref. No.	9626107000	
description	oven hinge mounting distance 118mm lug mounting 13mm lever length 119mm groove distance 12mm spring thickness 4mm mounting ear position right spring length 59mm L 155mm W 21mm			
For models:	ME103-03-013XL, ME106-03-010XL, MG106-03-010, MG106-03-010XL			
accessories for	690498			
	GEV No.	700003	Ref. No.	9626105200 RIC0002448
	opposite support L 110mm W 12mm mounting distance 94mm			





GEV No.	694505	Ref. No.	9626107100
description	oven hinge mounting distance 118mm mounting distance 2mm lug mounting 13mm lever length 125mm groove distance 12mm spring thickness 4mm mounting ear position left spring length 59mm L 155mm W 21mm with hook		
For models:	ME103-03-013XL, ME106-03-010XL, MG106-03-010, MG106-03-010XL		

Зип Общепит

vsezip.ru

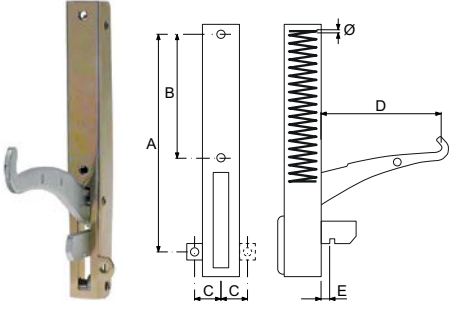
+7(812)987-08-81



GEV No.	700007	Ref. No.	RTCU900396
description	oven hinge mounting distance 173mm mounting distance 2 105mm lug mounting 14mm lever length 120mm groove distance 11mm spring thickness 3.5mm mounting ear position right spring length 112mm W 25mm		
For models:	MG117-03-110XL		
accessories for	700007		
	GEV No.	700001	Ref. No. RTCU900004
	opposite support L 118mm W 17mm mounting distance 94mm		

door bearing



GEV No.	690464	Ref. No.	01156100R
description	hinge bearing mounting pos. bottom left/upper right with bolt		



GEV No.	690984	Ref. No.	RTCP800028
description	hinge bearing mounting pos. left without bolt		
For models:	MG099-03-012, MG099-03-012M, MG099-13-012I, MG099-13-012IM		



GEV No.	690983	Ref. No.	RTCP800030
description	hinge bearing mounting pos. right without bolt		
For models:	MG099-03-012, MG099-03-012M, MG099-13-012I, MG099-13-012IM		



GEV No.	690986	Ref. No.	162198
description	hinge bearing mounting pos. upper left with bolt		
For models:	LX7EC4		



GEV No.	690463	Ref. No.	01156300R
description	hinge bearing mounting pos. upper left/bottom right with bolt		



GEV No.	690985	Ref. No.	162199
description	hinge bearing mounting pos. upper right		
For models:	LX7EC4		



GEV No.	690465	Ref. No.	01157600R
description	hinge bearing with bolt		

accessories

miscellaneous



GEV No.	693826	Ref. No.	RTCP800027
description	spring guide for hinge		
For models:	MG099-03-012, MG099-03-012M, MG099-13-012I, MG099-13-012IM		

pullouts

drawer slides

producer-specific





GEV No.	690721	Ref. No.	01513600R
description	drawer slide L 490mm pull-out length 410mm Qty 1 pair W 20mm H 33mm mounting pos. right/left for refrigerated counters 600mm		



Зип Общепит fittings for catering equipment

vsezip.ru

+7(812)987-08-81

1 			
GEV No.	690722	Ref. No.	01468200R
description	drawer slide L 590mm pull-out length 570mm Qty 1 pair W 17mm H 62mm mounting pos. right/left for refrigerated counter 700mm		
spare parts for	690722		
	GEV No.	690750	Ref. No.
	stop for telescopic rail L 20mm plastic H 12mm D 9mm		

rollers

rollers

1 			
GEV No.	690466	Ref. No.	01000600R
description	roller rollerø 25mm B1 6mm overall width 10mm A 25mm B 6mm C 10mm D 6mm E 10mm plastic bearing ball bearing		

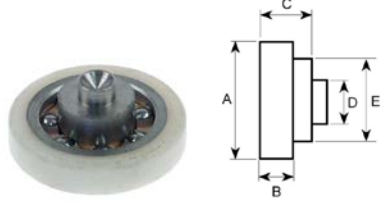
1 			
GEV No.	690467	Ref. No.	01000801R 010412-00
description	roller rollerø 28mm B1 6mm overall width 14mm A 28mm B 6mm C 9.5mm D 5.8mm E 12mm plastic bearing ball bearing		

roller with holder

1 			
GEV No.	690955	Ref. No.	2330706
description	roller rollerø 28mm B1 6mm with holder SS/Nylon mounting pos. upper bearing slide bearing Qty 1 pcs H 5mm L 62mm mounting distance 25/45mm		

outlet taps

producer-specific

miscellaneous

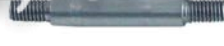
1 			
GEV No.	540862	Ref. No.	RTCU600422
description	lever for outlet tap thread M6 ET - M6 ET		
For models:	ME046-03-003, ME046-03-004, ME066-03-006, ME066-03-007, MG046-03-003, MG046-03-004, MG066-03-006, MG066-03-007		

1 			
GEV No.	540864	Ref. No.	RTCU700412
description	lever for outlet tap thread M6 ET - M6 ET		
For models:	ME066-03-008, MG066-03-008		

lid hinges

ELECTROLUX

1 			
GEV No.	700395	Ref. No.	RTBF800080
description	lid hinge		
For models:	MG099-03-012, MG099-03-012M, MG099-13-012I, MG099-13-012IM		

inlet taps

1 			
GEV No.	514048	Ref. No.	RTCU600075
description	ball valve connection 1/2" complete total length 55mm mounting pos. any brass H 30mm L 55mm rosette ø 70mm rosette thread G2 M22x1		
For models:	ME066-03-008, MG066-03-008		
spare parts for	514048		
	GEV No.	540871	Ref. No.
	lever handle cold water suitable for intake tap		

filters

device filters

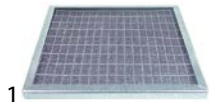

GEV No.	970666	Ref. No.	013524-00-R
description	air filter L 265mm W 252mm H 12mm metal for condenser		

equipment feet and end caps

screw-in feet



GEV No.	513284	Ref. No.	461019
description	equipment foot thread M8 thread L 20mm ø 30mm H 12mm Qty 1 pcs		
For models:	D500LS, D501LS		

shelves and shelf rails

grates

universal

without upstand



GEV No.	970125	Ref. No.	OA000-00-023
description	grate W 325mm D 530mm GN 1/1 plastic-coated steel crossing wires 1 white suitable for refrigerator		
accessories for	970125		
	GEV No.	690330	Ref. No. —
	rack L 1000mm W 22mm H 4mm aperture 3x8mm hole distance 12.5mm stainless steel		
	GEV No.	694700	Ref. No. —
	shelf support L 31/28mm W 22mm H 18mm SS Qty 12 pcs		
	GEV No.	694701	Ref. No. —
	shelf support L 31/28mm W 22mm H 17mm SS with hook Qty 12 pcs		

Зип Общепит

vsezip.ru

+7(812)987-08-81

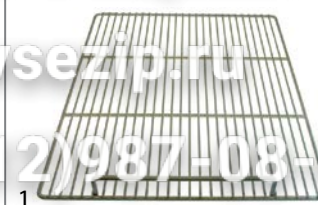

GEV No.	970557	Ref. No.	OA000-00-021
description	grate W 555mm D 670mm plastic-coated steel with hinge camp crossing wires 2 suitable for refrigerator		
accessories for	970557		
	GEV No.	690330	Ref. No. —
	rack L 1000mm W 22mm H 4mm aperture 3x8mm hole distance 12.5mm stainless steel		
	GEV No.	694700	Ref. No. —
	shelf support L 31/28mm W 22mm H 18mm SS Qty 12 pcs		
	GEV No.	694701	Ref. No. —
	shelf support L 31/28mm W 22mm H 17mm SS with hook Qty 12 pcs		

shelf rails and supports

producer-specific



GEV No.	692243	Ref. No.	010912-02
description	guide L 580mm W 16mm high 19mm mounting measurements 552mm mounting pos. left		



GEV No.	692244	Ref. No.	010911-02
description	guide L 580mm W 16mm inner high 19mm mounting measurements 552mm mounting pos. right		



GEV No.	690734	Ref. No.	OA00000800
description	pair of setting bar L-shape L 780mm W 40mm H 24mm		



Зип Общепит

vsezip.ru

+7(812)987-08-81



1			
GEV No.	695088	Ref. No.	OA000-SK-033
description	pair of setting bar U-shape L 570mm W 19mm inner height 20mm suitable for new Skin-Series		

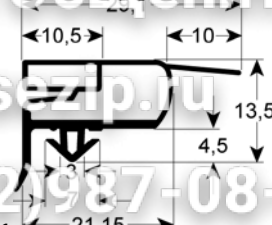

GEV No.	900334	Ref. No.	01153700R RIC0002904
description	refrigeration gasket profile 9773 W 690mm L 745mm external size W1 677mm L1 732mm plug size		

gaskets

refrigeration gaskets

miscellaneous



1			
GEV No.	900613	Ref. No.	01783000R
description	bottom gasket L 780mm		



1			
GEV No.	900365	Ref. No.	01746900R
description	bottom gasket L 810mm		

plug-in gaskets

profile 9773

We offer custom-made gaskets for this profile

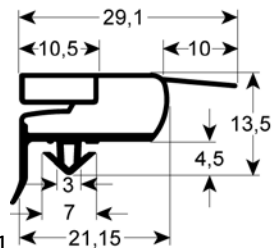

GEV No.	900603	Ref. No.	011536-00Gu
description	refrigeration gasket profile 9773 W 675mm L 740mm plug size		

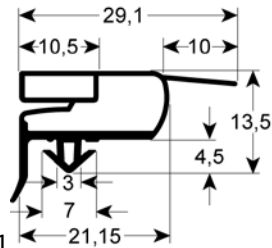

GEV No.	900335	Ref. No.	011535-00 01153500R RIC0002903
description	refrigeration gasket profile 9773 W 690mm L 1550mm external size W1 677mm L1 1537mm plug size		

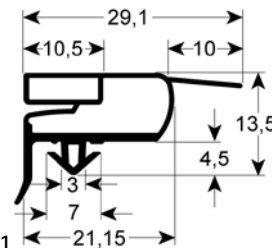

GEV No.	902305	Ref. No.	N/A
description	refrigeration gasket profile 9773 Wmm L 2500mm		

profile 9704

We offer custom-made gaskets for this profile

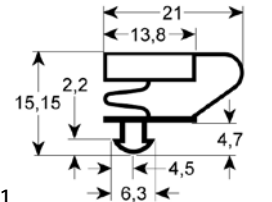

GEV No.	902299	Ref. No.	N/A
description	refrigeration gasket profile 9704 Wmm L 2500mm		

profile 9333

We offer custom-made gaskets for this profile

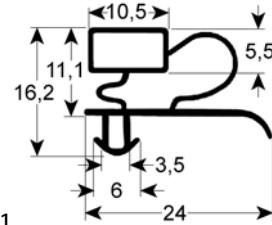

GEV No.	900343	Ref. No.	01746400R
description	refrigeration gasket profile 9333 W 687mm L 1554mm plug size glass door refrigeration		

Зип Общепит

vsezip.ru

+7(812)987-08-81

profile 9990

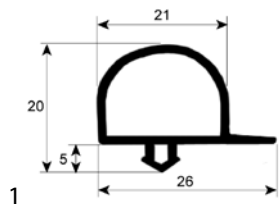

GEV No.	900364	Ref. No.	01746800R
description	refrigeration gasket profile 9990 W 695mm L 1825mm external size short side open		

screw-in gaskets

profile 9663

We offer custom-made gaskets for this profile

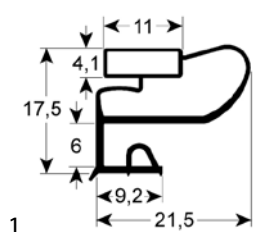

GEV No.	901981	Ref. No.	01710300R
description	refrigeration gasket profile 9663 W 182mm L 424mm external size		

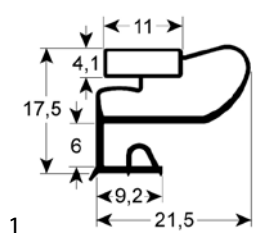

GEV No.	902177	Ref. No.	01710900R
description	refrigeration gasket profile 9663 W 182mm L 629mm external size		

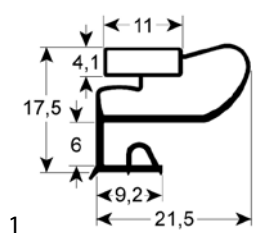

GEV No.	902169	Ref. No.	01236500R 012365-01R
description	refrigeration gasket profile 9663 W 185mm L 390mm external size		

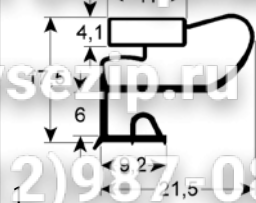

GEV No.	902178	Ref. No.	01711000R
description	refrigeration gasket profile 9663 W 198mm L 629mm external size		

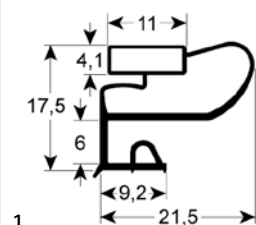

GEV No.	902171	Ref. No.	012361-00 01236100R
description	refrigeration gasket profile 9663 W 205mm L 390mm external size		

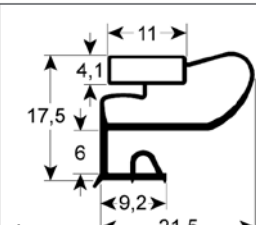

GEV No.	902180	Ref. No.	01346400R
description	refrigeration gasket profile 9663 W 250mm L 420mm external size		

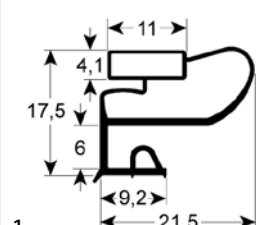

GEV No.	901980	Ref. No.	017102-00 01710200R 025698-00R
description	refrigeration gasket profile 9663 W 302mm L 424mm external size		

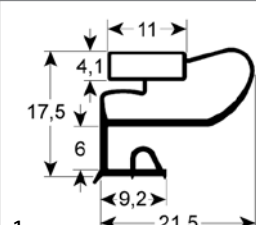

GEV No.	902176	Ref. No.	01710800R 107108-01
description	refrigeration gasket profile 9663 W 302mm L 629mm external size		



Зип Общепит

vsezip.ru

+7(812)987-08-81

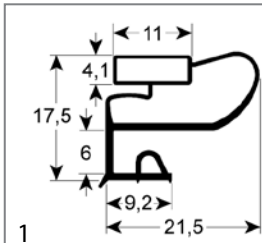

GEV No.	902170	Ref. No.	01236300R 025696-00 025696-00R
description	refrigeration gasket profile 9663 W 310mm L 390mm external size white		

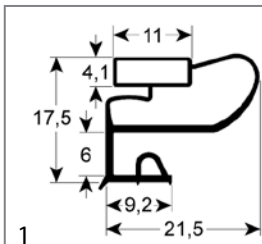

GEV No.	902172	Ref. No.	012362-00 01236200R
description	refrigeration gasket profile 9663 W 390mm L 435mm external size		

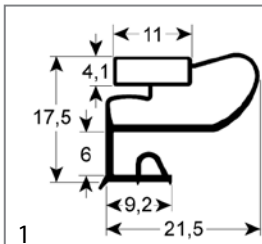

GEV No.	902173	Ref. No.	012364-00 01236400R 025695-00R
description	refrigeration gasket profile 9663 W 390mm L 645mm external size white		

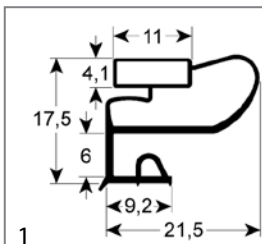

GEV No.	902174	Ref. No.	017105-00 01710500R
description	refrigeration gasket profile 9663 W 420mm L 420mm external size		



GEV No.	901893	Ref. No.	01288900R
description	refrigeration gasket profile 9663 W 422mm L 538mm external size		

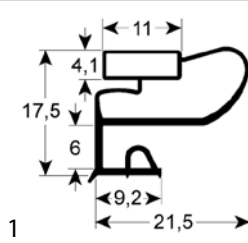

GEV No.	901879	Ref. No.	017104-00 01710400R
description	refrigeration gasket profile 9663 W 424mm L 198mm external size		

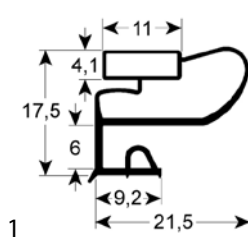

GEV No.	901979	Ref. No.	017101-00 017101-00R
description	refrigeration gasket profile 9663 W 424mm L 630mm external size		

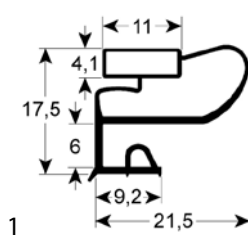

GEV No.	902179	Ref. No.	01710600R
description	refrigeration gasket profile 9663 W 499mm L 630mm external size		

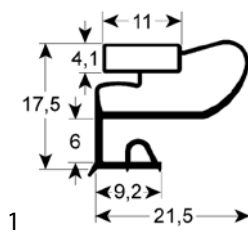

GEV No.	902168	Ref. No.	01288801R
description	refrigeration gasket profile 9663 W 535mm L 675mm external size size 2/1		

Зип.Общепит

vsezip.ru

+7(812)987-0881

GEV No.	902175	Ref. No.	01710700R
description	refrigeration gasket profile 9663 W 629mm L 630mm external size		

door seal with fixing hook

GEV No.	900231 ¹	Ref. No.	9686375000
description	door seal L 590mm W 300mm 3-sided long side open with mounting clip		
For models:	ME103-03-013XL, ME106-03-010XL, MG106-03-010, MG106-03-010XL		

3-sided, long side open

profile 9030
We offer custom-made gaskets for this profile

GEV No.	901273	Ref. No.	025699-00R
description	refrigeration gasket profile 9030 W 422mm L 540mm external size		

door gaskets (wire reinforced)

GEV No.	900300	Ref. No.	9686374100 RIC0002678
description	oven gasket wire reinforced L 430mm W 265mm		
For models:	ME066-03-010, ME066-03-013, ME106-03-013, MG066-03-010		

GEV No.	901948	Ref. No.	02569700R
description	refrigeration gasket profile 9030 W 424mm L 630mm external size		

GEV No.	900280	Ref. No.	9686374200
description	oven gasket wire reinforced L 575mm W 265mm		
For models:	ME103-03-013XL, ME106-03-010XL, MG106-03-010, MG106-03-010XL		

GEV No.	901010	Ref. No.	014052
description	refrigeration gasket profile 9030 W 598mm L 635mm external size		

O-rings

EPDM

GEV No.	528485	Ref. No.	456060
description	O-ring EPDM thickness 1.78mm ID ø 6.07mm Qty 1 pcs		
For models:	D500LS, D501LS		

gaskets for heated units

door seals

GEV No.	900251	Ref. No.	9686373100 RIC0002340
description	door seal profile 2920 L 1410mm Qty 1		
For models:	ME066-03-010, ME066-03-013, ME106-03-013, MG066-03-010		

GEV No.	510303	Ref. No.	456030
description	O-ring EPDM thickness 1.78mm ID ø 6.75mm Qty 1 pcs		
For models:	D500LS, D501LS		

Зип Общежит
Sealing washers

fibre gaskets
vsezip.ru

+7(812)987-08-81

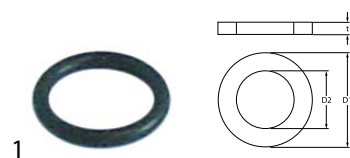

1

GEV No.	504574	Ref. No.	456019
description	O-ring EPDM thickness 1.78mm ID ø 9.25mm Qty 1 pcs		
For models:	D500LS, D501LS		

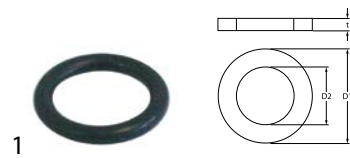

1

GEV No.	518227	Ref. No.	456020
description	O-ring EPDM thickness 2.62mm ID ø 12.37mm Qty 1 pcs		
For models:	D500LS, D501LS		

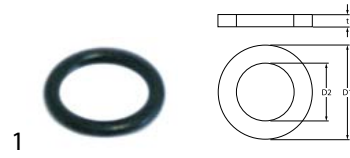

1

GEV No.	510893	Ref. No.	456015
description	O-ring EPDM thickness 2.62mm ID ø 9.92mm Qty 1 pcs		
For models:	D500LS, D501LS		

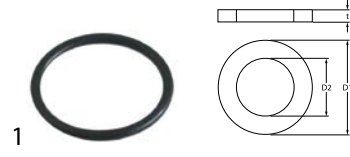

1

GEV No.	506015	Ref. No.	456052
description	O-ring EPDM thickness 3.53mm ID ø 39.69mm Qty 1 pcs		
For models:	D500LS, D501LS		

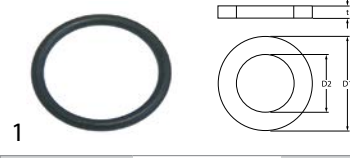

1

GEV No.	510408	Ref. No.	456002 REB456002
description	O-ring EPDM thickness 5.34mm ID ø 47mm Qty 1 pcs		
For models:	D500LS, D501LS, LB03100000, LB03300000, LP05500010		

Viton

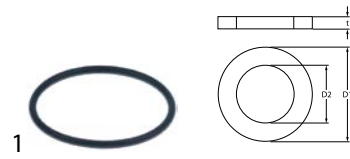

1

GEV No.	510243	Ref. No.	RTCU700565
description	O-ring Viton thickness 3.53mm ID ø 55.56mm Qty 1 pcs		
For models:	ME046-03-004, ME066-03-007		



1

GEV No.	518541	Ref. No.	REB437021
description	flat gasket FIBER ED ø 12mm ID ø 8mm thickness 1.5mm Qty 1 pcs		
For models:	LP05500010		



1

GEV No.	529349	Ref. No.	437030
description	flat gasket FIBER ED ø 22mm ID ø 16.5mm thickness 2mm for thread 3/8" Qty 1 pcs		
For models:	D500LS, D501LS		

rubber gaskets



1

GEV No.	519547	Ref. No.	437041
description	flat gasket rubber ED ø 14.4mm ID ø 15.5mm thickness 2mm Qty 1 pcs size 3/4"		
For models:	D500LS, D501LS		



1

GEV No.	510075	Ref. No.	437019
description	flat gasket rubber ED ø 22mm ID ø 13mm thickness 1.5mm Qty 1 pcs		
For models:	D500LS, D501LS		



1

GEV No.	513059	Ref. No.	437063
description	flat gasket rubber ED ø 52mm ID ø 40mm thickness 3mm Qty 1 pcs		
For models:	D500LS, D501LS		



1

GEV No.	510071	Ref. No.	437034
description	flat gasket rubber ED ø 81mm ID ø 68mm thickness 3mm for salt tank Qty 1 pcs		
For models:	D500LS, D501LS		

Зип.Общепит
refrigeration cycle components

valves
expansion Valves

DANFOSS
valves
+7(812)987-08-81

PTFE gaskets



GEV No.	513725	Ref. No.	437100
description	flat gasket PTFE ED ø 21.2mm ID ø 19mm thickness 0.5mm Qty 1 pcs		
For models:	D500LS, D501LS		

special gaskets

door seals for dishwashers

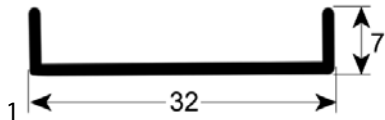

GEV No.	518536	Ref. No.	437081
description	door seal L 590mm W 32mm dishwasher suitable for ELETTROBAR, WOLK equiv. no. 437052		
For models:	D500LS, D501LS		

gaskets for wash arm support



GEV No.	518025	Ref. No.	437014
description	gasket D1 ø 50mm D2 ø 82mm thickness 2mm with 6 holes wash arm support equiv. no. 437014 suitable for COLGED		
For models:	D500LS, D501LS		



GEV No.	518339	Ref. No.	437064
description	gasket D2 ø 50mm thickness 2mm with 3 screw holes wash arm support equiv. no. 437064 suitable for COLGED hole ø 50mm hole distance 67mm		
For models:	D500LS, D501LS		

type TN2/TEN2



GEV No.	750012	Ref. No.	01460700R
description	expansion valve DANFOSS type TN2 coolant R134a angled 90° thermostatically controlled inlet 3/8" SAE outlet 1/2" SAE p max 34bar -40 up to +10°C capillary pipe 1500mm		

accessories for	750012			
	GEV No.	750020	Ref. No.	—
	nozzle insert size 0X type 068-2002 T/TE 2 DANFOSS			
	GEV No.	750021	Ref. No.	01348500R
	nozzle insert size 00 type 068-2003 T/TE 2 DANFOSS			
	GEV No.	750022	Ref. No.	—
	nozzle insert size 01 type 068-2010 T/TE 2 DANFOSS			
	GEV No.	750023	Ref. No.	—
	nozzle insert size 02 type 068-2015 T/TE 2 DANFOSS			
	GEV No.	750024	Ref. No.	—
	nozzle insert size 03 type 068-2006 T/TE 2 DANFOSS			
	GEV No.	750483	Ref. No.	—
	nozzle insert size 04 type 068-2007 T2/TE2 DANFOSS			
	GEV No.	750484	Ref. No.	—
	nozzle insert size 05 type 068-2008 T2/TE2 DANFOSS			
	GEV No.	750485	Ref. No.	—
	nozzle insert size 06 type 068-2009 T2/TE2 DANFOSS			



Зип Общепит

vsezip.ru

+7(812)987-08-81

type TS2/TE2			
1			
GEV No.	750014	Ref. No.	01859700R
description	expansion valve DANFOSS type TS2 coolant R404a/R507 angled 90° thermostatically controlled inlet 3/8" SAE outlet 1/2" SAE p max 34bar -40 up to +10°C capillary pipe 1500mm		
accessories for	750014		
	GEV No.	750020	Ref. No. —
	nozzle insert size 0X type 068-2002 T/TE 2 DANFOSS		
	GEV No.	750021	Ref. No. 01348500R
	nozzle insert size 00 type 068-2003 T/TE 2 DANFOSS		
	GEV No.	750022	Ref. No. —
	nozzle insert size 01 type 068-2010 T/TE 2 DANFOSS		
	GEV No.	750023	Ref. No. —
	nozzle insert size 02 type 068-2015 T/TE 2 DANFOSS		
	GEV No.	750024	Ref. No. —
	nozzle insert size 03 type 068-2006 T/TE 2 DANFOSS		
	GEV No.	750483	Ref. No. —
	nozzle insert size 04 type 068-2007 T2/TE2 DANFOSS		
	GEV No.	750484	Ref. No. —
	nozzle insert size 05 type 068-2008 T2/TE2 DANFOSS		
	GEV No.	750485	Ref. No. —
	nozzle insert size 06 type 068-2009 T2/TE2 DANFOSS		

type TX2/TEX2			
1			
GEV No.	750010	Ref. No.	01352700R
description	expansion valve DANFOSS type TX2 coolant R22/R407c angled 90° thermostatically controlled inlet 3/8" SAE outlet 1/2" SAE p max 34bar -40 up to +10°C capillary pipe 1500mm		

nozzle inserts			
1			
GEV No.	750021	Ref. No.	01348500R
description	nozzle insert size 00 type 068-2003 T/TE 2 DANFOSS		

evaporators

for fridges

producer-specific

1			
GEV No.	750123	Ref. No.	01264502R 01564501R 01564602R 02316700
description	evaporator L 380mm W 110mm H 150mm total length 400mm aluminium		

1			
GEV No.	750283	Ref. No.	FEQ321201Y Q32-1201Y
description	evaporator L 390mm W 315mm H 315mm H2 210mm		

1			
GEV No.	750124	Ref. No.	01152800R 02054001 020540-01R
description	evaporator L 420mm W 390mm H 35mm total length 470mm overall width 450mm overall height 40mm		

Зип-Общепит

vsezip.ru

7(812)987-08-81

1 

GEV No.	750120	Ref. No.	01152900R 01152901R 01152902R
description	evaporator L 455mm W 100mm H 150mm total length 490mm overall height 230mm mounting distance 1 435mm mounting distance 2 80mm		

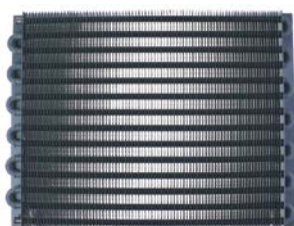
2 

GEV No.	750126	Ref. No.	01314500R
description	evaporator L 465mm W 360mm H 25mm		

1 

GEV No.	750121	Ref. No.	01153000R
description	evaporator L 610mm W 100mm H 150mm		

1 

GEV No.	693637	Ref. No.	RTCU700504
description	flange bearing type UCF204 shaft \varnothing 20mm W 60mm 2 hole flange hole distance 90mm H 34mm L 114mm		

drive belts

V-belts

profile Z/10

1 

GEV No.	693400	Ref. No.	RTBF900125
description	V-belt belt width 10mm L 915mm H 6mm CODE Z36 profile Z/10		
For models:	MG099-03-012, MG099-13-012I		

springs

torsion springs

1 

GEV No.	690371	Ref. No.	01157200R
description	torsion spring \varnothing 16.5mm wire gauge \varnothing 2.6mm L1 32mm L2 101mm L3 13mm mounting pos. left		

1 

GEV No.	690370	Ref. No.	01157300R
description	torsion spring \varnothing 16.5mm wire gauge \varnothing 2.6mm L1 35mm L2 101mm L3 16mm mounting pos. right		

1 

GEV No.	693627	Ref. No.	RTBF800103
description	torsion spring \varnothing 38.8mm wire gauge \varnothing 7.2mm L1 33mm L2 280mm L3 20mm		
For models:	MG099-03-012, MG099-03-012M, MG099-13-012I, MG099-13-012IM		

compression springs

1 

GEV No.	690372	Ref. No.	01157400R
description	compression spring \varnothing 20.6mm L 135mm wire gauge \varnothing 2.9mm		

transmission technology and ball bearings

ball bearings

deep-groove ball bearings 2RS

1 

GEV No.	523509	Ref. No.	314001
description	deep-groove ball bearing type 6201-2RS shaft \varnothing 12mm ED \varnothing 32mm W 10mm with sealing discs deep-groove ball bearing DIN 625-1		
For models:	D500LS, D501LS		



dosing pumps

peristaltic dosing pumps

SEKO

built-in version

with frequency control



1

GEV No.	361767 ¹	Ref. No.	209021
description	dosing pump SEKO 3l/h 230VAC detergent hose ø 4x6mm hose type K hose Santoprene suction level 1.5m type NBR 3 8W built-in version peristaltic pump		
For models:	D500LS, D501LS		
spare parts for	361767		
	GEV No.	Ref. No.	—
	361815		
	pump hose detergent hose ø 6x10mm hose ø 4x6mm hose type K hose Santoprene type SEKO		

¹incl. inlet and conveyor hose

spare parts



1

GEV No.	698712	Ref. No.	143219
description	dosing hose SEKO detergent hose ø 4x8.6mm hose ø 4x6mm hose type H hose Santoprene		
For models:	D500LS, D501LS		

membrane dosing pumps



self-priming

LANG

accessories



1

GEV No.	101286	Ref. No.	RTCU900018
description	olive ID ø 6mm Qty 1 pcs		
For models:	MG077-03-003, MG077-03-004, MG077-03-005, MG077-13-003, MG077-13-004, MG077-13-005, MG117-03-110XL		
accessories for	101286		
	GEV No.	Ref. No.	
	100909		RTCP800038 RTCU900019
	union screw thread M10x1 for pipe ø 6mm Qty 1 pcs		
	GEV No.	Ref. No.	—
	101464		
	union nut thread M12x1 for pipe ø 6mm		

Зип-Общепит

vsezip.ru

+7(812)987-08-81



1

GEV No.	361364 ¹	Ref. No.	209025
description	dosing pump type DIB5E self-sucking rinse aid pump rate 0-5cm ³ per stroke pressure connection ø 4x6mm suction connection ø 4x6mm SEKO supporting pressure closed		
For models:	D500LS, D501LS		
spare parts for	361364		
	GEV No.	Ref. No.	—
	361301		
	hose connector for type DIB3E/DIB5E		
	GEV No.	Ref. No.	—
	361302		
	valve bush for type DIB3E/DIB5E		
	GEV No.	Ref. No.	—
	361304		
	O-ring EPDM ID ø 11.11mm thickness 1.78mm Qty 1 pcs for type DIB3E/DIB5E		
	GEV No.	Ref. No.	—
	361305		
	valve disc for type DIB3E/DIB5E DIB3P/DIB5P		
	GEV No.	Ref. No.	—
	361306		
	membrane for type DIB3E/DIB5E ø 49mm hole ø 5mm		
	GEV No.	Ref. No.	—
	361307		
	membrane dosing pump ø 68mm hole ø 6mm for type DIB3P/DIB5P		
	GEV No.	Ref. No.	—
	361459		
	hose connector ø 6mm for dosing pump		
	GEV No.	Ref. No.	—
	361481		
	lip valve for type DIB3P/DIB5P DIB3E/DIB5E		
accessories for	361364		
	GEV No.	Ref. No.	—
	361240		
	hose connector 1-way hose ø 6mm plastic connection M10x1		
	GEV No.	Ref. No.	—
	361241		
	hose connector 1-way hose ø 9mm plastic connection M10x1		

¹auxiliary pressure connection closed

water and beverage technology

accessories

container filters



1	GEV No.	513043	Ref. No.	121017
	description	container filter hose ø 4mm		
	For models:	D500LS, D501LS		



1	GEV No.	361141	Ref. No.	121075
	description	container filter with weight ceramic hose ø 4mm		
	For models:	D500LS, D501LS		



1	GEV No.	361462	Ref. No.	121993
	description	container filter with weight SS hose ø 4x6mm		
	For models:	D500LS, D501LS		

hoses

PVC hoses



1	GEV No.	520090	Ref. No.	143194
	description	PVC hose ID ø 4mm ED ø 6mm L 2m thickness 1mm t.max. 60°C transparent		
	For models:	D500LS, D501LS		

accessories for 520090

	GEV No.	361058	Ref. No.	—
	description	container filter with non-return valve SS hose ø 4x6mm ø 20mm L 56mm		

	GEV No.	361066	Ref. No.	—
	description	container filter straight SS hose ø 4x6mm L 37mm non return valve ball valve		

	GEV No.	361106	Ref. No.	—
	description	container filter with weight and non-return valve SS hose ø 4x6mm ø 21mm L 51mm non return valve lip valve		

	GEV No.	361141	Ref. No.	121075
	description	container filter with weight ceramic hose ø 4mm		

	GEV No.	361230	Ref. No.	—
	description	container filter with weight stainless steel hose ø 4x6mm		

	GEV No.	361462	Ref. No.	121993
	description	container filter with weight SS hose ø 4x6mm		

	GEV No.	361728	Ref. No.	—
	description	container filter with 4m 4x6 hose SS hose ø 4x6mm hose length 4.00m		

tank inlets



1	GEV No.	361270	Ref. No.	468151
	description	tank inlet SS M12 hose ø 4mm		
	For models:	D500LS, D501LS		

hoses

supply hoses

PVC supply hoses



1	GEV No.	520011	Ref. No.	929169
	description	supply hose PVC straight-curved DN13 connections 3/4" L 2000mm operating p. 10bar burst p. 32bar t.max. 90°C approval VDE flat seal		
	For models:	D500LS, D501LS		

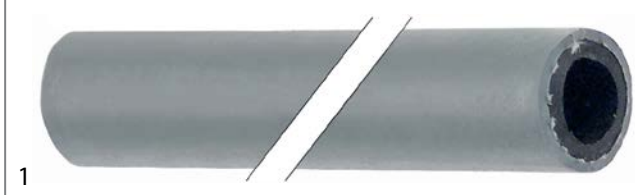

1	GEV No.	520015	Ref. No.	143004
	description	supply hose ID ø 10mm ED ø 17mm L 5m operating p. 20bar burst p. 60bar t.max. 95°C grey Qty 5m		
	For models:	D500LS, D501LS		

accessories for 520015

	GEV No.	504377	Ref. No.	—
	description	hose connector grommet ø 23mm grommet length 25mm total length 55mm for water filling		

drain hoses



1	GEV No.	513258	Ref. No.	127044
	description	drain hose DN19 L 270mm A int. ø 22mm A ext. ø 28mm B int. ø 24mm B ext. ø 28mm outer hose ø 22mm		
	For models:	D500LS, D501LS		



Зип Общепит

vsezip.ru

7(812)98708-81



1

GEV No.	518219	Ref. No.	127037
description	drain hose DN19 L 630mm A int. ø 20mm A ext. ø 27mm B int. ø 21mm B ext. ø 28mm outer hose ø 24mm		
For models:	D500LS, D501LS		

industrial hoses

pressure control hoses



1

GEV No.	530560	Ref. No.	143005
description	pressure control hose ID ø 5mm ED ø 9mm L 5m operating p. 30bar burst p. 90bar temp.-resist. 60°C		
For models:	D500LS, D501LS		

PVC hoses

PVC hoses without fabric









1

GEV No.	520383	Ref. No.	H.775601
description	PVC hose ID ø 4mm ED ø 6mm L 2m thickness 1mm t.max. 60°C blue		
For models:	D500LS, D501LS		
accessories for	520383		
	GEV No.	361058	Ref. No. —
	container filter with non-return valve SS hose ø 4x6mm ø 20mm L 56mm		
	GEV No.	361066	Ref. No. —
	container filter straight SS hose ø 4x6mm L 37mm non return valve ball valve		
	GEV No.	361106	Ref. No. —
	container filter with weight and non-return valve SS hose ø 4x6mm ø 21mm L 51mm non return valve lip valve		
	GEV No.	361141	Ref. No. 121075
	container filter with weight ceramic hose ø 4mm		
	GEV No.	361230	Ref. No. —
	container filter with weight stainless steel hose ø 4x6mm		
	GEV No.	361462	Ref. No. 121993
	container filter with weight SS hose ø 4x6mm		
	GEV No.	361728	Ref. No. —
	container filter with 4m 4x6 hose SS hose ø 4x6mm hose length 4000mm		



1

GEV No.	520090	Ref. No.	143194
description	PVC hose ID ø 4mm ED ø 6mm L 2m thickness 1mm t.max. 60°C transparent		
For models:	D500LS, D501LS		
accessories for	520090		
	GEV No.	361058	Ref. No. —
	container filter with non-return valve SS hose ø 4x6mm ø 20mm L 56mm		
	GEV No.	361066	Ref. No. —
	container filter straight SS hose ø 4x6mm L 37mm non return valve ball valve		
	GEV No.	361106	Ref. No. —
	container filter with weight and non-return valve SS hose ø 4x6mm ø 21mm L 51mm non return valve lip valve		
	GEV No.	361141	Ref. No. 121075
	container filter with weight ceramic hose ø 4mm		
	GEV No.	361230	Ref. No. —
	container filter with weight stainless steel hose ø 4x6mm		
	GEV No.	361462	Ref. No. 121993
	container filter with weight SS hose ø 4x6mm		
	GEV No.	361728	Ref. No. —
	container filter with 4m 4x6 hose SS hose ø 4x6mm hose length 4000mm		



1

GEV No.	520027	Ref. No.	143013
description	PVC hose ID ø 4mm ED ø 7mm L 10m thickness 1.5mm t.max. 60°C transparent		
For models:	D500LS, D501LS		

formed hoses

straight



1

GEV No.	518070	Ref. No.	127026
description	formed hose dishwasher straight mounting pos. upper equiv. no. 127026		
For models:	D500LS, D501LS		

Зип.Общепит
fittings, hose and pipe connectors

hose connectors

without screw connection

+7(812)987-08-81
vsezip.ru



1

GEV No.	541109	Ref. No.	035031
description	Y-piece plastic hose ø 8-6-8mm for pressure switch		
For models:	D500LS, D501LS		

hose connectors

brass



1

GEV No.	513253	Ref. No.	DZR2915
description	hose connector brass angled thread 1/4" hose ø 12mm Qty 1 pcs		
For models:	LB03100000, LB03300000, LP05500010		

valves and tank inlets

ball valves

universal

ball valves with lever handle



1

GEV No.	514325	Ref. No.	RTBF800073
description	ball valve connection 1" IT - 1" IT DN25 total length 83mm with lever handle		
For models:	LX7EC4		



1

GEV No.	518380	Ref. No.	127036
description	formed hose ext. ø 53 ID ø 43mm L 65mm dishwasher straight mounting pos. upper equiv. no. 127036		
For models:	D500LS, D501LS		

form L



1

GEV No.	518225	Ref. No.	127041
description	formed hose warewashing L-shape equiv. no. 127041		
For models:	D500LS, D501LS		

form U



1

GEV No.	518517	Ref. No.	127050
description	formed hose for drain pump D1 ø 28mm D2 ø 21mm warewashing U-shape		
For models:	D500LS, D501LS		

for dishwashers

ventilation hoses



1

GEV No.	513265	Ref. No.	143189
description	ventilation hose ext. ø 17 ID ø 14mm L 75mm warewashing back-flow restrictor		
For models:	D500LS, D501LS		



3ип.Общепит. measuring equipment

vsezip.ru

+7(812)987-08-81

shut-off valves

accessories



1			
GEV No.	540866	Ref. No.	RTCU900491
description	rosette		
For models:	ME066-03-008, MG066-03-008		

inlet taps



1			
GEV No.	542006	Ref. No.	RTBF800041
description	inlet spout connection 3/8" ET tube ø 16mm H1 90mm H2 40mm L 80mm pipe connection ø 10mm 1/2" ET		
For models:	MG099-03-012, MG099-03-012M, MG099-13-012I, MG099-13-012IM		

ancillary products

clamps

double wire clamps



1			
GEV No.	513268	Ref. No.	423011
description	hose clamp ø 8-10mm wire gauge ø 1mm Qty 1 pcs		
For models:	D500LS, D501LS		

pipes

miscellaneous



1			
GEV No.	693827	Ref. No.	PABF800292
description	water pipe		
For models:	MG099-03-012, MG099-03-012M, MG099-13-012I, MG099-13-012IM		

thermometers

built-in thermometers

ø52mm



1			
GEV No.	541413	Ref. No.	RIC0003065
description	thermometer mounting ø 52mm t.max. 120°C 0 up to +120°C probe ø 6mm probe L 36mm capillary pipe 1500mm		

fastening material

screws

knurled screws



1			
GEV No.	510112	Ref. No.	454002
description	Thumb screw thread M10 thread L 10mm ø 22mm H 4.5mm SS		
For models:	D500LS, D501LS		

nuts

knurled nuts



1			
GEV No.	517444	Ref. No.	80697
description	knurled nut thread M10x1 ø 25mm H 4mm SS		
For models:	D500LS, D501LS		

hexagonal nuts

hexagonal nuts metric (without norm)



1			
GEV No.	521134	Ref. No.	417017
description	hexagonal nut thread M14x1 SS		
For models:	D500LS, D501LS		

Зип-Общепит

DIN 7993

vsezip.ru

+7(812)987-08-81



1

GEV No.	105567	Ref. No.	RTCU900005
description	nut thread M16x1 H 4.5mm WS 19 zinc-coated steel Qty 1 pcs		
For models:	MG046-03-004, MG066-03-007, MG066-03-008, MG077-03-003, MG077-03-004, MG077-03-005, MG077-13-003, MG077-13-004, MG077-13-005		



1

GEV No.	102680	Ref. No.	RTCU600052
description	nut thread M6x0.75 H 2.6mm WS 8 brass Qty 1 pcs type SEF 2		
For models:	ME066-03-010, ME106-03-010XL, MG066-03-010, MG106-03-010, MG106-03-010XL		



1

GEV No.	102067	Ref. No.	9404701700
description	nut thread M8x1 H 3mm brass Qty 1 pcs type SEF 1		
For models:	MG066-03-010, MG106-03-010, MG106-03-010XL		

fasteners

clamps

double wire clamps



1

GEV No.	513268	Ref. No.	423011
description	hose clamp ø 8-10mm wire gauge ø 1mm Qty 1 pcs		
For models:	D500LS, D501LS		

retaining rings

DIN 471



1

GEV No.	510244	Ref. No.	RTMIN00283
description	retaining ring shaft ø 60mm thickness 2mm steel DIN 471		
For models:	ME046-03-004, ME066-03-007		

1

GEV No.	518308	Ref. No.	303019
description	retaining ring Din 7993 for drain assembly thickness 3mm ED ø 57mm		
For models:	D500LS, D501LS		

consumables

lava rocks / ceramic briquetts



1

GEV No.	211001	Ref. No.	A800001170
description	lava rocks Qty package content 9kg		
For models:	MG086-13-014P		

fuses

fine fuses



1

GEV No.	358677	Ref. No.	228010
description	fine fuse size ø5x20mm 4A fast-acting rated 250V Qty 10 pcs		
For models:	D500LS, D501LS		

Зип Общепит

vsezip.ru

+7(812)987-08-81

A		G	
axial fans	27	gas burners	41
B		gas control valves	35
ball valves	70	gas nozzles	45
bar burners	43	gas taps	32
bi-metal thermostats	9	gas thermostats	33
C		gaskets for heated units	62
cam switches	15	gaskets for wash arm support	64
ceramic heaters	5	grates	58
clamps	71, 72	H	
cold air circulating fans (complete)	28	handle latches	53
compressors	26	heating cables	5
condensators & interference suppression filters	31	heating elements	3
consumables	72	heating elements for bain maries	3
contactors	19	heating elements for condensate evaporation	4
container filters	68	heating elements for convection	6
control equipment	16	heating elements for defrosting	4
control thermostats	9, 11	heating elements for fryers	3
core probes	22	heating elements for frying pans	3
cross flow fans	29	heating elements for griddles	4
D		heating elements for heated cabinets	5
defrost timers	18	heating elements for ovens	3
door gaskets (wire reinforced)	62	heating elements for pasta cookers	5
door seals	62	heating elements for refrigeration	4
door seals for dishwashers	64	hexagonal nuts	71
door seals with fixing hook	62	hob burners	41
dosing pumps	67	hose connectors	70, 70
double wire clamps	71, 72	hoses	68
drain hoses	68	hot air fans	29
drain pumps	31	hot plates	8
E		I	
edgemount hinges	53	ignition cables	38
edgemount latches	53	ignition units	39
electric accessories	32	immersion heating elements	6
electronic controllers	20	indicator lights	16
energy regulators	9	indicator lights (complete)	16
evaporators	65	industrial hoses	69
expansion valves	64	inlet spouts	71
F		inlet taps	71
fans	27	K	
fasteners	72	knurled nuts	71
fastening material	71	knurled screws	71
fine fuses	72	L	
foil heating elements	7	lamps	16
formed hoses	69	lava rocks / ceramic briquetts	47, 72
fuses	31, 72	light bulbs	17

Зип Общепит

vsezip.ru

+7(812)987-08-81

M			
magnetic switches	16	switches and momentary switches	13
measuring equipment	71	system switches (ROLD)	14
microswitches	14		
motors	20	T	
		tank inlets	68
		temperature probes	22
		terminals	32
		thermocouples	39
		thermostats	9
N		time relays	19
nuts	71	timers	18
		transformers	20
		tube burners	44
		U	
		universal probes	22
		V	
		valves and tank inlets	70
		ventilation hoses	70
		W	
O		walk-in fridge catches	53
operating capacitors	31	wash and rinse pumps	30
O-rings	62		
oven hinges	54		
oven lamps	18		
P			
piezoelectric igniters	38		
pilot burners	35		
plug-in gaskets	59		
pressure control hoses	69		
pressure switches	25		
probes	22		
programme timers	18		
pumps	30		
pumps for ice machines	31		
push/momentary push switches	13		
PVC hoses	69		
PVC supply hoses	68		
R			
radiation heaters	7		
refrigeration cycle components	64		
refrigeration fans	28		
refrigeration gaskets	59		
refrigeration motors universal	28		
refrigeration thermostats	12		
relays	19		
retaining rings	72		
rocker/momentary rocker switches	13		
S			
safety bi-metal thermostats	9		
safety thermostats	10		
screw-in gaskets	60		
screws	71		
sealing washers	63		
shelves and shelf rails	58		
shut-off valves	71		
solenoid valves	23		
spring assisted hinges	54		
starting capacitors	31		
supply hoses	68		