



Зип Общепит

vsezip.ru

Spare Parts for

+7(812)987-08781 **Combi Ovens**



Spare parts suitable for

BOURGEOIS

2017

Find the complete and up-to-date range of products in our GEV Webshop



heating elements

immersion heating elements

with compression flange 50 x 26mm

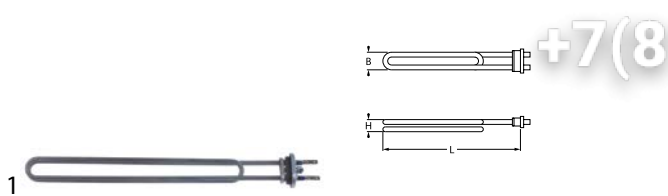

GEV No.	418932	Ref. No.	RC553
description	heating element 2000W 240V heating circuits 1 flange 50x26mm L 350mm W 30mm Hmm compression flange connection male faston 6.3mm tube ø 6.3mm immersion heater		

miscellaneous

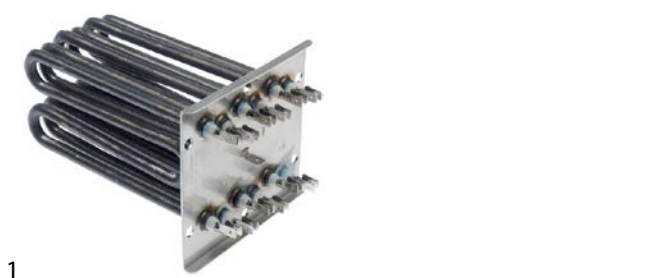

GEV No.	420200	Ref. No.	RC2035
description	heating element 12000W 240V heating circuits 6 L 155mm W 78mm H 83mm tube ø 8.4mm hole distance 61mm hole ø 7mm connection male faston 6.3mm immersion heater flange connection		

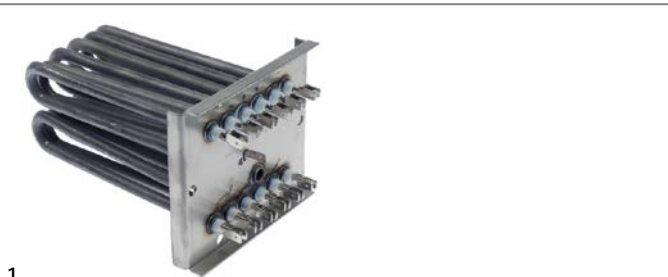

GEV No.	420203	Ref. No.	RC2029
description	heating element 12000W 240V heating circuits 6 L 165mm W 74mm H 83.5mm tube ø 8.4mm hole distance 61mm hole ø 7mm number of thermostat sleeves 1 thermostat sleeves ø 7.4mm length thermostat sleeves 73mm thermostat sleeve eccentric, clinging connection male faston 6.3mm immersion heater flange connection		

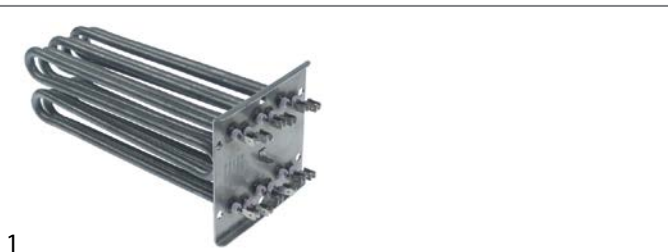

GEV No.	420202	Ref. No.	RC2034
description	heating element 18000W 240V heating circuits 6 L 229mm W 78mm H 83mm tube ø 8.4mm hole distance 61mm hole ø 7mm connection male faston 6.3mm immersion heater flange connection		

Зип Общепит

vsezip.ru

+7(812)987-08-81

GEV No.	420199	Ref. No.	RC2032
description	heating element 18000W 240V heating circuits 6 L 235mm W 78mm H 83mm tube ø 8.4mm hole distance 61mm hole ø 7mm connection male faston 6.3mm immersion heater flange connection		

GEV No.	416502	Ref. No.	RC231 RC802
description	heating element 8000W 240V heating circuits 3 L 305mm W 40mm Hmm number of thermostat sleeves thermostat sleeves ømm length thermostat sleevesmm tube ø 6.3mm hole distance 44.9mm hole ø 10mm connection length 23mm connection male faston 6.3mm 4 hole flange immersion heater flange width 63.5mm flange length 63.5mm ø 40mm		
accessories for	416502		
	GEV No.	505180	Ref. No. JOIN261
	O-ring EPDM thickness 3.53mm ID ø 47.22mm Qty 1 pcs		

GEV No.	420201	Ref. No.	RC2033
description	heating element 9000W 240V heating circuits 6 L 135mm W 78mm H 83.5mm tube ø 8.4mm hole distance 61mm hole ø 7mm connection male faston 6.3mm immersion heater flange connection		

heating elements for convection



GEV No.	418916	Ref. No.	RC018 RC048 RC17
description	heating element 12000W 240V heating circuits 3 ID ø 390mm ED ø 410mm L 410mm H 100mm H1 25mm H2 75mm thread M12x1 6 hole fixing connection male faston 6.3mm tube ø 8.5mm convection heating element		
accessories for	418916		
	GEV No.	101566	Ref. No. —
	nut thread M12x1 H 10mm WS 19 SS Qty 1 pcs		

Table continues overleaf



Зип Общепит
vsezip.ru
+7(812)987-08-81

accessories for	418916		
	GEV No.	506046	Ref. No. —
	flat gasket FIBER ED ø 19.5mm ID ø 13mm thickness 2mm Qty 1 pcs		
	GEV No.	528622	Ref. No. —
	spring ø 15.3mm L 25mm wire gauge ø 1.25mm for water filling		

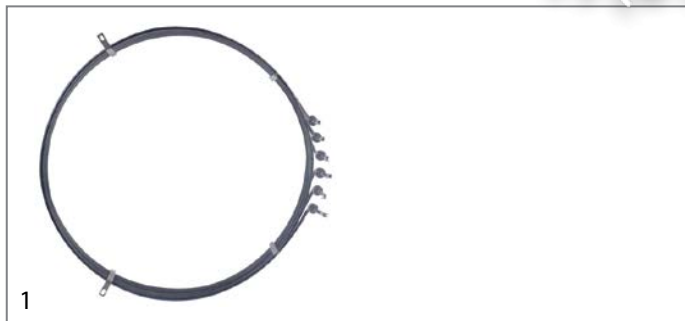

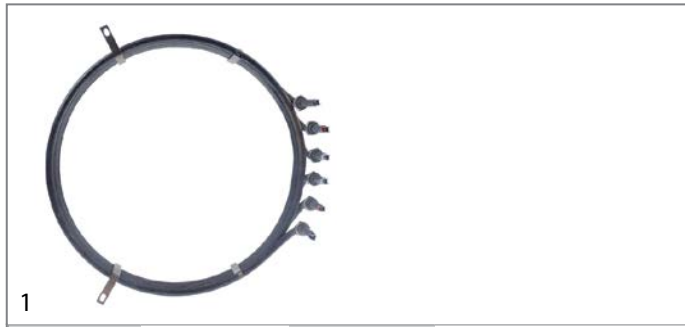

GEV No.	418927	Ref. No.	RC081
description	heating element 12000W 240V heating circuits 3 ID ø 440mm ED ø 458mm L 472mm H 80mm L1 15mm H1 8mm H2 72mm thread M12x1 6 hole fixing connection male faston 6.3mm tube ø 6.3mm convection oven convection heating element		

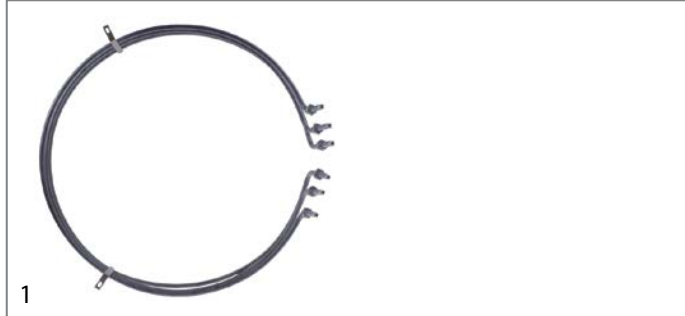

GEV No.	418926	Ref. No.	RC019
description	heating element 8000W 240V heating circuits 3 ID ø 301mm ED ø 317mm L 328mm H 95mm L1 11mm H1 12mm H2 83mm thread M12x1 6 hole fixing connection male faston 6.3mm tube ø 8.5mm convection oven convection heating element		



GEV No.	418928	Ref. No.	RC017 RC18
description	heating element 9000W 240V heating circuits 3 ID ø 458mm ED ø 475mm L 475mm H 114mm H1 31mm H2 73mm thread M12x1 6 hole fixing connection male faston 6.3mm tube ø 8.5mm convection oven convection heating element		

accessories for	418928		
	GEV No.	101566	Ref. No. —
	nut thread M12x1 H 10mm WS 19 SS Qty 1 pcs		
	GEV No.	506046	Ref. No. —
	flat gasket FIBER ED ø 19.5mm ID ø 13mm thickness 2mm Qty 1 pcs		
	GEV No.	528662	Ref. No. —
	flat gasket copper ED ø 16mm ID ø 12mm thickness 1.5mm		



GEV No.	418925	Ref. No.	RC611
description	heating element 1500W 230V heating circuits 1 L 293mm W 106mm L1 32mm L2 261mm W2 83mm flange length 50mm flange width 26mm connection length 63mm connection male faston 6.3mm tube ø 8.5mm hole ø 6.2mm W1 23mm convection heating element convection oven INCOLOY windings 2		

accessories for	418925		
	GEV No.	520588	Ref. No. JOIN071
	gasket L 46mm W 22mm hole distance 24.5mm silicone for heating element		



GEV No.	416500	Ref. No.	IR00612Y RC601
description	heating element 2000W 230V heating circuits 1 L 295mm W 110mm L1 35mm L2 260mm W2 88mm flange length 50mm flange width 26mm connection length 60mm connection male faston 6.3mm tube ø 8.5mm hole ø 6.2mm W1 15mm compression flange dry heating element		

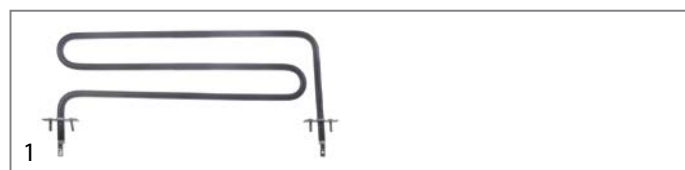

GEV No.	418933	Ref. No.	RC114 RC154
description	heating element 2000W 240V heating circuits 1 L 390mm W 134mm W2 100mm flange length 50mm flange width 20mm connection length 50mm connection M4 tube ø 10mm thread M4 W1 34mm rectangular flange convection heating element convection oven		

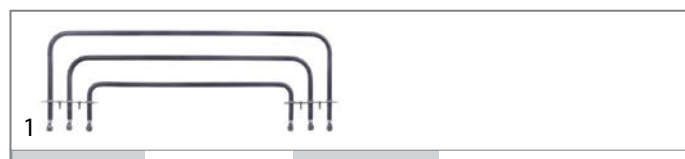

GEV No.	418917	Ref. No.	RC111 RC151
description	heating element 3000W 240V heating circuits 3 L 570mm W 140mm W2 110mm flange length 110mm flange width 20mm hole distance 40mm connection length 55mm connection M4 tube ø 10mm thread M4 W1 30mm rectangular flange convection heating element convection oven		



GEV No.	418918	Ref. No.	RC110 RC511
description	heating element 4000W 240V heating circuits 3 L 570mm W 140mm W2 110mm flange length 110mm flange width 20mm hole distance 40mm connection length 55mm connection M4 tube ø 10mm thread M4 W1 30mm rectangular flange convection heating element convection oven		



Зип.Общепит

thermostats

vsezip.ru

+7(812)987-08-81

accessories

sealing washers

O-rings

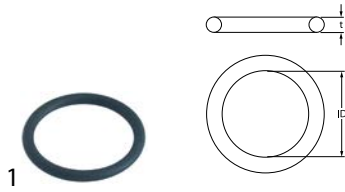

GEV No.	505092	Ref. No.	JOIN057
description	O-ring EPDM thickness 5.34mm ID ø 43.82mm Qty 1 pcs		

flange gaskets



GEV No.	511688	Ref. No.	JOIN2033
description	gasket silicone L 115mm W 114mm thickness 4mm		



GEV No.	511687	Ref. No.	JOIN2029
description	gasket silicone L 138mm W 107mm thickness 4mm		



GEV No.	520588	Ref. No.	JOIN071
description	gasket L 46mm W 22mm hole distance 24.5mm silicone for heating element		

control and safety thermostats

EGO

control thermostats

55.10/19_series

E·G·O



GEV No.	375002	Ref. No.	THER001
description	thermostat t.max. 320°C temperature range 55-320°C 1-pole 1NO 16A probe ø 3.1mm probe L 226mm capillary pipe 870mm capillary pipe isolated 850mm gland nut shaft L 23mm shaft position upper rotation 270°		

55.13_series

E·G·O

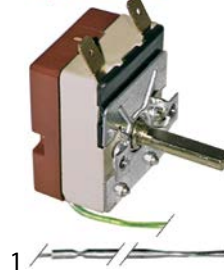

GEV No.	375154	Ref. No.	THER019
description	thermostat t.max. 250°C temperature range 50-250°C 1-pole 1NO 16A probe ø 3.1mm probe L 201mm capillary pipe 2970mm capillary pipe isolatedmm gland nut shaft L 23mm shaft position upper rotation 270° probe material SS		

55.34_series

E·G·O



GEV No.	376051	Ref. No.	THER102
description	thermostat t.max. 200°C temperature range 70-145-200°C 3-pole 3NC probe ø 3.1mm probe L 263mm capillary pipe 880mm capillary pipe isolated 400mm		



3ип Общепит

vsezip.ru

+7(812)987-08-81

IMIT / TEMPOMATIC / ARTHERMO

control thermostats



GEV No.	390186	Ref. No.	REGU010
description	thermostat t.max. 52°C temperature range fixed 52°C 1-pole 1CO 16A probe ø 6.5mm probe L 95mm capillary pipe 1000mm capillary pipe isolated 1000mm gland nut shaft Lmm contacts 1CO		

push/momentary push switches

ø12mm



GEV No.	347567	Ref. No.	INT003
description	momentary push switch mounting ø 12mm white 1NO 250V 4A connection male faston 6.3mm ambient temperature max. 85°C protection IP40		

CAEM

safety thermostats



GEV No.	375996	Ref. No.	THER3004
description	safety thermostat switch-off temp. 225°C 1-pole 1NC 16A probe ø 5mm probe L 80mm capillary pipe 900mm capillary pipe isolated 410mm gland nut M10 probe SS 250V		

microswitches

pin-plunger actuated

M12



GEV No.	345350	Ref. No.	INT008
description	microswitch with plunger mounting distance 22mm thread M12x0.75 thread L 16mm 250V 16A 1CO connection male faston 6.3mm stroke 4mm ambient temperature max. 125°C type EF83161.3 actuating force: 66g		

accessories for	345350	GEV No.	345351	Ref. No.	—
					nut thread M12x0.75 H 1.6mm WS 14 chrome-plated brass Qty 1 pcs

switches and momentary switches

rocker/momentary rocker switches

30x22mm



GEV No.	301004	Ref. No.	INT006
description	rocker switch mounting measurements 30x22mm black 2CO 250V 16A connection male faston 6.3mm ambient temperature max. 125/55°C protection IP40		

accessories for	301004	GEV No.	301036	Ref. No.	—
					protective cover internal size 30x22mm for rocker switch mounting measurementsmm

cam switches

4 operating positions



GEV No.	300077	Ref. No.	COMU004
description	cam switch 4 operating positions 5NO sequence 0-1-2-3 16A shaft ø 6x4.6mm shaft L 23mm connection male faston 6.3mm plastic		

blank



GEV No.	301165	Ref. No.	INT006
description	rocker switch mounting measurements 30x22mm black 2CO 250V 16A connection male faston 6.3mm ambient temperature max. 125/55°C protection IP65 with cover cap		

accessories for	301165	GEV No.	301036	Ref. No.	—
					protective cover internal size 30x22mm for rocker switch mounting measurementsmm



magnetic switches

M12x1

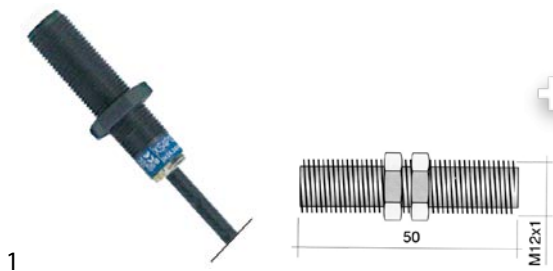

1

GEV No.	345900	Ref. No.	INT005
description	magnetic switch thread M12x1 1NO 24-240V AC/DCV 0.2A P max. 5-50W connection cable cable length 2000mm		

control equipment

SCHNEIDER ELECTRIC

rotary switches



1

GEV No.	347951	Ref. No.	INT037
description	rotary selector mounting measurements ø22mm green sequence 0-1 latching illuminated		

TELEMECANIQUE (EFA)

XB2 series

signal element



1

GEV No.	345397	Ref. No.	VOY103
description	signal element mounting measurements ø22mm red		

rotary switches



1

GEV No.	345222	Ref. No.	INT202
description	rotary selector mounting measurements ø22mm black latching sequence 0-1		

Зип Общепит

vsezip.ru

+7(812)987-08-81



1

GEV No.	345222	Ref. No.	INT205
description	rotary selector mounting measurements ø22mm black latching sequence 1-0-2		

ZB2 series

switch blocks



1

GEV No.	347566	Ref. No.	INT036
description	contact block 2NO illuminated		

ZB4 series

rotary switches



1

GEV No.	347951	Ref. No.	INT037
description	rotary selector mounting measurements ø22mm green sequence 0-1 latching illuminated		

miscellaneous



1

GEV No.	345903	Ref. No.	INT204
description	push button black		

lamps

indicator lights

indicator lights 2-piece (lens and indicator lamp)

indicator light lenses

ø12mm (type SDY-3)



1

GEV No.	359261	Ref. No.	VOT060 VOY060
description	indicator light housings mounting measurements ø12mm red round Qty 1 pcs		

indicator lights (complete)

ø13mm

with plug-in socket



1

GEV No.	359045	Ref. No.	VOY062
description	indicator light ø 13mm clear 230V connection male faston 6.3mm temp.-resist. 120°C Qty 1 pcs		



1

GEV No.	359141	Ref. No.	VOY060
description	indicator light ø 13mm red 230V connection male faston 6.3mm temp.-resist. 120°C Qty 1 pcs		

screw-on/push-on fit

halogen lamp

for socket G4 / G6.35 / G9



1

GEV No.	357193	Ref. No.	LAMP050
description	halogen lamp socket G4 12V 20W temp.-resist. 300°C OSRAM HALOSTAR OVEN		

3ип Общепит

oven lamps

producer-specific oven lamps

BOURGEOIS

+7(812)987-08-81

1

GEV No.	511690	Ref. No.	JOIN075 JOIN109
description	gasket L 78mm W 42mm silicone hole distance 66.5mm thickness 3mm for lamp		

1

GEV No.	360530	Ref. No.	HUBL009
description	lamp glass L 47.4mm W 32.8mm glas thickness 3.2mm		

1

GEV No.	359580	Ref. No.	LAMP011 Lamp012
description	lamp socket for halogen lamp		

lamps

halogen lamps

for socket G4 / G6.35 / G9



1

GEV No.	357193	Ref. No.	LAMP050
description	halogen lamp socket G4 12V 20W temp.-resist. 300°C OSRAM HALOSTAR OVEN		

timers

programme timers



1

GEV No.	360251	Ref. No.	05224C MOT010
description	gear motor CROUZET chambers 1 operation time 230V 50Hz shaft ømm shaft Lmm H 78mm L 116mm W 55mm type 88256462 shaft ø 5/6mm		



mechanical timers

			
1			
GEV No.	350214	Ref. No.	MIN014
description	timer M2 2-pole operation time 120min impulse mechanical 1NO/1NC at 250V 16A permanent position no shaft ø 6x4.6mm shaft 6x4.6mm shaft L 23mm mounting distance 28mm connection lateral		

power contactors

vsezip.ru

+7(812)987-08-81

			
1			
GEV No.	380479	Ref. No.	REL1607
description	power contactor resistive load 25A 230VAC (AC3/400V) 9A/4kW main contacts 3NO auxiliary contacts 1NO/1NC connection screw connection type LC1D09P7		

alarm devices

buzzers

			
1			
GEV No.	350050	Ref. No.	BRUI001
description	buzzer 230VAC connection male faston 6.3mm screw mounting thread M4 60dB		

			
1			
GEV No.	380976	Ref. No.	REL1600
description	power contactor resistive load 32A 230VAC (AC3/400V) 18A/7.5kW main contacts 3NO auxiliary contacts 1NO/1NC connection screw connection		

contactors

ISKRA (FANAL)

power contactors

			
1			
GEV No.	380204	Ref. No.	REL610
description	power contactor resistive load 25A 230VAC (AC3/400V) 9A/4kW main contacts 3NO auxiliary contacts 1NO connection screw connection type Fanal DSL9 10 type ISKRA KNL9 10		

			
1			
GEV No.	380603	Ref. No.	REL611
description	power contactor resistive load 40A 230VAC (AC3/400V) 25A/11kW main contacts 4NO auxiliary contacts connection screw connection type LC1D25004		



Зип Общепит
solid state relays

CROUZET
vsezip.ru

+7(812)987-08-81



1

GEV No.	380982	Ref. No.	REL1603
description	power contactor resistive load 80A 230VAC (AC3/400V) 50A/22kW main contacts 3NO auxiliary contacts 1NO/1NC connection screw connection type LC1D50P7		



1

GEV No.	403090	Ref. No.	REL232
description	solid state relay CROUZET 1 phase 125A 48-660V 4-32VDC L 57mm W 44mm screw type 84134180		

auxiliary contactors



1

GEV No.	381139	Ref. No.	REL622
description	auxiliary contactor 230VAC AC1 10A type CA2KN407M7 connection male faston 2.8mm/6.3mm contacts 4NO		



1

GEV No.	403089	Ref. No.	REL231
description	solid state relay CROUZET 1 phase 50A 48-660V 4-32VDC L 57mm W 44mm screw type 84134120		

auxiliary contacts



1

GEV No.	381140	Ref. No.	REL464
description	auxiliary contact contacts 1NO/1NC AC15 6A connection screw type GVAN11		

electronics

PCBs



1

GEV No.	402984	Ref. No.	280901 ELEC2003 ELEC2017
description	control PCB combi-steamer UC0611/1011/2011 L 140mm W 100mm		

miscellaneous

installation contactors



1

GEV No.	380601	Ref. No.	REL153
description	contactor		



1

GEV No.	400802	Ref. No.	NIV010
description	level relay 240V type ATO 600722/A		

1 electric components



1

GEV No.	403685	Ref. No.	ELEC2001 ELEC2015
description	PCB L 200mm W 95mm		



1

GEV No.	361851	Ref. No.	ELEC014
description	PCB L 70mm W 20mm		



1

GEV No.	402982	Ref. No.	ELEC2004
description	relay PCB combi-steamer UC0611/1011/2011 cable length 220mm push-in		

keypads

keypad units



1

GEV No.	403122	Ref. No.	20467
description	keypad unit combi-steamer UC0611/1011/2011 buttons 9 L 350mm W 153mm		

Зип.Общепит

solenoid valves

vsezip.ru

solenoid valves (water)

ROBERTS/RAW/INVENSYS



medium temperature: 90°C 90°C 60°C
 ambient temperature: 60°C 25°C 60°C
 duty cycle: 40% 100% 100%

solenoid valves with reducers

2-fold



1

GEV No.	370696	Ref. No.	ROB2000	
description	solenoid valve double straight 230VAC inlet 3/4" outlet 11.5mm t.max. 90°C Invensys plastic output A 1.2l/min flow regulating valve outlet A blue with non-return valve			
spare parts for	370696			
	GEV No.	371131	Ref. No.	—
	solenoid coil 230VAC			
	GEV No.	371174	Ref. No.	—
	solenoid coil 230VAC connection coded plug 6W			

with coded terminal



1

GEV No.	370269	Ref. No.	06245
description	solenoid valve double straight 230VAC inlet 3/4" outlet 11.5mm DN10 EATON (INVENSYS)		

electrodes



1

GEV No.	400807	Ref. No.	NIV007
description	level electrode 1/2" total length 112mm probe L 88mm insulated probe length uninsulatedmm connection bullet connector		



1

GEV No.	400804	Ref. No.	NIV602
description	level electrode 3/8" total length 75mm probe L 48mm insulated probe length 47mm conical connection M4		



Зип.Общепит

vsezip.ru

+7(812)987-08-81



fans

axial fans

import



1

GEV No.	601080 ¹	Ref. No.	MOT030
description	axial fan L 119mm W 119mm H 38mm 230VAC 50/60Hz 23/20W bearing ball bearing connection male faston 2.8mm metal ADDA fan wheel ø 110mm temp.-resist. 70°C		
accessories for	601080		
	GEV No.	550898	Ref. No. —
	connecting cable cable length 2000mm connection F 2.8 connection distance 7.9mm for axial flow fan		
	GEV No.	692519	Ref. No. —
	guard L 120mm W 120mm plastic		

¹with ball bearings

hot air fans

ebm-papst



1

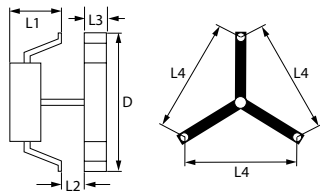

GEV No.	601808	Ref. No.	MOT2023
description	hot air fan 230/240V 50W L1 69mm L2mm L3mm L4 87mm fan wheel ø 150mm type RRL152/0020A92-3030LH-197 ebm-papst		

gear motors

for overalls



1

GEV No.	500811	Ref. No.	MOT018
description	gear motor AUTOM type ASR/30/FR 230V 50Hz shaft ø 8mm L 150mm W 65mm H 90mm		

pumps

drain pumps

HANNING



1

GEV No.	500573	Ref. No.	ROB013
description	drain pump 30W 4-piece 230V inlet ø 24/30mm outlet ø 24mm 50Hz HANNING type DPS25-032 1x pump, 3x pump cover		

service kits



1

GEV No.	500573	Ref. No.	ROB013
description	drain pump 30W 4-piece 230V inlet ø 24/30mm outlet ø 24mm 50Hz HANNING type DPS25-032 1x pump, 3x pump cover		

electric components



Зип.Общепит

vsezip.ru

+7(812)987-08-81

electric components

booster pumps II

accessories



1	GEV No.	365017	Ref. No.	MOT2013
description operating capacitor capacity 5µF 450V tolerance 5% 50/60Hz ambient temperature max. -25 to +85°C ø 28mm L 54mm M8 plastic connection male faston 6.3mm 16.10.08 protection				

vibration pumps



1	GEV No.	500219	Ref. No.	POMP001
description vibration pump type CP.3A.958.1/ST 230V 65W 50Hz inlet ø 6 outlet ø 1/8" IT EATON (INVENSYS) L 123mm				

condensators & interference suppression filters

operating capacitors

plastic



1	GEV No.	365150	Ref. No.	MOT2008
description operating capacitor capacity 20µF 425V tolerance 5% 50Hz ambient temperature max. -25 to +85°C ø 40mm L 70mm M8 plastic connection male faston 6.3mm 416.10.25 protection				



1	GEV No.	365017	Ref. No.	MOT2013
description operating capacitor capacity 5µF 450V tolerance 5% 50/60Hz ambient temperature max. -25 to +85°C ø 28mm L 54mm M8 plastic connection male faston 6.3mm 16.10.08 protection				

fine fuses



1	GEV No.	358532	Ref. No.	FUSI003
description fine fuse size ø5x20mm 2A fast-acting rated 250V Qty 10 pcs				



1	GEV No.	358607	Ref. No.	Fusi004
description fine fuse size ø5x20mm 6.3A slow-acting rated 250V Qty 10 pcs				

electric accessories

terminals

terminal blocks



1	GEV No.	550232	Ref. No.	BAR001
description lustre terminal 12-pole cross section 2.5mm ² max. 32A max 450V temp.-resist. 150°C				

rail-mounted terminals

WIELAND

rail-mounted terminals type 9700A



1	GEV No.	550374	Ref. No.	BORN101
description rail-mounted terminal WIELAND type 9700A/10 S35 1.5-16mm ² top-hat rail 35mm blue W 10mm L 49mm				



Зип Общепит

vsezip.ru

+7(812)987-08-81



1

GEV No.	550375	Ref. No.	BORN102A
description	rail-mounted terminal WIELAND type 9700A/10 SL2 S35 1.5-16mm ² top-hat rail 35mm yellow/green W 10mm L 53mm		



1

GEV No.	550377	Ref. No.	BORN105
description	rail-mounted terminal WIELAND type 9700A/16 S35 2.5-35mm ² top-hat rail 35mm blue W 16mm L 59mm		



1

GEV No.	550378	Ref. No.	BORN108
description	rail-mounted terminal WIELAND type 9700A/16 SL2 S35 2.5-35mm ² top-hat rail 35mm yellow/green W 16mm L 53mm		

accessories



1

GEV No.	550370	Ref. No.	BORN211
description	terminal block end bracket clampsmm ²		

ignition parts

electrodes



1

GEV No.	106928	Ref. No.	ALLU009
description	ignition electrode flange length 22mm flange width 1 16mm D1 ø 7mm L1 4mm BL1 49mm BL2 20mm connection ø 6mm		

ignition units



1

GEV No.	106925	Ref. No.	ALLU030
description	ignition unit outputs 1 230VAC dimensions 85x63x38mm mounting distance 60mm inlet F2.8x0.8 outlet ø4mm type EBI4 1P S service kit 90VA 50-60Hz		

doors



1

GEV No.	694536	Ref. No.	DECO214
description	door bolt for combi-steamer thread M5 ø 8mm L 46mm		



1

GEV No.	696417	Ref. No.	DECO364
description	locking screw for door thread M5		



1

GEV No.	696418	Ref. No.	DECO043
description	locking screw for door thread M5		



1

GEV No.	696419	Ref. No.	JOIN655
description	rubber sleeve for door		



1

GEV No.	696421	Ref. No.	DECO414
description	threaded bush for door thread M5 IT ø 9.5mm L 24mm		

1 electric components



Зип.Общепит

LOCKS
vsezip.ru

+7(812)987-08-81



1

GEV No.	696422	Ref. No.	DECO384
description	threaded bush for door thread M5 L 48mm		

door mechanics

accessories



1

GEV No.	694537	Ref. No.	CHAR203
description	base plate L 51mm W 22mm for catch plastic mounting distance 30mm thickness 2mm		

knobs

universal knobs



1

GEV No.	110865	Ref. No.	MAN130
description	knob switch zero mark t.max.°C ø 50mm shaft ø 6x4.6mm shaft flat left black		



1

GEV No.	110253	Ref. No.	MAN003
description	knob switch zero mark t.max.°C ø 50mm shaft ø 6x4.6mm shaft flat upper black		

accessories for

110253



GEV No.	550965	Ref. No.	—
description	knob spring ø 6x4.6mm Qty 1 pcs		

producer-specific knobs

BOURGEOIS



1

GEV No.	110865	Ref. No.	MAN130
description	knob switch zero mark t.max.°C ø 50mm shaft ø 6x4.6mm shaft flat left black		

handle latches
universal

inside fixing
locks



1

GEV No.	694054	Ref. No.	CHAR2006
description	door handle for headed units L 145mm W 40mm H 62mm spring length 33mm inner black		

spare parts for

694054



GEV No.	514390	Ref. No.	—
description	spring for door handle ø 6mm L 54mm W 27.5mm		



GEV No.	694675	Ref. No.	—
description	door catch L 88mm W 40mm H 37mm spring length 33mm mounting distance 60mm		



GEV No.	694734	Ref. No.	—
description	door handle L 165mm W 40mm H 25mm black		



GEV No.	694735	Ref. No.	—
description	cap ø 32mm black		

accessories for

694054



GEV No.	691123	Ref. No.	—
description	duct for door opener		



GEV No.	694055	Ref. No.	—
description	door catch L 25mm W 14mm total length 54mm thread M8 thread L 29mm		



GEV No.	694066	Ref. No.	—
description	door catch with spigot 2-stage L 28mm W 14mm H 15mm H1 16mm total length 51mm thread M8 thread L 23mm stainless steel		



GEV No.	694067	Ref. No.	CHAR2007
description	door catch with spigot 1-stage L 26mm total length 51mm thread M8		

mechanical components, equipment accessories



3ип Общеит
edge mount latches

push button latches
vsezip.ru

6186 PRESTO series

+7(812)987-08-81

producer-specific

BOURGOIS



1

GEV No.	694054	Ref. No.	CHAR2006
description	door handle for headed units L 145mm W 40mm H 62mm spring length 33mm inner black		
spare parts for	694054		
	GEV No.	514390	Ref. No. —
	spring for door handle ø 6mm L 54mm W 27.5mm		
	GEV No.	694675	Ref. No. —
	door catch L 88mm W 40mm H 37mm spring length 33mm mounting distance 60mm		
	GEV No.	694734	Ref. No. —
	door handle L 165mm W 40mm H 25mm black		
	GEV No.	694735	Ref. No. —
	cap ø 32mm black		
accessories for	694054		
	GEV No.	691123	Ref. No. —
	duct for door opener		
	GEV No.	694055	Ref. No. —
	door catch L 25mm W 14mm total length 54mm thread M8 thread L 29mm		
	GEV No.	694066	Ref. No. —
	door catch with spigot 2-stage L 28mm W 14mm H 15mm H1 16mm total length 51mm thread M8 thread L 23mm stainless steel		
	GEV No.	694067	Ref. No. CHAR2007
	door catch with spigot 1-stage L 26mm total length 51mm thread M8		

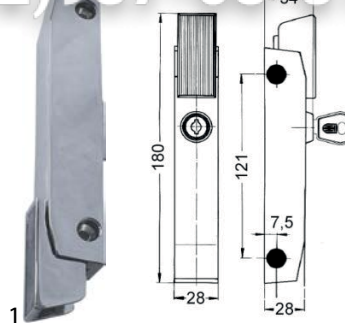

1

GEV No.	701042	Ref. No.	90000012 MB90000012
description	push button latch L 180mm mounting distance 121mm chrome-plated H 34mm W 28mm type PRESTO no. 6186		

snap locks

universal



1

GEV No.	700800	Ref. No.	CHAR150
description	snap lock L 59mm W 11.5mm H 15mm mounting distance 50mm complete with door catch nickel-plated brass thickness 2.7mm		

miscellaneous



1

GEV No.	511618	Ref. No.	00461A
description	door catch H 24.5mm L 31mm W 21mm mounting distance 21mm rollerø 14mm		



1

GEV No.	511619	Ref. No.	02668B
description	door catch with roller H 23mm adjustable L 90mm W 21mm mounting distance 52/76mm rollerø 14mm		

Зип.Общепит

gaskets
vsezip.ru

+7(812)987-08-81

hinges

door bearing



1

GEV No.	511603	Ref. No.	COUS002
description	bush H 7.5mm ID \varnothing 8.2mm with layer		



1

GEV No.	690835	Ref. No.	CHAR202
description	hinge bearing without bolt		

miscellaneous



1

GEV No.	511602	Ref. No.	CHAR201
description	hinge		

accessories

bushes



1

GEV No.	694336	Ref. No.	DECO 071
description	bush ID \varnothing 8mm ED \varnothing 12mm L 15mm		

gaskets for heated units

Window seals

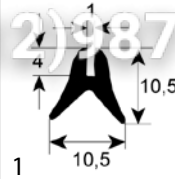

1

GEV No.	901512	Ref. No.	JOIN063
description	window gasket profile 1615 L 1350mm suitable for BOURGEOIS Qty 1		

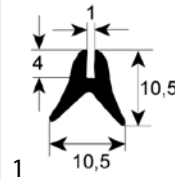

1

GEV No.	511610	Ref. No.	JOIN066
description	window gasket profile 1615 L 1950mm Qty 1		

door seals

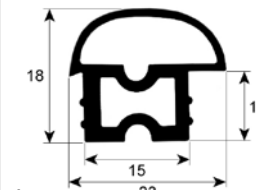

1

GEV No.	901411	Ref. No.	10683A MB10683A
description	door seal profile 2035 Qty supplied by meter		

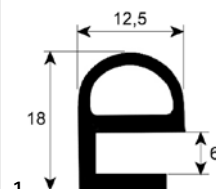

1

GEV No.	901516	Ref. No.	JOIN082 KITJOIN082
description	door seal profile 2225 perimeter 2030mm suitable for BOURGEOIS		

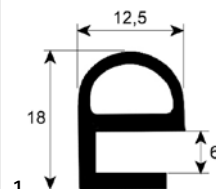

1

GEV No.	901409	Ref. No.	JOIN018
description	door seal profile 2225 perimeter 2530mm suitable for BOURGEOIS		

mechanical components, equipment accessories



Зип Общепит

vsezip.ru

+7(812)987-08-81

GEV No.	901427	Ref. No.	KITJOIN018
description	door seal profile 2225 perimeter 2530mm suitable for BOURGEOIS		

GEV No.	901424	Ref. No.	JOIN021 JOIN022 PROF777
description	door seal profile 2711 L 2600mm Qty 1		

GEV No.	901410	Ref. No.	JOIN019 KITJOIN019
description	door seal profile 2225 perimeter 3900mm suitable for BOURGEOIS Qty 1		

GEV No.	901655	Ref. No.	JOIN015
description	door seal profile 2980 L 2230mm		

GEV No.	901425	Ref. No.	JOIN1003
description	door seal profile 2226 L 3500mm Qty 1 W 700mm		

GEV No.	518126	Ref. No.	JOIN016 PROF1612
description	door seal profile 2980 L 2820mm		

GEV No.	901426	Ref. No.	JOIN155 JOIN180
description	door seal profile 2226 perimeter 2250mm Qty 1		

GEV No.	511620	Ref. No.	JOIN029
description	door seal profile 2985 L 4350mm Qty 1		

gaskets for control panels

GEV No.	901514	Ref. No.	JOIN1015
description	door seal profile 2227 perimeter 2650mm suitable for BOURGEOIS kit		

GEV No.	901510	Ref. No.	JOIN086
description	gasket for control panel W 13mm L 1500mm suitable for BOURGEOIS		

GEV No.	901508	Ref. No.	JOIN087
description	gasket for control panel W 13mm L 2050mm suitable for BOURGEOIS		

mechanical components, equipment accessories

Зип Общежит
sealing washers

silicone gaskets
vsezip.ru

+7(812)987-08-81

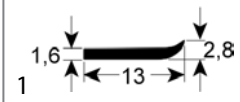

GEV No.	901509	Ref. No.	JOIN088
description	gasket for control panel W 13mm L 3500mm suitable for BOURGEOIS		

O-rings

EPDM

ø1.78mm

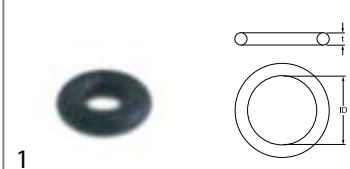

GEV No.	524421	Ref. No.	JOIN211
description	O-ring EPDM thickness 1.78mm ID ø 2.78mm Qty 1 pcs		

ø3.53mm

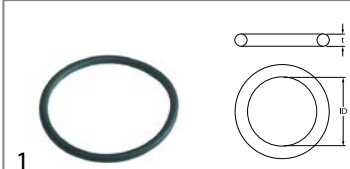

GEV No.	505180	Ref. No.	JOIN261
description	O-ring EPDM thickness 3.53mm ID ø 47.22mm Qty 1 pcs		

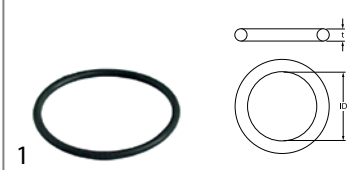

GEV No.	511331	Ref. No.	JOIN 261
description	O-ring EPDM thickness 3.53mm ID ø 53.57mm Qty 1 pcs		

ø5.34mm

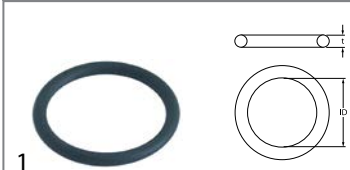

GEV No.	505092	Ref. No.	JOIN057
description	O-ring EPDM thickness 5.34mm ID ø 43.82mm Qty 1 pcs		

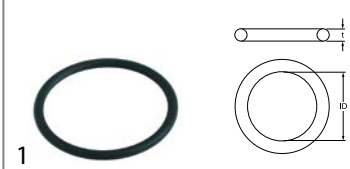

GEV No.	691033	Ref. No.	JOIN057
description	O-ring EPDM thickness 5.34mm ID ø 62.87mm Qty 1 pcs		

GEV No.	511691	Ref. No.	JOIN047
description	gasket silicone ED ø 51mm ID ø 4mm thickness 2mm Qty 1 pcs for combi-steamer		

special gaskets

miscellaneous



GEV No.	511615	Ref. No.	JOIN660
description	boiler gasket		



GEV No.	511600	Ref. No.	00288A JOIN084
description	gasket ED ø 80mm		



GEV No.	511689	Ref. No.	JOIN2026
description	gasket for lamp L 100mm W 24mm silicone thickness 2.8mm hole distance 22mm		



springs

compression springs



1

GEV No.	692202	Ref. No.	RES028
description	compression spring ϕ 4mm L 3mm wire gauge ϕ 0.5mm windings 2		

water cycle components

pressure reduction valves

pressure reduction valves

producer-specific



1

GEV No.	520589	Ref. No.	ROB028
description	pressure reduction valve Norgren series R91 connection 1/4" default settingbar setting range 0.1-3bar p max 10bar t.max. 50°C brass		



1

GEV No.	520553	Ref. No.	ROB2004
description	pressure reduction valve Norgren series R91 connection 3/4" default settingbar setting range 0.1-3bar p max 10bar t.max. 50°C with manometer and non-return valve brass		

fastening material

screws

grub screws

DIN 913/ISO 4026



1

GEV No.	504733	Ref. No.	VIS317
description	grub screw thread M4 L 5mm stainless steel DIN 913 intake internal hexagon WS 2 Qty 1 pcs		

miscellaneous



1

GEV No.	692200	Ref. No.	DECO366
description	grub screw thread M6 L 2.5mm SS intake slotted WS Qty 1 pcs		

washers

washers

miscellaneous



1

GEV No.	692198	Ref. No.	VIS276
description	plain washer ID ϕ 8.5mm ED ϕ 18mm thickness 1.4mm SS Qty 1 pcs		



consumables

sealants and adhesives

high temperature silicone



1

GEV No.	890059	Ref. No.	JOIN555
description	high temperature silicone FERMITOPP 300 neutral curing -40 up to +265°C black cartridge 310ml		
description	<p>Fermitopp HN 300 - cartridge 310ml - black Is used for sealing expansion joints on heating flues, ovens, reactors, chimneys, stacks, etc. The sealant is neutrally cross-linking, reacts with the moisture in the air and is characterised by extremely good hot air-resistance. The adhesive surfaces must be dry, clean and free of loose parts and in the case of porous substrates they should, if necessary, be given a first coat of primer. Post-smoothing e.g. with soap solution must take place before skinning. Highly refractory, odourless, UV/water/colour/hot-air resistant Temperature range -50°C to +250°C</p>		

Зип-Общепит

fuses

fine fuses

vsezip.ru

+7(812)987-08-81



1

GEV No.	358532	Ref. No.	FUSi003
description	fine fuse size ø5x20mm 2A fast-acting rated 250V Qty 10 pcs		



1

GEV No.	358607	Ref. No.	FUSi004
description	fine fuse size ø5x20mm 6.3A slow-acting rated 250V Qty 10 pcs		

Зип Общепит

vsezip.ru

+7(812)987-08-81

A		M	
alarm devices	8	magnetic switches	6
axial fans	11	mechanical timers	8
B		microswitches	5
booster pumps II	12	motors	11
C		O	
cam switches	5	operating capacitors	12
condensators & interference suppression filters	12	O-rings	18
consumables	20	oven lamps	7
contactors	8	P	
control equipment	6	pressure reduction valves	19, 19
control thermostats	4, 5	programme timers	7
D		pumps	11
door seals	16	push button latches	15
drain pumps	11	push/momentary push switches	5
E		R	
edgemount latches	15	rocker/momentary rocker switches	5
electric accessories	12	S	
electrodes	10	screws	19
F		sealants and adhesives	20
fans	11	sealing washers	18
fastening material	19	silicone	20
fine fuses	20	snap locks	15
fuses	12, 20	solenoid valves	10
G		solid state relays	9
gaskets for control panels	17	switches and momentary switches	5
gaskets for heated units	16	T	
grub screws	19	terminals	12
H		thermostats	4
halogen lamp	7	timers	7
heating elements	2	V	
heating elements for convection	2	vibration pumps	12
high temperature silicone	20	W	
hot air fans	11	washers	19
I		water cycle components	19
ignition units	13	window seals	16
immersion heating elements	2		
indicator lights	7		
indicator lights (complete)	7		
L			
lamps	7		