



Зип Общепит

vsezip.ru

Spare Parts for

+7(812)987-08-80 Dishwashing

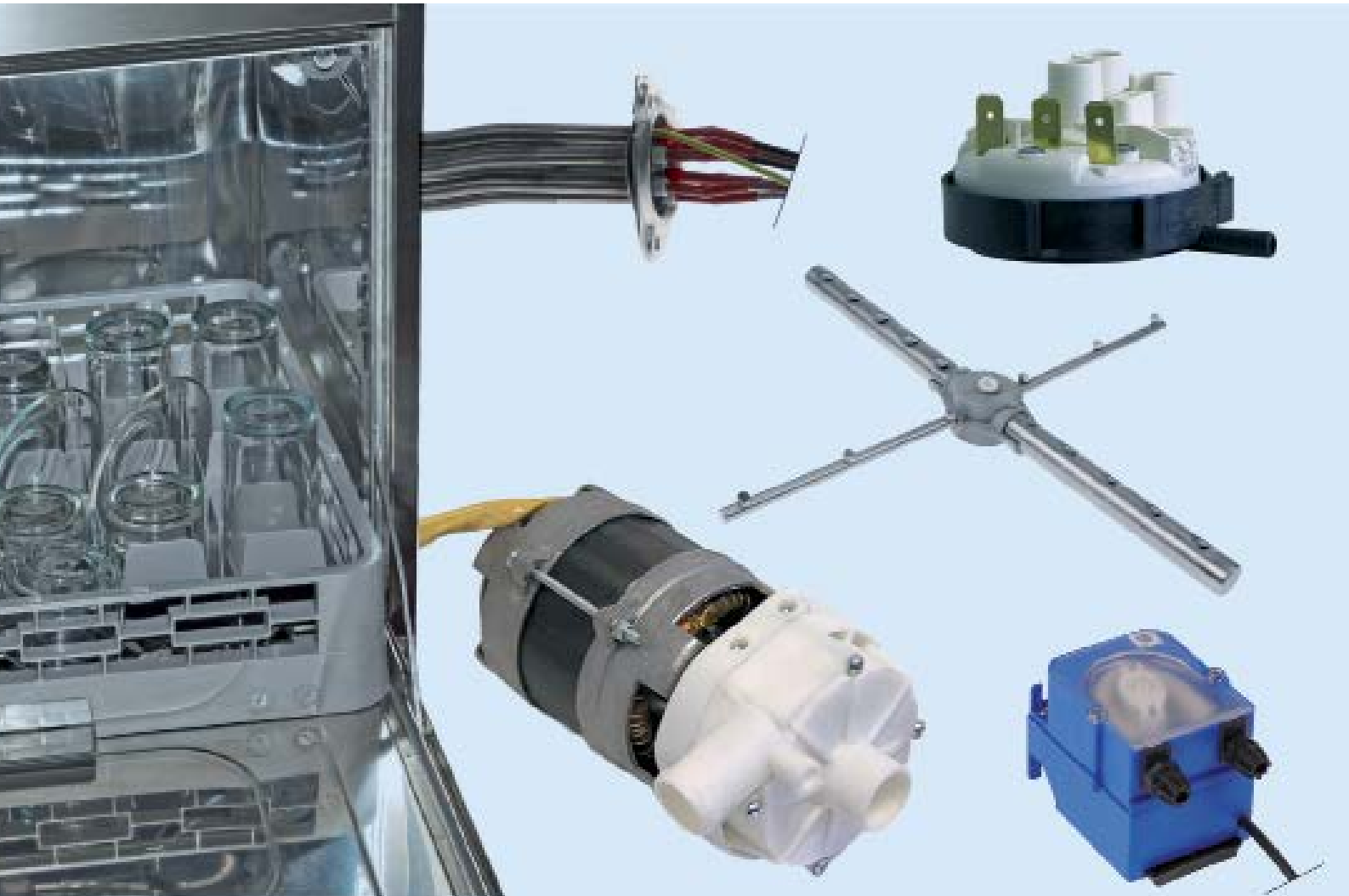

Spare parts suitable for

**MACH**

2018



Find the complete and up-to-date range of products in our GEV Webshop

## heating elements



## immersion heating elements

## 3 hole flange ø47.5mm



<b>GEV No.</b>	416205	<b>Ref. No.</b>	512019800 80001953
<b>description</b>	heating element 3000W 230V heating circuits 1 L 260mm W 29mm H 35mm number of thermostat sleeves 1 thermostat sleeves ø 10mm length thermostat sleeves 214mm tube ø 6.2mm hole distance 65mm hole ø 8mm connection M4 immersion heater		
<b>For models:</b>	GL220, GL250, MB235LI, MB240LI, MB510E, MB510ER, MB520, MB520K, MB530, MB530K, MB535, MB630, MB630PS, MB920E, MB920ER, MB930, MB930K, MB930PS, MB930T, MB9501, MGL40, MS350, MS350PS, MS350TRI, MS351, MS353, MS400B, MS400E, MS400T, MS450, MS450E, MS450PS, MS451, MS453, MS500B, MS500E, MS500PPB, MS500T, MS700E, MS905, MS9401, MS9451, MS9453		
<b>spare parts for</b>	416205		
	<b>GEV No.</b>	510408	<b>Ref. No.</b> —
	O-ring EPDM thickness 5.34mm ID ø 47mm Qty 1 pcs		
<b>accessories for</b>	416205		
	<b>GEV No.</b>	510562	<b>Ref. No.</b> —
	O-ring silicone thickness 5.34mm ID ø 47mm Qty 1 pcs		







<b>GEV No.</b>	416204	<b>Ref. No.</b>	512060200 80001977
<b>description</b>	heating element 3000W 230V mounting ø 47.5mm heating circuits 3 L 205mm W 26mm H 44mm number of thermostat sleeves 1 thermostat sleeves ø 8.7mm length thermostat sleeves 175mm thermostat sleeve not clinging tube ø 6.3mm hole distance 62mm hole ø 8mm connection M4 3 hole flange immersion heater		
<b>For models:</b>	MLP50, MS1100, MS1100E, MS1100T, MS350, MS350TRI, MS351, MS353, MS450, MS450E, MS450PS, MS451, MS453, MS700, MS900, MS900E, MS900T		
<b>spare parts for</b>	416204		
	<b>GEV No.</b>	510562	<b>Ref. No.</b> —
	O-ring silicone thickness 5.34mm ID ø 47mm Qty 1 pcs		
<b>accessories for</b>	416204		
	<b>GEV No.</b>	510408	<b>Ref. No.</b> —
	O-ring EPDM thickness 5.34mm ID ø 47mm Qty 1 pcs		

Зип Общепит



vsezip.ru

+7(812)987-08-81



<b>GEV No.</b>	416206	<b>Ref. No.</b>	512004310 80001979
<b>description</b>	heating element 4500W 230V mounting ø 47.5mm heating circuits 3 L 377mm W 27mm H 36mm number of thermostat sleeves 1 thermostat sleeves ø 9mm length thermostat sleeves 250mm thermostat sleeve not clinging tube ø 6.5mm hole distance 64mm hole ø 8mm connection M4 3 hole flange immersion heater		
<b>For models:</b>	MB9500, MB9503, MGL500, MLP50, MS1100, MS1100E, MS1100P, MS1100T, MS1300, MS1300E, MS1300P, MS1300T, MS351, MS353, MS400B, MS400T, MS450, MS450E, MS450PS, MS451, MS453, MS500B, MS500PPB, MS500T, MS700, MS900, MS900E, MS900T, MS9400, MS9403, MS9451, MS9453		
<b>spare parts for</b>	416206		
	<b>GEV No.</b>	510408	<b>Ref. No.</b> —
	O-ring EPDM thickness 5.34mm ID ø 47mm Qty 1 pcs		
<b>accessories for</b>	416206		
	<b>GEV No.</b>	510408	<b>Ref. No.</b> —
	O-ring EPDM thickness 5.34mm ID ø 47mm Qty 1 pcs		
	<b>GEV No.</b>	510562	<b>Ref. No.</b> —
	O-ring silicone thickness 5.34mm ID ø 47mm Qty 1 pcs		



<b>GEV No.</b>	416207	<b>Ref. No.</b>	512004410 80001981
<b>description</b>	heating element 6000W 230V mounting ø 47.5mm heating circuits 3 L 400mm W 24mm H 42mm number of thermostat sleeves 1 thermostat sleeves ø 9mm length thermostat sleeves 245mm thermostat sleeve not clinging tube ø 6.3mm hole distance 62mm hole ø 8mm connection M4 3 hole flange immersion heater		
<b>For models:</b>	MGL500, MLP140, MLP50, MLP56, MLP60, MLP60E, MS1100, MS1100E, MS1100P, MS1100T, MS1300, MS1300E, MS1300P, MS1300T, MS400B, MS400T, MS450, MS450E, MS450PS, MS500B, MS500PPB, MS500T, MS700, MS700E, MS800B, MS800E, MS800T, MS900, MS900E, MS900T, MS905		
<b>spare parts for</b>	416207		
	<b>GEV No.</b>	510408	<b>Ref. No.</b> —
	O-ring EPDM thickness 5.34mm ID ø 47mm Qty 1 pcs		
<b>accessories for</b>	416207		
	<b>GEV No.</b>	510408	<b>Ref. No.</b> —
	O-ring EPDM thickness 5.34mm ID ø 47mm Qty 1 pcs		
	<b>GEV No.</b>	510562	<b>Ref. No.</b> —
	O-ring silicone thickness 5.34mm ID ø 47mm Qty 1 pcs		



Зип Общежит

vsezip.ru

+7(812)987-0997

<b>GEV No.</b>	416208	<b>Ref. No.</b>	512004510 512004520 80001983
<b>description</b>	heating element 9000W 230V mounting $\phi$ 47.5mm heating circuits 3 L 395mm W 32mm H 36mm number of thermostat sleeves 1 thermostat sleeves $\phi$ 9mm length thermostat sleeves 240mm thermostat sleeve eccentric, non clinging tube $\phi$ 8.5mm hole distance 63mm hole $\phi$ 8mm connection M4 3 hole flange immersion heater with gasket		
<b>For models:</b>	MLP140, MLP70, MLP80, MS1100, MS1100E, MS1100P, MS1100T, MS1300, MS1300E, MS1300P, MS1300T, MS800B, MS800E, MS800T, MS900, MS900E, MS900T, MS905		
<b>spare parts for</b>	416208		
	<b>GEV No.</b>	510408	<b>Ref. No.</b> —
O-ring EPDM thickness 5.34mm ID $\phi$ 47mm Qty 1 pcs			

<b>GEV No.</b>	416203	<b>Ref. No.</b>	512036300 80001951
<b>description</b>	heating element 2600W 230V mounting $\phi$ 47.5mm heating circuits 1 L 250mm W 35mm H 24mm number of thermostat sleeves 1 thermostat sleeves $\phi$ 8.5mm length thermostat sleeves 235mm thermostat sleeve not clinging tube $\phi$ 6.3mm hole distance 62mm hole $\phi$ 8mm connection M4 3 hole flange immersion heater		
<b>For models:</b>	GL220, GL250, MB235LI, MB240LI, MB510E, MB510ER, MB520, MB520K, MB530, MB530K, MB535, MB630, MB630PS, MB920E, MB920ER, MB9235, MB9240, MB930, MB930K, MB930PS, MB930T, MB9510, MB9510R, MB9920, MB9920R		
<b>spare parts for</b>	416203		
	<b>GEV No.</b>	510408	<b>Ref. No.</b> —
O-ring EPDM thickness 5.34mm ID $\phi$ 47mm Qty 1 pcs			
<b>accessories for</b>	416203		
	<b>GEV No.</b>	510408	<b>Ref. No.</b> —
O-ring EPDM thickness 5.34mm ID $\phi$ 47mm Qty 1 pcs			
	<b>GEV No.</b>	510562	<b>Ref. No.</b> —
O-ring silicone thickness 5.34mm ID $\phi$ 47mm Qty 1 pcs			

with 3 hole flange $\phi$ 57.5mm			
<b>GEV No.</b>	415264	<b>Ref. No.</b>	2761 80002761
<b>description</b>	heating element 6000W 230V heating circuits 3 mounting $\phi$ 57.5mm L 480mm W 35mm H 42mm round flange connection M5 immersion heater tube $\phi$ 8.5mm connection length 19mm thermostat sleeves $\phi$ 7.5mm number of thermostat sleeves 1 length thermostat sleeves 268mm thermostat sleeve not clinging		
<b>For models:</b>	MLP55, MLP80		
<b>accessories for</b>	415264		
	<b>GEV No.</b>	550002	<b>Ref. No.</b> —
tension strap H 10mm L 21mm W 10mm hole $\phi$ 6.5mm for heating element			

<b>GEV No.</b>	419166	<b>Ref. No.</b>	512054600 80004609
<b>description</b>	heating element 1400W 230V heating circuits 1 L 235mm W 50mm H 30mm thread M10x1 tube $\phi$ 6.3mm connection male faston 6.3mm		
<b>For models:</b>	MB9235, MB9240, MB9510, MB9510R, MB9920, MB9920R, MGL500, MLP50, MLP56, MS400B, MS400E, MS400T, MS500B, MS500E, MS500PPB, MS500T, MS800B, MS800E, MS800T		

<b>GEV No.</b>	420364	<b>Ref. No.</b>	512077900
<b>description</b>	heating element 2500W 230V heating circuits 1 L 270mm W 145mm H 35mm W1 54mm W2 43mm thread M12x1 mounting distance 35mm tube $\phi$ 8.5mm 2 hole fixing connection male faston 6.3mm immersion heater		
<b>For models:</b>	MB9500, MB9501, MB9503, MLP50, MS9400, MS9401, MS9403, MS9451, MS9453		

<b>GEV No.</b>	416201	<b>Ref. No.</b>	512049900 80004269
<b>description</b>	heating element 2600W 230V heating circuits 1 L 275mm W 85mm H 26mm L1 65mm L2 210mm W1 23mm W2 40mm thread M10x1 mounting distance 33mm tube $\phi$ 6.3mm connection male faston 6.3mm immersion heater 2 hole fixing		
<b>For models:</b>	GL250, MB235LI, MB240LI, MB630, MB630PS, MB930, MB930K, MB930PS, MB930T, MGL40		
<b>accessories for</b>	416201		
	<b>GEV No.</b>	510416	<b>Ref. No.</b> —
flat gasket fibre ED $\phi$ 19mm ID $\phi$ 10.5mm thickness 1.5mm for thread M10 Qty 1 pcs			
	<b>GEV No.</b>	521129	<b>Ref. No.</b> —
nut thread M10 H 6mm SS W5 17 Qty 1 pcs DIN/ISO DIN 439			

electric components



## flow heaters

Зип Общежит  
control and safety thermostats

1

<b>GEV No.</b>	417708	<b>Ref. No.</b>	512081400
<b>description</b>	flow heater 3000W 230V ø 60mm L 225mm dishwasher		

## accessories

## sealing washers

## O-rings

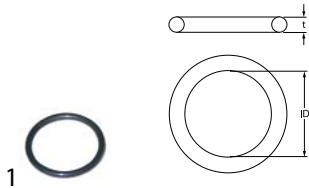

1

<b>GEV No.</b>	510072	<b>Ref. No.</b>	512013100 513013100 80002243
<b>description</b>	O-ring EPDM thickness 3.53mm ID ø 32.93mm Qty 1 pcs		
<b>For models:</b>	GL250, MB510E, MB510ER, MB630, MB920E, MB920ER, MB930, MB930K, MB930T, MGL40		



1

<b>GEV No.</b>	532158	<b>Ref. No.</b>	512006800 80004231
<b>description</b>	O-ring EPDM thickness 5.34mm ID ø 47mm Qty 10 pcs		

## thermostats

## bi-metal thermostats

## bi-metal thermostats



1

<b>GEV No.</b>	390441	<b>Ref. No.</b>	500065000 80004277
<b>description</b>	bi-metal thermostat hole distance 38mm switch-off temp. 55°C 1NC 1-pole 16A connection F6.3 2 hole fixing		
<b>For models:</b>	GL250, MB235LI, MB240LI, MB630, MB930, MB930K, MS400B, MS400T, MS500B, MS500PPB, MS500T		

EGO  
control and safety thermostats

55.10/19 series



1

<b>GEV No.</b>	390924	<b>Ref. No.</b>	500070700
<b>description</b>	thermostat t.max. 90°C temperature range 30-90°C 1-pole 1CO 16A probe ø 20mm probe L 12mm capillary pipe 1500mm capillary pipe isolatedmm gland nut shaft Lmm shaft position° shaft position		
<b>For models:</b>	MB235LI, MB240LI, MB630, MB930, MB930K, MLP50, MLP56, MS400B, MS400E, MS500B, MS500E, MS800B, MS800E		



1

<b>GEV No.</b>	375948	<b>Ref. No.</b>	500063900 500087600 80004311
<b>description</b>	thermostat t.max. 90°C temperature range 30-90°C 1-pole 1CO 16A probe ø 6mm probe L 102mm capillary pipe 1000mm capillary pipe isolated 960mm gland nut shaft Lmm shaft position rotation 180°		
<b>For models:</b>	MB235LI, MB240LI, MB510E, MB510ER, MB520, MB520K, MB530, MB530K, MB535, MB630, MB630PS, MB920E, MB920ER, MB9235, MB9240, MB930, MB930K, MB930PS, MB930T, MB9500, MB9501, MB9503, MB9510, MB9510R, MB9920, MB9920R, MLP140, MLP50, MLP56, MLP60, MLP60E, MLP70, MLP80, MS1100, MS1100E, MS1100P, MS1300, MS1300E, MS1300P, MS350, MS350TRI, MS351, MS353, MS400B, MS400E, MS400T, MS450, MS450E, MS451, MS453...(Other models you can see in the webshop)		



3 in 1 Общепит switches and momentary switches

vsezip.ru  
28.5x28.5mm

+7(812)987-08-81

safety thermostats

55.10/19\_ series



<b>GEV No.</b>	375902	<b>Ref. No.</b>	500064000 80004309
<b>description</b>	safety thermostat switch-off temp. 125°C 1-pole 1NC 16A probe ø 6mm probe L 77mm capillary pipe 870mm capillary pipe isolated 700mm gland nut probe material SS screw connection M8x1		
<b>For models:</b>	MB235LI, MB240LI, MB510E, MB510ER, MB520, MB520K, MB530, MB530K, MB535, MB630, MB630PS, MB920E, MB920ER, MB9235, MB9240, MB930, MB930K, MB930PS, MB930T, MB9500, MB9501, MB9503, MB9510, MB9510R, MB9920, MB9920R, MGL40, MGL500, MLP140, MLP50, MLP56, MLP60, MLP60E, MLP70, MLP80, MS1100, MS1100E, MS1100P, MS1100T, MS1300, MS1300E, MS1300P, MS1300T, MS350, MS350TRI, MS351, MS353, MS400B, MS400E, MS400T...(Other models you can see in the webshop)		

IMIT / TEMPOMATIC / ARTHERMO

control thermostats

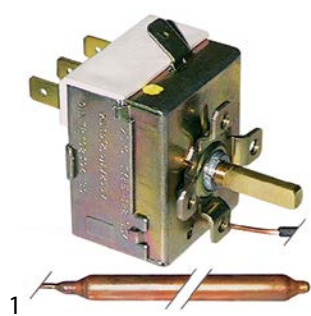

<b>GEV No.</b>	390192	<b>Ref. No.</b>	500000100 80001177
<b>description</b>	thermostat t.max. 90°C temperature range 0-90°C 1-pole 1CO 16A probe ø 6.5mm probe L 95mm capillary pipe 2000mm capillary pipe isolated 2000mm gland nut shaft ø 6x4.6mm shaft L 19mm shaft position upper° rotation 270° probe material copper		
<b>For models:</b>	GL220, GL250, MB510E, MB520, MB520K, MB530, MB530K, MB535, MB630, MB920E, MB930, MB930K, MLP140, MLP60, MLP60E, MLP70, MLP80, MS1100, MS1300, MS350, MS350PS, MS450, MS450E, MS450PS, MS700, MS700E, MS900		

accessories

plunger sockets



<b>GEV No.</b>	504139	<b>Ref. No.</b>	513135500 80002979
<b>description</b>	thermowell thread 3/8" L 38mm SS single ø 6.5mm		
<b>For models:</b>	MGL40, MS400T, MS500PPB, MS500T		

push/momentary push switches

<b>GEV No.</b>	345550	<b>Ref. No.</b>	500005400 80001547
<b>description</b>	momentary push switch mounting measurements 28.5x28.5mm yellow 1NO 250V 16A connection male faston 6.3mm ambient temperature max. 85°C protection IP40		
<b>For models:</b>	MB235LI, MB240LI, MB535, MB9235, MB9240, MS1100, MS1100E, MS1100P, MS1300, MS1300E, MS1300P, MS350, MS350PS, MS350TRI, MS351, MS353, MS400E, MS450E, MS450PS, MS451, MS453, MS500E, MS700E, MS900, MS900E		

<b>GEV No.</b>	345553	<b>Ref. No.</b>	500017800 80001955
<b>description</b>	push switch mounting measurements 28.5x28.5mm green 2NO 250V 16A connection male faston 6.3mm ambient temperature max. 150°C protection IP40		
<b>For models:</b>	MB235LI, MB240LI, MB535, MB9235, MB9240, MLP140, MLP60, MLP60E, MLP70, MLP80, MS351, MS353, MS400E, MS451, MS453, MS500E		

28.5x77.5mm

<b>GEV No.</b>	347621	<b>Ref. No.</b>	500074600
<b>description</b>	double momentary switch latching/momentary mounting measurements 28.5x77.5mm green/blue/yellow 2CO/2NO/2NO 250V 16A connection male faston 6.3mm ambient temperature max. 85°C protection IP40		

<b>GEV No.</b>	345555	<b>Ref. No.</b>	500040900 80001995
<b>description</b>	switch combination latching mounting measurements 28.5x77.5mm green/white/blue 2NO/2CO/2CO 250V 16A connection male faston 6.3mm ambient temperature max. 85°C protection IP40		
<b>For models:</b>	MS1100, MS1100E, MS1100P, MS1300, MS1300E, MS1300P, MS350, MS350PS, MS350TRI, MS450E, MS450PS, MS700E, MS900, MS900E		

electric components



# Зип Общепит

vsezip.ru

7(812)987-08-81

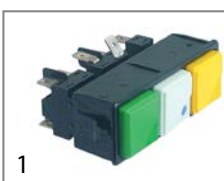

<b>GEV No.</b>	345554	<b>Ref. No.</b>	80001513 800087000
<b>description</b>	switch combination latching/latching/momentary mounting measurements 28.5x77.5mm green/white/yellow 2NO/2CO/1NO 250V 16A connection male faston 6.3mm ambient temperature max. 85°C protection IP40		
<b>For models:</b>	MB510E, MB520, MB520K, MB530, MB530K, MB630, MB920E, MB930, MB930K, MLP55, MLP60E, MLP80, MS350, MS350PS, MS350TRI		

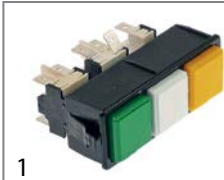

<b>GEV No.</b>	348018	<b>Ref. No.</b>	500005300
<b>description</b>	switch combination latching/latching/momentary mounting measurements 28.5x77.5mm green/white/yellow 2NO/2CO/1NO 250V 16A connection male faston 6.3mm ambient temperature max. 85°C protection IP40		
<b>For models:</b>	MLP50, MLP60E		

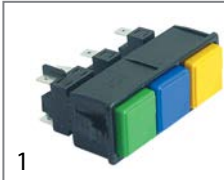

<b>GEV No.</b>	345556	<b>Ref. No.</b>	500074500 80002973 80004381
<b>description</b>	switch combination latching/momentary mounting measurements 28.5x77.5mm green/blue/yellow 2NO/1NO/1NO 250V 16A connection male faston 6.3mm ambient temperature max. 85°C protection IP40		
<b>For models:</b>	MB510E, MB510ER, MB520, MB520K, MB530, MB530K, MB630, MB630PS, MB920E, MB920ER, MB930, MB930K, MB930PS, MB930T, MB9510, MB9510R, MB9920, MB9920R, MGL40, MGL500, MLP50, MS1100, MS1100E, MS1100P, MS1100T, MS1300, MS1300E, MS1300P, MS1300T, MS400B, MS400T, MS500B, MS500PPB, MS500T, MS800B, MS800T, MS900, MS900E, MS900T		



<b>GEV No.</b>	347957	<b>Ref. No.</b>	500017900 500083100
<b>description</b>	switch combination mounting measurements 28.5x77.5mm yellow/green 2NO/1NO/1NO 250V 16A connection male faston 6.3mm ambient temperature max. 150°C 4-pole		
<b>For models:</b>	MS800E, MS905		

## position switches

PIZZATO PR Series



<b>GEV No.</b>	347958	<b>Ref. No.</b>	500036300 80001877
<b>description</b>	position switch plastic 2NO 400V 3A L 75mm W 31mm H 31mm protection IP67 actuating force: 350g screw connection PG13.5 mounting distance 22mm FR1001		
<b>For models:</b>	MS1100, MS1300, MS900		

## magnetic switches

### 65x20mm

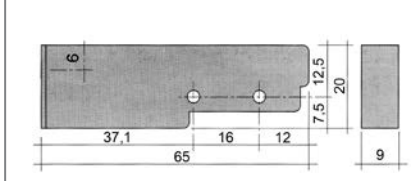

<b>GEV No.</b>	345116	<b>Ref. No.</b>	500046000 80002117
<b>description</b>	magnetic switch L 65mm W 20mm 1NO 250V 0.4A P max. 100W connection cable cable length 3000mm		
<b>For models:</b>	GL220, GL250, MB235LI, MB240LI, MB510E, MB510ER, MB520, MB520K, MB530, MB530K, MB535, MB630, MB630PS, MB920E, MB920ER, MB9235, MB9240, MB930, MB930K, MB930PS, MB930T, MB9500, MB9501, MB9503, MB9510, MB9510R, MB9920, MB9920R, MGL40, MGL500, MLP140, MLP50, MLP56, MLP60, MLP60E, MLP70, MLP80, MS1100, MS1100E, MS1100P, MS1100T, MS1300, MS1300E, MS1300P, MS1300T, MS350, MS350PS, MS350TRI, MS351, MS353... (Other models you can see in the webshop)		
<b>accessories for</b>	345116		

<b>GEV No.</b>	345399	<b>Ref. No.</b>	—
<b>description</b>	magnet ø 3.3mm L 40mm H 8mm W 13mm hole distance 30mm M3		



Зип.Общепит  
timers

vsezip.ru  
+7(812)987-08-81

accessories

magnets

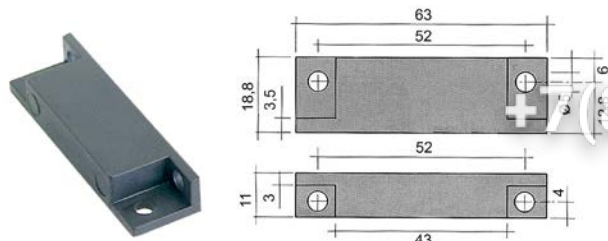

1

<b>GEV No.</b>	345336	<b>Ref. No.</b>	500046100
<b>description</b>	magnet ø 4.8mm L 63mm H 11mm W 18.8mm hole distance 51mm M4		
<b>For models:</b>	MB235LI, MB240LI, MB510E, MB510ER, MB520, MB520K, MB530, MB530K, MB535, MB630, MB630PS, MB920E, MB920ER, MB9235, MB9240, MB930, MB930K, MB930PS, MB930T, MB9500, MB9501, MB9503, MB9510, MB9510R, MB9920, MB9920R, MGL40, MGL500, MLP140, MLP50, MLP56, MLP60, MLP60E, MLP70, MLP80, MS1100, MS1100E, MS1100P, MS1100T, MS1300, MS1300E, MS1300P, MS1300T, MS351, MS353, MS400B, MS400E, MS400T, MS451, MS453...(Other models you can see in the webshop)		

lamps

indicator lights

indicator lights 2-piece (lens and indicator lamp)

indicator light lenses

ø 6mm (type SQ-20)



1

<b>GEV No.</b>	359804	<b>Ref. No.</b>	500064800
<b>description</b>	indicator light lens yellow Qty 1 pcs ø 6mm		
<b>For models:</b>	MB235LI, MB240LI, MB510E, MB510ER, MB520, MB520K, MB530, MB530K, MB535, MB630, MB630PS, MB920E, MB920ER, MB9235, MB9240, MB930, MB930K, MB930PS, MB930T, MB9500, MB9501, MB9503, MB9510, MB9510R, MB9920, MB9920R, MLP50, MLP56, MLP60E, MS1100, MS1100E, MS1100P, MS1300, MS1300E, MS1300P, MS351, MS353, MS400B, MS400E, MS451, MS453, MS500B, MS500E, MS800B, MS800E, MS900, MS900E, MS905, MS9400, MS9401...(Other models you can see in the webshop)		

programme timers



1

<b>GEV No.</b>	360737	<b>Ref. No.</b>	500068800 80004981
<b>description</b>	timer CDC 11901F1 engines 1 chambers 1 operation time 60s 230V		
<b>For models:</b>	MLP50		



1

<b>GEV No.</b>	360721	<b>Ref. No.</b>	500000900
<b>description</b>	timer CDC 4905MDV engines 2 chambers 5 operation time 6s / 3min 230V shaft ømm shaft Lmm manuf. no. 4905MDVAPE000.1000		
<b>For models:</b>	MS400B, MS500B		



1

<b>GEV No.</b>	360202	<b>Ref. No.</b>	500001000 80002359
<b>description</b>	timer FIBER P25 engines 1 chambers 4 operation time 4min 230V shaft ømm shaft Lmm manuf. no. P255J04H699 motor type M51B-J0R6400		
<b>For models:</b>	MS350, MS350PS, MS350TRI		

<b>spare parts for</b>	360202	<b>GEV No.</b>	360673	<b>Ref. No.</b>	—
					motor kit pinion ø 6.8mm teeth 15 230V voltage AC 50/60Hz turn direction clockwise motor ø 48mm H 18.5mm motor type UDS-40NE1RNZ165 cable length 150mm with holder

→ electric components



Зип Общепит

vsezip.ru

+7(812)987-08-81



1

<b>GEV No.</b>	360203	<b>Ref. No.</b>	500016900 80001553
<b>description</b>	timer FIBER P26 engines 1 chambers 3 operation time 20min 230V shaft ømm shaft Lmm manuf. no. P265J03L103 motor type M61B40R6400		
<b>For models:</b>	MB520K, MB530K, MB930K, MS1300		



<b>GEV No.</b>	380213	<b>Ref. No.</b>	500035100 80001857 80001LT029
<b>description</b>	power contactor resistive load 20A 230VAC (AC3/400V) 8.5A/5.5kW main contacts 3NO auxiliary contacts 1NO connection screw connection type Fanal DSL7 10 type ISKRA K07M 10		
<b>For models:</b>	MB510E, MB510ER, MB520, MB520K, MB530, MB530K, MB535, MB630, MB920E, MB920ER, MB930, MB930K, MB930T, MB9500, MB9503, MGL40, MGL500, MLP140, MLP50, MLP55, MLP56, MLP60, MLP60E, MLP70, MLP80, MS1100, MS1100E, MS1100P, MS1100T, MS1300, MS1300E, MS1300P, MS1300T, MS350, MS350PS, MS350TRI, MS351, MS353, MS400B, MS400T, MS450, MS450E, MS450PS, MS451, MS453, MS500B, MS500PPB, MS500T, MS700, MS700E...(Other models you can see in the webshop)		



1

<b>GEV No.</b>	360344	<b>Ref. No.</b>	4603 500068300 80004603
<b>description</b>	timer FIBER PWE engines 1 chambers 3 operation time 150s 230V shaft ømm shaft Lmm manuf. no. PWE5J03H408 motor type M51B-J0R6400		
<b>For models:</b>	GL220, GL250, MB235LI, MB240LI, MB510E, MB510ER, MB520, MB520K, MB530, MB530K, MB535, MB630, MB920E, MB920ER, MB930, MB930K, MS351, MS353, MS400E, MS451, MS453, MS500E		
<b>spare parts for</b>	360344		
	<b>GEV No.</b>	360673	<b>Ref. No.</b> —
	motor kit pinion ø 6.8mm teeth 15 230V voltage AC 50/60Hz turn direction clockwise motor ø 48mm H 18.5mm motor type UDS-40NE1RNZ165 cable length 150mm with holder		

## relays

## power relays

## with bracket mounting



1

<b>GEV No.</b>	380312	<b>Ref. No.</b>	1LT080 80001LT080
<b>description</b>	power relays FINDER 230VAC 10A 3CO connection male faston 4.8mm bracket mounting dimensions 52x32.2x36.5mm manuf. no. 60.63.8.230.0000		
<b>For models:</b>	IMP25, IMP35, IMP45, IMP55, IMP70, IMP85		

## contactors

## ISKRA (FANAL)

## power contactors



1

<b>GEV No.</b>	380212	<b>Ref. No.</b>	500000600 80001173
<b>description</b>	power contactor resistive load 20A 230VAC (AC3/400V) 8.5A/5.5kW main contacts 3NO auxiliary contacts 1NC connection screw connection type Fanal K07M 01 type ISKRA DSL7 01		
<b>For models:</b>	GL220, GL250, MGL40, MLP140, MLP60, MLP60E, MLP70, MLP80, MS1100, MS1100E, MS1100P, MS1300, MS1300E, MS1300P, MS350, MS350TRI, MS450, MS450E, MS450PS, MS700, MS700E, MS900, MS900E		



1

<b>GEV No.</b>	380368	<b>Ref. No.</b>	500019000 500019100 80004105 80004251
<b>description</b>	power relays ZETTLER ELECTRONICS 230VAC 30A 1NO/1NC connection male faston 6.3mm bracket mounting manuf. no. AZ 2280-1A-240AF AZ2280-1C-240AF		
<b>For models:</b>	MB235LI, MB240LI, MB930T, MGL500, MLP140, MLP50, MLP60, MLP60E, MLP70, MLP80, MS1100, MS1100E, MS1100P, MS1300, MS1300E, MS1300P, MS350, MS350TRI, MS351, MS353, MS400B, MS400E, MS400T, MS450, MS450E, MS451, MS453, MS500B, MS500E, MS500PPB, MS500T, MS700, MS700E, MS800B, MS800E, MS800T, MS900, MS900E, MS905		





## electronic controllers

### EVCO - EVERY CONTROL

#### electronic thermometers

##### built-in version



<b>GEV No.</b>	400754	<b>Ref. No.</b>	512063000
<b>description</b>	thermometer EVERY CONTROL type TM103T N7 mounting measurements 58x25.5mm 230V voltage AC -40 up to +110°C measuring input NTC front measurements 31x64mm protection IP54 accuracy 1%		
<b>For models:</b>	MGL40, MGL500, MLP140, MLP60, MLP70, MLP80		
<b>accessories for</b>	400754		
	<b>GEV No.</b>	379161	<b>Ref. No.</b>
			—
	temperature probe NTC 10kOhm cable thermoplastic probe -40 up to +110°C cable -40 up to +110°C probe ø6x14mm cable length 3m without screw connection 2-wire		

### miscellaneous

#### universal controllers



<b>GEV No.</b>	400710	<b>Ref. No.</b>	500017100 80003939
<b>description</b>	electronic controller type 9.5.17.90 00G 230V		
<b>For models:</b>	MLP140, MLP60, MLP60E, MLP70, MLP80		

## probes

### universal probes

#### temperature probes



<b>GEV No.</b>	379458	<b>Ref. No.</b>	512063100
<b>description</b>	temperature probe NTC 10kOhm cable silicone probe -40 up to +110°C cable -50 up to +180°C probe ø6x40mm cable length 1.5m without screw connection 2-wire		
<b>For models:</b>	MGL40, MGL500, MLP140, MLP60, MLP70, MLP80		



<b>GEV No.</b>	379052	<b>Ref. No.</b>	512042300 80002959
<b>description</b>	temperature probe PTC 1kOhm cable silicone probe -50 up to +150°C cable -50 up to +180°C probe ø6x40mm cable length 1.5m without screw connection 2-wire		
<b>For models:</b>	MGL40, MGL500		

Зип Общепит  
product-specific probes

#### probes



<b>GEV No.</b>	400714	<b>Ref. No.</b>	500054800 80002963
<b>description</b>	temperature probe NTC 100kOhm cable PVC probe -40 up to +125°C cable -10 up to 100°C connection male faston thread probe ø7x25mm cable length 3m		
<b>For models:</b>	MB930T, MGL40, MGL500, MS1100T, MS1300T, MS400T, MS500PPB, MS500T, MS800T, MS900T		

## electronics

### PCBs



<b>GEV No.</b>	402953	<b>Ref. No.</b>	500086900
<b>description</b>	control PCB dishwasher MB630/930 L 133mm W 82mm		
<b>For models:</b>	MB630, MB630PS, MB9235, MB9240, MB930, MB930K, MB930PS, MB930T, MB9500, MB9501, MB9503, MB9510, MB9510R, MB9920, MB9920R, MLP50, MLP56, MS9400, MS9401, MS9403, MS9451, MS9453		



<b>GEV No.</b>	400717	<b>Ref. No.</b>	500055900 50055900 80002967
<b>description</b>	PCB		
<b>For models:</b>	MB930T, MGL40, MGL500, MS1100T, MS1300T, MS400T, MS500PPB, MS500T, MS800T, MS900T		

Зип Общепит

vsezip.ru

+7(812)987-08-81



1

<b>GEV No.</b>	403892	<b>Ref. No.</b>	500095100
<b>description</b>	PCB L 135mm W 85mm		



1

<b>GEV No.</b>	504155	<b>Ref. No.</b>	512048600 80003863
<b>description</b>	keypad foil		
<b>For models:</b>	MLP60, MLP60E		

## keypads

### front foils



1

<b>GEV No.</b>	504117	<b>Ref. No.</b>	512027600 512028500 80002511
<b>description</b>	keypad foil		
<b>For models:</b>	GL220, MB510E, MB510ER, MB520, MB520K, MB530, MB530K		



1

<b>GEV No.</b>	504172	<b>Ref. No.</b>	512040000 80004013
<b>description</b>	keypad foil		
<b>For models:</b>	MLP140, MLP70, MLP80		



1

<b>GEV No.</b>	504119	<b>Ref. No.</b>	512027500 80002543
<b>description</b>	keypad foil		
<b>For models:</b>	MB535		



1

<b>GEV No.</b>	504201	<b>Ref. No.</b>	512050700 80004289
<b>description</b>	keypad foil		
<b>For models:</b>	MLP60, MLP60E		



1

<b>GEV No.</b>	504129	<b>Ref. No.</b>	512044800 80002921
<b>description</b>	keypad foil		
<b>For models:</b>	MB630, MB930, MB930K, MB930PS, MB930T, MGL40		



1

<b>GEV No.</b>	504108	<b>Ref. No.</b>	512027800 512028600 80002431
<b>description</b>	keypad foil dishwasher MB920/930		
<b>For models:</b>	MB630, MB920E, MB920ER, MB930, MB930K		

### membrane keypads



1

<b>GEV No.</b>	504146	<b>Ref. No.</b>	512046000 80003827
<b>description</b>	keypad foil		
<b>For models:</b>	MLP140		



1

<b>GEV No.</b>	400712	<b>Ref. No.</b>	500032400 80001799
<b>description</b>	membrane keypad warewashing MS1100		
<b>For models:</b>	MS1100, MS1100E, MS1300, MS1300E, MS450, MS450E, MS450PS, MS700, MS900, MS900E		

### keypad units



1

<b>GEV No.</b>	504147	<b>Ref. No.</b>	512048500 80003829
<b>description</b>	keypad foil		
<b>For models:</b>	MLP80		



1

<b>GEV No.</b>	400711	<b>Ref. No.</b>	500017600 80003941
<b>description</b>	keypad unit		
<b>For models:</b>	MLP140, MLP60, MLP60E, MLP70, MLP80		



Зип-Общепит

vsezip.ru

+7(812)987-08-81

control panel



<b>GEV No.</b>	504384	<b>Ref. No.</b>	600007100
<b>description</b>	control panel W 650mm H 600mm complete		

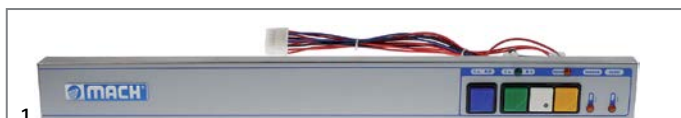

<b>GEV No.</b>	504338	<b>Ref. No.</b>	600064500
<b>description</b>	switch panel MS/450 and MS/700 L 595mm W 65mm edition until year of construction 05/1995		

solenoid valves

solenoid valves (water)

RPE







<b>GEV No.</b>	374020	<b>Ref. No.</b>	500001300 80004479
<b>description</b>	solenoid valve double angled 230VAC inlet 3/4" outlet 13mm DN10 RPE		
<b>For models:</b>	GL220, GL250, MB510E, MB510ER, MB520, MB520K, MB530, MB530K, MB535, MB630, MB630PS, MB920E, MB920ER, MB930, MB930K, MB930PS, MB930T, MB9510, MB9510R, MB9920, MB9920R, MGL40, MLP140, MLP50, MLP60, MLP60E, MLP70, MLP80, MS1100, MS1100E, MS1100P, MS1100T, MS1300, MS1300E, MS1300P, MS1300T, MS350, MS350TRI, MS400B, MS400T, MS450, MS450E, MS500B, MS500PPB, MS500T, MS700, MS700E, MS800B, MS800T, MS900...(Other models you can see in the webshop)		











<b>GEV No.</b>	370021	<b>Ref. No.</b>	500047800 80001537
<b>description</b>	solenoid valve double straight 230VAC inlet 3/4" outlet 11.5mm DN10 TP flow regulating valve inlet white		
<b>For models:</b>	GL220, GL250, MB510E, MB510ER, MB520, MB520K, MB530, MB530K, MB535, MB630, MB920E, MB930, MB930K, MGL40, MLP140, MLP60, MLP60E, MLP70, MLP80, MS1100, MS1300, MS350, MS350PS, MS450, MS450E, MS450PS, MS700, MS700E, MS900		
<b>spare parts for</b>	370021		
	<b>GEV No.</b>	371013	<b>Ref. No.</b> —
	solenoid coil TP 230VAC 50/60Hz		
<b>accessories for</b>	370021		
	<b>GEV No.</b>	371220	<b>Ref. No.</b> —
	reducer TP flow rate 3l/min red tolerance ±15%		
	<b>GEV No.</b>	371221	<b>Ref. No.</b> —
	reducer TP flow rate 5.5l/min yellow tolerance ±15%		
	<b>GEV No.</b>	371222	<b>Ref. No.</b> —
	reducer TP flow rate 6l/min grey tolerance ±15%		
	<b>GEV No.</b>	371223	<b>Ref. No.</b> —
	reducer TP flow rate 10l/min white tolerance ±15%		
	<b>GEV No.</b>	371224	<b>Ref. No.</b> —
	reducer TP flow rate 12l/min bronze tolerance ±15%		
	<b>GEV No.</b>	371225	<b>Ref. No.</b> —
	reducer TP flow rate 16l/min light brown tolerance ±15%		
	<b>GEV No.</b>	371226	<b>Ref. No.</b> —
	reducer TP flow rate 20l/min red tolerance ±15%		
	<b>GEV No.</b>	371230	<b>Ref. No.</b> —
	reducer TP flow rate 0.25l/min red tolerance ±25%		
	<b>GEV No.</b>	371231	<b>Ref. No.</b> —
	reducer TP flow rate 0.35l/min violet tolerance ±25%		
	<b>GEV No.</b>	371232	<b>Ref. No.</b> —
	reducer TP flow rate 0.5l/min orange tolerance ±25%		
	<b>GEV No.</b>	371233	<b>Ref. No.</b> —
	reducer TP flow rate 0.8l/min white tolerance ±25%		
	<b>GEV No.</b>	371234	<b>Ref. No.</b> —
	reducer TP flow rate 1l/min light blue tolerance ±25%		
	<b>GEV No.</b>	371235	<b>Ref. No.</b> —
	reducer TP flow rate 1.2l/min brown tolerance ±25%		

Table continues overleaf

electric components

Зип-Общепит  
vsezip.ru  
+7(812)987-08-81

accessories for		370021	
	GEV No.	371236	Ref. No. —
reducer TP flow rate 1.5l/min light brown tolerance ±25%			
	GEV No.	371237	Ref. No. —
reducer TP flow rate 2.5l/min yellow tolerance ±25%			
	GEV No.	371238	Ref. No. —
reducer TP flow rate 3.4l/min dark green tolerance ±25%			
	GEV No.	371239	Ref. No. —
reducer TP flow rate 5l/min black tolerance ±25%			
	GEV No.	371240	Ref. No. —
reducer TP flow rate 8l/min blue tolerance ±20%			

  <b>1</b>			
<b>GEV No.</b>	370017	<b>Ref. No.</b>	500081300 80004267
<b>description</b>	solenoid valve single straight 230VAC inlet 3/4" outlet 11.5mm DN10 TP p max 10bar		
<b>For models:</b>	MB235LI, MB240LI, MB9235, MB9240, MB9500, MB9501, MB9503, MLP50, MLP56, MS351, MS353, MS400E, MS451, MS453, MS500E, MS800E, MS905, MS9400, MS9401, MS9403, MS9451, MS9453		
<b>spare parts for</b>	370017		
	GEV No.	371013	Ref. No. —
solenoid coil TP 230VAC 50/60Hz			
<b>accessories for</b>	370017		
	GEV No.	371220	Ref. No. —
reducer TP flow rate 3l/min red tolerance ±15%			
	GEV No.	371221	Ref. No. —
reducer TP flow rate 5.5l/min yellow tolerance ±15%			
	GEV No.	371222	Ref. No. —
reducer TP flow rate 6l/min grey tolerance ±15%			
	GEV No.	371223	Ref. No. —
reducer TP flow rate 10l/min white tolerance ±15%			
	GEV No.	371224	Ref. No. —
reducer TP flow rate 12l/min bronze tolerance ±15%			
	GEV No.	371225	Ref. No. —
reducer TP flow rate 16l/min light brown tolerance ±15%			
	GEV No.	371226	Ref. No. —
reducer TP flow rate 20l/min red tolerance ±15%			
	GEV No.	371230	Ref. No. —
reducer TP flow rate 0.25l/min red tolerance ±25%			

accessories for		370017	
	GEV No.	371231	Ref. No. —
reducer TP flow rate 0.35l/min violet tolerance ±25%			
	GEV No.	371232	Ref. No. —
reducer TP flow rate 0.5l/min orange tolerance ±25%			
	GEV No.	371233	Ref. No. —
reducer TP flow rate 0.8l/min white tolerance ±25%			
	GEV No.	371234	Ref. No. —
reducer TP flow rate 1l/min light blue tolerance ±25%			
	GEV No.	371235	Ref. No. —
reducer TP flow rate 1.2l/min brown tolerance ±25%			
	GEV No.	371236	Ref. No. —
reducer TP flow rate 1.5l/min light brown tolerance ±25%			
	GEV No.	371237	Ref. No. —
reducer TP flow rate 2.5l/min yellow tolerance ±25%			
	GEV No.	371238	Ref. No. —
reducer TP flow rate 3.4l/min dark green tolerance ±25%			
	GEV No.	371239	Ref. No. —
reducer TP flow rate 5l/min black tolerance ±25%			
	GEV No.	371240	Ref. No. —
reducer TP flow rate 8l/min blue tolerance ±20%			







  <b>1</b>			
<b>GEV No.</b>	370025	<b>Ref. No.</b>	500001200 80001195
<b>description</b>	solenoid valve triple straight 230VAC inlet 3/4" outlet 11.5mm DN10 TP		
<b>For models:</b>	MB520K, MB530K, MB930K, MGL500		
<b>spare parts for</b>	370025		
	GEV No.	371013	Ref. No. —
solenoid coil TP 230VAC 50/60Hz			
<b>accessories for</b>	370025		
	GEV No.	371220	Ref. No. —
reducer TP flow rate 3l/min red tolerance ±15%			
	GEV No.	371221	Ref. No. —
reducer TP flow rate 5.5l/min yellow tolerance ±15%			
	GEV No.	371222	Ref. No. —
reducer TP flow rate 6l/min grey tolerance ±15%			
	GEV No.	371223	Ref. No. —
reducer TP flow rate 10l/min white tolerance ±15%			



Table continues overleaf



Зип Общепит

vsezip.ru

+7(812)987-08-81

accessories for		370025	
	GEV No.	371224	Ref. No. —
reducer TP flow rate 12l/min bronze tolerance ±15%			
	GEV No.	371225	Ref. No. —
reducer TP flow rate 16l/min light brown tolerance ±15%			
	GEV No.	371226	Ref. No. —
reducer TP flow rate 20l/min red tolerance ±15%			
	GEV No.	371230	Ref. No. —
reducer TP flow rate 0.25l/min red tolerance ±25%			
	GEV No.	371231	Ref. No. —
reducer TP flow rate 0.35l/min violet tolerance ±25%			
	GEV No.	371232	Ref. No. —
reducer TP flow rate 0.5l/min orange tolerance ±25%			
	GEV No.	371233	Ref. No. —
reducer TP flow rate 0.8l/min white tolerance ±25%			
	GEV No.	371234	Ref. No. —
reducer TP flow rate 1l/min light blue tolerance ±25%			
	GEV No.	371235	Ref. No. —
reducer TP flow rate 1.2l/min brown tolerance ±25%			
	GEV No.	371236	Ref. No. —
reducer TP flow rate 1.5l/min light brown tolerance ±25%			
	GEV No.	371237	Ref. No. —
reducer TP flow rate 2.5l/min yellow tolerance ±25%			
	GEV No.	371238	Ref. No. —
reducer TP flow rate 3.4l/min dark green tolerance ±25%			
	GEV No.	371239	Ref. No. —
reducer TP flow rate 5l/min black tolerance ±25%			
	GEV No.	371240	Ref. No. —
reducer TP flow rate 8l/min blue tolerance ±20%			

	GEV No.	504133	Ref. No.	511042400 80002937
<b>description</b> solenoid valve connection T-shape thread 1¼"				
<b>For models:</b> MGL40				

### pressure switches

for warewashing

ø 58mm with male faston 6.3mm

with connection horizontal

	1		
GEV No.	541142	Ref. No.	50000500 80002283 80002285 80002287
<b>description</b> pressure control pressure range 123/75mbar connection 6mm ø 58mm pressure connection horizontal warewashing			
<b>For models:</b> MLP50, MS1100, MS1100E, MS1100P, MS1300, MS1300E, MS1300P, MS700, MS700E, MS900, MS900E, MS905			

	1		
GEV No.	542428	Ref. No.	500043700
<b>description</b> pressure control pressure range 200/60mbar connection 6mm ø 58mm pressure connection horizontal warewashing			
<b>For models:</b> MLP140, MLP60, MLP60E, MLP70, MLP80			

	1		
GEV No.	541001	Ref. No.	500042700 80002273 80002289
<b>description</b> pressure control pressure range 35/17mbar connection 6mm ø 58mm pressure connection horizontal warewashing			
<b>For models:</b> GL220, MB235LI, MB240LI, MB510E, MB510ER, MB520, MB520K, MB530, MB530K, MB535, MB630, MB630PS, MB920E, MB920ER, MB9235, MB9240, MB930, MB930K, MB930PS, MB930T, MB9510, MB9510R, MB9920, MB9920R, MGL500, MLP140, MLP50, MLP60, MLP60E, MLP70, MLP80			

### Solenoid valve - accessories

	1		
GEV No.	504132	Ref. No.	511042300 80002935
<b>description</b> solenoid valve connection thread 1¼"			
<b>For models:</b> MGL40			



Зип.Общепит pumps

wash and rinse pumps  
vsezip.ru

electric components

1 

<b>GEV No.</b>	541159	<b>Ref. No.</b>	500000400 80002277 80002279 80002281
<b>description</b>	pressure control pressure range 56/25mbar connection 6mm ø 58mm pressure connection horizontal warewashing pressure connection ø 6mm		
<b>For models:</b>	GL250, MB235LI, MB240LI, MB510E, MB510ER, MB630, MB920E, MB920ER, MB930, MB930K, MB9500, MB9501, MB9503, MLP50, MLP56, MS1100E, MS1100P, MS1100T, MS1300E, MS1300P, MS1300T, MS350, MS350PS, MS350TRI, MS351, MS353, MS400B, MS400E, MS400T, MS450, MS450E, MS450PS, MS451, MS453, MS500B, MS500E, MS500T, MS800B, MS800E, MS800T, MS900E, MS900T, MS905, MS9400, MS9401, MS9403, MS9451, MS9453		

accessories

1 

<b>GEV No.</b>	504112	<b>Ref. No.</b>	513060600 80002463
<b>description</b>	bracket for pressure switch		
<b>For models:</b>	GL220, GL250, MB510E, MB520, MB520K, MB530, MB530K, MB535, MB630, MB930, MB930K, MLP140, MLP60, MLP60E, MLP70, MLP80, MS1100, MS1100E, MS1100P, MS1100T, MS1300, MS1300E, MS1300P, MS1300T, MS350, MS350PS, MS450, MS450E, MS450PS, MS700, MS700E, MS900, MS900E, MS900T, MS905		

electrodes

1 

<b>GEV No.</b>	504138	<b>Ref. No.</b>	513135200 80002975
<b>description</b>	level electrode M10 total length 56mm probe L 30mm insulated probe length 26mm connection bullet connector ø 14mm		
<b>For models:</b>	MGL40, MGL500, MLP140, MLP70, MLP80		

1 

<b>GEV No.</b>	500333	<b>Ref. No.</b>	512040200 512044300 512046400 80004015
<b>description</b>	pump inlet ø 1 1/4" IT outlet ø 1" type CDXHM/A 70/5 230V 50Hz 0.37kW capacitor 12.5µF EBARA 0.5HP		
<b>For models:</b>	MLP140, MLP70, MLP80		
<b>accessories for</b>	500333		
	<b>GEV No.</b>	365014	<b>Ref. No.</b> —
	operating capacitor capacity 12.5µF 450V tolerance 5%Hz ambient temperature max. -25 to +85°C ø 35mm L 70mm M8 plastic connection male faston 6.3mm 45S.C3DS.12.5 protection		

FIR pumps

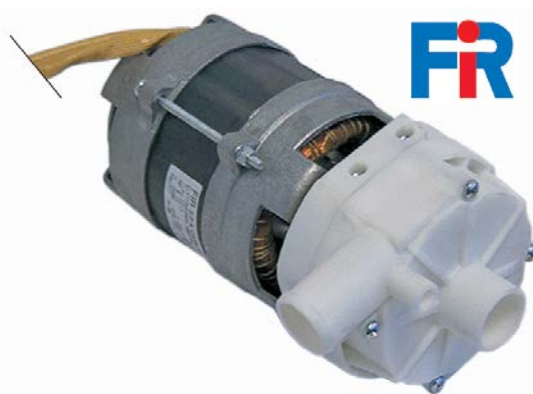
1 





<b>GEV No.</b>	500037	<b>Ref. No.</b>	512073800
<b>description</b>	pump inlet ø 28mm outlet ø 26mm type 2211.1410 230V 50Hz 1 phase 0.074kW 0.1HP L 190mm rotation direction left capacitor 5µF FIR		
<b>spare parts for</b>	500037		
	<b>GEV No.</b>	365017	<b>Ref. No.</b> —
	operating capacitor capacity 5µF 450V tolerance 5% 50/60Hz ambient temperature max. -25 to +85°C ø 28mm L 54mm M8 plastic connection male faston 6.3mm 16.10.08 protection		
	<b>GEV No.</b>	510384	<b>Ref. No.</b> —
	pump cover inlet ø 28mm outlet ø 26mm ø 100mm ID ø 76mm		
	<b>GEV No.</b>	510695	<b>Ref. No.</b> 512014800 80001523
	mechanical shaft seal height counter ring 5.5mm ID ø 11mm		

Table continues overleaf







Зип Общепит







vsezip.ru

+7(812)987-08-81

spare parts for		500037	
	GEV No.	521203	Ref. No. —
	impellor ø 72mm H 18mm thread M7 shaft ø 11mm shaft length 32mm blades 3		
	GEV No.	521703	Ref. No. —
	pump cover gasket EPDM thickness 2.5mm ID ø 75mm Qr. 1 pcs		



1		GEV No.	365014	Ref. No.	—
	operating capacitor capacity 12.5µF 450V tolerance 5%Hz ambient temperature max. -25 to +85°C ø 35mm L 70mm M8 plastic connection male faston 6.3mm 45S.C3DS.12.5 protection				
		GEV No.	510607	Ref. No.	—
	impellor ø 85mm H 29mm shaft intake ø 9x8mm rotation direction right blades 6				
		GEV No.	510695	Ref. No.	512014800 80001523
	mechanical shaft seal height counter ring 5.5mm ID ø 11mm				
		GEV No.	521571	Ref. No.	512012700
	pump cover FIR inlet ø 30mm outlet ø 30mm turn direction right ø 128mm ID ø 100mm inner hight 21mm				
		GEV No.	521701	Ref. No.	512014700 80002157
	pump cover gasket				
		GEV No.	521707	Ref. No.	—
	pump cover gasket				

1		GEV No.	365015	Ref. No.	512008200 80001509
	operating capacitor capacity 10µF 400V tolerance 5%Hz ambient temperature max. -25 to +85°C ø 35.5mm L 59mm M8 plastic connection male faston 6.3mm protection				
		GEV No.	510607	Ref. No.	—
	impellor ø 85mm H 29mm shaft intake ø 9x8mm rotation direction right blades 6				
		GEV No.	510695	Ref. No.	512014800 80001523
	mechanical shaft seal height counter ring 5.5mm ID ø 11mm				
		GEV No.	521571	Ref. No.	512012700
	pump cover FIR inlet ø 30mm outlet ø 30mm turn direction right ø 128mm ID ø 100mm inner hight 21mm				
		GEV No.	521701	Ref. No.	512014700 80002157
	pump cover gasket				
		GEV No.	521707	Ref. No.	—
	pump cover gasket				



Зип Общепит

vsezip.ru

+7(812)987-08-81



1

<b>GEV No.</b>	500038	<b>Ref. No.</b>	512074800
<b>description</b>	pump inlet ø 45mm outlet ø 40mm type 3911.1425 230V 50Hz 1 phase 0.55kW 0.75HP L 205mm rotation direction right capacitor 10µF FIR		
<b>spare parts for</b>	500038		
	<b>GEV No.</b>	510508	<b>Ref. No.</b> —
	pump cover FIR inlet ø 45mm outlet ø 40mm pump type PU 0.5/3911 turn direction right ø 160mm ID ø 125mm inner height 25mm		
	<b>GEV No.</b>	510610	<b>Ref. No.</b> 512012000 80001287
	impeller ø 95.5mm H 23mm shaft intake ø 9/8mm rotation direction right seat ø 16mm blades 6		
	<b>GEV No.</b>	510692	<b>Ref. No.</b> 512012100 80001285
	mechanical shaft seal for shaft ø 11mm slide ring ext. ø 24mm slide ring H 13mm counter ring mounting ø 26mm height counter ring 8mm counter ring int. ø 14mm		
	<b>GEV No.</b>	521702	<b>Ref. No.</b> 512013500 80001289
	pump cover gasket thickness 3.5x4.5mm Qty 1 pcs		
<b>accessories for</b>	500038		
	<b>GEV No.</b>	365015	<b>Ref. No.</b> 512008200 80001509
	operating capacitor capacity 10µF 400V tolerance 5%Hz ambient temperature max. -25 to +85°C ø 35.5mm L 59mm M8 plastic connection male faston 6.3mm protection		
	<b>GEV No.</b>	551286	<b>Ref. No.</b> —
	adapter L 120mm 4-pole for Meiko pump suitable for 500038 plug type dependent on equipment		



1

<b>GEV No.</b>	500981	<b>Ref. No.</b>	512055400
<b>description</b>	pump inlet ø 45mm outlet ø 40mm type 4281.2350 230V 50Hz 1 phase 0.55kW 0.75HP L 230mm rotation direction right capacitor 12.5µF FIR		
<b>For models:</b>	MGL500, MS400B, MS400T, MS500B, MS500T		



1

<b>GEV No.</b>	499362	<b>Ref. No.</b>	512080700 512080800
<b>description</b>	pump inlet ø 63 outlet ø 48 type 4295.2351 230V 50Hz 1 phase 0.9kW L 270mm rotation direction right capacitor 16µF FIR with mounting angle 2800rpm nominal 4.2A		







Зип-Общепит

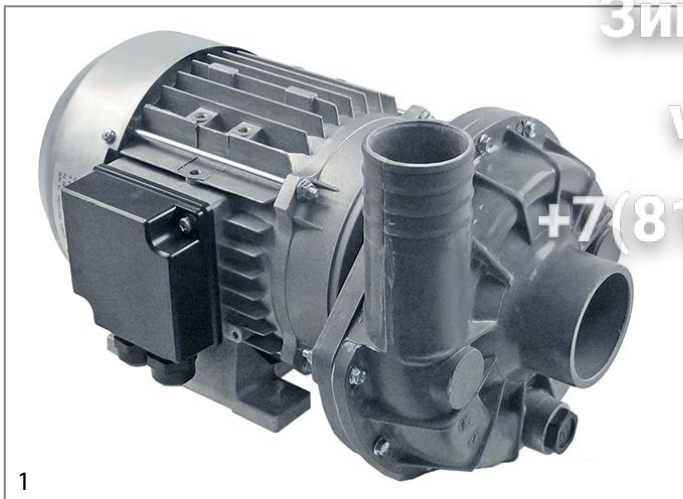

vsezip.ru

+7(812)987-08-81



1

<b>GEV No.</b>	500023	<b>Ref. No.</b>	512032400 80002409
<b>description</b>	pump inlet ø 63mm outlet ø 47mm type 1225.2725 230/400V 50Hz 3 phase 1.1kW 1.5HP L 335mm rotation direction right FIR		
<b>For models:</b>	MS1100, MS1100E, MS1100T, MS900, MS900E, MS900T		
<b>spare parts for</b>	500023		
	<b>GEV No.</b>	510602	<b>Ref. No.</b> 512047100 80002859
	impellor ø 110mm H 34mm rotation direction right thread M8L shaft ø 28mm seat ø 12.2mm blades 6		
	<b>GEV No.</b>	510693	<b>Ref. No.</b> 512011200 80001305 80004115 80004671
	mechanical shaft seal for shaft ø 12mm slide ring ext. ø 24mm slide ring H 15.5mm slide ring int. ø 11mm counter ring mounting ø 24mm height counter ring 8mm counter ring int. ø 13.5mm		
	<b>GEV No.</b>	521513	<b>Ref. No.</b> 512012500
	pump cover FIR inlet ø 63mm outlet ø 47mm turn direction right ID ø 150mm inner height 32mm		
	<b>GEV No.</b>	524416	<b>Ref. No.</b> —
	pump cover gasket thickness 4x4mm Qty 1 pcs		

<b>GEV No.</b>	510693	<b>Ref. No.</b>	512011200 80001305 80004115 80004671
	mechanical shaft seal for shaft ø 12mm slide ring ext. ø 24mm slide ring H 15.5mm slide ring int. ø 11mm counter ring mounting ø 24mm height counter ring 8mm counter ring int. ø 13.5mm		
	<b>GEV No.</b>	521513	<b>Ref. No.</b> 512012500
	pump cover FIR inlet ø 63mm outlet ø 47mm turn direction right ID ø 150mm inner height 32mm		
	<b>GEV No.</b>	524416	<b>Ref. No.</b> —
	pump cover gasket thickness 4x4mm Qty 1 pcs		



1

<b>GEV No.</b>	500325	<b>Ref. No.</b>	512007600 80001297
<b>description</b>	pump inlet ø 63mm outlet ø 47mm type 1293.1603 230V 50Hz 1 phase 0.55kW 0.75HP L 300mm rotation direction right capacitor 12.5µF FIR		
<b>For models:</b>	MS450, MS450E, MS450PS		
<b>spare parts for</b>	500325		
	<b>GEV No.</b>	365014	<b>Ref. No.</b> —
	operating capacitor capacity 12.5µF 450V tolerance 5%Hz ambient temperature max. -25 to +85°C ø 35mm L 70mm M8 plastic connection male faston 6.3mm 45S.C3DS.12.5 protection		
	<b>GEV No.</b>	510601	<b>Ref. No.</b> 512011700 80001307
	impellor ø 103mm H 25mm rotation direction right thread M8L seat ø 12.2mm blades 6		
	<b>GEV No.</b>	510693	<b>Ref. No.</b> 512011200 80001305 80004115 80004671
	mechanical shaft seal for shaft ø 12mm slide ring ext. ø 24mm slide ring H 15.5mm slide ring int. ø 11mm counter ring mounting ø 24mm height counter ring 8mm counter ring int. ø 13.5mm		
	<b>GEV No.</b>	521513	<b>Ref. No.</b> 512012500
	pump cover FIR inlet ø 63mm outlet ø 47mm turn direction right ID ø 150mm inner height 32mm		
	<b>GEV No.</b>	524416	<b>Ref. No.</b> —
	pump cover gasket thickness 4x4mm Qty 1 pcs		



1

<b>GEV No.</b>	500323	<b>Ref. No.</b>	512049800 80004255
<b>description</b>	pump inlet ø 63mm outlet ø 47mm type 1227.2721 230/400V 50Hz 3 phase 2kW 2.7HP L 335mm rotation direction right FIR		
<b>For models:</b>	MB240LI, MLP60, MLP60E		
<b>spare parts for</b>	500323		
	<b>GEV No.</b>	510599	<b>Ref. No.</b> 512052800 80004669
	impellor ø 123mm H 34mm M8L		



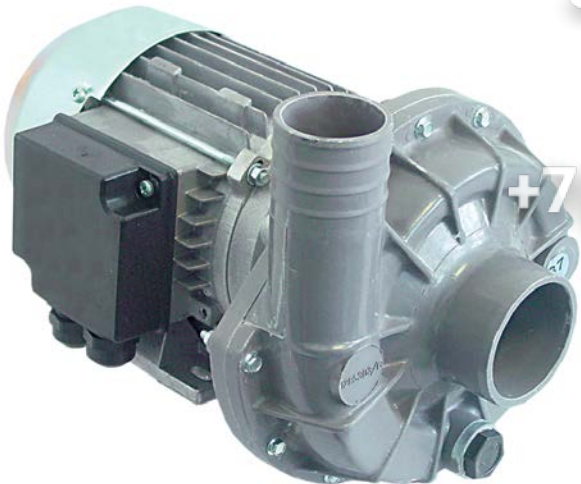

Зип Общепит

vsezip.ru





+7(812)987-08-81



1

<b>GEV No.</b>	500330	<b>Ref. No.</b>	512014400 80004225
<b>description</b>	pump inlet ø 63mm outlet ø 47mm type 1295.1409 230V 50Hz 1 phase 0.88kW 1.2HP L 305mm rotation direction right capacitor 12.5µF FIR		
<b>For models:</b>	MS1100, MS1100E, MS1100T, MS900, MS900E, MS900T, MS905		
<b>spare parts for</b>	500330		
	<b>GEV No.</b>	365014	<b>Ref. No.</b> —
	operating capacitor capacity 12.5µF 450V tolerance 5%Hz ambient temperature max. -25 to +85°C ø 35mm L 70mm M8 plastic connection male faston 6.3mm 45S.C3DS.12.5 protection		
	<b>GEV No.</b>	510693	<b>Ref. No.</b> 512011200 80001305 80004115 80004671
	mechanical shaft seal for shaft ø 12mm slide ring ext. ø 24mm slide ring H 15.5mm slide ring int. ø 11mm counter ring mounting ø 24mm height counter ring 8mm counter ring int. ø 13.5mm		
	<b>GEV No.</b>	521213	<b>Ref. No.</b> 512011800 80001697
	impellor ø 117mm H 24mm M8L		
	<b>GEV No.</b>	521513	<b>Ref. No.</b> 512012500
	pump cover FIR inlet ø 63mm outlet ø 47mm turn direction right ID ø 150mm inner height 32mm		
	<b>GEV No.</b>	524416	<b>Ref. No.</b> —
	pump cover gasket thickness 4x4mm Qty 1 pcs		

1

<b>GEV No.</b>	500029	<b>Ref. No.</b>	512007700 512024200 51204400 80001685 80002139
<b>description</b>	pump inlet ø 63mm outlet ø 47mm type 1295.2503 230/400V 50Hz 3 phase 0.88kW 1.2HP L 305mm rotation direction right FIR		
<b>For models:</b>	MS1100, MS1100E, MS1100T, MS700, MS700E, MS900, MS900E, MS900T		
<b>spare parts for</b>	500029		
	<b>GEV No.</b>	510693	<b>Ref. No.</b> 512011200 80001305 80004115 80004671
	mechanical shaft seal for shaft ø 12mm slide ring ext. ø 24mm slide ring H 15.5mm slide ring int. ø 11mm counter ring mounting ø 24mm height counter ring 8mm counter ring int. ø 13.5mm		
	<b>GEV No.</b>	521213	<b>Ref. No.</b> 512011800 80001697
	impellor ø 117mm H 24mm M8L		
	<b>GEV No.</b>	521513	<b>Ref. No.</b> 512012500
	pump cover FIR inlet ø 63mm outlet ø 47mm turn direction right ID ø 150mm inner height 32mm		
	<b>GEV No.</b>	524416	<b>Ref. No.</b> —
	pump cover gasket thickness 4x4mm Qty 1 pcs		

Зип Общепит





vsezip.ru

+7(812)987-08-81



<b>GEV No.</b>	500031	<b>Ref. No.</b>	512039800 80003823
<b>description</b>	pump inlet ø 63mm outlet ø 53mm type 1205.2528 230/400V 50Hz 3 phase 2kW 2.7HP L 330mm rotation direction left FIR		
<b>For models:</b>	MLP70, MLP80, MS1100P, MS1300P		
<b>spare parts for</b>	500031		
	<b>GEV No.</b>	510357	<b>Ref. No.</b> 512052700 80004113
	impellor ø 124mm H 34/16mm thread M8R blades 6		
	<b>GEV No.</b>	510523	<b>Ref. No.</b> —
	fan wheel ø 142mm shaft intake ø 15mm blades 12		
	<b>GEV No.</b>	510531	<b>Ref. No.</b> 512013700
	pump cover FIR inlet ø 63mm outlet ø 53mm auxiliary pressure connection M16x1.5mm supporting pressure open turn direction left ø 185mm ID ø 150mm inner hight 37mm		
	<b>GEV No.</b>	510693	<b>Ref. No.</b> 512011200 80001305 80004115 80004671
	mechanical shaft seal for shaft ø 12mm slide ringext. ø 24mm slide ring H 15.5mm slide ring int. ø 11mm counter ring mounting ø 24mm height counter ring 8mm counter ring int. ø 13.5mm		
	<b>GEV No.</b>	524416	<b>Ref. No.</b> —
	pump cover gasket thickness 4x4mm Qty 1 pcs		



<b>GEV No.</b>	500119	<b>Ref. No.</b>	512014500 80004221
<b>description</b>	pump inlet ø 63mm outlet ø 53mm type 1241.1402 230V 50Hz 1 phase 1.1kW 1.5HP L 330mm rotation direction left capacitor 31.5µF FIR		
<b>For models:</b>	MS1300, MS1300E, MS1300T		
<b>spare parts for</b>	500119		
	<b>GEV No.</b>	365016	<b>Ref. No.</b> —
	operating capacitor capacity 31.5µF 400V tolerance 5%Hz ambient temperature max. -25 to +85°C ø 45mm L 95mm M8 plastic connection male faston 6.3mm protection		
	<b>GEV No.</b>	510531	<b>Ref. No.</b> 512013700
	pump cover FIR inlet ø 63mm outlet ø 53mm auxiliary pressure connection M16x1.5mm supporting pressure open turn direction left ø 185mm ID ø 150mm inner hight 37mm		
	<b>GEV No.</b>	510612	<b>Ref. No.</b> 512011900 80001441
	impellor ø 110mm H 34mm M8R		
	<b>GEV No.</b>	510693	<b>Ref. No.</b> 512011200 80001305 80004115 80004671
	mechanical shaft seal for shaft ø 12mm slide ringext. ø 24mm slide ring H 15.5mm slide ring int. ø 11mm counter ring mounting ø 24mm height counter ring 8mm counter ring int. ø 13.5mm		
	<b>GEV No.</b>	524416	<b>Ref. No.</b> —
	pump cover gasket thickness 4x4mm Qty 1 pcs		



Зиг-Общепит



spare parts for 500324			
GEV No.	510531	Ref. No.	512013700
pump cover FIR inlet ø 63mm outlet ø 53mm auxiliary pressure connection M16x1.5mm supporting pressure open turn direction left ø 185mm ID ø 150mm inner height 37mm			
GEV No.	510693	Ref. No.	512011200 80001305 80004115 80004671
mechanical shaft seal for shaft ø 12mm slide ring ext. ø 24mm slide ring H 15.5mm slide ring int. ø 11mm counter ring mounting ø 24mm height counter ring 8mm counter ring int. ø 13.5mm			
GEV No.	524416	Ref. No.	—
pump cover gasket thickness 4x4mm Qty 1 pcs			

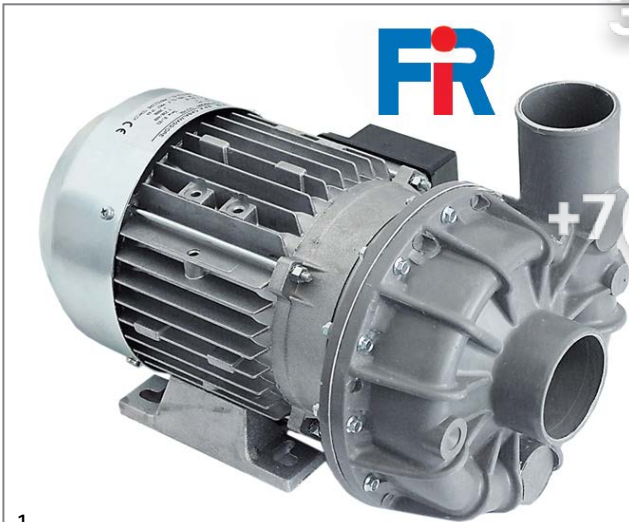

1

GEV No.	500111	Ref. No.	512007800 80001423
description pump inlet ø 63mm outlet ø 53mm type 1241.2500 230/400V 50Hz 3 phase 1.1kW 1.5HP L 330mm rotation direction left FIR			
For models: MS1300, MS1300E, MS1300T			
spare parts for 500111			
GEV No.	510531	Ref. No.	512013700
pump cover FIR inlet ø 63mm outlet ø 53mm auxiliary pressure connection M16x1.5mm supporting pressure open turn direction left ø 185mm ID ø 150mm inner height 37mm			
GEV No.	510612	Ref. No.	512011900 80001441
impellor ø 110mm H 34mm M8R			
GEV No.	510693	Ref. No.	512011200 80001305 80004115 80004671
mechanical shaft seal for shaft ø 12mm slide ring ext. ø 24mm slide ring H 15.5mm slide ring int. ø 11mm counter ring mounting ø 24mm height counter ring 8mm counter ring int. ø 13.5mm			
GEV No.	524416	Ref. No.	—
pump cover gasket thickness 4x4mm Qty 1 pcs			

LGB



1

GEV No.	499061	Ref. No.	512050800 80004317
description pump inlet ø 28mm outlet ø 26mm type ZF115SX 230V 50Hz 1 phase 0.21kW L 190mm capacitor 5µF LGB			
For models: MB235LI, MB9235, MB9240			
spare parts for 499061			
GEV No.	510122	Ref. No.	—
pump cover LGB inlet ø 28mm outlet ø 26mm auxiliary pressure connection 13mm supporting pressure open ø 98mm ID ø 77mm inner height 31mm			
GEV No.	510703	Ref. No.	512063400
mechanical shaft seal for shaft ø 13mm slide ring H 13mm height counter ring 5.5mm ED ø 26mm			
GEV No.	521221	Ref. No.	—
impellor ø 67mm H 16mm rotation direction right thread M7L shaft ø 13mm shaft length 12mm blades 8			
GEV No.	528800	Ref. No.	—
O-ring EPDM thickness 2.62mm ID ø 75.87mm Qty 1 pcs			
accessories for 499061			
GEV No.	365017	Ref. No.	—
operating capacitor capacity 5µF 450V tolerance 5% 50/60Hz ambient temperature max. -25 to +85°C ø 28mm L 54mm M8 plastic connection male faston 6.3mm 16.10.08 protection			



1

GEV No.	500324	Ref. No.	512044700 80004023
description pump inlet ø 63mm outlet ø 53mm type 1243.2591 230/400V 50Hz 3 phase 2.35kW 3.2HP L 365mm rotation direction left FIR			
For models: MLP140, MLP70, MLP80			
spare parts for 500324			
GEV No.	510357	Ref. No.	512052700 80004113
impellor ø 124mm H 34/16mm thread M8R blades 6			

# Зип Общежит





drain pumps

ASKOLL  
vsezip.ru

+7(812)987-08-81



1

<b>GEV No.</b>	499154	<b>Ref. No.</b>	51205500 80004611
<b>description</b>	pump inlet $\varnothing$ 45mm outlet $\varnothing$ 38mm type ZF320SX 230V 50Hz 1 phase 0.55kW 0.75HP L 205mm rotation direction right capacitor 12.5 $\mu$ F LGB		
<b>For models:</b>	MB9500, MB9501, MB9503, MS351, MS353, MS400E, MS451, MS453, MS500E, MS9400, MS9401, MS9403, MS9451, MS9453		
<b>spare parts for</b>	499154		
	<b>GEV No.</b>	365014	<b>Ref. No.</b> —
	operating capacitor capacity 12.5 $\mu$ F 450V tolerance 5%Hz ambient temperature max. -25 to +85°C $\varnothing$ 35mm L 70mm M8 plastic connection male faston 6.3mm 45S.C3DS.12.5 protection		
	<b>GEV No.</b>	510702	<b>Ref. No.</b> 512031300 80002321
	mechanical shaft seal height counter ring 5.5mm ID $\varnothing$ 12mm		
	<b>GEV No.</b>	521247	<b>Ref. No.</b> —
	impellor $\varnothing$ 80mm H 27mm rotation direction right thread M8L blades 6		
	<b>GEV No.</b>	521542	<b>Ref. No.</b> 512031600 80002311
	pump cover LGB inlet $\varnothing$ 45mm outlet $\varnothing$ 40mm auxiliary pressure connection 13mm supporting pressure open $\varnothing$ 150mm ID $\varnothing$ 120mm inner high 25mm		
	<b>GEV No.</b>	521714	<b>Ref. No.</b> 512034400 80002313
	pump cover gasket thickness 4x4mm Qty 1 pcs		

## booster pumps I



1

<b>GEV No.</b>	500944	<b>Ref. No.</b>	512023600 80004253
<b>description</b>	pump inlet $\varnothing$ 3/8" IT outlet $\varnothing$ 3/8" IT type PS45DX 230V 50Hz 0.3kW 2800rpm $\varnothing$ 100mm L 170mm rotation direction left capacitor 8 $\mu$ F LGB		
<b>For models:</b>	MGL500, MLP50, MLP56, MLP60, MLP60E, MS1100P, MS1300P, MS400T, MS500PPB, MS500T, MS800B, MS800T		
<b>accessories for</b>	500944		
	<b>GEV No.</b>	365013	<b>Ref. No.</b> —
	operating capacitor capacity 8 $\mu$ F 400V tolerance 5%Hz ambient temperature max. -25 to +85°C $\varnothing$ 31.5mm L 55mm M8 plastic connection male faston 6.3mm protection		



1

<b>GEV No.</b>	499310	<b>Ref. No.</b>	512052100
<b>description</b>	drain pump 40W 220V inlet $\varnothing$ 24mm outlet $\varnothing$ 22mm 50Hz ASKOLL type M231 XP complete		
<b>For models:</b>	MB630PS, MB9235, MB9240, MB930PS, MB9510, MB9510R, MB9920, MB9920R, MGL40, MLP50		

## GRE



1

<b>GEV No.</b>	500039	<b>Ref. No.</b>	512006900 80002817
<b>description</b>	pump inlet $\varnothing$ 24mm outlet $\varnothing$ 24mm 190W 230V 50Hz GRE		
<b>For models:</b>	MS350PS, MS450PS		

## PLASET



1

<b>GEV No.</b>	500926	<b>Ref. No.</b>	512052200 512055700 80004473 80004617
<b>description</b>	drain pump inlet $\varnothing$ 30mm outlet $\varnothing$ 22mm 230V 34W 50Hz PLASET type 53176		
<b>For models:</b>	MB630, MB630PS, MB930, MB930K, MB930PS, MB930T, MB9500, MB9501, MB9503, MGL500, MLP50, MS1100T, MS1300T, MS400T, MS500PPB, MS500T, MS800T, MS900T, MS9400, MS9401, MS9403, MS9451, MS9453		

booster pumps II

accessories



<b>GEV No.</b>	365015	<b>Ref. No.</b>	512008200 80001509
<b>description</b>	operating capacitor capacity 10µF 400V tolerance 5%Hz ambient temperature max. -25 to +85°C ø 35.5mm L 59mm M8 plastic connection male faston 6.3mm protection		
<b>For models:</b>	GL220, MB510E, MB510ER, MB520, MB520K, MB530, MB530K, MB535, MB630, MB630PS, MB920E, MB920ER, MB930, MB930K, MB930PS, MB930T		

condensators & interference suppression filters

operating capacitors

plastic



<b>GEV No.</b>	365015	<b>Ref. No.</b>	512008200 80001509
<b>description</b>	operating capacitor capacity 10µF 400V tolerance 5%Hz ambient temperature max. -25 to +85°C ø 35.5mm L 59mm M8 plastic connection male faston 6.3mm protection		
<b>For models:</b>	GL220, MB510E, MB510ER, MB520, MB520K, MB530, MB530K, MB535, MB630, MB630PS, MB920E, MB920ER, MB930, MB930K, MB930PS, MB930T		



<b>GEV No.</b>	365009	<b>Ref. No.</b>	512008300
<b>description</b>	operating capacitor capacity 2.5µF 400V tolerance 5% 50Hz ambient temperature max. -25 to +85°C ø 36.5mm L 55mm M8 plastic connection male faston 6.3mm 1.27.65C3 protection		
<b>For models:</b>	MB235LI, MB240LI, MB9510, MB9510R, MB9920, MB9920R		

filters

interference suppression filters



<b>GEV No.</b>	365043	<b>Ref. No.</b>	500011600 80003933
<b>description</b>	interference suppression filter type 790Y2 240V 50/60Hz conductor 2 with E connection cable 100mm L 42mm ø 23.5mm Hmm Wmm plastic Qty 1 pcs		
<b>For models:</b>	MLP140, MLP60, MLP60E, MLP70, MLP80		

Зип Общепит

vsezip.ru

+7(812)987-08-81



<b>GEV No.</b>	365169	<b>Ref. No.</b>	500088000
<b>description</b>	interference suppression filter type FC489001 400V 50/60Hz conductor 4 with E connection cable 200mm L 55mm ø 37.5mm Hmm Wmm plastic Qty 1 pcs		
<b>For models:</b>	MB9500, MB9503, MGL500, MLP50, MLP56, MS1100E, MS1100P, MS1100T, MS1300E, MS1300P, MS1300T, MS351, MS353, MS400B, MS400T, MS451, MS453, MS500B, MS500T, MS800B, MS800E, MS800T, MS900E, MS900T, MS905, MS9400, MS9403, MS9451, MS9453		



<b>GEV No.</b>	365044	<b>Ref. No.</b>	500011400 80002441
<b>description</b>	interference suppression filter type FC701Y2F 250V 50-60Hz conductor 2 with E connection cable 200mm L 42mm ø 23mm Hmm Wmm plastic Qty 1 pcs		
<b>For models:</b>	GL220, GL250, MB235LI, MB240LI, MB510E, MB510ER, MB520, MB520K, MB530, MB530K, MB535, MB630, MB630PS, MB920E, MB920ER, MB9235, MB9240, MB930, MB930K, MB930PS, MB930T, MB9501, MB9510, MB9510R, MB9920, MB9920R, MGL40, MGL500, MLP50, MS1100, MS1100E, MS1100P, MS1100T, MS1300, MS1300E, MS1300P, MS1300T, MS350, MS350PS, MS350TRI, MS351, MS353, MS400B, MS400E, MS400T, MS450, MS450E, MS450PS, MS451, MS453...(Other models you can see in the webshop)		

fuses

fine fuses



<b>GEV No.</b>	358678	<b>Ref. No.</b>	500087200
<b>description</b>	fine fuse size ø5x20mm 8A fast-acting rated 250V Qty 10 pcs		
<b>For models:</b>	MB9500, MB9501, MB9503, MLP50, MLP56, MS9400, MS9401, MS9403, MS9451, MS9453		



<b>GEV No.</b>	358690	<b>Ref. No.</b>	500014700 80002983
<b>description</b>	fine fuse size ø5x20mm 1A medium lag rated 250V Qty 10 pcs		
<b>For models:</b>	MGL40, MGL500, MLP140, MLP60, MLP60E, MLP70, MLP80, MS1100T, MS1300T, MS400T, MS500T, MS800T, MS900T		



Зип Общежит  
for dishwashers

vsezip.ru

+7 (812) 987-08-81

 <p>1</p>			
<b>GEV No.</b>	358697	<b>Ref. No.</b>	500014900 80002985
<b>description</b>	fine fuse size ø5x20mm 6.3A medium lag rated 250V Qty 10 pcs		
<b>For models:</b>	MB630, MB630PS, MB9235, MB9240, MB930, MB930K, MB930PS, MB930T, MB9510, MB9510R, MB9920, MB9920R, MGL40, MLP140, MLP60, MLP70, MLP80		

## electric accessories

### cables

#### ribbon cables

##### group 1

 <p>1</p>			
<b>GEV No.</b>	400718	<b>Ref. No.</b>	500032500 80001797
<b>description</b>	ribbon cable 20-pole L 1000mm plug type FC-20P raster size 2.54mm		
<b>For models:</b>	MS1100, MS1100E, MS1300, MS1300E, MS450, MS450E, MS450PS, MS700, MS900, MS900E		

### terminals

#### terminal blocks with fuse holder

 <p>1</p>			
<b>GEV No.</b>	358389	<b>Ref. No.</b>	512044100 80002981
<b>description</b>	lustre terminal 0-pole max. 10A max 250V suitable fuse ø5x20mm cross section 2.5mm <sup>2</sup> with fuse holder		
<b>For models:</b>	MB630, MB630PS, MB9235, MB9240, MB930, MB930K, MB930PS, MB930T, MB9500, MB9501, MB9503, MB9510, MB9510R, MB9920, MB9920R, MGL40, MGL500, MLP140, MLP50, MLP56, MLP60, MLP70, MLP80, MS1100T, MS1300T, MS400T, MS500T, MS800T, MS900T, MS9400, MS9401, MS9403, MS9451, MS9453		

### non-return valves

#### complete

 <p>1</p>			
<b>GEV No.</b>	543266	<b>Ref. No.</b>	500046300 80003889
<b>description</b>	non-return valve brass connection 3/8" IT - 3/8" IT total length 55mm DN10 Qty 1 pcs		
<b>For models:</b>	MGL500, MLP50, MLP60, MLP60E, MS800B, MS800T		

#### drain and intake components

#### drain /intake bodies

 <p>1</p>			
<b>GEV No.</b>	504135	<b>Ref. No.</b>	500055600 80002941
<b>description</b>	drain valve		
<b>For models:</b>	MGL40		

#### filters

 <p>1</p>			
<b>GEV No.</b>	504111	<b>Ref. No.</b>	513111200 80002459
<b>description</b>	bar for filter fixing L 44mm		
<b>For models:</b>	MB235LI, MB240LI, MB510E, MB510ER, MB920E, MB920ER		

 <p>1</p>			
<b>GEV No.</b>	504060	<b>Ref. No.</b>	513064900 80001817
<b>description</b>	centre web		
<b>For models:</b>	MS1100P, MS1300, MS1300E, MS1300P, MS1300T		

 <p>1</p>			
<b>GEV No.</b>	504061	<b>Ref. No.</b>	513065000 80001847
<b>description</b>	centre web		
<b>For models:</b>	MS1100, MS1100E, MS1100T, MS900, MS900E, MS900T, MS905		

 <p>1</p>			
<b>GEV No.</b>	504101	<b>Ref. No.</b>	513091300 80002403
<b>description</b>	centre web		
<b>For models:</b>	MS700, MS700E		

Зип Общепит  
vsezip.ru  
7(812)987-08-81

mechanical components, equipment accessories



1

<b>GEV No.</b>	504130	<b>Ref. No.</b>	511042800 80002923
<b>description</b>	drain filter		
<b>For models:</b>	MGL40		



1

<b>GEV No.</b>	517722	<b>Ref. No.</b>	512074900
<b>description</b>	filter ø 193mm H 84mm SS hole ø 37mm		
<b>For models:</b>	MS9451, MS9453		



1

<b>GEV No.</b>	504213	<b>Ref. No.</b>	513122800 80004027
<b>description</b>	filter support		
<b>For models:</b>	MLP140, MLP60, MLP60E, MLP70, MLP80		



1

<b>GEV No.</b>	504070	<b>Ref. No.</b>	513072700 80001961
<b>description</b>	filter support L 90mm		
<b>For models:</b>	GL220, MB520, MB520K, MB530, MB530K, MB535		



1

<b>GEV No.</b>	504039	<b>Ref. No.</b>	513045500 51345500 80001435
<b>description</b>	filter support ø 5mm L 49mm		
<b>For models:</b>	MLP50, MS1100, MS1100E, MS1100P, MS1100T, MS1300, MS1300E, MS1300P, MS1300T, MS350, MS350PS, MS350TRI, MS351, MS353, MS450, MS450E, MS450PS, MS451, MS453, MS700, MS700E, MS900, MS900E, MS900T, MS905		



1

<b>GEV No.</b>	504102	<b>Ref. No.</b>	511027400 80002405
<b>description</b>	flat filter		
<b>For models:</b>	MS700, MS700E		



1

<b>GEV No.</b>	504149	<b>Ref. No.</b>	511048200 80003851
<b>description</b>	flat filter		
<b>For models:</b>	MLP60, MLP60E		



1

<b>GEV No.</b>	504150	<b>Ref. No.</b>	511048300 80003853
<b>description</b>	flat filter		
<b>For models:</b>	MLP60, MLP60E		



1

<b>GEV No.</b>	504164	<b>Ref. No.</b>	511039900 80003997
<b>description</b>	flat filter		
<b>For models:</b>	MLP70, MLP80		



1

<b>GEV No.</b>	504165	<b>Ref. No.</b>	511040000 80003999
<b>description</b>	flat filter		
<b>For models:</b>	MLP70, MLP80		







Зип Общепит

vsezip.ru

7(812)987-08-81



 <p>1</p>			
<b>GEV No.</b>	504189	<b>Ref. No.</b>	511044400 80004161
<b>description</b>	flat filter		
<b>For models:</b>	MLP140		

 <p>1</p>			
<b>GEV No.</b>	504190	<b>Ref. No.</b>	511044500 80004163
<b>description</b>	flat filter		
<b>For models:</b>	MLP140		

 <p>1</p>			
<b>GEV No.</b>	504211	<b>Ref. No.</b>	511049100 80004419
<b>description</b>	flat filter		
<b>For models:</b>	MS1100P, MS1300, MS1300E, MS1300P, MS1300T		

 <p>1</p>			
<b>GEV No.</b>	504210	<b>Ref. No.</b>	511049000 80004411
<b>description</b>	flat filter H 15mm L 225mm W 215mm		
<b>For models:</b>	MS1100, MS1100E, MS900, MS900E, MS905		

 <p>1</p>			
<b>GEV No.</b>	507368	<b>Ref. No.</b>	51.2.0728.00 511061000 511062400 80004535
<b>description</b>	round filters mounting pos. lower suction		
<b>For models:</b>	MLP50, MS400B, MS400E, MS400T, MS500B, MS500E, MS500T, MS800B, MS800E, MS800T		

 <p>1</p>			
<b>GEV No.</b>	504106	<b>Ref. No.</b>	511033200 80002427
<b>description</b>	round filters outflow		
<b>For models:</b>	MB235LI, MB240LI, MB510E, MB510ER, MB920E, MB920ER		
<b>accessories for</b>	504106		
			
<b>GEV No.</b>	504111	<b>Ref. No.</b>	513111200 80002459
bar for filter fixing L 44mm			

 <p>1</p>			
<b>GEV No.</b>	504126	<b>Ref. No.</b>	511031400 80002833
<b>description</b>	round filters outflow ø 109mm H 50mm		
<b>For models:</b>	MS350PS, MS450PS		

 <p>1</p>			
<b>GEV No.</b>	504005	<b>Ref. No.</b>	511020600 80001051
<b>description</b>	round filters outflow ø 190mm		
<b>For models:</b>	MS1100, MS1100E, MS1100P, MS1100T, MS1300, MS1300E, MS1300P, MS1300T, MS350, MS350PS, MS350TRI, MS351, MS353, MS450, MS450E, MS450PS, MS451, MS453, MS700, MS700E, MS900, MS900E, MS900T, MS905		

<p>overflow pipes</p>			
 <p>1</p>			
<b>GEV No.</b>	510072	<b>Ref. No.</b>	512013100 513013100 80002243
<b>description</b>	O-ring EPDM thickness 3.53mm ID ø 32.93mm Qty 1 pcs		
<b>For models:</b>	GL250, MB510E, MB510ER, MB630, MB920E, MB920ER, MB930, MB930K, MB930T, MGL40		

mechanical components, equipment accessories

Зип-Общепит

boilers

boilers for dishwashers

vsezip.ru

+7(812)987-08-81

			
1			
<b>GEV No.</b>	504064	<b>Ref. No.</b>	511023500 80001233 80001913
<b>description</b>	overflow pipe L 115mm ø 27mm		
<b>For models:</b>	GL220, MB235LI, MB240LI, MB510E, MB510ER, MB520, MB520K, MB530, MB530K, MB535, MB920E, MB920ER, MS350, MS350PS, MS350TRI, MS351, MS353, MS450, MS450E, MS450PS, MS451, MS453		

			
1			
<b>GEV No.</b>	504016	<b>Ref. No.</b>	511000200 80001101
<b>description</b>	boiler		
<b>For models:</b>	MS450, MS450E, MS450PS, MS700, MS700E		

			
1			
<b>GEV No.</b>	504200	<b>Ref. No.</b>	511051100 80004287
<b>description</b>	overflow pipe L 300mm ø 27mm		
<b>For models:</b>	MLP60, MLP60E		

			
1			
<b>GEV No.</b>	504034	<b>Ref. No.</b>	511006300 80001385
<b>description</b>	boiler		
<b>For models:</b>	MS1100P, MS1300, MS1300E, MS1300P		

			
1			
<b>GEV No.</b>	517723	<b>Ref. No.</b>	511099600
<b>description</b>	overflow pipe ø 28mm L 113mm		
<b>For models:</b>	MS9451, MS9453		

			
1			
<b>GEV No.</b>	504067	<b>Ref. No.</b>	511018600 80001935 S11018600
<b>description</b>	boiler		
<b>For models:</b>	GL220, MB520, MB520K, MB530, MB530K, MB535		

			
1			
<b>GEV No.</b>	517724	<b>Ref. No.</b>	511099700
<b>description</b>	overflow pipe ø 28mm L 139mm		
<b>For models:</b>	MB630, MB630PS, MB9235, MB9240, MB930, MB930K, MB930PS, MB930T, MB9510, MB9510R, MB9920, MB9920R		

			
1			
<b>GEV No.</b>	504094	<b>Ref. No.</b>	511030400 80002329
<b>description</b>	boiler		
<b>For models:</b>	GL250, MS350, MS350PS, MS350TRI		



Зип Общепит

vsezip.ru

+7(812)987-08-81

1



<b>GEV No.</b>	504137	<b>Ref. No.</b>	511042700 511071800 80002953
<b>description</b>	boiler		
<b>For models:</b>	MGL40		

1



<b>GEV No.</b>	504274	<b>Ref. No.</b>	511052300 80002505
<b>description</b>	boiler ø 130mm L 320mm new edition		
<b>For models:</b>	MB235LI, MB240LI, MB510E, MB510ER		

1



<b>GEV No.</b>	504148	<b>Ref. No.</b>	511047500 80003837
<b>description</b>	boiler		
<b>For models:</b>	MLP60, MLP60E		

1



<b>GEV No.</b>	504087	<b>Ref. No.</b>	511050300 80002235
<b>description</b>	boiler ø 132mm L 375mm inlet ø 12		
<b>For models:</b>	GL250, MB240LI, MB630, MB630PS, MB920E, MB920ER, MB930, MB930K, MB930PS, MB930T		

1



<b>GEV No.</b>	504158	<b>Ref. No.</b>	511046100 80003897
<b>description</b>	boiler		
<b>For models:</b>	MLP70, MLP80		

1







<b>GEV No.</b>	504091	<b>Ref. No.</b>	511031000 80002259
<b>description</b>	boiler with insulation ø 158mm L 580mm connection 1/2" hose ø 12mm		
<b>For models:</b>	MS1100, MS1100E, MS900, MS900E		
<b>accessories for</b>	504091		

1



<b>GEV No.</b>	504195	<b>Ref. No.</b>	511045100 80004257
<b>description</b>	boiler		
<b>For models:</b>	MLP140		

	<b>GEV No.</b>	504050	<b>Ref. No.</b>	513000200 80001647
				nut thread M20x1.5
	<b>GEV No.</b>	504078	<b>Ref. No.</b>	513074700 80002023
				end cap
	<b>GEV No.</b>	504081	<b>Ref. No.</b>	512006500 512045300 80002189
				flat gasket FIBER ED ø 28mm ID ø 20mm thickness 2mm Qty 1 pcs
	<b>GEV No.</b>	504082	<b>Ref. No.</b>	513003400 80002195
				hose connector

1



<b>GEV No.</b>	504215	<b>Ref. No.</b>	511060100 511103100 80004599
<b>description</b>	boiler		
<b>For models:</b>	MS351, MS353, MS400B, MS400E, MS400T, MS451, MS453, MS500B, MS500E, MS500PPB, MS500T		

1



<b>GEV No.</b>	517726	<b>Ref. No.</b>	511080300
<b>description</b>	boiler with insulation ø 160mm L 574mm inlet ø 12		
<b>For models:</b>	MS1100, MS1100E, MS1100T, MS900, MS900E, MS900T, MS905		

mechanical components, equipment accessories

Зип Общепит

housing and covers

## accessories

			
1			
<b>GEV No.</b>	504078	<b>Ref. No.</b>	513074700 80002023
<b>description</b>	end cap		
<b>For models:</b>	MS1100, MS1300, MS450, MS450E, MS450PS, MS700, MS700E, MS900		

			
1			
<b>GEV No.</b>	504082	<b>Ref. No.</b>	513003400 80002195
<b>description</b>	hose connector		
<b>For models:</b>	GL220, GL250, MB235LI, MB240LI, MB510E, MB510ER, MB520, MB520K, MB530, MB530K, MB535, MB630, MB920E, MB930, MB930K, MGL40, MLP140, MLP60, MLP60E, MLP70, MLP80, MS1100, MS1300, MS350, MS350PS, MS450, MS450E, MS450PS, MS700, MS700E, MS900		

## rotation plates

## rotation plates

			
1			
<b>GEV No.</b>	504047	<b>Ref. No.</b>	512001700 80001591
<b>description</b>	rotation plate $\varnothing$ 280mm seat $\varnothing$ 15mm		
<b>For models:</b>	MB520, MB520K, MB530, MB530K, MB630, MB630PS, MB930, MB930K, MB930T		

## softener cartridges

## softening columns

			
1			
<b>GEV No.</b>	504046	<b>Ref. No.</b>	512008900 80001555
<b>description</b>	softener 4-fold L 380mm W 180mm		
<b>For models:</b>	MB520K, MB530K, MB930K		

## fascias

			
1			
<b>GEV No.</b>	504384	<b>Ref. No.</b>	600007100
<b>description</b>	control panel W 650mm H 600mm complete		

## hood mechanics for dishwashers

## bolts

			
1			
<b>GEV No.</b>	504264	<b>Ref. No.</b>	513233700
<b>description</b>	roller ED $\varnothing$ 25mm L 21mm thread M12x1.75/M6 hood mechanics warewashing		
<b>For models:</b>	MS1100E, MS1100P, MS1100T, MS1300E, MS1300P, MS1300T, MS900E, MS900T, MS905		

			
1			
<b>GEV No.</b>	504056	<b>Ref. No.</b>	513052700 80001711
<b>description</b>	screw bolt for hood joint		
<b>For models:</b>	MS1100, MS1100E, MS1100P, MS1300, MS1300E, MS1300P, MS900, MS900E, MS905		

## bushes

			
1			
<b>GEV No.</b>	504271	<b>Ref. No.</b>	513233800
<b>description</b>	bush ED $\varnothing$ 10mm ID $\varnothing$ 6.4mm L 3.6mm SS		
<b>For models:</b>	MS1100E, MS1100P, MS1100T, MS1300E, MS1300P, MS1300T, MS900E, MS900T, MS905		



Зип Общепит  
vsezip.ru

51304500  
80001359 (812)987-08-81



1

<b>GEV No.</b>	504031	<b>Ref. No.</b>	51304500 80001359
<b>description</b>	bush slotted hood mechanics		
<b>For models:</b>	MS1100, MS1100E, MS1100P, MS1100T, MS1300, MS1300E, MS1300P, MS1300T, MS900, MS900E, MS900T, MS905		

linkage

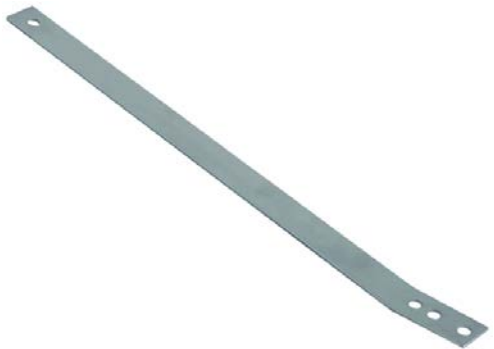

1

<b>GEV No.</b>	504029	<b>Ref. No.</b>	513029400 80001357
<b>description</b>	lace hood mechanics		
<b>For models:</b>	MLP55, MLP80, MS1100, MS1100E, MS1100P, MS1100T, MS1300, MS1300E, MS1300P, MS1300T, MS900, MS900E, MS900T, MS905		

hood handles



1

<b>GEV No.</b>	504452	<b>Ref. No.</b>	511086200
<b>description</b>	hood handle L 900mm W 700mm tube ø 25mm		
<b>For models:</b>	MS1100E, MS1100T, MS900E, MS900T, MS905		

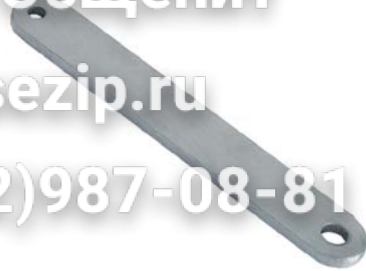

1

<b>GEV No.</b>	504054	<b>Ref. No.</b>	513052500 80001707
<b>description</b>	lever joint hood mechanics		
<b>For models:</b>	MS1100, MS1100E, MS1100P, MS1300, MS1300E, MS1300P, MS900, MS900E, MS905		



1

<b>GEV No.</b>	504267	<b>Ref. No.</b>	513233600
<b>description</b>	lever joint L 185mm W 25mm thickness 3mm hole ø 10mm hood mechanics SS		
<b>For models:</b>	MS1100E, MS1100P, MS1100T, MS1300E, MS1300P, MS1300T, MS900E, MS900T, MS905		

rollers



1

<b>GEV No.</b>	504055	<b>Ref. No.</b>	513052600 80001709
<b>description</b>	roller hood mechanics		
<b>For models:</b>	MS1100, MS1100E, MS1100P, MS1300, MS1300E, MS1300P, MS900, MS900E, MS905		

miscellaneous



1

<b>GEV No.</b>	504032	<b>Ref. No.</b>	513023300 80001371
<b>description</b>	clamp hood mechanics		
<b>For models:</b>	MS1100, MS1100E, MS1100P, MS1100T, MS1300, MS1300E, MS1300P, MS1300T, MS900, MS900E, MS900T, MS905		

mechanical components, equipment accessories

Зип Общепит

vsezip.ru

+7(812)987-08-81



<b>GEV No.</b>	504257	<b>Ref. No.</b>	1367 511011400 80001367
<b>description</b>	guide for hood linkage		
<b>For models:</b>	MS1100, MS1100E, MS1100P, MS1100T, MS1300, MS1300E, MS1300P, MS1300T, MS900, MS900E, MS900T, MS905		



<b>GEV No.</b>	504268	<b>Ref. No.</b>	513233900
<b>description</b>	plate L 38mm H 9mm W 26mm		
<b>For models:</b>	MS1100E, MS1100P, MS1100T, MS1300E, MS1300P, MS1300T, MS900E, MS900T, MS905		
<b>accessories for</b>	504268		
	<b>GEV No.</b>	<b>Ref. No.</b>	—
	560159		
	blind rivet SS $\phi$ 3.2mm L 10mm Qty 50 pcs DIN 1700		





<b>GEV No.</b>	504385	<b>Ref. No.</b>	511105500
<b>description</b>	plate with bolts D1 $\phi$ 14mm H 13mm W 25mm hole $\phi$ 7mm		



## air traps

## air traps





<b>GEV No.</b>	504028	<b>Ref. No.</b>	511007000 80001273
<b>description</b>	air trap		
<b>For models:</b>	MS450, MS450E, MS450PS, MS700		
<b>accessories for</b>	504028		
	<b>GEV No.</b>	<b>Ref. No.</b>	513000400 80001165
	503042		
	nut thread 3/8" H 6mm brass WS 22 Qty 1 pcs		
	<b>GEV No.</b>	<b>Ref. No.</b>	512006700 80001167
	504020		
	flat gasket FIBER ED $\phi$ 24mm ID $\phi$ 17mm thickness 2mm Qty 1 pcs		



<b>GEV No.</b>	504062	<b>Ref. No.</b>	511007700 511023300 80001885 80002917
<b>description</b>	air trap		
<b>For models:</b>	GL220, MB520, MB520K, MB530, MB530K, MB535, MS700E		
<b>accessories for</b>	504062		
	<b>GEV No.</b>	<b>Ref. No.</b>	513000400 80001165
	503042		
	nut thread 3/8" H 6mm brass WS 22 Qty 1 pcs		
	<b>GEV No.</b>	<b>Ref. No.</b>	512006700 80001167
	504020		
	flat gasket FIBER ED $\phi$ 24mm ID $\phi$ 17mm thickness 2mm Qty 1 pcs		



<b>GEV No.</b>	504116	<b>Ref. No.</b>	511037400 80002507
<b>description</b>	air trap		
<b>For models:</b>	MB235LI, MB240LI, MB510E, MB510ER, MB920E, MB920ER		
<b>accessories for</b>	504116		
	<b>GEV No.</b>	<b>Ref. No.</b>	513000400 80001165
	503042		
	nut thread 3/8" H 6mm brass WS 22 Qty 1 pcs		
	<b>GEV No.</b>	<b>Ref. No.</b>	512006700 80001167
	504020		
	flat gasket FIBER ED $\phi$ 24mm ID $\phi$ 17mm thickness 2mm Qty 1 pcs		



<b>GEV No.</b>	504193	<b>Ref. No.</b>	511029900 80004247
<b>description</b>	air trap		
<b>For models:</b>	MS350, MS350PS, MS350TRI		
<b>accessories for</b>	504193		
	<b>GEV No.</b>	<b>Ref. No.</b>	513000400 80001165
	503042		
	nut thread 3/8" H 6mm brass WS 22 Qty 1 pcs		

Table continues overleaf





Зип Общепит

vsezip.ru

+7(812)987-08-81

<b>accessories for</b> 504193			
	<b>GEV No.</b> 504020	<b>Ref. No.</b>	512006700 80001167
flat gasket FIBER ED ø 24mm ID ø 17mm thickness 2mm Qty 1 pcs			

<b>1</b>			
	<b>GEV No.</b> 504207	<b>Ref. No.</b>	511051000 80004343
<b>description</b> air trap			
<b>For models:</b> GL220, MB520, MB520K, MB530, MB530K, MB535, MLP140, MLP60, MLP60E, MLP70, MLP80, MS1100, MS1100E, MS1100P, MS1300, MS1300E, MS1300P, MS900, MS900E, MS905			

<b>accessories for</b> 504207			
	<b>GEV No.</b> 504208	<b>Ref. No.</b>	502004000 80004345
nut thread M10			
	<b>GEV No.</b> 504209	<b>Ref. No.</b>	512015300 80004347
flat gasket FIBER ED ø 18.5mm ID ø 11mm thickness 2mm Qty 1 pcs			

<b>miscellaneous</b>			
			
<b>1</b>			
<b>GEV No.</b> 701382	<b>Ref. No.</b>	514217700	
<b>description</b> bush plastic H 17mm D1 ø 37.2mm D2 ø 35.4mm for Mach			

<b>door mechanics</b>			
<b>linkage</b>			
			
<b>1</b>			
<b>GEV No.</b> 504192	<b>Ref. No.</b>	513144200 80004183	
<b>description</b> door pin extension			
<b>For models:</b> MLP140			



<b>1</b>			
<b>GEV No.</b> 504000	<b>Ref. No.</b>	511000500 80001011 80003911	
<b>description</b> door hinge hinge left mounting pos. left			
<b>For models:</b> GL220, GL250, MB235LI, MB240LI, MB510E, MB510ER, MB520, MB520K, MB530, MB530K, MB535, MB630, MB920E, MB920ER, MB930, MB930K, MB930T, MGL40, MLP50, MLP70, MLP80, MS350, MS350PS, MS350TRI, MS351, MS353, MS450, MS450E, MS450PS, MS451, MS453, MS700, MS700E			



<b>1</b>			
<b>GEV No.</b> 504153	<b>Ref. No.</b>	511048500 80003859 8000859	
<b>description</b> door hinge hinge left mounting pos. left			
<b>For models:</b> MLP60, MLP60E			

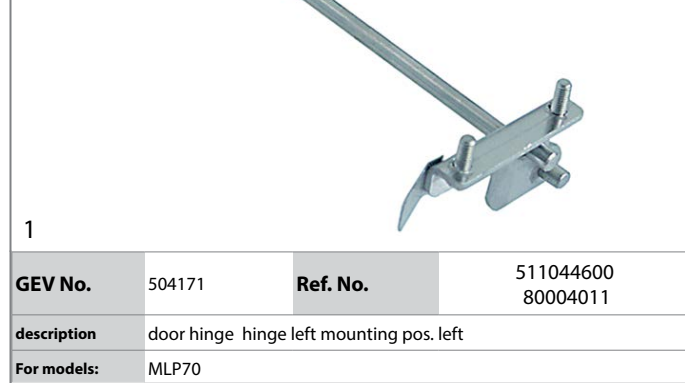

<b>1</b>			
<b>GEV No.</b> 504171	<b>Ref. No.</b>	511044600 80004011	
<b>description</b> door hinge hinge left mounting pos. left			
<b>For models:</b> MLP70			

mechanical components, equipment accessories

Зип Общепит

vsezip.ru

+7(812)987-08-81

mechanical components, equipment accessories



1

<b>GEV No.</b>	504191	<b>Ref. No.</b>	511045000 80004165
<b>description</b>	door hinge hinge left mounting pos. left		
<b>For models:</b>	MLP140		



1

<b>GEV No.</b>	504052	<b>Ref. No.</b>	511008100 80001679
<b>description</b>	door hinge hinge right mounting pos. right		
<b>For models:</b>	MLP140, MLP50, MLP70, MLP80, MS450, MS450E, MS450PS, MS451, MS453, MS700, MS700E		



1

<b>GEV No.</b>	504001	<b>Ref. No.</b>	511000400 80001013
<b>description</b>	door hinge hinge right mounting pos. right		
<b>For models:</b>	MB535, MS350, MS350PS, MS350TRI, MS351, MS353		



1

<b>GEV No.</b>	504063	<b>Ref. No.</b>	511019100 80001895 80002499
<b>description</b>	door hinge hinge right mounting pos. right		
<b>For models:</b>	GL220, MB235LI, MB510E, MB510ER, MB520, MB520K, MB530, MB530K, MB535		



1

<b>GEV No.</b>	504038	<b>Ref. No.</b>	511003700 80001475
<b>description</b>	door hinge hinge right mounting pos. right		
<b>For models:</b>	MB240LI, MB630, MB920E, MB920ER, MB930, MB930K, MB930T, MGL40		



1

<b>GEV No.</b>	504154	<b>Ref. No.</b>	511048400 80003861
<b>description</b>	door hinge hinge right mounting pos. right		
<b>For models:</b>	MLP60, MLP60E		





Зип Общепит

vsezip.ru

+7(812)987-08-81

miscellaneous



1			
<b>GEV No.</b>	504004	<b>Ref. No.</b>	513000300 80001019
<b>description</b>	spring compressor		
<b>For models:</b>	GL220, GL250, MB235LI, MB240LI, MB510E, MB510ER, MB520, MB520K, MB530, MB530K, MB535, MB630, MB920E, MB920ER, MB930, MB930K, MB930T, MGL40, MGL500, MLP140, MLP50, MLP60, MLP60E, MLP70, MLP80, MS350, MS350PS, MS350TRI, MS351, MS353, MS400B, MS400E, MS400T, MS450, MS450E, MS450PS, MS451, MS453, MS500B, MS500E, MS500PPB, MS500T, MS700, MS700E, MS800B, MS800E, MS800T		

washing and rinsing systems



1			
<b>GEV No.</b>	504072	<b>Ref. No.</b>	513079500 80002001
<b>description</b>	bush		
<b>For models:</b>	GL220, GL250, MB235LI, MB240LI, MB510E, MB510ER, MB520, MB520K, MB530, MB530K, MB535, MB630, MB630PS, MB920E, MB920ER, MB930, MB930K, MB930PS, MB930T, MGL40, MLP50, MS1100, MS1100E, MS1300, MS1300E, MS350, MS350PS, MS350TRI, MS450, MS450E, MS450PS, MS700, MS700E, MS900, MS900E, MS905		



1			
<b>GEV No.</b>	504177	<b>Ref. No.</b>	513128700 80004073
<b>description</b>	bush		
<b>For models:</b>	MLP140, MLP60, MLP60E, MLP70, MLP80, MS1100P, MS1300P		



1			
<b>GEV No.</b>	504180	<b>Ref. No.</b>	513129000 80004079
<b>description</b>	bush for rinse arm		
<b>For models:</b>	MLP140, MLP60, MLP60E, MLP70, MLP80, MS1100P, MS1300P		



1			
<b>GEV No.</b>	504181	<b>Ref. No.</b>	513129100 80004081
<b>description</b>	bush for rinse arm		
<b>For models:</b>	MLP140, MLP60, MLP60E, MLP70, MLP80, MS1100P, MS1300P		



1			
<b>GEV No.</b>	504787	<b>Ref. No.</b>	513186100 51386100 80004573
<b>description</b>	bush for rinse arm ø 15mm ID ø 7mm H 18.5mm		
<b>For models:</b>	MB235LI, MB240LI, MB630, MB630PS, MB9235, MB9240, MB930, MB930K, MB930PS, MB930T, MB9500, MB9501, MB9503, MB9510, MB9510R, MB9920, MB9920R, MGL500, MLP140, MLP50, MLP56, MLP60, MLP60E, MLP70, MLP80, MS1100E, MS1100T, MS1100T, MS1300E, MS1300P, MS1300T, MS351, MS353, MS400B, MS400E, MS400T, MS451, MS453, MS500B, MS500E, MS500PPB, MS500T, MS800B, MS800E, MS800T, MS900E, MS900T, MS905, MS9400, MS9401...(Other models you can see in the webshop)		



1			
<b>GEV No.</b>	504236	<b>Ref. No.</b>	513219400
<b>description</b>	bush for rinse arm ø 22mm H 34mm		
<b>For models:</b>	MLP140, MLP60, MLP60E, MLP70, MLP80, MS1100P, MS1300P		



1			
<b>GEV No.</b>	517728	<b>Ref. No.</b>	513185900 80004577
<b>description</b>	bush for wash arm ø 45mm H 16mm ID ø 18mm Qty 1 pcs		
<b>For models:</b>	MB630, MB630PS, MB9235, MB9240, MB930, MB930K, MB930PS, MB930T, MB9500, MB9501, MB9503, MB9510, MB9510R, MB9920, MB9920R, MGL500, MLP50, MLP56, MS1100E, MS1100T, MS1300E, MS1300T, MS351, MS353, MS400B, MS400E, MS400T, MS451, MS453, MS500B, MS500E, MS500PPB, MS500T, MS800B, MS800E, MS800T, MS900E, MS900T, MS905, MS9400, MS9401, MS9403, MS9451, MS9453		

mechanical components, equipment accessories

Зип Общепит  
vsezip.ru  
812 987-08-81



1

<b>GEV No.</b>	504109	<b>Ref. No.</b>	513072300 80002435
<b>description</b>	extension for wash arm		
<b>For models:</b>	GL220, GL250, MB510E, MB530, MB530K, MB535, MB920E, MB930, MB930K		



1

<b>GEV No.</b>	504073	<b>Ref. No.</b>	513080800 80002003
<b>description</b>	flange		
<b>For models:</b>	GL220, GL250, MB235LI, MB240LI, MB510E, MB510ER, MB520, MB520K, MB530, MB530K, MB535, MB630, MB630PS, MB920E, MB920ER, MB930, MB930K, MB930PS, MB930T, MGL40, MLP50, MS1100, MS1100E, MS1300, MS1300E, MS350, MS350PS, MS350TRI, MS450, MS450E, MS450PS, MS700, MS700E, MS900, MS900E, MS905		



1

<b>GEV No.</b>	504179	<b>Ref. No.</b>	513128900 80004077
<b>description</b>	knurled nut		
<b>For models:</b>	MLP140, MLP60, MLP60E, MLP70, MLP80, MS1100P, MS1300P		



1

<b>GEV No.</b>	504231	<b>Ref. No.</b>	513227000
<b>description</b>	manifold		
<b>For models:</b>	MB510E, MB510ER, MB520, MB520K, MB530, MB530K, MB535, MB630, MB630PS, MB920E, MB920ER, MB930, MB930K, MB930PS, MB930T, MB9510, MB9510R, MB9920, MB9920R, MGL40, MGL500, MLP50, MLP60, MLP60E, MS1100E, MS1100P, MS1100T, MS1300E, MS1300P, MS1300T, MS400B, MS400T, MS500B, MS500T, MS800B, MS800T, MS900E, MS900T		



1

<b>GEV No.</b>	504170	<b>Ref. No.</b>	511043100 80004009
<b>description</b>	manifold connection 4-way		
<b>For models:</b>	MLP70, MLP80		



GEV No.

504188

Ref. No.

511043600  
80004147

description

manifold connection 6-way

For models:

MLP140



1

<b>GEV No.</b>	504127	<b>Ref. No.</b>	513224800
<b>description</b>	manifold triple ø 13mm		
<b>For models:</b>	MB235LI, MB240LI, MB9235, MB9240, MB9500, MB9501, MB9503, MLP50, MLP56, MS351, MS353, MS400E, MS451, MS453, MS500E, MS800E, MS905, MS9400, MS9401, MS9403, MS9451, MS9453		



1

<b>GEV No.</b>	504007	<b>Ref. No.</b>	513000500 80001069
<b>description</b>	nut		
<b>For models:</b>	MB630, MB630PS, MLP140, MLP60, MLP60E, MLP70, MLP80, MS1100, MS1100E, MS1100P, MS1100T, MS1300, MS1300E, MS1300P, MS1300T, MS350, MS350PS, MS350TRI, MS450, MS450E, MS450PS, MS700, MS700E, MS900, MS900E, MS900T, MS905		



1

<b>GEV No.</b>	504050	<b>Ref. No.</b>	513000200 80001647
<b>description</b>	nut thread M20x1.5		
<b>For models:</b>	MB235LI, MB240LI, MB630, MB630PS, MLP140, MLP60, MLP60E, MLP70, MLP80, MS1100, MS1100E, MS1100P, MS1300, MS1300E, MS1300P, MS450, MS450E, MS450PS, MS700, MS700E, MS900, MS900E		



1

<b>GEV No.</b>	504092	<b>Ref. No.</b>	511029600 513211900 80002267
<b>description</b>	rinse arm support mounting pos. upper		
<b>For models:</b>	MB630, MB630PS, MLP140, MLP60, MLP60E, MLP70, MLP80, MS1100, MS1100E, MS1100P, MS1100T, MS1300, MS1300E, MS1300P, MS1300T, MS900, MS900E, MS900T, MS905		
<b>accessories for</b>	504092		



GEV No.

101248

Ref. No.

502009100  
80001071

olive for pipe ø 12mm Qty 1 pcs suitable for PEL



Table continues overleaf





Зип Общепит

vsezip.ru

+7(812)987-08-81

accessories for 504092				
	GEV No.	504007	Ref. No.	513000500 80001069
nut				
	GEV No.	504050	Ref. No.	513000200 80001647
nut thread M20x1.5				
	GEV No.	504081	Ref. No.	512006500 512045300 80002189
flat gasket FIBER ED ø 28mm ID ø 20mm thickness 2mm Qty 1 pcs				

	GEV No.	504178	Ref. No.	513128800 80004075
description wash arm bearing				
For models: MLP140, MLP60, MLP60E, MLP70, MLP80, MS1100P, MS1300P				

	GEV No.	504197	Ref. No.	513156700 80004273
description rinse arm support mounting pos. upper				
For models: MB235LI, MB240LI				

	GEV No.	504229	Ref. No.	513149700
description washer ø 20mm H 3.5mm				
For models: MB235LI, MB240LI, MB510E, MB510ER, MB520, MB520K, MB530, MB530K, MB535, MB630, MB630PS, MB920E, MB920ER, MB930, MB930K, MB930PS, MB930T, MGL40, MLP50, MS1100, MS1100E, MS1300, MS1300E, MS900, MS900E, MS905				

	GEV No.	504095	Ref. No.	511030900 80002331
description rinse pipe with manifold connection				
For models: MS350, MS350PS, MS350TRI				

washing and rinsing systems (sorted by producer)

MACH

	GEV No.	517729	Ref. No.	513185600 513856000 80004561
description slide ring for wash arm ED ø 46mm ID ø 36mm thickness 18mm				
For models: MB630, MB630PS, MB9235, MB9240, MB930, MB930K, MB930PS, MB930T, MB9500, MB9501, MB9503, MB9510, MB9510R, MB9920, MB9920R, MGL500, MLP50, MLP56, MS1100E, MS1100T, MS1300E, MS1300T, MS351, MS353, MS400B, MS400E, MS400T, MS451, MS453, MS500B, MS500E, MS500PPB, MS500T, MS800B, MS800E, MS800T, MS900E, MS900T, MS905, MS9400, MS9401, MS9403, MS9451, MS9453				

	GEV No.	504217	Ref. No.	600062600 80004997
description wash and rinse arm wash arm L 340mm rinse arm L 340mm w. jets 5 r. jets 4 mounting ø 12/42mm mounting pos. lower complete				
For models: MB235LI, MB510E, MB510ER, MB520, MB520K, MB530, MB530K, MB535				

	GEV No.	504228	Ref. No.	513149900
description Thumb screw thread M6 thread L 13mm ø 24mm H 4mm SS				
For models: MB235LI, MB240LI, MB510E, MB510ER, MB520, MB520K, MB530, MB530K, MB535, MB630, MB630PS, MB920E, MB920ER, MB930, MB930K, MB930PS, MB930T, MGL40, MLP50, MS1100, MS1100E, MS1300, MS1300E, MS900, MS900E, MS905				

	GEV No.	504219	Ref. No.	600062500 80004951
description wash and rinse arm wash arm L 420mm rinse arm L 420mm w. jets 6 r. jets 5 mounting ø 12/42mm mounting pos. lower 2 wash arms/ 2 rinse arms				
For models: MB240LI, MB630, MB630PS, MB920E, MB920ER, MB930, MB930K, MB930PS, MB930T, MGL40				

mechanical components, equipment accessories

Зип Общепит

vsezip.ru

(812) 980 88 00

			
1			
<b>GEV No.</b>	504216	<b>Ref. No.</b>	511009700 600063900
<b>description</b>	wash and rinse arm wash arm L 515mm rinse arm L 520mm w. jets 11 r. jets 6 mounting ø 12/61mm mounting pos. upper/lower complete		
<b>For models:</b>	MLP50, MS1100, MS1100E, MS1300, MS1300E, MS900, MS900E, MS905		

			
1			
<b>GEV No.</b>	517811	<b>Ref. No.</b>	600061800
<b>description</b>	wash arm L 520mm nozzles 11 mounting ø 18mm		
<b>For models:</b>	MLP50, MLP56, MS1100E, MS1100T, MS1300E, MS1300T, MS900E, MS900T, MS905		

			
1			
<b>GEV No.</b>	517720	<b>Ref. No.</b>	600062900
<b>description</b>	wash arm mounting pos. lower L 480mm nozzles 10		
<b>For models:</b>	MB9500, MB9501, MB9503, MGL500, MS351, MS353, MS400B, MS400E, MS400T, MS451, MS453, MS500B, MS500E, MS500T, MS800B, MS800E, MS800T, MS9400, MS9401, MS9403, MS9451, MS9453		

			
1			
<b>GEV No.</b>	504079	<b>Ref. No.</b>	513002600 80002171
<b>description</b>	bearing		
<b>For models:</b>	GL220, GL250, MB235LI, MB240LI, MB510E, MB510ER, MB520, MB520K, MB530, MB530K, MB535, MB630, MB630PS, MB920E, MB920ER, MB930, MB930K, MGL40, MLP140, MLP60, MLP60E, MLP70, MLP80, MS1100, MS1300, MS350, MS350PS, MS450, MS450E, MS450PS, MS700, MS700E, MS900		



			
1			
<b>GEV No.</b>	504066	<b>Ref. No.</b>	513061800 80001933
<b>description</b>	connector holder		
<b>For models:</b>	GL220, GL250, MB235LI, MB240LI, MB510E, MB510ER, MB520, MB520K, MB530, MB530K, MB535, MB630, MB630PS, MB920E, MB920ER, MB930, MB930K, MB930PS, MB930T, MGL40, MLP50, MS1100, MS1100E, MS1300, MS1300E, MS350, MS350PS, MS350TRI, MS450, MS450E, MS450PS, MS700, MS700E, MS900, MS900E, MS905		

			
1			
<b>GEV No.</b>	504080	<b>Ref. No.</b>	513002700 80002173
<b>description</b>	end cap		
<b>For models:</b>	GL220, GL250, MB235LI, MB240LI, MB510E, MB510ER, MB520, MB520K, MB530, MB530K, MB535, MB630, MB920E, MB920ER, MB930, MB930K, MGL40, MLP140, MLP60, MLP60E, MLP70, MLP80, MS1100, MS1300, MS350, MS350PS, MS450, MS450E, MS450PS, MS700, MS700E, MS900		

			
1			
<b>GEV No.</b>	504203	<b>Ref. No.</b>	513159700 51359700 80004323
<b>description</b>	end cap		
<b>For models:</b>	GL220, GL250, MB235LI, MB240LI, MB510E, MB510ER, MB520, MB520K, MB530, MB530K, MB535, MB630, MB920E, MB920ER, MB930, MB930K, MB930T, MGL40, MGL500, MLP140, MLP50, MLP60, MLP60E, MLP70, MLP80, MS1100, MS1100E, MS1100P, MS1300, MS1300E, MS1300P, MS350, MS350TRI, MS351, MS353, MS400B, MS400E, MS400T, MS450, MS450E, MS451, MS453, MS500B, MS500E, MS500PPB, MS500T, MS700, MS700E, MS800B, MS800T...(Other models you can see in the webshop)		

			
1			
<b>GEV No.</b>	504798	<b>Ref. No.</b>	513202900 80004953
<b>description</b>	end cap H 7mm thread L 2.5mm ø 55mm		
<b>For models:</b>	MB235LI, MB240LI, MB510E, MB510ER, MB520, MB520K, MB530, MB530K, MB535, MB630, MB630PS, MB920E, MB920ER, MB9235, MB9240, MB930, MB930K, MB930PS, MB930T, MB9500, MB9501, MB9503, MB9510, MB9510R, MB9920, MB9920R, MGL40, MGL500, MLP140, MLP50, MLP56, MLP60, MLP60E, MLP70, MLP80, MS1100, MS1100E, MS1100P, MS1100T, MS1300, MS1300E, MS1300P, MS1300T, MS351, MS353, MS400B, MS400E, MS400T, MS451, MS453...(Other models you can see in the webshop)		

			
1			
<b>GEV No.</b>	504204	<b>Ref. No.</b>	513159800 80004325
<b>description</b>	nozzle holder		
<b>For models:</b>	GL220, GL250, MB235LI, MB240LI, MB510E, MB510ER, MB520, MB520K, MB530, MB530K, MB535, MB630, MB920E, MB920ER, MB930, MB930K, MB930T, MGL40, MGL500, MLP140, MLP50, MLP60, MLP60E, MLP70, MLP80, MS1100, MS1100E, MS1100P, MS1300, MS1300E, MS1300P, MS350, MS350TRI, MS351, MS353, MS400B, MS400E, MS400T, MS450, MS450E, MS451, MS453, MS500B, MS500E, MS500PPB, MS500T, MS700, MS700E, MS800B, MS800T...(Other models you can see in the webshop)		

			
1			
<b>GEV No.</b>	504013	<b>Ref. No.</b>	513001300 80001089
<b>description</b>	nozzle holder with O-ring		
<b>For models:</b>	GL220, GL250, MB235LI, MB240LI, MB510E, MB510ER, MB520, MB520K, MB530, MB530K, MB535, MB630, MB920E, MB930, MB930K, MGL40, MLP140, MLP60, MLP60E, MLP70, MLP80, MS1100, MS1300, MS350, MS350PS, MS450, MS450E, MS450PS, MS700, MS700E, MS900		
<b>accessories for</b>	504013		
	<b>GEV No.</b>	528815	<b>Ref. No.</b>
			
	O-ring EPDM thickness 1.78mm ID ø 3.69mm Qty 1 pcs		





Зип Общепит

vsezip.ru

(812)987-08-81

			
1			
<b>GEV No.</b>	504015	<b>Ref. No.</b>	513001200 80001093
<b>description</b>	rinse jet		
<b>For models:</b>	GL220, GL250, MB235LI, MB240LI, MB510E, MB510ER, MB520, MB520K, MB530, MB530K, MB535, MB630, MB920E, MB920ER, MB930, MB930K, MGL40, MGL500, MLP140, MLP50, MLP60, MLP60E, MLP70, MLP80, MS1100, MS1100E, MS1100P, MS1300, MS1300E, MS1300P, MS350, MS350TRI, MS351, MS353, MS400B, MS400E, MS400T, MS450, MS450E, MS451, MS453, MS500B, MS500E, MS500PPB, MS500T, MS700, MS700E, MS800B, MS800T...(Other models you can see in the webshop)		

			
1			
<b>GEV No.</b>	504205	<b>Ref. No.</b>	513159600 51359800 80004327
<b>description</b>	rinse jet		
<b>For models:</b>	GL220, GL250, MB235LI, MB240LI, MB510E, MB510ER, MB520, MB520K, MB530, MB530K, MB535, MB630, MB920E, MB920ER, MB930, MB930K, MB930T, MGL40, MGL500, MLP140, MLP50, MLP60, MLP60E, MLP70, MLP80, MS1100, MS1100E, MS1100P, MS1300, MS1300E, MS1300P, MS350, MS350TRI, MS351, MS353, MS400B, MS400E, MS400T, MS450, MS450E, MS451, MS453, MS500B, MS500E, MS500PPB, MS500T, MS700, MS700E, MS800B, MS800T...(Other models you can see in the webshop)		
<b>accessories for</b>	504205		
			
<b>GEV No.</b>	504204	<b>Ref. No.</b>	513159800 80004325
nozzle holder			

			
1			
<b>GEV No.</b>	504151	<b>Ref. No.</b>	511048700 80003855
<b>description</b>	wash arm L 240mm		
<b>For models:</b>	MLP60, MLP60E		

			
1			
<b>GEV No.</b>	504167	<b>Ref. No.</b>	511040200 80004003
<b>description</b>	wash arm L 270mm		
<b>For models:</b>	MLP140, MLP60, MLP60E, MLP70, MLP80		

			
1			
<b>GEV No.</b>	504145	<b>Ref. No.</b>	511047000 80003825
<b>description</b>	wash arm L 300mm		
<b>For models:</b>	MLP70, MLP80		

			
1			
<b>GEV No.</b>	504166	<b>Ref. No.</b>	511040100 80004001
<b>description</b>	wash arm boss		
<b>For models:</b>	MLP140, MLP60, MLP60E, MLP70, MLP80, MS1100P, MS1300P		

			
1			
<b>GEV No.</b>	504093	<b>Ref. No.</b>	511029500 80002269
<b>description</b>	rinse arm mounting pos. lower L 220mm nozzles 4 mounting ø 12mm		
<b>For models:</b>	MB630		
<b>accessories for</b>	504093		
			
<b>GEV No.</b>	101248	<b>Ref. No.</b>	502009100 80001071
olive for pipe ø 12mm Qty 1 pcs suitable for PEL			
			
<b>GEV No.</b>	504007	<b>Ref. No.</b>	513000500 80001069
nut			
			
<b>GEV No.</b>	504050	<b>Ref. No.</b>	513000200 80001647
nut thread M20x1.5			
			
<b>GEV No.</b>	504081	<b>Ref. No.</b>	512006500 512045300 80002189
flat gasket FIBER ED ø 28mm ID ø 20mm thickness 2mm Qty 1 pcs			
			
<b>GEV No.</b>	504092	<b>Ref. No.</b>	511029600 513211900 80002267
rinse arm support mounting pos. upper			
			
<b>GEV No.</b>	504204	<b>Ref. No.</b>	513159800 80004325
nozzle holder			
			
<b>GEV No.</b>	504205	<b>Ref. No.</b>	513159600 51359800 80004327
rinse jet			

mechanical components, equipment accessories

Зип Общепит

vsezip.ru

+7(812)987-08-81



1

<b>GEV No.</b>	504203	<b>Ref. No.</b>	513159700 51359700 80004323
<b>description</b>	end cap		
<b>For models:</b>	GL220, GL250, MB235LI, MB240LI, MB510E, MB510ER, MB520, MB520K, MB530, MB530K, MB535, MB630, MB920E, MB920ER, MB930, MB930K, MB930T, MGL40, MGL500, MLP140, MLP50, MLP60, MLP60E, MLP70, MLP80, MS1100, MS1100E, MS1100P, MS1300, MS1300E, MS1300P, MS350, MS350TRI, MS351, MS353, MS400B, MS400E, MS400T, MS450, MS450E, MS451, MS453, MS500B, MS500E, MS500PPB, MS500T, MS700, MS700E, MS800B, MS800T...(Other models you can see in the webshop)		



1

<b>GEV No.</b>	504204	<b>Ref. No.</b>	513159800 80004325
<b>description</b>	nozzle holder		
<b>For models:</b>	GL220, GL250, MB235LI, MB240LI, MB510E, MB510ER, MB520, MB520K, MB530, MB530K, MB535, MB630, MB920E, MB920ER, MB930, MB930K, MB930T, MGL40, MGL500, MLP140, MLP50, MLP60, MLP60E, MLP70, MLP80, MS1100, MS1100E, MS1100P, MS1300, MS1300E, MS1300P, MS350, MS350TRI, MS351, MS353, MS400B, MS400E, MS400T, MS450, MS450E, MS451, MS453, MS500B, MS500E, MS500PPB, MS500T, MS700, MS700E, MS800B, MS800T...(Other models you can see in the webshop)		



1

<b>GEV No.</b>	504205	<b>Ref. No.</b>	513159600 51359800 80004327
<b>description</b>	rinse jet		
<b>For models:</b>	GL220, GL250, MB235LI, MB240LI, MB510E, MB510ER, MB520, MB520K, MB530, MB530K, MB535, MB630, MB920E, MB920ER, MB930, MB930K, MB930T, MGL40, MGL500, MLP140, MLP50, MLP60, MLP60E, MLP70, MLP80, MS1100, MS1100E, MS1100P, MS1300, MS1300E, MS1300P, MS350, MS350TRI, MS351, MS353, MS400B, MS400E, MS400T, MS450, MS450E, MS451, MS453, MS500B, MS500E, MS500PPB, MS500T, MS700, MS700E, MS800B, MS800T...(Other models you can see in the webshop)		

<b>accessories for</b>	504205			
	<b>GEV No.</b>	504204	<b>Ref. No.</b>	513159800 80004325
	nozzle holder			





1

<b>GEV No.</b>	504373	<b>Ref. No.</b>	600062700
<b>description</b>	rinse arm L 340mm nozzles 4 mounting ø 15mm mounting pos. upper/lower		
<b>For models:</b>	MB235LI, MB9235, MB930, MB930K, MB930PS, MB930T, MB9510, MB9510R, MB9920, MB9920R		

	<b>GEV No.</b>	504860	<b>Ref. No.</b>	600064400
	<b>description</b>	rinse arm L 557mm nozzles 7 mounting ø 15mm		
	<b>For models:</b>	MLP50, MLP56, MS1100P, MS1300E, MS1300P, MS1300T		

	<b>GEV No.</b>	504233	<b>Ref. No.</b>	600064100
	<b>description</b>	rinse arm L 580mm nozzles 7 mounting ø 15mm mounting pos. upper/lower		
	<b>For models:</b>	MLP60, MLP60E		

	<b>GEV No.</b>	504234	<b>Ref. No.</b>	600064200
	<b>description</b>	rinse arm L 633mm nozzles 8 mounting ø 15mm mounting pos. upper/lower		
	<b>For models:</b>	MLP140, MLP70, MLP80		

	<b>GEV No.</b>	517721	<b>Ref. No.</b>	511060900 511069900 80004555
	<b>description</b>	rinse arm mounting pos. upper/lower L 480mm nozzles 6 mounting ø 11mm		
	<b>For models:</b>	MB9500, MB9501, MB9503, MGL500, MS1100E, MS1100T, MS351, MS353, MS400B, MS400E, MS400T, MS451, MS453, MS500B, MS500E, MS500PPB, MS500T, MS800B, MS800E, MS800T, MS900E, MS900T, MS905, MS9400, MS9401, MS9403, MS9451, MS9453		







Зип Общепит

vsezip.ru



+7(812)987-08-81

			
1			
<b>GEV No.</b>	504374	<b>Ref. No.</b>	511028100
<b>description</b>	rinse arm mounting pos. lower L 235mm nozzles 4 mounting ø 12mm thread 3/8"		
<b>For models:</b>	MB520, MB520K		

			
1			
<b>GEV No.</b>	504203	<b>Ref. No.</b>	513159700 51359700 80004323
<b>description</b>	end cap		
<b>For models:</b>	GL220, GL250, MB235LI, MB240LI, MB510E, MB510ER, MB520, MB520K, MB530, MB530K, MB535, MB630, MB920E, MB920ER, MB930, MB930K, MB930T, MGL40, MGL500, MLP140, MLP50, MLP60, MLP60E, MLP70, MLP80, MS1100, MS1100E, MS1100P, MS1300, MS1300E, MS1300P, MS350, MS350TRI, MS351, MS353, MS400B, MS400E, MS400T, MS450, MS450E, MS451, MS453, MS500B, MS500E, MS500PPB, MS500T, MS700, MS700E, MS800B, MS800T...(Other models you can see in the webshop)		

				
1				
<b>GEV No.</b>	504075	<b>Ref. No.</b>	511028000 80002015	
<b>description</b>	wash arm H 70mm L 200mm nozzles 3 mounting pos. lower			
<b>For models:</b>	MB520, MB520K, MB530K, MB630			
<b>accessories for</b>	504075			
	<b>GEV No.</b>	504018	<b>Ref. No.</b>	512021800 80001159
	gasket for wash arm support ø 60/101mm rubber thickness 2mm with 3 screw holes			
	<b>GEV No.</b>	504048	<b>Ref. No.</b>	513077800 80001597
	wash jet			
	<b>GEV No.</b>	504049	<b>Ref. No.</b>	513077700 80001599
	swirl			

			
1			
<b>GEV No.</b>	504049	<b>Ref. No.</b>	513077700 80001599
<b>description</b>	swirl		
<b>For models:</b>	MB520, MB520K, MB530K, MB630, MB630PS		

				
1				
<b>GEV No.</b>	504048	<b>Ref. No.</b>	513077800 80001597	
<b>description</b>	wash jet			
<b>For models:</b>	MB520, MB520K, MB530K, MB630, MB630PS			
<b>accessories for</b>	504048			
	<b>GEV No.</b>	504049	<b>Ref. No.</b>	513077700 80001599
	swirl			

			
1			
<b>GEV No.</b>	512481	<b>Ref. No.</b>	513186200 80004571
<b>description</b>	knurled nut for wash arm mounting pos. upper/lower thread M18x1 ø 34mm H 8mm stainless steel		
<b>For models:</b>	MB235LI, MB240LI, MB630, MB630PS, MB9235, MB9240, MB930, MB930K, MB930PS, MB930T, MB9500, MB9501, MB9503, MB9510, MB9510R, MB9920, MB9920R, MGL500, MLP140, MLP50, MLP56, MLP60, MLP60E, MLP70, MLP80, MS1100E, MS1100P, MS1100T, MS1300E, MS1300P, MS1300T, MS351, MS353, MS400B, MS400E, MS400T, MS451, MS453, MS500B, MS500E, MS500PPB, MS500T, MS800B, MS800E, MS800T, MS900E, MS900T, MS905, MS9400, MS9401...(Other models you can see in the webshop)		

			
1			
<b>GEV No.</b>	504859	<b>Ref. No.</b>	513186900 80004565
<b>description</b>	flange wash arm ø 43mm H 3mm		
<b>For models:</b>	MB630, MB630PS, MB930, MB930K, MB930PS, MB930T, MB9500, MB9501, MB9503, MB9510, MB9510R, MB9920, MB9920R, MGL500, MLP50, MLP56, MS1100E, MS1100T, MS1300E, MS1300T, MS351, MS353, MS400B, MS400E, MS400T, MS451, MS453, MS500B, MS500E, MS500PPB, MS500T, MS800B, MS800E, MS800T, MS900E, MS900T, MS905, MS9400, MS9401, MS9403, MS9451, MS9453		

			
1			
<b>GEV No.</b>	504136	<b>Ref. No.</b>	511042500 80002945
<b>description</b>	wash arm support mounting pos. lower		
<b>For models:</b>	MB930, MB930K, MB930T, MGL40		

mechanical components, equipment accessories

Зип Общепит

vsezip.ru

+7(812)987-08-81



1

<b>GEV No.</b>	504143	<b>Ref. No.</b>	511038500 80003321
<b>description</b>	wash arm support mounting pos. lower		
<b>For models:</b>	MLP140, MLP60, MLP60E, MLP70, MLP80		



1

<b>GEV No.</b>	504089	<b>Ref. No.</b>	511027900 80002241
<b>description</b>	wash arm support mounting pos. upper		
<b>For models:</b>	GL250, MB510E, MB510ER, MB630, MB920E, MB920ER, MB930, MB930K, MB930T, MGL40		



1

<b>GEV No.</b>	504142	<b>Ref. No.</b>	511046600 80003819
<b>description</b>	wash arm support mounting pos. upper		
<b>For models:</b>	MLP140, MLP70, MLP80		



1

<b>GEV No.</b>	504035	<b>Ref. No.</b>	511004600 80001395
<b>description</b>	wash arm support mounting pos. upper/lower		
<b>For models:</b>	MS1300, MS1300E		



1

<b>GEV No.</b>	504053	<b>Ref. No.</b>	511011300 80001687
<b>description</b>	wash arm support mounting pos. upper/lower		
<b>For models:</b>	MS700, MS700E		

**accessories for** 504053



<b>GEV No.</b>	101248	<b>Ref. No.</b>	502009100 80001071
----------------	--------	-----------------	-----------------------

olive for pipe  $\varnothing$  12mm Qty 1 pcs suitable for PEL



<b>GEV No.</b>	504007	<b>Ref. No.</b>	513000500 80001069
----------------	--------	-----------------	-----------------------

nut



<b>GEV No.</b>	504009	<b>Ref. No.</b>	513001800 80001075
----------------	--------	-----------------	-----------------------

rinse arm shaft



<b>GEV No.</b>	504018	<b>Ref. No.</b>	512021800 80001159
----------------	--------	-----------------	-----------------------

gasket for wash arm support  $\varnothing$   $\varnothing$ 60/101mm rubber thickness 2mm with 3 screw holes



1

<b>GEV No.</b>	504050	<b>Ref. No.</b>	511014900 80001761
<b>description</b>	wash arm support mounting pos. upper/lower		
<b>For models:</b>	MS1100, MS1100E, MS900, MS900E, MS905		



1

<b>GEV No.</b>	504096	<b>Ref. No.</b>	511030600 80002333
<b>description</b>	wash arm support mounting pos. upper/lower		
<b>For models:</b>	MS350, MS350PS, MS350TRI		

**accessories for** 504096



<b>GEV No.</b>	101248	<b>Ref. No.</b>	502009100 80001071
----------------	--------	-----------------	-----------------------

olive for pipe  $\varnothing$  12mm Qty 1 pcs suitable for PEL



<b>GEV No.</b>	504007	<b>Ref. No.</b>	513000500 80001069
----------------	--------	-----------------	-----------------------

nut



<b>GEV No.</b>	504009	<b>Ref. No.</b>	513001800 80001075
----------------	--------	-----------------	-----------------------

rinse arm shaft



<b>GEV No.</b>	504018	<b>Ref. No.</b>	512021800 80001159
----------------	--------	-----------------	-----------------------

gasket for wash arm support  $\varnothing$   $\varnothing$ 60/101mm rubber thickness 2mm with 3 screw holes



<b>GEV No.</b>	504097	<b>Ref. No.</b>	513099600 80002335
----------------	--------	-----------------	-----------------------

screw connection



<b>GEV No.</b>	504121	<b>Ref. No.</b>	511038000 80002549
----------------	--------	-----------------	-----------------------

rinse arm shaft



1

<b>GEV No.</b>	504018	<b>Ref. No.</b>	512021800 80001159
----------------	--------	-----------------	-----------------------

**description** gasket for wash arm support  $\varnothing$   $\varnothing$ 60/101mm rubber thickness 2mm with 3 screw holes

**For models:** MLP140, MLP60, MLP60E, MLP70, MLP80, MS1100, MS1100E, MS1100P, MS1100T, MS1300, MS1300E, MS1300P, MS1300T, MS350, MS350PS, MS350TRI, MS450, MS450E, MS450PS, MS700, MS700E, MS900, MS900E, MS900T, MS905





Зип Общепит  
vsezip.ru  
+7(812)987-08-81

rinse arm shafts			
			
1			
<b>GEV No.</b>	504009	<b>Ref. No.</b>	513001800 80001075
<b>description</b>	rinse arm shaft		
<b>For models:</b>	GL250, MB235LI, MB240LI, MB510E, MB510ER, MB520, MB520K, MB530, MB530K, MB535, MB630, MB630PS, MB920E, MB920ER, MB930, MB930K, MB930PS, MB930T, MGL40, MS1100, MS1100E, MS1300, MS1300E, MS350, MS350PS, MS350TRI, MS450, MS450E, MS450PS, MS700, MS700E, MS900, MS900E, MS905		

<b>GEV No.</b>	503185	<b>Ref. No.</b>	513186000 51386000 80004569
<b>description</b>	rinse arm shaft total length 36mm ED ø 18mm		
<b>For models:</b>	MB630, MB630PS, MB9235, MB9240, MB930, MB930K, MB930PS, MB930T, MB9500, MB9501, MB9503, MB9510, MB9510R, MB9920, MB9920R, MGL500, MLP50, MLP56, MS1100E, MS1100T, MS1300E, MS1300T, MS351, MS353, MS400B, MS400E, MS400T, MS451, MS453, MS500B, MS500E, MS500PPB, MS500T, MS800B, MS800E, MS800T, MS900E, MS900T, MS905, MS9400, MS9401, MS9403, MS9451, MS9453		

			
1			
<b>GEV No.</b>	504121	<b>Ref. No.</b>	511038000 80002549
<b>description</b>	rinse arm shaft		
<b>For models:</b>	MS350, MS350PS, MS350TRI		

## knobs

### producer-specific knobs

MACH			
			
1			
<b>GEV No.</b>	110100	<b>Ref. No.</b>	500000300 80001175
<b>description</b>	knob thermostat t.max. 90°C 0-90°C ø 42mm shaft ø 6x4.6mm shaft flat -135° black		
<b>For models:</b>	GL220, GL250, MB510E, MB520, MB520K, MB530, MB530K, MB535, MB630, MB920E, MB930, MB930K, MLP140, MLP60, MLP60E, MLP70, MLP80, MS1100, MS1300, MS350, MS350PS, MS450, MS450E, MS450PS, MS700, MS700E, MS900		

			
1			
<b>GEV No.</b>	504176	<b>Ref. No.</b>	513128600 80004071
<b>description</b>	rinse arm shaft		
<b>For models:</b>	MLP140, MLP60, MLP60E, MLP70, MLP80		

			
1			
<b>GEV No.</b>	504194	<b>Ref. No.</b>	511045700 80004249
<b>description</b>	rinse arm shaft		
<b>For models:</b>	GL220, GL250, MB235LI, MB240LI, MB510E, MB510ER, MB530, MB530K, MB535, MB920E, MB920ER, MB930, MB930K, MB930PS, MB930T, MGL40, MS1100, MS1100E, MS1300, MS1300E, MS900, MS900E, MS905		

## handles and hand wheels

### bracket handles

			
1			
<b>GEV No.</b>	504163	<b>Ref. No.</b>	511039400 80003987
<b>description</b>	pull handle		
<b>For models:</b>	MLP140, MLP60, MLP60E, MLP70, MLP80		

			
1			
<b>GEV No.</b>	504235	<b>Ref. No.</b>	513219300
<b>description</b>	rinse arm shaft ø 18mm		
<b>For models:</b>	MLP140, MLP60, MLP60E, MLP70, MLP80		

mechanical components, equipment accessories

## gaskets

## O-rings

## EPDM

ø1.78mm

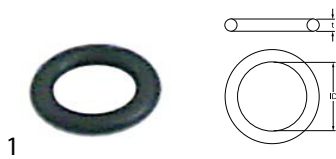

1

<b>GEV No.</b>	505045	<b>Ref. No.</b>	512006600 80002387
<b>description</b>	O-ring EPDM thickness 1.78mm ID ø 5.28mm Qty 1 pcs		
<b>For models:</b>	GL220, GL250, MB235LI, MB240LI, MB510E, MB510ER, MB520, MB520K, MB530, MB530K, MB535, MB630, MB920E, MB930, MB930K, MGL40, MLP140, MLP60, MLP60E, MLP70, MLP80, MS1100, MS1300, MS350, MS350PS, MS450, MS450E, MS450PS, MS700, MS700E, MS900		

ø2.62mm

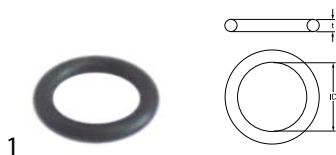

1

<b>GEV No.</b>	528487	<b>Ref. No.</b>	512006400 80002429
<b>description</b>	O-ring EPDM thickness 2.62mm ID ø 9.19mm Qty 1 pcs		
<b>For models:</b>	GL220, GL250, MB235LI, MB240LI, MB510E, MB510ER, MB520, MB520K, MB530, MB530K, MB535, MB630, MB920E, MB930, MB930K, MGL40, MLP140, MLP60, MLP60E, MLP70, MLP80, MS1100, MS1300, MS350, MS350PS, MS450, MS450E, MS450PS, MS700, MS700E, MS900		

ø3.53mm



1

<b>GEV No.</b>	510072	<b>Ref. No.</b>	512013100 513013100 80002243
<b>description</b>	O-ring EPDM thickness 3.53mm ID ø 32.93mm Qty 1 pcs		
<b>For models:</b>	GL250, MB510E, MB510ER, MB630, MB920E, MB920ER, MB930, MB930K, MB930T, MGL40		

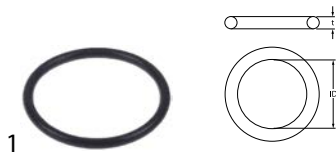

1

<b>GEV No.</b>	519179	<b>Ref. No.</b>	512029500 80002557
<b>description</b>	O-ring EPDM thickness 3.53mm ID ø 41.28mm Qty 1 pcs		
<b>For models:</b>	MLP140, MLP70, MS350, MS350PS, MS350TRI		

Зип-Общепит

ø5.34mm



1

<b>GEV No.</b>	532158	<b>Ref. No.</b>	512006800 80004231
<b>description</b>	O-ring EPDM thickness 5.34mm ID ø 47mm Qty 10 pcs		

## sealing washers

## fibre gaskets



1

<b>GEV No.</b>	504209	<b>Ref. No.</b>	512015300 80004347
<b>description</b>	flat gasket FIBER ED ø 18.5mm ID ø 11mm thickness 2mm Qty 1 pcs		
<b>For models:</b>	GL220, GL250, MB520, MB520K, MB530, MB530K, MB535, MB630, MB930, MB930K, MB930T, MLP140, MLP50, MLP60, MLP60E, MLP70, MLP80, MS1100, MS1100E, MS1100P, MS1300, MS1300E, MS1300P, MS351, MS353, MS400B, MS400E, MS400T, MS451, MS453, MS500B, MS500E, MS500PPB, MS500T, MS800B, MS800E, MS800T, MS900, MS900E, MS905		



1

<b>GEV No.</b>	504020	<b>Ref. No.</b>	512006700 80001167
<b>description</b>	flat gasket FIBER ED ø 24mm ID ø 17mm thickness 2mm Qty 1 pcs		
<b>For models:</b>	GL220, MB235LI, MB240LI, MB510E, MB510ER, MB520, MB520K, MB530, MB530K, MB535, MB920E, MB920ER, MGL40, MS1100, MS1300, MS350, MS350PS, MS350TRI, MS400T, MS450, MS450E, MS450PS, MS500PPB, MS500T, MS700, MS700E, MS900		



1

<b>GEV No.</b>	504081	<b>Ref. No.</b>	512006500 512045300 80002189
<b>description</b>	flat gasket FIBER ED ø 28mm ID ø 20mm thickness 2mm Qty 1 pcs		
<b>For models:</b>	MB235LI, MB240LI, MB630, MB630PS, MLP140, MLP60, MLP60E, MLP70, MLP80, MS1100, MS1100E, MS1100P, MS1300, MS1300E, MS1300P, MS450, MS450E, MS450PS, MS700, MS700E, MS900, MS900E		



Зип-Общепит

vsezip.ru

+7(812)987-08-81

rubber gaskets



1

<b>GEV No.</b>	504014	<b>Ref. No.</b>	512021600
<b>description</b>	flat gasket rubber ED ø 10mm ID ø 6.5mm thickness 1.5mm Qty 1 pcs		

special gaskets

door seals for dishwashers



<b>GEV No.</b>	518618	<b>Ref. No.</b>	512054900 80004513
----------------	--------	-----------------	-----------------------

**description** door seal L 600mm for dishwasher suitable for Mach

**For models:** MB235LI, MB240LI, MB510E, MB510ER, MB520, MB520K, MB530, MB530K, MB630, MB630PS, MB920E, MB920ER, MB9235, MB9240, MB930, MB930K, MB930PS, MB930T, MB9500, MB9501, MB9503, MB9510, MB9510R, MB9920, MB9920R, MGL40, MGL500, MLP50, MLP56, MS351, MS353, MS400B, MS400E, MS400T, MS451, MS453, MS500B, MS500E, MS500PPB, MS500T, MS800B, MS800E, MS800T, MS9400, MS9401, MS9403, MS9451, MS9453

gaskets for wash arm support



1

<b>GEV No.</b>	504041	<b>Ref. No.</b>	512021700 80001485
----------------	--------	-----------------	-----------------------

**description** gasket D1 ø 50mm D2 ø 80mm thickness 3mm rubber with 3 screw holes equiv. no. 1485 suitable for Mach

**For models:** GL220, GL250, MB235LI, MB240LI, MB510E, MB510ER, MB520, MB520K, MB530, MB530K, MB535, MB630, MB630PS, MB920E, MB920ER, MB930, MB930K, MGL40

torsion springs



1

<b>GEV No.</b>	504002	<b>Ref. No.</b>	512006200 80001015
----------------	--------	-----------------	-----------------------

**description** torsion spring

**For models:** GL220, GL250, MB235LI, MB240LI, MB510E, MB510ER, MB520, MB520K, MB530, MB530K, MB535, MB630, MB630PS, MB920E, MB920ER, MB9235, MB9240, MB930, MB930K, MB930PS, MB930T, MB9500, MB9501, MB9503, MB9510, MB9510R, MB9920, MB9920R, MGL40, MGL500, MLP140, MLP50, MLP56, MLP60, MLP60E, MLP70, MLP80, MS350, MS350PS, MS350TRI, MS351, MS353, MS400B, MS400E, MS400T, MS450, MS450E, MS450PS, MS451, MS453...(Other models you can see in the webshop)

spring compressors



1

<b>GEV No.</b>	504033	<b>Ref. No.</b>	513003200 80001383
----------------	--------	-----------------	-----------------------

**description** spring compressor

**For models:** MS1100, MS1100E, MS1100P, MS1100T, MS1300, MS1300E, MS1300P, MS1300T, MS900, MS900E, MS900T, MS905

tension springs



1

<b>GEV No.</b>	504030	<b>Ref. No.</b>	512006300 80001359
----------------	--------	-----------------	-----------------------

**description** tension spring ø 40mm total length 283mm wire gauge ø 5mm

**For models:** MS1100, MS1100E, MS1100P, MS1100T, MS1300, MS1300E, MS1300P, MS1300T, MS900, MS900E, MS900T, MS905

dosing pumps

peristaltic dosing pumps

MICRODOS

built-in version

with frequency control



<b>GEV No.</b>	361803	<b>Ref. No.</b>	512072000
<b>description</b>	dosing pump MICRODOS frequency control 4l/h 230VAC detergent hose ø 4x6mm hose Santoprene suction level 1.5m type MP3-T		
<b>For models:</b>	MGL40, MGL500, MLP140, MLP50, MLP56, MLP60, MLP60E, MLP70, MLP80		
<b>spare parts for</b>	361803		
	<b>GEV No.</b>	<b>361977</b>	<b>Ref. No.</b>
			—
	pump hose MICRODOS detergent ID ø 6.4mm ED ø 9.6mm hose ø 6mm hose type Santoprene		

with time control



<b>GEV No.</b>	361915	<b>Ref. No.</b>	512072100
<b>description</b>	dosing pump MICRODOS time control 1l/h 230VAC rinse aid hose ø 4x6mm hose silicone suction level 1.5m type MP3-T CODE P09CA0301237 dosing time 1-25s		
<b>For models:</b>	MGL500, MLP50, MLP56, MS800B, MS800T		
<b>spare parts for</b>	361915		
	<b>GEV No.</b>	<b>362022</b>	<b>Ref. No.</b>
			—
	pump hose MICRODOS with non-return valve hose ø 10mm hose length 110mm hose type silicone		

Зип-Общепит

SEKO wall-mounted version

with speed control

vsezip.ru

+7(812)987-08-81

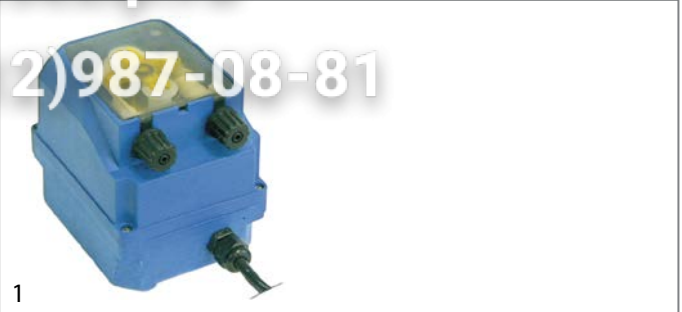

<b>GEV No.</b>	361156 <sup>1</sup>	<b>Ref. No.</b>	512047200 80004167
<b>description</b>	dosing pump SEKO speed control 0.6-4l/h 230VAC detergent hose ø 4x6mm hose type K hose Santoprene suction level 1.5m type PR wall-mounted version dimensions 103x82x92mm		
<b>For models:</b>	MLP140, MS500PPB		
<b>spare parts for</b>	361156		
	<b>GEV No.</b>	<b>361136</b>	<b>Ref. No.</b>
			—
	roller assembly for dosing pump hole ø 4.8x4mm		
	<b>GEV No.</b>	<b>361815</b>	<b>Ref. No.</b>
			—
	pump hose detergent hose ø 6x10mm hose ø 4x6mm hose type K hose Santoprene type SEKO		
<b>accessories for</b>	361156		
	<b>GEV No.</b>	<b>361142</b>	<b>Ref. No.</b>
			—
	mounting set detergent hose type 4x6mm hose length 2m PVC 2x hose/container filter/tank intake transparent		
	<b>GEV No.</b>	<b>361891</b>	<b>Ref. No.</b>
			—
	mounting set detergent hose type 4x6mm hose length 2m PVC 2x hose/container filter/tank intake transparent		
	<b>GEV No.</b>	<b>520090</b>	<b>Ref. No.</b>
			512009100
	PVC hose ID ø 4mm ED ø 6mm L 2m thickness 1mm t.max. 60°C transparent		
	<b>GEV No.</b>	<b>520091</b>	<b>Ref. No.</b>
			—
	nylon hose ID ø 4mm ED ø 6mm L 2m thickness 1mm operating p. 10bar burst p. 50bar t.max. 100°C transparent		

<sup>1</sup>with accessories



Зип-Общепит

vsezip.ru





+7(812)987-08-81

built-in version

with frequency control



1

<b>GEV No.</b>	361215	<b>Ref. No.</b>	512060700 80002955 80004021 80004219
<b>description</b>	dosing pump SEKO frequency control 0.3-3.0l/h 230VAC detergent hose $\varnothing$ 4x6mm hose type K hose Santoprene suction level 1.5m type PBR protection IP55 dimensions 100x67x68mm power input 3.5W		
<b>For models:</b>	MGL40, MGL500, MLP50, MLP60, MLP60E, MLP70, MLP80		
<b>spare parts for</b>	361215		
	<b>GEV No.</b>	361136	<b>Ref. No.</b> —
	roller assembly for dosing pump hole $\varnothing$ 4.8x4mm		
	<b>GEV No.</b>	361226	<b>Ref. No.</b> —
	PCB L 59mm W 26mm electronic control		
<b>accessories for</b>	361215		
	<b>GEV No.</b>	361142	<b>Ref. No.</b> —
	mounting set detergent hose type 4x6mm hose length 2m PVC 2x hose/container filter/tank intake transparent		
	<b>GEV No.</b>	520090	<b>Ref. No.</b> 512009100
	PVC hose ID $\varnothing$ 4mm ED $\varnothing$ 6mm L 2m thickness 1mm t.max. 60°C transparent		
	<b>GEV No.</b>	520091	<b>Ref. No.</b> —
	nylon hose ID $\varnothing$ 4mm ED $\varnothing$ 6mm L 2m thickness 1mm operating p. 10bar burst p. 50bar t.max. 100°C transparent		



with time control



1

<b>GEV No.</b>	361250 <sup>1</sup>	<b>Ref. No.</b>	4233 512046900 80004233
<b>description</b>	dosing pump SEKO with single time control 0.7l/h 230VAC rinse aid hose $\varnothing$ 4x6mm hose type B hose Sekobril suction level 1.5m type PBM built-in version dosing time 1-20s		
<b>For models:</b>	MGL500, MS800B, MS800T		
<b>spare parts for</b>	361250		
	<b>GEV No.</b>	361136	<b>Ref. No.</b> —
	roller assembly for dosing pump hole $\varnothing$ 4.8x4mm		

<sup>1</sup>with accessories

<b>spare parts for</b>	361250		
	<b>GEV No.</b>	361562	<b>Ref. No.</b> —
	pump cover for dosing pump yellow		
	<b>GEV No.</b>	361882	<b>Ref. No.</b> —
	pump hose SEKO rinse aid hose $\varnothing$ 3x7.4mm hose length 135mm hose $\varnothing$ 6mm hose type B hose Sekobril		

piston pumps

dosing pumps



1

<b>GEV No.</b>	361800	<b>Ref. No.</b>	512025600
<b>description</b>	dosing pump type EKP-R/E 230V detergent inlet 8x12mm outlet 8x12mm 60 strokes/min		
<b>spare parts for</b>	361800		
	<b>GEV No.</b>	361047	<b>Ref. No.</b> —
	pressure/suction valve suitable for EKP-R L 38.7mm 3/8" WS 22		
	<b>GEV No.</b>	361652	<b>Ref. No.</b> —
	union nut suitable for EKP-RT1: 3/8"		
	<b>GEV No.</b>	361653	<b>Ref. No.</b> —
	olive suitable for EKP-R		
	<b>GEV No.</b>	361654	<b>Ref. No.</b> —
	hose tail suitable for EKP-R		
	<b>GEV No.</b>	361655	<b>Ref. No.</b> —
	O-ring suitable for EKP-R		
	<b>GEV No.</b>	361857	<b>Ref. No.</b> —
	pump head type EKP-R for dosing pump plastic		







Зип-Общепит



vsezip.ru

+7(812)987-08-81

with solenoid coil



<b>GEV No.</b>	361013	<b>Ref. No.</b>	512021900 80001965
<b>description</b>	dosing pump inlet 4x6mm outlet 5mm 230V rinse aid duty cycle 25% type EKP-M 50Hz impulse 3imp/s		
<b>For models:</b>	GL220, GL250, MB520, MB520K, MB530, MB530K, MB535, MB630, MB930, MB930K, MGL40, MLP50, MS1100, MS1100E, MS1100P, MS1300, MS1300E, MS1300P, MS350, MS350PS, MS350TRI, MS450, MS450E, MS450PS, MS700, MS700E, MS900, MS900E		
<b>spare parts for</b>	361013		
	<b>GEV No.</b>	361482	<b>Ref. No.</b> —
solenoid coil 230VAC for type EKP-M			
	<b>GEV No.</b>	361811	<b>Ref. No.</b> —
hose connector for dosing pump hose ø 6.3mm T1: M12x1.5 chrome-plated brass			
	<b>GEV No.</b>	371090	<b>Ref. No.</b> —
power socket plug type DIN 43650A screw			
<b>accessories for</b>	361013		
	<b>GEV No.</b>	361366	<b>Ref. No.</b> —
PCB dishwasher 11F suitable for DB2 type DB2/EV1/EKP-M			
	<b>GEV No.</b>	361505	<b>Ref. No.</b> —
screw pipe fitting straight nickel-plated brass thread 3/8" IT hose ø 6x8mm			

<b>spare parts for</b>	361013		
	<b>GEV No.</b>	361188	<b>Ref. No.</b> —
disc type DELTA			
	<b>GEV No.</b>	361319	<b>Ref. No.</b> —
flat gasket rubber ID ø 9mm FD ø 14.5mm thickness 1mm type DELTA			

self-priming

LANG





<b>GEV No.</b>	361817	<b>Ref. No.</b>	512005700 80001839
<b>description</b>	dosing pump type N6 membrane dosing pump rinse aid p min 0.5bar pressure connection ø straight, 4x6mm suction connection ø angled, 6mm LANG		
<b>For models:</b>	GL220, GL250, MB235LI, MB240LI, MB510E, MB510ER, MB520, MB520K, MB530, MB530K, MB535, MB630, MB630PS, MB920E, MB920ER, MB9235, MB9240, MB930, MB930K, MB930PS, MB930T, MB9500, MB9501, MB9503, MB9510, MB9510R, MB9920, MB9920R, MGL40, MGL500, MS1100, MS1100E, MS1100P, MS1100T, MS1300, MS1300E, MS1300P, MS1300T, MS351, MS353, MS400B, MS400E, MS400T, MS451, MS453, MS500B, MS500E, MS500T, MS800E, MS900... (Other models you can see in the webshop)		
<b>spare parts for</b>	361817		
	<b>GEV No.</b>	361886	<b>Ref. No.</b> —
non-return valve inletmm outletmm outlet ø 12.4mm L 12.7mm			

membrane dosing pumps

electric dosing pumps



Delta



<b>GEV No.</b>	361003	<b>Ref. No.</b>	512033500
<b>description</b>	dosing pump 220V rinse aid duty cycle 25% type EL-1 valve lip valve		
<b>spare parts for</b>	361003		
	<b>GEV No.</b>	361122	<b>Ref. No.</b> —
lip valve type DELTA			
	<b>GEV No.</b>	361123	<b>Ref. No.</b> —
membrane type DELTA			
	<b>GEV No.</b>	361169	<b>Ref. No.</b> —
hose connector type DELTA			

various



<b>GEV No.</b>	361015	<b>Ref. No.</b>	80002787
<b>description</b>	dosing pump membrane dosing pump rinse aid inlet 6x8mm outlet 4x6mm pressure connection ø 4x6mm suction connection ø 6x8mm		
<b>For models:</b>	MLP55, MLP80		
<b>spare parts for</b>	361015		
	<b>GEV No.</b>	361132	<b>Ref. No.</b> —
membrane dosing pump			
	<b>GEV No.</b>	510298	<b>Ref. No.</b> 512033600
lip valve dosing pump suitable for DB2/DS5			



self-priming with supporting pressure

SEKO



1

<b>GEV No.</b>	361218	<b>Ref. No.</b>	512032200 80004285
<b>description</b>	dosing pump type DIB3P rinse aid 0-3cm <sup>3</sup> per stroke/h pressure connection ø 4x6mm suction connection ø 4x6mm auxiliary pressure connection 10mm SEKO		
<b>For models:</b>	MB235LI, MB240LI, MB510E, MB510ER, MB520, MB520K, MB530, MB530K, MB535, MB930, MB930K		
<b>spare parts for</b>	361218		
	<b>GEV No.</b>	361301	<b>Ref. No.</b> —
hose connector for type DIB3E/DIB5E			
	<b>GEV No.</b>	361302	<b>Ref. No.</b> —
valve bush for type DIB3E/DIB5E			
	<b>GEV No.</b>	361304	<b>Ref. No.</b> —
O-ring EPDM ID ø 11.11mm thickness 1.78mm Qty 1 pcs for type DIB3E/DIB5E			
	<b>GEV No.</b>	361305	<b>Ref. No.</b> —
valve disc for type DIB3E/DIB5E DIB3P/DIB5P			
	<b>GEV No.</b>	361306	<b>Ref. No.</b> —
membrane for type DIB3E/DIB5E ø 49mm hole ø 5mm			
	<b>GEV No.</b>	361481	<b>Ref. No.</b> —
lip valve for type DIB3P/DIB5P DIB3E/DIB5E			



accessories

hoses





PVC hoses



1

<b>GEV No.</b>	520090	<b>Ref. No.</b>	512009100
<b>description</b>	PVC hose ID ø 4mm ED ø 6mm L 2m thickness 1mm t.max. 60°C transparent		
<b>For models:</b>	MB235LI, MB240LI, MB510E, MB510ER, MB520, MB520K, MB530, MB530K, MB535, MB630, MB920E, MB920ER, MB930, MB930K, MB930T, MGL40, MGL500, MLP140, MLP50, MLP56, MLP60, MLP60E, MLP70, MLP80, MS1100, MS1100E, MS1100P, MS1100T, MS1300, MS1300E, MS1300P, MS351, MS353, MS400B, MS400E, MS400T, MS451, MS453, MS500B, MS500E, MS500T, MS800B, MS800E, MS800T, MS900, MS900E, MS900T, MS905		
<b>accessories for</b>	520090		
	<b>GEV No.</b>	361058	<b>Ref. No.</b> —
container filter with non-return valve SS hose ø 4x6mm ø 20mm L 56mm			
	<b>GEV No.</b>	361066	<b>Ref. No.</b> —
container filter straight SS hose ø 4x6mm L 37mm non return valve ball valve			

accessories for 520090

	<b>GEV No.</b>	361106	<b>Ref. No.</b>	—
container filter with weight and non-return valve SS hose ø 4x6mm ø 21mm L 51mm non return valve lip valve				
	<b>GEV No.</b>	361141	<b>Ref. No.</b>	—
container filter with weight ceramic hose ø 4mm				
	<b>GEV No.</b>	361230	<b>Ref. No.</b>	—
container filter with weight stainless steel hose ø 4x6mm				
	<b>GEV No.</b>	361462	<b>Ref. No.</b>	—
container filter with weight SS hose ø 4x6mm				
	<b>GEV No.</b>	361728	<b>Ref. No.</b>	—
container filter with 4m 4x6 hose SS hose ø 4x6mm hose length 4000mm				

tank inlets



1

<b>GEV No.</b>	504125	<b>Ref. No.</b>	513159100 80002819
<b>description</b>	tank inlet		
<b>For models:</b>	MB930T, MGL40, MGL500, MLP140, MLP50, MLP60, MLP60E, MLP70, MLP80, MS1100T, MS1300T, MS350PS, MS400T, MS450PS, MS500PPB, MS500T, MS900T, MS9400		

hoses

supply hoses

PVC supply hoses



1

<b>GEV No.</b>	520631	<b>Ref. No.</b>	1143 1779 512047500
<b>description</b>	supply hose PVC straight-straight DN13 connections 3/4" L 1500mm operating p. 10bar burst p. 32bar t.max. 90°C approval VDE flat seal		
<b>For models:</b>	MB235LI, MB240LI, MB510E, MB510ER, MB520, MB520K, MB530, MB530K, MB535, MB630, MB630PS, MB920E, MB920ER, MB9235, MB9240, MB930, MB930K, MB930PS, MB930T, MB9500, MB9501, MB9503, MB9510, MB9510R, MB9920, MB9920R, MGL40, MGL500, MLP140, MLP50, MLP56, MLP60, MLP60E, MLP70, MLP80, MS1100, MS1100E, MS1100P, MS1100T, MS1300, MS1300E, MS1300P, MS1300T, MS351, MS353, MS400B, MS400E, MS400T, MS451, MS453...(Other models you can see in the webshop)		

water and beverage technology



## drain hoses

Зип-Общепит

accessories for 520090



1

<b>GEV No.</b>	530571	<b>Ref. No.</b>	512035300 80002513
<b>description</b>	drain hose DN24 L 1500mm straight $\phi$ inside 24mm straight ext. $\phi$ 29mm elbow $\phi$ inside 29mm elbow ext. $\phi$ 35mm outer hose $\phi$ 28mm		
<b>For models:</b>	GL220, GL250, MB235LI, MB240LI, MB510E, MB510ER, MB520, MB520K, MB530, MB530K, MB535, MB630, MB630PS, MB920E, MB920ER, MB9235, MB9240, MB930, MB930K, MB930PS, MB930T, MB9501, MB9503, MB9510, MB9510R, MB9920, MB9920R, MGL40, MLP50, MLP56, MS1100, MS1100E, MS1100P, MS1300, MS1300E, MS1300P, MS1300T, MS351, MS353, MS400B, MS400E, MS451, MS453, MS500B, MS500E, MS800B, MS800E, MS900, MS900E, MS905...(Other models you can see in the webshop)		

	<b>GEV No.</b>	361106	<b>Ref. No.</b>	—
	container filter with weight and non-return valve SS hose $\phi$ 4x6mm $\phi$ 2 mm L 5 mm non return valve lip valve			
	<b>GEV No.</b>	361141	<b>Ref. No.</b>	—
	container filter with weight ceramic hose $\phi$ 4mm			
	<b>GEV No.</b>	361230	<b>Ref. No.</b>	—
	container filter with weight stainless steel hose $\phi$ 4x6mm			
	<b>GEV No.</b>	361462	<b>Ref. No.</b>	—
	container filter with weight SS hose $\phi$ 4x6mm			
	<b>GEV No.</b>	361728	<b>Ref. No.</b>	—
	container filter with 4m 4x6 hose SS hose $\phi$ 4x6mm hose length 4000mm			

## industrial hoses

## pressure control hoses



1

<b>GEV No.</b>	530560	<b>Ref. No.</b>	512009900 80001651
<b>description</b>	pressure control hose ID $\phi$ 5mm ED $\phi$ 9mm L 5m operating p. 30bar burst p. 90bar temp.-resist. 60°C		
<b>For models:</b>	MB235LI, MB240LI, MB510E, MB510ER, MB520, MB520K, MB530, MB530K, MB535, MB630, MB920E, MB920ER, MB930, MB930K, MB930T, MGL40, MGL500, MLP140, MLP50, MLP60, MLP60E, MLP70, MLP80, MS1100, MS1100E, MS1100P, MS1100T, MS1300, MS1300E, MS1300P, MS1300T, MS351, MS353, MS400B, MS400E, MS400T, MS451, MS453, MS500B, MS500E, MS500T, MS800B, MS800E, MS800T, MS900, MS900E, MS900T, MS905, MS9400, MS9401...(Other models you can see in the webshop)		

## formed hoses

## straight



1

<b>GEV No.</b>	504071	<b>Ref. No.</b>	512027300 80001963
<b>description</b>	formed hose L 100mm dishwasher straight hose ext. $\phi$ 30mm equiv. no. 1963		
<b>For models:</b>	GL220, GL250, MB235LI, MB240LI, MB520, MB520K, MB530, MB530K, MB535, MB630, MB630PS, MB9235, MB9240, MB930, MB930K, MB930PS, MB930T, MGL40, MGL500, MS350PS, MS400T, MS450PS, MS500PPB, MS500T		

## PVC hoses

## PVC hoses without fabric



1

<b>GEV No.</b>	520090	<b>Ref. No.</b>	512009100
<b>description</b>	PVC hose ID $\phi$ 4mm ED $\phi$ 6mm L 2m thickness 1mm t.max. 60°C transparent		
<b>For models:</b>	MB235LI, MB240LI, MB510E, MB510ER, MB520, MB520K, MB530, MB530K, MB535, MB630, MB920E, MB920ER, MB930, MB930K, MB930T, MGL40, MGL500, MLP140, MLP50, MLP56, MLP60, MLP60E, MLP70, MLP80, MS1100, MS1100E, MS1100P, MS1100T, MS1300, MS1300E, MS1300P, MS351, MS353, MS400B, MS400E, MS400T, MS451, MS453, MS500B, MS500E, MS500T, MS800B, MS800E, MS800T, MS900, MS900E, MS900T, MS905		



1

<b>GEV No.</b>	504160	<b>Ref. No.</b>	512010600 80003927 80004085
<b>description</b>	formed hose L 100mm dishwasher straight hose ext. $\phi$ 60mm equiv. no. 4085, 3927		
<b>For models:</b>	MLP140, MLP70, MLP80		

## accessories for 520090



<b>GEV No.</b>	361058	<b>Ref. No.</b>	—
container filter with non-return valve SS hose $\phi$ 4x6mm $\phi$ 20mm L 56mm			



<b>GEV No.</b>	361066	<b>Ref. No.</b>	—
container filter straight SS hose $\phi$ 4x6mm L 37mm non return valve ball valve			





Зип Общепит

vsezip.ru

+7(812)987-08-81



1

<b>GEV No.</b>	504186	<b>Ref. No.</b>	512045800 80004097 80004099
<b>description</b>	formed hose L 155mm dishwasher straight hose int. ø 50mm		
<b>For models:</b>	MLP140, MLP60, MLP60E, MLP70, MLP80		



1

<b>GEV No.</b>	504027	<b>Ref. No.</b>	512027000 80001255
<b>description</b>	formed hose L 40mm dishwasher straight hose ext. ø 45mm equiv. no. 1255		
<b>For models:</b>	MLP50, MS450, MS450E, MS450PS, MS700, MS700E		



1

<b>GEV No.</b>	504042	<b>Ref. No.</b>	512026800 80001487
<b>description</b>	formed hose L 45mm dishwasher straight hose ext. ø 30mm equiv. no. 1487		
<b>For models:</b>	MB235LI, MB240LI, MB510E, MB510ER, MB520, MB520K, MB530, MB530K, MB535, MB630, MB630PS, MB920E, MB920ER, MB930, MB930K, MB930PS, MB930T, MB9510, MB9510R, MB9920, MB9920R, MGL40, MLP50		



1

<b>GEV No.</b>	504012	<b>Ref. No.</b>	512026900 80001085
<b>description</b>	formed hose L 46mm dishwasher straight hose ext. ø 40mm equiv. no.		
<b>For models:</b>	MGL500, MLP50, MS350, MS350PS, MS350TRI, MS351, MS353, MS400B, MS400E, MS400T, MS451, MS453, MS500B, MS500E, MS500PPB, MS500T, MS800B, MS800E, MS800T		



1

<b>GEV No.</b>	504036	<b>Ref. No.</b>	512027100 80001401
<b>description</b>	formed hose L 60mm dishwasher straight hose ext. ø 45mm equiv. no. 1401		
<b>For models:</b>	MLP50, MS1100, MS1100E, MS1100P, MS1100T, MS1300, MS1300E, MS1300P, MS1300T, MS900, MS900E, MS900T, MS905		

form L



1

<b>GEV No.</b>	504037	<b>Ref. No.</b>	512026600 80001405
<b>description</b>	formed hose L 110/145mm warewashing L-shape equiv. no. 1405 ID ø 60mm		
<b>For models:</b>	MLP140, MLP60, MLP60E, MLP70, MLP80, MS1100, MS1100E, MS1100P, MS1100T, MS1300, MS1300E, MS1300P, MS1300T, MS351, MS353, MS450, MS450E, MS450PS, MS451, MS453, MS700, MS700E, MS900, MS900E, MS900T, MS905		



1

<b>GEV No.</b>	504011	<b>Ref. No.</b>	512026700 80001081
<b>description</b>	formed hose warewashing L-shape equiv. no. 1801 ID ø 45mm		
<b>For models:</b>	MLP50, MS350, MS350PS, MS350TRI, MS351, MS353, MS451, MS453, MS9451, MS9453		



1

<b>GEV No.</b>	504068	<b>Ref. No.</b>	512016900 80001937
<b>description</b>	formed hose warewashing L-shape equiv. no. 1937 ID ø 30mm		
<b>For models:</b>	GL220, GL250, MB235LI, MB240LI, MB510E, MB510ER, MB520, MB520K, MB530, MB530K, MB535, MB630, MB630PS, MB920E, MB920ER, MB9235, MB9240, MB930, MB930K, MB930PS, MB930T, MB9510, MB9510R, MB9920, MB9920R, MGL40, MGL500, MS400T, MS500PPB, MS500T		

with branch



1

<b>GEV No.</b>	504237	<b>Ref. No.</b>	512068600
<b>description</b>	formed hose		
<b>For models:</b>	MB9500, MB9501, MB9503, MGL500, MLP50, MLP56, MS351, MS353, MS400B, MS400E, MS400T, MS451, MS453, MS500B, MS500E, MS500T, MS800B, MS800E, MS800T, MS9400, MS9401, MS9403, MS9451, MS9453		

for dishwashers

miscellaneous



1

<b>GEV No.</b>	504173	<b>Ref. No.</b>	512040500 80004017
<b>description</b>	braided hose ED ø 30mm ID ø 24mm PVC warewashing equiv. no. 4017		
<b>For models:</b>	MLP140, MLP60, MLP60E, MLP70, MLP80		

fittings, hose and pipe connectors

fittings

double nipples



1

<b>GEV No.</b>	520166	<b>Ref. No.</b>	500070900 80003887
<b>description</b>	double nipple nickel-plated brass thread 3/8" - 3/8" Qty 1 pcs		
<b>For models:</b>	MGL500, MLP60, MLP60E, MS800B, MS800T		

Зип-Общепит

hose connectors

producer-specific

vsezip.ru

+7(812)987-08-81



1

<b>GEV No.</b>	504141	<b>Ref. No.</b>	500046400 80003815
<b>description</b>	hose connector thread 3/8" straight hose ø 14mm nickel-plated brass		
<b>For models:</b>	MGL500, MLP50, MLP56, MLP60, MLP60E, MS800B, MS800T		



1

<b>GEV No.</b>	504097	<b>Ref. No.</b>	513099600 80002335
<b>description</b>	screw connection		
<b>For models:</b>	MS350, MS350PS, MS350TRI		

valves and tank inlets

ball valves

universal

ball valves with lever handle



1

<b>GEV No.</b>	504162	<b>Ref. No.</b>	500031100 80003943
<b>description</b>	ball valve connection 1 1/4" IT - 1 1/4" ET DN32 total length 96mm with lever handle handle length 145mm		
<b>For models:</b>	MLP140, MLP60, MLP60E, MLP70, MLP80		

accessories

lever handles



1

<b>GEV No.</b>	504869	<b>Ref. No.</b>	513306800
<b>description</b>	lever handle L 150mm shaft diameter 10x10mm		



## connection fittings

### screw pipe fittings

			
1			
<b>GEV No.</b>	540056	<b>Ref. No.</b>	500037100 80002021
<b>description</b>	T-piece thread 1/2" tube ø 12mm chrome-plated brass		
<b>For models:</b>	MS1100, MS1300, MS450, MS450E, MS450PS, MS700, MS700E, MS900		

Зип Общепит

vsezip.ru

+7(812)987-08-81

<b>GEV No.</b>	520120	<b>Ref. No.</b>	502000800
<b>description</b>	hose clamp SS W4 ø 12-20mm width 9mm Qty 1 pcs DIN 3017		
<b>For models:</b>	MB235LI, MB240LI, MB510E, MB510ER, MB520, MB520K, MB530, MB530K, MB535, MB630, MB630PS, MB920E, MB920ER, MB9235, MB9240, MB930, MB930K, MB930PS, MB930T, MB9500, MB9501, MB9503, MB9510, MB9510R, MB9920, MB9920R, MGL40, MGL500, MLP140, MLP50, MLP56, MLP60, MLP60E, MLP70, MLP80, MS1100, MS1100E, MS1100P, MS1100T, MS1300, MS1300E, MS1300P, MS1300T, MS351, MS353, MS400B, MS400E, MS400T, MS451, MS453...(Other models you can see in the webshop)		

## water cycle components

### non-return valves

			
1			
<b>GEV No.</b>	543266	<b>Ref. No.</b>	500046300 80003889
<b>description</b>	non-return valve brass connection 3/8" IT - 3/8" IT total length 55mm DN10 Qty 1 pcs		
<b>For models:</b>	MGL500, MLP50, MLP60, MLP60E, MS800B, MS800T		

### miscellaneous

			
1			
<b>GEV No.</b>	504392	<b>Ref. No.</b>	502000400
<b>description</b>	hose clamp stainless steel ø 30-60mm width 9mm Qty 1 pcs		
<b>For models:</b>	MB9500, MB9501, MB9503, MGL500, MLP140, MLP50, MLP56, MLP60, MLP60E, MLP70, MLP80, MS351, MS353, MS400B, MS400E, MS400T, MS451, MS453, MS500B, MS500E, MS500T, MS800B, MS800E, MS800T, MS9400, MS9401, MS9403, MS9451, MS9453		

## ancillary products

### clamps

#### hose clamps

#### DIN 3017 - W2

			
1			
<b>GEV No.</b>	520110	<b>Ref. No.</b>	502000200
<b>description</b>	hose clamp ø 8-12mm width 9mm Qty 10 pcs DIN 3017		
<b>For models:</b>	MB235LI, MB240LI, MB510E, MB510ER, MB520, MB520K, MB530, MB530K, MB535, MB630, MB630PS, MB920E, MB920ER, MB9235, MB9240, MB930, MB930K, MB930PS, MB930T, MB9500, MB9501, MB9503, MB9510, MB9510R, MB9920, MB9920R, MGL40, MGL500, MLP140, MLP50, MLP56, MLP60E, MLP70, MLP80, MS1100, MS1100E, MS1100P, MS1100T, MS1300, MS1300E, MS1300P, MS1300T, MS351, MS353, MS400B, MS400E, MS400T, MS451, MS453, MS500B...(Other models you can see in the webshop)		

### pipe clamps

			
1			
<b>GEV No.</b>	504110	<b>Ref. No.</b>	513095500 513109100 80002457 80002909
<b>description</b>	pipe clamp ø 68/66mm SS		
<b>For models:</b>	GL220, GL250, MB510E, MB510ER, MB520, MB520K, MB530, MB530K, MB535, MB630, MB630PS, MB920E, MB920ER, MB930, MB930K, MB930PS, MB930T, MGL40		



## measuring equipment

## thermometers

## built-in thermometers



1

<b>GEV No.</b>	541086	<b>Ref. No.</b>	500002500 80001409
<b>description</b>	thermometer mounting measurements 58x25.5mm 0 up to +120°C capillary pipe 2000mm probe ø 6mm probe L 23mm		
<b>For models:</b>	MLP55, MLP60E, MLP80, MS1100, MS1100E, MS1100P, MS1100T, MS1300, MS1300E, MS1300P, MS1300T, MS900, MS900E, MS900T		

## hexagonal nuts

## hexagonal nuts metric (without norm)



1

<b>GEV No.</b>	504208	<b>Ref. No.</b>	502004000 80004345
<b>description</b>	nut thread M10		
<b>For models:</b>	GL220, GL250, MB520, MB520K, MB530, MB530K, MB535, MB630, MB930, MB930K, MB930T, MGL500, MLP140, MLP50, MLP60, MLP60E, MLP70, MLP80, MS1100, MS1100E, MS1100P, MS1300, MS1300E, MS1300P, MS351, MS353, MS400B, MS400E, MS400T, MS451, MS453, MS500B, MS500E, MS500PPB, MS500T, MS800B, MS800E, MS800T, MS900, MS900E, MS905		

## fastening material

## screws

## side bolts



1

<b>GEV No.</b>	560289	<b>Ref. No.</b>	502016000
<b>description</b>	side bolts thread M6 L 12mm SS Qty 1 pcs intake Phillips head ø 12.6mm		
<b>For models:</b>	MS1100E, MS1100P, MS1100T, MS1300E, MS1300P, MS1300T, MS900E, MS900T, MS905		

## knurled screws



1

<b>GEV No.</b>	504228	<b>Ref. No.</b>	513149900
<b>description</b>	Thumb screw thread M6 thread L 13mm ø 24mm H 4mm SS		
<b>For models:</b>	MB235LI, MB240LI, MB510E, MB510ER, MB520, MB520K, MB530, MB530K, MB535, MB630, MB630PS, MB920E, MB920ER, MB930, MB930K, MB930PS, MB930T, MGL40, MLP50, MS1100, MS1100E, MS1300, MS1300E, MS900, MS900E, MS905		

## hexagonal nuts inch thread



1

<b>GEV No.</b>	504134	<b>Ref. No.</b>	513134600 80002939
<b>description</b>	nut thread 1¼"		
<b>For models:</b>	MGL40		



1

<b>GEV No.</b>	503042	<b>Ref. No.</b>	513000400 80001165
<b>description</b>	nut thread 3/8" H 6mm brass WS 22 Qty 1 pcs		
<b>For models:</b>	GL220, MB235LI, MB240LI, MB510E, MB510ER, MB520, MB520K, MB530, MB530K, MB535, MB920E, MB920ER, MGL40, MS1100, MS1300, MS350, MS350PS, MS350TRI, MS400T, MS450, MS450E, MS450PS, MS500PPB, MS500T, MS700, MS700E, MS900		



Зип Общепит

pipe clamps

fasteners

clamps

hose clamps

DIN 3017 - W2



1

<b>GEV No.</b>	520110	<b>Ref. No.</b>	502000200
<b>description</b>	hose clamp ø 8-12mm width 9mm Qty 10 pcs DIN 3017		
<b>For models:</b>	MB235LI, MB240LI, MB510E, MB510ER, MB520, MB520K, MB530, MB530K, MB535, MB630, MB630PS, MB920E, MB920ER, MB9235, MB9240, MB930, MB930K, MB930PS, MB930T, MB9500, MB9501, MB9503, MB9510, MB9510R, MB9920, MB9920R, MGL40, MGL500, MLP140, MLP50, MLP60, MLP60E, MLP70, MLP80, MS1100, MS1100E, MS1100P, MS1100T, MS1300, MS1300E, MS1300P, MS1300T, MS351, MS353, MS400B, MS400E, MS400T, MS451, MS453, MS500B...(Other models you can see in the webshop)		

DIN 3017 - W4



1

<b>GEV No.</b>	520120	<b>Ref. No.</b>	502000800
<b>description</b>	hose clamp SS W4 ø 12-20mm width 9mm Qty 1 pcs DIN 3017		
<b>For models:</b>	MB235LI, MB240LI, MB510E, MB510ER, MB520, MB520K, MB530, MB530K, MB535, MB630, MB630PS, MB920E, MB920ER, MB9235, MB9240, MB930, MB930K, MB930PS, MB930T, MB9500, MB9501, MB9503, MB9510, MB9510R, MB9920, MB9920R, MGL40, MGL500, MLP140, MLP50, MLP56, MLP60, MLP60E, MLP70, MLP80, MS1100, MS1100E, MS1100P, MS1100T, MS1300, MS1300E, MS1300P, MS1300T, MS351, MS353, MS400B, MS400E, MS400T, MS451, MS453...(Other models you can see in the webshop)		

miscellaneous



1

<b>GEV No.</b>	504392	<b>Ref. No.</b>	502000400
<b>description</b>	hose clamp stainless steel ø 30-60mm width 9mm Qty 1 pcs		
<b>For models:</b>	MB9500, MB9501, MB9503, MGL500, MLP140, MLP50, MLP56, MLP60, MLP60E, MLP70, MLP80, MS351, MS353, MS400B, MS400E, MS400T, MS451, MS453, MS500B, MS500E, MS500T, MS800B, MS800E, MS800T, MS9400, MS9401, MS9403, MS9451, MS9453		

vsezip.ru

+7(812)987-08-81

<b>GEV No.</b>	504110	<b>Ref. No.</b>	513095500 513109100 80002457 80002909
<b>description</b>	pipe clamp ø 68/66mm SS		
<b>For models:</b>	GL220, GL250, MB510E, MB510ER, MB520, MB520K, MB530, MB530K, MB535, MB630, MB630PS, MB920E, MB920ER, MB930, MB930K, MB930PS, MB930T, MGL40		

retaining rings

DIN 7993



1

<b>GEV No.</b>	523029	<b>Ref. No.</b>	512053100 80004563
<b>description</b>	retaining ring shaft ø 47mm DIN 7993 thickness 3mm		
<b>For models:</b>	MB630, MB630PS, MB9235, MB9240, MB930, MB930K, MB930PS, MB930T, MB9500, MB9501, MB9503, MB9510, MB9510R, MB9920, MB9920R, MGL500, MLP50, MLP56, MS1100E, MS1100T, MS1300E, MS1300T, MS351, MS353, MS400B, MS400E, MS400T, MS451, MS453, MS500B, MS500E, MS500PPB, MS500T, MS800B, MS800E, MS800T, MS900E, MS900T, MS905, MS9400, MS9401, MS9403, MS9451, MS9453		

roll pins



1

<b>GEV No.</b>	691637	<b>Ref. No.</b>	502001800
<b>description</b>	roll pin ø 3mm L 20mm		
<b>For models:</b>	MB520, MB520K, MB530, MB530K, MB535, MB630, MB630PS, MB9235, MB9240, MB930, MB930K, MB930PS, MB930T, MB9500, MB9501, MB9503, MB9510, MB9510R, MB9920, MB9920R, MGL40, MGL500, MLP140, MLP50, MLP56, MLP60, MLP60E, MLP70, MLP80, MS351, MS353, MS400B, MS400E, MS400T, MS451, MS453, MS500B, MS500E, MS500T, MS800B, MS800E, MS800T, MS9400, MS9401, MS9403, MS9451, MS9453		

consumables

fuses

fine fuses



1

<b>GEV No.</b>	358678	<b>Ref. No.</b>	500087200
<b>description</b>	fine fuse size ø5x20mm 8A fast-acting rated 250V Qty 10 pcs		
<b>For models:</b>	MB9500, MB9501, MB9503, MLP50, MLP56, MS9400, MS9401, MS9403, MS9451, MS9453		



1

<b>GEV No.</b>	358690	<b>Ref. No.</b>	500014700 80002983
<b>description</b>	fine fuse size ø5x20mm 1A medium lag rated 250V Qty 10 pcs		
<b>For models:</b>	MGL40, MGL500, MLP140, MLP60, MLP60E, MLP70, MLP80, MS1100T, MS1300T, MS400T, MS500T, MS800T, MS900T		

Зип Общепит

vsezip.ru

+7(812)987-08-81

<b>GEV No.</b>	358697	<b>Ref. No.</b>	500014900 80002985
<b>description</b>	fine fuse size ø5x20mm 6.3A medium lag rated 250V Qty 10 pcs		
<b>For models:</b>	MB630, MB630PS, MB9235, MB9240, MB930, MB930K, MB930PS, MB930T, MB9510, MB9510R, MB9920, MB9920R, MGL40, MLP140, MLP60, MLP70, MLP80		

Зип Общепит

K

vsezip.ru

L

+7(812)987-08-81

<b>B</b>			
ball valves	50	knurled screws	52
bi-metal thermostats	4, 4		
booster pumps I	21		
booster pumps II	22	lamps	7
<b>C</b>		<b>M</b>	
cables	23	magnetic switches	6
clamps	51, 53	measuring equipment	52
condensators & interference suppression filters	22	<b>N</b>	
connection fittings	51	non-return valves	51
consumables	54	nuts	52
contactors	8	<b>O</b>	
control thermostats	4, 5	operating capacitors	22
<b>D</b>		O-rings	42
door seals for dishwashers	43	<b>P</b>	
dosing pumps	44	pipe clamps	51, 53
double nipples	50	plunger sockets	5
drain hoses	48	position switches	6
drain pumps	21	pressure control hoses	48
<b>E</b>		pressure switches	13
electric accessories	23	probes	9
electrodes	14	programme timers	7
electronic controllers	9	pumps	14
<b>F</b>		push/momentary push switches	5
fasteners	53	PVC hoses	48
fastening material	52	PVC supply hoses	47
filters	22	<b>R</b>	
fine fuses	54	relays	8
fittings	50	retaining rings	53
flow heaters	4	ribbon cables	23
formed hoses	48	roll pins	53
fuses	22, 54	<b>S</b>	
<b>G</b>		safety thermostats	5
gaskets for wash arm support	43	screw pipe fittings	51
<b>H</b>		screws	52
heating elements	2	sealing washers	42
hexagonal nuts	52	side bolts	52
hose clamps	51, 53	solenoid valves	11
hose connectors	50	supply hoses	47
hoses	47	switches and momentary switches	5
<b>I</b>		<b>T</b>	
immersion heating elements	2	tank inlets	47
indicator lights	7	temperature probes	9
industrial hoses	48	terminals	23
		thermostats	4

timers 7

T-pieces 51

## U

universal probes 9

## V

valves and tank inlets 50

## W

wash and rinse pumps 14

water cycle components 51

Зип Общепит

vsezip.ru

+7(812)987-08-81