

Зип Общепит

vsezip.ru

+7(812)987-08-81

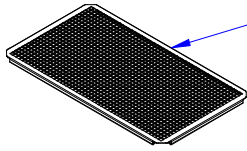

8077  
 Drawer Tray  
 (FWDG only)

FWDG takes TA09 (1/1GN, 100mm deep) and 8077 drawer tray (illustrated above).

DR14  
 Drawer Assembly for FWDG.  
 Comes with SL05.

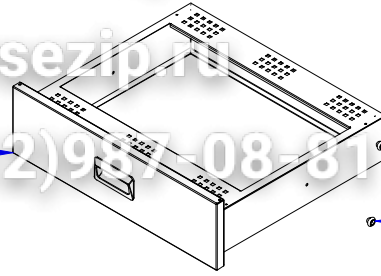

SL05  
 Roller

SL05  
 Roller  
 (4 fit to each drawer)

FWD and KFC/WD take TA68 pan with TR32 wire tray.

DR13  
 Drawer Assembly for FWD and KFC/WD.  
 Comes with SL05.

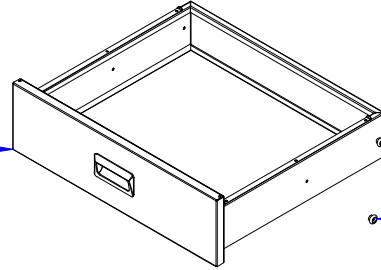

SL05  
 Roller

SL05  
 Roller

### SL05

Each SL05 comprises:

- 1 x LH runner,
- 1 x RH runner,
- 8 x Rollers,
- 8 x M5 x 20 c/sunk head screws

6776  
 Vented Base  
 (remove for access to element)

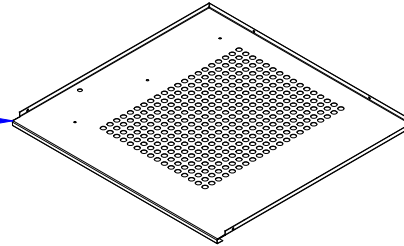

## KFC/WD FWD - A001 FWDG - A001

EL93  
 1500W Element

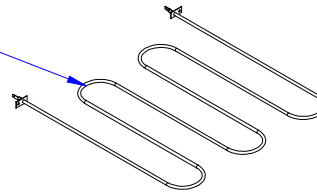

PL143  
 Plug & Lead



Heyco Bush

SL05  
 LH Runner  
 (see note above)

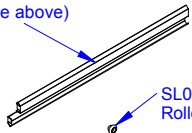

SL05  
 Roller

SL05  
 Roller

SL05  
 LH Runner

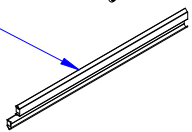

SL05  
 Roller

SL05  
 Roller

6791  
 Anti-Surge Bar  
 (2 x 6791 spot welded together make up assembly)

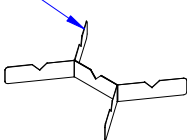

SL05  
 Roller  
 (2 per runner, fit to cabinet side) (see note above)

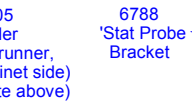

6788  
 'Stat Probe Bracket



6792  
 Water Tray

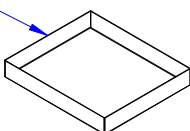

SW18  
 I/O Switch



NE38  
 Green Neon



SP44



NE37  
 Amber Neon



FAS256  
 Blanking Grommet



SP44  
 Spacer  
 (2 off)



TH27  
 Control Thermostat



WT110  
 Water Tray  
 Drawer Assembly

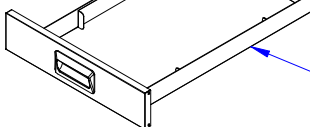

SL05  
 RH Runner  
 (see note above left)

SL05  
 Roller

SL05  
 Roller

SL05  
 Roller

SL05  
 Roller

SL05  
 Roller

SL05  
 Roller

SL05  
 Roller