



Зип Общепит

vsezip.ru

+7(812)987-08-81



GAS COMPONENTS



ELECTRIC COMPONENTS



WATER TECHNOLOGY



MECHANICAL COMPONENTS



TOOLS

Spare parts suitable for

EMMEPI

Find the complete and up-to-date range of products in our GEV Webshop

Зип Общепит

vsezip.ru

+7(812)987-08-81

Manufacturer catalogue

The most important spare parts and accessories arranged clearly for every manufacturer



Complete product range and all appliance data always up to date in the GEV Webshop







Alphabetical Index at the end of the catalogue

GEV Webshop

www.gev-online.co.uk

www.gev-online.com





-  Add to Favourites
-  Sign In with email address and usual password
-  Easy-order – place several items in your basket at the same time
-  Quick Item search – no login needed



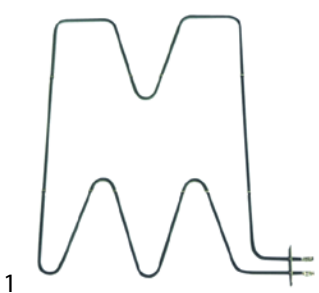

heating elements

heating elements for ovens

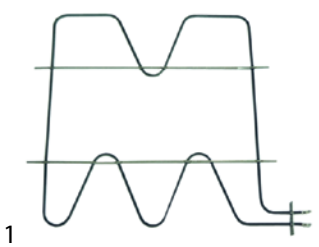

GEV No.	416074	Ref. No.	C00215
description	heating element 2500W 230V L 523mm W 555mm L1 64mm L2 458mm W1 525mm W2 30mm flange length 70mm flange width 22mm hole distance 56mm hole ø 5mm tube ø 6.3mm heating circuits 1 rectangular flange dry heating element		
accessories for	416074		
	GEV No.	510368	Ref. No. 8C0286
	gasket L 70mm W 23.5mm hole ø 5mm hole distance 56mm FIBER thickness 2mm for heating element		



GEV No.	416068	Ref. No.	C00215
description	heating element 2500W 230V L 525mm W 500mm L1 60mm L2 460mm W1 524mm W2 31mm flange length 70mm flange width 22mm hole distance 56mm hole ø 5mm tube ø 6.3mm connection M4 heating circuits 1 rectangular flange oven		
accessories for	416068		
	GEV No.	510368	Ref. No. 8C0286
	gasket L 70mm W 23.5mm hole ø 5mm hole distance 56mm FIBER thickness 2mm for heating element		

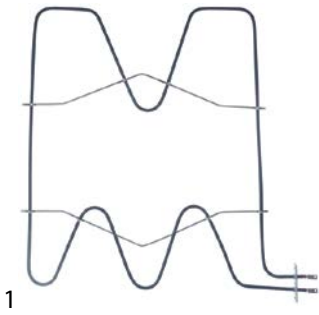



GEV No.	419171	Ref. No.	C10194
description	heating element 2500W 230V L 525mm W 560mm L2 465mm W1 525mm W2 30mm flange length 70mm flange width 23mm hole distance 56mm hole ø 5mm tube ø 6.3mm connection length 41mm heating circuits 1 mounting thread M4 oven heating element		

Зип Общепит

vsezip.ru

+7(812)987-08-81



GEV No.	416061	Ref. No.	C10193
description	heating element 3000W 230V L 715mm W 470mm L1 60mm L2 655mm W1 436mm W2 34mm flange length 70mm flange width 22mm hole distance 56mm hole ø 4mm tube ø 9mm connection length 53mm connection M4 heating circuits 1 rectangular flange dry heating element oven		
accessories for	416061		
	GEV No.	510368	Ref. No. 8C0286
	gasket L 70mm W 23.5mm hole ø 5mm hole distance 56mm FIBER thickness 2mm for heating element		

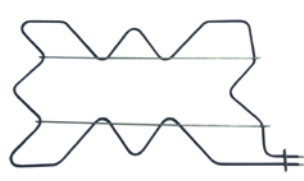

GEV No.	416069	Ref. No.	C10195
description	heating element 4000W 230V L 860mm W 500mm L1 60mm L2 800mm W1 466mm W2 34mm flange length 70mm flange width 22mm hole distance 56mm hole ø 5mm tube ø 8.5mm connection length 45mm connection M4 heating circuits 1 rectangular flange dry heating element oven		
accessories for	416069		
	GEV No.	510368	Ref. No. 8C0286
	gasket L 70mm W 23.5mm hole ø 5mm hole distance 56mm FIBER thickness 2mm for heating element		

heating elements for bain maries









GEV No.	416067	Ref. No.	808174
description	heating element 1380W 230V heating circuits 1 L 346mm W 190mm connection M5 tube ø 8.5mm 2 hole fixing thread 1/4" immersion heater W1 70mm W2 105mm H 27mm mounting distance 67mm		
spare parts for	416067		
	GEV No.	510417	Ref. No. —
	flat gasket fibre ED ø 20mm ID ø 14mm thickness 2mm Qty 1 pcs		
accessories for	416067		
	GEV No.	361182	Ref. No. —
	nut thread 1/4" H 5mm nickel-plated brass WS 17 Qty 1 pcs		
	GEV No.	520228	Ref. No. —
	tooth lock washer ID ø 15.3mm ED ø 24mm steel Qty 1 pcs for thread M14		
	GEV No.	550262	Ref. No. —
	flat gasket copper ED ø 20mm ID ø 14mm thickness 2mm		
	GEV No.	560112	Ref. No. —
	plain washer ID ø 5.3mm ED ø 10mm thickness 1mm SS Qty 20 pcs DIN 125A for thread M5		

Table continues overleaf

Зип Общежит
heating elements for fryers

accessories for	416067		
	GEV No.	560132	Ref. No.
			—
	hexagonal nut thread M5 H 4mm WS 8 SS DIN/ISO DIN 934 / ISO 4032/8673 Qty 20 pcs		



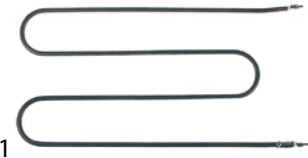

	1		
GEV No.	418335	Ref. No.	ED1110004
description	heating element 500W 230V heating circuits 1 L 430mm L1 38mm W 280mm connection M4 connection distance 271mm tube \varnothing 8.5mm dry heating element L2 392mm H 16mm		

heating elements for chip scuttles





	1		
GEV No.	416067	Ref. No.	808174
description	heating element 1380W 230V heating circuits 1 L 346mm W 190mm connection M5 tube \varnothing 8.5mm 2 hole fixing thread 1/4" immersion heater W1 70mm W2 105mm H 27mm mounting distance 67mm		
spare parts for	416067		
	GEV No.	510417	Ref. No.
			—
	flat gasket fibre ED \varnothing 20mm ID \varnothing 14mm thickness 2mm Qty 1 pcs		
accessories for	416067		
	GEV No.	361182	Ref. No.
			—
	nut thread 1/4" H 5mm nickel-plated brass WS 17 Qty 1 pcs		
	GEV No.	520228	Ref. No.
			—
	tooth lock washer ID \varnothing 15.3mm ED \varnothing 24mm steel Qty 1 pcs for thread M14		
	GEV No.	550262	Ref. No.
			—
	flat gasket copper ED \varnothing 20mm ID \varnothing 14mm thickness 2mm		
	GEV No.	560112	Ref. No.
			—
	plain washer ID \varnothing 5.3mm ED \varnothing 10mm thickness 1mm SS Qty 20 pcs DIN 125A for thread M5		
	GEV No.	560132	Ref. No.
			—
	hexagonal nut thread M5 H 4mm WS 8 SS DIN/ISO DIN 934 / ISO 4032/8673 Qty 20 pcs		

off-center connection

vsezip.ru

	1		
GEV No.	416070	Ref. No.	808256
description	heating element 10200W 230/400V heating circuits 3 L 300mm W 180mm H 33mm flange length 19.5mm flange length 1 9.5mm flange length 2 9.8mm flange \varnothing 1 62mm flange \varnothing 2 57mm thermostat sleeves \varnothing 6.5mm sensor screw connection 2x M10x1 thermostat sleeve upper/lower L1 18mm L2 282mm W1 30mm W2 35mm thread M54x1.5 windings 5 tube \varnothing 8.5mm cable length 450mm rotation flange immersion heater fryer connection length 130mm 2		
spare parts for	416070		
	GEV No.	510243	Ref. No.
			808055
	O-ring Viton thickness 3.53mm ID \varnothing 55.56mm Qty 1 pcs		
accessories for	416070		
	GEV No.	510243	Ref. No.
			808055
	O-ring Viton thickness 3.53mm ID \varnothing 55.56mm Qty 1 pcs		
	GEV No.	550662	Ref. No.
			808892
	ring nut thread M54x1.5 H 7mm		

center connection

	1		
GEV No.	415297	Ref. No.	808689
description	heating element 6800W 230/400V heating circuits 3 L 299mm W 107mm H 35mm flange length 19.5mm flange length 1 9.5mm flange length 2 9.8mm flange \varnothing 1 62mm flange \varnothing 2 57mm thermostat sleeves \varnothing 8.5mm sensor screw connection 2x M10x1 thermostat sleeve upper/lower L1 16mm L2 283mm W1 30mm W2 77mm thread M54x1.5 tube \varnothing 8.5mm cable length 450mm rotation flange immersion heater		
accessories for	415297		
	GEV No.	510243	Ref. No.
			808055
	O-ring Viton thickness 3.53mm ID \varnothing 55.56mm Qty 1 pcs		
	GEV No.	510245	Ref. No.
			808054
	O-ring Viton thickness 3.53mm ID \varnothing 50.8mm Qty 1 pcs		
	GEV No.	550447	Ref. No.
			808892
	ring nut thread M54x1.5		



Зип Общепит

vsezip.ru

+7(812)987-08-81

2 hole fixing

GEV No.	416065	Ref. No.	808620
description	heating element 1333W 230V heating circuits 1 L 283mm W 20mm H 40mm thread M12x1 tube ø 8.5mm connection M4 connection length 52mm mounting distance 31mm windings 2 immersion heater 2 hole fixing		
spare parts for	416065		
	GEV No.	507313	Ref. No. —
	O-ring EPDM thickness 2.62mm ID ø 13.95mm Qty 1 pcs		
accessories for	416065		
	GEV No.	361182	Ref. No. —
	nut thread 1/4" H 5mm nickel-plated brass WS 17 Qty 1 pcs		
	GEV No.	510417	Ref. No. —
	flat gasket fibre ED ø 20mm ID ø 14mm thickness 2mm Qty 1 pcs		
	GEV No.	520228	Ref. No. —
	tooth lock washer ID ø 15.3mm ED ø 24mm steel Qty 1 pcs for thread M14		
	GEV No.	521103	Ref. No. —
	nut thread M4 H 3mm WS 7 brass Qty 20 pcs		
	GEV No.	521104	Ref. No. —
	washer ID ø 4.3mm ED ø 8mm thickness 0.5mm brass Qty 20 pcs for thread M4		
	GEV No.	550262	Ref. No. —
	flat gasket copper ED ø 20mm ID ø 14mm thickness 2mm		
	GEV No.	560111	Ref. No. —
	plain washer ID ø 4.3mm ED ø 9mm thickness 0.8mm SS Qty 20 pcs DIN 125A for thread M4		
	GEV No.	560131	Ref. No. —
	hexagonal nut thread M4 H 3.2mm WS 7 SS DIN/ISO DIN 934 / ISO 4032/8673 Qty 20 pcs		

GEV No.	416064	Ref. No.	809460
description	heating element 3300W 230V heating circuits 1 L 285mm W 74mm H 42mm thread M12x1 tube ø 8.5mm connection M4 connection length 37mm windings 5 fryer heaters 2 hole fixing		
accessories for	416064		
	GEV No.	520229	Ref. No. —
	nut thread M12x1 H 4mm WS 16 zinc-coated steel Qty 1 pcs		
	GEV No.	521103	Ref. No. —
	nut thread M4 H 3mm WS 7 brass Qty 20 pcs		

GEV No.	521104	Ref. No.	—
	washer ID ø 4.3mm ED ø 8mm thickness 0.5mm brass Qty 20 pcs for thread M4		
GEV No.	521110	Ref. No.	—
	flat gasket fibre ED ø 20mm ID ø 13mm thickness 2mm Qty 1 pcs		
GEV No.	521131	Ref. No.	—
	nut thread M12x1 H 3.5mm WS 17 SS Qty 1 pcs		
GEV No.	528110	Ref. No.	—
	O-ring EPDM thickness 2.62mm ID ø 12.37mm Qty 1 pcs		
GEV No.	560111	Ref. No.	—
	plain washer ID ø 4.3mm ED ø 9mm thickness 0.8mm SS Qty 20 pcs DIN 125A for thread M4		
GEV No.	560131	Ref. No.	—
	hexagonal nut thread M4 H 3.2mm WS 7 SS DIN/ISO DIN 934 / ISO 4032/8673 Qty 20 pcs		

heating elements for griddles

GEV No.	416062	Ref. No.	C10199
description	heating element 1000W 230V heating circuits 1 L 220mm W 103mm H 32mm tube ø 6.3mm L1 42mm L2 178mm W1 28mm W2 45mm connection length 19mm griddle dry heating element		

GEV No.	416075	Ref. No.	C00650
description	heating element 1200W 230V heating circuits 1 L 295mm W 105mm H 32mm tube ø 6.5mm L1 40mm L2 252mm W1 35mm W2 35mm connection M4 connection length 23mm tilting bratt pan connection distance 29mm dry heating element		

GEV No.	416072	Ref. No.	C00644
description	heating element 1800W 230V L 290mm W 130mm H 30mm tube ø 6.5mm L1 130mm L2 160mm W1 60mm W2 20mm connection M4 connection length 20mm dry heating element		









heating elements for pasta cookers

GEV No.	416066	Ref. No.	808056
description	heating element 1840W 230V heating circuits 1 L 275mm W 64mm H 42mm 2 hole fixing connection M4 thread 1/4" tube ø 8.5mm		
accessories for	416066		
	GEV No.	361182	Ref. No. —
	nut thread 1/4" H 5mm nickel-plated brass WS 17 Qty 1 pcs		

Table continues overleaf







accessories for	416066		
	GEV No.	510417	Ref. No.
			—
	flat gasket fibre ED ø 20mm ID ø 14mm thickness 2mm Qty 1 pcs		
	GEV No.	520228	Ref. No.
			—
	tooth lock washer ID ø 15.3mm ED ø 24mm steel Qty 1 pcs for thread M14		
	GEV No.	521103	Ref. No.
			—
	nut thread M4 H 3mm WS 7 brass Qty 20 pcs		
	GEV No.	521104	Ref. No.
			—
	washer ID ø 4.3mm ED ø 8mm thickness 0.5mm brass Qty 20 pcs for thread M4		
	GEV No.	550262	Ref. No.
			—
	flat gasket copper ED ø 20mm ID ø 14mm thickness 2mm		
	GEV No.	560111	Ref. No.
			—
	plain washer ID ø 4.3mm ED ø 9mm thickness 0.8mm SS Qty 20 pcs DIN 125A for thread M4		
	GEV No.	560131	Ref. No.
			—
	hexagonal nut thread M4 H 3.2mm WS 7 SS DIN/ISO DIN 934 / ISO 4032/8673 Qty 20 pcs		

	1		
GEV No.	416077	Ref. No.	808756
description	heating element 2520/3000W 220/240V heating circuits 1 L 445mm W 66mm H mm 2 hole fixing connection M4 thread 1/4" tube ø 8.5mm mounting distance 58mm connection length 34mm pasta cooker immersion heater		
accessories for	416077		
	GEV No.	361182	Ref. No.
			—
	nut thread 1/4" H 5mm nickel-plated brass WS 17 Qty 1 pcs		
	GEV No.	510417	Ref. No.
			—
	flat gasket fibre ED ø 20mm ID ø 14mm thickness 2mm Qty 1 pcs		
	GEV No.	520228	Ref. No.
			—
	tooth lock washer ID ø 15.3mm ED ø 24mm steel Qty 1 pcs for thread M14		
	GEV No.	521103	Ref. No.
			—
	nut thread M4 H 3mm WS 7 brass Qty 20 pcs		
	GEV No.	521104	Ref. No.
			—
	washer ID ø 4.3mm ED ø 8mm thickness 0.5mm brass Qty 20 pcs for thread M4		
	GEV No.	550262	Ref. No.
			—
	flat gasket copper ED ø 20mm ID ø 14mm thickness 2mm		
	GEV No.	560111	Ref. No.
			—
	plain washer ID ø 4.3mm ED ø 9mm thickness 0.8mm SS Qty 20 pcs DIN 125A for thread M4		
	GEV No.	560131	Ref. No.
			—
	hexagonal nut thread M4 H 3.2mm WS 7 SS DIN/ISO DIN 934 / ISO 4032/8673 Qty 20 pcs		

Зип Общепит

vsezip.ru

+7(812)987-0881

	1		
GEV No.	416071	Ref. No.	809070
description	heating element 800W 230V L 350mm W 87mm H 36mm 2 hole fixing connection male faston 6.3mm thread 1/4" tube ø 8.5mm mounting distance 74mm dry heating element		
spare parts for	416071		
	GEV No.	510417	Ref. No.
			—
	flat gasket fibre ED ø 20mm ID ø 14mm thickness 2mm Qty 1 pcs		
accessories for	416071		
	GEV No.	361182	Ref. No.
			—
	nut thread 1/4" H 5mm nickel-plated brass WS 17 Qty 1 pcs		
	GEV No.	520228	Ref. No.
			—
	tooth lock washer ID ø 15.3mm ED ø 24mm steel Qty 1 pcs for thread M14		
	GEV No.	550262	Ref. No.
			—
	flat gasket copper ED ø 20mm ID ø 14mm thickness 2mm		

heating elements for pizza ovens

	1		
GEV No.	415917	Ref. No.	808633
description	heating element 1400W 230V L 572mm W 159mm flange length 220mm flange width 32mm hole distance 199mm connection length 134mm connection M5 L1 30mm L2 27mm L3 515mm W1 25mm W2 110mm tube ø 10.2mm heating circuits 1 rectangular flange hole ø 4mm dry heating element		

heating elements for heated cabinets

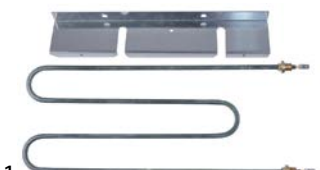
	1		
GEV No.	419155	Ref. No.	8C2213
description	heating element 1200W 230V heating circuits 1 L 350mm W 150mm connection male faston 6.3mm tube ø 6.3mm thread M12x1.25 mounting distance 145mm		

heating cables

connection on both sides			
with wire end ferrules			
	1		
GEV No.	420387	Ref. No.	8C1890
description	heating cable 37W 220V L 4900mm for blast chiller		



heater battery

Зип-Общепит

vsezip.ru

+7(812)987-08-81



GEV No.	415115	Ref. No.	827915
description	heater battery mounting distance 185mm W 38mm H 40mm 2000W 230V temperature restriction 125°C heating circuits 2 connection male faston 6.3mm L 195mm		
spare parts for	415115		
	GEV No.	375095	Ref. No. —
	bi-metal thermostat hole distance 18mm switch-off temp. 105°C 1NC 1-pole 16A connection F6.3 2 hole fixing		



	GEV No.	415122	Ref. No.	827915
description	heater battery mounting distance 185mm W 40mm H 35mm 2000W 230V temperature restriction 105°C heating circuits 2 connection cable cable length 340mm L 197mm for cross flow fan			



coil heating elements

	GEV No.	420345	Ref. No.	8C0424
description	heating element 1400W 230V L 285mm W 135mm ø 19.5mm thread 3/8" connection M5 for drying heating circuits 1 2 hole fixing			

immersion heating elements

3 hole flange ø47.5mm



	GEV No.	418136	Ref. No.	808674
description	heating element 4360W 240V mounting ø 47.5mm heating circuits 3 L 310mm W 31mm H 35mm number of thermostat sleeves 1 thermostat sleeves ø 7mm length thermostat sleeves 200mm thermostat sleeve clinging tube ø 6.3mm hole distance 62mm hole ø 8mm connection M4 3 hole flange immersion heater			
spare parts for	418136			
	GEV No.	510408	Ref. No.	—
	O-ring EPDM thickness 5.34mm ID ø 47mm Qty 1 pcs			



accessories for	418136	GEV No.	510408	Ref. No.	—
		O-ring EPDM thickness 5.34mm ID ø 47mm Qty 1 pcs			
accessories for	418136	GEV No.	510562	Ref. No.	—
		O-ring silicone thickness 5.34mm ID ø 47mm Qty 1 pcs			

3 hole flange ø57.5mm

	GEV No.	418084	Ref. No.	807858
description	heating element 7599W 230V mounting ø 57.5mm heating circuits 3 L 340mm W 36mm H 42mm number of thermostat sleeves 1 thermostat sleeves ø 7mm length thermostat sleeves 270mm thermostat sleeve clinging tube ø 8.5mm hole distance 72mm hole ø 8mm connection M4 3 hole flange immersion heater			

miscellaneous

	GEV No.	418548	Ref. No.	809218 8C0728
description	heating element 5200W 230V heating circuits 3 L 325mm W 47mm H 50mm tube ø 8.5mm hole distance 62mm hole ø 9.3mm connection M4 4 hole flange immersion heater flange width 81mm flange length 96mm with thermal fuse			
spare parts for	418548			
	GEV No.	510401	Ref. No.	—
	gasket rubber L 88mm W 73mm thickness 5mm hole ø 7mm hole distance 65mm for heating element 4 holes ID ø 50mm			

	GEV No.	415550	Ref. No.	809556
description	heating element 9000W 230V heating circuits 3 L 205mm W 38mm H 70mm number of thermostat sleeves 1 thermostat sleeves ø 2.5mm length thermostat sleeves 120mm thermostat sleeve eccentric, clinging tube ø 6.3mm hole distance 64mm hole ø 8mm connection male faston 6.3mm 4 hole flange immersion heater flange width 82mm flange length 82mm			
accessories for	415550			
	GEV No.	379078	Ref. No.	—
	temperature probe thermocouple K (NiCr-Ni) cable silicone probe -50 up to 1150°C cable -50 up to +180°C connection 2-wire thread probe ø1.5x100mm cable length 1.8m			
	GEV No.	510565	Ref. No.	—
	gasket rubber L 82mm W 82mm thickness 4mm hole ø 9mm hole distance 64mm for heating element suitable for RATIONAL 4 holes			

electric components



Зип Общепит

vsezip.ru

8(12)987-08-81

2"



1

GEV No.	416073	Ref. No.	808525
description	heating element 6000W 220V heating circuits 3 L 315mm W 43mm H 39mm tube \varnothing 8.5mm thermostat sleeves \varnothing 5mm length thermostat sleeves 280mm number of thermostat sleeves 1 thermostat sleeve eccentric, clinging connection M4 immersion heater flange with thread 2"		
accessories for	416073		
	GEV No.	510407	Ref. No. —
	flat gasket fibre ED \varnothing 78mm ID \varnothing 60mm thickness 2mm for heating element for thread 2" Qty 1 pcs		



1

GEV No.	416078	Ref. No.	808595
description	heating element 8000W 230V heating circuits 3 L 305mm W 39mm H 43mm tube \varnothing 8.5mm thermostat sleeves \varnothing 5mm length thermostat sleeves 285mm number of thermostat sleeves 1 thermostat sleeve clinging connection M4 connection length 48mm immersion heater flange with thread 2"		
accessories for	416078		
	GEV No.	510407	Ref. No. —
	flat gasket fibre ED \varnothing 78mm ID \varnothing 60mm thickness 2mm for heating element for thread 2" Qty 1 pcs		





1

GEV No.	416076	Ref. No.	808756
description	heating element 2520W 220V L 445mm W 60mm thread 1/4" mounting distance 52mm tube \varnothing 8.5mm 2 hole fixing immersion heater connection M5		

heating elements for convection





1

GEV No.	415914	Ref. No.	809571
description	heating element 15000W 230V heating circuits 6 ID \varnothing 505mm ED \varnothing 520mm L 615mm H 180mm L1 50mm W1 156mm H1 35mm H2 145mm flange length 210mm flange width 24mm hole distance 30mm connection male faston 6.3mm connection length 80mm tube \varnothing 6.5mm convection heating element hole \varnothing 8mm mounting pos. inner rectangular flange		
accessories for	415914		
	GEV No.	521127	Ref. No. —
	gasket L 210mm W 24mm thickness 2mm for heating element		
	GEV No.	693548	Ref. No. —
	flange suitable for convection heating element W 23mm mounting pos. outer length 210		



1

GEV No.	415915	Ref. No.	809570
description	heating element 15000W 230V heating circuits 6 ID \varnothing 635mm ED \varnothing 650mm L 696mm H 200mm L1 23mm W1 156mm H1 35mm H2 165mm flange length 210mm flange width 24mm hole distance 31mm connection male faston 6.3mm connection length 80mm tube \varnothing 6.3mm convection heating element hole \varnothing 7mm mounting pos. outer rectangular flange		
accessories for	415915		
	GEV No.	521127	Ref. No. —
	gasket L 210mm W 24mm thickness 2mm for heating element		
	GEV No.	693548	Ref. No. —
	flange suitable for convection heating element W 23mm mounting pos. outer length 210		



1

GEV No.	415119	Ref. No.	132110020
description	heating element 1600W 230V heating circuits 1 ID \varnothing 179mm ED \varnothing 197mm L 254mm H 30mm L1 51mm W1 31mm H1 9mm H2 21mm flange length 70mm flange width 22mm hole distance 56mm connection male faston 6.3mm connection length 41mm tube \varnothing 6.3mm convection heating element hole \varnothing 4mm rectangular flange		
accessories for	415119		
	GEV No.	510368	Ref. No. 8C0286
	gasket L 70mm W 23.5mm hole \varnothing 5mm hole distance 56mm FIBER thickness 2mm for heating element		



1

GEV No.	418861	Ref. No.	828041
description	heating element 2400W 220V heating circuits 1 ID \varnothing 185mm ED \varnothing 200mm L 210mm H 35mm L1 10mm W1 61mm H1 5mm H2 30mm flange length 100mm flange width 22mm hole distance 86mm connection male faston 6.3mm connection length 36mm tube \varnothing 6.3mm convection heating element hole \varnothing 5mm rectangular flange angled		



Зип Общепит

vsezip.ru

+7(812)987-08-81



1

GEV No.	418986	Ref. No.	9629911
description	heating element 3000W 240V heating circuits 1 ID \varnothing 180mm ED \varnothing 186mm L 210mm H 31mm L1 11mm W1 60mm H1 7mm H2 24.5mm flange length 100mm flange width 22mm hole distance 86mm connection male faston 6.3mm connection length 34.5mm tube \varnothing 6.25mm convection heating element hole \varnothing 5mm rectangular flange		



1

GEV No.	418858	Ref. No.	806187
description	heating element 7350W 230V heating circuits 3 ID \varnothing 215mm ED \varnothing 230mm L 267mm H 85mm L1 38mm W1 102mm H1 5mm H2 80mm flange length 142mm flange width 25mm hole distance 63mm cable length 1000mm convection heating element hole \varnothing 6mm		





1

GEV No.	415845	Ref. No.	142110001
description	heating element 3150W 230V heating circuits 3 ID \varnothing 201mm ED \varnothing 215mm L 272mm H 35mm L1 57mm W1 60mm H1 8mm H2 27mm flange length 95mm flange width 22mm hole distance 77mm connection male faston 6.3mm connection length 20mm tube \varnothing 6.5mm convection heating element hole \varnothing 6mm rectangular flange		



1

GEV No.	415912	Ref. No.	809555
description	heating element 9000W 230V heating circuits 3 ID \varnothing 445mm ED \varnothing 458mm L 474mm H 130mm W1 156mm H1 33mm H2 97mm flange length 210mm flange width 24mm hole distance 31mm connection male faston 6.3mm connection length 80mm tube \varnothing 6.5mm dry heating element hole \varnothing 7.5mm mounting pos. inner rectangular flange L1 16mm		
accessories for	415912		
	GEV No.	521127	Ref. No. —
	gasket L 210mm W 24mm thickness 2mm for heating element		
	GEV No.	693548	Ref. No. —
	flange suitable for convection heating element W 23mm mounting pos. outer length 210		





1

GEV No.	418134	Ref. No.	808778
description	heating element 3300W 240V heating circuits 1 ID \varnothing 185mm ED \varnothing 200mm L 215mm H 30mm W1 60mm H1 5mm H2 25mm flange length 100mm flange width 22mm hole distance 85mm connection male faston 6.3mm connection length 22mm tube \varnothing 6.5mm convection heating element hole \varnothing 5mm rectangular flange		



1

GEV No.	415913	Ref. No.	809554
description	heating element 9000W 230V heating circuits 3 ID \varnothing 504mm ED \varnothing 516mm L 535mm H 130mm W1 156mm H1 35mm H2 95mm flange length 210mm flange width 25mm hole distance 31mm connection male faston 6.3mm connection length 80mm tube \varnothing 6.5mm dry heating element hole \varnothing 7.5mm mounting pos. outer rectangular flange L1 19mm		
accessories for	415913		
	GEV No.	521127	Ref. No. —
	gasket L 210mm W 24mm thickness 2mm for heating element		
	GEV No.	693548	Ref. No. —
	flange suitable for convection heating element W 23mm mounting pos. outer length 210		



1

GEV No.	418131	Ref. No.	808781
description	heating element 6000W 230V heating circuits 3 ID \varnothing 217mm ED \varnothing 231mm L 271mm H 90mm L1 41mm W1 103mm H1 24mm H2 66mm flange length 140mm flange width 22mm hole distance 63mm tube \varnothing 6.3mm convection heating element hole \varnothing 5mm rectangular flange		



Зип Общежит
radiation heaters

vsezip.ru

+7(812)987-08-81



1

GEV No.	418135	Ref. No.	808779
description	heating element 920W 230V heating circuits 1 ID ø 200mm ED ø 215mm L 255mm H 40mm thread 1/4" connection male faston 6.3mm 2 hole fixing mounting distance 24mm tube ø 8.5mm convection heating element		
accessories for	418135		
	GEV No. 361182	Ref. No.	—
	nut thread 1/4" H 5mm nickel-plated brass WS 17 Qty 1 pcs		
	GEV No. 510417	Ref. No.	—
	flat gasket fibre ED ø 20mm ID ø 14mm thickness 2mm Qty 1 pcs		
	GEV No. 520228	Ref. No.	—
	tooth lock washer ID ø 15.3mm ED ø 24mm steel Qty 1 pcs for thread M14		
	GEV No. 550262	Ref. No.	—
	flat gasket copper ED ø 20mm ID ø 14mm thickness 2mm		

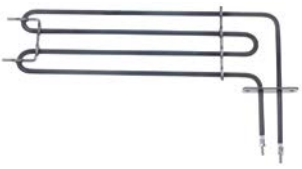

1

GEV No.	419140	Ref. No.	8C0256 J03RST1B50
description	heating element 1500W 230V heating circuits 1 L 340mm W 105mm L1 30mm L2 310mm W2 90mm flange length 70mm flange width 22mm hole distance 56mm connection M4 tube ø 6.3mm W1 15mm windings 2		

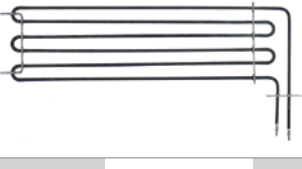

1

GEV No.	419235	Ref. No.	8C0392
description	heating element 3500W 230V heating circuits 1 L 560mm W 175mm L1 30mm L2 530mm W2 145mm flange length 70mm flange width 22.5mm hole distance 56mm connection M4 tube ø 6.3mm W1 33mm convection heating element combi-steamer windings 3		

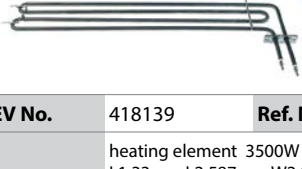

1

GEV No.	418139	Ref. No.	808780
description	heating element 3500W 240V heating circuits 1 L 620mm W 120mm L1 33mm L2 587mm W2 90mm flange length 70mm flange width 22mm hole distance 56mm connection length 100mm connection M4 tube ø 8.5mm hole ø 6mm W1 30mm rectangular flange convection heating element windings 2		



1

GEV No.	490079	Ref. No.	809045
description	radiation heater octagonal 3400W 230V L 300mm W 300mm heating circuits 2 H 30mm with heating coil energy regulation with temperature signalization connections 4+2 connection type cable AD		
spare parts for	490079		
	GEV No. 390931	Ref. No.	—
	safety thermostat for radiation heater		

2-circuit



1

GEV No.	490080	Ref. No.	809127
description	radiation heater ø 250mm 2400W heating circuits 2 partial power 1000W		

hot plates

square & rectangular

with radiused edge



1

GEV No.	490066 ¹	Ref. No.	C00637
description	hot plate dimensions 220x220mm 2600W 230V with spill ring connection 4 screw clamps protector yes square		

¹incl. protector



Зип Общепит
energy regulators

EGO
1-circuit

+7(812)987-08-81

			
1			
GEV No.	490071 ¹	Ref. No.	C00212
description	hot plate dimensions 300x300mm 4000W 230V with spill ring connection 4 screw clamps protector yes square		

¹incl. protector

round

with radiused edge

for domestic and commercial kitchens

			
1			
GEV No.	490016	Ref. No.	C10000
description	hot plate ø 180mm 2000W 230V connection 4 screw clamps with 8mm spill ring		

			
1			
GEV No.	490020	Ref. No.	C00208
description	hot plate ø 220mm 2600W 230V connection 4 screw clamps with 8mm spill ring		
accessories for	490020		
	GEV No.	Ref. No.	—
	550796		
	fixing plate for hot plate ø220mm		

			
1			
GEV No.	490062	Ref. No.	C00210
description	hot plate ø 300mm 3500W 220V connection 4 screw clamps with 8mm spill ring		

			
1			
GEV No.	380015	Ref. No.	809397
description	energy regulator 230V 13A single-circuit turn direction right shaft ø 6x4.6mm shaft L 23mm mounting thread M4 power release 6-100% no. 50.57021.010		

			
1			
GEV No.	380019	Ref. No.	806287
description	energy regulator 240V 13A single-circuit turn direction right shaft ø 6x4.6mm shaft L 23mm mounting thread M4 power release 6-100% no. 50.57071.010		

<p>2-circuit</p> 			
1			
GEV No.	380024	Ref. No.	unbekannt
description	energy regulator 240V 13A turn direction right shaft ø 6x4.6mm shaft L 36mm mounting thread M4 no. 50.67079.601 with operation switch 1-pole		

thermostats

bi-metal thermostats

<p>bi-metal thermostats</p> 			
1			
GEV No.	375160	Ref. No.	809559
description	bi-metal thermostat hole distancemm switch-off temp. 110°C 1NC 1-pole 16A connection F6.3 M4		



control and safety thermostats

EGO

control thermostats

51._ series

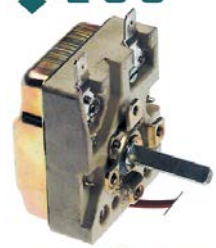

GEV No.	375334	Ref. No.	808144
description	thermostat t.max. 85°C temperature range 30-85°C 1-pole 1NO 16A probe ø 6mm probe L 130mm capillary pipe 900mm capillary pipe isolated 900mm gland nut shaft ø 6x4.6mm shaft L 23mm shaft position upper rotation 270°		

55.10/19_ series



GEV No.	375055	Ref. No.	828838
description	thermostat t.max. 110°C temperature range 30-110°C 1-pole 1CO 16A probe ø 6mm probe L 130mm capillary pipe 1500mm capillary pipe isolatedmm gland nut shaft L 23mm shaft position upper rotation 318° 250V		



GEV No.	375647	Ref. No.	809017
description	thermostat t.max. 110°C temperature range 31-110°C 1-pole 1NO 16A probe ø 6mm probe L 133mm capillary pipe 870mm capillary pipe isolatedmm gland nut shaft ø 6x4.6mm shaft L 23mm shaft position upper rotation 318°		

Зип Общепит

vsezip.ru

+7(812)987-08-81



GEV No.	375341	Ref. No.	809036
description	thermostat t.max. 150°C temperature range 60-150°C 1-pole 1NO 16A probe ø 3mm probe L 219mm capillary pipe 900mm capillary pipe isolated 900mm gland nut shaft ø 6x4.6mm shaft L 23mm shaft position upper rotation 270°		



GEV No.	375718	Ref. No.	C10379
description	thermostat t.max. 180°C temperature range 70-180°C 1-pole 1NO 16A probe ø 6mm probe L 87mm capillary pipe 1500mm capillary pipe isolatedmm gland nut shaft ø 6x4.6mm shaft L 23mm shaft position upper rotation 270°		



GEV No.	375336	Ref. No.	C00545
description	thermostat t.max. 255°C temperature range 45-255°C 1-pole 1CO 16A probe ø 6mm probe L 74mm capillary pipe 900mm capillary pipe isolated 900mm gland nut shaft ø 6x4.6mm shaft L 23mm shaft position upper rotation 270°		



Зип Общежит

vsezip.ru

+7(812)987-08-81



GEV No.	375216	Ref. No.	808672
description	thermostat t.max. 280°C temperature range 50-280°C 1-pole 1NO 16A probe ø 3mm probe L 228mm capillary pipe 1300mm capillary pipe isolated 1150mm gland nut shaft L 23mm shaft position upper rotation 318°		



GEV No.	375594	Ref. No.	132110015
description	thermostat t.max. 318°C temperature range 60-318°C 1-pole 1NO 16A probe ø 3.03mm probe L 139mm capillary pipe 870mm capillary pipe isolatedmm gland nut shaft ø 6x4.6mm shaft L 23mm shaft position upper rotation 270°		



GEV No.	375860	Ref. No.	8C0888 8C1605
description	thermostat t.max. 289°C temperature range 57-289°C 1-pole 1NO 16A probe ø 3.1mm probe L 226mm capillary pipe 1780mm capillary pipe isolated 1770mm gland nut shaft ø 6x4.6mm shaft L 23mm shaft position upper° rotation 270° probe material SS		



GEV No.	375002	Ref. No.	C00563
description	thermostat t.max. 320°C temperature range 55-320°C 1-pole 1NO 16A probe ø 3.1mm probe L 226mm capillary pipe 870mm capillary pipe isolated 850mm gland nut shaft L 23mm shaft position upper rotation 270°		



GEV No.	375800	Ref. No.	132110016
description	thermostat t.max. 308°C temperature range 65-308°C 1-pole 1NO 16A probe ø 3.03mm probe L 120mm capillary pipe 600mm capillary pipe isolatedmm gland nut shaft ø 6x4.6mm shaft L 23mm shaft position upper rotation 270° with 2 probes		



GEV No.	375232	Ref. No.	C00563
description	thermostat t.max. 320°C temperature range 55-320°C 1-pole capillary pipe isolatedmm gland nut		



GEV No.	375253	Ref. No.	8C0363
description	thermostat t.max. 455°C temperature range 85-455°C 1-pole 1NO 16A probe ø 3.9mm probe L 228mm capillary pipe 870mm capillary pipe isolated 660mm gland nut shaft ø 6x4.6mm shaft L 23mm shaft position upper rotation 270°		

→ electric components

Зип-Общепит

vsezip.ru

+7(812)987-08-81



GEV No.	375247	Ref. No.	808542
description	thermostat t.max. 500°C temperature range 75-500°C 1-pole 1NO 16A probe ø 4mm probe L 228mm capillary pipe 900mm capillary pipe isolated gland nut shaft ø 6x4.6mm shaft L 23mm shaft position upper rotation 270°		



GEV No.	375534	Ref. No.	809260
description	thermostat t.max. 90°C temperature range 19-90°C 1-pole 1CO 16A probe ø 6mm probe L 129mm capillary pipe 980mm capillary pipe isolated 960mm gland nut shaft Lmm shaft position rotation 180°		

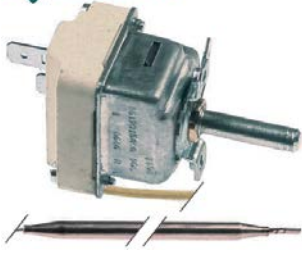

GEV No.	375809	Ref. No.	809890 J0THR090
description	thermostat t.max. 90°C temperature range 30-90°C 1-pole 1NO 16A probe ø 6mm probe L 130mm capillary pipe 1800mm capillary pipe isolated 1800mm gland nut shaft ø 6x4.6mm shaft L 23mm shaft position upper rotation 270°		

55.13_series



GEV No.	375492	Ref. No.	808935
description	thermostat t.max. 190°C temperature range 94-190°C 1-pole 1NO 16A probe ø 6mm probe L 94mm capillary pipe 1090mm capillary pipe isolated 960mm gland nut M10x1 shaft ø 6x4.6mm shaft L 23mm shaft position upper rotation 310° probe material SS		

55.34_series



GEV No.	375021	Ref. No.	808058
description	thermostat t.max. 110°C temperature range 32-110°C 3-pole 3CO 16A probe ø 6mm probe L 138mm capillary pipe 2980mm capillary pipe isolated 2200mm gland nut M9x1 shaft ø 6x4.6mm shaft L 23mm shaft position upper rotation 270°		



GEV No.	375410	Ref. No.	807603
description	thermostat t.max. 180°C temperature range 95-180°C 3-pole 3NO 16A probe ø 6mm probe L 133mm capillary pipe 1780mm capillary pipe isolated 1400mm gland nut M10x1 shaft ø 6x4.6mm shaft L 23mm shaft position upper rotation 270°		



Зип Общепит

vsezip.ru

+7(812)987-08-81

E-G-O



1

GEV No.	375929	Ref. No.	X12076
description	thermostat t.max. 182°C temperature range 101-182°C 3-pole 3NO 16A probe ø 6mm probe L 133mm capillary pipe 1180mm capillary pipe isolated 1040mm gland nut shaft ø 6x4.6mm shaft L 23mm shaft position upper rotation 270°		

E-G-O



1

GEV No.	375435	Ref. No.	807603
description	thermostat t.max. 190°C temperature range 56-190°C 3-pole 3NO 16A probe ø 6mm probe L 130mm capillary pipe 900mm capillary pipe isolated 670mm gland nut M10x1 shaft ø 6x4.6mm shaft L 23mm shaft position upper rotation 318° probe material SS		

55.40_series

E-G-O



1

GEV No.	375185	Ref. No.	806189
description	thermostat t.max. 320°C temperature range 53-320°C 4-pole 4NO 16A probe ø 3.9mm probe L 228mm capillary pipe 880mm capillary pipe isolatedmm gland nut shaft ø 6x4.6mm shaft L 23mm shaft position upper rotation 270°		

safety thermostats

55.10/19_series

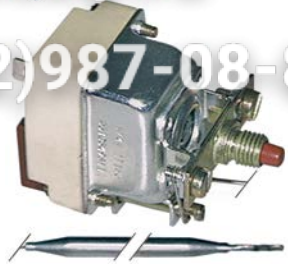

1

GEV No.	375250	Ref. No.	808671	
description	safety thermostat capillary pipe 870mm probe ø 6mm 1-pole probe L 129mm 16A capillary pipe isolatedmm gland nut switch-off temp. 130°C probe SS			
spare parts for	375250			
	GEV No.	551083	Ref. No.	—
	cap for safety thermostat thread M8x1			

E-G-O



1

GEV No.	375376	Ref. No.	808181
description	safety thermostat capillary pipe 870mm probe ø 6mm 1-pole probe L 133mm 0.5A capillary pipe isolatedmm gland nut M10x1 switch-off temp. 224°C probe		

E-G-O



1

GEV No.	375339	Ref. No.	808181	
description	safety thermostat switch-off temp. 225°C 1-pole 0.5A probe ø 6mm probe L 133mm capillary pipe 870mm capillary pipe isolatedmm gland nut M10x1 probe			
accessories for	375339			
	GEV No.	551083	Ref. No.	—
	cap for safety thermostat thread M8x1			

electric components

Зип Общепит

vsezip.ru

+7(812)987-08-81

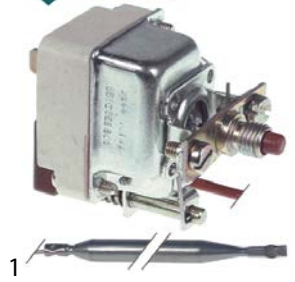

GEV No.	375337	Ref. No.	C00546
description	safety thermostat switch-off temp. 300°C 1-pole 16A probe ø 6mm probe L 74mm capillary pipe 900mm capillary pipe isolated 700mm gland nut probe		



GEV No.	375277	Ref. No.	808057
description	safety thermostat switch-off temp. 150°C 3-pole 3NC 20A probe ø 6mm probe L 79mm capillary pipe 900mm capillary pipe isolated 700mm gland nut probe		

55.14_series



GEV No.	375260	Ref. No.	808430 813430
description	safety thermostat switch-off temp. 240°C 1-pole 16A probe ø 6mm probe L 77mm capillary pipe 1280mm capillary pipe isolated 1050mm gland nut M10x1 probe SS		

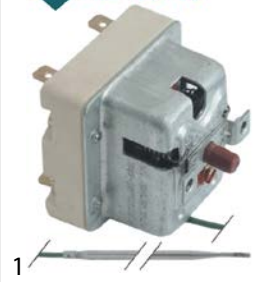

GEV No.	390338	Ref. No.	C00686
description	safety thermostat switch-off temp. 169°C		

55.32_series

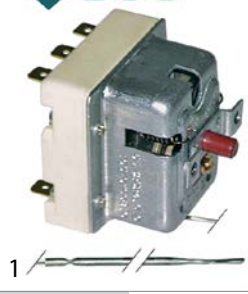

GEV No.	375281	Ref. No.	808203
description	safety thermostat switch-off temp. 150°C 3-pole 0.5A probe ø 3mm probe L 188mm capillary pipe 1100mm capillary pipe isolated 670mm gland nut probe SS		

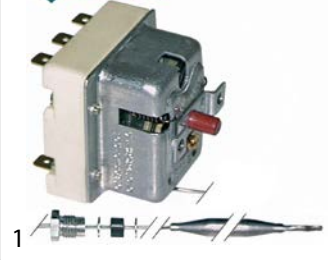

GEV No.	375258	Ref. No.	807349
description	safety thermostat switch-off temp. 232°C 3-pole 20A probe ø 6mm probe L 94mm capillary pipe 900mm capillary pipe isolated 670mm gland nut M10x1 probe SS		



GEV No.	375628	Ref. No.	808718
description	safety thermostat switch-off temp. 350°C 3-pole 20A probe ø 4mm probe L 120mm capillary pipe 900mm capillary pipe isolated 670mm gland nut M10x1 probe SS		

Зип Общепит

vsezip.ru

+7(812)987-08-81



1

GEV No.	375338	Ref. No.	C00098 C00686
description	safety thermostat switch-off temp. 350°C 3-pole 20A probe ø 6mm probe L 79mm capillary pipe 900mm capillary pipe isolated 700mm gland nut probe SS		



1

GEV No.	390797	Ref. No.	809505
description	safety thermostat switch-off temp. 157°C 1-pole 16A probe ø 6mm probe L 62mm capillary pipe 1520mm capillary pipe isolated 1380mm gland nut probe		



1

GEV No.	390141	Ref. No.	513130206
description	safety thermostat switch-off temp. 350°C 3-pole 3NC 20A probe ø 6mm probe L 77mm capillary pipe 1490mm capillary pipe isolated 800mm gland nut probe SS		



1

GEV No.	390714	Ref. No.	C00926
description	safety thermostat switch-off temp. 230°C 1-pole 1NC 16A probe ø 6mm probe L 75mm capillary pipe 740mm capillary pipe isolated 200mm gland nut probe SS		

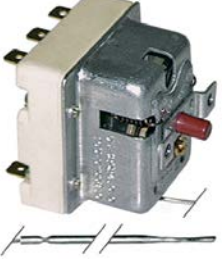

1

GEV No.	390142	Ref. No.	807790
description	safety thermostat switch-off temp. 360°C 3-pole 20A probe ø 3.1mm probe L 188mm capillary pipe 1490mm capillary pipe isolated 800mm gland nut probe SS		



1

GEV No.	375159	Ref. No.	809504
description	safety thermostat switch-off temp. 365°C 1-pole 16A probe ø 4mm probe L 96mm capillary pipe 1160mm capillary pipe isolated 1100mm gland nut probe with special screwing screw connection M14x1		



control thermostats with operation switch

55.10/19_ series

E.G.O



1

GEV No.	375119	Ref. No.	C98972
description	thermostat t.max. 255°C temperature range 45-255°C 1-pole 1CO 16A probe ø 6mm probe L 74mm capillary pipe 900mm capillary pipe isolated 900mm gland nut shaft L 23mm shaft position upper rotation 270° outer switch 2NO		
spare parts for	375119		
	GEV No.	300091	Ref. No. 806286 C00217
	operation switch EGO 2 operating positions 2NO 16A sequence 0-1 shaft ø 6x4.6mm shaft L 23mm connection screw ceramic		
	GEV No.	375778	Ref. No. —
	thermostat t.max. 255°C temperature range 45-255°C 1-pole 1CO probe ø 6mm probe L 74mm capillary pipe 900mm capillary pipe isolated 900mm gland nut shaft ø 6x4.6mm shaft L 23mm shaft position upper rotation 270°		
	GEV No.	550060	Ref. No. C00218
	connecting bow long for thermostat Qty 1 pcs		

CAEM

control thermostats



1

GEV No.	390082	Ref. No.	807256
description	thermostat t.max. 100°C temperature range 30-90°C 1-pole 1CO 16A probe ø 6mm probe L 94mm capillary pipe 1600mm capillary pipe isolatedmm gland nut shaft ø 6x4.6mm shaft L 22mm shaft position upper rotation 270° probe material copper		

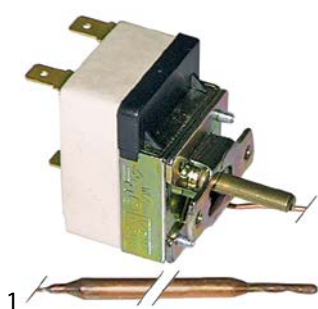

1

GEV No.	375094	Ref. No.	828838
description	thermostat t.max. 110°C temperature range 30-110°C 1-pole 1CO 16A probe ø 6mm probe L 75mm capillary pipe 1600mm capillary pipe isolatedmm gland nut shaft ø 6x4.6mm shaft L 22mm shaft position upper rotation 270° probe material copper		

Зип Общепит

vsezip.ru

+7(812)987-08-81



1

GEV No.	375456	Ref. No.	808809
description	thermostat t.max. 120°C temperature range 30-120°C 1-pole 1CO 16A probe ø 6mm probe L 110mm capillary pipe 1600mm capillary pipe isolated 1550mm gland nut shaft ø 6x4.6mm shaft L 22mm shaft position upper rotation 270° probe material copper 250V		

safety thermostats



1

GEV No.	375456	Ref. No.	809891
description	safety thermostat switch-off temp. 335°C 2-pole 20A probe ø 3mm probe L 200mm capillary pipe 1050mm capillary pipe isolated 650mm gland nut probe SS at 250V 20A at 400V 10A		

refrigeration thermostats

RANCO

K50 series

RANCO



1

GEV No.	390292	Ref. No.	828317
description	thermostat RANCO type K50P1118 probe ømm probe Lmm capillary pipe 1250mm temperature range -3 up to +2.5°C		

accessories

capillary tube clips



1

GEV No.	550138	Ref. No.	C10433
description	capillary tube clip for pipe ø 8.5mm for circular tube heating elements		







connecting bows

			
1			
GEV No.	550060	Ref. No.	C00218
description	connecting bow long for thermostat Qty 1 pcs		

switches and momentary switches
rocker/momentary rocker switches



30x22mm

			
1			
GEV No.	301003	Ref. No.	712110000 818181
description	rocker switch mounting measurements 30x22mm green 2NO 250V 16A illuminated 0-I connection male faston 6.3mm ambient temperature max. 125/55°C protection IP65		
accessories for	301003		
	GEV No.	301036	Ref. No. —
	protective cover internal size 30x22mm for rocker switch mounting measurementsmm		

			
1			
GEV No.	301001	Ref. No.	E61110003
description	rocker switch mounting measurements 30x22mm red 2NO 250V 16A illuminated 0-I connection male faston 6.3mm ambient temperature max. 125/55°C protection IP65		
accessories for	301001		
	GEV No.	301036	Ref. No. —
	protective cover internal size 30x22mm for rocker switch mounting measurementsmm		



			
1			
GEV No.	300136	Ref. No.	C00610
description	rocker switch mounting measurements 30x22mm green 2NO 24V 16A illuminated connection male faston 6.3mm ambient temperature max. 125/55°C protection IP40		

blank

			
1			
GEV No.	347675	Ref. No.	809832
description	momentary rocker switch mounting measurements 30x22mm green 2CO 250V 16A illuminated connection male faston 6.3mm ambient temperature max. 125/55°C protection IP65 with cover cap		
accessories for	347675		
	GEV No.	301036	Ref. No. —
	protective cover internal size 30x22mm for rocker switch mounting measurementsmm		

push/momentary push switches

19x13mm

			
1			
GEV No.	347605 ¹	Ref. No.	809883
description	push switch mounting measurements 19x13mm yellow 2NO 250V 16A illuminated connection male faston 6.3mm ambient temperature max. 105°C protection IP40		
accessories for	347605		
	GEV No.	346541	Ref. No. —
	protective cover for rocker switch external size 23.4x17.4mm internal size 19x13mm H 9.5mm mounting measurementsmm		

¹illuminated

28.5x28.5mm

			
1			
GEV No.	347617	Ref. No.	809337
description	momentary push switch mounting measurements 28.5x28.5mm grey 2CO 250V 16A clock connection male faston 6.3mm ambient temperature max. 150°C protection IP40		

			
1			
GEV No.	100160	Ref. No.	C10250
description	momentary push switch mounting measurements 28.5x28.5mm red 1NO 250V 12A ignition connection male faston 6.3mm ambient temperature max. 85°C protection IP40 mounting ømm		

ø16mm

			
1			
GEV No.	346287 ¹	Ref. No.	809886
description	momentary push switch mounting ø 16mm red 1NO 250V 3A illuminated connection male faston 2.8mm ambient temperature max. 125/55°C protection IP65 with cover cap		

¹illuminated

			
1			
GEV No.	346346	Ref. No.	809600
description	momentary push switch mounting ø 16mm red 1NO/indicator light 250V 3A connection male faston 2.8mm ambient temperature max. 125/55°C protection IP40		





Зип Общежит

microswitches

ø22mm



1

GEV No.	401357	Ref. No.	8C1407
description	momentary push switch mounting measurements ø22mm 1NO/1NC/indicator light 400V 4A indicator lamp 24V 0-1 connection screw ambient temperature max. 125/55°C protection IP40		
spare parts for	401357		
	GEV No.	346181	Ref. No. —
	push button mounting ø 21mm external size 30x55mm oval		
accessories for	401357		
	GEV No.	401709	Ref. No. —
	protective cover external size 57x32mm internal size 47x22mm matt finish rubber H 27.5mm		



1

GEV No.	699002	Ref. No.	809151
description	momentary push switch mounting ø 22mm black/white 1NO/1NC/indicator light 230V 6A 0-1 connection screw ambient temperature max. 70°C protection IP40		

ø25mm



1

GEV No.	345162 ¹	Ref. No.	8C0427
description	push switch mounting ø 25mm yellow 2NO 250V 16A illuminated connection male faston 6.3mm ambient temperature max. 85°C protection IP40		

¹illuminated

1

GEV No.	348211	Ref. No.	244230001
description	push switch mounting ø 25mm red 1NO/indicator light 250V 16A illuminated connection male faston 6.3mm ambient temperature max. 85°C protection IP65 with cover		

universal

vsezip.ru
CROUZET

7(812)987-08-81



1

GEV No.	345042	Ref. No.	809481
description	microswitch with plunger 250V 16A 1CO connection male faston 6.3mm L 28mm ambient temperature max. 125°C mounting distance 22mm type EF83161.3 actuating force: 75g blue/black		
accessories for	345042		
	GEV No.	345043	Ref. No. —
	lever set 5-piece		



1

GEV No.	348043	Ref. No.	E61110082
description	microswitch with plunger 250V 16A 1CO connection male faston 6.3mm Lmm L1 27.8mm ambient temperature max. 125°C mounting distance 22mm with lever set type MS1-16 actuating force: 100g white		

lever actuated



1

GEV No.	345254	Ref. No.	E00010041
description	microswitch with lever 250V 16A 1CO connection male faston 6.3mm ambient temperature max. 120°C mounting distance 22mm actuating force: 60g lever length 58mm		





1

GEV No.	300128	Ref. No.	807999 808053
description	microswitch with lever 250V 16A 1CO connection male faston 6.3mm ambient temperature max. 85°C lever length 63mm		



Зип Общепит
vsezip.ru
+7(812)987-08-81

			
1			
GEV No.	346314	Ref. No.	132110023
description	microswitch with lever 250V 16A 1CO connection male faston 6.3mm L 56mm ambient temperature max. 125°C mounting distance 22mm type VRSR01DA1 actuating force: 50g		

			
1			
GEV No.	345156	Ref. No.	809173
description	microswitch with plunger thread M10x1 thread L 13mm 250V 16A 1CO connection male faston 6.3mm stroke 6mm mounting distance 25mm L 46mm L1 13mm ambient temperature max. 85°C type C4A-ZN3 actuating force: 340g		

			
1			
GEV No.	345125	Ref. No.	809568
description	microswitch with lever 250V 16A 1CO connection male faston 6.3mm ambient temperature max. 85°C mounting distance 25mm type C9ZP3 actuating force: 25g lever length 63.5mm		

accessories			
			
1			
GEV No.	698204	Ref. No.	809479
description	bracket for microswitch C4-C6		

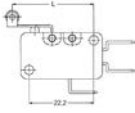

roller-lever actuated
microswitches

 			
1			
GEV No.	345041	Ref. No.	E61110082
description	microswitch with handle with a switch 250V 16A 1CO connection male faston 6.3mm ambient temperature max. 85°C black lever length 20.5mm		

position switches

PIZZATO			
FA series			
			
1			
GEV No.	300137	Ref. No.	C00430
description	position switch cast aluminum 1NO/1NC 400V 3A L 49mm W 30mm H 16mm protection IP67 actuating force: 1000g screw connection mounting distance 20mm cable length 1800mm		

pin-plunger actuated

			
			
1			
GEV No.	345042	Ref. No.	809481
description	microswitch with plunger 250V 16A 1CO connection male faston 6.3mm L 28mm ambient temperature max. 125°C mounting distance 22mm type EF83161.3 actuating force: 75g blue/black		
accessories for	345042		
	GEV No.	345043	Ref. No. —
	lever set 5-piece		

system switches (ROLD)

			
1			
GEV No.	345131	Ref. No.	808948
description	element holder mounting measurements 28.5x28.5mm grey single element holder		

M10

			
1			
GEV No.	347216	Ref. No.	807351 E61110053
description	microswitch with plunger thread M10x0.75 thread L 14mm 250V 10A 1CO connection male faston 6.3mm stroke 7.5mm mounting distance 22mm L 28mm ambient temperature max. 125°C type NR6K5 actuating force: 260g		

			
1			
GEV No.	345606	Ref. No.	809021
description	momentary switch unit 2CO 250V 16A connection male faston 6.3mm		

1 electric components



Зип Оффенит

vsezip.ru

+7(812)987-08-81

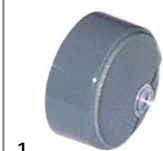

1	
GEV No. 346211	Ref. No. 808950
description	push button ø 23mm grey with lens



1	
GEV No. 346364	Ref. No. 808949
description	rotary disc red/white disc ø 20.6mm



1	
GEV No. 345605	Ref. No. 808807
description	switch 2CO 250V 16A connection male faston 6.3mm

cam switches

on/off



1	
GEV No. 300129	Ref. No. 808145
description	cam switch 2 operating positions 2NO sequence 0-1 16A shaft ø 6x4.6mm shaft L 23mm connection male faston 6.3mm ceramic



1	
GEV No. 300088	Ref. No. C00685
description	cam switch 2 operating positions 4NO sequence 0-1 16A shaft ø 6x4.6mm shaft L 23mm connection male faston 6.3mm ceramic





1	
GEV No. 300074	Ref. No. 806286
description	cam switch 4 operating positions 2NO sequence 0-1-0-1 16A shaft ø 6x4.6mm shaft L 23mm connection male faston 6.3mm ceramic

7-position



1	
GEV No. 300025	Ref. No. C00213
description	cam switch 7 operating positions 1NO/2CO sequence 0-1-2-3-4-5-6 16A shaft ø 6x4.6mm shaft L 23mm connection screw 7-position ceramic

accessories for 300025		
	GEV No. 112172	Ref. No. —
knob universal ø 70mm black without adaptor/dial plate		
	GEV No. 112213	Ref. No. —
knob dial plate silver switch 7-position t.max.°C ED ø 63mm ID ø 45.5mm		
	GEV No. 112311	Ref. No. —
knob adapter shaft ø 6x4.6mm L 0mm with spring		



1	
GEV No. 300106	Ref. No. C00214
description	cam switch 7 operating positions 1NO/2CO sequence 0-1-2-3-4-5-6 32A shaft ø 6x4.6mm shaft L 23mm connection screw 7-position shaft flat upper



Зип Общежит

vsezip.ru

+7(812)987-08-81

4 operating positions

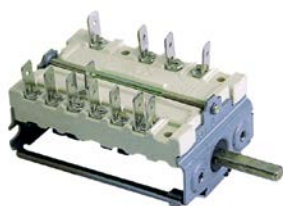

1	GEV No.	300010	Ref. No.	807290
description	cam switch 4 operating positions 2NO/2CO sequence 0-1-2-3 16A shaft ϕ 6x4.6mm shaft L 23mm connection male faston 6.3mm ceramic			



1	GEV No.	300091	Ref. No.	806286 C00217
description	operation switch EGO 2 operating positions 2NO 16A sequence 0-1 shaft ϕ 6x4.6mm shaft L 23mm connection screw ceramic			

5 operating positions

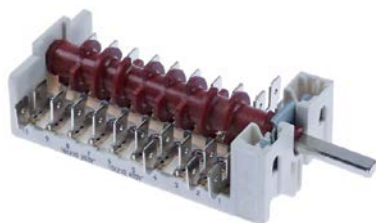

1	GEV No.	347652	Ref. No.	808962
description	cam switch 5 operating positions 5NO/2CO sequence 0-1-2-3-4 16A shaft ϕ 6x4.6mm shaft L 23mm connection male faston 6.3mm plastic			

operation switches



1	GEV No.	300002	Ref. No.	808052 C00690
description	cam switch 2 operating positions 4NO 16A sequence 0-1 shaft ϕ 6x4.6mm shaft L 23mm connection male faston 6.3mm ceramic			



1	GEV No.	300200	Ref. No.	C00217
description	operation switch 2 operating positions 2NO 16A sequence 0-1 shaft ϕ 6x4.6mm shaft L 23mm connection male faston 6.3mm operation switch ceramic			

magnetic switches

29x19mm



1	GEV No.	345217	Ref. No.	809557
description	magnetic switch L 29mm W 19mm 1NO 125V 0.5A P max. 10W connection cable cable length 2000mm			

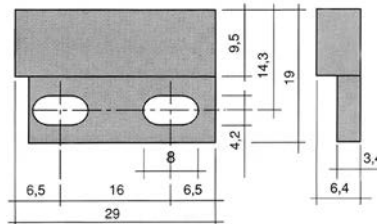

36x13mm



1	GEV No.	345335	Ref. No.	8C0129
description	magnetic switch L 36mm W 13mm 1NO 250V 0.04A P max. 10W connection cable cable length 960mm			
accessories for	345335			
	GEV No.	519049	Ref. No.	TR0220
	magnet ϕ mm L 63mm H 10.7mm W 18.8mm hole distance 52mm M2 hole ϕ 2mm			

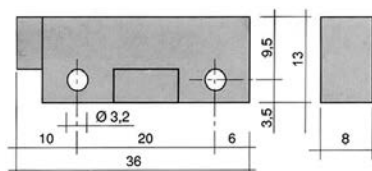

Зип-Общепит

accessories

magnets

vsezip.ru

+7(812)987-08-81

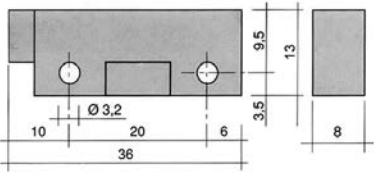
GEV No.	345118 ¹	Ref. No.	E61110057
description	magnetic switch L 36mm W 13mm 1NO 250V 1A P max. 50W connection cable cable length 980mm		
accessories for	345118		
	GEV No.	345399	Ref. No. —
	magnet ø 3.3mm L 40mm H 8mm W 13mm hole distance 30mm M3		





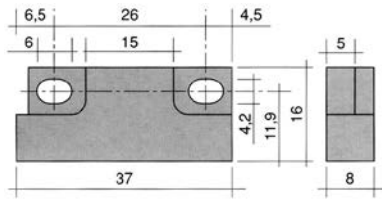

GEV No.	345398	Ref. No.	E00010012
description	magnet ømm L 36mm H 8mm W 13mm hole distance 20mm M3 hole ø 3mm		

¹with coded connector

37x16mm



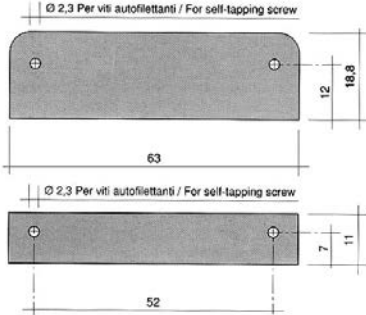

GEV No.	345600	Ref. No.	TR0666
description	magnetic switch L 37mm W 16mm 1NO 250V 0.2A P max. 50W connection cable cable length 960mm		
accessories for	345600		
	GEV No.	519049	Ref. No. TR0220
	magnet ømm L 63mm H 10.7mm W 18.8mm hole distance 52mm M2 hole ø 2mm		

GEV No.	519049	Ref. No.	TR0220
description	magnet ømm L 63mm H 10.7mm W 18.8mm hole distance 52mm M2 hole ø 2mm		
accessories for	519049		
	GEV No.	560095	Ref. No. —
	sheet metal screws ø 2.9mm L 9.5mm SS Qty 20 pcs DIN 7981/ISO 7049 head ø 5.6mm oval head		

M10x0.75

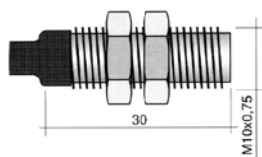
GEV No.	345632	Ref. No.	TR0309
description	magnetic switch thread M10x0.75 1NO 250V 0.5A P max. 50W connection cable cable length 2000mm type 102		
accessories for	345632		
	GEV No.	100779	Ref. No. —
	nut thread M10x0.75 H 3mm WS 14 SS Qty 2 pcs		

control equipment

MOELLER/EATON

switches (complete)

rotary switches



GEV No.	300132	Ref. No.	808641
description	rotary switch mounting measurements ø22mm green complete		

push/momentary push switches



1

GEV No.	300131	Ref. No.	800472
description	momentary push switch mounting measurements ø22mm red illuminated, 80-264V 1NO momentary		

ERSCE

rotary switches



1



GEV No.	346691	Ref. No.	8C0281
description	rotary selector mounting measurements ø22mm black complete 1 latching / 2 momentary sequence 1-0-2 2NO/1NO 10(4)A max 400V		

GIOVENZANA

switches (complete)



1

GEV No.	401357	Ref. No.	8C1437	
description	momentary push switch mounting measurements ø22mm 1NO/1NC/indicator light 400V 4A indicator lamp 24V 0-1 connection screw ambient temperature max. 125/55°C protection IP40			
spare parts for	401357			
	GEV No.	346181	Ref. No.	—
	push button mounting ø 21mm external size 30x55mm oval			
accessories for	401357			
	GEV No.	401709	Ref. No.	—
	protective cover external size 57x32mm internal size 47x22mm matt finish rubber H 27.5mm			

TELEMECANIQUE (EFA)

XB2 series

push buttons



1

GEV No.	300134	Ref. No.	C00278 C00278+C00279
description	push button mounting measurements ø22mm black		

Зип Общепит

vsezip.ru

+7(812)987-08-81



1

GEV No.	345412	Ref. No.	C00279
----------------	--------	-----------------	--------

description contact block with holder 1NO**spare parts for** 345412

GEV No.	345220	Ref. No.	—
----------------	--------	-----------------	---

contact block EFA ZB2BE101 1NO max 230V 10(6)A black



GEV No.	345221	Ref. No.	—
----------------	--------	-----------------	---

contact block EFA ZB2BE102 1NC max 230V 10(6)A black



GEV No.	347526	Ref. No.	—
----------------	--------	-----------------	---

contact block holder for XB2

encoders and potentiometers



1

GEV No.	401953	Ref. No.	IB5944010
----------------	--------	-----------------	-----------

description PCB hand blenders VORTEX with potentiometer 230V

lamps

indicator lights

indicator lights 2-piece (lens and indicator lamp)

indicator light lenses

ø10mm (type SRZ-3)



1

GEV No.	359124	Ref. No.	C00614
----------------	--------	-----------------	--------

description indicator light housings mounting measurements ø10mm yellow round Qty 1 pcs**accessories for** 359124

GEV No.	359132	Ref. No.	808943
----------------	--------	-----------------	--------

indicator lamp green 250V connection male faston 6.3mm protection IP54 ambient temperature max. 85°C

ø13mm (type SFK-3)



1

GEV No.	359126	Ref. No.	808461
----------------	--------	-----------------	--------

description indicator light housings mounting measurements ø13mm green Qty 1 pcs





Зип.Общепит

vsezip.ru

+7(812)987-08-81

			
1			
GEV No.	359127	Ref. No.	809085
description	indicator light housings mounting measurements ø13mm yellow Qty 1 pcs		

indicator lamps for socket type SRZ / SDK / SDY / SFK			
			
1			
GEV No.	359130	Ref. No.	809084
description	indicator lamp 230V clear connection male faston 6.3mm ø 8mm		

			
1			
GEV No.	359129	Ref. No.	C00614
description	indicator lamp 24V clear connection male faston 6.3mm		

			
1			
GEV No.	359132	Ref. No.	808943
description	indicator lamp green 250V connection male faston 6.3mm protection IP54 ambient temperature max. 85°C		

indicator lights (complete)			
ø 6mm			
			
1			
GEV No.	359031	Ref. No.	8C0298
description	indicator light ø 6mm 230V green		



ø10mm			
with plug-in socket			
			
1			
GEV No.	359138	Ref. No.	808969
description	indicator light ø 10mm red 230V connection male faston 6.3mm Qty 1 pcs		

			
1			
GEV No.	359334	Ref. No.	C00614
description	indicator light ø 10mm yellow 24V connection male faston 6.3mm Qty 1 pcs		

ø12mm			
with screw socket			
			
1			
GEV No.	359291	Ref. No.	809133
description	indicator light ø 12mm 400V green connection male faston 6.3mm		

ø13mm			
with plug-in socket			
			
1			
GEV No.	359142	Ref. No.	807773
description	indicator light ø 13mm green 230V connection male faston 6.3mm temp.-resist. 120°C Qty 1 pcs		

			
1			
GEV No.	359143	Ref. No.	806128
description	indicator light ø 13mm yellow 230V connection male faston 6.3mm temp.-resist. 120°C Qty 1 pcs		

30x22mm			
			
1			
GEV No.	359157	Ref. No.	806080
description	indicator light mounting measurements 30x22mm 230V green connection male faston 6.3mm temp.-resist. 125/55°C type RL2		
accessories for	359157		
	GEV No.	301036	Ref. No.
			—
	protective cover internal size 30x22mm for rocker switch mounting measurementsmm		

miscellaneous			
			
Image not available			
1			
GEV No.	359335	Ref. No.	809133
description	indicator light		



Зип-Общепит

vsezip.ru

+7(812)987-08-81

screw-on/push-on fit

light bulbs

for ovens



1

GEV No.	357153	Ref. No.	809884
description	light bulb t.max. 300°C socket E14 25W 230V ø 25mm L 55mm lens L 30mm for oven type		

hard-glass infrared lamps



1

GEV No.	359463	Ref. No.	40XX-XX40999
description	infrared lamp socket E27 240V 250W ø 125mm L 173mm type BR125 red hard glas		



oven lamps

universal oven lamps

mounting diameter 35.5mm







1

GEV No.	359718	Ref. No.	809935
description	oven lamp mounting ø 35.5mm 230V 15W socket E14 temp.-resist. 300°C connection male faston 6.3mm hard glas		
spare parts for	359718		
	GEV No.	359701	Ref. No.
			809715 8C0278
	lamp socket socket E14 220-230V mounting ø 35.5mm connection male faston 6.3mm 15W		
	GEV No.	359740	Ref. No.
			—
	light bulb t.max. 300°C socket E14 15W 230V ø 22mm L 48mm lens L 20mm for oven lamp IMPORT		



1

GEV No.	359701	Ref. No.	809715 8C0278
description	lamp socket socket E14 220-230V mounting ø 35.5mm connection male faston 6.3mm 15W		
accessories for	359701		
	GEV No.	359705	Ref. No.
			—
	oven lamp glass thr.ø 33.5mm ø 52mm hard glas temp.-resist. 350°C		

accessories for	359701		
	GEV No.	359709	Ref. No.
			—
	oven lamp glass thr.ø 33.5mm ø 42mm hard glas temp.-resist. 350°C		
	GEV No.	359721	Ref. No.
			—
	gasket silicone ED ø 44mm ID ø 39.5mm thickness 5mm Qty 1 pcs		
	GEV No.	359942	Ref. No.
			—
	oven lamp glass thr.ø 33.5mm ø 41mm hard glas temp.-resist. 350°C		



1

GEV No.	359661	Ref. No.	808808
description	oven lamp glass thread 32.1 ø 58mm hard glas temp.-resist. 350°C		
accessories for	359661		
	GEV No.	359700	Ref. No.
			—
	gasket for pizza oven fibre glass ID ø 32.5mm ED ø 55mm thickness 5mm		

mounting diameter 47.8mm

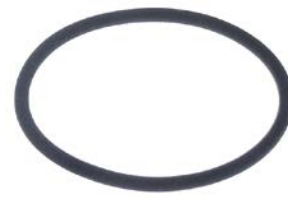

1

GEV No.	525313	Ref. No.	808709
description	O-ring Viton ID ø 60.33mm thickness 3.53mm Qty 1 pcs		



1

GEV No.	532649	Ref. No.	808710
description	O-ring Viton ID ø 63.17mm thickness 2.62mm Qty 1 pcs		



Зип-Общепит





vsezip.ru

+7(812)987-08-81

mounting diameter 65.5mm



1

GEV No.	359712	Ref. No.	808850
description	oven lamp mounting ϕ 65.5mm 230V 40W socket E14 temp.-resist. 300°C connection male faston 6.3mm hard glas		
spare parts for	359712		
	GEV No.	359022	Ref. No. —
	lamp socket socket E14 mounting ϕ 65.5mm connection male faston 6.3mm		
	GEV No.	359611	Ref. No. —
	light bulb t.max. 300°C socket E14 40W 230V ϕ 45mm L 75mm lens L 50mm for oven lamp IMPORT		
	GEV No.	359722	Ref. No. —
	gasket silicone ID ϕ 57.5mm ED ϕ 68mm thickness 2mm		
	GEV No.	359724	Ref. No. 808851
	oven lamp glass thread ϕ 62mm H 46mm ϕ 74mm hard glas temp.-resist. 350°C		



1

GEV No.	359724	Ref. No.	808851
description	oven lamp glass thread ϕ 62mm H 46mm ϕ 74mm hard glas temp.-resist. 350°C		

55x70mm











1

GEV No.	359297	Ref. No.	131110027
description	frame L 95mm W 81mm mounting distance 68/83mm thickness 6mm		
accessories for	359297		
	GEV No.	359299	Ref. No. —
	gasket L 91mm W 77mm hole ϕ 3mm for oven lamp		

55x70mm



1

GEV No.	359698	Ref. No.	808979
description	lamp socket L 100mm W 55mm socket E14 connection male faston 6.3mm		
spare parts for	359698		
	GEV No.	358119	Ref. No. —
	frame L 118mm W 72mm mounting distance 143mm for bulb socket		
	GEV No.	358122	Ref. No. —
	gasket L 112mm W 68mm silicone thickness 3mm for bulb socket		
	GEV No.	358123	Ref. No. —
	lamp glass L 112mm W 68mm		
	GEV No.	359612	Ref. No. —
	light bulb t.max. 300°C socket E14 25W 230V ϕ 25mm L 56mm lens L 30mm for oven lamp type Philips		
	GEV No.	359714	Ref. No. 808977
	gasket for bulb socket		
	GEV No.	359715	Ref. No. 808976
	lamp glass L 110mm W 65mm thickness 5mm		
	GEV No.	359716	Ref. No. 808975
	frame for bulb socket		
accessories for	359698		
	GEV No.	359612	Ref. No. —
	light bulb t.max. 300°C socket E14 25W 230V ϕ 25mm L 56mm lens L 30mm for oven lamp type Philips		
	GEV No.	359938	Ref. No. —
	borosilicate glass L 115mm W 69mm		



1

GEV No.	359716	Ref. No.	808975
description	frame for bulb socket		



Зип Общепит









vsezip.ru







+7(812)987-08-81

	
1	
GEV No.	359714
Ref. No.	808977
description	gasket for bulb socket

	
1	
GEV No.	359715
Ref. No.	808976
description	lamp glass L 110mm W 65mm thickness 5mm

	
1	
GEV No.	359698
Ref. No.	808979
description	lamp socket L 100mm W 55mm socket E14 connection male faston 6.3mm

spare parts for	359698
	GEV No. 358119 Ref. No. —
frame L 118mm W 72mm mounting distance 143mm for bulb socket	
	GEV No. 358122 Ref. No. —
gasket L 112mm W 68mm silicone thickness 3mm for bulb socket	
	GEV No. 358123 Ref. No. —
lamp glass L 112mm W 68mm	
	GEV No. 359612 Ref. No. —
light bulb t.max. 300°C socket E14 25W 230V ø 25mm L 56mm lens L 30mm for oven lamp type Philips	
	GEV No. 359714 Ref. No. 808977
gasket for bulb socket	
	GEV No. 359715 Ref. No. 808976
lamp glass L 110mm W 65mm thickness 5mm	
	GEV No. 359716 Ref. No. 808975
frame for bulb socket	
accessories for	359698
	GEV No. 359612 Ref. No. —
light bulb t.max. 300°C socket E14 25W 230V ø 25mm L 56mm lens L 30mm for oven lamp type Philips	
	GEV No. 359938 Ref. No. —
borosilicate glass L 115mm W 69mm	

	
GEV No.	101372
Ref. No.	808569
description	oven lamp complete L 100mm W 55mm 230V 25W socket E14 rectangular temp.-resist. 300°C connection male faston 6.3mm
spare parts for	101372
	GEV No. 359612 Ref. No. —
light bulb t.max. 300°C socket E14 25W 230V ø 25mm L 56mm lens L 30mm for oven lamp type Philips	
	GEV No. 359698 Ref. No. 808979
lamp socket L 100mm W 55mm socket E14 connection male faston 6.3mm	
	GEV No. 359714 Ref. No. 808977
gasket for bulb socket	
	GEV No. 359715 Ref. No. 808976
lamp glass L 110mm W 65mm thickness 5mm	
	GEV No. 359716 Ref. No. 808975
frame for bulb socket	

lamps

light bulbs

	
1	
GEV No.	357153
Ref. No.	809884
description	light bulb t.max. 300°C socket E14 25W 230V ø 25mm L 55mm lens L 30mm for oven type

residual heat indicators

	
1	
GEV No.	359326
Ref. No.	809047
description	residual heat indicator 4-fold

	
1	
GEV No.	359327
Ref. No.	809398
description	residual heat indicator single

electric components



timers

Зип Общежит

electric timers

programme timers



1

GEV No.	360525	Ref. No.	809346
description	timer CDC 11904 engines 1 chambers 4 operation time 10min 230V shaft \varnothing mm shaft Lmm manif. no. 11904F1 / BCR000.0000 motor type M48R ATS		
spare parts for	360525		
	GEV No.	360118	Ref. No.
			—
	motor CDC pinion \varnothing 4.9mm teeth 10 230V voltage AC 50/60Hz turn direction right motor \varnothing 47mm H 19.3mm motor type M48R ATS for timer cable length 260mm 1.9/2.5W		





1

GEV No.	360511	Ref. No.	8C0289 J03CCL001
description	timer FIBER P19 engines 1 chambers 4 operation time 270s 230V shaft \varnothing mm shaft Lmm manif. no. P195JV4H700 motor type M51B-J0R6400		



1

GEV No.	360303	Ref. No.	809247
description	timer FIBER P25 engines 2 chambers 5 operation time 72s / 4.8min 230V shaft \varnothing mm shaft Lmm manif. no. P255J05ANM0 motor type M51BJ0R6400 / M51BJ0L6400		
spare parts for	360303		
	GEV No.	360673	Ref. No.
			—
	motor kit pinion \varnothing 6.8mm teeth 15 230V voltage AC 50/60Hz turn direction clockwise motor \varnothing 48mm H 18.5mm motor type UDS-40NE1RNZ165 cable length 150mm with holder		
	GEV No.	360674	Ref. No.
			—
	motor kit pinion \varnothing 6.8mm teeth 15 230V voltage AC 50/60Hz turn direction counterclockwise motor \varnothing 48mm H 18.5mm motor type UDS40NE1RNZ165 cable length 150mm with holder		

with time spread

vsezip.ru

+7(812)987-08-81



1

GEV No.	350074	Ref. No.	809442
description	timer MS65 operation time 120min time spread 30min 1CO/2NO/1NC at 250V 16A permanent position yes impulse electric shaft \varnothing 6x4.6mm shaft L 22mm mounting distance 28mm connection lateral Invensys 4-pole shaft position lower°		





1

GEV No.	350073	Ref. No.	8C1391
description	timer MS65 with buzzer board operation time 120min time spread 30min 1CO/1NC/2NO at 250V 16A permanent position yes impulse electric shaft \varnothing 6x4.6mm shaft L 20mm with bell mounting distance 28mm connection lateral 3-pole		

mechanical timers



1

GEV No.	350159	Ref. No.	132110014
description	timer M2 2-pole operation time 120min impulse mechanical 2CO at 250V 16A permanent position yes shaft \varnothing 6x4.6mm shaft 6x4.6mm shaft L 22mm mounting distance 28mm mounting thread M4 connection male faston 6.3mm ambient temperature max. 125°C with buzzer		
spare parts for	350159		
	GEV No.	350186	Ref. No.
			—
	timer M2 2-pole operation time 120min impulse mechanical 2CO at 250V 16A permanent position yes shaft \varnothing 6x4.6mm shaft 6x4.6mm shaft L 23mm mounting distance 28mm		
	GEV No.	401062	Ref. No.
			—
	buzzer board 230VAC L 48mm W 45mm connection Faston 6.3mm		

Зип Общедит

alarm devices

buzzers

vsezip.ru

+7(812)987-08-81

 <p>1</p>			
GEV No.	350030	Ref. No.	8C2008
description	timer M2 2-pole operation time 120min impulse mechanical 2NO at 250V 16A permanent position no shaft ø 6x4.6mm shaft L 23mm mounting distance 28mm connection lateral		
accessories for	350030		
	GEV No.	110366	Ref. No. —
	knob switch zero mark t.max.°C ø 44mm shaft ø 6x4.6mm shaft flat upper black		
	GEV No.	111199	Ref. No. —
	dial plate graduation 120min permanent position no rotation 0-330° ø 60mm timers knob ø 45mm		

 <p>1</p>			
GEV No.	350003	Ref. No.	813170
description	timer M2 with bell 2-pole operation time 120min impulse mechanical 2NO at 250V 16A permanent position no shaft ø 6x4.6mm shaft L 23mm mounting distance 28mm connection lateral		
accessories for	350003		
	GEV No.	110366	Ref. No. —
	knob switch zero mark t.max.°C ø 44mm shaft ø 6x4.6mm shaft flat upper black		
	GEV No.	111199	Ref. No. —
	dial plate graduation 120min permanent position no rotation 0-330° ø 60mm timers knob ø 45mm		

 <p>1</p>			
GEV No.	350008	Ref. No.	809674
description	timer M2 with bell 2-pole operation time 120min impulse mechanical 2NO at 250V 16A permanent position yes shaft ø 6x4.6mm shaft L 24mm mounting distance 28mm connection lateral		

 <p>1</p>			
GEV No.	350136	Ref. No.	809553
description	buzzer 12VAC connection cable 200mm screw mounting 63dB		

contactors

GENERAL ELECTRIC (AEG)

power contactors

 <p>1</p>			
GEV No.	380244	Ref. No.	807553 8C0148
description	power contactor resistive load 25A 230VAC (AC3/400V) 9A/4kW main contacts 3NO auxiliary contacts 1NO connection screw connection type AEG LS4K 10A type GE CL00A 310		

 <p>1</p>			
GEV No.	380261	Ref. No.	C00571
description	power contactor resistive load 32A 230VAC (AC3/400V) 17A/7.5kW main contacts 3NO auxiliary contacts 1NO connection screw connection type AEG LS7K 10A type GE CL02A 310		



Зип-Общепит

LOVATO

power contactors



1

GEV No.	380705	Ref. No.	C00287
description	power contactor resistive load 20A 230VAC (AC3/400V) 9A/4kW main contacts 3NO auxiliary contacts 1NO connection screw connection type 11BG0910A230		
accessories for	380705		
	GEV No.	380057	Ref. No. —
	auxiliary contact contacts 1NO/1NC AC1 10A for contactors BG series connection screw type BGX1011		



1

GEV No.	380082	Ref. No.	C00287
description	power contactor resistive load 20A 240VAC (AC3/400V) 9A/4kW main contacts 4NO		

SIEMENS

power contactors



1

GEV No.	380645	Ref. No.	809820
description	power contactor 230VAC with auxiliary contacts		

power contactors



1

GEV No.	380882	Ref. No.	8C0216
description	power contactor resistive load 25A 230VAC AC3 10A main contacts 3NO auxiliary contacts 1NO connection screw connection type J7KN-10D-10 OMRON		

solid state relays

CELDUC



1

GEV No.	400105	Ref. No.	809558
description	solid state relay CELDUC 2 phase 65A 400V 24VDC L 58mm W 45mm plug-in connection screw type 40.00.453		
accessories for	400105		
	GEV No.	401794	Ref. No. —
	connecting cable L 1440mm 4-pole suitable for RATIONAL		

relays

power relays

with bracket mounting

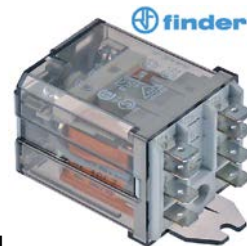

1

GEV No.	380139	Ref. No.	809863
description	power relays FINDER 230VAC 16A 2CO connection F6.3 bracket mounting dimensions 68x38.2x35.8mm manuf. no. 62.82.8.230.0000		



Зип-Общепит

vsezip.ru

+7(812)987-08-81



1

GEV No.	380403	Ref. No.	905475
description	power relays FINDER 230VAC 16A 3CO connection F6.3 bracket mounting manuf. no. 62.83.8.230.0500		



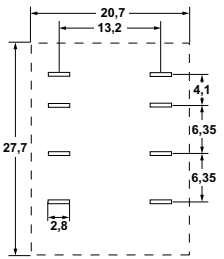

with male contacts
female contact 2.0mm

1

GEV No.	380129	Ref. No.	809015
description	power relays 24VAC 12A 2CO connection F2 plug-in connection 94.92.3 250V connection 2mm		

accessories for 380129

	GEV No.	380341	Ref. No.	—
	description	relay socket 4-pole contacts 12 300V voltage AC 6A Italiana Relè manuf. no. ZMD4		
	GEV No.	380378	Ref. No.	—
	description	relay socket 2-pole 55/85 dimensions 70.5x30x27mm 250V voltage AC 10A FINDER manuf. no. 94.72		
	GEV No.	380384	Ref. No.	—
	description	relay socket 2-pole contacts male faston 2.8mm 250V voltage AC 10A W 23mm for		
	GEV No.	380399	Ref. No.	—
	description	relay socket 4-pole dimensions 76.2x27x86.1mm 250V voltage AC 1A FINDER manuf. no. 94.94.3		

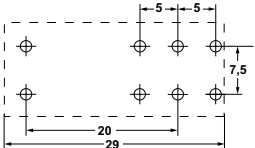

plug-in/print relays

1

GEV No.	380333	Ref. No.	J03REL001
description	print relay 230VAC 2CO at 250V 8A connection pins raster size 5mm FINDER manuf. no. 40.52.8.230.0000 95.65/95.75		

accessories for 380333

	GEV No.	380340	Ref. No.	—
	description	relay socket dimensions 62x36x15mm 250V voltage AC 10A Italiana Relè manuf. no. ZMEM/5		
	GEV No.	380505	Ref. No.	—
	description	relay socket 2CO 40.52 dimensions 81.9x15.5x75mm 250V voltage AC 10A FINDER manuf. no. 95.95.3		

accessories for 380333

GEV No.	381181	Ref. No.	—
description	relay socket 2-pole 40.51/40.52/40.61 connection screw clamp dimensions 15.8x78.6mm 250V voltage AC 10A FINDER manuf. no. 95.75		

relays sockets



1

GEV No.	380638	Ref. No.	809018
description	relay socket 8-pole dimensions 51x41x23mm 250V 10A FINDER manuf. no. 90.26		

level relays

GICAR



1

GEV No.	401173	Ref. No.	807853
description	level relay 230V connection F6.3 type RL30/3ES/F		

time relays

time relays



1

GEV No.	380639	Ref. No.	809016
description	time relay TECNOLOGIC RTR12DS06S time range 6s 230VAC 5A mounting measurements 34x34mm 1CO connection plug-in connection round 8-pole		

accessories for 380639

	GEV No.	380638	Ref. No.	809018
	description	relay socket 8-pole dimensions 51x41x23mm 250V 10A FINDER manuf. no. 90.26		

Зип Обществит
electronic controllersDIXELL
refrigeration controllers

built-in version

+7(812)987-08-81













1

GEV No.	380640	Ref. No.	809019
description	time relay TECNOLOGIC RTR12DS60S time range 60s 230VAC 5A 1CO connection plug-in connection round 8-pole		
accessories for	380640		
	GEV No.	380638	Ref. No. 809018
	relay socket 8-pole dimensions 51x41x23mm 250V 10A FINDER manuf. no. 90.26		



1

GEV No.	378384	Ref. No.	246430107
description	electronic controller DIXELL XR40CX-5N0C1 mounting measurements 71x29mm 230V voltage AC NTC/PTC relay outputs 2 NO-20A(8) CO-8A(3) NTC/PTC NTC/PTC DI -50 up to +150°C display 3½ digits		
accessories for	378384		
	GEV No.	378551	Ref. No. —
	adapter for reducer mounting measurements 71x29mm		
	GEV No.	379053	Ref. No. —
	temperature probe PTC 1kOhm cable PVC probe -50 up to +150°C cable -10 up to 100°C probe ø6x30mm cable length 3m without screw connection 2-wire		
	GEV No.	379057	Ref. No. —
	temperature probe NTC 10kOhm cable PVC probe -20 up to +80°C cable -10 up to 100°C probe ø6x25mm cable length 3m 2-wire		
	GEV No.	379064	Ref. No. —
	temperature probe PTC 1kOhm cable silicone probe -50 up to +150°C cable -50 up to +180°C probe ø6x40mm cable length 3m without screw connection 2-wire		
	GEV No.	379142	Ref. No. E25110070
	temperature probe PTC 1kOhm cable PVC probe -50 up to +150°C cable -10 up to 100°C probe ø6x30mm cable length 1.5m without screw connection 2-wire		
	GEV No.	379160	Ref. No. —
	temperature probe NTC 10kOhm cable thermoplastic probe -40 up to +110°C cable -40 up to +110°C probe ø6x14mm cable length 1.5m without screw connection 2-wire		
	GEV No.	379161	Ref. No. —
	temperature probe NTC 10kOhm cable thermoplastic probe -40 up to +110°C cable -40 up to +110°C probe ø6x14mm cable length 3m without screw connection 2-wire		
	GEV No.	379343	Ref. No. 825830
	temperature probe NTC 10kOhm cable silicone probe -40 up to +110°C cable -50 up to +180°C probe ø6x40mm cable length 3m 2-wire		
	GEV No.	379749	Ref. No. —
	temperature probe NTC 10kOhm cable silicone probe -40 up to +110°C cable -50 up to +180°C probe ø6x30mm cable length 1.5m without screw connection 2-wire		
	GEV No.	379782	Ref. No. —
	temperature probe PTC 1kOhm cable thermoplastic probe -50 up to +150°C cable -40 up to +110°C probe ø6x14mm cable length 3m 2-wire resistor 1kOhm		
	GEV No.	402818	Ref. No. —
	programming key 4K for electronic controller DIXELL		

transformers

open transformers

with clamp terminal



1

GEV No.	401983	Ref. No.	C00718
description	transformer primary 230V secondary 24V 30VA connection screw 50/60Hz		



1

GEV No.	400203	Ref. No.	C00506
description	transformer primary 230V secondary 24V 30VA H 64mm L 75mm W 65mm connection screw 50/60Hz		



Зип Общепит

universal controllers

vsezip.ru

built-in version

+7(812)987-08-81



1

GEV No.	378229	Ref. No.	246430103
description	electronic controller DIXELL XW60L-5NOC1 mounting measurements 150x30mm built-in depth 65.5mm 230V voltage AC NTC/PTC relay outputs 4 CO-20A(8) CO-8A(3) NO-8A(3) NO-8A(3) NTC/PTC NTC/PTC DI -50 up to +150°C display 3½ digits		
accessories for	378229		
	GEV No.	Ref. No.	—
	378194		
	temperature probe NTC 10kOhm cable PVC probe -20 up to +80°C cable -10 up to 100°C probe ø7x24.5mm cable length 1.5m without screw connection 2-wire		
	GEV No.	Ref. No.	—
	379052		
	temperature probe PTC 1kOhm cable silicone probe -50 up to +150°C cable -50 up to +180°C probe ø6x40mm cable length 1.5m without screw connection 2-wire		
	GEV No.	Ref. No.	—
	379053		
	temperature probe PTC 1kOhm cable PVC probe -50 up to +150°C cable -10 up to 100°C probe ø6x30mm cable length 3m without screw connection 2-wire		
	GEV No.	Ref. No.	—
	379057		
	temperature probe NTC 10kOhm cable PVC probe -20 up to +80°C cable -10 up to 100°C probe ø6x25mm cable length 3m 2-wire		
	GEV No.	Ref. No.	—
	379064		
	temperature probe PTC 1kOhm cable silicone probe -50 up to +150°C cable -50 up to +180°C probe ø6x40mm cable length 3m without screw connection 2-wire		
	GEV No.	Ref. No.	—
	379160		
	temperature probe NTC 10kOhm cable thermoplastic probe -40 up to +110°C cable -40 up to +110°C probe ø6x14mm cable length 1.5m without screw connection 2-wire		
	GEV No.	Ref. No.	—
	379161		
	temperature probe NTC 10kOhm cable thermoplastic probe -40 up to +110°C cable -40 up to +110°C probe ø6x14mm cable length 3m without screw connection 2-wire		
	GEV No.	Ref. No.	825830
	379343		
	temperature probe NTC 10kOhm cable silicone probe -40 up to +110°C cable -50 up to +180°C probe ø6x40mm cable length 3m 2-wire		
	GEV No.	Ref. No.	—
	379458		
	temperature probe NTC 10kOhm cable silicone probe -40 up to +110°C cable -50 up to +180°C probe ø6x40mm cable length 1.5m without screw connection 2-wire		
	GEV No.	Ref. No.	—
	402818		
	programming key 4K for electronic controller DIXELL		



1

GEV No.	379605	Ref. No.	831131 8C0227
description	electronic controller ELIWELL type ICPlus915 model ICP22J135000 mounting measurements 71x29mm 12V voltage AC/DC Pt100/TC (J,K) relay outputs 2 NO-8A(4) NO-8A(4) Pt100/TC (J,K) cooking front measurements 78x37mm built-in depth 59mm mode of operation cooking protection IPx0 accuracy 1% built-in version defr. funct. no dependend on probe°C display 3½ digits		
accessories for	379605		
	GEV No.	Ref. No.	—
	379050		
	temperature probe Pt100 cable Vetrotex probe -200 up to +600°C cable -50 up to +350°C probe ø6x100mm cable length 2.7m without screw connection 3-wire		
	GEV No.	Ref. No.	—
	379054		
	transformer primary 230VAC secondary 12VAC 3VA secondary 0.25A H 40mm L 45mm W 50mm connection screw 50/60Hz type 153/M		
	GEV No.	Ref. No.	—
	379785		
	temperature probe Pt100 cable silicone probe -100 up to 450°C cable -50 up to +180°C probe ø6x100mm cable length 1.5m without screw connection 2-wire resistor 0.1kOhm		
	GEV No.	Ref. No.	—
	379786		
	temperature probe Pt100 cable silicone probe -100 up to 450°C cable -50 up to +180°C probe ø6x100mm cable length 3m without screw connection 2-wire resistor 0.1kOhm		
	GEV No.	Ref. No.	—
	379787		
	temperature probe Pt100 cable Vetrotex probe -200 up to +600°C cable -50 up to +350°C probe ø6x100mm cable length 1.4m without screw connection 2-wire resistor 0.1kOhm		

refrigeration controllers

built-in version



1

GEV No.	379645	Ref. No.	712110005
description	electronic controller ELIWELL type ID961 mounting measurements 71x29mm 230V voltage AC NTC/PTC relay outputs 1 relay -55 up to +150°C display 3½ digits compressor relay 15A		
accessories for	379645		
	GEV No.	Ref. No.	—
	379053		
	temperature probe PTC 1kOhm cable PVC probe -50 up to +150°C cable -10 up to 100°C probe ø6x30mm cable length 3m without screw connection 2-wire		

Table continues overleaf

Зип Общепит

vsezip.ru

(812)987-08-81

accessories for	379645		
	GEV No.	379064	Ref. No.
			—
	temperature probe PTC 1kOhm cable silicone probe -50 up to +150°C cable -50 up to +180°C probe ø6x40mm cable length 3m without screw connection 2-wire		
	GEV No.	379161	Ref. No.
			—
	temperature probe NTC 10kOhm cable thermoplastic probe -40 up to +110°C cable -40 up to +110°C probe ø6x14mm cable length 3m without screw connection 2-wire		
	GEV No.	379782	Ref. No.
			—
	temperature probe PTC 1kOhm cable thermoplastic probe -50 up to +150°C cable -40 up to +110°C probe ø6x14mm cable length 3m 2-wire resistor 1kOhm		

EVCO - EVERY CONTROL

universal controllers

built-in version



GEV No.	378169	Ref. No.	807302
description	electronic controller EVERY CONTROL EV7401 mounting measurements 66.5x66.5mm built-in depth 90mm 24/230V voltage AC NTC/PTC/Pt100/TC(J,K)/mA relay outputs 1 CO-8A(3) NTC/PTC/Pt100/TC(-J,K)/mA yes protection IP54 dependent on probe°C display 4 digits		
accessories for	378169		
	GEV No.	379053	Ref. No.
			—
	temperature probe PTC 1kOhm cable PVC probe -50 up to +150°C cable -10 up to 100°C probe ø6x30mm cable length 3m without screw connection 2-wire		
	GEV No.	379062	Ref. No.
			—
	temperature probe thermocouple J (Fe-CuNi) cable Vetrotex probe -50 up to +750°C cable -50 up to +350°C probe ø6x50mm cable length 3m without screw connection 2-wire		
	GEV No.	379064	Ref. No.
			—
	temperature probe PTC 1kOhm cable silicone probe -50 up to +150°C cable -50 up to +180°C probe ø6x40mm cable length 3m without screw connection 2-wire		
	GEV No.	379131	Ref. No.
			—
	temperature probe Pt100 cable Vetrotex probe -200 up to +600°C cable -50 up to +350°C probe ø6x85mm cable length 3m without screw connection 3-wire resistance at 0°C 100Ohm		
	GEV No.	379161	Ref. No.
			—
	temperature probe NTC 10kOhm cable thermoplastic probe -40 up to +110°C cable -40 up to +110°C probe ø6x14mm cable length 3m without screw connection 2-wire		

GEV No.	378151	Ref. No.	809889 8C0257 8C0258
description	electronic controller EVERY CONTROL EVK412 mounting measurements 71x29mm built-in depth 59mm 12/24V voltage AC/DC NTC/PTC/Pt100/Pt1000/TC(J,K)/mV/mA relay outputs 2 CO-16A(8) CO-8A(3) NTC/PTC/Pt100/Pt1000/TC(J,K)/mV/mA yes protection IP54 dependent on probe°C display 4 digits		

refrigeration controllers

built-in version



GEV No.	379524	Ref. No.	809889 8C0257 8C0258
description	electronic controller EVERY CONTROL type EVK412 mounting measurements 71x29mm 12/24V voltage AC TC/J -100 to +800°C		

timers



GEV No.	379522	Ref. No.	809892
description	electronic timer EVERY CONTROL type EVK702D2VXS mounting measurements 71x29mm 12V voltage AC/DC time setting range 0.1s.-99h:59min display 4 digits relay outputs 2 8A 8A front measurements 75x33mm		

probes

universal probes

temperature probes



GEV No.	379343	Ref. No.	825830
description	temperature probe NTC 10kOhm cable silicone probe -40 up to +110°C cable -50 up to +180°C probe ø6x40mm cable length 3m 2-wire		

Зип Общепит

vsezip.ru

+7(812)987-08-81

GEV No.	379142	Ref. No.	E25110070
description	temperature probe PTC 1kOhm cable PVC probe -50 up to +150°C cable -10 up to 100°C probe ø6x30mm cable length 1.5m without screw connection 2-wire		

GEV No.	379051	Ref. No.	8C0221
description	temperature probe thermocouple J (Fe-CuNi) cable Vetrotex probe -50 up to +750°C cable -50 up to +350°C probe ø6x100mm cable length 3m without screw connection cable colours red/blue 2-wire		
accessories for	379051		
	GEV No.	379877	Ref. No. —
description	electronic controller HONEYWELL type DC10N-400 mounting measurements 92x92mm 24/230V voltage ACT TC (J) relay outputs 1 CO-10A(6) TC (J) universal built-in depth 55mm protection IP54 accuracy 1% built-in version defr. funct. no 0 up to +400°C display 3 digits		

GEV No.	379945	Ref. No.	808682
description	core temperature probe Pt100 cable PTFE probe -40 up to +250°C cable -40 up to +250°C connection plug probe ø3.5x100mm thread cable length 0.5m handle ø10mm handle length 80mm		

GEV No.	379946	Ref. No.	8C1187
description	core temperature probe Pt100 cable PTFE probe -40 up to +250°C cable -40 up to +250°C connection plug probe ø3.5x100mm thread cable length 0.7m handle ø10mm handle length 80mm		

GEV No.	379548	Ref. No.	8C1881
description	core temperature probe PTC 1kOhm cable silicone probe -50 up to +150°C cable -50 up to +180°C connection 4-wire probe ø5x70mm thread cable length 1.2m handle ø10mm handle length 120mm L1 150mm L2 80mm		

GEV No.	381426	Ref. No.	809658
description	core temperature probe thermocouple K (NiCr-Ni) cable PTFE probe -40 up to +250°C cable -40 up to +250°C connection 2-wire probe ø3.2x100mm thread M12 cable length 1.9m handle ø10mm handle length 100mm		

producer-specific probes

probes

GEV No.	378011	Ref. No.	809887
description	core temperature probe Pt100 cable silicone probe -40 up to +120°C cable -50 up to +180°C connection 2-wire thread probe ø3x150mm cable length 2m		

GEV No.	379756	Ref. No.	9629931
description	probe Pt100 cable PTFE probe -100 up to 450°C cable -40 up to +250°C connection 3-wire thread M12x1 probe ø4x50mm cable length 1.5m		

GEV No.	381430	Ref. No.	809525
description	temperature probe thermocouple K (NiCr-Ni) cable silicone probe -50 up to 1150°C cable -50 up to +180°C connection 2-wire thread probe ø2x100mm cable length 0.25m		

GEV No.	379124	Ref. No.	809564
description	temperature probe thermocouple K (NiCr-Ni) cable silicone probe -50 up to 1150°C cable -50 up to +180°C connection 2-wire thread probe ø2x100mm cable length 2.2m		

electric components



electronics

PCBs

electric components

Зип Общепит

vsezip.ru

+7(812)987-08-81



1	
GEV No. 400098	Ref. No. 809736
description	control PCB combi-steamer CD 101/CM 101 without EPROM



1	
GEV No. 400200	Ref. No. 809431
description	PCB



1	
GEV No. 400202	Ref. No. C00566
description	PCB 24V



1	
GEV No. 401171	Ref. No. 809099
description	PCB combi-steamer



GEV No. 401953	Ref. No. IB5944010
description	PCB hand blenders VORTEX with potentiometer 230V



1	
GEV No. 697908	Ref. No. 807598
description	PCB L 102mm W 95mm 50/60Hz 230/400V



1	
GEV No. 401451	Ref. No. 809432
description	PCB pyroceram range 110/920 series



1	
GEV No. 400955	Ref. No. 808629
description	PCB slicer 230/400V
accessories for 400955	

	GEV No. 401357	Ref. No. 8C1437
momentary push switch mounting measurements ø22mm 1NO/1NC/indicator light 400V 4A indicator lamp 24V 0-1 connection screw ambient temperature max. 125/55°C protection IP40		

	GEV No. 401709	Ref. No. —
protective cover external size 57x32mm internal size 47x22mm matt finish rubber H 27.5mm		



1	
GEV No. 403575	Ref. No. E61110058 E61110059
description	PCB slicer L 128mm W 43mm 230-400V

Зип Общепит

vs.p.ru

+7(812)987-08-81

			
1			
GEV No.	400954	Ref. No.	808742
description	PCB slicer/cutter 50/60Hz 230V		

keypads

keypad units

			
1			
GEV No.	401735	Ref. No.	8C0477
description	keypad unit meat mincer TC12 buttons 3 cable length 90mm L 130mm W 41mm cable colours brown/yellow/grey/green/pink/white		
accessories for	401735		
	GEV No.	Ref. No.	—
	401373		
	gasket for keypad housing L 135mm W 50mm		

			
1			
GEV No.	403002	Ref. No.	808612
description	keypad unit slicer buttons 2 MIRRA/SAN-DANIELE/YORK L 120mm W 48mm		
accessories for	403002		
	GEV No.	Ref. No.	—
	403004		
	gasket for keypad housing L 122mm W 52mm		

solenoid valves

solenoid valves (water)

ELBI			
straight			
			
1			
GEV No.	373018	Ref. No.	809566
description	solenoid valve single straight 230VAC inlet 3/4" outlet 14mm DN10 ELBI		
spare parts for	373018		
	GEV No.	Ref. No.	—
	370467		
	solenoid valve filter suitable for ELBI		

ROBERTO AW INVENYS

medium temperature: 90°C 90°C 60°C
 ambient temperature: 60°C 25°C 60°C
 duty cycle: 40% 100% 100%

with coded terminal

			
1			
GEV No.	370269	Ref. No.	809565
description	solenoid valve double straight 230VAC inlet 3/4" outlet 11.5mm DN10 EATON (INVENSYS)		

RPE

reducers

outlet side

			
1			
GEV No.	371269	Ref. No.	8C0117
description	reducer flow rate 0.07-0.14l/min brown		

TP

			
1			
GEV No.	370017	Ref. No.	809327
description	solenoid valve single straight 230VAC inlet 3/4" outlet 11.5mm DN10 TP p max 10bar		
spare parts for	370017		
	GEV No.	Ref. No.	—
	371013		
	solenoid coil TP 230VAC 50/60Hz		
accessories for	370017		
	GEV No.	Ref. No.	—
	371220		
	reducer TP flow rate 3l/min red tolerance ±15%		
	GEV No.	Ref. No.	—
	371221		
	reducer TP flow rate 5.5l/min yellow tolerance ±15%		
	GEV No.	Ref. No.	—
	371222		
	reducer TP flow rate 6l/min grey tolerance ±15%		
	GEV No.	Ref. No.	—
	371223		
	reducer TP flow rate 10l/min white tolerance ±15%		
	GEV No.	Ref. No.	—
	371224		
	reducer TP flow rate 12l/min bronze tolerance ±15%		
	GEV No.	Ref. No.	—
	371225		
	reducer TP flow rate 16l/min light brown tolerance ±15%		



Table continues overleaf







Зип-Общепит

vsezip.ru

+7(812)987-08-81

accessories for		370017	
GEV No.	371226	Ref. No.	—
	reducer TP flow rate 20l/min red tolerance ±15%		
	371230	Ref. No.	—
reducer TP flow rate 0.25l/min red tolerance ±25%			
	371231	Ref. No.	—
reducer TP flow rate 0.35l/min violet tolerance ±25%			
	371232	Ref. No.	—
reducer TP flow rate 0.5l/min orange tolerance ±25%			
	371233	Ref. No.	—
reducer TP flow rate 0.8l/min white tolerance ±25%			
	371234	Ref. No.	—
reducer TP flow rate 1l/min light blue tolerance ±25%			
	371235	Ref. No.	—
reducer TP flow rate 1.2l/min brown tolerance ±25%			
	371236	Ref. No.	—
reducer TP flow rate 1.5l/min light brown tolerance ±25%			
	371237	Ref. No.	—
reducer TP flow rate 2.5l/min yellow tolerance ±25%			
	371238	Ref. No.	—
reducer TP flow rate 3.4l/min dark green tolerance ±25%			
	371239	Ref. No.	—
reducer TP flow rate 5l/min black tolerance ±25%			
	371240	Ref. No.	—
reducer TP flow rate 8l/min blue tolerance ±20%			

			
1			
GEV No.	370026	Ref. No.	E00010011
description	solenoid valve triple straight 230VAC inlet 3/4" outlet 14mm DN10 TP		
spare parts for	370026		
	371013	Ref. No.	—
solenoid coil TP 230VAC 50/60Hz			
accessories for	370026		
	371220	Ref. No.	—
reducer TP flow rate 3l/min red tolerance ±15%			
	371221	Ref. No.	—
reducer TP flow rate 5.5l/min yellow tolerance ±15%			
	371222	Ref. No.	—
reducer TP flow rate 6l/min grey tolerance ±15%			

accessories for		370026	
GEV No.	371223	Ref. No.	—
	reducer TP flow rate 10l/min white tolerance ±15%		
	371224	Ref. No.	—
reducer TP flow rate 12l/min bronze tolerance ±15%			
	371225	Ref. No.	—
reducer TP flow rate 16l/min light brown tolerance ±15%			
	371226	Ref. No.	—
reducer TP flow rate 20l/min red tolerance ±15%			
	371230	Ref. No.	—
reducer TP flow rate 0.25l/min red tolerance ±25%			
	371231	Ref. No.	—
reducer TP flow rate 0.35l/min violet tolerance ±25%			
	371232	Ref. No.	—
reducer TP flow rate 0.5l/min orange tolerance ±25%			
	371233	Ref. No.	—
reducer TP flow rate 0.8l/min white tolerance ±25%			
	371234	Ref. No.	—
reducer TP flow rate 1l/min light blue tolerance ±25%			
	371235	Ref. No.	—
reducer TP flow rate 1.2l/min brown tolerance ±25%			
	371236	Ref. No.	—
reducer TP flow rate 1.5l/min light brown tolerance ±25%			
	371237	Ref. No.	—
reducer TP flow rate 2.5l/min yellow tolerance ±25%			
	371238	Ref. No.	—
reducer TP flow rate 3.4l/min dark green tolerance ±25%			
	371239	Ref. No.	—
reducer TP flow rate 5l/min black tolerance ±25%			
	371240	Ref. No.	—
reducer TP flow rate 8l/min blue tolerance ±20%			





Зип-Общепит

vsezip.ru

+7(812)987-08-81

			
			
GEV No.	370015	Ref. No.	051J00002
description	solenoid valve single angled 230VAC inlet 3/4" outlet 11.5mm DN10 TP		
accessories for	370015		
	GEV No.	371220	Ref. No. —
	reducer TP flow rate 3l/min red tolerance ±15%		
	GEV No.	371221	Ref. No. —
	reducer TP flow rate 5.5l/min yellow tolerance ±15%		
	GEV No.	371222	Ref. No. —
	reducer TP flow rate 6l/min grey tolerance ±15%		
	GEV No.	371223	Ref. No. —
	reducer TP flow rate 10l/min white tolerance ±15%		
	GEV No.	371224	Ref. No. —
	reducer TP flow rate 12l/min bronze tolerance ±15%		
	GEV No.	371225	Ref. No. —
	reducer TP flow rate 16l/min light brown tolerance ±15%		
	GEV No.	371226	Ref. No. —
	reducer TP flow rate 20l/min red tolerance ±15%		
	GEV No.	371230	Ref. No. —
	reducer TP flow rate 0.25l/min red tolerance ±25%		
	GEV No.	371231	Ref. No. —
	reducer TP flow rate 0.35l/min violet tolerance ±25%		
	GEV No.	371232	Ref. No. —
	reducer TP flow rate 0.5l/min orange tolerance ±25%		
	GEV No.	371233	Ref. No. —
	reducer TP flow rate 0.8l/min white tolerance ±25%		
	GEV No.	371234	Ref. No. —
	reducer TP flow rate 1l/min light blue tolerance ±25%		
	GEV No.	371235	Ref. No. —
	reducer TP flow rate 1.2l/min brown tolerance ±25%		
	GEV No.	371236	Ref. No. —
	reducer TP flow rate 1.5l/min light brown tolerance ±25%		
	GEV No.	371237	Ref. No. —
	reducer TP flow rate 2.5l/min yellow tolerance ±25%		
	GEV No.	371238	Ref. No. —
	reducer TP flow rate 3.4l/min dark green tolerance ±25%		

accessories for	370015		
	GEV No.	371239	Ref. No. —
	reducer TP flow rate 5l/min black tolerance ±25%		
	GEV No.	371240	Ref. No. —
	reducer TP flow rate 8l/min blue tolerance ±20%		

solenoid valves with reducers

			
GEV No.	370628	Ref. No.	8C0145
description	solenoid valve double straight 230VAC inlet 3/4" input 16l/min DN10 TP plastic outlet 11.5mm		

			
GEV No.	370250	Ref. No.	902410
description	solenoid valve triple straight 230VAC inlet 3/4" outlet 11.5mm t.max. 90°C TP plastic output B 0.25l/min flow regulating valve outlet B red		

pressure switches

for steam control

			
GEV No.	541074	Ref. No.	8C0444
description	pressure control ø 45mm triggering pressure 0.5bar reset pressure 0.35bar pressure connection vertical steam control pressure range 0.35/0.51bar connection 1/8" pressure connection 1/8"		

			
GEV No.	541025	Ref. No.	808590
description	pressure control pressure connection vertical steam control pressure range adjustable 0.2-0.9bar connection male faston 6.3mm pressure connection ø 1/4"mm		



electric components

Зип.Общепит

vsezip.ru

+7(812)987-08-81

for combi-steamers



1

GEV No.	345218	Ref. No.	809509
description	pressure control pressure range 0-3mbar connection 6mm pressure connection 6mm		



1

GEV No.	541329	Ref. No.	809754
description	pressure control pressure range 350/150mbar connection 8mm pressure connection 8mm		

electrodes





1

GEV No.	400021	Ref. No.	809561
description	level electrode PG9 total length 110mm probe L 70/47/24mm insulated probe length 62/38/16mm with 3 probes connection grip connection		



1

GEV No.	400022	Ref. No.	809569	
description	level electrode PG9 total length 135mm probe L 89/59/28mm insulated probe length 80mm with 3 probes connection grip connection			
accessories for	400022			
	GEV No.	379729	Ref. No.	—
	connection cable L 1230mm 4-pole for level electrode plug type coded			
	GEV No.	550574	Ref. No.	—
	nut thread PG9 H 3mm WS 28 nickel-plated brass Qty 1 pcs mounting ømm cable ømm			

ACC/ZEL

R404a/R507

HMBP monophasе

High/Medium evaporation temperature above -20/-15 °C



1

GEV No.	605068	Ref. No.	8C1859
description	compressor coolant R404a/R507 type ML45TB 220-240V 50Hz HMBP fully hermetic 10kg 1/5HP cylinder capacity 4.5cm ³ CSIR H 175.5mmW 192W 246W 309W 382W 465W 557W 659W 771W test method ASHRAE		



1

GEV No.	605014	Ref. No.	8C1862
description	compressor coolant R404a/R507 type ML80TB 220-240V 50Hz HMBP fully hermetic 11.4kg 3/8HP cylinder capacity 7.57cm ³ CSIR H 175.5mmW 261W 346W 446W 561W 691W 835W 993W 1167W test method ASHRAE ambient temperature max. 43°C		



CUBIGEL

R404a/R507

LBP monophase

Lower evaporation temperature below -20°C



1

GEV No.	605180	Ref. No.	772110024 772110027
description	compressor coolant R404a/R507 type MX23FB 220-240V 50Hz LBP 17.5kg 1HP power input 7/8W cylinder capacity 23.2cm ³ CSIR H 221mm 749W 982W 1246W 1541W 1868W		

Зип Общепит

HMBP, monophase

High/Medium evaporation temperature above -20/-15 °C

vsezip.ru

+7(812)987-08-81



1

GEV No.	605125	Ref. No.	8C1300
description	compressor coolant R404a/R507 type NEK6213GK 220-240V 50Hz HMBP 11.6kg 1/2HP cylinder capacity 12.12cm ³ CSIR H 206mmW 695W 884W 1093W 1333W 1600W 1894W 2215W test method ASHRAE		

EMBRACO / ASPERA



R404a/R507

MBP monophase

Medium evaporation temperature above -20°C



1

GEV No.	605003	Ref. No.	826841
description	compressor coolant R404a/R507 type NB6144GK 230V 50Hz MBP fully hermetic 10.3kg cylinder capacity 4.52cm ³ CSIR H 187mm 226W 288W 301W 375W 459W 553W 658W test method ASHRAE		
spare parts for	605003		
	GEV No.	601022	Ref. No. —
	fan motor 10W 230V 50-60Hz L1 44mm L2 54mm L3 85mm W 84mm cable length 500mm 1300rpm YZF10-20-18/26 5 mounting options bearing slide bearing		
	GEV No.	601071	Ref. No. —
	fan wheel sucking ø 230mm fan wheel mounting 25.4mm blade angle 25° W 37mm aluminium		
	GEV No.	605003	Ref. No. 826841
	compressor coolant R404a/R507 type NB6144GK 230V 50Hz MBP fully hermetic 10.3kg cylinder capacity 4.52cm ³ CSIR H 187mm 226W 288W 301W 375W 459W 553W 658W test method ASHRAE		



fans

axial fans

ebm-papst



1

GEV No.	601030 ¹	Ref. No.	809503 831100001
description	axial fan L 119mm W 119mm H 38mm 230VAC 50Hz 18W bearing ball bearing manuf. no. 4656Z metal connection male faston 2.8mm ebm-papst fan wheel ø 110mm temp.-resist. 75°C		
accessories for	601030		
	GEV No.	550898	Ref. No. —
	connecting cable cable length 2000mm connection F 2.8 connection distance 7.9mm for axial flow fan		
	GEV No.	692497	Ref. No. —
	guard ø 105mm mounting distance 150mm for axial fan ebm-papst-mm		

¹with ball bearings



Зип-Общепит

refrigeration fans

import



1			
GEV No.	601080 ¹	Ref. No.	827851
description	axial fan L 119mm W 119mm H 38mm 230VAC 50/60Hz 23/20W bearing ball bearing connection male faston 2.8mm metal ADDA fan wheel ø 110mm temp.-resist. 70°C		
accessories for	601080		
	GEV No.	550898	Ref. No. —
	connecting cable cable length 2000mm connection F 2.8 connection distance 7.9mm for axial flow fan		
	GEV No.	692519	Ref. No. —
	guard L 120mm W 120mm plastic		

¹with ball bearings



1			
GEV No.	601081 ¹	Ref. No.	827852
description	axial fan L 80mm W 80mm H 38mm 230VAC 50/60Hz 14/13.5W bearing ball bearing connection male faston 2.8mm metal ADDA fan wheel ø 75mm temp.-resist. 70°C		
accessories for	601081		
	GEV No.	691102	Ref. No. —
	guard ø 75mm mounting distance 71 mm for axial fan 80mm		

¹with ball bearings

refrigeration motors universal

BT series - capacitor motors



1			
GEV No.	601420 ¹	Ref. No.	8C0807
description	fan motor 45W 230V 50Hz L1 53mm L2 18mm L3 120mm W 103mm cable length 500mm 1300rpm ELCO 3FBT 50-40/15 3 mounting options bearing slide bearing		

¹incl. capacitor

cold air circulating fans (complete)

ebm-papst

A4E series

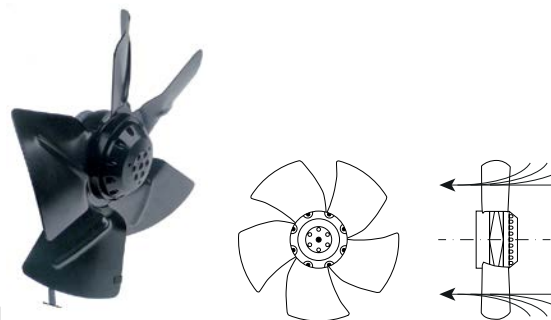

1			
GEV No.	601623	Ref. No.	771110007
description	fan A4E315-AC08-19 fan wheel ø 315mm blades 5 230V 50Hz 95W 1370rpm cable length 450mm ebm-papst sucking suitable capacitor 3µF		
accessories for	601623		
	GEV No.	365137	Ref. No. —
	capacitor capacity 3µF 450V tolerance 5% 50/60Hz ambient temperature max. -25 to +85°C ø 25mm L 56mm M8 plastic connection cable 250mm 416.17.77GF protection		

cross flow fans

EMMEVI - FERGAS

with moulded coils



1			
GEV No.	601110	Ref. No.	8C0495
description	cross flow fan TGO 60/1-180/20 roller ø 60mm roller length 180mm laminated core thickness 20mm motor position left 230V/50Hz 28W refrigeration bearing rubber connection male faston 6.3mm -30 up to +100°C 230V cable length 1800mm		



Зип Общепит

vsezip.ru

+7(812)987-08-81

COPREL
with standard coil



1

GEV No.	602044	Ref. No.	8C0496
description	cross flow fan COPREL TFR 180/20-14CSN roller \varnothing 60mm roller length 180mm laminated core thickness 20mm motor position right 230V/50Hz 27W refrigeration bearing rubber connection male faston 6.3mm t.max. 60°C airflow 144m ³ /h -30 bis +60°C		



GEV No.	415122	Ref. No.	827915
description	heater battery mounting distance 185mm W 40mm H 35mm 2000W 230V temperature restriction 105°C heating circuits 2 connection cable cable length 340mm L 197mm for cross flow fan		



1

GEV No.	601453	Ref. No.	827914
description	cross flow fan TFR 180 roller \varnothing 60mm roller length 180mm laminated core thickness 16mm motor position right 230V/50-60Hz 17W universal bearing silicone connection male faston 6.3mm airflow 100m ³ /h -30 up to +100°C 230V 50Hz		
accessories for	601453		
	GEV No.	Ref. No.	—
	415114		
description	heater battery mounting distance 185mm W 40mm H 35mm 2000W 230V temperature restriction 105°C heating circuits 2 connection cable cable length 150mm L 192mm for cross flow fan		

hot air motors



1

GEV No.	550859	Ref. No.	809828
description	counterflange for fan motor ED \varnothing 60mm int. \varnothing 1 34mm int. \varnothing 2 25mm thickness 6mm brass		

accessories for cross flow fans
heater battery



1

GEV No.	415115	Ref. No.	827915
description	heater battery mounting distance 185mm W 38mm H 40mm 2000W 230V temperature restriction 125°C heating circuits 2 connection male faston 6.3mm L 195mm		
spare parts for	415115		
	GEV No.	Ref. No.	—
	375095		
description	bi-metal thermostat hole distance 18mm switch-off temp. 105°C 1NC 1-pole 16A connection F6.3 2 hole fixing		

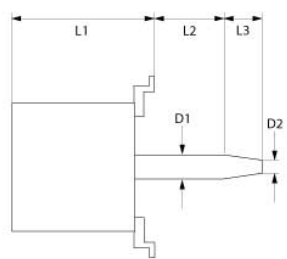
1

GEV No.	601046	Ref. No.	807314 809406
description	fan motor 220/380V 3 phase 50/60Hz 0.75kW 1350/1650rpm speeds 1 L1 185mm L2 42mm L3 47mm D1 \varnothing 24mm D2 \varnothing 20mm M12L IT 1.9/3.3A Cos(fi) 0.83 at 50Hz 200-240/346-415V at 60Hz 200-277/346-480V at 50Hz 1350rpm at 60Hz 1650rpm type ST80/4 no. 661512		

1

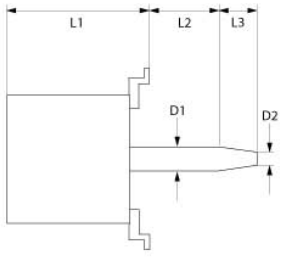
GEV No.	500641	Ref. No.	807314
description	fan motor 220/380V 3 phase 50Hz 0.75kW 1420rpm speeds 1 L1 166mm L2 47mm L3 65mm D1 \varnothing 24mm D2 \varnothing 20mm M6R IT 1.4/2.4A Cos(fi) 0.83 at 50Hz 220/380V at 60Hz 240/415V type ST80/4 no. 643515 mounting distance 150mm		

Зип Общепит

vsezip.ru

+7(812)987-08-81



1

GEV No.	601043	Ref. No.	808973
description	fan motor 220-240V 1 phase 50Hz 0.37/0.07kW 0.1/0.5HP 1400/2700rpm speeds 2 L1 123mm L2 107mm L3 15mm D1 ø 15mm D2 ø 12mm M10L ET 2/0.7A suitable capacitor 20µF/250V at 50Hz 1400/2700rpm type 1057		





1

GEV No.	500642	Ref. No.	813154
description	fan motor 380-415V 3 phase 50Hz 0.22/0.75kW 700/1400rpm speeds 2 L1 166mm L2 45mm L3 67mm D1 ø 24mm D2 ø 20mm M6R ITA at 50Hz 380-415V at 50Hz 700/1400rpm type FB80 4/8 no. 629764		



1

GEV No.	601166	Ref. No.	131110010
description	fan motor 220-240V 1 phase 50Hz 0.37kW 2700rpm speeds 1 L1 123mm L2 77mm L3 30mm D1 ø 15mm D2 ø 12mm M10L ET 2A suitable capacitor 12.5µF/450V at 50Hz 2700rpm type 1057.2157		
spare parts for	601166		
	GEV No.	365014	Ref. No. 901740
accessories for	601166		
	GEV No.	601165	Ref. No. —
description	fan wheel D1 ø 160mm H1 60mm blades 15 D2 ø 16mm D3 ø 16mm H2 29mm		



1

GEV No.	601067	Ref. No.	809000
description	fan wheel D1 ø 150mm H1 38mm blades 36 D2 ø 6mm D3 ø 6mm H2 14mm		



1

GEV No.	601223	Ref. No.	809000
description	fan wheel D1 ø 150mm H1 39mm blades 36 D2 ø 6mm D3 ø 6mm H2 13.5mm		



1

GEV No.	500652	Ref. No.	808856
description	fan motor 380-415V 3 phase 50Hz 0.13/0.55kW 700/1350rpm speeds 2 L1 188mm L2 44mm L3 48mm D1 ø 24mm D2 ø 20mm M12L ITA Cos(φ) 0.13/0.55 at 50Hz 700/1350rpm 4P/8P type FB80 4/8 no. 390133		



1

GEV No.	601060	Ref. No.	807604
description	fan wheel D1 ø 180mm H1 60mm blades 16 D2 ø 11mm D3 ø 16mm H2 30mm		



Зип Общепит

vsezip.ru

+7(812)987-08-81



1

GEV No.	601224	Ref. No.	809407
description	fan wheel D1 ø 300mm H1 100mm blades 24 D2 ø 19.5mm D3 ø 23mm H2 46mm		



1

GEV No.	601063	Ref. No.	8C0003
description	fan wheel D1 ø 350mm H1 100mm blades 24 D2 ø 19.5mm D3 ø 23mm H2 46mm		



1

GEV No.	691810	Ref. No.	809827
description	flange for fan motor ED ø 48mm int. ø 1 19.5mm int. ø 2 15mm thickness 3.5mm brass		



1

GEV No.	511171	Ref. No.	809829
description	shaft seal ID ø 14.5mm ED ø 20mm thickness 3mm		

hot air fans

miscellaneous

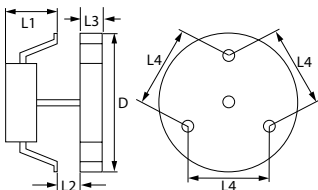



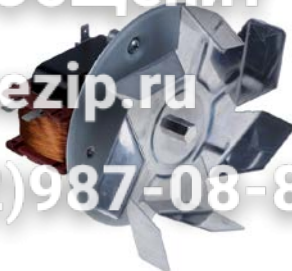

1

GEV No.	601273	Ref. No.	8C0432
description	hot air fan 220-240V 32W 50/60Hz L1 60mm L2 10mm L3 25mm L4 87mm fan wheel ø 155mm FIME type C20X0E01/15CLH		

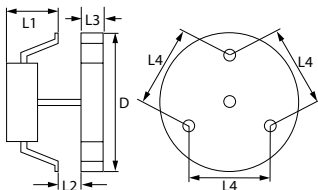

1



GEV No.	601011	Ref. No.	8C0758	
description	hot air fan 220-240V 40W 50/60Hz L1 65mm L2 15mm L3 25mm L4 87mm fan wheel ø 150mm FIME type C25R8023CLH			
accessories for	601011			
	GEV No.	550879	Ref. No.	—
	insulation ø 130mm thickness 3mm hole ø 20mm for hot air fan			
	GEV No.	601260	Ref. No.	—
	nut thread M6L IT for hot air fan			

motors

gear motors

for ice-cube maker

miscellaneous



1

GEV No.	500675	Ref. No.	809160
description	gear motor 220/240V 50Hz for flake ice maker		



for ovens

for flues



1

GEV No.	601138	Ref. No.	809507
description	gear motor CROUZET type G70C10AFTEG 12V voltage DCHz shaft \varnothing 4mm L 66mm W 50mm H 61mm		



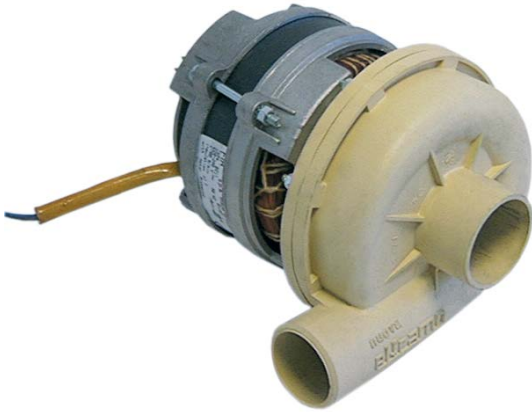

pumps

wash and rinse pumps

LGB



1

GEV No.	500093	Ref. No.	809261	
description	pump inlet \varnothing 50mm outlet \varnothing 44mm type W500SX 230V 50Hz 1 phase 0.5kW 0.7HP L 200mm rotation direction right capacitor 16 μ F LGB			
spare parts for	500093			
	GEV No.	365021	Ref. No.	—
	operating capacitor capacity 16 μ F 425V tolerance 5% 50/60Hz ambient temperature max. -25 to +85°C \varnothing 35mm L 73mm single M8 plastic connection male faston 6.3mm 416.10.99 protection			
	GEV No.	510607	Ref. No.	—
	impellor \varnothing 85mm H 29mm shaft intake \varnothing 9x8mm rotation direction right blades 6			
	GEV No.	510693	Ref. No.	—
	mechanical shaft seal for shaft \varnothing 12mm slide ring ext. \varnothing 24mm slide ring H 15.5mm slide ring int. \varnothing 11mm counter ring mounting \varnothing 24mm height counter ring 8mm counter ring int. \varnothing 13.5mm			
	GEV No.	521564	Ref. No.	—
	pump cover			
	GEV No.	521717	Ref. No.	—
	O-ring EPDM thickness 1.78mm ID \varnothing 120.37mm Qty 1 pcs			

Зип Общепит

booster pumps

vsezip.ru

+7(812)987-08-81





1

GEV No.	500540	Ref. No.	8C1367	
description	pump inlet \varnothing 1" IT outlet \varnothing 1" IT type PKM60 230V 50Hz 1 phase 0.37kW PEDRELLO 0.5HP			
accessories for	500540			
	GEV No.	365015	Ref. No.	—
	operating capacitor capacity 10 μ F 400V tolerance 5%Hz ambient temperature max. -25 to +85°C \varnothing 35.5mm L 59mm M8 plastic connection male faston 6.3mm protection			



1

GEV No.	500395	Ref. No.	8C1339	
description	pump inlet \varnothing 3/8" IT outlet \varnothing 3/8" IT type PS45DX 230V 50Hz 0.35kW capacitor 8 μ F LGB			
spare parts for	500395			
	GEV No.	365013	Ref. No.	132110008
	operating capacitor capacity 8 μ F 400V tolerance 5%Hz ambient temperature max. -25 to +85°C \varnothing 31.5mm L 55mm M8 plastic connection male faston 6.3mm protection			
	GEV No.	698400	Ref. No.	—
	pump cover gasket pump type PS46 thickness 2mm ID \varnothing 66mm Qty 1 pcs			

drain pumps

ASKOLL



1

GEV No.	500565	Ref. No.	808670
description	drain pump 30W		



HANNING

Зип Общепит

vsezip.ru

+7(812)987-08-81





1

GEV No.	500042	Ref. No.	809563
description	drain pump inlet \varnothing 24mm outlet \varnothing 24mm 230V 80W 50Hz HANNING type KD22B3-679		
spare parts for	500042		
	GEV No.	510168	Ref. No. —
	fan wheel shaft intake \varnothing 5mm \varnothing 62mm H 14mm		



1

GEV No.	500165	Ref. No.	808236
description	pump REBO type 63/35 120W 230V 50/60Hz inlet \varnothing 28mm outlet \varnothing 26mm L 180mm rotation direction right for ice-cube maker capacitor 5 μ F		
spare parts for	500165		
	GEV No.	365017	Ref. No. —
	operating capacitor capacity 5 μ F 450V tolerance 5% 50/60Hz ambient temperature max. -25 to +85°C \varnothing 28mm L 54mm M8 plastic connection male faston 6.3mm 16.10.08 protection		
	GEV No.	601412	Ref. No. —
	fan wheel sucking \varnothing 154mm fan wheel mounting 25.4mm blade angle 28° W 34mm plastic		
	GEV No.	601413	Ref. No. —
	fixing plate suitable for fanwheel ED \varnothing 32mm shaft \varnothing 7 mounting distance 26mm		

booster pumps II

accessories



1

GEV No.	365012	Ref. No.	8C1588
description	operating capacitor capacity 6.3 μ F 450V tolerance 5% 50Hz ambient temperature max. -25 to +85°C \varnothing 30mm L 61mm M8 plastic connection male faston 6.3mm protection		

condensators & interference suppression filters

operating capacitors

plastic

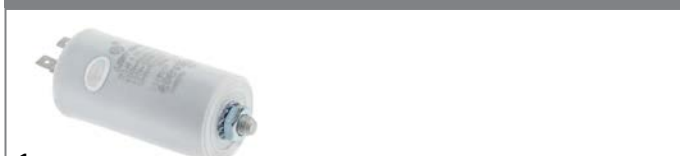



1

GEV No.	365014	Ref. No.	901740
description	operating capacitor capacity 12.5 μ F 450V tolerance 5% ambient temperature max. -25 to +85°C \varnothing 35mm L 70mm M8 plastic connection male faston 6.3mm 45S.C3DS.12.5 protection		

pumps for ice machines



1

GEV No.	500590	Ref. No.	8C1356
description	pump FIR type 4240.2300 120W 230V 50/60Hz inlet \varnothing 22mm outlet \varnothing 22mm L 240mm rotation direction right for ice-cube maker capacitor 5 μ F		
spare parts for	500590		
	GEV No.	601412	Ref. No. —
	fan wheel sucking \varnothing 154mm fan wheel mounting 25.4mm blade angle 28° W 34mm plastic		
	GEV No.	601413	Ref. No. —
	fixing plate suitable for fanwheel ED \varnothing 32mm shaft \varnothing 7 mounting distance 26mm		



1

GEV No.	365012	Ref. No.	8C1588
description	operating capacitor capacity 6.3 μ F 450V tolerance 5% 50Hz ambient temperature max. -25 to +85°C \varnothing 30mm L 61mm M8 plastic connection male faston 6.3mm protection		



Зип.Общепит
terminals

vsezip.ru
connection terminals with screw/faston connec-

+7(812)987-08-81

				
1	GEV No.	365013	Ref. No.	132110008
description operating capacitor capacity 8µF 400V tolerance 5%Hz ambient temperature max. -25 to +85°C ø 31.5mm L 55mm M8 plastic connection male faston 6.3mm protection				

				
1	GEV No.	550411	Ref. No.	C00395
description power terminal block 6-pole max. 40A max 450V connection ø6mm ² / F6.3 temp.-resist. 150°C cross section 6mm ²				

electric accessories

cables

earthing cables

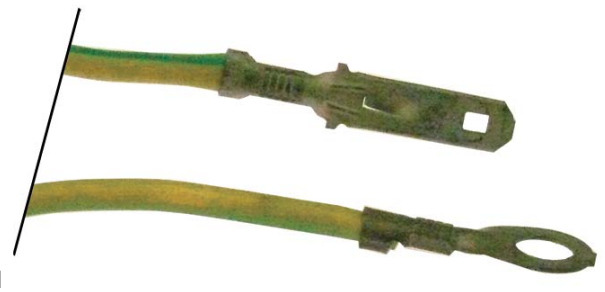
				
1	GEV No.	102149	Ref. No.	C10362
description earthing cable				

accessories

cable glands

threaded cable glands

screw connections

				
1	GEV No.	550971	Ref. No.	809010
description cable gland thread PG16 cable ø 14mm mounting ø 22.5mm Qty 1 pcs plastic WS 27				

gas taps

PEL

22S/O series

								
1	GEV No.	101086	Ref. No.	512250003 808186 C00085				
description gas tap PEL type 22S/O gas inlet M20x1.5 (tube ø 12mm) bypass nozzle ø 0.35mm gas outlet M20x1.5 (tube ø 12/10mm) thermocouple connection M9x1 pilot connection M10x1 shaft ø 10x8mm shaft L 25/17mm shaft flat lower								
spare parts for 101086								
 <table border="1"> <tr> <td>GEV No.</td> <td>100259</td> <td>Ref. No.</td> <td>—</td> </tr> </table> <p>bypass nozzle type PEL22 bore ø 0.35mm thread M6x0.5</p>					GEV No.	100259	Ref. No.	—
GEV No.	100259	Ref. No.	—					
 <table border="1"> <tr> <td>GEV No.</td> <td>101058</td> <td>Ref. No.</td> <td>—</td> </tr> </table> <p>magnet unit L 39mm D1 ø 15.4mm D2 ø 13.5mm suitable for PEL22/EGA24197 standard</p>					GEV No.	101058	Ref. No.	—
GEV No.	101058	Ref. No.	—					
 <table border="1"> <tr> <td>GEV No.</td> <td>101201</td> <td>Ref. No.</td> <td>—</td> </tr> </table> <p>gas tap front part shaft ø 10x8mm shaft L 25/17mm shaft flat upper/lower suitable for PEL22</p>					GEV No.	101201	Ref. No.	—
GEV No.	101201	Ref. No.	—					
 <table border="1"> <tr> <td>GEV No.</td> <td>101231</td> <td>Ref. No.</td> <td>—</td> </tr> </table> <p>thermocouple nut T1: M9x1 T2: M18x1</p>					GEV No.	101231	Ref. No.	—
GEV No.	101231	Ref. No.	—					
 <table border="1"> <tr> <td>GEV No.</td> <td>101240</td> <td>Ref. No.</td> <td>—</td> </tr> </table> <p>gas connection thread M20x1.5 tube ø 12/10mm for PEL gas taps with gasket and screws horizontal</p>					GEV No.	101240	Ref. No.	—
GEV No.	101240	Ref. No.	—					
 <table border="1"> <tr> <td>GEV No.</td> <td>101460</td> <td>Ref. No.</td> <td>—</td> </tr> </table> <p>O-ring ø 12.37mm D1 ø 2.62mm suitable for PEL22</p>					GEV No.	101460	Ref. No.	—
GEV No.	101460	Ref. No.	—					
 <table border="1"> <tr> <td>GEV No.</td> <td>101461</td> <td>Ref. No.</td> <td>—</td> </tr> </table> <p>screw kit suitable for PEL22 Qty 4 pcs</p>					GEV No.	101461	Ref. No.	—
GEV No.	101461	Ref. No.	—					
accessories for 101086								
 <table border="1"> <tr> <td>GEV No.</td> <td>100908</td> <td>Ref. No.</td> <td>806019</td> </tr> </table> <p>union screw thread M10x1 for pipe ø 4mm Qty 1 pcs</p>					GEV No.	100908	Ref. No.	806019
GEV No.	100908	Ref. No.	806019					
 <table border="1"> <tr> <td>GEV No.</td> <td>100909</td> <td>Ref. No.</td> <td>—</td> </tr> </table> <p>union screw thread M10x1 for pipe ø 6mm Qty 1 pcs</p>					GEV No.	100909	Ref. No.	—
GEV No.	100909	Ref. No.	—					

Table continues overleaf



Зип-Общепит

vsezip.ru





+7(812)987-08-81

accessories for 101086		GEV No.	Ref. No.	
	gas connection thread M20x1.5 tube ø 12/10mm for PEL gas taps vertical	101241	—	
	olive for pipe ø 4mm Qty 1 pcs	101246	—	
	olive for pipe ø 12mm Qty 1 pcs suitable for PEL	101248	8C0412	
	olive for pipe ø 10mm Qty 1 pcs	101249	—	
	union nut thread M20x1.5 for pipe ø 10mm	101250	—	
	union nut thread M20x1.5 for pipe ø 12mm	101251	—	
	olive ID ø 6mm Qty 1 pcs	101286	—	
	knob ø 70mm shaft ø 10x8mm shaft flat universal	110080	—	
	knob dial plate silver gas tap PEL21/22/23 t.max.°C ED ø 63mm ID ø 45.5mm	112206	—	

accessories for 101341		GEV No.	Ref. No.	
	union screw thread M10x1 for pipe ø 4mm Qty 1 pcs	100908	806019	
	union screw thread M10x1 for pipe ø 6mm Qty 1 pcs	100909	—	
	gas connection thread M20x1.5 tube ø 12/10mm for PEL gas taps with gasket and screws horizontal	101240	—	
	olive for pipe ø 4mm Qty 1 pcs	101246	—	
	olive for pipe ø 12mm Qty 1 pcs suitable for PEL	101248	8C0412	
	olive for pipe ø 10mm Qty 1 pcs	101249	—	
	union nut thread M20x1.5 for pipe ø 10mm	101250	—	
	union nut thread M20x1.5 for pipe ø 12mm	101251	—	
	olive ID ø 6mm Qty 1 pcs	101286	—	
	knob ø 70mm shaft ø 10x8mm shaft flat universal	110080	—	
	knob dial plate silver gas tap PEL21/22/23 t.max.°C ED ø 63mm ID ø 45.5mm	112206	—	

22S/V series



GEV No.	Ref. No.	
101341	809469	
description	gas tap PEL type 22S/V gas inlet M20x1.5 (tube ø 12mm) bypass nozzle ø 0.35mm gas outlet M20x1.5 (tube ø 12/10mm) thermocouple connection M10x1 pilot connection M10x1 shaft ø 10x8mm shaft L 25/17mm shaft flat lower	
spare parts for	101341	
	GEV No. 101058	Ref. No. —
description	magnet unit L 39mm D1 ø 15.4mm D2 ø 13.5mm suitable for PEL22/EGA24197 standard	
	GEV No. 101201	Ref. No. —
description	gas tap front part shaft ø 10x8mm shaft L 25/17mm shaft flat upper/lower suitable for PEL22	
	GEV No. 101241	Ref. No. —
description	gas connection thread M20x1.5 tube ø 12/10mm for PEL gas taps vertical	
	GEV No. 101290	Ref. No. —
description	thermocouple nut T1: M10x1 T2: M18x1 suitable for PEL20/21	
	GEV No. 101460	Ref. No. —
description	O-ring ø 12.37mm D1 ø 2.62mm suitable for PEL22	
	GEV No. 101461	Ref. No. —
description	screw kit suitable for PEL22 Qty 4 pcs	

GEV No.	Ref. No.	
101087	809469 C00779	
description	gas tap PEL type 22S/V gas inlet M20x1.5 (tube ø 12mm) bypass nozzle ø 0.35mm gas outlet M20x1.5 (tube ø 12/10mm) thermocouple connection M9x1 pilot connection M10x1 shaft ø 10x8mm shaft L 25/17mm shaft flat upper	
spare parts for	101087	
	GEV No. 100259	Ref. No. —
description	bypass nozzle type PEL22 bore ø 0.35mm thread M6x0.5	
	GEV No. 101058	Ref. No. —
description	magnet unit L 39mm D1 ø 15.4mm D2 ø 13.5mm suitable for PEL22/EGA24197 standard	
	GEV No. 101201	Ref. No. —
description	gas tap front part shaft ø 10x8mm shaft L 25/17mm shaft flat upper/lower suitable for PEL22	
	GEV No. 101231	Ref. No. —
description	thermocouple nut T1: M9x1 T2: M18x1	

Table continues overleaf



spare parts for		101087	
	GEV No.	101241	Ref. No. —
gas connection thread M20x1.5 tube ø 12/10mm for PEL gas taps vertical			
	GEV No.	101460	Ref. No. —
O-ring ø 12.37mm D1 ø 2.62mm suitable for PEL22			
	GEV No.	101461	Ref. No. —
screw kit suitable for PEL22 Qty 4 pcs			
accessories for		101087	
	GEV No.	100908	Ref. No. 806019
union screw thread M10x1 for pipe ø 4mm Qty 1 pcs			
	GEV No.	100909	Ref. No. —
union screw thread M10x1 for pipe ø 6mm Qty 1 pcs			
	GEV No.	101240	Ref. No. —
gas connection thread M20x1.5 tube ø 12/10mm for PEL gas taps with gasket and screws horizontal			
	GEV No.	101246	Ref. No. —
olive for pipe ø 4mm Qty 1 pcs			
	GEV No.	101248	Ref. No. 8C0412
olive for pipe ø 12mm Qty 1 pcs suitable for PEL			
	GEV No.	101249	Ref. No. —
olive for pipe ø 10mm Qty 1 pcs			
	GEV No.	101250	Ref. No. —
union nut thread M20x1.5 for pipe ø 10mm			
	GEV No.	101251	Ref. No. —
union nut thread M20x1.5 for pipe ø 12mm			
	GEV No.	101286	Ref. No. —
olive ID ø 6mm Qty 1 pcs			
	GEV No.	110080	Ref. No. —
knob ø 70mm shaft ø 10x8mm shaft flat universal			
	GEV No.	112206	Ref. No. —
knob dial plate silver gas tap PEL21/22/23 t.max.°C ED ø 63mm ID ø 45.5mm			

Зип-Общепит

235/O series

vsezip.ru

+7(812)987-08-81

1















GEV No.	101092	Ref. No.	808520
description	gas tap PEL type 235/O gas inlet M28x1.5 (tube ø 20mm) bypass nozzle ø 0.35mm gas outlet M24x1.5 (tube ø 16mm) thermocouple connection M10x1 pilot connection M10x1 shaft ø 10x8mm shaft L 25/17mm shaft flat upper		
spare parts for		101092	
	GEV No.	100455	Ref. No. —
bypass nozzle type PEL23/24 bore ø 0.35mm thread M8x0.5			
	GEV No.	101059	Ref. No. —
magnet unit T1: M10x1 T2: M22x1 L 46mm ø 18mm suitable for PEL235 M10x1			
	GEV No.	101204	Ref. No. —
gas tap front part shaft ø 10x8mm shaft L 25/17mm shaft flat upper/lower suitable for PEL235			
	GEV No.	101244	Ref. No. —
gas connection thread M24x1.5 tube ø 12/16mm horizontal for PEL gas taps			
	GEV No.	101463	Ref. No. —
screw suitable for PEL235 Qty 4 pcs			
	GEV No.	528455	Ref. No. —
O-ring Viton thickness 2.62mm ID ø 18.72mm Qty 1 pcs			
accessories for		101092	
	GEV No.	100908	Ref. No. 806019
union screw thread M10x1 for pipe ø 4mm Qty 1 pcs			
	GEV No.	100909	Ref. No. —
union screw thread M10x1 for pipe ø 6mm Qty 1 pcs			
	GEV No.	101246	Ref. No. —
olive for pipe ø 4mm Qty 1 pcs			
	GEV No.	101252	Ref. No. —
union nut thread M24x1.5 for pipe ø 12mm			
	GEV No.	101253	Ref. No. —
union nut thread M24x1.5 PEL for pipe ø 16mm			
	GEV No.	101254	Ref. No. —
union nut thread M28x1.5 tube ø 20mm			
	GEV No.	101255	Ref. No. —
olive for pipe ø 12mm Qty 1 pcs			
	GEV No.	101256	Ref. No. —
olive for pipe ø 16mm Qty 1 pcs			
	GEV No.	101257	Ref. No. —
olive for pipe ø 20mm Qty 1 pcs			



Table continues overleaf







Зип-Общепит

vsezip.ru

+7(812)987-08-81

accessories for	101092		
	GEV No.	101286	Ref. No. —
	olive ID ø 6mm Qty 1 pcs		
	GEV No.	110080	Ref. No. —
	knob ø 70mm shaft ø 10x8mm shaft flat universal		
	GEV No.	112206	Ref. No. —
	knob dial plate silver gas tap PEL21/22/23 t.max.°C ED ø 63mm ID ø 45.5mm		





accessories for	101188		
	GEV No.	100905	Ref. No. 8C0070
	locking screw M10x1 for pipe ø 6mm Qty 1 pcs		
	GEV No.	101273	Ref. No. —
	olive for pipe ø 12mm L 9.5mm brass Qty 1 pcs suitable for universal		
	GEV No.	101276	Ref. No. —
	union screw thread 3/8" tube ø 12mm Qty 1 pcs		
	GEV No.	101333	Ref. No. —
	plug thread 3/8" with O-ring		

SABAF

			
1			
GEV No.	101458	Ref. No.	C10107
description	gas tap SABAF type 11 gas inlet 1/4" (tube ø 6mm) bypass nozzle ø 0mm gas outlet 1/4" (tube ø 8mm) front fixing thermocouple connection plug-in connection shaft ø 8x6.5mm shaft L 40/15mm shaft flat upper		
spare parts for	101458		
	GEV No.	106723	Ref. No. —
	magnet unit L 29mm D1 ø 12.5mm D2 ø 8.5mm suitable for SABAF		
accessories for	101458		
	GEV No.	101277	Ref. No. —
	olive ID ø 8mm Qty 1 pcs		
	GEV No.	520656	Ref. No. —
	union nut thread 1/4" tube ø 6/8mm		

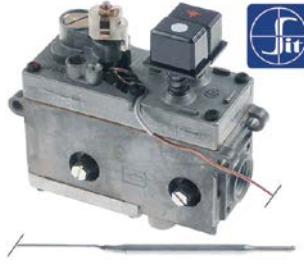
			
1			
GEV No.	103076	Ref. No.	512250006
description	gas thermostat type 630 Eurosit series t.max. 190°C 110-190°C gas inlet 3/8" gas outlet 3/8" thermocouple connection M9x1 pilot connection M10x1 probe ø 4mm probe L 202mm capillary pipe 1050mm SIT		

710 Minisit series

			
1			
GEV No.	101135	Ref. No.	C00897
description	gas thermostat SIT type MINISIT 710 t.max. 190°C 110-190°C gas inlet 1/2" gas outlet 3/8" thermocouple connection M9x1 pilot connection M10x1 probe ø 6mm probe L 102mm capillary pipe 1050mm probe type type A3 pressure controller no pressure regulator mbar gland nut		
spare parts for	101135		
	GEV No.	101053	Ref. No. —
	magnet unit T1: M9x1 T2: M24x1 L 45mm ø 17mm suitable for Minisit		
	GEV No.	102118	Ref. No. —
	probe 110-190°C probe ø 6mm probe L 102mm capillary pipe 1050mm t.max. 190°C fryer probe type type A3 suitable for MINISIT 710		
accessories for	101135		
	GEV No.	100809	Ref. No. —
	O-ring EPDM thickness 2mm ID ø 21mm Qty 1 pcs		
	GEV No.	100820	Ref. No. —
	gland duct ET M14x1.5 IT M10x0.75 probe ø max. 6.5mm WS 22		

gas thermostats

SIT

630 Eurosit series



			
1			
GEV No.	101188	Ref. No.	808934 C00753
description	gas thermostat type 630 Eurosit series t.max. 190°C 110-190°C gas inlet 3/8" gas outlet 3/8" thermocouple connection M9x1 pilot connection M10x1 probe ø 4mm probe L 202mm capillary pipe 1050mm SIT		
accessories for	101188		
	GEV No.	100904	Ref. No. —
	locking screw M10x1 for pipe ø 4mm Qty 1 pcs		

Table continues overleaf

Зип Общепит
vsezip.ru
+7(812)987-08-81

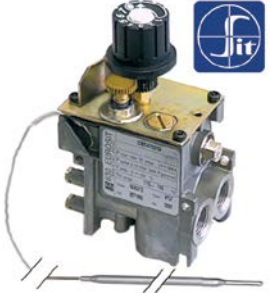

accessories for		101135	
GEV No.		Ref. No.	
	100904	—	
locking screw M10x1 for pipe ø 4mm Qty 1 pcs			
	100905	8C0070	
locking screw M10x1 for pipe ø 6mm Qty 1 pcs			
	101054	—	
magnet unit T1: M10x1 T2: M24x1 L 45mm ø 17mm suitable for Minisit			
	101136	807697	
piezoelectric igniter suitable for Minisit with cover cap ømm connection F6.3x0.8			
	101137	—	
cover cap without piezoelectric igniter			
	101267	—	
reducer IT 3/8" ET 1/2" L 21mm			
	101268	—	
gas connection thread 3/8" angled with O-ring MINISIT 710			
	101269	—	
gas connection thread 1/2" angled with O-ring MINISIT 710			
	101270	—	
screw connection IT 3/8" ET 3/8" L 28mm			
	101272	—	
screw connection IT 1/2" ET 3/8" L 57mm			
	101273	—	
olive for pipe ø 12mm L 9.5mm brass Qty 1 pcs suitable for universal			
	101274	—	
olive for pipe ø 16mm Qty 1 pcs			
	101275	—	
union screw thread 1/2" for pipe ø 16mm Qty 1 pcs			
	101276	—	
union screw thread 3/8" tube ø 12mm Qty 1 pcs			
	110068	814979	
knob suitable for Minisit ø 37mm			

GEV No.	101132	Ref. No.	806192
description	gas thermostat SIT type MINISIT 710 t.max. 340°C 100-340°C gas inlet 1/2" gas outlet 3/8" thermocouple connection M9x1 pilot connection M10x1 probe ø 5mm probe L 68mm capillary pipe 1050mm probe type type B1 pressure controller no pressure regulator mbar gland nut ignition gas no		
spare parts for	101132		
	GEV No.	101053	Ref. No. —
magnet unit T1: M9x1 T2: M24x1 L 45mm ø 17mm suitable for Minisit			
accessories for	101132		
	GEV No.	100809	Ref. No. —
O-ring EPDM thickness 2mm ID ø 21mm Qty 1 pcs			
	GEV No.	100904	Ref. No. —
locking screw M10x1 for pipe ø 4mm Qty 1 pcs			
	GEV No.	100905	Ref. No. 8C0070
locking screw M10x1 for pipe ø 6mm Qty 1 pcs			
	GEV No.	101054	Ref. No. —
magnet unit T1: M10x1 T2: M24x1 L 45mm ø 17mm suitable for Minisit			
	GEV No.	101136	Ref. No. 807697
piezoelectric igniter suitable for Minisit with cover cap ømm connection F6.3x0.8			
	GEV No.	101137	Ref. No. —
cover cap without piezoelectric igniter			
	GEV No.	101267	Ref. No. —
reducer IT 3/8" ET 1/2" L 21mm			
	GEV No.	101268	Ref. No. —
gas connection thread 3/8" angled with O-ring MINISIT 710			
	GEV No.	101269	Ref. No. —
gas connection thread 1/2" angled with O-ring MINISIT 710			
	GEV No.	101270	Ref. No. —
screw connection IT 3/8" ET 3/8" L 28mm			
	GEV No.	101272	Ref. No. —
screw connection IT 1/2" ET 3/8" L 57mm			
	GEV No.	101273	Ref. No. —
olive for pipe ø 12mm L 9.5mm brass Qty 1 pcs suitable for universal			
	GEV No.	101274	Ref. No. —
olive for pipe ø 16mm Qty 1 pcs			
	GEV No.	101275	Ref. No. —
union screw thread 1/2" for pipe ø 16mm Qty 1 pcs			



Table continues overleaf



Зип-Общепит



vsezip.ru

+7(812)987-08-81

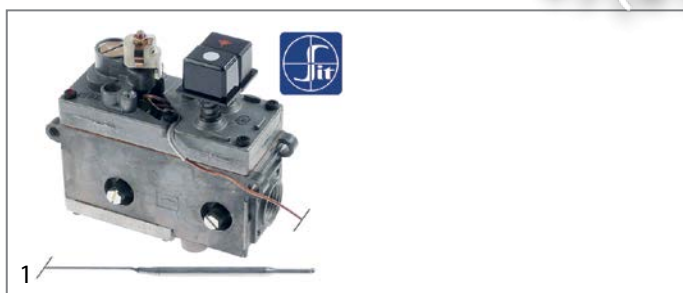
accessories for	101132			
	GEV No.	101276	Ref. No.	—
union screw thread 3/8" tube ø 12mm Qty 1 pcs				
	GEV No.	110068	Ref. No.	814979
knob suitable for Minisit ø 37mm				



GEV No.	101131	Ref. No.	806267
description	gas thermostat without cap, button and angle SIT type MINISIT 710 t.max. 190°C 50-190°C gas inlet 1/2" gas outlet 3/8" thermocouple connection M9x1 pilot connection M10x1 probe ø 5mm probe L 98mm capillary pipe 1200mm probe type type A2 pressure controller no pressure regulator mbar gland nut		

spare parts for	101131			
	GEV No.	101053	Ref. No.	—
magnet unit T1: M9x1 T2: M24x1 L 45mm ø 17mm suitable for Minisit				
	GEV No.	102103	Ref. No.	—
probe 60-200°C probe ø 5mm probe L 98mm capillary pipe 1050mm t.max. 200°C fryer probe type type A2 suitable for MINISIT 710				

accessories for	101131			
	GEV No.	100809	Ref. No.	—
O-ring EPDM thickness 2mm ID ø 21mm Qty 1 pcs				
	GEV No.	100820	Ref. No.	—
gland duct ET M14x1.5 IT M10x0.75 probe ø max. 6.5mm WS 22				
	GEV No.	100904	Ref. No.	—
locking screw M10x1 for pipe ø 4mm Qty 1 pcs				
	GEV No.	100905	Ref. No.	8C0070
locking screw M10x1 for pipe ø 6mm Qty 1 pcs				
	GEV No.	101054	Ref. No.	—
magnet unit T1: M10x1 T2: M24x1 L 45mm ø 17mm suitable for Minisit				
	GEV No.	101136	Ref. No.	807697
piezoelectric igniter suitable for Minisit with cover cap ømm connection F6.3x0.8				
	GEV No.	101137	Ref. No.	—
cover cap without piezoelectric igniter				
	GEV No.	101267	Ref. No.	—
reducer IT 3/8" ET 1/2" L 21mm				
	GEV No.	101268	Ref. No.	—
gas connection thread 3/8" angled with O-ring MINISIT 710				
	GEV No.	101269	Ref. No.	—
gas connection thread 1/2" angled with O-ring MINISIT 710				



accessories for	101131			
	GEV No.	101270	Ref. No.	—
union screw connection IT 3/8" ET 3/8" L 28mm				
	GEV No.	101272	Ref. No.	—
union screw connection IT 1/2" ET 3/8" L 57mm				
	GEV No.	101273	Ref. No.	—
olive for pipe ø 12mm L 9.5mm brass Qty 1 pcs suitable for universal				
	GEV No.	101274	Ref. No.	—
olive for pipe ø 16mm Qty 1 pcs				
	GEV No.	101275	Ref. No.	—
union screw thread 1/2" for pipe ø 16mm Qty 1 pcs				
	GEV No.	101276	Ref. No.	—
union screw thread 3/8" tube ø 12mm Qty 1 pcs				
	GEV No.	110068	Ref. No.	814979
knob suitable for Minisit ø 37mm				

PEL

24ST series



GEV No.	101078	Ref. No.	C00417
description	gas thermostat PEL type 24ST 55-110°C gas inlet M20x1.5 (tube ø 12mm) bypass nozzle ø 0.35mm gas outlet M20x1.5 (tube ø 12/10mm) thermocouple connection M9x1 pilot connection M10x1 capillary pipe 1200mm probe ø 6mm probe L 160mm shaft ø 10x8mm shaft L 27/17mm shaft flat upper		

spare parts for	101078			
	GEV No.	100455	Ref. No.	—
bypass nozzle type PEL23/24 bore ø 0.35mm thread M8x0.5				
	GEV No.	101058	Ref. No.	—
magnet unit L 39mm D1 ø 15.4mm D2 ø 13.5mm suitable for PEL22/ EGA24197 standard				
	GEV No.	106200	Ref. No.	—
nut thread M9x1 suitable for PEL 24/255				





accessories for	101078			
	GEV No.	100908	Ref. No.	806019
union screw thread M10x1 for pipe ø 4mm Qty 1 pcs				
	GEV No.	100909	Ref. No.	—
union screw thread M10x1 for pipe ø 6mm Qty 1 pcs				
	GEV No.	101246	Ref. No.	—
olive for pipe ø 4mm Qty 1 pcs				
	GEV No.	101248	Ref. No.	8C0412
olive for pipe ø 12mm Qty 1 pcs suitable for PEL				







Table continues overleaf

1 gas components

Зип-Общепит

vsezip.ru











+7(812)9811111

accessories for		101078	
GEV No.	Ref. No.	Qty	—
	101249	1	—
olive for pipe ø 10mm Qty 1 pcs			
	101250	1	—
union nut thread M20x1.5 for pipe ø 10mm			
	101251	1	—
union nut thread M20x1.5 for pipe ø 12mm			
	101286	1	—
olive ID ø 6mm Qty 1 pcs			
	110079	1	—
knob dial plate gas thermostat 1-8 silver			
	110080	1	—
knob ø 70mm shaft ø 10x8mm shaft flat universal			

accessories for		101159	
GEV No.	Ref. No.	Qty	—
	101251	1	—
union nut thread M20x1.5 for pipe ø 12mm			
	101356	1	—
gas tap PEL-type 215 gas inlet M16x1.5 (tube ø 10mm) bypass nozzle ø 0.35 mm gas outlet M16x1.5 (tube ø 10/8mm) thermocouple connection M10x1 pilot connection M10x1 shaft ø 8x6.5mm shaft L 22/15mm shaft flat lower			
	101460	1	—
O-ring ø 12.37mm D1 ø 2.62mm suitable for PEL22			
	101461	4	—
screw kit suitable for PEL22 Qty 4 pcs			
	106165	1	—
gasket ø 27mm			
	110079	1	—
knob dial plate gas thermostat 1-8 silver			
	110080	1	—
knob ø 70mm shaft ø 10x8mm shaft flat universal			

24STS series



GEV No.	Ref. No.	Qty	—
101159	C00600	1	—
description gas thermostat PEL type 24STS 120-320°C gas inlet flange bypass nozzle ø 0.35mm gas outlet flange thermocouple connection M9x1 pilot connection M10x1 capillary pipe 1200mm probe ø 6mm probe L 100mm shaft ø 10x8mm shaft L 27/17mm shaft flat upper			
spare parts for 101159			
	100455	1	—
bypass nozzle type PEL23/24 bore ø 0.35mm thread M8x0.5			
	101058	1	—
magnet unit L 39mm D1 ø 15.4mm D2 ø 13.5mm suitable for PEL22/EGA24197 standard			
	106200	1	—
nut thread M9x1 suitable for PEL 24/25S			
accessories for 101159			
	101235	1	—
gas connection thread M20x1.5 tube ø 12/10mm for PEL gas taps horizontal			
	101236	1	—
gas connection thread M20x1.5 tube ø 12/10mm for PEL gas taps vertical			
	101240	1	—
gas connection thread M20x1.5 tube ø 12/10mm for PEL gas taps with gasket and screws horizontal			
	101241	1	—
gas connection thread M20x1.5 tube ø 12/10mm for PEL gas taps vertical			
	101248	1	8C0412
olive for pipe ø 12mm Qty 1 pcs suitable for PEL			
	101249	1	—
olive for pipe ø 10mm Qty 1 pcs			
	101250	1	—
union nut thread M20x1.5 for pipe ø 10mm			







GEV No.	Ref. No.	Qty	—
101161	C00084 C00600	1	—
description gas thermostat PEL type 24STS 120-320°C gas inlet M20x1.5 (tube ø 12/10mm) bypass nozzle ø 0.35mm gas outlet M20x1.5 (tube ø 12/10mm) thermocouple connection M9x1 pilot connection M10x1 capillary pipe 1200mm probe ø 6mm probe L 100mm shaft ø 10x8mm shaft L 27/17mm shaft flat upper			
spare parts for 101161			
	101058	1	—
magnet unit L 39mm D1 ø 15.4mm D2 ø 13.5mm suitable for PEL22/EGA24197 standard			
accessories for 101161			
	101235	1	—
gas connection thread M20x1.5 tube ø 12/10mm for PEL gas taps horizontal			
	101236	1	—
gas connection thread M20x1.5 tube ø 12/10mm for PEL gas taps vertical			
	101240	1	—
gas connection thread M20x1.5 tube ø 12/10mm for PEL gas taps with gasket and screws horizontal			
	101241	1	—
gas connection thread M20x1.5 tube ø 12/10mm for PEL gas taps vertical			
	101248	1	8C0412
olive for pipe ø 12mm Qty 1 pcs suitable for PEL			
	101249	1	—
olive for pipe ø 10mm Qty 1 pcs			

Table continues overleaf



Зип-Общепит

vsezip.ru



+7(812)987-08-81

accessories for		101161	
	GEV No.	101250	Ref. No. —
union nut thread M20x1.5 for pipe ø 10mm			
	GEV No.	101251	Ref. No. —
union nut thread M20x1.5 for pipe ø 12mm			
	GEV No.	101365	Ref. No. —
gas connection thread M20x1.5 tube ø 12mm for PEL gas taps horizontal			
	GEV No.	101460	Ref. No. —
O-ring ø 12.37mm D1 ø 2.62mm suitable for PEL22			
	GEV No.	101461	Ref. No. —
screw kit suitable for PEL22 Qty 4 pcs			
	GEV No.	110079	Ref. No. —
knob dial plate gas thermostat 1-8 silver			
	GEV No.	110080	Ref. No. —
knob ø 70mm shaft ø 10x8mm shaft flat universal			

gas valves and ignition boxes

gas control valves

HONEYWELL

			
1			
GEV No.	101186	Ref. No.	809510
description	gas valve type VK4105C 220-240V 50/60Hz gas inlet flange 32x32mm gas outlet flange 32x32mm thermocouple connection pilot connection pressure range 15-60mbar max 60mbar operator type pressure controller type V5360E 1226 1 HONEYWELL flange 32x32mm		
accessories for	101186		
	GEV No.	102845	Ref. No. —
gas connection angled 1/2" flange 32x32mm hole distance 24x24mm Tandem			
	GEV No.	102846	Ref. No. —
gas connection straight 1/2" flange 32x32mm hole distance 24x24mm suitable for Tandem			

ELETTROSIT

			
1			
GEV No.	101126	Ref. No.	C00302
description	gas valve SIT type ELETTROSIT 230V gas inlet 1/2" gas outlet 1/2" thermocouple connection M9x1 pilot connection M10x1 bottom equiv. no. 0.810.136		
spare parts for	101126		
	GEV No.	101312	Ref. No. C00309
microswitch			
	GEV No.	101352	Ref. No. —
solenoid coil 230V 50Hz suitable for ELETTROSIT			
accessories for	101126		
	GEV No.	100006	Ref. No. —
piezoelectric igniter suitable for ELETTROSIT body plastic blowing connection ø2.4mm ø 14mm			
	GEV No.	100904	Ref. No. —
locking screw M10x1 for pipe ø 4mm Qty 1 pcs			
	GEV No.	100905	Ref. No. 8C0070
locking screw M10x1 for pipe ø 6mm Qty 1 pcs			
	GEV No.	101301	Ref. No. —
gas connection thread 1/2" straight ELETTROSIT screw with O-ring			
	GEV No.	101303	Ref. No. —
gas connection straight thread 3/4" ELETTROSIT			
	GEV No.	101309	Ref. No. —
extension			

1 gas components



Зип Общепит

vsezip.ru

+7(812)987-08-81

NOVASIT

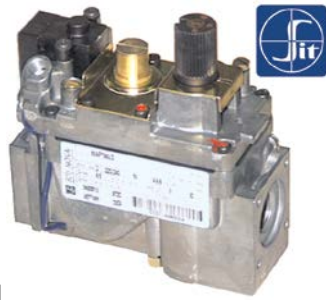

1			
GEV No.	101162	Ref. No.	813436
description	gas valve SIT series Novasit 820 230V 50Hz gas inlet 1/2" gas outlet 1/2" thermocouple connection M9x1 pilot connection M10x1 ignition pressure 3-5mbar pressure range 3-30mbar pressure regulator connection blind equiv. no. 0.820.010		
spare parts for	101162		
	GEV No.	101065	Ref. No. —
	magnet unit with cable L 44mm D1 ø 30mm D2 ø 20mm suitable for NOVASIT		
	GEV No.	101313	Ref. No. —
	solenoid coil 230V 50Hz		
accessories for	101162		
	GEV No.	100006	Ref. No. —
	piezoelectric igniter suitable for ELETTROSIT body plastic blowing connection ø2.4mm ø 14mm		
	GEV No.	101305	Ref. No. —
	gas connection straight 1/2" flange 45x45mm ELETTROSIT/V4400/4600/4605 suitable for SIT/HONEYWELL hole distance 36x36mm		
	GEV No.	101306	Ref. No. —
	gas connection angled flange 45x45mm hole distance 36x36mm 1/2" ELETTROSIT/V4400/4600/4605 screw with O-ring suitable for SIT/HONEYWELL		
	GEV No.	101307	Ref. No. —
	gas connection straight flange 45x45mm hole distance 36x36mm 3/4" ELETTROSIT/V4400/4600/4605 screw with O-ring suitable for SIT/HONEYWELL		
	GEV No.	101308	Ref. No. —
	gas connection angled flange 45x45mm hole distance 36x36mm 3/4" ELETTROSIT/V4400/4600/4605 screw with O-ring suitable for SIT/HONEYWELL		
	GEV No.	101312	Ref. No. C00309
	microswitch		
	GEV No.	101314	Ref. No. —
	solenoid coil 24V 50Hz		
	GEV No.	101317	Ref. No. C00974
	plug with cable L 1000mm suitable for NOVASIT		
	GEV No.	101318	Ref. No. —
	cover cap for solenoid coil suitable for NOVASIT		

1			
GEV No.	101956	Ref. No.	C00946
description	gas valve SIT series Novasit 820 230V 50Hz gas inlet 1/2" gas outlet 1/2" thermocouple connection M9x1 pilot connection M10x1 ignition pressure 3-5mbar pressure range 3-30mbar pressure regulator connection blind equiv. no. 0.820.031		
spare parts for	101956		
	GEV No.	101065	Ref. No. —
	magnet unit with cable L 44mm D1 ø 30mm D2 ø 20mm suitable for NOVASIT		
	GEV No.	101313	Ref. No. —
	solenoid coil 230V 50Hz		
accessories for	101956		
	GEV No.	100006	Ref. No. —
	piezoelectric igniter suitable for ELETTROSIT body plastic blowing connection ø2.4mm ø 14mm		
	GEV No.	101305	Ref. No. —
	gas connection straight 1/2" flange 45x45mm ELETTROSIT/V4400/4600/4605 suitable for SIT/HONEYWELL hole distance 36x36mm		
	GEV No.	101306	Ref. No. —
	gas connection angled flange 45x45mm hole distance 36x36mm 1/2" ELETTROSIT/V4400/4600/4605 screw with O-ring suitable for SIT/HONEYWELL		
	GEV No.	101307	Ref. No. —
	gas connection straight flange 45x45mm hole distance 36x36mm 3/4" ELETTROSIT/V4400/4600/4605 screw with O-ring suitable for SIT/HONEYWELL		
	GEV No.	101308	Ref. No. —
	gas connection angled flange 45x45mm hole distance 36x36mm 3/4" ELETTROSIT/V4400/4600/4605 screw with O-ring suitable for SIT/HONEYWELL		
	GEV No.	101312	Ref. No. C00309
	microswitch		
	GEV No.	101314	Ref. No. —
	solenoid coil 24V 50Hz		
	GEV No.	101317	Ref. No. C00974
	plug with cable L 1000mm suitable for NOVASIT		
	GEV No.	101318	Ref. No. —
	cover cap for solenoid coil suitable for NOVASIT		











Зип-Общепит

vsezip.ru

+7(812)987-08-81









1

GEV No.	101914	Ref. No.	808578
description	gas valve SIT series Novasit 822 230V 50Hz gas inlet 1/2" gas outlet 1/2" thermocouple connection pilot connection closed ignition pressure range 3-30mbar pressure regulator connection blind equiv. no. 0.822.144		
spare parts for	101914		
	GEV No.	101313	Ref. No. —
	solenoid coil 230V 50Hz		
	GEV No.	101542	Ref. No. —
	solenoid coil 50Hz NOVA 822/826/827 suitable for NOVASIT 230V		
accessories for	101914		
	GEV No.	101305	Ref. No. —
	gas connection straight 1/2" flange 45x45mm ELETTROSIT/V4400/4600/4605 suitable for SIT/HONEYWELL hole distance 36x36mm		
	GEV No.	101306	Ref. No. —
	gas connection angled flange 45x45mm hole distance 36x36mm 1/2" ELETTROSIT/V4400/4600/4605 screw with O-ring suitable for SIT/HONEYWELL		
	GEV No.	101307	Ref. No. —
	gas connection straight flange 45x45mm hole distance 36x36mm 3/4" ELETTROSIT/V4400/4600/4605 screw with O-ring suitable for SIT/HONEYWELL		
	GEV No.	101308	Ref. No. —
	gas connection angled flange 45x45mm hole distance 36x36mm 3/4" ELETTROSIT/V4400/4600/4605 screw with O-ring suitable for SIT/HONEYWELL		
	GEV No.	101503	Ref. No. —
	O-ring EPDM thickness 2mm ID ø 32mm Qty 1 pcs		
	GEV No.	101924	Ref. No. —
	plug with cable L 1090mm suitable for NOVA 822/826/827		



1

GEV No.	101984	Ref. No.	809326
description	gas valve 230V 50Hz gas inlet 1/2" gas outlet 1/2" pilot connection level slow ignition ignition times pressure range 2-50mbar power supply for modulator 230VAC rectified Tandem equiv. no. 0.836.010		
spare parts for	101984		
	GEV No.	101379	Ref. No. —
	solenoid coil 230V 50Hz suitable for Tandem		
accessories for	101984		
	GEV No.	101274	Ref. No. —
	olive for pipe ø 16mm Qty 1 pcs		
	GEV No.	101275	Ref. No. —
	union screw thread 1/2" for pipe ø 16mm Qty 1 pcs		
	GEV No.	101925	Ref. No. —
	plug with O-ring thread M10x1 for pilot burner suitable for NOVASIT		
	GEV No.	102845	Ref. No. —
	gas connection angled 1/2" flange 32x32mm hole distance 24x24mm Tandem		
	GEV No.	102846	Ref. No. —
	gas connection straight 1/2" flange 32x32mm hole distance 24x24mm suitable for Tandem		
	GEV No.	102847	Ref. No. —
	O-ring		



1







GEV No.	101684	Ref. No.	809595 8C0068
description	gas valve 230V 50Hz gas inlet 1/2" gas outlet 1/2" pilot connection level slow ignition standard ignition time 3-7s pressure range 3-50mbar power supply for modulator type SIT equiv. no. 0.830.034		
spare parts for	101684		
	GEV No.	101379	Ref. No. —
	solenoid coil 230V 50Hz suitable for Tandem		

Table continues overleaf

1 gas components



Зип Общепит
vsezip.ru
+7(812)987-08-81

accessories for	101684			
	GEV No.	101274	Ref. No.	—
	olive for pipe ø 16mm Qty 1 pcs			
	GEV No.	101275	Ref. No.	—
	union screw thread 1/2" for pipe ø 16mm Qty 1 pcs			
	GEV No.	102845	Ref. No.	—
	gas connection angled 1/2" flange 32x32mm hole distance 24x24mm Tandem			
	GEV No.	102846	Ref. No.	—
	gas connection straight 1/2" flange 32x32mm hole distance 24x24mm suitable for Tandem			
	GEV No.	102847	Ref. No.	—
	O-ring			

			
GEV No.	101166	Ref. No.	808611
description	ignition box HONEYWELL type S4560B 1006 electrodes 1 waiting time 0s safety time 10s 220-240V 10VA 50Hz		



ignition boxes

BRAHMA

			
GEV No.	107471	Ref. No.	809878
description	ignition box BRAHMA type CM11 electrodes 2 waiting time 1.5s safety time 10s 230V 7VA 50-60Hz		

SIT			
			
GEV No.	101685	Ref. No.	809602 8C0069
description	ignition box SIT type 503EFD electrodes 2 waiting time 1.5s safety time 10s 220/240V 10VA 50-60Hz protection IP40		

HONEYWELL

				
GEV No.	101165	Ref. No.	809751	
description	ignition box HONEYWELL type S4560A 1008 equiv. no. S4560A 1008 electrodes 1 waiting time 0s safety time 10s 220-240V 10VA 50Hz			
spare parts for	101165			
	GEV No.	358696	Ref. No.	—
	fine fuse size ø5x20mm 4A medium lag rated 250V Qty 10 pcs			

			
GEV No.	102309	Ref. No.	809752
description	ignition box SIT type 537ABC electrodes 3 waiting time 1.5s safety time 10s 230V 10VA 50-60Hz protection IP44		



ignition parts

pilot burners

SIT

100 series





1









GEV No.	107139	Ref. No.	C00391
description	pilot burner SIT type 100 series 1 flame nozzle \varnothing 0.2mm gas connection mm		
spare parts for	107139		
	GEV No.	100854	Ref. No. —
pilot burner bracket double			
	GEV No.	100885	Ref. No. —
air mixing sleeve for pilot burner Qty 1 pcs			
	GEV No.	107160	Ref. No. —
pilot burner cap SIT 1 flame Hmm Lmm Qty 1 pcs			
accessories for	107139		
	GEV No.	100904	Ref. No. —
locking screw M10x1 for pipe \varnothing 4mm Qty 1 pcs			
	GEV No.	100905	Ref. No. 8C0070
locking screw M10x1 for pipe \varnothing 6mm Qty 1 pcs			
	GEV No.	100998	Ref. No. —
pilot burner bottom part nozzle \varnothing 0.21mm suitable for 100 series			
	GEV No.	102110	Ref. No. —
pilot tube copper pipe \varnothing 4mm thickness 1mm L 3000mm			
	GEV No.	102111	Ref. No. —
pilot tube copper pipe \varnothing 6mm thickness 1mm L 3000mm			



1

GEV No.	106906	Ref. No.	C00711
description	pilot burner SIT type 100 series 3 flames nozzle \varnothing 0.2mm gas connection 6mm		
spare parts for	106906		
	GEV No.	100245	Ref. No. 8C0030
pilot burner nozzle LPG code 20 bore \varnothing 0.2mm Qty 1 pcs thread M8x0.75			
	GEV No.	100855	Ref. No. —
pilot burner bracket triple			

Зип-Общепит

	GEV No.	100885	Ref. No.	—
air mixing sleeve for pilot burner Qty 1 pcs				
	GEV No.	100916	Ref. No.	—
compression spring for pilot burner Qty 1 pcs				
	GEV No.	100917	Ref. No.	—
gasket for pilot burner Qty 1 pcs aluminium				
	GEV No.	100918	Ref. No.	—
screw for pilot burner				
	GEV No.	107162	Ref. No.	—
pilot burner cap SIT 3 flames Hmm Lmm Qty 1 pcs				
	GEV No.	107701	Ref. No.	—
pilot burner bottom part SIT 100 series nozzle \varnothing 0.2mm				
accessories for	106906			
	GEV No.	100245	Ref. No.	8C0030
pilot burner nozzle LPG code 20 bore \varnothing 0.2mm Qty 1 pcs thread M8x0.75				
	GEV No.	100246	Ref. No.	8C0031
pilot burner nozzle natural gas bore \varnothing 0.35mm Qty 1 pcs thread M8x0.75				
	GEV No.	100904	Ref. No.	—
locking screw M10x1 for pipe \varnothing 4mm Qty 1 pcs				
	GEV No.	100905	Ref. No.	8C0070
locking screw M10x1 for pipe \varnothing 6mm Qty 1 pcs				
	GEV No.	102110	Ref. No.	—
pilot tube copper pipe \varnothing 4mm thickness 1mm L 3000mm				
	GEV No.	102111	Ref. No.	—
pilot tube copper pipe \varnothing 6mm thickness 1mm L 3000mm				
	GEV No.	107171	Ref. No.	—
pilot burner nozzle SIT natural/liquid gas bore \varnothing 0.25mm Qty 1 pcs				
	GEV No.	107700	Ref. No.	—
pilot burner bottom part SIT 100 series nozzle \varnothing 0.25mm				
	GEV No.	107702	Ref. No.	—
pilot burner bottom part SIT 100 series nozzle \varnothing 0.35mm				







1 gas components

	GEV No. 106907	Ref. No. C00166
description	pilot burner SIT type 100 series 3 flames nozzle ϕ 0.35mm gas connection 6mm	
spare parts for	106907	
	GEV No. 100246	Ref. No. 8C0031
description	pilot burner nozzle natural gas bore ϕ 0.35mm Qty 1 pcs thread M8x0.75	
	GEV No. 100855	Ref. No. —
description	pilot burner bracket triple	
	GEV No. 100885	Ref. No. —
description	air mixing sleeve for pilot burner Qty 1 pcs	
	GEV No. 100916	Ref. No. —
description	compression spring for pilot burner Qty 1 pcs	
	GEV No. 100917	Ref. No. —
description	gasket for pilot burner Qty 1 pcs aluminium	
	GEV No. 100918	Ref. No. —
description	screw for pilot burner	
	GEV No. 107162	Ref. No. —
description	pilot burner cap SIT 3 flames Hmm Lmm Qty 1 pcs	
	GEV No. 107702	Ref. No. —
description	pilot burner bottom part SIT 100 series nozzle ϕ 0.35mm	
accessories for	106907	
	GEV No. 100245	Ref. No. 8C0030
description	pilot burner nozzle LPG code 20 bore ϕ 0.2mm Qty 1 pcs thread M8x0.75	
	GEV No. 100904	Ref. No. —
description	locking screw M10x1 for pipe ϕ 4mm Qty 1 pcs	
	GEV No. 100905	Ref. No. 8C0070
description	locking screw M10x1 for pipe ϕ 6mm Qty 1 pcs	
	GEV No. 102110	Ref. No. —
description	pilot tube copper pipe ϕ 4mm thickness 1mm L 3000mm	
	GEV No. 102111	Ref. No. —
description	pilot tube copper pipe ϕ 6mm thickness 1mm L 3000mm	
	GEV No. 107171	Ref. No. —
description	pilot burner nozzle SIT natural/liquid gas bore ϕ 0.25mm Qty 1 pcs	
	GEV No. 107700	Ref. No. —
description	pilot burner bottom part SIT 100 series nozzle ϕ 0.25mm	
	GEV No. 107701	Ref. No. —
description	pilot burner bottom part SIT 100 series nozzle ϕ 0.2mm	

Зип Общепит

vsezip.ru

+7(812)987-08-81

	GEV No. 107140	Ref. No. C00392
description	pilot burner SIT type 100 series 3 flames nozzle ϕ 20mm gas connectionmm	
spare parts for	107140	
	GEV No. 100855	Ref. No. —
description	pilot burner bracket triple	
	GEV No. 100885	Ref. No. —
description	air mixing sleeve for pilot burner Qty 1 pcs	
	GEV No. 100916	Ref. No. —
description	compression spring for pilot burner Qty 1 pcs	
	GEV No. 107162	Ref. No. —
description	pilot burner cap SIT 3 flames Hmm Lmm Qty 1 pcs	
accessories for	107140	
	GEV No. 100904	Ref. No. —
description	locking screw M10x1 for pipe ϕ 4mm Qty 1 pcs	
	GEV No. 100905	Ref. No. 8C0070
description	locking screw M10x1 for pipe ϕ 6mm Qty 1 pcs	

accessories

pilot burner nozzles

	GEV No. 100245	Ref. No. 8C0030
description	pilot burner nozzle LPG code 20 bore ϕ 0.2mm Qty 1 pcs thread M8x0.75	

	GEV No. 100246	Ref. No. 8C0031
description	pilot burner nozzle natural gas bore ϕ 0.35mm Qty 1 pcs thread M8x0.75	



Зип-Общепит

vsezip.ru

+7(812)987-08-81

ignition electrodes

GEV No.	100706	Ref. No.	051H10002 808177
description	ignition electrode connection M4 Qty 1 pcs		

GEV No.	100707	Ref. No.	807741
description	ignition electrode D1 ø 7mm D2 ø 9mm connection ø2.4mm L1 14mm L2 6mm BL1 18mm BL2 3mm BL3 23mm to clip Qty 1 pcs		

140 - 145 -150 series

GEV No.	107133	Ref. No.	808353
description	pilot burner SIT type 140 series 1 flame nozzle ømm gas connecti-onmm		
accessories for	107133		
	GEV No.	Ref. No.	80C955
	100204		
description	pilot burner nozzle SIT LPG code 14 bore ø 0.18/0.20mm Qty 1 pcs suitable for 140 series		
	GEV No.	Ref. No.	809996
	100205		
description	pilot burner nozzle SIT LPG code 19 bore ø 0.23/0.26mm Qty 1 pcs suitable for SIT 150 series		
	GEV No.	Ref. No.	809994
	100206		
description	pilot burner nozzle SIT natural gas code 36 bore ø 0.60/0.55mm Qty 1 pcs suitable for SIT 150 series		
	GEV No.	Ref. No.	8C1497
	100207		
description	pilot burner nozzle SIT natural gas code 27 bore ø 0.40/0.38mm suitable for SIT 140 series		
	GEV No.	Ref. No.	—
	100216		
description	pilot burner nozzle SIT natural gas code 38 bore ø 0.45mm Qty 1 pcs suitable for SIT 150 series		
	GEV No.	Ref. No.	807905 809475 C00173
	100701		
description	ignition electrode connection M4 Qty 1 pcs		

accessories for	107133		
	GEV No.	Ref. No.	—
	100897		
description	nozzle for pipe ø4mm Qty 1 pcs for pilot burner		
	GEV No.	Ref. No.	—
	100898		
description	nozzle for pipe ø6mm Qty 1 pcs for pilot burner		
	GEV No.	Ref. No.	—
	100906		
description	screw connection thread M10x1 for ignition electrode brass Qty 1 pcs WS 10		
	GEV No.	Ref. No.	—
	100907		
description	screw connection thread M10x1 Qty 1 pcs type SEF 1 ømm for thermocouple		
	GEV No.	Ref. No.	806019
	100908		
description	union screw thread M10x1 for pipe ø 4mm Qty 1 pcs		
	GEV No.	Ref. No.	—
	100909		
description	union screw thread M10x1 for pipe ø 6mm Qty 1 pcs		
	GEV No.	Ref. No.	—
	102110		
description	pilot tube copper pipe ø 4mm thickness 1mm L 3000mm		
	GEV No.	Ref. No.	—
	102111		
description	pilot tube copper pipe ø 6mm thickness 1mm L 3000mm		

GEV No.	107114 ¹	Ref. No.	809474
description	pilot burner SIT type 140 series 2 flames nozzle ømm gas connecti-onmm		
spare parts for	107114		
	GEV No.	Ref. No.	—
	100907		
description	screw connection thread M10x1 Qty 1 pcs type SEF 1 ømm for thermocouple		
accessories for	107114		
	GEV No.	Ref. No.	80C955
	100204		
description	pilot burner nozzle SIT LPG code 14 bore ø 0.18/0.20mm Qty 1 pcs suitable for 140 series		
	GEV No.	Ref. No.	809996
	100205		
description	pilot burner nozzle SIT LPG code 19 bore ø 0.23/0.26mm Qty 1 pcs suitable for SIT 150 series		
	GEV No.	Ref. No.	809994
	100206		
description	pilot burner nozzle SIT natural gas code 36 bore ø 0.60/0.55mm Qty 1 pcs suitable for SIT 150 series		
	GEV No.	Ref. No.	8C1497
	100207		
description	pilot burner nozzle SIT natural gas code 27 bore ø 0.40/0.38mm suitable for SIT 140 series		
	GEV No.	Ref. No.	—
	100216		
description	pilot burner nozzle SIT natural gas code 38 bore ø 0.45mm Qty 1 pcs suitable for SIT 150 series		
	GEV No.	Ref. No.	807905 809475 C00173
	100701		
description	ignition electrode connection M4 Qty 1 pcs		
	GEV No.	Ref. No.	—
	100801		
description	gasket for pilot burner Qty 1 pcs		

¹incl. thermocouple fitting
Table continues overleaf









1 gas components





Зип-Общепит

vsezip.ru

+7(812)987-08-81

accessories for 107114			
	GEV No.	100897	Ref. No. —
olive for pipe ø 4mm Qty 1 pcs for pilot burner			
	GEV No.	100898	Ref. No. —
olive for pipe ø 6mm Qty 1 pcs for pilot burner			
	GEV No.	100906	Ref. No. —
screw connection thread M10x1 for ignition electrode brass Qty 1 pcs WS 10			
	GEV No.	100908	Ref. No. 806019
union screw thread M10x1 for pipe ø 4mm Qty 1 pcs			
	GEV No.	100909	Ref. No. —
union screw thread M10x1 for pipe ø 6mm Qty 1 pcs			
	GEV No.	102110	Ref. No. —
pilot tube copper pipe ø 4mm thickness 1mm L 3000mm			
	GEV No.	102111	Ref. No. —
pilot tube copper pipe ø 6mm thickness 1mm L 3000mm			

160 series			
			
1			
GEV No.	100052	Ref. No.	806153
description	pilot burner SIT type 160 series 2 flames nozzle ømm gas connectionmm		
spare parts for	100052		
	GEV No.	100907	Ref. No. —
screw connection thread M10x1 Qty 1 pcs type SEF 1 ømm for thermocouple			
accessories for	100052		
	GEV No.	100202	Ref. No. —
pilot burner nozzle natural gas code 41 Qty 1 pcs nozzle ø 0.41mm			
	GEV No.	100203	Ref. No. —
pilot burner nozzle LPG code 25 Qty 1 pcs nozzle ø 0.25mm			
	GEV No.	100701	Ref. No. 807905 809475 C00173
ignition electrode connection M4 Qty 1 pcs			
	GEV No.	100801	Ref. No. —
gasket for pilot burner Qty 1 pcs			
	GEV No.	100906	Ref. No. —
screw connection thread M10x1 for ignition electrode brass Qty 1 pcs WS 10			
	GEV No.	100908	Ref. No. 806019
union screw thread M10x1 for pipe ø 4mm Qty 1 pcs			
	GEV No.	100909	Ref. No. —
union screw thread M10x1 for pipe ø 6mm Qty 1 pcs			

accessories for 100052			
	GEV No.	101282	Ref. No. —
olive for pipe ø 4mm L 7.4mm Qty 1 pcs			
	GEV No.	101287	Ref. No. —
olive for pipe ø 6mm Qty 1 pcs			
	GEV No.	102110	Ref. No. —
pilot tube copper pipe ø 4mm thickness 1mm L 3000mm			
	GEV No.	102111	Ref. No. —
pilot tube copper pipe ø 6mm thickness 1mm L 3000mm			
	GEV No.	107650	Ref. No. 808365
pilot burner nozzle SIT LPG code 30 Qty 1 pcs			

POLIDORO

pilot burners











			
1			
GEV No.	100051	Ref. No.	808039 808197
description	pilot burner POLIDORO 3 flames code gas connectionmm		
spare parts for	100051		
	GEV No.	100907	Ref. No. —
screw connection thread M10x1 Qty 1 pcs type SEF 1 ømm for thermocouple			
accessories for	100051		
	GEV No.	100000	Ref. No. —
pilot burner nozzle POLIDORO LPG code 22 bore ø 0.22mm Qty 1 pcs			
	GEV No.	100208	Ref. No. 512120005 512120010 C00170
pilot burner nozzle POLIDORO LPG code 20 bore ø 0.2mm Qty 1 pcs			
	GEV No.	100209	Ref. No. —
pilot burner nozzle POLIDORO natural gas code 40 bore ø 0.4mm Qty 1 pcs			
	GEV No.	100701	Ref. No. 807905 809475 C00173
ignition electrode connection M4 Qty 1 pcs			
	GEV No.	100906	Ref. No. —
screw connection thread M10x1 for ignition electrode brass Qty 1 pcs WS 10			
	GEV No.	100907	Ref. No. —
screw connection thread M10x1 Qty 1 pcs type SEF 1 ømm for thermocouple			
	GEV No.	100908	Ref. No. 806019
union screw thread M10x1 for pipe ø 4mm Qty 1 pcs			
	GEV No.	100909	Ref. No. —
union screw thread M10x1 for pipe ø 6mm Qty 1 pcs			

Table continues overleaf























Зип Общепит

vsezip.ru

+7(812)987-08-81

accessories for		100051	
	GEV No.	102110	Ref. No. —
pilot tube copper pipe ø 4mm thickness 1mm L 3000mm			
	GEV No.	102111	Ref. No. —
pilot tube copper pipe ø 6mm thickness 1mm L 3000mm			
	GEV No.	102508	Ref. No. —
union screw thread M10x1 for pipe ø 4mm Qty 5 pcs			
	GEV No.	102509	Ref. No. —
union screw thread M10x1 for pipe ø 6mm Qty 5 pcs			
	GEV No.	102699	Ref. No. —
pilot burner nozzle POLIDORO natural gas code 25.2 bore ø 2x0.25mm Qty 1 pcs 2 bores			
	GEV No.	102795	Ref. No. —
olive for pipe ø 4mm Qty 1 pcs			
	GEV No.	102797	Ref. No. —
olive for pipe ø 6mm Qty 1 pcs			
	GEV No.	106703	Ref. No. 512120007
pilot burner nozzle POLIDORO natural gas code 27.2 bore ø 2x0.27mm Qty 1 pcs			
	GEV No.	106704	Ref. No. —
pilot burner nozzle POLIDORO LPG code 16.2 bore ø 2x0.16mm Qty 1 pcs			
	GEV No.	106763	Ref. No. —
pilot burner nozzle POLIDORO natural gas code 27.2A bore ø 2x 0.27mm Qty 1 pcs			
	GEV No.	106859	Ref. No. —
pilot burner nozzle POLIDORO LPG code 24 bore ø 0.24mm Qty 1 pcs			

 <p>1</p>			
GEV No.	100162	Ref. No.	809195
description	pilot burner POLIDORO 3 flames code gas connectionmm		
spare parts for	100162		
	GEV No.	100907	Ref. No. —
screw connection thread M10x1 Qty 1 pcs type SEF 1 ømm for thermocouple			
accessories for	100162		
	GEV No.	100000	Ref. No. —
pilot burner nozzle POLIDORO LPG code 22 bore ø 0.22mm Qty 1 pcs			
	GEV No.	100208	Ref. No. 512120005 512120010 C00170
pilot burner nozzle POLIDORO LPG code 20 bore ø 0.2mm Qty 1 pcs			
	GEV No.	100209	Ref. No. —
pilot burner nozzle POLIDORO natural gas code 40 bore ø 0.4mm Qty 1 pcs			
	GEV No.	100701	Ref. No. 807905 809475 C00173
ignition electrode connection M4 Qty 1 pcs			

accessories for		100162	
	GEV No.	100906	Ref. No. —
screw connection thread M10x1 for ignition electrode brass Qty 1 pcs V/S 10			
	GEV No.	100907	Ref. No. —
screw connection thread M10x1 Qty 1 pcs type SEF 1 ømm for thermocouple			
	GEV No.	100908	Ref. No. 806019
union screw thread M10x1 for pipe ø 4mm Qty 1 pcs			
	GEV No.	100909	Ref. No. —
union screw thread M10x1 for pipe ø 6mm Qty 1 pcs			
	GEV No.	102110	Ref. No. —
pilot tube copper pipe ø 4mm thickness 1mm L 3000mm			
	GEV No.	102111	Ref. No. —
pilot tube copper pipe ø 6mm thickness 1mm L 3000mm			
	GEV No.	102508	Ref. No. —
union screw thread M10x1 for pipe ø 4mm Qty 5 pcs			
	GEV No.	102509	Ref. No. —
union screw thread M10x1 for pipe ø 6mm Qty 5 pcs			
	GEV No.	102699	Ref. No. —
pilot burner nozzle POLIDORO natural gas code 25.2 bore ø 2x0.25mm Qty 1 pcs 2 bores			
	GEV No.	102795	Ref. No. —
olive for pipe ø 4mm Qty 1 pcs			
	GEV No.	102797	Ref. No. —
olive for pipe ø 6mm Qty 1 pcs			
	GEV No.	106703	Ref. No. 512120007
pilot burner nozzle POLIDORO natural gas code 27.2 bore ø 2x0.27mm Qty 1 pcs			
	GEV No.	106704	Ref. No. —
pilot burner nozzle POLIDORO LPG code 16.2 bore ø 2x0.16mm Qty 1 pcs			
	GEV No.	106763	Ref. No. —
pilot burner nozzle POLIDORO natural gas code 27.2A bore ø 2x 0.27mm Qty 1 pcs			
	GEV No.	106859	Ref. No. —
pilot burner nozzle POLIDORO LPG code 24 bore ø 0.24mm Qty 1 pcs			



 <p>1</p>			
GEV No.	100076	Ref. No.	806154 807835
description	pilot burner POLIDORO 3 flames natural gas code 29.2 gas connection 6mm		
spare parts for	100076		
	GEV No.	100907	Ref. No. —
screw connection thread M10x1 Qty 1 pcs type SEF 1 ømm for thermocouple			













Table continues overleaf





1 gas components

Зип Общепит

vsezip.ru

+7(812)987-08-81

accessories for 100076	
	GEV No. 100000 Ref. No. — pilot burner nozzle POLIDORO LPG code 22 bore ø 0.22mm Qty 1 pcs
	GEV No. 100208 Ref. No. 512120005 512120010 C00170 pilot burner nozzle POLIDORO LPG code 20 bore ø 0.2mm Qty 1 pcs
	GEV No. 100209 Ref. No. — pilot burner nozzle POLIDORO natural gas code 40 bore ø 0.4mm Qty 1 pcs
	GEV No. 100701 Ref. No. 807905 809475 C00173 ignition electrode connection M4 Qty 1 pcs
	GEV No. 100906 Ref. No. — screw connection thread M10x1 for ignition electrode brass Qty 1 pcs WS 10
	GEV No. 100907 Ref. No. — screw connection thread M10x1 Qty 1 pcs type SEF 1 ømm for thermocouple
	GEV No. 100908 Ref. No. 806019 union screw thread M10x1 for pipe ø 4mm Qty 1 pcs
	GEV No. 100909 Ref. No. — union screw thread M10x1 for pipe ø 6mm Qty 1 pcs
	GEV No. 102110 Ref. No. — pilot tube copper pipe ø 4mm thickness 1mm L 3000mm
	GEV No. 102111 Ref. No. — pilot tube copper pipe ø 6mm thickness 1mm L 3000mm
	GEV No. 102508 Ref. No. — union screw thread M10x1 for pipe ø 4mm Qty 5 pcs
	GEV No. 102509 Ref. No. — union screw thread M10x1 for pipe ø 6mm Qty 5 pcs
	GEV No. 102699 Ref. No. — pilot burner nozzle POLIDORO natural gas code 25.2 bore ø 2x0.25mm Qty 1 pcs 2 bores
	GEV No. 102795 Ref. No. — olive for pipe ø 4mm Qty 1 pcs
	GEV No. 102797 Ref. No. — olive for pipe ø 6mm Qty 1 pcs
	GEV No. 106703 Ref. No. 512120007 pilot burner nozzle POLIDORO natural gas code 27.2 bore ø 2x0.27mm Qty 1 pcs
	GEV No. 106704 Ref. No. — pilot burner nozzle POLIDORO LPG code 16.2 bore ø 2x0.16mm Qty 1 pcs
	GEV No. 106763 Ref. No. — pilot burner nozzle POLIDORO natural gas code 27.2A bore ø 2x 0.27mm Qty 1 pcs
	GEV No. 106859 Ref. No. — pilot burner nozzle POLIDORO LPG code 24 bore ø 0.24mm Qty 1 pcs

GEV No. 106580 Ref. No. C10515	
	description pilot burner POLIDORO 3 flames natural gas nozzle 27.2 code 27.2 gas connection 6mm
spare parts for 106680	
	GEV No. 106703 Ref. No. 512120007 pilot burner nozzle POLIDORO natural gas code 27.2 bore ø 2x0.27mm Qty 1 pcs
accessories for 106680	
	GEV No. 100701 Ref. No. 807905 809475 C00173 ignition electrode connection M4 Qty 1 pcs
	GEV No. 100908 Ref. No. 806019 union screw thread M10x1 for pipe ø 4mm Qty 1 pcs
	GEV No. 100909 Ref. No. — union screw thread M10x1 for pipe ø 6mm Qty 1 pcs









GEV No. 100148 Ref. No. 808524	
	description pilot burner POLIDORO type A 3 flames LPG code 20 gas connectionmm
accessories for 100148	
	GEV No. 100000 Ref. No. — pilot burner nozzle POLIDORO LPG code 22 bore ø 0.22mm Qty 1 pcs
	GEV No. 100208 Ref. No. 512120005 512120010 C00170 pilot burner nozzle POLIDORO LPG code 20 bore ø 0.2mm Qty 1 pcs
	GEV No. 100209 Ref. No. — pilot burner nozzle POLIDORO natural gas code 40 bore ø 0.4mm Qty 1 pcs
	GEV No. 100701 Ref. No. 807905 809475 C00173 ignition electrode connection M4 Qty 1 pcs
	GEV No. 100906 Ref. No. — screw connection thread M10x1 for ignition electrode brass Qty 1 pcs WS 10
	GEV No. 100907 Ref. No. — screw connection thread M10x1 Qty 1 pcs type SEF 1 ømm for thermocouple
	GEV No. 100908 Ref. No. 806019 union screw thread M10x1 for pipe ø 4mm Qty 1 pcs
	GEV No. 100909 Ref. No. — union screw thread M10x1 for pipe ø 6mm Qty 1 pcs

Table continues overleaf



Зип Общепит

vsezip.ru

+7(812)987-08-81

accessories for	100148		
	GEV No.	102110	Ref. No. —
	pilot tube copper pipe \varnothing 4mm thickness 1mm L 3000mm		
	GEV No.	102111	Ref. No. —
	pilot tube copper pipe \varnothing 6mm thickness 1mm L 3000mm		
	GEV No.	102699	Ref. No. —
	pilot burner nozzle POLIDORO natural gas code 25.2 bore \varnothing 2x0.25mm Qty 1 pcs 2 bores		
	GEV No.	102795	Ref. No. —
	olive for pipe \varnothing 4mm Qty 1 pcs		
	GEV No.	102797	Ref. No. —
	olive for pipe \varnothing 6mm Qty 1 pcs		
	GEV No.	106703	Ref. No. 512120007
	pilot burner nozzle POLIDORO natural gas code 27.2 bore \varnothing 2x0.27mm Qty 1 pcs		
	GEV No.	106704	Ref. No. —
	pilot burner nozzle POLIDORO LPG code 16.2 bore \varnothing 2x0.16mm Qty 1 pcs		
	GEV No.	106763	Ref. No. —
	pilot burner nozzle POLIDORO natural gas code 27.2A bore \varnothing 2x 0.27mm Qty 1 pcs		
	GEV No.	106859	Ref. No. —
	pilot burner nozzle POLIDORO LPG code 24 bore \varnothing 0.24mm Qty 1 pcs		



GEV No.	100706	Ref. No.	051H10002 808177
description	ignition electrode connection M4 Qty 1 pcs		



GEV No.	100753	Ref. No.	C10085
description	ignition electrode D1 \varnothing 6mm cable length 600mm connection F 2.8x0.8mm D2 \varnothing 10mm L1 1mm BL1 15mm BL2 2mm BL3 22mm to clip		



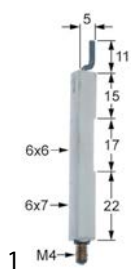

GEV No.	100754	Ref. No.	C10161
description	ignition electrode D1 \varnothing 6mm cable length 750mm connection F 2.8x0.8mm D2 \varnothing 10mm L1 4.5mm BL1 14mm BL2 2mm BL3 22mm		

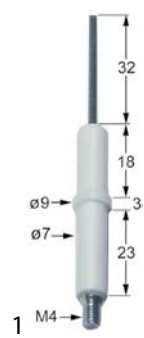

GEV No.	100708	Ref. No.	C00172
description	ignition electrode D1 \varnothing 6x7mm connection M4 D2 \varnothing 6x6mm L1 11mm L2 5mm BL1 15mm BL2 16mm BL3 23mm		

electrodes



GEV No.	100701	Ref. No.	807905 809475 C00173
description	ignition electrode connection M4 Qty 1 pcs		
accessories for	100701		
	GEV No.	100906	Ref. No. —
	screw connection thread M10x1 for ignition electrode brass Qty 1 pcs WS 10		

1 gas components



Зип Общепит

vsezip.ru

+7(812)987-08-81



GEV No.	100707	Ref. No.	807741
description	ignition electrode D1 ø 7mm D2 ø 9mm connection ø2.4mm L1 14mm L2 6mm BL1 18mm BL2 3mm BL3 23mm to clip Qty 1 pcs		



GEV No.	100756	Ref. No.	808593
description	ignition electrode flange length 24mm flange width 17mm fixing dimensions ø4.5mm with flange		

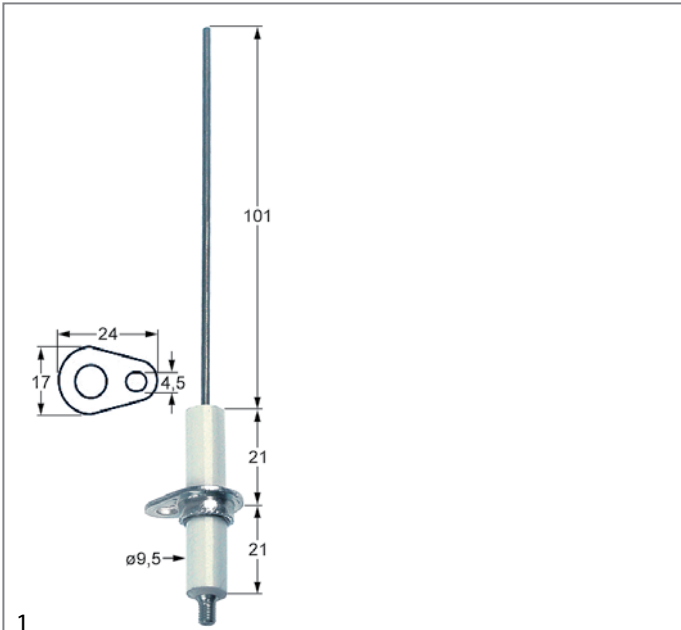

GEV No.	102323	Ref. No.	808592
description	ignition electrode flange length 24mm flange width 17mm D1 ø 9.5mm L1 101mm BL2 21mm BL3 21mm connection M4 fixing dimensions ø4.5mm with flange		



GEV No.	100755	Ref. No.	808592
description	ignition electrode flange length 38mm flange width 17mm connection M4 fixing dimensions ø4.5mm mounting distance 28mm with flange with earthing contact connection ø 4mm		

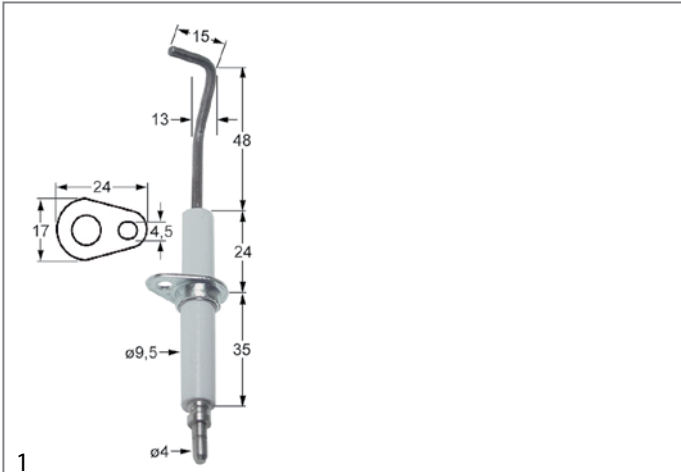

GEV No.	102342	Ref. No.	809281
description	ignition electrode flange length 24mm flange width 17mm D1 ø 9.5mm L1 48mm L2 13mm L3 15mm BL1 24mm BL2 35mm fixing dimensions ø4.5mm with flange connection ø 4mm		

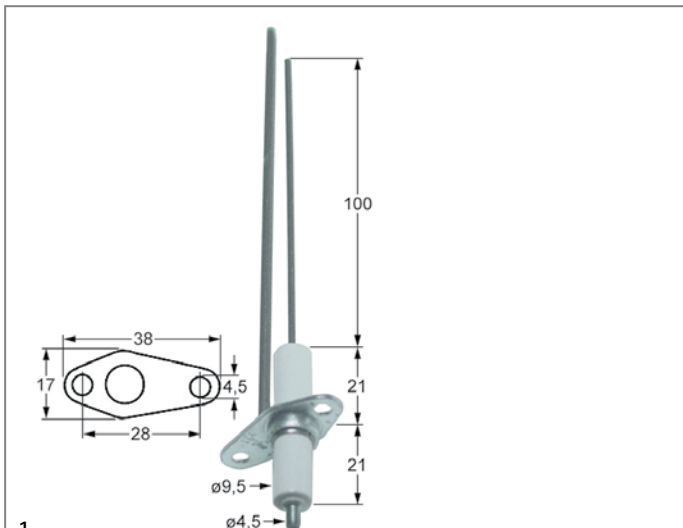

GEV No.	102322	Ref. No.	808592
description	ignition electrode flange length 38mm flange width 17mm D1 ø 9.5mm L1 100mm BL1 21mm BL2 21mm connection M4 fixing dimensions ø4.5mm mounting distance 28mm with flange with earthing contact		



3in1 Общепит
vsezip.ru
+7(812)987-08-81

ignition cables

pre-assembled cables

1			
GEV No.	100026	Ref. No.	809430
description	ignition cable cable length 1000mm connection ø4mm / F6.3mm		

1			
GEV No.	100164	Ref. No.	C10259
description	ignition cable cable length 1200mm connection ø4mm / F2.8mm		

1			
GEV No.	102163	Ref. No.	808276
description	ignition cable cable length 1500mm connection F2.8mm / ø2.4mm		

1			
GEV No.	100147	Ref. No.	809468
description	ignition cable cable length 1500mm connection ø2.4mm / ø4mm		

1			
GEV No.	100014	Ref. No.	C00808
description	ignition cable cable length 300mm connection ø2.4mm / ø2.4mm		

1			
GEV No.	100197	Ref. No.	051E10008
description	ignition cable cable length 600mm connection F2.8mm / ø2.4mm		

1			
GEV No.	100018	Ref. No.	808230 C00171
description	ignition cable cable length 600mm connection ø2.4mm / ø4mm permanent temperature 200°C		

1			
GEV No.	100025	Ref. No.	809439
description	ignition cable cable length 600mm connection ø4mm / F6.3mm		

1			
GEV No.	100019	Ref. No.	809389
description	ignition cable cable length 900mm connection ø2.4mm / ø4mm		

mounting diameter 18mm



1	GEV No.	100009	Ref. No.	809476
description	piezoelectric igniter body plastic blowing mounting ø 18mm connection ø2.4mm front measurements 26mm M18x1.5			

accessories for	100009			
	GEV No.	101339	Ref. No.	—
	cover cap for piezoelectric igniter			
	GEV No.	106869	Ref. No.	—
	cover cap for piezoelectric igniter ID ø 22mm ED ø 35mm H 25mm			
	GEV No.	107931	Ref. No.	—
	cover cap for piezoelectric igniter ID ø 21mm ED ø 36mm			

mounting diameter 22mm



1	GEV No.	100005	Ref. No.	C00069
description	piezoelectric igniter body plastic blowing mounting ø 22mm connection ø2.4mm cable lengthmm SIT			

miscellaneous



1	GEV No.	nla ¹	Ref. No.	806090
description	piezoelectric igniter body metal connection F6.3x0.8 2 hole fixing ø 22mm			

¹no longer available



1	GEV No.	nla ¹	Ref. No.	807697
description	piezoelectric igniter suitable for Minisit with cover cap ømm connection F6.3x0.8			

spare parts for	101136			
	GEV No.	100001	Ref. No.	—
	piezoelectric igniter suitable for Minisit connection F6.3x0.8 ømm			

¹no longer available

1 gas components

ignition units



1

GEV No.	101030	Ref. No.	C10167
description	ignition unit outputs 2 1.5 V/DC		



1

GEV No.	101002	Ref. No.	C00507
description	ignition unit outputs 2 230VAC dimensions 88x23x34mm mounting distance 73mm inlet F6.3x0.8 outlet F2.8x0.8 0.6VA 50/60Hz		



1

GEV No.	101031	Ref. No.	C10168
description	ignition unit outputs 4 1.5 V/DC dimensions 111x23x34mm mounting distance 100mm inlet F6.3x0.8 outlet F2.8x0.8 mounting ø 100mm		



1

GEV No.	101032	Ref. No.	C10169
description	ignition unit outputs 6 1.5 V/DC dimensions 135x23x34mm mounting distance 123mm inlet F6.3x0.8 outlet F2.8x0.8 mounting ø 122mm		

ignition switches



1

GEV No.	100160	Ref. No.	C10250
description	momentary push switch mounting measurements 28.5x28.5mm red 1NO 250V 12A ignition connection male faston 6.3mm ambient temperature max. 85°C protection IP40 mounting ømm		



1

GEV No.	101036	Ref. No.	C10166
description	battery holder for battery type AA 1.5V mounting ø 22mm connection male faston 2.8mm/6.3mm		

thermocouples

plug-in thermocouples
 plug-in thermocouples standard
 with barrel socket ø6(6.5)mm
 thermocouples SIT

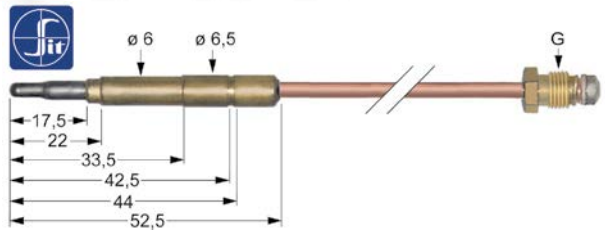

1

GEV No.	107621	Ref. No.	808521
description	thermocouple SIT M10x1 L 1500mm plug connection ø6.0(6.5)mm		

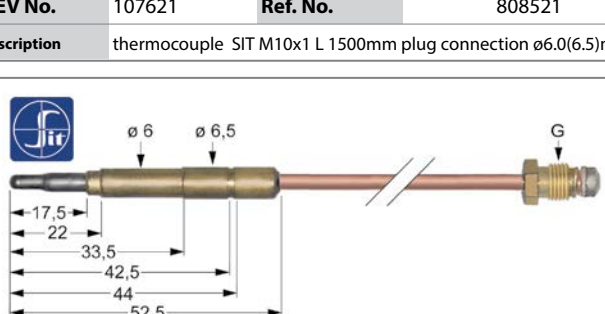

1

GEV No.	107612	Ref. No.	806185
description	thermocouple SIT M9x1 L 1000mm plug connection ø6.0(6.5)mm		

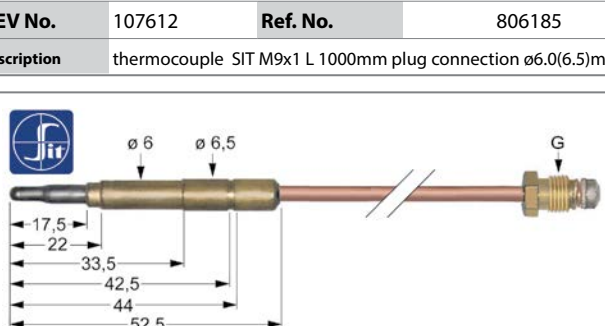

1

GEV No.	107613	Ref. No.	8C0639
description	thermocouple SIT M9x1 L 1200mm plug connection ø6.0(6.5)mm		

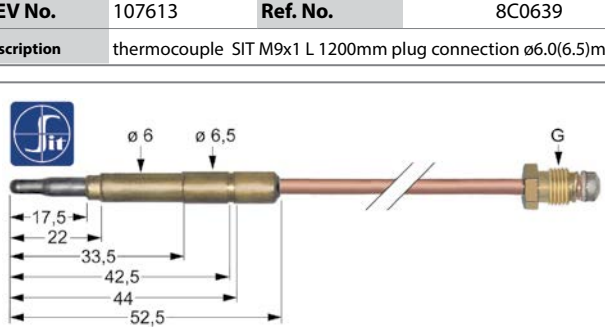

1

GEV No.	107614	Ref. No.	814980 C10201
description	thermocouple SIT M9x1 L 1500mm plug connection ø6.0(6.5)mm		



Зип Общепит

plug thermocouples with interruption

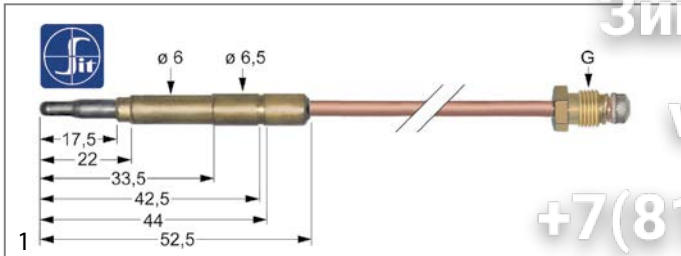

GEV No.	107606	Ref. No.	C00072
description	thermocouple SIT M9x1 L 320mm plug connection $\varnothing 6.0(6.5)$ mm		

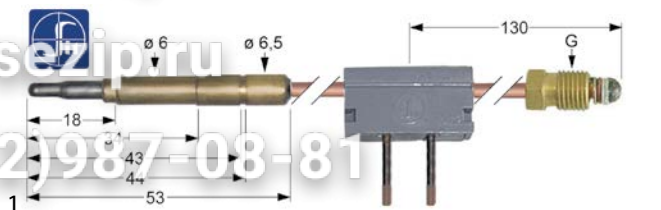

GEV No.	107164	Ref. No.	513120001
description	thermocouple SIT with interrupter M9x1 L 1000mm plug connection $\varnothing 6.0(6.5)$ mm soldering connection		

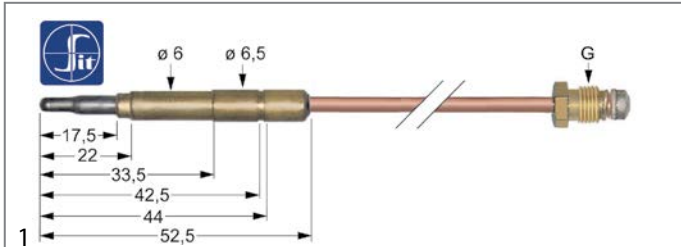

GEV No.	107609	Ref. No.	806271
description	thermocouple SIT M9x1 L 600mm plug connection $\varnothing 6.0(6.5)$ mm		

threaded thermocouples

threaded thermocouples with cable link



GEV No.	102145	Ref. No.	C10067	
description	thermocouple L 600mm connection F 7.7mm M6x0.75			
accessories for	102145			
	GEV No.	102680	Ref. No.	—
	nut thread M6x0.75 H 2.6mm WS 8 brass Qty 1 pcs type SEF 2			

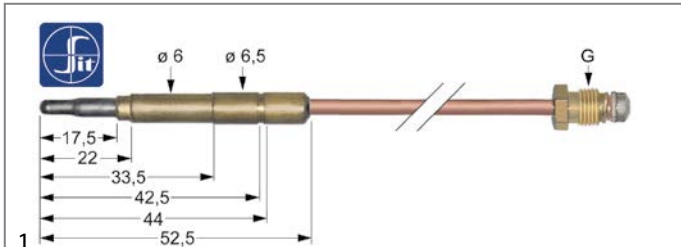

GEV No.	107611	Ref. No.	C00377
description	thermocouple SIT M9x1 L 850mm plug connection $\varnothing 6.0(6.5)$ mm		

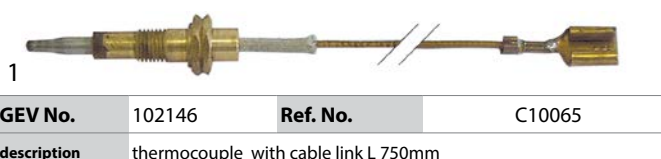

GEV No.	102146	Ref. No.	C10065
description	thermocouple with cable link L 750mm		

thermocouples with aluminised tip

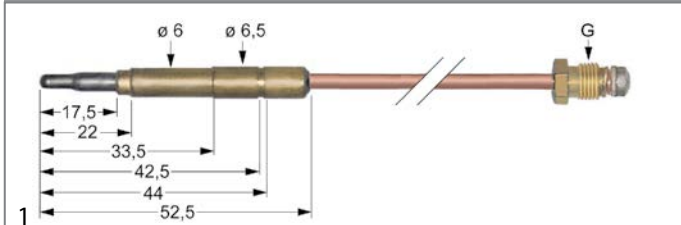

GEV No.	102034	Ref. No.	808151
description	thermocouple M8x1 L 600mm plug connection $\varnothing 6.0(6.5)$ mm		

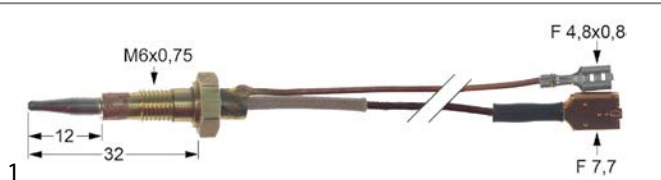

GEV No.	102147	Ref. No.	C10065 C10334
description	thermocouple L 750mm M6x0.75 F 7.7mm F 4.8x0.8mm		

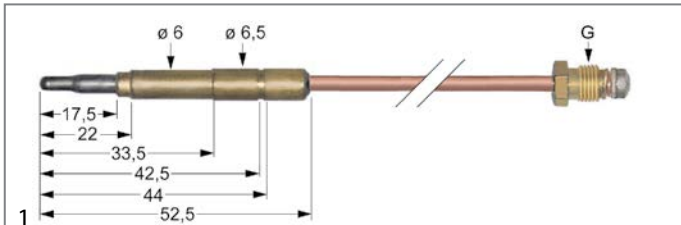

GEV No.	102041	Ref. No.	806183
description	thermocouple M9x1 L 600mm plug connection $\varnothing 6.0(6.5)$ mm		



GEV No.	102148	Ref. No.	C10333	
description	thermocouple with two-conductors L 600mm M6x0.75 F 7.7mm F 4.8x0.8mm			
accessories for	102148			
	GEV No.	102680	Ref. No.	—
	nut thread M6x0.75 H 2.6mm WS 8 brass Qty 1 pcs type SEF 2			



Зип Общепит

vsezip.ru

+7(812)987-08-81

accessories

interrupters



1

GEV No.	101264	Ref. No.	8C1701
description	interrupter thread M8x1		



1

GEV No.	101265	Ref. No.	807842
description	interrupter thread M9x1		

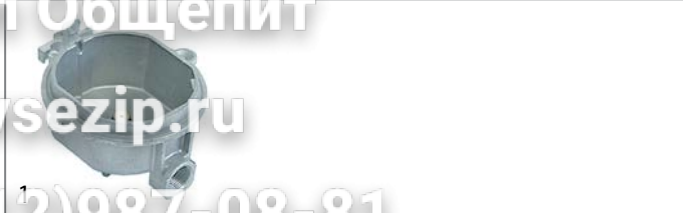

GEV No.	105120	Ref. no.	C10046
----------------	--------	-----------------	--------

description burner lower part 3kW for igniter ø 7mm for thermocouple ø 6mm with nozzle ø1.15mm for burner cap ø 100mm

accessories for 105120

	GEV No.	105121	Ref. No.	C10045
description burner head 3kW for igniter ø 7.5mm for burner cap ø 100mm				

	GEV No.	105122	Ref. No.	C10196
description burner cap 3kW ø 100mm H 6mm matt finish				

gas burners

hob burners

universal hob burners

SABAF

2 series - standard



1

GEV No.	105122	Ref. No.	C10196
description	burner cap 3kW ø 100mm H 6mm matt finish		

accessories for 105122



GEV No.	105120	Ref. No.	C10046
description burner lower part 3kW for igniter ø 7mm for thermocouple ø 6mm with nozzle ø1.15mm for burner cap ø 100mm			



GEV No.	105121	Ref. No.	C10045
description burner head 3kW for igniter ø 7.5mm for burner cap ø 100mm			



1

GEV No.	105121	Ref. No.	C10045
description	burner head 3kW for igniter ø 7.5mm for burner cap ø 100mm		

accessories for 105121



GEV No.	105120	Ref. No.	C10046
description burner lower part 3kW for igniter ø 7mm for thermocouple ø 6mm with nozzle ø1.15mm for burner cap ø 100mm			



GEV No.	105122	Ref. No.	C10196
description burner cap 3kW ø 100mm H 6mm matt finish			

2 series - flat skirt version



1

GEV No.	105120	Ref. No.	C10046
----------------	--------	-----------------	--------

description burner lower part 3kW for igniter ø 7mm for thermocouple ø 6mm with nozzle ø1.15mm for burner cap ø 100mm

accessories for 105120

	GEV No.	105121	Ref. No.	C10045
description burner head 3kW for igniter ø 7.5mm for burner cap ø 100mm				

	GEV No.	105122	Ref. No.	C10196
description burner cap 3kW ø 100mm H 6mm matt finish				

triple ring burner series - standard version



1

GEV No.	105125	Ref. No.	C10197
----------------	--------	-----------------	--------

description burner cap 3.6kW ø 131mm H 7mm mounting pos. outer

accessories for 105125

	GEV No.	105123	Ref. No.	C10049
description burner lower part 3.6kW for igniter ø 7mm for thermocouple ø 6mm with nozzle ø1.35mm ID ø 75mm for burner cap ø 61/131mm				

	GEV No.	105124	Ref. No.	C10048
description burner head 3.6kW for burner cap ø 61/131mm				

	GEV No.	105126	Ref. No.	C10198
description burner cap 3.6kW ø 61mm H 9mm mounting pos. inner matt finish				











Зип-Общепит





the following burner series flat skirt version





vsezip.ru





+7(812)987-08-81

			
GEV No.	105126	Ref. No.	C10198
description	burner cap 3.6kW ø 61mm H 9mm mounting pos. inner matt finish		
accessories for	105126		
	GEV No.	105123	Ref. No. C10049
	GEV No.	105124	Ref. No. C10048
	GEV No.	105125	Ref. No. C10197
description	burner cap 3.6kW ø 131mm H 7mm mounting pos. outer		

			
GEV No.	105125	Ref. No.	C10197
description	burner cap 3.6kW ø 131mm H 7mm mounting pos. outer		
accessories for	105125		
	GEV No.	105123	Ref. No. C10049
	GEV No.	105124	Ref. No. C10048
	GEV No.	105126	Ref. No. C10198
description	burner cap 3.6kW ø 61mm H 9mm mounting pos. inner matt finish		

			
GEV No.	105124	Ref. No.	C10048
description	burner head 3.6kW for burner cap ø 61/131mm		
accessories for	105124		
	GEV No.	105123	Ref. No. C10049
	GEV No.	105125	Ref. No. C10197
	GEV No.	105126	Ref. No. C10198
description	burner cap 3.6kW ø 61mm H 9mm mounting pos. inner matt finish		

			
GEV No.	105126	Ref. No.	C10198
description	burner cap 3.6kW ø 61mm H 9mm mounting pos. inner matt finish		
accessories for	105126		
	GEV No.	105123	Ref. No. C10049
	GEV No.	105124	Ref. No. C10048
	GEV No.	105125	Ref. No. C10197
description	burner cap 3.6kW ø 131mm H 7mm mounting pos. outer		

			
GEV No.	105123	Ref. No.	C10049
description	burner lower part 3.6kW for igniter ø 7mm for thermocouple ø 6mm with nozzle ø1.35mm ID ø 75mm for burner cap ø 61/131mm		
accessories for	105123		
	GEV No.	105124	Ref. No. C10048
	GEV No.	105125	Ref. No. C10197
	GEV No.	105126	Ref. No. C10198
description	burner cap 3.6kW ø 61mm H 9mm mounting pos. inner matt finish		

			
GEV No.	105123	Ref. No.	C10049
description	burner lower part 3.6kW for igniter ø 7mm for thermocouple ø 6mm with nozzle ø1.35mm ID ø 75mm for burner cap ø 61/131mm		
accessories for	105123		
	GEV No.	105124	Ref. No. C10048
	GEV No.	105125	Ref. No. C10197
	GEV No.	105126	Ref. No. C10198
description	burner cap 3.6kW ø 61mm H 9mm mounting pos. inner matt finish		

1 gas components



producer-specific hob burners

EMMEPI

Snack series



1

GEV No.	105125	Ref. No.	C10197
description	burner cap 3.6kW ø 131mm H 7mm mounting pos. outer		
accessories for	105125		
	GEV No.	105123	Ref. No. C10049
	GEV No.	105124	Ref. No. C10048
	GEV No.	105126	Ref. No. C10198



1

GEV No.	105126	Ref. No.	C10198
description	burner cap 3.6kW ø 61mm H 9mm mounting pos. inner matt finish		
accessories for	105126		
	GEV No.	105123	Ref. No. C10049
	GEV No.	105124	Ref. No. C10048
	GEV No.	105125	Ref. No. C10197



1

GEV No.	105122	Ref. No.	C10196
description	burner cap 3kW ø 100mm H 6mm matt finish		
accessories for	105122		
	GEV No.	105120	Ref. No. C10046
	GEV No.	105121	Ref. No. C10045



1

GEV No.	105124	Ref. No.	C10048
description	burner head 3.6kW for burner cap ø 61/131mm		
accessories for	105124		
	GEV No.	105123	Ref. No. C10049

accessories for 105124

	GEV No.	105125	Ref. No.	C10197
	GEV No.	105126	Ref. No.	C10198



1

GEV No.	105121	Ref. No.	C10045
description	burner head 3kW for igniter ø 7.5mm for burner cap ø 100mm		
accessories for	105121		
	GEV No.	105120	Ref. No. C10046
	GEV No.	105122	Ref. No. C10196



1

GEV No.	105123	Ref. No.	C10049
description	burner lower part 3.6kW for igniter ø 7mm for thermocouple ø 6mm with nozzle ø 1.35mm ID ø 75mm for burner cap ø 61/131mm		
accessories for	105123		
	GEV No.	105124	Ref. No. C10048
	GEV No.	105125	Ref. No. C10197
	GEV No.	105126	Ref. No. C10198



1

GEV No.	105120	Ref. No.	C10046
description	burner lower part 3kW for igniter ø 7mm for thermocouple ø 6mm with nozzle ø 1.15mm for burner cap ø 100mm		
accessories for	105120		
	GEV No.	105121	Ref. No. C10045
	GEV No.	105122	Ref. No. C10196





Зип Общепит
vsezip.ru

+7(812)987-08-81



700 Daga series



1



GEV No.	105137	Ref. No.	C10285
description	burner cap ø 100mm 5kW		
accessories for	105137		
	GEV No.	105136	Ref. No. C89437
	burner head for burner cap ø 100mm 5kW		
	GEV No.	105138	Ref. No. C10274
	burner holder for burner cap ø 100mm 5kW		



GEV No.	105139	Ref. No.	C89438
description	burner head for burner cap ø 70mm 3kW		
accessories for	105139		
	GEV No.	105140	Ref. No. C10284
	burner cap ø 70mm 3kW		
	GEV No.	105141	Ref. No. C10273
	burner holder for burner cap ø 70mm 3kW		





1

GEV No.	105140	Ref. No.	C10284
description	burner cap ø 70mm 3kW		
accessories for	105140		
	GEV No.	105139	Ref. No. C89438
	burner head for burner cap ø 70mm 3kW		
	GEV No.	105140	Ref. No. C10284
	burner cap ø 70mm 3kW		



1

GEV No.	105138	Ref. No.	C10274
description	burner holder for burner cap ø 100mm 5kW		
accessories for	105138		
	GEV No.	105136	Ref. No. C89437
	burner head for burner cap ø 100mm 5kW		
	GEV No.	105137	Ref. No. C10285
	burner cap ø 100mm 5kW		





1

GEV No.	105136	Ref. No.	C89437
description	burner head for burner cap ø 100mm 5kW		
accessories for	105136		
	GEV No.	105137	Ref. No. C10285
	burner cap ø 100mm 5kW		
	GEV No.	105138	Ref. No. C10274
	burner holder for burner cap ø 100mm 5kW		



1

GEV No.	105141	Ref. No.	C10273
description	burner holder for burner cap ø 70mm 3kW		
accessories for	105141		
	GEV No.	105139	Ref. No. C89438
	burner head for burner cap ø 70mm 3kW		
	GEV No.	105140	Ref. No. C10284
	burner cap ø 70mm 3kW		

700 Professional, 900 Classica series



1

GEV No.	107539	Ref. No.	C00108
description	air mixing tube L 58mm D1 ø 16mm D2 ø 19mm ID ø 14mm aluminium		



Зип Общепит



vsezip.ru



+7(812)987-08-81

			
1			
GEV No.	107540	Ref. No.	C00109
description	air mixing tube L 58mm D1 ø 20mm D2 ø 24.5mm ID ø 17.6mm aluminium		





			
1			
GEV No.	104649	Ref. No.	C00110
description	air mixing tube L 83mm D1 ø 28mm D2 ø 32mm ID ø 24.5mm brass		

			
1			
GEV No.	105128	Ref. No.	C00457
description	burner cap ø 100mm 5.5kW		
accessories for	105128		
	GEV No.	105127	Ref. No. C99637
	burner head for burner cap ø 100mm 5.5kW		
	GEV No.	105129	Ref. No. C00011 C00815
	burner holder for burner cap ø 100mm 5.5kW		

			
1			
GEV No.	105134	Ref. No.	C00458
description	burner cap ø 120mm 7.5kW with central hole		
accessories for	105134		
	GEV No.	105133	Ref. No. C99638 C99638 + 511120104
	burner head for burner cap ø 120mm 7.5kW		
	GEV No.	105135	Ref. No. C00012 C00816
	burner holder for burner cap ø 120mm 7.5kW		

			
1			
GEV No.	105131	Ref. No.	C00456
description	burner cap ø 70mm 3.5kW		
accessories for	105131		
	GEV No.	105130	Ref. No. C99636
	burner head for burner cap ø 70mm 3.5kW		
	GEV No.	105132	Ref. No. C00010 C00814
	burner holder for burner cap ø 70mm 3.5kW		

			
1			
GEV No.	105127	Ref. No.	C99637
description	burner head for burner cap ø 100mm 5.5kW		
accessories for	105127		
	GEV No.	105128	Ref. No. C00457
	burner cap ø 100mm 5.5kW		
	GEV No.	105129	Ref. No. C00011 C00815
	burner holder for burner cap ø 100mm 5.5kW		
	GEV No.	107540	Ref. No. C00109
	air mixing tube L 58mm D1 ø 20mm D2 ø 24.5mm ID ø 17.6mm aluminium		

			
1			
GEV No.	105133	Ref. No.	C99638 C99638 + 511120104
description	burner head for burner cap ø 120mm 7.5kW		
spare parts for	105133		
	GEV No.	104649	Ref. No. C00110
	air mixing tube L 83mm D1 ø 28mm D2 ø 32mm ID ø 24.5mm brass		
	GEV No.	560366	Ref. No. C00513
	grub screw thread M6 L 20mm SS intake internal hexagon WS 3 Qty 1 pcs		
accessories for	105133		
	GEV No.	105134	Ref. No. C00458
	burner cap ø 120mm 7.5kW with central hole		
	GEV No.	105135	Ref. No. C00012 C00816
	burner holder for burner cap ø 120mm 7.5kW		



			
1			
GEV No.	105130	Ref. No.	C99636
description	burner head for burner cap ø 70mm 3.5kW		
accessories for	105130		
	GEV No.	105131	Ref. No. C00456
	burner cap ø 70mm 3.5kW		
	GEV No.	105132	Ref. No. C00010 C00814
	burner holder for burner cap ø 70mm 3.5kW		

Table continues overleaf



Зип Общепит



parts supplies

vsezip.ru



+7(812)987-08-81

accessories for	105130		
	GEV No.	107539	Ref. No. C00108
	air mixing tube L 58mm D1 ø 16mm D2 ø 19mm ID ø 14mm aluminium		



	1		
GEV No.	105129	Ref. No.	C00011 C00815
description	burner holder for burner cap ø 100mm 5.5kW		

accessories for	105129		
	GEV No.	105127	Ref. No. C99637
	burner head for burner cap ø 100mm 5.5kW		
	GEV No.	105128	Ref. No. C00457
	burner cap ø 100mm 5.5kW		

	1		
GEV No.	105135	Ref. No.	C00012 C00816
description	burner holder for burner cap ø 120mm 7.5kW		

accessories for	105135		
	GEV No.	105133	Ref. No. C99638 C99638 + 511120104
	burner head for burner cap ø 120mm 7.5kW		
	GEV No.	105134	Ref. No. C00458
	burner cap ø 120mm 7.5kW with central hole		

	1		
GEV No.	105132	Ref. No.	C00010 C00814
description	burner holder for burner cap ø 70mm 3.5kW		

accessories for	105132		
	GEV No.	105130	Ref. No. C99636
	burner head for burner cap ø 70mm 3.5kW		
	GEV No.	105131	Ref. No. C00456
	burner cap ø 70mm 3.5kW		

	1		
GEV No.	210030	Ref. No.	C00859
description	pan support W 313mm L 390mm H 47mm suitable for EMMEPI		

accessories	pan supports		
	1		
GEV No.	210030	Ref. No.	C00859
description	pan support W 313mm L 390mm H 47mm suitable for EMMEPI		

simmering plates	1		
	1		
GEV No.	109723	Ref. No.	100083
description	simmer plate L 365mm W 355mm		

bar burners	1		
	1		
GEV No.	105788	Ref. No.	809328
description	bar burner 1-row ø 50mm Wmm Hmm L 483mm flange width 71mm convection oven flange ø 75mm		

1 gas components





Зип Общежит

vsezip.ru

+7(812)987-08-81

gas components

			
1			
GEV No.	105687	Ref. No.	8C2060
description	bar burner 2 row L 370mm W 220mm ømm H 50mm chargrill		

			
1			
GEV No.	105326	Ref. No.	C00082+C00083+C00290 C99716
description	bar burner 4 row L 440mm W 300mm ømm H 50mm solid top		

			
1			
GEV No.	105323	Ref. No.	C10074+C10060+C00290 C89456
description	bar burner 2 row L 390mm W 160mm ømm H 50mm solid top		

			
1			
GEV No.	105312	Ref. No.	C10076+C10060+C00290 C89435 C89435+C10060+C00290
description	bar burner 4 row L 460mm W 545mm ømm H 40mm oven		

			
1			
GEV No.	105320	Ref. No.	C89458
description	bar burner 2 row L 950mm W 180mm ømm H 50mm		

			
1			
GEV No.	105321	Ref. No.	C00886 C89436
description	bar burner angled L 524mm W 243mm ømm H 5.8kW oven		

			
1			
GEV No.	105311	Ref. No.	809388
description	bar burner 3 row L 370mm W 345mm ømm H 145mm chargrill		

			
1			
GEV No.	105325	Ref. No.	C00885 C99724
description	bar burner angled L 625mm W 250mm ømm H oven		

			
1			
GEV No.	105327	Ref. No.	C0080+C00111+C00290 C99717
description	bar burner 3 row L 490mm W 240mm ømm H 60mm grill		

			
1			
GEV No.	105328	Ref. No.	C99711
description	bar burner ø 25mm Wmm Hmm L 520mm bain marie		

			
1			
GEV No.	105319	Ref. No.	809467
description	bar burner 4 row L 390mm W 270mm ømm H 60mm kettle		

			
1			
GEV No.	105718	Ref. No.	8C1040
description	bar burner ø 40mm Wmm Hmm L 395mm flange ø 61mm tilting bratt pan		

			
1			
GEV No.	105324	Ref. No.	C10077+C10060+C00290 C89457
description	bar burner 4 row L 425mm W 470mm ømm H 50mm 9kW grill		





Зип Общепит

vsezip.ru

+7(812)987-08-81

			
1			
GEV No.	105330	Ref. No.	808738
description	bar burner ø 40mm Wmm Hmm L 500mm mounting thread with bolt M5x12 flange width 43mm flange length 43mm bain marie		

			
1			
GEV No.	105314	Ref. No.	808417
description	tubular burner L 295mm W 55mm H 70mm 4.7kW mounting pos. centre oval		

			
1			
GEV No.	105310	Ref. No.	808726 809434
description	bar burner ø 60mm Wmm Hmm L 260mm flange width 67mm flange length 67mm pasta cooker		

			
1			
GEV No.	105313	Ref. No.	808419
description	tubular burner L 295mm W 55mm H 70mm 4.7kW mounting pos. left oval		

			
1			
GEV No.	105317	Ref. No.	808434
description	bar burner ø 60mm Wmm Hmm L 388mm flange width 67mm flange length 67mm		

			
1			
GEV No.	105329	Ref. No.	808418
description	tubular burner L 295mm W 55mm H 70mm 4.7kW mounting pos. right oval		

tube burners

			
1			
GEV No.	105315	Ref. No.	809428
description	tubular burner L 170mm W 55mm H 70mm 3.8kW mounting pos. left oval		

gas nozzles

main nozzles

gas nozzles M10x1

			
1			
GEV No.	106466	Ref. No.	809960
description	gas injector thread M10x1 WS 12 bore ø 1.15mm		

			
1			
GEV No.	105316	Ref. No.	809429
description	tubular burner L 170mm W 55mm H 70mm 3.8kW mounting pos. right oval		

gas nozzles M12x1

			
1			
GEV No.	106266	Ref. No.	C00112
description	gas injector thread M12x1 WS 13 bore ø 0.81mm		

1 gas components



Зип Общепит

vsezip.ru

+7(812)987-08-81

1 gas components



1

GEV No.	106674	Ref. No.	C00113
description	gas injector thread M12x1 WS 13 bore ø 0.95mm		



1

GEV No.	106267	Ref. No.	C00114
description	gas injector thread M12x1 WS 13 bore ø 1.05mm		



1

GEV No.	107791	Ref. No.	C00525
description	gas injector thread M12x1 WS 13 bore ø 1.15mm		



1

GEV No.	106423	Ref. No.	C00116
description	gas injector thread M12x1 WS 13 bore ø 1.25mm		



1

GEV No.	106268	Ref. No.	C00115
description	gas injector thread M12x1 WS 13 bore ø 1.2mm		



1

GEV No.	107785	Ref. No.	C00117
description	gas injector thread M12x1 WS 13 bore ø 1.35mm		

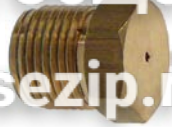

1

GEV No.	106857	Ref. No.	C00804
description	gas injector thread M12x1 WS 13 bore ø 1.3mm		



1

GEV No.	106856	Ref. No.	C00536
description	gas injector thread M12x1 WS 13 bore ø 1.7mm		



1

GEV No.	100282	Ref. No.	C00113
description	gas injector thread M12x1 WS 14 bore ø 0.95mm		

pilot burner nozzles

pilot burner nozzles POLIDORO



1

GEV No.	100208	Ref. No.	512120005 512120010 C00170
description	pilot burner nozzle POLIDORO LPG code 20 bore ø 0.2mm Qty 1 pcs		



1

GEV No.	106703	Ref. No.	512120007
description	pilot burner nozzle POLIDORO natural gas code 27.2 bore ø 2x0.27mm Qty 1 pcs		

pilot burner nozzles SIT

100 series



1

GEV No.	100245	Ref. No.	8C0030
description	pilot burner nozzle LPG code 20 bore ø 0.2mm Qty 1 pcs thread M8x0.75		



Зип Общепит

vsezip.ru

+7(812)987-08-81

1	
GEV No.	100246
Ref. No.	8C0031
description	pilot burner nozzle natural gas bore ø 0.35mm Qty 1 pcs thread M8x0.75

1	
GEV No.	107170
Ref. No.	8C0031
description	pilot burner nozzle SIT natural gas bore ø 0.35mm Qty 1 pcs

140/150 series

1	
GEV No.	100204
Ref. No.	8C0955
description	pilot burner nozzle SIT LPG code 14 bore ø 0.18/0.20mm Qty 1 pcs suitable for 140 series

1	
GEV No.	100205
Ref. No.	809996
description	pilot burner nozzle SIT LPG code 19 bore ø 0.23/0.26mm Qty 1 pcs suitable for SIT 150 series

1	
GEV No.	100207
Ref. No.	8C1497
description	pilot burner nozzle SIT natural gas code 27 bore ø 0.40/0.38mm suitable for SIT 140 series

1	
GEV No.	100206
Ref. No.	809994
description	pilot burner nozzle SIT natural gas code 36 bore ø 0.60/0.55mm Qty 1 pcs suitable for SIT 150 series

160 series



1	
GEV No.	107650
Ref. No.	808365
description	pilot burner nozzle SIT LPG code 30 Qty 1 pcs

1	
GEV No.	107175
Ref. No.	808364
description	pilot burner nozzle SIT natural gas code 51 Qty 1 pcs suitable for 160 series

auxiliary gas parts

screw connections

olives

1	
GEV No.	101248
Ref. No.	8C0412
description	olive for pipe ø 12mm Qty 1 pcs suitable for PEL
accessories for	101248
	GEV No. 101251 Ref. No. —
	union nut thread M20x1.5 for pipe ø 12mm

1	
GEV No.	100870
Ref. No.	830885
description	olive for pipe ø 4mm Qty 1 pcs suitable for 160 series for pilot burner

union screws

1	
GEV No.	100905
Ref. No.	8C0070
description	locking screw M10x1 for pipe ø 6mm Qty 1 pcs







1	
GEV No.	100908
Ref. No.	806019
description	union screw thread M10x1 for pipe ø 4mm Qty 1 pcs
accessories for	100908
	GEV No. 100897 Ref. No. —
	olive for pipe ø 4mm Qty 1 pcs for pilot burner
	GEV No. 101246 Ref. No. —
	olive for pipe ø 4mm Qty 1 pcs
	GEV No. 101280 Ref. No. —
	olive for pipe ø 4mm Qty 1 pcs

Table continues overleaf

accessories for	100908		
	GEV No.	101282	Ref. No.
			—
olive for pipe ø 4mm L 7.4mm Qty 1 pcs			

drive shafts

for blades

1 

GEV No.	698292	Ref. No.	808559
description	drive shaft ENTERPRISE model 12 ø 9.5mm L 67mm thread M12x1.75 D1 ø 18mm thread L 698mm		

equipment-specific units

for slicers

hand guard



1

GEV No.	698196	Ref. No.	808991
description	hand protection for carriage 275-300 H 220mm W 150mm thickness 4mm hole ø 6mm mounting distance 88mm		

food holders

handles



1

GEV No.	111123	Ref. No.	808764
description	handle thread M10 IT ø 30mm L 110mm D1 ø 65mm		

for bandsaws

saw blades

width 20mm



1

GEV No.	699083	Ref. No.	807993
description	saw blade L 1800mm W 20mm thickness 0.5mm tooth spacing 6mm		

for meat mincers

gear wheels



1

GEV No.	698286	Ref. No.	808554
description	gear wheel ø 64mm shaft intake ø 16mm teeth 40 splitting tooth width 13mm DIN/ISO groove width 0mm		

blades

ENTERPRISE



1

GEV No.	696023	Ref. No.	809654 8C1342
description	knife type ENTERPRISE size 22 ø 73mm internal size 13x13mm stainless steel		

augers

complete



1

GEV No.	698282	Ref. No.	808651
description	auger model 12 ø 54mm L 150mm stainless steel with spindle ENTERPRISE		

for vegetable slicers

ejector discs



1

GEV No.	699016	Ref. No.	808636
description	ejector disc high H 25mm ø 200mm seat ø 21mm hole distance 40mm		

for potato peelers

abrasive side elements

grinding discs



1

GEV No.	696201	Ref. No.	809309
description	grating disc ø 280mm potato peeler PP4-PP8 Expo		



1

GEV No.	696377	Ref. No.	809399 8C0950
description	grating disc ø 350mm for potato peeler device		

for ice-cube maker

floats

float containers



1

GEV No.	695072	Ref. No.	8C0072
description	float container for ice maker with microswitch plastic		

for deep fryers

door magnets



1

GEV No.	690524	Ref. No.	808161 C00247
description	door magnet L 87mm W 18mm H 15mm mounting distance 73mm for folding door hinge		

Зип Общежит

miscellaneous



1

GEV No.	550449	Ref. No.	808893
description	special wrench for ring nut		



1

GEV No.	550448	Ref. No.	808894
description	tubular box wrench special for fryer L 280mm WS 10		

for convection ovens/combi-steamers

glass panels



1

GEV No.	694847	Ref. No.	8C1724
description	glass panel L 673mm W 510mm H 5mm		

air filters



1

GEV No.	692695	Ref. No.	809502
description	filter insert L 213mm W 60mm ømm H 90mm		

miscellaneous



1

GEV No.	512184	Ref. No.	809567
description	hose connector plastic thread 3/4" Qty 1 pcs connection distance 60mm T-shape		

for tilting bratt pans

miscellaneous



1

GEV No.	523510	Ref. No.	EC1110002
description	deep-groove ball bearing type 6202-2RS shaft \varnothing 15mm ED \varnothing 35mm W 11mm with sealing discs deep-groove ball bearing DIN 625-1		

for boiling pans

level glasses

complete



1

GEV No.	540706	Ref. No.	808704
description	level glass hole distance 76mm mounting thread M10 L 107mm W 28mm plastic/SS for kettle model ELESA HCX-76-BW-SST		

for pizza ovens

glass panels



1

GEV No.	700205	Ref. No.	808440
description	glass panel L 320mm W 100mm thickness 5mm rectangular		

for dishwashers

boilers

boilers for dishwashers



1

GEV No.	519022	Ref. No.	900353
description	boiler \varnothing 150mm L 400mm		

backflow preventers

backflow preventers



1

GEV No.	504140	Ref. No.	907460
description	backflow preventer		

miscellaneous



1

GEV No.	506160	Ref. No.	8C0647
description	plain washer ID \varnothing 8.6mm ED \varnothing 16mm thickness 1.5mm SS Qty 1 pcs		

door mechanics

rollers



1

GEV No.	501431	Ref. No.	8C1472
description	roller ED \varnothing 9mm for door mechanism shaft diameter 3.5mm W 5mm		

+7(812)987-08-81

Зип-Общепит

vsezip.ru



Зип-Общепит

vsezip.ru

+7(812)987-08-81

locks





1

GEV No.	511083	Ref. No.	809676
description	counterpart door catch		



1

GEV No.	511082	Ref. No.	809675	
description	door catch complete catch			
accessories for	511082			
	GEV No.	511083	Ref. No.	809676
	counterpart door catch			



1

GEV No.	519247	Ref. No.	906113	
description	door catch door locking catch			
accessories for	519247			
	GEV No.	519050	Ref. No.	—
	nut thread M12x1.75 H 4mm WS 16 SS Qty 1 pcs for snap lock			

miscellaneous



1

GEV No.	524047	Ref. No.	8C1197
description	hauling cable for door mechanism ø 1.5mm L 475mm		

curtains



1

GEV No.	533016	Ref. No.	TR0460
description	curtain W 640mm H 410mm plastic thickness 1.5mm warewashing		

universal knobs



1

GEV No.	110811	Ref. No.	C99683
description	knob gas tap with ignition flame ø 70mm shaft ø 10x8mm shaft flat universal black/silver		



1

GEV No.	110817	Ref. No.	C98971
description	knob switch 7-position ø 70mm shaft ø 6x4.6mm shaft flat universal black/silver		



1

GEV No.	110816	Ref. No.	C99704
description	knob thermostat t.max. 90°C 30-90°C ø 70mm shaft ø 6x4.6mm shaft flat universal black/silver rotation 270°		

producer-specific knobs

EMMEPI



1

GEV No.	110810	Ref. No.	C89433 C89459
description	knob gas tap without ignition flame ø 75mm shaft ø 8x6.5mm shaft flat upper black		

Зип Общепит

vsezip.ru

+7(812)987-08-81

			
1			
GEV No.	110812	Ref. No.	C99698
description	knob gas thermostat 1-8 ø 75mm shaft ø 10x8mm shaft flat lower		

			
1			
GEV No.	110813	Ref. No.	C99707
description	knob switch 0-1 ø 75mm shaft ø 6x4.6mm shaft flat upper black		

			
1			
GEV No.	110818	Ref. No.	C99695
description	knob switch 7-position ø 75mm shaft ø 6x4.6mm shaft flat upper black		

			
1			
GEV No.	110819	Ref. No.	C99692
description	knob thermostat t.max. 110°C ø 75mm shaft ø 6x4.6mm shaft flat upper black temperature range 30-110°C rotation 270°		

			
1			
GEV No.	110815	Ref. No.	C99686
description	knob thermostat t.max. 200°C 150-200°C ø 76mm shaft ø 6x4.6mm shaft flat upper black temperature range 150-200°C		

			
1			
GEV No.	110814	Ref. No.	C99639
description	knob thermostat t.max. 250°C 100-250°C ø 75mm shaft ø 6x4.6mm shaft flat upper black rotation 270°		

accessories

button springs

			
1			
GEV No.	550132	Ref. No.	C00196
description	knob spring ø 6x4.6mm Qty 10 pcs		

handles and hand wheels

hand wheels

hand wheels

			
1			
GEV No.	540715	Ref. No.	C00248
description	hand wheel ø 200mm bore ø 16mm		

			
1			
GEV No.	690609	Ref. No.	C00248
description	hand wheel ø 200mm D1 ø 50mm bore ø 16mm thread groove width-mm L1 28mm L2 55mm handle length 85mm with folding handle		
spare parts for	690609		
	GEV No.	514255	Ref. No.
			
	folding handle ø 26mm total length 85mm seat ø 20mm shaft ø 6mm thread M6 with pin L 85mm		



cylindrical handles

fixed



1			
GEV No.	540713	Ref. No.	809039
description	cylindrical handle thread M8 ø 17mm L 38mm		

levers

without handle



1			
GEV No.	540712	Ref. No.	809038
description	lever		

locks

edgmount latches

handle latches

CAFF/FERMOD

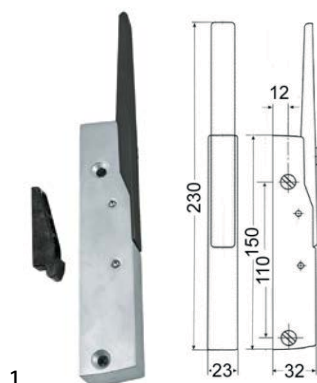

1			
GEV No.	690454	Ref. No.	8C2082
description	handle latch L 150mm mounting distance 110mm matt chrome-plated/Rilsan non lockable heated units 560 black complete with door catch		
spare parts for	690454		
	GEV No.	690429	Ref. No.
			—
	door catch CT 25.5mm		
accessories for	690454		
	GEV No.	690428	Ref. No.
			—
	door catch H 51mm W 13.9mm mounting distance 30mm plastic CT 16.5mm		
	GEV No.	690445	Ref. No.
			—
	base plate H 2mm		

Зип Общепит

vsezip.ru

+7(812)987-08-81

accessories for	690454		
GEV No.	690446	Ref. No.	—
	base plate H 5mm L 56mm W 18mm		

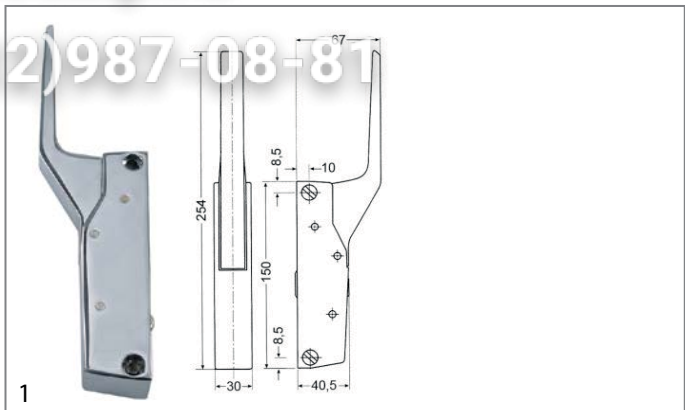

1			
GEV No.	700060	Ref. No.	9629921
description	handle latch L 150mm mounting distance 133mm non lockable heated units G 791		
accessories for	700060		
	GEV No.	700061	Ref. No.
			8C0315
	door catch L 58mm W 20mm H 35mm mounting distance 42mm chrome-plated brass for headed units		
	GEV No.	700062	Ref. No.
			—
	handle protection heated units		

door catches

1			
GEV No.	700061	Ref. No.	8C0315
description	door catch L 58mm W 20mm H 35mm mounting distance 42mm chrome-plated brass for headed units		
accessories for	700061		
	GEV No.	690414	Ref. No.
			—
	handle latch L 150mm mounting distance 133mm non lockable refrigeration units G 791		

1			
GEV No.	700435	Ref. No.	809875 8C0315
description	door catch L 58mm W 20mm H 35mm mounting distance 42mm zamak for refrigeration units		

snap locks

universal



1	GEV No.	690596	Ref. No.	131110006
description snap lock L 60mm W 15mm H 36mm mounting distance 48/28mm spring thickness 1.5mm complete with door catch zamak				

miscellaneous



1	GEV No.	511482	Ref. No.	809708
description pressure pin L 52mm thread M10x1.5				

hinges

oven hinges



1	GEV No.	690535	Ref. No.	C00132
description opposite support				

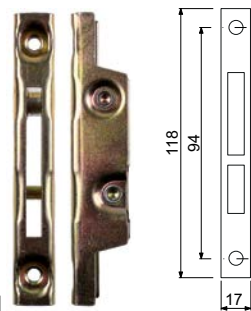

1	GEV No.	700001	Ref. No.	C00132
description opposite support L 118mm W 17mm mounting distance 94mm				

Зип Общепит

vsezip.ru

+7(812)987-08-81



1	GEV No.	690532	Ref. No.	C00131
description oven hinge left				

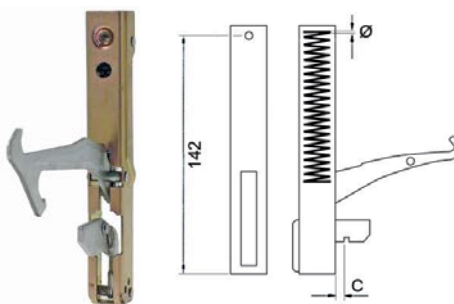

1	GEV No.	700433	Ref. No.	132110006
description oven hinge mounting distance 142mm mounting distance 2mm lug mountingmm lever length 100mm groove distance 14mm spring thickness 4mm mounting ear position spring length 55mm L 155mm mounting pos. left/right				

accessories for 700433				
	GEV No.	700434	Ref. No.	—
opposite support oven hinge				



1	GEV No.	700006	Ref. No.	C00130
description oven hinge mounting distance 173mm mounting distance 2 105mm lug mounting 14mm lever length 120mm groove distance 11mm spring thickness 3.5mm mounting ear position left spring length 112mm W 25mm				

accessories for 700006				
	GEV No.	700001	Ref. No.	C00132
opposite support L 118mm W 17mm mounting distance 94mm				

	GEV No.	700007	Ref. No.	C00131
oven hinge mounting distance 173mm mounting distance 2 105mm lug mounting 14mm lever length 120mm groove distance 11mm spring thickness 3.5mm mounting ear position right spring length 112mm W 25mm				

Зип Общепит

vsezip.ru

+7(812)987-08-81

1

GEV No.	700007	Ref. No.	C00131
description	oven hinge mounting distance 173mm mounting distance 2 105mm lug mounting 14mm lever length 120mm groove distance 11mm spring thickness 3.5mm mounting ear position right spring length 112mm W 25mm		
accessories for	700007		
	GEV No.	Ref. No.	C00132
	opposite support L 118mm W 17mm mounting distance 94mm		

1

GEV No.	690533	Ref. No.	C10079
description	oven hinge mounting distance 173mm mounting distance 2 105mm lug mounting 14mm lever length 120mm groove distance 11mm spring thickness 4mm mounting ear position left spring length 112mm L 206mm W 25mm		

1

GEV No.	690534	Ref. No.	C10080
description	oven hinge mounting distance 173mm mounting distance 2 105mm lug mounting 14mm lever length 120mm groove distance 11mm spring thickness 4mm mounting ear position right spring length 112mm L 206mm W 25mm		

door bearing

1

GEV No.	690523	Ref. No.	C98973
description	hinge bearing mounting pos. bottom left with bolt		

1

GEV No.	690526	Ref. No.	809412
description	hinge bearing mounting pos. bottom left/upper right with bolt		

1

GEV No.	690527	Ref. No.	809400
description	hinge bearing mounting pos. bottom right with bolt		

1

GEV No.	690522	Ref. No.	C98974
description	hinge bearing mounting pos. upper left with bolt		

1

GEV No.	690530	Ref. No.	809403
description	hinge bearing mounting pos. upper left with bolt		

1

GEV No.	514309	Ref. No.	8C1386
description	hinge bearing mounting pos. upper left without bolt		

1

GEV No.	690525	Ref. No.	809411
description	hinge bearing mounting pos. upper left/bottom right with bolt		

Зип Общепит

vsezip.ru

+7(812)987-08-81

			
1			
GEV No.	690521	Ref. No.	C98975
description	hinge bearing mounting pos. upper right with bolt		



			
1			
GEV No.	690528	Ref. No.	809401
description	hinge bearing mounting pos. upper right with bolt		

fittings for catering equipment

outlet taps

producer-specific

EMMEPI

			
1			
GEV No.	540700	Ref. No.	808037 808037+808432
description	ball valve straight thread 1/2" IT - 1/2" IT connection 1/2" mounting pos. total length 64mm shaft intake ø 9x7.5mm 1/2" rosette thread G2 3/8" total length 64mm		
spare parts for	540700		
	GEV No.	540701	Ref. No. 808432
	lever handle plastic L 65mm H 40mm thread connection 9x7.5		

			
1			
GEV No.	540701	Ref. No.	808432
description	lever handle plastic L 65mm H 40mm thread connection 9x7.5		

			
GEV No.	540776	Ref. No.	809040
description	outlet tap L 83mm without handle thread 3/4" IT shaft L 9mm shaft ø 10x7.3mm handle M6		
spare parts for	540776		
	GEV No.	532453	Ref. No. —
	O-ring EPDM thickness 2.62mm ID ø 21.89mm Qty 1 pcs		
accessories for	540776		
	GEV No.	514006	Ref. No. 808931
	drain pipe L 200mm thread ø 22mm		
	GEV No.	514217	Ref. No. —
	handle for outlet tap		
	GEV No.	540651	Ref. No. —
	drain pipe total length 210mm shaft ø 22mm		
	GEV No.	540734	Ref. No. —
	drain pipe thread		
	GEV No.	693082	Ref. No. —
	lever handle thread		

aerators and air bleeders

			
1			
GEV No.	540827	Ref. No.	809385
description	aerator and air bleeder thread 3/4" ET chrome-plated L 45mm ø 36mm		



inlet taps

Зип Общепит

vsezip.ru

+7(812)987-08-81



1

GEV No.	514048	Ref. No.	C10510+224110004
description	ball valve connection 1/2" complete total length 55mm mounting pos. any brass H 30mm L 55mm rosette ø 70mm rosette thread G2 M22x1		
spare parts for	514048		
	GEV No.	540871	Ref. No. —
	lever handle cold water suitable for intake tap		



1

GEV No.	540134	Ref. No.	806172
description	drain tap 2" IT fixed A 115mm B1 90mm B2 165mm chrome-plated brass		
spare parts for	540134		
	GEV No.	540214	Ref. No. —
	handle ID ø 6mm L 145mm		
	GEV No.	540462	Ref. No. —
	ring for drain tap		
	GEV No.	540465	Ref. No. —
	nut for drain tap thread 2 3/4"		
accessories for	540134		
	GEV No.	529484	Ref. No. —
	flat gasket fibre ED ø 58mm ID ø 50mm thickness 2mm Qty 1 pcs		

drain taps

brass

drain taps



1

GEV No.	540131	Ref. No.	808350
description	drain tap 1 1/4" IT chrome-plated brass		
spare parts for	540131		
	GEV No.	540213	Ref. No. —
	handle ID ø 5mm L 117mm		
	GEV No.	540461	Ref. No. —
	shim for drain tap		
	GEV No.	540464	Ref. No. —
	nut for drain tap thread 1 1/2"		

safety valves



1

GEV No.	540708	Ref. No.	809470
description	safety valve		

equipment feet and end caps

bullet feet

zamak/SS



1

GEV No.	700112	Ref. No.	819841
description	equipment foot pipe type 40x40 thickness 1mm H 33-60mm Zamak/SS Qty 1 pcs		

screw-in feet



1

GEV No.	802136	Ref. No.	E6111092
description	equipment foot thread M8 thread L 15mm ø 47mm H 40mm		

baskets

fryer baskets

EMMEPI



1

GEV No.	970577	Ref. No.	808182
description	fryer basket L1 270mm W1 185mm H1 120mm chrome-plated steel		



1

GEV No.	970240	Ref. No.	205011
description	fryer basket L1 285mm W1 230mm H1 105mm		



1

GEV No.	970244	Ref. No.	299939
description	fryer basket L1 290mm W1 115mm H1 120mm		



1

GEV No.	970355	Ref. No.	CFR142812
description	fryer basket L1 290mm W1 115mm H1 120mm L2 50mm H2 180mm H3 220mm chrome-plated steel L3 160mm		



1

GEV No.	970243	Ref. No.	CF518120017 CFR232910
description	fryer basket L1 290mm W1 230mm H1 105mm L2 470mm H2 175mm H3 220mm chrome-plated steel		

Зип Общепит

vsezip.ru

+7(812)987-08-81



1

GEV No.	970242	Ref. No.	299938
description	fryer basket L1 290mm W1 230mm H1 120mm		



1

GEV No.	970356	Ref. No.	299938 CFR242812
description	fryer basket L1 290mm W1 230mm H1 120mm chrome-plated steel		



1

GEV No.	970249	Ref. No.	299935 CFR303112
description	fryer basket L1 290mm W1 330mm H1 120mm		



1

GEV No.	540714	Ref. No.	808735 8C1875
description	handle for fryer basket complete L 140mm H 22.5mm W 40mm hole ø 5.5mm		

pasta baskets

EMMEPI



1

GEV No.	970746	Ref. No.	CP2-3
description	pasta basket H1 217mm W1 290mm L1 290mm		



Зип Общепит

vsezip.ru

+7(812)987-08-81



1

GEV No.	970253	Ref. No.	205070
description	pasta basket L1 335mm W1 300mm H1 225mm H3 337mm stainless steel		



1

GEV No.	970252	Ref. No.	299977
description	pasta basket L1 335mm W1 300mm H1 225mm H3 365mm stainless steel		

shelves and shelf rails

grates

producer-specific



1

GEV No.	970491	Ref. No.	834385
description	grate W 518mm D 408mm plastic-coated steel		

shelf rails and supports

producer-specific



1

GEV No.	691841	Ref. No.	A73310008
description	guide U-shape L 430mm W 13mm mounting pos. left inner height 21mm		



1

GEV No.	691925	Ref. No.	A73310007
description	guide U-shape L 430mm W 13mm mounting pos. right inner height 21mm		

gaskets

refrigeration gaskets

plug-in gaskets

profile 9048

We offer custom-made gaskets for this profile

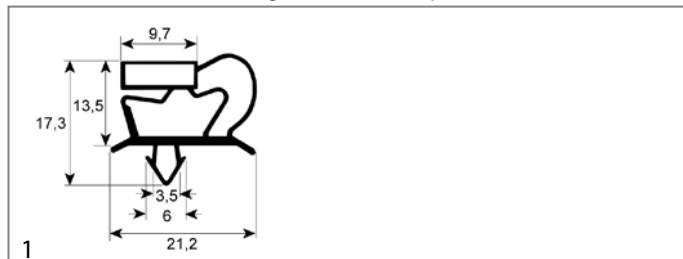

1

GEV No.	900359	Ref. No.	827880
description	refrigeration gasket profile 9048 W 296mm L 405mm plug size drawer size 1/2		

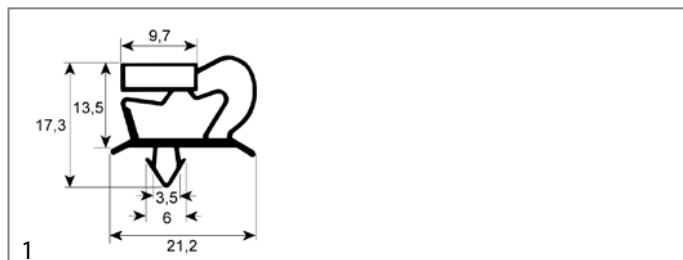

1

GEV No.	901250	Ref. No.	827705
description	refrigeration gasket profile 9048 W 403mm L 400mm plug size		

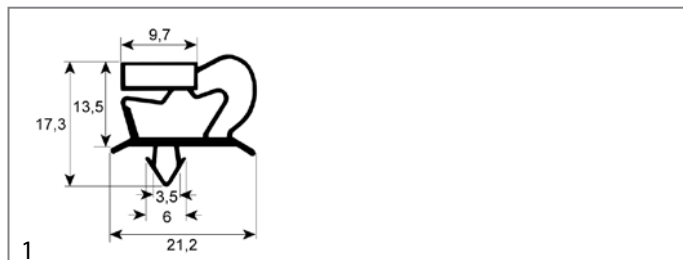

1

GEV No.	901238	Ref. No.	827881
description	refrigeration gasket profile 9048 W 407mm L 184mm plug size		

Зип Общежит

vsezip.ru

+7(812)987-08-81

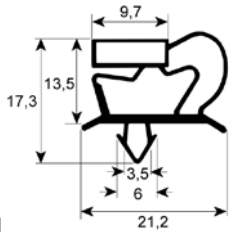

1

GEV No.	901240	Ref. No.	827879
description	refrigeration gasket profile 9048 W 407mm L 620mm plug size		

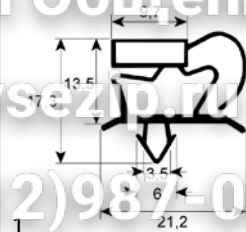

1

GEV No.	901258	Ref. No.	827785
description	refrigeration gasket profile 9048 W 457mm L 500mm plug size		

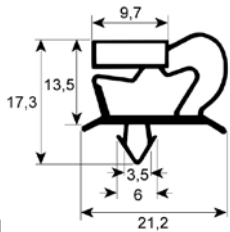

1

GEV No.	901222	Ref. No.	8C1879
description	refrigeration gasket profile 9048 W 415mm L 709mm plug size for blast chiller		

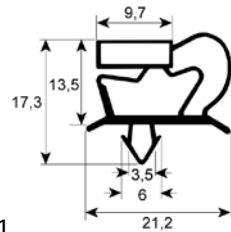

1

GEV No.	901256	Ref. No.	827786
description	refrigeration gasket profile 9048 W 488mm L 233mm plug size		

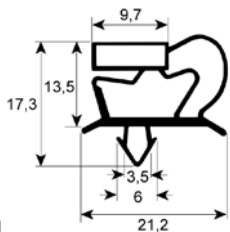

1

GEV No.	901262	Ref. No.	808421
description	refrigeration gasket profile 9048 W 445mm L 288mm plug size		

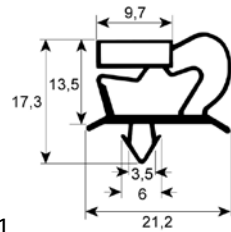

1

GEV No.	901257	Ref. No.	827787
description	refrigeration gasket profile 9048 W 488mm L 500mm plug size		

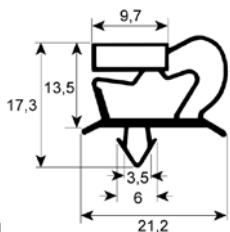

1

GEV No.	901261	Ref. No.	807584
description	refrigeration gasket profile 9048 W 445mm L 620mm plug size		

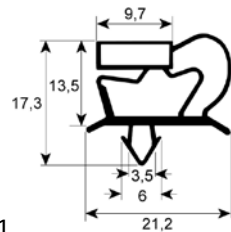

1

GEV No.	901251	Ref. No.	827875
description	refrigeration gasket profile 9048 W 496mm L 184mm plug size		

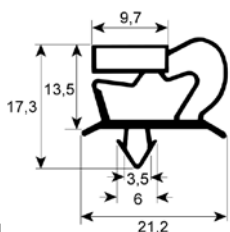

1

GEV No.	901255	Ref. No.	827784
description	refrigeration gasket profile 9048 W 457mm L 233mm plug size		

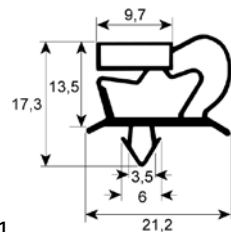

1

GEV No.	901252	Ref. No.	827874
description	refrigeration gasket profile 9048 W 496mm L 293mm plug size		



Зип Общепит

vsezip.ru

+7(812)987-08-81

GEV No.	901253	Ref. No.	827666
description	refrigeration gasket profile 9048 W 496mm L 402mm plug size		

GEV No.	900350	Ref. No.	807997
description	refrigeration gasket profile 9048 W 670mm L 760mm plug size 1/2 door		

GEV No.	901254	Ref. No.	827873
description	refrigeration gasket profile 9048 W 496mm L 620mm plug size		

GEV No.	900351	Ref. No.	807996
description	refrigeration gasket profile 9048 W 672mm L 1587mm plug size door		

GEV No.	901062	Ref. No.	827873
description	refrigeration gasket profile 9048 W 510mm L 633mm plug size		

GEV No.	901244	Ref. No.	807160
description	refrigeration gasket profile 9048 W 690mm L 1510mm plug size		

GEV No.	901127	Ref. No.	827632
description	refrigeration gasket profile 9048 W 560mm L 1420mm plug size		

GEV No.	901243	Ref. No.	814600
description	refrigeration gasket profile 9048 W 690mm L 735mm plug size		

GEV No.	900710	Ref. No.	8C1563
description	refrigeration gasket profile 9048 W 655mm L 1500mm plug size		

GEV No.	901220	Ref. No.	8C1888
description	refrigeration gasket profile 9048 W 721mm L 929mm plug size for blast chiller		

Зип Общепит

vsezip.ru

+7(812)987-08-81

profile 9046

We offer custom-made gaskets for this profile

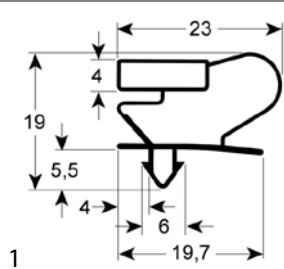

GEV No.	902257	Ref. No.	N/A
description	refrigeration gasket profile 9046 Wmm L 2500mm		

profile 9773

We offer custom-made gaskets for this profile

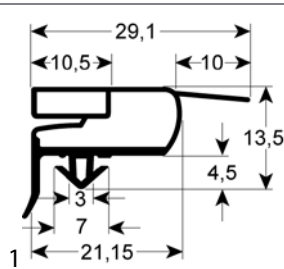

GEV No.	901089	Ref. No.	8C2123
description	refrigeration gasket profile 9773 W 640mm L 1540mm external size W1 627mm L1 1527mm plug size		

profile 9703

We offer custom-made gaskets for this profile

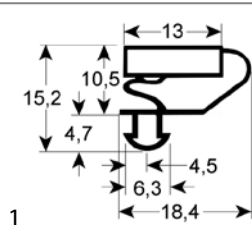

GEV No.	901189	Ref. No.	818998
description	refrigeration gasket profile 9703 W 387mm L 603mm plug size		

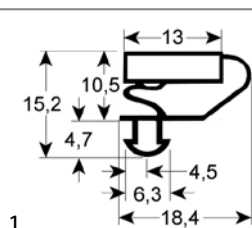

GEV No.	901190	Ref. No.	828532
description	refrigeration gasket profile 9703 W 390mm L 310mm plug size		

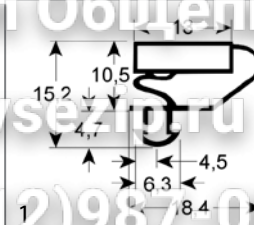

GEV No.	901191	Ref. No.	828533
description	refrigeration gasket profile 9703 W 390mm L 663mm plug size		

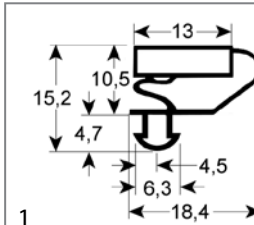

GEV No.	901266	Ref. No.	819854
description	refrigeration gasket profile 9703 W 452mm L 259mm plug size		

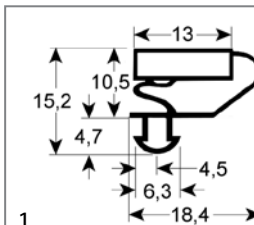

GEV No.	901271	Ref. No.	819853
description	refrigeration gasket profile 9703 W 452mm L 603mm plug size		

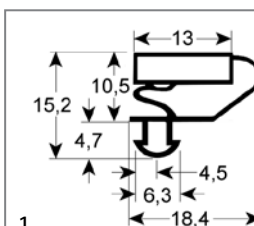

GEV No.	901192	Ref. No.	828138
description	refrigeration gasket profile 9703 W 460mm L 505mm plug size		

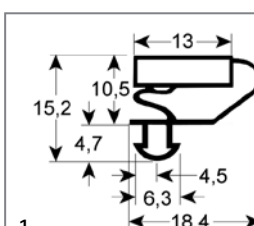

GEV No.	901265	Ref. No.	828289
description	refrigeration gasket profile 9703 W 462mm L 194mm plug size		



Зип Общепит

vsezip.ru

+7(812)987-08-81

GEV No.	901270	Ref. No.	828288
description	refrigeration gasket profile 9703 W 462mm L 309mm plug size		

GEV No.	902265	Ref. No.	N/A
description	refrigeration gasket profile 9151 Wmm L 2500mm		

GEV No.	901269	Ref. No.	828431
description	refrigeration gasket profile 9703 W 462mm L 418mm plug size		

profile 9010

We offer custom-made gaskets for this profile

GEV No.	901249	Ref. No.	807832
description	gasket profile 9010 W 650mm L 745mm plug size		

GEV No.	901268	Ref. No.	828392
description	refrigeration gasket profile 9703 W 462mm L 659mm plug size		

GEV No.	900598	Ref. No.	807830
description	refrigeration gasket profile 9010 W 655mm L 1550mm plug size		

profile 9151

We offer custom-made gaskets for this profile

GEV No.	901168	Ref. No.	715210005
description	refrigeration gasket profile 9151 W 737mm L 1699mm plug size		

GEV No.	902251	Ref. No.	N/A
description	refrigeration gasket profile 9010 Wmm L 2500mm		

GEV No.	901092	Ref. No.	714410002
description	refrigeration gasket profile 9151 W 755mm L 1705mm plug size L1 1695mm W1 745mm external size		

profile 9012

We offer custom-made gaskets for this profile

GEV No.	900353	Ref. No.	818997
description	refrigeration gasket profile 9012 W 242mm L 367mm plug size drawer size 1/2		

Зип Общежит

vsezip.ru

+7(812)987-08-81

GEV No.	901186	Ref. No.	808451
description	refrigeration gasket profile 9012 W 375mm L 243mm plug size		

GEV No.	901196	Ref. No.	806370
description	refrigeration gasket profile 9140 W 390mm L 640mm external size		

GEV No.	901263	Ref. No.	808450
description	refrigeration gasket profile 9012 W 435mm L 243mm plug size		

GEV No.	901267	Ref. No.	808428
description	refrigeration gasket profile 9140 W 465mm L 315mm external size		

GEV No.	902252	Ref. No.	N/A
description	refrigeration gasket profile 9012 Wmm L 2500mm		

GEV No.	901198	Ref. No.	806335
description	refrigeration gasket profile 9140 W 670mm L 1575mm external size		

screw-in gaskets
profile 9140

We offer custom-made gaskets for this profile

GEV No.	901194	Ref. No.	818396
description	refrigeration gasket profile 9140 W 370mm L 620mm external size		

GEV No.	901197	Ref. No.	813377
description	refrigeration gasket profile 9140 W 670mm L 770mm external size		

gaskets for heated units

window seals

GEV No.	901195	Ref. No.	813417
description	refrigeration gasket profile 9140 W 390mm L 310mm external size		

GEV No.	900472	Ref. No.	807587
description	window gasket profile 1650 L 1700mm Qty 1		

Зип Общепит

vsezip.ru

+7(812)987-08-81

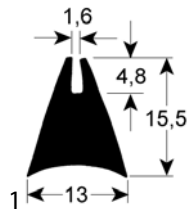

GEV No.	900881	Ref. No.	809024
description	window gasket profile 1650 Qty supplied by meter		

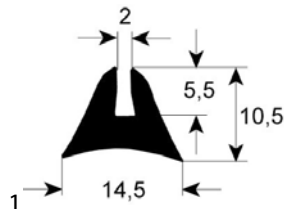

GEV No.	900601	Ref. No.	809882
description	window gasket profile 1660 Qty supplied by meter		

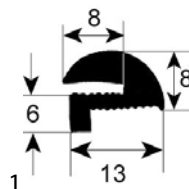

GEV No.	900782	Ref. No.	9629920
description	window gasket profile 1889 Qty supplied by meter		

door seals

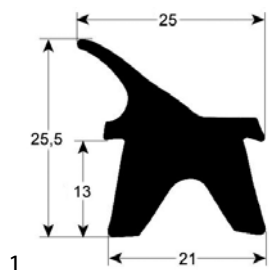

GEV No.	900348	Ref. No.	8C1193
description	door seal profile 2402 Qty supplied by meter		

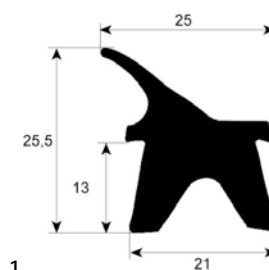

GEV No.	901351	Ref. No.	809796
description	door seal profile 2402 W 490mm L 635mm external size		



GEV No.	901158	Ref. No.	8C0029
description	door seal profile 2402 W 640mm L 740mm		

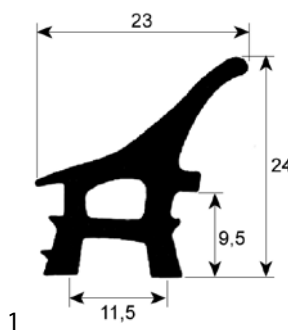

GEV No.	900781	Ref. No.	9629918
description	door seal profile 2403 Qty supplied by meter		

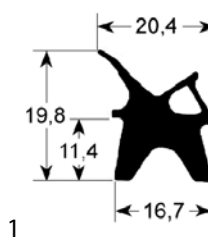

GEV No.	900059	Ref. No.	807582 807583 808226
description	door seal profile 2410 Qty supplied by meter		

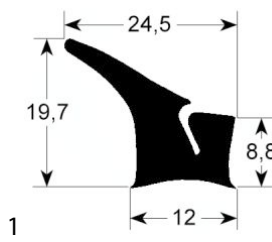

GEV No.	900602	Ref. No.	809881
description	door seal profile 2430 Qty supplied by meter		

Зип Общепит

vsezip.ru

+7(812)987-08-81

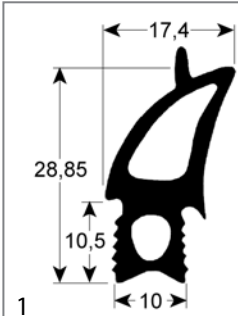

GEV No.	902219	Ref. No.	902219
description	door seal profile 2730 W 465mm L 520mm external size Qty 1		

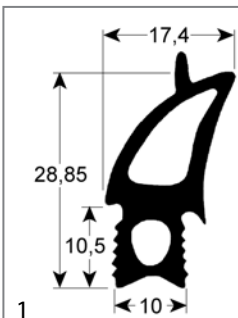

GEV No.	902247	Ref. No.	809562
description	door seal profile 2730 W 470mm L 785mm suitable for RATIONAL for model CPC 101 outer plug size Qty 1		

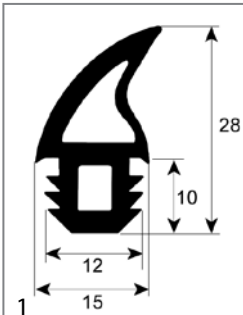

GEV No.	901331	Ref. No.	8C0917
description	door seal profile 2756 Qty supplied by meter		

door seals with fixing hook



GEV No.	900224	Ref. No.	C10088
description	door seal W 480mm long side open with mounting clip H 400mm		



GEV No.	900225	Ref. No.	C00165
description	door seal W 510mm long side open H 300mm		



GEV No.	900227	Ref. No.	C10090
description	door seal W 560mm long side open with mounting clip H 360mm		



GEV No.	900228	Ref. No.	C10091
description	door seal W 840mm long side open with mounting clip H 370mm		



GEV No.	900394	Ref. No.	132110003
description	oven gasket L 370mm W 640mm 6 hooks external size		

gaskets for tray rack trolleys

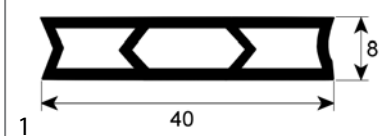

GEV No.	901330	Ref. No.	141110016
description	tray rack trolley gasket profile 4065 silicone Qty supplied by meter		

O-rings

EPDM

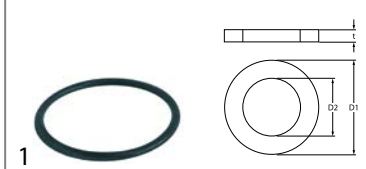

GEV No.	532118	Ref. No.	808043 808055
description	O-ring EPDM thickness 3.53mm ID ø 55.56mm Qty 10 pcs		

Viton

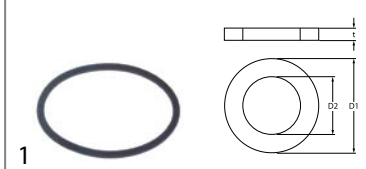

GEV No.	525313	Ref. No.	808709
description	O-ring Viton ID ø 60.33mm thickness 3.53mm Qty 1 pcs		



Зип, Общепит
transmission technology and ball bearings
vsezip.ru
drive bits

+7(812)987-08-81

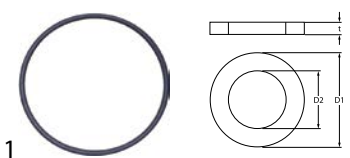

GEV No.	532649	Ref. No.	808710
description	O-ring Viton ID \varnothing 63.17mm thickness 2.62mm Qty 1 pcs		



GEV No.	510245	Ref. No.	808054
description	O-ring Viton thickness 3.53mm ID \varnothing 50.8mm Qty 1 pcs		



GEV No.	510243	Ref. No.	808055
description	O-ring Viton thickness 3.53mm ID \varnothing 55.56mm Qty 1 pcs		

sealing washers

fibre gaskets



GEV No.	510405	Ref. No.	903300
description	flat gasket fibre ED 56mm ID \varnothing 42mm thickness 2mm for thread 1 1/4" Qty 1 pcs		

shaft gaskets

shaft gaskets



GEV No.	511171	Ref. No.	809829
description	shaft seal ID \varnothing 14.5mm ED \varnothing 20mm thickness 3mm		

poly-v belts



GEV No.	693939	Ref. No.	8C0949
description	poly-v belt grooves 6 W 12mm L 630mm profile TB2		

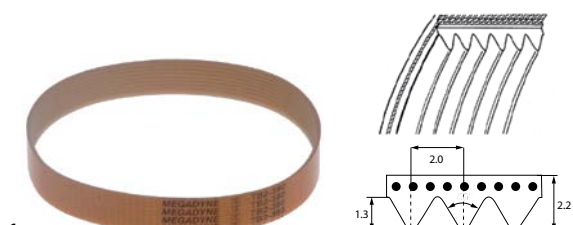

GEV No.	697367	Ref. No.	808759
description	poly-v belt grooves 8 W 16mm L 330mm profile TB2		

springs

torsion springs





GEV No.	690081	Ref. No.	808873
description	torsion spring \varnothing 19.4mm L2 36mm wire gauge \varnothing 3.3mm mounting pos. left L1 42mm L3 36mm Qty 1 pcs		
accessories for	690081		
GEV No.	690080	Ref. No.	808874
description	torsion spring \varnothing 19.4mm L2 37mm wire gauge \varnothing 3.4mm mounting pos. right L1 42mm L3 37mm Qty 1 pcs		

Зип-Общепит



vsezip.ru

+7(812)987-08-81

			
1			
GEV No.	690080	Ref. No.	808874
description	torsion spring \varnothing 19.4mm L2 37mm wire gauge \varnothing 3.4mm mounting pos. right L1 42mm L3 37mm Qty 1 pcs		
accessories for	690080		
	GEV No.	690081	Ref. No. 808873
description	torsion spring \varnothing 19.4mm L2 36mm wire gauge \varnothing 3.3mm mounting pos. left L1 42mm L3 36mm Qty 1 pcs		

			
1			
GEV No.	700171	Ref. No.	8C0361
description	torsion spring \varnothing 21.4mm L2 40mm wire gauge \varnothing 3.3mm L1 100mm L3 34mm		

manometers

			
1			
GEV No.	541062	Ref. No.	808347
description	manometer \varnothing 63mm pressure range 0 up to 1bar connection marking adjustable kettle thread 1/4"		
spare parts for	541062		
	GEV No.	541130	Ref. No. —
description	glass panel \varnothing 58mm thickness 2mm		

hose reels and spray guns

cleaning guns

			
1			
GEV No.	541473	Ref. No.	8C2178
description	cleaning spray gun connection with snap-on connection DN13 brass		
spare parts for	541473		
	GEV No.	540516	Ref. No. —
description	coupling bush type DN13 chrome-plated brass connection 1/2" IT		

spare parts for	541473		
GEV No.	540535	Ref. No.	—
description	nozzle connection snap-on connection short SS		
accessories for	541473		
GEV No.	540536	Ref. No.	—
description	foam lance connection snap-on connection plastic total length 182mm		
GEV No.	541870	Ref. No.	—
description	foam lance connection snap-on connection aluminium L 450mm		







dosing pumps

peristaltic dosing pumps

SEKO

built-in version

with frequency control

			
1			
GEV No.	361215	Ref. No.	8C0900
description	dosing pump SEKO frequency control 0.3-3.0l/h 230VAC detergent hose \varnothing 4x6mm hose type K hose Santoprene suction level 1.5m type PBR protection IP55 dimensions 100x67x68mm power input 3.5W		
spare parts for	361215		
	GEV No.	361136	Ref. No. —
description	roller assembly for dosing pump hole \varnothing 4.8x4mm		
	GEV No.	361226	Ref. No. —
description	PCB L 59mm W 26mm electronic control		
	GEV No.	361815	Ref. No. —
description	pump hose detergent hose \varnothing 6x10mm hose \varnothing 4x6mm hose type K hose Santoprene type SEKO		
accessories for	361215		
	GEV No.	361142	Ref. No. —
description	mounting set detergent hose type 4x6mm hose length 2m PVC 2x hose/container filter/tank intake transparent		
	GEV No.	520090	Ref. No. —
description	PVC hose ID \varnothing 4mm ED \varnothing 6mm L 2m thickness 1mm t.max. 60°C transparent		
	GEV No.	520091	Ref. No. —
description	nylon hose ID \varnothing 4mm ED \varnothing 6mm L 2m thickness 1mm operating p. 10bar burst p. 50bar t.max. 100°C transparent		

accessories

non-return valves



1

GEV No.	361821	Ref. No.	809742 8C0192
description	non-return valve inlet 4x6mm outlet 1/4" L 45mm		

hoses

drain hoses



1

GEV No.	513718	Ref. No.	8C0154
description	drain hose DN19 L 1500mm straight ø inside 24mm straight ext. ø 28mm outer hose ø 23mm		

for dishwashers

miscellaneous



1

GEV No.	511467	Ref. No.	907295
description	pressure hose L 1000mm		

valves and tank inlets

ball valves

universal

ball valves with lever handle



1

GEV No.	514325	Ref. No.	C00913
description	ball valve connection 1" IT - 1" IT DN25 total length 83mm with lever handle		

Зип Общепит

vsezip.ru

+7(812)987-08-81



1

GEV No.	520280	Ref. No.	827969
description	ball valve connection 1/2" IT - 1/2" IT DN15 total length 50mm with lever handle handle length 85mm		



1

GEV No.	540730	Ref. No.	808433
description	ball valve connection 3/4" IT - 3/4" IT DN20 total length 70mm with lever handle handle length 95mm		

inlet taps



1

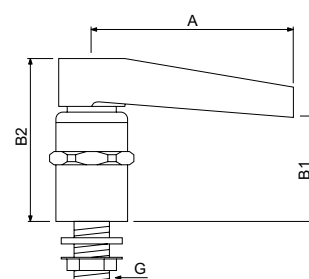

GEV No.	540705	Ref. No.	809314
description	inlet tap connection 1/2" ET tube ø 40mm projection 120mm overall height 95mm spout height 60mm rotation 360°		



1





GEV No.	540704	Ref. No.	808420
description	inlet spout		

drain systems and wash basins ancillary products

drain fittings

universal







GEV No.	515041	Ref. No.	825827
description	drain fitting size 3/4" usable height 30mm overall height 30mm ED ø 38mm chrome-plated brass		
accessories for	515041		
	GEV No.	515047	Ref. No. —
	standpipe size 3/4" usable height 28mm overall height 54mm ED ø 20mm chrome-plated brass with O-ring		
	GEV No.	515048	Ref. No. —
	standpipe size 3/4" usable height 48mm overall height 74mm ED ø 20mm chrome-plated brass with O-ring		
	GEV No.	515049	Ref. No. —
	standpipe size 3/4" usable height 68mm overall height 94mm ED ø 20mm chrome-plated brass with O-ring		
	GEV No.	515050	Ref. No. —
	standpipe size 3/4" usable height 98mm overall height 124mm ED ø 20mm chrome-plated brass with O-ring		

standpipes

3/4"



GEV No.	515041	Ref. No.	825827
description	drain fitting size 3/4" usable height 30mm overall height 30mm ED ø 38mm chrome-plated brass		
accessories for	515041		
	GEV No.	515047	Ref. No. —
	standpipe size 3/4" usable height 28mm overall height 54mm ED ø 20mm chrome-plated brass with O-ring		
	GEV No.	515048	Ref. No. —
	standpipe size 3/4" usable height 48mm overall height 74mm ED ø 20mm chrome-plated brass with O-ring		
	GEV No.	515049	Ref. No. —
	standpipe size 3/4" usable height 68mm overall height 94mm ED ø 20mm chrome-plated brass with O-ring		
	GEV No.	515050	Ref. No. —
	standpipe size 3/4" usable height 98mm overall height 124mm ED ø 20mm chrome-plated brass with O-ring		

clamps

hose clamps

DIN 3017 - W2



GEV No.	520112	Ref. No.	902440
description	hose clamp ø 12-20mm width 9mm Qty 10 pcs DIN 3017		



GEV No.	520119	Ref. No.	902490
description	hose clamp ø 60-80mm width 9mm Qty 5 pcs DIN 3017		



GEV No.	520454	Ref. No.	E23110007
description	hose clamp ø 70-90mm width 9mm Qty 5 pcs DIN 3017		

tools

hand tools

wrenches

miscellaneous



GEV No.	550449	Ref. No.	808893
description	special wrench for ring nut		

Зип Общепит
vsezip.ru
+7(812)987-08-81



socket wrenches

tubular box wrenches



1

GEV No.	550448	Ref. No.	808894
description	tubular box wrench special for fryer L 280mm WS 10		

measuring equipment

thermometers

built-in thermometers

ø52mm



1

GEV No.	541077	Ref. No.	808667
description	thermometer mounting ø 52mm t.max. 350°C +50 up to +350°C probe ø 6mm probe L 30mm capillary pipe 1000mm built-in depth 28mm		

ø60mm



1

GEV No.	541863	Ref. No.	809747
description	thermometer mounting ø 60mm 50-350°C probe ø 6mm probe L 19mm capillary pipe 1600mm		

fastening material

screws

grub screws

DIN 916/ISO 4029

+7(812)987-08-81



1

GEV No.	560366	Ref. No.	C00513
description	grub screw thread M6 L 20mm SS intake internal hexagon WS 3 Qty 1 pcs		

nuts

cap nuts



1

GEV No.	560137	Ref. No.	808998
description	cap nuts thread M6 WS 10 SS Qty 20 pcs DIN/ISO DIN 1587		

washers

washers

DIN 125A



1

GEV No.	560312	Ref. No.	8C0631
description	plain washer ID ø 10.5mm ED ø 20mm thickness 2mm SS Qty 1 pcs DIN 125A for thread M10		

miscellaneous



1

GEV No.	524117	Ref. No.	E25110025
description	plain washer ID ø 6.4mm ED ø 12mm thickness 1.6mm SS Qty 1 pcs		



1

GEV No.	506160	Ref. No.	8C0647
description	plain washer ID ø 8.6mm ED ø 16mm thickness 1.5mm SS Qty 1 pcs		

Зип-Общепит

roll pins

vsezip.ru

+7(812)987-08-81

fasteners

clamps

hose clamps

DIN 3017 - W2



1

GEV No.	520112	Ref. No.	902440
----------------	--------	-----------------	--------

description	hose clamp ø 12-20mm width 9mm Qty 10 pcs DIN 3017		
--------------------	--	--	--



1

GEV No.	520119	Ref. No.	902490
----------------	--------	-----------------	--------

description	hose clamp ø 60-80mm width 9mm Qty 5 pcs DIN 3017		
--------------------	---	--	--



1

GEV No.	520454	Ref. No.	E23110007
----------------	--------	-----------------	-----------

description	hose clamp ø 70-90mm width 9mm Qty 5 pcs DIN 3017		
--------------------	---	--	--

consumables

containers

bags



1

GEV No.	960027	Ref. No.	825873 TA-G
----------------	--------	-----------------	----------------

description	bag polypropylene L 475mm ø 130mm		
--------------------	-----------------------------------	--	--

Зип Общепит

fastening material

105

A

alarm devices 31
axial fans 43

B

ball valves 103
bar burners 77
bi-metal thermostats 11, 11
booster pumps I 48
booster pumps II 49

C

cable glands 50
cables 50
cam switches 22
cap nuts 105
capillary tube clips 18
clamps 104, 106
cleaning guns 102, 102
coil heating elements 7
cold air circulating fans (complete) 44
compressors 42
condensators & interference suppression filters 49
consumables 106
contactors 31
containers 106
control equipment 24
control thermostats 12
cross flow fans 44

D

door catches 87
door seals 99
door seals with fixing hook 100
dosing pumps 102
drain fittings 104
drain hoses 103
drain pumps 48
drain systems and wash basins 104

E

earthing cables 50
edgemount latches 87
electric accessories 50
electric timers 30
electrodes 42
electronic controllers 34
energy regulators 11

F

fans 43
fasteners 106

vsezip.ru

+7(812)987-08-81

gas burners 72

gas control valves 57

gas nozzles 79

gas taps 50

gas thermostats 53

gaskets for heated units 98

gaskets for tray rack trolleys 100

grates 93

grub screws 105

H

hand tools 104

handle latches 87

heater battery 7

heating cables 6

heating elements 3

heating elements for bain maries 3

heating elements for chip scuttles 4

heating elements for convection 8

heating elements for fryers 4

heating elements for griddles 5

heating elements for heated cabinets 6

heating elements for ovens 3

heating elements for pasta cookers 5

heating elements for pizza ovens 6

hob burners 72

hose clamps 104, 106

hoses 103

hot air fans 47

hot air motors 45

hot plates 10

I

ignition boxes 60

ignition cables 69

ignition switches 70

ignition units 70

immersion heating elements 7

indicator lights 25

indicator lights (complete) 26

inlet spouts 103

inlet taps 103

L

lamps 25

light bulbs 27

M

magnetic switches 23

measuring equipment 105

Зип Общепит

T

vsezip.ru

+7(812)987-08-81

mechanical timers	30	temperature probes	36
microswitches	20	terminals	50
motors	47	thermocouples	70
N		thermostats	11
non-return valves	103	threaded cable glands	50
nuts	105	time relays	33
O		timers	30
operating capacitors	49	tools	104
O-rings	100	transformers	34
oven hinges	88	tube burners	79
oven lamps	27	tubular box wrenches	105
P		U	
piezoelectric igniters	69	universal probes	36
pilot burners	61	V	
plug-in gaskets	93	valves and tank inlets	103
position switches	21	W	
pressure switches	41	wash and rinse pumps	48
probes	36	washers	105
programme timers	30	window seals	98
pumps	48	wrenches	104
pumps for ice machines	49		
push/momentary push switches	19		
R			
radiation heaters	10		
refrigeration fans	44		
refrigeration gaskets	93		
refrigeration motors universal	44		
refrigeration thermostats	18		
relays	32		
residual heat indicators	29		
rocker/momentary rocker switches	19		
roll pins	106		
S			
safety thermostats	15		
screw-in gaskets	98		
screws	105		
sealing washers	101		
shaft gaskets	101		
shelves and shelf rails	93		
snap locks	88		
socket wrenches	105		
solenoid valves	39		
solid state relays	32		
standpipes	104		
switches and momentary switches	19		
system switches (ROLD)	21		