



Зип Общепит

vsezip.ru

+7(812)987-08-81



**GAS COMPONENTS**



**ELECTRIC COMPONENTS**



**WATER TECHNOLOGY**



**MECHANICAL COMPONENTS**



**TOOLS**

Spare parts suitable for

**EMMEPI**

Find the complete and up-to-date range of products in our GEV Webshop

Зип Общепит

vsezip.ru

+7(812)987-08-81

# Manufacturer catalogue

The most important spare parts and accessories arranged clearly for every manufacturer



**Complete product range and all appliance data always up to date in the GEV Webshop**







**Alphabetical Index at the end of the catalogue**

## GEV Webshop

[www.gev-online.co.uk](http://www.gev-online.co.uk)

[www.gev-online.com](http://www.gev-online.com)





-  Add to Favourites
-  Sign In with email address and usual password
-  Easy-order – place several items in your basket at the same time
-  Quick Item search – no login needed



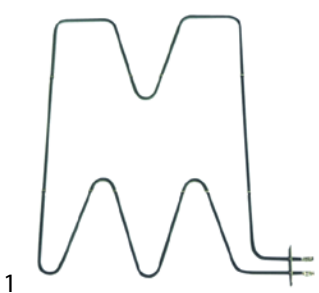

# heating elements

## heating elements for ovens

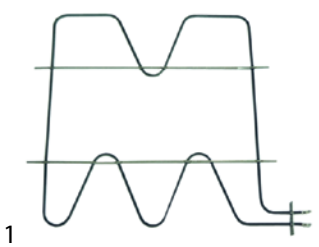

<b>GEV No.</b>	416074	<b>Ref. No.</b>	C00215
<b>description</b>	heating element 2500W 230V L 523mm W 555mm L1 64mm L2 458mm W1 525mm W2 30mm flange length 70mm flange width 22mm hole distance 56mm hole ø 5mm tube ø 6.3mm heating circuits 1 rectangular flange dry heating element		
<b>accessories for</b>	416074		
	<b>GEV No.</b>	510368	<b>Ref. No.</b> 8C0286
	gasket L 70mm W 23.5mm hole ø 5mm hole distance 56mm FIBER thickness 2mm for heating element		



<b>GEV No.</b>	416068	<b>Ref. No.</b>	C00215
<b>description</b>	heating element 2500W 230V L 525mm W 500mm L1 60mm L2 460mm W1 524mm W2 31mm flange length 70mm flange width 22mm hole distance 56mm hole ø 5mm tube ø 6.3mm connection M4 heating circuits 1 rectangular flange oven		
<b>accessories for</b>	416068		
	<b>GEV No.</b>	510368	<b>Ref. No.</b> 8C0286
	gasket L 70mm W 23.5mm hole ø 5mm hole distance 56mm FIBER thickness 2mm for heating element		

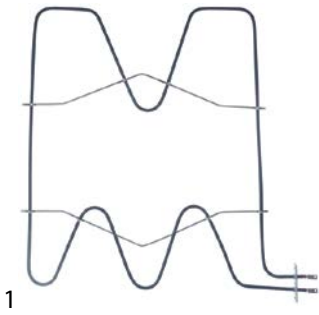

<b>GEV No.</b>	419171	<b>Ref. No.</b>	C10194
<b>description</b>	heating element 2500W 230V L 525mm W 560mm L2 465mm W1 525mm W2 30mm flange length 70mm flange width 23mm hole distance 56mm hole ø 5mm tube ø 6.3mm connection length 41mm heating circuits 1 mounting thread M4 oven heating element		

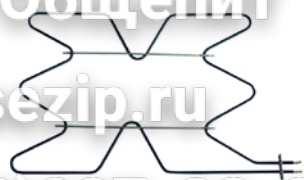

<b>GEV No.</b>	416061	<b>Ref. No.</b>	C10193
<b>description</b>	heating element 3000W 230V L 715mm W 470mm L1 60mm L2 655mm W1 436mm W2 34mm flange length 70mm flange width 22mm hole distance 56mm hole ø 4mm tube ø 9mm connection length 53mm connection M4 heating circuits 1 rectangular flange dry heating element oven		
<b>accessories for</b>	416061		
	<b>GEV No.</b>	510368	<b>Ref. No.</b> 8C0286
	gasket L 70mm W 23.5mm hole ø 5mm hole distance 56mm FIBER thickness 2mm for heating element		

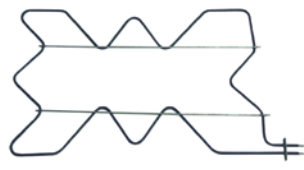

<b>GEV No.</b>	416069	<b>Ref. No.</b>	C10195
<b>description</b>	heating element 4000W 230V L 860mm W 500mm L1 60mm L2 800mm W1 466mm W2 34mm flange length 70mm flange width 22mm hole distance 56mm hole ø 5mm tube ø 8.5mm connection length 45mm connection M4 heating circuits 1 rectangular flange dry heating element oven		
<b>accessories for</b>	416069		
	<b>GEV No.</b>	510368	<b>Ref. No.</b> 8C0286
	gasket L 70mm W 23.5mm hole ø 5mm hole distance 56mm FIBER thickness 2mm for heating element		

## heating elements for bain maries









<b>GEV No.</b>	416067	<b>Ref. No.</b>	808174
<b>description</b>	heating element 1380W 230V heating circuits 1 L 346mm W 190mm connection M5 tube ø 8.5mm 2 hole fixing thread 1/4" immersion heater W1 70mm W2 105mm H 27mm mounting distance 67mm		
<b>spare parts for</b>	416067		
	<b>GEV No.</b>	510417	<b>Ref. No.</b> —
	flat gasket fibre ED ø 20mm ID ø 14mm thickness 2mm Qty 1 pcs		
<b>accessories for</b>	416067		
	<b>GEV No.</b>	361182	<b>Ref. No.</b> —
	nut thread 1/4" H 5mm nickel-plated brass WS 17 Qty 1 pcs		
	<b>GEV No.</b>	520228	<b>Ref. No.</b> —
	tooth lock washer ID ø 15.3mm ED ø 24mm steel Qty 1 pcs for thread M14		
	<b>GEV No.</b>	550262	<b>Ref. No.</b> —
	flat gasket copper ED ø 20mm ID ø 14mm thickness 2mm		
	<b>GEV No.</b>	560112	<b>Ref. No.</b> —
	plain washer ID ø 5.3mm ED ø 10mm thickness 1mm SS Qty 20 pcs DIN 125A for thread M5		





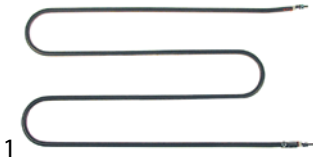

Table continues overleaf

Зип Общежит  
heating elements for fryers

accessories for	416067		
	GEV No.	560132	Ref. No.
			—
	hexagonal nut thread M5 H 4mm WS 8 SS DIN/ISO DIN 934 / ISO 4032/8673 Qty 20 pcs		





	1		
GEV No.	418335	Ref. No.	ED1110004
description	heating element 500W 230V heating circuits 1 L 430mm L1 38mm W 280mm connection M4 connection distance 271mm tube ø 8.5mm dry heating element L2 392mm H 16mm		

## heating elements for chip scuttles





	1		
GEV No.	416067	Ref. No.	808174
description	heating element 1380W 230V heating circuits 1 L 346mm W 190mm connection M5 tube ø 8.5mm 2 hole fixing thread 1/4" immersion heater W1 70mm W2 105mm H 27mm mounting distance 67mm		
spare parts for	416067		
	GEV No.	510417	Ref. No.
			—
	flat gasket fibre ED ø 20mm ID ø 14mm thickness 2mm Qty 1 pcs		
accessories for	416067		
	GEV No.	361182	Ref. No.
			—
	nut thread 1/4" H 5mm nickel-plated brass WS 17 Qty 1 pcs		
	GEV No.	520228	Ref. No.
			—
	tooth lock washer ID ø 15.3mm ED ø 24mm steel Qty 1 pcs for thread M14		
	GEV No.	550262	Ref. No.
			—
	flat gasket copper ED ø 20mm ID ø 14mm thickness 2mm		
	GEV No.	560112	Ref. No.
			—
	plain washer ID ø 5.3mm ED ø 10mm thickness 1mm SS Qty 20 pcs DIN 125A for thread M5		
	GEV No.	560132	Ref. No.
			—
	hexagonal nut thread M5 H 4mm WS 8 SS DIN/ISO DIN 934 / ISO 4032/8673 Qty 20 pcs		

## off-center connection

vsezip.ru

	1		
GEV No.	416070	Ref. No.	808256
description	heating element 10200W 230/400V heating circuits 3 L 300mm W 180mm H 33mm flange length 19.5mm flange length 1 9.5mm flange length 2 9.8mm flange ø1 62mm flange ø2 57mm thermostat sleeves ø 6.5mm sensor screw connection 2x M10x1 thermostat sleeve upper/lower L1 18mm L2 282mm W1 30mm W2 35mm thread M54x1.5 windings 5 tube ø 8.5mm cable length 450mm rotation flange immersion heater fryer connection length 130mm 2		
spare parts for	416070		
	GEV No.	510243	Ref. No.
			808055
	O-ring Viton thickness 3.53mm ID ø 55.56mm Qty 1 pcs		
accessories for	416070		
	GEV No.	510243	Ref. No.
			808055
	O-ring Viton thickness 3.53mm ID ø 55.56mm Qty 1 pcs		
	GEV No.	550662	Ref. No.
			808892
	ring nut thread M54x1.5 H 7mm		

## center connection

	1		
GEV No.	415297	Ref. No.	808689
description	heating element 6800W 230/400V heating circuits 3 L 299mm W 107mm H 35mm flange length 19.5mm flange length 1 9.5mm flange length 2 9.8mm flange ø1 62mm flange ø2 57mm thermostat sleeves ø 8.5mm sensor screw connection 2x M10x1 thermostat sleeve upper/lower L1 16mm L2 283mm W1 30mm W2 77mm thread M54x1.5 tube ø 8.5mm cable length 450mm rotation flange immersion heater		
accessories for	415297		
	GEV No.	510243	Ref. No.
			808055
	O-ring Viton thickness 3.53mm ID ø 55.56mm Qty 1 pcs		
	GEV No.	510245	Ref. No.
			808054
	O-ring Viton thickness 3.53mm ID ø 50.8mm Qty 1 pcs		
	GEV No.	550447	Ref. No.
			808892
	ring nut thread M54x1.5		





Зип Общепит

vsezip.ru

+7(812)987-08-81

electric components

2 hole fixing

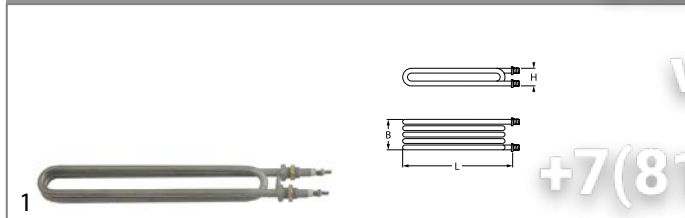

<b>GEV No.</b>	416065	<b>Ref. No.</b>	808620
<b>description</b>	heating element 1333W 230V heating circuits 1 L 283mm W 20mm H 40mm thread M12x1 tube ø 8.5mm connection M4 connection length 52mm mounting distance 31mm windings 2 immersion heater 2 hole fixing		
<b>spare parts for</b>	416065		
	<b>GEV No.</b>	507313	<b>Ref. No.</b> —
	O-ring EPDM thickness 2.62mm ID ø 13.95mm Qty 1 pcs		
<b>accessories for</b>	416065		
	<b>GEV No.</b>	361182	<b>Ref. No.</b> —
	nut thread 1/4" H 5mm nickel-plated brass WS 17 Qty 1 pcs		
	<b>GEV No.</b>	510417	<b>Ref. No.</b> —
	flat gasket fibre ED ø 20mm ID ø 14mm thickness 2mm Qty 1 pcs		
	<b>GEV No.</b>	520228	<b>Ref. No.</b> —
	tooth lock washer ID ø 15.3mm ED ø 24mm steel Qty 1 pcs for thread M14		
	<b>GEV No.</b>	521103	<b>Ref. No.</b> —
	nut thread M4 H 3mm WS 7 brass Qty 20 pcs		
	<b>GEV No.</b>	521104	<b>Ref. No.</b> —
	washer ID ø 4.3mm ED ø 8mm thickness 0.5mm brass Qty 20 pcs for thread M4		
	<b>GEV No.</b>	550262	<b>Ref. No.</b> —
	flat gasket copper ED ø 20mm ID ø 14mm thickness 2mm		
	<b>GEV No.</b>	560111	<b>Ref. No.</b> —
	plain washer ID ø 4.3mm ED ø 9mm thickness 0.8mm SS Qty 20 pcs DIN 125A for thread M4		
	<b>GEV No.</b>	560131	<b>Ref. No.</b> —
	hexagonal nut thread M4 H 3.2mm WS 7 SS DIN/ISO DIN 934 / ISO 4032/8673 Qty 20 pcs		

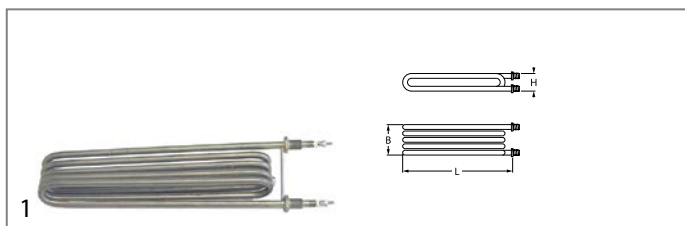

<b>GEV No.</b>	416064	<b>Ref. No.</b>	809460
<b>description</b>	heating element 3300W 230V heating circuits 1 L 285mm W 74mm H 42mm thread M12x1 tube ø 8.5mm connection M4 connection length 37mm windings 5 fryer heaters 2 hole fixing		
<b>accessories for</b>	416064		
	<b>GEV No.</b>	520229	<b>Ref. No.</b> —
	nut thread M12x1 H 4mm WS 16 zinc-coated steel Qty 1 pcs		
	<b>GEV No.</b>	521103	<b>Ref. No.</b> —
	nut thread M4 H 3mm WS 7 brass Qty 20 pcs		

<b>GEV No.</b>	521104	<b>Ref. No.</b>	—
	washer ID ø 4.3mm ED ø 8mm thickness 0.5mm brass Qty 20 pcs for thread M4		
<b>GEV No.</b>	521110	<b>Ref. No.</b>	—
	flat gasket fibre ED ø 20mm ID ø 13mm thickness 2mm Qty 1 pcs		
<b>GEV No.</b>	521131	<b>Ref. No.</b>	—
	nut thread M12x1 H 3.5mm WS 17 SS Qty 1 pcs		
<b>GEV No.</b>	528110	<b>Ref. No.</b>	—
	O-ring EPDM thickness 2.62mm ID ø 12.37mm Qty 1 pcs		
<b>GEV No.</b>	560111	<b>Ref. No.</b>	—
	plain washer ID ø 4.3mm ED ø 9mm thickness 0.8mm SS Qty 20 pcs DIN 125A for thread M4		
<b>GEV No.</b>	560131	<b>Ref. No.</b>	—
	hexagonal nut thread M4 H 3.2mm WS 7 SS DIN/ISO DIN 934 / ISO 4032/8673 Qty 20 pcs		

heating elements for griddles



<b>GEV No.</b>	416062	<b>Ref. No.</b>	C10199
<b>description</b>	heating element 1000W 230V heating circuits 1 L 220mm W 103mm H 32mm tube ø 6.3mm L1 42mm L2 178mm W1 28mm W2 45mm connection length 19mm griddle dry heating element		



<b>GEV No.</b>	416075	<b>Ref. No.</b>	C00650
<b>description</b>	heating element 1200W 230V heating circuits 1 L 295mm W 105mm H 32mm tube ø 6.5mm L1 40mm L2 252mm W1 35mm W2 35mm connection M4 connection length 23mm tilting bratt pan connection distance 29mm dry heating element		

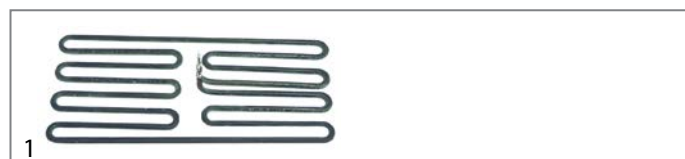

<b>GEV No.</b>	416072	<b>Ref. No.</b>	C00644
<b>description</b>	heating element 1800W 230V L 290mm W 130mm H 30mm tube ø 6.5mm L1 130mm L2 160mm W1 60mm W2 20mm connection M4 connection length 20mm dry heating element		

heating elements for pasta cookers











<b>GEV No.</b>	416066	<b>Ref. No.</b>	808056
<b>description</b>	heating element 1840W 230V heating circuits 1 L 275mm W 64mm Hmm 2 hole fixing connection M4 thread 1/4" tube ø 8.5mm		
<b>accessories for</b>	416066		
	<b>GEV No.</b>	361182	<b>Ref. No.</b> —
	nut thread 1/4" H 5mm nickel-plated brass WS 17 Qty 1 pcs		

Table continues overleaf







accessories for		416066	
	GEV No.	510417	Ref. No. —
flat gasket fibre ED ø 20mm ID ø 14mm thickness 2mm Qty 1 pcs			
	GEV No.	520228	Ref. No. —
tooth lock washer ID ø 15.3mm ED ø 24mm steel Qty 1 pcs for thread M14			
	GEV No.	521103	Ref. No. —
nut thread M4 H 3mm WS 7 brass Qty 20 pcs			
	GEV No.	521104	Ref. No. —
washer ID ø 4.3mm ED ø 8mm thickness 0.5mm brass Qty 20 pcs for thread M4			
	GEV No.	550262	Ref. No. —
flat gasket copper ED ø 20mm ID ø 14mm thickness 2mm			
	GEV No.	560111	Ref. No. —
plain washer ID ø 4.3mm ED ø 9mm thickness 0.8mm SS Qty 20 pcs DIN 125A for thread M4			
	GEV No.	560131	Ref. No. —
hexagonal nut thread M4 H 3.2mm WS 7 SS DIN/ISO DIN 934 / ISO 4032/8673 Qty 20 pcs			

			
1			
GEV No.	416077	Ref. No.	808756
description	heating element 2520/3000W 220/240V heating circuits 1 L 445mm W 66mm H mm 2 hole fixing connection M4 thread 1/4" tube ø 8.5mm mounting distance 58mm connection length 34mm pasta cooker immersion heater		
accessories for 416077			
	GEV No.	361182	Ref. No. —
nut thread 1/4" H 5mm nickel-plated brass WS 17 Qty 1 pcs			
	GEV No.	510417	Ref. No. —
flat gasket fibre ED ø 20mm ID ø 14mm thickness 2mm Qty 1 pcs			
	GEV No.	520228	Ref. No. —
tooth lock washer ID ø 15.3mm ED ø 24mm steel Qty 1 pcs for thread M14			
	GEV No.	521103	Ref. No. —
nut thread M4 H 3mm WS 7 brass Qty 20 pcs			
	GEV No.	521104	Ref. No. —
washer ID ø 4.3mm ED ø 8mm thickness 0.5mm brass Qty 20 pcs for thread M4			
	GEV No.	550262	Ref. No. —
flat gasket copper ED ø 20mm ID ø 14mm thickness 2mm			
	GEV No.	560111	Ref. No. —
plain washer ID ø 4.3mm ED ø 9mm thickness 0.8mm SS Qty 20 pcs DIN 125A for thread M4			
	GEV No.	560131	Ref. No. —
hexagonal nut thread M4 H 3.2mm WS 7 SS DIN/ISO DIN 934 / ISO 4032/8673 Qty 20 pcs			

Зип Общепит

vsezip.ru

+7(812)987-0881

			
GEV No.	416071	Ref. No.	809070
description	heating element 800W 230V L 350mm W 87mm H 36mm 2 hole fixing connection male faston 6.3mm thread 1/4" tube ø 8.5mm mounting distance 74mm dry heating element		
spare parts for 416071			
	GEV No.	510417	Ref. No. —
flat gasket fibre ED ø 20mm ID ø 14mm thickness 2mm Qty 1 pcs			
accessories for 416071			
	GEV No.	361182	Ref. No. —
nut thread 1/4" H 5mm nickel-plated brass WS 17 Qty 1 pcs			
	GEV No.	520228	Ref. No. —
tooth lock washer ID ø 15.3mm ED ø 24mm steel Qty 1 pcs for thread M14			
	GEV No.	550262	Ref. No. —
flat gasket copper ED ø 20mm ID ø 14mm thickness 2mm			

## heating elements for pizza ovens

			
1			
GEV No.	415917	Ref. No.	808633
description	heating element 1400W 230V L 572mm W 159mm flange length 220mm flange width 32mm hole distance 199mm connection length 134mm connection M5 L1 30mm L2 27mm L3 515mm W1 25mm W2 110mm tube ø 10.2mm heating circuits 1 rectangular flange hole ø 4mm dry heating element		

## heating elements for heated cabinets

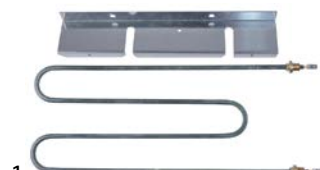
			
1			
GEV No.	419155	Ref. No.	8C2213
description	heating element 1200W 230V heating circuits 1 L 350mm W 150mm connection male faston 6.3mm tube ø 6.3mm thread M12x1.25 mounting distance 145mm		

## heating cables

connection on both sides			
with wire end ferrules			
			
1			
GEV No.	420387	Ref. No.	8C1890
description	heating cable 37W 220V L 4900mm for blast chiller		



heater battery

Зип-Общепит

vsezip.ru

+7(812)987-08-81



<b>GEV No.</b>	415115	<b>Ref. No.</b>	827915
<b>description</b>	heater battery mounting distance 185mm W 38mm H 40mm 2000W 230V temperature restriction 125°C heating circuits 2 connection male faston 6.3mm L 195mm		
<b>spare parts for</b>	415115		
	<b>GEV No.</b>	375095	<b>Ref. No.</b>
			—
<b>description</b>	bi-metal thermostat hole distance 18mm switch-off temp. 105°C 1NC 1-pole 16A connection F6.3 2 hole fixing		



	<b>GEV No.</b>	415122	<b>Ref. No.</b>	827915
<b>description</b>	heater battery mounting distance 185mm W 40mm H 35mm 2000W 230V temperature restriction 105°C heating circuits 2 connection cable cable length 340mm L 197mm for cross flow fan			

coil heating elements

	<b>GEV No.</b>	420345	<b>Ref. No.</b>	8C0424
<b>description</b>	heating element 1400W 230V L 285mm W 135mm ø 19.5mm thread 3/8" connection M5 for drying heating circuits 1 2 hole fixing			

immersion heating elements

3 hole flange ø47.5mm



	<b>GEV No.</b>	418136	<b>Ref. No.</b>	808674
<b>description</b>	heating element 4360W 240V mounting ø 47.5mm heating circuits 3 L 310mm W 31mm H 35mm number of thermostat sleeves 1 thermostat sleeves ø 7mm length thermostat sleeves 200mm thermostat sleeve clinging tube ø 6.3mm hole distance 62mm hole ø 8mm connection M4 3 hole flange immersion heater			
<b>spare parts for</b>	418136			
	<b>GEV No.</b>	510408	<b>Ref. No.</b>	—
				—
<b>description</b>	O-ring EPDM thickness 5.34mm ID ø 47mm Qty 1 pcs			



<b>accessories for</b>	418136	<b>GEV No.</b>	510408	<b>Ref. No.</b>	—
					—
<b>description</b>	O-ring EPDM thickness 5.34mm ID ø 47mm Qty 1 pcs				
<b>accessories for</b>	418136	<b>GEV No.</b>	510562	<b>Ref. No.</b>	—
					—
<b>description</b>	O-ring silicone thickness 5.34mm ID ø 47mm Qty 1 pcs				

3 hole flange ø57.5mm

	<b>GEV No.</b>	418084	<b>Ref. No.</b>	807858
<b>description</b>	heating element 7599W 230V mounting ø 57.5mm heating circuits 3 L 340mm W 36mm H 42mm number of thermostat sleeves 1 thermostat sleeves ø 7mm length thermostat sleeves 270mm thermostat sleeve clinging tube ø 8.5mm hole distance 72mm hole ø 8mm connection M4 3 hole flange immersion heater			

miscellaneous

	<b>GEV No.</b>	418548	<b>Ref. No.</b>	809218 8C0728
<b>description</b>	heating element 5200W 230V heating circuits 3 L 325mm W 47mm H 50mm tube ø 8.5mm hole distance 62mm hole ø 9.3mm connection M4 4 hole flange immersion heater flange width 81mm flange length 96mm with thermal fuse			
<b>spare parts for</b>	418548			
	<b>GEV No.</b>	510401	<b>Ref. No.</b>	—
				—
<b>description</b>	gasket rubber L 88mm W 73mm thickness 5mm hole ø 7mm hole distance 65mm for heating element 4 holes ID ø 50mm			

	<b>GEV No.</b>	415550	<b>Ref. No.</b>	809556
<b>description</b>	heating element 9000W 230V heating circuits 3 L 205mm W 38mm H 70mm number of thermostat sleeves 1 thermostat sleeves ø 2.5mm length thermostat sleeves 120mm thermostat sleeve eccentric, clinging tube ø 6.3mm hole distance 64mm hole ø 8mm connection male faston 6.3mm 4 hole flange immersion heater flange width 82mm flange length 82mm			
<b>accessories for</b>	415550			
	<b>GEV No.</b>	379078	<b>Ref. No.</b>	—
				—
<b>description</b>	temperature probe thermocouple K (NiCr-Ni) cable silicone probe -50 up to 1150°C cable -50 up to +180°C connection 2-wire thread probe ø1.5x100mm cable length 1.8m			
	<b>GEV No.</b>	510565	<b>Ref. No.</b>	—
				—
<b>description</b>	gasket rubber L 82mm W 82mm thickness 4mm hole ø 9mm hole distance 64mm for heating element suitable for RATIONAL 4 holes			



Зип Общепит

vsezip.ru

8(12)987-08-81

2"



1

<b>GEV No.</b>	416073	<b>Ref. No.</b>	808525
<b>description</b>	heating element 6000W 220V heating circuits 3 L 315mm W 43mm H 39mm tube $\varnothing$ 8.5mm thermostat sleeves $\varnothing$ 5mm length thermostat sleeves 280mm number of thermostat sleeves 1 thermostat sleeve eccentric, clinging connection M4 immersion heater flange with thread 2"		
<b>accessories for</b>	416073		
	<b>GEV No.</b>	510407	<b>Ref. No.</b> —
	flat gasket fibre ED $\varnothing$ 78mm ID $\varnothing$ 60mm thickness 2mm for heating element for thread 2" Qty 1 pcs		



1

<b>GEV No.</b>	416078	<b>Ref. No.</b>	808595
<b>description</b>	heating element 8000W 230V heating circuits 3 L 305mm W 39mm H 43mm tube $\varnothing$ 8.5mm thermostat sleeves $\varnothing$ 5mm length thermostat sleeves 285mm number of thermostat sleeves 1 thermostat sleeve clinging connection M4 connection length 48mm immersion heater flange with thread 2"		
<b>accessories for</b>	416078		
	<b>GEV No.</b>	510407	<b>Ref. No.</b> —
	flat gasket fibre ED $\varnothing$ 78mm ID $\varnothing$ 60mm thickness 2mm for heating element for thread 2" Qty 1 pcs		





1

<b>GEV No.</b>	416076	<b>Ref. No.</b>	808756
<b>description</b>	heating element 2520W 220V L 445mm W 60mm thread 1/4" mounting distance 52mm tube $\varnothing$ 8.5mm 2 hole fixing immersion heater connection M5		

## heating elements for convection





1

<b>GEV No.</b>	415914	<b>Ref. No.</b>	809571
<b>description</b>	heating element 15000W 230V heating circuits 6 ID $\varnothing$ 505mm ED $\varnothing$ 520mm L 615mm H 180mm L1 50mm W1 156mm H1 35mm H2 145mm flange length 210mm flange width 24mm hole distance 30mm connection male faston 6.3mm connection length 80mm tube $\varnothing$ 6.5mm convection heating element hole $\varnothing$ 8mm mounting pos. inner rectangular flange		
<b>accessories for</b>	415914		
	<b>GEV No.</b>	521127	<b>Ref. No.</b> —
	gasket L 210mm W 24mm thickness 2mm for heating element		
	<b>GEV No.</b>	693548	<b>Ref. No.</b> —
	flange suitable for convection heating element W 23mm mounting pos. outer length 210		



1

<b>GEV No.</b>	415915	<b>Ref. No.</b>	809570
<b>description</b>	heating element 15000W 230V heating circuits 6 ID $\varnothing$ 635mm ED $\varnothing$ 650mm L 696mm H 200mm L1 23mm W1 156mm H1 35mm H2 165mm flange length 210mm flange width 24mm hole distance 31mm connection male faston 6.3mm connection length 80mm tube $\varnothing$ 6.3mm convection heating element hole $\varnothing$ 7mm mounting pos. outer rectangular flange		
<b>accessories for</b>	415915		
	<b>GEV No.</b>	521127	<b>Ref. No.</b> —
	gasket L 210mm W 24mm thickness 2mm for heating element		
	<b>GEV No.</b>	693548	<b>Ref. No.</b> —
	flange suitable for convection heating element W 23mm mounting pos. outer length 210		



1

<b>GEV No.</b>	415119	<b>Ref. No.</b>	132110020
<b>description</b>	heating element 1600W 230V heating circuits 1 ID $\varnothing$ 179mm ED $\varnothing$ 197mm L 254mm H 30mm L1 51mm W1 31mm H1 9mm H2 21mm flange length 70mm flange width 22mm hole distance 56mm connection male faston 6.3mm connection length 41mm tube $\varnothing$ 6.3mm convection heating element hole $\varnothing$ 4mm rectangular flange		
<b>accessories for</b>	415119		
	<b>GEV No.</b>	510368	<b>Ref. No.</b> 8C0286
	gasket L 70mm W 23.5mm hole $\varnothing$ 5mm hole distance 56mm FIBER thickness 2mm for heating element		



1

<b>GEV No.</b>	418861	<b>Ref. No.</b>	828041
<b>description</b>	heating element 2400W 220V heating circuits 1 ID $\varnothing$ 185mm ED $\varnothing$ 200mm L 210mm H 35mm L1 10mm W1 61mm H1 5mm H2 30mm flange length 100mm flange width 22mm hole distance 86mm connection male faston 6.3mm connection length 36mm tube $\varnothing$ 6.3mm convection heating element hole $\varnothing$ 5mm rectangular flange angled		





Зип Общепит

vsezip.ru

+7(812)987-08-81



1

<b>GEV No.</b>	418986	<b>Ref. No.</b>	9629911
<b>description</b>	heating element 3000W 240V heating circuits 1 ID $\varnothing$ 180mm ED $\varnothing$ 186mm L 210mm H 31mm L1 11mm W1 60mm H1 7mm H2 24.5mm flange length 100mm flange width 22mm hole distance 86mm connection male faston 6.3mm connection length 34.5mm tube $\varnothing$ 6.25mm convection heating element hole $\varnothing$ 5mm rectangular flange		



1

<b>GEV No.</b>	418858	<b>Ref. No.</b>	806187
<b>description</b>	heating element 7350W 230V heating circuits 3 ID $\varnothing$ 215mm ED $\varnothing$ 230mm L 267mm H 85mm L1 38mm W1 102mm H1 5mm H2 80mm flange length 142mm flange width 25mm hole distance 63mm cable length 1000mm convection heating element hole $\varnothing$ 6mm		





1

<b>GEV No.</b>	415845	<b>Ref. No.</b>	142110001
<b>description</b>	heating element 3150W 230V heating circuits 3 ID $\varnothing$ 201mm ED $\varnothing$ 215mm L 272mm H 35mm L1 57mm W1 60mm H1 8mm H2 27mm flange length 95mm flange width 22mm hole distance 77mm connection male faston 6.3mm connection length 20mm tube $\varnothing$ 6.5mm convection heating element hole $\varnothing$ 6mm rectangular flange		



1

<b>GEV No.</b>	415912	<b>Ref. No.</b>	809555
<b>description</b>	heating element 9000W 230V heating circuits 3 ID $\varnothing$ 445mm ED $\varnothing$ 458mm L 474mm H 130mm W1 156mm H1 33mm H2 97mm flange length 210mm flange width 24mm hole distance 31mm connection male faston 6.3mm connection length 80mm tube $\varnothing$ 6.5mm dry heating element hole $\varnothing$ 7.5mm mounting pos. inner rectangular flange L1 16mm		
<b>accessories for</b>	415912		
	<b>GEV No.</b>	521127	<b>Ref. No.</b> —
	gasket L 210mm W 24mm thickness 2mm for heating element		
	<b>GEV No.</b>	693548	<b>Ref. No.</b> —
	flange suitable for convection heating element W 23mm mounting pos. outer length 210		





1

<b>GEV No.</b>	418134	<b>Ref. No.</b>	808778
<b>description</b>	heating element 3300W 240V heating circuits 1 ID $\varnothing$ 185mm ED $\varnothing$ 200mm L 215mm H 30mm W1 60mm H1 5mm H2 25mm flange length 100mm flange width 22mm hole distance 85mm connection male faston 6.3mm connection length 22mm tube $\varnothing$ 6.5mm convection heating element hole $\varnothing$ 5mm rectangular flange		



1

<b>GEV No.</b>	415913	<b>Ref. No.</b>	809554
<b>description</b>	heating element 9000W 230V heating circuits 3 ID $\varnothing$ 504mm ED $\varnothing$ 516mm L 535mm H 130mm W1 156mm H1 35mm H2 95mm flange length 210mm flange width 25mm hole distance 31mm connection male faston 6.3mm connection length 80mm tube $\varnothing$ 6.5mm dry heating element hole $\varnothing$ 7.5mm mounting pos. outer rectangular flange L1 19mm		
<b>accessories for</b>	415913		
	<b>GEV No.</b>	521127	<b>Ref. No.</b> —
	gasket L 210mm W 24mm thickness 2mm for heating element		
	<b>GEV No.</b>	693548	<b>Ref. No.</b> —
	flange suitable for convection heating element W 23mm mounting pos. outer length 210		



1



<b>GEV No.</b>	418131	<b>Ref. No.</b>	808781
<b>description</b>	heating element 6000W 230V heating circuits 3 ID $\varnothing$ 217mm ED $\varnothing$ 231mm L 271mm H 90mm L1 41mm W1 103mm H1 24mm H2 66mm flange length 140mm flange width 22mm hole distance 63mm tube $\varnothing$ 6.3mm convection heating element hole $\varnothing$ 5mm rectangular flange		



Зип Общежит  
radiation heaters

vsezip.ru

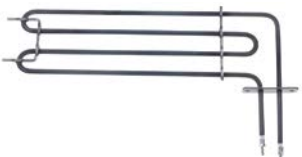

+7(812)987-08-81

 <p>1</p>			
<b>GEV No.</b>	418135	<b>Ref. No.</b>	808779
<b>description</b>	heating element 920W 230V heating circuits 1 ID ø 200mm ED ø 215mm L 255mm H 40mm thread 1/4" connection male faston 6.3mm 2 hole fixing mounting distance 24mm tube ø 8.5mm convection heating element		
<b>accessories for</b>	418135		
	<b>GEV No.</b>	361182	<b>Ref. No.</b> —
	nut thread 1/4" H 5mm nickel-plated brass WS 17 Qty 1 pcs		
	<b>GEV No.</b>	510417	<b>Ref. No.</b> —
	flat gasket fibre ED ø 20mm ID ø 14mm thickness 2mm Qty 1 pcs		
	<b>GEV No.</b>	520228	<b>Ref. No.</b> —
	tooth lock washer ID ø 15.3mm ED ø 24mm steel Qty 1 pcs for thread M14		
	<b>GEV No.</b>	550262	<b>Ref. No.</b> —
	flat gasket copper ED ø 20mm ID ø 14mm thickness 2mm		

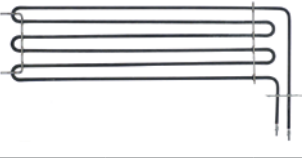
 <p>1</p>			
<b>GEV No.</b>	419140	<b>Ref. No.</b>	8C0256 J03RST1B50
<b>description</b>	heating element 1500W 230V heating circuits 1 L 340mm W 105mm L1 30mm L2 310mm W2 90mm flange length 70mm flange width 22mm hole distance 56mm connection M4 tube ø 6.3mm W1 15mm windings 2		

 <p>1</p>			
<b>GEV No.</b>	419235	<b>Ref. No.</b>	8C0392
<b>description</b>	heating element 3500W 230V heating circuits 1 L 560mm W 175mm L1 30mm L2 530mm W2 145mm flange length 70mm flange width 22.5mm hole distance 56mm connection M4 tube ø 6.3mm W1 33mm convection heating element combi-steamer windings 3		

 <p>1</p>			
<b>GEV No.</b>	418139	<b>Ref. No.</b>	808780
<b>description</b>	heating element 3500W 240V heating circuits 1 L 620mm W 120mm L1 33mm L2 587mm W2 90mm flange length 70mm flange width 22mm hole distance 56mm connection length 100mm connection M4 tube ø 8.5mm hole ø 6mm W1 30mm rectangular flange convection heating element windings 2		

 <p>1</p>			
<b>GEV No.</b>	490079	<b>Ref. No.</b>	809045
<b>description</b>	radiation heater octagonal 3400W 230V L 300mm W 300mm heating circuits 2 H 30mm with heating coil energy regulation with temperature signalization connections 4+2 connection type cable AD		
<b>spare parts for</b>	490079		
	<b>GEV No.</b>	390931	<b>Ref. No.</b> —
	safety thermostat for radiation heater		

<p>2-circuit</p>  <p>1</p>			
<b>GEV No.</b>	490080	<b>Ref. No.</b>	809127
<b>description</b>	radiation heater ø 250mm 2400W heating circuits 2 partial power 1000W		

hot plates

square & rectangular

with radiused edge

 <p>1</p>			
<b>GEV No.</b>	490066 <sup>1</sup>	<b>Ref. No.</b>	C00637
<b>description</b>	hot plate dimensions 220x220mm 2600W 230V with spill ring connection 4 screw clamps protector yes square		

<sup>1</sup>incl. protector



Зип Обществит  
energy regulators

EGO  
1-circuit

+7(812)987-08-81



1

<b>GEV No.</b>	490071 <sup>1</sup>	<b>Ref. No.</b>	C00212
<b>description</b>	hot plate dimensions 300x300mm 4000W 230V with spill ring connection 4 screw clamps protector yes square		

<sup>1</sup>incl. protector

round

with radiused edge

for domestic and commercial kitchens





1

<b>GEV No.</b>	490016	<b>Ref. No.</b>	C10000
<b>description</b>	hot plate ø 180mm 2000W 230V connection 4 screw clamps with 8mm spill ring		



1

<b>GEV No.</b>	490020	<b>Ref. No.</b>	C00208
<b>description</b>	hot plate ø 220mm 2600W 230V connection 4 screw clamps with 8mm spill ring		
<b>accessories for</b>	490020		
	<b>GEV No.</b>	<b>Ref. No.</b>	—
	550796		
	fixing plate for hot plate ø220mm		



1

<b>GEV No.</b>	490062	<b>Ref. No.</b>	C00210
<b>description</b>	hot plate ø 300mm 3500W 220V connection 4 screw clamps with 8mm spill ring		



1

<b>GEV No.</b>	380015	<b>Ref. No.</b>	809397
<b>description</b>	energy regulator 230V 13A single-circuit turn direction right shaft ø 6x4.6mm shaft L 23mm mounting thread M4 power release 6-100% no. 50.57021.010		



1

<b>GEV No.</b>	380019	<b>Ref. No.</b>	806287
<b>description</b>	energy regulator 240V 13A single-circuit turn direction right shaft ø 6x4.6mm shaft L 23mm mounting thread M4 power release 6-100% no. 50.57071.010		

2-circuit



1

<b>GEV No.</b>	380024	<b>Ref. No.</b>	unbekannt
<b>description</b>	energy regulator 240V 13A turn direction right shaft ø 6x4.6mm shaft L 36mm mounting thread M4 no. 50.67079.601 with operation switch 1-pole		

thermostats

bi-metal thermostats

bi-metal thermostats



1

<b>GEV No.</b>	375160	<b>Ref. No.</b>	809559
<b>description</b>	bi-metal thermostat hole distancemm switch-off temp. 110°C 1NC 1-pole 16A connection F6.3 M4		



control and safety thermostats

EGO

control thermostats

51.\_ series

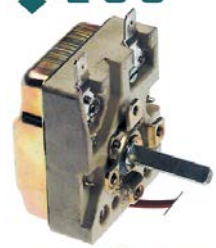

<b>GEV No.</b>	375334	<b>Ref. No.</b>	808144
<b>description</b>	thermostat t.max. 85°C temperature range 30-85°C 1-pole 1NO 16A probe ø 6mm probe L 130mm capillary pipe 900mm capillary pipe isolated 900mm gland nut shaft ø 6x4.6mm shaft L 23mm shaft position upper rotation 270°		

55.10/19\_ series



<b>GEV No.</b>	375055	<b>Ref. No.</b>	828838
<b>description</b>	thermostat t.max. 110°C temperature range 30-110°C 1-pole 1CO 16A probe ø 6mm probe L 130mm capillary pipe 1500mm capillary pipe isolatedmm gland nut shaft L 23mm shaft position upper rotation 318° 250V		



<b>GEV No.</b>	375647	<b>Ref. No.</b>	809017
<b>description</b>	thermostat t.max. 110°C temperature range 31-110°C 1-pole 1NO 16A probe ø 6mm probe L 133mm capillary pipe 870mm capillary pipe isolatedmm gland nut shaft ø 6x4.6mm shaft L 23mm shaft position upper rotation 318°		

Зип Общепит

vsezip.ru

+7(812)987-08-81



<b>GEV No.</b>	375341	<b>Ref. No.</b>	809036
<b>description</b>	thermostat t.max. 150°C temperature range 60-150°C 1-pole 1NO 16A probe ø 3mm probe L 219mm capillary pipe 900mm capillary pipe isolated 900mm gland nut shaft ø 6x4.6mm shaft L 23mm shaft position upper rotation 270°		



<b>GEV No.</b>	375718	<b>Ref. No.</b>	C10379
<b>description</b>	thermostat t.max. 180°C temperature range 70-180°C 1-pole 1NO 16A probe ø 6mm probe L 87mm capillary pipe 1500mm capillary pipe isolatedmm gland nut shaft ø 6x4.6mm shaft L 23mm shaft position upper rotation 270°		



<b>GEV No.</b>	375336	<b>Ref. No.</b>	C00545
<b>description</b>	thermostat t.max. 255°C temperature range 45-255°C 1-pole 1CO 16A probe ø 6mm probe L 74mm capillary pipe 900mm capillary pipe isolated 900mm gland nut shaft ø 6x4.6mm shaft L 23mm shaft position upper rotation 270°		





Зип Общежит

vsezip.ru

+7(812)987-08-81



<b>GEV No.</b>	375216	<b>Ref. No.</b>	808672
<b>description</b>	thermostat t.max. 280°C temperature range 50-280°C 1-pole 1NO 16A probe ø 3mm probe L 228mm capillary pipe 1300mm capillary pipe isolated 1150mm gland nut shaft L 23mm shaft position upper rotation 318°		



<b>GEV No.</b>	375594	<b>Ref. No.</b>	132110015
<b>description</b>	thermostat t.max. 318°C temperature range 60-318°C 1-pole 1NO 16A probe ø 3.03mm probe L 139mm capillary pipe 870mm capillary pipe isolatedmm gland nut shaft ø 6x4.6mm shaft L 23mm shaft position upper rotation 270°		



<b>GEV No.</b>	375860	<b>Ref. No.</b>	8C0888 8C1605
<b>description</b>	thermostat t.max. 289°C temperature range 57-289°C 1-pole 1NO 16A probe ø 3.1mm probe L 226mm capillary pipe 1780mm capillary pipe isolated 1770mm gland nut shaft ø 6x4.6mm shaft L 23mm shaft position upper° rotation 270° probe material SS		



<b>GEV No.</b>	375002	<b>Ref. No.</b>	C00563
<b>description</b>	thermostat t.max. 320°C temperature range 55-320°C 1-pole 1NO 16A probe ø 3.1mm probe L 226mm capillary pipe 870mm capillary pipe isolated 850mm gland nut shaft L 23mm shaft position upper rotation 270°		



<b>GEV No.</b>	375800	<b>Ref. No.</b>	132110016
<b>description</b>	thermostat t.max. 308°C temperature range 65-308°C 1-pole 1NO 16A probe ø 3.03mm probe L 120mm capillary pipe 600mm capillary pipe isolatedmm gland nut shaft ø 6x4.6mm shaft L 23mm shaft position upper rotation 270° with 2 probes		



<b>GEV No.</b>	375232	<b>Ref. No.</b>	C00563
<b>description</b>	thermostat t.max. 320°C temperature range 55-320°C 1-pole capillary pipe isolatedmm gland nut		



<b>GEV No.</b>	375253	<b>Ref. No.</b>	8C0363
<b>description</b>	thermostat t.max. 455°C temperature range 85-455°C 1-pole 1NO 16A probe ø 3.9mm probe L 228mm capillary pipe 870mm capillary pipe isolated 660mm gland nut shaft ø 6x4.6mm shaft L 23mm shaft position upper rotation 270°		

→ electric components

Зип-Общепит

vsezip.ru

+7(812)987-08-81



<b>GEV No.</b>	375247	<b>Ref. No.</b>	808542
<b>description</b>	thermostat t.max. 500°C temperature range 75-500°C 1-pole 1NO 16A probe ø 4mm probe L 228mm capillary pipe 900mm capillary pipe isolated gland nut shaft ø 6x4.6mm shaft L 23mm shaft position upper rotation 270°		



<b>GEV No.</b>	375534	<b>Ref. No.</b>	809260
<b>description</b>	thermostat t.max. 90°C temperature range 19-90°C 1-pole 1CO 16A probe ø 6mm probe L 129mm capillary pipe 980mm capillary pipe isolated 960mm gland nut shaft Lmm shaft position rotation 180°		

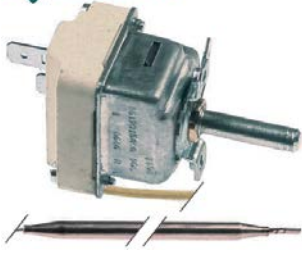

<b>GEV No.</b>	375809	<b>Ref. No.</b>	809890 J0THR090
<b>description</b>	thermostat t.max. 90°C temperature range 30-90°C 1-pole 1NO 16A probe ø 6mm probe L 130mm capillary pipe 1800mm capillary pipe isolated 1800mm gland nut shaft ø 6x4.6mm shaft L 23mm shaft position upper rotation 270°		

55.13\_series



<b>GEV No.</b>	375492	<b>Ref. No.</b>	808935
<b>description</b>	thermostat t.max. 190°C temperature range 94-190°C 1-pole 1NO 16A probe ø 6mm probe L 94mm capillary pipe 1090mm capillary pipe isolated 960mm gland nut M10x1 shaft ø 6x4.6mm shaft L 23mm shaft position upper rotation 310° probe material SS		

55.34\_series



<b>GEV No.</b>	375021	<b>Ref. No.</b>	808058
<b>description</b>	thermostat t.max. 110°C temperature range 32-110°C 3-pole 3CO 16A probe ø 6mm probe L 138mm capillary pipe 2980mm capillary pipe isolated 2200mm gland nut M9x1 shaft ø 6x4.6mm shaft L 23mm shaft position upper rotation 270°		



<b>GEV No.</b>	375410	<b>Ref. No.</b>	807603
<b>description</b>	thermostat t.max. 180°C temperature range 95-180°C 3-pole 3NO 16A probe ø 6mm probe L 133mm capillary pipe 1780mm capillary pipe isolated 1400mm gland nut M10x1 shaft ø 6x4.6mm shaft L 23mm shaft position upper rotation 270°		



Зип Общепит

vsezip.ru

+7(812)987-08-81

**E-G-O**



1

<b>GEV No.</b>	375929	<b>Ref. No.</b>	X12076
<b>description</b>	thermostat t.max. 182°C temperature range 101-182°C 3-pole 3NO 16A probe ø 6mm probe L 133mm capillary pipe 1180mm capillary pipe isolated 1040mm gland nut shaft ø 6x4.6mm shaft L 23mm shaft position upper rotation 270°		

**E-G-O**



1

<b>GEV No.</b>	375435	<b>Ref. No.</b>	807603
<b>description</b>	thermostat t.max. 190°C temperature range 56-190°C 3-pole 3NO 16A probe ø 6mm probe L 130mm capillary pipe 900mm capillary pipe isolated 670mm gland nut M10x1 shaft ø 6x4.6mm shaft L 23mm shaft position upper rotation 318° probe material SS		

55.40\_series

**E-G-O**



1

<b>GEV No.</b>	375185	<b>Ref. No.</b>	806189
<b>description</b>	thermostat t.max. 320°C temperature range 53-320°C 4-pole 4NO 16A probe ø 3.9mm probe L 228mm capillary pipe 880mm capillary pipe isolatedmm gland nut shaft ø 6x4.6mm shaft L 23mm shaft position upper rotation 270°		

safety thermostats

55.10/19\_series

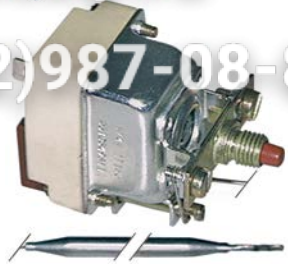

1

<b>GEV No.</b>	375250	<b>Ref. No.</b>	808671	
<b>description</b>	safety thermostat capillary pipe 870mm probe ø 6mm 1-pole probe L 129mm 16A capillary pipe isolatedmm gland nut switch-off temp. 130°C probe SS			
<b>spare parts for</b>	375250			
	<b>GEV No.</b>	551083	<b>Ref. No.</b>	—
	cap for safety thermostat thread M8x1			

**E-G-O**



1

<b>GEV No.</b>	375376	<b>Ref. No.</b>	808181
<b>description</b>	safety thermostat capillary pipe 870mm probe ø 6mm 1-pole probe L 133mm 0.5A capillary pipe isolatedmm gland nut M10x1 switch-off temp. 224°C probe		

**E-G-O**



1

<b>GEV No.</b>	375339	<b>Ref. No.</b>	808181	
<b>description</b>	safety thermostat switch-off temp. 225°C 1-pole 0.5A probe ø 6mm probe L 133mm capillary pipe 870mm capillary pipe isolatedmm gland nut M10x1 probe			
<b>accessories for</b>	375339			
	<b>GEV No.</b>	551083	<b>Ref. No.</b>	—
	cap for safety thermostat thread M8x1			

electric components

Зип Общепит

vsezip.ru

+7(812)987-08-81



<b>GEV No.</b>	375337	<b>Ref. No.</b>	C00546
<b>description</b>	safety thermostat switch-off temp. 300°C 1-pole 16A probe ø 6mm probe L 74mm capillary pipe 900mm capillary pipe isolated 700mm gland nut probe		



<b>GEV No.</b>	375277	<b>Ref. No.</b>	808057
<b>description</b>	safety thermostat switch-off temp. 150°C 3-pole 3NC 20A probe ø 6mm probe L 79mm capillary pipe 900mm capillary pipe isolated 700mm gland nut probe		

55.14\_series

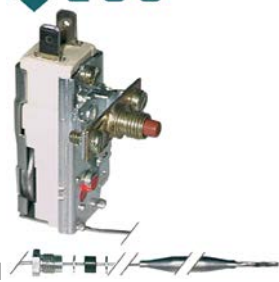

<b>GEV No.</b>	375260	<b>Ref. No.</b>	808430 813430
<b>description</b>	safety thermostat switch-off temp. 240°C 1-pole 16A probe ø 6mm probe L 77mm capillary pipe 1280mm capillary pipe isolated 1050mm gland nut M10x1 probe SS		



<b>GEV No.</b>	390338	<b>Ref. No.</b>	C00686
<b>description</b>	safety thermostat switch-off temp. 169°C		

55.32\_series

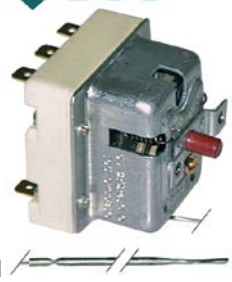

<b>GEV No.</b>	375281	<b>Ref. No.</b>	808203
<b>description</b>	safety thermostat switch-off temp. 150°C 3-pole 0.5A probe ø 3mm probe L 188mm capillary pipe 1100mm capillary pipe isolated 670mm gland nut probe SS		

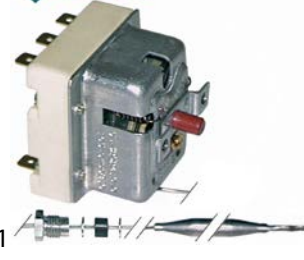

<b>GEV No.</b>	375258	<b>Ref. No.</b>	807349
<b>description</b>	safety thermostat switch-off temp. 232°C 3-pole 20A probe ø 6mm probe L 94mm capillary pipe 900mm capillary pipe isolated 670mm gland nut M10x1 probe SS		



<b>GEV No.</b>	375628	<b>Ref. No.</b>	808718
<b>description</b>	safety thermostat switch-off temp. 350°C 3-pole 20A probe ø 4mm probe L 120mm capillary pipe 900mm capillary pipe isolated 670mm gland nut M10x1 probe SS		





Зип Общепит

vsezip.ru

+7(812)987-08-81



1

<b>GEV No.</b>	375338	<b>Ref. No.</b>	C00098 C00686
<b>description</b>	safety thermostat switch-off temp. 350°C 3-pole 20A probe ø 6mm probe L 79mm capillary pipe 900mm capillary pipe isolated 700mm gland nut probe SS		



1

<b>GEV No.</b>	390797	<b>Ref. No.</b>	809505
<b>description</b>	safety thermostat switch-off temp. 157°C 1-pole 16A probe ø 6mm probe L 62mm capillary pipe 1520mm capillary pipe isolated 1380mm gland nut probe		



1

<b>GEV No.</b>	390141	<b>Ref. No.</b>	513130206
<b>description</b>	safety thermostat switch-off temp. 350°C 3-pole 3NC 20A probe ø 6mm probe L 77mm capillary pipe 1490mm capillary pipe isolated 800mm gland nut probe SS		



1

<b>GEV No.</b>	390714	<b>Ref. No.</b>	C00926
<b>description</b>	safety thermostat switch-off temp. 230°C 1-pole 1NC 16A probe ø 6mm probe L 75mm capillary pipe 740mm capillary pipe isolated 200mm gland nut probe SS		



1

<b>GEV No.</b>	390142	<b>Ref. No.</b>	807790
<b>description</b>	safety thermostat switch-off temp. 360°C 3-pole 20A probe ø 3.1mm probe L 188mm capillary pipe 1490mm capillary pipe isolated 800mm gland nut probe SS		



1

<b>GEV No.</b>	375159	<b>Ref. No.</b>	809504
<b>description</b>	safety thermostat switch-off temp. 365°C 1-pole 16A probe ø 4mm probe L 96mm capillary pipe 1160mm capillary pipe isolated 1100mm gland nut probe with special screwing screw connection M14x1		

electric components

Зип Общепит

vsezip.ru

+7(812)987-08-81

control thermostats with operation switch

55.10/19\_ series

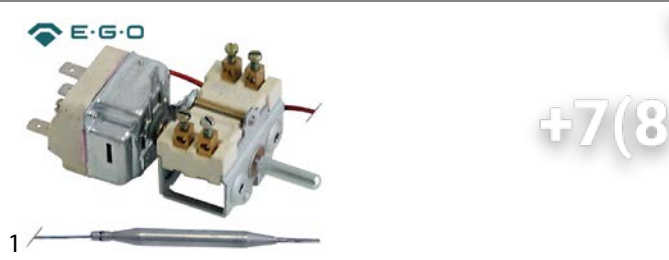

<b>GEV No.</b>	375119	<b>Ref. No.</b>	C98972
<b>description</b>	thermostat t.max. 255°C temperature range 45-255°C 1-pole 1CO 16A probe ø 6mm probe L 74mm capillary pipe 900mm capillary pipe isolated 900mm gland nut shaft L 23mm shaft position upper rotation 270° outer switch 2NO		
<b>spare parts for</b>	375119		
	<b>GEV No.</b>	300091	<b>Ref. No.</b> 806286 C00217
	operation switch EGO 2 operating positions 2NO 16A sequence 0-1 shaft ø 6x4.6mm shaft L 23mm connection screw ceramic		
	<b>GEV No.</b>	375778	<b>Ref. No.</b> —
	thermostat t.max. 255°C temperature range 45-255°C 1-pole 1CO probe ø 6mm probe L 74mm capillary pipe 900mm capillary pipe isolated 900mm gland nut shaft ø 6x4.6mm shaft L 23mm shaft position upper rotation 270°		
	<b>GEV No.</b>	550060	<b>Ref. No.</b> C00218
	connecting bow long for thermostat Qty 1 pcs		

CAEM

control thermostats



<b>GEV No.</b>	390082	<b>Ref. No.</b>	807256
<b>description</b>	thermostat t.max. 100°C temperature range 30-90°C 1-pole 1CO 16A probe ø 6mm probe L 94mm capillary pipe 1600mm capillary pipe isolatedmm gland nut shaft ø 6x4.6mm shaft L 22mm shaft position upper rotation 270° probe material copper		

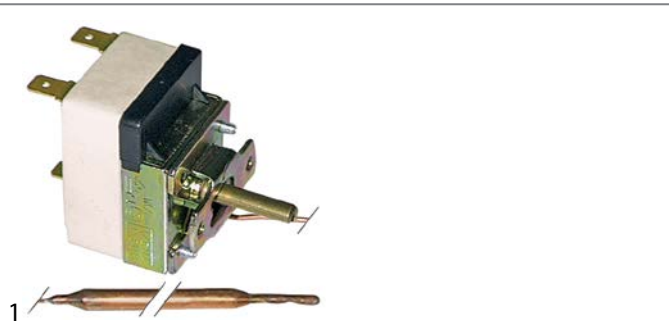

<b>GEV No.</b>	375094	<b>Ref. No.</b>	828838
<b>description</b>	thermostat t.max. 110°C temperature range 30-110°C 1-pole 1CO 16A probe ø 6mm probe L 75mm capillary pipe 1600mm capillary pipe isolatedmm gland nut shaft ø 6x4.6mm shaft L 22mm shaft position upper rotation 270° probe material copper		



<b>GEV No.</b>	375545	<b>Ref. No.</b>	808809
<b>description</b>	thermostat t.max. 120°C temperature range 30-120°C 1-pole 1CO 16A probe ø 6mm probe L 110mm capillary pipe 1600mm capillary pipe isolated 1550mm gland nut shaft ø 6x4.6mm shaft L 22mm shaft position upper rotation 270° probe material copper 250V		

safety thermostats



<b>GEV No.</b>	375456	<b>Ref. No.</b>	809891
<b>description</b>	safety thermostat switch-off temp. 335°C 2-pole 20A probe ø 3mm probe L 200mm capillary pipe 1050mm capillary pipe isolated 650mm gland nut probe SS at 250V 20A at 400V 10A		

refrigeration thermostats

RANCO

K50 series



<b>GEV No.</b>	390292	<b>Ref. No.</b>	828317
<b>description</b>	thermostat RANCO type K50P1118 probe ømm probe Lmm capillary pipe 1250mm temperature range -3 up to +2.5°C		

accessories

capillary tube clips

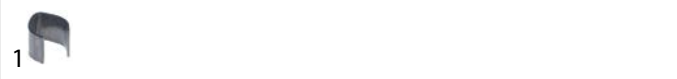

<b>GEV No.</b>	550138	<b>Ref. No.</b>	C10433
<b>description</b>	capillary tube clip for pipe ø 8.5mm for circular tube heating elements		



Зип Общепит

vsezip.ru

7 (812) 987-08-81



connecting bows



			
1			
<b>GEV No.</b>	550060	<b>Ref. No.</b>	C00218
<b>description</b>	connecting bow long for thermostat Qty 1 pcs		

switches and momentary switches

rocker/momentary rocker switches



30x22mm

			
1			
<b>GEV No.</b>	301003	<b>Ref. No.</b>	712110000 818181
<b>description</b>	rocker switch mounting measurements 30x22mm green 2NO 250V 16A illuminated 0-I connection male faston 6.3mm ambient temperature max. 125/55°C protection IP65		
<b>accessories for</b>	301003		
	<b>GEV No.</b>	301036	<b>Ref. No.</b> —
	protective cover internal size 30x22mm for rocker switch mounting measurementsmm		

			
1			
<b>GEV No.</b>	301001	<b>Ref. No.</b>	E61110003
<b>description</b>	rocker switch mounting measurements 30x22mm red 2NO 250V 16A illuminated 0-I connection male faston 6.3mm ambient temperature max. 125/55°C protection IP65		
<b>accessories for</b>	301001		
	<b>GEV No.</b>	301036	<b>Ref. No.</b> —
	protective cover internal size 30x22mm for rocker switch mounting measurementsmm		



			
1			
<b>GEV No.</b>	300136	<b>Ref. No.</b>	C00610
<b>description</b>	rocker switch mounting measurements 30x22mm green 2NO 24V 16A illuminated connection male faston 6.3mm ambient temperature max. 125/55°C protection IP40		

blank

			
1			
<b>GEV No.</b>	347675	<b>Ref. No.</b>	809832
<b>description</b>	momentary rocker switch mounting measurements 30x22mm green 2CO 250V 16A illuminated connection male faston 6.3mm ambient temperature max. 125/55°C protection IP65 with cover cap		
<b>accessories for</b>	347675		
	<b>GEV No.</b>	301036	<b>Ref. No.</b> —
	protective cover internal size 30x22mm for rocker switch mounting measurementsmm		

push/momentary push switches

19x13mm

			
1			
<b>GEV No.</b>	347605 <sup>1</sup>	<b>Ref. No.</b>	809883
<b>description</b>	push switch mounting measurements 19x13mm yellow 2NO 250V 16A illuminated connection male faston 6.3mm ambient temperature max. 105°C protection IP40		
<b>accessories for</b>	347605		
	<b>GEV No.</b>	346541	<b>Ref. No.</b> —
	protective cover for rocker switch external size 23.4x17.4mm internal size 19x13mm H 9.5mm mounting measurementsmm		

<sup>1</sup>illuminated

28.5x28.5mm

			
1			
<b>GEV No.</b>	347617	<b>Ref. No.</b>	809337
<b>description</b>	momentary push switch mounting measurements 28.5x28.5mm grey 2CO 250V 16A clock connection male faston 6.3mm ambient temperature max. 150°C protection IP40		

			
1			
<b>GEV No.</b>	100160	<b>Ref. No.</b>	C10250
<b>description</b>	momentary push switch mounting measurements 28.5x28.5mm red 1NO 250V 12A ignition connection male faston 6.3mm ambient temperature max. 85°C protection IP40 mounting ømm		

ø16mm

			
1			
<b>GEV No.</b>	346287 <sup>1</sup>	<b>Ref. No.</b>	809886
<b>description</b>	momentary push switch mounting ø 16mm red 1NO 250V 3A illuminated connection male faston 2.8mm ambient temperature max. 125/55°C protection IP65 with cover cap		

<sup>1</sup>illuminated

			
1			
<b>GEV No.</b>	346346	<b>Ref. No.</b>	809600
<b>description</b>	momentary push switch mounting ø 16mm red 1NO/indicator light 250V 3A connection male faston 2.8mm ambient temperature max. 125/55°C protection IP40		





Зип Общежит

microswitches

ø22mm



1

<b>GEV No.</b>	401357	<b>Ref. No.</b>	8C1407
<b>description</b>	momentary push switch mounting measurements ø22mm 1NO/1NC/indicator light 400V 4A indicator lamp 24V 0-1 connection screw ambient temperature max. 125/55°C protection IP40		
<b>spare parts for</b>	401357		
	<b>GEV No.</b>	346181	<b>Ref. No.</b>
	push button mounting ø 21mm external size 30x55mm oval		
<b>accessories for</b>	401357		
	<b>GEV No.</b>	401709	<b>Ref. No.</b>
	protective cover external size 57x32mm internal size 47x22mm matt finish rubber H 27.5mm		



1

<b>GEV No.</b>	699002	<b>Ref. No.</b>	809151
<b>description</b>	momentary push switch mounting ø 22mm black/white 1NO/1NC/indicator light 230V 6A 0-1 connection screw ambient temperature max. 70°C protection IP40		

ø25mm



1

<b>GEV No.</b>	345162 <sup>1</sup>	<b>Ref. No.</b>	8C0427
<b>description</b>	push switch mounting ø 25mm yellow 2NO 250V 16A illuminated connection male faston 6.3mm ambient temperature max. 85°C protection IP40		

<sup>1</sup>illuminated

1

<b>GEV No.</b>	348211	<b>Ref. No.</b>	244230001
<b>description</b>	push switch mounting ø 25mm red 1NO/indicator light 250V 16A illuminated connection male faston 6.3mm ambient temperature max. 85°C protection IP65 with cover		

universal

vsezip.ru  
CROUZET

7(812)987-08-81



1

<b>GEV No.</b>	345042	<b>Ref. No.</b>	809481
<b>description</b>	microswitch with plunger 250V 16A 1CO connection male faston 6.3mm L 28mm ambient temperature max. 125°C mounting distance 22mm type EF83161.3 actuating force: 75g blue/black		
<b>accessories for</b>	345042		
	<b>GEV No.</b>	345043	<b>Ref. No.</b>
	lever set 5-piece		



1

<b>GEV No.</b>	348043	<b>Ref. No.</b>	E61110082
<b>description</b>	microswitch with plunger 250V 16A 1CO connection male faston 6.3mm Lmm L1 27.8mm ambient temperature max. 125°C mounting distance 22mm with lever set type MS1-16 actuating force: 100g white		

lever actuated



1

<b>GEV No.</b>	345254	<b>Ref. No.</b>	E00010041
<b>description</b>	microswitch with lever 250V 16A 1CO connection male faston 6.3mm ambient temperature max. 120°C mounting distance 22mm actuating force: 60g lever length 58mm		



1

<b>GEV No.</b>	300128	<b>Ref. No.</b>	807999 808053
<b>description</b>	microswitch with lever 250V 16A 1CO connection male faston 6.3mm ambient temperature max. 85°C lever length 63mm		







Зип Общепит  
vsezip.ru  
+7(812)987-08-81

			
1			
<b>GEV No.</b>	346314	<b>Ref. No.</b>	132110023
<b>description</b>	microswitch with lever 250V 16A 1CO connection male faston 6.3mm L 56mm ambient temperature max. 125°C mounting distance 22mm type VRSR01DA1 actuating force: 50g		

			
1			
<b>GEV No.</b>	345156	<b>Ref. No.</b>	809173
<b>description</b>	microswitch with plunger thread M10x1 thread L 13mm 250V 16A 1CO connection male faston 6.3mm stroke 6mm mounting distance 25mm L 46mm L1 13mm ambient temperature max. 85°C type C4A-ZN3 actuating force: 340g		

			
1			
<b>GEV No.</b>	345125	<b>Ref. No.</b>	809568
<b>description</b>	microswitch with lever 250V 16A 1CO connection male faston 6.3mm ambient temperature max. 85°C mounting distance 25mm type C99ZP3 actuating force: 25g lever length 63.5mm		

accessories			
			
1			
<b>GEV No.</b>	698204	<b>Ref. No.</b>	809479
<b>description</b>	bracket for microswitch C4-C6		

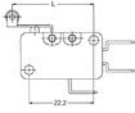

roller-lever actuated  
microswitches

 			
1			
<b>GEV No.</b>	345041	<b>Ref. No.</b>	E61110082
<b>description</b>	microswitch with handle with a switch 250V 16A 1CO connection male faston 6.3mm ambient temperature max. 85°C black lever length 20.5mm		

position switches

PIZZATO			
FA series			
			
1			
<b>GEV No.</b>	300137	<b>Ref. No.</b>	C00430
<b>description</b>	position switch cast aluminum 1NO/1NC 400V 3A L 49mm W 30mm H 16mm protection IP67 actuating force: 1000g screw connection mounting distance 20mm cable length 1800mm		

pin-plunger actuated

			
			
1			
<b>GEV No.</b>	345042	<b>Ref. No.</b>	809481
<b>description</b>	microswitch with plunger 250V 16A 1CO connection male faston 6.3mm L 28mm ambient temperature max. 125°C mounting distance 22mm type EF83161.3 actuating force: 75g blue/black		
<b>accessories for</b>	345042		
	<b>GEV No.</b>	345043	<b>Ref. No.</b> —
	lever set 5-piece		

system switches (ROLD)

			
1			
<b>GEV No.</b>	345131	<b>Ref. No.</b>	808948
<b>description</b>	element holder mounting measurements 28.5x28.5mm grey single element holder		

M10

			
1			
<b>GEV No.</b>	347216	<b>Ref. No.</b>	807351 E61110053
<b>description</b>	microswitch with plunger thread M10x0.75 thread L 14mm 250V 10A 1CO connection male faston 6.3mm stroke 7.5mm mounting distance 22mm L 28mm ambient temperature max. 125°C type NR6K5 actuating force: 260g		

			
1			
<b>GEV No.</b>	345606	<b>Ref. No.</b>	809021
<b>description</b>	momentary switch unit 2CO 250V 16A connection male faston 6.3mm		



Зип Оффенит

vsezip.ru

+7(812)987-08-81

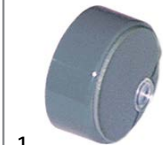

1	<b>GEV No.</b>	346211	<b>Ref. No.</b>	808950
	<b>description</b>	push button ø 23mm grey with lens		



1	<b>GEV No.</b>	346364	<b>Ref. No.</b>	808949
	<b>description</b>	rotary disc red/white disc ø 20.6mm		



1	<b>GEV No.</b>	345605	<b>Ref. No.</b>	808807
	<b>description</b>	switch 2CO 250V 16A connection male faston 6.3mm		

cam switches

on/off



1	<b>GEV No.</b>	300129	<b>Ref. No.</b>	808145
	<b>description</b>	cam switch 2 operating positions 2NO sequence 0-1 16A shaft ø 6x4.6mm shaft L 23mm connection male faston 6.3mm ceramic		



1	<b>GEV No.</b>	300088	<b>Ref. No.</b>	C00685
	<b>description</b>	cam switch 2 operating positions 4NO sequence 0-1 16A shaft ø 6x4.6mm shaft L 23mm connection male faston 6.3mm ceramic		

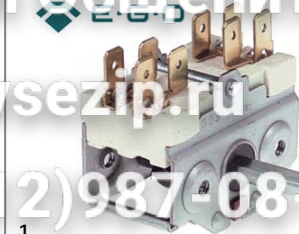

1	<b>GEV No.</b>	300074	<b>Ref. No.</b>	806286
	<b>description</b>	cam switch 4 operating positions 2NO sequence 0-1-0-1 16A shaft ø 6x4.6mm shaft L 23mm connection male faston 6.3mm ceramic		

7-position



1	<b>GEV No.</b>	300025	<b>Ref. No.</b>	C00213
	<b>description</b>	cam switch 7 operating positions 1NO/2CO sequence 0-1-2-3-4-5-6 16A shaft ø 6x4.6mm shaft L 23mm connection screw 7-position ceramic		

<b>accessories for</b>	300025			
	<b>GEV No.</b>	112172	<b>Ref. No.</b>	—
		knob universal ø 70mm black without adaptor/dial plate		
	<b>GEV No.</b>	112213	<b>Ref. No.</b>	—
		knob dial plate silver switch 7-position t.max.°C ED ø 63mm ID ø 45.5mm		
	<b>GEV No.</b>	112311	<b>Ref. No.</b>	—
		knob adapter shaft ø 6x4.6mm L 0mm with spring		



1	<b>GEV No.</b>	300106	<b>Ref. No.</b>	C00214
	<b>description</b>	cam switch 7 operating positions 1NO/2CO sequence 0-1-2-3-4-5-6 32A shaft ø 6x4.6mm shaft L 23mm connection screw 7-position shaft flat upper		



Зип Общежит

vsezip.ru

+7(812)987-08-81

4 operating positions

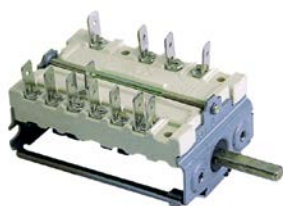

1	<b>GEV No.</b>	300010	<b>Ref. No.</b>	807290
<b>description</b>	cam switch 4 operating positions 2NO/2CO sequence 0-1-2-3 16A shaft $\phi$ 6x4.6mm shaft L 23mm connection male faston 6.3mm ceramic			



1	<b>GEV No.</b>	300091	<b>Ref. No.</b>	806286 C00217
<b>description</b>	operation switch EGO 2 operating positions 2NO 16A sequence 0-1 shaft $\phi$ 6x4.6mm shaft L 23mm connection screw ceramic			

5 operating positions

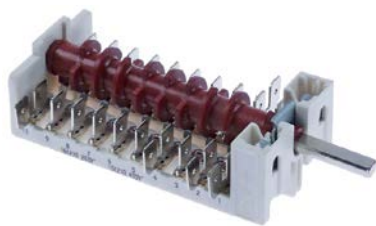

1	<b>GEV No.</b>	347652	<b>Ref. No.</b>	808962
<b>description</b>	cam switch 5 operating positions 5NO/2CO sequence 0-1-2-3-4 16A shaft $\phi$ 6x4.6mm shaft L 23mm connection male faston 6.3mm plastic			

operation switches



1	<b>GEV No.</b>	300002	<b>Ref. No.</b>	808052 C00690
<b>description</b>	cam switch 2 operating positions 4NO 16A sequence 0-1 shaft $\phi$ 6x4.6mm shaft L 23mm connection male faston 6.3mm ceramic			



1	<b>GEV No.</b>	300200	<b>Ref. No.</b>	C00217
<b>description</b>	operation switch 2 operating positions 2NO 16A sequence 0-1 shaft $\phi$ 6x4.6mm shaft L 23mm connection male faston 6.3mm operation switch ceramic			

magnetic switches

29x19mm



1	<b>GEV No.</b>	345217	<b>Ref. No.</b>	809557
<b>description</b>	magnetic switch L 29mm W 19mm 1NO 125V 0.5A P max. 10W connection cable cable length 2000mm			

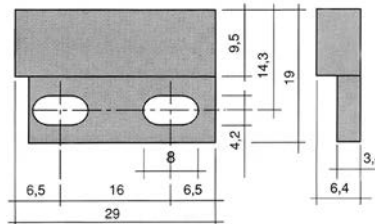

36x13mm



1	<b>GEV No.</b>	345335	<b>Ref. No.</b>	8C0129
<b>description</b>	magnetic switch L 36mm W 13mm 1NO 250V 0.04A P max. 10W connection cable cable length 960mm			
<b>accessories for</b>	345335			
	<b>GEV No.</b>	519049	<b>Ref. No.</b>	TR0220
	magnet $\phi$ mm L 63mm H 10.7mm W 18.8mm hole distance 52mm M2 hole $\phi$ 2mm			

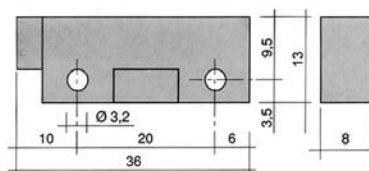

Зип-Общепит

accessories

magnets

vsezip.ru

+7(812)987-08-81

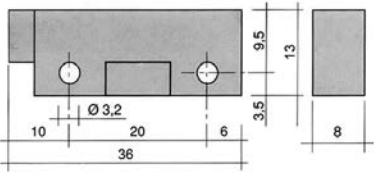
<b>GEV No.</b>	345118 <sup>1</sup>	<b>Ref. No.</b>	E61110057
<b>description</b>	magnetic switch L 36mm W 13mm 1NO 250V 1A P max. 50W connection cable cable length 980mm		
<b>accessories for</b>	345118		
	<b>GEV No.</b>	345399	<b>Ref. No.</b> —
	magnet ø 3.3mm L 40mm H 8mm W 13mm hole distance 30mm M3		





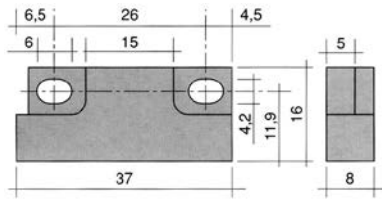

<b>GEV No.</b>	345398	<b>Ref. No.</b>	E00010012
<b>description</b>	magnet ømm L 36mm H 8mm W 13mm hole distance 20mm M3 hole ø 3mm		

<sup>1</sup>with coded connector

37x16mm



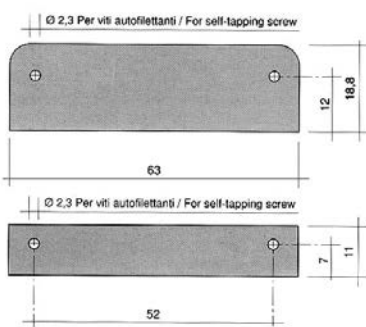

<b>GEV No.</b>	345600	<b>Ref. No.</b>	TR0666
<b>description</b>	magnetic switch L 37mm W 16mm 1NO 250V 0.2A P max. 50W connection cable cable length 960mm		
<b>accessories for</b>	345600		
	<b>GEV No.</b>	519049	<b>Ref. No.</b> TR0220
	magnet ømm L 63mm H 10.7mm W 18.8mm hole distance 52mm M2 hole ø 2mm		

<b>GEV No.</b>	519049	<b>Ref. No.</b>	TR0220
<b>description</b>	magnet ømm L 63mm H 10.7mm W 18.8mm hole distance 52mm M2 hole ø 2mm		
<b>accessories for</b>	519049		
	<b>GEV No.</b>	560095	<b>Ref. No.</b> —
	sheet metal screws ø 2.9mm L 9.5mm SS Qty 20 pcs DIN 7981/ISO 7049 head ø 5.6mm oval head		

M10x0.75

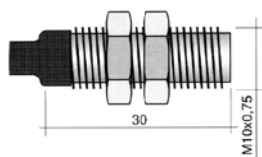
<b>GEV No.</b>	345632	<b>Ref. No.</b>	TR0309
<b>description</b>	magnetic switch thread M10x0.75 1NO 250V 0.5A P max. 50W connection cable cable length 2000mm type 102		
<b>accessories for</b>	345632		
	<b>GEV No.</b>	100779	<b>Ref. No.</b> —
	nut thread M10x0.75 H 3mm WS 14 SS Qty 2 pcs		

control equipment

MOELLER/EATON

switches (complete)

rotary switches



<b>GEV No.</b>	300132	<b>Ref. No.</b>	808641
<b>description</b>	rotary switch mounting measurements ø22mm green complete		





## push/momentary push switches



1

<b>GEV No.</b>	300131	<b>Ref. No.</b>	800472
<b>description</b>	momentary push switch mounting measurements ø22mm red illuminated, 80-264V 1NO momentary		

## ERSCE

## rotary switches



1



<b>GEV No.</b>	346691	<b>Ref. No.</b>	8C0281
<b>description</b>	rotary selector mounting measurements ø22mm black complete 1 latching / 2 momentary sequence 1-0-2 2NO/1NO 10(4)A max 400V		

## GIOVENZANA

## switches (complete)



1

<b>GEV No.</b>	401357	<b>Ref. No.</b>	8C1437	
<b>description</b>	momentary push switch mounting measurements ø22mm 1NO/1NC/indicator light 400V 4A indicator lamp 24V 0-1 connection screw ambient temperature max. 125/55°C protection IP40			
<b>spare parts for</b>	401357			
	<b>GEV No.</b>	346181	<b>Ref. No.</b>	—
	push button mounting ø 21mm external size 30x55mm oval			
<b>accessories for</b>	401357			
	<b>GEV No.</b>	401709	<b>Ref. No.</b>	—
	protective cover external size 57x32mm internal size 47x22mm matt finish rubber H 27.5mm			

## TELEMECANIQUE (EFA)

## XB2 series

## push buttons



1

<b>GEV No.</b>	300134	<b>Ref. No.</b>	C00278 C00278+C00279
<b>description</b>	push button mounting measurements ø22mm black		

Зип Общепит

vsezip.ru

+7(812)987-08-81



1

<b>GEV No.</b>	345412	<b>Ref. No.</b>	C00279
----------------	--------	-----------------	--------

**description** contact block with holder 1NO**spare parts for** 345412

<b>GEV No.</b>	345220	<b>Ref. No.</b>	—
<b>description</b>	contact block EFA ZB2BE101 1NO max 230V 10(6)A black		



<b>GEV No.</b>	345221	<b>Ref. No.</b>	—
<b>description</b>	contact block EFA ZB2BE102 1NC max 230V 10(6)A black		



<b>GEV No.</b>	347526	<b>Ref. No.</b>	—
<b>description</b>	contact block holder for XB2		

## encoders and potentiometers



1

<b>GEV No.</b>	401953	<b>Ref. No.</b>	IB5944010
<b>description</b>	PCB hand blenders VORTEX with potentiometer 230V		

## lamps

## indicator lights

## indicator lights 2-piece (lens and indicator lamp)

## indicator light lenses

ø10mm (type SRZ-3)



1

<b>GEV No.</b>	359124	<b>Ref. No.</b>	C00614
<b>description</b>	indicator light housings mounting measurements ø10mm yellow round Qty 1 pcs		

**accessories for** 359124

<b>GEV No.</b>	359132	<b>Ref. No.</b>	808943
<b>description</b>	indicator lamp green 250V connection male faston 6.3mm protection IP54 ambient temperature max. 85°C		

ø13mm (type SFK-3)



1

<b>GEV No.</b>	359126	<b>Ref. No.</b>	808461
<b>description</b>	indicator light housings mounting measurements ø13mm green Qty 1 pcs		

Зип.Общепит

vsezip.ru

+7(812)987-08-81

			
1			
<b>GEV No.</b>	359127	<b>Ref. No.</b>	809085
<b>description</b>	indicator light housings mounting measurements ø13mm yellow Qty 1 pcs		

indicator lamps for socket type SRZ / SDK / SDY / SFK			
			
1			
<b>GEV No.</b>	359130	<b>Ref. No.</b>	809084
<b>description</b>	indicator lamp 230V clear connection male faston 6.3mm ø 8mm		

			
1			
<b>GEV No.</b>	359129	<b>Ref. No.</b>	C00614
<b>description</b>	indicator lamp 24V clear connection male faston 6.3mm		

			
1			
<b>GEV No.</b>	359132	<b>Ref. No.</b>	808943
<b>description</b>	indicator lamp green 250V connection male faston 6.3mm protection IP54 ambient temperature max. 85°C		

indicator lights (complete)			
ø 6mm			
			
1			
<b>GEV No.</b>	359031	<b>Ref. No.</b>	8C0298
<b>description</b>	indicator light ø 6mm 230V green		



ø10mm			
with plug-in socket			
			
1			
<b>GEV No.</b>	359138	<b>Ref. No.</b>	808969
<b>description</b>	indicator light ø 10mm red 230V connection male faston 6.3mm Qty 1 pcs		

			
1			
<b>GEV No.</b>	359334	<b>Ref. No.</b>	C00614
<b>description</b>	indicator light ø 10mm yellow 24V connection male faston 6.3mm Qty 1 pcs		

ø12mm			
with screw socket			
			
1			
<b>GEV No.</b>	359291	<b>Ref. No.</b>	809133
<b>description</b>	indicator light ø 12mm 400V green connection male faston 6.3mm		

ø13mm			
with plug-in socket			
			
1			
<b>GEV No.</b>	359142	<b>Ref. No.</b>	807773
<b>description</b>	indicator light ø 13mm green 230V connection male faston 6.3mm temp.-resist. 120°C Qty 1 pcs		

			
1			
<b>GEV No.</b>	359143	<b>Ref. No.</b>	806128
<b>description</b>	indicator light ø 13mm yellow 230V connection male faston 6.3mm temp.-resist. 120°C Qty 1 pcs		

30x22mm			
			
1			
<b>GEV No.</b>	359157	<b>Ref. No.</b>	806080
<b>description</b>	indicator light mounting measurements 30x22mm 230V green connection male faston 6.3mm temp.-resist. 125/55°C type RL2		
<b>accessories for</b>	359157		
	<b>GEV No.</b>	301036	<b>Ref. No.</b> —
	protective cover internal size 30x22mm for rocker switch mounting measurementsmm		

miscellaneous			
			
Image not available			
1			
<b>GEV No.</b>	359335	<b>Ref. No.</b>	809133
<b>description</b>	indicator light		



Зип-Общепит

vsezip.ru

+7(812)987-08-81

screw-on/push-on fit

light bulbs

for ovens



1

<b>GEV No.</b>	357153	<b>Ref. No.</b>	809884
<b>description</b>	light bulb t.max. 300°C socket E14 25W 230V ø 25mm L 55mm lens L 30mm for oven type		

hard-glass infrared lamps



1

<b>GEV No.</b>	359463	<b>Ref. No.</b>	40XX-XX40999
<b>description</b>	infrared lamp socket E27 240V 250W ø 125mm L 173mm type BR125 red hard glas		



oven lamps

universal oven lamps

mounting diameter 35.5mm







1

<b>GEV No.</b>	359718	<b>Ref. No.</b>	809935
<b>description</b>	oven lamp mounting ø 35.5mm 230V 15W socket E14 temp.-resist. 300°C connection male faston 6.3mm hard glas		
<b>spare parts for</b>	359718		
	<b>GEV No.</b>	359701	<b>Ref. No.</b>
			809715 8C0278
	lamp socket socket E14 220-230V mounting ø 35.5mm connection male faston 6.3mm 15W		
	<b>GEV No.</b>	359740	<b>Ref. No.</b>
			—
	light bulb t.max. 300°C socket E14 15W 230V ø 22mm L 48mm lens L 20mm for oven lamp IMPORT		



1

<b>GEV No.</b>	359701	<b>Ref. No.</b>	809715 8C0278
<b>description</b>	lamp socket socket E14 220-230V mounting ø 35.5mm connection male faston 6.3mm 15W		
<b>accessories for</b>	359701		
	<b>GEV No.</b>	359705	<b>Ref. No.</b>
			—
	oven lamp glass thr.ø 33.5mm ø 52mm hard glas temp.-resist. 350°C		

<b>accessories for</b>	359701		
	<b>GEV No.</b>	359709	<b>Ref. No.</b>
			—
	oven lamp glass thr.ø 33.5mm ø 42mm hard glas temp.-resist. 350°C		
	<b>GEV No.</b>	359721	<b>Ref. No.</b>
			—
	gasket silicone ED ø 44mm ID ø 39.5mm thickness 5mm Qty 1 pcs		
	<b>GEV No.</b>	359942	<b>Ref. No.</b>
			—
	oven lamp glass thr.ø 33.5mm ø 41mm hard glas temp.-resist. 350°C		



1

<b>GEV No.</b>	359661	<b>Ref. No.</b>	808808
<b>description</b>	oven lamp glass thread 32.1 ø 58mm hard glas temp.-resist. 350°C		
<b>accessories for</b>	359661		
	<b>GEV No.</b>	359700	<b>Ref. No.</b>
			—
	gasket for pizza oven fibre glass ID ø 32.5mm ED ø 55mm thickness 5mm		

mounting diameter 47.8mm

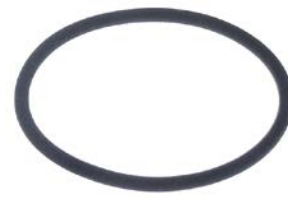

1

<b>GEV No.</b>	525313	<b>Ref. No.</b>	808709
<b>description</b>	O-ring Viton ID ø 60.33mm thickness 3.53mm Qty 1 pcs		



1

<b>GEV No.</b>	532649	<b>Ref. No.</b>	808710
<b>description</b>	O-ring Viton ID ø 63.17mm thickness 2.62mm Qty 1 pcs		



## Зип-Общепит





vsezip.ru

+7(812)987-08-81

mounting diameter 65.5mm



1

<b>GEV No.</b>	359712	<b>Ref. No.</b>	808850
<b>description</b>	oven lamp mounting $\phi$ 65.5mm 230V 40W socket E14 temp.-resist. 300°C connection male faston 6.3mm hard glas		
<b>spare parts for</b>	359712		
	<b>GEV No.</b>	359022	<b>Ref. No.</b> —
	lamp socket socket E14 mounting $\phi$ 65.5mm connection male faston 6.3mm		
	<b>GEV No.</b>	359611	<b>Ref. No.</b> —
	light bulb t.max. 300°C socket E14 40W 230V $\phi$ 45mm L 75mm lens L 50mm for oven lamp IMPORT		
	<b>GEV No.</b>	359722	<b>Ref. No.</b> —
	gasket silicone ID $\phi$ 57.5mm ED $\phi$ 68mm thickness 2mm		
	<b>GEV No.</b>	359724	<b>Ref. No.</b> 808851
	oven lamp glass thread $\phi$ 62mm H 46mm $\phi$ 74mm hard glas temp.-resist. 350°C		



1

<b>GEV No.</b>	359724	<b>Ref. No.</b>	808851
<b>description</b>	oven lamp glass thread $\phi$ 62mm H 46mm $\phi$ 74mm hard glas temp.-resist. 350°C		

55x70mm











1

<b>GEV No.</b>	359297	<b>Ref. No.</b>	131110027
<b>description</b>	frame L 95mm W 81mm mounting distance 68/83mm thickness 6mm		
<b>accessories for</b>	359297		
	<b>GEV No.</b>	359299	<b>Ref. No.</b> —
	gasket L 91mm W 77mm hole $\phi$ 3mm for oven lamp		

55x70mm



1

<b>GEV No.</b>	359698	<b>Ref. No.</b>	808979
<b>description</b>	lamp socket L 100mm W 55mm socket E14 connection male faston 6.3mm		
<b>spare parts for</b>	359698		
	<b>GEV No.</b>	358119	<b>Ref. No.</b> —
	frame L 118mm W 72mm mounting distance 143mm for bulb socket		
	<b>GEV No.</b>	358122	<b>Ref. No.</b> —
	gasket L 112mm W 68mm silicone thickness 3mm for bulb socket		
	<b>GEV No.</b>	358123	<b>Ref. No.</b> —
	lamp glass L 112mm W 68mm		
	<b>GEV No.</b>	359612	<b>Ref. No.</b> —
	light bulb t.max. 300°C socket E14 25W 230V $\phi$ 25mm L 56mm lens L 30mm for oven lamp type Philips		
	<b>GEV No.</b>	359714	<b>Ref. No.</b> 808977
	gasket for bulb socket		
	<b>GEV No.</b>	359715	<b>Ref. No.</b> 808976
	lamp glass L 110mm W 65mm thickness 5mm		
	<b>GEV No.</b>	359716	<b>Ref. No.</b> 808975
	frame for bulb socket		
<b>accessories for</b>	359698		
	<b>GEV No.</b>	359612	<b>Ref. No.</b> —
	light bulb t.max. 300°C socket E14 25W 230V $\phi$ 25mm L 56mm lens L 30mm for oven lamp type Philips		
	<b>GEV No.</b>	359938	<b>Ref. No.</b> —
	borosilicate glass L 115mm W 69mm		



1

<b>GEV No.</b>	359716	<b>Ref. No.</b>	808975
<b>description</b>	frame for bulb socket		













Зип Общепит  
vsezip.ru







+7(812)987-08-81

			
1			
<b>GEV No.</b>	359714	<b>Ref. No.</b>	808977
<b>description</b>	gasket for bulb socket		

			
1			
<b>GEV No.</b>	359715	<b>Ref. No.</b>	808976
<b>description</b>	lamp glass L 110mm W 65mm thickness 5mm		

			
1			
<b>GEV No.</b>	359698	<b>Ref. No.</b>	808979
<b>description</b>	lamp socket L 100mm W 55mm socket E14 connection male faston 6.3mm		

<b>spare parts for</b>	359698			
	<b>GEV No.</b>	358119	<b>Ref. No.</b>	—
	frame L 118mm W 72mm mounting distance 143mm for bulb socket			
	<b>GEV No.</b>	358122	<b>Ref. No.</b>	—
	gasket L 112mm W 68mm silicone thickness 3mm for bulb socket			
	<b>GEV No.</b>	358123	<b>Ref. No.</b>	—
	lamp glass L 112mm W 68mm			
	<b>GEV No.</b>	359612	<b>Ref. No.</b>	—
	light bulb t.max. 300°C socket E14 25W 230V ø 25mm L 56mm lens L 30mm for oven lamp type Philips			
	<b>GEV No.</b>	359714	<b>Ref. No.</b>	808977
	gasket for bulb socket			
	<b>GEV No.</b>	359715	<b>Ref. No.</b>	808976
	lamp glass L 110mm W 65mm thickness 5mm			
	<b>GEV No.</b>	359716	<b>Ref. No.</b>	808975
	frame for bulb socket			
<b>accessories for</b>	359698			
	<b>GEV No.</b>	359612	<b>Ref. No.</b>	—
	light bulb t.max. 300°C socket E14 25W 230V ø 25mm L 56mm lens L 30mm for oven lamp type Philips			
	<b>GEV No.</b>	359938	<b>Ref. No.</b>	—
	borosilicate glass L 115mm W 69mm			

				
<b>GEV No.</b>	101372	<b>Ref. No.</b>	808569	
<b>description</b>	oven lamp complete L 100mm W 55mm 230V 25W socket E14 rectangular temp.-resist. 300°C connection male faston 6.3mm			
<b>spare parts for</b>	101372			
	<b>GEV No.</b>	359612	<b>Ref. No.</b>	—
	light bulb t.max. 300°C socket E14 25W 230V ø 25mm L 56mm lens L 30mm for oven lamp type Philips			
	<b>GEV No.</b>	359698	<b>Ref. No.</b>	808979
	lamp socket L 100mm W 55mm socket E14 connection male faston 6.3mm			
	<b>GEV No.</b>	359714	<b>Ref. No.</b>	808977
	gasket for bulb socket			
	<b>GEV No.</b>	359715	<b>Ref. No.</b>	808976
	lamp glass L 110mm W 65mm thickness 5mm			
	<b>GEV No.</b>	359716	<b>Ref. No.</b>	808975
	frame for bulb socket			

lamps

light bulbs

			
1			
<b>GEV No.</b>	357153	<b>Ref. No.</b>	809884
<b>description</b>	light bulb t.max. 300°C socket E14 25W 230V ø 25mm L 55mm lens L 30mm for oven type		

residual heat indicators

			
1			
<b>GEV No.</b>	359326	<b>Ref. No.</b>	809047
<b>description</b>	residual heat indicator 4-fold		

			
1			
<b>GEV No.</b>	359327	<b>Ref. No.</b>	809398
<b>description</b>	residual heat indicator single		



## timers

## Зип Общежит

electric timers

## programme timers



1

<b>GEV No.</b>	360525	<b>Ref. No.</b>	809346
<b>description</b>	timer CDC 11904 engines 1 chambers 4 operation time 10min 230V shaft $\varnothing$ mm shaft Lmm manif. no. 11904F1 / BCR000.0000 motor type M48R ATS		
<b>spare parts for</b>	360525		
	<b>GEV No.</b>	360118	<b>Ref. No.</b>
			—
	motor CDC pinion $\varnothing$ 4.9mm teeth 10 230V voltage AC 50/60Hz turn direction right motor $\varnothing$ 47mm H 19.3mm motor type M48R ATS for timer cable length 260mm 1.9/2.5W		





1

<b>GEV No.</b>	360511	<b>Ref. No.</b>	8C0289 J03CCL001
<b>description</b>	timer FIBER P19 engines 1 chambers 4 operation time 270s 230V shaft $\varnothing$ mm shaft Lmm manif. no. P195JV4H700 motor type M51B-J0R6400		



1

<b>GEV No.</b>	360303	<b>Ref. No.</b>	809247
<b>description</b>	timer FIBER P25 engines 2 chambers 5 operation time 72s / 4.8min 230V shaft $\varnothing$ mm shaft Lmm manif. no. P255J05ANM0 motor type M51BJ0R6400 / M51BJ0L6400		
<b>spare parts for</b>	360303		
	<b>GEV No.</b>	360673	<b>Ref. No.</b>
			—
	motor kit pinion $\varnothing$ 6.8mm teeth 15 230V voltage AC 50/60Hz turn direction clockwise motor $\varnothing$ 48mm H 18.5mm motor type UDS-40NE1RNZ165 cable length 150mm with holder		
	<b>GEV No.</b>	360674	<b>Ref. No.</b>
			—
	motor kit pinion $\varnothing$ 6.8mm teeth 15 230V voltage AC 50/60Hz turn direction counterclockwise motor $\varnothing$ 48mm H 18.5mm motor type UDS40NE1RNZ165 cable length 150mm with holder		

## with time spread

vsezip.ru

+7(812)987-08-81



1

<b>GEV No.</b>	350074	<b>Ref. No.</b>	809442
<b>description</b>	timer MS65 operation time 120min time spread 30min 1CO/2NO/1NC at 250V 16A permanent position yes impulse electric shaft $\varnothing$ 6x4.6mm shaft L 22mm mounting distance 28mm connection lateral Invensys 4-pole shaft position lower°		





1

<b>GEV No.</b>	350073	<b>Ref. No.</b>	8C1391
<b>description</b>	timer MS65 with buzzer board operation time 120min time spread 30min 1CO/1NC/2NO at 250V 16A permanent position yes impulse electric shaft $\varnothing$ 6x4.6mm shaft L 20mm with bell mounting distance 28mm connection lateral 3-pole		

## mechanical timers



1

<b>GEV No.</b>	350159	<b>Ref. No.</b>	132110014
<b>description</b>	timer M2 2-pole operation time 120min impulse mechanical 2CO at 250V 16A permanent position yes shaft $\varnothing$ 6x4.6mm shaft 6x4.6mm shaft L 22mm mounting distance 28mm mounting thread M4 connection male faston 6.3mm ambient temperature max. 125°C with buzzer		
<b>spare parts for</b>	350159		
	<b>GEV No.</b>	350186	<b>Ref. No.</b>
			—
	timer M2 2-pole operation time 120min impulse mechanical 2CO at 250V 16A permanent position yes shaft $\varnothing$ 6x4.6mm shaft 6x4.6mm shaft L 23mm mounting distance 28mm		
	<b>GEV No.</b>	401062	<b>Ref. No.</b>
			—
	buzzer board 230VAC L 48mm W 45mm connection Faston 6.3mm		

Зип Общедит

alarm devices

buzzers

vsezip.ru

+7(812)987-08-81

			
1			
<b>GEV No.</b>	350030	<b>Ref. No.</b>	8C2008
<b>description</b>	timer M2 2-pole operation time 120min impulse mechanical 2NO at 250V 16A permanent position no shaft ø 6x4.6mm shaft L 23mm mounting distance 28mm connection lateral		
<b>accessories for</b>	350030		
	<b>GEV No.</b>	110366	<b>Ref. No.</b> —
	knob switch zero mark t.max.°C ø 44mm shaft ø 6x4.6mm shaft flat upper black		
	<b>GEV No.</b>	111199	<b>Ref. No.</b> —
	dial plate graduation 120min permanent position no rotation 0-330° ø 60mm timers knob ø 45mm		

			
1			
<b>GEV No.</b>	350003	<b>Ref. No.</b>	813170
<b>description</b>	timer M2 with bell 2-pole operation time 120min impulse mechanical 2NO at 250V 16A permanent position no shaft ø 6x4.6mm shaft L 23mm mounting distance 28mm connection lateral		
<b>accessories for</b>	350003		
	<b>GEV No.</b>	110366	<b>Ref. No.</b> —
	knob switch zero mark t.max.°C ø 44mm shaft ø 6x4.6mm shaft flat upper black		
	<b>GEV No.</b>	111199	<b>Ref. No.</b> —
	dial plate graduation 120min permanent position no rotation 0-330° ø 60mm timers knob ø 45mm		

			
1			
<b>GEV No.</b>	350008	<b>Ref. No.</b>	809674
<b>description</b>	timer M2 with bell 2-pole operation time 120min impulse mechanical 2NO at 250V 16A permanent position yes shaft ø 6x4.6mm shaft L 24mm mounting distance 28mm connection lateral		

			
1			
<b>GEV No.</b>	350136	<b>Ref. No.</b>	809553
<b>description</b>	buzzer 12VAC connection cable 200mm screw mounting 63dB		

## contactors

### GENERAL ELECTRIC (AEG)

#### power contactors

			
1			
<b>GEV No.</b>	380244	<b>Ref. No.</b>	807553 8C0148
<b>description</b>	power contactor resistive load 25A 230VAC (AC3/400V) 9A/4kW main contacts 3NO auxiliary contacts 1NO connection screw connection type AEG LS4K 10A type GE CL00A 310		

			
1			
<b>GEV No.</b>	380261	<b>Ref. No.</b>	C00571
<b>description</b>	power contactor resistive load 32A 230VAC (AC3/400V) 17A/7.5kW main contacts 3NO auxiliary contacts 1NO connection screw connection type AEG LS7K 10A type GE CL02A 310		



Зип-Общепит

## LOVATO

## power contactors



1

<b>GEV No.</b>	380705	<b>Ref. No.</b>	C00287
<b>description</b>	power contactor resistive load 20A 230VAC (AC3/400V) 9A/4kW main contacts 3NO auxiliary contacts 1NO connection screw connection type 11BG0910A230		

accessories for 380705



<b>GEV No.</b>	380057	<b>Ref. No.</b>	—
<b>description</b>	auxiliary contact contacts 1NO/1NC AC1 10A for contactors BG series connection screw type BGX1011		



1

<b>GEV No.</b>	380082	<b>Ref. No.</b>	C00287
<b>description</b>	power contactor resistive load 20A 240VAC (AC3/400V) 9A/4kW main contacts 4NO		

## SIEMENS

## power contactors



1

<b>GEV No.</b>	380645	<b>Ref. No.</b>	809820
<b>description</b>	power contactor 230VAC with auxiliary contacts		

## power contactors



1

<b>GEV No.</b>	380882	<b>Ref. No.</b>	8C0216
<b>description</b>	power contactor resistive load 25A 230VAC AC3 10A main contacts 3NO auxiliary contacts 1NO connection screw connection type J7KN-10D-10 OMRON		

## solid state relays

## CELDUC



1

<b>GEV No.</b>	400105	<b>Ref. No.</b>	809558
<b>description</b>	solid state relay CELDUC 2 phase 65A 400V 24VDC L 58mm W 45mm plug-in connection screw type 40.00.453		

accessories for 400105



<b>GEV No.</b>	401794	<b>Ref. No.</b>	—
<b>description</b>	connecting cable L 1440mm 4-pole suitable for RATIONAL		

## relays

## power relays

## with bracket mounting

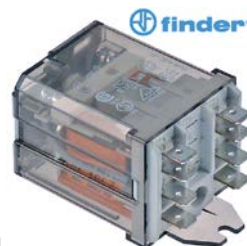

1

<b>GEV No.</b>	380139	<b>Ref. No.</b>	809863
<b>description</b>	power relays FINDER 230VAC 16A 2CO connection F6.3 bracket mounting dimensions 68x38.2x35.8mm manuf. no. 62.82.8.230.0000		





Зип-Общепит

vsezip.ru

+7(812)987-08-81



1

<b>GEV No.</b>	380403	<b>Ref. No.</b>	905475
<b>description</b>	power relays FINDER 230VAC 16A 3CO connection F6.3 bracket mounting manuf. no. 62.83.8.230.0500		

with male contacts  
female contact 2.0mm





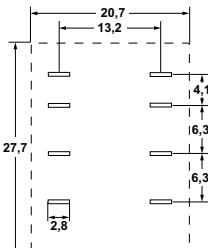

1



<b>GEV No.</b>	380129	<b>Ref. No.</b>	809015
<b>description</b>	power relays 24VAC 12A 2CO connection F2 plug-in connection 94.92.3 250V connection 2mm		

**accessories for** 380129

	<b>GEV No.</b>	380341	<b>Ref. No.</b>	—
	<b>description</b>	relay socket 4-pole contacts 12 300V voltage AC 6A Italiana Relè manuf. no. ZMD4		
	<b>GEV No.</b>	380378	<b>Ref. No.</b>	—
	<b>description</b>	relay socket 2-pole 55/85 dimensions 70.5x30x27mm 250V voltage AC 10A FINDER manuf. no. 94.72		
	<b>GEV No.</b>	380384	<b>Ref. No.</b>	—
	<b>description</b>	relay socket 2-pole contacts male faston 2.8mm 250V voltage AC 10A W 23mm for		
	<b>GEV No.</b>	380399	<b>Ref. No.</b>	—
	<b>description</b>	relay socket 4-pole dimensions 76.2x27x86.1mm 250V voltage AC 1A FINDER manuf. no. 94.94.3		

plug-in/print relays



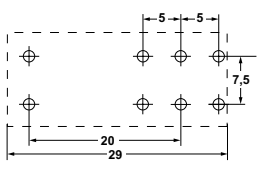

1



<b>GEV No.</b>	380333	<b>Ref. No.</b>	J03REL001
<b>description</b>	print relay 230VAC 2CO at 250V 8A connection pins raster size 5mm FINDER manuf. no. 40.52.8.230.0000 95.65/95.75		

**accessories for** 380333

	<b>GEV No.</b>	380340	<b>Ref. No.</b>	—
	<b>description</b>	relay socket dimensions 62x36x15mm 250V voltage AC 10A Italiana Relè manuf. no. ZMEM/5		
	<b>GEV No.</b>	380505	<b>Ref. No.</b>	—
	<b>description</b>	relay socket 2CO 40.52 dimensions 81.9x15.5x75mm 250V voltage AC 10A FINDER manuf. no. 95.95.3		

**accessories for** 380333

<b>GEV No.</b>	381181	<b>Ref. No.</b>	—
<b>description</b>	relay socket 2-pole 40.51/40.52/40.61 connection screw clamp dimensions 15.8x78.6mm 250V voltage AC 10A FINDER manuf. no. 95.75		

relays sockets



1

<b>GEV No.</b>	380638	<b>Ref. No.</b>	809018
<b>description</b>	relay socket 8-pole dimensions 51x41x23mm 250V 10A FINDER manuf. no. 90.26		

level relays

GICAR



1

<b>GEV No.</b>	401173	<b>Ref. No.</b>	807853
<b>description</b>	level relay 230V connection F6.3 type RL30/3ES/F		

time relays

time relays



1

<b>GEV No.</b>	380639	<b>Ref. No.</b>	809016
<b>description</b>	time relay TECNOLOGIC RTR12DS06S time range 6s 230VAC 5A mounting measurements 34x34mm 1CO connection plug-in connection round 8-pole		

**accessories for** 380639

	<b>GEV No.</b>	380638	<b>Ref. No.</b>	809018
	<b>description</b>	relay socket 8-pole dimensions 51x41x23mm 250V 10A FINDER manuf. no. 90.26		

Зип Обществит  
electronic controllersDIXELL  
vsezip.ru  
refrigeration controllers

built-in version

+7(812)987-08-81













1

<b>GEV No.</b>	380640	<b>Ref. No.</b>	809019
<b>description</b>	time relay TECNOLOGIC RTR12DS60S time range 60s 230VAC 5A 1CO connection plug-in connection round 8-pole		
<b>accessories for</b>	380640		
	<b>GEV No.</b>	380638	<b>Ref. No.</b> 809018
	relay socket 8-pole dimensions 51x41x23mm 250V 10A FINDER manuf. no. 90.26		



1

<b>GEV No.</b>	378384	<b>Ref. No.</b>	246430107
<b>description</b>	electronic controller DIXELL XR40CX-5NOC1 mounting measurements 71x29mm 230V voltage AC NTC/PTC relay outputs 2 NO-20A(8) CO-8A(3) NTC/PTC NTC/PTC DI -50 up to +150°C display 3½ digits		
<b>accessories for</b>	378384		
	<b>GEV No.</b>	378551	<b>Ref. No.</b> —
	adapter for reducer mounting measurements 71x29mm		
	<b>GEV No.</b>	379053	<b>Ref. No.</b> —
	temperature probe PTC 1kOhm cable PVC probe -50 up to +150°C cable -10 up to 100°C probe ø6x30mm cable length 3m without screw connection 2-wire		
	<b>GEV No.</b>	379057	<b>Ref. No.</b> —
	temperature probe NTC 10kOhm cable PVC probe -20 up to +80°C cable -10 up to 100°C probe ø6x25mm cable length 3m 2-wire		
	<b>GEV No.</b>	379064	<b>Ref. No.</b> —
	temperature probe PTC 1kOhm cable silicone probe -50 up to +150°C cable -50 up to +180°C probe ø6x40mm cable length 3m without screw connection 2-wire		
	<b>GEV No.</b>	379142	<b>Ref. No.</b> E25110070
	temperature probe PTC 1kOhm cable PVC probe -50 up to +150°C cable -10 up to 100°C probe ø6x30mm cable length 1.5m without screw connection 2-wire		
	<b>GEV No.</b>	379160	<b>Ref. No.</b> —
	temperature probe NTC 10kOhm cable thermoplastic probe -40 up to +110°C cable -40 up to +110°C probe ø6x14mm cable length 1.5m without screw connection 2-wire		
	<b>GEV No.</b>	379161	<b>Ref. No.</b> —
	temperature probe NTC 10kOhm cable thermoplastic probe -40 up to +110°C cable -40 up to +110°C probe ø6x14mm cable length 3m without screw connection 2-wire		
	<b>GEV No.</b>	379343	<b>Ref. No.</b> 825830
	temperature probe NTC 10kOhm cable silicone probe -40 up to +110°C cable -50 up to +180°C probe ø6x40mm cable length 3m 2-wire		
	<b>GEV No.</b>	379749	<b>Ref. No.</b> —
	temperature probe NTC 10kOhm cable silicone probe -40 up to +110°C cable -50 up to +180°C probe ø6x30mm cable length 1.5m without screw connection 2-wire		
	<b>GEV No.</b>	379782	<b>Ref. No.</b> —
	temperature probe PTC 1kOhm cable thermoplastic probe -50 up to +150°C cable -40 up to +110°C probe ø6x14mm cable length 3m 2-wire resistor 1kOhm		
	<b>GEV No.</b>	402818	<b>Ref. No.</b> —
	programming key 4K for electronic controller DIXELL		

## transformers

## open transformers

## with clamp terminal



1

<b>GEV No.</b>	401983	<b>Ref. No.</b>	C00718
<b>description</b>	transformer primary 230V secondary 24V 30VA connection screw 50/60Hz		



1

<b>GEV No.</b>	400203	<b>Ref. No.</b>	C00506
<b>description</b>	transformer primary 230V secondary 24V 30VA H 64mm L 75mm W 65mm connection screw 50/60Hz		



Зип Общепит

universal controllers

vsezip.ru

built-in version

+7(812)987-08-81



1

<b>GEV No.</b>	378229	<b>Ref. No.</b>	246430103
<b>description</b>	electronic controller DIXELL XW60L-5N0C1 mounting measurements 150x30mm built-in depth 65.5mm 230V voltage AC NTC/PTC relay outputs 4 CO-20A(8) CO-8A(3) NO-8A(3) NO-8A(3) NTC/PTC NTC/PTC DI -50 up to +150°C display 3½ digits		
<b>accessories for</b>	378229		
	<b>GEV No.</b>	<b>Ref. No.</b>	
	378194	—	temperature probe NTC 10kOhm cable PVC probe -20 up to +80°C cable -10 up to 100°C probe ø7x24.5mm cable length 1.5m without screw connection 2-wire
	379052	—	temperature probe PTC 1kOhm cable silicone probe -50 up to +150°C cable -50 up to +180°C probe ø6x40mm cable length 1.5m without screw connection 2-wire
	379053	—	temperature probe PTC 1kOhm cable PVC probe -50 up to +150°C cable -10 up to 100°C probe ø6x30mm cable length 3m without screw connection 2-wire
	379057	—	temperature probe NTC 10kOhm cable PVC probe -20 up to +80°C cable -10 up to 100°C probe ø6x25mm cable length 3m 2-wire
	379064	—	temperature probe PTC 1kOhm cable silicone probe -50 up to +150°C cable -50 up to +180°C probe ø6x40mm cable length 3m without screw connection 2-wire
	379160	—	temperature probe NTC 10kOhm cable thermoplastic probe -40 up to +110°C cable -40 up to +110°C probe ø6x14mm cable length 1.5m without screw connection 2-wire
	379161	—	temperature probe NTC 10kOhm cable thermoplastic probe -40 up to +110°C cable -40 up to +110°C probe ø6x14mm cable length 3m without screw connection 2-wire
	379343	825830	temperature probe NTC 10kOhm cable silicone probe -40 up to +110°C cable -50 up to +180°C probe ø6x40mm cable length 3m 2-wire
	379458	—	temperature probe NTC 10kOhm cable silicone probe -40 up to +110°C cable -50 up to +180°C probe ø6x40mm cable length 1.5m without screw connection 2-wire
	402818	—	programming key 4K for electronic controller DIXELL



1

<b>GEV No.</b>	379605	<b>Ref. No.</b>	831131 8C0227
<b>description</b>	electronic controller ELIWELL type ICPlus915 model ICP22J135000 mounting measurements 71x29mm 12V voltage AC/DC Pt100/TC (J,K) relay outputs 2 NO-8A(4) NO-8A(4) Pt100/TC (J,K) cooking front measurements 78x37mm built-in depth 59mm mode of operation cooking protection IPx0 accuracy 1% built-in version defr. funct. no dependend on probe°C display 3½ digits		
<b>accessories for</b>	379605		
	<b>GEV No.</b>	<b>Ref. No.</b>	
	379050	—	temperature probe Pt100 cable Vetrotex probe -200 up to +600°C cable -50 up to +350°C probe ø6x100mm cable length 2.7m without screw connection 3-wire
	379054	—	transformer primary 230VAC secondary 12VAC 3VA secondary 0.25A H 40mm L 45mm W 50mm connection screw 50/60Hz type 153/M
	379785	—	temperature probe Pt100 cable silicone probe -100 up to 450°C cable -50 up to +180°C probe ø6x100mm cable length 1.5m without screw connection 2-wire resistor 0.1kOhm
	379786	—	temperature probe Pt100 cable silicone probe -100 up to 450°C cable -50 up to +180°C probe ø6x100mm cable length 3m without screw connection 2-wire resistor 0.1kOhm
	379787	—	temperature probe Pt100 cable Vetrotex probe -200 up to +600°C cable -50 up to +350°C probe ø6x100mm cable length 1.4m without screw connection 2-wire resistor 0.1kOhm

refrigeration controllers

built-in version



1

<b>GEV No.</b>	379645	<b>Ref. No.</b>	712110005
<b>description</b>	electronic controller ELIWELL type ID961 mounting measurements 71x29mm 230V voltage AC NTC/PTC relay outputs 1 relay -55 up to +150°C display 3½ digits compressor relay 15A		
<b>accessories for</b>	379645		
	<b>GEV No.</b>	<b>Ref. No.</b>	
	379053	—	temperature probe PTC 1kOhm cable PVC probe -50 up to +150°C cable -10 up to 100°C probe ø6x30mm cable length 3m without screw connection 2-wire

Table continues overleaf

electric components

Зип Общепит

vsezip.ru

(812)987-08-81

<b>accessories for</b>	379645		
	GEV No.	379064	Ref. No.
			—
	temperature probe PTC 1kOhm cable silicone probe -50 up to +150°C cable -50 up to +180°C probe ø6x40mm cable length 3m without screw connection 2-wire		
	GEV No.	379161	Ref. No.
			—
	temperature probe NTC 10kOhm cable thermoplastic probe -40 up to +110°C cable -40 up to +110°C probe ø6x14mm cable length 3m without screw connection 2-wire		
	GEV No.	379782	Ref. No.
			—
	temperature probe PTC 1kOhm cable thermoplastic probe -50 up to +150°C cable -40 up to +110°C probe ø6x14mm cable length 3m 2-wire resistor 1kOhm		

## EVCO - EVERY CONTROL

### universal controllers

#### built-in version



	GEV No.	378169	Ref. No.	807302
<b>description</b>	electronic controller EVERY CONTROL EV7401 mounting measurements 66.5x66.5mm built-in depth 90mm 24/230V voltage AC NTC/PTC/Pt100/TC(J,K)/mA relay outputs 1 CO-8A(3) NTC/PTC/Pt100/TC(-J,K)/mA yes protection IP54 dependent on probe°C display 4 digits			
<b>accessories for</b>	378169			
	GEV No.	379053	Ref. No.	—
	temperature probe PTC 1kOhm cable PVC probe -50 up to +150°C cable -10 up to 100°C probe ø6x30mm cable length 3m without screw connection 2-wire			
	GEV No.	379062	Ref. No.	—
	temperature probe thermocouple J (Fe-CuNi) cable Vetrotex probe -50 up to +750°C cable -50 up to +350°C probe ø6x50mm cable length 3m without screw connection 2-wire			
	GEV No.	379064	Ref. No.	—
	temperature probe PTC 1kOhm cable silicone probe -50 up to +150°C cable -50 up to +180°C probe ø6x40mm cable length 3m without screw connection 2-wire			
	GEV No.	379131	Ref. No.	—
	temperature probe Pt100 cable Vetrotex probe -200 up to +600°C cable -50 up to +350°C probe ø6x85mm cable length 3m without screw connection 3-wire resistance at 0°C 100Ohm			
	GEV No.	379161	Ref. No.	—
	temperature probe NTC 10kOhm cable thermoplastic probe -40 up to +110°C cable -40 up to +110°C probe ø6x14mm cable length 3m without screw connection 2-wire			

	GEV No.	378151	Ref. No.	809889 8C0257 8C0258
<b>description</b>	electronic controller EVERY CONTROL EVK412 mounting measurements 71x29mm built-in depth 59mm 12/24V voltage AC/DC NTC/PTC/Pt100/Pt1000/TC(J,K)/mV/mA relay outputs 2 CO-16A(8) CO-8A(3) NTC/PTC/Pt100/Pt1000/TC(J,K)/mV/mA yes protection IP54 dependent on probe°C display 4 digits			

### refrigeration controllers

#### built-in version



	GEV No.	379524	Ref. No.	809889 8C0257 8C0258
<b>description</b>	electronic controller EVERY CONTROL type EVK412 mounting measurements 71x29mm 12/24V voltage AC TC/J -100 to +800°C			

### timers



	GEV No.	379522	Ref. No.	809892
<b>description</b>	electronic timer EVERY CONTROL type EVK702D2VXS mounting measurements 71x29mm 12V voltage AC/DC time setting range 0.1s.-99h:59min display 4 digits relay outputs 2 8A 8A front measurements 75x33mm			

### probes

#### universal probes

#### temperature probes



	GEV No.	379343	Ref. No.	825830
<b>description</b>	temperature probe NTC 10kOhm cable silicone probe -40 up to +110°C cable -50 up to +180°C probe ø6x40mm cable length 3m 2-wire			







Зип Общепит

vsezip.ru

+7(812)987-08-81



<b>GEV No.</b>	379142	<b>Ref. No.</b>	E25110070
<b>description</b>	temperature probe PTC 1kOhm cable PVC probe -50 up to +150°C cable -10 up to 100°C probe ø6x30mm cable length 1.5m without screw connection 2-wire		



<b>GEV No.</b>	379051	<b>Ref. No.</b>	8C0221	
<b>description</b>	temperature probe thermocouple J (Fe-CuNi) cable Vetrotex probe -50 up to +750°C cable -50 up to +350°C probe ø6x100mm cable length 3m without screw connection cable colours red/blue 2-wire			
<b>accessories for</b>	379051			
	<b>GEV No.</b>	379877	<b>Ref. No.</b>	—
<b>description</b>	electronic controller HONEYWELL type DC10N-400 mounting measurements 92x92mm 24/230V voltage ACT TC (J) relay outputs 1 CO-10A(6) TC (J) universal built-in depth 55mm protection IP54 accuracy 1% built-in version defr. funct. no 0 up to +400°C display 3 digits			



<b>GEV No.</b>	379945	<b>Ref. No.</b>	808682
<b>description</b>	core temperature probe Pt100 cable PTFE probe -40 up to +250°C cable -40 up to +250°C connection plug probe ø3.5x100mm thread cable length 0.5m handle ø 10mm handle length 80mm		

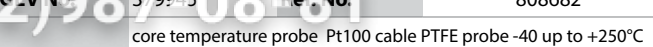

<b>GEV No.</b>	379946	<b>Ref. No.</b>	8C1187
<b>description</b>	core temperature probe Pt100 cable PTFE probe -40 up to +250°C cable -40 up to +250°C connection plug probe ø3.5x100mm thread cable length 0.7m handle ø 10mm handle length 80mm		

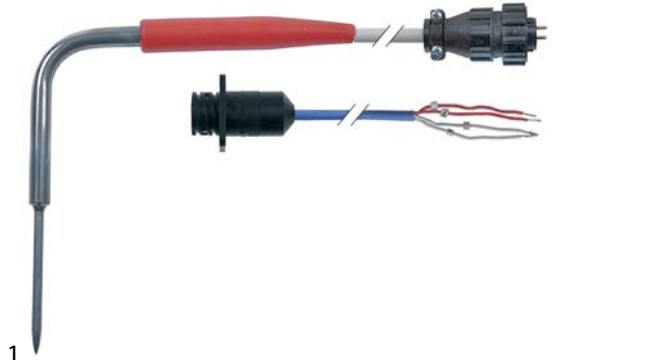

<b>GEV No.</b>	379548	<b>Ref. No.</b>	8C1881
<b>description</b>	core temperature probe PTC 1kOhm cable silicone probe -50 up to +150°C cable -50 up to +180°C connection 4-wire probe ø5x70mm thread cable length 1.2m handle ø 10mm handle length 120mm L1 150mm L2 80mm		



<b>GEV No.</b>	381426	<b>Ref. No.</b>	809658
<b>description</b>	core temperature probe thermocouple K (NiCr-Ni) cable PTFE probe -40 up to +250°C cable -40 up to +250°C connection 2-wire probe ø3.2x100mm thread M12 cable length 1.9m handle ø 10mm handle length 100mm		

producer-specific probes



<b>GEV No.</b>	378011	<b>Ref. No.</b>	809887
<b>description</b>	core temperature probe Pt100 cable silicone probe -40 up to +120°C cable -50 up to +180°C connection 2-wire thread probe ø3x150mm cable length 2m		



<b>GEV No.</b>	379756	<b>Ref. No.</b>	9629931
<b>description</b>	probe Pt100 cable PTFE probe -100 up to 450°C cable -40 up to +250°C connection 3-wire thread M12x1 probe ø4x50mm cable length 1.5m		



<b>GEV No.</b>	381430	<b>Ref. No.</b>	809525
<b>description</b>	temperature probe thermocouple K (NiCr-Ni) cable silicone probe -50 up to 1150°C cable -50 up to +180°C connection 2-wire thread probe ø2x100mm cable length 0.25m		



<b>GEV No.</b>	379124	<b>Ref. No.</b>	809564
<b>description</b>	temperature probe thermocouple K (NiCr-Ni) cable silicone probe -50 up to 1150°C cable -50 up to +180°C connection 2-wire thread probe ø2x100mm cable length 2.2m		

electric components



## electronics

## PCBs



1

<b>GEV No.</b>	400098	<b>Ref. No.</b>	809736
<b>description</b>	control PCB combi-steamer CD 101/CM 101 without EPROM		



1

<b>GEV No.</b>	400200	<b>Ref. No.</b>	809431
<b>description</b>	PCB		



1

<b>GEV No.</b>	400202	<b>Ref. No.</b>	C00566
<b>description</b>	PCB 24V		



1

<b>GEV No.</b>	401171	<b>Ref. No.</b>	809099
<b>description</b>	PCB combi-steamer		

Зип Общепит

vsezip.ru

+7(812)987-08-81



<b>GEV No.</b>	401953	<b>Ref. No.</b>	IB5944010
<b>description</b>	PCB hand blenders VORTEX with potentiometer 230V		



1

<b>GEV No.</b>	697908	<b>Ref. No.</b>	807598
<b>description</b>	PCB L 102mm W 95mm 50/60Hz 230/400V		



1

<b>GEV No.</b>	401451	<b>Ref. No.</b>	809432
<b>description</b>	PCB pyroceram range 110/920 series		



1

<b>GEV No.</b>	400955	<b>Ref. No.</b>	808629
<b>description</b>	PCB slicer 230/400V		

**accessories for** 400955

	<b>GEV No.</b>	401357	<b>Ref. No.</b>	8C1437
momentary push switch mounting measurements $\varnothing 22\text{mm}$ 1NO/1NC/indicator light 400V 4A indicator lamp 24V 0-1 connection screw ambient temperature max. 125/55°C protection IP40				

	<b>GEV No.</b>	401709	<b>Ref. No.</b>	—
protective cover external size 57x32mm internal size 47x22mm matt finish rubber H 27.5mm				



1

<b>GEV No.</b>	403575	<b>Ref. No.</b>	E61110058 E61110059
<b>description</b>	PCB slicer L 128mm W 43mm 230-400V		



Зип Общепит vs.p.ru



+7(812)987-08-81



			
1			
<b>GEV No.</b>	400954	<b>Ref. No.</b>	808742
<b>description</b>	PCB slicer/cutter 50/60Hz 230V		

ROBERTO LAY INVENYS			
medium temperature: 90°C 90°C 60°C			
ambient temperature: 60°C 25°C 60°C			
duty cycle: 40% 100% 100%			
with coded terminal			
			
1			
<b>GEV No.</b>	370269	<b>Ref. No.</b>	809565
<b>description</b>	solenoid valve double straight 230VAC inlet 3/4" outlet 11.5mm DN10 EATON (INVENSYS)		

keypads



keypad units

			
1			
<b>GEV No.</b>	401735	<b>Ref. No.</b>	8C0477
<b>description</b>	keypad unit meat mincer TC12 buttons 3 cable length 90mm L 130mm W 41mm cable colours brown/yellow/grey/green/pink/white		
<b>accessories for</b>	401735		
	<b>GEV No.</b>	401373	<b>Ref. No.</b>
			—
	gasket for keypad housing L 135mm W 50mm		

			
1			
<b>GEV No.</b>	403002	<b>Ref. No.</b>	808612
<b>description</b>	keypad unit slicer buttons 2 MIRRA/SAN-DANIELE/YORK L 120mm W 48mm		
<b>accessories for</b>	403002		
	<b>GEV No.</b>	403004	<b>Ref. No.</b>
			—
	gasket for keypad housing L 122mm W 52mm		

solenoid valves

solenoid valves (water)

ELBI			
straight			
			
1			
<b>GEV No.</b>	373018	<b>Ref. No.</b>	809566
<b>description</b>	solenoid valve single straight 230VAC inlet 3/4" outlet 14mm DN10 ELBI		
<b>spare parts for</b>	373018		
	<b>GEV No.</b>	370467	<b>Ref. No.</b>
			—
	solenoid valve filter suitable for ELBI		

RPE			
reducers			
outlet side			
			
1			
<b>GEV No.</b>	371269	<b>Ref. No.</b>	8C0117
<b>description</b>	reducer flow rate 0.07-0.14l/min brown		









TP			
			
1			
<b>GEV No.</b>	370017	<b>Ref. No.</b>	809327
<b>description</b>	solenoid valve single straight 230VAC inlet 3/4" outlet 11.5mm DN10 TP p max 10bar		
<b>spare parts for</b>	370017		
	<b>GEV No.</b>	371013	<b>Ref. No.</b>
			—
	solenoid coil TP 230VAC 50/60Hz		
<b>accessories for</b>	370017		
	<b>GEV No.</b>	371220	<b>Ref. No.</b>
			—
	reducer TP flow rate 3l/min red tolerance ±15%		
	<b>GEV No.</b>	371221	<b>Ref. No.</b>
			—
	reducer TP flow rate 5.5l/min yellow tolerance ±15%		
	<b>GEV No.</b>	371222	<b>Ref. No.</b>
			—
	reducer TP flow rate 6l/min grey tolerance ±15%		
	<b>GEV No.</b>	371223	<b>Ref. No.</b>
			—
	reducer TP flow rate 10l/min white tolerance ±15%		
	<b>GEV No.</b>	371224	<b>Ref. No.</b>
			—
	reducer TP flow rate 12l/min bronze tolerance ±15%		
	<b>GEV No.</b>	371225	<b>Ref. No.</b>
			—
	reducer TP flow rate 16l/min light brown tolerance ±15%		

Table continues overleaf



electric components







Зип-Общепит

vsezip.ru

+7(812)987-08-81

accessories for		370017	
GEV No.	371226	Ref. No.	—
	reducer TP flow rate 20l/min red tolerance ±15%		
	371230	Ref. No.	—
reducer TP flow rate 0.25l/min red tolerance ±25%			
	371231	Ref. No.	—
reducer TP flow rate 0.35l/min violet tolerance ±25%			
	371232	Ref. No.	—
reducer TP flow rate 0.5l/min orange tolerance ±25%			
	371233	Ref. No.	—
reducer TP flow rate 0.8l/min white tolerance ±25%			
	371234	Ref. No.	—
reducer TP flow rate 1l/min light blue tolerance ±25%			
	371235	Ref. No.	—
reducer TP flow rate 1.2l/min brown tolerance ±25%			
	371236	Ref. No.	—
reducer TP flow rate 1.5l/min light brown tolerance ±25%			
	371237	Ref. No.	—
reducer TP flow rate 2.5l/min yellow tolerance ±25%			
	371238	Ref. No.	—
reducer TP flow rate 3.4l/min dark green tolerance ±25%			
	371239	Ref. No.	—
reducer TP flow rate 5l/min black tolerance ±25%			
	371240	Ref. No.	—
reducer TP flow rate 8l/min blue tolerance ±20%			

			
1			
GEV No.	370026	Ref. No.	E00010011
description	solenoid valve triple straight 230VAC inlet 3/4" outlet 14mm DN10 TP		
spare parts for	370026		
	371013	Ref. No.	—
solenoid coil TP 230VAC 50/60Hz			
accessories for	370026		
	371220	Ref. No.	—
reducer TP flow rate 3l/min red tolerance ±15%			
	371221	Ref. No.	—
reducer TP flow rate 5.5l/min yellow tolerance ±15%			
	371222	Ref. No.	—
reducer TP flow rate 6l/min grey tolerance ±15%			

accessories for		370026	
GEV No.	371223	Ref. No.	—
	reducer TP flow rate 10l/min white tolerance ±15%		
	371224	Ref. No.	—
reducer TP flow rate 12l/min bronze tolerance ±15%			
	371225	Ref. No.	—
reducer TP flow rate 16l/min light brown tolerance ±15%			
	371226	Ref. No.	—
reducer TP flow rate 20l/min red tolerance ±15%			
	371230	Ref. No.	—
reducer TP flow rate 0.25l/min red tolerance ±25%			
	371231	Ref. No.	—
reducer TP flow rate 0.35l/min violet tolerance ±25%			
	371232	Ref. No.	—
reducer TP flow rate 0.5l/min orange tolerance ±25%			
	371233	Ref. No.	—
reducer TP flow rate 0.8l/min white tolerance ±25%			
	371234	Ref. No.	—
reducer TP flow rate 1l/min light blue tolerance ±25%			
	371235	Ref. No.	—
reducer TP flow rate 1.2l/min brown tolerance ±25%			
	371236	Ref. No.	—
reducer TP flow rate 1.5l/min light brown tolerance ±25%			
	371237	Ref. No.	—
reducer TP flow rate 2.5l/min yellow tolerance ±25%			
	371238	Ref. No.	—
reducer TP flow rate 3.4l/min dark green tolerance ±25%			
	371239	Ref. No.	—
reducer TP flow rate 5l/min black tolerance ±25%			
	371240	Ref. No.	—
reducer TP flow rate 8l/min blue tolerance ±20%			





Зип-Общепит

vsezip.ru

+7(812)987-08-81

			
<b>GEV No.</b>	370015	<b>Ref. No.</b>	051J00002
<b>description</b>	solenoid valve single angled 230VAC inlet 3/4" outlet 11.5mm DN10 TP		
<b>accessories for</b>	370015		
	<b>GEV No.</b>	371220	<b>Ref. No.</b> —
	reducer TP flow rate 3l/min red tolerance ±15%		
	<b>GEV No.</b>	371221	<b>Ref. No.</b> —
	reducer TP flow rate 5.5l/min yellow tolerance ±15%		
	<b>GEV No.</b>	371222	<b>Ref. No.</b> —
	reducer TP flow rate 6l/min grey tolerance ±15%		
	<b>GEV No.</b>	371223	<b>Ref. No.</b> —
	reducer TP flow rate 10l/min white tolerance ±15%		
	<b>GEV No.</b>	371224	<b>Ref. No.</b> —
	reducer TP flow rate 12l/min bronze tolerance ±15%		
	<b>GEV No.</b>	371225	<b>Ref. No.</b> —
	reducer TP flow rate 16l/min light brown tolerance ±15%		
	<b>GEV No.</b>	371226	<b>Ref. No.</b> —
	reducer TP flow rate 20l/min red tolerance ±15%		
	<b>GEV No.</b>	371230	<b>Ref. No.</b> —
	reducer TP flow rate 0.25l/min red tolerance ±25%		
	<b>GEV No.</b>	371231	<b>Ref. No.</b> —
	reducer TP flow rate 0.35l/min violet tolerance ±25%		
	<b>GEV No.</b>	371232	<b>Ref. No.</b> —
	reducer TP flow rate 0.5l/min orange tolerance ±25%		
	<b>GEV No.</b>	371233	<b>Ref. No.</b> —
	reducer TP flow rate 0.8l/min white tolerance ±25%		
	<b>GEV No.</b>	371234	<b>Ref. No.</b> —
	reducer TP flow rate 1l/min light blue tolerance ±25%		
	<b>GEV No.</b>	371235	<b>Ref. No.</b> —
	reducer TP flow rate 1.2l/min brown tolerance ±25%		
	<b>GEV No.</b>	371236	<b>Ref. No.</b> —
	reducer TP flow rate 1.5l/min light brown tolerance ±25%		
	<b>GEV No.</b>	371237	<b>Ref. No.</b> —
	reducer TP flow rate 2.5l/min yellow tolerance ±25%		
	<b>GEV No.</b>	371238	<b>Ref. No.</b> —
	reducer TP flow rate 3.4l/min dark green tolerance ±25%		

<b>accessories for</b>	370015		
	<b>GEV No.</b>	371239	<b>Ref. No.</b> —
	reducer TP flow rate 5l/min black tolerance ±25%		
	<b>GEV No.</b>	371240	<b>Ref. No.</b> —
	reducer TP flow rate 8l/min blue tolerance ±20%		

solenoid valves with reducers

			
<b>GEV No.</b>	370628	<b>Ref. No.</b>	8C0145
<b>description</b>	solenoid valve double straight 230VAC inlet 3/4" input 16l/min DN10 TP plastic outlet 11.5mm		

			
<b>GEV No.</b>	370250	<b>Ref. No.</b>	902410
<b>description</b>	solenoid valve triple straight 230VAC inlet 3/4" outlet 11.5mm t.max. 90°C TP plastic output B 0.25l/min flow regulating valve outlet B red		

pressure switches for steam control

			
<b>GEV No.</b>	541074	<b>Ref. No.</b>	8C0444
<b>description</b>	pressure control ø 45mm triggering pressure 0.5bar reset pressure 0.35bar pressure connection vertical steam control pressure range 0.35/0.51bar connection 1/8" pressure connection 1/8"		

			
<b>GEV No.</b>	541025	<b>Ref. No.</b>	808590
<b>description</b>	pressure control pressure connection vertical steam control pressure range adjustable 0.2-0.9bar connection male faston 6.3mm pressure connection ø 1/4"mm		

electric components





for combi-steamers

Зип.Общепит  
compressors

ACC/ZEL  
R404a/R507  
vsezip.ru

HMBP monophase  
High/Medium evaporation temperature above -20/-15 °C

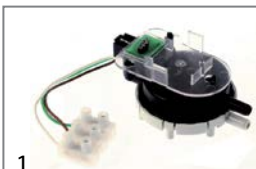

<b>GEV No.</b>	345218	<b>Ref. No.</b>	809509
<b>description</b>	pressure control pressure range 0-3mbar connection 6mm pressure connection 6mm		



<b>GEV No.</b>	541329	<b>Ref. No.</b>	809754
<b>description</b>	pressure control pressure range 350/150mbar connection 8mm pressure connection 8mm		



<b>GEV No.</b>	605068	<b>Ref. No.</b>	8C1859
<b>description</b>	compressor coolant R404a/R507 type ML45TB 220-240V 50Hz HMBP fully hermetic 10kg 1/5HP cylinder capacity 4.5cm <sup>3</sup> CSIR H 175.5mmW 192W 246W 309W 382W 465W 557W 659W 771W test method ASHRAE		



<b>GEV No.</b>	605014	<b>Ref. No.</b>	8C1862
<b>description</b>	compressor coolant R404a/R507 type ML80TB 220-240V 50Hz HMBP fully hermetic 11.4kg 3/8HP cylinder capacity 7.57cm <sup>3</sup> CSIR H 175.5mmW 261W 346W 446W 561W 691W 835W 993W 1167W test method ASHRAE ambient temperature max. 43°C		

electrodes



<b>GEV No.</b>	400021	<b>Ref. No.</b>	809561
<b>description</b>	level electrode PG9 total length 110mm probe L 70/47/24mm insulated probe length 62/38/16mm with 3 probes connection grip connection		



<b>GEV No.</b>	400022	<b>Ref. No.</b>	809569
<b>description</b>	level electrode PG9 total length 135mm probe L 89/59/28mm insulated probe length 80mm with 3 probes connection grip connection		

**accessories for** 400022

<b>GEV No.</b>	379729	<b>Ref. No.</b>	—
----------------	--------	-----------------	---

connection cable L 1230mm 4-pole for level electrode plug type coded

<b>GEV No.</b>	550574	<b>Ref. No.</b>	—
----------------	--------	-----------------	---

nut thread PG9 H 3mm WS 28 nickel-plated brass Qty 1 pcs mounting ømm cable ømm

electric components

## CUBIGEL

R404a/R507

LBP monophase

Lower evaporation temperature below -20°C



1

<b>GEV No.</b>	605180	<b>Ref. No.</b>	772110024 772110027
<b>description</b>	compressor coolant R404a/R507 type MX23FB 220-240V 50Hz LBP 17.5kg 1HP power input 7/8W cylinder capacity 23.2cm <sup>3</sup> CSIR H 221mm 749W 982W 1246W 1541W 1868W		

Зип Общепит

HMBP, monophase

High/Medium evaporation temperature above -20/-15 °C

vsezip.ru

+7(812)987-08-81



1

<b>GEV No.</b>	605125	<b>Ref. No.</b>	8C1300
<b>description</b>	compressor coolant R404a/R507 type NEK6213GK 220-240V 50Hz HMBP 11.6kg 1/2HP cylinder capacity 12.12cm <sup>3</sup> CSIR H 206mmW 695W 884W 1093W 1333W 1600W 1894W 2215W test method ASHRAE		

## EMBRACO / ASPERA

R404a/R507

MBP monophase

Medium evaporation temperature above -20°C



1

<b>GEV No.</b>	605003	<b>Ref. No.</b>	826841	
<b>description</b>	compressor coolant R404a/R507 type NB6144GK 230V 50Hz MBP fully hermetic 10.3kg cylinder capacity 4.52cm <sup>3</sup> CSIR H 187mm 226W 288W 301W 375W 459W 553W 658W test method ASHRAE			
<b>spare parts for</b>	605003			
	<b>GEV No.</b>	601022	<b>Ref. No.</b>	—
	fan motor 10W 230V 50-60Hz L1 44mm L2 54mm L3 85mm W 84mm cable length 500mm 1300rpm YZF10-20-18/26 5 mounting options bearing slide bearing			
	<b>GEV No.</b>	601071	<b>Ref. No.</b>	—
	fan wheel sucking ø 230mm fan wheel mounting 25.4mm blade angle 25° W 37mm aluminium			
	<b>GEV No.</b>	605003	<b>Ref. No.</b>	826841
	compressor coolant R404a/R507 type NB6144GK 230V 50Hz MBP fully hermetic 10.3kg cylinder capacity 4.52cm <sup>3</sup> CSIR H 187mm 226W 288W 301W 375W 459W 553W 658W test method ASHRAE			

## fans

axial fans

ebm-papst



1

<b>GEV No.</b>	601030 <sup>1</sup>	<b>Ref. No.</b>	809503 831100001	
<b>description</b>	axial fan L 119mm W 119mm H 38mm 230VAC 50Hz 18W bearing ball bearing manuf. no. 4656Z metal connection male faston 2.8mm ebm-papst fan wheel ø 110mm temp.-resist. 75°C			
<b>accessories for</b>	601030			
	<b>GEV No.</b>	550898	<b>Ref. No.</b>	—
	connecting cable cable length 2000mm connection F 2.8 connection distance 7.9mm for axial flow fan			
	<b>GEV No.</b>	692497	<b>Ref. No.</b>	—
	guard ø 105mm mounting distance 150mm for axial fan ebm-papst-mm			

<sup>1</sup>with ball bearings



import

Зип Общежит



refrigeration fans

vsezip.ru

+7(812)987-08-81



1

<b>GEV No.</b>	601080 <sup>1</sup>	<b>Ref. No.</b>	827851
<b>description</b>	axial fan L 119mm W 119mm H 38mm 230VAC 50/60Hz 23/20W bearing ball bearing connection male faston 2.8mm metal ADDA fan wheel ø 110mm temp.-resist. 70°C		
<b>accessories for</b>	601080		
	<b>GEV No.</b>	550898	<b>Ref. No.</b> —
	connecting cable cable length 2000mm connection F 2.8 connection distance 7.9mm for axial flow fan		
	<b>GEV No.</b>	692519	<b>Ref. No.</b> —
	guard L 120mm W 120mm plastic		

<sup>1</sup>with ball bearings

1

<b>GEV No.</b>	601081 <sup>1</sup>	<b>Ref. No.</b>	827852
<b>description</b>	axial fan L 80mm W 80mm H 38mm 230VAC 50/60Hz 14/13.5W bearing ball bearing connection male faston 2.8mm metal ADDA fan wheel ø 75mm temp.-resist. 70°C		
<b>accessories for</b>	601081		
	<b>GEV No.</b>	691102	<b>Ref. No.</b> —
	guard ø 75mm mounting distance 71 mm for axial fan 80mm		

<sup>1</sup>with ball bearings

refrigeration motors universal

ELCO

BT series - capacitor motors



1

<b>GEV No.</b>	601420 <sup>1</sup>	<b>Ref. No.</b>	8C0807
<b>description</b>	fan motor 45W 230V 50Hz L1 53mm L2 18mm L3 120mm W 103mm cable length 500mm 1300rpm ELCO 3FBT 50-40/15 3 mounting options bearing slide bearing		

<sup>1</sup>incl. capacitor

cold air circulating fans (complete)

ebm-papst

A4E series

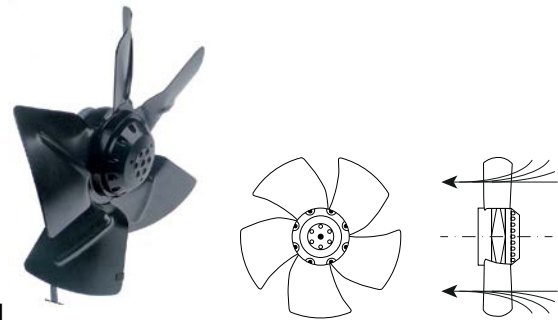

1

<b>GEV No.</b>	601623	<b>Ref. No.</b>	771110007
<b>description</b>	fan A4E315-AC08-19 fan wheel ø 315mm blades 5 230V 50Hz 95W 1370rpm cable length 450mm ebm-papst sucking suitable capacitor 3µF		
<b>accessories for</b>	601623		
	<b>GEV No.</b>	365137	<b>Ref. No.</b> —
	capacitor capacity 3µF 450V tolerance 5% 50/60Hz ambient temperature max. -25 to +85°C ø 25mm L 56mm M8 plastic connection cable 250mm 416.17.77GF protection		

cross flow fans

EMMEVI - FERGAS

with moulded coils



1

<b>GEV No.</b>	601110	<b>Ref. No.</b>	8C0495
<b>description</b>	cross flow fan TGO 60/1-180/20 roller ø 60mm roller length 180mm laminated core thickness 20mm motor position left 230V/50Hz 28W refrigeration bearing rubber connection male faston 6.3mm -30 up to +100°C 230V cable length 1800mm		



Зип Общепит

vsezip.ru

+7(812)987-08-81

COPREL

with standard coil



1			
<b>GEV No.</b>	602044	<b>Ref. No.</b>	8C0496
<b>description</b>	cross flow fan COPREL TFR 180/20-14CSN roller $\varnothing$ 60mm roller length 180mm laminated core thickness 20mm motor position right 230V/50Hz 27W refrigeration bearing rubber connection male faston 6.3mm t.max. 60°C airflow 144m <sup>3</sup> /h -30 bis +60°C		



1			
<b>GEV No.</b>	601453	<b>Ref. No.</b>	827914
<b>description</b>	cross flow fan TFR 180 roller $\varnothing$ 60mm roller length 180mm laminated core thickness 16mm motor position right 230V/50-60Hz 17W universal bearing silicone connection male faston 6.3mm airflow 100m <sup>3</sup> /h -30 up to +100°C 230V 50Hz		
<b>accessories for</b>	601453		
	<b>GEV No.</b>	415114	<b>Ref. No.</b>
			—
	heater battery mounting distance 185mm W 40mm H 35mm 2000W 230V temperature restriction 105°C heating circuits 2 connection cable length 150mm L 192mm for cross flow fan		

accessories for cross flow fans

heater battery



1			
<b>GEV No.</b>	415115	<b>Ref. No.</b>	827915
<b>description</b>	heater battery mounting distance 185mm W 38mm H 40mm 2000W 230V temperature restriction 125°C heating circuits 2 connection male faston 6.3mm L 195mm		
<b>spare parts for</b>	415115		
	<b>GEV No.</b>	375095	<b>Ref. No.</b>
			—
	bi-metal thermostat hole distance 18mm switch-off temp. 105°C 1NC 1-pole 16A connection F6.3 2 hole fixing		



<b>GEV No.</b>	415122	<b>Ref. No.</b>	827915
<b>description</b>	heater battery mounting distance 185mm W 40mm H 35mm 2000W 230V temperature restriction 105°C heating circuits 2 connection cable length 340mm L 197mm for cross flow fan		

hot air motors



1			
<b>GEV No.</b>	550859	<b>Ref. No.</b>	809828
<b>description</b>	counterflange for fan motor ED $\varnothing$ 60mm int. $\varnothing$ 1 34mm int. $\varnothing$ 2 25mm thickness 6mm brass		

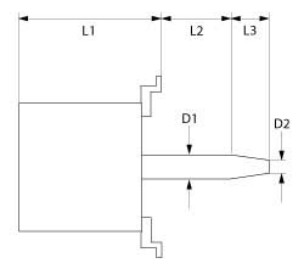

1			
<b>GEV No.</b>	601046	<b>Ref. No.</b>	807314 809406
<b>description</b>	fan motor 220/380V 3 phase 50/60Hz 0.75kW 1350/1650rpm speeds 1 L1 185mm L2 42mm L3 47mm D1 $\varnothing$ 24mm D2 $\varnothing$ 20mm M12L IT 1.9/3.3A Cos(fi) 0.83 at 50Hz 200-240/346-415V at 60Hz 200-277/346-480V at 50Hz 1350rpm at 60Hz 1650rpm type ST80/4 no. 661512		

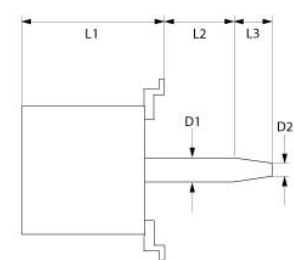

1			
<b>GEV No.</b>	500641	<b>Ref. No.</b>	807314
<b>description</b>	fan motor 220/380V 3 phase 50Hz 0.75kW 1420rpm speeds 1 L1 166mm L2 47mm L3 65mm D1 $\varnothing$ 24mm D2 $\varnothing$ 20mm M6R IT 1.4/2.4A Cos(fi) 0.83 at 50Hz 220/380V at 60Hz 240/415V type ST80/4 no. 643515 mounting distance 150mm		

electric components



Зип Общепит

vsezip.ru

+7(812)987-08-81



1

<b>GEV No.</b>	601043	<b>Ref. No.</b>	808973
<b>description</b>	fan motor 220-240V 1 phase 50Hz 0.37/0.07kW 0.1/0.5HP 1400/2700rpm speeds 2 L1 123mm L2 107mm L3 15mm D1 ø 15mm D2 ø 12mm M10L ET 2/0.7A suitable capacitor 20µF/250V at 50Hz 1400/2700rpm type 1057		





1

<b>GEV No.</b>	500642	<b>Ref. No.</b>	813154
<b>description</b>	fan motor 380-415V 3 phase 50Hz 0.22/0.75kW 700/1400rpm speeds 2 L1 166mm L2 45mm L3 67mm D1 ø 24mm D2 ø 20mm M6R ITA at 50Hz 380-415V at 50Hz 700/1400rpm type FB80 4/8 no. 629764		



1

<b>GEV No.</b>	601166	<b>Ref. No.</b>	131110010
<b>description</b>	fan motor 220-240V 1 phase 50Hz 0.37kW 2700rpm speeds 1 L1 123mm L2 77mm L3 30mm D1 ø 15mm D2 ø 12mm M10L ET 2A suitable capacitor 12.5µF/450V at 50Hz 2700rpm type 1057.2157		
<b>spare parts for</b>	601166		
	<b>GEV No.</b>	<b>Ref. No.</b>	901740
	operating capacitor capacity 12.5µF 450V tolerance 5%Hz ambient temperature max. -25 to +85°C ø 35mm L 70mm M8 plastic connection male faston 6.3mm 455.C3DS.12.5 protection		
<b>accessories for</b>	601166		
	<b>GEV No.</b>	<b>Ref. No.</b>	—
	fan wheel D1 ø 160mm H1 60mm blades 15 D2 ø 16mm D3 ø 16mm H2 29mm		



1

<b>GEV No.</b>	601067	<b>Ref. No.</b>	809000
<b>description</b>	fan wheel D1 ø 150mm H1 38mm blades 36 D2 ø 6mm D3 ø 6mm H2 14mm		



1

<b>GEV No.</b>	601223	<b>Ref. No.</b>	809000
<b>description</b>	fan wheel D1 ø 150mm H1 39mm blades 36 D2 ø 6mm D3 ø 6mm H2 13.5mm		



1

<b>GEV No.</b>	500652	<b>Ref. No.</b>	808856
<b>description</b>	fan motor 380-415V 3 phase 50Hz 0.13/0.55kW 700/1350rpm speeds 2 L1 188mm L2 44mm L3 48mm D1 ø 24mm D2 ø 20mm M12L ITA Cos(φ) 0.13/0.55 at 50Hz 700/1350rpm 4P/8P type FB80 4/8 no. 390133		



1

<b>GEV No.</b>	601060	<b>Ref. No.</b>	807604
<b>description</b>	fan wheel D1 ø 180mm H1 60mm blades 16 D2 ø 11mm D3 ø 16mm H2 30mm		



Зип Общепит

vsezip.ru

+7(812)987-08-81



1

<b>GEV No.</b>	601224	<b>Ref. No.</b>	809407
<b>description</b>	fan wheel D1 $\varnothing$ 300mm H1 100mm blades 24 D2 $\varnothing$ 19.5mm D3 $\varnothing$ 23mm H2 46mm		



1

<b>GEV No.</b>	601063	<b>Ref. No.</b>	8C0003
<b>description</b>	fan wheel D1 $\varnothing$ 350mm H1 100mm blades 24 D2 $\varnothing$ 19.5mm D3 $\varnothing$ 23mm H2 46mm		



1

<b>GEV No.</b>	691810	<b>Ref. No.</b>	809827
<b>description</b>	flange for fan motor ED $\varnothing$ 48mm int. $\varnothing$ 1 19.5mm int. $\varnothing$ 2 15mm thickness 3.5mm brass		



1

<b>GEV No.</b>	511171	<b>Ref. No.</b>	809829
<b>description</b>	shaft seal ID $\varnothing$ 14.5mm ED $\varnothing$ 20mm thickness 3mm		

hot air fans

miscellaneous

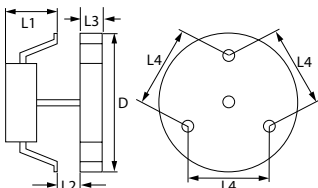



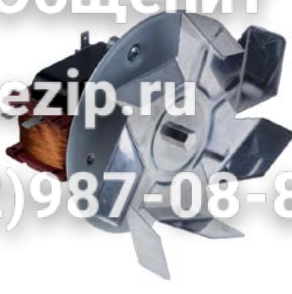

1

<b>GEV No.</b>	601273	<b>Ref. No.</b>	8C0432
<b>description</b>	hot air fan 220-240V 32W 50/60Hz L1 60mm L2 10mm L3 25mm L4 87mm fan wheel $\varnothing$ 155mm FIME type C20X0E01/15CLH		

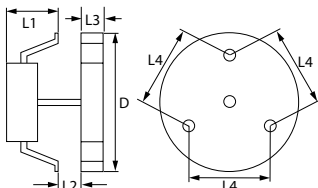

1



<b>GEV No.</b>	601011	<b>Ref. No.</b>	8C0758	
<b>description</b>	hot air fan 220-240V 40W 50/60Hz L1 65mm L2 15mm L3 25mm L4 87mm fan wheel $\varnothing$ 150mm FIME type C25R8023CLH			
<b>accessories for</b>	601011			
	<b>GEV No.</b>	550879	<b>Ref. No.</b>	—
	insulation $\varnothing$ 130mm thickness 3mm hole $\varnothing$ 20mm for hot air fan			
	<b>GEV No.</b>	601260	<b>Ref. No.</b>	—
	nut thread M6L IT for hot air fan			

motors

gear motors

for ice-cube maker

miscellaneous



1

<b>GEV No.</b>	500675	<b>Ref. No.</b>	809160
<b>description</b>	gear motor 220/240V 50Hz for flake ice maker		



for ovens

for flues



1

<b>GEV No.</b>	601138	<b>Ref. No.</b>	809507
<b>description</b>	gear motor CROUZET type G70C10AFTEG 12V voltage DCHz shaft $\varnothing$ 4mm L 66mm W 50mm H 61mm		





## pumps

wash and rinse pumps

LGB



1

<b>GEV No.</b>	500093	<b>Ref. No.</b>	809261	
<b>description</b>	pump inlet $\varnothing$ 50mm outlet $\varnothing$ 44mm type W500SX 230V 50Hz 1 phase 0.5kW 0.7HP L 200mm rotation direction right capacitor 16 $\mu$ F LGB			
<b>spare parts for</b>	500093			
	<b>GEV No.</b>	365021	<b>Ref. No.</b>	—
	operating capacitor capacity 16 $\mu$ F 425V tolerance 5% 50/60Hz ambient temperature max. -25 to +85°C $\varnothing$ 35mm L 73mm single M8 plastic connection male faston 6.3mm 416.10.99 protection			
	<b>GEV No.</b>	510607	<b>Ref. No.</b>	—
	impellor $\varnothing$ 85mm H 29mm shaft intake $\varnothing$ 9x8mm rotation direction right blades 6			
	<b>GEV No.</b>	510693	<b>Ref. No.</b>	—
	mechanical shaft seal for shaft $\varnothing$ 12mm slide ring ext. $\varnothing$ 24mm slide ring H 15.5mm slide ring int. $\varnothing$ 11mm counter ring mounting $\varnothing$ 24mm height counter ring 8mm counter ring int. $\varnothing$ 13.5mm			
	<b>GEV No.</b>	521564	<b>Ref. No.</b>	—
	pump cover			
	<b>GEV No.</b>	521717	<b>Ref. No.</b>	—
	O-ring EPDM thickness 1.78mm ID $\varnothing$ 120.37mm Qty 1 pcs			

Зип Общепит

booster pumps

vsezip.ru

+7(812)987-08-81





1

<b>GEV No.</b>	500540	<b>Ref. No.</b>	8C1367	
<b>description</b>	pump inlet $\varnothing$ 1" IT outlet $\varnothing$ 1" IT type PKM60 230V 50Hz 1 phase 0.37kW PEDRELLO 0.5HP			
<b>accessories for</b>	500540			
	<b>GEV No.</b>	365015	<b>Ref. No.</b>	—
	operating capacitor capacity 10 $\mu$ F 400V tolerance 5%Hz ambient temperature max. -25 to +85°C $\varnothing$ 35.5mm L 59mm M8 plastic connection male faston 6.3mm protection			



1

<b>GEV No.</b>	500395	<b>Ref. No.</b>	8C1339	
<b>description</b>	pump inlet $\varnothing$ 3/8" IT outlet $\varnothing$ 3/8" IT type PS45DX 230V 50Hz 0.35kW capacitor 8 $\mu$ F LGB			
<b>spare parts for</b>	500395			
	<b>GEV No.</b>	365013	<b>Ref. No.</b>	132110008
	operating capacitor capacity 8 $\mu$ F 400V tolerance 5%Hz ambient temperature max. -25 to +85°C $\varnothing$ 31.5mm L 55mm M8 plastic connection male faston 6.3mm protection			
	<b>GEV No.</b>	698400	<b>Ref. No.</b>	—
	pump cover gasket pump type PS46 thickness 2mm ID $\varnothing$ 66mm Qty 1 pcs			

drain pumps

ASKOLL



1

<b>GEV No.</b>	500565	<b>Ref. No.</b>	808670
<b>description</b>	drain pump 30W		

## HANNING

Зип Общепит

vsezip.ru

+7(812)987-08-81

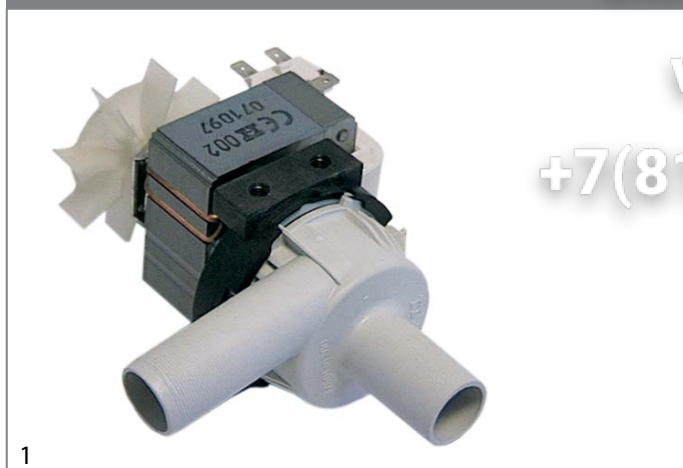



1

<b>GEV No.</b>	500042	<b>Ref. No.</b>	809563
<b>description</b>	drain pump inlet $\varnothing$ 24mm outlet $\varnothing$ 24mm 230V 80W 50Hz HANNING type KD22B3-679		
<b>spare parts for</b>	500042		
	<b>GEV No.</b>	510168	<b>Ref. No.</b> —
	fan wheel shaft intake $\varnothing$ 5mm $\varnothing$ 62mm H 14mm		



1

<b>GEV No.</b>	500165	<b>Ref. No.</b>	808236
<b>description</b>	pump REBO type 63/35 120W 230V 50/60Hz inlet $\varnothing$ 28mm outlet $\varnothing$ 26mm L 180mm rotation direction right for ice-cube maker capacitor 5 $\mu$ F		
<b>spare parts for</b>	500165		
	<b>GEV No.</b>	365017	<b>Ref. No.</b> —
	operating capacitor capacity 5 $\mu$ F 450V tolerance 5% 50/60Hz ambient temperature max. -25 to +85°C $\varnothing$ 28mm L 54mm M8 plastic connection male faston 6.3mm 16.10.08 protection		
	<b>GEV No.</b>	601412	<b>Ref. No.</b> —
	fan wheel sucking $\varnothing$ 154mm fan wheel mounting 25.4mm blade angle 28° W 34mm plastic		
	<b>GEV No.</b>	601413	<b>Ref. No.</b> —
	fixing plate suitable for fanwheel ED $\varnothing$ 32mm shaft $\varnothing$ 7 mounting distance 26mm		

## booster pumps II

## accessories



1

<b>GEV No.</b>	365012	<b>Ref. No.</b>	8C1588
<b>description</b>	operating capacitor capacity 6.3 $\mu$ F 450V tolerance 5% 50Hz ambient temperature max. -25 to +85°C $\varnothing$ 30mm L 61mm M8 plastic connection male faston 6.3mm protection		

## condensators &amp; interference suppression filters

## operating capacitors

## plastic

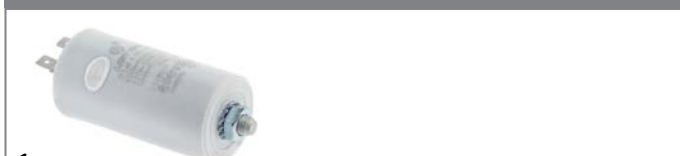



1

<b>GEV No.</b>	365014	<b>Ref. No.</b>	901740
<b>description</b>	operating capacitor capacity 12.5 $\mu$ F 450V tolerance 5%Hz ambient temperature max. -25 to +85°C $\varnothing$ 35mm L 70mm M8 plastic connection male faston 6.3mm 45S.C3DS.12.5 protection		

## pumps for ice machines



1

<b>GEV No.</b>	500590	<b>Ref. No.</b>	8C1356
<b>description</b>	pump FIR type 4240.2300 120W 230V 50/60Hz inlet $\varnothing$ 22mm outlet $\varnothing$ 22mm L 240mm rotation direction right for ice-cube maker capacitor 5 $\mu$ F		
<b>spare parts for</b>	500590		
	<b>GEV No.</b>	601412	<b>Ref. No.</b> —
	fan wheel sucking $\varnothing$ 154mm fan wheel mounting 25.4mm blade angle 28° W 34mm plastic		
	<b>GEV No.</b>	601413	<b>Ref. No.</b> —
	fixing plate suitable for fanwheel ED $\varnothing$ 32mm shaft $\varnothing$ 7 mounting distance 26mm		



1

<b>GEV No.</b>	365012	<b>Ref. No.</b>	8C1588
<b>description</b>	operating capacitor capacity 6.3 $\mu$ F 450V tolerance 5% 50Hz ambient temperature max. -25 to +85°C $\varnothing$ 30mm L 61mm M8 plastic connection male faston 6.3mm protection		





electric components

Зип.Общепит

terminals

connection terminals with screw/faston connec-

vsezip.ru

+7(812)987-08-81

1

<b>GEV No.</b>	550411	<b>Ref. No.</b>	C00395
<b>description</b>	power terminal block 6-pole max. 40A max 450V connection $\phi 6\text{mm}^2$ / F6.3 temp.-resist. 150°C cross section 6mm <sup>2</sup>		

1

<b>GEV No.</b>	365013	<b>Ref. No.</b>	132110008
<b>description</b>	operating capacitor capacity 8 $\mu\text{F}$ 400V tolerance 5%Hz ambient temperature max. -25 to +85°C $\phi$ 31.5mm L 55mm M8 plastic connection male faston 6.3mm protection		

## electric accessories

### cables

#### earthing cables

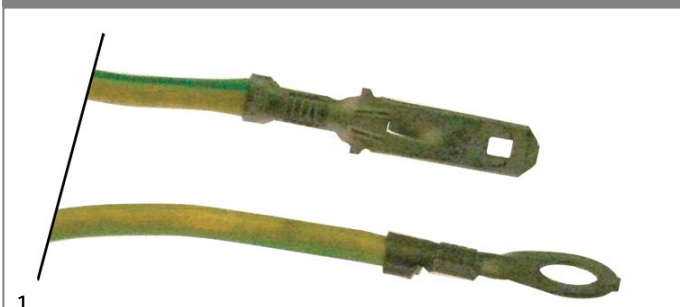

<b>GEV No.</b>	102149	<b>Ref. No.</b>	C10362
<b>description</b>	earthing cable		

#### accessories

##### cable glands

##### threaded cable glands

##### screw connections

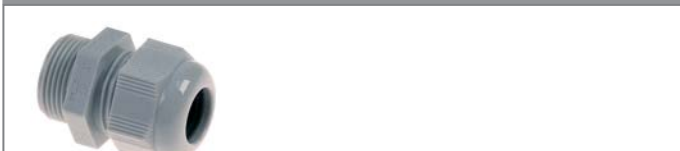

<b>GEV No.</b>	550971	<b>Ref. No.</b>	809010
<b>description</b>	cable gland thread PG16 cable $\phi$ 14mm mounting $\phi$ 22.5mm Qty 1 pcs plastic WS 27		

## gas taps

### PEL

#### 22S/O series



<b>GEV No.</b>	101086	<b>Ref. No.</b>	512250003 808186 C00085
<b>description</b>	gas tap PEL type 22S/O gas inlet M20x1.5 (tube $\phi$ 12mm) bypass nozzle $\phi$ 0.35mm gas outlet M20x1.5 (tube $\phi$ 12/10mm) thermocouple connection M9x1 pilot connection M10x1 shaft $\phi$ 10x8mm shaft L 25/17mm shaft flat lower		

<b>spare parts for</b>	101086			
	<b>GEV No.</b>	100259	<b>Ref. No.</b>	—
	bypass nozzle type PEL22 bore $\phi$ 0.35mm thread M6x0.5			
	<b>GEV No.</b>	101058	<b>Ref. No.</b>	—
	magnet unit L 39mm D1 $\phi$ 15.4mm D2 $\phi$ 13.5mm suitable for PEL22/EGA24197 standard			
	<b>GEV No.</b>	101201	<b>Ref. No.</b>	—
	gas tap front part shaft $\phi$ 10x8mm shaft L 25/17mm shaft flat upper/lower suitable for PEL22			
	<b>GEV No.</b>	101231	<b>Ref. No.</b>	—
	thermocouple nut T1: M9x1 T2: M18x1			
	<b>GEV No.</b>	101240	<b>Ref. No.</b>	—
	gas connection thread M20x1.5 tube $\phi$ 12/10mm for PEL gas taps with gasket and screws horizontal			
	<b>GEV No.</b>	101460	<b>Ref. No.</b>	—
	O-ring $\phi$ 12.37mm D1 $\phi$ 2.62mm suitable for PEL22			
	<b>GEV No.</b>	101461	<b>Ref. No.</b>	—
	screw kit suitable for PEL22 Qty 4 pcs			
<b>accessories for</b>	101086			
	<b>GEV No.</b>	100908	<b>Ref. No.</b>	806019
	union screw thread M10x1 for pipe $\phi$ 4mm Qty 1 pcs			
	<b>GEV No.</b>	100909	<b>Ref. No.</b>	—
	union screw thread M10x1 for pipe $\phi$ 6mm Qty 1 pcs			

Table continues overleaf



Зип-Общепит

vsezip.ru

+7(812)987-08-81

accessories for 101086		GEV No.	Ref. No.	
	gas connection thread M20x1.5 tube ø 12/10mm for PEL gas taps vertical	101241		—
	olive for pipe ø 4mm Qty 1 pcs	101246		—
	olive for pipe ø 12mm Qty 1 pcs suitable for PEL	101248		8C0412
	olive for pipe ø 10mm Qty 1 pcs	101249		—
	union nut thread M20x1.5 for pipe ø 10mm	101250		—
	union nut thread M20x1.5 for pipe ø 12mm	101251		—
	olive ID ø 6mm Qty 1 pcs	101286		—
	knob ø 70mm shaft ø 10x8mm shaft flat universal	110080		—
	knob dial plate silver gas tap PEL21/22/23 t.max.°C ED ø 63mm ID ø 45.5mm	112206		—

accessories for 101341		GEV No.	Ref. No.	
	union screw thread M10x1 for pipe ø 4mm Qty 1 pcs	100908		806019
	union screw thread M10x1 for pipe ø 6mm Qty 1 pcs	100909		—
	gas connection thread M20x1.5 tube ø 12/10mm for PEL gas taps with gasket and screws horizontal	101240		—
	olive for pipe ø 4mm Qty 1 pcs	101246		—
	olive for pipe ø 12mm Qty 1 pcs suitable for PEL	101248		8C0412
	olive for pipe ø 10mm Qty 1 pcs	101249		—
	union nut thread M20x1.5 for pipe ø 10mm	101250		—
	union nut thread M20x1.5 for pipe ø 12mm	101251		—
	olive ID ø 6mm Qty 1 pcs	101286		—
	knob ø 70mm shaft ø 10x8mm shaft flat universal	110080		—
	knob dial plate silver gas tap PEL21/22/23 t.max.°C ED ø 63mm ID ø 45.5mm	112206		—

22S/V series

 <p>1</p>				
<b>GEV No.</b>	101341	<b>Ref. No.</b>		809469
<b>description</b>	gas tap PEL type 22S/V gas inlet M20x1.5 (tube ø 12mm) bypass nozzle ø 0.35mm gas outlet M20x1.5 (tube ø 12/10mm) thermocouple connection M10x1 pilot connection M10x1 shaft ø 10x8mm shaft L 25/17mm shaft flat lower			
<b>spare parts for</b>	101341			
	GEV No.	101058	Ref. No.	—
	magnet unit L 39mm D1 ø 15.4mm D2 ø 13.5mm suitable for PEL22/EGA24197 standard			
	GEV No.	101201	Ref. No.	—
	gas tap front part shaft ø 10x8mm shaft L 25/17mm shaft flat upper/lower suitable for PEL22			
	GEV No.	101241	Ref. No.	—
	gas connection thread M20x1.5 tube ø 12/10mm for PEL gas taps vertical			
	GEV No.	101290	Ref. No.	—
	thermocouple nut T1: M10x1 T2: M18x1 suitable for PEL20/21			
	GEV No.	101460	Ref. No.	—
	O-ring ø 12.37mm D1 ø 2.62mm suitable for PEL22			
	GEV No.	101461	Ref. No.	—
	screw kit suitable for PEL22 Qty 4 pcs			

 <p>1</p>				
<b>GEV No.</b>	101087	<b>Ref. No.</b>		809469 C00779
<b>description</b>	gas tap PEL type 22S/V gas inlet M20x1.5 (tube ø 12mm) bypass nozzle ø 0.35mm gas outlet M20x1.5 (tube ø 12/10mm) thermocouple connection M9x1 pilot connection M10x1 shaft ø 10x8mm shaft L 25/17mm shaft flat upper			
<b>spare parts for</b>	101087			
	GEV No.	100259	Ref. No.	—
	bypass nozzle type PEL22 bore ø 0.35mm thread M6x0.5			
	GEV No.	101058	Ref. No.	—
	magnet unit L 39mm D1 ø 15.4mm D2 ø 13.5mm suitable for PEL22/EGA24197 standard			
	GEV No.	101201	Ref. No.	—
	gas tap front part shaft ø 10x8mm shaft L 25/17mm shaft flat upper/lower suitable for PEL22			
	GEV No.	101231	Ref. No.	—
	thermocouple nut T1: M9x1 T2: M18x1			

Table continues overleaf



spare parts for		101087	
	GEV No.	101241	Ref. No. —
gas connection thread M20x1.5 tube ø 12/10mm for PEL gas taps vertical			
	GEV No.	101460	Ref. No. —
O-ring ø 12.37mm D1 ø 2.62mm suitable for PEL22			
	GEV No.	101461	Ref. No. —
screw kit suitable for PEL22 Qty 4 pcs			
accessories for		101087	
	GEV No.	100908	Ref. No. 806019
union screw thread M10x1 for pipe ø 4mm Qty 1 pcs			
	GEV No.	100909	Ref. No. —
union screw thread M10x1 for pipe ø 6mm Qty 1 pcs			
	GEV No.	101240	Ref. No. —
gas connection thread M20x1.5 tube ø 12/10mm for PEL gas taps with gasket and screws horizontal			
	GEV No.	101246	Ref. No. —
olive for pipe ø 4mm Qty 1 pcs			
	GEV No.	101248	Ref. No. 8C0412
olive for pipe ø 12mm Qty 1 pcs suitable for PEL			
	GEV No.	101249	Ref. No. —
olive for pipe ø 10mm Qty 1 pcs			
	GEV No.	101250	Ref. No. —
union nut thread M20x1.5 for pipe ø 10mm			
	GEV No.	101251	Ref. No. —
union nut thread M20x1.5 for pipe ø 12mm			
	GEV No.	101286	Ref. No. —
olive ID ø 6mm Qty 1 pcs			
	GEV No.	110080	Ref. No. —
knob ø 70mm shaft ø 10x8mm shaft flat universal			
	GEV No.	112206	Ref. No. —
knob dial plate silver gas tap PEL21/22/23 t.max.°C ED ø 63mm ID ø 45.5mm			

Зип-Общепит

235/O series

vsezip.ru

+7(812)987-08-81

1















GEV No.	101092	Ref. No.	808520
<b>description</b>	gas tap PEL type 235/O gas inlet M28x1.5 (tube ø 20mm) bypass nozzle ø 0.35mm gas outlet M24x1.5 (tube ø 16mm) thermocouple connection M10x1 pilot connection M10x1 shaft ø 10x8mm shaft L 25/17mm shaft flat upper		
spare parts for		101092	
	GEV No.	100455	Ref. No. —
bypass nozzle type PEL23/24 bore ø 0.35mm thread M8x0.5			
	GEV No.	101059	Ref. No. —
magnet unit T1: M10x1 T2: M22x1 L 46mm ø 18mm suitable for PEL235 M10x1			
	GEV No.	101204	Ref. No. —
gas tap front part shaft ø 10x8mm shaft L 25/17mm shaft flat upper/lower suitable for PEL235			
	GEV No.	101244	Ref. No. —
gas connection thread M24x1.5 tube ø 12/16mm horizontal for PEL gas taps			
	GEV No.	101463	Ref. No. —
screw suitable for PEL235 Qty 4 pcs			
	GEV No.	528455	Ref. No. —
O-ring Viton thickness 2.62mm ID ø 18.72mm Qty 1 pcs			
accessories for		101092	
	GEV No.	100908	Ref. No. 806019
union screw thread M10x1 for pipe ø 4mm Qty 1 pcs			
	GEV No.	100909	Ref. No. —
union screw thread M10x1 for pipe ø 6mm Qty 1 pcs			
	GEV No.	101246	Ref. No. —
olive for pipe ø 4mm Qty 1 pcs			
	GEV No.	101252	Ref. No. —
union nut thread M24x1.5 for pipe ø 12mm			
	GEV No.	101253	Ref. No. —
union nut thread M24x1.5 PEL for pipe ø 16mm			
	GEV No.	101254	Ref. No. —
union nut thread M28x1.5 tube ø 20mm			
	GEV No.	101255	Ref. No. —
olive for pipe ø 12mm Qty 1 pcs			
	GEV No.	101256	Ref. No. —
olive for pipe ø 16mm Qty 1 pcs			
	GEV No.	101257	Ref. No. —
olive for pipe ø 20mm Qty 1 pcs			



Table continues overleaf







Зип-Общепит

vsezip.ru

+7(812)987-08-81

<b>accessories for</b>	101092		
	GEV No.	101286	Ref. No. —
	olive ID ø 6mm Qty 1 pcs		
	GEV No.	110080	Ref. No. —
	knob ø 70mm shaft ø 10x8mm shaft flat universal		
	GEV No.	112206	Ref. No. —
	knob dial plate silver gas tap PEL21/22/23 t.max.°C ED ø 63mm ID ø 45.5mm		





<b>accessories for</b>	101188		
	GEV No.	100905	Ref. No. 8C0070
	locking screw M10x1 for pipe ø 6mm Qty 1 pcs		
	GEV No.	101273	Ref. No. —
	olive for pipe ø 12mm L 9.5mm brass Qty 1 pcs suitable for universal		
	GEV No.	101276	Ref. No. —
	union screw thread 3/8" tube ø 12mm Qty 1 pcs		
	GEV No.	101333	Ref. No. —
	plug thread 3/8" with O-ring		

SABAF

			
<b>1</b>			
<b>GEV No.</b>	101458	<b>Ref. No.</b>	C10107
<b>description</b>	gas tap SABAF type 11 gas inlet 1/4" (tube ø 6mm) bypass nozzle ø 0mm gas outlet 1/4" (tube ø 8mm) front fixing thermocouple connection plug-in connection shaft ø 8x6.5mm shaft L 40/15mm shaft flat upper		
<b>spare parts for</b>	101458		
	GEV No.	106723	Ref. No. —
	magnet unit L 29mm D1 ø 12.5mm D2 ø 8.5mm suitable for SABAF		
<b>accessories for</b>	101458		
	GEV No.	101277	Ref. No. —
	olive ID ø 8mm Qty 1 pcs		
	GEV No.	520656	Ref. No. —
	union nut thread 1/4" tube ø 6/8mm		

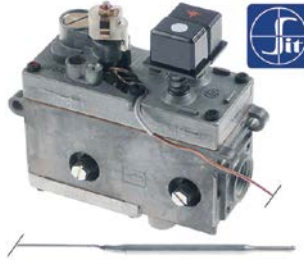
			
<b>1</b>			
<b>GEV No.</b>	103076	<b>Ref. No.</b>	512250006
<b>description</b>	gas thermostat type 630 Eurosit series t.max. 190°C 110-190°C gas inlet 3/8" gas outlet 3/8" thermocouple connection M9x1 pilot connection M10x1 probe ø 4mm probe L 202mm capillary pipe 1050mm SIT		

710 Minisit series

			
<b>1</b>			
<b>GEV No.</b>	101135	<b>Ref. No.</b>	C00897
<b>description</b>	gas thermostat SIT type MINISIT 710 t.max. 190°C 110-190°C gas inlet 1/2" gas outlet 3/8" thermocouple connection M9x1 pilot connection M10x1 probe ø 6mm probe L 102mm capillary pipe 1050mm probe type type A3 pressure controller no pressure regulator mbar gland nut		
<b>spare parts for</b>	101135		
	GEV No.	101053	Ref. No. —
	magnet unit T1: M9x1 T2: M24x1 L 45mm ø 17mm suitable for Minisit		
	GEV No.	102118	Ref. No. —
	probe 110-190°C probe ø 6mm probe L 102mm capillary pipe 1050mm t.max. 190°C fryer probe type type A3 suitable for MINISIT 710		
<b>accessories for</b>	101135		
	GEV No.	100809	Ref. No. —
	O-ring EPDM thickness 2mm ID ø 21mm Qty 1 pcs		
	GEV No.	100820	Ref. No. —
	gland duct ET M14x1.5 IT M10x0.75 probe ø max. 6.5mm WS 22		

gas thermostats

SIT

630 Eurosit series



			
<b>1</b>			
<b>GEV No.</b>	101188	<b>Ref. No.</b>	808934 C00753
<b>description</b>	gas thermostat type 630 Eurosit series t.max. 190°C 110-190°C gas inlet 3/8" gas outlet 3/8" thermocouple connection M9x1 pilot connection M10x1 probe ø 4mm probe L 202mm capillary pipe 1050mm SIT		
<b>accessories for</b>	101188		
	GEV No.	100904	Ref. No. —
	locking screw M10x1 for pipe ø 4mm Qty 1 pcs		

Table continues overleaf



Зип Общепит  
vsezip.ru  
+7(812)987-08-81

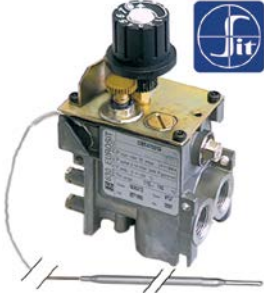

accessories for		101135	
	GEV No.	100904	Ref. No. —
locking screw M10x1 for pipe ø 4mm Qty 1 pcs			
	GEV No.	100905	Ref. No. 8C0070
locking screw M10x1 for pipe ø 6mm Qty 1 pcs			
	GEV No.	101054	Ref. No. —
magnet unit T1: M10x1 T2: M24x1 L 45mm ø 17mm suitable for Minisit			
	GEV No.	101136	Ref. No. 807697
piezoelectric igniter suitable for Minisit with cover cap ømm connection F6.3x0.8			
	GEV No.	101137	Ref. No. —
cover cap without piezoelectric igniter			
	GEV No.	101267	Ref. No. —
reducer IT 3/8" ET 1/2" L 21mm			
	GEV No.	101268	Ref. No. —
gas connection thread 3/8" angled with O-ring MINISIT 710			
	GEV No.	101269	Ref. No. —
gas connection thread 1/2" angled with O-ring MINISIT 710			
	GEV No.	101270	Ref. No. —
screw connection IT 3/8" ET 3/8" L 28mm			
	GEV No.	101272	Ref. No. —
screw connection IT 1/2" ET 3/8" L 57mm			
	GEV No.	101273	Ref. No. —
olive for pipe ø 12mm L 9.5mm brass Qty 1 pcs suitable for universal			
	GEV No.	101274	Ref. No. —
olive for pipe ø 16mm Qty 1 pcs			
	GEV No.	101275	Ref. No. —
union screw thread 1/2" for pipe ø 16mm Qty 1 pcs			
	GEV No.	101276	Ref. No. —
union screw thread 3/8" tube ø 12mm Qty 1 pcs			
	GEV No.	110068	Ref. No. 814979
knob suitable for Minisit ø 37mm			

GEV No.		101132		Ref. No.		806192	
<b>description</b>							
gas thermostat SIT type MINISIT 710 t.max. 340°C 100-340°C gas inlet 1/2" gas outlet 3/8" thermocouple connection M9x1 pilot connection M10x1 probe ø 5mm probe L 68mm capillary pipe 1050mm probe type type B1 pressure controller no pressure regulator mbar gland nut ignition gas no							
<b>spare parts for</b>							
101132							
	GEV No.	101053	Ref. No.	—			
magnet unit T1: M9x1 T2: M24x1 L 45mm ø 17mm suitable for Minisit							
<b>accessories for</b>							
101132							
	GEV No.	100809	Ref. No.	—			
O-ring EPDM thickness 2mm ID ø 21mm Qty 1 pcs							
	GEV No.	100904	Ref. No.	—			
locking screw M10x1 for pipe ø 4mm Qty 1 pcs							
	GEV No.	100905	Ref. No.	8C0070			
locking screw M10x1 for pipe ø 6mm Qty 1 pcs							
	GEV No.	101054	Ref. No.	—			
magnet unit T1: M10x1 T2: M24x1 L 45mm ø 17mm suitable for Minisit							
	GEV No.	101136	Ref. No.	807697			
piezoelectric igniter suitable for Minisit with cover cap ømm connection F6.3x0.8							
	GEV No.	101137	Ref. No.	—			
cover cap without piezoelectric igniter							
	GEV No.	101267	Ref. No.	—			
reducer IT 3/8" ET 1/2" L 21mm							
	GEV No.	101268	Ref. No.	—			
gas connection thread 3/8" angled with O-ring MINISIT 710							
	GEV No.	101269	Ref. No.	—			
gas connection thread 1/2" angled with O-ring MINISIT 710							
	GEV No.	101270	Ref. No.	—			
screw connection IT 3/8" ET 3/8" L 28mm							
	GEV No.	101272	Ref. No.	—			
screw connection IT 1/2" ET 3/8" L 57mm							
	GEV No.	101273	Ref. No.	—			
olive for pipe ø 12mm L 9.5mm brass Qty 1 pcs suitable for universal							
	GEV No.	101274	Ref. No.	—			
olive for pipe ø 16mm Qty 1 pcs							
	GEV No.	101275	Ref. No.	—			
union screw thread 1/2" for pipe ø 16mm Qty 1 pcs							



Table continues overleaf



Зип-Общепит



vsezip.ru

+7(812)987-08-81

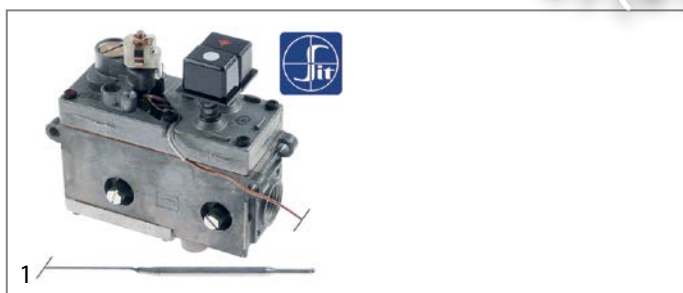
<b>accessories for</b> 101132			
	GEV No.	101276	Ref. No. —
union screw thread 3/8" tube ø 12mm Qty 1 pcs			
	GEV No.	110068	Ref. No. 814979
knob suitable for Minisit ø 37mm			



<b>GEV No.</b>	101131	<b>Ref. No.</b>	806267
<b>description</b>	gas thermostat without cap, button and angle SIT type MINISIT 710 t.max. 190°C 50-190°C gas inlet 1/2" gas outlet 3/8" thermocouple connection M9x1 pilot connection M10x1 probe ø 5mm probe L 98mm capillary pipe 1200mm probe type type A2 pressure controller no pressure regulator mbar gland nut		

<b>spare parts for</b> 101131			
	GEV No.	101053	Ref. No. —
magnet unit T1: M9x1 T2: M24x1 L 45mm ø 17mm suitable for Minisit			
	GEV No.	102103	Ref. No. —
probe 60-200°C probe ø 5mm probe L 98mm capillary pipe 1050mm t.max. 200°C fryer probe type type A2 suitable for MINISIT 710			

<b>accessories for</b> 101131			
	GEV No.	100809	Ref. No. —
O-ring EPDM thickness 2mm ID ø 21mm Qty 1 pcs			
	GEV No.	100820	Ref. No. —
gland duct ET M14x1.5 IT M10x0.75 probe ø max. 6.5mm WS 22			
	GEV No.	100904	Ref. No. —
locking screw M10x1 for pipe ø 4mm Qty 1 pcs			
	GEV No.	100905	Ref. No. 8C0070
locking screw M10x1 for pipe ø 6mm Qty 1 pcs			
	GEV No.	101054	Ref. No. —
magnet unit T1: M10x1 T2: M24x1 L 45mm ø 17mm suitable for Minisit			
	GEV No.	101136	Ref. No. 807697
piezoelectric igniter suitable for Minisit with cover cap ømm connection F6.3x0.8			
	GEV No.	101137	Ref. No. —
cover cap without piezoelectric igniter			
	GEV No.	101267	Ref. No. —
reducer IT 3/8" ET 1/2" L 21mm			
	GEV No.	101268	Ref. No. —
gas connection thread 3/8" angled with O-ring MINISIT 710			
	GEV No.	101269	Ref. No. —
gas connection thread 1/2" angled with O-ring MINISIT 710			

<b>accessories for</b> 101131			
	GEV No.	101270	Ref. No. —
union screw connection IT 3/8" ET 3/8" L 28mm			
	GEV No.	101272	Ref. No. —
union screw connection IT 1/2" ET 3/8" L 57mm			
	GEV No.	101273	Ref. No. —
olive for pipe ø 12mm L 9.5mm brass Qty 1 pcs suitable for universal			
	GEV No.	101274	Ref. No. —
olive for pipe ø 16mm Qty 1 pcs			
	GEV No.	101275	Ref. No. —
union screw thread 1/2" for pipe ø 16mm Qty 1 pcs			
	GEV No.	101276	Ref. No. —
union screw thread 3/8" tube ø 12mm Qty 1 pcs			
	GEV No.	110068	Ref. No. 814979
knob suitable for Minisit ø 37mm			

PEL

24ST series









<b>GEV No.</b>	101078	<b>Ref. No.</b>	C00417
<b>description</b>	gas thermostat PEL type 24ST 55-110°C gas inlet M20x1.5 (tube ø 12mm) bypass nozzle ø 0.35mm gas outlet M20x1.5 (tube ø 12/10mm) thermocouple connection M9x1 pilot connection M10x1 capillary pipe 1200mm probe ø 6mm probe L 160mm shaft ø 10x8mm shaft L 27/17mm shaft flat upper		
<b>spare parts for</b> 101078			
	GEV No.	100455	Ref. No. —
bypass nozzle type PEL23/24 bore ø 0.35mm thread M8x0.5			
	GEV No.	101058	Ref. No. —
magnet unit L 39mm D1 ø 15.4mm D2 ø 13.5mm suitable for PEL22/ EGA24197 standard			
	GEV No.	106200	Ref. No. —
nut thread M9x1 suitable for PEL 24/255			
<b>accessories for</b> 101078			
	GEV No.	100908	Ref. No. 806019
union screw thread M10x1 for pipe ø 4mm Qty 1 pcs			
	GEV No.	100909	Ref. No. —
union screw thread M10x1 for pipe ø 6mm Qty 1 pcs			
	GEV No.	101246	Ref. No. —
olive for pipe ø 4mm Qty 1 pcs			
	GEV No.	101248	Ref. No. 8C0412
olive for pipe ø 12mm Qty 1 pcs suitable for PEL			

Table continues overleaf

Зип-Общепит











vsezip.ru







+7(812)9811111

accessories for		101078	
	GEV No.	101249	Ref. No. —
olive for pipe ø 10mm Qty 1 pcs			
	GEV No.	101250	Ref. No. —
union nut thread M20x1.5 for pipe ø 10mm			
	GEV No.	101251	Ref. No. —
union nut thread M20x1.5 for pipe ø 12mm			
	GEV No.	101286	Ref. No. —
olive ID ø 6mm Qty 1 pcs			
	GEV No.	110079	Ref. No. —
knob dial plate gas thermostat 1-8 silver			
	GEV No.	110080	Ref. No. —
knob ø 70mm shaft ø 10x8mm shaft flat universal			

24STS series



GEV No.	101159	Ref. No.	C00600
<b>description</b>	gas thermostat PEL type 24STS 120-320°C gas inlet flange bypass nozzle ø 0.35mm gas outlet flange thermocouple connection M9x1 pilot connection M10x1 capillary pipe 1200mm probe ø 6mm probe L 100mm shaft ø 10x8mm shaft L 27/17mm shaft flat upper		
<b>spare parts for</b>	101159		
	GEV No.	100455	Ref. No. —
bypass nozzle type PEL23/24 bore ø 0.35mm thread M8x0.5			
	GEV No.	101058	Ref. No. —
magnet unit L 39mm D1 ø 15.4mm D2 ø 13.5mm suitable for PEL22/EGA24197 standard			
	GEV No.	106200	Ref. No. —
nut thread M9x1 suitable for PEL 24/25S			
<b>accessories for</b>	101159		
	GEV No.	101235	Ref. No. —
gas connection thread M20x1.5 tube ø 12/10mm for PEL gas taps horizontal			
	GEV No.	101236	Ref. No. —
gas connection thread M20x1.5 tube ø 12/10mm for PEL gas taps vertical			
	GEV No.	101240	Ref. No. —
gas connection thread M20x1.5 tube ø 12/10mm for PEL gas taps with gasket and screws horizontal			
	GEV No.	101241	Ref. No. —
gas connection thread M20x1.5 tube ø 12/10mm for PEL gas taps vertical			
	GEV No.	101248	Ref. No. 8C0412
olive for pipe ø 12mm Qty 1 pcs suitable for PEL			
	GEV No.	101249	Ref. No. —
olive for pipe ø 10mm Qty 1 pcs			
	GEV No.	101250	Ref. No. —
union nut thread M20x1.5 for pipe ø 10mm			

accessories for		101159	
	GEV No.	101251	Ref. No. —
union nut thread M20x1.5 for pipe ø 12mm			
	GEV No.	101356	Ref. No. —
gas tap PEL-type 21S gas inlet M16x1.5 (tube ø 10mm) bypass nozzle ø 0.35mm gas outlet M16x1.5 (tube ø 10/8mm) thermocouple connection M10x1 pilot connection M10x1 shaft ø 8x6.5mm shaft L 22/15mm shaft flat lower			
	GEV No.	101460	Ref. No. —
O-ring ø 12.37mm D1 ø 2.62mm suitable for PEL22			
	GEV No.	101461	Ref. No. —
screw kit suitable for PEL22 Qty 4 pcs			
	GEV No.	106165	Ref. No. —
gasket ø 27mm			
	GEV No.	110079	Ref. No. —
knob dial plate gas thermostat 1-8 silver			
	GEV No.	110080	Ref. No. —
knob ø 70mm shaft ø 10x8mm shaft flat universal			









GEV No.	101161	Ref. No.	C00084 C00600
<b>description</b>	gas thermostat PEL type 24STS 120-320°C gas inlet M20x1.5 (tube ø 12/10mm) bypass nozzle ø 0.35mm gas outlet M20x1.5 (tube ø 12/10mm) thermocouple connection M9x1 pilot connection M10x1 capillary pipe 1200mm probe ø 6mm probe L 100mm shaft ø 10x8mm shaft L 27/17mm shaft flat upper		
<b>spare parts for</b>	101161		
	GEV No.	101058	Ref. No. —
magnet unit L 39mm D1 ø 15.4mm D2 ø 13.5mm suitable for PEL22/EGA24197 standard			
<b>accessories for</b>	101161		
	GEV No.	101235	Ref. No. —
gas connection thread M20x1.5 tube ø 12/10mm for PEL gas taps horizontal			
	GEV No.	101236	Ref. No. —
gas connection thread M20x1.5 tube ø 12/10mm for PEL gas taps vertical			
	GEV No.	101240	Ref. No. —
gas connection thread M20x1.5 tube ø 12/10mm for PEL gas taps with gasket and screws horizontal			
	GEV No.	101241	Ref. No. —
gas connection thread M20x1.5 tube ø 12/10mm for PEL gas taps vertical			
	GEV No.	101248	Ref. No. 8C0412
olive for pipe ø 12mm Qty 1 pcs suitable for PEL			
	GEV No.	101249	Ref. No. —
olive for pipe ø 10mm Qty 1 pcs			

Table continues overleaf



Зип-Общепит

vsezip.ru



+7(812)987-08-81

<b>accessories for</b> 101161	
	GEV No. 101250 Ref. No. — union nut thread M20x1.5 for pipe ø 10mm
	GEV No. 101251 Ref. No. — union nut thread M20x1.5 for pipe ø 12mm
	GEV No. 101365 Ref. No. — gas connection thread M20x1.5 tube ø 12mm for PEL gas taps horizontal
	GEV No. 101460 Ref. No. — O-ring ø 12.37mm D1 ø 2.62mm suitable for PEL22
	GEV No. 101461 Ref. No. — screw kit suitable for PEL22 Qty 4 pcs
	GEV No. 110079 Ref. No. — knob dial plate gas thermostat 1-8 silver
	GEV No. 110080 Ref. No. — knob ø 70mm shaft ø 10x8mm shaft flat universal

## gas valves and ignition boxes

### gas control valves

#### HONEYWELL

	
1	
<b>GEV No.</b> 101186	<b>Ref. No.</b> 809510
<b>description</b>	gas valve type VK4105C 220-240V 50/60Hz gas inlet flange 32x32mm gas outlet flange 32x32mm thermocouple connection pilot connection pressure range 15-60mbar max 60mbar operator type pressure controller type V5360E 1226 1 HONEYWELL flange 32x32mm
<b>accessories for</b> 101186	
	GEV No. 102845 Ref. No. — gas connection angled 1/2" flange 32x32mm hole distance 24x24mm Tandem
	GEV No. 102846 Ref. No. — gas connection straight 1/2" flange 32x32mm hole distance 24x24mm suitable for Tandem

#### ELETTROSIT

	
1	
<b>GEV No.</b> 101126	<b>Ref. No.</b> C00302
<b>description</b>	gas valve SIT type ELETTROSIT 230V gas inlet 1/2" gas outlet 1/2" thermocouple connection M9x1 pilot connection M10x1 bottom equiv. no. 0.810.136
<b>spare parts for</b> 101126	
	GEV No. 101312 Ref. No. C00309 microswitch
	GEV No. 101352 Ref. No. — solenoid coil 230V 50Hz suitable for ELETTROSIT
<b>accessories for</b> 101126	
	GEV No. 100006 Ref. No. — piezoelectric igniter suitable for ELETTROSIT body plastic blowing connection ø2.4mm ø 14mm
	GEV No. 100904 Ref. No. — locking screw M10x1 for pipe ø 4mm Qty 1 pcs
	GEV No. 100905 Ref. No. 8C0070 locking screw M10x1 for pipe ø 6mm Qty 1 pcs
	GEV No. 101301 Ref. No. — gas connection thread 1/2" straight ELETTROSIT screw with O-ring
	GEV No. 101303 Ref. No. — gas connection straight thread 3/4" ELETTROSIT
	GEV No. 101309 Ref. No. — extension

1 gas components





Зип Общепит

vsezip.ru

+7(812)987-08-81

**NOVASIT**

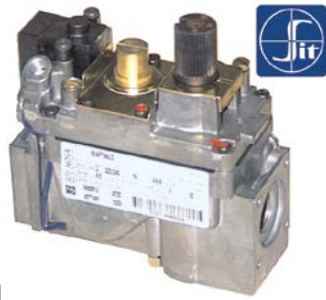

<b>1</b>			
<b>GEV No.</b>	101162	<b>Ref. No.</b>	813436
<b>description</b>	gas valve SIT series Novasit 820 230V 50Hz gas inlet 1/2" gas outlet 1/2" thermocouple connection M9x1 pilot connection M10x1 ignition pressure 3-5mbar pressure range 3-30mbar pressure regulator connection blind equiv. no. 0.820.010		
<b>spare parts for</b>	101162		
	<b>GEV No.</b>	101065	<b>Ref. No.</b> —
	magnet unit with cable L 44mm D1 ø 30mm D2 ø 20mm suitable for NOVASIT		
	<b>GEV No.</b>	101313	<b>Ref. No.</b> —
	solenoid coil 230V 50Hz		
<b>accessories for</b>	101162		
	<b>GEV No.</b>	100006	<b>Ref. No.</b> —
	piezoelectric igniter suitable for ELETTROSIT body plastic blowing connection ø2.4mm ø 14mm		
	<b>GEV No.</b>	101305	<b>Ref. No.</b> —
	gas connection straight 1/2" flange 45x45mm ELETTROSIT/V4400/4600/4605 suitable for SIT/HONEYWELL hole distance 36x36mm		
	<b>GEV No.</b>	101306	<b>Ref. No.</b> —
	gas connection angled flange 45x45mm hole distance 36x36mm 1/2" ELETTROSIT/V4400/4600/4605 screw with O-ring suitable for SIT/HONEYWELL		
	<b>GEV No.</b>	101307	<b>Ref. No.</b> —
	gas connection straight flange 45x45mm hole distance 36x36mm 3/4" ELETTROSIT/V4400/4600/4605 screw with O-ring suitable for SIT/HONEYWELL		
	<b>GEV No.</b>	101308	<b>Ref. No.</b> —
	gas connection angled flange 45x45mm hole distance 36x36mm 3/4" ELETTROSIT/V4400/4600/4605 screw with O-ring suitable for SIT/HONEYWELL		
	<b>GEV No.</b>	101312	<b>Ref. No.</b> C00309
	microswitch		
	<b>GEV No.</b>	101314	<b>Ref. No.</b> —
	solenoid coil 24V 50Hz		
	<b>GEV No.</b>	101317	<b>Ref. No.</b> C00974
	plug with cable L 1000mm suitable for NOVASIT		
	<b>GEV No.</b>	101318	<b>Ref. No.</b> —
	cover cap for solenoid coil suitable for NOVASIT		

<b>1</b>			
<b>GEV No.</b>	101956	<b>Ref. No.</b>	C00946
<b>description</b>	gas valve SIT series Novasit 820 230V 50Hz gas inlet 1/2" gas outlet 1/2" thermocouple connection M9x1 pilot connection M10x1 ignition pressure 3-5mbar pressure range 3-30mbar pressure regulator connection blind equiv. no. 0.820.031		
<b>spare parts for</b>	101956		
	<b>GEV No.</b>	101065	<b>Ref. No.</b> —
	magnet unit with cable L 44mm D1 ø 30mm D2 ø 20mm suitable for NOVASIT		
	<b>GEV No.</b>	101313	<b>Ref. No.</b> —
	solenoid coil 230V 50Hz		
<b>accessories for</b>	101956		
	<b>GEV No.</b>	100006	<b>Ref. No.</b> —
	piezoelectric igniter suitable for ELETTROSIT body plastic blowing connection ø2.4mm ø 14mm		
	<b>GEV No.</b>	101305	<b>Ref. No.</b> —
	gas connection straight 1/2" flange 45x45mm ELETTROSIT/V4400/4600/4605 suitable for SIT/HONEYWELL hole distance 36x36mm		
	<b>GEV No.</b>	101306	<b>Ref. No.</b> —
	gas connection angled flange 45x45mm hole distance 36x36mm 1/2" ELETTROSIT/V4400/4600/4605 screw with O-ring suitable for SIT/HONEYWELL		
	<b>GEV No.</b>	101307	<b>Ref. No.</b> —
	gas connection straight flange 45x45mm hole distance 36x36mm 3/4" ELETTROSIT/V4400/4600/4605 screw with O-ring suitable for SIT/HONEYWELL		
	<b>GEV No.</b>	101308	<b>Ref. No.</b> —
	gas connection angled flange 45x45mm hole distance 36x36mm 3/4" ELETTROSIT/V4400/4600/4605 screw with O-ring suitable for SIT/HONEYWELL		
	<b>GEV No.</b>	101312	<b>Ref. No.</b> C00309
	microswitch		
	<b>GEV No.</b>	101314	<b>Ref. No.</b> —
	solenoid coil 24V 50Hz		
	<b>GEV No.</b>	101317	<b>Ref. No.</b> C00974
	plug with cable L 1000mm suitable for NOVASIT		
	<b>GEV No.</b>	101318	<b>Ref. No.</b> —
	cover cap for solenoid coil suitable for NOVASIT		











Зип-Общепит

vsezip.ru

+7(812)987-08-81









1

<b>GEV No.</b>	101914	<b>Ref. No.</b>	808578
<b>description</b>	gas valve SIT series Novasit 822 230V 50Hz gas inlet 1/2" gas outlet 1/2" thermocouple connection pilot connection closed ignition pressure range 3-30mbar pressure regulator connection blind equiv. no. 0.822.144		
<b>spare parts for</b>	101914		
	<b>GEV No.</b>	101313	<b>Ref. No.</b> —
	solenoid coil 230V 50Hz		
	<b>GEV No.</b>	101542	<b>Ref. No.</b> —
	solenoid coil 50Hz NOVA 822/826/827 suitable for NOVASIT 230V		
<b>accessories for</b>	101914		
	<b>GEV No.</b>	101305	<b>Ref. No.</b> —
	gas connection straight 1/2" flange 45x45mm ELETTROSIT/V4400/4600/4605 suitable for SIT/HONEYWELL hole distance 36x36mm		
	<b>GEV No.</b>	101306	<b>Ref. No.</b> —
	gas connection angled flange 45x45mm hole distance 36x36mm 1/2" ELETTROSIT/V4400/4600/4605 screw with O-ring suitable for SIT/HONEYWELL		
	<b>GEV No.</b>	101307	<b>Ref. No.</b> —
	gas connection straight flange 45x45mm hole distance 36x36mm 3/4" ELETTROSIT/V4400/4600/4605 screw with O-ring suitable for SIT/HONEYWELL		
	<b>GEV No.</b>	101308	<b>Ref. No.</b> —
	gas connection angled flange 45x45mm hole distance 36x36mm 3/4" ELETTROSIT/V4400/4600/4605 screw with O-ring suitable for SIT/HONEYWELL		
	<b>GEV No.</b>	101503	<b>Ref. No.</b> —
	O-ring EPDM thickness 2mm ID ø 32mm Qty 1 pcs		
	<b>GEV No.</b>	101924	<b>Ref. No.</b> —
	plug with cable L 1090mm suitable for NOVA 822/826/827		



1

<b>GEV No.</b>	101984	<b>Ref. No.</b>	809326
<b>description</b>	gas valve 230V 50Hz gas inlet 1/2" gas outlet 1/2" pilot connection level slow ignition ignition times pressure range 2-50mbar power supply for modulator 230VAC rectified Tandem equiv. no. 0.836.010		
<b>spare parts for</b>	101984		
	<b>GEV No.</b>	101379	<b>Ref. No.</b> —
	solenoid coil 230V 50Hz suitable for Tandem		
<b>accessories for</b>	101984		
	<b>GEV No.</b>	101274	<b>Ref. No.</b> —
	olive for pipe ø 16mm Qty 1 pcs		
	<b>GEV No.</b>	101275	<b>Ref. No.</b> —
	union screw thread 1/2" for pipe ø 16mm Qty 1 pcs		
	<b>GEV No.</b>	101925	<b>Ref. No.</b> —
	plug with O-ring thread M10x1 for pilot burner suitable for NOVASIT		
	<b>GEV No.</b>	102845	<b>Ref. No.</b> —
	gas connection angled 1/2" flange 32x32mm hole distance 24x24mm Tandem		
	<b>GEV No.</b>	102846	<b>Ref. No.</b> —
	gas connection straight 1/2" flange 32x32mm hole distance 24x24mm suitable for Tandem		
	<b>GEV No.</b>	102847	<b>Ref. No.</b> —
	O-ring		



1







<b>GEV No.</b>	101684	<b>Ref. No.</b>	809595 8C0068
<b>description</b>	gas valve 230V 50Hz gas inlet 1/2" gas outlet 1/2" pilot connection level slow ignition standard ignition time 3-7s pressure range 3-50mbar power supply for modulator type SIT equiv. no. 0.830.034		
<b>spare parts for</b>	101684		
	<b>GEV No.</b>	101379	<b>Ref. No.</b> —
	solenoid coil 230V 50Hz suitable for Tandem		

Table continues overleaf



Зип Общепит  
vsezip.ru  
+7(812)987-08-81

<b>accessories for</b>	101684			
	GEV No.	101274	Ref. No.	—
	olive for pipe ø 16mm Qty 1 pcs			
	GEV No.	101275	Ref. No.	—
	union screw thread 1/2" for pipe ø 16mm Qty 1 pcs			
	GEV No.	102845	Ref. No.	—
	gas connection angled 1/2" flange 32x32mm hole distance 24x24mm Tandem			
	GEV No.	102846	Ref. No.	—
	gas connection straight 1/2" flange 32x32mm hole distance 24x24mm suitable for Tandem			
	GEV No.	102847	Ref. No.	—
	O-ring			

			
<b>GEV No.</b>	101166	<b>Ref. No.</b>	808611
<b>description</b>	ignition box HONEYWELL type S4560B 1006 electrodes 1 waiting time 0s safety time 10s 220-240V 10VA 50Hz		

### ignition boxes



#### BRAHMA

			
<b>GEV No.</b>	107471	<b>Ref. No.</b>	809878
<b>description</b>	ignition box BRAHMA type CM11 electrodes 2 waiting time 1.5s safety time 10s 230V 7VA 50-60Hz		

#### SIT

			
<b>GEV No.</b>	101685	<b>Ref. No.</b>	809602 8C0069
<b>description</b>	ignition box SIT type 503EFD electrodes 2 waiting time 1.5s safety time 10s 220/240V 10VA 50-60Hz protection IP40		

#### HONEYWELL

				
<b>GEV No.</b>	101165	<b>Ref. No.</b>	809751	
<b>description</b>	ignition box HONEYWELL type S4560A 1008 equiv. no. S4560A 1008 electrodes 1 waiting time 0s safety time 10s 220-240V 10VA 50Hz			
<b>spare parts for</b>	101165			
	GEV No.	358696	Ref. No.	—
	fine fuse size ø5x20mm 4A medium lag rated 250V Qty 10 pcs			

			
<b>GEV No.</b>	102309	<b>Ref. No.</b>	809752
<b>description</b>	ignition box SIT type 537ABC electrodes 3 waiting time 1.5s safety time 10s 230V 10VA 50-60Hz protection IP44		



ignition parts

pilot burners

SIT

100 series





1











<b>GEV No.</b>	107139	<b>Ref. No.</b>	C00391
<b>description</b>	pilot burner SIT type 100 series 1 flame nozzle $\varnothing$ 0.2mm gas connection mm		
<b>spare parts for</b>	107139		
	GEV No.	100854	Ref. No. —
pilot burner bracket double			
	GEV No.	100885	Ref. No. —
air mixing sleeve for pilot burner Qty 1 pcs			
	GEV No.	107160	Ref. No. —
pilot burner cap SIT 1 flame Hmm Lmm Qty 1 pcs			
<b>accessories for</b>	107139		
	GEV No.	100904	Ref. No. —
locking screw M10x1 for pipe $\varnothing$ 4mm Qty 1 pcs			
	GEV No.	100905	Ref. No. 8C0070
locking screw M10x1 for pipe $\varnothing$ 6mm Qty 1 pcs			
	GEV No.	100998	Ref. No. —
pilot burner bottom part nozzle $\varnothing$ 0.21mm suitable for 100 series			
	GEV No.	102110	Ref. No. —
pilot tube copper pipe $\varnothing$ 4mm thickness 1mm L 3000mm			
	GEV No.	102111	Ref. No. —
pilot tube copper pipe $\varnothing$ 6mm thickness 1mm L 3000mm			



1

<b>GEV No.</b>	106906	<b>Ref. No.</b>	C00711
<b>description</b>	pilot burner SIT type 100 series 3 flames nozzle $\varnothing$ 0.2mm gas connection 6mm		
<b>spare parts for</b>	106906		
	GEV No.	100245	Ref. No. 8C0030
pilot burner nozzle LPG code 20 bore $\varnothing$ 0.2mm Qty 1 pcs thread M8x0.75			
	GEV No.	100855	Ref. No. —
pilot burner bracket triple			

Зип-Общепит

	GEV No.	100885	Ref. No.	—
air mixing sleeve for pilot burner Qty 1 pcs				
	GEV No.	100916	Ref. No.	—
compression spring for pilot burner Qty 1 pcs				
	GEV No.	100917	Ref. No.	—
gasket for pilot burner Qty 1 pcs aluminium				
	GEV No.	100918	Ref. No.	—
screw for pilot burner				
	GEV No.	107162	Ref. No.	—
pilot burner cap SIT 3 flames Hmm Lmm Qty 1 pcs				
	GEV No.	107701	Ref. No.	—
pilot burner bottom part SIT 100 series nozzle $\varnothing$ 0.2mm				
<b>accessories for</b>	106906			
	GEV No.	100245	Ref. No.	8C0030
pilot burner nozzle LPG code 20 bore $\varnothing$ 0.2mm Qty 1 pcs thread M8x0.75				
	GEV No.	100246	Ref. No.	8C0031
pilot burner nozzle natural gas bore $\varnothing$ 0.35mm Qty 1 pcs thread M8x0.75				
	GEV No.	100904	Ref. No.	—
locking screw M10x1 for pipe $\varnothing$ 4mm Qty 1 pcs				
	GEV No.	100905	Ref. No.	8C0070
locking screw M10x1 for pipe $\varnothing$ 6mm Qty 1 pcs				
	GEV No.	102110	Ref. No.	—
pilot tube copper pipe $\varnothing$ 4mm thickness 1mm L 3000mm				
	GEV No.	102111	Ref. No.	—
pilot tube copper pipe $\varnothing$ 6mm thickness 1mm L 3000mm				
	GEV No.	107171	Ref. No.	—
pilot burner nozzle SIT natural/liquid gas bore $\varnothing$ 0.25mm Qty 1 pcs				
	GEV No.	107700	Ref. No.	—
pilot burner bottom part SIT 100 series nozzle $\varnothing$ 0.25mm				
	GEV No.	107702	Ref. No.	—
pilot burner bottom part SIT 100 series nozzle $\varnothing$ 0.35mm				

1 gas components









Зип Общепит

vsezip.ru

+7(812)987-08-81

	<b>GEV No.</b> 106907	<b>Ref. No.</b> C00166
<b>description</b>	pilot burner SIT type 100 series 3 flames nozzle $\phi$ 0.35mm gas connection 6mm	
<b>spare parts for</b>	106907	
	<b>GEV No.</b> 100246	<b>Ref. No.</b> 8C0031
<b>description</b>	pilot burner nozzle natural gas bore $\phi$ 0.35mm Qty 1 pcs thread M8x0.75	
	<b>GEV No.</b> 100855	<b>Ref. No.</b> —
<b>description</b>	pilot burner bracket triple	
	<b>GEV No.</b> 100885	<b>Ref. No.</b> —
<b>description</b>	air mixing sleeve for pilot burner Qty 1 pcs	
	<b>GEV No.</b> 100916	<b>Ref. No.</b> —
<b>description</b>	compression spring for pilot burner Qty 1 pcs	
	<b>GEV No.</b> 100917	<b>Ref. No.</b> —
<b>description</b>	gasket for pilot burner Qty 1 pcs aluminium	
	<b>GEV No.</b> 100918	<b>Ref. No.</b> —
<b>description</b>	screw for pilot burner	
	<b>GEV No.</b> 107162	<b>Ref. No.</b> —
<b>description</b>	pilot burner cap SIT 3 flames Hmm Lmm Qty 1 pcs	
	<b>GEV No.</b> 107702	<b>Ref. No.</b> —
<b>description</b>	pilot burner bottom part SIT 100 series nozzle $\phi$ 0.35mm	
<b>accessories for</b>	106907	
	<b>GEV No.</b> 100245	<b>Ref. No.</b> 8C0030
<b>description</b>	pilot burner nozzle LPG code 20 bore $\phi$ 0.2mm Qty 1 pcs thread M8x0.75	
	<b>GEV No.</b> 100904	<b>Ref. No.</b> —
<b>description</b>	locking screw M10x1 for pipe $\phi$ 4mm Qty 1 pcs	
	<b>GEV No.</b> 100905	<b>Ref. No.</b> 8C0070
<b>description</b>	locking screw M10x1 for pipe $\phi$ 6mm Qty 1 pcs	
	<b>GEV No.</b> 102110	<b>Ref. No.</b> —
<b>description</b>	pilot tube copper pipe $\phi$ 4mm thickness 1mm L 3000mm	
	<b>GEV No.</b> 102111	<b>Ref. No.</b> —
<b>description</b>	pilot tube copper pipe $\phi$ 6mm thickness 1mm L 3000mm	
	<b>GEV No.</b> 107171	<b>Ref. No.</b> —
<b>description</b>	pilot burner nozzle SIT natural/liquid gas bore $\phi$ 0.25mm Qty 1 pcs	
	<b>GEV No.</b> 107700	<b>Ref. No.</b> —
<b>description</b>	pilot burner bottom part SIT 100 series nozzle $\phi$ 0.25mm	
	<b>GEV No.</b> 107701	<b>Ref. No.</b> —
<b>description</b>	pilot burner bottom part SIT 100 series nozzle $\phi$ 0.2mm	

	<b>GEV No.</b> 107140	<b>Ref. No.</b> C00392
<b>description</b>	pilot burner SIT type 100 series 3 flames nozzle $\phi$ 20mm gas connectionmm	
<b>spare parts for</b>	107140	
	<b>GEV No.</b> 100855	<b>Ref. No.</b> —
<b>description</b>	pilot burner bracket triple	
	<b>GEV No.</b> 100885	<b>Ref. No.</b> —
<b>description</b>	air mixing sleeve for pilot burner Qty 1 pcs	
	<b>GEV No.</b> 100916	<b>Ref. No.</b> —
<b>description</b>	compression spring for pilot burner Qty 1 pcs	
	<b>GEV No.</b> 107162	<b>Ref. No.</b> —
<b>description</b>	pilot burner cap SIT 3 flames Hmm Lmm Qty 1 pcs	
<b>accessories for</b>	107140	
	<b>GEV No.</b> 100904	<b>Ref. No.</b> —
<b>description</b>	locking screw M10x1 for pipe $\phi$ 4mm Qty 1 pcs	
	<b>GEV No.</b> 100905	<b>Ref. No.</b> 8C0070
<b>description</b>	locking screw M10x1 for pipe $\phi$ 6mm Qty 1 pcs	

accessories

pilot burner nozzles

	<b>GEV No.</b> 100245	<b>Ref. No.</b> 8C0030
<b>description</b>	pilot burner nozzle LPG code 20 bore $\phi$ 0.2mm Qty 1 pcs thread M8x0.75	

	<b>GEV No.</b> 100246	<b>Ref. No.</b> 8C0031
<b>description</b>	pilot burner nozzle natural gas bore $\phi$ 0.35mm Qty 1 pcs thread M8x0.75	



Зип-Общепит

vsezip.ru

+7(812)987-08-81

ignition electrodes

<b>GEV No.</b>	100706	<b>Ref. No.</b>	051H10002 808177
<b>description</b>	ignition electrode connection M4 Qty 1 pcs		

<b>GEV No.</b>	100707	<b>Ref. No.</b>	807741
<b>description</b>	ignition electrode D1 ø 7mm D2 ø 9mm connection ø2.4mm L1 14mm L2 6mm BL1 18mm BL2 3mm BL3 23mm to clip Qty 1 pcs		

140 - 145 -150 series

<b>GEV No.</b>	107133	<b>Ref. No.</b>	808353
<b>description</b>	pilot burner SIT type 140 series 1 flame nozzle ømm gas connecti-onmm		
<b>accessories for</b>	107133		
	<b>GEV No.</b>	<b>Ref. No.</b>	80C955
	100204		
	<b>GEV No.</b>	<b>Ref. No.</b>	809996
	100205		
	<b>GEV No.</b>	<b>Ref. No.</b>	809994
	100206		
	<b>GEV No.</b>	<b>Ref. No.</b>	8C1497
	100207		
	<b>GEV No.</b>	<b>Ref. No.</b>	—
	100216		
	<b>GEV No.</b>	<b>Ref. No.</b>	807905 809475 C00173
	100701		
	<b>description</b>	ignition electrode connection M4 Qty 1 pcs	

	<b>GEV No.</b>	100897	<b>Ref. No.</b>	—
	<b>description</b>	olive for pipe ø4mm Qty 1 pcs for pilot burner		
	<b>GEV No.</b>	100898	<b>Ref. No.</b>	—
	<b>description</b>	olive for pipe ø6mm Qty 1 pcs for pilot burner		
	<b>GEV No.</b>	100906	<b>Ref. No.</b>	—
	<b>description</b>	screw connection thread M10x1 for ignition electrode brass Qty 1 pcs WS 10		
	<b>GEV No.</b>	100907	<b>Ref. No.</b>	—
	<b>description</b>	screw connection thread M10x1 Qty 1 pcs type SEF 1 ømm for thermocouple		
	<b>GEV No.</b>	100908	<b>Ref. No.</b>	806019
	<b>description</b>	union screw thread M10x1 for pipe ø4mm Qty 1 pcs		
	<b>GEV No.</b>	100909	<b>Ref. No.</b>	—
	<b>description</b>	union screw thread M10x1 for pipe ø6mm Qty 1 pcs		
	<b>GEV No.</b>	102110	<b>Ref. No.</b>	—
	<b>description</b>	pilot tube copper pipe ø4mm thickness 1mm L 3000mm		
	<b>GEV No.</b>	102111	<b>Ref. No.</b>	—
	<b>description</b>	pilot tube copper pipe ø6mm thickness 1mm L 3000mm		

<b>GEV No.</b>	107114 <sup>1</sup>	<b>Ref. No.</b>	809474
<b>description</b>	pilot burner SIT type 140 series 2 flames nozzle ømm gas connecti-onmm		
<b>spare parts for</b>	107114		
	<b>GEV No.</b>	<b>Ref. No.</b>	—
	100907		
<b>accessories for</b>	107114		
	<b>GEV No.</b>	<b>Ref. No.</b>	80C955
	100204		
	<b>GEV No.</b>	<b>Ref. No.</b>	809996
	100205		
	<b>GEV No.</b>	<b>Ref. No.</b>	809994
	100206		
	<b>GEV No.</b>	<b>Ref. No.</b>	8C1497
	100207		
	<b>GEV No.</b>	<b>Ref. No.</b>	—
	100216		
	<b>GEV No.</b>	<b>Ref. No.</b>	807905 809475 C00173
	100701		
<b>description</b>	ignition electrode connection M4 Qty 1 pcs		
	<b>GEV No.</b>	<b>Ref. No.</b>	—
	100801		
<b>description</b>	gasket for pilot burner Qty 1 pcs		





<sup>1</sup>incl. thermocouple fitting  
Table continues overleaf

1 gas components

Зип-Общепит







vsezip.ru





+7(812)987-08-81

<b>accessories for</b>	107114		
	GEV No.	100897	Ref. No. —
olive for pipe ø 4mm Qty 1 pcs for pilot burner			
	GEV No.	100898	Ref. No. —
olive for pipe ø 6mm Qty 1 pcs for pilot burner			
	GEV No.	100906	Ref. No. —
screw connection thread M10x1 for ignition electrode brass Qty 1 pcs WS 10			
	GEV No.	100908	Ref. No. 806019
union screw thread M10x1 for pipe ø 4mm Qty 1 pcs			
	GEV No.	100909	Ref. No. —
union screw thread M10x1 for pipe ø 6mm Qty 1 pcs			
	GEV No.	102110	Ref. No. —
pilot tube copper pipe ø 4mm thickness 1mm L 3000mm			
	GEV No.	102111	Ref. No. —
pilot tube copper pipe ø 6mm thickness 1mm L 3000mm			

160 series



<b>GEV No.</b>	100052	<b>Ref. No.</b>	806153
<b>description</b>	pilot burner SIT type 160 series 2 flames nozzle ømm gas connectionmm		
<b>spare parts for</b>	100052		
	GEV No.	100907	Ref. No. —
screw connection thread M10x1 Qty 1 pcs type SEF 1 ømm for thermocouple			
<b>accessories for</b>	100052		
	GEV No.	100202	Ref. No. —
pilot burner nozzle natural gas code 41 Qty 1 pcs nozzle ø 0.41mm			
	GEV No.	100203	Ref. No. —
pilot burner nozzle LPG code 25 Qty 1 pcs nozzle ø 0.25mm			
	GEV No.	100701	Ref. No. 807905 809475 C00173
ignition electrode connection M4 Qty 1 pcs			
	GEV No.	100801	Ref. No. —
gasket for pilot burner Qty 1 pcs			
	GEV No.	100906	Ref. No. —
screw connection thread M10x1 for ignition electrode brass Qty 1 pcs WS 10			
	GEV No.	100908	Ref. No. 806019
union screw thread M10x1 for pipe ø 4mm Qty 1 pcs			
	GEV No.	100909	Ref. No. —
union screw thread M10x1 for pipe ø 6mm Qty 1 pcs			

<b>accessories for</b>	100052		
	GEV No.	101282	Ref. No. —
olive for pipe ø 4mm L 7.4mm Qty 1 pcs			
	GEV No.	101287	Ref. No. —
olive for pipe ø 6mm Qty 1 pcs			
	GEV No.	102110	Ref. No. —
pilot tube copper pipe ø 4mm thickness 1mm L 3000mm			
	GEV No.	102111	Ref. No. —
pilot tube copper pipe ø 6mm thickness 1mm L 3000mm			
	GEV No.	107650	Ref. No. 808365
pilot burner nozzle SIT LPG code 30 Qty 1 pcs			

POLIDORO

pilot burners











<b>1</b>			
<b>GEV No.</b>	100051	<b>Ref. No.</b>	808039 808197
<b>description</b>	pilot burner POLIDORO 3 flames code gas connectionmm		
<b>spare parts for</b>	100051		
	GEV No.	100907	Ref. No. —
screw connection thread M10x1 Qty 1 pcs type SEF 1 ømm for thermocouple			
<b>accessories for</b>	100051		
	GEV No.	100000	Ref. No. —
pilot burner nozzle POLIDORO LPG code 22 bore ø 0.22mm Qty 1 pcs			
	GEV No.	100208	Ref. No. 512120005 512120010 C00170
pilot burner nozzle POLIDORO LPG code 20 bore ø 0.2mm Qty 1 pcs			
	GEV No.	100209	Ref. No. —
pilot burner nozzle POLIDORO natural gas code 40 bore ø 0.4mm Qty 1 pcs			
	GEV No.	100701	Ref. No. 807905 809475 C00173
ignition electrode connection M4 Qty 1 pcs			
	GEV No.	100906	Ref. No. —
screw connection thread M10x1 for ignition electrode brass Qty 1 pcs WS 10			
	GEV No.	100907	Ref. No. —
screw connection thread M10x1 Qty 1 pcs type SEF 1 ømm for thermocouple			
	GEV No.	100908	Ref. No. 806019
union screw thread M10x1 for pipe ø 4mm Qty 1 pcs			
	GEV No.	100909	Ref. No. —
union screw thread M10x1 for pipe ø 6mm Qty 1 pcs			

Table continues overleaf



Зип Общепит

vsezip.ru

+7(812)987-08-81

accessories for		100051	
GEV No.	Ref. No.	GEV No.	Ref. No.
102110	—	102110	—
pilot tube copper pipe ø 4mm thickness 1mm L 3000mm			
102111	—	102111	—
pilot tube copper pipe ø 6mm thickness 1mm L 3000mm			
102508	—	102508	—
union screw thread M10x1 for pipe ø 4mm Qty 5 pcs			
102509	—	102509	—
union screw thread M10x1 for pipe ø 6mm Qty 5 pcs			
102699	—	102699	—
pilot burner nozzle POLIDORO natural gas code 25.2 bore ø 2x0.25mm Qty 1 pcs 2 bores			
102795	—	102795	—
olive for pipe ø 4mm Qty 1 pcs			
102797	—	102797	—
olive for pipe ø 6mm Qty 1 pcs			
106703	512120007	106703	512120007
pilot burner nozzle POLIDORO natural gas code 27.2 bore ø 2x0.27mm Qty 1 pcs			
106704	—	106704	—
pilot burner nozzle POLIDORO LPG code 16.2 bore ø 2x0.16mm Qty 1 pcs			
106763	—	106763	—
pilot burner nozzle POLIDORO natural gas code 27.2A bore ø 2x 0.27mm Qty 1 pcs			
106859	—	106859	—
pilot burner nozzle POLIDORO LPG code 24 bore ø 0.24mm Qty 1 pcs			

<p>1</p>			
GEV No.	Ref. No.	GEV No.	Ref. No.
100162	809195	100162	809195
description pilot burner POLIDORO 3 flames code gas connectionmm			
spare parts for		100162	
100907	—	100907	—
screw connection thread M10x1 Qty 1 pcs type SEF 1 ømm for thermocouple			
accessories for		100162	
100000	—	100000	—
pilot burner nozzle POLIDORO LPG code 22 bore ø 0.22mm Qty 1 pcs			
100208	512120005 512120010 C00170	100208	512120005 512120010 C00170
pilot burner nozzle POLIDORO LPG code 20 bore ø 0.2mm Qty 1 pcs			
100209	—	100209	—
pilot burner nozzle POLIDORO natural gas code 40 bore ø 0.4mm Qty 1 pcs			
100701	807905 809475 C00173	100701	807905 809475 C00173
ignition electrode connection M4 Qty 1 pcs			



















accessories for		100162	
GEV No.	Ref. No.	GEV No.	Ref. No.
100906	—	100906	—
screw connection thread M10x1 for ignition electrode brass Qty 1 pcs V/S 10			
100907	—	100907	—
screw connection thread M10x1 Qty 1 pcs type SEF 1 ømm for thermocouple			
100908	806019	100908	806019
union screw thread M10x1 for pipe ø 4mm Qty 1 pcs			
100909	—	100909	—
union screw thread M10x1 for pipe ø 6mm Qty 1 pcs			
102110	—	102110	—
pilot tube copper pipe ø 4mm thickness 1mm L 3000mm			
102111	—	102111	—
pilot tube copper pipe ø 6mm thickness 1mm L 3000mm			
102508	—	102508	—
union screw thread M10x1 for pipe ø 4mm Qty 5 pcs			
102509	—	102509	—
union screw thread M10x1 for pipe ø 6mm Qty 5 pcs			
102699	—	102699	—
pilot burner nozzle POLIDORO natural gas code 25.2 bore ø 2x0.25mm Qty 1 pcs 2 bores			
102795	—	102795	—
olive for pipe ø 4mm Qty 1 pcs			
102797	—	102797	—
olive for pipe ø 6mm Qty 1 pcs			
106703	512120007	106703	512120007
pilot burner nozzle POLIDORO natural gas code 27.2 bore ø 2x0.27mm Qty 1 pcs			
106704	—	106704	—
pilot burner nozzle POLIDORO LPG code 16.2 bore ø 2x0.16mm Qty 1 pcs			
106763	—	106763	—
pilot burner nozzle POLIDORO natural gas code 27.2A bore ø 2x 0.27mm Qty 1 pcs			
106859	—	106859	—
pilot burner nozzle POLIDORO LPG code 24 bore ø 0.24mm Qty 1 pcs			

<p>1</p>			
GEV No.	Ref. No.	GEV No.	Ref. No.
100076	806154 807835	100076	806154 807835
description pilot burner POLIDORO 3 flames natural gas code 29.2 gas connection 6mm			
spare parts for		100076	
100907	—	100907	—
screw connection thread M10x1 Qty 1 pcs type SEF 1 ømm for thermocouple			

Table continues overleaf

1 gas components







accessories for		100076	
	GEV No.	100000	Ref. No. —
	pilot burner nozzle POLIDORO LPG code 22 bore $\varnothing$ 0.22mm Qty 1 pcs		
	GEV No.	100208	Ref. No. 512120005 512120010 C00170
	pilot burner nozzle POLIDORO LPG code 20 bore $\varnothing$ 0.2mm Qty 1 pcs		
	GEV No.	100209	Ref. No. —
	pilot burner nozzle POLIDORO natural gas code 40 bore $\varnothing$ 0.4mm Qty 1 pcs		
	GEV No.	100701	Ref. No. 807905 809475 C00173
	ignition electrode connection M4 Qty 1 pcs		
	GEV No.	100906	Ref. No. —
	screw connection thread M10x1 for ignition electrode brass Qty 1 pcs WS 10		
	GEV No.	100907	Ref. No. —
	screw connection thread M10x1 Qty 1 pcs type SEF 1 $\varnothing$ mm for thermocouple		
	GEV No.	100908	Ref. No. 806019
	union screw thread M10x1 for pipe $\varnothing$ 4mm Qty 1 pcs		
	GEV No.	100909	Ref. No. —
	union screw thread M10x1 for pipe $\varnothing$ 6mm Qty 1 pcs		
	GEV No.	102110	Ref. No. —
	pilot tube copper pipe $\varnothing$ 4mm thickness 1mm L 3000mm		
	GEV No.	102111	Ref. No. —
	pilot tube copper pipe $\varnothing$ 6mm thickness 1mm L 3000mm		
	GEV No.	102508	Ref. No. —
	union screw thread M10x1 for pipe $\varnothing$ 4mm Qty 5 pcs		
	GEV No.	102509	Ref. No. —
	union screw thread M10x1 for pipe $\varnothing$ 6mm Qty 5 pcs		
	GEV No.	102699	Ref. No. —
	pilot burner nozzle POLIDORO natural gas code 25.2 bore $\varnothing$ 2x0.25mm Qty 1 pcs 2 bores		
	GEV No.	102795	Ref. No. —
	olive for pipe $\varnothing$ 4mm Qty 1 pcs		
	GEV No.	102797	Ref. No. —
	olive for pipe $\varnothing$ 6mm Qty 1 pcs		
	GEV No.	106703	Ref. No. 512120007
	pilot burner nozzle POLIDORO natural gas code 27.2 bore $\varnothing$ 2x0.27mm Qty 1 pcs		
	GEV No.	106704	Ref. No. —
	pilot burner nozzle POLIDORO LPG code 16.2 bore $\varnothing$ 2x0.16mm Qty 1 pcs		
	GEV No.	106763	Ref. No. —
	pilot burner nozzle POLIDORO natural gas code 27.2A bore $\varnothing$ 2x 0.27mm Qty 1 pcs		
	GEV No.	106859	Ref. No. —
	pilot burner nozzle POLIDORO LPG code 24 bore $\varnothing$ 0.24mm Qty 1 pcs		

Зип Общепит

vsezip.ru

+7(812)987-08-81

accessories for		106580	
	GEV No.	106580	Ref. No. C10515
	description pilot burner POLIDORO 3 flames natural gas nozzle 27.2 code 27.2 gas connection 6mm		
spare parts for		106680	
	GEV No.	106703	Ref. No. 512120007
	pilot burner nozzle POLIDORO natural gas code 27.2 bore $\varnothing$ 2x0.27mm Qty 1 pcs		
accessories for		106680	
	GEV No.	100701	Ref. No. 807905 809475 C00173
	ignition electrode connection M4 Qty 1 pcs		
	GEV No.	100908	Ref. No. 806019
	union screw thread M10x1 for pipe $\varnothing$ 4mm Qty 1 pcs		
	GEV No.	100909	Ref. No. —
	union screw thread M10x1 for pipe $\varnothing$ 6mm Qty 1 pcs		









accessories for		100148	
	GEV No.	100148	Ref. No. 808524
	description pilot burner POLIDORO type A 3 flames LPG code 20 gas connectionmm		
accessories for		100148	
	GEV No.	100000	Ref. No. —
	pilot burner nozzle POLIDORO LPG code 22 bore $\varnothing$ 0.22mm Qty 1 pcs		
	GEV No.	100208	Ref. No. 512120005 512120010 C00170
	pilot burner nozzle POLIDORO LPG code 20 bore $\varnothing$ 0.2mm Qty 1 pcs		
	GEV No.	100209	Ref. No. —
	pilot burner nozzle POLIDORO natural gas code 40 bore $\varnothing$ 0.4mm Qty 1 pcs		
	GEV No.	100701	Ref. No. 807905 809475 C00173
	ignition electrode connection M4 Qty 1 pcs		
	GEV No.	100906	Ref. No. —
	screw connection thread M10x1 for ignition electrode brass Qty 1 pcs WS 10		
	GEV No.	100907	Ref. No. —
	screw connection thread M10x1 Qty 1 pcs type SEF 1 $\varnothing$ mm for thermocouple		
	GEV No.	100908	Ref. No. 806019
	union screw thread M10x1 for pipe $\varnothing$ 4mm Qty 1 pcs		
	GEV No.	100909	Ref. No. —
	union screw thread M10x1 for pipe $\varnothing$ 6mm Qty 1 pcs		

Table continues overleaf



Зип Общепит

vsezip.ru

+7(812)987-08-81

<b>accessories for</b>	100148		
	GEV No.	102110	Ref. No. —
	pilot tube copper pipe $\varnothing$ 4mm thickness 1mm L 3000mm		
	GEV No.	102111	Ref. No. —
	pilot tube copper pipe $\varnothing$ 6mm thickness 1mm L 3000mm		
	GEV No.	102699	Ref. No. —
	pilot burner nozzle POLIDORO natural gas code 25.2 bore $\varnothing$ 2x0.25mm Qty 1 pcs 2 bores		
	GEV No.	102795	Ref. No. —
	olive for pipe $\varnothing$ 4mm Qty 1 pcs		
	GEV No.	102797	Ref. No. —
	olive for pipe $\varnothing$ 6mm Qty 1 pcs		
	GEV No.	106703	Ref. No. 512120007
	pilot burner nozzle POLIDORO natural gas code 27.2 bore $\varnothing$ 2x0.27mm Qty 1 pcs		
	GEV No.	106704	Ref. No. —
	pilot burner nozzle POLIDORO LPG code 16.2 bore $\varnothing$ 2x0.16mm Qty 1 pcs		
	GEV No.	106763	Ref. No. —
	pilot burner nozzle POLIDORO natural gas code 27.2A bore $\varnothing$ 2x 0.27mm Qty 1 pcs		
	GEV No.	106859	Ref. No. —
	pilot burner nozzle POLIDORO LPG code 24 bore $\varnothing$ 0.24mm Qty 1 pcs		



<b>GEV No.</b>	100706	<b>Ref. No.</b>	051H10002 808177
<b>description</b>	ignition electrode connection M4 Qty 1 pcs		



<b>GEV No.</b>	100753	<b>Ref. No.</b>	C10085
<b>description</b>	ignition electrode D1 $\varnothing$ 6mm cable length 600mm connection F 2.8x0.8mm D2 $\varnothing$ 10mm L1 15mm BL1 15mm BL2 2mm BL3 22mm to clip		



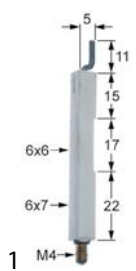

<b>GEV No.</b>	100754	<b>Ref. No.</b>	C10161
<b>description</b>	ignition electrode D1 $\varnothing$ 6mm cable length 750mm connection F 2.8x0.8mm D2 $\varnothing$ 10mm L1 4.5mm BL1 14mm BL2 2mm BL3 22mm		

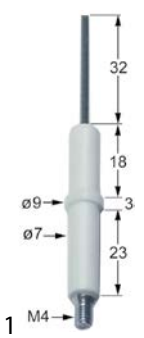

<b>GEV No.</b>	100708	<b>Ref. No.</b>	C00172
<b>description</b>	ignition electrode D1 $\varnothing$ 6x7mm connection M4 D2 $\varnothing$ 6x6mm L1 11mm L2 5mm BL1 15mm BL2 16mm BL3 23mm		

electrodes



<b>GEV No.</b>	100701	<b>Ref. No.</b>	807905 809475 C00173
<b>description</b>	ignition electrode connection M4 Qty 1 pcs		
<b>accessories for</b>	100701		
	GEV No.	100906	Ref. No. —
	screw connection thread M10x1 for ignition electrode brass Qty 1 pcs WS 10		

1 gas components



Зип Общепит

vsezip.ru

+7(812)987-08-81



<b>GEV No.</b>	100707	<b>Ref. No.</b>	807741
<b>description</b>	ignition electrode D1 ø 7mm D2 ø 9mm connection ø2.4mm L1 14mm L2 6mm BL1 18mm BL2 3mm BL3 23mm to clip Qty 1 pcs		



<b>GEV No.</b>	100756	<b>Ref. No.</b>	808593
<b>description</b>	ignition electrode flange length 24mm flange width 17mm fixing dimensions ø 4.5mm with flange		

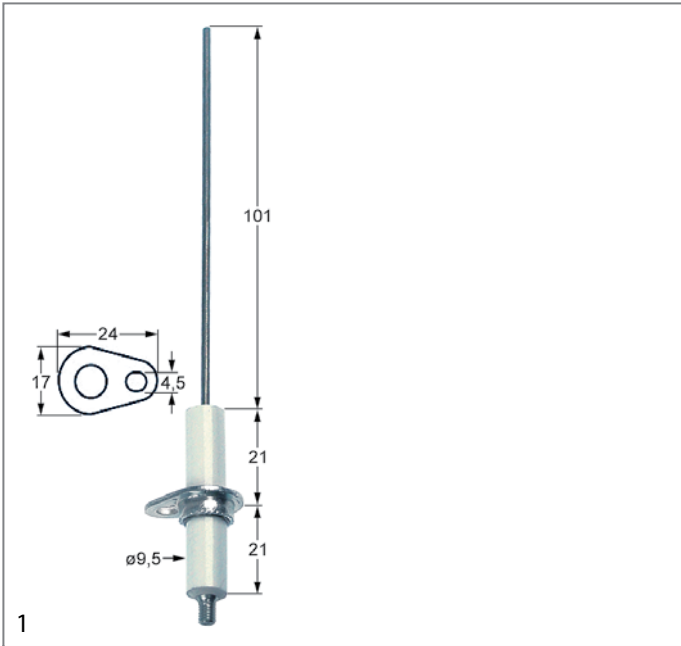

<b>GEV No.</b>	102323	<b>Ref. No.</b>	808592
<b>description</b>	ignition electrode flange length 24mm flange width 17mm D1 ø 9.5mm L1 101mm BL2 21mm BL3 21mm connection M4 fixing dimensions ø4.5mm with flange		



<b>GEV No.</b>	100755	<b>Ref. No.</b>	808592
<b>description</b>	ignition electrode flange length 38mm flange width 17mm connection M4 fixing dimensions ø4.5mm mounting distance 28mm with flange with earthing contact connection ø 4mm		

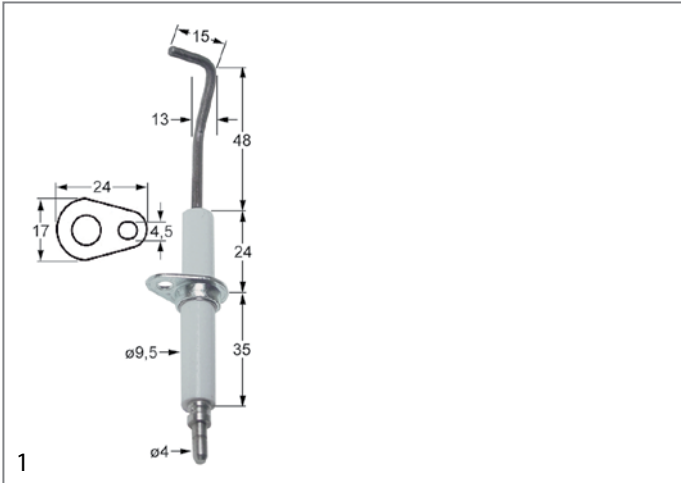

<b>GEV No.</b>	102342	<b>Ref. No.</b>	809281
<b>description</b>	ignition electrode flange length 24mm flange width 17mm D1 ø 9.5mm L1 48mm L2 13mm L3 15mm BL1 24mm BL2 35mm fixing dimensions ø4.5mm with flange connection ø 4mm		

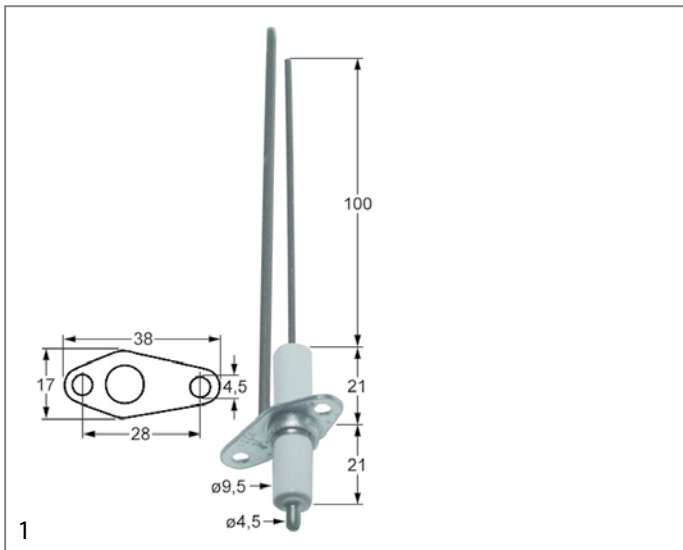

<b>GEV No.</b>	102322	<b>Ref. No.</b>	808592
<b>description</b>	ignition electrode flange length 38mm flange width 17mm D1 ø 9.5mm L1 100mm BL1 21mm BL2 21mm connection M4 fixing dimensions ø4.5mm mounting distance 28mm with flange with earthing contact		



## ignition cables

3 in 1 Общепит  
piezoelectric igniters

## pre-assembled cables



1	<b>GEV No.</b>	100026	<b>Ref. No.</b>	809430
<b>description</b> ignition cable cable length 1000mm connection ø4mm / F6.3mm				



1	<b>GEV No.</b>	100164	<b>Ref. No.</b>	C10259
<b>description</b> ignition cable cable length 1200mm connection ø4mm / F2.8mm				



1	<b>GEV No.</b>	102163	<b>Ref. No.</b>	808276
<b>description</b> ignition cable cable length 1500mm connection F2.8mm / ø2.4mm				



1	<b>GEV No.</b>	100147	<b>Ref. No.</b>	809468
<b>description</b> ignition cable cable length 1500mm connection ø2.4mm / ø4mm				



1	<b>GEV No.</b>	100014	<b>Ref. No.</b>	C00808
<b>description</b> ignition cable cable length 300mm connection ø2.4mm / ø2.4mm				



1	<b>GEV No.</b>	100197	<b>Ref. No.</b>	051E10008
<b>description</b> ignition cable cable length 600mm connection F2.8mm / ø2.4mm				



1	<b>GEV No.</b>	100018	<b>Ref. No.</b>	808230 C00171
<b>description</b> ignition cable cable length 600mm connection ø2.4mm / ø4mm permanent temperature 200°C				



1	<b>GEV No.</b>	100025	<b>Ref. No.</b>	809439
<b>description</b> ignition cable cable length 600mm connection ø4mm / F6.3mm				



1	<b>GEV No.</b>	100019	<b>Ref. No.</b>	809389
<b>description</b> ignition cable cable length 900mm connection ø2.4mm / ø4mm				

## mounting diameter 18mm



1	<b>GEV No.</b>	100009	<b>Ref. No.</b>	809476
<b>description</b> piezoelectric igniter body plastic blowing mounting ø 18mm connection ø2.4mm front measurements 26mm M18x1.5				

## accessories for 100009

	<b>GEV No.</b>	101339	<b>Ref. No.</b>	—
cover cap for piezoelectric igniter				
	<b>GEV No.</b>	106869	<b>Ref. No.</b>	—
cover cap for piezoelectric igniter ID ø 22mm ED ø 35mm H 25mm				
	<b>GEV No.</b>	107931	<b>Ref. No.</b>	—
cover cap for piezoelectric igniter ID ø 21mm ED ø 36mm				

## mounting diameter 22mm



1	<b>GEV No.</b>	100005	<b>Ref. No.</b>	C00069
<b>description</b> piezoelectric igniter body plastic blowing mounting ø 22mm connection ø2.4mm cable length 1mm SIT				

## miscellaneous



1	<b>GEV No.</b>	nla <sup>1</sup>	<b>Ref. No.</b>	806090
<b>description</b> piezoelectric igniter body metal connection F6.3x0.8 2 hole fixing ø 22mm				

<sup>1</sup>no longer available

1	<b>GEV No.</b>	nla <sup>1</sup>	<b>Ref. No.</b>	807697
<b>description</b> piezoelectric igniter suitable for Minisit with cover cap ømm connection F6.3x0.8				

## spare parts for 101136

	<b>GEV No.</b>	100001	<b>Ref. No.</b>	—
piezoelectric igniter suitable for Minisit connection F6.3x0.8 ømm				

<sup>1</sup>no longer available



ignition units



1	<b>GEV No.</b> 101030	<b>Ref. No.</b> C10167
<b>description</b>	ignition unit outputs 2 1.5 V/DC	



1	<b>GEV No.</b> 101002	<b>Ref. No.</b> C00507
<b>description</b>	ignition unit outputs 2 230VAC dimensions 88x23x34mm mounting distance 73mm inlet F6.3x0.8 outlet F2.8x0.8 0.6VA 50/60Hz	



1	<b>GEV No.</b> 101031	<b>Ref. No.</b> C10168
<b>description</b>	ignition unit outputs 4 1.5 V/DC dimensions 111x23x34mm mounting distance 100mm inlet F6.3x0.8 outlet F2.8x0.8 mounting ø 100mm	



1	<b>GEV No.</b> 101032	<b>Ref. No.</b> C10169
<b>description</b>	ignition unit outputs 6 1.5 V/DC dimensions 135x23x34mm mounting distance 123mm inlet F6.3x0.8 outlet F2.8x0.8 mounting ø 122mm	

ignition switches



1	<b>GEV No.</b> 100160	<b>Ref. No.</b> C10250
<b>description</b>	momentary push switch mounting measurements 28.5x28.5mm red 1NO 250V 12A ignition connection male faston 6.3mm ambient temperature max. 85°C protection IP40 mounting ømm	



1	<b>GEV No.</b> 101036	<b>Ref. No.</b> C10166
<b>description</b>	battery holder for battery type AA 1.5V mounting ø 22mm connection male faston 2.8mm/6.3mm	

thermocouples

plug-in thermocouples

plug-in thermocouples standard

with barrel socket ø6(6.5)mm

thermocouples SIT

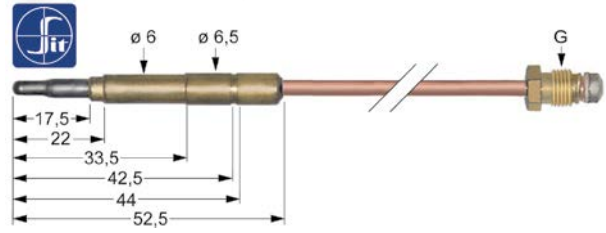

<b>GEV No.</b> 107621	<b>Ref. No.</b> 808521
<b>description</b>	thermocouple SIT M10x1 L 1500mm plug connection ø6.0(6.5)mm

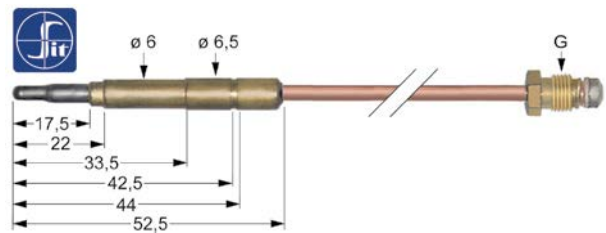

<b>GEV No.</b> 107612	<b>Ref. No.</b> 806185
<b>description</b>	thermocouple SIT M9x1 L 1000mm plug connection ø6.0(6.5)mm

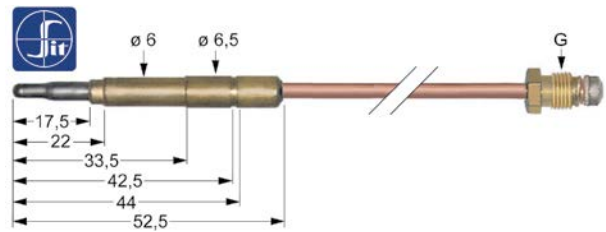

<b>GEV No.</b> 107613	<b>Ref. No.</b> 8C0639
<b>description</b>	thermocouple SIT M9x1 L 1200mm plug connection ø6.0(6.5)mm

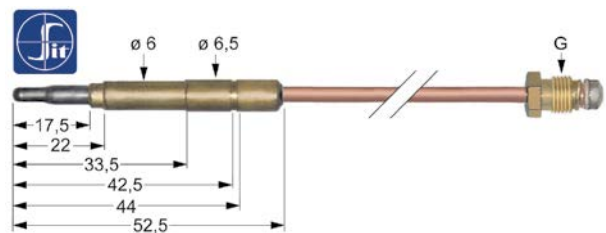

<b>GEV No.</b> 107614	<b>Ref. No.</b> 814980 C10201
<b>description</b>	thermocouple SIT M9x1 L 1500mm plug connection ø6.0(6.5)mm



Зип Общепит

plug thermocouples with interruption

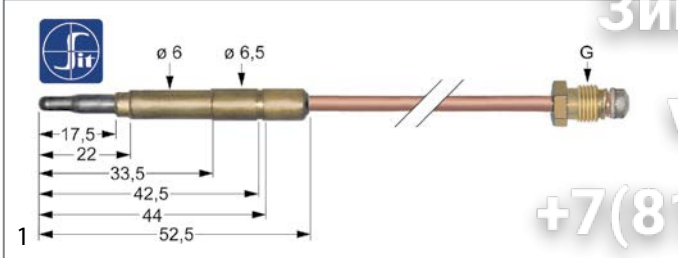

<b>GEV No.</b>	107606	<b>Ref. No.</b>	C00072
<b>description</b>	thermocouple SIT M9x1 L 320mm plug connection $\varnothing 6.0(6.5)$ mm		

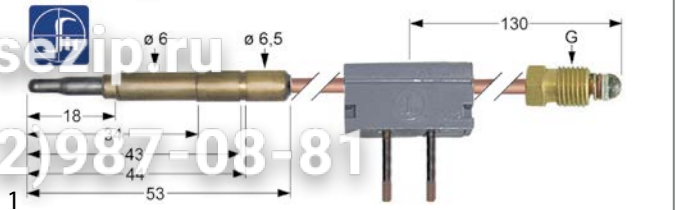

<b>GEV No.</b>	107164	<b>Ref. No.</b>	513120001
<b>description</b>	thermocouple SIT with interrupter M9x1 L 1000mm plug connection $\varnothing 6.0(6.5)$ mm soldering connection		

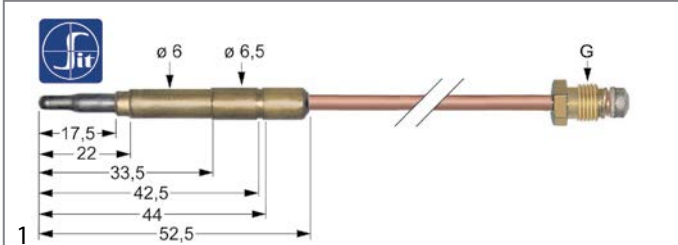

<b>GEV No.</b>	107609	<b>Ref. No.</b>	806271
<b>description</b>	thermocouple SIT M9x1 L 600mm plug connection $\varnothing 6.0(6.5)$ mm		

threaded thermocouples

threaded thermocouples with cable link

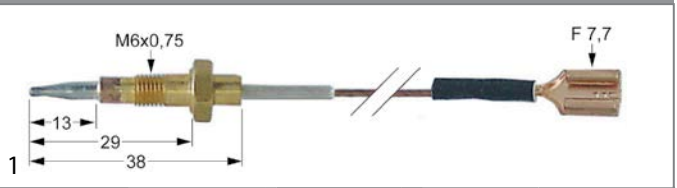

<b>GEV No.</b>	102145	<b>Ref. No.</b>	C10067	
<b>description</b>	thermocouple L 600mm connection F 7.7mm M6x0.75			
<b>accessories for</b>	102145			
	<b>GEV No.</b>	102680	<b>Ref. No.</b>	—
	nut thread M6x0.75 H 2.6mm WS 8 brass Qty 1 pcs type SEF 2			

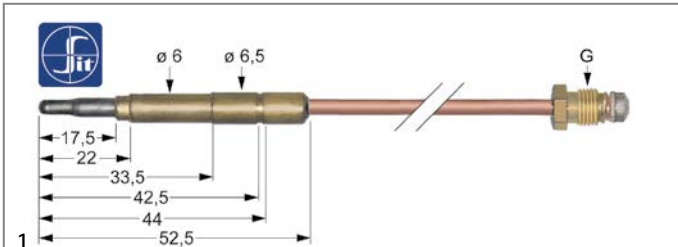

<b>GEV No.</b>	107611	<b>Ref. No.</b>	C00377
<b>description</b>	thermocouple SIT M9x1 L 850mm plug connection $\varnothing 6.0(6.5)$ mm		

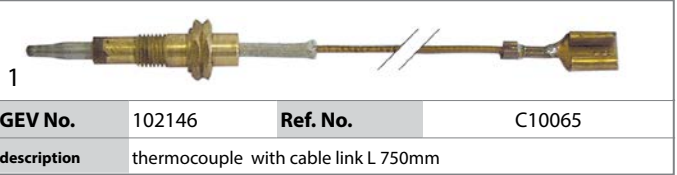

<b>GEV No.</b>	102146	<b>Ref. No.</b>	C10065
<b>description</b>	thermocouple with cable link L 750mm		

thermocouples with aluminised tip

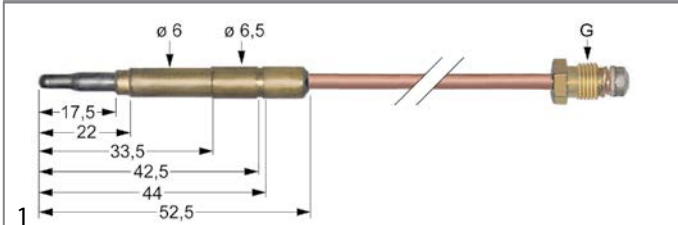

<b>GEV No.</b>	102034	<b>Ref. No.</b>	808151
<b>description</b>	thermocouple M8x1 L 600mm plug connection $\varnothing 6.0(6.5)$ mm		



<b>GEV No.</b>	102147	<b>Ref. No.</b>	C10065 C10334
<b>description</b>	thermocouple L 750mm M6x0.75 F 7.7mm F 4.8x0.8mm		

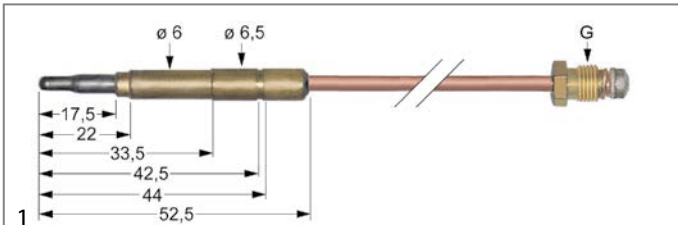

<b>GEV No.</b>	102041	<b>Ref. No.</b>	806183
<b>description</b>	thermocouple M9x1 L 600mm plug connection $\varnothing 6.0(6.5)$ mm		



<b>GEV No.</b>	102148	<b>Ref. No.</b>	C10333	
<b>description</b>	thermocouple with two-conductors L 600mm M6x0.75 F 7.7mm F 4.8x0.8mm			
<b>accessories for</b>	102148			
	<b>GEV No.</b>	102680	<b>Ref. No.</b>	—
	nut thread M6x0.75 H 2.6mm WS 8 brass Qty 1 pcs type SEF 2			



Зип Общепит

vsezip.ru



+7(812)987-08-81

accessories

interrupters

	1		
<b>GEV No.</b>	101264	<b>Ref. No.</b>	8C1701
<b>description</b>	interrupter thread M8x1		

	1		
<b>GEV No.</b>	101265	<b>Ref. No.</b>	807842
<b>description</b>	interrupter thread M9x1		

	1			
<b>GEV No.</b>	105120	<b>Ref. no.</b>	C10046	
<b>description</b>	burner lower part 3kW for igniter ø 7mm for thermocouple ø 6mm with nozzle ø1.15mm for burner cap ø 100mm			
<b>accessories for</b>	105120			
	<b>GEV No.</b>	105121	<b>Ref. No.</b>	C10045
	burner head 3kW for igniter ø 7.5mm for burner cap ø 100mm			
	<b>GEV No.</b>	105122	<b>Ref. No.</b>	C10196
	burner cap 3kW ø 100mm H 6mm matt finish			



gas burners



hob burners

universal hob burners



SABAF

2 series - standard





	1			
<b>GEV No.</b>	105122	<b>Ref. No.</b>	C10196	
<b>description</b>	burner cap 3kW ø 100mm H 6mm matt finish			
<b>accessories for</b>	105122			
	<b>GEV No.</b>	105120	<b>Ref. No.</b>	C10046
	burner lower part 3kW for igniter ø 7mm for thermocouple ø 6mm with nozzle ø1.15mm for burner cap ø 100mm			
	<b>GEV No.</b>	105121	<b>Ref. No.</b>	C10045
	burner head 3kW for igniter ø 7.5mm for burner cap ø 100mm			

	1			
<b>GEV No.</b>	105121	<b>Ref. No.</b>	C10045	
<b>description</b>	burner head 3kW for igniter ø 7.5mm for burner cap ø 100mm			
<b>accessories for</b>	105121			
	<b>GEV No.</b>	105120	<b>Ref. No.</b>	C10046
	burner lower part 3kW for igniter ø 7mm for thermocouple ø 6mm with nozzle ø1.15mm for burner cap ø 100mm			
	<b>GEV No.</b>	105122	<b>Ref. No.</b>	C10196
	burner cap 3kW ø 100mm H 6mm matt finish			

2 series - flat skirt version

	1			
<b>GEV No.</b>	105120	<b>Ref. No.</b>	C10046	
<b>description</b>	burner lower part 3kW for igniter ø 7mm for thermocouple ø 6mm with nozzle ø1.15mm for burner cap ø 100mm			
<b>accessories for</b>	105120			
	<b>GEV No.</b>	105121	<b>Ref. No.</b>	C10045
	burner head 3kW for igniter ø 7.5mm for burner cap ø 100mm			
	<b>GEV No.</b>	105122	<b>Ref. No.</b>	C10196
	burner cap 3kW ø 100mm H 6mm matt finish			

triple ring burner series - standard version

	1			
<b>GEV No.</b>	105125	<b>Ref. No.</b>	C10197	
<b>description</b>	burner cap 3.6kW ø 131mm H 7mm mounting pos. outer			
<b>accessories for</b>	105125			
	<b>GEV No.</b>	105123	<b>Ref. No.</b>	C10049
	burner lower part 3.6kW for igniter ø 7mm for thermocouple ø 6mm with nozzle ø1.35mm ID ø 75mm for burner cap ø 61/131mm			
	<b>GEV No.</b>	105124	<b>Ref. No.</b>	C10048
	burner head 3.6kW for burner cap ø 61/131mm			
	<b>GEV No.</b>	105126	<b>Ref. No.</b>	C10198
	burner cap 3.6kW ø 61mm H 9mm mounting pos. inner matt finish			











Зип-Общепит





the following burner series flat skirt version





vsezip.ru





+7(812)987-08-81

			
<b>GEV No.</b>	105126	<b>Ref. No.</b>	C10198
<b>description</b>	burner cap 3.6kW ø 61mm H 9mm mounting pos. inner matt finish		
<b>accessories for</b>	105126		
	<b>GEV No.</b>	105123	<b>Ref. No.</b> C10049
	<b>GEV No.</b>	105124	<b>Ref. No.</b> C10048
	<b>GEV No.</b>	105125	<b>Ref. No.</b> C10197
<b>description</b>	burner cap 3.6kW ø 131mm H 7mm mounting pos. outer		

			
<b>GEV No.</b>	105125	<b>Ref. No.</b>	C10197
<b>description</b>	burner cap 3.6kW ø 131mm H 7mm mounting pos. outer		
<b>accessories for</b>	105125		
	<b>GEV No.</b>	105123	<b>Ref. No.</b> C10049
	<b>GEV No.</b>	105124	<b>Ref. No.</b> C10048
	<b>GEV No.</b>	105126	<b>Ref. No.</b> C10198
<b>description</b>	burner cap 3.6kW ø 61mm H 9mm mounting pos. inner matt finish		

			
<b>GEV No.</b>	105124	<b>Ref. No.</b>	C10048
<b>description</b>	burner head 3.6kW for burner cap ø 61/131mm		
<b>accessories for</b>	105124		
	<b>GEV No.</b>	105123	<b>Ref. No.</b> C10049
	<b>GEV No.</b>	105125	<b>Ref. No.</b> C10197
	<b>GEV No.</b>	105126	<b>Ref. No.</b> C10198
<b>description</b>	burner cap 3.6kW ø 61mm H 9mm mounting pos. inner matt finish		

			
<b>GEV No.</b>	105126	<b>Ref. No.</b>	C10198
<b>description</b>	burner cap 3.6kW ø 61mm H 9mm mounting pos. inner matt finish		
<b>accessories for</b>	105126		
	<b>GEV No.</b>	105123	<b>Ref. No.</b> C10049
	<b>GEV No.</b>	105124	<b>Ref. No.</b> C10048
	<b>GEV No.</b>	105125	<b>Ref. No.</b> C10197
<b>description</b>	burner cap 3.6kW ø 131mm H 7mm mounting pos. outer		

			
<b>GEV No.</b>	105123	<b>Ref. No.</b>	C10049
<b>description</b>	burner lower part 3.6kW for igniter ø 7mm for thermocouple ø 6mm with nozzle ø1.35mm ID ø 75mm for burner cap ø 61/131mm		
<b>accessories for</b>	105123		
	<b>GEV No.</b>	105124	<b>Ref. No.</b> C10048
	<b>GEV No.</b>	105125	<b>Ref. No.</b> C10197
	<b>GEV No.</b>	105126	<b>Ref. No.</b> C10198
<b>description</b>	burner cap 3.6kW ø 61mm H 9mm mounting pos. inner matt finish		

			
<b>GEV No.</b>	105123	<b>Ref. No.</b>	C10049
<b>description</b>	burner lower part 3.6kW for igniter ø 7mm for thermocouple ø 6mm with nozzle ø1.35mm ID ø 75mm for burner cap ø 61/131mm		
<b>accessories for</b>	105123		
	<b>GEV No.</b>	105124	<b>Ref. No.</b> C10048
	<b>GEV No.</b>	105125	<b>Ref. No.</b> C10197
	<b>GEV No.</b>	105126	<b>Ref. No.</b> C10198
<b>description</b>	burner cap 3.6kW ø 61mm H 9mm mounting pos. inner matt finish		

1 gas components





## producer-specific hob burners

EMMEPI

Snack series



1

<b>GEV No.</b>	105125	<b>Ref. No.</b>	C10197
<b>description</b>	burner cap 3.6kW ø 131mm H 7mm mounting pos. outer		
<b>accessories for</b>	105125		
	<b>GEV No.</b>	105123	<b>Ref. No.</b> C10049
	<b>GEV No.</b>	105124	<b>Ref. No.</b> C10048
	<b>GEV No.</b>	105126	<b>Ref. No.</b> C10198



1

<b>GEV No.</b>	105126	<b>Ref. No.</b>	C10198
<b>description</b>	burner cap 3.6kW ø 61mm H 9mm mounting pos. inner matt finish		
<b>accessories for</b>	105126		
	<b>GEV No.</b>	105123	<b>Ref. No.</b> C10049
	<b>GEV No.</b>	105124	<b>Ref. No.</b> C10048
	<b>GEV No.</b>	105125	<b>Ref. No.</b> C10197



1

<b>GEV No.</b>	105122	<b>Ref. No.</b>	C10196
<b>description</b>	burner cap 3kW ø 100mm H 6mm matt finish		
<b>accessories for</b>	105122		
	<b>GEV No.</b>	105120	<b>Ref. No.</b> C10046
	<b>GEV No.</b>	105121	<b>Ref. No.</b> C10045



1

<b>GEV No.</b>	105124	<b>Ref. No.</b>	C10048
<b>description</b>	burner head 3.6kW for burner cap ø 61/131mm		
<b>accessories for</b>	105124		
	<b>GEV No.</b>	105123	<b>Ref. No.</b> C10049

accessories for 105124

	<b>GEV No.</b>	105125	<b>Ref. No.</b>	C10197
	<b>GEV No.</b>	105126	<b>Ref. No.</b>	C10198



1

<b>GEV No.</b>	105121	<b>Ref. No.</b>	C10045
<b>description</b>	burner head 3kW for igniter ø 7.5mm for burner cap ø 100mm		
<b>accessories for</b>	105121		
	<b>GEV No.</b>	105120	<b>Ref. No.</b> C10046
	<b>GEV No.</b>	105122	<b>Ref. No.</b> C10196



1

<b>GEV No.</b>	105123	<b>Ref. No.</b>	C10049
<b>description</b>	burner lower part 3.6kW for igniter ø 7mm for thermocouple ø 6mm with nozzle ø 1.35mm ID ø 75mm for burner cap ø 61/131mm		
<b>accessories for</b>	105123		
	<b>GEV No.</b>	105124	<b>Ref. No.</b> C10048
	<b>GEV No.</b>	105125	<b>Ref. No.</b> C10197
	<b>GEV No.</b>	105126	<b>Ref. No.</b> C10198



1

<b>GEV No.</b>	105120	<b>Ref. No.</b>	C10046
<b>description</b>	burner lower part 3kW for igniter ø 7mm for thermocouple ø 6mm with nozzle ø 1.15mm for burner cap ø 100mm		
<b>accessories for</b>	105120		
	<b>GEV No.</b>	105121	<b>Ref. No.</b> C10045
	<b>GEV No.</b>	105122	<b>Ref. No.</b> C10196



Зип Общепит  
vsezip.ru

+7(812)987-08-81



700 Daga series



1



<b>GEV No.</b>	105137	<b>Ref. No.</b>	C10285
<b>description</b>	burner cap ø 100mm 5kW		
<b>accessories for</b>	105137		
	<b>GEV No.</b>	105136	<b>Ref. No.</b> C89437
	burner head for burner cap ø 100mm 5kW		
	<b>GEV No.</b>	105138	<b>Ref. No.</b> C10274
	burner holder for burner cap ø 100mm 5kW		



<b>GEV No.</b>	105139	<b>Ref. No.</b>	C89438
<b>description</b>	burner head for burner cap ø 70mm 3kW		
<b>accessories for</b>	105139		
	<b>GEV No.</b>	105140	<b>Ref. No.</b> C10284
	burner cap ø 70mm 3kW		
	<b>GEV No.</b>	105141	<b>Ref. No.</b> C10273
	burner holder for burner cap ø 70mm 3kW		





1

<b>GEV No.</b>	105140	<b>Ref. No.</b>	C10284
<b>description</b>	burner cap ø 70mm 3kW		
<b>accessories for</b>	105140		
	<b>GEV No.</b>	105139	<b>Ref. No.</b> C89438
	burner head for burner cap ø 70mm 3kW		
	<b>GEV No.</b>	105140	<b>Ref. No.</b> C10284
	burner cap ø 70mm 3kW		



1

<b>GEV No.</b>	105138	<b>Ref. No.</b>	C10274
<b>description</b>	burner holder for burner cap ø 100mm 5kW		
<b>accessories for</b>	105138		
	<b>GEV No.</b>	105136	<b>Ref. No.</b> C89437
	burner head for burner cap ø 100mm 5kW		
	<b>GEV No.</b>	105137	<b>Ref. No.</b> C10285
	burner cap ø 100mm 5kW		





1

<b>GEV No.</b>	105136	<b>Ref. No.</b>	C89437
<b>description</b>	burner head for burner cap ø 100mm 5kW		
<b>accessories for</b>	105136		
	<b>GEV No.</b>	105137	<b>Ref. No.</b> C10285
	burner cap ø 100mm 5kW		
	<b>GEV No.</b>	105138	<b>Ref. No.</b> C10274
	burner holder for burner cap ø 100mm 5kW		



1

<b>GEV No.</b>	105141	<b>Ref. No.</b>	C10273
<b>description</b>	burner holder for burner cap ø 70mm 3kW		
<b>accessories for</b>	105141		
	<b>GEV No.</b>	105139	<b>Ref. No.</b> C89438
	burner head for burner cap ø 70mm 3kW		
	<b>GEV No.</b>	105140	<b>Ref. No.</b> C10284
	burner cap ø 70mm 3kW		

700 Professional, 900 Classica series



1

<b>GEV No.</b>	107539	<b>Ref. No.</b>	C00108
<b>description</b>	air mixing tube L 58mm D1 ø 16mm D2 ø 19mm ID ø 14mm aluminium		



Зип Общепит



vsezip.ru



+7(812)987-08-81

			
<b>1</b>			
<b>GEV No.</b>	107540	<b>Ref. No.</b>	C00109
<b>description</b>	air mixing tube L 58mm D1 ø 20mm D2 ø 24.5mm ID ø 17.6mm aluminium		





			
<b>1</b>			
<b>GEV No.</b>	104649	<b>Ref. No.</b>	C00110
<b>description</b>	air mixing tube L 83mm D1 ø 28mm D2 ø 32mm ID ø 24.5mm brass		

			
<b>1</b>			
<b>GEV No.</b>	105128	<b>Ref. No.</b>	C00457
<b>description</b>	burner cap ø 100mm 5.5kW		
<b>accessories for</b>	105128		
	<b>GEV No.</b>	105127	<b>Ref. No.</b> C99637
	burner head for burner cap ø 100mm 5.5kW		
	<b>GEV No.</b>	105129	<b>Ref. No.</b> C00011 C00815
	burner holder for burner cap ø 100mm 5.5kW		

			
<b>1</b>			
<b>GEV No.</b>	105134	<b>Ref. No.</b>	C00458
<b>description</b>	burner cap ø 120mm 7.5kW with central hole		
<b>accessories for</b>	105134		
	<b>GEV No.</b>	105133	<b>Ref. No.</b> C99638 C99638 + 511120104
	burner head for burner cap ø 120mm 7.5kW		
	<b>GEV No.</b>	105135	<b>Ref. No.</b> C00012 C00816
	burner holder for burner cap ø 120mm 7.5kW		

			
<b>1</b>			
<b>GEV No.</b>	105131	<b>Ref. No.</b>	C00456
<b>description</b>	burner cap ø 70mm 3.5kW		
<b>accessories for</b>	105131		
	<b>GEV No.</b>	105130	<b>Ref. No.</b> C99636
	burner head for burner cap ø 70mm 3.5kW		
	<b>GEV No.</b>	105132	<b>Ref. No.</b> C00010 C00814
	burner holder for burner cap ø 70mm 3.5kW		

			
<b>1</b>			
<b>GEV No.</b>	105127	<b>Ref. No.</b>	C99637
<b>description</b>	burner head for burner cap ø 100mm 5.5kW		
<b>accessories for</b>	105127		
	<b>GEV No.</b>	105128	<b>Ref. No.</b> C00457
	burner cap ø 100mm 5.5kW		
	<b>GEV No.</b>	105129	<b>Ref. No.</b> C00011 C00815
	burner holder for burner cap ø 100mm 5.5kW		
	<b>GEV No.</b>	107540	<b>Ref. No.</b> C00109
	air mixing tube L 58mm D1 ø 20mm D2 ø 24.5mm ID ø 17.6mm aluminium		

			
<b>1</b>			
<b>GEV No.</b>	105133	<b>Ref. No.</b>	C99638 C99638 + 511120104
<b>description</b>	burner head for burner cap ø 120mm 7.5kW		
<b>spare parts for</b>	105133		
	<b>GEV No.</b>	104649	<b>Ref. No.</b> C00110
	air mixing tube L 83mm D1 ø 28mm D2 ø 32mm ID ø 24.5mm brass		
	<b>GEV No.</b>	560366	<b>Ref. No.</b> C00513
	grub screw thread M6 L 20mm SS intake internal hexagon WS 3 Qty 1 pcs		
<b>accessories for</b>	105133		
	<b>GEV No.</b>	105134	<b>Ref. No.</b> C00458
	burner cap ø 120mm 7.5kW with central hole		
	<b>GEV No.</b>	105135	<b>Ref. No.</b> C00012 C00816
	burner holder for burner cap ø 120mm 7.5kW		



			
<b>1</b>			
<b>GEV No.</b>	105130	<b>Ref. No.</b>	C99636
<b>description</b>	burner head for burner cap ø 70mm 3.5kW		
<b>accessories for</b>	105130		
	<b>GEV No.</b>	105131	<b>Ref. No.</b> C00456
	burner cap ø 70mm 3.5kW		
	<b>GEV No.</b>	105132	<b>Ref. No.</b> C00010 C00814
	burner holder for burner cap ø 70mm 3.5kW		

Table continues overleaf



Зип Общепит



part supplies

vsezip.ru



+7(812)987-08-81

<b>accessories for</b>	105130		
	<b>GEV No.</b>	107539	<b>Ref. No.</b> C00108
	air mixing tube L 58mm D1 ø 16mm D2 ø 19mm ID ø 14mm aluminium		



	1		
<b>GEV No.</b>	105129	<b>Ref. No.</b>	C00011 C00815
<b>description</b>	burner holder for burner cap ø 100mm 5.5kW		

<b>accessories for</b>	105129		
	<b>GEV No.</b>	105127	<b>Ref. No.</b> C99637
	burner head for burner cap ø 100mm 5.5kW		
	<b>GEV No.</b>	105128	<b>Ref. No.</b> C00457
	burner cap ø 100mm 5.5kW		

	1		
<b>GEV No.</b>	105135	<b>Ref. No.</b>	C00012 C00816
<b>description</b>	burner holder for burner cap ø 120mm 7.5kW		

<b>accessories for</b>	105135		
	<b>GEV No.</b>	105133	<b>Ref. No.</b> C99638 C99638 + 511120104
	burner head for burner cap ø 120mm 7.5kW		
	<b>GEV No.</b>	105134	<b>Ref. No.</b> C00458
	burner cap ø 120mm 7.5kW with central hole		

	1		
<b>GEV No.</b>	105132	<b>Ref. No.</b>	C00010 C00814
<b>description</b>	burner holder for burner cap ø 70mm 3.5kW		

<b>accessories for</b>	105132		
	<b>GEV No.</b>	105130	<b>Ref. No.</b> C99636
	burner head for burner cap ø 70mm 3.5kW		
	<b>GEV No.</b>	105131	<b>Ref. No.</b> C00456
	burner cap ø 70mm 3.5kW		

	1		
<b>GEV No.</b>	210030	<b>Ref. No.</b>	C00859
<b>description</b>	pan support W 313mm L 390mm H 47mm suitable for EMMEPI		

<b>accessories</b>	pan supports		
	1		
<b>GEV No.</b>	210030	<b>Ref. No.</b>	C00859
<b>description</b>	pan support W 313mm L 390mm H 47mm suitable for EMMEPI		

<b>simmering plates</b>	1		
	1		
<b>GEV No.</b>	109723	<b>Ref. No.</b>	100083
<b>description</b>	simmer plate L 365mm W 355mm		

<b>bar burners</b>	1		
	1		
<b>GEV No.</b>	105788	<b>Ref. No.</b>	809328
<b>description</b>	bar burner 1-row ø 50mm Wmm Hmm L 483mm flange width 71mm convection oven flange ø 75mm		

1 gas components







Зип Общежит

vsezip.ru

+7(812)987-08-81

gas components

			
1			
<b>GEV No.</b>	105687	<b>Ref. No.</b>	8C2060
<b>description</b>	bar burner 2 row L 370mm W 220mm ømm H 50mm chargrill		

			
1			
<b>GEV No.</b>	105326	<b>Ref. No.</b>	C00082+C00083+C00290 C99716
<b>description</b>	bar burner 4 row L 440mm W 300mm ømm H 50mm solid top		

			
1			
<b>GEV No.</b>	105323	<b>Ref. No.</b>	C10074+C10060+C00290 C89456
<b>description</b>	bar burner 2 row L 390mm W 160mm ømm H 50mm solid top		

			
1			
<b>GEV No.</b>	105312	<b>Ref. No.</b>	C10076+C10060+C00290 C89435 C89435+C10060+C00290
<b>description</b>	bar burner 4 row L 460mm W 545mm ømm H 40mm oven		

			
1			
<b>GEV No.</b>	105320	<b>Ref. No.</b>	C89458
<b>description</b>	bar burner 2 row L 950mm W 180mm ømm H 50mm		

			
1			
<b>GEV No.</b>	105321	<b>Ref. No.</b>	C00886 C89436
<b>description</b>	bar burner angled L 524mm W 243mm ømm H 5.8kW oven		

			
1			
<b>GEV No.</b>	105311	<b>Ref. No.</b>	809388
<b>description</b>	bar burner 3 row L 370mm W 345mm ømm H 145mm chargrill		

			
1			
<b>GEV No.</b>	105325	<b>Ref. No.</b>	C00885 C99724
<b>description</b>	bar burner angled L 625mm W 250mm ømm H oven		

			
1			
<b>GEV No.</b>	105327	<b>Ref. No.</b>	C0080+C00111+C00290 C99717
<b>description</b>	bar burner 3 row L 490mm W 240mm ømm H 60mm grill		

			
1			
<b>GEV No.</b>	105328	<b>Ref. No.</b>	C99711
<b>description</b>	bar burner ø 25mm Wmm Hmm L 520mm bain marie		

			
1			
<b>GEV No.</b>	105319	<b>Ref. No.</b>	809467
<b>description</b>	bar burner 4 row L 390mm W 270mm ømm H 60mm kettle		

			
1			
<b>GEV No.</b>	105718	<b>Ref. No.</b>	8C1040
<b>description</b>	bar burner ø 40mm Wmm Hmm L 395mm flange ø 61mm tilting bratt pan		

			
1			
<b>GEV No.</b>	105324	<b>Ref. No.</b>	C10077+C10060+C00290 C89457
<b>description</b>	bar burner 4 row L 425mm W 470mm ømm H 50mm 9kW grill		





Зип Общепит

vsezip.ru

+7(812)987-08-81

			
1			
<b>GEV No.</b>	105330	<b>Ref. No.</b>	808738
<b>description</b>	bar burner ø 40mm Wmm Hmm L 500mm mounting thread with bolt M5x12 flange width 43mm flange length 43mm bain marie		

			
1			
<b>GEV No.</b>	105314	<b>Ref. No.</b>	808417
<b>description</b>	tubular burner L 295mm W 55mm H 70mm 4.7kW mounting pos. centre oval		

			
1			
<b>GEV No.</b>	105310	<b>Ref. No.</b>	808726 809434
<b>description</b>	bar burner ø 60mm Wmm Hmm L 260mm flange width 67mm flange length 67mm pasta cooker		

			
1			
<b>GEV No.</b>	105313	<b>Ref. No.</b>	808419
<b>description</b>	tubular burner L 295mm W 55mm H 70mm 4.7kW mounting pos. left oval		

			
1			
<b>GEV No.</b>	105317	<b>Ref. No.</b>	808434
<b>description</b>	bar burner ø 60mm Wmm Hmm L 388mm flange width 67mm flange length 67mm		

			
1			
<b>GEV No.</b>	105329	<b>Ref. No.</b>	808418
<b>description</b>	tubular burner L 295mm W 55mm H 70mm 4.7kW mounting pos. right oval		

tube burners

			
1			
<b>GEV No.</b>	105315	<b>Ref. No.</b>	809428
<b>description</b>	tubular burner L 170mm W 55mm H 70mm 3.8kW mounting pos. left oval		

gas nozzles

main nozzles

gas nozzles M10x1

			
1			
<b>GEV No.</b>	106466	<b>Ref. No.</b>	809960
<b>description</b>	gas injector thread M10x1 WS 12 bore ø 1.15mm		

			
1			
<b>GEV No.</b>	105316	<b>Ref. No.</b>	809429
<b>description</b>	tubular burner L 170mm W 55mm H 70mm 3.8kW mounting pos. right oval		

gas nozzles M12x1

			
1			
<b>GEV No.</b>	106266	<b>Ref. No.</b>	C00112
<b>description</b>	gas injector thread M12x1 WS 13 bore ø 0.81mm		

1 gas components



Зип Общепит  
vsezip.ru  
+7(812)987-08-81



<b>GEV No.</b>	106674	<b>Ref. No.</b>	C00113
<b>description</b>	gas injector thread M12x1 WS 13 bore ø 0.95mm		



<b>GEV No.</b>	106267	<b>Ref. No.</b>	C00114
<b>description</b>	gas injector thread M12x1 WS 13 bore ø 1.05mm		



<b>GEV No.</b>	107791	<b>Ref. No.</b>	C00525
<b>description</b>	gas injector thread M12x1 WS 13 bore ø 1.15mm		



<b>GEV No.</b>	106423	<b>Ref. No.</b>	C00116
<b>description</b>	gas injector thread M12x1 WS 13 bore ø 1.25mm		



<b>GEV No.</b>	106268	<b>Ref. No.</b>	C00115
<b>description</b>	gas injector thread M12x1 WS 13 bore ø 1.2mm		



<b>GEV No.</b>	107785	<b>Ref. No.</b>	C00117
<b>description</b>	gas injector thread M12x1 WS 13 bore ø 1.35mm		



<b>GEV No.</b>	106857	<b>Ref. No.</b>	C00804
<b>description</b>	gas injector thread M12x1 WS 13 bore ø 1.3mm		



<b>GEV No.</b>	106856	<b>Ref. No.</b>	C00536
<b>description</b>	gas injector thread M12x1 WS 13 bore ø 1.7mm		



<b>GEV No.</b>	100282	<b>Ref. No.</b>	C00113
<b>description</b>	gas injector thread M12x1 WS 14 bore ø 0.95mm		

### pilot burner nozzles

#### pilot burner nozzles POLIDORO

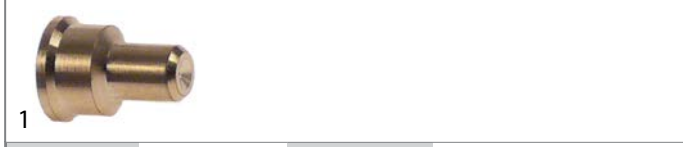

<b>GEV No.</b>	100208	<b>Ref. No.</b>	512120005 512120010 C00170
<b>description</b>	pilot burner nozzle POLIDORO LPG code 20 bore ø 0.2mm Qty 1 pcs		



<b>GEV No.</b>	106703	<b>Ref. No.</b>	512120007
<b>description</b>	pilot burner nozzle POLIDORO natural gas code 27.2 bore ø 2x0.27mm Qty 1 pcs		

#### pilot burner nozzles SIT

##### 100 series



<b>GEV No.</b>	100245	<b>Ref. No.</b>	8C0030
<b>description</b>	pilot burner nozzle LPG code 20 bore ø 0.2mm Qty 1 pcs thread M8x0.75		



Зип Общепит

vsezip.ru

+7(812)987-08-81

1	
<b>GEV No.</b>	100246
<b>Ref. No.</b>	8C0031
<b>description</b>	pilot burner nozzle natural gas bore ø 0.35mm Qty 1 pcs thread M8x0.75

1	
<b>GEV No.</b>	107170
<b>Ref. No.</b>	8C0031
<b>description</b>	pilot burner nozzle SIT natural gas bore ø 0.35mm Qty 1 pcs

140/150 series

1	
<b>GEV No.</b>	100204
<b>Ref. No.</b>	8C0955
<b>description</b>	pilot burner nozzle SIT LPG code 14 bore ø 0.18/0.20mm Qty 1 pcs suitable for 140 series

1	
<b>GEV No.</b>	100205
<b>Ref. No.</b>	809996
<b>description</b>	pilot burner nozzle SIT LPG code 19 bore ø 0.23/0.26mm Qty 1 pcs suitable for SIT 150 series

1	
<b>GEV No.</b>	100207
<b>Ref. No.</b>	8C1497
<b>description</b>	pilot burner nozzle SIT natural gas code 27 bore ø 0.40/0.38mm suitable for SIT 140 series

1	
<b>GEV No.</b>	100206
<b>Ref. No.</b>	809994
<b>description</b>	pilot burner nozzle SIT natural gas code 36 bore ø 0.60/0.55mm Qty 1 pcs suitable for SIT 150 series

160 series

1	
<b>GEV No.</b>	107650
<b>Ref. No.</b>	808365
<b>description</b>	pilot burner nozzle SIT LPG code 30 Qty 1 pcs

1	
<b>GEV No.</b>	107175
<b>Ref. No.</b>	808364
<b>description</b>	pilot burner nozzle SIT natural gas code 51 Qty 1 pcs suitable for 160 series

auxiliary gas parts

screw connections

olives

1	
<b>GEV No.</b>	101248
<b>Ref. No.</b>	8C0412
<b>description</b>	olive for pipe ø 12mm Qty 1 pcs suitable for PEL

<b>accessories for</b>	101248
	<b>GEV No.</b> 101251 <b>Ref. No.</b> —
	union nut thread M20x1.5 for pipe ø 12mm

1	
<b>GEV No.</b>	100870
<b>Ref. No.</b>	830885
<b>description</b>	olive for pipe ø 4mm Qty 1 pcs suitable for 160 series for pilot burner

union screws

1	
<b>GEV No.</b>	100905
<b>Ref. No.</b>	8C0070
<b>description</b>	locking screw M10x1 for pipe ø 6mm Qty 1 pcs

1	
<b>GEV No.</b>	100908
<b>Ref. No.</b>	806019
<b>description</b>	union screw thread M10x1 for pipe ø 4mm Qty 1 pcs





<b>accessories for</b>	100908
	<b>GEV No.</b> 100897 <b>Ref. No.</b> —
	olive for pipe ø 4mm Qty 1 pcs for pilot burner
	<b>GEV No.</b> 101246 <b>Ref. No.</b> —
	olive for pipe ø 4mm Qty 1 pcs
	<b>GEV No.</b> 101280 <b>Ref. No.</b> —
	olive for pipe ø 4mm Qty 1 pcs

Table continues overleaf

1 gas components



accessories for	100908		
	GEV No.	101282	Ref. No.
			—
	olive for pipe ø 4mm L 7.4mm Qty 1 pcs		

drive shafts

for blades

1 

GEV No.	698292	Ref. No.	808559
description	drive shaft ENTERPRISE model 12 ø 9.5mm L 67mm thread M12x1.75 D1 ø 18mm thread L 698mm		

## equipment-specific units

### for slicers

#### hand guard



1

GEV No.	698196	Ref. No.	808991
description	hand protection for carriage 275-300 H 220mm W 150mm thickness 4mm hole ø 6mm mounting distance 88mm		

#### food holders

##### handles



1

GEV No.	111123	Ref. No.	808764
description	handle thread M10 IT ø 30mm L 110mm D1 ø 65mm		

### for bandsaws

#### saw blades

##### width 20mm



1

GEV No.	699083	Ref. No.	807993
description	saw blade L 1800mm W 20mm thickness 0.5mm tooth spacing 6mm		

### for meat mincers

#### gear wheels



1

GEV No.	698286	Ref. No.	808554
description	gear wheel ø 64mm shaft intake ø 16mm teeth 40 splitting tooth width 13mm DIN/ISO groove width 0mm		

#### blades

##### ENTERPRISE



1

GEV No.	696023	Ref. No.	809654 8C1342
description	knife type ENTERPRISE size 22 ø 73mm internal size 13x13mm stainless steel		

#### augers

##### complete



1

GEV No.	698282	Ref. No.	808651
description	auger model 12 ø 54mm L 150mm stainless steel with spindle ENTERPRISE		

### for vegetable slicers

#### ejector discs



1

GEV No.	699016	Ref. No.	808636
description	ejector disc high H 25mm ø 200mm seat ø 21mm hole distance 40mm		

## for potato peelers

## abrasive side elements

## grinding discs



1

<b>GEV No.</b>	696201	<b>Ref. No.</b>	809309
<b>description</b>	grating disc ø 280mm potato peeler PP4-PP8 Expo		



1

<b>GEV No.</b>	696377	<b>Ref. No.</b>	809399 8C0950
<b>description</b>	grating disc ø 350mm for potato peeler device		

## for ice-cube maker

## floats

## float containers



1

<b>GEV No.</b>	695072	<b>Ref. No.</b>	8C0072
<b>description</b>	float container for ice maker with microswitch plastic		

## for deep fryers

## door magnets



1

<b>GEV No.</b>	690524	<b>Ref. No.</b>	808161 C00247
<b>description</b>	door magnet L 87mm W 18mm H 15mm mounting distance 73mm for folding door hinge		

Зип Общежит

miscellaneous



1

<b>GEV No.</b>	550449	<b>Ref. No.</b>	808893
<b>description</b>	special wrench for ring nut		



1

<b>GEV No.</b>	550448	<b>Ref. No.</b>	808894
<b>description</b>	tubular box wrench special for fryer L 280mm WS 10		

## for convection ovens/combi-steamers

## glass panels



1

<b>GEV No.</b>	694847	<b>Ref. No.</b>	8C1724
<b>description</b>	glass panel L 673mm W 510mm H 5mm		

## air filters



1

<b>GEV No.</b>	692695	<b>Ref. No.</b>	809502
<b>description</b>	filter insert L 213mm W 60mm ømm H 90mm		

## miscellaneous



1

<b>GEV No.</b>	512184	<b>Ref. No.</b>	809567
<b>description</b>	hose connector plastic thread 3/4" Qty 1 pcs connection distance 60mm T-shape		

## for tilting bratt pans

## miscellaneous



1

<b>GEV No.</b>	523510	<b>Ref. No.</b>	EC1110002
<b>description</b>	deep-groove ball bearing type 6202-2RS shaft $\varnothing$ 15mm ED $\varnothing$ 35mm W 11mm with sealing discs deep-groove ball bearing DIN 625-1		

## for boiling pans

## level glasses

## complete



1

<b>GEV No.</b>	540706	<b>Ref. No.</b>	808704
<b>description</b>	level glass hole distance 76mm mounting thread M10 L 107mm W 28mm plastic/SS for kettle model ELESA HCX-76-BW-SST		

## for pizza ovens

## glass panels



1

<b>GEV No.</b>	700205	<b>Ref. No.</b>	808440
<b>description</b>	glass panel L 320mm W 100mm thickness 5mm rectangular		

## for dishwashers

## boilers

## boilers for dishwashers



1

<b>GEV No.</b>	519022	<b>Ref. No.</b>	900353
<b>description</b>	boiler $\varnothing$ 150mm L 400mm		

## backflow preventers

## backflow preventers



1

<b>GEV No.</b>	504140	<b>Ref. No.</b>	907460
<b>description</b>	backflow preventer		

## miscellaneous



1

<b>GEV No.</b>	506160	<b>Ref. No.</b>	8C0647
<b>description</b>	plain washer ID $\varnothing$ 8.6mm ED $\varnothing$ 16mm thickness 1.5mm SS Qty 1 pcs		

## door mechanics

## rollers



1

<b>GEV No.</b>	501431	<b>Ref. No.</b>	8C1472
<b>description</b>	roller ED $\varnothing$ 9mm for door mechanism shaft diameter 3.5mm W 5mm		

+7(812)987-08-81



Зип-Общепит

vsezip.ru

+7(812)987-08-81

locks





1

<b>GEV No.</b>	511083	<b>Ref. No.</b>	809676
<b>description</b>	counterpart door catch		



1

<b>GEV No.</b>	511082	<b>Ref. No.</b>	809675	
<b>description</b>	door catch complete catch			
<b>accessories for</b>	511082			
	<b>GEV No.</b>	511083	<b>Ref. No.</b>	809676
	counterpart door catch			



1

<b>GEV No.</b>	519247	<b>Ref. No.</b>	906113	
<b>description</b>	door catch door locking catch			
<b>accessories for</b>	519247			
	<b>GEV No.</b>	519050	<b>Ref. No.</b>	—
	nut thread M12x1.75 H 4mm WS 16 SS Qty 1 pcs for snap lock			

miscellaneous



1

<b>GEV No.</b>	524047	<b>Ref. No.</b>	8C1197
<b>description</b>	hauling cable for door mechanism ø 1.5mm L 475mm		

curtains



1

<b>GEV No.</b>	533016	<b>Ref. No.</b>	TR0460
<b>description</b>	curtain W 640mm H 410mm plastic thickness 1.5mm warewashing		

universal knobs



1

<b>GEV No.</b>	110811	<b>Ref. No.</b>	C99683
<b>description</b>	knob gas tap with ignition flame ø 70mm shaft ø 10x8mm shaft flat universal black/silver		



1

<b>GEV No.</b>	110817	<b>Ref. No.</b>	C98971
<b>description</b>	knob switch 7-position ø 70mm shaft ø 6x4.6mm shaft flat universal black/silver		



1

<b>GEV No.</b>	110816	<b>Ref. No.</b>	C99704
<b>description</b>	knob thermostat t.max. 90°C 30-90°C ø 70mm shaft ø 6x4.6mm shaft flat universal black/silver rotation 270°		

producer-specific knobs

EMMEPI



1

<b>GEV No.</b>	110810	<b>Ref. No.</b>	C89433 C89459
<b>description</b>	knob gas tap without ignition flame ø 75mm shaft ø 8x6.5mm shaft flat upper black		





Зип Общепит

vsezip.ru

+7(812)987-08-81

			
1			
<b>GEV No.</b>	110812	<b>Ref. No.</b>	C99698
<b>description</b>	knob gas thermostat 1-8 ø 75mm shaft ø 10x8mm shaft flat lower		

			
1			
<b>GEV No.</b>	110813	<b>Ref. No.</b>	C99707
<b>description</b>	knob switch 0-1 ø 75mm shaft ø 6x4.6mm shaft flat upper black		

			
1			
<b>GEV No.</b>	110818	<b>Ref. No.</b>	C99695
<b>description</b>	knob switch 7-position ø 75mm shaft ø 6x4.6mm shaft flat upper black		

			
1			
<b>GEV No.</b>	110819	<b>Ref. No.</b>	C99692
<b>description</b>	knob thermostat t.max. 110°C ø 75mm shaft ø 6x4.6mm shaft flat upper black temperature range 30-110°C rotation 270°		

			
1			
<b>GEV No.</b>	110815	<b>Ref. No.</b>	C99686
<b>description</b>	knob thermostat t.max. 200°C 150-200°C ø 76mm shaft ø 6x4.6mm shaft flat upper black temperature range 150-200°C		

			
1			
<b>GEV No.</b>	110814	<b>Ref. No.</b>	C99639
<b>description</b>	knob thermostat t.max. 250°C 100-250°C ø 75mm shaft ø 6x4.6mm shaft flat upper black rotation 270°		

### accessories

#### button springs

			
1			
<b>GEV No.</b>	550132	<b>Ref. No.</b>	C00196
<b>description</b>	knob spring ø 6x4.6mm Qty 10 pcs		

### handles and hand wheels

#### hand wheels

##### hand wheels

			
1			
<b>GEV No.</b>	540715	<b>Ref. No.</b>	C00248
<b>description</b>	hand wheel ø 200mm bore ø 16mm		

			
1			
<b>GEV No.</b>	690609	<b>Ref. No.</b>	C00248
<b>description</b>	hand wheel ø 200mm D1 ø 50mm bore ø 16mm thread groove width-mm L1 28mm L2 55mm handle length 85mm with folding handle		
<b>spare parts for</b>	690609		
	<b>GEV No.</b>	514255	<b>Ref. No.</b>
			
	folding handle ø 26mm total length 85mm seat ø 20mm shaft ø 6mm thread M6 with pin L 85mm		

cylindrical handles

fixed



1			
<b>GEV No.</b>	540713	<b>Ref. No.</b>	809039
<b>description</b>	cylindrical handle thread M8 ø 17mm L 38mm		

levers

without handle



1			
<b>GEV No.</b>	540712	<b>Ref. No.</b>	809038
<b>description</b>	lever		

locks

edgmount latches

handle latches

CAFF/FERMOD

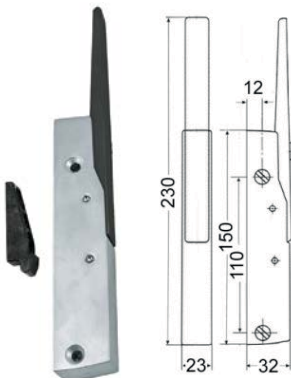

1			
<b>GEV No.</b>	690454	<b>Ref. No.</b>	8C2082
<b>description</b>	handle latch L 150mm mounting distance 110mm matt chrome-plated/Rilsan non lockable heated units 560 black complete with door catch		
<b>spare parts for</b>	690454		
	<b>GEV No.</b>	690429	<b>Ref. No.</b>
			—
	door catch CT 25.5mm		
<b>accessories for</b>	690454		
	<b>GEV No.</b>	690428	<b>Ref. No.</b>
			—
	door catch H 51mm W 13.9mm mounting distance 30mm plastic CT 16.5mm		
	<b>GEV No.</b>	690445	<b>Ref. No.</b>
			—
	base plate H 2mm		

<b>accessories for</b>	690454		
<b>GEV No.</b>	690446	<b>Ref. No.</b>	—
	base plate H 5mm L 56mm W 18mm		

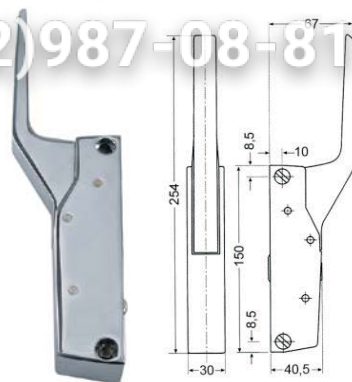

1			
<b>GEV No.</b>	700060	<b>Ref. No.</b>	9629921
<b>description</b>	handle latch L 150mm mounting distance 133mm non lockable heated units G 791		
<b>accessories for</b>	700060		
	<b>GEV No.</b>	700061	<b>Ref. No.</b>
			8C0315
	door catch L 58mm W 20mm H 35mm mounting distance 42mm chrome-plated brass for headed units		
	<b>GEV No.</b>	700062	<b>Ref. No.</b>
			—
	handle protection heated units		

door catches



1			
<b>GEV No.</b>	700061	<b>Ref. No.</b>	8C0315
<b>description</b>	door catch L 58mm W 20mm H 35mm mounting distance 42mm chrome-plated brass for headed units		
<b>accessories for</b>	700061		
	<b>GEV No.</b>	690414	<b>Ref. No.</b>
			—
	handle latch L 150mm mounting distance 133mm non lockable refrigeration units G 791		



1			
<b>GEV No.</b>	700435	<b>Ref. No.</b>	809875 8C0315
<b>description</b>	door catch L 58mm W 20mm H 35mm mounting distance 42mm zamak for refrigeration units		

snap locks

universal



<b>GEV No.</b>	690596	<b>Ref. No.</b>	131110006
<b>description</b>	snap lock L 60mm W 15mm H 36mm mounting distance 48/28mm spring thickness 1.5mm complete with door catch zamak		

miscellaneous



<b>GEV No.</b>	511482	<b>Ref. No.</b>	809708
<b>description</b>	pressure pin L 52mm thread M10x1.5		

hinges

oven hinges

 Image not available			
<b>GEV No.</b>	690535	<b>Ref. No.</b>	C00132
<b>description</b>	opposite support		

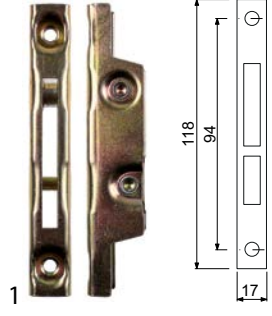

			
<b>GEV No.</b>	700001	<b>Ref. No.</b>	C00132
<b>description</b>	opposite support L 118mm W 17mm mounting distance 94mm		



Зип Общепит

vsezip.ru

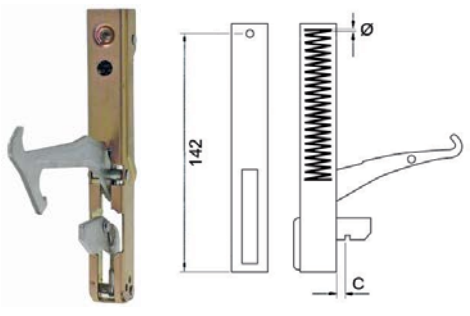
+7(812)987-08-81

			
<b>GEV No.</b>	690532	<b>Ref. No.</b>	C00131
<b>description</b>	oven hinge left		

			
<b>GEV No.</b>	700433	<b>Ref. No.</b>	132110006
<b>description</b>	oven hinge mounting distance 142mm mounting distance 2mm lug mountingmm lever length 100mm groove distance 14mm spring thickness 4mm mounting ear position spring length 55mm L 155mm mounting pos. left/right		
<b>accessories for</b>	700433		
	<b>GEV No.</b>	700434	<b>Ref. No.</b>
			—
	opposite support oven hinge		

			
<b>GEV No.</b>	700006	<b>Ref. No.</b>	C00130
<b>description</b>	oven hinge mounting distance 173mm mounting distance 2 105mm lug mounting 14mm lever length 120mm groove distance 11mm spring thickness 3.5mm mounting ear position left spring length 112mm W 25mm		
<b>accessories for</b>	700006		
	<b>GEV No.</b>	700001	<b>Ref. No.</b>
			C00132
	opposite support L 118mm W 17mm mounting distance 94mm		
	<b>GEV No.</b>	700007	<b>Ref. No.</b>
			C00131
	oven hinge mounting distance 173mm mounting distance 2 105mm lug mounting 14mm lever length 120mm groove distance 11mm spring thickness 3.5mm mounting ear position right spring length 112mm W 25mm		

Зип Общепит

vsezip.ru

+7(812)987-08-81

1

<b>GEV No.</b>	700007	<b>Ref. No.</b>	C00131
<b>description</b>	oven hinge mounting distance 173mm mounting distance 2 105mm lug mounting 14mm lever length 120mm groove distance 11mm spring thickness 3.5mm mounting ear position right spring length 112mm W 25mm		
<b>accessories for</b>	700007		
	<b>GEV No.</b>	<b>Ref. No.</b>	C00132
	opposite support L 118mm W 17mm mounting distance 94mm		

1

<b>GEV No.</b>	690533	<b>Ref. No.</b>	C10079
<b>description</b>	oven hinge mounting distance 173mm mounting distance 2 105mm lug mounting 14mm lever length 120mm groove distance 11mm spring thickness 4mm mounting ear position left spring length 112mm L 206mm W 25mm		

1

<b>GEV No.</b>	690534	<b>Ref. No.</b>	C10080
<b>description</b>	oven hinge mounting distance 173mm mounting distance 2 105mm lug mounting 14mm lever length 120mm groove distance 11mm spring thickness 4mm mounting ear position right spring length 112mm L 206mm W 25mm		

door bearing

1

<b>GEV No.</b>	690523	<b>Ref. No.</b>	C98973
<b>description</b>	hinge bearing mounting pos. bottom left with bolt		

1

<b>GEV No.</b>	690526	<b>Ref. No.</b>	809412
<b>description</b>	hinge bearing mounting pos. bottom left/upper right with bolt		

1

<b>GEV No.</b>	690527	<b>Ref. No.</b>	809400
<b>description</b>	hinge bearing mounting pos. bottom right with bolt		

1

<b>GEV No.</b>	690522	<b>Ref. No.</b>	C98974
<b>description</b>	hinge bearing mounting pos. upper left with bolt		

1

<b>GEV No.</b>	690530	<b>Ref. No.</b>	809403
<b>description</b>	hinge bearing mounting pos. upper left with bolt		

1

<b>GEV No.</b>	514309	<b>Ref. No.</b>	8C1386
<b>description</b>	hinge bearing mounting pos. upper left without bolt		

1

<b>GEV No.</b>	690525	<b>Ref. No.</b>	809411
<b>description</b>	hinge bearing mounting pos. upper left/bottom right with bolt		



Зип Общепит

vsezip.ru

+7(812)987-08-81

			
1			
<b>GEV No.</b>	690521	<b>Ref. No.</b>	C98975
<b>description</b>	hinge bearing mounting pos. upper right with bolt		



			
1			
<b>GEV No.</b>	690528	<b>Ref. No.</b>	809401
<b>description</b>	hinge bearing mounting pos. upper right with bolt		

## fittings for catering equipment

### outlet taps

#### producer-specific

#### EMMEPI

			
1			
<b>GEV No.</b>	540700	<b>Ref. No.</b>	808037 808037+808432
<b>description</b>	ball valve straight thread 1/2" IT - 1/2" IT connection 1/2" mounting pos. total length 64mm shaft intake ø 9x7.5mm 1/2" rosette thread G2 3/8" total length 64mm		
<b>spare parts for</b>	540700		
	<b>GEV No.</b>	540701	<b>Ref. No.</b> 808432
	lever handle plastic L 65mm H 40mm thread connection 9x7.5		

			
1			
<b>GEV No.</b>	540701	<b>Ref. No.</b>	808432
<b>description</b>	lever handle plastic L 65mm H 40mm thread connection 9x7.5		

			
<b>GEV No.</b>	540776	<b>Ref. No.</b>	809040
<b>description</b>	outlet tap L 83mm without handle thread 3/4" IT shaft L 9mm shaft ø 10x7.3mm handle M6		
<b>spare parts for</b>	540776		
	<b>GEV No.</b>	532453	<b>Ref. No.</b> —
	O-ring EPDM thickness 2.62mm ID ø 21.89mm Qty 1 pcs		
<b>accessories for</b>	540776		
	<b>GEV No.</b>	514006	<b>Ref. No.</b> 808931
	drain pipe L 200mm thread ø 22mm		
	<b>GEV No.</b>	514217	<b>Ref. No.</b> —
	handle for outlet tap		
	<b>GEV No.</b>	540651	<b>Ref. No.</b> —
	drain pipe total length 210mm shaft ø 22mm		
	<b>GEV No.</b>	540734	<b>Ref. No.</b> —
	drain pipe thread		
	<b>GEV No.</b>	693082	<b>Ref. No.</b> —
	lever handle thread		

### aerators and air bleeders

			
1			
<b>GEV No.</b>	540827	<b>Ref. No.</b>	809385
<b>description</b>	aerator and air bleeder thread 3/4" ET chrome-plated L 45mm ø 36mm		



## inlet taps

1



<b>GEV No.</b>	514048	<b>Ref. No.</b>	C10510+224110004
<b>description</b>	ball valve connection 1/2" complete total length 55mm mounting pos. any brass H 30mm L 55mm rosette ø 70mm rosette thread G2 M22x1		
<b>spare parts for</b>	514048		
	<b>GEV No.</b>	540871	<b>Ref. No.</b>
			—
	lever handle cold water suitable for intake tap		

## drain taps

## brass

## drain taps

1



<b>GEV No.</b>	540131	<b>Ref. No.</b>	808350
<b>description</b>	drain tap 1 1/4" IT chrome-plated brass		
<b>spare parts for</b>	540131		
	<b>GEV No.</b>	540213	<b>Ref. No.</b>
			—
	handle ID ø 5mm L 117mm		
	<b>GEV No.</b>	540461	<b>Ref. No.</b>
			—
	shim for drain tap		
	<b>GEV No.</b>	540464	<b>Ref. No.</b>
			—
	nut for drain tap thread 1 1/2"		





Зип Общепит

vsezip.ru

+7(812)987-08-81

1



<b>GEV No.</b>	540134	<b>Ref. No.</b>	806172
<b>description</b>	drain tap 2" IT fixed A 115mm B1 90mm B2 165mm chrome-plated brass		
<b>spare parts for</b>	540134		
	<b>GEV No.</b>	540214	<b>Ref. No.</b>
			—
	handle ID ø 6mm L 145mm		
	<b>GEV No.</b>	540462	<b>Ref. No.</b>
			—
	ring for drain tap		
	<b>GEV No.</b>	540465	<b>Ref. No.</b>
			—
	nut for drain tap thread 2 3/4"		
<b>accessories for</b>	540134		
	<b>GEV No.</b>	529484	<b>Ref. No.</b>
			—
	flat gasket fibre ED ø 58mm ID ø 50mm thickness 2mm Qty 1 pcs		

## safety valves

1



<b>GEV No.</b>	540708	<b>Ref. No.</b>	809470
<b>description</b>	safety valve		

## equipment feet and end caps

## bullet feet

## zamak/SS

1



<b>GEV No.</b>	700112	<b>Ref. No.</b>	819841
<b>description</b>	equipment foot pipe type 40x40 thickness 1mm H 33-60mm Zamak/SS Qty 1 pcs		

## screw-in feet



1

<b>GEV No.</b>	802136	<b>Ref. No.</b>	E6111092
----------------	--------	-----------------	----------

<b>description</b>	equipment foot thread M8 thread L 15mm ø 47mm H 40mm		
--------------------	--	--	--

## baskets

## fryer baskets

## EMMEPI



1

<b>GEV No.</b>	970577	<b>Ref. No.</b>	808182
----------------	--------	-----------------	--------

<b>description</b>	fryer basket L1 270mm W1 185mm H1 120mm chrome-plated steel		
--------------------	---	--	--



1

<b>GEV No.</b>	970240	<b>Ref. No.</b>	205011
----------------	--------	-----------------	--------

<b>description</b>	fryer basket L1 285mm W1 230mm H1 105mm		
--------------------	---	--	--



1

<b>GEV No.</b>	970244	<b>Ref. No.</b>	299939
----------------	--------	-----------------	--------

<b>description</b>	fryer basket L1 290mm W1 115mm H1 120mm		
--------------------	---	--	--



1

<b>GEV No.</b>	970355	<b>Ref. No.</b>	CFR142812
----------------	--------	-----------------	-----------

<b>description</b>	fryer basket L1 290mm W1 115mm H1 120mm L2 50mm H2 180mm H3 220mm chrome-plated steel L3 160mm		
--------------------	--	--	--



1

<b>GEV No.</b>	970243	<b>Ref. No.</b>	CF518120017 CFR232910
----------------	--------	-----------------	--------------------------

<b>description</b>	fryer basket L1 290mm W1 230mm H1 105mm L2 470mm H2 175mm H3 220mm chrome-plated steel		
--------------------	--	--	--

Зип Общепит

vsezip.ru

+7(812)987-08-81



1

<b>GEV No.</b>	970242	<b>Ref. No.</b>	299938
----------------	--------	-----------------	--------

<b>description</b>	fryer basket L1 290mm W1 230mm H1 120mm		
--------------------	---	--	--



1

<b>GEV No.</b>	970356	<b>Ref. No.</b>	299938 CFR242812
----------------	--------	-----------------	---------------------

<b>description</b>	fryer basket L1 290mm W1 230mm H1 120mm chrome-plated steel		
--------------------	---	--	--



1

<b>GEV No.</b>	970249	<b>Ref. No.</b>	299935 CFR303112
----------------	--------	-----------------	---------------------

<b>description</b>	fryer basket L1 290mm W1 330mm H1 120mm		
--------------------	---	--	--



1

<b>GEV No.</b>	540714	<b>Ref. No.</b>	808735 8C1875
----------------	--------	-----------------	------------------

<b>description</b>	handle for fryer basket complete L 140mm H 22.5mm W 40mm hole ø 5.5mm		
--------------------	---	--	--

## pasta baskets

## EMMEPI



1

<b>GEV No.</b>	970746	<b>Ref. No.</b>	CP2-3
----------------	--------	-----------------	-------

<b>description</b>	pasta basket H1 217mm W1 290mm L1 290mm		
--------------------	---	--	--



Зип Общепит

vsezip.ru

+7(812)987-08-81



1

<b>GEV No.</b>	970253	<b>Ref. No.</b>	205070
<b>description</b>	pasta basket L1 335mm W1 300mm H1 225mm H3 337mm stainless steel		



1

<b>GEV No.</b>	970252	<b>Ref. No.</b>	299977
<b>description</b>	pasta basket L1 335mm W1 300mm H1 225mm H3 365mm stainless steel		

## shelves and shelf rails

### grates

#### producer-specific



1

<b>GEV No.</b>	970491	<b>Ref. No.</b>	834385
<b>description</b>	grate W 518mm D 408mm plastic-coated steel		

### shelf rails and supports

#### producer-specific



1

<b>GEV No.</b>	691841	<b>Ref. No.</b>	A73310008
<b>description</b>	guide U-shape L 430mm W 13mm mounting pos. left inner height 21mm		

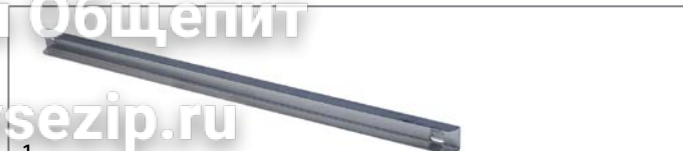

1

<b>GEV No.</b>	691925	<b>Ref. No.</b>	A73310007
<b>description</b>	guide U-shape L 430mm W 13mm mounting pos. right inner height 21mm		

## gaskets

### refrigeration gaskets

#### plug-in gaskets

#### profile 9048

We offer custom-made gaskets for this profile

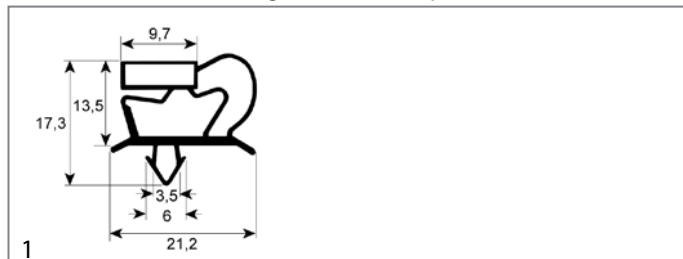

1

<b>GEV No.</b>	900359	<b>Ref. No.</b>	827880
<b>description</b>	refrigeration gasket profile 9048 W 296mm L 405mm plug size drawer size 1/2		

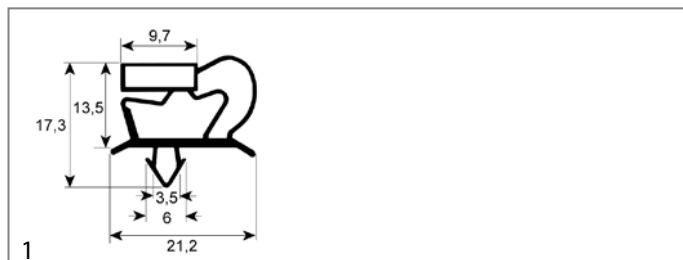

1

<b>GEV No.</b>	901250	<b>Ref. No.</b>	827705
<b>description</b>	refrigeration gasket profile 9048 W 403mm L 400mm plug size		

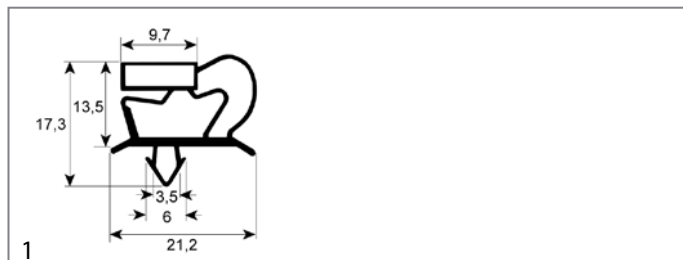

1

<b>GEV No.</b>	901238	<b>Ref. No.</b>	827881
<b>description</b>	refrigeration gasket profile 9048 W 407mm L 184mm plug size		

Зип Общепит

vsezip.ru

+7(812)987-08-81

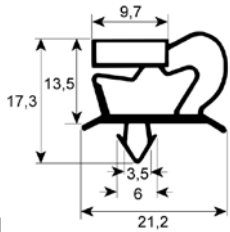

<b>GEV No.</b>	901240	<b>Ref. No.</b>	827879
<b>description</b>	refrigeration gasket profile 9048 W 407mm L 620mm plug size		

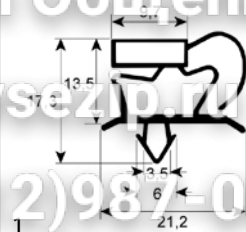

<b>GEV No.</b>	901258	<b>Ref. No.</b>	827785
<b>description</b>	refrigeration gasket profile 9048 W 457mm L 500mm plug size		

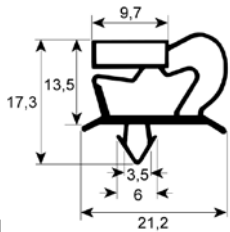

<b>GEV No.</b>	901222	<b>Ref. No.</b>	8C1879
<b>description</b>	refrigeration gasket profile 9048 W 415mm L 709mm plug size for blast chiller		

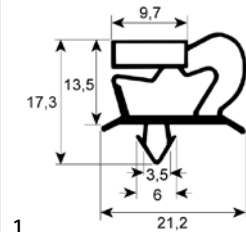

<b>GEV No.</b>	901256	<b>Ref. No.</b>	827786
<b>description</b>	refrigeration gasket profile 9048 W 488mm L 233mm plug size		

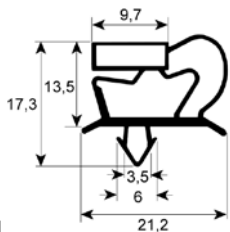

<b>GEV No.</b>	901262	<b>Ref. No.</b>	808421
<b>description</b>	refrigeration gasket profile 9048 W 445mm L 288mm plug size		

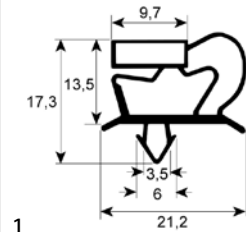

<b>GEV No.</b>	901257	<b>Ref. No.</b>	827787
<b>description</b>	refrigeration gasket profile 9048 W 488mm L 500mm plug size		

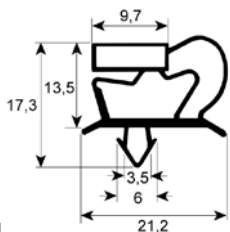

<b>GEV No.</b>	901261	<b>Ref. No.</b>	807584
<b>description</b>	refrigeration gasket profile 9048 W 445mm L 620mm plug size		

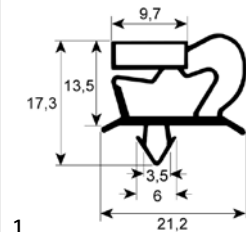

<b>GEV No.</b>	901251	<b>Ref. No.</b>	827875
<b>description</b>	refrigeration gasket profile 9048 W 496mm L 184mm plug size		

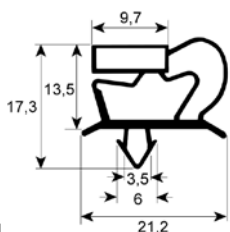

<b>GEV No.</b>	901255	<b>Ref. No.</b>	827784
<b>description</b>	refrigeration gasket profile 9048 W 457mm L 233mm plug size		

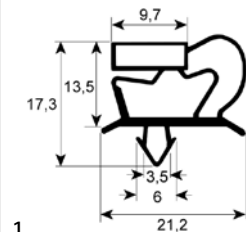

<b>GEV No.</b>	901252	<b>Ref. No.</b>	827874
<b>description</b>	refrigeration gasket profile 9048 W 496mm L 293mm plug size		





Зип Общепит

vsezip.ru

+7(812)987-08-81

<b>GEV No.</b>	901253	<b>Ref. No.</b>	827666
<b>description</b>	refrigeration gasket profile 9048 W 496mm L 402mm plug size		

<b>GEV No.</b>	900350	<b>Ref. No.</b>	807997
<b>description</b>	refrigeration gasket profile 9048 W 670mm L 760mm plug size 1/2 door		

<b>GEV No.</b>	901254	<b>Ref. No.</b>	827873
<b>description</b>	refrigeration gasket profile 9048 W 496mm L 620mm plug size		

<b>GEV No.</b>	900351	<b>Ref. No.</b>	807996
<b>description</b>	refrigeration gasket profile 9048 W 672mm L 1587mm plug size door		

<b>GEV No.</b>	901062	<b>Ref. No.</b>	827873
<b>description</b>	refrigeration gasket profile 9048 W 510mm L 633mm plug size		

<b>GEV No.</b>	901244	<b>Ref. No.</b>	807160
<b>description</b>	refrigeration gasket profile 9048 W 690mm L 1510mm plug size		

<b>GEV No.</b>	901127	<b>Ref. No.</b>	827632
<b>description</b>	refrigeration gasket profile 9048 W 560mm L 1420mm plug size		

<b>GEV No.</b>	901243	<b>Ref. No.</b>	814600
<b>description</b>	refrigeration gasket profile 9048 W 690mm L 735mm plug size		

<b>GEV No.</b>	900710	<b>Ref. No.</b>	8C1563
<b>description</b>	refrigeration gasket profile 9048 W 655mm L 1500mm plug size		

<b>GEV No.</b>	901220	<b>Ref. No.</b>	8C1888
<b>description</b>	refrigeration gasket profile 9048 W 721mm L 929mm plug size for blast chiller		

Зип Общепит

vsezip.ru

+7(812)987-08-81

profile 9046

We offer custom-made gaskets for this profile

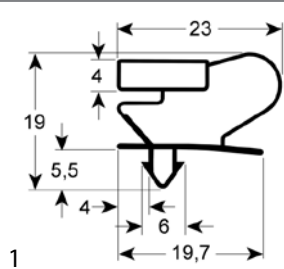

<b>GEV No.</b>	902257	<b>Ref. No.</b>	N/A
<b>description</b>	refrigeration gasket profile 9046 Wmm L 2500mm		

profile 9773

We offer custom-made gaskets for this profile

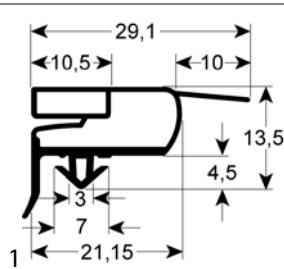

<b>GEV No.</b>	901089	<b>Ref. No.</b>	8C2123
<b>description</b>	refrigeration gasket profile 9773 W 640mm L 1540mm external size W1 627mm L1 1527mm plug size		

profile 9703

We offer custom-made gaskets for this profile

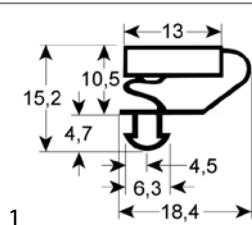

<b>GEV No.</b>	901189	<b>Ref. No.</b>	818998
<b>description</b>	refrigeration gasket profile 9703 W 387mm L 603mm plug size		

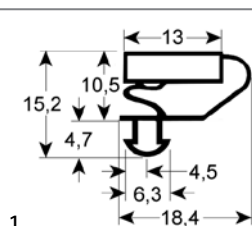

<b>GEV No.</b>	901190	<b>Ref. No.</b>	828532
<b>description</b>	refrigeration gasket profile 9703 W 390mm L 310mm plug size		

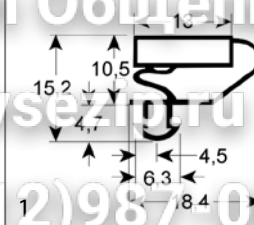

<b>GEV No.</b>	901191	<b>Ref. No.</b>	828533
<b>description</b>	refrigeration gasket profile 9703 W 390mm L 663mm plug size		

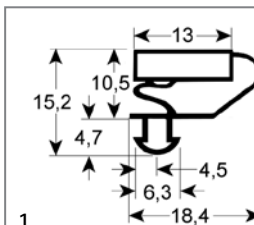

<b>GEV No.</b>	901266	<b>Ref. No.</b>	819854
<b>description</b>	refrigeration gasket profile 9703 W 452mm L 259mm plug size		

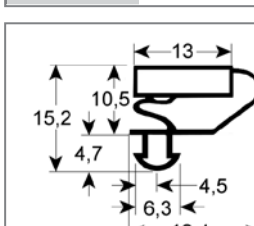

<b>GEV No.</b>	901271	<b>Ref. No.</b>	819853
<b>description</b>	refrigeration gasket profile 9703 W 452mm L 603mm plug size		

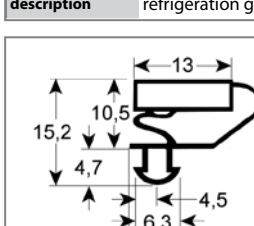

<b>GEV No.</b>	901192	<b>Ref. No.</b>	828138
<b>description</b>	refrigeration gasket profile 9703 W 460mm L 505mm plug size		

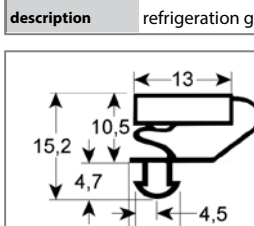

<b>GEV No.</b>	901265	<b>Ref. No.</b>	828289
<b>description</b>	refrigeration gasket profile 9703 W 462mm L 194mm plug size		



Зип Общепит  
vsezip.ru  
+7(812)987-08-81

<b>GEV No.</b>	901270	<b>Ref. No.</b>	828288
<b>description</b>	refrigeration gasket profile 9703 W 462mm L 309mm plug size		

<b>GEV No.</b>	902265	<b>Ref. No.</b>	N/A
<b>description</b>	refrigeration gasket profile 9151 Wmm L 2500mm		

<b>GEV No.</b>	901269	<b>Ref. No.</b>	828431
<b>description</b>	refrigeration gasket profile 9703 W 462mm L 418mm plug size		

**profile 9010**

We offer custom-made gaskets for this profile

<b>GEV No.</b>	901249	<b>Ref. No.</b>	807832
<b>description</b>	gasket profile 9010 W 650mm L 745mm plug size		

<b>GEV No.</b>	901268	<b>Ref. No.</b>	828392
<b>description</b>	refrigeration gasket profile 9703 W 462mm L 659mm plug size		

<b>GEV No.</b>	900598	<b>Ref. No.</b>	807830
<b>description</b>	refrigeration gasket profile 9010 W 655mm L 1550mm plug size		

**profile 9151**

We offer custom-made gaskets for this profile

<b>GEV No.</b>	901168	<b>Ref. No.</b>	715210005
<b>description</b>	refrigeration gasket profile 9151 W 737mm L 1699mm plug size		

<b>GEV No.</b>	902251	<b>Ref. No.</b>	N/A
<b>description</b>	refrigeration gasket profile 9010 Wmm L 2500mm		

<b>GEV No.</b>	901092	<b>Ref. No.</b>	714410002
<b>description</b>	refrigeration gasket profile 9151 W 755mm L 1705mm plug size L1 1695mm W1 745mm external size		

**profile 9012**

We offer custom-made gaskets for this profile

<b>GEV No.</b>	900353	<b>Ref. No.</b>	818997
<b>description</b>	refrigeration gasket profile 9012 W 242mm L 367mm plug size drawer size 1/2		

Зип Общежит

vsezip.ru

+7(812)987-08-81

<b>GEV No.</b>	901186	<b>Ref. No.</b>	808451
<b>description</b>	refrigeration gasket profile 9012 W 375mm L 243mm plug size		

<b>GEV No.</b>	901196	<b>Ref. No.</b>	806370
<b>description</b>	refrigeration gasket profile 9140 W 390mm L 640mm external size		

<b>GEV No.</b>	901263	<b>Ref. No.</b>	808450
<b>description</b>	refrigeration gasket profile 9012 W 435mm L 243mm plug size		

<b>GEV No.</b>	901267	<b>Ref. No.</b>	808428
<b>description</b>	refrigeration gasket profile 9140 W 465mm L 315mm external size		

<b>GEV No.</b>	902252	<b>Ref. No.</b>	N/A
<b>description</b>	refrigeration gasket profile 9012 Wmm L 2500mm		

<b>GEV No.</b>	901198	<b>Ref. No.</b>	806335
<b>description</b>	refrigeration gasket profile 9140 W 670mm L 1575mm external size		

screw-in gaskets  
profile 9140

We offer custom-made gaskets for this profile

<b>GEV No.</b>	901194	<b>Ref. No.</b>	818396
<b>description</b>	refrigeration gasket profile 9140 W 370mm L 620mm external size		

<b>GEV No.</b>	901197	<b>Ref. No.</b>	813377
<b>description</b>	refrigeration gasket profile 9140 W 670mm L 770mm external size		

<b>GEV No.</b>	901195	<b>Ref. No.</b>	813417
<b>description</b>	refrigeration gasket profile 9140 W 390mm L 310mm external size		

gaskets for heated units

window seals

<b>GEV No.</b>	900472	<b>Ref. No.</b>	807587
<b>description</b>	window gasket profile 1650 L 1700mm Qty 1		



Зип Общепит

vsezip.ru

+7(812)987-08-81

<b>GEV No.</b>	900881	<b>Ref. No.</b>	809024
<b>description</b>	window gasket profile 1650 Qty supplied by meter		

<b>GEV No.</b>	901158	<b>Ref. No.</b>	8C0029
<b>description</b>	door seal profile 2402 W 640mm L 740mm		

<b>GEV No.</b>	900601	<b>Ref. No.</b>	809882
<b>description</b>	window gasket profile 1660 Qty supplied by meter		

<b>GEV No.</b>	900781	<b>Ref. No.</b>	9629918
<b>description</b>	door seal profile 2403 Qty supplied by meter		

<b>GEV No.</b>	900782	<b>Ref. No.</b>	9629920
<b>description</b>	window gasket profile 1889 Qty supplied by meter		

<b>GEV No.</b>	900059	<b>Ref. No.</b>	807582 807583 808226
<b>description</b>	door seal profile 2410 Qty supplied by meter		

**door seals**

<b>GEV No.</b>	900348	<b>Ref. No.</b>	8C1193
<b>description</b>	door seal profile 2402 Qty supplied by meter		

<b>GEV No.</b>	900602	<b>Ref. No.</b>	809881
<b>description</b>	door seal profile 2430 Qty supplied by meter		

<b>GEV No.</b>	901351	<b>Ref. No.</b>	809796
<b>description</b>	door seal profile 2402 W 490mm L 635mm external size		



Зип Общепит

vsezip.ru

+7(812)987-08-81

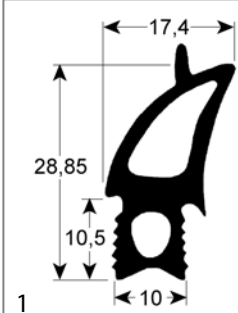

<b>GEV No.</b>	902219	<b>Ref. No.</b>	902219
<b>description</b>	door seal profile 2730 W 465mm L 520mm external size Qty 1		

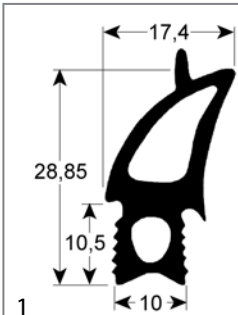

<b>GEV No.</b>	902247	<b>Ref. No.</b>	809562
<b>description</b>	door seal profile 2730 W 470mm L 785mm suitable for RATIONAL for model CPC 101 outer plug size Qty 1		

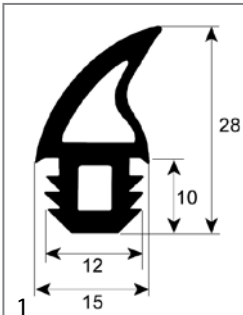

<b>GEV No.</b>	901331	<b>Ref. No.</b>	8C0917
<b>description</b>	door seal profile 2756 Qty supplied by meter		

door seals with fixing hook



<b>GEV No.</b>	900224	<b>Ref. No.</b>	C10088
<b>description</b>	door seal W 480mm long side open with mounting clip H 400mm		



<b>GEV No.</b>	900225	<b>Ref. No.</b>	C00165
<b>description</b>	door seal W 510mm long side open H 300mm		



<b>GEV No.</b>	900227	<b>Ref. No.</b>	C10090
<b>description</b>	door seal W 560mm long side open with mounting clip H 360mm		



<b>GEV No.</b>	900228	<b>Ref. No.</b>	C10091
<b>description</b>	door seal W 840mm long side open with mounting clip H 370mm		



<b>GEV No.</b>	900394	<b>Ref. No.</b>	132110003
<b>description</b>	oven gasket L 370mm W 640mm 6 hooks external size		

gaskets for tray rack trolleys

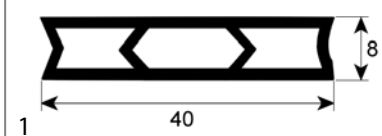

<b>GEV No.</b>	901330	<b>Ref. No.</b>	141110016
<b>description</b>	tray rack trolley gasket profile 4065 silicone Qty supplied by meter		

O-rings

EPDM

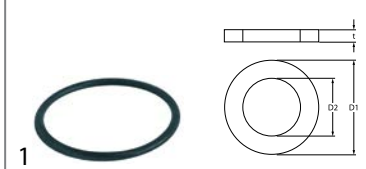

<b>GEV No.</b>	532118	<b>Ref. No.</b>	808043 808055
<b>description</b>	O-ring EPDM thickness 3.53mm ID ø 55.56mm Qty 10 pcs		

Viton

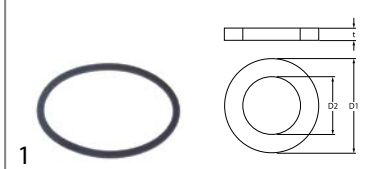

<b>GEV No.</b>	525313	<b>Ref. No.</b>	808709
<b>description</b>	O-ring Viton ID ø 60.33mm thickness 3.53mm Qty 1 pcs		



Зип.Общепит  
transmission technology and ball bearings  
vsezip.ru  
drive bits

77(812)987-08-81

1

<b>GEV No.</b>	532649	<b>Ref. No.</b>	808710
<b>description</b>	O-ring Viton ID $\varnothing$ 63.17mm thickness 2.62mm Qty 1 pcs		

1

<b>GEV No.</b>	510245	<b>Ref. No.</b>	808054
<b>description</b>	O-ring Viton thickness 3.53mm ID $\varnothing$ 50.8mm Qty 1 pcs		

1

<b>GEV No.</b>	510243	<b>Ref. No.</b>	808055
<b>description</b>	O-ring Viton thickness 3.53mm ID $\varnothing$ 55.56mm Qty 1 pcs		

sealing washers

fibre gaskets

1

<b>GEV No.</b>	510405	<b>Ref. No.</b>	903300
<b>description</b>	flat gasket fibre ED $\varnothing$ 56mm ID $\varnothing$ 42mm thickness 2mm for thread 1 1/4" Qty 1 pcs		

shaft gaskets

shaft gaskets

1

<b>GEV No.</b>	511171	<b>Ref. No.</b>	809829
<b>description</b>	shaft seal ID $\varnothing$ 14.5mm ED $\varnothing$ 20mm thickness 3mm		

poly-v belts

1

<b>GEV No.</b>	693939	<b>Ref. No.</b>	8C0949
<b>description</b>	poly-v belt grooves 6 W 12mm L 630mm profile TB2		

1

<b>GEV No.</b>	697367	<b>Ref. No.</b>	808759
<b>description</b>	poly-v belt grooves 8 W 16mm L 330mm profile TB2		

springs

torsion springs



1

<b>GEV No.</b>	690081	<b>Ref. No.</b>	808873	
<b>description</b>	torsion spring $\varnothing$ 19.4mm L2 36mm wire gauge $\varnothing$ 3.3mm mounting pos. left L1 42mm L3 36mm Qty 1 pcs			
<b>accessories for</b>	690081			
	<b>GEV No.</b>	690080	<b>Ref. No.</b>	808874
	torsion spring $\varnothing$ 19.4mm L2 37mm wire gauge $\varnothing$ 3.4mm mounting pos. right L1 42mm L3 37mm Qty 1 pcs			

Зип-Общепит



vsezip.ru

+7(812)987-08-81

			
1			
<b>GEV No.</b>	690080	<b>Ref. No.</b>	808874
<b>description</b>	torsion spring $\phi$ 19.4mm L2 37mm wire gauge $\phi$ 3.4mm mounting pos. right L1 42mm L3 37mm Qty 1 pcs		
<b>accessories for</b>	690080		
	<b>GEV No.</b>	690081	<b>Ref. No.</b> 808873
<b>description</b>	torsion spring $\phi$ 19.4mm L2 36mm wire gauge $\phi$ 3.3mm mounting pos. left L1 42mm L3 36mm Qty 1 pcs		

			
1			
<b>GEV No.</b>	700171	<b>Ref. No.</b>	8C0361
<b>description</b>	torsion spring $\phi$ 21.4mm L2 40mm wire gauge $\phi$ 3.3mm L1 100mm L3 34mm		

### manometers

			
1			
<b>GEV No.</b>	541062	<b>Ref. No.</b>	808347
<b>description</b>	manometer $\phi$ 63mm pressure range 0 up to 1bar connection marking adjustable kettle thread 1/4"		
<b>spare parts for</b>	541062		
	<b>GEV No.</b>	541130	<b>Ref. No.</b> —
<b>description</b>	glass panel $\phi$ 58mm thickness 2mm		

### hose reels and spray guns

#### cleaning guns

			
1			
<b>GEV No.</b>	541473	<b>Ref. No.</b>	8C2178
<b>description</b>	cleaning spray gun connection with snap-on connection DN13 brass		
<b>spare parts for</b>	541473		
	<b>GEV No.</b>	540516	<b>Ref. No.</b> —
<b>description</b>	coupling bush type DN13 chrome-plated brass connection 1/2" IT		

<b>spare parts for</b>	541473		
<b>GEV No.</b>	540535	<b>Ref. No.</b>	—
<b>description</b>	nozzle connection snap-on connection short SS		
<b>accessories for</b>	541473		
<b>GEV No.</b>	540536	<b>Ref. No.</b>	—
<b>description</b>	foam lance connection snap-on connection plastic total length 182mm		
<b>GEV No.</b>	541870	<b>Ref. No.</b>	—
<b>description</b>	foam lance connection snap-on connection aluminium L 450mm		







### dosing pumps

#### peristaltic dosing pumps

SEKO

built-in version

with frequency control

			
1			
<b>GEV No.</b>	361215	<b>Ref. No.</b>	8C0900
<b>description</b>	dosing pump SEKO frequency control 0.3-3.0l/h 230VAC detergent hose $\phi$ 4x6mm hose type K hose Santoprene suction level 1.5m type PBR protection IP55 dimensions 100x67x68mm power input 3.5W		
<b>spare parts for</b>	361215		
	<b>GEV No.</b>	361136	<b>Ref. No.</b> —
<b>description</b>	roller assembly for dosing pump hole $\phi$ 4.8x4mm		
	<b>GEV No.</b>	361226	<b>Ref. No.</b> —
<b>description</b>	PCB L 59mm W 26mm electronic control		
	<b>GEV No.</b>	361815	<b>Ref. No.</b> —
<b>description</b>	pump hose detergent hose $\phi$ 6x10mm hose $\phi$ 4x6mm hose type K hose Santoprene type SEKO		
<b>accessories for</b>	361215		
	<b>GEV No.</b>	361142	<b>Ref. No.</b> —
<b>description</b>	mounting set detergent hose type 4x6mm hose length 2m PVC 2x hose/container filter/tank intake transparent		
	<b>GEV No.</b>	520090	<b>Ref. No.</b> —
<b>description</b>	PVC hose ID $\phi$ 4mm ED $\phi$ 6mm L 2m thickness 1mm t.max. 60°C transparent		
	<b>GEV No.</b>	520091	<b>Ref. No.</b> —
<b>description</b>	nylon hose ID $\phi$ 4mm ED $\phi$ 6mm L 2m thickness 1mm operating p. 10bar burst p. 50bar t.max. 100°C transparent		

## accessories

## non-return valves



1

<b>GEV No.</b>	361821	<b>Ref. No.</b>	809742 8C0192
<b>description</b>	non-return valve inlet 4x6mm outlet 1/4" L 45mm		

## hoses

## drain hoses



1

<b>GEV No.</b>	513718	<b>Ref. No.</b>	8C0154
<b>description</b>	drain hose DN19 L 1500mm straight ø inside 24mm straight ext. ø 28mm outer hose ø 23mm		

## for dishwashers

## miscellaneous



1

<b>GEV No.</b>	511467	<b>Ref. No.</b>	907295
<b>description</b>	pressure hose L 1000mm		

## valves and tank inlets

## ball valves

## universal

## ball valves with lever handle



1

<b>GEV No.</b>	514325	<b>Ref. No.</b>	C00913
<b>description</b>	ball valve connection 1" IT - 1" IT DN25 total length 83mm with lever handle		

Зип Общепит

vsezip.ru

+7(812)987-08-81



1

<b>GEV No.</b>	520280	<b>Ref. No.</b>	827969
<b>description</b>	ball valve connection 1/2" IT - 1/2" IT DN15 total length 50mm with lever handle handle length 85mm		



1

<b>GEV No.</b>	540730	<b>Ref. No.</b>	808433
<b>description</b>	ball valve connection 3/4" IT - 3/4" IT DN20 total length 70mm with lever handle handle length 95mm		

## inlet taps



1

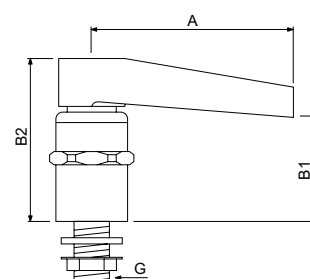

<b>GEV No.</b>	540705	<b>Ref. No.</b>	809314
<b>description</b>	inlet tap connection 1/2" ET tube ø 40mm projection 120mm overall height 95mm spout height 60mm rotation 360°		



1





<b>GEV No.</b>	540704	<b>Ref. No.</b>	808420
<b>description</b>	inlet spout		

drain systems and wash basins ancillary products

drain fittings

universal







<b>GEV No.</b>	515041	<b>Ref. No.</b>	825827
<b>description</b>	drain fitting size 3/4" usable height 30mm overall height 30mm ED ø 38mm chrome-plated brass		
<b>accessories for</b>	515041		
	<b>GEV No.</b>	515047	<b>Ref. No.</b> —
	standpipe size 3/4" usable height 28mm overall height 54mm ED ø 20mm chrome-plated brass with O-ring		
	<b>GEV No.</b>	515048	<b>Ref. No.</b> —
	standpipe size 3/4" usable height 48mm overall height 74mm ED ø 20mm chrome-plated brass with O-ring		
	<b>GEV No.</b>	515049	<b>Ref. No.</b> —
	standpipe size 3/4" usable height 68mm overall height 94mm ED ø 20mm chrome-plated brass with O-ring		
	<b>GEV No.</b>	515050	<b>Ref. No.</b> —
	standpipe size 3/4" usable height 98mm overall height 124mm ED ø 20mm chrome-plated brass with O-ring		

standpipes

3/4"



<b>GEV No.</b>	515041	<b>Ref. No.</b>	825827
<b>description</b>	drain fitting size 3/4" usable height 30mm overall height 30mm ED ø 38mm chrome-plated brass		
<b>accessories for</b>	515041		
	<b>GEV No.</b>	515047	<b>Ref. No.</b> —
	standpipe size 3/4" usable height 28mm overall height 54mm ED ø 20mm chrome-plated brass with O-ring		
	<b>GEV No.</b>	515048	<b>Ref. No.</b> —
	standpipe size 3/4" usable height 48mm overall height 74mm ED ø 20mm chrome-plated brass with O-ring		
	<b>GEV No.</b>	515049	<b>Ref. No.</b> —
	standpipe size 3/4" usable height 68mm overall height 94mm ED ø 20mm chrome-plated brass with O-ring		
	<b>GEV No.</b>	515050	<b>Ref. No.</b> —
	standpipe size 3/4" usable height 98mm overall height 124mm ED ø 20mm chrome-plated brass with O-ring		

clamps

hose clamps

DIN 3017 - W2



<b>GEV No.</b>	520112	<b>Ref. No.</b>	902440
<b>description</b>	hose clamp ø 12-20mm width 9mm Qty 10 pcs DIN 3017		



<b>GEV No.</b>	520119	<b>Ref. No.</b>	902490
<b>description</b>	hose clamp ø 60-80mm width 9mm Qty 5 pcs DIN 3017		



<b>GEV No.</b>	520454	<b>Ref. No.</b>	E23110007
<b>description</b>	hose clamp ø 70-90mm width 9mm Qty 5 pcs DIN 3017		

tools

hand tools

wrenches

miscellaneous



<b>GEV No.</b>	550449	<b>Ref. No.</b>	808893
<b>description</b>	special wrench for ring nut		





## socket wrenches

## tubular box wrenches



1

<b>GEV No.</b>	550448	<b>Ref. No.</b>	808894
<b>description</b>	tubular box wrench special for fryer L 280mm WS 10		

## measuring equipment

## thermometers

## built-in thermometers

ø52mm



1

<b>GEV No.</b>	541077	<b>Ref. No.</b>	808667
<b>description</b>	thermometer mounting ø 52mm t.max. 350°C +50 up to +350°C probe ø 6mm probe L 30mm capillary pipe 1000mm built-in depth 28mm		

ø60mm



1

<b>GEV No.</b>	541863	<b>Ref. No.</b>	809747
<b>description</b>	thermometer mounting ø 60mm 50-350°C probe ø 6mm probe L 19mm capillary pipe 1600mm		

## fastening material

## screws

## grub screws

DIN 916/ISO 4029

+7(812)987-08-81



1

<b>GEV No.</b>	560366	<b>Ref. No.</b>	C00513
<b>description</b>	grub screw thread M6 L 20mm SS intake internal hexagon WS 3 Qty 1 pcs		

## nuts

## cap nuts



1

<b>GEV No.</b>	560137	<b>Ref. No.</b>	808998
<b>description</b>	cap nuts thread M6 WS 10 SS Qty 20 pcs DIN/ISO DIN 1587		

## washers

## washers

DIN 125A



1

<b>GEV No.</b>	560312	<b>Ref. No.</b>	8C0631
<b>description</b>	plain washer ID ø 10.5mm ED ø 20mm thickness 2mm SS Qty 1 pcs DIN 125A for thread M10		

## miscellaneous



1

<b>GEV No.</b>	524117	<b>Ref. No.</b>	E25110025
<b>description</b>	plain washer ID ø 6.4mm ED ø 12mm thickness 1.6mm SS Qty 1 pcs		



1

<b>GEV No.</b>	506160	<b>Ref. No.</b>	8C0647
<b>description</b>	plain washer ID ø 8.6mm ED ø 16mm thickness 1.5mm SS Qty 1 pcs		

Зип-Общепит

roll pins

vsezip.ru

+7(812)987-08-81

## fasteners

## clamps

## hose clamps

DIN 3017 - W2



1

<b>GEV No.</b>	520112	<b>Ref. No.</b>	902440
----------------	--------	-----------------	--------

<b>description</b>	hose clamp ø 12-20mm width 9mm Qty 10 pcs DIN 3017		
--------------------	--	--	--



1

<b>GEV No.</b>	520119	<b>Ref. No.</b>	902490
----------------	--------	-----------------	--------

<b>description</b>	hose clamp ø 60-80mm width 9mm Qty 5 pcs DIN 3017		
--------------------	---	--	--



1

<b>GEV No.</b>	520454	<b>Ref. No.</b>	E23110007
----------------	--------	-----------------	-----------

<b>description</b>	hose clamp ø 70-90mm width 9mm Qty 5 pcs DIN 3017		
--------------------	---	--	--

## consumables

## containers

## bags



1

<b>GEV No.</b>	960027	<b>Ref. No.</b>	825873 TA-G
----------------	--------	-----------------	----------------

<b>description</b>	bag polypropylene L 475mm ø 130mm		
--------------------	-----------------------------------	--	--

Зип Общепит

fastening material

105

vsezip.ru

+7(812)987-08-81

<b>A</b>			
alarm devices	31		
axial fans	43	gas burners	72
<b>B</b>		gas control valves	57
ball valves	103	gas nozzles	79
bar burners	77	gas taps	50
bi-metal thermostats	11, 11	gas thermostats	53
booster pumps I	48	gaskets for heated units	98
booster pumps II	49	gaskets for tray rack trolleys	100
<b>C</b>		grates	93
cable glands	50	grub screws	105
cables	50	<b>H</b>	
cam switches	22	hand tools	104
cap nuts	105	handle latches	87
capillary tube clips	18	heater battery	7
clamps	104, 106	heating cables	6
cleaning guns	102, 102	heating elements	3
coil heating elements	7	heating elements for bain maries	3
cold air circulating fans (complete)	44	heating elements for chip scuttles	4
compressors	42	heating elements for convection	8
condensators & interference suppression filters	49	heating elements for fryers	4
consumables	106	heating elements for griddles	5
contactors	31	heating elements for heated cabinets	6
containers	106	heating elements for ovens	3
control equipment	24	heating elements for pasta cookers	5
control thermostats	12	heating elements for pizza ovens	6
cross flow fans	44	hob burners	72
<b>D</b>		hose clamps	104, 106
door catches	87	hoses	103
door seals	99	hot air fans	47
door seals with fixing hook	100	hot air motors	45
dosing pumps	102	hot plates	10
drain fittings	104	<b>I</b>	
drain hoses	103	ignition boxes	60
drain pumps	48	ignition cables	69
drain systems and wash basins	104	ignition switches	70
<b>E</b>		ignition units	70
earthing cables	50	immersion heating elements	7
edgemount latches	87	indicator lights	25
electric accessories	50	indicator lights (complete)	26
electric timers	30	inlet spouts	103
electrodes	42	inlet taps	103
electronic controllers	34	<b>L</b>	
energy regulators	11	lamps	25
<b>F</b>		light bulbs	27
fans	43	<b>M</b>	
fasteners	106	magnetic switches	23
		measuring equipment	105

Зип Общепит

T

vsezip.ru

+7(812)987-08-81

mechanical timers	30	temperature probes	36
microswitches	20	terminals	50
motors	47	thermocouples	70
<b>N</b>		thermostats	11
non-return valves	103	threaded cable glands	50
nuts	105	time relays	33
<b>O</b>		timers	30
operating capacitors	49	tools	104
O-rings	100	transformers	34
oven hinges	88	tube burners	79
oven lamps	27	tubular box wrenches	105
<b>P</b>		<b>U</b>	
piezoelectric igniters	69	universal probes	36
pilot burners	61	<b>V</b>	
plug-in gaskets	93	valves and tank inlets	103
position switches	21	<b>W</b>	
pressure switches	41	wash and rinse pumps	48
probes	36	washers	105
programme timers	30	window seals	98
pumps	48	wrenches	104
pumps for ice machines	49		
push/momentary push switches	19		
<b>R</b>			
radiation heaters	10		
refrigeration fans	44		
refrigeration gaskets	93		
refrigeration motors universal	44		
refrigeration thermostats	18		
relays	32		
residual heat indicators	29		
rocker/momentary rocker switches	19		
roll pins	106		
<b>S</b>			
safety thermostats	15		
screw-in gaskets	98		
screws	105		
sealing washers	101		
shaft gaskets	101		
shelves and shelf rails	93		
snap locks	88		
socket wrenches	105		
solenoid valves	39		
solid state relays	32		
standpipes	104		
switches and momentary switches	19		
system switches (ROLD)	21		