



Зип Общепит

vsezip.ru

+7(812)987-08-81



**GAS COMPONENTS**



**ELECTRIC COMPONENTS**



**WATER TECHNOLOGY**



**MECHANICAL COMPONENTS**



**TOOLS**

Spare parts suitable for

**LINCAT**

Find the complete and up-to-date range of products in our GEV Webshop

Зип Общепит

vsezip.ru

+7(812)987-08-81

# Manufacturer catalogue

The most important spare parts and accessories arranged clearly for every manufacturer



**Complete product range and all appliance data always up to date in the GEV Webshop**







**Alphabetical Index at the end of the catalogue**

## GEV Webshop

[www.gev-online.co.uk](http://www.gev-online.co.uk)

[www.gev-online.com](http://www.gev-online.com)



-  Add to Favourites
-  Sign In with email address and usual password
-  Easy-order – place several items in your basket at the same time
-  Quick Item search – no login needed



## heating elements

### heating elements for ovens

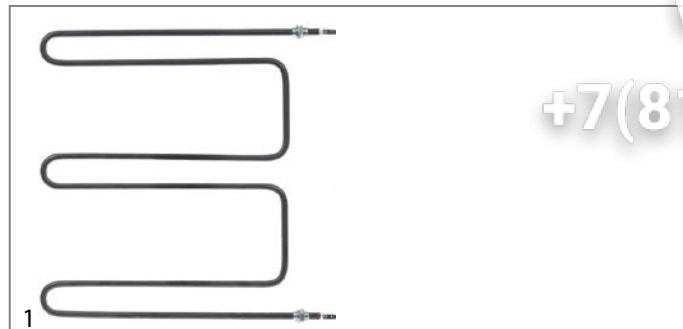

<b>GEV No.</b>	420569	<b>Ref. No.</b>	EL31
<b>description</b>	heating element 1000W 240V heating circuits 1 L 360mm thread M12x1 tube ø 8.5mm connection male faston 6.3mm W 355mm		

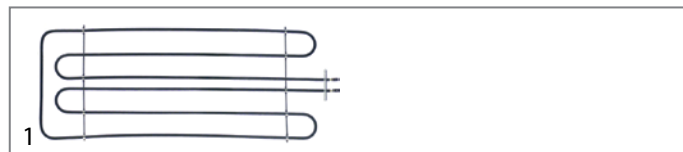

<b>GEV No.</b>	419278	<b>Ref. No.</b>	EL190
<b>description</b>	heating element 1400W 240V heating circuits 1 L 618mm W 235mm L1 602mm L2 16mm W1 102mm W2 30mm flange length 70mm flange width 22.5mm hole distance 55mm bridge length 250mm hole ø 5mm tube ø 6.3mm connection 6.3x0.8 mounting pos. lower		
<b>For models:</b>	ECO9		

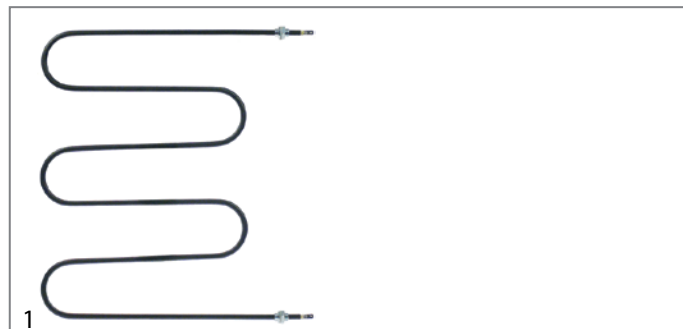

<b>GEV No.</b>	417758	<b>Ref. No.</b>	EL30
<b>description</b>	heating element 2000W 240V heating circuits 1 L 355mm thread 1/4" W 430mm tube ø 8.5mm mounting distance 420mm bridge length-mm connection male faston 6.3mm 2 hole fixing		

### heating elements for bain maries

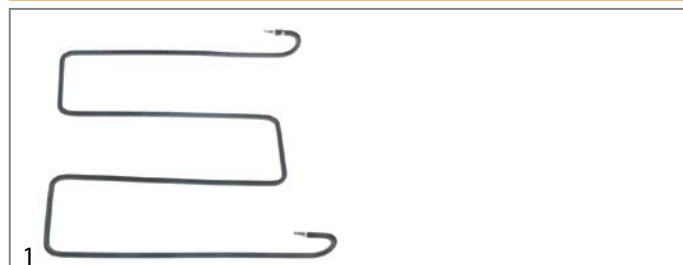

<b>GEV No.</b>	418975	<b>Ref. No.</b>	EL152
<b>description</b>	heating element 2000W 230V heating circuits 1 L 400mm L1 50mm W 505mm connection plug connection ø6.5mm tube ø 8.5mm dry heating element H 50mm		
<b>For models:</b>	BM6W, BM7W, BS7W		

Зип Общепит

vsezip.ru

+7(812)987-08-81

<b>GEV No.</b>	418992	<b>Ref. No.</b>	EL19-CS6
<b>description</b>	heating element 750W 240V heating circuits 1 L 353mm W 245mm connection male faston 6.3mm tube ø 8.5mm thread M12x1 mounting distance 236.5mm		

<b>GEV No.</b>	420470	<b>Ref. No.</b>	EL19/UL
<b>description</b>	heating element 750W 240V heating circuits 1 L 910mm connection male faston 6.3mm to be bend tube ø 8.5mm 2 hole fixing thread M12x1 dry heating element		
<b>For models:</b>	GBM2		

### heating elements for fryers



<b>GEV No.</b>	420000	<b>Ref. No.</b>	EL209
<b>description</b>	heating element 6000W 230V heating circuits 2 L 315mm W 350mm H 174mm rectangular flange connection male faston 6.3mm immersion heater W2 164mm hole distance 181mm hole ø 4mm flange length 185mm flange width 34mm tube ø 8.6mm		
<b>For models:</b>	DF46		

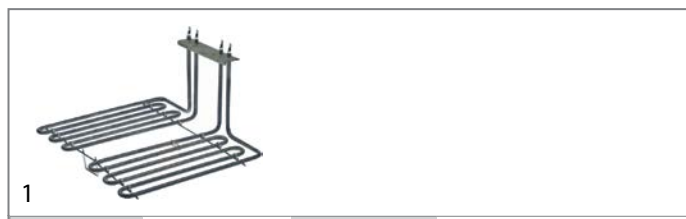

<b>GEV No.</b>	420587	<b>Ref. No.</b>	EL211
<b>description</b>	heating element 6000W 230V heating circuits 2 L 317mm W 410mm H 165mm rectangular flange connection male faston 6.3mm hole ø 4mm flange length 185mm flange width 35mm tube ø 8.5mm		
<b>For models:</b>	DF66ST		

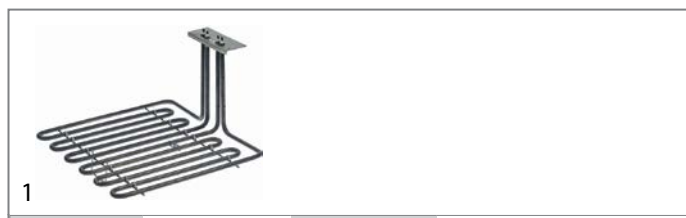

<b>GEV No.</b>	419266	<b>Ref. No.</b>	EL266
<b>description</b>	heating element 6000W 230V heating circuits 2 L 325mm W 350mm H 190mm rectangular flange connection male faston 6.3mm flange length 145mm flange width 48mm tube ø 8.5mm		



Зип Общепит

vsezip.ru

+7(812)987-08-81

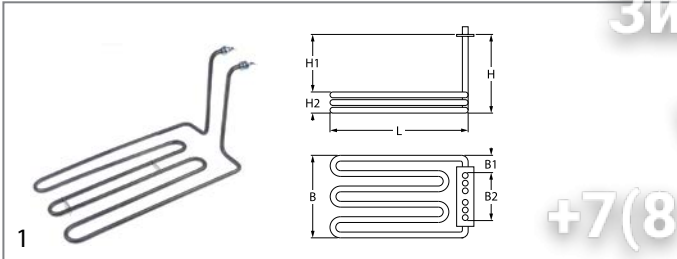

<b>GEV No.</b>	418989	<b>Ref. No.</b>	EL13
<b>description</b>	heating element 3000W 230V heating circuits 1 L 390mm W 195mm H 190mm 2 hole fixing connection male faston 6.3mm immersion heater L1 30mm L2 360mm W1 70mm W2 55mm tube $\varnothing$ 8.6mm thread M12x1 mounting distance 46mm windings 3		

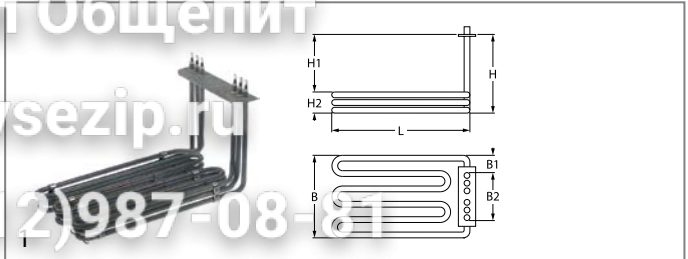

<b>GEV No.</b>	419282	<b>Ref. No.</b>	EL200
<b>description</b>	heating element 9000W 230V heating circuits 3 L 325mm W 170mm H 163mm rectangular flange connection F6.3x0.8 fryer heaters W2 162mm H1 135mm H2 35mm hole $\varnothing$ 4mm flange length 185mm flange width 34mm tube $\varnothing$ 8.5mm		
<b>For models:</b>	DF39, DF618, J18, J9		

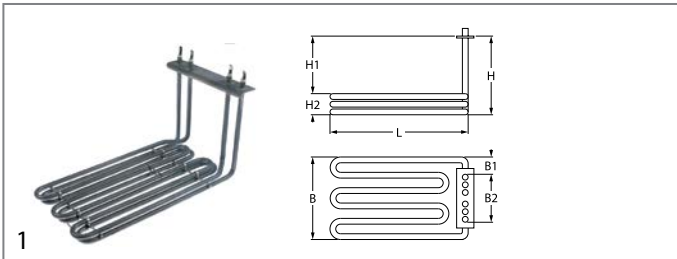

<b>GEV No.</b>	418990	<b>Ref. No.</b>	EL198
<b>description</b>	heating element 6000W 230V heating circuits 2 L 325mm W 163mm H 170mm immersion heater H1 148mm H2 22mm hole distance 77mm hole $\varnothing$ 4mm flange length 185mm flange width 34mm tube $\varnothing$ 8.6mm		
<b>For models:</b>	DF36, DF612, J12, J6		

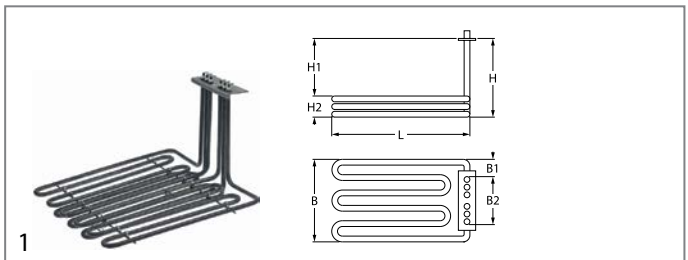

<b>GEV No.</b>	419265	<b>Ref. No.</b>	EL267
<b>description</b>	heating element 9000W 230V heating circuits 3 L 325mm W 350mm H 195mm rectangular flange connection male faston 6.3mm H1 175mm H2 20mm flange length 145mm flange width 48mm tube $\varnothing$ 8.5mm		

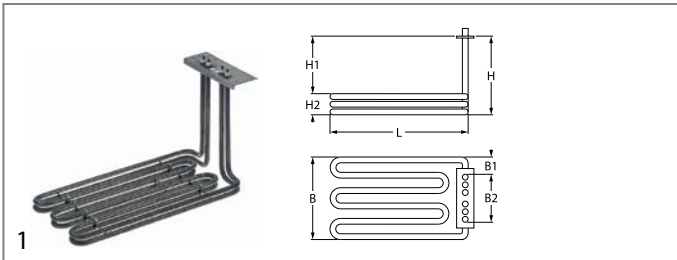

<b>GEV No.</b>	419263	<b>Ref. No.</b>	EL265
<b>description</b>	heating element 6000W 230V heating circuits 2 L 325mm W 165mm H 190mm rectangular flange connection male faston 6.3mm H1 170mm H2 20mm flange length 145mm flange width 48mm tube $\varnothing$ 8.5mm		

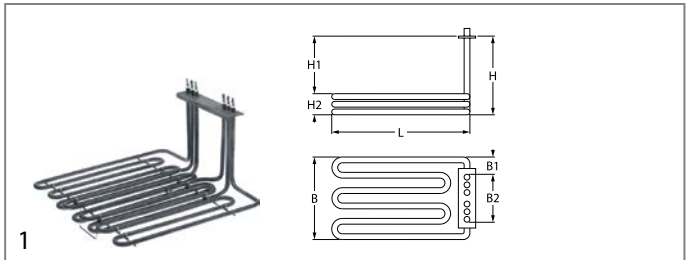

<b>GEV No.</b>	419267	<b>Ref. No.</b>	EL210
<b>description</b>	heating element 9000W 230V heating circuits 3 L 325mm W 350mm H 220mm rectangular flange connection male faston 6.3mm W1 95mm W2 163mm H1 146mm H2 23mm hole $\varnothing$ 4mm flange length 185mm flange width 34mm tube $\varnothing$ 8.5mm		
<b>For models:</b>	DF49		

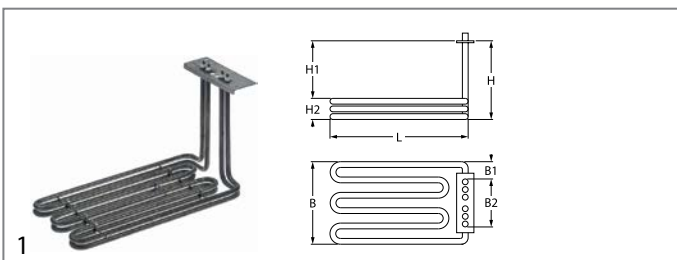

<b>GEV No.</b>	419264	<b>Ref. No.</b>	EL268
<b>description</b>	heating element 6000W 230V heating circuits 2 L 325mm W 165mm H 190mm rectangular flange connection male faston 6.3mm H1 170mm H2 20mm flange length 145mm flange width 48mm tube $\varnothing$ 8.5mm		

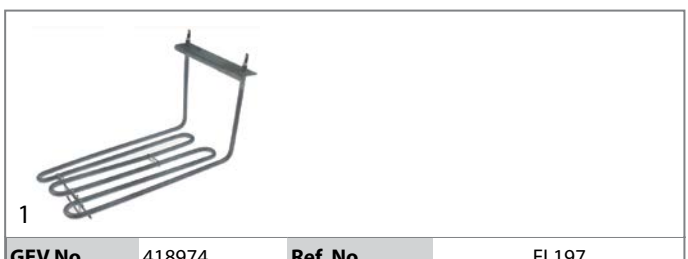

<b>GEV No.</b>	418974	<b>Ref. No.</b>	EL197
<b>description</b>	heating element 3000W 230V heating circuits 1 L 320mm W 170mm H 165mm rectangular flange fryer flange length 185mm flange width 35mm tube $\varnothing$ 8.5mm		
<b>For models:</b>	DF33, DF66		



Зип Общепит

vsezip.ru

+7(812)987-0881



1

<b>GEV No.</b>	419260	<b>Ref. No.</b>	EL264
<b>description</b>	heating element 3000W 230V heating circuits 1 L 320mm W 170mm H 190mm rectangular flange connection male faston 6.3mm fryer flange length 145mm flange width 48mm tube $\varnothing$ 8.5mm		



1

<b>GEV No.</b>	419262	<b>Ref. No.</b>	EL269
<b>description</b>	heating element 3000W 230V heating circuits 1 L 325mm W 160mm H 185mm rectangular flange connection male faston 6.3mm fryer flange length 145mm flange width 48mm tube $\varnothing$ 8.5mm		

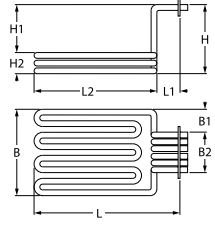
1

<b>GEV No.</b>	418965	<b>Ref. No.</b>	EL88
<b>description</b>	heating element 6000W 240V heating circuits 2 L 360mm W 160mm H 213mm L1 30mm L2 320mm W1 55mm W2 50mm H1 195mm H2 20mm windings 3 flange length 100mm flange width 25mm hole distance 90mm hole $\varnothing$ 6mm connection male faston 6.3mm tube $\varnothing$ 8mm for fryer		

2 hole fixing

1

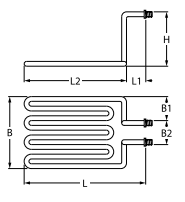
<b>GEV No.</b>	417760	<b>Ref. No.</b>	EL229
<b>description</b>	heating element 2500W 230V heating circuits 1 L 280mm W 125mm H 152mm 2 hole fixing connection male faston 6.3mm L1 55mm L2 250mm W1 40mm W2 33mm tube $\varnothing$ 8.5mm thread M12x1 mounting distance 25mm windings 3		

1

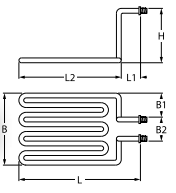
<b>GEV No.</b>	420588	<b>Ref. No.</b>	EL228
<b>description</b>	heating element 3000W 230V L 245mm W 180mm H 155mm screw mounting connection male faston 6.3mm L1 20mm L2 225mm W1 65mm W2 33mm tube $\varnothing$ 8.5mm thread M12 suitable for fryer		
<b>For models:</b>	LDF, LDF2, LFF		

1

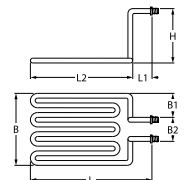
<b>GEV No.</b>	418973	<b>Ref. No.</b>	EL10 EL10/UL
<b>description</b>	heating element 3000W 240V heating circuits 1 L 220mm W 210mm H 175mm 2 hole fixing connection male faston 6.3mm fryer heaters L1 20mm L2 200mm W1 85mm W2 40mm tube $\varnothing$ 8.5mm thread M12x1 mounting distance 32mm connection length 2mm windings 5		

6 hole fixing



1

<b>GEV No.</b>	417759	<b>Ref. No.</b>	EL185
<b>description</b>	heating element 11000W 230V heating circuits 3 L 370mm W 213mm H 222mm H1 180mm H2 32mm thread M12x1 tube $\varnothing$ 8.5mm screw mounting connection M4 fryer		



1

<b>GEV No.</b>	417749	<b>Ref. No.</b>	EL220
<b>description</b>	heating element 12000W 230V heating circuits 3 L 370mm W 213mm H 222mm H1 180mm H2 32mm thread M12x1 tube $\varnothing$ 8.5mm connection M4 screw mounting fryer		
<b>For models:</b>	OE7112, OE7113		





Зип Общепит

vsezip.ru

+7(812)987-08-81

			
1			
<b>GEV No.</b>	417754	<b>Ref. No.</b>	EL189
<b>description</b>	heating element 12000W 230V heating circuits 3 L 370mm W 257mm H 225mm H2 32mm thread M12x1 tube ø 8.5mm screw mounting connection M4 fryer		
<b>For models:</b>	OE7104		

			
1			
<b>GEV No.</b>	417755	<b>Ref. No.</b>	EL180
<b>description</b>	heating element 7000W 230V heating circuits 3 L 345mm W 112mm H 220mm H2 32mm thread M12x1 tube ø 8.5mm screw mounting connection M4 fryer		
<b>For models:</b>	OE7105		

			
1			
<b>GEV No.</b>	420570	<b>Ref. No.</b>	EL310
<b>description</b>	heating element 2000W 230V heating circuits 1 L 405mm W 85mm H 80mm thread M4 tube ø 8.5mm		

## heating elements for griddles

			
1			
<b>GEV No.</b>	420589	<b>Ref. No.</b>	EL273
<b>description</b>	heating element 11200W 230V heating circuits 3 L 515mm W 535mm H 150mm tube ø 8.5mm connection M5 flange 145x48mm		

			
1			
<b>GEV No.</b>	420566	<b>Ref. No.</b>	EL104
<b>description</b>	heating element 2000W 240V heating circuits 1 L 330mm W 185mm H 50mm tube ø 8.5mm		
<b>For models:</b>	GS3, GS6T		

			
1			
<b>GEV No.</b>	420567	<b>Ref. No.</b>	EL105
<b>description</b>	heating element 2700W 240V heating circuits 1 L 325mm W 350mm H 50mm tube ø 8.5mm		
<b>For models:</b>	GS4		

			
1			
<b>GEV No.</b>	417746	<b>Ref. No.</b>	EL155
<b>description</b>	heating element 2800W 230V heating circuits 1 L 330mm W 180mm H 55mm tube ø 8.5mm		
<b>For models:</b>	GS6TE, GS9		

			
1			
<b>GEV No.</b>	420563	<b>Ref. No.</b>	EL108
<b>description</b>	heating element 3000W 240V L 330mm W 310mm H 55mm connection male faston 6.3mm tube ø 8.5mm heating circuits 1		
<b>For models:</b>	GS7, GS7E, GS9		

			
1			
<b>GEV No.</b>	420564	<b>Ref. No.</b>	EL106
<b>description</b>	heating element 3000W 240V L 340mm W 500mm H 70mm W2 45mm connection male faston 6.3mm tube ø 8.5mm heating circuits 1		
<b>For models:</b>	GS6		



Зип Общепит  
vsezip.ru  
+7(812)987-08-81



1

<b>GEV No.</b>	417751	<b>Ref. No.</b>	EL202
<b>description</b>	heating element 3500W 230V heating circuits 1 L 405mm W 188mm H 60mm tube ø 8.5mm griddle connection type grip connection		
<b>For models:</b>	OE7206, OE7209		



1

<b>GEV No.</b>	420573	<b>Ref. No.</b>	EL313
<b>description</b>	heating element 6400W 230V heating circuits 3 L 515mm W 535mm H 140mm tube ø 8.5mm connection M5		



1

<b>GEV No.</b>	417753	<b>Ref. No.</b>	EL201
<b>description</b>	heating element 4000W 230V heating circuits 1 L 400mm W 190mm H 60mm tube ø 8.5mm griddle connection type grip connection		
<b>For models:</b>	OE7206, OE7209		



1

<b>GEV No.</b>	420574	<b>Ref. No.</b>	EL270
<b>description</b>	heating element 8000W 230V heating circuits 3 L 415mm W 465mm H 150mm tube ø 8.5mm		



1

<b>GEV No.</b>	420565	<b>Ref. No.</b>	EL107
<b>description</b>	heating element 4500W 230V heating circuits 1 L 325mm W 500mm H 60mm tube ø 8.5mm		



1

<b>GEV No.</b>	420590	<b>Ref. No.</b>	EL272
<b>description</b>	heating element 8250W 230V heating circuits 3 L 515mm W 395mm H 150mm tube ø 8.5mm connection M5 flange 145x48mm		

heating elements for large hobs



1

<b>GEV No.</b>	420591	<b>Ref. No.</b>	EL276
<b>description</b>	heating element 5333W 230V heating circuits 2 L 420mm W 290mm H 150mm tube ø 8.5mm connection male faston 6.3mm flange 145x48mm		



1

<b>GEV No.</b>	420571	<b>Ref. No.</b>	EL306
<b>description</b>	heating element 2150W 400V heating circuits 1 L 430mm W 260mm H 100mm connection cable tube ø 13x6mm cable length 700mm dry heating element		

heating elements for contact grills



1

<b>GEV No.</b>	420572	<b>Ref. No.</b>	EL314
<b>description</b>	heating element 6200W 230V heating circuits 3 L 515mm W 395mm H 125mm tube ø 8.5mm connection M5		



1

<b>GEV No.</b>	419279	<b>Ref. No.</b>	EL280
<b>description</b>	heating element 4300W heating circuits 1 L 450mm W 280mm cable length 700mm connection 2-wire		
<b>For models:</b>	OE7210		



## heating elements for pizza ovens

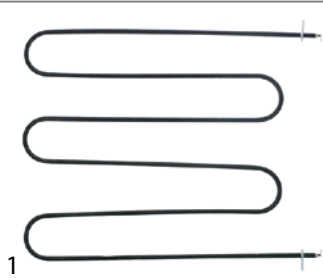

<b>GEV No.</b>	419276	<b>Ref. No.</b>	EL258
<b>description</b>	heating element 1000W 230V heating circuits 1 L 502mm W 185mm lug length 40mm lug width 18mm hole distance 210mm connection 6.3x0.8 tube ø 8.5mm mounting pos. upper hole ø 5mm pizza oven		

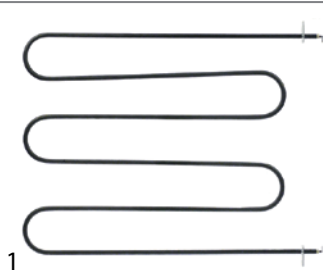

<b>GEV No.</b>	417757	<b>Ref. No.</b>	EL177
<b>description</b>	heating element 1100W 230V heating circuits 1 L 510mm W 400mm lug length 40mm lug width 18mm connection male faston 6.3mm tube ø 8.5mm bracket mounting mounting pos. lower hole ø 5mm pizza oven		

<b>accessories for</b>	417757			
	<b>GEV No.</b>	417756	<b>Ref. No.</b>	EL176
	heating element 1750W 230V heating circuits 1 L 510mm W 410mm lug length 40mm lug width 18mm connection male faston 6.3mm tube ø 8.5mm bracket mounting mounting pos. upper hole ø 5mm pizza oven			

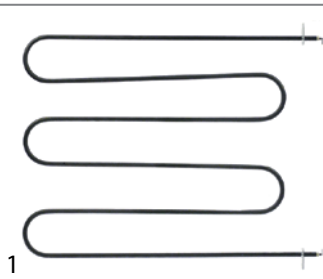

<b>GEV No.</b>	417756	<b>Ref. No.</b>	EL176
<b>description</b>	heating element 1750W 230V heating circuits 1 L 510mm W 410mm lug length 40mm lug width 18mm connection male faston 6.3mm tube ø 8.5mm bracket mounting mounting pos. upper hole ø 5mm pizza oven		

<b>accessories for</b>	417756			
	<b>GEV No.</b>	417757	<b>Ref. No.</b>	EL177
	heating element 1100W 230V heating circuits 1 L 510mm W 400mm lug length 40mm lug width 18mm connection male faston 6.3mm tube ø 8.5mm bracket mounting mounting pos. lower hole ø 5mm pizza oven			

Зип Общепит

vsezip.ru

+7(812)987-08-81



<b>GEV No.</b>	419277	<b>Ref. No.</b>	EL259
<b>description</b>	heating element 950W 230V heating circuits 1 L 506mm W 440mm lug length 40mm lug width 18mm hole distance 460mm connection 6.3x0.8 tube ø 8.5mm mounting pos. lower hole ø 5mm pizza oven		

## heating elements for salamanders/toast-

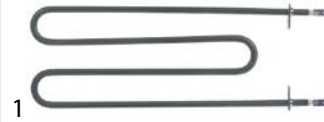

<b>GEV No.</b>	418963	<b>Ref. No.</b>	EL128
<b>description</b>	heating element 1100W 240V L 250mm W 95mm tube ø 6.3mm with strap connection male faston 6.3mm		



<b>GEV No.</b>	418964	<b>Ref. No.</b>	EL145
<b>description</b>	heating element 1300W 240V L 250mm W 95mm tube ø 6.3mm with strap connection male faston 6.3mm		

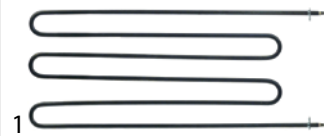

<b>GEV No.</b>	417752	<b>Ref. No.</b>	EL223
<b>description</b>	heating element 2750W 230V L 530mm W 220mm tube ø 8.5mm bracket mounting connection grip connection hole ø 4.3mm mounting distance 189mm heating circuits 1 lug length 25mm lug width 15mm suitable for salamander grill		
<b>For models:</b>	OE7304		

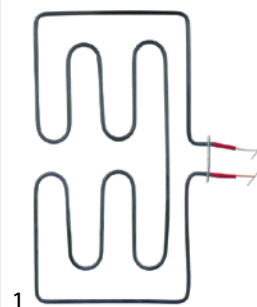

<b>GEV No.</b>	418967	<b>Ref. No.</b>	EL50
<b>description</b>	heating element 2800W 240V heating circuits 1 L 275mm W 447mm flange length 72mm flange width 19mm tube ø 6.3mm for salamander grill cable length 800mm hole ø 8mm		
<b>For models:</b>	AS3, LGT		





Зип Общепит

vsezip.ru

+7(812)987-08-81

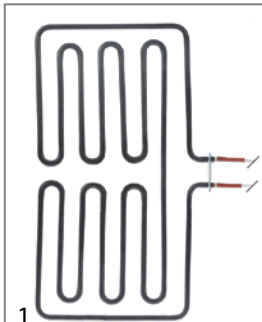

1

<b>GEV No.</b>	419283	<b>Ref. No.</b>	EL237
<b>description</b>	heating element 4500W 240V heating circuits 1 L 265mm W 460mm flange length 60mm flange width 20mm tube ø 8.5mm salamander grill cable length 1000mm		
<b>For models:</b>	AS4		

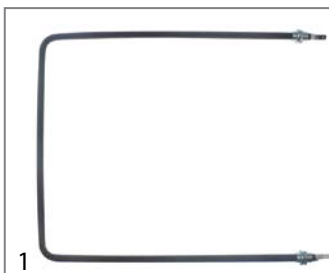

1

<b>GEV No.</b>	418993	<b>Ref. No.</b>	EL19-CS4
<b>description</b>	heating element 750W 240V L 330mm W 285mm thread M12x1 mounting distance 276.5mm connection male faston 6.3mm tube ø 8.5mm heating circuits 1 dry heating element for toaster		



1

<b>GEV No.</b>	417750	<b>Ref. No.</b>	EL203
<b>description</b>	heating element 3400W 230V heating circuits 1 L 335mm W 305mm H 45mm tube ø 8.5mm connection male faston 6.3mm for salamander grill		
<b>For models:</b>	OE7303		

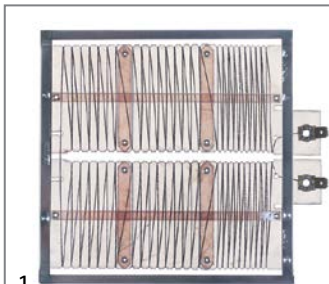

1

<b>GEV No.</b>	418979	<b>Ref. No.</b>	EL151
<b>description</b>	hot plate 370W 240V heating circuits 1 L 145mm W 145mm toaster connection male faston 6.3mm		

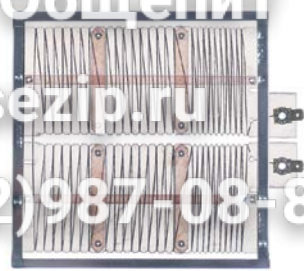

1

<b>GEV No.</b>	418980	<b>Ref. No.</b>	EL150
<b>description</b>	hot plate 475W 240V heating circuits 1 L 145mm W 145mm toaster connection male faston 6.3mm		

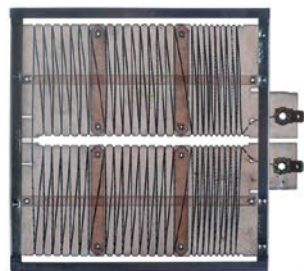



1

<b>GEV No.</b>	418991	<b>Ref. No.</b>	EL183
<b>description</b>	hot plate 500W 230V heating circuits 1 L 145mm W 145mm connection male faston 6.3mm		



1

<b>GEV No.</b>	416001	<b>Ref. No.</b>	EL309
<b>description</b>	radiation heater rectangular 1500W 230/240V L 265mm W 165mm H 32mm heating circuits 1 connections 2 connection type cable cable length 700mm EGO salamander grill		

<b>accessories for</b>	416001			
	<b>GEV No.</b>	390880	<b>Ref. No.</b>	—
	safety rod thermostat switch-off temp. 780°C temperature range°C 2-pole 1NC/1NOA probe ø 4mm probe L 170mm capillary pipemm capillary pipe isolatedmm gland nut shaft ømm			
	<b>GEV No.</b>	403523	<b>Ref. No.</b>	—
	solid state relay ANLY 1 phase 40A 24-280V 4-32VDC L 47.5mm W 43mm screw type ASR-40DA			

heating elements for heated cabinets



1

<b>GEV No.</b>	418978	<b>Ref. No.</b>	EL01 EL01+LN04
<b>description</b>	heating element 3000W 240V heating circuits 1 L 150mm W 225mm H 35mm connection length 15mm connection male faston 6.3mm vertical tube ø 8.6mm water boiler with safety thermostat		
<b>For models:</b>	OE7503		



bottom heaters



<b>GEV No.</b>	418994	<b>Ref. No.</b>	EL208
<b>description</b>	bottom heater 3000W 230V heating circuits 2 ø 196mm safety thermostat 250°C M5 mounting distance 180mm		

quartz heating elements



<b>GEV No.</b>	418968	<b>Ref. No.</b>	EL26
<b>description</b>	quartz heating element 500W 240V L 460mm ø 9mm for salamander grill		
<b>For models:</b>	LPC, LSC		

immersion heating elements

with compression flange 50 x 26mm



<b>GEV No.</b>	419280	<b>Ref. No.</b>	EB3F EL238 EL235
<b>description</b>	heating element 3000W 230V heating circuits 1 flange 50x26mm L 145mm W 225mm mounting distance 25mm connection male faston 6.3mm tube ø 8.5mm for Water boiler		



<b>GEV No.</b>	419273	<b>Ref. No.</b>	EL297
<b>description</b>	heating element 3000W 230V heating circuits 1 flange 50x26mm L 190mm W 165mm mounting distance 24.5mm connection male faston 6.3mm tube ø 8.5mm for Water boiler		

Зип Общепит

vsezip.ru

+7(812)987-08-81

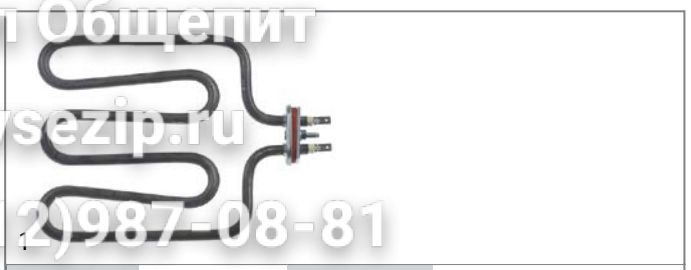

<b>GEV No.</b>	418966	<b>Ref. No.</b>	EL178
<b>description</b>	heating element 3000W 240V heating circuits 1 flange 50x26mm L 200mm W 170mm L1 30mm L2 170mm W1 137mm W2 33mm mounting distance 24.5mm connection male faston 6.3mm tube ø 8.5mm water boiler		
<b>For models:</b>	EB3, EB4, EB6, EB6T		

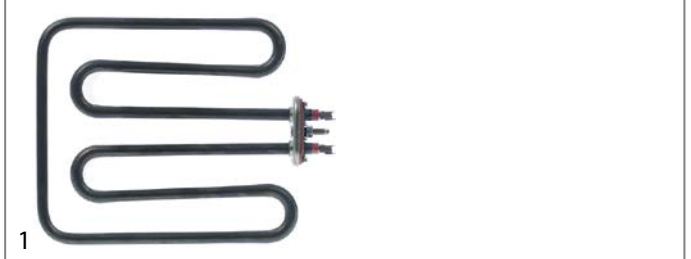

<b>GEV No.</b>	419272	<b>Ref. No.</b>	EL298
<b>description</b>	heating element 4500W 230V heating circuits 1 flange 50x26mm L 190mm W 160mm mounting distance 24.5mm connection male faston 6.3mm tube ø 8.5mm for Water boiler		



<b>GEV No.</b>	418977	<b>Ref. No.</b>	EL179
<b>description</b>	heating element 4500W 240V heating circuits 1 flange 50x26mm L 200mm W 170mm connection male faston 6.3mm tube ø 8.5mm water boiler		
<b>For models:</b>	EB4		



<b>GEV No.</b>	419274	<b>Ref. No.</b>	EL299
<b>description</b>	heating element 1450W 230V heating circuits 1 flange 50x26mm L 150mm W 33mm H 72mm mounting distance 23mm connection male faston 6.3mm tube ø 8.5mm for Water boiler		



<b>GEV No.</b>	419275	<b>Ref. No.</b>	EL277
<b>description</b>	heating element 3000W 230V heating circuits 1 flange 50x26mm L 150mm W 33mm L1 70mm mounting distance 25mm connection male faston 6.3mm tube ø 8.5mm for Water boiler		



Зип Общепит

vsezip.ru

+7(812)987-08-81

special flanges



1

<b>GEV No.</b>	420519	<b>Ref. No.</b>	OEL32
<b>description</b>	heating element 18000W 230/400V heating circuits 1 L 188mm W 66mm flange length 123mm flange width 102mm connection cable included cable length 850mm boiler		

miscellaneous



1

<b>GEV No.</b>	418370	<b>Ref. No.</b>	OEL18
<b>description</b>	heating element 18000W 230V heating circuits 6 L 194mm W 87mm H 68mm hole distance 50mm hole ø 8mm number of thermostat sleeves 2 thermostat sleeves ø 6/2mm length thermostat sleeves 142/105mm thermostat sleeve clinging cable length 730mm immersion heater 10 hole flange		
<b>accessories for</b>	418370		
	<b>GEV No.</b>	379078	<b>Ref. No.</b> —
	temperature probe thermocouple K (NiCr-Ni) cable silicone probe -50 up to 1150°C cable -50 up to +180°C connection 2-wire thread probe ø1.5x100mm cable length 1.8m		
	<b>GEV No.</b>	550894	<b>Ref. No.</b> OGA14
	gasket L 122mm W 101mm thickness 4mm for heating element suitable for RATIONAL equiv. no. 4400279		



1

<b>GEV No.</b>	418369	<b>Ref. No.</b>	OEL17
<b>description</b>	heating element 9000W 230V heating circuits 3 L 192mm W 39mm H 68mm hole distance 90mm hole ø 8mm thermostat sleeves ø 2.5/6.5mm length thermostat sleeves 155mm number of thermostat sleeves 2 thermostat sleeve eccentric, clinging flange length 82mm flange width 82mm tube ø 6.5mm cable length 200mm immersion heater 5 hole flange		
<b>accessories for</b>	418369		
	<b>GEV No.</b>	379078	<b>Ref. No.</b> —
	temperature probe thermocouple K (NiCr-Ni) cable silicone probe -50 up to 1150°C cable -50 up to +180°C connection 2-wire thread probe ø1.5x100mm cable length 1.8m		
	<b>GEV No.</b>	550893	<b>Ref. No.</b> OGA15
	gasket L 81mm W 81mm hole distance 65mm thickness 4mm for heating element suitable for RATIONAL equiv. no. 4400280		



1

<b>GEV No.</b>	415550	<b>Ref. No.</b>	OEL02
<b>description</b>	heating element 9000W 230V heating circuits 3 L 205mm W 38mm H 70mm number of thermostat sleeves 1 thermostat sleeves ø 2.5mm length thermostat sleeves 120mm thermostat sleeve eccentric, clinging tube ø 6.3mm hole distance 64mm hole ø 8mm connection male faston 6.3mm 4 hole flange immersion heater flange width 82mm flange length 82mm		
<b>accessories for</b>	415550		
	<b>GEV No.</b>	379078	<b>Ref. No.</b> —
	temperature probe thermocouple K (NiCr-Ni) cable silicone probe -50 up to 1150°C cable -50 up to +180°C connection 2-wire thread probe ø1.5x100mm cable length 1.8m		
	<b>GEV No.</b>	510565	<b>Ref. No.</b> —
	gasket rubber L 82mm W 82mm thickness 4mm hole ø 9mm hole distance 64mm for heating element suitable for RATIONAL 4 holes		



1

<b>GEV No.</b>	417646	<b>Ref. No.</b>	OEL10 OEL34
<b>description</b>	heating element 9000W 400V L 195mm W 40mm H 80mm number of thermostat sleeves 1 thermostat sleeves ø 6mm length thermostat sleeves 132mm tube ø 6mm hole distance 61mm hole ø 7.5mm cable length 60mm combi-steamer flange width 82mm flange length 82mm with gasket with thermowell		

heating elements for convection



1

<b>GEV No.</b>	418376	<b>Ref. No.</b>	OEL23
<b>description</b>	heating element 18000W 230V heating circuits 3 ID ø 410mm ED ø 477mm L 477mm H 110mm W1 110mm H1 20mm H2 90mm flange length 140mm flange width 62mm hole distance 64mm connection cable connection length 70mm tube ø 6.3mm convection heating element		
<b>accessories for</b>	418376		
	<b>GEV No.</b>	550696	<b>Ref. No.</b> OGA36
	gasket L 140mm W 62mm hole ø 5mm hole distance 56mm 6 holes thickness 2mm for heating element suitable for RATIONAL equiv. no. 4000332		



Зип Общепит

vsezip.ru

+7(812)987-08-81



1

<b>GEV No.</b>	418382	<b>Ref. No.</b>	OEL24
<b>description</b>	heating element 18000W 230V heating circuits 6 ID $\phi$ 407mm ED $\phi$ 485mm L 485mm H 106mm W1 111mm H1 11mm H2 85mm flange length 140mm flange width 72mm hole distance 128mm connection cable connection length 98mm tube $\phi$ 6.6mm cable length 600mm convection heating element hole $\phi$ 5mm rectangular flange L1 485mm		



1

<b>GEV No.</b>	417761	<b>Ref. No.</b>	EL248
<b>description</b>	heating element 3000W 230V heating circuits 3 ID $\phi$ 206mm ED $\phi$ 245mm L 290mm H 44mm L1 40mm W1 97mm H1 8mm H2 37mm flange length 110mm flange width 20mm hole distance 35mm connection male faston 6.3mm tube $\phi$ 6.3mm convection heating element hole $\phi$ 6.5mm rectangular flange		



1

<b>GEV No.</b>	420592	<b>Ref. No.</b>	EL232
<b>description</b>	heating element 2500W 230V heating circuits 1 ID $\phi$ 175mm ED $\phi$ 195mm L 245mm H 35mm L1 45mm W1 30mm H2 27mm flange length 70mm flange width 22mm hole distance 56mm connection male faston 6.3mm tube $\phi$ 6.5mm convection heating element hole $\phi$ 5mm		
<b>For models:</b>	ECO8, LCO		





1

<b>GEV No.</b>	419255	<b>Ref. No.</b>	EL103
<b>description</b>	heating element 3000W 240V heating circuits 1 ID $\phi$ 330mm ED $\phi$ 365mm L 390mm H 90mm L1 22mm H1 60mm H2 40mm flange length 75mm flange width 30mm hole distance 35mm connection male faston 6.3mm tube $\phi$ 8.5mm		
<b>For models:</b>	ECO7, V6, V6D, V6F, V7		



1

<b>GEV No.</b>	418385	<b>Ref. No.</b>	OEL25	
<b>description</b>	heating element 30000W 230V heating circuits 6 ID $\phi$ 573mm ED $\phi$ 630mm L 655mm H 120mm W1 135mm H1 15mm H2 110mm flange length 160mm flange width 75mm hole distance 74mm connection cable connection length 95mm tube $\phi$ 8.5mm cable length 600mm convection heating element hole $\phi$ 6mm rectangular flange L1 8mm			
<b>accessories for</b>	418385			
	<b>GEV No.</b>	560611	<b>Ref. No.</b>	—
	gasket L 160mm W 75mm for heating element thickness 2mm hole distance 74mm SCC Linie 102/202			



1

<b>GEV No.</b>	419259	<b>Ref. No.</b>	EL295
<b>description</b>	heating element 4000W 230V heating circuits 3 ID $\phi$ 210mm ED $\phi$ 245mm L 290mm H 90mm L1 45mm W1 95mm H1 40mm H2 50mm flange length 110mm flange width 20mm hole distance 35mm connection male faston 6.3mm tube $\phi$ 6.5mm hole $\phi$ 6mm		



1

<b>GEV No.</b>	418995	<b>Ref. No.</b>	EL141
<b>description</b>	heating element 3000W 230V heating circuits 1 ID $\phi$ 193mm ED $\phi$ 205mm L 225mm H 35mm L1 15mm W1 30mm H1 8mm H2 28mm flange length 70mm flange width 22.5mm hole distance 56mm connection male faston 6.3mm vertical tube $\phi$ 6.3mm		
<b>For models:</b>	ECO9, OE7008		



1

<b>GEV No.</b>	419253	<b>Ref. No.</b>	EL110
<b>description</b>	heating element 4000W 240V heating circuits 1 ID $\phi$ 340mm ED $\phi$ 360mm L 395mm H 40mm L1 48mm H1 25mm H2 28mm flange length 75mm flange width 32mm hole distance 35mm connection male faston 6.3mm vertical tube $\phi$ 8.5mm		



Зип Общепит



vsezip.ru

+7(812)987-08-81

			
1			
<b>GEV No.</b>	418377	<b>Ref. No.</b>	OEL35
<b>description</b>	heating element 6000W 230V heating circuits 3 ID ø 404mm ED ø 420mm L 440mm H 107mm W1 112mm H1 20mm H2 84mm flange length 140mm flange width 61mm hole distance 65mm connection cable tube ø 6.5mm cable length 300mm convection heating element hole ø 5.5mm rectangular flange L1 7mm		

			
1			
<b>GEV No.</b>	490183	<b>Ref. No.</b>	HO11
<b>description</b>	hot plate ø 180mm 1500W 240V connection 4 screw clamps with 8mm spill ring		
<b>For models:</b>	ESLR9, HT3, HT6, HT7, LBR2		

radiation heaters

			
1			
<b>GEV No.</b>	416001	<b>Ref. No.</b>	EL309
<b>description</b>	radiation heater rectangular 1500W 230/240V L 265mm W 165mm H 32mm heating circuits 1 connections 2 connection type cable cable length 700mm EGO salamander grill		
<b>accessories for</b>	416001		
	<b>GEV No.</b>	390880	<b>Ref. No.</b> —
	safety rod thermostat switch-off temp. 780°C temperature range°C 2-pole 1NC/1NOA probe ø 4mm probe L 170mm capillary pipemm capillary pipe isolatedmm gland nut shaft ømm		
	<b>GEV No.</b>	403523	<b>Ref. No.</b> —
	solid state relay ANLY 1 phase 40A 24-280V 4-32VDC L 47.5mm W 43mm screw type ASR-40DA		

			
1			
<b>GEV No.</b>	490184	<b>Ref. No.</b>	HO10
<b>description</b>	hot plate ø 180mm 2000W 240V connection 4 screw clamps with 8mm spill ring		
<b>For models:</b>	ESLR9, HT6, HT7, LBR		

			
1			
<b>GEV No.</b>	490223	<b>Ref. No.</b>	EL290
<b>description</b>	hot plate ø 220mm 2600W 230V connection 4 screw clamps with 8mm spill ring		

hot plates

square & rectangular

with radiused edge

			
1			
<b>GEV No.</b>	490066 <sup>1</sup>	<b>Ref. No.</b>	EL188
<b>description</b>	hot plate dimensions 220x220mm 2600W 230V with spill ring connection 4 screw clamps protector yes square		
<b>For models:</b>	OE7008, OE7010, OE7012		

<sup>1</sup>incl. protector

energy regulators

EGO

1-circuit

			
1			
<b>GEV No.</b>	380019	<b>Ref. No.</b>	EN10
<b>description</b>	energy regulator 240V 13A single-circuit turn direction right shaft ø 6x4.6mm shaft L 23mm mounting thread M4 power release 6-100% no. 50.57071.010		
<b>For models:</b>	BM3, BM4, BM6, BM7, BS3, BS4, BS7, CS4, CS4G, CS6, CT1, ECG6, LBM, LBM2, LBM2W, LBM3, LBMW, LCS, LGT, LPB, LPC, LRB, LRB2W, LRB3, LRBW, LSC, OE7303, OE7304		



## thermostats

## bi-metal thermostats

## safety bi-metal thermostats



1

<b>GEV No.</b>	375753	<b>Ref. No.</b>	TH88
<b>description</b>	bi-metal safety thermostat hole distance 23.5mm switch-off temp. 120°C 1NC 1-pole 16A connection F6.3 2 hole fixing		
<b>For models:</b>	EB3F, EB4F, EB6, EB6T		



1

<b>GEV No.</b>	390461	<b>Ref. No.</b>	TH87
<b>description</b>	bi-metal safety thermostat hole distance 23.8mm switch-off temp. 95°C 1NC 1-pole 16A connection F6.3 2 hole fixing		
<b>For models:</b>	EB3F, EB4F, EB6, EB6T		

<b>accessories for</b>	390461		
	<b>GEV No.</b>	550388	<b>Ref. No.</b>
			—



1

<b>GEV No.</b>	391026	<b>Ref. No.</b>	TH87/S
<b>description</b>	bi-metal safety thermostat hole distance 30mm switch-off temp. 120°C 1NC 1-pole 16A 250V Qty 1 pcs incl. accessories		



1

<b>GEV No.</b>	391027	<b>Ref. No.</b>	TH88/S
<b>description</b>	bi-metal safety thermostat hole distance 30mm switch-off temp. 120°C 1NC 1-pole 16A 250V connection F6.3 content with accessories		

## bi-metal thermostats



1

<b>GEV No.</b>	375750	<b>Ref. No.</b>	TH40
<b>description</b>	bi-metal thermostat hole distance 23.8mm switch-off temp. 85°C 1NC 1-pole 16A connection F6.3 2 hole fixing		



1

<b>GEV No.</b>	390950	<b>Ref. No.</b>	TH76
<b>description</b>	temperature limiter hole distance 23.5mm switch-off temp. 100°C 1NC 10A 240V connection F6.3 2 hole fixing cavity Qty 1 pcs KSD1XT2		

Зип Общепит

vsezip.ru

+7(812)987-08-81



1

<b>GEV No.</b>	390948	<b>Ref. No.</b>	TH80
<b>description</b>	temperature limiter hole distance 23.5mm switch-off temp. 110°C 1NC 10A 240V connection F6.3 2 hole fixing cavity Qty 1 pcs GKSD201110		
<b>For models:</b>	UMO50, UMSO50, UMSO50D		

## control and safety thermostats

## EGO

## control thermostats

## 55.10/19\_series



1

<b>GEV No.</b>	375477	<b>Ref. No.</b>	TH95
<b>description</b>	thermostat t.max. 190°C temperature range 48-190°C 1-pole 1NO 16A probe ø 6mm probe L 107mm capillary pipe 1470mm capillary pipe isolated gland nut M9x1 shaft ø 6x4.6mm shaft L 23mm shaft position upper shaft position lower rotation 270°		
<b>For models:</b>	OG7106		



1

<b>GEV No.</b>	391025	<b>Ref. No.</b>	TH99
<b>description</b>	thermostat t.max. 200°C temperature range 30-200°C 1-pole 1NO 16A probe ø 6mm probe L 110mm capillary pipe 1460mm gland nut M9x1 shaft ø 6x4.6mm shaft L 26mm shaft position upper		



Зип Общепит

vsezip.ru

+7(812)987-08-81

55.13\_series



<b>GEV No.</b>	375086	<b>Ref. No.</b>	OTH09
<b>description</b>	thermostat t.max. 180°C temperature range 60-180°C 1-pole 1CO 16A probe ø 6mm probe L 90mm capillary pipe 2400mm capillary pipe isolated 2300mm gland nut shaft ø 6x4.6mm shaft L 25mm shaft position upper rotation 270° probe material SS		



<b>GEV No.</b>	375484	<b>Ref. No.</b>	TH46
<b>description</b>	thermostat t.max. 260°C temperature range 48-260°C 1-pole NO 16A probe ø 3mm probe L 160mm capillary pipe 1580mm capillary pipe isolatedmm gland nut shaft ø 6x4.6mm shaft L 23mm shaft position upper rotation 270°		
<b>For models:</b>	ECO76, LCG, LCO, LPG, LRG, OE7008, OE7010, UMO50, UMSO50, UMSO50D		



<b>GEV No.</b>	375497	<b>Ref. No.</b>	TH62
<b>description</b>	thermostat t.max. 182°C 1-pole 1NO probe ø 6mm probe L 115mm capillary pipe 900mm capillary pipe isolatedmm gland nut rotation 270° probe thread M9x1 230V		
<b>For models:</b>	OE7104, OE7105		



<b>GEV No.</b>	391028	<b>Ref. No.</b>	TH58
<b>description</b>	thermostat t.max. 400°C temperature range 100-400°C 1-pole 1NO 16A probe ø 4mm probe L 160mm capillary pipe 840mm capillary pipe isolatedmm gland nut shaft ø 6x4.6mm shaft L 26mm shaft position lower		



<b>GEV No.</b>	390910	<b>Ref. No.</b>	TH29
<b>description</b>	thermostat t.max. 190°C temperature range 130-190°C 1-pole 1NOA probe ø 6mm probe L 117mm capillary pipe 890mm capillary pipe isolatedmm gland nut M9x1 shaft ø 6x4.6mm shaft L 25mm shaft position upper rotation 270° probe material SS		



<b>GEV No.</b>	375440	<b>Ref. No.</b>	TH27
<b>description</b>	thermostat t.max. 93°C temperature range 30-93°C 1-pole 1CO 16A probe ø 6mm probe L 98mm capillary pipe 830mm capillary pipe isolatedmm gland nut M9x1 shaft L 23mm shaft position upper rotation 270° probe material SS		
<b>For models:</b>	FWD, FWDG, GBM2, GBM3, KFCWD		

Зип Общепит

vsezip.ru

+7(812)987-08-81

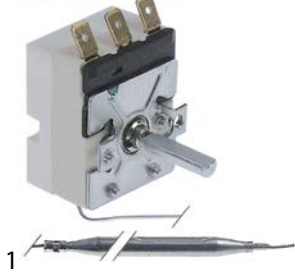

<b>GEV No.</b>	375566	<b>Ref. No.</b>	TH09
<b>description</b>	thermostat t.max. 96°C temperature range 82-96°C 1-pole 1CO 16A probe ø 6mm probe L 147mm capillary pipe 870mm capillary pipe isolatedmm gland nut M9x1 shaft L 23mm shaft position upper rotation 120°		
<b>For models:</b>	EB3, EB4, EB6, EB6T		



<b>GEV No.</b>	375486	<b>Ref. No.</b>	TH69
<b>description</b>	thermostat t.max. 190°C temperature range 130-190°C 1-pole 1NO 16A probe ø 6mm probe L 115mm capillary pipe 1300mm capillary pipe isolatedmm gland nut shaft ø 6x4.6mm shaft L 23mm shaft position° shaft position rotation 270°		
<b>For models:</b>	DF33, DF36, DF39, DF46, DF49, DF612, DF618, DF66, DF66ST, HB2, HB3, HB4, J12, J18, J6, J9, LD2, LD3		

55.14\_series

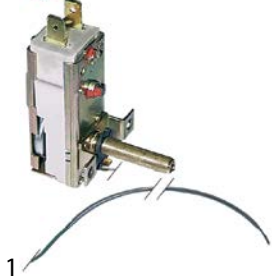

<b>GEV No.</b>	375300	<b>Ref. No.</b>	TH66
<b>description</b>	thermostat t.max. 128°C temperature range 35-128°C 1-pole 1NO 16A probe ø 3.1mm probe L 174mm capillary pipe 880mm capillary pipe isolated 800mm gland nut shaft L 23mm shaft position lower rotation 270°		

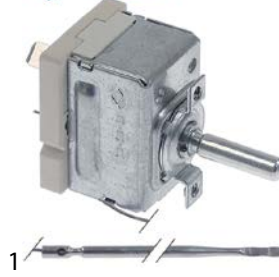

<b>GEV No.</b>	391024	<b>Ref. No.</b>	TH107
<b>description</b>	thermostat t.max. 320°C temperature range 50-320°C 1-pole 1NO 16A probe ø 3.1mm probe L 163mm capillary pipe 880mm capillary pipe isolatedmm gland nut shaft ø 6x4.6mm shaft L 23mm shaft position lower probe material SS		

55.17\_series



<b>GEV No.</b>	391011	<b>Ref. No.</b>	TH106 TH106 + GL66
<b>description</b>	thermostat t.max. 103°C temperature range 30-103°C 1-pole 1NO 16A probe ø 6mm probe L 70mm capillary pipe 1450mm capillary pipe isolatedmm gland nut shaft ø 6x4.6mm shaft L 23mm shaft position left		

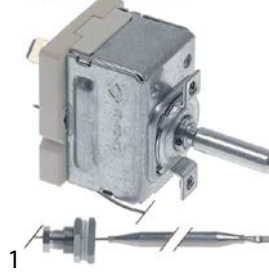

<b>GEV No.</b>	391012	<b>Ref. No.</b>	TH105
<b>description</b>	thermostat t.max. 93°C temperature range 30-93°C 1-pole 1CO 16A probe ø 6mm probe L 97mm capillary pipe 845mm capillary pipe isolatedmm gland nut M9x1 shaft ø 6x4.6mm shaft L 23mm shaft position 90		





Зип Общежит

vsezip.ru

+7(812)987-08-81

55.18\_series



<b>GEV No.</b>	391020	<b>Ref. No.</b>	TH70
<b>description</b>	thermostat t.max. 110°C temperature range 30-110°C 1-pole 1NO 16A probe ø 6mm probe L 114mm capillary pipe 1280mm capillary pipe isolated 1010mm gland nut shaft ø 6x4.6mm shaft L 23mm shaft position upper rotation 270°		
<b>For models:</b>	PB33, PB66		



<b>GEV No.</b>	375989	<b>Ref. No.</b>	TH10
<b>description</b>	thermostat t.max. 190°C temperature range 130-190°C 1-pole 1NO 16A probe ø 6mm probe L 118mm capillary pipe 890mm gland nut shaft ø 6x4.6mm shaft L 23mm shaft position upper rotation 270°		
<b>For models:</b>	GS3, GS4, GS4E, GS6, GS7, GS7E, GS9, V6D		



<b>GEV No.</b>	390703	<b>Ref. No.</b>	TH34
<b>description</b>	thermostat t.max. 120°C temperature range 32-110°C 1-pole 1NO 16A probe ø 6mm probe L 110mm capillary pipe 870mm capillary pipe isolatedmm gland nut M9x1 shaft ø 6x4.6mm shaft L 25mm shaft position upper rotation 270° 240V		
<b>For models:</b>	BM3W, BM4W, BM6W, BM7W, BS3W, BS4W, BS7W		



<b>GEV No.</b>	375485	<b>Ref. No.</b>	TH82
<b>description</b>	thermostat t.max. 190°C temperature range 130-190°C 1-pole NO 16A probe ø 6mm probe L 119mm capillary pipe 400mm capillary pipe isolated 190mm gland nut shaft ø 6x4.6mm shaft L 23mm shaft position upper rotation 270°		
<b>For models:</b>	LDF, LDF2, LFF		



<b>GEV No.</b>	390831	<b>Ref. No.</b>	TH59
<b>description</b>	thermostat t.max. 190°C temperature range 130-190°C 1-pole 1NO 16A probe ø 6mm probe L 113mm capillary pipe 870mm capillary pipe isolatedmm gland nut M9x1 shaft ø 6x4.6mm shaft L 25mm shaft position upper rotation 270°		



<b>GEV No.</b>	375483	<b>Ref. No.</b>	TH12
<b>description</b>	thermostat t.max. 320°C temperature range 50-320°C 1-pole NO 16A probe ø 3mm probe L 158mm capillary pipe 870mm capillary pipe isolatedmm gland nut shaft ø 6x4.6mm shaft L 23mm shaft position upper rotation 270°		
<b>For models:</b>	ECO76, ECO8, ECO9, ESLR9, GG1, GS6T, GS6TE, LGR, LGR2, LPO, OE7206, OE7209		

electric components

Зип Общепит

vsezip.ru

+7(812)987-08-81

55.34\_series

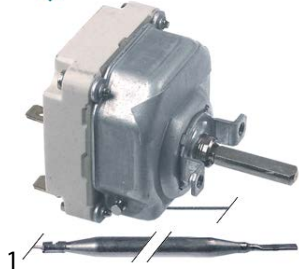

<b>GEV No.</b>	375428	<b>Ref. No.</b>	TH24
<b>description</b>	thermostat t.max. 190°C temperature range 130-190°C 3-pole 3NO 16A probe ø 6mm probe L 219mm capillary pipe 880mm capillary pipe isolatedmm gland nut shaft ø 6x4.6mm shaft L 23mm shaft position upper rotation 270°		

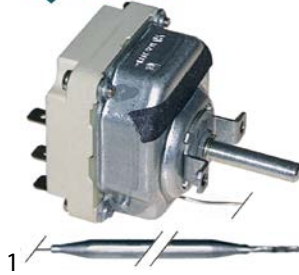

<b>GEV No.</b>	375038	<b>Ref. No.</b>	TH110
<b>description</b>	thermostat t.max. 300°C temperature range 50-300°C 3-pole 3NO 16A probe ø 6mm probe L 79mm capillary pipe 1740mm capillary pipe isolated 800mm gland nut shaft ø 6x4.6mm shaft L 23mm shaft position upper rotation 270°		
<b>accessories for</b>	375038		
	<b>GEV No.</b>	110123	<b>Ref. No.</b> —
	knob thermostat t.max. 300°C ø 50mm shaft ø 6x4.6mm shaft flat upper black temperature range 50-300°C rotation 270°		

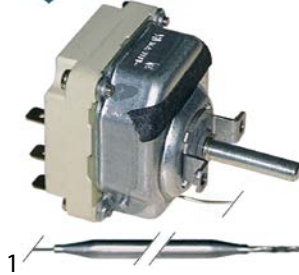

<b>GEV No.</b>	375024	<b>Ref. No.</b>	TH32
<b>description</b>	thermostat t.max. 300°C temperature range 50-300°C 3-pole 3NO 16A probe ø 6mm probe L 79mm capillary pipe 840mm capillary pipe isolatedmm gland nut		



<b>GEV No.</b>	375383	<b>Ref. No.</b>	TH39
<b>description</b>	thermostat t.max. 350°C temperature range 100-350°C 3-pole 3NO 16A probe ø 6mm probe L 75mm capillary pipe 870mm capillary pipe isolatedmm gland nut shaft ø 6x4.6mm shaft L 23mm shaft position upper rotation 270°		



<b>GEV No.</b>	391019	<b>Ref. No.</b>	TH101
<b>description</b>	thermostat t.max. 500°C 3-pole 3NO 16A probe ø 4mm probe L 228mm capillary pipe 1200mm capillary pipe isolatedmm gland nut shaft ø 6x4.6mm shaft L 26mm shaft position lower		

safety thermostats

55.11\_series



<b>GEV No.</b>	390878	<b>Ref. No.</b>	TH35
<b>description</b>	safety thermostat switch-off temp. 80°C 1-pole 1NC 16A probe ø 4mm probe L 89mm capillary pipe 195mm capillary pipe isolatedmm gland nut probe		
<b>For models:</b>	ECO76		



Зип ОбщеПИТ

vsezip.ru

+7(812)987-08-81

electric components

55.13\_series



<b>GEV No.</b>	390911	<b>Ref. No.</b>	TH11
<b>description</b>	safety thermostat switch-off temp. 230°C 1-pole 16A probe ø 6mm probe L 77mm capillary pipe 670mm capillary pipe isolated 180mm gland nut probe screw connection M8x1		

55.31\_series



<b>GEV No.</b>	375803	<b>Ref. No.</b>	TH19
<b>description</b>	safety thermostat switch-off temp. 225°C 3-pole 3NC 20A probe ø 6mm probe L 269mm capillary pipe 830mm capillary pipe isolated mm gland nut probe		



<b>GEV No.</b>	375138	<b>Ref. No.</b>	TH51
<b>description</b>	safety thermostat switch-off temp. 230°C 1-pole 1NO 16A probe ø 6mm probe L 96mm capillary pipe 1050mm capillary pipe isolated mm gland nut M9x1 probe SS		

55.32\_series

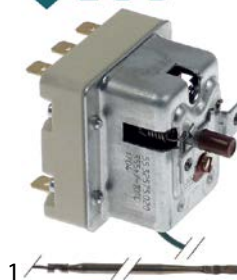

<b>GEV No.</b>	391042	<b>Ref. No.</b>	TH111
<b>description</b>	safety thermostat switch-off temp. 355°C 3-pole 20A probe ø 3mm probe L 160mm capillary pipe 1790mm capillary pipe isolated 450mm		
<b>For models:</b>	OE7210		

55.14\_series



<b>GEV No.</b>	375137	<b>Ref. No.</b>	TH67
<b>description</b>	safety thermostat switch-off temp. 250°C 1-pole 16A probe ø 3.03mm probe L 160mm capillary pipe 880mm capillary pipe isolated 800mm gland nut probe SS with curved probe		



<b>GEV No.</b>	375684	<b>Ref. No.</b>	TH63
<b>description</b>	safety thermostat switch-off temp. 360°C 1-pole 20A probe ø 11mm probe L 16mm capillary pipe 900mm capillary pipe isolated 900mm gland nut probe screw-in probe probe thread M14x1		
<b>For models:</b>	ECO9, ESLR9, OE7008, OE7010		

Зип Общепит

vsezip.ru

+7(812)987-08-81



<b>GEV No.</b>	391013	<b>Ref. No.</b>	TH102
<b>description</b>	safety thermostat switch-off temp. 580°C 3-pole 3NC 16A probe ø 4mm probe L 233mm capillary pipe 1170mm capillary pipe isolated 310mm gland nut shaft ømm probe		
<b>For models:</b>	V7		



<b>GEV No.</b>	391017	<b>Ref. No.</b>	TH81
<b>description</b>	safety thermostat switch-off temp. 230°C 3-pole 3NC 16A probe ø 6mm probe L 106mm capillary pipe 390mm capillary pipe isolated 185mm gland nut shaft ømm starting temperature 14°C probe SS		
<b>For models:</b>	LDF, LDF2, LFF, LPB		

55.33\_series



<b>GEV No.</b>	391016	<b>Ref. No.</b>	TH73 TH73+GL66
<b>description</b>	safety thermostat switch-off temp. 135°C 3-pole 3NC 16A probe ø 6mm probe L 99mm capillary pipe 790mm capillary pipe isolated 780mm gland nut shaft ømm probe SS		
<b>For models:</b>	ECG6, OE7503, OG7502		



<b>GEV No.</b>	375430	<b>Ref. No.</b>	TH25
<b>description</b>	safety thermostat switch-off temp. 230°C 3-pole 3NC 20A probe ø 6mm probe L 107mm capillary pipe 870mm capillary pipe isolated-mm gland nut starting temperature 216°C probe		
<b>For models:</b>	DF33, DF36, DF46, DF49, DF612, DF618, DF66ST, J12, J18, J6, J9, LCO, PB33, PB66		

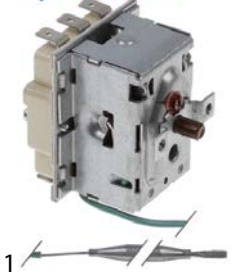

<b>GEV No.</b>	391014	<b>Ref. No.</b>	TH78
<b>description</b>	safety thermostat switch-off temp. 225°C 3-pole 3NC 16A probe ø 6mm probe L 114mm capillary pipe 2250mm capillary pipe isolated 1980mm gland nut shaft ømm probe SS		
<b>For models:</b>	OE7112, OE7113		



<b>GEV No.</b>	375487	<b>Ref. No.</b>	TH61
<b>description</b>	safety thermostat switch-off temp. 230°C 3-pole NC 20A probe ø 6mm probe L 103mm capillary pipe 1170mm capillary pipe isolated-mm gland nut starting temperature 116°C probe		
<b>For models:</b>	DF33, DF36, DF39, DF46, DF49, DF618, DF66, DF66ST, J12, J18, J6, J9, OE7105		

Зип Общежит

vsezip.ru

+7(812)987-08-81

56\_ series



1

<b>GEV No.</b>	375862	<b>Ref. No.</b>	OTH07
<b>description</b>	safety thermostat switch-off temp. 183°C 1-pole 16A probe ø 6mm probe L 61mm capillary pipe 1460mm capillary pipe isolated 1400mm gland nut probe SS		



1

<b>GEV No.</b>	391015	<b>Ref. No.</b>	TH104
<b>description</b>	safety thermostat switch-off temp. 217°C 1-pole 1NC 16A probe ø 6mm probe L 79mm capillary pipe 890mm capillary pipe isolated 198mm gland nut M9x1 probe SS		



1

<b>GEV No.</b>	390714	<b>Ref. No.</b>	TH44
<b>description</b>	safety thermostat switch-off temp. 230°C 1-pole 1NC 16A probe ø 6mm probe L 75mm capillary pipe 740mm capillary pipe isolated 200mm gland nut probe SS		



1

<b>GEV No.</b>	375508	<b>Ref. No.</b>	TH71 TH96
<b>description</b>	safety thermostat switch-off temp. 235°C 1-pole 16A probe ø 3mm probe L 155mm capillary pipe 1100mm capillary pipe isolatedmm gland nut probe		
<b>For models:</b>	DF4, DF7, J10		



1

<b>GEV No.</b>	390854	<b>Ref. No.</b>	TH97
<b>description</b>	safety thermostat switch-off temp. 245°C 1-pole 1NC 16A probe ø 3.1mm probe L 155mm capillary pipe 1130mm capillary pipe isolatedmm gland nut M9x1 probe		



1

<b>GEV No.</b>	375774	<b>Ref. No.</b>	OTH08
<b>description</b>	safety thermostat switch-off temp. 365°C 1-pole 16A probe ø 4mm probe L 96mm capillary pipe 1160mm capillary pipe isolated 1100mm gland nut probe SS with special screwing screw connection M10x1		

control thermostats with operation switch

55.13\_ series



1

<b>GEV No.</b>	390834	<b>Ref. No.</b>	N/A
<b>description</b>	thermostat temperature range 50-320°C 1-pole 1NO 16A probe ø 3mm probe L 160mm capillary pipe 870mm capillary pipe isolatedmm gland nut shaft ø 6x4.6mm shaft L 23mm shaft position right rotation 270° outer switch 2NO		



## TECASA

## safety thermostats



<b>GEV No.</b>	391021	<b>Ref. No.</b>	TH86
<b>description</b>	safety thermostat switch-off temp. 115°C 2-pole 2NC 16A probe ø 6mm probe L 69mm capillary pipe 630mm capillary pipe isolated 630mm gland nut shaft ømm spiral		

## CAMPINI

## control thermostats



<b>GEV No.</b>	391023	<b>Ref. No.</b>	TH75
<b>description</b>	thermostat t.max. 70°C temperature range 0-70°C 1-pole 1NO 16A probe ømm probe Lmm capillary pipemm capillary pipe isolatedm gland nut shaft ø 6x4.6mm shaft L 14mm shaft position left bottom		
<b>For models:</b>	HC3, HC4, HC6, HC7, HCL3, HCL4		

## various

## control thermostats



<b>GEV No.</b>	390701	<b>Ref. No.</b>	TH79
<b>description</b>	thermostat t.max. 177°C 1-pole NC probe ø 6mm probe L 114mm capillary pipe 900mm shaft ø 4.5x6mm shaft L 25mm		
<b>For models:</b>	OE7112		

Зип-Общепит

accessories

## gland nut accessories

## ducts



<b>GEV No.</b>	550148	<b>Ref. No.</b>	GL66
<b>description</b>	gland duct ET M12x0.75 IT M9x1 probe ø max. 6.5mm WS 17 silicone		

## switches and momentary switches

## rocker/momentary rocker switches

## 26.5x22mm



<b>GEV No.</b>	301252	<b>Ref. No.</b>	SW66
<b>description</b>	rocker switch mounting measurements 26.5x22mm green 2NO 250V 16A illuminated 0-1 connection male faston 6.3mm ambient temperature max. 125°C protection IP40		
<b>For models:</b>	ECO76, ECO8, HC3, HC4, HC6, HC7, HCL3, HCL4, HCL6, HCL7, HCL9, L3, L4		

## 28x22mm



<b>GEV No.</b>	301305	<b>Ref. No.</b>	SW10 SW18
<b>description</b>	rocker switch mounting measurements 28.5x22mm black 2NO 240V 16A 0-1 connection male faston 6.3mm ambient temperature max. 85/125°C protection IP44		
<b>For models:</b>	FWD, FWDG, KFCWD		



<b>GEV No.</b>	301253 <sup>1</sup>	<b>Ref. No.</b>	SW59
<b>description</b>	rocker switch mounting measurements 28x22mm green 2NO 250V 16A illuminated connection male faston 6.3mm ambient temperature max. 90°C protection IP40		
<b>For models:</b>	AS3, AS4		

<sup>1</sup>illuminated

## 30x11mm







<b>GEV No.</b>	301014	<b>Ref. No.</b>	SW72
<b>description</b>	momentary rocker switch mounting measurements 30x11mm black 1NO 250V 16A connection male faston 6.3mm ambient temperature max. 85/125°C protection IP40 mounting ømm male faston 6.3mm		





Зип Общепит  
vsezip.ru  
+7(812)987-08-81

			
1			
<b>GEV No.</b>	301038	<b>Ref. No.</b>	SW53
<b>description</b>	rocker switch mounting measurements 30x11mm green 1NO/indicator light 250V 16A connection male faston 6.3mm		
<b>For models:</b>	CT1		

			
1			
<b>GEV No.</b>	301004	<b>Ref. No.</b>	SW23 SW34
<b>description</b>	rocker switch mounting measurements 30x22mm black 2CO 250V 16A connection male faston 6.3mm ambient temperature max. 125/55°C protection IP40		
<b>For models:</b>	ECO76, ECO8, ECO9		
<b>accessories for</b>	301004		
	<b>GEV No.</b>	301036	<b>Ref. No.</b> —
	protective cover internal size 30x22mm for rocker switch mounting measurementsmm		



<b>30x22mm</b>			
			
1			
<b>GEV No.</b>	301003	<b>Ref. No.</b>	N/A SW69 SW89
<b>description</b>	rocker switch mounting measurements 30x22mm green 2NO 250V 16A illuminated 0-I connection male faston 6.3mm ambient temperature max. 125/55°C protection IP65		
<b>For models:</b>	OE7503, SCH1085, SCH785		
<b>accessories for</b>	301003		
	<b>GEV No.</b>	301036	<b>Ref. No.</b> —
	protective cover internal size 30x22mm for rocker switch mounting measurementsmm		

			
1			
<b>GEV No.</b>	301251	<b>Ref. No.</b>	SW11 SW70
<b>description</b>	rocker switch mounting measurements 30x22mm green 2NO 250V 16A illuminated lighting connection male faston 6.3mm ambient temperature max. 85°C protection IP40		
<b>For models:</b>	L3, L4, SCH1085, SCH785		

			
1			
<b>GEV No.</b>	301001	<b>Ref. No.</b>	NE14
<b>description</b>	rocker switch mounting measurements 30x22mm red 2NO 250V 16A illuminated 0-I connection male faston 6.3mm ambient temperature max. 125/55°C protection IP65		
<b>For models:</b>	OE7503		
<b>accessories for</b>	301001		
	<b>GEV No.</b>	301036	<b>Ref. No.</b> —
	protective cover internal size 30x22mm for rocker switch mounting measurementsmm		

push/momentary push switches

<b>19x13mm</b>			
			
1			
<b>GEV No.</b>	345690	<b>Ref. No.</b>	SW88
<b>description</b>	momentary push switch mounting measurements 19x13mm black 1NO 250V 16A connection male faston 4.8mm ambient temperature max. 105°C protection IP40		

			
1			
<b>GEV No.</b>	346978	<b>Ref. No.</b>	SW35
<b>description</b>	momentary rocker switch mounting measurements 30x22mm black 2CO 250V 16A connection male faston 6.3mm ambient temperature max. 125/55°C protection IP40		
<b>For models:</b>	ECO76, ECO8, ECO9		
<b>accessories for</b>	346978		
	<b>GEV No.</b>	301036	<b>Ref. No.</b> —
	protective cover internal size 30x22mm for rocker switch mounting measurementsmm		

microswitches

<b>lever actuated</b>			
			
1			
<b>GEV No.</b>	345773	<b>Ref. No.</b>	X52800
<b>description</b>	microswitch with lever 250V 16A 1CO connection male faston 6.3mm L 60mm ambient temperature max. 125°C mounting distance 22mm actuating force: 65g lever length 51mm		

electric components



ЗипОбщепит

float switches

roller-lever actuated

microswitches



1

<b>GEV No.</b>	347949	<b>Ref. No.</b>	OSW11
<b>description</b>	microswitch with handle with a switch 250V 0.1A 1NC connection male faston 6.3mm L 21mm L1 12mm mounting distance 24mm white		



1

<b>GEV No.</b>	345250	<b>Ref. No.</b>	SW64
<b>description</b>	microswitch with handle with a switch 250V 16A 1CO connection male faston 6.3mm L 27mm L1 36mm ambient temperature max. 125°C mounting distance 22mm type RL6-1-FGE-P12-5-L actuating force: 90g		
<b>For models:</b>	ECG6, UM50, UM50D, UMO50, UMS50, UMS50D, UMSO50, UMSO50D		

pin-plunger actuated



1

<b>GEV No.</b>	300092	<b>Ref. No.</b>	SW38
<b>description</b>	microswitch with plunger 400V 16A 2NO connection male faston 6.3mm ambient temperature max. 85°C mounting distance 22mm type XTD22A21 actuating force: 150g fryer black		
<b>For models:</b>	LDF, LDF2, LFF, LPB		

M12



1

<b>GEV No.</b>	346176	<b>Ref. No.</b>	X54900
<b>description</b>	microswitch with plunger mounting distance 25mm thread M12x0.75 250V 1CO ambient temperature max. 125°C type MK V11D10		

accessories



1

<b>GEV No.</b>	511566	<b>Ref. No.</b>	IN41
<b>description</b>	bracket for switch L 50mm W 27.5mm		



1

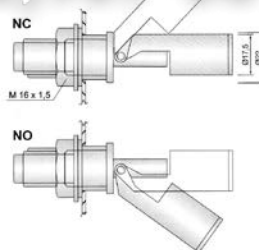

<b>GEV No.</b>	348189	<b>Ref. No.</b>	FS01
<b>description</b>	float switch thread M16x2 1NO or 1NC ø 18mm L 100mm mounting ø 16mm 240VACV 0.6A cable cable length 500mm		
<b>For models:</b>	OE7503, OG7502		

cam switches

on/off



1

<b>GEV No.</b>	301115	<b>Ref. No.</b>	SW58
<b>description</b>	cam switch 2 operating positions 2NO sequence 0-1 16A shaft ø 6x4.6mm shaft L 23mm connection male faston 6.3mm		
<b>For models:</b>	ESLR9, OE7008, OE7010		



1

<b>GEV No.</b>	300021	<b>Ref. No.</b>	SW42
<b>description</b>	cam switch 4 operating positions 4NO sequence 0-1-0-1 16A shaft ø 6x4.6mm shaft L 23mm connection screw ceramic		





Зип Общежит

vsezip.ru

+7(812)987-08-81

7-position



1			
<b>GEV No.</b>	300031	<b>Ref. No.</b>	SW14
<b>description</b>	cam switch 7 operating positions 1NO/2CO sequence 0-1-2-3-4-5-6 16A shaft ø 6x4.6mm shaft L 23mm connection male faston 6.3mm 7-position plastic		
<b>For models:</b>	ESLR9, HT3, HT6, HT7, LBR, OE7008, OE7010, OE7012		

operation switches



1			
<b>GEV No.</b>	301109	<b>Ref. No.</b>	SW71
<b>description</b>	cam switch 2 operating positions 4NO 16A sequence 0-1 shaft ø 6x4.6mm shaft L 23mm connection male faston 6.3mm plastic 4-pole		

magnetic switches

32x15mm



1			
<b>GEV No.</b>	346510	<b>Ref. No.</b>	OSW09
<b>description</b>	magnetic switch		

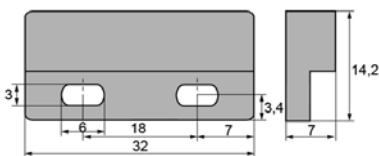

1			
<b>GEV No.</b>	346515 <sup>1</sup>	<b>Ref. No.</b>	ODO17
<b>description</b>	magnetic switch L 32mm W 15mm 1NO 250V 0.5A P max. 50W connection coded plug cable length 1750mm		

<sup>1</sup>with coded connector

accessories

magnets



<b>GEV No.</b>	346514	<b>Ref. No.</b>	ODO18
<b>description</b>	magnet ø 10mm L 40mm Hmm Wmm		



1			
<b>GEV No.</b>	345110	<b>Ref. No.</b>	ODO15
<b>description</b>	magnet ømm L 25mm H 9mm W 15mm		

magnetic holders



1			
<b>GEV No.</b>	541986	<b>Ref. No.</b>	ODO21
<b>description</b>	magnet holder with magnet ø 13mm		

encoders and potentiometers





1			
<b>GEV No.</b>	300198	<b>Ref. No.</b>	OGE02
<b>description</b>	encoder		





1			
<b>GEV No.</b>	402390	<b>Ref. No.</b>	MC15
<b>description</b>	potentiometer 0.5KOhm rotation 270° RHS500 shaft L 19mm type 1004MX plug type male faston 6.3mm cable length 400mm		

Зип-Общепит  
vsezip.ru  
+7(812)987-08-81

			
1			
<b>GEV No.</b>	402391	<b>Ref. No.</b>	MC16
<b>description</b>	potentiometer 0.5KOhm rotation 270° shaft L 19mm plug type male faston 6.3mm cable length 450mm		
<b>For models:</b>	CT1		

			
1			
<b>GEV No.</b>	348226	<b>Ref. No.</b>	EN02
<b>description</b>	potentiometer 3-pole cable length 300mm		

			
1			
<b>GEV No.</b>	300197	<b>Ref. No.</b>	OPO02
<b>description</b>	potentiometer 4.7KOhm rotation 360° shaft ø 5.9mm with switch shaft L 22mm		



			
1			
<b>GEV No.</b>	400106	<b>Ref. No.</b>	OGE01
<b>description</b>	pulsar KOhm rotation 360° shaft ø 6mm type CPC		

## lamps

### indicator lights

#### indicator lights 2-piece (lens and indicator lamp)

#### indicator lamps for socket type RL

			
1			
<b>GEV No.</b>	359818	<b>Ref. No.</b>	NE04
<b>description</b>	indicator light 230V clear connection male faston 6.3mm		
<b>accessories for</b>	359818		
	<b>GEV No.</b>	359820	<b>Ref. No.</b>
			—
	indicator light lens yellow Qty 1 pcs ø 8mm		
	<b>GEV No.</b>	359833	<b>Ref. No.</b>
			—
	indicator light lens red Qty 1 pcs ø 8mm		

			
<b>GEV No.</b>	359948	<b>Ref. No.</b>	—
<b>description</b>	indicator light lens clear Qty 1 pcs ø 8mm		

#### indicator lights (complete) ø 10mm

<b>with plug-in socket</b>			
			
1			
<b>GEV No.</b>	359139	<b>Ref. No.</b>	NE43
<b>description</b>	indicator light ø 10mm green 230V connection male faston 6.3mm Qty 1 pcs		

			
1			
<b>GEV No.</b>	359140	<b>Ref. No.</b>	NE42
<b>description</b>	indicator light ø 10mm yellow 230V connection male faston 6.3mm Qty 1 pcs		
<b>For models:</b>	DF33, DF36, DF39, DF46, DF49, DF612, DF618, DF66, DF66ST, ECO76, ECO8, ECO9, ESLR9, GG1, GS3, GS4, GS4E, GS6, GS6T, GS6TE, GS7, GS7E, GS9, J12, J18, J6, J9, LCG, LCG2, LCO, LDF, LDF2, LFF, LGR, LGR2, LPG, LPG2, LPO, LRG, LRG2, LSC, PB33, PB66, UM50, UM50D, UMO50, UMS50, UMS50D, UMSO50, UMSO50D		

#### ø 13mm with plug-in socket

			
1			
<b>GEV No.</b>	359142	<b>Ref. No.</b>	NE38
<b>description</b>	indicator light ø 13mm green 230V connection male faston 6.3mm temp.-resist. 120°C Qty 1 pcs		
<b>For models:</b>	FWD, FWDG, G1A, GBM2, GBM3, KFCWD		

			
1			
<b>GEV No.</b>	359143	<b>Ref. No.</b>	NE37
<b>description</b>	indicator light ø 13mm yellow 230V connection male faston 6.3mm temp.-resist. 120°C Qty 1 pcs		
<b>For models:</b>	FWD, FWDG, G1A, GBM2, GBM3, KFCWD		

#### ø 19mm

			
1			
<b>GEV No.</b>	359563	<b>Ref. No.</b>	NE39
<b>description</b>	indicator light ø 19mm 230V green connection male faston 6.3mm		
<b>For models:</b>	OE7008, OE7010, OE7012, OE7104, OE7105, OE7112, OE7113, OE7206, OE7209, OE7210, OE7303, OE7304		





Зип Общежит

vsezip.ru

87(812)987-08-81

			
1			
<b>GEV No.</b>	359564	<b>Ref. No.</b>	NE40
<b>description</b>	indicator light ø 19mm 230V orange connection male faston 6.3mm		
<b>For models:</b>	OE7008, OE7010, OE7104, OE7105, OE7112, OE7113, OE7206, OE7209, OE7210, OE7503		

30x11 mm			
			
1			
<b>GEV No.</b>	359160	<b>Ref. No.</b>	NE34
<b>description</b>	indicator light mounting measurements 30x11mm 230V green connection male faston 6.3mm rectangular temp.-resist. 125°C		
<b>For models:</b>	V6, V6D, V6F		

			
1			
<b>GEV No.</b>	359159	<b>Ref. No.</b>	NE41
<b>description</b>	indicator light mounting measurements 30x11mm 230V yellow connection male faston 6.3mm temp.-resist. 125°C		
<b>For models:</b>	ECO7, V6, V6D, V6F, V7		

miscellaneous			
			
1			
<b>GEV No.</b>	359066	<b>Ref. No.</b>	ONE02
<b>description</b>	indicator light mounting measurements 30x21mm green 230V		

screw-on/push-on fit

light bulbs			
for ovens			
			
1			
<b>GEV No.</b>	357153	<b>Ref. No.</b>	LA08
<b>description</b>	light bulb t.max. 300°C socket E14 25W 230V ø 25mm L 55mm lens L 30mm for oven type		



			
1			
<b>GEV No.</b>	359611	<b>Ref. No.</b>	LA)S LA94
<b>description</b>	light bulb t.max. 300°C socket E14 40W 230V ø 45mm L 75mm lens L 50mm for oven lamp IMPORT		
<b>For models:</b>	ECO76		

halogen lamp			
for socket G4 / G6.35 / G9			
			
1			
<b>GEV No.</b>	359596	<b>Ref. No.</b>	OBU02
<b>description</b>	halogen lamp socket G4 12V 10W temp.-resist. 500°C		

linear lamps

infrared lamps

with base type R7s

			
1			
<b>GEV No.</b>	359536 <sup>1</sup>	<b>Ref. No.</b>	LA210
<b>description</b>	infrared lamp socket R7s L 218mm 240V 500W jacketed		
<b>For models:</b>	CS4G, LD2, LD3, LD4		
<b>accessories for</b>	359536		
	<b>GEV No.</b>	359583	<b>Ref. No.</b>
			—
	lamp socket socket R7s 250V ømm for length of lamp 218mm H 62mm connection cable 200mm mounting distance 120mm holder length 246mm mounting thread M4 Qty 1 pcs		

<sup>1</sup>with double glass

with base type Z ceramic

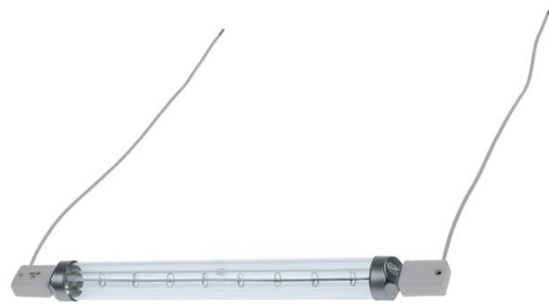
			
1			
<b>GEV No.</b>	359470 <sup>1</sup>	<b>Ref. No.</b>	LA12
<b>description</b>	infrared lamp socket Z-ceramic L 225mm 240V 500W cable length 215mm		
<b>For models:</b>	CS4G		

<sup>1</sup>with double glass

sockets for linear lamps

R7s



			
1			
<b>GEV No.</b>	359726	<b>Ref. No.</b>	LA211
<b>description</b>	lamp socket socket R7s 250V ø 18mm Lmm H 28mm connection cable 230mm mounting distance mm mounting thread M14x1 cable material silicone Qty 1 pcs		
<b>For models:</b>	CS4G, LD2, LD3, LD4		





Зип-Общепит

vsezip.ru

(812) 987-08-81

			
1			
<b>GEV No.</b>	359544	<b>Ref. No.</b>	LA325
<b>description</b>	lamp socket socket R7s 250V ømm for length of lamp 117.6mm H 40mm connection cable 230mm mounting distance 70mm holder length 140mm cable material silicone Qty 1 pcs		
<b>accessories for</b>	359544		
	<b>GEV No.</b>	359545	<b>Ref. No.</b> LA326
	reflector for length of lamp 117.6mm for infrared quartz lamp		

			
1			
<b>GEV No.</b>	359545	<b>Ref. No.</b>	LA326
<b>description</b>	reflector for length of lamp 117.6mm for infrared quartz lamp		
<b>accessories for</b>	359545		
	<b>GEV No.</b>	359544	<b>Ref. No.</b> LA325
	lamp socket socket R7s 250V ømm for length of lamp 117.6mm H 40mm connection cable 230mm mounting distance 70mm holder length 140mm cable material silicone Qty 1 pcs		

### fluorescent lamps

#### fluorescent lamps

<b>G13</b>			
			
1			
<b>GEV No.</b>	357145	<b>Ref. No.</b>	BU173
<b>description</b>	fluorescent lamp socket G13 L 438mm 15W ø 27mm 230V Qty 1 pcs light colour 865		
<b>For models:</b>	SCH785, SCR785		

			
1			
<b>GEV No.</b>	359371	<b>Ref. No.</b>	BU171
<b>description</b>	fluorescent lamp socket G13 L 590mm 18W 230V Qty 1 pcs		
<b>For models:</b>	C6A-100, C6A-75, C6H-100, C6H-75, C6R-100, C6R-105L, C6R-105R, C6R-130L, C6R-130R, C6R-75, D3H-75, D3R-100, D5H-100, D5H-75, D5R-100, D5R-125, D6R-100, D6R-75		

			
1			
<b>GEV No.</b>	357147	<b>Ref. No.</b>	BU172
<b>description</b>	fluorescent lamp socket G13 L 895mm 30W ø 26mm 230V T8/765 Qty 1 pcs		
<b>For models:</b>	C6R-125, D6R-125, SCH1085, SCR1085		

#### accessories

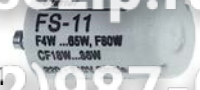
<b>starter</b>			
			
1			
<b>GEV No.</b>	380464	<b>Ref. No.</b>	GL68
<b>description</b>	starter 4-65W		
<b>For models:</b>	SCH1085, SCH785, SCR785		

### microwave lamps



#### light bulbs

			
1			
<b>GEV No.</b>	359492	<b>Ref. No.</b>	BU10
<b>description</b>	light bulb socket B22 200-250V 25W		

### oven lamps

#### universal oven lamps

mounting diameter 65.5mm

			
1			
<b>GEV No.</b>	359712	<b>Ref. No.</b>	LA87
<b>description</b>	oven lamp mounting ø 65.5mm 230V 40W socket E14 temp.-resist. 300°C connection male faston 6.3mm hard glas		
<b>For models:</b>	ECO76		
<b>spare parts for</b>	359712		
	<b>GEV No.</b>	359022	<b>Ref. No.</b> —
	lamp socket socket E14 mounting ø 65.5mm connection male faston 6.3mm		
	<b>GEV No.</b>	359611	<b>Ref. No.</b> LA)S LA94
	light bulb t.max. 300°C socket E14 40W 230V ø 45mm L 75mm lens L 50mm for oven lamp IMPORT		
	<b>GEV No.</b>	359722	<b>Ref. No.</b> —
	gasket silicone ID ø 57.5mm ED ø 68mm thickness 2mm		
	<b>GEV No.</b>	359724	<b>Ref. No.</b> —
	oven lamp glass thread ø 62mm H 46mm ø 74mm hard glas temp.-resist. 350°C		



Зип Общепит  
vsezip.ru  
+7(812)987-08-81

50x75.5mm



1

<b>GEV No.</b>	359309	<b>Ref. No.</b>	LA19
<b>description</b>	oven lamp L 75mm W 50mm 230V 40W socket E14 temp.-resist. 300°C connection male faston 6.3mm		
<b>For models:</b>	LCO, UM50, UM50D, UMO50, UMS50, UMS50D, UMSO50, UMSO50D		



1

<b>GEV No.</b>	359880	<b>Ref. No.</b>	OBU04
<b>description</b>	gasket L 95mm W 72mm C-Line, CPC, SCC 61-202		

producer-specific oven lamps

LINCAT



1

<b>GEV No.</b>	360718	<b>Ref. No.</b>	LA118
<b>description</b>	bracket for lamp ø 37.6mm		



1

<b>GEV No.</b>	359879	<b>Ref. No.</b>	OBU05
<b>description</b>	gasket L 99mm W 75mm C-Line, CPC, SCC 61-202		



1

<b>GEV No.</b>	359876	<b>Ref. No.</b>	OBU07
<b>description</b>	frame SS for lamp lenses W 90mm L 113mm C-Line, CPC, SCC 61-202		
<b>accessories for</b>	359876		
	<b>GEV No.</b>	<b>Ref. No.</b>	OBU03
	359877		
<b>description</b>	lamp glass L 95mm W 72mm thickness 4mm C-Line, CPC, SCC 61-202		
	<b>GEV No.</b>	<b>Ref. No.</b>	OBU05
	359879		
<b>description</b>	gasket L 99mm W 75mm C-Line, CPC, SCC 61-202		
	<b>GEV No.</b>	<b>Ref. No.</b>	OBU04
	359880		
<b>description</b>	gasket L 95mm W 72mm C-Line, CPC, SCC 61-202		
	<b>GEV No.</b>	<b>Ref. No.</b>	—
	560448		
<b>description</b>	hexagonal screw thread M5 thread L 8mm SS WS 8 Qty 1 pcs head thickness 4mm DIN 933 / ISO 4017		









1

<b>GEV No.</b>	359878	<b>Ref. No.</b>	OBU11
<b>description</b>	lamp glass L 80mm W 65mm thickness 4mm		



1

<b>GEV No.</b>	359873	<b>Ref. No.</b>	OBU06
<b>description</b>	lamp socket socket G4 for halogen lamp		
<b>accessories for</b>	359873		
	<b>GEV No.</b>	<b>Ref. No.</b>	OBU07
	359876		
<b>description</b>	frame SS for lamp lenses W 90mm L 113mm C-Line, CPC, SCC 61-202		
	<b>GEV No.</b>	<b>Ref. No.</b>	OBU03
	359877		
<b>description</b>	lamp glass L 95mm W 72mm thickness 4mm C-Line, CPC, SCC 61-202		
	<b>GEV No.</b>	<b>Ref. No.</b>	OBU05
	359879		
<b>description</b>	gasket L 99mm W 75mm C-Line, CPC, SCC 61-202		
	<b>GEV No.</b>	<b>Ref. No.</b>	OBU04
	359880		
<b>description</b>	gasket L 95mm W 72mm C-Line, CPC, SCC 61-202		
	<b>GEV No.</b>	<b>Ref. No.</b>	—
	360724		
<b>description</b>	lamp glass L 113mm W 90mm C-Line, CPC, SCC 61-202		



1

<b>GEV No.</b>	359882	<b>Ref. No.</b>	OBU09
<b>description</b>	gasket L 81mm W 65mm		



1

<b>GEV No.</b>	359874	<b>Ref. No.</b>	OBU13
<b>description</b>	lamp socket socket G4 for halogen lamp		



1

<b>GEV No.</b>	359881	<b>Ref. No.</b>	OBU10
<b>description</b>	gasket L 85mm W 70mm		



Зип Общепит  
lamp accessories



1

<b>GEV No.</b>	360716	<b>Ref. No.</b>	LA14
<b>description</b>	oven lamp mounting measurements 55x70mm 250V 25W socket E14 rectangular temp.-resist. 300°C connection F6.3		
<b>For models:</b>	ECO8, ECO9, L3, L4, LPW, LPW-LR		

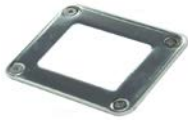

1

<b>GEV No.</b>	359875	<b>Ref. No.</b>	OBU08
<b>description</b>	press frame with gasket		

### lamps

#### light bulbs



1

<b>GEV No.</b>	357153	<b>Ref. No.</b>	LA08
<b>description</b>	light bulb t.max. 300°C socket E14 25W 230V ø 25mm L 55mm lens L 30mm for oven type		



1

<b>GEV No.</b>	359611	<b>Ref. No.</b>	LA)S LA94
<b>description</b>	light bulb t.max. 300°C socket E14 40W 230V ø 45mm L 75mm lens L 50mm for oven lamp IMPORT		
<b>For models:</b>	ECO76		

#### halogen lamps

for socket G4 / G6.35 / G9



1

<b>GEV No.</b>	359596	<b>Ref. No.</b>	OBU02
<b>description</b>	halogen lamp socket G4 12V 10W temp.-resist. 500°C		

#### fasteners

#### lamp holders



1

<b>GEV No.</b>	360757	<b>Ref. No.</b>	LA112
<b>description</b>	lamp holder L 665mm W 80mm		



1

<b>GEV No.</b>	360715	<b>Ref. No.</b>	LA02
<b>description</b>	lamp holder L 774mm W 60mm		



1

<b>GEV No.</b>	360714	<b>Ref. No.</b>	LA119
<b>description</b>	reflector complete incl. holder L 170mm W 61mm thickness 28mm		

### alarm devices

#### buzzers



1

<b>GEV No.</b>	350136	<b>Ref. No.</b>	OBU01
<b>description</b>	buzzer 12VAC connection cable 200mm screw mounting 63dB		

### contactors

#### BENEDIKT & JÄGER

#### power contactors



1

<b>GEV No.</b>	380772	<b>Ref. No.</b>	OCA30
<b>description</b>	power contactor resistive load 25A 230VAC (AC3/400V) 10A/4kW main contacts 3NO auxiliary contacts 1NO connection screw connection type K3-10A10230		

Зип Общепит



vsezip.ru

+7(812)987-08-81



1

<b>GEV No.</b>	381173	<b>Ref. No.</b>	OCO29
<b>description</b>	power contactor resistive load 50A 230VAC (AC3/400V) 24A/11kW main contacts 3NO auxiliary contacts 1NO connection torx type K3-24B00 50/60Hz		



1





<b>GEV No.</b>	380244	<b>Ref. No.</b>	OCO04
<b>description</b>	power contactor resistive load 25A 230VAC (AC3/400V) 9A/4kW main contacts 3NO auxiliary contacts 1NO connection screw connection type AEG LS4K 10A type GE CL00A 310		

GENERAL ELECTRIC (AEG)

power contactors



1

<b>GEV No.</b>	380267	<b>Ref. No.</b>	OCO24	
<b>description</b>	power contactor resistive load 110A 230VAC (AC3/400V) 65A/30kW main contacts 3NO auxiliary contacts connection screw connection type AEG LS30K 00A type GE CL07A 300			
<b>accessories for</b>	380267			
	<b>GEV No.</b>	380268	<b>Ref. No.</b>	—
	auxiliary contact contacts 1NO for contactors CL+LS_K connection screw AC-12 10A type AEG HS07K 10 type GE BCLF 10			
	<b>GEV No.</b>	380269	<b>Ref. No.</b>	—
	auxiliary contact contacts 1NC AC15 6A for contactors CL+LS_K connection screw AC-12 10A type AEG HS07K 01 type GE BCLF 01			
	<b>GEV No.</b>	380270	<b>Ref. No.</b>	—
	auxiliary contact contacts 1NO/1NC for contactors CL+LS_K connection screw AC-12 10A type AEG HS08K 11 type GE BCLL 11			
	<b>GEV No.</b>	380271	<b>Ref. No.</b>	—
	auxiliary contact contacts 2NO for contactors CL+LS_K connection screw AC-12 10A type AEG HS08K 20 type GE BCLL 20			



1

<b>GEV No.</b>	380498	<b>Ref. No.</b>	CO111 OCO19
<b>description</b>	power contactor resistive load 20A 230VAC (AC3/400V) 9A/4kW main contacts 4NO auxiliary contacts connection male faston 6.3mm type MC1A 400A type AEG LS05 01 FA type GE MC1A 400A		
<b>For models:</b>	DF36, DF39, DF46, DF49, DF612, DF618, DF66ST, EB4F, EB6, EB6T, ECG6, ECO76, ESLR9, J12, J18, J6, J9, OE7008, OE7010, OE7104, OE7206, OE7209		



1

<b>GEV No.</b>	380261	<b>Ref. No.</b>	OCO05
<b>description</b>	power contactor resistive load 32A 230VAC (AC3/400V) 17A/7.5kW main contacts 3NO auxiliary contacts 1NO connection screw connection type AEG LS7K 10A type GE CL02A 310		

MOELLER/EATON

power contactors



1

<b>GEV No.</b>	380167	<b>Ref. No.</b>	OCO20
<b>description</b>	power contactor resistive load 66A 230VAC (AC3/400V) 50A/22kW main contacts 3NO auxiliary contacts 1NO connection screw connection type DILM 50		

Зип.Общепит  
relayspower relays  
with bracket mountingvsezip.ru  
+7(812)987-08-81

SIEMENS

power contactors



1

<b>GEV No.</b>	380614	<b>Ref. No.</b>	CO215
<b>description</b>	power contactor resistive load 22A 230VAC (AC3/400V) 9A/4kW main contacts 3NO auxiliary contacts 1NO connection elastic terminals type 3RT2016-2AP01		

TELEMECANIQUE (Schneider Electric)

power contactors



1

<b>GEV No.</b>	380967	<b>Ref. No.</b>	CO112
<b>description</b>	power contactor resistive load 20A 230VAC (AC3/400V) 9A/4kW main contacts 3NO auxiliary contacts 1NO connection screw connection type LC1K0910M7		
<b>For models:</b>	AS4, EB3, EB4, ECO9, OE7105, OE7112, OE7113, OE7206, OE7209, OE7503		

solid state relays

CELDUC



1

<b>GEV No.</b>	400105	<b>Ref. No.</b>	ORO01
<b>description</b>	solid state relay CELDUC 2 phase 65A 400V 24VDC L 58mm W 45mm plug-in connection screw type 40.00.453		
<b>accessories for</b>	400105		
	<b>GEV No.</b>	<b>Ref. No.</b>	—
	connecting cable L 1440mm 4-pole suitable for RATIONAL		



1

<b>GEV No.</b>	380812	<b>Ref. No.</b>	RE28
<b>description</b>	power relays FINDER 230VAC 30A 2CO connection F6.3 bracket mounting manuf. no. 66.82.8.230.0000		



1

<b>GEV No.</b>	380311	<b>Ref. No.</b>	CO09
<b>description</b>	power relays Italiana Relè 230VAC 20A 1NC/1NO connection F6.3 bracket mounting manuf. no. A1B-230AC-FA		
<b>For models:</b>	OE7303		

transformers

encapsulated transformers

with plug connection



1

<b>GEV No.</b>	401472	<b>Ref. No.</b>	OTR06
<b>description</b>	transformer 1/20/50VA secondaryA H 70mm L 76mm W 104mm connection plug 50/60Hz type 110170 with fuse secondary 2.1/11.5/12VAC primary 230VAC		
<b>spare parts for</b>	401472		
	<b>GEV No.</b>	<b>Ref. No.</b>	—
	fine fuse size ø5x20mm 1.6A slow-acting rated 250V Qty 10 pcs		









Зип-Общество

vsezip.ru

+7(812)9870680

			
1			
<b>GEV No.</b>	401473	<b>Ref. No.</b>	OTR09
<b>description</b>	transformer 21.6VA H 70mm L 94mm W 71mm connection plug 50-60Hz type 40.00.592 moulded secondary 12VDC primary 200-250VAC		

			
<b>GEV No.</b>	379160	<b>Ref. No.</b>	—
<b>description</b>	temperature probe NTC 10kOhm cable thermoplastic probe -40 up to +110°C cable -40 up to +110°C probe ø6x14mm cable length 1.5m without screw connection 2-wire		
			
<b>GEV No.</b>	379161	<b>Ref. No.</b>	—
<b>description</b>	temperature probe NTC 10kOhm cable thermoplastic probe -40 up to +110°C cable -40 up to +110°C probe ø6x14mm cable length 3m without screw connection 2-wire		
			
<b>GEV No.</b>	379343	<b>Ref. No.</b>	—
<b>description</b>	temperature probe NTC 10kOhm cable silicone probe -40 up to +110°C cable -50 up to +180°C probe ø6x40mm cable length 3m 2-wire		
			
<b>GEV No.</b>	379458	<b>Ref. No.</b>	—
<b>description</b>	temperature probe NTC 10kOhm cable silicone probe -40 up to +110°C cable -50 up to +180°C probe ø6x40mm cable length 1.5m without screw connection 2-wire		







## electronic controllers

### DIXELL

#### refrigeration controllers

##### built-in version

			
1			
<b>GEV No.</b>	378273	<b>Ref. No.</b>	EC15
<b>description</b>	electronic controller DIXELL XR06CX-5N0C1 mounting measurements 71x29mm 230V voltage AC NTC/PTC relay outputs 1 NO-20A(8) NTC/PTC DI protection IP54 -50 up to +110°C display 2½ digit DEF Relay 8A fan relay 8A compressor relay 20A		

			
1			
<b>GEV No.</b>	402192	<b>Ref. No.</b>	EC17
<b>description</b>	electronic controller DIXELL XR10CX mounting measurements 71x29mm 230V voltage AC NTC/PTC relay outputs 1 NO-20A(8) NTC/PTC DI protection IP54 -50 up to +150°C display 3½ digits		
<b>accessories for</b>	402192		
			
<b>GEV No.</b>	378194	<b>Ref. No.</b>	—
<b>description</b>	temperature probe NTC 10kOhm cable PVC probe -20 up to +80°C cable -10 up to 100°C probe ø7x24.5mm cable length 1.5m without screw connection 2-wire		
			
<b>GEV No.</b>	379052	<b>Ref. No.</b>	—
<b>description</b>	temperature probe PTC 1kOhm cable silicone probe -50 up to +150°C cable -50 up to +180°C probe ø6x40mm cable length 1.5m without screw connection 2-wire		
			
<b>GEV No.</b>	379053	<b>Ref. No.</b>	—
<b>description</b>	temperature probe PTC 1kOhm cable PVC probe -50 up to +150°C cable -10 up to 100°C probe ø6x30mm cable length 3m without screw connection 2-wire		
			
<b>GEV No.</b>	379057	<b>Ref. No.</b>	—
<b>description</b>	temperature probe NTC 10kOhm cable PVC probe -20 up to +80°C cable -10 up to 100°C probe ø6x25mm cable length 3m 2-wire		
			
<b>GEV No.</b>	379064	<b>Ref. No.</b>	—
<b>description</b>	temperature probe PTC 1kOhm cable silicone probe -50 up to +150°C cable -50 up to +180°C probe ø6x40mm cable length 3m without screw connection 2-wire		

## probes

### producer-specific probes

			
1			
<b>GEV No.</b>	379430	<b>Ref. No.</b>	OTC14
<b>description</b>	core temperature probe thermocouple K (NiCr-Ni) cable silicone probe -50 up to 1150°C cable -50 up to +180°C connection coded plug thread probe ø1.5x140mm cable length 1.65m		

			
1			
<b>GEV No.</b>	379469	<b>Ref. No.</b>	TH90
<b>description</b>	temperature probe NTC 10kOhm cable thermoplastic probe -40 up to +110°C cable -40 up to +110°C connection coded plug thread probe eye M3 cable length 0.6m		

			
1			
<b>GEV No.</b>	378641	<b>Ref. No.</b>	TH103
<b>description</b>	temperature probe Pt100 cable PVC probe -100 up to 450°C connection plug thread M10x1 probe 5x26 cable length 0.68m		

			
1			
<b>GEV No.</b>	378642	<b>Ref. No.</b>	TH98
<b>description</b>	temperature probe PTC 1kOhm cable PVC probe -50 up to +150°C connection plug probe eye M3 cable length 780mm		

			
1			
<b>GEV No.</b>	378351	<b>Ref. No.</b>	OTC09
<b>description</b>	temperature probe thermocouple K (NiCr-Ni) cable silicone probe -50 up to 1150°C cable -50 up to +180°C connection coded plug thread M8 probe ø2x135mm cable length 1.3m		

Зип-Общепит

core probes

vsezip.ru

+7(812)987-08-81

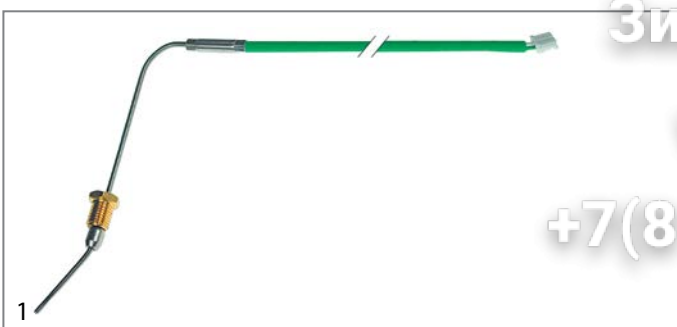

<b>GEV No.</b>	379864	<b>Ref. No.</b>	OTC07
<b>description</b>	temperature probe thermocouple K (NiCr-Ni) cable silicone probe -50 up to 1150°C cable -50 up to +180°C connection coded plug thread M8 probe ø2x50mm cable length 1.2m		

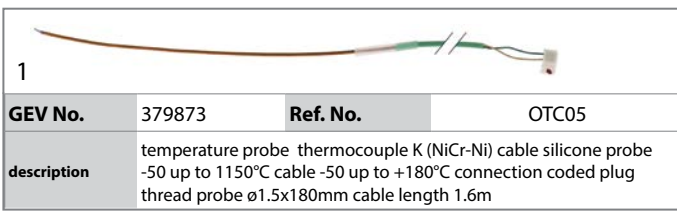

<b>GEV No.</b>	379873	<b>Ref. No.</b>	OTC05
<b>description</b>	temperature probe thermocouple K (NiCr-Ni) cable silicone probe -50 up to 1150°C cable -50 up to +180°C connection coded plug thread probe ø1.5x180mm cable length 1.6m		

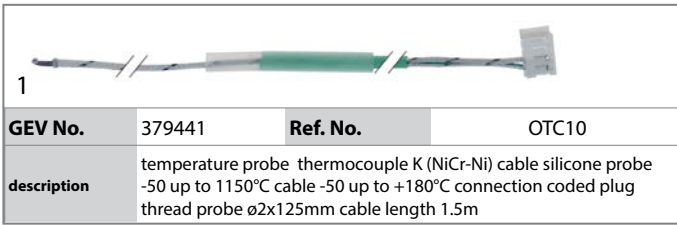

<b>GEV No.</b>	379441	<b>Ref. No.</b>	OTC10
<b>description</b>	temperature probe thermocouple K (NiCr-Ni) cable silicone probe -50 up to 1150°C cable -50 up to +180°C connection coded plug thread probe ø2x125mm cable length 1.5m		



<b>GEV No.</b>	379869	<b>Ref. No.</b>	OTC06
<b>description</b>	temperature probe thermocouple K (NiCr-Ni) cable silicone probe -50 up to 1150°C cable -50 up to +180°C connection coded plug thread probe ø2x70mm cable length 2.5m		

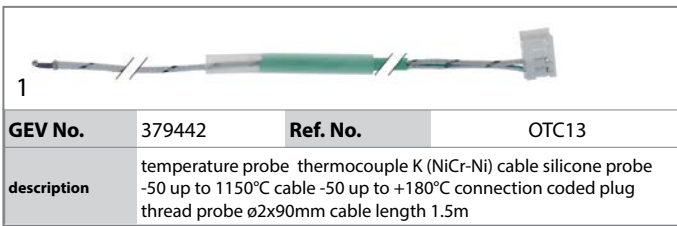

<b>GEV No.</b>	379442	<b>Ref. No.</b>	OTC13
<b>description</b>	temperature probe thermocouple K (NiCr-Ni) cable silicone probe -50 up to 1150°C cable -50 up to +180°C connection coded plug thread probe ø2x90mm cable length 1.5m		

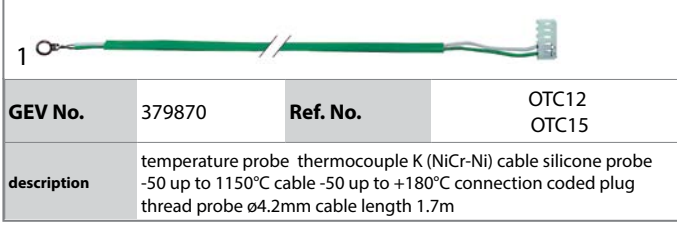

<b>GEV No.</b>	379870	<b>Ref. No.</b>	OTC12 OTC15
<b>description</b>	temperature probe thermocouple K (NiCr-Ni) cable silicone probe -50 up to 1150°C cable -50 up to +180°C connection coded plug thread probe ø4.2mm cable length 1.7m		



<b>GEV No.</b>	379367	<b>Ref. No.</b>	OPR10
<b>description</b>	conversion kit thermocouple K (NiCr-Ni) cable PTFE probe -40 up to +250°C cable -40 up to +250°C connection plug probe ø3x100mm thread M16 cable length 2.2m handle ø 10mm handle length 40mm		

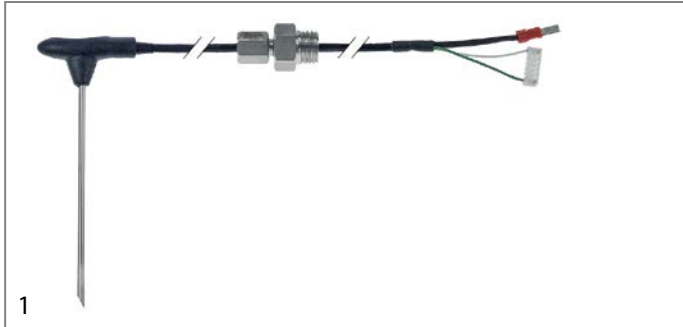

<b>GEV No.</b>	381443	<b>Ref. No.</b>	OPR18
<b>description</b>	core temperature probe CM_P 61-102 cable PTFE insulated probe -40 up to +250°C probe ø3.2x100mm cable length 2.45m handle ø 12mm handle length 44mm		



<b>GEV No.</b>	379792 <sup>1</sup>	<b>Ref. No.</b>	OPR07
<b>description</b>	core temperature probe thermocouple K (NiCr-Ni) cable PTFE probe -40 up to +250°C cable -40 up to +250°C connection grip connection probe ø3.2x100mm thread M16x2 cable length 1.9m handle ø 10mm handle length 40mm		

**accessories for** 379792

<b>GEV No.</b>	510179	<b>Ref. No.</b>	—
<b>description</b>	flat gasket fibre ED ø 18mm ID ø 13mm thickness 1.5mm Qty 1 pcs		

<b>GEV No.</b>	560519	<b>Ref. No.</b>	—
<b>description</b>	nut thread M12x1 H 5mm WS 17 SS Qty 1 pcs		

<sup>1</sup>multipoint probe



<b>GEV No.</b>	379868 <sup>1</sup>	<b>Ref. No.</b>	OPR09
<b>description</b>	core temperature probe thermocouple K (NiCr-Ni) cable PTFE probe -40 up to +250°C cable -40 up to +250°C connection plug probe ø3x100mm thread M16 cable length 2.2m handle ø 10mm handle length 40mm		

<sup>1</sup>multipoint probe



Зип Общепит

electronics

vsezip.ru

+7(812)987-08-81



1

<b>GEV No.</b>	379865	<b>Ref. No.</b>	OPR15
<b>description</b>	core temperature probe thermocouple K (NiCr-Ni) cable PTFE probe -40 up to +250°C cable -40 up to +250°C connection plug probe ø3x100mm thread M16 cable length 2.3m handle ømm handle length 50mm		



1

<b>GEV No.</b>	379866 <sup>1</sup>	<b>Ref. No.</b>	OPR14
<b>description</b>	core temperature probe thermocouple K (NiCr-Ni) cable PTFE probe -40 up to +250°C cable -40 up to +250°C connection plug probe ø3x100mm thread M16 cable length 2.3m handle ømm handle length 50mm		

<sup>1</sup> multipoint probe

sensors



1

<b>GEV No.</b>	403896	<b>Ref. No.</b>	LE49
<b>description</b>	sensor Lower Level for Water boiler probe L 275mm probe ø 6mm		
<b>For models:</b>	EB3F, EB4F, EB6, EB6T		



1

<b>GEV No.</b>	403897	<b>Ref. No.</b>	LE64
<b>description</b>	sensor Lower Level kit for Water boiler probe L 220mm probe ø 6mm		



1

<b>GEV No.</b>	403898	<b>Ref. No.</b>	LE48
<b>description</b>	sensor Upper Level for Water boiler probe L 60mm probe ø 6mm		
<b>For models:</b>	EB3F, EB4F, EB6, EB6T		

PCBs



1

<b>GEV No.</b>	402827	<b>Ref. No.</b>	OPR13
<b>description</b>	control PCB combi-steamer CM101 L 372mm W 120mm type RAL115ET		



1

<b>GEV No.</b>	401475	<b>Ref. No.</b>	OPR11
<b>description</b>	control PCB combi-steamer SCC Line		
<b>accessories for</b>	401475		
<b>GEV No.</b>	358791	<b>Ref. No.</b>	OFU01
<b>description</b>	fine fuse size ø6.3x32mm 6.3A slow-acting rated 250V Qty 10 pcs		



1

<b>GEV No.</b>	403796	<b>Ref. No.</b>	OPR20
<b>description</b>	control PCB for combi-steamer CM_P 61-202 suitable for RATIONAL model Sicotronic		



1

<b>GEV No.</b>	403797	<b>Ref. No.</b>	OPR23
<b>description</b>	control PCB for combi-steamer SCC_WE, CM_P 61-202 model Sicotronic		



electric components

Зип.Общепит  
solenoid valves

solenoid valves (water)  
HYDRA



+7(812)987-08-81

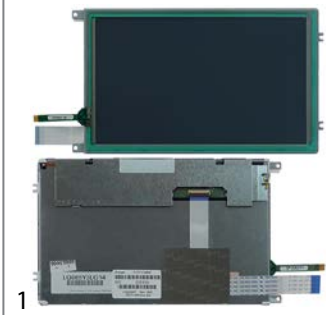

<b>GEV No.</b>	403889	<b>Ref. No.</b>	OSC09
<b>description</b>	display for combi-steamer SCC_WE 61-202 complete incl. control		

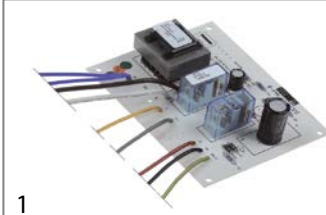

<b>GEV No.</b>	401903	<b>Ref. No.</b>	PR10
<b>description</b>	PCB		
<b>For models:</b>	EB3, EB4, EB6, EB6T		



<b>GEV No.</b>	401662	<b>Ref. No.</b>	OPR12
<b>description</b>	PCB combi-steamer CM101 conversion kit		



<b>GEV No.</b>	403048	<b>Ref. No.</b>	N/A
<b>description</b>	PCB for fryer L 135mm W 135mm		

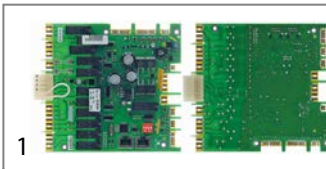

<b>GEV No.</b>	401629	<b>Ref. No.</b>	ORE03	
<b>description</b>	relay shroud I/O-Board SCC Line			
<b>accessories for</b>	401629			
	<b>GEV No.</b>	358786	<b>Ref. No.</b>	—
	fine fuse size ø6.3x32mm 2A slow-acting rated 250V Qty 10 pcs			



<b>GEV No.</b>	374095	<b>Ref. No.</b>	SO24
<b>description</b>	solenoid valve single straight 230VAC inlet 3/4" outlet 3/4" flow regulating valve outlet green output 0.8l/min DN10 total length 68.5mm		



<b>GEV No.</b>	374096	<b>Ref. No.</b>	SO23
<b>description</b>	solenoid valve single straight 230VAC inlet 3/4" outlet 3/4" flow regulating valve outlet light blue output 2l/min DN10 total length 68.5mm		
<b>For models:</b>	EB3F, EB4F, EB6, EB6T		

MÜLLER

medium temperature: 90°C  
duty cycle: 100%



<b>GEV No.</b>	374099	<b>Ref. No.</b>	SV03
<b>description</b>	solenoid valve single angled 230VAC inlet 12mm outlet 10.4mm t.max. 98°C		



Зип Общежит

with model terminals

vsezip.ru

+7(812)987-08-81

ROBERTSHAW/INVENSYS

medium temperature: 90°C 90°C 60°C  
 ambient temperature: 60°C 25°C 60°C  
 duty cycle: 40% 100% 100%

			
1			
<b>GEV No.</b>	374097	<b>Ref. No.</b>	SO22
<b>description</b>	solenoid valve single straight 230VAC inlet 1/2" outlet 1/2" DN10 t.max. 90°C flow regulating valve outlet orange		
<b>For models:</b>	OE7503, OG7502		

			
1			
<b>GEV No.</b>	374098	<b>Ref. No.</b>	SO16
<b>description</b>	solenoid valve single straight 230VAC inlet 3/4" outlet 11.5mm with backflow preventer		
<b>For models:</b>	ECO76		

solenoid valves with reducers

single

			
1			
<b>GEV No.</b>	370652	<b>Ref. No.</b>	OSO09
<b>description</b>	solenoid valve single straight 230VAC inlet 3/4" outlet 11.5mm input 10l/min 10 EATON (INVENSYS) flow regulating valve inlet white		

3-fold

			
1			
<b>GEV No.</b>	370672	<b>Ref. No.</b>	OSO07
<b>description</b>	solenoid valve triple straight 230VAC inlet 3/4" outlet 11.5mm 10 EATON (INVENSYS) plastic output C 5l/min flow regulating valve outlet C black		

			
1			
<b>GEV No.</b>	370266	<b>Ref. No.</b>	OSO03
<b>description</b>	solenoid valve double straight 230VAC inlet 3/4" outlet 11.5mm DN10 EATON (INVENSYS)		

			
1			
<b>GEV No.</b>	370267	<b>Ref. No.</b>	OSO04
<b>description</b>	solenoid valve single straight 230VAC inlet 3/4" outlet 11.5mm DN10 EATON (INVENSYS)		

			
1			
<b>GEV No.</b>	370268	<b>Ref. No.</b>	OSO06
<b>description</b>	solenoid valve single straight 230VAC inlet 3/4" outlet 11.5mm DN10 EATON (INVENSYS)		

			
1			
<b>GEV No.</b>	370270	<b>Ref. No.</b>	OSO05
<b>description</b>	solenoid valve single straight 230VAC inlet 3/8" outlet 3/8" DN10 Invensys		

various

			
1			
<b>GEV No.</b>	371332	<b>Ref. No.</b>	SO27
<b>description</b>	solenoid valve single straight 230VAC inlet 3/4" input 10-12l/min DN10 t.max. 90°C duty cycle 100% ROBERTSHAW plastic flow regulating valve inlet white with backflow preventer		

1 electric components

Зип.Общелит  
pressure switchesfor combi-steamers  
vsezip.ru

+7(812)987-08-81

various





1

<b>GEV No.</b>	370548	<b>Ref. No.</b>	SO1
<b>description</b>	solenoid valve single 240VAC inlet 3/4"		
<b>For models:</b>	ECO8, ECO9		

## drain valves



1

<b>GEV No.</b>	401889	<b>Ref. No.</b>	ODR10
<b>description</b>	drain valve 12V single inlet 40mm outlet 40mm for combi-steamer		
<b>accessories for</b>	401889		
	<b>GEV No.</b>	532727	<b>Ref. No.</b> OGA38
	O-ring silicone thickness 3.5mm ID ø 26mm Qty 5 pcs for model SCC, CM		
	<b>GEV No.</b>	532728	<b>Ref. No.</b> OGA37
	O-ring silicone thickness 3.5mm ID ø 46mm Qty 5 pcs for model SCC, CM		

## solenoid valves (refrigeration)

SANHUA

valves



1

<b>GEV No.</b>	374100	<b>Ref. No.</b>	SO21
<b>description</b>	solenoid valve single type FDF6A37 connection 1/4" L 45mm coolant R22/R134a/R404a/R407c/R507a		
<b>For models:</b>	SCR1085, SCR785		

for combi-steamers



1

<b>GEV No.</b>	345709	<b>Ref. No.</b>	OSW10
<b>description</b>	pressure control ø 84mm pressure range 0-3mbar for humidity measuring connection 6mm p max 0.025bar pressure connection 6mm		



1

<b>GEV No.</b>	541329	<b>Ref. No.</b>	OSW03
<b>description</b>	pressure control pressure range 350/150mbar connection 8mm pressure connection 8mm		

## for pasta cookers



1

<b>GEV No.</b>	542344	<b>Ref. No.</b>	PS05
<b>description</b>	pressure control pressure range 60/25mbar connection 6mm size 73x43mm pasta cooker pressure connection ø 6mm		

## electrodes



1

<b>GEV No.</b>	401912	<b>Ref. No.</b>	LE18
<b>description</b>	level electrode 1/8" total length 230mm probe L 225mm insulated probe lengthmm connection bullet connector ø 6mm		
<b>For models:</b>	EB3, EB4, EB6, EB6T		



1

<b>GEV No.</b>	401913	<b>Ref. No.</b>	LE21
<b>description</b>	level electrode 1/8" total length 23mm		
<b>For models:</b>	EB3, EB4, EB6, EB6T		





Зип Общепит

vsezip.ru

+7(812)987-08-81

			
1			
<b>GEV No.</b>	403805	<b>Ref. No.</b>	OEL20 OEL28
<b>description</b>	level electrode M15x1.5 probe L 12mm total length 325mm insulated probe length 114mm straight connection plug-in connection ø 1.5mm EPDM		

			
1			
<b>GEV No.</b>	401492	<b>Ref. No.</b>	OEL19
<b>description</b>	level electrode probe L 85mm		

			
1			
<b>GEV No.</b>	403298	<b>Ref. No.</b>	OEL29 OEL33
<b>description</b>	level electrode M15x1.5 total length 110mm probe L 85mm insulated probe length 75mm with extension connection coded plug ø 2mm suitable for RATIONAL		

			
1			
<b>GEV No.</b>	403804	<b>Ref. No.</b>	OEL20 OEL28
<b>description</b>	level electrode with cable M15x1.5 probe L 12mm total length 325mm insulated probe length 114mm straight connection plug-in connection ø 1.5mm EPDM		

			
1			
<b>GEV No.</b>	403297	<b>Ref. No.</b>	OEL21
<b>description</b>	level electrode M15x1.5 total length 190mm probe L 165mm insulated probe length 153mm with extension connection coded plug ø 2mm suitable for RATIONAL		

## flow meters and flow sensors

### flow sensors

			
1			
<b>GEV No.</b>	400163	<b>Ref. No.</b>	OEL03
<b>description</b>	level electrode PG9 total length 100mm probe L 72/43/22mm insulated probe length 70/62/52mm with 3 probes connection grip connection		

			
1			
<b>GEV No.</b>	403301	<b>Ref. No.</b>	OLE05
<b>description</b>	flow sensor inlet ø 10mm outlet ø 10mm L 104mm connection coded plug cable length 1300mm flow rate 1-25l/min		

			
1			
<b>GEV No.</b>	400021	<b>Ref. No.</b>	OEL05
<b>description</b>	level electrode PG9 total length 110mm probe L 70/47/24mm insulated probe length 62/38/16mm with 3 probes connection grip connection		

			
1			
<b>GEV No.</b>	402256	<b>Ref. No.</b>	OLE03
<b>description</b>	flow sensor inlet ø 10mm outlet ø 10mm L 110mm flow rate 1-25l/min		

			
1			
<b>GEV No.</b>	400022	<b>Ref. No.</b>	OEL04
<b>description</b>	level electrode PG9 total length 135mm probe L 89/59/28mm insulated probe length 80mm with 3 probes connection grip connection		
<b>accessories for</b>	400022		
	<b>GEV No.</b>	<b>Ref. No.</b>	<b>OCA21</b>
	379729		
	connection cable L 1230mm 4-pole for level electrode plug type coded		
	<b>GEV No.</b>	<b>Ref. No.</b>	—
	550574		
	nut thread PG9 H 3mm WS 28 nickel-plated brass Qty 1 pcs mounting ømm cable ømm		

			
1			
<b>GEV No.</b>	403302	<b>Ref. No.</b>	OSE15
<b>description</b>	flow sensor inlet ø 3/4" ET outlet ø 3/4" IT L 78mm connection coded plug cable length 1300mm flow rate 1-25l/min		



## compressors

EMBRACO / ASPERA

R134A

HBP monophase

High evaporation temperature above -15°C



1

<b>GEV No.</b>	605086	<b>Ref. No.</b>	G/CR10
<b>description</b>	compressor coolant R134a type EMT45HDR 220-240V 50Hz HBP fully hermetic 7.7kg 1/8HP power inputW cylinder capacity 3.97cm <sup>3</sup> CSIRWW 162W 207W 256W 314W 383W 467W test method ASHRAE		
<b>For models:</b>	FDB4, FPB5		

R404a/R507

HMBP monophase

High/Medium evaporation temperature above -20/-15 °C



1

<b>GEV No.</b>	605004	<b>Ref. No.</b>	CR08
<b>description</b>	compressor coolant R404a/R507 type EMT6152GK 220-240V 50Hz HMBP fully hermetic 7.8kg 1/5HP cylinder capacity 4.5cm <sup>3</sup> CSIR H 166mmWWW 267W 332W 351W 437W 535W 646W 769W test method ASHRAE		

Зип Общежит

vsezip.ru

+7(812)987-08-81



1

<b>GEV No.</b>	605161	<b>Ref. No.</b>	CR07
<b>description</b>	compressor coolant R404a/R507 type NEK6210GK 220-240V 50Hz HMBP fully hermetic 8.5kg 3/8HP cylinder capacity 8.78cm <sup>3</sup> CSIR H 200mmW 566W 674W 815W 988W 1195W 1435W 1707W		
<b>For models:</b>	SCR1085, SCR785		



1

<b>GEV No.</b>	605125	<b>Ref. No.</b>	CR06
<b>description</b>	compressor coolant R404a/R507 type NEK6213GK 220-240V 50Hz HMBP 11.6kg 1/2HP cylinder capacity 12.12cm <sup>3</sup> CSIR H 206mmW 695W 884W 1093W 1333W 1600W 1894W 2215W test method ASHRAE		

## fans

axial fans

ebm-papst



1

<b>GEV No.</b>	601309 <sup>1</sup>	<b>Ref. No.</b>	OFA16
<b>description</b>	axial fan L 127mm W 127mm H 38mm 12VDC 21W bearing ball bearing manuf. no. DV5212N metal connection cable ebm-papst suitable for RATIONAL fan wheel ø 120mm temp.-resist. 65°C		

<sup>1</sup>with ball bearings





Зип Общепит

vsezip.ru

+7(812)987-08-81



1

<b>GEV No.</b>	601752 <sup>1</sup>	<b>Ref. No.</b>	OFA18
<b>description</b>	axial fan L 127mm W 127mm H 38mm 12VDC 21W bearing ball bearing manuf. no. DV5212N plastic/metal connection cable 310mm ebm-papst fan wheel ø 120mm temp.-resist. 65°C SCC Line since 05/2008		

<sup>1</sup>with ball bearings



1

<b>GEV No.</b>	602118	<b>Ref. No.</b>	FA120
<b>description</b>	axial fan L 60mm W 60mm H 25.3mm 220-240VAC 50/60Hz 4.4W bearing slide bearing cable length 300mm SUNON		

import



1

<b>GEV No.</b>	601131 <sup>1</sup>	<b>Ref. No.</b>	S/R0181
<b>description</b>	axial fan L 119mm W 119mm H 25mm 230VAC 50/60Hz 19/18W bearing ball bearing connection male faston 2.8mm metal ADDA fan wheel ø 110mm temp.-resist. 70°C		
<b>accessories for</b>	601131		
	<b>GEV No.</b>	<b>Ref. No.</b>	—
	connecting cable cable length 2000mm connection F 2.8 connection distance 7.9mm for axial flow fan		

<sup>1</sup>with ball bearings

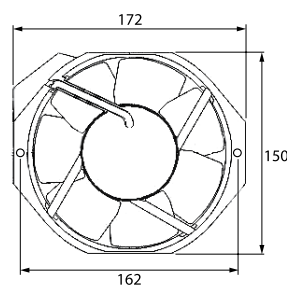
1

<b>GEV No.</b>	601654 <sup>1</sup>	<b>Ref. No.</b>	FA62
<b>description</b>	axial fan L 172mm W 150mm H 51mm 230VAC 50/60Hz 28/24W bearing ball bearing manuf. no. A2175-HBL T.G.N connection cable cable length 280mm metal SUNON fan wheel ø 142mm temp.-resist. -10 up to +80°C mounting distance 162mm		
<b>For models:</b>	SCR1085, SCR785		

<sup>1</sup>with ball bearings



1

<b>GEV No.</b>	698721 <sup>1</sup>	<b>Ref. No.</b>	S/R0079
<b>description</b>	axial fan L 119mm W 119mm H 38mm 230VAC 50/60Hz 17/15W bearing ball bearing manuf. no. connection cable cable length 3000mm COMMONWEALTH fan wheel ø 110mm temp.-resist. 70°C input current 0.1A airflow 130m <sup>3</sup> /h 2600rpm		
<b>For models:</b>	CT1, ECO9		

<sup>1</sup>with ball bearings

accessories

fan guards



1

<b>GEV No.</b>	602141	<b>Ref. No.</b>	OFI02
<b>description</b>	guard with filter for axial flow fan L 126mm W 126mm H 13.5mm mounting distance 115mm suitable for ebm-papst		

converters



1

<b>GEV No.</b>	381451	<b>Ref. No.</b>	OCO07
<b>description</b>	converter ebm-papst type AC 4400HT 100-240V for combi-steamer SCC_WE, CM_P		



## refrigeration fans

Зип Общепит  
CROSS FLOW FANS

## refrigeration motors universal

ebm-papst

multi fit fan motors



1

<b>GEV No.</b>	601756	<b>Ref. No.</b>	FA44
<b>description</b>	fan motor 5W 230V 50/60Hz L1 43.5mm L3 76mm W 61mm cable length 1500mm 1300/1550rpm ebm-papst M4Q045-BD01-75 5 mounting options bearing slide bearing		
<b>spare parts for</b>	601756		
	<b>GEV No.</b>	601413	<b>Ref. No.</b> —
	fixing plate suitable for fanwheel ED ø 32mm shaft ø 7 mounting distance 26mm		

## ELCO

N series - standard



1

<b>GEV No.</b>	601687	<b>Ref. No.</b>	FA109
<b>description</b>	fan motor ELCO 7W 230V 50/60Hz bearing ball bearing connection cable 1500mm cable length 1500mm 1320/1550rpm 3 mounting options VN7-20/1397		

## cooling fans



1

<b>GEV No.</b>	602120	<b>Ref. No.</b>	FA25
<b>description</b>	fan 230V 50Hz 66W W 210mm H 170mm D 160mm shaft Lmm shaft ømm ebm-papst 1450rpm		
<b>For models:</b>	L3, L4		

## EMMEVI - FERGAS

WITH STARTER COIL



1

<b>GEV No.</b>	602122	<b>Ref. No.</b>	FA51
<b>description</b>	cross flow fan 112904 roller ø 60mm roller length 180mm laminated core thickness 30mm 230VAC 28W refrigeration bearing rubber connection F6.3 t.max. -10 up to +80°C 50Hz		
<b>For models:</b>	FDB4, FPB5		



1

<b>GEV No.</b>	602169	<b>Ref. No.</b>	FA63
<b>description</b>	cross flow fan Emmevi roller ø 60mm roller length 300mm laminated core thickness 20mm motor position right 230V/50Hz 26W refrigeration bearing rubber connection male faston 6.3mm		
<b>For models:</b>	SCR1085, SCR785		



1

<b>GEV No.</b>	602170	<b>Ref. No.</b>	FA61
<b>description</b>	cross flow fan Emmevi roller ø 60mm roller length 300mm laminated core thickness 20mm motor position right 230V/50Hz 26W refrigeration bearing rubber connection male faston 6.3mm		

## hot air motors



1

<b>GEV No.</b>	601301	<b>Ref. No.</b>	OFA12
<b>description</b>	fan motor 100-240V 1 phase 50/60Hz 0.45kW 2000rpm speeds 1 L1 160mm L2mm L3mm L4mm M8R IT fan wheel ø 130mm type M3G084-FA22-16		
<b>accessories for</b>	601301		
	<b>GEV No.</b>	511685	<b>Ref. No.</b> OGA29
	shaft seal kit ID ø 15mm ED ø 27mm shaft seal flange mounting gauge with mountign material		

Table continues overleaf



Зип Общепит



vsezip.ru

+7(812)987-08-81

<b>accessories for</b>	601301		
	<b>GEV No.</b>	601327	<b>Ref. No.</b> —
	fan wheel D1 ø 340mm H1 135mm blades 9 D2 ø 13mm D3 ø 16mm H2 38mm		





1

<b>GEV No.</b>	602128	<b>Ref. No.</b>	OMO14
<b>description</b>	fan motor 100-240V 50/60Hz 0.55kW 1800rpm L1 162mm L2 52mm L3 14mm with engine shaft gasket type SCC_WE, CM_P 61-202		
<b>spare parts for</b>	602128		
	<b>GEV No.</b>	551347	<b>Ref. No.</b> —
	gasket set SCC_WE, CM_P 61-202		
	<b>GEV No.</b>	551348	<b>Ref. No.</b> —
	insulation SCC_WE, CM_P 61-202 L 248mm bore ø 30mm W 193mm H 15mm		



1

<b>GEV No.</b>	602126	<b>Ref. No.</b>	OFA21
<b>description</b>	fan motor 200-240V 50/60Hz 0.75kW 1820rpm L1 160mm L2 49mm L3 16mm 3.75A for fan wheel ø 15mm		
<b>spare parts for</b>	602126		
	<b>GEV No.</b>	551347	<b>Ref. No.</b> —
	gasket set SCC_WE, CM_P 61-202		
	<b>GEV No.</b>	551348	<b>Ref. No.</b> —
	insulation SCC_WE, CM_P 61-202 L 248mm bore ø 30mm W 193mm H 15mm		



1

<b>GEV No.</b>	602121	<b>Ref. No.</b>	FA102
<b>description</b>	fan wheel blades 12 D1 ø 160mm D2 ø 5x6mm H1 27mm		
<b>For models:</b>	ECO76, ECO9, ESLR9, OE7008, OE7010		

	<b>GEV No.</b>	511682	<b>Ref. No.</b>	OGA09
<b>description</b>	shaft seal kit ID ø 17mm ED ø 29mm shaft seal flange mounting gauge with mountign material			

hot air fans

ebm-papst



1

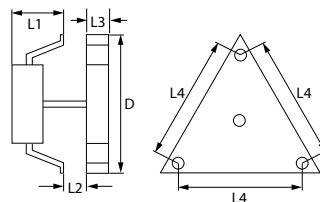

<b>GEV No.</b>	601249	<b>Ref. No.</b>	FA12
<b>description</b>	hot air fan 230V 32W 0.27A L1 60mm L2 20mm L3 20mm L4 157mm fan wheel ø 150mm ebm-papst type R2K150-AC01-15		
<b>For models:</b>	ECO7, ECO76, ECO9, ESLR9, OE7008, OE7010, V6, V6D, V6F, V7		



Зип Общепит

vsezip.ru

+7(812)987-08-81

miscellaneous



1

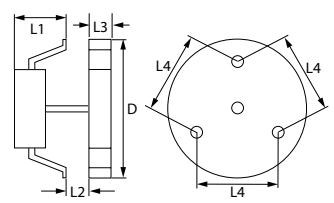

<b>GEV No.</b>	601681	<b>Ref. No.</b>	FA106
<b>description</b>	hot air fan 230V 50Hz L1 59mm L2 13mm L3 21mm L4 86mm fan wheel ø 152mm Emmevi type 260130X		
<b>For models:</b>	ECO8, LCO		

radial fans



1

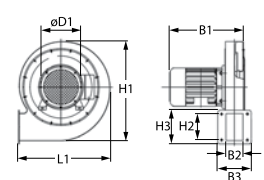

<b>GEV No.</b>	601296	<b>Ref. No.</b>	OMO11
<b>description</b>	radial fan 230V voltage AC 50Hz 140W H1 190mm L1 190mm D1 ø 50mm W1 133mm W2 28mm H2 55mm W3 83mm H3 83mm		



1

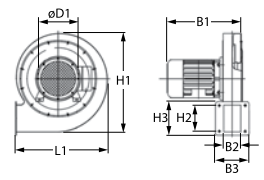

<b>GEV No.</b>	601295	<b>Ref. No.</b>	OMO12
<b>description</b>	radial fan 230V voltage AC 50Hz 50W H1 180mm L1 180mm D1 ø 43mm W1 105mm W2 33mm H2 59mm W3 66mm H3 83mm		



1

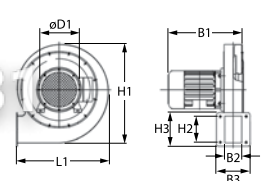

<b>GEV No.</b>	602116	<b>Ref. No.</b>	FA112
<b>description</b>	radial fan 230V voltage AC 50Hz 60W H1 165mm L1 175mm D1 ø 127mm W1 110mm W2 50mm H2 50mm W3 83mm H3 35mm		

motors

gear motors

for conveyor toaster

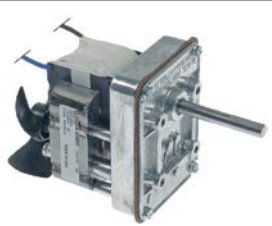

1

<b>GEV No.</b>	601978	<b>Ref. No.</b>	M013
<b>description</b>	gear motor GLEASON AVERY type RMS125 230V 50Hz 1 phase shaft ø 8x7mm		



1

<b>GEV No.</b>	601682	<b>Ref. No.</b>	MO12
<b>description</b>	gear motor MELLOR type UB1062 230V voltage AC 50Hz 5.2rpm shaft ø 8mm L 140mm W 65mm H 95mm for toaster		



1

<b>GEV No.</b>	601673	<b>Ref. No.</b>	MO25
<b>description</b>	gear motor SPG type ISG-31220ADA 230V voltage AC 50Hz 5.5rpm shaft ø 8x7mm for conveyor toaster		



Зип Общепит

vsezip.ru

+7(812)987-08-81



1

<b>GEV No.</b>	601674	<b>Ref. No.</b>	MCK01
<b>description</b>	gear motor SPG type ISG-31220ADA 230V voltage AC 50Hz 5.5rpm shaft ø 8x7mm for conveyor toaster complete		

for ovens

for flues



1

<b>GEV No.</b>	500873	<b>Ref. No.</b>	OMO10
<b>description</b>	ventilation valve CROUZET type G70C10AFTEG 12V voltage DC shaft ø 6mm L 95mm W 63mm H 136mm for combi-steamer ø 50mm		

pumps

wash and rinse pumps

HANNING pumps



1

<b>GEV No.</b>	500578	<b>Ref. No.</b>	OPU06
<b>description</b>	pump inlet ø 24mm outlet ø 24mm type UP30-274 230V 50/60Hz 1 phase 0.09kW 0.12HP L 145mm rotation direction left capacitor 2.5µF HANNING		
<b>spare parts for</b>	500578		
	<b>GEV No.</b>	<b>Ref. No.</b>	—
	501345		
	O-ring EPDM thickness 3mm ID ø 58mm Qty 1 pcs		



1

<b>GEV No.</b>	500579	<b>Ref. No.</b>	OPU03
<b>description</b>	pump inlet ø 24mm outlet ø 24mm type UP30-275 230V 50/60Hz 1 phase 0.09kW 0.12HP L 145mm rotation direction left capacitor 2.5µF HANNING		
<b>spare parts for</b>	500579		
	<b>GEV No.</b>	<b>Ref. No.</b>	—
	501345		
	O-ring EPDM thickness 3mm ID ø 58mm Qty 1 pcs		



1

<b>GEV No.</b>	499168	<b>Ref. No.</b>	OPU02
<b>description</b>	pump inlet ø 24mm type UP30-890 200-240V 50/60Hz 1 phase 0.1kW L 145mm rotation direction left capacitor 2.5µF HANNING		

drain pumps

HANNING



1

<b>GEV No.</b>	500573	<b>Ref. No.</b>	ODR06
<b>description</b>	drain pump 30W 4-piece 230V inlet ø 24/30mm outlet ø 24mm 50Hz HANNING type DPS25-032 1x pump, 3x pump cover		

Зип.Общепит

Fuses  
vsezip.ru

+7(812)987-08-81



<b>GEV No.</b>	499215	<b>Ref. No.</b>	OPU05
<b>description</b>	drain pump kit inlet ø 24mm outlet ø 24mm 200-240V 42W 50-60Hz mode of operation S2 max. 15min HANNING type DPS35		



<b>GEV No.</b>	499354	<b>Ref. No.</b>	OPU07
<b>description</b>	drain pump kit inlet ø 24mm outlet ø 24mm 60/62W 50/60Hz 200-240V mode of operation S2 type DPS35 HANNING		

service kits



<b>GEV No.</b>	500573	<b>Ref. No.</b>	ODR06
<b>description</b>	drain pump 30W 4-piece 230V inlet ø 24/30mm outlet ø 24mm 50Hz HANNING type DPS25-032 1x pump, 3x pump cover		

## condensators & interference suppression filters

### filters

#### interference suppression filters



<b>GEV No.</b>	365216	<b>Ref. No.</b>	OF110
<b>description</b>	interference suppression filter capacity 3x0.27µFX1+3x0.47µFX1µF 400V for combi-steamer SCC, CM 61-202/E		

fine fuses

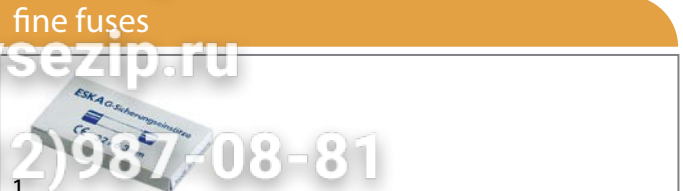

<b>GEV No.</b>	358792	<b>Ref. No.</b>	OFU02
<b>description</b>	fine fuse size ø6.3x32mm 10A slow-acting rated 250V Qty 10 pcs		



<b>GEV No.</b>	358791	<b>Ref. No.</b>	OFU01
<b>description</b>	fine fuse size ø6.3x32mm 6.3A slow-acting rated 250V Qty 10 pcs		

## electric accessories

### cables

#### power supply cables



<b>GEV No.</b>	551441	<b>Ref. No.</b>	PL202
<b>description</b>	power lead BS1363 angled 3-pole contacts P+N+E max. 13A max 250V with fuse thermoplastic countries GB		
<b>For models:</b>	C6A-100, C6A-75, C6H-100, C6H-75, C6R-105L, C6R-105R, C6R-130L, C6R-130R, CT1, D3H-75, D3R-100, D5H-100, D5H-75, D5R-100, D5R-125, EB3F, ECO8, GG1, HB2, HB3, HB4, HT3, LCG, LCG2, LCO, LD2, LD3, LD4, LDF, LDF2, LGR, LGR2, LGT, LPB, LPG, LPG2, LPO, LRG, LRG2, SCH1085, SCH785, SCR1085, SCR785, UM50, UM50D, UM050, UMS50, UMS50D, UMSO50, UMSO50D		



<b>GEV No.</b>	551454	<b>Ref. No.</b>	PL201
<b>description</b>	power lead BS1363/A 3-pole contacts P+N+E 1mm <sup>2</sup> max. 10A max 250V 1.4m with fuse countries UK Qty 1 pcs connection with power terminal block black H05RN-F		
<b>For models:</b>	BM3, BM3W, BM4, BM4W, BM6, BM6W, BM7, BM7W, BS3, BS3W, BS4, BS4W, BS7, BS7W, CS4, CS4G, CS6, FDB4, FPB5, G1A, HC3, HC4, HC6, HC7, HCL3, HCL4, HCL6, HCL7, HCL9, L3, L4, LBM, LBM2, LBM2W, LBM3, LBMW, LCS, LPW, LPW-LR, LRB, LRB2W, LRB3, LRB3W, LRBW		



<b>GEV No.</b>	551455	<b>Ref. No.</b>	PL143
<b>description</b>	power lead BS1363/A 3-pole contacts P+N+E 1mm <sup>2</sup> max. 13A max 250V 1.9m with fuse countries UK Qty 1 pcs connection black H05RN-F		
<b>For models:</b>	FWD, FWDG, KFCWD		



spiral cables

1			
<b>GEV No.</b>	551329	<b>Ref. No.</b>	PL157
<b>description</b>	spiral cable plug type BS1363 1.5mm <sup>2</sup> 3-pole with plug L 500mm expansion 5:1 countries GB black		
<b>For models:</b>	GBM2, GBM3		

earthing cables

1			
<b>GEV No.</b>	104684	<b>Ref. No.</b>	IG37
<b>description</b>	earthing cable connection F2.8mm / lug M5 cable length 350mm 1.5mm <sup>2</sup>		

silicone cable

up to 180°C

1			
<b>GEV No.</b>	551312	<b>Ref. No.</b>	CA87
<b>description</b>	silicone cable 3-pole 1.5mm <sup>2</sup> insulation silicone red permanent temperature -60 up to +180°C t.max. 230°C conductor copper		

accessories

protection hoses

miscellaneous

1			
<b>GEV No.</b>	550997	<b>Ref. No.</b>	CO239 CO76
<b>description</b>	protection pipe ED ø 16mm plastic		

connection cables

1			
<b>GEV No.</b>	379729	<b>Ref. No.</b>	OCA21
<b>description</b>	connection cable L 1230mm 4-pole for level electrode plug type coded		
<b>accessories for</b>	379729		
	<b>GEV No.</b>	<b>Ref. No.</b>	<b>OEL04</b>
	level electrode PG9 total length 135mm probe L 89/59/28mm insulated probe length 80mm with 3 probes connection grip connection		

Зип Общежит

vsezip.ru

+7(812)987-08-81

1			
<b>GEV No.</b>	579001	<b>Ref. No.</b>	OCA12
<b>description</b>	data cable L 1300mm 8-pole suitable for RATIONAL plug type RJ45		
1			
<b>GEV No.</b>	579002	<b>Ref. No.</b>	OCA19
<b>description</b>	data cable L 800mm 8-pole for combi-steamer suitable for SCC Line plug type RJ45		

terminals

terminal blocks

1			
<b>GEV No.</b>	550232	<b>Ref. No.</b>	TE10
<b>description</b>	lustre terminal 12-pole cross section 2.5mm <sup>2</sup> max. 32A max 450V temp.-resist. 150°C		
<b>For models:</b>	AS3, AS4		

1			
<b>GEV No.</b>	550838	<b>Ref. No.</b>	TE14
<b>description</b>	lustre terminal 12-pole cross section 6mm <sup>2</sup> max. 41A max 750V temp.-resist. 150°C		
<b>For models:</b>	OE7112		

connection terminals with screw/faston connections

1			
<b>GEV No.</b>	551260	<b>Ref. No.</b>	TE47
<b>description</b>	power terminal block 7-pole max. 40A max 450V connection M5/ male faston 6.3mm temp.-resist. 150°C		
<b>For models:</b>	OE7008		

electric components



## connection boxes



1			
<b>GEV No.</b>	551337	<b>Ref. No.</b>	TE45
<b>description</b>	power terminal block 5-pole contacts 3P+N+E with lid		
<b>For models:</b>	AS4, DF36, DF39, DF46, DF49, DF612, DF618, DF665T, ECG6, ECO9, HT6, HT7, J6, J9, OE7012, OE7303, OE7304, OE7503		

## gas taps

## PEL

## 20S series



1			
<b>GEV No.</b>	107798	<b>Ref. No.</b>	VA41
<b>description</b>	gas tap PEL type 20S gas inlet pipe flange ø21mm bypass nozzle ø 0.8 bar mm gas outlet M16x1.5 (tube ø 10/8mm) thermocouple connection M8x1 pilot connection shaft ø 8x6.5mm shaft L 45/17mm shaft flat upper without ignition flame connection		



1			
<b>GEV No.</b>	107799	<b>Ref. No.</b>	VA42
<b>description</b>	gas tap PEL type 20S gas inlet pipe flange ø21mm bypass nozzle ø 0mm gas outlet M16x1.5 (tube ø 10/8mm) thermocouple connection M9x1 pilot connection shaft ø 8x6.5mm shaft L 45/17mm shaft flat lower without ignition flame connection		



## 21S series



1			
<b>GEV No.</b>	107797	<b>Ref. No.</b>	VA40
<b>description</b>	gas tap PEL type 21S/O gas inlet pipe flange ø21mm bypass nozzle ø 0mm gas outlet M16x1.5 (tube ø 10/8mm) thermocouple connection M9x1 pilot connection M10x1 shaft ø 8x6.5mm shaft L 45/17mm shaft flat lower		

**spare parts for** 107797

	<b>GEV No.</b>	101060	<b>Ref. No.</b>	—
magnet unit standard L 39mm D1 ø 15.4mm D2 ø 11mm suitable for PEL20-21/JUNKERS/EGA				

<b>spare parts for</b> 107797	<b>GEV No.</b>	101231	<b>Ref. No.</b>	—
thermocouple nut T1: M9x1 T2: M18x1				
	<b>GEV No.</b>	101880	<b>Ref. No.</b>	—
gasket Viton ED ø 14mm ID ø 9mm thickness 7.7mm Qty 1 pcs				
<b>accessories for</b> 107797	<b>GEV No.</b>	101278	<b>Ref. No.</b>	—
 olive for pipe ø 10mm Qty 1 pcs				
	<b>GEV No.</b>	101300	<b>Ref. No.</b>	—
union nut thread M16x1.5 tube ø 10mm				

## 22S/O series



1			
<b>GEV No.</b>	107800	<b>Ref. No.</b>	V43
<b>description</b>	gas tap PEL type 22S/O gas inlet pipe flange ø21mm bypass nozzle ø 0mm gas outlet M20x1.5 (tube ø 12/10mm) thermocouple connection M9x1 pilot connection M10x1 shaft ø 8x6.5mm shaft L 33/17mm shaft flat left		



1			
<b>GEV No.</b>	107803	<b>Ref. No.</b>	VA45
<b>description</b>	gas tap PEL type 22S/O gas inlet pipe flange ø21mm bypass nozzle ø 0mm gas outlet M20x1.5 (tube ø 12/10mm) thermocouple connection M9x1 pilot connection M10x1 shaft ø 8x6.5mm shaft L 33/17mm shaft flat lower		

## COPRECI

## CAL-24200



1			
<b>GEV No.</b>	109202	<b>Ref. No.</b>	VA09
<b>description</b>	gas tap COPRECI type CAL-24200 gas inlet pipe flange ø14mm bypass nozzle ø 0.35mm gas outlet 1/4" thermocouple connection M8x1 pilot connection shaft ø 6x4.6mm shaft flat upper shaft L 28/13mm pipe input ø 8mm		
<b>For models:</b>	CG4, CG6		







Зип Общежит  
miscellaneous

vsezip.ru







+7(812)987-08-81

			
1			
<b>GEV No.</b>	109203	<b>Ref. No.</b>	VA11
<b>description</b>	gas tap with pin COPRECI type CAL-24200 gas inlet pipe flange ø14mm bypass nozzle ø 0.35mm gas outlet 1/4" thermocouple connection M8x1 pilot connection shaft ø 6x4.6mm shaft flat upper shaft L 28/13mm pipe input ø 8mm		
<b>For models:</b>	GS4, GS7		

			
1			
<b>GEV No.</b>	107810	<b>Ref. No.</b>	VA70/S
<b>description</b>	gas tap gas inlet 1/4" gas outlet 1/4" pilot connection M8x1 thermocouple connection M8x1 shaft ø 6x4.6mm shaft L 34/12mm shaft flat upper with screw connection		

<p>CAL-5200</p> 			
1			
<b>GEV No.</b>	109138	<b>Ref. No.</b>	VA64 VA64/S
<b>description</b>	gas tap COPRECI type CAL-5200 gas inlet pipe flange ø21mm bypass nozzle ø 0.76+0.51mm gas outlet M14x1.5 (tube ø 8mm) thermocouple connection M8x1 pilot connection shaft ø 7x5mm shaft L 45/20mm shaft flat lower pipe input ø 8mm		

			
1			
<b>GEV No.</b>	107808	<b>Ref. No.</b>	VA17
<b>description</b>	gas tap gas inlet pipe flange ø14mm bypass nozzle ø 0.35mm gas outlet M13x1 IT thermocouple connection M8x1 pilot connection shaft ø 6x4.6mm shaft flat upper shaft L 22/13mm pipe input ø 8mm		

<p>SABAF</p> 			
1			
<b>GEV No.</b>	106692	<b>Ref. No.</b>	VA10A VA10S
<b>description</b>	gas tap SABAF type 10 gas inlet pipe flange ø16mm bypass nozzle ø 0.5mm gas outlet M13x1 IT (tube ø 8mm) front fixing thermocouple connection M8x1 shaft ø 8x6.5mm shaft L 31/12mm shaft flat lower pipe outlet ø 8mm		
<b>spare parts for</b>	106692		
	<b>GEV No.</b>	101051	<b>Ref. No.</b> —
	magnet unit L 27mm D1 ø 12.5mm D2 ø 8.5mm suitable for JUNKERS/EGA/MADEC/SABAF standard		
	<b>GEV No.</b>	101376	<b>Ref. No.</b> —
	gasket ID ø 8mm ED ø 12mm H 3/5mm		
	<b>GEV No.</b>	101751	<b>Ref. No.</b> —
	bracket		
<b>accessories for</b>	106692		
	<b>GEV No.</b>	101277	<b>Ref. No.</b> —
	olive ID ø 8mm Qty 1 pcs		
	<b>GEV No.</b>	101477	<b>Ref. No.</b> —
	union screw thread M13x1 tube ø 8mm Qty 1 pcs		

NEGABAN GAS

			
1			
<b>GEV No.</b>	107820	<b>Ref. No.</b>	VA01
<b>description</b>	gas tap type NGC 6802 gas inlet 1/4" bypass nozzle ømm gas outlet 1/4" thermocouple connection M9x1 pilot connection M10x1 for ignition electrode		
<b>For models:</b>	CS4N, CS4P		

gas thermostats

DUNGS

			
1			
<b>GEV No.</b>	103309	<b>Ref. No.</b>	VA08
<b>description</b>	gas thermostat DUNGS type BM 751 0-80°C gas inlet 1/2" bypass nozzle ø 0.7mm gas outlet 1/2" thermocouple connection M9x1 pilot connection M10x1 capillary pipe 950mm probe ø 8mm probe L 76mm		

1 gas components

SIT

710 Minisit series



<b>GEV No.</b>	103308	<b>Ref. No.</b>	VA18
<b>description</b>	gas thermostat SIT type 0710763 t.max. 200°C 120-200°C gas inlet 1/2" gas outlet 3/8" thermocouple connection M9x1 pilot connection M10x1 probe ø 6mm probe L 102mm capillary pipe 990mm probe type type D1 pressure regulator 3-18mbar gland nut M14x1.5		
<b>spare parts for</b>	103308		
	<b>GEV No.</b>	101053	<b>Ref. No.</b> —
	magnet unit T1: M9x1 T2: M24x1 L 45mm ø 17mm suitable for Minisit		
	<b>GEV No.</b>	101504	<b>Ref. No.</b> —
	gas connection thread 1/2" angled without O-ring MINISIT 710		
	<b>GEV No.</b>	106225	<b>Ref. No.</b> —
	probe 120-200°C probe ø 6mm probe L 102mm capillary pipe 1050mm t.max. 200°C fryer probe type type D1 suitable for MINISIT 710		

PEL

25ST series



<b>GEV No.</b>	106658	<b>Ref. No.</b>	TH64
<b>description</b>	gas thermostat PEL type 25ST up to 280°C gas inlet pipe flange ø21mm bypass nozzle ø 0.8mm gas outlet M16x1.5 (tube ø 10/8mm) thermocouple connection M9x1 pilot connection M10x1 capillary pipe 1200mm probe ø 6mm probe L 120mm shaft ø 8x6.5mm shaft L 45x22mm		
<b>spare parts for</b>	106658		
	<b>GEV No.</b>	100409	<b>Ref. No.</b> —
	bypass nozzle type PEL22 bore ø 0.8mm thread M6x0.5		
	<b>GEV No.</b>	101060	<b>Ref. No.</b> —
	magnet unit standard L 39mm D1 ø 15.4mm D2 ø 11mm suitable for PEL20-21/JUNKERS/EGA		
	<b>GEV No.</b>	106200	<b>Ref. No.</b> —
	nut thread M9x1 suitable for PEL 24/25S		
<b>accessories for</b>	106658		
	<b>GEV No.</b>	100908	<b>Ref. No.</b> —
	union screw thread M10x1 for pipe ø 4mm Qty 1 pcs		
	<b>GEV No.</b>	100909	<b>Ref. No.</b> —
	union screw thread M10x1 for pipe ø 6mm Qty 1 pcs		
	<b>GEV No.</b>	101246	<b>Ref. No.</b> —
	olive for pipe ø 4mm Qty 1 pcs		

	<b>GEV No.</b>	101278	<b>Ref. No.</b>	—
	olive for pipe ø 10mm Qty 1 pcs			
	<b>GEV No.</b>	101286	<b>Ref. No.</b>	—
	olive ID ø 6mm Qty 1 pcs			
	<b>GEV No.</b>	101300	<b>Ref. No.</b>	—
	union nut thread M16x1.5 tube ø 10mm			
	<b>GEV No.</b>	101450	<b>Ref. No.</b>	—
	olive for pipe ø 8mm L 12.7mm Qty 1 pcs ED ø 10mm			
	<b>GEV No.</b>	101451	<b>Ref. No.</b>	—
	union nut thread M16x1.5 tube ø 8mm			
	<b>GEV No.</b>	110079	<b>Ref. No.</b>	—
	knob dial plate gas thermostat 1-8 silver			
	<b>GEV No.</b>	110081	<b>Ref. No.</b>	—
	knob ø 70mm shaft ø 8x6.5mm shaft flat universal			



<b>GEV No.</b>	106648	<b>Ref. No.</b>	TH65
<b>description</b>	gas thermostat PEL type 25ST up to 280°C gas inlet pipe flange ø21mm bypass nozzle ø 0mm gas outlet M16x1.5 (tube ø 10/8mm) thermocouple connection M9x1 pilot connection M10x1 capillary pipe 1200mm probe ø 6mm probe L 120mm shaft ø 8x6.5mm shaft L 45/22mm shaft flat lower		
<b>For models:</b>	OG7202N, OG7202P, OG7204N, OG7204P, OG7208N, OG7208P		
<b>spare parts for</b>	106648		
	<b>GEV No.</b>	101060	<b>Ref. No.</b> —
	magnet unit standard L 39mm D1 ø 15.4mm D2 ø 11mm suitable for PEL20-21/JUNKERS/EGA		
	<b>GEV No.</b>	106191	<b>Ref. No.</b> —
	bypass nozzle type PEL22 bore ø 0mm thread M6x0.5		
	<b>GEV No.</b>	106200	<b>Ref. No.</b> —
	nut thread M9x1 suitable for PEL 24/25S		
<b>accessories for</b>	106648		
	<b>GEV No.</b>	100908	<b>Ref. No.</b> —
	union screw thread M10x1 for pipe ø 4mm Qty 1 pcs		
	<b>GEV No.</b>	100909	<b>Ref. No.</b> —
	union screw thread M10x1 for pipe ø 6mm Qty 1 pcs		
	<b>GEV No.</b>	101246	<b>Ref. No.</b> —
	olive for pipe ø 4mm Qty 1 pcs		
	<b>GEV No.</b>	101278	<b>Ref. No.</b> —
	olive for pipe ø 10mm Qty 1 pcs		
	<b>GEV No.</b>	101286	<b>Ref. No.</b> —
	olive ID ø 6mm Qty 1 pcs		

Table continues overleaf



Зип Общепит

SABAF





vsezip.ru





+7(812)907-08-81

1





image not available

<b>accessories for</b> 106648			
	GEV No.	101300	Ref. No. —
union nut thread M16x1.5 tube ø 10mm			
	GEV No.	101450	Ref. No. —
olive for pipe ø 8mm L 12.7mm Qty 1 pcs ED ø 10mm			
	GEV No.	101451	Ref. No. —
union nut thread M16x1.5 tube ø 8mm			
	GEV No.	110079	Ref. No. —
knob dial plate gas thermostat 1-8 silver			
	GEV No.	110081	Ref. No. —
knob ø 70mm shaft ø 8x6.5mm shaft flat universal			

<b>GEV No.</b> 106729		<b>Ref. No.</b>		TH17 TH17 (nozzle 0,54mm)
<b>description</b> gas thermostat SABAF t.max. 300°C gas inlet pipe flange bypass nozzle ø 0.54mm gas outlet 3/8" ET (tube ø 10mm) thermocouple connection M8x1 capillary pipe 1200mm probe ø 4mm probe L 140mm shaft ø 6x4.6mm shaft L 22/13mm				
<b>accessories for</b> 106729				
	GEV No.	101278	Ref. No.	—
olive for pipe ø 10mm Qty 1 pcs				
	GEV No.	101478	Ref. No.	—
union nut thread 3/8" for pipe ø 10mm				
	GEV No.	101751	Ref. No.	—
bracket				

COPRECI

			
1			
<b>GEV No.</b> 109201		<b>Ref. No.</b> TH201/S	
<b>description</b> gas thermostat COPRECI type MT7200 gas inlet pipe flange ø21mm bypass nozzle ø 0.74+0.51mm gas outlet M16x1.5 (tube ø 10mm) pilot connection closed thermocouple connection M8x1 capillary pipe 835mm probe ø 4.5mm probe L 92mm shaft ø 7x5mm shaft L 41.5/20mm shaft flat lower with knob pipe input ø 8mm			
<b>spare parts for</b> 109201			
	GEV No.	101040	Ref. No. —
magnet unit high temperature L 35mm D1 ø 15.4mm D2 ø 11mm suitable for PEL20-21/JUNKERS/EGA			
	GEV No.	101060	Ref. No. —
magnet unit standard L 39mm D1 ø 15.4mm D2 ø 11mm suitable for PEL20-21/JUNKERS/EGA			
	GEV No.	101376	Ref. No. —
gasket ID ø 8mm ED ø 12mm H 3/5mm			
	GEV No.	101537	Ref. No. —
gasket ID ø 8mm ED ø 11.5mm H 3mm Qty 1 pcs			
	GEV No.	101538	Ref. No. —
clamp			
	GEV No.	107431	Ref. No. —
gasket set ID ø 8mm ED ø 11.5mm H 3mm Qty 7 pcs			

				
1				
<b>GEV No.</b> 101819		<b>Ref. No.</b>		TH17 TH17 (nozzle 0,5mm) TH17/S
<b>description</b> gas thermostat SABAF t.max. 300°C gas inlet pipe flange bypass nozzle ø 0.5mm gas outlet 3/8" ET (tube ø 10mm) thermocouple connection M8x1 capillary pipe 1200mm probe ø 4mm probe L 140mm shaft ø 6x4.6mm shaft L 22/13mm				
<b>spare parts for</b> 101819				
	GEV No.	101376	Ref. No.	—
gasket ID ø 8mm ED ø 12mm H 3/5mm				
<b>accessories for</b> 101819				
	GEV No.	101278	Ref. No.	—
olive for pipe ø 10mm Qty 1 pcs				
	GEV No.	101478	Ref. No.	—
union nut thread 3/8" for pipe ø 10mm				
	GEV No.	101751	Ref. No.	—
bracket				

1 gas components

Зип-Общепит

vsezip.ru

+7(812)987-08-81



1

<b>GEV No.</b>	107809	<b>Ref. No.</b>	TH16/S
<b>description</b>	gas thermostat SABAF t.max. 300°C gas inlet pipe flange ø16mm bypass nozzle ø 0.5mm gas outlet 3/8" ET (tube ø 10mm) thermocouple connection M8x1 pilot connection capillary pipe 2120mm probe ø 4mm probe L 140mm shaft ø 6x4.6mm shaft L 22/13mm shaft flat lower		



1

<b>GEV No.</b>	106012	<b>Ref. No.</b>	VA57
<b>description</b>	gas valve type VK4115V 220-240V 50/60Hz gas inlet flange 32x32mm gas outlet flange 32x32mm thermocouple connection pilot connection pressure range 15-60mbar max 60mbar operator type HONEYWELL flange 32x32mm		

gas valves and ignition boxes



gas control valves

DUNGS



1

<b>GEV No.</b>	106050	<b>Ref. No.</b>	OVA04
<b>description</b>	gas valve 230V 50/60Hz gas inlet 1/2" gas outlet 1/2" DUNGS type GB 055 243 443		

<b>accessories for</b>	106012			
	<b>GEV No.</b>	102845	<b>Ref. No.</b>	—
	gas connection angled 1/2" flange 32x32mm hole distance 24x24mm Tandem			
	<b>GEV No.</b>	102846	<b>Ref. No.</b>	—
	gas connection straight 1/2" flange 32x32mm hole distance 24x24mm suitable for Tandem			



1

<b>GEV No.</b>	106051	<b>Ref. No.</b>	OVA03
<b>description</b>	gas valve 230V 50/60Hz gas inlet 1/2" gas outlet 1/2" DUNGS type GB-WND 055 243 442		

SIT  
NOVASIT



1

<b>GEV No.</b>	107239	<b>Ref. No.</b>	VA20
<b>description</b>	gas valve SIT series Novasit 820 0.17VHz gas inlet 1/2" gas outlet 1/2" thermocouple connection M9x1 pilot connection M10x1 ignition pressure 3-5mbar pressure range 3-30mbar pressure regulator connection blind equiv. no. 0820303 supply Operator millivolt		





<b>For models:</b>	DF4, DF7, J10, J5, OG7106, OG7502			
<b>spare parts for</b>	107239			
	<b>GEV No.</b>	100110	<b>Ref. No.</b>	PI08
	pilot burner SIT type 190 series 3 flames nozzle ømm gas connectionmm			
	<b>GEV No.</b>	101065	<b>Ref. No.</b>	—
	magnet unit with cable L 44mm D1 ø 30mm D2 ø 20mm suitable for NOVASIT			
	<b>GEV No.</b>	101305	<b>Ref. No.</b>	—
	gas connection straight 1/2" flange 45x45mm ELETTROSIT/V4400/4600/4605 suitable for SIT/HONEYWELL hole distance 36x36mm			
	<b>GEV No.</b>	101306	<b>Ref. No.</b>	—
	gas connection angled flange 45x45mm hole distance 36x36mm 1/2" ELETTROSIT/V4400/4600/4605 screw with O-ring suitable for SIT/HONEYWELL			
	<b>GEV No.</b>	101307	<b>Ref. No.</b>	—
	gas connection straight flange 45x45mm hole distance 36x36mm 3/4" ELETTROSIT/V4400/4600/4605 screw with O-ring suitable for SIT/HONEYWELL			

Table continues overleaf



Зип.Общепит  
ignition parts





pilot burners  
vsezip.ru

160 series

+7(812)987-08-81



1

spare parts for 107239			
	GEV No.	101308	Ref. No. —
gas connection angled flange 45x45mm hole distance 36x36mm 3/4" ELETTROSIT/V4400/4600/4605 screw with O-ring suitable for SIT HONEYWELL			
	GEV No.	101312	Ref. No. —
microswitch			
	GEV No.	101799	Ref. No. —
knob adapter shaft ø 10x8mm shaft L 18mm catch lower suitable for ZANUSSI shaft flat upper			
	GEV No.	102116	Ref. No. TC41
thermopile ROBERTSHAW L 900mm probe ø 9mm probe L 57mm 250-750mV screw connection 7/16"			

ignition boxes

miscellaneous



1















GEV No.	107679	Ref. No.	OIG13
description ignition box type			
spare parts for 107679			
	GEV No.	579004	Ref. No. —
data cable L 1800mm 6-pole for combi-steamer SCC, CM plug type RJ45/YY			



1

GEV No.	107191 <sup>1</sup>	Ref. No.	OIG05
description ignition box type with connection cable			
accessories for 107191			
	GEV No.	579004	Ref. No. —
data cable L 1800mm 6-pole for combi-steamer SCC, CM plug type RJ45/YY			

<sup>1</sup>with connection cable













GEV No.	100105	Ref. No.	PI27
description pilot burner SIT type 160 series 3 flames nozzle ømm gas connectionmm			
For models: CS4N, CS4P			
spare parts for 100105			
	GEV No.	100907	Ref. No. —
screw connection thread M10x1 Qty 1 pcs type SEF 1 ømm for thermocouple			
accessories for 100105			
	GEV No.	100202	Ref. No. —
pilot burner nozzle natural gas code 41 Qty 1 pcs nozzle ø 0.41mm			
	GEV No.	100203	Ref. No. —
pilot burner nozzle LPG code 25 Qty 1 pcs nozzle ø 0.25mm			
	GEV No.	100701	Ref. No. IIG08
ignition electrode connection M4 Qty 1 pcs			
	GEV No.	100801	Ref. No. —
gasket for pilot burner Qty 1 pcs			
	GEV No.	100869	Ref. No. —
pilot burner nozzle natural gas code 51 Qty 1 pcs suitable for 160 series nozzle ø 0.51mm			
	GEV No.	100906	Ref. No. —
screw connection thread M10x1 for ignition electrode brass Qty 1 pcs WS 10			
	GEV No.	100908	Ref. No. —
union screw thread M10x1 for pipe ø 4mm Qty 1 pcs			
	GEV No.	100909	Ref. No. —
union screw thread M10x1 for pipe ø 6mm Qty 1 pcs			
	GEV No.	101282	Ref. No. —
olive for pipe ø 4mm L 7.4mm Qty 1 pcs			
	GEV No.	101287	Ref. No. —
olive for pipe ø 6mm Qty 1 pcs			
	GEV No.	102110	Ref. No. —
pilot tube copper pipe ø 4mm thickness 1mm L 3000mm			
	GEV No.	102111	Ref. No. —
pilot tube copper pipe ø 6mm thickness 1mm L 3000mm			
	GEV No.	107650	Ref. No. JE56
pilot burner nozzle SIT LPG code 30 Qty 1 pcs			

1 gas components

## 190 series



1

<b>GEV No.</b>	100110	<b>Ref. No.</b>	PI08
<b>description</b>	pilot burner SIT type 190 series 3 flames nozzle ømm gas connectionmm		
<b>For models:</b>	DF4, DF7, OG7502		
<b>accessories for</b>	100110		
	<b>GEV No.</b>	100202	<b>Ref. No.</b> —
	pilot burner nozzle natural gas code 41 Qty 1 pcs nozzle ø 0.41mm		
	<b>GEV No.</b>	100203	<b>Ref. No.</b> —
	pilot burner nozzle LPG code 25 Qty 1 pcs nozzle ø 0.25mm		
	<b>GEV No.</b>	100701	<b>Ref. No.</b> IIG08
	ignition electrode connection M4 Qty 1 pcs		
	<b>GEV No.</b>	100906	<b>Ref. No.</b> —
	screw connection thread M10x1 for ignition electrode brass Qty 1 pcs WS 10		
	<b>GEV No.</b>	100907	<b>Ref. No.</b> —
	screw connection thread M10x1 Qty 1 pcs type SEF 1 ømm for thermocouple		
	<b>GEV No.</b>	100908	<b>Ref. No.</b> —
	union screw thread M10x1 for pipe ø 4mm Qty 1 pcs		
	<b>GEV No.</b>	100909	<b>Ref. No.</b> —
	union screw thread M10x1 for pipe ø 6mm Qty 1 pcs		
	<b>GEV No.</b>	101282	<b>Ref. No.</b> —
	olive for pipe ø 4mm L 7.4mm Qty 1 pcs		
	<b>GEV No.</b>	101287	<b>Ref. No.</b> —
	olive for pipe ø 6mm Qty 1 pcs		
	<b>GEV No.</b>	102110	<b>Ref. No.</b> —
	pilot tube copper pipe ø 4mm thickness 1mm L 3000mm		
	<b>GEV No.</b>	102111	<b>Ref. No.</b> —
	pilot tube copper pipe ø 6mm thickness 1mm L 3000mm		
	<b>GEV No.</b>	107650	<b>Ref. No.</b> JE56
	pilot burner nozzle SIT LPG code 30 Qty 1 pcs		

Зип-Общепит

POLYBOND

pilot burners

vsezip.ru

+7(812)987-08-81

1

<b>GEV No.</b>	107817	<b>Ref. No.</b>	PI30
<b>description</b>	pilot burner 3 natural/liquid gas nozzle nozzle ømm gas pressure-bar code gas connection M10x1mm		

## ROBERTSHAW

pilot burners

universal series - type 5



1

<b>GEV No.</b>	106088	<b>Ref. No.</b>	PI14
<b>description</b>	pilot burner ROBERTSHAW type 5CHL-1 2 flames code for pipe ø		

universal series - type 6

Width of caps:  
 6CH10 = 1" (25,4mm)  
 6CH14 = 1½" (38,1mm)  
 6CH24 = 2½" (63,5mm)  
 6CH30 = 3" (76,2mm)



1

<b>GEV No.</b>	106117	<b>Ref. No.</b>	PI125 PI25
<b>description</b>	pilot burner ROBERTSHAW type 6CH24-1 3 flames natural gas code 26 for pipe ø 1/4" CCT gas connection 1/4" CCTmm nozzle ømm		
<b>For models:</b>	J10, J5, OG7106, OG7202N, OG7202P, OG7204N, OG7204P, OG7208N, OG7208P		



Зип-Общепит

vsezip.ru

+7(812)987-08-81

producer-specific pilot burners

LINCAT



<b>GEV No.</b>	107815	<b>Ref. No.</b>	PI18
<b>description</b>	pilot burner 1 LPG nozzle nozzle $\varnothing$ mm code gas connection M10x1mm		

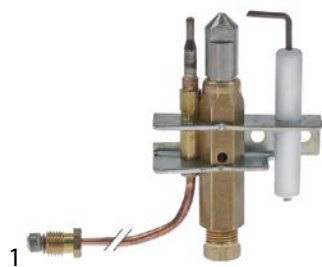

<b>GEV No.</b>	107816	<b>Ref. No.</b>	PI17
<b>description</b>	pilot burner 1 natural gas nozzle nozzle $\varnothing$ mm code gas connection M10x1mm		



<b>GEV No.</b>	107817	<b>Ref. No.</b>	PI30
<b>description</b>	pilot burner 3 natural/liquid gas nozzle nozzle $\varnothing$ mm gas pressure-bar code gas connection M10x1mm		

electrodes



<b>GEV No.</b>	106829	<b>Ref. No.</b>	OGA26
<b>description</b>	gasket for ignition electrode ID $\varnothing$ 10mm hole $\varnothing$ 4.5mm L 27mm W 17mm		



<b>GEV No.</b>	550897	<b>Ref. No.</b>	OGA23
<b>description</b>	gasket ignition electrode graphite thickness 2.5mm hole distance 27mm		



<b>GEV No.</b>	100701	<b>Ref. No.</b>	IIG08	
<b>description</b>	ignition electrode connection M4 Qty 1 pcs			
<b>accessories for</b>	100701			
	<b>GEV No.</b>	100906	<b>Ref. No.</b>	—
	screw connection thread M10x1 for ignition electrode brass Qty 1 pcs WS 10			

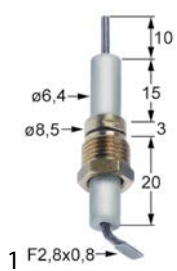

<b>GEV No.</b>	107281	<b>Ref. No.</b>	IG15
<b>description</b>	ignition electrode D1 $\varnothing$ 6.4mm D2 $\varnothing$ 8.5mm L1 10mm BL1 15mm BL2 3mm BL3 20mm connection male faston 2.8mm M10x1		
<b>For models:</b>	DF4, DF7		

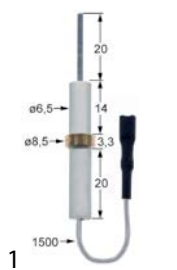

<b>GEV No.</b>	107818	<b>Ref. No.</b>	IG17
<b>description</b>	ignition electrode D1 $\varnothing$ 6.5mm cable length 1500mm connection F2.8 D2 $\varnothing$ 8.5mm L1 20mm BL1 14mm BL2 3.3mm BL3 20mm		



<b>GEV No.</b>	107819	<b>Ref. No.</b>	IG05
<b>description</b>	ignition electrode D1 $\varnothing$ 6x7mm connection F2.8 L1 10mm L2 3mm BL1 14.5mm BL2 15mm BL3 14mm		



Зип Общепит

vsezip.ru

+7(812)987-08-81



<b>GEV No.</b>	107891	<b>Ref. No.</b>	IG03
<b>description</b>	ignition electrode D1 ø 7mm D2 ø 8.5mm connection male faston 2.8mm BL1 28mm BL2 3mm BL3 22mm		



<b>GEV No.</b>	102645	<b>Ref. No.</b>	IG14
<b>description</b>	ignition electrode flange length 19mm flange width 12mm D1 ø 6.3mm D2 ø 6.3mm L1 11mm L2 15mm BL1 16mm BL2 12mm connection male faston 2.8mm		
<b>For models:</b>	J10, J5, OG7202N, OG7202P, OG7204N, OG7204P, OG7208N, OG7208P		



<b>GEV No.</b>	107811	<b>Ref. No.</b>	IG30
<b>description</b>	ignition electrode flange length 20mm flange width 12mm D1 ø 6.5mm D2 ø 6.5mm L1 14mm L2 14mm L4 10mm BL1 16mm BL2 12mm connection F 2.8		



<b>GEV No.</b>	107812	<b>Ref. No.</b>	IG16
<b>description</b>	ignition electrode flange length 20mm flange width 12mm D1 ø 6.5mm D2 ø 6.5mm L1 4mm L2 16mm BL1 12mm BL2 16mm		
<b>For models:</b>	SLR6, SLR9		



<b>GEV No.</b>	102879	<b>Ref. No.</b>	OIG08
<b>description</b>	ignition electrode flange length 26mm flange width 16mm D1 ø 9mm L1 9mm L2 73mm BL1 82mm BL2 14mm connection F 4.8x0.8mm cable length 400mm mounting distance 19mm with flange		



<b>GEV No.</b>	103326	<b>Ref. No.</b>	OEL31
<b>description</b>	ignition electrode flange length 30mm flange width 17.5mm D1 ø 9mm L1 60mm L2 18mm BL1 27mm BL2 29mm fixing dimensions M4mm flange SCC_WE, CM_P 61-101/201G		



<b>GEV No.</b>	103333	<b>Ref. No.</b>	OIG09
<b>description</b>	ignition electrode flange length 30mm flange width 17mm D1 ø 9mm L1 37mm L2 10mm BL1 15mm BL2 25mm fixing dimensions M4mm with flange with earthing contact		





Зип Общепит

vsezip.ru

+7(812)987-08-81

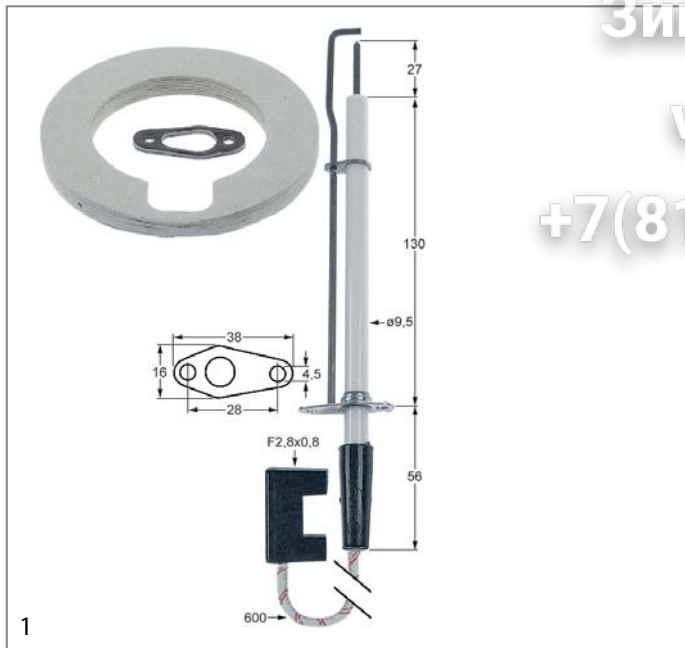

<b>GEV No.</b>	102884	<b>Ref. No.</b>	OIG06
<b>description</b>	ignition electrode flange length 38mm flange width 16mm D1 ø 9.5mm L1 27mm BL1 130mm BL2 56mm connection F 2.8x0.8mm cable length 600mm fixing dimensions ø4.5mm mounting distance 28mm with flange with earthing contact		



<b>GEV No.</b>	107814	<b>Ref. No.</b>	IG46
<b>description</b>	ignition electrode flange length 38mm flange width 17mm D1 ø 9.5mm D2 ø 9.5mm L1 45mm L2 5mm BL1 24mm BL2 5mm BL3 50mm connection ø 6mm		



<b>GEV No.</b>	107813	<b>Ref. No.</b>	IG43
<b>description</b>	ignition electrode flange length 38mm flange width 17mm D1 ø 9.5mm D2 ø 9.5mm L1 9mm L2 44.5mm BL1 24mm BL2 41mm connection ø 4mm		

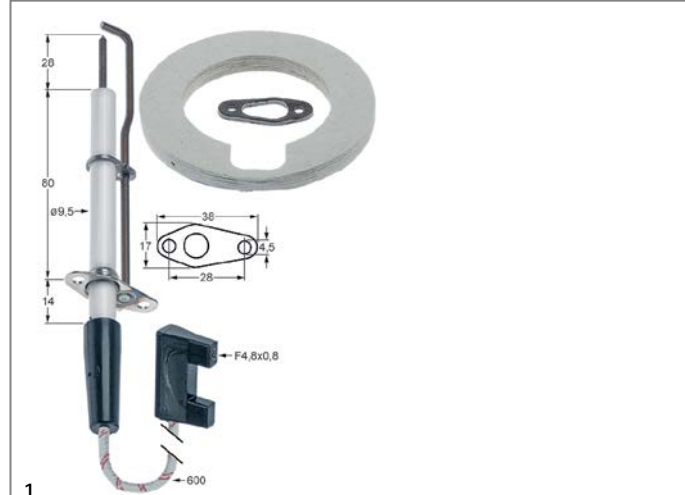

<b>GEV No.</b>	102883	<b>Ref. No.</b>	OIG07
<b>description</b>	ignition electrode flange length 38mm flange width 17mm D1 ø 9.5mm L1 28mm BL1 80mm BL2 14mm connection F 4.8x0.8mm cable length 600mm fixing dimensions ø4.5mm mounting distance 28mm with flange with earthing contact		

Зип Общепит

<b>GEV No.</b>	100037	<b>Ref. No.</b>	IG06
<b>description</b>	ignition cable cable length 900mm connection F2.8mm / F2.8mm		
<b>For models:</b>	J10		

+7(812)987-08-81

piezoelectric igniters

mounting diameter 22mm



<b>GEV No.</b>	103304	<b>Ref. No.</b>	OIG12
<b>description</b>	ignition electrode with accessories flange length 38mm flange width 16mm D1 ø 9mm BL1 54mm BL2 144mm cable length 575mm		



<b>GEV No.</b>	102647	<b>Ref. No.</b>	IG12
<b>description</b>	piezoelectric igniter body plastic blowing mounting ø 22mm connection F2.8x0.8 cable lengthmm		
<b>For models:</b>	SLR9		

ignition cables

pre-assembled cables

<b>GEV No.</b>	100190	<b>Ref. No.</b>	IG18
<b>description</b>	ignition cable cable length 1200mm connection F2.8mm / F2.8mm		
<b>For models:</b>	SLR6, SLR9		

<b>GEV No.</b>	102184	<b>Ref. No.</b>	IG11
<b>description</b>	ignition cable cable length 1500mm connection ø2.4mm / lug M4		

<b>GEV No.</b>	103306	<b>Ref. No.</b>	IG44
<b>description</b>	ignition cable cable length 445mm connection F4.8/ø4mm silicone ED ø 5mm		

<b>GEV No.</b>	100036	<b>Ref. No.</b>	IG39
<b>description</b>	ignition cable cable length 500mm connection F2.8mm / F2.8mm		

<b>GEV No.</b>	103305	<b>Ref. No.</b>	IG45
<b>description</b>	ignition cable cable length 645mm connection F6.3mm / ø6.5mm ED ø 5mmmm		



<b>GEV No.</b>	102639	<b>Ref. No.</b>	IG38
<b>description</b>	piezoelectric igniter body plastic blowing mounting ø 22mm connection male faston 2.8mm cable lengthmm		
<b>For models:</b>	OG7202N, OG7202P, OG7204N, OG7204P, OG7208N, OG7208P, OG7502		



<b>GEV No.</b>	100013	<b>Ref. No.</b>	IG35
<b>description</b>	piezoelectric igniter body plastic blowing mounting ø 22mm connection ø2.4mm cable lengthmm		
<b>accessories for</b>	100013		

<b>GEV No.</b>	100023	<b>Ref. No.</b>	—
<b>description</b>	female bullet size 2.3mm 0.5-1.5mm <sup>2</sup> CuZn t.max. 125°C Qty 20 pcs		

miscellaneous



<b>GEV No.</b>	102635	<b>Ref. No.</b>	SI13
<b>description</b>	piezoelectric igniter		



Зип Общепит

vsezip.ru

+7(812)987-08-81



1

<b>GEV No.</b>	100006	<b>Ref. No.</b>	IG19
<b>description</b>	piezoelectric igniter suitable for ELETROSIT body plastic blowing connection $\varnothing 2.4\text{mm}$ $\varnothing 14\text{mm}$		

ignition switches



1

<b>GEV No.</b>	301014	<b>Ref. No.</b>	SW72
<b>description</b>	momentary rocker switch mounting measurements 30x11mm black 1NO 250V 16A connection male faston 6.3mm ambient temperature max. 85/125°C protection IP40 mounting $\varnothing\text{mm}$ male faston 6.3mm		

thermocouples

plug-in thermocouples

plug-in thermocouples standard

with barrel socket  $\varnothing 5\text{mm}$  - type Junkers with aluminised tip

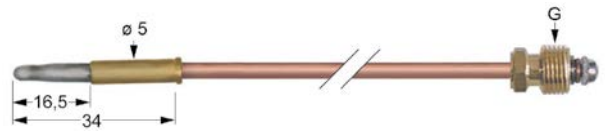

1

<b>GEV No.</b>	102205	<b>Ref. No.</b>	PI48	
<b>description</b>	thermocouple M8x1 L 750mm plug connection $\varnothing 5.0\text{mm}$			
<b>accessories for</b>	102205			
	<b>GEV No.</b>	101260	<b>Ref. No.</b>	—
	thermocouple fitting thread M8x1 Qty 1 pcs			

with barrel socket  $\varnothing 6\text{mm}$

SIT

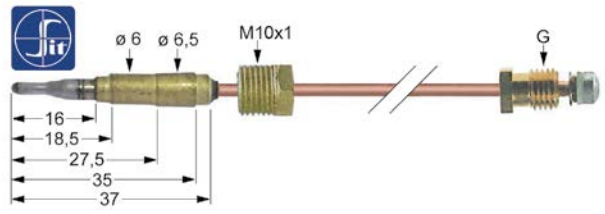

1

<b>GEV No.</b>	102944	<b>Ref. No.</b>	TC51
<b>description</b>	thermocouple M9x1 L 1500mm M10x1		

with barrel socket  $\varnothing 6.5\text{mm}$

thermocouples SIT

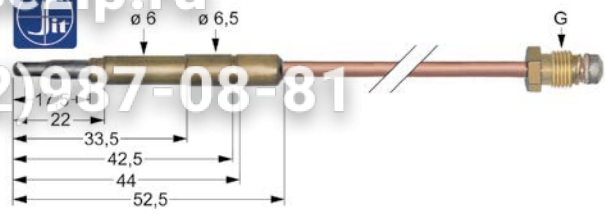

1

<b>GEV No.</b>	107614	<b>Ref. No.</b>	TC23
<b>description</b>	thermocouple SIT M9x1 L 1500mm plug connection $\varnothing 6.0(6.5)\text{mm}$		

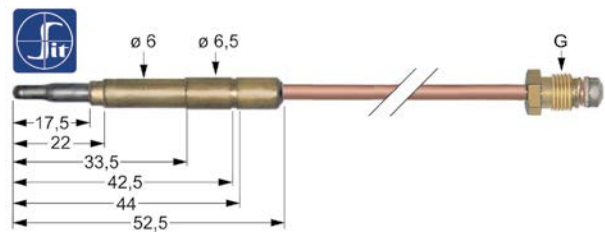

1

<b>GEV No.</b>	107609	<b>Ref. No.</b>	TC13
<b>description</b>	thermocouple SIT M9x1 L 600mm plug connection $\varnothing 6.0(6.5)\text{mm}$		
<b>For models:</b>	CS4N, CS4P		

threaded thermocouples (miscellaneous)





1

<b>GEV No.</b>	102577	<b>Ref. No.</b>	TC04	
<b>description</b>	thermocouple L 1200mm plug connection $\varnothing 6.0\text{mm}$			
<b>For models:</b>	OG7302			
<b>accessories for</b>	102577			
	<b>GEV No.</b>	101261	<b>Ref. No.</b>	TC24
	thermocouple fitting thread M9x1 Qty 1 pcs			



1

<b>GEV No.</b>	102576	<b>Ref. No.</b>	TC03	
<b>description</b>	thermocouple L 900mm plug connection $\varnothing 6.0\text{mm}$			
<b>For models:</b>	OG7202N, OG7202P, OG7204N, OG7204P, OG7208N, OG7208P			
<b>accessories for</b>	102576			
	<b>GEV No.</b>	101262	<b>Ref. No.</b>	TC09
	thermocouple fitting thread M10x1 Qty 1 pcs			



1

<b>GEV No.</b>	102579	<b>Ref. No.</b>	TC14
<b>description</b>	thermocouple M8x1 L 360mm plug connection $\varnothing 6.0\text{mm}$		
<b>For models:</b>	CG4, CG6, HT3, HT6N, HT6P, HT9, SLR6, SLR9		

Зип-Общепит

vsezip.ru

+7(812)987-08-81

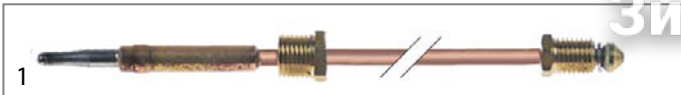

<b>GEV No.</b>	102593	<b>Ref. No.</b>	TC15
<b>description</b>	thermocouple M8x1 L 600mm plug connection ø6.0mm		
<b>For models:</b>	GR3, GR7, HT3, HT6N, HT6P, HT9, SLR6, SLR9		

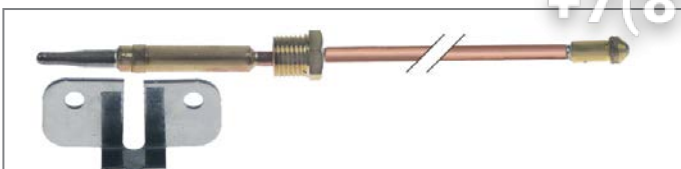

<b>GEV No.</b>	102575	<b>Ref. No.</b>	GRTC03
<b>description</b>	thermocouple M8x1 L 900mm plug connection ø6.0mm		



<b>GEV No.</b>	102578	<b>Ref. No.</b>	TC26
<b>description</b>	thermocouple M9x1 L 1000mm plug connection ø6.0mm		



<b>GEV No.</b>	102634	<b>Ref. No.</b>	TC40
<b>description</b>	thermocouple M9x1 L 400mm plug connection ø6.0mm		
<b>For models:</b>	OG7106, OG7502		

plug-in thermocouples with interruption

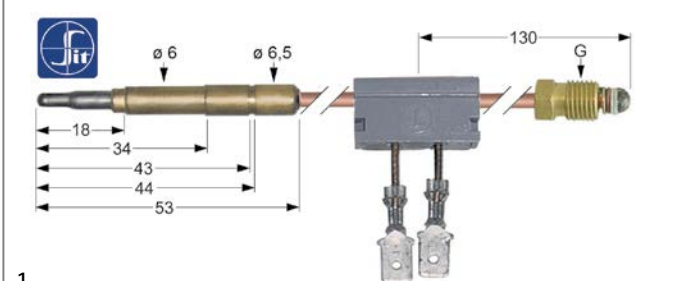

<b>GEV No.</b>	107177	<b>Ref. No.</b>	TC18
<b>description</b>	thermocouple SIT with interrupter M9x1 L 600mm plug connection ø6.0mm F 6.3mm		



<b>GEV No.</b>	102650	<b>Ref. No.</b>	TC38
<b>description</b>	thermocouple with interrupter M9x1 L 1000mm plug connection ø6.0(6.5)mm		
<b>For models:</b>	DF4		



<b>GEV No.</b>	102648	<b>Ref. No.</b>	TC39
<b>description</b>	thermocouple with interrupter M9x1 L 400mm plug connection ø6.0(6.5)mm plug/soldering connection		
<b>For models:</b>	DF7		

threaded thermocouples standard

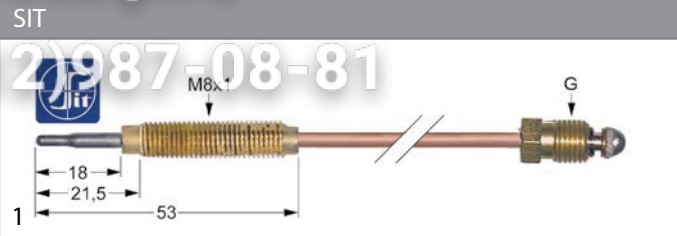

<b>GEV No.</b>	107636	<b>Ref. No.</b>	TC28
<b>description</b>	thermocouple SIT M9x1 L 600mm M8x1		
<b>accessories for</b>	107636		

<b>GEV No.</b>	102067	<b>Ref. No.</b>	—
<b>description</b>	nut thread M8x1 H 3mm brass Qty 1 pcs type SEF 1		

threaded thermocouples (miscellaneous)



<b>GEV No.</b>	102638	<b>Ref. No.</b>	TC33 TC49+TC07
<b>description</b>	thermocouple M8x1 L 1400mm M6x0.5		
<b>For models:</b>	SLR6, SLR9		



<b>GEV No.</b>	102572	<b>Ref. No.</b>	TC35
<b>description</b>	thermocouple M8x1 L 450mm M8x1		
<b>accessories for</b>	102572		

<b>GEV No.</b>	102630	<b>Ref. No.</b>	TC37
<b>description</b>	spacer bush with plain washer for thermocouple ø 8mm suitable for TC35/36 Qty 1 pcs		



<b>GEV No.</b>	102594	<b>Ref. No.</b>	TC36
<b>description</b>	thermocouple M8x1 L 700mm M8x1		
<b>accessories for</b>	102594		

<b>GEV No.</b>	102630	<b>Ref. No.</b>	TC37
<b>description</b>	spacer bush with plain washer for thermocouple ø 8mm suitable for TC35/36 Qty 1 pcs		



<b>GEV No.</b>	102652	<b>Ref. No.</b>	TC34
<b>description</b>	thermocouple M8x1 L 750mm M8x1		



Зип Общепит

accessories

screws

vsezip.ru

+7(812)987-08-81

			
GEV No.	103351	Ref. No.	TC50
description	thermocouple M8x1 L 750mm M8x1		

threaded thermocouples with interruption

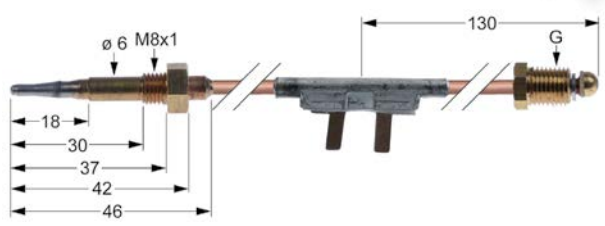
			
GEV No.	102651	Ref. No.	TC19
description	thermocouple with interrupter M9x1 L 1000mm M8x1 plug/soldering connection		
For models:	J10, J5		

GEV No.	102651	Ref. No.	TC19
description	thermocouple with interrupter M9x1 L 1000mm M8x1 plug/soldering connection		
For models:	J10, J5		

producer-specific thermocouples

			
GEV No.	107821	Ref. No.	TC01
description	thermocouple L 600mm M12x1 M9x1		

thermopiles

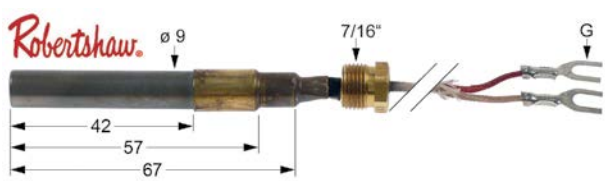
			
GEV No.	102116	Ref. No.	TC41
description	thermopile ROBERTSHAW L 900mm probe ø 9mm probe L 57mm 250-750mV screw connection 7/16"		
For models:	OG7502		

GEV No.	102116	Ref. No.	TC41
description	thermopile ROBERTSHAW L 900mm probe ø 9mm probe L 57mm 250-750mV screw connection 7/16"		
For models:	OG7502		

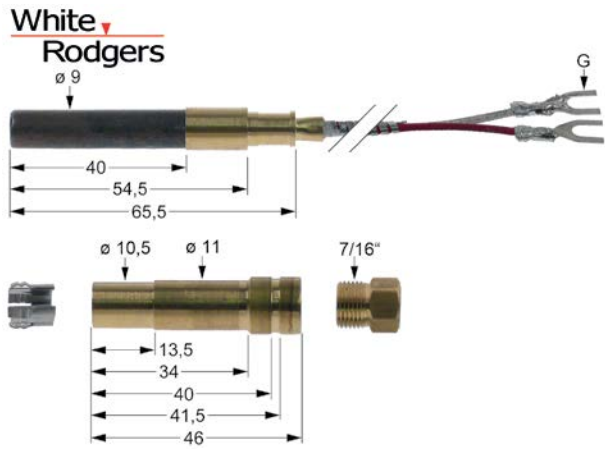
			
GEV No.	103243	Ref. No.	TC20
description	thermopile with PG9 adapter WHITE RODGERS L 36" - 915mm probe ø 9mm probe L 40mm 250-750mV screw connection 7/16" connection spate terminals		
For models:	DF4, DF7, J10, J5		

GEV No.	103243	Ref. No.	TC20
description	thermopile with PG9 adapter WHITE RODGERS L 36" - 915mm probe ø 9mm probe L 40mm 250-750mV screw connection 7/16" connection spate terminals		
For models:	DF4, DF7, J10, J5		

GEV No.	102636	Ref. No.	TC05
description	thermocouple fitting brass Qty 1 pcs for thermocouple suitable for LINCAT		
For models:	OG7202N, OG7202P, OG7204N, OG7204P, OG7208N, OG7208P		

			
GEV No.	101262	Ref. No.	TC09
description	thermocouple fitting thread M10x1 Qty 1 pcs		

			
GEV No.	102566	Ref. No.	TC07
description	thermocouple fitting thread M8x1 Qty 10 pcs		

			
GEV No.	101261	Ref. No.	TC24
description	thermocouple fitting thread M9x1 Qty 1 pcs		
For models:	OG7202N, OG7202P, OG7204N, OG7204P, OG7208N, OG7208P, OG7302		

interrupters

			
GEV No.	101753	Ref. No.	IN23
description	interrupter brass		

Зип Общепит

vsezip.ru

+7(812)987-08-81

1 gas components

			
1			
<b>GEV No.</b>	101265	<b>Ref. No.</b>	IN08
<b>description</b>	interrupter thread M9x1		
<b>For models:</b>	OG7106		

miscellaneous			
			
1			
<b>GEV No.</b>	102637	<b>Ref. No.</b>	TC06
<b>description</b>	sleeve for thermocouple L 25mm ø 6.5mm Qty 1 pcs		
<b>For models:</b>	OG7202N, OG7202P, OG7204N, OG7204P, OG7208N, OG7208P		

			
1			
<b>GEV No.</b>	102630	<b>Ref. No.</b>	TC37
<b>description</b>	spacer bush with plain washer for thermocouple ø 8mm suitable for TC35/36 Qty 1 pcs		

## gas burners

### hob burners

#### producer-specific hob burners

#### LINCAT

			
1			
<b>GEV No.</b>	103057	<b>Ref. No.</b>	BU80
<b>description</b>	burner ø 94mm 5kW complete		

			
1			
<b>GEV No.</b>	103037	<b>Ref. No.</b>	BU36
<b>description</b>	burner cap ø 95mm		
<b>For models:</b>	HT3, HT6N, HT6P, HT9, SLR6, SLR9		

			
1			
<b>GEV No.</b>	103054	<b>Ref. No.</b>	BU100
<b>description</b>	burner cap ø 95mm H 15mm		

			
1			
<b>GEV No.</b>	103044	<b>Ref. No.</b>	BU35
<b>description</b>	burner head ø 100mm for burner cap ø 95mm nozzle mounting M6x0.75		
<b>For models:</b>	HT3, HT6N, HT6P, HT9, SLR6, SLR9		
<b>accessories for</b>	103044		
	<b>GEV No.</b>	109092	<b>Ref. No.</b>
			GA25
			
	gasket for burner head suitable for BU35		

			
1			
<b>GEV No.</b>	109092	<b>Ref. No.</b>	GA25
<b>description</b>	gasket for burner head suitable for BU35		

			
1			
<b>GEV No.</b>	104511	<b>Ref. No.</b>	BU111
<b>description</b>	gasket ø 72mm ID ø 45mm for burner head H 1.2mm perforation ø 5mm		

### bar burners

#### bar burners

			
1			
<b>GEV No.</b>	109091	<b>Ref. No.</b>	BU27
<b>description</b>	bar burner 1-row L 330mm W 72mm ømm H 25mm		

			
1			
<b>GEV No.</b>	103050	<b>Ref. No.</b>	BU66
<b>description</b>	bar burner 1-row L 380mm Wmm ø 40mm Hmm		



Зип-Общепит  
forced air burners

vsezip.ru

+7(812)987-08-81



1

<b>GEV No.</b>	109184	<b>Ref. No.</b>	OGA20
<b>description</b>	insulation for burner ø 97.5mm ID ø 62.5mm thickness 9.5mm		

ceramic burners



1

<b>GEV No.</b>	103036	<b>Ref. No.</b>	BU13
<b>description</b>	burner L 415mm W 123mm firing range 395x90mm salamander grill 3.1kW		
<b>For models:</b>	OG7302		



1

<b>GEV No.</b>	101673	<b>Ref. No.</b>	BU03
<b>description</b>	ceramic burner L 500mm W 163mm firing range 460x119mm		



1

<b>GEV No.</b>	101645	<b>Ref. No.</b>	BU69	
<b>description</b>	ceramic burner L 585mm W 163mm firing range 540x119mm			
<b>accessories for</b>	101645			
	<b>GEV No.</b>	106671	<b>Ref. No.</b>	JE15
	gas injector thread 12-28 UNF code 240 bore ø 1.3mm L 12mm			



1

<b>GEV No.</b>	108152	<b>Ref. No.</b>	OBL01
<b>description</b>	blower for burner combi-steamer SCC_WE, CM_P 61-202 230V 110W hole distance 50mm NRG118/0800-3612-030203		

accessories

gaskets

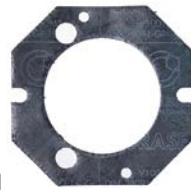

1

<b>GEV No.</b>	104283	<b>Ref. No.</b>	OGA32
<b>description</b>	gasket L 100mm W 100mm hole ø 64mm		

gas nozzles

main nozzles

gas nozzles 1/8"



1

<b>GEV No.</b>	106689	<b>Ref. No.</b>	JE51
<b>description</b>	gas injector thread 1/8" bore ø 1.5mm code 150		

gas nozzles M6x0.75



1

<b>GEV No.</b>	106662	<b>Ref. No.</b>	JE22
<b>description</b>	gas injector thread M6x0.75 WS 7 bore ø 0.9mm		



1

<b>GEV No.</b>	106485	<b>Ref. No.</b>	JE39
<b>description</b>	gas injector thread M6x0.75 WS 7 bore ø 1.6mm		

1 gas components

## gas nozzles M12x1



1

<b>GEV No.</b>	100293	<b>Ref. No.</b>	JE103
<b>description</b>	gas injector thread M12x1 WS 14 bore ø 2.20mm		

## gas nozzles (other)



1

<b>GEV No.</b>	106691	<b>Ref. No.</b>	JE47
<b>description</b>	gas injector code 340 bore ø 1.58mm L 12mm LPG		



1

<b>GEV No.</b>	106671	<b>Ref. No.</b>	JE15
<b>description</b>	gas injector thread 12-28 UNF code 240 bore ø 1.3mm L 12mm		
<b>For models:</b>	J10, J5, OG7302		



1

<b>GEV No.</b>	106690	<b>Ref. No.</b>	JE45
<b>description</b>	gas injector thread 12-28 UNF code 310 bore ø 1.55mm L 12mm LPG		
<b>For models:</b>	OG7202N, OG7204N, OG7208N		



1

<b>GEV No.</b>	106687	<b>Ref. No.</b>	JE14
<b>description</b>	gas injector thread 12-28 UNF code 520 bore ø 2mm L 12mm natural gas		
<b>For models:</b>	J10, J5		

## pilot burner nozzles

## pilot burner nozzles ROBERTSHAW



1

<b>GEV No.</b>	106105	<b>Ref. No.</b>	JE32
<b>description</b>	pilot burner nozzle LPG code 16 suitable for ROBERTSHAW		
<b>For models:</b>	J10, OG7106		

Зип Общепит

vsezip.ru

+7(812)987-08-81



<b>GEV No.</b>	106108	<b>Ref. No.</b>	JE110
<b>description</b>	pilot burner nozzle natural gas code 22 suitable for ROBERTSHAW		



1

<b>GEV No.</b>	100277	<b>Ref. No.</b>	JE31
<b>description</b>	pilot burner nozzle natural gas code 26 suitable for ROBERTSHAW		
<b>For models:</b>	J10, OG7106		

## pilot burner nozzles SIT

## 160 series



1

<b>GEV No.</b>	107650	<b>Ref. No.</b>	JE56
<b>description</b>	pilot burner nozzle SIT LPG code 30 Qty 1 pcs		
<b>For models:</b>	OG7502		

## pilot burner nozzles (other)

## LINCAT



1

<b>GEV No.</b>	106672	<b>Ref. No.</b>	JE87
<b>description</b>	gas injector code 35 L 8mm		
<b>For models:</b>	OG7106		



1

<b>GEV No.</b>	106688	<b>Ref. No.</b>	JE105
<b>description</b>	gas injector natural gas code 41 bore ø 0.41mm thread 10-32 UNF Qty 1 pcs		





bypass nozzles

Зип Общедит  
gas ball valves

bypass nozzles SABAF



<b>GEV No.</b>	106661	<b>Ref. No.</b>	JE117
<b>description</b>	bypass nozzle bore ø 0.54mm thread M4x0.5 SABAF		



<b>GEV No.</b>	106660	<b>Ref. No.</b>	JE116
<b>description</b>	bypass nozzle bore ø 0.85mm thread M4x0.5 SABAF		

auxiliary gas parts

gas pressure regulators

Standard pressure according to country:  
Germany 50mbar  
France 37mbar  
Italy 30mbar  
Spain 37/50mbar  
UK 20mbar



<b>GEV No.</b>	250098	<b>Ref. No.</b>	PG10
<b>description</b>	gas pressure regulator RV48LM connection 3/4" - 3/4" countries UK output pressure 10-20mbar		
<b>description</b>	low pressure gas regulator type RV48LM - 1-2kPa, 4.8m³/h inlet 3/4", outlet 3/4"		



<b>GEV No.</b>	106693	<b>Ref. No.</b>	PG10
<b>description</b>	gas pressure regulator RV48LM countries UK input pressure max. 0.1bar output pressure 12.5-30mbar gas inlet 1/2" gas outlet 1/2"		
<b>description</b>	low pressure gas regulator type RV48LM - 1.25-3kPa, 4.8m³/h inlet 1/2", outlet 1/2"		

with DIN-DVGW approval



<b>GEV No.</b>	520288	<b>Ref. No.</b>	TA97
<b>description</b>	ball valve straight lever handle inlet 1" IT outlet 1" IT DN25 L 86mm approval DVGW gas technology operating p. 1bar		



<b>GEV No.</b>	520286	<b>Ref. No.</b>	TA29
<b>description</b>	ball valve straight lever handle inlet 1/2" IT outlet 1/2" IT DN15 L 61mm approval DVGW gas technology operating p. 1bar		
<b>For models:</b>	J10, OG7502		

equipment-specific units

for display coolers

housing and bezels

miscellaneous



<b>GEV No.</b>	692852	<b>Ref. No.</b>	DI29
<b>description</b>	cover transparent for lamp L 630mm W 140mm H 25mm plastic for type 750		
<b>For models:</b>	C6A-75, C6H-75, C6R-105L, C6R-105R, D3H-75, D3R-100, D5H-75, D5R-100, SCH785, SCR785		



<b>GEV No.</b>	692853	<b>Ref. No.</b>	DI30
<b>description</b>	cover transparent for lamp L 880mm W 140mm H 25mm plastic for type 1000		
<b>For models:</b>	C6A-100, C6H-100, C6R-130L, C6R-130R, D5H-100, D5R-125, SCH1085, SCR1085		

1 gas components

## for pour machines

## drain taps

## drain taps



1

<b>GEV No.</b>	527557	<b>Ref. No.</b>	SL15 SL27 SL34
<b>description</b>	outlet tap complete pipe lengthmm thread 3/4" ET black/chrome suitable for COFFEE QUEEN		

## for pressure steamers

## valves and tank inlets



1

<b>GEV No.</b>	699188	<b>Ref. No.</b>	TA98
<b>description</b>	ball valve L 70mm W 22.5mm H 76.5mm 3-way 3/8"		



1

<b>GEV No.</b>	699187	<b>Ref. No.</b>	FL29
<b>description</b>	inlet tap L 370mm 1/2"		

## for deep fryers

## spouts



1

<b>GEV No.</b>	696730	<b>Ref. No.</b>	TU68
<b>description</b>	drain pipe for fryer ø 33.6mm 1" L 135mm		
<b>For models:</b>	OE7112		

Зип Общепит

vsezip.ru

+7(812)987-08-81



1

<b>GEV No.</b>	696731	<b>Ref. No.</b>	TU64
<b>description</b>	drain pipe ø 33.6mm 1" L 180mm		
<b>For models:</b>	OE7105		

## for convection ovens/combi-steamers

## spare parts and accessories



1

<b>GEV No.</b>	108152	<b>Ref. No.</b>	OBL01
<b>description</b>	blower for burner combi-steamer SCC_WE, CM_P 61-202 230V 110W hole distance 50mm NRG118/0800-3612-030203		



1

<b>GEV No.</b>	694998	<b>Ref. No.</b>	ODR18
<b>description</b>	container L 160mm W 135mm H 66mm suitable for combi-steamer SCC Linie 61-202		



1

<b>GEV No.</b>	694996	<b>Ref. No.</b>	OCO28 OPI14
<b>description</b>	sleeve with clip ø 61/73mm suitable for combi-steamer SCC_WE, CM_P 61/62/101		



Зип Общепит

vsezip.ru

7(812)987-08-81

housing and bezels



1

<b>GEV No.</b>	699801	<b>Ref. No.</b>	CPU08
<b>description</b>	cover for drain assembly L 325mm W 162mm H 92mm		

glass panels



1

<b>GEV No.</b>	692856	<b>Ref. No.</b>	OGL03
<b>description</b>	door glass for combi-steamer SCC/CM202 L 1340mm mounting pos. inner W 680mm thickness 6mm		



1

<b>GEV No.</b>	694937	<b>Ref. No.</b>	ODO28
<b>description</b>	glass panel for door inside combi-steamer CPC-Linie 61 L 573mm W 495mm thickness 7mm		



1

<b>GEV No.</b>	694492	<b>Ref. No.</b>	OGL02
<b>description</b>	glass panel L 485mm W 508mm thickness 6mm mounting pos. inner for combi-steamer		

air filters



1

<b>GEV No.</b>	691620	<b>Ref. No.</b>	OFI05
<b>description</b>	filter L 220mm W 50mm ømm H 150mm SCC Line		



<b>GEV No.</b>	693329	<b>Ref. No.</b>	OFI03
<b>description</b>	filter insert L 213mm W 50mm ømm H 90mm		

cleaning system

pumps

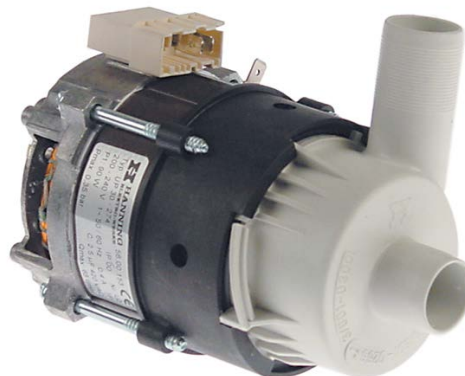

1

<b>GEV No.</b>	500578	<b>Ref. No.</b>	OPU06
<b>description</b>	pump inlet ø 24mm outlet ø 24mm type UP30-274 230V 50/60Hz 1 phase 0.09kW 0.12HP L 145mm rotation direction left capacitor 2.5µF HANNING		

<b>spare parts for</b>	500578			
	<b>GEV No.</b>	501345	<b>Ref. No.</b>	—
	O-ring EPDM thickness 3mm ID ø 58mm Qty 1 pcs			



1

<b>GEV No.</b>	500579	<b>Ref. No.</b>	OPU03
<b>description</b>	pump inlet ø 24mm outlet ø 24mm type UP30-275 230V 50/60Hz 1 phase 0.09kW 0.12HP L 145mm rotation direction left capacitor 2.5µF HANNING		

<b>spare parts for</b>	500579			
	<b>GEV No.</b>	501345	<b>Ref. No.</b>	—
	O-ring EPDM thickness 3mm ID ø 58mm Qty 1 pcs			

## cleaning arms



1

<b>GEV No.</b>	541433	<b>Ref. No.</b>	OCL02
----------------	--------	-----------------	-------

<b>description</b>	cleaning arm CleanJet suitable for RATIONAL _101-_202
--------------------	---



1

<b>GEV No.</b>	541432	<b>Ref. No.</b>	OCL03
----------------	--------	-----------------	-------

<b>description</b>	cleaning arm CleanJet suitable for RATIONAL _61
--------------------	---

## hoses



1

<b>GEV No.</b>	694491	<b>Ref. No.</b>	OHA21
----------------	--------	-----------------	-------

<b>description</b>	supply tube for hose reel
--------------------	---------------------------

## hoses



1

<b>GEV No.</b>	530793	<b>Ref. No.</b>	OHO13
----------------	--------	-----------------	-------

<b>description</b>	formed hose ID $\varnothing$ 22mm ED $\varnothing$ 28mm L 640mm for combi-steamer SCC, CM201/202 since 04/2004
--------------------	--

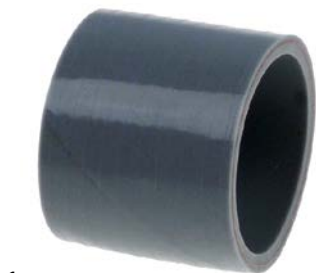

1

<b>GEV No.</b>	692102	<b>Ref. No.</b>	OHO07
----------------	--------	-----------------	-------

<b>description</b>	hose ID $\varnothing$ 50mm ED $\varnothing$ 60mm L 50mm
--------------------	---

## Зип-Общепит

service kits



1

<b>GEV No.</b>	699811	<b>Ref. No.</b>	OBU14
----------------	--------	-----------------	-------

<b>description</b>	service kit for bulb socket RATIONAL
--------------------	--------------------------------------

## drip water trays



1

<b>GEV No.</b>	699800	<b>Ref. No.</b>	ODR08
----------------	--------	-----------------	-------

<b>description</b>	drip tray plastic L 745mm W 47mm H 20mm
--------------------	---

## door mechanics

## miscellaneous



1

<b>GEV No.</b>	694934	<b>Ref. No.</b>	ODO26
----------------	--------	-----------------	-------

<b>description</b>	cover for door latch suitable for combi-steamer CPC-Linie 201/202 aluminium L 96.5mm W 65.5mm
--------------------	---

## miscellaneous



1

<b>GEV No.</b>	694433	<b>Ref. No.</b>	OVA05
----------------	--------	-----------------	-------

<b>description</b>	air valve for combi-steamer bore $\varnothing$ 2mm L 18mm plastic $\varnothing$ 20mm
--------------------	--

<b>accessories for</b>	694433
------------------------	--------



<b>GEV No.</b>	694402	<b>Ref. No.</b>	—
----------------	--------	-----------------	---

<b>description</b>	valve body for air valve hose $\varnothing$ 10mm
--------------------	--



1

<b>GEV No.</b>	699809	<b>Ref. No.</b>	OHA20
----------------	--------	-----------------	-------

<b>description</b>	clamp for spray gun L 24mm
--------------------	----------------------------



Зип Общелит

vsezip.ru

+7(812)987-08-81



1

<b>GEV No.</b>	694786	<b>Ref. No.</b>	OHO21 OHO22 OPI12
<b>description</b>	conversion kit for ventilation for combi-steamer		



1

<b>GEV No.</b>	520917	<b>Ref. No.</b>	OGA34
<b>description</b>	gasket for heat exchanger D1 ø 104mm D2 ø 132mm		



1

<b>GEV No.</b>	694650	<b>Ref. No.</b>	ODR17
<b>description</b>	drain pipe for combi-steamer L 555mm plastic		

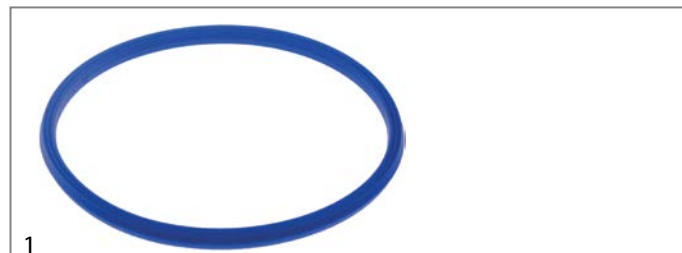

1

<b>GEV No.</b>	694320	<b>Ref. No.</b>	OGA03
<b>description</b>	gasket for lid ø 145mm		



1

<b>GEV No.</b>	694391	<b>Ref. No.</b>	ODR14
<b>description</b>	drain pipe with sleeve for drip pan L 560mm PE		



1

<b>GEV No.</b>	512184	<b>Ref. No.</b>	OCO10
<b>description</b>	hose connector plastic thread 3/4" Qty 1 pcs connection distance 60mm T-shape		



1

<b>GEV No.</b>	524459	<b>Ref. No.</b>	ODR07
<b>description</b>	drip rail L 540mm plastic W 63mm		
<b>accessories for</b>	524459		
	<b>GEV No.</b>	<b>Ref. No.</b>	ODR11
	697931		
<b>description</b>	mounting clip plastic W 20mm Qty 5 pcs		



1

<b>GEV No.</b>	697931	<b>Ref. No.</b>	ODR11
<b>description</b>	mounting clip plastic W 20mm Qty 5 pcs		



1

<b>GEV No.</b>	694651	<b>Ref. No.</b>	OSI03
<b>description</b>	filter for combi-steamer ø 97mm hole ø 6mm H 17.5mm		



1

<b>GEV No.</b>	694322	<b>Ref. No.</b>	ODR12
<b>description</b>	sleeve for drip pan D1 ø 15mm D2 ø 20mm L 62mm		



1

<b>GEV No.</b>	694657	<b>Ref. No.</b>	OSI04
<b>description</b>	thread bolt straight L 44mm SS thread M6 ø 6mm		

## for heated display cases

## housing and bezels

## covers



<b>GEV No.</b>	692852	<b>Ref. No.</b>	DI29
<b>description</b>	cover transparent for lamp L 630mm W 140mm H 25mm plastic for type 750		
<b>For models:</b>	C6A-75, C6H-75, C6R-105L, C6R-105R, D3H-75, D3R-100, D5H-75, D5R-100, SCH785, SCR785		



<b>GEV No.</b>	692853	<b>Ref. No.</b>	DI30
<b>description</b>	cover transparent for lamp L 880mm W 140mm H 25mm plastic for type 1000		
<b>For models:</b>	C6A-100, C6H-100, C6R-130L, C6R-130R, D5H-100, D5R-125, SCH1085, SCR1085		

## knobs

## producer-specific knobs

## LINCAT



<b>GEV No.</b>	113027	<b>Ref. No.</b>	KN182
<b>description</b>	knob 1-6 ø 55mm black		
<b>For models:</b>	BM3W, BM4W, BM6W, BM7W, BS3W, BS4W, BS7W, ECG6, GS3, GS4, GS4E, GS6, GS6T, GS6TE, GS7, GS7E, GS9, PB33, PB66		



<b>GEV No.</b>	113028	<b>Ref. No.</b>	KN178 KN263
<b>description</b>	knob 1-6 t.max.°C ø 55mm shaft ø 6x4.6mm shaft flat upper black		
<b>For models:</b>	BM3, BM4, BM6, BM7, BS3, BS4, BS7, CS4, CS4G, CS6		

Зип Общепит

vsezip.ru

+7(812)987-08-81

<b>GEV No.</b>	113007	<b>Ref. No.</b>	KN230
<b>description</b>	knob gas thermostat t.max. 250°C 170-250°C ø 70-80mm shaft ø 8mm black		



<b>GEV No.</b>	111649	<b>Ref. No.</b>	OKN06
<b>description</b>	knob ø 69mm shaft ø 5mm silver		

## handles and hand wheels

## mushroom cap handles



<b>GEV No.</b>	111782	<b>Ref. No.</b>	KN10
<b>description</b>	mushroom cap handle thread M6 handle ø 25mm L 17mm plastic black		
<b>For models:</b>	CS4, CS4N, CS4P, CS6, DF33, DF36, DF39, DF4, DF46, DF49, DF612, DF618, DF66, DF66ST, DF7, GBM2, GBM3, J10, J12, J18, J5, J6, J9, LCS, LDF, LDF2, LPB, PB33, PB66		

## bracket handles



<b>GEV No.</b>	701558	<b>Ref. No.</b>	HA92
<b>description</b>	pull handle L 175mm H 62mm mounting distance 145mm thread M8		
<b>For models:</b>	ECO7, SLR6, SLR9, V6, V6D, V6F, V7		



<b>GEV No.</b>	701557	<b>Ref. No.</b>	HA68
<b>description</b>	pull handle L 200mm H 45mm mounting distance 132.5mm thread M8		
<b>For models:</b>	ECO76		





1

<b>GEV No.</b>	701632	<b>Ref. No.</b>	HA77
<b>description</b>	pull handle L 227mm H 50mm mounting distance 170mm thread M8 black suitable for LINCAT		
<b>For models:</b>	OE7010, OE7104, OE7105, OE7112, OE7113, OG7106		



1

<b>GEV No.</b>	693577	<b>Ref. No.</b>	ODO11
<b>description</b>	D-lock W 29mm H 17mm spring length 50mm spring thickness 3mm		



1

<b>GEV No.</b>	693579	<b>Ref. No.</b>	OCA11
<b>description</b>	door catch H 10.5mm L 42mm W 13mm M5		

## locks

### handle latches

#### producer-specific

##### LINCAT





1

<b>GEV No.</b>	693578	<b>Ref. No.</b>	ODO22
<b>description</b>	bracket for door catch L 66mm W 23.5mm H 19mm mounting distance 46mm		
<b>accessories for</b>	693578		
	<b>GEV No.</b>	<b>Ref. No.</b>	OCA11
	693579		
	door catch H 10.5mm L 42mm W 13mm M5		



1

<b>GEV No.</b>	693576	<b>Ref. No.</b>	ODO14
<b>description</b>	catch L 83mm $\varnothing$ 41mm clamp length 43mm BL 45mm		
<b>spare parts for</b>	693576		
	<b>GEV No.</b>	<b>Ref. No.</b>	ODO11
	693577		
	D-lock W 29mm H 17mm spring length 50mm spring thickness 3mm		



1

<b>GEV No.</b>	693580	<b>Ref. No.</b>	OLO02
<b>description</b>	cover for catch		



1

<b>GEV No.</b>	693582	<b>Ref. No.</b>	ODO24
<b>description</b>	cover for door latch L 97mm W 10.5mm mounting distance 71mm H 65mm		

## hinges

### door bearing



1

<b>GEV No.</b>	693587	<b>Ref. No.</b>	ODO32
<b>description</b>	hinge mounting pos. bottom right		

## fittings for catering equipment

### outlet taps

#### universal



1

<b>GEV No.</b>	514506	<b>Ref. No.</b>	VA05
<b>description</b>	outlet tap stainless steel W 38mm H 40mm thread 3/4" IT		

#### producer-specific

##### LINCAT



1

<b>GEV No.</b>	514434 <sup>1</sup>	<b>Ref. No.</b>	DS24
<b>description</b>	ball valve thread 1/2" ET		
<b>For models:</b>	BM3W, BM4W, BM6W, BM7W, BS3W, BS4W, BS7W, DF33, DF36, DF39, DF4, DF46, DF49, DF612, DF618, DF66, DF66ST, DF7, ECG6, J12, J18, J6, J9, PB33, PB66		

<sup>1</sup>pipe connection  $\varnothing$ 16mm

dispenser tap

complete



1

<b>GEV No.</b>	527590	<b>Ref. No.</b>	SL27
<b>description</b>	outlet tap complete inlet 3/4" blue		
<b>For models:</b>	EB3, EB4, EB6, EB6T		
<b>spare parts for</b>	527590		
	<b>GEV No.</b>	527591	<b>Ref. No.</b> SL28
	tap head blue		



1

<b>GEV No.</b>	527557	<b>Ref. No.</b>	SL15 SL27 SL34
<b>description</b>	outlet tap complete pipe lengthmm thread 3/4" ET black/chrome suitable for COFFEE QUEEN		

tap heads



1

<b>GEV No.</b>	527592	<b>Ref. No.</b>	— SL22
<b>description</b>	tap head black		

Зип Общепит

vsezip.ru

+7(812)987-08-81



1

<b>GEV No.</b>	527591	<b>Ref. No.</b>	SL28
<b>description</b>	tap head blue		

filters

device filters



1

<b>GEV No.</b>	698609	<b>Ref. No.</b>	OFI09
<b>description</b>	filter insert L 180mm W 140mm H 22mm plastic suitable for RATIONAL		

equipment feet and end caps

equipment feet

with screw mounting

universal



1

<b>GEV No.</b>	700866	<b>Ref. No.</b>	LE37
<b>description</b>	equipment foot tube ø 64mm thread M10 thread L 18mm H 135-190mm stainless steel Qty 1 pcs		
<b>For models:</b>	OA7920, OA7934, OE7105, OE7112		





Зип Общежит

screw-in feet

vsezip.ru

+7(812)987-08-81



1

<b>GEV No.</b>	700867	<b>Ref. No.</b>	LE42
<b>description</b>	equipment foot tube ø 64mm thread M12 thread L 23mm H 135-215mm SS size 2 1/2" Qty 1 pcs		
<b>For models:</b>	OE7010, OE7503, OG7502		



1

<b>GEV No.</b>	699192	<b>Ref. No.</b>	LE38
<b>description</b>	equipment foot tube ø 31mm thread 3/8" UNC thread L 25mm H 55-84mm Qty 1 pcs		
<b>For models:</b>	OA7919, OA7936, OE7012, OE7206, OE7209, OE7210		



1

<b>GEV No.</b>	701560	<b>Ref. No.</b>	FE29
<b>description</b>	equipment foot tube ø 50.5mm thread M12 thread L 16mm H 158-200mm		
<b>For models:</b>	ESLR9, HCL3, HCL4, HCL6, HCL7, HCL9, J10, J5, SLR6, SLR9		



1

<b>GEV No.</b>	701637	<b>Ref. No.</b>	FE40
<b>description</b>	equipment foot tube ø 52mm thread M10 thread L 36mm H 150-190mm SS Qty 1 pcs		

<b>GEV No.</b>	699190	<b>Ref. No.</b>	FE10
<b>description</b>	equipment foot thread M8 thread L 24mm ø 28.5mm H 16mm		
<b>For models:</b>	CC3, CC4, CC6, CC7, CN3, CN4, CN6, CN7, CT1, ECO76, ECO8, ECO9, G1A, GG1, HB2, HB3, HB4, HC3, HC4, HC6, HC7, J12, J18, J6, J9, LD2, LD3, LPO, LPW, LPW-LR, UMO50, UMSO50, UMSO50D		



1

<b>GEV No.</b>	699189	<b>Ref. No.</b>	FE28
<b>description</b>	equipment foot thread M8 thread L 32mm ø 26mm H 9.5mm Qty 1 pcs		

bolting feet



1

<b>GEV No.</b>	692157	<b>Ref. No.</b>	FE35 FE37
<b>description</b>	equipment foot ø 19mm H 12mm bore ø 5mm Qty 1 pcs		
<b>For models:</b>	AS3, AS4, BM3, BM3W, BM4, BM4W, BM6, BM6W, BM7, BM7W, BS3, BS3W, BS4, BS4W, BS7, BS7W, CG4, CS4, CS4G, CS4N, CS4P, CS6, DF33, DF36, DF39, DF4, DF46, DF49, DF612, DF618, DF66, DF66ST, DF7, ECC6, GS3, GS4, GS4E, GS6, GS6T, GS6TE, GS7, GS7E, GS9, HT3, HT6, HT7, J12, J18, J6, J9...(Other models you can see in the webshop)		



1

<b>GEV No.</b>	699191	<b>Ref. No.</b>	FE01
<b>description</b>	equipment foot ø 29.2mm H 39.5mm bore ø 6.2mm Qty 1 pcs		
<b>For models:</b>	EB3, EB4, EB6, EB6T, FDB4, FPB5		

## miscellaneous

## with fixing plate

ø100mm



1

<b>GEV No.</b>	701634	<b>Ref. No.</b>	CA150
<b>description</b>	swivel castor ø 100mm plate size 105x80mm hole distance 80x60mm H 125mm wheel width 32mm Qty 1 pcs		

ø125mm



1

<b>GEV No.</b>	701633	<b>Ref. No.</b>	CA145
<b>description</b>	swivel castor ø 125mm bearing ball bearing plate size 105x80mm hole distance 80x60mm H 155mm wheel width 32mm Qty 1 pcs		



1

<b>GEV No.</b>	701635	<b>Ref. No.</b>	CA184
<b>description</b>	swivel castor without brake ø 125mm plate fixing housing stainless steel bearing ball bearing plate size 100x86mm hole distance 78x60mm wheel body polypropylene H 160mm wheel width 31.5mm		

## with bolt hole

ø125mm



1

<b>GEV No.</b>	710028	<b>Ref. No.</b>	CA113
<b>description</b>	swivel castor ø 125mm bolt hole ø12.0mm bolt hole ø 12mm H 155mm wheel width 36.5mm		
<b>For models:</b>	OA7905, OE7113		

Зип Общепит

vsezip.ru

+7(812)987-08-81



<b>GEV No.</b>	710029	<b>Ref. No.</b>	CA112
<b>description</b>	swivel castor with brake ø 125mm bolt hole ø12.0mm bolt hole ø 12mm H 155mm wheel width 36.5mm		
<b>For models:</b>	OA7905, OE7113		

## baskets

## fryer baskets

## LINCAT



1

<b>GEV No.</b>	970985	<b>Ref. No.</b>	BA96
<b>description</b>	fryer basket W1 100mm L1 310mm H1 100mm L2 470mm H2 160mm H3 213mm chrome-plated steel rubber with holder		



1

<b>GEV No.</b>	970973	<b>Ref. No.</b>	BA122
<b>description</b>	fryer basket W1 110mm L1 340mm H1 150mm L2 620mm H2 192mm H3 330mm chrome-plated steel plastic-coated steel with holder W2 85mm		



1

<b>GEV No.</b>	970977	<b>Ref. No.</b>	BA156
<b>description</b>	fryer basket W1 120mm L1 240mm H1 88mm L2 395mm H2 162mm H3 238mm chrome-plated steel with holder		



1

<b>GEV No.</b>	970979	<b>Ref. No.</b>	BA159
<b>description</b>	fryer basket W1 133mm L1 337mm H1 144mm L2 610mm H2 197mm H3 335mm chrome-plated steel rubber with holder		



1

<b>GEV No.</b>	970987	<b>Ref. No.</b>	BA83
<b>description</b>	fryer basket W1 140mm L1 337mm H1 145mm L2 598mm H2 185mm H3 305mm chrome-plated steel rubber with holder		
<b>For models:</b>	OE7105, OG7106		

Зип Общепит  
vsezip.ru  
+7(812)987-08-81

			
1			
<b>GEV No.</b>	970984	<b>Ref. No.</b>	BA93
<b>description</b>	fryer basket W1 160mm L1 295mm H1 100mm L2 460mm H2 160mm H3 220mm chrome-plated steel rubber with holder		

			
1			
<b>GEV No.</b>	970988	<b>Ref. No.</b>	BA82
<b>description</b>	fryer basket W1 220mm L1 340mm H1 145mm L2 615mm H2 200mm H3 297mm chrome-plated steel rubber with holder		
<b>For models:</b>	OE7104, OE7112, OE7113		

			
1			
<b>GEV No.</b>	970972	<b>Ref. No.</b>	BA113
<b>description</b>	fryer basket W1 160mm L1 310mm H1 102mm L2 490mm H2 162mm H3 213mm chrome-plated steel with holder		

			
1			
<b>GEV No.</b>	970976	<b>Ref. No.</b>	BA155
<b>description</b>	fryer basket W1 197mm L1 218mm H1 85mm L2 395mm H2 165mm H3 220mm chrome-plated steel with holder		

			
1			
<b>GEV No.</b>	970986	<b>Ref. No.</b>	BA94
<b>description</b>	fryer basket W1 200mm L1 260mm H1 100mm L2 415mm H2 167mm H3 218mm chrome-plated steel rubber with holder		

			
1			
<b>GEV No.</b>	970691	<b>Ref. No.</b>	BA92
<b>description</b>	fryer basket W1 200mm L1 280mm H1 100mm		

			
1			
<b>GEV No.</b>	970989	<b>Ref. No.</b>	BA98
<b>description</b>	fryer basket W1 200mm L1 297mm H1 150mm L2 560mm H2 220mm H3 280mm chrome-plated steel rubber with holder		
<b>For models:</b>	J10, J5		

			
1			
<b>GEV No.</b>	970690	<b>Ref. No.</b>	BA91
<b>description</b>	fryer basket W1 200mm L1 310mm H1 100mm		
<b>For models:</b>	DF33, DF36, DF39, DF46, DF49, DF612, DF618, DF66, J12, J18, J6, J9		

pasta baskets

LINCAT

			
1			
<b>GEV No.</b>	970967	<b>Ref. No.</b>	BA116
<b>description</b>	pasta basket H1 101mm W1 102mm L1 155mm size 1/4 L2 210mm H3 220mm stainless steel		

			
1			
<b>GEV No.</b>	970969	<b>Ref. No.</b>	BA115
<b>description</b>	pasta basket H1 101mm W1 102mm L1 155mm size 1/4 L2 210mm H3 220mm stainless steel		

			
1			
<b>GEV No.</b>	970968	<b>Ref. No.</b>	BA114
<b>description</b>	pasta basket H1 103mm W1 101mm L1 310mm size 1/2 size L2 540mm H2 153mm H3 210mm stainless steel		

Зип Общепит

vsezip.ru

+7(812)987-08-81



1

<b>GEV No.</b>	970966	<b>Ref. No.</b>	BA112
<b>description</b>	pasta basket H1 103mm W1 202mm L1 310mm L2 540mm H2 153mm H3 210mm stainless steel		
<b>For models:</b>	PB33, PB66		



1

<b>GEV No.</b>	970970	<b>Ref. No.</b>	OA7923
<b>description</b>	pasta basket H1 225mm W1 216mm L1 300mm L2 525mm H2 278mm H3 330mm stainless steel		



1

<b>GEV No.</b>	970975	<b>Ref. No.</b>	OA7925 OA8925
<b>description</b>	pasta basket H1 215mm W1 145mm L1 164mm H3 375mm stainless steel		



1

<b>GEV No.</b>	970978	<b>Ref. No.</b>	BA157
<b>description</b>	pasta basket H1 79mm W1 205mm L1 217mm L2 365mm H2 122mm H3 190mm with holder		

## miscellaneous



1

<b>GEV No.</b>	970974	<b>Ref. No.</b>	OA7922 OA8922
<b>description</b>	pasta basket H1 217mm W1 298mm L1 327mm H2 250mm H3 357mm stainless steel		

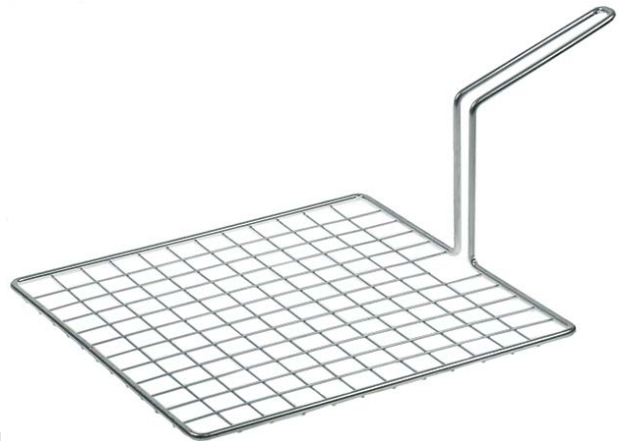

1

<b>GEV No.</b>	692896	<b>Ref. No.</b>	BA41
<b>description</b>	grate L 320mm W 320mm H 187mm with handle		



1

<b>GEV No.</b>	970971	<b>Ref. No.</b>	OA7924 OA8924
<b>description</b>	pasta basket H1 218mm W1 142mm L1 288mm L2 510mm H2 300mm H3 350mm stainless steel		

**gaskets**

**gaskets for heated units**

**door seals**

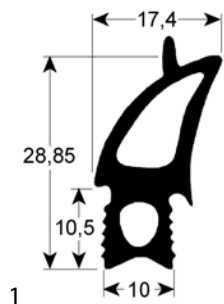

<b>GEV No.</b>	900290	<b>Ref. No.</b>	OSE06
<b>description</b>	door seal profile 2730 W 465mm L 520mm external size Qty 1		

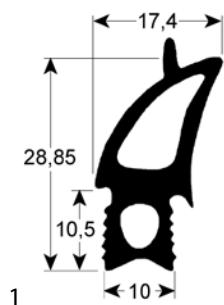

<b>GEV No.</b>	900262	<b>Ref. No.</b>	OSE10
<b>description</b>	door seal profile 2730 W 470mm L 1475mm outer plug size Qty 1		

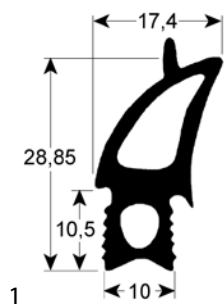

<b>GEV No.</b>	900291	<b>Ref. No.</b>	OSE02
<b>description</b>	door seal profile 2730 W 470mm L 785mm outer plug size Qty 1		

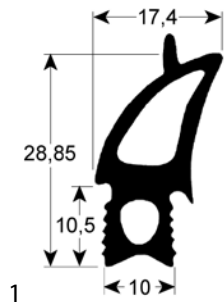

<b>GEV No.</b>	900574	<b>Ref. No.</b>	OSE13
<b>description</b>	door seal profile 2730 W 675mm L 1475mm outer plug size		

Зип Общепит

vsezip.ru

+7(812)987-08-81



<b>GEV No.</b>	900573	<b>Ref. No.</b>	OSE12
<b>description</b>	door seal profile 2730 W 675mm L 760mm outer plug size		

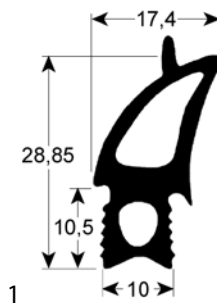

<b>GEV No.</b>	900292	<b>Ref. No.</b>	OSE03
<b>description</b>	door seal profile 2730 W 685mm L 780mm outer plug size		

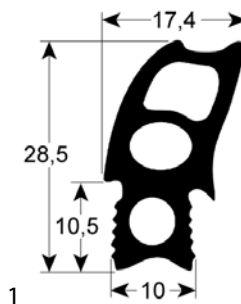

<b>GEV No.</b>	901403	<b>Ref. No.</b>	OSE08
<b>description</b>	door seal profile 2731 W 470mm L 500mm outer plug size Qty 1		

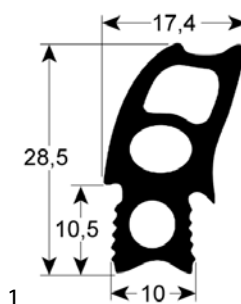

<b>GEV No.</b>	901405	<b>Ref. No.</b>	OSE09
<b>description</b>	door seal profile 2731 W 470mm L 760mm outer plug size		

Зип Общепит

vsezip.ru

+7(812)987 08 01

<b>GEV No.</b>	901438	<b>Ref. No.</b>	OSE04
<b>description</b>	door seal profile 2732 W 485mm L 1495mm external size Qty 1		

<b>GEV No.</b>	901439	<b>Ref. No.</b>	OSE05
<b>description</b>	door seal profile 2732 W 680mm L 1495mm outer plug size		

<b>GEV No.</b>	902322	<b>Ref. No.</b>	SE42
<b>description</b>	door seal profile 2991 W 535mm L 705mm external size Qty 1		

<b>GEV No.</b>	902323	<b>Ref. No.</b>	SE38
<b>description</b>	door seal profile 2991 W 590mm L 710mm external size Qty 1		

door seals with fixing hook

<b>GEV No.</b>	901163	<b>Ref. No.</b>	SE25
<b>description</b>	door seal L 1000mm with mounting clip Qty supplied by meter		

<b>GEV No.</b>	902321	<b>Ref. No.</b>	SE22
<b>description</b>	door seal L 420mm W 10mm		

<b>GEV No.</b>	902317	<b>Ref. No.</b>	SE05
<b>description</b>	door seal L 470mm W 430mm 4-sided with mounting clip		
<b>For models:</b>	ECO9		

<b>GEV No.</b>	902320	<b>Ref. No.</b>	SE23
<b>description</b>	door seal L 475mm W 9mm with mounting clip		

<b>GEV No.</b>	902318	<b>Ref. No.</b>	SE27
<b>description</b>	door seal L 510mm W 10mm with mounting clip		

<b>GEV No.</b>	902319	<b>Ref. No.</b>	SE17
<b>description</b>	door seal L 530mm W 12mm		

<b>GEV No.</b>	902316	<b>Ref. No.</b>	SE76
<b>description</b>	door seal L 560mm W 400mm 4-sided with mounting clip		
<b>For models:</b>	ECO8		

door gaskets (wire reinforced)

<b>GEV No.</b>	902324	<b>Ref. No.</b>	SE75
<b>description</b>	door seal wire reinforced L 1380mm ø 7.5mm		



Зип Общежит

vsezip.ru

+7(812)987-08-81

gaskets for tray rack trolleys



<b>GEV No.</b>	900566	<b>Ref. No.</b>	OGA25
<b>description</b>	tray rack trolley gasket profile 4095 L 575mm Qty 1		

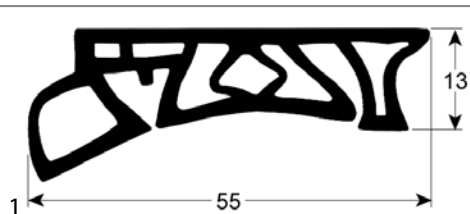

<b>GEV No.</b>	900255	<b>Ref. No.</b>	OGA30
<b>description</b>	tray rack trolley gasket profile 4095 L 780mm Qty 1		

O-rings

silicone

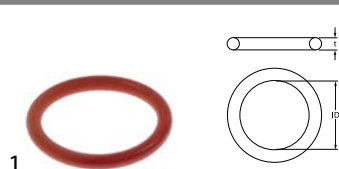

<b>GEV No.</b>	532727	<b>Ref. No.</b>	OGA38
<b>description</b>	O-ring silicone thickness 3.5mm ID $\varnothing$ 26mm Qty 5 pcs for model SCC, CM		

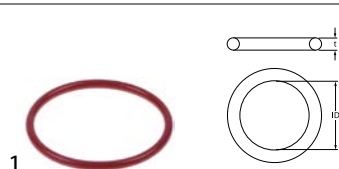

<b>GEV No.</b>	532728	<b>Ref. No.</b>	OGA37
<b>description</b>	O-ring silicone thickness 3.5mm ID $\varnothing$ 46mm Qty 5 pcs for model SCC, CM		

sealing cords

round



<b>GEV No.</b>	694917	<b>Ref. No.</b>	SE30
<b>description</b>	sealing cord L 106.5m for pizza oven $\varnothing$ 9mm		

shaft gaskets

miscellaneous



<b>GEV No.</b>	511685	<b>Ref. No.</b>	OGA29
<b>description</b>	shaft seal kit ID $\varnothing$ 15mm ED $\varnothing$ 27mm shaft seal flange mounting gauge with mountign material		



<b>GEV No.</b>	511682	<b>Ref. No.</b>	OGA09
<b>description</b>	shaft seal kit ID $\varnothing$ 17mm ED $\varnothing$ 29mm shaft seal flange mounting gauge with mountign material		

special gaskets

for combi-steamers



<b>GEV No.</b>	560599	<b>Ref. No.</b>	OGA16
<b>description</b>	gasket ED $\varnothing$ 132mm ID $\varnothing$ 105mm thickness 2mm CPC-Linie CM 61-202/G		



<b>GEV No.</b>	560597	<b>Ref. No.</b>	OGA40
<b>description</b>	gasket ED $\varnothing$ 140mm ID $\varnothing$ 128mm SCC Line		



<b>GEV No.</b>	560596	<b>Ref. No.</b>	OGA39
<b>description</b>	gasket ED $\varnothing$ 60mm ID $\varnothing$ 50mm SCC, SCC_WE, CM,CM_P since 04/2004		

Зип Общепит

vsezip.ru

+7(812)987-08-81



1

<b>GEV No.</b>	699803	<b>Ref. No.</b>	OGA24
<b>description</b>	gasket L 139mm W 130mm silicone thickness 4mm		



1

<b>GEV No.</b>	560613	<b>Ref. No.</b>	OGA33
<b>description</b>	gasket L 43mm W 67mm thickness 4mm SCC, CM61-202 since 06/2007 for combi-steamer		

## miscellaneous

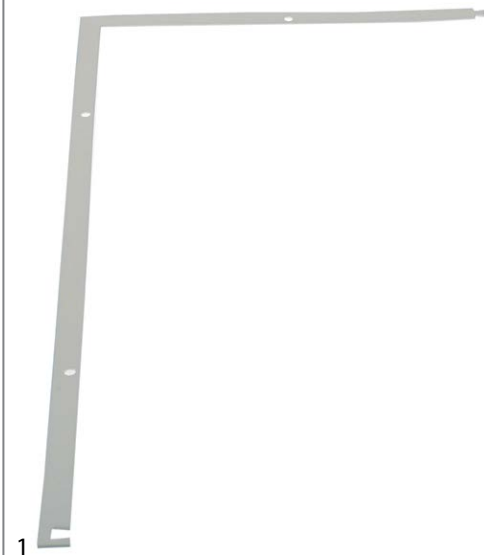

1

<b>GEV No.</b>	512473	<b>Ref. No.</b>	GA38
<b>description</b>	gasket suitable for LINCAT equiv. no. GA38 for tank L 398mm W 221mm without screws		



1

<b>GEV No.</b>	510658	<b>Ref. No.</b>	GA39
<b>description</b>	gasket suitable for LINCAT equiv. no. GA39 for tank L 303mm external weith 233mm Qty 1m with screws EB4		

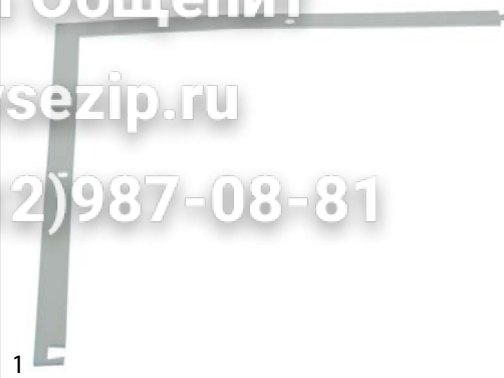

1

<b>GEV No.</b>	512393	<b>Ref. No.</b>	GA40
<b>description</b>	gasket suitable for LINCAT equiv. no. GA40 for tank L 233mm external weith 233mm without screws		
<b>For models:</b>	EB3, EB4, EB6, EB6T		



1

<b>GEV No.</b>	510660	<b>Ref. No.</b>	GA44
<b>description</b>	gasket suitable for LINCAT equiv. no. GA44 L 68mm W 50mm Qty 1m hole distance 57mm		
<b>For models:</b>	DF33, DF36, DF39, ECG6, J6, J9, PB33		



1

<b>GEV No.</b>	510661	<b>Ref. No.</b>	GA45
<b>description</b>	gasket suitable for LINCAT equiv. no. GA45 L 59mm W 30mm Qty 1m thickness 1.5mm hole distance 50mm		
<b>For models:</b>	DF33, DF36, DF39, ECG6, J12, J18, J6, J9, PB33		



1

<b>GEV No.</b>	550895	<b>Ref. No.</b>	OGA07
<b>description</b>	gasket suitable for RATIONAL equiv. no. 51101308 L 179mm W 90mm electrode thickness 3mm		





refrigeration cycle components

Зип Общежит  
vsezip.ru  
+7(812)987-08-81

valves

Schrader valves

Schrader valves (complete)



1	<b>GEV No.</b>	750101	<b>Ref. No.</b>	VA16
	<b>description</b>	Schrader valve complete connection 1/4" SAE L 130mm		
	<b>For models:</b>	FDB4, FPB5, SCR1085, SCR785		

filter driers

miscellaneous



1	<b>GEV No.</b>	750734	<b>Ref. No.</b>	G/DR02
	<b>description</b>	dryer size 10g ø 16mm L 115mm connection 2,5/6,2mm		
	<b>For models:</b>	FDB4, FPB5		



1	<b>GEV No.</b>	750616	<b>Ref. No.</b>	DR26
	<b>description</b>	dryer size 15g ø 19mm L 121mm connection 2,7/6,5mm type XH20P Qty 1 pcs		
	<b>For models:</b>	SCR1085, SCR785		

for saladettes



1	<b>GEV No.</b>	750733	<b>Ref. No.</b>	G/CD01
	<b>description</b>	evaporator L 240mm W 125mm D 45mm total length 260mm		
	<b>For models:</b>	FDB4, FPB5		

transmission technology and ball bearings

drive belts

toothed belts



1	<b>GEV No.</b>	697828	<b>Ref. No.</b>	BE14
	<b>description</b>	toothed belt profile XL L 400mm H 2mm teeth 80 rubber with textile insertion CODE B191009 W 6mm type 160XL		

springs

compression springs



1	<b>GEV No.</b>	693591	<b>Ref. No.</b>	OSP04
	<b>description</b>	compression spring ø 14mm L 27mm wire gauge ø 1.5mm		



## hose reels and spray guns





3zip.Общепит

hose reels

## spray guns



1

<b>GEV No.</b>	540302	<b>Ref. No.</b>	OHA01
<b>description</b>	spray gun for appliances 1/2" ET L 135mm type RATIONAL		
<b>spare parts for</b>	540302		
	<b>GEV No.</b>	517056	<b>Ref. No.</b> —
	O-ring EPDM thickness 2mm ID ø 6.5mm Qty 1 pcs		
	<b>GEV No.</b>	532535	<b>Ref. No.</b> —
	O-ring EPDM thickness 5mm ID ø 10mm Qty 1 pcs		
	<b>GEV No.</b>	548016	<b>Ref. No.</b> —
	compression spring ø 10mm L 17mm wire gauge ø 0.9mm for hand spray		
	<b>GEV No.</b>	548017	<b>Ref. No.</b> —
	pressure bolt for hand spray		



1

<b>GEV No.</b>	540664	<b>Ref. No.</b>	OHA10
<b>description</b>	spray gun for appliances 1/2" (12.83mm) L 165mm		
<b>spare parts for</b>	540664		
	<b>GEV No.</b>	699809	<b>Ref. No.</b> OHA20
	clamp for spray gun L 24mm		

## appliance hose reels

vsezip.ru

+7(812)987-08-81

1

<b>GEV No.</b>	541444	<b>Ref. No.</b>	OHA13
<b>description</b>	hose reel without spray gun hose length 1.5m		

1

<b>GEV No.</b>	540661	<b>Ref. No.</b>	OHA12
<b>description</b>	hose reel without spray gun hose length 1m		

<b>accessories for</b>	540661		
------------------------	--------	--	--

	<b>GEV No.</b>	540664	<b>Ref. No.</b> OHA10
---	----------------	--------	-----------------------

	spray gun for appliances 1/2" (12.83mm) L 165mm		
--	---	--	--

	<b>GEV No.</b>	560630	<b>Ref. No.</b> —
---	----------------	--------	-------------------

	clamping washer nominal-ø 4mm ED ø 11.5mm SS thickness 0.2mm		
--	--	--	--

	<b>GEV No.</b>	694491	<b>Ref. No.</b> OHA21
---	----------------	--------	-----------------------

	supply tube for hose reel		
--	---------------------------	--	--

	<b>GEV No.</b>	699802	<b>Ref. No.</b> —
---	----------------	--------	-------------------

	cover for spray gun D1 ø 90/145mm L 145mm H 68mm		
--	--	--	--

1

<b>GEV No.</b>	540483	<b>Ref. No.</b>	OHA02
<b>description</b>	hose reel without spray gun hose length 2.1m		





spare parts and accessories

hoses

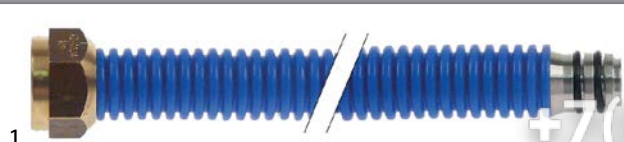



<b>GEV No.</b>	520915	<b>Ref. No.</b>	OHO24
<b>description</b>	connection hose for hose reel connections ø14.6mm / 3/4" length 0.7m		

hoses

supply hoses

PVC supply hoses



<b>GEV No.</b>	520010	<b>Ref. No.</b>	PI12
<b>description</b>	supply hose PVC straight-curved DN13 connections 3/4" L 1500mm operating p. 10bar burst p. 32bar t.max. 90°C blue approval VDE flat seal		
<b>For models:</b>	ECO76		
<b>accessories for</b>	520010		
	<b>GEV No.</b>	520053	<b>Ref. No.</b> —
	screen connection 3/4" D1 ø 26mm D2 ø 15mm Qty 10 pcs rubber thickness 8mm		
	<b>GEV No.</b>	520054	<b>Ref. No.</b> —
	flat gasket rubber ED ø 23.5mm ID ø 14mm thickness 2.3mm Qty 10 pcs		

industrial hoses

silicone hoses

without fabric



<b>GEV No.</b>	530067	<b>Ref. No.</b>	OHO14
<b>description</b>	silicone hose ID ø 50mm ED ø 56mm L 0.13m thickness 3mm t.max. 200°C		

Зип Общежит

formed hoses

straight

vsezip.ru

+7(812)987-08-81

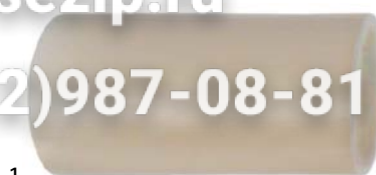

<b>GEV No.</b>	530067	<b>Ref. No.</b>	OHO14
<b>description</b>	silicone hose ID ø 50mm ED ø 56mm L 0.13m thickness 3mm t.max. 200°C		

form L



<b>GEV No.</b>	530716	<b>Ref. No.</b>	OHO18
<b>description</b>	formed hose ID ø 18/23mm ED ø 25/28mm L 170mm Qty 1 L-shape for combi-steamer ø ø22(19)mm thickness 3mm		



<b>GEV No.</b>	530717	<b>Ref. No.</b>	OHO12
<b>description</b>	formed hose ID ø 19/22mm ED ø 25/28mm L 225mm L-shape for combi-steamer thickness 3.5mm		



<b>GEV No.</b>	530793	<b>Ref. No.</b>	OHO13
<b>description</b>	formed hose ID ø 22mm ED ø 28mm L 640mm for combi-steamer SCC, CM201/202 since 04/2004		



<b>GEV No.</b>	694323	<b>Ref. No.</b>	ODR16
<b>description</b>	formed hose ID ø 23mm ED ø 28mm L 480mm combi-steamer for drain		

Зип.Общепит  
fittings, hose and pipe connectors

hose connectors  
producer-specific

+7(812)987-08-81



1

<b>GEV No.</b>	694324	<b>Ref. No.</b>	OHO08
<b>description</b>	formed hose ID ø 23mm ED ø 28mm L 480mm for combi-steamer		

form U

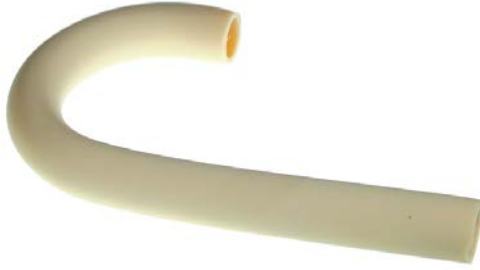

1

<b>GEV No.</b>	530715	<b>Ref. No.</b>	OHO11
<b>description</b>	formed hose L 450mm ID ø 22mm ED ø 29mm for combi-steamer U-shape		

miscellaneous



1

<b>GEV No.</b>	524453	<b>Ref. No.</b>	OHO16
<b>description</b>	formed hose ext. ø 29 D1 ø 23mm D2 ø 23mm L 340mm white Qty 1		



1

<b>GEV No.</b>	530066	<b>Ref. No.</b>	OHO06
<b>description</b>	formed hose ID ø 24mm ED ø 30mm L 380mm		



1

<b>GEV No.</b>	512183	<b>Ref. No.</b>	OHA22
<b>description</b>	hose connector for hose reel T-shape plastic ø 20/12mm 3/4"		

valves and tank inlets  
ball valves

universal

mini ball valves



1

<b>GEV No.</b>	520956	<b>Ref. No.</b>	DV02
<b>description</b>	ball valve DN8 total length 54mm chrome-plated brass		
<b>For models:</b>	EB3F, EB4F, EB6, EB6T		



1

<b>GEV No.</b>	520957	<b>Ref. No.</b>	VA19
<b>description</b>	ball valve connection 1/2" IT - tube ø15mm DN8 total length 52mm chrome-plated brass		
<b>For models:</b>	GBM2, GBM3, OG7302		

producer-specific  
LINCAT



1

<b>GEV No.</b>	514188	<b>Ref. No.</b>	TA101/A TA74
<b>description</b>	ball valve connection 1" IT - 1" IT total length 81mm handle length 116mm		
<b>For models:</b>	OE7104		



shut-off valves

producer-specific

LINCAT



1

<b>GEV No.</b>	514187	<b>Ref. No.</b>	CO167
<b>description</b>	shut-off valve connection 1/2" 1/2" cold/warm total length 50mm		

Зип Общепит

for cold drinks

vsezip.ru

+7(812)987-08-81



1

<b>GEV No.</b>	530478	<b>Ref. No.</b>	FC02
<b>description</b>	filter type AP2-C405-SG capacity 4000l flow rate 114l/h operation p max 8.6bar water temperature max. 38°C for filter head AP2 ø 13/22mm H 240mm activated carbon filtration for beverage vending machine		

water filters

CUNO

filters

for hot drinks



1

<b>GEV No.</b>	530078	<b>Ref. No.</b>	FC02
<b>description</b>	water filter CUNO type FC02 capacity 4000l flow rate 120l/h operation p max 8.6bar operation pressure max 25-120psi water temperature 40-100°C ø 57mm H 250mm for filter head AP2		

miscellaneous

connection heads



1

<b>GEV No.</b>	530079	<b>Ref. No.</b>	CF1
<b>description</b>	filter head		

filters



1

<b>GEV No.</b>	530077	<b>Ref. No.</b>	CFC01
<b>description</b>	water filter flow rate 2l/min operation p max 7bar water temperature 38°C ø 67mm H 230mm		

measuring equipment

thermometers

built-in thermometers

ø60mm



1

<b>GEV No.</b>	542345	<b>Ref. No.</b>	DT5
<b>description</b>	thermometer mounting ø 60mm t.max. 500°C 0 up to +500°C probe ø 8mm probe L 101mm capillary pipe 1070mm		

fastening material

washers

washers

miscellaneous



1

<b>GEV No.</b>	560401	<b>Ref. No.</b>	CO113
<b>description</b>	plain washer ID ø 5mm ED ø 8mm thickness 1mm copper Qty 1 pcs		
<b>For models:</b>	CG4, CG6, ECO9, J10, OG7202N, OG7202P, OG7204N, OG7204P, OG7208N, OG7208P		

consumables

fuses

fine fuses

ø6.3x32mm 250V



1

<b>GEV No.</b>	358792	<b>Ref. No.</b>	OFU02
<b>description</b>	fine fuse size ø6.3x32mm 10A slow-acting rated 250V Qty 10 pcs		



1

<b>GEV No.</b>	358791	<b>Ref. No.</b>	OFU01
<b>description</b>	fine fuse size ø6.3x32mm 6.3A slow-acting rated 250V Qty 10 pcs		

Зип.Общепит  
vsezip.ru  
+7(812)987-08-81

Зип Общепит

G

vsezip.ru

+7(812)987-08-81

**A**

alarm devices	30
appliance hose reels	82
axial fans	40

**B**

ball valves	84
bar burners	62
bi-metal thermostats	14, 14
bottom heaters	10

**C**

cables	46
cam switches	24
castors and bumper angles	74
ceramic burners	63
compressors	40
condensators & interference suppression filters	46
connection cables	47
consumables	86
contactors	30
control thermostats	14
cooling fans	42
cross flow fans	42

**D**

door gaskets (wire reinforced)	78
door seals	77
door seals with fixing hook	78
drain pumps	45

**E**

earthing cables	47
electric accessories	46
electrodes	38
electronic controllers	33
energy regulators	13
evaporators	81

**F**

fans	40
fastening material	86
filter driers	81
filters	46
fine fuses	86
float switches	24
flow sensors	39
fluorescent lamps	28, 28
forced air burners	63
formed hoses	83
fuses	46, 86

gas ball valves

65

gas burners

62

gas control valves

52

gas nozzles

63

gas pressure regulators

65

gas taps

48

gas thermostats

49

gaskets for heated units

77

gaskets for tray rack trolleys

79

**H**

halogen lamp	27
heating elements	3
heating elements for bain maries	3
heating elements for contact grills	7
heating elements for convection	11
heating elements for fryers	3
heating elements for griddles	6
heating elements for heated cabinets	9
heating elements for large hobs	7
heating elements for ovens	3
heating elements for pizza ovens	8
heating elements for salamanders/toasters	8
hob burners	62
hose connectors	84
hose reels	82
hoses	83
hot air fans	43
hot air motors	42
hot plates	13

**I**

ignition boxes	53
ignition cables	58
ignition switches	59
immersion heating elements	10
indicator lights	26
indicator lights (complete)	26
industrial hoses	83
infrared lamps	27

**L**

lamp accessories	30
lamps	26
light bulbs	27
linear lamps	27

**M**

magnetic switches	25
measuring equipment	86
microswitches	23

87

microwave lamps	28	transformers	32
miscellaneous	47		
motors	44		
<b>O</b>			
O-rings	79		
oven lamps	28	valves and tank inlets	84
<b>P</b>			
piezoelectric igniters	58	wash and rinse pumps	45
pilot burners	53	washers	86
power supply cables	46	water filters	85
pressure switches	38		
probes	33		
protection hoses	47		
pumps	45		
push/momentary push switches	23		
PVC supply hoses	83		
<b>Q</b>			
quartz heating elements	10		
<b>R</b>			
radial fans	44		
radiation heaters	13		
refrigeration cycle components	81		
refrigeration fans	42		
refrigeration motors universal	42		
relays	32		
rocker/momentary rocker switches	22		
<b>S</b>			
safety bi-metal thermostats	14		
safety thermostats	18		
Schrader valves	81		
sealing cords	79		
shaft gaskets	79		
shut-off valves	85		
silicone cable	47		
silicone hoses	83		
solenoid valves	36		
solid state relays	32		
spiral cables	47		
spray guns	82		
spray guns with external thread	82		
starter	28		
supply hoses	83		
switches and momentary switches	22		
<b>T</b>			
terminals	47		
thermocouples	59		
thermostats	14		