



Зип Общепит

vsezip.ru

+7(812)987-08-81



GAS COMPONENTS



ELECTRIC COMPONENTS



WATER TECHNOLOGY



MECHANICAL COMPONENTS



TOOLS

Spare parts suitable for

LINCAT

Find the complete and up-to-date range of products in our GEV Webshop

Зип Общепит

vsezip.ru

+7(812)987-08-81

Manufacturer catalogue

The most important spare parts and accessories arranged clearly for every manufacturer



Complete product range and all appliance data always up to date in the GEV Webshop







Alphabetical Index at the end of the catalogue

GEV Webshop

www.gev-online.co.uk

www.gev-online.com



-  Add to Favourites
-  Sign In with email address and usual password
-  Easy-order – place several items in your basket at the same time
-  Quick Item search – no login needed



heating elements

heating elements for ovens

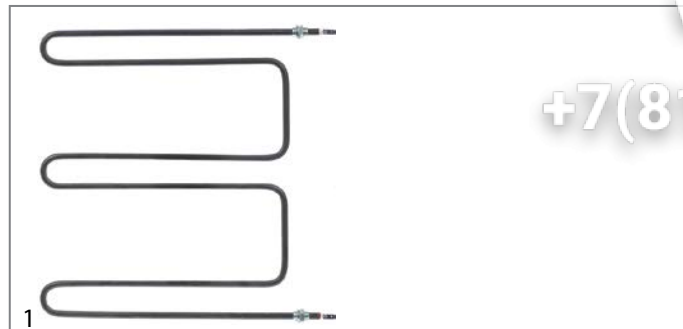

GEV No.	420569	Ref. No.	EL31
description	heating element 1000W 240V heating circuits 1 L 360mm thread M12x1 tube ø 8.5mm connection male faston 6.3mm W 355mm		

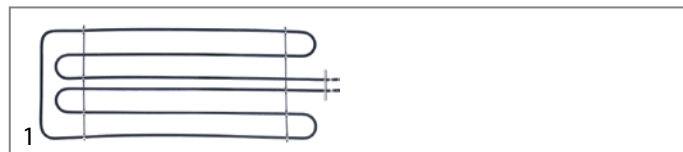

GEV No.	419278	Ref. No.	EL190
description	heating element 1400W 240V heating circuits 1 L 618mm W 235mm L1 602mm L2 16mm W1 102mm W2 30mm flange length 70mm flange width 22.5mm hole distance 55mm bridge length 250mm hole ø 5mm tube ø 6.3mm connection 6.3x0.8 mounting pos. lower		
For models:	ECO9		

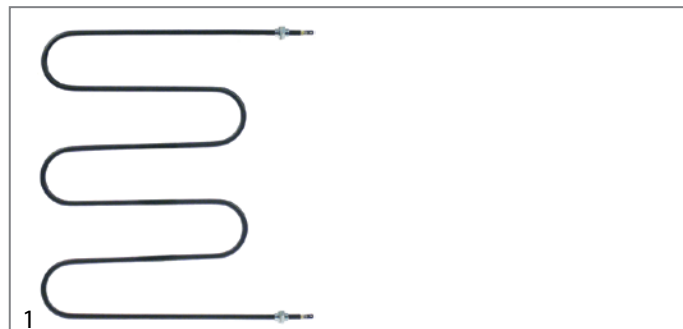

GEV No.	417758	Ref. No.	EL30
description	heating element 2000W 240V heating circuits 1 L 355mm thread 1/4" W 430mm tube ø 8.5mm mounting distance 420mm bridge length-mm connection male faston 6.3mm 2 hole fixing		

heating elements for bain maries

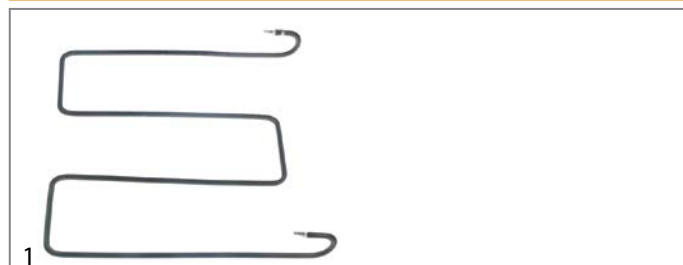

GEV No.	418975	Ref. No.	EL152
description	heating element 2000W 230V heating circuits 1 L 400mm L1 50mm W 505mm connection plug connection ø6.5mm tube ø 8.5mm dry heating element H 50mm		
For models:	BM6W, BM7W, BS7W		

Зип Общепит

vsezip.ru

+7(812)987-08-81

GEV No.	418992	Ref. No.	EL19-CS6
description	heating element 750W 240V heating circuits 1 L 353mm W 245mm connection male faston 6.3mm tube ø 8.5mm thread M12x1 mounting distance 236.5mm		

GEV No.	420470	Ref. No.	EL19/UL
description	heating element 750W 240V heating circuits 1 L 910mm connection male faston 6.3mm to be bend tube ø 8.5mm 2 hole fixing thread M12x1 dry heating element		
For models:	GBM2		

heating elements for fryers



GEV No.	420000	Ref. No.	EL209
description	heating element 6000W 230V heating circuits 2 L 315mm W 350mm H 174mm rectangular flange connection male faston 6.3mm immersion heater W2 164mm hole distance 181mm hole ø 4mm flange length 185mm flange width 34mm tube ø 8.6mm		
For models:	DF46		

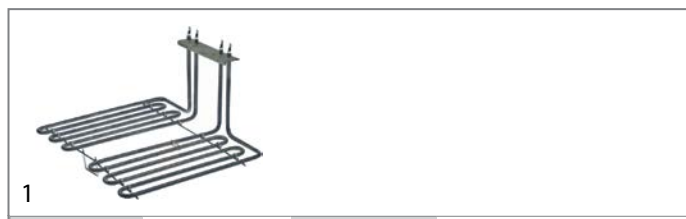

GEV No.	420587	Ref. No.	EL211
description	heating element 6000W 230V heating circuits 2 L 317mm W 410mm H 165mm rectangular flange connection male faston 6.3mm hole ø 4mm flange length 185mm flange width 35mm tube ø 8.5mm		
For models:	DF66ST		

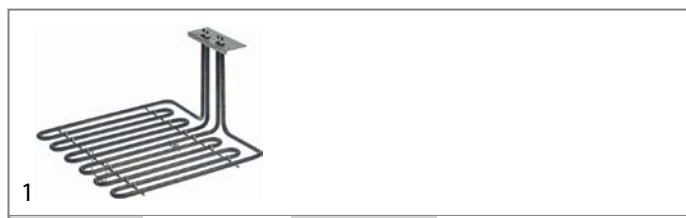

GEV No.	419266	Ref. No.	EL266
description	heating element 6000W 230V heating circuits 2 L 325mm W 350mm H 190mm rectangular flange connection male faston 6.3mm flange length 145mm flange width 48mm tube ø 8.5mm		



Зип Общепит

vsezip.ru

+7(812)987-08-81

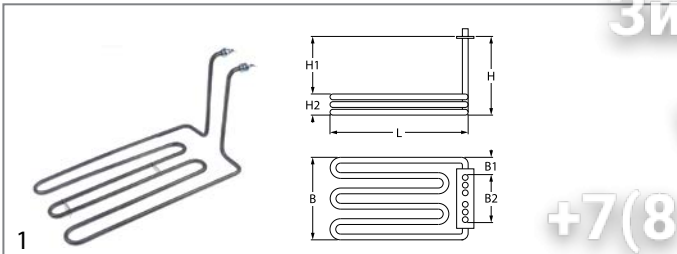

GEV No.	418989	Ref. No.	EL13
description	heating element 3000W 230V heating circuits 1 L 390mm W 195mm H 190mm 2 hole fixing connection male faston 6.3mm immersion heater L1 30mm L2 360mm W1 70mm W2 55mm tube \varnothing 8.6mm thread M12x1 mounting distance 46mm windings 3		

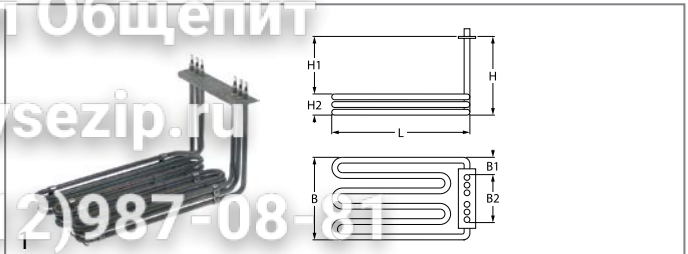

GEV No.	419282	Ref. No.	EL200
description	heating element 9000W 230V heating circuits 3 L 325mm W 170mm H 163mm rectangular flange connection F6.3x0.8 fryer heaters W2 162mm H1 135mm H2 35mm hole \varnothing 4mm flange length 185mm flange width 34mm tube \varnothing 8.5mm		
For models:	DF39, DF618, J18, J9		

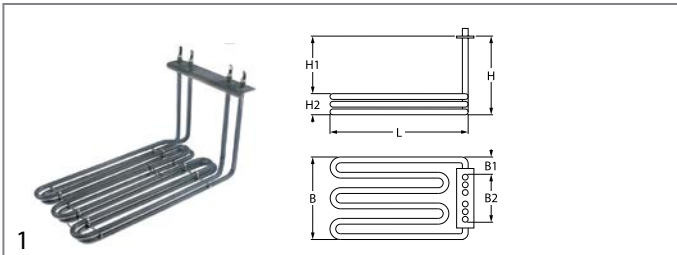

GEV No.	418990	Ref. No.	EL198
description	heating element 6000W 230V heating circuits 2 L 325mm W 163mm H 170mm immersion heater H1 148mm H2 22mm hole distance 77mm hole \varnothing 4mm flange length 185mm flange width 34mm tube \varnothing 8.6mm		
For models:	DF36, DF612, J12, J6		

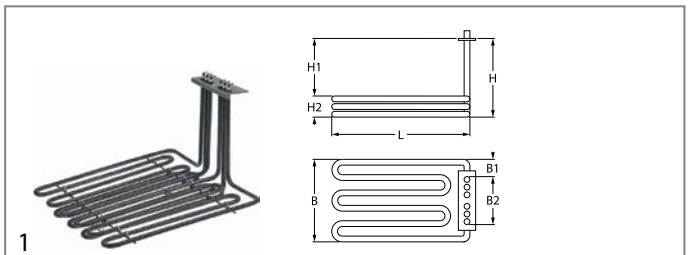

GEV No.	419265	Ref. No.	EL267
description	heating element 9000W 230V heating circuits 3 L 325mm W 350mm H 195mm rectangular flange connection male faston 6.3mm H1 175mm H2 20mm flange length 145mm flange width 48mm tube \varnothing 8.5mm		

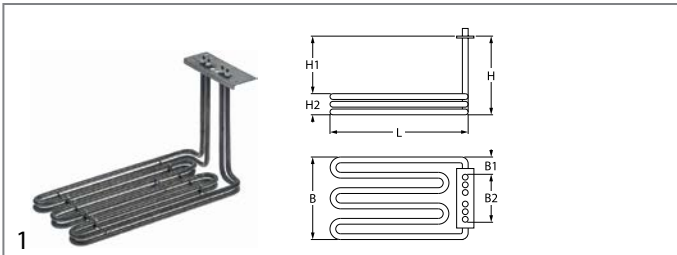

GEV No.	419263	Ref. No.	EL265
description	heating element 6000W 230V heating circuits 2 L 325mm W 165mm H 190mm rectangular flange connection male faston 6.3mm H1 170mm H2 20mm flange length 145mm flange width 48mm tube \varnothing 8.5mm		

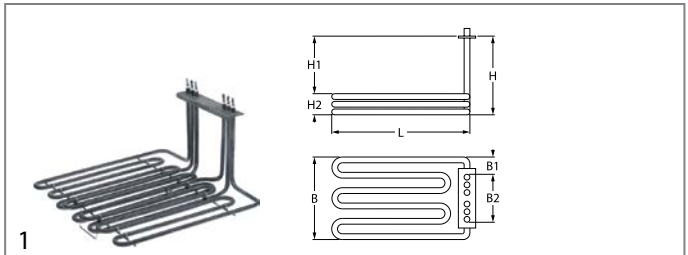

GEV No.	419267	Ref. No.	EL210
description	heating element 9000W 230V heating circuits 3 L 325mm W 350mm H 220mm rectangular flange connection male faston 6.3mm W1 95mm W2 163mm H1 146mm H2 23mm hole \varnothing 4mm flange length 185mm flange width 34mm tube \varnothing 8.5mm		
For models:	DF49		

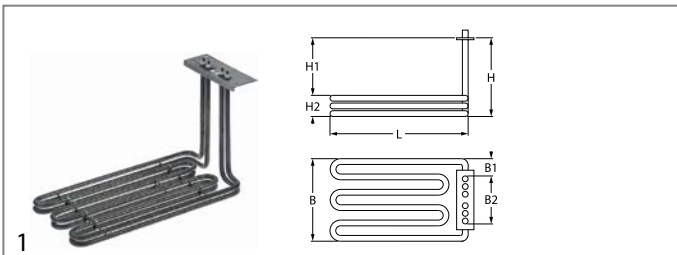

GEV No.	419264	Ref. No.	EL268
description	heating element 6000W 230V heating circuits 2 L 325mm W 165mm H 190mm rectangular flange connection male faston 6.3mm H1 170mm H2 20mm flange length 145mm flange width 48mm tube \varnothing 8.5mm		



GEV No.	418974	Ref. No.	EL197
description	heating element 3000W 230V heating circuits 1 L 320mm W 170mm H 165mm rectangular flange fryer flange length 185mm flange width 35mm tube \varnothing 8.5mm		
For models:	DF33, DF66		



Зип Общепит

vsezip.ru

+7(812)987-0881



1

GEV No.	419260	Ref. No.	EL264
description	heating element 3000W 230V heating circuits 1 L 320mm W 170mm H 190mm rectangular flange connection male faston 6.3mm fryer flange length 145mm flange width 48mm tube ø 8.5mm		



1

GEV No.	419262	Ref. No.	EL269
description	heating element 3000W 230V heating circuits 1 L 325mm W 160mm H 185mm rectangular flange connection male faston 6.3mm fryer flange length 145mm flange width 48mm tube ø 8.5mm		

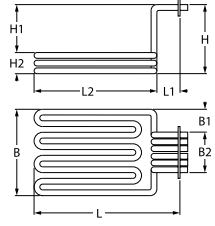
1

GEV No.	418965	Ref. No.	EL88
description	heating element 6000W 240V heating circuits 2 L 360mm W 160mm H 213mm L1 30mm L2 320mm W1 55mm W2 50mm H1 195mm H2 20mm windings 3 flange length 100mm flange width 25mm hole distance 90mm hole ø 6mm connection male faston 6.3mm tube ø 8mm for fryer		

2 hole fixing

1

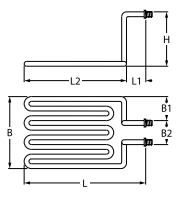
GEV No.	417760	Ref. No.	EL229
description	heating element 2500W 230V heating circuits 1 L 280mm W 125mm H 152mm 2 hole fixing connection male faston 6.3mm L1 55mm L2 250mm W1 40mm W2 33mm tube ø 8.5mm thread M12x1 mounting distance 25mm windings 3		

1

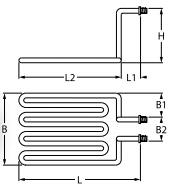
GEV No.	420588	Ref. No.	EL228
description	heating element 3000W 230V L 245mm W 180mm H 155mm screw mounting connection male faston 6.3mm L1 20mm L2 225mm W1 65mm W2 33mm tube ø 8.5mm thread M12 suitable for fryer		
For models:	LDF, LDF2, LFF		

1

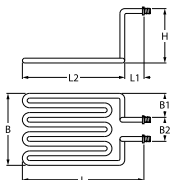
GEV No.	418973	Ref. No.	EL10 EL10/UL
description	heating element 3000W 240V heating circuits 1 L 220mm W 210mm H 175mm 2 hole fixing connection male faston 6.3mm fryer heaters L1 20mm L2 200mm W1 85mm W2 40mm tube ø 8.5mm thread M12x1 mounting distance 32mm connection length 2mm windings 5		

6 hole fixing



1

GEV No.	417759	Ref. No.	EL185
description	heating element 11000W 230V heating circuits 3 L 370mm W 213mm H 222mm H1 180mm H2 32mm thread M12x1 tube ø 8.5mm screw mounting connection M4 fryer		



1

GEV No.	417749	Ref. No.	EL220
description	heating element 12000W 230V heating circuits 3 L 370mm W 213mm H 222mm H1 180mm H2 32mm thread M12x1 tube ø 8.5mm connection M4 screw mounting fryer		
For models:	OE7112, OE7113		





Зип Общепит

vsezip.ru

+7(812)987-08-81

			
1			
GEV No.	417754	Ref. No.	EL189
description	heating element 12000W 230V heating circuits 3 L 370mm W 257mm H 225mm H2 32mm thread M12x1 tube ø 8.5mm screw mounting connection M4 fryer		
For models:	OE7104		

			
1			
GEV No.	417755	Ref. No.	EL180
description	heating element 7000W 230V heating circuits 3 L 345mm W 112mm H 220mm H2 32mm thread M12x1 tube ø 8.5mm screw mounting connection M4 fryer		
For models:	OE7105		

			
1			
GEV No.	420570	Ref. No.	EL310
description	heating element 2000W 230V heating circuits 1 L 405mm W 85mm H 80mm thread M4 tube ø 8.5mm		

heating elements for griddles

			
1			
GEV No.	420589	Ref. No.	EL273
description	heating element 11200W 230V heating circuits 3 L 515mm W 535mm H 150mm tube ø 8.5mm connection M5 flange 145x48mm		

			
1			
GEV No.	420566	Ref. No.	EL104
description	heating element 2000W 240V heating circuits 1 L 330mm W 185mm H 50mm tube ø 8.5mm		
For models:	GS3, GS6T		

			
1			
GEV No.	420567	Ref. No.	EL105
description	heating element 2700W 240V heating circuits 1 L 325mm W 350mm H 50mm tube ø 8.5mm		
For models:	GS4		

			
1			
GEV No.	417746	Ref. No.	EL155
description	heating element 2800W 230V heating circuits 1 L 330mm W 180mm H 55mm tube ø 8.5mm		
For models:	GS6TE, GS9		

			
1			
GEV No.	420563	Ref. No.	EL108
description	heating element 3000W 240V L 330mm W 310mm H 55mm connection male faston 6.3mm tube ø 8.5mm heating circuits 1		
For models:	GS7, GS7E, GS9		

			
1			
GEV No.	420564	Ref. No.	EL106
description	heating element 3000W 240V L 340mm W 500mm H 70mm W2 45mm connection male faston 6.3mm tube ø 8.5mm heating circuits 1		
For models:	GS6		



Зип Общепит

vsezip.ru

+7(812)987-08-81



1

GEV No.	417751	Ref. No.	EL202
description	heating element 3500W 230V heating circuits 1 L 405mm W 188mm H 60mm tube ø 8.5mm griddle connection type grip connection		
For models:	OE7206, OE7209		



1

GEV No.	420573	Ref. No.	EL313
description	heating element 6400W 230V heating circuits 3 L 515mm W 535mm H 140mm tube ø 8.5mm connection M5		



1

GEV No.	417753	Ref. No.	EL201
description	heating element 4000W 230V heating circuits 1 L 400mm W 190mm H 60mm tube ø 8.5mm griddle connection type grip connection		
For models:	OE7206, OE7209		



1

GEV No.	420574	Ref. No.	EL270
description	heating element 8000W 230V heating circuits 3 L 415mm W 465mm H 150mm tube ø 8.5mm		



1

GEV No.	420565	Ref. No.	EL107
description	heating element 4500W 230V heating circuits 1 L 325mm W 500mm H 60mm tube ø 8.5mm		



1

GEV No.	420590	Ref. No.	EL272
description	heating element 8250W 230V heating circuits 3 L 515mm W 395mm H 150mm tube ø 8.5mm connection M5 flange 145x48mm		

heating elements for large hobs



1

GEV No.	420591	Ref. No.	EL276
description	heating element 5333W 230V heating circuits 2 L 420mm W 290mm H 150mm tube ø 8.5mm connection male faston 6.3mm flange 145x48mm		



1

GEV No.	420571	Ref. No.	EL306
description	heating element 2150W 400V heating circuits 1 L 430mm W 260mm H 100mm connection cable tube ø 13x6mm cable length 700mm dry heating element		

heating elements for contact grills



1

GEV No.	420572	Ref. No.	EL314
description	heating element 6200W 230V heating circuits 3 L 515mm W 395mm H 125mm tube ø 8.5mm connection M5		

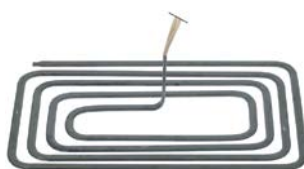

1

GEV No.	419279	Ref. No.	EL280
description	heating element 4300W heating circuits 1 L 450mm W 280mm cable length 700mm connection 2-wire		
For models:	OE7210		



heating elements for pizza ovens

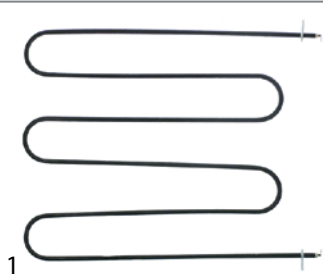

GEV No.	419276	Ref. No.	EL258
description	heating element 1000W 230V heating circuits 1 L 502mm W 185mm lug length 40mm lug width 18mm hole distance 210mm connection 6.3x0.8 tube ø 8.5mm mounting pos. upper hole ø 5mm pizza oven		

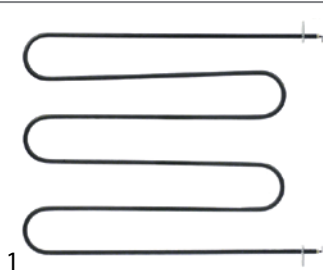

GEV No.	417757	Ref. No.	EL177
description	heating element 1100W 230V heating circuits 1 L 510mm W 400mm lug length 40mm lug width 18mm connection male faston 6.3mm tube ø 8.5mm bracket mounting mounting pos. lower hole ø 5mm pizza oven		

accessories for	417757			
	GEV No.	417756	Ref. No.	EL176
	heating element 1750W 230V heating circuits 1 L 510mm W 410mm lug length 40mm lug width 18mm connection male faston 6.3mm tube ø 8.5mm bracket mounting mounting pos. upper hole ø 5mm pizza oven			

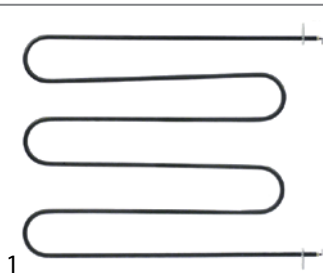

GEV No.	417756	Ref. No.	EL176
description	heating element 1750W 230V heating circuits 1 L 510mm W 410mm lug length 40mm lug width 18mm connection male faston 6.3mm tube ø 8.5mm bracket mounting mounting pos. upper hole ø 5mm pizza oven		

accessories for	417756			
	GEV No.	417757	Ref. No.	EL177
	heating element 1100W 230V heating circuits 1 L 510mm W 400mm lug length 40mm lug width 18mm connection male faston 6.3mm tube ø 8.5mm bracket mounting mounting pos. lower hole ø 5mm pizza oven			

Зип Общепит

vsezip.ru

+7(812)987-08-81



GEV No.	419277	Ref. No.	EL259
description	heating element 950W 230V heating circuits 1 L 506mm W 440mm lug length 40mm lug width 18mm hole distance 460mm connection 6.3x0.8 tube ø 8.5mm mounting pos. lower hole ø 5mm pizza oven		

heating elements for salamanders/toast-



GEV No.	418963	Ref. No.	EL128
description	heating element 1100W 240V L 250mm W 95mm tube ø 6.3mm with strap connection male faston 6.3mm		



GEV No.	418964	Ref. No.	EL145
description	heating element 1300W 240V L 250mm W 95mm tube ø 6.3mm with strap connection male faston 6.3mm		

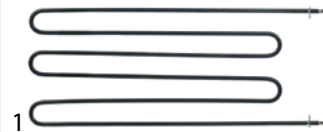

GEV No.	417752	Ref. No.	EL223
description	heating element 2750W 230V L 530mm W 220mm tube ø 8.5mm bracket mounting connection grip connection hole ø 4.3mm mounting distance 189mm heating circuits 1 lug length 25mm lug width 15mm suitable for salamander grill		
For models:	OE7304		

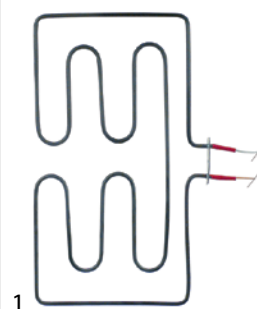

GEV No.	418967	Ref. No.	EL50
description	heating element 2800W 240V heating circuits 1 L 275mm W 447mm flange length 72mm flange width 19mm tube ø 6.3mm for salamander grill cable length 800mm hole ø 8mm		
For models:	AS3, LGT		



Зип Общепит

vsezip.ru

+7(812)987-08-81

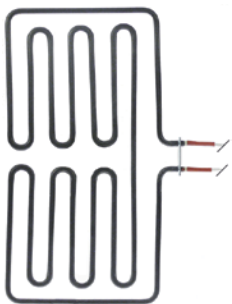

1

GEV No.	419283	Ref. No.	EL237
description	heating element 4500W 240V heating circuits 1 L 265mm W 460mm flange length 60mm flange width 20mm tube ø 8.5mm salamander grill cable length 1000mm		
For models:	AS4		



1

GEV No.	418993	Ref. No.	EL19-CS4
description	heating element 750W 240V L 330mm W 285mm thread M12x1 mounting distance 276.5mm connection male faston 6.3mm tube ø 8.5mm heating circuits 1 dry heating element for toaster		



1

GEV No.	417750	Ref. No.	EL203
description	heating element 3400W 230V heating circuits 1 L 335mm W 305mm H 45mm tube ø 8.5mm connection male faston 6.3mm for salamander grill		
For models:	OE7303		

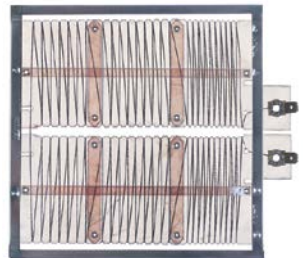

1

GEV No.	418979	Ref. No.	EL151
description	hot plate 370W 240V heating circuits 1 L 145mm W 145mm toaster connection male faston 6.3mm		

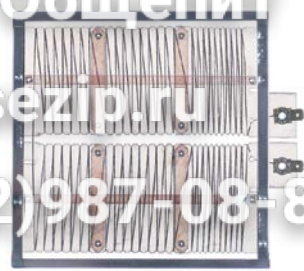

1

GEV No.	418980	Ref. No.	EL150
description	hot plate 475W 240V heating circuits 1 L 145mm W 145mm toaster connection male faston 6.3mm		

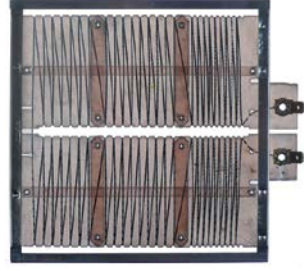



1

GEV No.	418991	Ref. No.	EL183
description	hot plate 500W 230V heating circuits 1 L 145mm W 145mm connection male faston 6.3mm		



1

GEV No.	416001	Ref. No.	EL309	
description	radiation heater rectangular 1500W 230/240V L 265mm W 165mm H 32mm heating circuits 1 connections 2 connection type cable cable length 700mm EGO salamander grill			
accessories for	416001			
	GEV No.	390880	Ref. No.	—
	safety rod thermostat switch-off temp. 780°C temperature range°C 2-pole 1NC/1NOA probe ø 4mm probe L 170mm capillary pipemm capillary pipe isolatedmm gland nut shaft ømm			
	GEV No.	403523	Ref. No.	—
	solid state relay ANLY 1 phase 40A 24-280V 4-32VDC L 47.5mm W 43mm screw type ASR-40DA			

heating elements for heated cabinets



1

GEV No.	418978	Ref. No.	EL01 EL01+LN04
description	heating element 3000W 240V heating circuits 1 L 150mm W 225mm H 35mm connection length 15mm connection male faston 6.3mm vertical tube ø 8.6mm water boiler with safety thermostat		
For models:	OE7503		



bottom heaters



GEV No.	418994	Ref. No.	EL208
description	bottom heater 3000W 230V heating circuits 2 ø 196mm safety thermostat 250°C M5 mounting distance 180mm		

quartz heating elements



GEV No.	418968	Ref. No.	EL26
description	quartz heating element 500W 240V L 460mm ø 9mm for salamander grill		
For models:	LPC, LSC		

immersion heating elements

with compression flange 50 x 26mm



GEV No.	419280	Ref. No.	EB3F EL238 EL235
description	heating element 3000W 230V heating circuits 1 flange 50x26mm L 145mm W 225mm mounting distance 25mm connection male faston 6.3mm tube ø 8.5mm for Water boiler		



GEV No.	419273	Ref. No.	EL297
description	heating element 3000W 230V heating circuits 1 flange 50x26mm L 190mm W 165mm mounting distance 24.5mm connection male faston 6.3mm tube ø 8.5mm for Water boiler		

Зип Общепит

vsezip.ru

+7(812)987-08-81

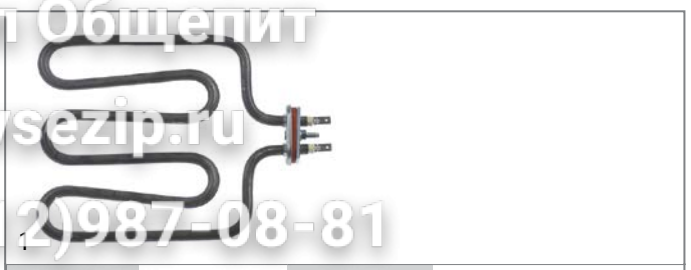

GEV No.	418966	Ref. No.	EL178
description	heating element 3000W 240V heating circuits 1 flange 50x26mm L 200mm W 170mm L1 30mm L2 170mm W1 137mm W2 33mm mounting distance 24.5mm connection male faston 6.3mm tube ø 8.5mm water boiler		
For models:	EB3, EB4, EB6, EB6T		



GEV No.	419272	Ref. No.	EL298
description	heating element 4500W 230V heating circuits 1 flange 50x26mm L 190mm W 160mm mounting distance 24.5mm connection male faston 6.3mm tube ø 8.5mm for Water boiler		



GEV No.	418977	Ref. No.	EL179
description	heating element 4500W 240V heating circuits 1 flange 50x26mm L 200mm W 170mm connection male faston 6.3mm tube ø 8.5mm water boiler		
For models:	EB4		



GEV No.	419274	Ref. No.	EL299
description	heating element 1450W 230V heating circuits 1 flange 50x26mm L 150mm W 33mm H 72mm mounting distance 23mm connection male faston 6.3mm tube ø 8.5mm for Water boiler		



GEV No.	419275	Ref. No.	EL277
description	heating element 3000W 230V heating circuits 1 flange 50x26mm L 150mm W 33mm L1 70mm mounting distance 25mm connection male faston 6.3mm tube ø 8.5mm for Water boiler		



Зип Общепит

vsezip.ru

+7(812)987-08-81

special flanges



1

GEV No.	420519	Ref. No.	OEL32
description	heating element 18000W 230/400V heating circuits 1 L 188mm W 66mm flange length 123mm flange width 102mm connection cable included cable length 850mm boiler		

miscellaneous



1

GEV No.	418370	Ref. No.	OEL18
description	heating element 18000W 230V heating circuits 6 L 194mm W 87mm H 68mm hole distance 50mm hole ø 8mm number of thermostat sleeves 2 thermostat sleeves ø 6/2mm length thermostat sleeves 142/105mm thermostat sleeve clinging cable length 730mm immersion heater 10 hole flange		
accessories for	418370		
	GEV No.	379078	Ref. No. —
	temperature probe thermocouple K (NiCr-Ni) cable silicone probe -50 up to 1150°C cable -50 up to +180°C connection 2-wire thread probe ø1.5x100mm cable length 1.8m		
	GEV No.	550894	Ref. No. OGA14
	gasket L 122mm W 101mm thickness 4mm for heating element suitable for RATIONAL equiv. no. 4400279		



1

GEV No.	418369	Ref. No.	OEL17
description	heating element 9000W 230V heating circuits 3 L 192mm W 39mm H 68mm hole distance 90mm hole ø 8mm thermostat sleeves ø 2.5/6.5mm length thermostat sleeves 155mm number of thermostat sleeves 2 thermostat sleeve eccentric, clinging flange length 82mm flange width 82mm tube ø 6.5mm cable length 200mm immersion heater 5 hole flange		
accessories for	418369		
	GEV No.	379078	Ref. No. —
	temperature probe thermocouple K (NiCr-Ni) cable silicone probe -50 up to 1150°C cable -50 up to +180°C connection 2-wire thread probe ø1.5x100mm cable length 1.8m		
	GEV No.	550893	Ref. No. OGA15
	gasket L 81mm W 81mm hole distance 65mm thickness 4mm for heating element suitable for RATIONAL equiv. no. 4400280		



1

GEV No.	415550	Ref. No.	OEL02
description	heating element 9000W 230V heating circuits 3 L 205mm W 38mm H 70mm number of thermostat sleeves 1 thermostat sleeves ø 2.5mm length thermostat sleeves 120mm thermostat sleeve eccentric, clinging tube ø 6.3mm hole distance 64mm hole ø 8mm connection male faston 6.3mm 4 hole flange immersion heater flange width 82mm flange length 82mm		
accessories for	415550		
	GEV No.	379078	Ref. No. —
	temperature probe thermocouple K (NiCr-Ni) cable silicone probe -50 up to 1150°C cable -50 up to +180°C connection 2-wire thread probe ø1.5x100mm cable length 1.8m		
	GEV No.	510565	Ref. No. —
	gasket rubber L 82mm W 82mm thickness 4mm hole ø 9mm hole distance 64mm for heating element suitable for RATIONAL 4 holes		



1

GEV No.	417646	Ref. No.	OEL10 OEL34
description	heating element 9000W 400V L 195mm W 40mm H 80mm number of thermostat sleeves 1 thermostat sleeves ø 6mm length thermostat sleeves 132mm tube ø 6mm hole distance 61mm hole ø 7.5mm cable length 60mm combi-steamer flange width 82mm flange length 82mm with gasket with thermowell		

heating elements for convection



1

GEV No.	418376	Ref. No.	OEL23
description	heating element 18000W 230V heating circuits 3 ID ø 410mm ED ø 477mm L 477mm H 110mm W1 110mm H1 20mm H2 90mm flange length 140mm flange width 62mm hole distance 64mm connection cable connection length 70mm tube ø 6.3mm convection heating element		
accessories for	418376		
	GEV No.	550696	Ref. No. OGA36
	gasket L 140mm W 62mm hole ø 5mm hole distance 56mm 6 holes thickness 2mm for heating element suitable for RATIONAL equiv. no. 4000332		



Зип Общепит

vsezip.ru

+7(812)987-08-81



1

GEV No.	418382	Ref. No.	OEL24
description	heating element 18000W 230V heating circuits 6 ID ϕ 407mm ED ϕ 485mm L 485mm H 106mm W1 111mm H1 11mm H2 85mm flange length 140mm flange width 72mm hole distance 128mm connection cable connection length 98mm tube ϕ 6.6mm cable length 600mm convection heating element hole ϕ 5mm rectangular flange L1 485mm		



1

GEV No.	417761	Ref. No.	EL248
description	heating element 3000W 230V heating circuits 3 ID ϕ 206mm ED ϕ 245mm L 290mm H 44mm L1 40mm W1 97mm H1 8mm H2 37mm flange length 110mm flange width 20mm hole distance 35mm connection male faston 6.3mm tube ϕ 6.3mm convection heating element hole ϕ 6.5mm rectangular flange		



1

GEV No.	420592	Ref. No.	EL232
description	heating element 2500W 230V heating circuits 1 ID ϕ 175mm ED ϕ 195mm L 245mm H 35mm L1 45mm W1 30mm H2 27mm flange length 70mm flange width 22mm hole distance 56mm connection male faston 6.3mm tube ϕ 6.5mm convection heating element hole ϕ 5mm		
For models:	ECO8, LCO		





1

GEV No.	419255	Ref. No.	EL103
description	heating element 3000W 240V heating circuits 1 ID ϕ 330mm ED ϕ 365mm L 390mm H 90mm L1 22mm H1 60mm H2 40mm flange length 75mm flange width 30mm hole distance 35mm connection male faston 6.3mm tube ϕ 8.5mm		
For models:	ECO7, V6, V6D, V6F, V7		



1

GEV No.	418385	Ref. No.	OEL25	
description	heating element 30000W 230V heating circuits 6 ID ϕ 573mm ED ϕ 630mm L 655mm H 120mm W1 135mm H1 15mm H2 110mm flange length 160mm flange width 75mm hole distance 74mm connection cable connection length 95mm tube ϕ 8.5mm cable length 600mm convection heating element hole ϕ 6mm rectangular flange L1 8mm			
accessories for	418385			
	GEV No.	560611	Ref. No.	—
	gasket L 160mm W 75mm for heating element thickness 2mm hole distance 74mm SCC Linie 102/202			



1

GEV No.	419259	Ref. No.	EL295
description	heating element 4000W 230V heating circuits 3 ID ϕ 210mm ED ϕ 245mm L 290mm H 90mm L1 45mm W1 95mm H1 40mm H2 50mm flange length 110mm flange width 20mm hole distance 35mm connection male faston 6.3mm tube ϕ 6.5mm hole ϕ 6mm		



1

GEV No.	418995	Ref. No.	EL141
description	heating element 3000W 230V heating circuits 1 ID ϕ 193mm ED ϕ 205mm L 225mm H 35mm L1 15mm W1 30mm H1 8mm H2 28mm flange length 70mm flange width 22.5mm hole distance 56mm connection male faston 6.3mm vertical tube ϕ 6.3mm		
For models:	ECO9, OE7008		



1

GEV No.	419253	Ref. No.	EL110
description	heating element 4000W 240V heating circuits 1 ID ϕ 340mm ED ϕ 360mm L 395mm H 40mm L1 48mm H1 25mm H2 28mm flange length 75mm flange width 32mm hole distance 35mm connection male faston 6.3mm vertical tube ϕ 8.5mm		



Зип Общепит

vsezip.ru

+7(812)987-08-81



GEV No.	418377	Ref. No.	OEL35
description	heating element 6000W 230V heating circuits 3 ID ø 404mm ED ø 420mm L 440mm H 107mm W1 112mm H1 20mm H2 84mm flange length 140mm flange width 61mm hole distance 65mm connection cable tube ø 6.5mm cable length 300mm convection heating element hole ø 5.5mm rectangular flange L1 7mm		

round

with radiused edge



for domestic and commercial kitchens



GEV No.	490183	Ref. No.	HO11
description	hot plate ø 180mm 1500W 240V connection 4 screw clamps with 8mm spill ring		
For models:	ESLR9, HT3, HT6, HT7, LBR2		

radiation heaters



GEV No.	416001	Ref. No.	EL309
description	radiation heater rectangular 1500W 230/240V L 265mm W 165mm H 32mm heating circuits 1 connections 2 connection type cable cable length 700mm EGO salamander grill		
accessories for	416001		
	GEV No.	390880	Ref. No. —
	safety rod thermostat switch-off temp. 780°C temperature range°C 2-pole 1NC/1NOA probe ø 4mm probe L 170mm capillary pipemm capillary pipe isolatedmm gland nut shaft ømm		
	GEV No.	403523	Ref. No. —
	solid state relay ANLY 1 phase 40A 24-280V 4-32VDC L 47.5mm W 43mm screw type ASR-40DA		



GEV No.	490184	Ref. No.	HO10
description	hot plate ø 180mm 2000W 240V connection 4 screw clamps with 8mm spill ring		
For models:	ESLR9, HT6, HT7, LBR		



GEV No.	490223	Ref. No.	EL290
description	hot plate ø 220mm 2600W 230V connection 4 screw clamps with 8mm spill ring		

hot plates

square & rectangular

with radiused edge



GEV No.	490066 ¹	Ref. No.	EL188
description	hot plate dimensions 220x220mm 2600W 230V with spill ring connection 4 screw clamps protector yes square		
For models:	OE7008, OE7010, OE7012		

¹incl. protector

energy regulators

EGO

1-circuit



GEV No.	380019	Ref. No.	EN10
description	energy regulator 240V 13A single-circuit turn direction right shaft ø 6x4.6mm shaft L 23mm mounting thread M4 power release 6-100% no. 50.57071.010		
For models:	BM3, BM4, BM6, BM7, BS3, BS4, BS7, CS4, CS4G, CS6, CT1, ECG6, LBM, LBM2, LBM2W, LBM3, LBMW, LCS, LGT, LPB, LPC, LRB, LRB2W, LRB3, LRBW, LSC, OE7303, OE7304		

electric components

thermostats

bi-metal thermostats

safety bi-metal thermostats



GEV No.	375753	Ref. No.	TH88
description	bi-metal safety thermostat hole distance 23.5mm switch-off temp. 120°C 1NC 1-pole 16A connection F6.3 2 hole fixing		
For models:	EB3F, EB4F, EB6, EB6T		



GEV No.	390461	Ref. No.	TH87
description	bi-metal safety thermostat hole distance 23.8mm switch-off temp. 95°C 1NC 1-pole 16A connection F6.3 2 hole fixing		
For models:	EB3F, EB4F, EB6, EB6T		

accessories for	390461		
	GEV No.	550388	Ref. No.
			—



GEV No.	391026	Ref. No.	TH87/S
description	bi-metal safety thermostat hole distance 30mm switch-off temp. 120°C 1NC 1-pole 16A 250V Qty 1 pcs incl. accessories		



GEV No.	391027	Ref. No.	TH88/S
description	bi-metal safety thermostat hole distance 30mm switch-off temp. 120°C 1NC 1-pole 16A 250V connection F6.3 content with accessories		

bi-metal thermostats



GEV No.	375750	Ref. No.	TH40
description	bi-metal thermostat hole distance 23.8mm switch-off temp. 85°C 1NC 1-pole 16A connection F6.3 2 hole fixing		



GEV No.	390950	Ref. No.	TH76
description	temperature limiter hole distance 23.5mm switch-off temp. 100°C 1NC 10A 240V connection F6.3 2 hole fixing cavity Qty 1 pcs KSD1XT2		

Зип Общепит

vsezip.ru

+7(812)987-08-81



GEV No.	390948	Ref. No.	TH80
description	temperature limiter hole distance 23.5mm switch-off temp. 110°C 1NC 10A 240V connection F6.3 2 hole fixing cavity Qty 1 pcs GKSD201110		
For models:	UM050, UMS050, UMS050D		

control and safety thermostats

EGO

control thermostats

55.10/19_ series



GEV No.	375477	Ref. No.	TH95
description	thermostat t.max. 190°C temperature range 48-190°C 1-pole 1NO 16A probe ø 6mm probe L 107mm capillary pipe 1470mm capillary pipe isolated gland nut M9x1 shaft ø 6x4.6mm shaft L 23mm shaft position upper shaft position lower rotation 270°		
For models:	OG7106		



GEV No.	391025	Ref. No.	TH99
description	thermostat t.max. 200°C temperature range 30-200°C 1-pole 1NO 16A probe ø 6mm probe L 110mm capillary pipe 1460mm gland nut M9x1 shaft ø 6x4.6mm shaft L 26mm shaft position upper		



Зип Общежит

vsezip.ru

+7(812)987-08-81

55.13_series



GEV No.	375086	Ref. No.	OTH09
description	thermostat t.max. 180°C temperature range 60-180°C 1-pole 1CO 16A probe ø 6mm probe L 90mm capillary pipe 2400mm capillary pipe isolated 2300mm gland nut shaft ø 6x4.6mm shaft L 25mm shaft position upper rotation 270° probe material SS		



GEV No.	375484	Ref. No.	TH46
description	thermostat t.max. 260°C temperature range 48-260°C 1-pole NO 16A probe ø 3mm probe L 160mm capillary pipe 1580mm capillary pipe isolatedmm gland nut shaft ø 6x4.6mm shaft L 23mm shaft position upper rotation 270°		
For models:	ECO76, LCG, LCO, LPG, LRG, OE7008, OE7010, UMO50, UMSO50, UMSO50D		



GEV No.	375497	Ref. No.	TH62
description	thermostat t.max. 182°C 1-pole 1NO probe ø 6mm probe L 115mm capillary pipe 900mm capillary pipe isolatedmm gland nut rotation 270° probe thread M9x1 230V		
For models:	OE7104, OE7105		



GEV No.	391028	Ref. No.	TH58
description	thermostat t.max. 400°C temperature range 100-400°C 1-pole 1NO 16A probe ø 4mm probe L 160mm capillary pipe 840mm capillary pipe isolatedmm gland nut shaft ø 6x4.6mm shaft L 26mm shaft position lower		



GEV No.	390910	Ref. No.	TH29
description	thermostat t.max. 190°C temperature range 130-190°C 1-pole 1NOA probe ø 6mm probe L 117mm capillary pipe 890mm capillary pipe isolatedmm gland nut M9x1 shaft ø 6x4.6mm shaft L 25mm shaft position upper rotation 270° probe material SS		



GEV No.	375440	Ref. No.	TH27
description	thermostat t.max. 93°C temperature range 30-93°C 1-pole 1CO 16A probe ø 6mm probe L 98mm capillary pipe 830mm capillary pipe isolatedmm gland nut M9x1 shaft L 23mm shaft position upper rotation 270° probe material SS		
For models:	FWD, FWDG, GBM2, GBM3, KFCWD		

electric components

Зип Общепит

vsezip.ru

+7(812)987-08-81

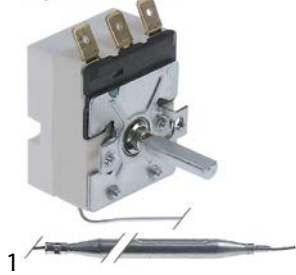

GEV No.	375566	Ref. No.	TH09
description	thermostat t.max. 96°C temperature range 82-96°C 1-pole 1CO 16A probe ø 6mm probe L 147mm capillary pipe 870mm capillary pipe isolatedmm gland nut M9x1 shaft L 23mm shaft position upper rotation 120°		
For models:	EB3, EB4, EB6, EB6T		



GEV No.	375486	Ref. No.	TH69
description	thermostat t.max. 190°C temperature range 130-190°C 1-pole 1NO 16A probe ø 6mm probe L 115mm capillary pipe 1300mm capillary pipe isolatedmm gland nut shaft ø 6x4.6mm shaft L 23mm shaft position° shaft position rotation 270°		
For models:	DF33, DF36, DF39, DF46, DF49, DF612, DF618, DF66, DF66ST, HB2, HB3, HB4, J12, J18, J6, J9, LD2, LD3		

55.14_series

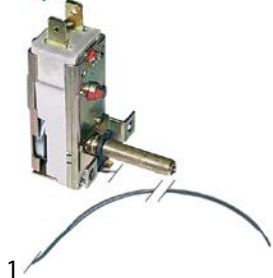

GEV No.	375300	Ref. No.	TH66
description	thermostat t.max. 128°C temperature range 35-128°C 1-pole 1NO 16A probe ø 3.1mm probe L 174mm capillary pipe 880mm capillary pipe isolated 800mm gland nut shaft L 23mm shaft position lower rotation 270°		

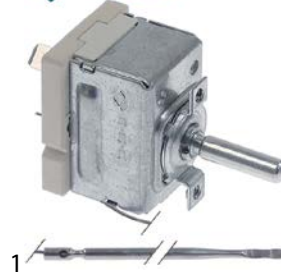

GEV No.	391024	Ref. No.	TH107
description	thermostat t.max. 320°C temperature range 50-320°C 1-pole 1NO 16A probe ø 3.1mm probe L 163mm capillary pipe 880mm capillary pipe isolatedmm gland nut shaft ø 6x4.6mm shaft L 23mm shaft position lower probe material SS		

55.17_series



GEV No.	391011	Ref. No.	TH106 TH106 + GL66
description	thermostat t.max. 103°C temperature range 30-103°C 1-pole 1NO 16A probe ø 6mm probe L 70mm capillary pipe 1450mm capillary pipe isolatedmm gland nut shaft ø 6x4.6mm shaft L 23mm shaft position left		

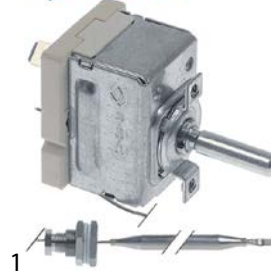

GEV No.	391012	Ref. No.	TH105
description	thermostat t.max. 93°C temperature range 30-93°C 1-pole 1CO 16A probe ø 6mm probe L 97mm capillary pipe 845mm capillary pipe isolatedmm gland nut M9x1 shaft ø 6x4.6mm shaft L 23mm shaft position 90		



Зип Общепит

vsezip.ru

+7(812)987-08-81

55.18_series



GEV No.	391020	Ref. No.	TH70
description	thermostat t.max. 110°C temperature range 30-110°C 1-pole 1NO 16A probe ø 6mm probe L 114mm capillary pipe 1280mm capillary pipe isolated 1010mm gland nut shaft ø 6x4.6mm shaft L 23mm shaft position upper rotation 270°		
For models:	PB33, PB66		



GEV No.	375989	Ref. No.	TH10
description	thermostat t.max. 190°C temperature range 130-190°C 1-pole 1NO 16A probe ø 6mm probe L 118mm capillary pipe 890mm gland nut shaft ø 6x4.6mm shaft L 23mm shaft position upper rotation 270°		
For models:	GS3, GS4, GS4E, GS6, GS7, GS7E, GS9, V6D		



GEV No.	390703	Ref. No.	TH34
description	thermostat t.max. 120°C temperature range 32-110°C 1-pole 1NO 16A probe ø 6mm probe L 110mm capillary pipe 870mm capillary pipe isolatedmm gland nut M9x1 shaft ø 6x4.6mm shaft L 25mm shaft position upper rotation 270° 240V		
For models:	BM3W, BM4W, BM6W, BM7W, BS3W, BS4W, BS7W		



GEV No.	375485	Ref. No.	TH82
description	thermostat t.max. 190°C temperature range 130-190°C 1-pole NO 16A probe ø 6mm probe L 119mm capillary pipe 400mm capillary pipe isolated 190mm gland nut shaft ø 6x4.6mm shaft L 23mm shaft position upper rotation 270°		
For models:	LDF, LDF2, LFF		



GEV No.	390831	Ref. No.	TH59
description	thermostat t.max. 190°C temperature range 130-190°C 1-pole 1NO 16A probe ø 6mm probe L 113mm capillary pipe 870mm capillary pipe isolatedmm gland nut M9x1 shaft ø 6x4.6mm shaft L 25mm shaft position upper rotation 270°		



GEV No.	375483	Ref. No.	TH12
description	thermostat t.max. 320°C temperature range 50-320°C 1-pole NO 16A probe ø 3mm probe L 158mm capillary pipe 870mm capillary pipe isolatedmm gland nut shaft ø 6x4.6mm shaft L 23mm shaft position upper rotation 270°		
For models:	ECO76, ECO8, ECO9, ESLR9, GG1, GS6T, GS6TE, LGR, LGR2, LPO, OE7206, OE7209		

electric components

Зип Общепит

vsezip.ru

+7(812)987-08-81

55.34_series

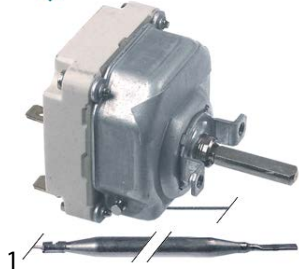

GEV No.	375428	Ref. No.	TH24
description	thermostat t.max. 190°C temperature range 130-190°C 3-pole 3NO 16A probe ø 6mm probe L 219mm capillary pipe 880mm capillary pipe isolatedmm gland nut shaft ø 6x4.6mm shaft L 23mm shaft position upper rotation 270°		

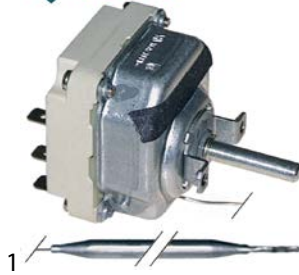

GEV No.	375038	Ref. No.	TH110
description	thermostat t.max. 300°C temperature range 50-300°C 3-pole 3NO 16A probe ø 6mm probe L 79mm capillary pipe 1740mm capillary pipe isolated 800mm gland nut shaft ø 6x4.6mm shaft L 23mm shaft position upper rotation 270°		
accessories for	375038		
	GEV No.	110123	Ref. No. —
	knob thermostat t.max. 300°C ø 50mm shaft ø 6x4.6mm shaft flat upper black temperature range 50-300°C rotation 270°		

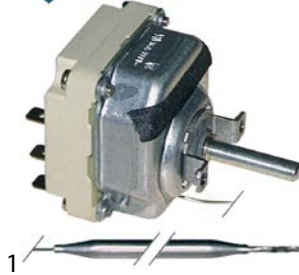

GEV No.	375024	Ref. No.	TH32
description	thermostat t.max. 300°C temperature range 50-300°C 3-pole 3NO 16A probe ø 6mm probe L 79mm capillary pipe 840mm capillary pipe isolatedmm gland nut		



GEV No.	375383	Ref. No.	TH39
description	thermostat t.max. 350°C temperature range 100-350°C 3-pole 3NO 16A probe ø 6mm probe L 75mm capillary pipe 870mm capillary pipe isolatedmm gland nut shaft ø 6x4.6mm shaft L 23mm shaft position upper rotation 270°		



GEV No.	391019	Ref. No.	TH101
description	thermostat t.max. 500°C 3-pole 3NO 16A probe ø 4mm probe L 228mm capillary pipe 1200mm capillary pipe isolatedmm gland nut shaft ø 6x4.6mm shaft L 26mm shaft position lower		

safety thermostats

55.11_series



GEV No.	390878	Ref. No.	TH35
description	safety thermostat switch-off temp. 80°C 1-pole 1NC 16A probe ø 4mm probe L 89mm capillary pipe 195mm capillary pipe isolatedmm gland nut probe		
For models:	ECO76		

Зип Общежит

vsezip.ru

+7(812)987-08-81

55.13_series



GEV No.	390911	Ref. No.	TH11
description	safety thermostat switch-off temp. 230°C 1-pole 16A probe ø 6mm probe L 77mm capillary pipe 670mm capillary pipe isolated 180mm gland nut probe screw connection M8x1		

55.31_series



GEV No.	375803	Ref. No.	TH19
description	safety thermostat switch-off temp. 225°C 3-pole 3NC 20A probe ø 6mm probe L 269mm capillary pipe 830mm capillary pipe isolated mm gland nut probe		

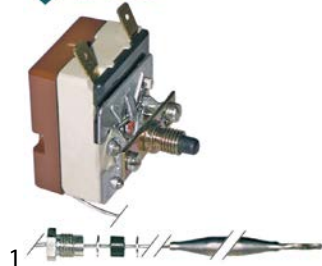

GEV No.	375138	Ref. No.	TH51
description	safety thermostat switch-off temp. 230°C 1-pole 1NO 16A probe ø 6mm probe L 96mm capillary pipe 1050mm capillary pipe isolated mm gland nut M9x1 probe SS		

55.32_series

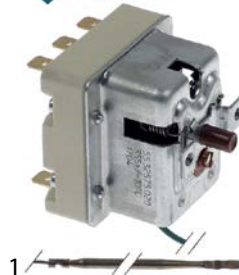

GEV No.	391042	Ref. No.	TH111
description	safety thermostat switch-off temp. 355°C 3-pole 20A probe ø 3mm probe L 160mm capillary pipe 1790mm capillary pipe isolated 450mm		
For models:	OE7210		

55.14_series



GEV No.	375137	Ref. No.	TH67
description	safety thermostat switch-off temp. 250°C 1-pole 16A probe ø 3.03mm probe L 160mm capillary pipe 880mm capillary pipe isolated 800mm gland nut probe SS with curved probe		



GEV No.	375684	Ref. No.	TH63
description	safety thermostat switch-off temp. 360°C 1-pole 20A probe ø 11mm probe L 16mm capillary pipe 900mm capillary pipe isolated 900mm gland nut probe screw-in probe probe thread M14x1		
For models:	ECO9, ESLR9, OE7008, OE7010		

Зип Общепит

vsezip.ru

+7(812)987-08-81

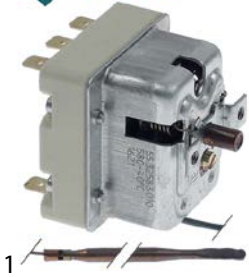

GEV No.	391013	Ref. No.	TH102
description	safety thermostat switch-off temp. 580°C 3-pole 3NC 16A probe ø 4mm probe L 233mm capillary pipe 1170mm capillary pipe isolated 310mm gland nut shaft ømm probe		
For models:	V7		



GEV No.	391017	Ref. No.	TH81
description	safety thermostat switch-off temp. 230°C 3-pole 3NC 16A probe ø 6mm probe L 106mm capillary pipe 390mm capillary pipe isolated 185mm gland nut shaft ømm starting temperature 14°C probe SS		
For models:	LDF, LDF2, LFF, LPB		

55.33_series



GEV No.	391016	Ref. No.	TH73 TH73+GL66
description	safety thermostat switch-off temp. 135°C 3-pole 3NC 16A probe ø 6mm probe L 99mm capillary pipe 790mm capillary pipe isolated 780mm gland nut shaft ømm probe SS		
For models:	ECG6, OE7503, OG7502		



GEV No.	375430	Ref. No.	TH25
description	safety thermostat switch-off temp. 230°C 3-pole 3NC 20A probe ø 6mm probe L 107mm capillary pipe 870mm capillary pipe isolated-mm gland nut starting temperature 216°C probe		
For models:	DF33, DF36, DF46, DF49, DF612, DF618, DF66ST, J12, J18, J6, J9, LCO, PB33, PB66		

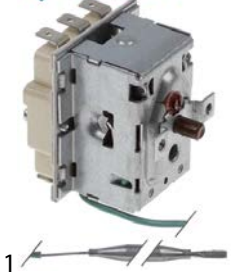

GEV No.	391014	Ref. No.	TH78
description	safety thermostat switch-off temp. 225°C 3-pole 3NC 16A probe ø 6mm probe L 114mm capillary pipe 2250mm capillary pipe isolated 1980mm gland nut shaft ømm probe SS		
For models:	OE7112, OE7113		



GEV No.	375487	Ref. No.	TH61
description	safety thermostat switch-off temp. 230°C 3-pole NC 20A probe ø 6mm probe L 103mm capillary pipe 1170mm capillary pipe isolated-mm gland nut starting temperature 116°C probe		
For models:	DF33, DF36, DF39, DF46, DF49, DF618, DF66, DF66ST, J12, J18, J6, J9, OE7105		



Зип Общепит

vsezip.ru

+7(812)987-08-81

56_ series



1

GEV No.	375862	Ref. No.	OTH07
description	safety thermostat switch-off temp. 183°C 1-pole 16A probe ø 6mm probe L 61mm capillary pipe 1460mm capillary pipe isolated 1400mm gland nut probe SS		



1

GEV No.	391015	Ref. No.	TH104
description	safety thermostat switch-off temp. 217°C 1-pole 1NC 16A probe ø 6mm probe L 79mm capillary pipe 890mm capillary pipe isolated 198mm gland nut M9x1 probe SS		



1

GEV No.	390714	Ref. No.	TH44
description	safety thermostat switch-off temp. 230°C 1-pole 1NC 16A probe ø 6mm probe L 75mm capillary pipe 740mm capillary pipe isolated 200mm gland nut probe SS		



1

GEV No.	375508	Ref. No.	TH71 TH96
description	safety thermostat switch-off temp. 235°C 1-pole 16A probe ø 3mm probe L 155mm capillary pipe 1100mm capillary pipe isolatedmm gland nut probe		
For models:	DF4, DF7, J10		



1

GEV No.	390854	Ref. No.	TH97
description	safety thermostat switch-off temp. 245°C 1-pole 1NC 16A probe ø 3.1mm probe L 155mm capillary pipe 1130mm capillary pipe isolatedmm gland nut M9x1 probe		



1

GEV No.	375774	Ref. No.	OTH08
description	safety thermostat switch-off temp. 365°C 1-pole 16A probe ø 4mm probe L 96mm capillary pipe 1160mm capillary pipe isolated 1100mm gland nut probe SS with special screwing screw connection M10x1		

control thermostats with operation switch

55.13_ series



1

GEV No.	390834	Ref. No.	N/A
description	thermostat temperature range 50-320°C 1-pole 1NO 16A probe ø 3mm probe L 160mm capillary pipe 870mm capillary pipe isolatedmm gland nut shaft ø 6x4.6mm shaft L 23mm shaft position right rotation 270° outer switch 2NO		



TECASA

safety thermostats



GEV No.	391021	Ref. No.	TH86
description	safety thermostat switch-off temp. 115°C 2-pole 2NC 16A probe ø 6mm probe L 69mm capillary pipe 630mm capillary pipe isolated 630mm gland nut shaft ømm spiral		

CAMPINI

control thermostats



GEV No.	391023	Ref. No.	TH75
description	thermostat t.max. 70°C temperature range 0-70°C 1-pole 1NO 16A probe ømm probe Lmm capillary pipemm capillary pipe isolatedm gland nut shaft ø 6x4.6mm shaft L 14mm shaft position left bottom		
For models:	HC3, HC4, HC6, HC7, HCL3, HCL4		

various

control thermostats



GEV No.	390701	Ref. No.	TH79
description	thermostat t.max. 177°C 1-pole NC probe ø 6mm probe L 114mm capillary pipe 900mm shaft ø 4.5x6mm shaft L 25mm		
For models:	OE7112		

Зип Общепит

accessories

gland nut accessories

ducts



GEV No.	550148	Ref. No.	GL66
description	gland duct ET M12x0.75 IT M9x1 probe ø max. 6.5mm WS 17 silicone		

switches and momentary switches

rocker/momentary rocker switches

26.5x22mm



GEV No.	301252	Ref. No.	SW66
description	rocker switch mounting measurements 26.5x22mm green 2NO 250V 16A illuminated 0-1 connection male faston 6.3mm ambient temperature max. 125°C protection IP40		
For models:	ECO76, ECO8, HC3, HC4, HC6, HC7, HCL3, HCL4, HCL6, HCL7, HCL9, L3, L4		

28x22mm



GEV No.	301305	Ref. No.	SW10 SW18
description	rocker switch mounting measurements 28.5x22mm black 2NO 240V 16A 0-1 connection male faston 6.3mm ambient temperature max. 85/125°C protection IP44		
For models:	FWD, FWDG, KFCWD		



GEV No.	301253 ¹	Ref. No.	SW59
description	rocker switch mounting measurements 28x22mm green 2NO 250V 16A illuminated connection male faston 6.3mm ambient temperature max. 90°C protection IP40		
For models:	AS3, AS4		

¹illuminated

30x11mm







GEV No.	301014	Ref. No.	SW72
description	momentary rocker switch mounting measurements 30x11mm black 1NO 250V 16A connection male faston 6.3mm ambient temperature max. 85/125°C protection IP40 mounting ømm male faston 6.3mm		





Зип Общепит
vsezip.ru
+7(812)987-08-81

			
1			
GEV No.	301038	Ref. No.	SW53
description	rocker switch mounting measurements 30x11mm green 1NO/indicator light 250V 16A connection male faston 6.3mm		
For models:	CT1		

			
1			
GEV No.	301004	Ref. No.	SW23 SW34
description	rocker switch mounting measurements 30x22mm black 2CO 250V 16A connection male faston 6.3mm ambient temperature max. 125/55°C protection IP40		
For models:	ECO76, ECO8, ECO9		
accessories for	301004		
	GEV No.	301036	Ref. No. —
	protective cover internal size 30x22mm for rocker switch mounting measurementsmm		



30x22mm			
			
1			
GEV No.	301003	Ref. No.	N/A SW69 SW89
description	rocker switch mounting measurements 30x22mm green 2NO 250V 16A illuminated 0-I connection male faston 6.3mm ambient temperature max. 125/55°C protection IP65		
For models:	OE7503, SCH1085, SCH785		
accessories for	301003		
	GEV No.	301036	Ref. No. —
	protective cover internal size 30x22mm for rocker switch mounting measurementsmm		

			
1			
GEV No.	301251	Ref. No.	SW11 SW70
description	rocker switch mounting measurements 30x22mm green 2NO 250V 16A illuminated lighting connection male faston 6.3mm ambient temperature max. 85°C protection IP40		
For models:	L3, L4, SCH1085, SCH785		

			
1			
GEV No.	301001	Ref. No.	NE14
description	rocker switch mounting measurements 30x22mm red 2NO 250V 16A illuminated 0-I connection male faston 6.3mm ambient temperature max. 125/55°C protection IP65		
For models:	OE7503		
accessories for	301001		
	GEV No.	301036	Ref. No. —
	protective cover internal size 30x22mm for rocker switch mounting measurementsmm		

push/momentary push switches

19x13mm			
			
1			
GEV No.	345690	Ref. No.	SW88
description	momentary push switch mounting measurements 19x13mm black 1NO 250V 16A connection male faston 4.8mm ambient temperature max. 105°C protection IP40		

			
1			
GEV No.	346978	Ref. No.	SW35
description	momentary rocker switch mounting measurements 30x22mm black 2CO 250V 16A connection male faston 6.3mm ambient temperature max. 125/55°C protection IP40		
For models:	ECO76, ECO8, ECO9		
accessories for	346978		
	GEV No.	301036	Ref. No. —
	protective cover internal size 30x22mm for rocker switch mounting measurementsmm		

microswitches

lever actuated			
			
1			
GEV No.	345773	Ref. No.	X52800
description	microswitch with lever 250V 16A 1CO connection male faston 6.3mm L 60mm ambient temperature max. 125°C mounting distance 22mm actuating force: 65g lever length 51mm		

electric components



ЗипОбщепит

float switches

roller-lever actuated

microswitches



1	GEV No.	347949	Ref. No.	OSW11
description microswitch with handle with a switch 250V 0.1A 1NC connection male faston 6.3mm L 21mm L1 12mm mounting distance 24mm white				



1	GEV No.	345250	Ref. No.	SW64
description microswitch with handle with a switch 250V 16A 1CO connection male faston 6.3mm L 27mm L1 36mm ambient temperature max. 125°C mounting distance 22mm type RL6-1-FGE-P12-5-L actuating force: 90g				
For models: ECG6, UM50, UM50D, UMO50, UMS50, UMS50D, UMSO50, UMSO50D				

pin-plunger actuated



1	GEV No.	300092	Ref. No.	SW38
description microswitch with plunger 400V 16A 2NO connection male faston 6.3mm ambient temperature max. 85°C mounting distance 22mm type XTD22A21 actuating force: 150g fryer black				
For models: LDF, LDF2, LFF, LPB				

M12



1	GEV No.	346176	Ref. No.	X54900
description microswitch with plunger mounting distance 25mm thread M12x0.75 250V 1CO ambient temperature max. 125°C type MK V11D10				

accessories



1	GEV No.	511566	Ref. No.	IN41
description bracket for switch L 50mm W 27.5mm				



1

+7(812)987-08-81

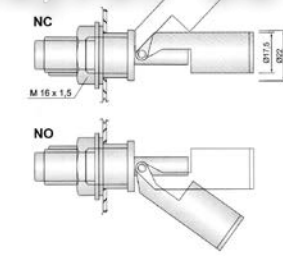

GEV No.	348189	Ref. No.	FS01
description float switch thread M16x2 1NO or 1NC ø 18mm L 100mm mounting ø 16mm 240VACV 0.6A cable cable length 500mm			
For models: OE7503, OG7502			

cam switches

on/off

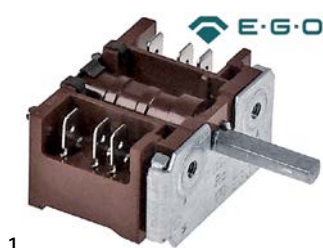

1

GEV No.	301115	Ref. No.	SW58
description cam switch 2 operating positions 2NO sequence 0-1 16A shaft ø 6x4.6mm shaft L 23mm connection male faston 6.3mm			
For models: ESLR9, OE7008, OE7010			



1

GEV No.	300021	Ref. No.	SW42
description cam switch 4 operating positions 4NO sequence 0-1-0-1 16A shaft ø 6x4.6mm shaft L 23mm connection screw ceramic			



Зип Общежит

vsezip.ru

+7(812)987-08-81

7-position



1			
GEV No.	300031	Ref. No.	SW14
description	cam switch 7 operating positions 1NO/2CO sequence 0-1-2-3-4-5-6 16A shaft ø 6x4.6mm shaft L 23mm connection male faston 6.3mm 7-position plastic		
For models:	ESLR9, HT3, HT6, HT7, LBR, OE7008, OE7010, OE7012		

operation switches

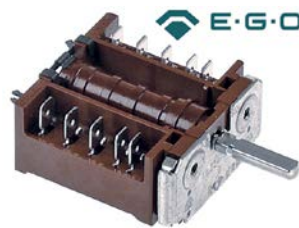

1			
GEV No.	301109	Ref. No.	SW71
description	cam switch 2 operating positions 4NO 16A sequence 0-1 shaft ø 6x4.6mm shaft L 23mm connection male faston 6.3mm plastic 4-pole		

magnetic switches

32x15mm



1			
GEV No.	346510	Ref. No.	OSW09
description	magnetic switch		

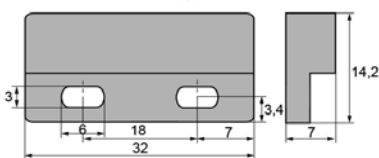

1			
GEV No.	346515 ¹	Ref. No.	ODO17
description	magnetic switch L 32mm W 15mm 1NO 250V 0.5A P max. 50W connection coded plug cable length 1750mm		

¹with coded connector

accessories

magnets



GEV No.	346514	Ref. No.	ODO18
description	magnet ø 10mm L 40mm Hmm Wmm		



1			
GEV No.	345110	Ref. No.	ODO15
description	magnet ømm L 25mm H 9mm W 15mm		

magnetic holders



1			
GEV No.	541986	Ref. No.	ODO21
description	magnet holder with magnet ø 13mm		

encoders and potentiometers





1			
GEV No.	300198	Ref. No.	OGE02
description	encoder		





1			
GEV No.	402390	Ref. No.	MC15
description	potentiometer 0.5KOhm rotation 270° RHS500 shaft L 19mm type 1004MX plug type male faston 6.3mm cable length 400mm		

Зип-Общепит
vsezip.ru
+7(812)987-08-81

			
1			
GEV No.	402391	Ref. No.	MC16
description	potentiometer 0.5KOhm rotation 270° shaft L 19mm plug type male faston 6.3mm cable length 450mm		
For models:	CT1		

			
1			
GEV No.	348226	Ref. No.	EN02
description	potentiometer 3-pole cable length 300mm		

			
1			
GEV No.	300197	Ref. No.	OPO02
description	potentiometer 4.7KOhm rotation 360° shaft ø 5.9mm with switch shaft L 22mm		



			
1			
GEV No.	400106	Ref. No.	OGE01
description	pulsar KOhm rotation 360° shaft ø 6mm type CPC		

lamps

indicator lights

indicator lights 2-piece (lens and indicator lamp)

indicator lamps for socket type RL

			
1			
GEV No.	359818	Ref. No.	NE04
description	indicator light 230V clear connection male faston 6.3mm		
accessories for	359818		
	GEV No.	359820	Ref. No.
			—
	indicator light lens yellow Qty 1 pcs ø 8mm		
	GEV No.	359833	Ref. No.
			—
	indicator light lens red Qty 1 pcs ø 8mm		

			
GEV No.	359948	Ref. No.	—
description	indicator light lens clear Qty 1 pcs ø 8mm		

indicator lights (complete) ø 10mm

			
1			
GEV No.	359139	Ref. No.	NE43
description	indicator light ø 10mm green 230V connection male faston 6.3mm Qty 1 pcs		

			
1			
GEV No.	359140	Ref. No.	NE42
description	indicator light ø 10mm yellow 230V connection male faston 6.3mm Qty 1 pcs		
For models:	DF33, DF36, DF39, DF46, DF49, DF612, DF618, DF66, DF66ST, ECO76, ECO8, ECO9, ESLR9, GG1, GS3, GS4, GS4E, GS6, GS6T, GS6TE, GS7, GS7E, GS9, J12, J18, J6, J9, LCG, LCG2, LCO, LDF, LDF2, LFF, LGR, LGR2, LPG, LPG2, LPO, LRG, LRG2, LSC, PB33, PB66, UM50, UM50D, UMO50, UMS50, UMS50D, UMSO50, UMSO50D		

ø 13mm with plug-in socket

			
1			
GEV No.	359142	Ref. No.	NE38
description	indicator light ø 13mm green 230V connection male faston 6.3mm temp.-resist. 120°C Qty 1 pcs		
For models:	FWD, FWDG, G1A, GBM2, GBM3, KFCWD		

			
1			
GEV No.	359143	Ref. No.	NE37
description	indicator light ø 13mm yellow 230V connection male faston 6.3mm temp.-resist. 120°C Qty 1 pcs		
For models:	FWD, FWDG, G1A, GBM2, GBM3, KFCWD		

ø 19mm

			
1			
GEV No.	359563	Ref. No.	NE39
description	indicator light ø 19mm 230V green connection male faston 6.3mm		
For models:	OE7008, OE7010, OE7012, OE7104, OE7105, OE7112, OE7113, OE7206, OE7209, OE7210, OE7303, OE7304		





Зип Общежит

vsezip.ru

87(812)987-08-81

			
1			
GEV No.	359564	Ref. No.	NE40
description	indicator light ø 19mm 230V orange connection male faston 6.3mm		
For models:	OE7008, OE7010, OE7104, OE7105, OE7112, OE7113, OE7206, OE7209, OE7210, OE7503		

30x11 mm			
			
1			
GEV No.	359160	Ref. No.	NE34
description	indicator light mounting measurements 30x11mm 230V green connection male faston 6.3mm rectangular temp.-resist. 125°C		
For models:	V6, V6D, V6F		

			
1			
GEV No.	359159	Ref. No.	NE41
description	indicator light mounting measurements 30x11mm 230V yellow connection male faston 6.3mm temp.-resist. 125°C		
For models:	ECO7, V6, V6D, V6F, V7		

miscellaneous			
			
1			
GEV No.	359066	Ref. No.	ONE02
description	indicator light mounting measurements 30x21mm green 230V		

screw-on/push-on fit



light bulbs			
for ovens			
			
1			
GEV No.	357153	Ref. No.	LA08
description	light bulb t.max. 300°C socket E14 25W 230V ø 25mm L 55mm lens L 30mm for oven type		

			
1			
GEV No.	359611	Ref. No.	LA)S LA94
description	light bulb t.max. 300°C socket E14 40W 230V ø 45mm L 75mm lens L 50mm for oven lamp IMPORT		
For models:	ECO76		

halogen lamp			
for socket G4 / G6.35 / G9			
			
1			
GEV No.	359596	Ref. No.	OBU02
description	halogen lamp socket G4 12V 10W temp.-resist. 500°C		

linear lamps

infrared lamps

with base type R7s				
				
1				
GEV No.	359536 ¹	Ref. No.	LA210	
description	infrared lamp socket R7s L 218mm 240V 500W jacketed			
For models:	CS4G, LD2, LD3, LD4			
accessories for	359536			
	GEV No.	359583	Ref. No.	—
	lamp socket socket R7s 250V ømm for length of lamp 218mm H 62mm connection cable 200mm mounting distance 120mm holder length 246mm mounting thread M4 Qty 1 pcs			

¹with double glass

with base type Z ceramic

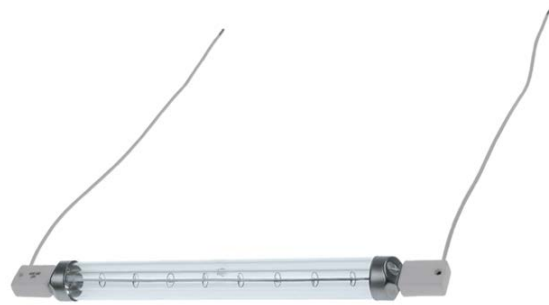
			
1			
GEV No.	359470 ¹	Ref. No.	LA12
description	infrared lamp socket Z-ceramic L 225mm 240V 500W cable length 215mm		
For models:	CS4G		

¹with double glass

sockets for linear lamps



R7s			
			
1			
GEV No.	359726	Ref. No.	LA211
description	lamp socket socket R7s 250V ø 18mm Lmm H 28mm connection cable 230mm mounting distance mm mounting thread M14x1 cable material silicone Qty 1 pcs		
For models:	CS4G, LD2, LD3, LD4		





Зип-Общепит

vsezip.ru

(812) 987-08-81

			
1			
GEV No.	359544	Ref. No.	LA325
description	lamp socket socket R7s 250V ømm for length of lamp 117.6mm H 40mm connection cable 230mm mounting distance 70mm holder length 140mm cable material silicone Qty 1 pcs		
accessories for	359544		
	GEV No.	359545	Ref. No. LA326
	reflector for length of lamp 117.6mm for infrared quartz lamp		

			
1			
GEV No.	359545	Ref. No.	LA326
description	reflector for length of lamp 117.6mm for infrared quartz lamp		
accessories for	359545		
	GEV No.	359544	Ref. No. LA325
	lamp socket socket R7s 250V ømm for length of lamp 117.6mm H 40mm connection cable 230mm mounting distance 70mm holder length 140mm cable material silicone Qty 1 pcs		

fluorescent lamps

fluorescent lamps

G13			
			
1			
GEV No.	357145	Ref. No.	BU173
description	fluorescent lamp socket G13 L 438mm 15W ø 27mm 230V Qty 1 pcs light colour 865		
For models:	SCH785, SCR785		

			
1			
GEV No.	359371	Ref. No.	BU171
description	fluorescent lamp socket G13 L 590mm 18W 230V Qty 1 pcs		
For models:	C6A-100, C6A-75, C6H-100, C6H-75, C6R-100, C6R-105L, C6R-105R, C6R-130L, C6R-130R, C6R-75, D3H-75, D3R-100, D5H-100, D5H-75, D5R-100, D5R-125, D6R-100, D6R-75		

			
1			
GEV No.	357147	Ref. No.	BU172
description	fluorescent lamp socket G13 L 895mm 30W ø 26mm 230V T8/765 Qty 1 pcs		
For models:	C6R-125, D6R-125, SCH1085, SCR1085		

accessories

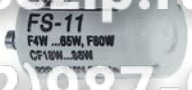
starter			
			
1			
GEV No.	380464	Ref. No.	GL68
description	starter 4-65W		
For models:	SCH1085, SCH785, SCR785		

microwave lamps





light bulbs

			
1			
GEV No.	359492	Ref. No.	BU10
description	light bulb socket B22 200-250V 25W		

oven lamps

universal oven lamps

mounting diameter 65.5mm

			
1			
GEV No.	359712	Ref. No.	LA87
description	oven lamp mounting ø 65.5mm 230V 40W socket E14 temp.-resist. 300°C connection male faston 6.3mm hard glas		
For models:	ECO76		
spare parts for	359712		
	GEV No.	359022	Ref. No. —
	lamp socket socket E14 mounting ø 65.5mm connection male faston 6.3mm		
	GEV No.	359611	Ref. No. LA)S LA94
	light bulb t.max. 300°C socket E14 40W 230V ø 45mm L 75mm lens L 50mm for oven lamp IMPORT		
	GEV No.	359722	Ref. No. —
	gasket silicone ID ø 57.5mm ED ø 68mm thickness 2mm		
	GEV No.	359724	Ref. No. —
	oven lamp glass thread ø 62mm H 46mm ø 74mm hard glas temp.-resist. 350°C		



Зип Общепит
vsezip.ru
+7(812)987-08-81

50x75.5mm



1

GEV No.	359309	Ref. No.	LA19
description	oven lamp L 75mm W 50mm 230V 40W socket E14 temp.-resist. 300°C connection male faston 6.3mm		
For models:	LCO, UM50, UM50D, UMO50, UMS50, UMS50D, UMSO50, UMSO50D		



1

GEV No.	359880	Ref. No.	OBU04
description	gasket L 95mm W 72mm C-Line, CPC, SCC 61-202		

producer-specific oven lamps

LINCAT



1

GEV No.	360718	Ref. No.	LA118
description	bracket for lamp ø 37.6mm		



1

GEV No.	359879	Ref. No.	OBU05
description	gasket L 99mm W 75mm C-Line, CPC, SCC 61-202		



1

GEV No.	359876	Ref. No.	OBU07
description	frame SS for lamp lenses W 90mm L 113mm C-Line, CPC, SCC 61-202		
accessories for	359876		
	GEV No.	Ref. No.	OBU03
	359877		
description	lamp glass L 95mm W 72mm thickness 4mm C-Line, CPC, SCC 61-202		
	GEV No.	Ref. No.	OBU05
	359879		
description	gasket L 99mm W 75mm C-Line, CPC, SCC 61-202		
	GEV No.	Ref. No.	OBU04
	359880		
description	gasket L 95mm W 72mm C-Line, CPC, SCC 61-202		
	GEV No.	Ref. No.	—
	560448		
description	hexagonal screw thread M5 thread L 8mm SS WS 8 Qty 1 pcs head thickness 4mm DIN 933 / ISO 4017		









1

GEV No.	359878	Ref. No.	OBU11
description	lamp glass L 80mm W 65mm thickness 4mm		



1

GEV No.	359873	Ref. No.	OBU06
description	lamp socket socket G4 for halogen lamp		
accessories for	359873		
	GEV No.	Ref. No.	OBU07
	359876		
description	frame SS for lamp lenses W 90mm L 113mm C-Line, CPC, SCC 61-202		
	GEV No.	Ref. No.	OBU03
	359877		
description	lamp glass L 95mm W 72mm thickness 4mm C-Line, CPC, SCC 61-202		
	GEV No.	Ref. No.	OBU05
	359879		
description	gasket L 99mm W 75mm C-Line, CPC, SCC 61-202		
	GEV No.	Ref. No.	OBU04
	359880		
description	gasket L 95mm W 72mm C-Line, CPC, SCC 61-202		
	GEV No.	Ref. No.	—
	360724		
description	lamp glass L 113mm W 90mm C-Line, CPC, SCC 61-202		



1

GEV No.	359882	Ref. No.	OBU09
description	gasket L 81mm W 65mm		



1

GEV No.	359874	Ref. No.	OBU13
description	lamp socket socket G4 for halogen lamp		



1

GEV No.	359881	Ref. No.	OBU10
description	gasket L 85mm W 70mm		

electric components



Зип Общепит
lamp accessories



1

GEV No.	360716	Ref. No.	LA14
description	oven lamp mounting measurements 55x70mm 250V 25W socket E14 rectangular temp.-resist. 300°C connection F6.3		
For models:	ECO8, ECO9, L3, L4, LPW, LPW-LR		

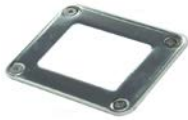

1

GEV No.	359875	Ref. No.	OBU08
description	press frame with gasket		

lamps

light bulbs



1

GEV No.	357153	Ref. No.	LA08
description	light bulb t.max. 300°C socket E14 25W 230V ø 25mm L 55mm lens L 30mm for oven type		



1

GEV No.	359611	Ref. No.	LA)S LA94
description	light bulb t.max. 300°C socket E14 40W 230V ø 45mm L 75mm lens L 50mm for oven lamp IMPORT		
For models:	ECO76		

halogen lamps

for socket G4 / G6.35 / G9



1

GEV No.	359596	Ref. No.	OBU02
description	halogen lamp socket G4 12V 10W temp.-resist. 500°C		

fasteners

lamp holders



1

GEV No.	360757	Ref. No.	LA112
description	lamp holder L 665mm W 80mm		



1

GEV No.	360715	Ref. No.	LA02
description	lamp holder L 774mm W 60mm		



1

GEV No.	360714	Ref. No.	LA119
description	reflector complete incl. holder L 170mm W 61mm thickness 28mm		

alarm devices

buzzers



1

GEV No.	350136	Ref. No.	OBU01
description	buzzer 12VAC connection cable 200mm screw mounting 63dB		

contactors

BENEDIKT & JÄGER

power contactors



1

GEV No.	380772	Ref. No.	OCA30
description	power contactor resistive load 25A 230VAC (AC3/400V) 10A/4kW main contacts 3NO auxiliary contacts 1NO connection screw connection type K3-10A10230		

Зип Общепит



vsezip.ru

+7(812)987-08-81



1

GEV No.	381173	Ref. No.	OCO29
description	power contactor resistive load 50A 230VAC (AC3/400V) 24A/11kW main contacts 3NO auxiliary contacts 1NO connection torx type K3-24B00 50/60Hz		



1





GEV No.	380244	Ref. No.	OCO04
description	power contactor resistive load 25A 230VAC (AC3/400V) 9A/4kW main contacts 3NO auxiliary contacts 1NO connection screw connection type AEG LS4K 10A type GE CL00A 310		

GENERAL ELECTRIC (AEG)

power contactors



1

GEV No.	380267	Ref. No.	OCO24
description	power contactor resistive load 110A 230VAC (AC3/400V) 65A/30kW main contacts 3NO auxiliary contacts connection screw connection type AEG LS30K 00A type GE CL07A 300		
accessories for	380267		
	GEV No.	380268	Ref. No. —
	auxiliary contact contacts 1NO for contactors CL+LS_K connection screw AC-12 10A type AEG HS07K 10 type GE BCLF 10		
	GEV No.	380269	Ref. No. —
	auxiliary contact contacts 1NC AC15 6A for contactors CL+LS_K connection screw AC-12 10A type AEG HS07K 01 type GE BCLF 01		
	GEV No.	380270	Ref. No. —
	auxiliary contact contacts 1NO/1NC for contactors CL+LS_K connection screw AC-12 10A type AEG HS08K 11 type GE BCLL 11		
	GEV No.	380271	Ref. No. —
	auxiliary contact contacts 2NO for contactors CL+LS_K connection screw AC-12 10A type AEG HS08K 20 type GE BCLL 20		



1

GEV No.	380498	Ref. No.	CO111 OCO19
description	power contactor resistive load 20A 230VAC (AC3/400V) 9A/4kW main contacts 4NO auxiliary contacts connection male faston 6.3mm type MC1A 400A type AEG LS05 01 FA type GE MC1A 400A		
For models:	DF36, DF39, DF46, DF49, DF612, DF618, DF66ST, EB4F, EB6, EB6T, ECG6, ECO76, ESLR9, J12, J18, J6, J9, OE7008, OE7010, OE7104, OE7206, OE7209		



1

GEV No.	380261	Ref. No.	OCO05
description	power contactor resistive load 32A 230VAC (AC3/400V) 17A/7.5kW main contacts 3NO auxiliary contacts 1NO connection screw connection type AEG LS7K 10A type GE CL02A 310		

MOELLER/EATON

power contactors



1

GEV No.	380167	Ref. No.	OCO20
description	power contactor resistive load 66A 230VAC (AC3/400V) 50A/22kW main contacts 3NO auxiliary contacts 1NO connection screw connection type DILM 50		

Зип.Общепит
relayspower relays
with bracket mountingvsezip.ru
+7(812)987-08-81

SIEMENS

power contactors



1

GEV No.	380614	Ref. No.	CO215
description	power contactor resistive load 22A 230VAC (AC3/400V) 9A/4kW main contacts 3NO auxiliary contacts 1NO connection elastic terminals type 3RT2016-2AP01		

TELEMECANIQUE (Schneider Electric)

power contactors



1

GEV No.	380967	Ref. No.	CO112
description	power contactor resistive load 20A 230VAC (AC3/400V) 9A/4kW main contacts 3NO auxiliary contacts 1NO connection screw connection type LC1K0910M7		
For models:	AS4, EB3, EB4, ECO9, OE7105, OE7112, OE7113, OE7206, OE7209, OE7503		

transformers

encapsulated transformers

with plug connection



1

GEV No.	401472	Ref. No.	OTR06	
description	transformer 1/20/50VA secondaryA H 70mm L 76mm W 104mm connection plug 50/60Hz type 110170 with fuse secondary 2.1/11.5/12VAC primary 230VAC			
spare parts for	401472			
	GEV No.	358602	Ref. No.	—
	fine fuse size ø5x20mm 1.6A slow-acting rated 250V Qty 10 pcs			

solid state relays

CELDUC



1

GEV No.	400105	Ref. No.	ORO01	
description	solid state relay CELDUC 2 phase 65A 400V 24VDC L 58mm W 45mm plug-in connection screw type 40.00.453			
accessories for	400105			
	GEV No.	401794	Ref. No.	—
	connecting cable L 1440mm 4-pole suitable for RATIONAL			







Зип Общепит

vsezip.ru

+7(812)9870680

			
1			
GEV No.	401473	Ref. No.	OTR09
description	transformer 21.6VA H 70mm L 94mm W 71mm connection plug 50-60Hz type 40.00.592 moulded secondary 12VDC primary 200-250VAC		

			
GEV No.	379160	Ref. No.	—
description	temperature probe NTC 10kOhm cable thermoplastic probe -40 up to +110°C cable -40 up to +110°C probe ø6x14mm cable length 1.5m without screw connection 2-wire		
			
GEV No.	379161	Ref. No.	—
description	temperature probe NTC 10kOhm cable thermoplastic probe -40 up to +110°C cable -40 up to +110°C probe ø6x14mm cable length 3m without screw connection 2-wire		
			
GEV No.	379343	Ref. No.	—
description	temperature probe NTC 10kOhm cable silicone probe -40 up to +110°C cable -50 up to +180°C probe ø6x40mm cable length 3m 2-wire		
			
GEV No.	379458	Ref. No.	—
description	temperature probe NTC 10kOhm cable silicone probe -40 up to +110°C cable -50 up to +180°C probe ø6x40mm cable length 1.5m without screw connection 2-wire		







electronic controllers

DIXELL

refrigeration controllers

built-in version

			
1			
GEV No.	378273	Ref. No.	EC15
description	electronic controller DIXELL XR06CX-5N0C1 mounting measurements 71x29mm 230V voltage AC NTC/PTC relay outputs 1 NO-20A(8) NTC/PTC DI protection IP54 -50 up to +110°C display 2½ digit DEF Relay 8A fan relay 8A compressor relay 20A		

			
1			
GEV No.	402192	Ref. No.	EC17
description	electronic controller DIXELL XR10CX mounting measurements 71x29mm 230V voltage AC NTC/PTC relay outputs 1 NO-20A(8) NTC/PTC DI protection IP54 -50 up to +150°C display 3½ digits		
accessories for	402192		
			
GEV No.	378194	Ref. No.	—
description	temperature probe NTC 10kOhm cable PVC probe -20 up to +80°C cable -10 up to 100°C probe ø7x24.5mm cable length 1.5m without screw connection 2-wire		
			
GEV No.	379052	Ref. No.	—
description	temperature probe PTC 1kOhm cable silicone probe -50 up to +150°C cable -50 up to +180°C probe ø6x40mm cable length 1.5m without screw connection 2-wire		
			
GEV No.	379053	Ref. No.	—
description	temperature probe PTC 1kOhm cable PVC probe -50 up to +150°C cable -10 up to 100°C probe ø6x30mm cable length 3m without screw connection 2-wire		
			
GEV No.	379057	Ref. No.	—
description	temperature probe NTC 10kOhm cable PVC probe -20 up to +80°C cable -10 up to 100°C probe ø6x25mm cable length 3m 2-wire		
			
GEV No.	379064	Ref. No.	—
description	temperature probe PTC 1kOhm cable silicone probe -50 up to +150°C cable -50 up to +180°C probe ø6x40mm cable length 3m without screw connection 2-wire		

probes

producer-specific probes

			
1			
GEV No.	379430	Ref. No.	OTC14
description	core temperature probe thermocouple K (NiCr-Ni) cable silicone probe -50 up to 1150°C cable -50 up to +180°C connection coded plug thread probe ø1.5x140mm cable length 1.65m		

			
1			
GEV No.	379469	Ref. No.	TH90
description	temperature probe NTC 10kOhm cable thermoplastic probe -40 up to +110°C cable -40 up to +110°C connection coded plug thread probe eye M3 cable length 0.6m		

			
1			
GEV No.	378641	Ref. No.	TH103
description	temperature probe Pt100 cable PVC probe -100 up to 450°C connection plug thread M10x1 probe 5x26 cable length 0.68m		

			
1			
GEV No.	378642	Ref. No.	TH98
description	temperature probe PTC 1kOhm cable PVC probe -50 up to +150°C connection plug probe eye M3 cable length 780mm		

			
1			
GEV No.	378351	Ref. No.	OTC09
description	temperature probe thermocouple K (NiCr-Ni) cable silicone probe -50 up to 1150°C cable -50 up to +180°C connection coded plug thread M8 probe ø2x135mm cable length 1.3m		

Зип-Общепит

core probes

vsezip.ru

+7(812)987-08-81

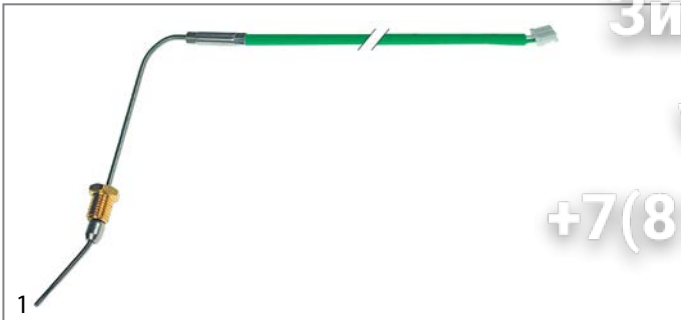

GEV No.	379864	Ref. No.	OTC07
description	temperature probe thermocouple K (NiCr-Ni) cable silicone probe -50 up to 1150°C cable -50 up to +180°C connection coded plug thread M8 probe ø2x50mm cable length 1.2m		

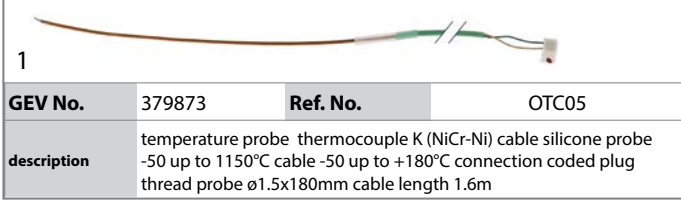

GEV No.	379873	Ref. No.	OTC05
description	temperature probe thermocouple K (NiCr-Ni) cable silicone probe -50 up to 1150°C cable -50 up to +180°C connection coded plug thread probe ø1.5x180mm cable length 1.6m		

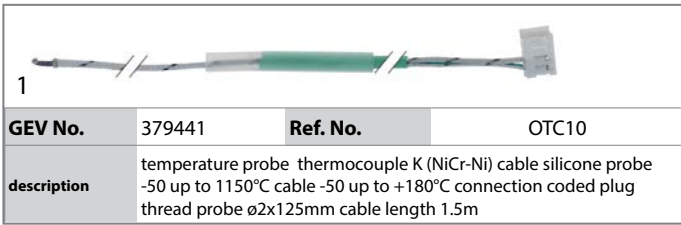

GEV No.	379441	Ref. No.	OTC10
description	temperature probe thermocouple K (NiCr-Ni) cable silicone probe -50 up to 1150°C cable -50 up to +180°C connection coded plug thread probe ø2x125mm cable length 1.5m		



GEV No.	379869	Ref. No.	OTC06
description	temperature probe thermocouple K (NiCr-Ni) cable silicone probe -50 up to 1150°C cable -50 up to +180°C connection coded plug thread probe ø2x70mm cable length 2.5m		

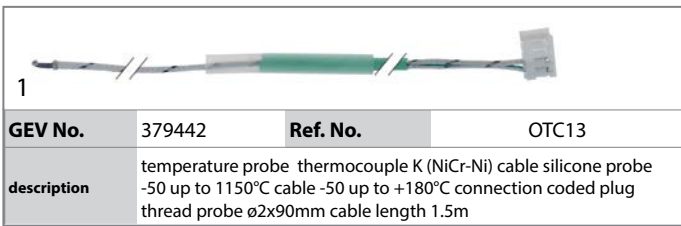

GEV No.	379442	Ref. No.	OTC13
description	temperature probe thermocouple K (NiCr-Ni) cable silicone probe -50 up to 1150°C cable -50 up to +180°C connection coded plug thread probe ø2x90mm cable length 1.5m		

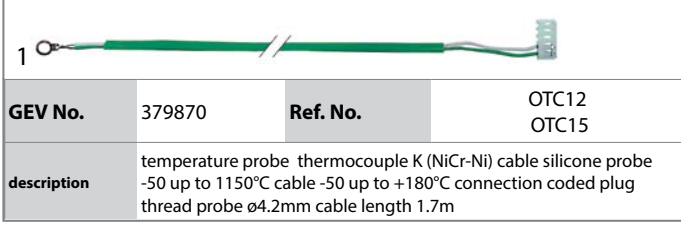

GEV No.	379870	Ref. No.	OTC12 OTC15
description	temperature probe thermocouple K (NiCr-Ni) cable silicone probe -50 up to 1150°C cable -50 up to +180°C connection coded plug thread probe ø4.2mm cable length 1.7m		



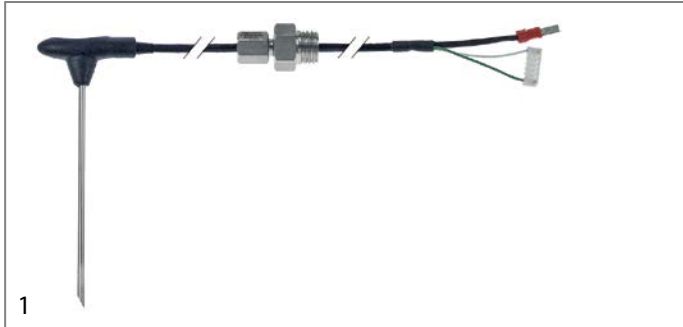

GEV No.	379367	Ref. No.	OPR10
description	conversion kit thermocouple K (NiCr-Ni) cable PTFE probe -40 up to +250°C cable -40 up to +250°C connection plug probe ø3x100mm thread M16 cable length 2.2m handle ø 10mm handle length 40mm		



GEV No.	381443	Ref. No.	OPR18
description	core temperature probe CM_P 61-102 cable PTFE insulated probe -40 up to +250°C probe ø3.2x100mm cable length 2.45m handle ø 12mm handle length 44mm		



GEV No.	379792 ¹	Ref. No.	OPR07
description	core temperature probe thermocouple K (NiCr-Ni) cable PTFE probe -40 up to +250°C cable -40 up to +250°C connection grip connection probe ø3.2x100mm thread M16x2 cable length 1.9m handle ø 10mm handle length 40mm		

accessories for	379792			
	GEV No.	510179	Ref. No.	—
	flat gasket fibre ED ø 18mm ID ø 13mm thickness 1.5mm Qty 1 pcs			
	GEV No.	560519	Ref. No.	—
	nut thread M12x1 H 5mm WS 17 SS Qty 1 pcs			

¹multipoint probe



GEV No.	379868 ¹	Ref. No.	OPR09
description	core temperature probe thermocouple K (NiCr-Ni) cable PTFE probe -40 up to +250°C cable -40 up to +250°C connection plug probe ø3x100mm thread M16 cable length 2.2m handle ø 10mm handle length 40mm		

¹multipoint probe



Зип Общепит

electronics

vsezip.ru

+7(812)987-08-81



1

GEV No.	379865	Ref. No.	OPR15
description	core temperature probe thermocouple K (NiCr-Ni) cable PTFE probe -40 up to +250°C cable -40 up to +250°C connection plug probe ø3x100mm thread M16 cable length 2.3m handle ømm handle length 50mm		



1

GEV No.	379866 ¹	Ref. No.	OPR14
description	core temperature probe thermocouple K (NiCr-Ni) cable PTFE probe -40 up to +250°C cable -40 up to +250°C connection plug probe ø3x100mm thread M16 cable length 2.3m handle ømm handle length 50mm		

¹ multipoint probe

sensors



1

GEV No.	403896	Ref. No.	LE49
description	sensor Lower Level for Water boiler probe L 275mm probe ø 6mm		
For models:	EB3F, EB4F, EB6, EB6T		



1

GEV No.	403897	Ref. No.	LE64
description	sensor Lower Level kit for Water boiler probe L 220mm probe ø 6mm		



1

GEV No.	403898	Ref. No.	LE48
description	sensor Upper Level for Water boiler probe L 60mm probe ø 6mm		
For models:	EB3F, EB4F, EB6, EB6T		

PCBs



1

GEV No.	402827	Ref. No.	OPR13
description	control PCB combi-steamer CM101 L 372mm W 120mm type RAL115ET		



1

GEV No.	401475	Ref. No.	OPR11
description	control PCB combi-steamer SCC Line		
accessories for	401475		
GEV No.	358791	Ref. No.	OFU01
description	fine fuse size ø6.3x32mm 6.3A slow-acting rated 250V Qty 10 pcs		



1

GEV No.	403796	Ref. No.	OPR20
description	control PCB for combi-steamer CM_P 61-202 suitable for RATIONAL model Sicotronic		



1

GEV No.	403797	Ref. No.	OPR23
description	control PCB for combi-steamer SCC_WE, CM_P 61-202 model Sicotronic		

1 electric components



Зип.Общепит
solenoid valves

vsezip.ru
HYDRA

+7(812)987-08-81



GEV No.	403889	Ref. No.	OSC09
description	display for combi-steamer SCC_WE 61-202 complete incl. control		



GEV No.	401903	Ref. No.	PR10
description	PCB		
For models:	EB3, EB4, EB6, EB6T		



GEV No.	401662	Ref. No.	OPR12
description	PCB combi-steamer CM101 conversion kit		



GEV No.	403048	Ref. No.	N/A
description	PCB for fryer L 135mm W 135mm		



GEV No.	401629	Ref. No.	ORE03	
description	relay shroud I/O-Board SCC Line			
accessories for	401629			
	GEV No.	358786	Ref. No.	—
	fine fuse size ø6.3x32mm 2A slow-acting rated 250V Qty 10 pcs			

solenoid valves (water)



GEV No.	374095	Ref. No.	SO24
description	solenoid valve single straight 230VAC inlet 3/4" outlet 3/4" flow regulating valve outlet green output 0.8l/min DN10 total length 68.5mm		



GEV No.	374096	Ref. No.	SO23
description	solenoid valve single straight 230VAC inlet 3/4" outlet 3/4" flow regulating valve outlet light blue output 2l/min DN10 total length 68.5mm		
For models:	EB3F, EB4F, EB6, EB6T		

MÜLLER

medium temperature: 90°C
duty cycle: 100%



GEV No.	374099	Ref. No.	SV03
description	solenoid valve single angled 230VAC inlet 12mm outlet 10.4mm t.max. 98°C		



Зип Общежит

with model terminals

vsezip.ru

+7(812)987-08-81

ROBERTSHAW/INVENSYS

medium temperature: 90°C 90°C 60°C
 ambient temperature: 60°C 25°C 60°C
 duty cycle: 40% 100% 100%

 <p>1</p>			
GEV No.	374097	Ref. No.	SO22
description	solenoid valve single straight 230VAC inlet 1/2" outlet 1/2" DN10 t.max. 90°C flow regulating valve outlet orange		
For models:	OE7503, OG7502		

 <p>1</p>			
GEV No.	374098	Ref. No.	SO16
description	solenoid valve single straight 230VAC inlet 3/4" outlet 11.5mm with backflow preventer		
For models:	ECO76		

solenoid valves with reducers

single

 <p>1</p>			
GEV No.	370652	Ref. No.	OSO09
description	solenoid valve single straight 230VAC inlet 3/4" outlet 11.5mm input 10l/min 10 EATON (INVENSYS) flow regulating valve inlet white		

3-fold

 <p>1</p>			
GEV No.	370672	Ref. No.	OSO07
description	solenoid valve triple straight 230VAC inlet 3/4" outlet 11.5mm 10 EATON (INVENSYS) plastic output C 5l/min flow regulating valve outlet C black		

 <p>1</p>			
GEV No.	370266	Ref. No.	OSO03
description	solenoid valve double straight 230VAC inlet 3/4" outlet 11.5mm DN10 EATON (INVENSYS)		

 <p>1</p>			
GEV No.	370267	Ref. No.	OSO04
description	solenoid valve single straight 230VAC inlet 3/4" outlet 11.5mm DN10 EATON (INVENSYS)		

 <p>1</p>			
GEV No.	370268	Ref. No.	OSO06
description	solenoid valve single straight 230VAC inlet 3/4" outlet 11.5mm DN10 EATON (INVENSYS)		

 <p>1</p>			
GEV No.	370270	Ref. No.	OSO05
description	solenoid valve single straight 230VAC inlet 3/8" outlet 3/8" DN10 Invensys		

various

 <p>1</p>			
GEV No.	371332	Ref. No.	SO27
description	solenoid valve single straight 230VAC inlet 3/4" input 10-12l/min DN10 t.max. 90°C duty cycle 100% ROBERTSHAW plastic flow regulating valve inlet white with backflow preventer		

electric components

Зип.Общепит
pressure switchesfor combi-steamers
vsezip.ru

+7(812)987-08-81

various





1

GEV No.	370548	Ref. No.	SO1
description	solenoid valve single 240VAC inlet 3/4"		
For models:	ECO8, ECO9		

drain valves



1

GEV No.	401889	Ref. No.	ODR10
description	drain valve 12V single inlet 40mm outlet 40mm for combi-steamer		
accessories for	401889		
	GEV No.	532727	Ref. No. OGA38
	O-ring silicone thickness 3.5mm ID ø 26mm Qty 5 pcs for model SCC, CM		
	GEV No.	532728	Ref. No. OGA37
	O-ring silicone thickness 3.5mm ID ø 46mm Qty 5 pcs for model SCC, CM		

solenoid valves (refrigeration)

SANHUA

valves



1

GEV No.	374100	Ref. No.	SO21
description	solenoid valve single type FDF6A37 connection 1/4" L 45mm coolant R22/R134a/R404a/R407c/R507a		
For models:	SCR1085, SCR785		

for combi-steamers



1

GEV No.	345709	Ref. No.	OSW10
description	pressure control ø 84mm pressure range 0-3mbar for humidity measuring connection 6mm p max 0.025bar pressure connection 6mm		



1

GEV No.	541329	Ref. No.	OSW03
description	pressure control pressure range 350/150mbar connection 8mm pressure connection 8mm		

for pasta cookers



1

GEV No.	542344	Ref. No.	PS05
description	pressure control pressure range 60/25mbar connection 6mm size 73x43mm pasta cooker pressure connection ø 6mm		

electrodes



1

GEV No.	401912	Ref. No.	LE18
description	level electrode 1/8" total length 230mm probe L 225mm insulated probe lengthmm connection bullet connector ø 6mm		
For models:	EB3, EB4, EB6, EB6T		



1

GEV No.	401913	Ref. No.	LE21
description	level electrode 1/8" total length 23mm		
For models:	EB3, EB4, EB6, EB6T		



Зип Общепит
vsezip.ru
+7(812)987-08-81



1

GEV No.	403805	Ref. No.	OEL20 OEL28
description	level electrode M15x1.5 probe L 12mm total length 325mm insulated probe length 114mm straight connection plug-in connection ø 1.5mm EPDM		



1

GEV No.	401492	Ref. No.	OEL19
description	level electrode probe L 85mm		



1

GEV No.	403298	Ref. No.	OEL29 OEL33
description	level electrode M15x1.5 total length 110mm probe L 85mm insulated probe length 75mm with extension connection coded plug ø 2mm suitable for RATIONAL		



1

GEV No.	403804	Ref. No.	OEL20 OEL28
description	level electrode with cable M15x1.5 probe L 12mm total length 325mm insulated probe length 114mm straight connection plug-in connection ø 1.5mm EPDM		



1

GEV No.	403297	Ref. No.	OEL21
description	level electrode M15x1.5 total length 190mm probe L 165mm insulated probe length 153mm with extension connection coded plug ø 2mm suitable for RATIONAL		

flow meters and flow sensors

flow sensors



1

GEV No.	400163	Ref. No.	OEL03
description	level electrode PG9 total length 100mm probe L 72/43/22mm insulated probe length 70/62/52mm with 3 probes connection grip connection		



1

GEV No.	403301	Ref. No.	OLE05
description	flow sensor inlet ø 10mm outlet ø 10mm L 104mm connection coded plug cable length 1300mm flow rate 1-25l/min		



1

GEV No.	400021	Ref. No.	OEL05
description	level electrode PG9 total length 110mm probe L 70/47/24mm insulated probe length 62/38/16mm with 3 probes connection grip connection		





1

GEV No.	402256	Ref. No.	OLE03
description	flow sensor inlet ø 10mm outlet ø 10mm L 110mm flow rate 1-25l/min		



1

GEV No.	400022	Ref. No.	OEL04	
description	level electrode PG9 total length 135mm probe L 89/59/28mm insulated probe length 80mm with 3 probes connection grip connection			
accessories for	400022			
	GEV No.	379729	Ref. No.	OCA21
description	connection cable L 1230mm 4-pole for level electrode plug type coded			
	GEV No.	550574	Ref. No.	—
description	nut thread PG9 H 3mm WS 28 nickel-plated brass Qty 1 pcs mounting ømm cable ømm			



1

GEV No.	403302	Ref. No.	OSE15
description	flow sensor inlet ø 3/4" ET outlet ø 3/4" IT L 78mm connection coded plug cable length 1300mm flow rate 1-25l/min		



compressors

EMBRACO / ASPERA

R134A

HBP monophase

High evaporation temperature above -15°C



1

GEV No.	605086	Ref. No.	G/CR10
description	compressor coolant R134a type EMT45HDR 220-240V 50Hz HBP fully hermetic 7.7kg 1/8HP power inputW cylinder capacity 3.97cm ³ CSIRWW 162W 207W 256W 314W 383W 467W test method ASHRAE		
For models:	FDB4, FPB5		

R404a/R507

HMBP monophase

High/Medium evaporation temperature above -20/-15 °C



1

GEV No.	605004	Ref. No.	CR08
description	compressor coolant R404a/R507 type EMT6152GK 220-240V 50Hz HMBP fully hermetic 7.8kg 1/5HP cylinder capacity 4.5cm ³ CSIR H 166mmWWW 267W 332W 351W 437W 535W 646W 769W test method ASHRAE		

Зип Общепит

vsezip.ru

+7(812)987-08-81



1

GEV No.	605161	Ref. No.	CR07
description	compressor coolant R404a/R507 type NEK6210GK 220-240V 50Hz HMBP fully hermetic 8.5kg 3/8HP cylinder capacity 8.78cm ³ CSIR H 200mmW 566W 674W 815W 988W 1195W 1435W 1707W		
For models:	SCR1085, SCR785		



1

GEV No.	605125	Ref. No.	CR06
description	compressor coolant R404a/R507 type NEK6213GK 220-240V 50Hz HMBP 11.6kg 1/2HP cylinder capacity 12.12cm ³ CSIR H 206mmW 695W 884W 1093W 1333W 1600W 1894W 2215W test method ASHRAE		

fans

axial fans

ebm-papst



1

GEV No.	601309 ¹	Ref. No.	OFA16
description	axial fan L 127mm W 127mm H 38mm 12VDC 21W bearing ball bearing manuf. no. DV5212N metal connection cable ebm-papst suitable for RATIONAL fan wheel ø 120mm temp.-resist. 65°C		

¹with ball bearings

electric components



Зип Общепит

vsezip.ru

+7(812)987-08-81



1

GEV No.	601752 ¹	Ref. No.	OFA18
description	axial fan L 127mm W 127mm H 38mm 12VDC 21W bearing ball bearing manuf. no. DV5212N plastic/metal connection cable 310mm ebm-papst fan wheel ø 120mm temp.-resist. 65°C SCC Line since 05/2008		

¹with ball bearings



1

GEV No.	602118	Ref. No.	FA120
description	axial fan L 60mm W 60mm H 25.3mm 220-240VAC 50/60Hz 4.4W bearing slide bearing cable length 300mm SUNON		

import



1

GEV No.	601131 ¹	Ref. No.	S/R0181
description	axial fan L 119mm W 119mm H 25mm 230VAC 50/60Hz 19/18W bearing ball bearing connection male faston 2.8mm metal ADDA fan wheel ø 110mm temp.-resist. 70°C		
accessories for	601131		
	GEV No.	Ref. No.	—
	connecting cable cable length 2000mm connection F 2.8 connection distance 7.9mm for axial flow fan		

¹with ball bearings

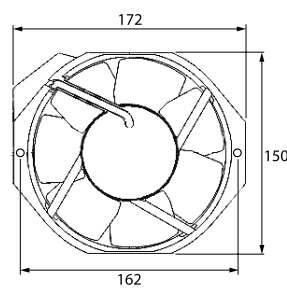
1

GEV No.	601654 ¹	Ref. No.	FA62
description	axial fan L 172mm W 150mm H 51mm 230VAC 50/60Hz 28/24W bearing ball bearing manuf. no. A2175-HBL T.G.N connection cable cable length 280mm metal SUNON fan wheel ø 142mm temp.-resist. -10 up to +80°C mounting distance 162mm		
For models:	SCR1085, SCR785		

¹with ball bearings

accessories

fan guards



1

GEV No.	602141	Ref. No.	OFI02
description	guard with filter for axial flow fan L 126mm W 126mm H 13.5mm mounting distance 115mm suitable for ebm-papst		



1

GEV No.	698721 ¹	Ref. No.	S/R0079
description	axial fan L 119mm W 119mm H 38mm 230VAC 50/60Hz 17/15W bearing ball bearing manuf. no. connection cable cable length 3000mm COMMONWEALTH fan wheel ø 110mm temp.-resist. 70°C input current 0.1A airflow 130m ³ /h 2600rpm		
For models:	CT1, ECO9		

¹with ball bearings

converters



1

GEV No.	381451	Ref. No.	OCO07
description	converter ebm-papst type AC 4400HT 100-240V for combi-steamer SCC_WE, CM_P		



3ип Общежит

Cross flow fans

EMMEVI - FERGAS
with star fixed coil

+7(812)987-08-81

refrigeration fans

refrigeration motors universal

ebm-papst

multi fit fan motors



GEV No.	601756	Ref. No.	FA44
description	fan motor 5W 230V 50/60Hz L1 43.5mm L3 76mm W 61mm cable length 1500mm 1300/1550rpm ebm-papst M4Q045-BD01-75 5 mounting options bearing slide bearing		
spare parts for	601756		
	GEV No.	601413	Ref. No. —
	fixing plate suitable for fanwheel ED ø 32mm shaft ø 7 mounting distance 26mm		

ELCO

N series - standard



GEV No.	601687	Ref. No.	FA109
description	fan motor ELCO 7W 230V 50/60Hz bearing ball bearing connection cable 1500mm cable length 1500mm 1320/1550rpm 3 mounting options VN7-20/1397		

cooling fans



GEV No.	602120	Ref. No.	FA25
description	fan 230V 50Hz 66W W 210mm H 170mm D 160mm shaft Lmm shaft ømm ebm-papst 1450rpm		
For models:	L3, L4		

GEV No.	602122	Ref. No.	FA51
description	cross flow fan 112904 roller ø 60mm roller length 180mm laminated core thickness 30mm 230VAC 28W refrigeration bearing rubber connection F6.3 t.max. -10 up to +80°C 50Hz		
For models:	FDB4, FPB5		

GEV No.	602169	Ref. No.	FA63
description	cross flow fan Emmevi roller ø 60mm roller length 300mm laminated core thickness 20mm motor position right 230V/50Hz 26W refrigeration bearing rubber connection male faston 6.3mm		
For models:	SCR1085, SCR785		

GEV No.	602170	Ref. No.	FA61
description	cross flow fan Emmevi roller ø 60mm roller length 300mm laminated core thickness 20mm motor position right 230V/50Hz 26W refrigeration bearing rubber connection male faston 6.3mm		

hot air motors

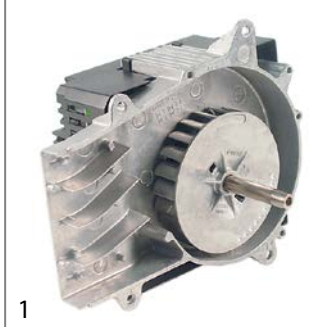

GEV No.	601301	Ref. No.	OFA12
description	fan motor 100-240V 1 phase 50/60Hz 0.45kW 2000rpm speeds 1 L1 160mm L2mm L3mm L4mm M8R IT fan wheel ø 130mm type M3G084-FA22-16		
accessories for	601301		
	GEV No.	511685	Ref. No. OGA29
	shaft seal kit ID ø 15mm ED ø 27mm shaft seal flange mounting gauge with mountign material		

Table continues overleaf

electric components





Зип Общепит

vsezip.ru



+7(812)987-08-81

accessories for	601301		
	GEV No.	601327	Ref. No. —
	fan wheel D1 ø 340mm H1 135mm blades 9 D2 ø 13mm D3 ø 16mm H2 38mm		



GEV No.	602128	Ref. No.	OMO14
description	fan motor 100-240V 50/60Hz 0.55kW 1800rpm L1 162mm L2 52mm L3 14mm with engine shaft gasket type SCC_WE, CM_P 61-202		
spare parts for	602128		
	GEV No.	551347	Ref. No. —
	gasket set SCC_WE, CM_P 61-202		
	GEV No.	551348	Ref. No. —
	insulation SCC_WE, CM_P 61-202 L 248mm bore ø 30mm W 193mm H 15mm		



GEV No.	602126	Ref. No.	OFA21
description	fan motor 200-240V 50/60Hz 0.75kW 1820rpm L1 160mm L2 49mm L3 16mm 3.75A for fan wheel ø 15mm		
spare parts for	602126		
	GEV No.	551347	Ref. No. —
	gasket set SCC_WE, CM_P 61-202		
	GEV No.	551348	Ref. No. —
	insulation SCC_WE, CM_P 61-202 L 248mm bore ø 30mm W 193mm H 15mm		



GEV No.	602121	Ref. No.	FA102
description	fan wheel blades 12 D1 ø 160mm D2 ø 5x6mm H1 27mm		
For models:	ECO76, ECO9, ESLR9, OE7008, OE7010		

GEV No.	511682	Ref. No.	OGA09
description	shaft seal kit ID ø 17mm ED ø 29mm shaft seal flange mounting gauge with mountign material		

hot air fans

ebm-papst

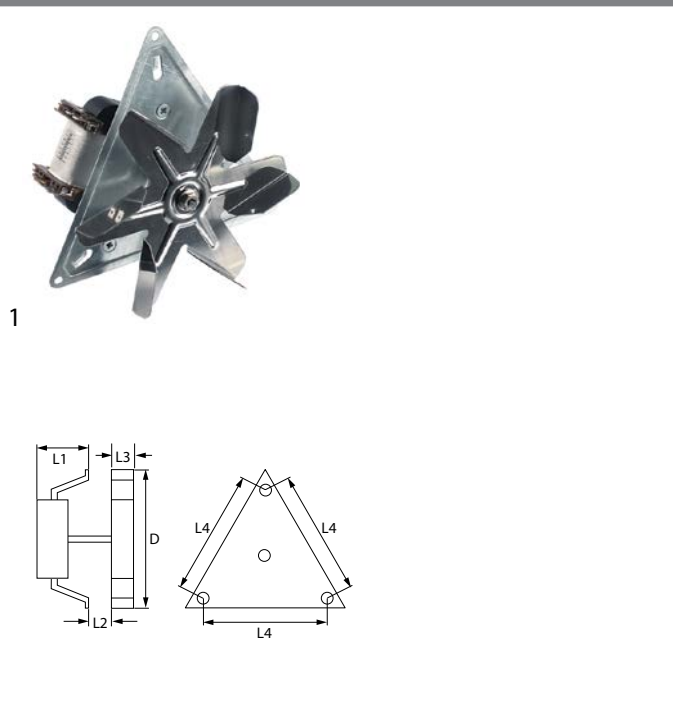

GEV No.	601249	Ref. No.	FA12
description	hot air fan 230V 32W 0.27A L1 60mm L2 20mm L3 20mm L4 157mm fan wheel ø 150mm ebm-papst type R2K150-AC01-15		
For models:	ECO7, ECO76, ECO9, ESLR9, OE7008, OE7010, V6, V6D, V6F, V7		

electric components



Зип Общепит

vsezip.ru

+7(812)987-08-81

miscellaneous



1

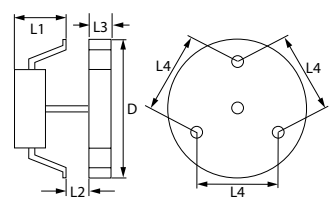

GEV No.	601681	Ref. No.	FA106
description	hot air fan 230V 50Hz L1 59mm L2 13mm L3 21mm L4 86mm fan wheel ø 152mm Emmevi type 260130X		
For models:	ECO8, LCO		

radial fans



1

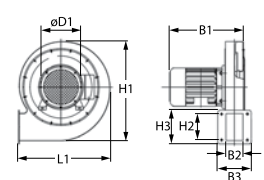

GEV No.	601296	Ref. No.	OMO11
description	radial fan 230V voltage AC 50Hz 140W H1 190mm L1 190mm D1 ø 50mm W1 133mm W2 28mm H2 55mm W3 83mm H3 83mm		



1

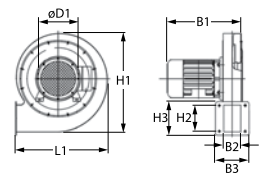

GEV No.	601295	Ref. No.	OMO12
description	radial fan 230V voltage AC 50Hz 50W H1 180mm L1 180mm D1 ø 43mm W1 105mm W2 33mm H2 59mm W3 66mm H3 83mm		



1

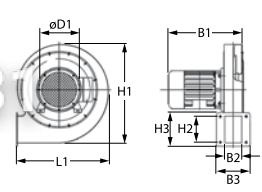

GEV No.	602116	Ref. No.	FA112
description	radial fan 230V voltage AC 50Hz 60W H1 165mm L1 175mm D1 ø 127mm W1 110mm W2 50mm H2 50mm W3 83mm H3 35mm		

motors

gear motors

for conveyor toaster



1

GEV No.	601978	Ref. No.	M013
description	gear motor GLEASON AVERY type RMS125 230V 50Hz 1 phase shaft ø 8x7mm		



1

GEV No.	601682	Ref. No.	MO12
description	gear motor MELLOR type UB1062 230V voltage AC 50Hz 5.2rpm shaft ø 8mm L 140mm W 65mm H 95mm for toaster		



1

GEV No.	601673	Ref. No.	MO25
description	gear motor SPG type ISG-31220ADA 230V voltage AC 50Hz 5.5rpm shaft ø 8x7mm for conveyor toaster		



Зип Общепит

vsezip.ru

+7(812)987-08-81



1

GEV No.	601674	Ref. No.	MCK01
description	gear motor SPG type ISG-31220ADA 230V voltage AC 50Hz 5.5rpm shaft ø 8x7mm for conveyor toaster complete		

for ovens

for flues



1

GEV No.	500873	Ref. No.	OMO10
description	ventilation valve CROUZET type G70C10AFTEG 12V voltage DC shaft ø 6mm L 95mm W 63mm H 136mm for combi-steamer ø 50mm		

pumps

wash and rinse pumps

HANNING pumps

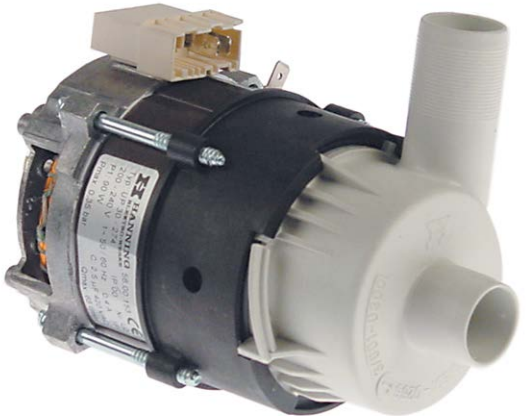

1

GEV No.	500578	Ref. No.	OPU06
description	pump inlet ø 24mm outlet ø 24mm type UP30-274 230V 50/60Hz 1 phase 0.09kW 0.12HP L 145mm rotation direction left capacitor 2.5µF HANNING		
spare parts for	500578		
	GEV No.	Ref. No.	—
	501345		
	O-ring EPDM thickness 3mm ID ø 58mm Qty 1 pcs		



1

GEV No.	500579	Ref. No.	OPU03
description	pump inlet ø 24mm outlet ø 24mm type UP30-275 230V 50/60Hz 1 phase 0.09kW 0.12HP L 145mm rotation direction left capacitor 2.5µF HANNING		
spare parts for	500579		
	GEV No.	Ref. No.	—
	501345		
	O-ring EPDM thickness 3mm ID ø 58mm Qty 1 pcs		



1

GEV No.	499168	Ref. No.	OPU02
description	pump inlet ø 24mm type UP30-890 200-240V 50/60Hz 1 phase 0.1kW L 145mm rotation direction left capacitor 2.5µF HANNING		

drain pumps

HANNING



1

GEV No.	500573	Ref. No.	ODR06
description	drain pump 30W 4-piece 230V inlet ø 24/30mm outlet ø 24mm 50Hz HANNING type DPS25-032 1x pump, 3x pump cover		

Зип.Общепит

fuses
vsezip.ru

+7(812)987-08-81



GEV No.	499215	Ref. No.	OPU05
description	drain pump kit inlet ø 24mm outlet ø 24mm 200-240V 42W 50-60Hz mode of operation S2 max. 15min HANNING type DPS35		



GEV No.	499354	Ref. No.	OPU07
description	drain pump kit inlet ø 24mm outlet ø 24mm 60/62W 50/60Hz 200-240V mode of operation S2 type DPS35 HANNING		

service kits



GEV No.	500573	Ref. No.	ODR06
description	drain pump 30W 4-piece 230V inlet ø 24/30mm outlet ø 24mm 50Hz HANNING type DPS25-032 1x pump, 3x pump cover		

condensators & interference suppression filters

filters

interference suppression filters



GEV No.	365216	Ref. No.	OF110
description	interference suppression filter capacity 3x0.27µFX1+3x0.47µFX1µF 400V for combi-steamer SCC, CM 61-202/E		

fine fuses



GEV No.	358792	Ref. No.	OFU02
description	fine fuse size ø6.3x32mm 10A slow-acting rated 250V Qty 10 pcs		



GEV No.	358791	Ref. No.	OFU01
description	fine fuse size ø6.3x32mm 6.3A slow-acting rated 250V Qty 10 pcs		

electric accessories

cables

power supply cables



GEV No.	551441	Ref. No.	PL202
description	power lead BS1363 angled 3-pole contacts P+N+E max. 13A max 250V with fuse thermoplastic countries GB		
For models:	C6A-100, C6A-75, C6H-100, C6H-75, C6R-105L, C6R-105R, C6R-130L, C6R-130R, CT1, D3H-75, D3R-100, D5H-100, D5H-75, D5R-100, D5R-125, EB3F, ECO8, GG1, HB2, HB3, HB4, HT3, LCG, LCG2, LCO, LD2, LD3, LD4, LDF, LDF2, LGR, LGR2, LGT, LPB, LPG, LPG2, LPO, LRG, LRG2, SCH1085, SCH785, SCR1085, SCR785, UM50, UM50D, UM050, UMS50, UMS50D, UMSO50, UMSO50D		



GEV No.	551454	Ref. No.	PL201
description	power lead BS1363/A 3-pole contacts P+N+E 1mm ² max. 10A max 250V 1.4m with fuse countries UK Qty 1 pcs connection with power terminal block black H05RN-F		
For models:	BM3, BM3W, BM4, BM4W, BM6, BM6W, BM7, BM7W, BS3, BS3W, BS4, BS4W, BS7, BS7W, CS4, CS4G, CS6, FDB4, FPB5, G1A, HC3, HC4, HC6, HC7, HCL3, HCL4, HCL6, HCL7, HCL9, L3, L4, LBM, LBM2, LBM2W, LBM3, LBMW, LCS, LPW, LPW-LR, LRB, LRB2W, LRB3, LRB3W, LRBW		





GEV No.	551455	Ref. No.	PL143
description	power lead BS1363/A 3-pole contacts P+N+E 1mm ² max. 13A max 250V 1.9m with fuse countries UK Qty 1 pcs connection black H05RN-F		
For models:	FWD, FWDG, KFCWD		



Зип Общепит
vsezip.ru
+7(812)987-08-81

spiral cables

			
1			
GEV No.	551329	Ref. No.	PL157
description	spiral cable plug type BS1363 1.5mm ² 3-pole with plug L 500mm expansion 5:1 countries GB black		
For models:	GBM2, GBM3		

			
1			
GEV No.	579001	Ref. No.	OCA12
description	data cable L 1300mm 8-pole suitable for RATIONAL plug type RJ45		
			
1			
GEV No.	579002	Ref. No.	OCA19
description	data cable L 800mm 8-pole for combi-steamer suitable for SCC Line plug type RJ45		

earthing cables

			
1			
GEV No.	104684	Ref. No.	IG37
description	earthing cable connection F2.8mm / lug M5 cable length 350mm 1.5mm ²		

silicone cable

up to 180°C

			
1			
GEV No.	551312	Ref. No.	CA87
description	silicone cable 3-pole 1.5mm ² insulation silicone red permanent temperature -60 up to +180°C t.max. 230°C conductor copper		

accessories

protection hoses

miscellaneous

			
1			
GEV No.	550997	Ref. No.	CO239 CO76
description	protection pipe ED ø 16mm plastic		

connection cables

			
1			
GEV No.	379729	Ref. No.	OCA21
description	connection cable L 1230mm 4-pole for level electrode plug type coded		
accessories for	379729		
	GEV No.	Ref. No.	OEL04
	level electrode PG9 total length 135mm probe L 89/59/28mm insulated probe length 80mm with 3 probes connection grip connection		

terminals

terminal blocks

			
1			
GEV No.	550232	Ref. No.	TE10
description	lustre terminal 12-pole cross section 2.5mm ² max. 32A max 450V temp.-resist. 150°C		
For models:	AS3, AS4		

			
1			
GEV No.	550838	Ref. No.	TE14
description	lustre terminal 12-pole cross section 6mm ² max. 41A max 750V temp.-resist. 150°C		
For models:	OE7112		

connection terminals with screw/faston connections

			
1			
GEV No.	551260	Ref. No.	TE47
description	power terminal block 7-pole max. 40A max 450V connection M5/ male faston 6.3mm temp.-resist. 150°C		
For models:	OE7008		



connection boxes



1			
GEV No.	551337	Ref. No.	TE45
description	power terminal block 5-pole contacts 3P+N+E with lid		
For models:	AS4, DF36, DF39, DF46, DF49, DF612, DF618, DF665T, ECG6, ECO9, HT6, HT7, J6, J9, OE7012, OE7303, OE7304, OE7503		

gas taps

PEL

20S series



1			
GEV No.	107798	Ref. No.	VA41
description	gas tap PEL type 20S gas inlet pipe flange ø21mm bypass nozzle ø 0.8 barmm gas outlet M16x1.5 (tube ø 10/8mm) thermocouple connection M8x1 pilot connection shaft ø 8x6.5mm shaft L 45/17mm shaft flat upper without ignition flame connection		



1			
GEV No.	107799	Ref. No.	VA42
description	gas tap PEL type 20S gas inlet pipe flange ø21mm bypass nozzle ø 0mm gas outlet M16x1.5 (tube ø 10/8mm) thermocouple connection M9x1 pilot connection shaft ø 8x6.5mm shaft L 45/17mm shaft flat lower without ignition flame connection		

21S series



1			
GEV No.	107797	Ref. No.	VA40
description	gas tap PEL type 21S/O gas inlet pipe flange ø21mm bypass nozzle ø 0mm gas outlet M16x1.5 (tube ø 10/8mm) thermocouple connection M9x1 pilot connection M10x1 shaft ø 8x6.5mm shaft L 45/17mm shaft flat lower		

spare parts for 107797



GEV No.	101060	Ref. No.	—
description	magnet unit standard L 39mm D1 ø 15.4mm D2 ø 11mm suitable for PEL20-21/JUNKERS/EGA		

Зип-Общепит

vsezip.ru

+7(812)987-08-81

spare parts for 107797			
GEV No.	101231	Ref. No.	—
description	thermocouple nut T1: M9x1 T2: M18x1		
GEV No.	101880	Ref. No.	—
description	gasket Viton ED ø 14mm ID ø 9mm thickness 7.7mm Qty 1 pcs		
accessories for 107797			
GEV No.	101278	Ref. No.	—
description	olive for pipe ø 10mm Qty 1 pcs		
GEV No.	101300	Ref. No.	—
description	union nut thread M16x1.5 tube ø 10mm		

22S/O series



1			
GEV No.	107800	Ref. No.	V43
description	gas tap PEL type 22S/O gas inlet pipe flange ø21mm bypass nozzle ø 0mm gas outlet M20x1.5 (tube ø 12/10mm) thermocouple connection M9x1 pilot connection M10x1 shaft ø 8x6.5mm shaft L 33/17mm shaft flat left		



1			
GEV No.	107803	Ref. No.	VA45
description	gas tap PEL type 22S/O gas inlet pipe flange ø21mm bypass nozzle ø 0mm gas outlet M20x1.5 (tube ø 12/10mm) thermocouple connection M9x1 pilot connection M10x1 shaft ø 8x6.5mm shaft L 33/17mm shaft flat lower		

COPRECI

CAL-24200



1			
GEV No.	109202	Ref. No.	VA09
description	gas tap COPRECI type CAL-24200 gas inlet pipe flange ø14mm bypass nozzle ø 0.35mm gas outlet 1/4" thermocouple connection M8x1 pilot connection shaft ø 6x4.6mm shaft flat upper shaft L 28/13mm pipe input ø 8mm		
For models:	CG4, CG6		





Зип Общежит
miscellaneous

vsezip.ru







+7(812)987-08-81

			
1			
GEV No.	109203	Ref. No.	VA11
description	gas tap with pin COPRECI type CAL-24200 gas inlet pipe flange ø14mm bypass nozzle ø 0.35mm gas outlet 1/4" thermocouple connection M8x1 pilot connection shaft ø 6x4.6mm shaft flat upper shaft L 28/13mm pipe input ø 8mm		
For models:	GS4, GS7		

			
1			
GEV No.	107810	Ref. No.	VA70/S
description	gas tap gas inlet 1/4" gas outlet 1/4" pilot connection M8x1 thermocouple connection M8x1 shaft ø 6x4.6mm shaft L 34/12mm shaft flat upper with screw connection		

<p>CAL-5200</p> 			
1			
GEV No.	109138	Ref. No.	VA64 VA64/S
description	gas tap COPRECI type CAL-5200 gas inlet pipe flange ø21mm bypass nozzle ø 0.76+0.51mm gas outlet M14x1.5 (tube ø 8mm) thermocouple connection M8x1 pilot connection shaft ø 7x5mm shaft L 45/20mm shaft flat lower pipe input ø 8mm		

			
1			
GEV No.	107808	Ref. No.	VA17
description	gas tap gas inlet pipe flange ø14mm bypass nozzle ø 0.35mm gas outlet M13x1 IT thermocouple connection M8x1 pilot connection shaft ø 6x4.6mm shaft flat upper shaft L 22/13mm pipe input ø 8mm		

<p>SABAF</p> 			
1			
GEV No.	106692	Ref. No.	VA10A VA10S
description	gas tap SABAF type 10 gas inlet pipe flange ø16mm bypass nozzle ø 0.5mm gas outlet M13x1 IT (tube ø 8mm) front fixing thermocouple connection M8x1 shaft ø 8x6.5mm shaft L 31/12mm shaft flat lower pipe outlet ø 8mm		
spare parts for	106692		
	GEV No.	101051	Ref. No. —
	magnet unit L 27mm D1 ø 12.5mm D2 ø 8.5mm suitable for JUNKERS/EGA/MADEC/SABAF standard		
	GEV No.	101376	Ref. No. —
	gasket ID ø 8mm ED ø 12mm H 3/5mm		
	GEV No.	101751	Ref. No. —
	bracket		
accessories for	106692		
	GEV No.	101277	Ref. No. —
	olive ID ø 8mm Qty 1 pcs		
	GEV No.	101477	Ref. No. —
	union screw thread M13x1 tube ø 8mm Qty 1 pcs		

NEGABAN GAS

			
1			
GEV No.	107820	Ref. No.	VA01
description	gas tap type NGC 6802 gas inlet 1/4" bypass nozzle ømm gas outlet 1/4" thermocouple connection M9x1 pilot connection M10x1 for ignition electrode		
For models:	CS4N, CS4P		

gas thermostats

DUNGS

			
1			
GEV No.	103309	Ref. No.	VA08
description	gas thermostat DUNGS type BM 751 0-80°C gas inlet 1/2" bypass nozzle ø 0.7mm gas outlet 1/2" thermocouple connection M9x1 pilot connection M10x1 capillary pipe 950mm probe ø 8mm probe L 76mm		

SIT

710 Minisit series



GEV No.	103308	Ref. No.	VA18
description	gas thermostat SIT type 0710763 t.max. 200°C 120-200°C gas inlet 1/2" gas outlet 3/8" thermocouple connection M9x1 pilot connection M10x1 probe ø 6mm probe L 102mm capillary pipe 990mm probe type type D1 pressure regulator 3-18mbar gland nut M14x1.5		
spare parts for	103308		
	GEV No.	101053	Ref. No. —
	magnet unit T1: M9x1 T2: M24x1 L 45mm ø 17mm suitable for Minisit		
	GEV No.	101504	Ref. No. —
	gas connection thread 1/2" angled without O-ring MINISIT 710		
	GEV No.	106225	Ref. No. —
	probe 120-200°C probe ø 6mm probe L 102mm capillary pipe 1050mm t.max. 200°C fryer probe type type D1 suitable for MINISIT 710		

PEL

25ST series



GEV No.	106658	Ref. No.	TH64
description	gas thermostat PEL type 25ST up to 280°C gas inlet pipe flange ø21mm bypass nozzle ø 0.8mm gas outlet M16x1.5 (tube ø 10/8mm) thermocouple connection M9x1 pilot connection M10x1 capillary pipe 1200mm probe ø 6mm probe L 120mm shaft ø 8x6.5mm shaft L 45x22mm		
spare parts for	106658		
	GEV No.	100409	Ref. No. —
	bypass nozzle type PEL22 bore ø 0.8mm thread M6x0.5		
	GEV No.	101060	Ref. No. —
	magnet unit standard L 39mm D1 ø 15.4mm D2 ø 11mm suitable for PEL20-21/JUNKERS/EGA		
	GEV No.	106200	Ref. No. —
	nut thread M9x1 suitable for PEL 24/25S		
accessories for	106658		
	GEV No.	100908	Ref. No. —
	union screw thread M10x1 for pipe ø 4mm Qty 1 pcs		
	GEV No.	100909	Ref. No. —
	union screw thread M10x1 for pipe ø 6mm Qty 1 pcs		
	GEV No.	101246	Ref. No. —
	olive for pipe ø 4mm Qty 1 pcs		

Зип-Общепит

vsezip.ru

+7(812)987-08-81

	GEV No.	101278	Ref. No.	—
	olive for pipe ø 10mm Qty 1 pcs			
	GEV No.	101286	Ref. No.	—
	olive ID ø 6mm Qty 1 pcs			
	GEV No.	101300	Ref. No.	—
	union nut thread M16x1.5 tube ø 10mm			
	GEV No.	101450	Ref. No.	—
	olive for pipe ø 8mm L 12.7mm Qty 1 pcs ED ø 10mm			
	GEV No.	101451	Ref. No.	—
	union nut thread M16x1.5 tube ø 8mm			
	GEV No.	110079	Ref. No.	—
	knob dial plate gas thermostat 1-8 silver			
	GEV No.	110081	Ref. No.	—
	knob ø 70mm shaft ø 8x6.5mm shaft flat universal			

	GEV No.	106648	Ref. No.	TH65
description	gas thermostat PEL type 25ST up to 280°C gas inlet pipe flange ø21mm bypass nozzle ø 0mm gas outlet M16x1.5 (tube ø 10/8mm) thermocouple connection M9x1 pilot connection M10x1 capillary pipe 1200mm probe ø 6mm probe L 120mm shaft ø 8x6.5mm shaft L 45/22mm shaft flat lower			
For models:	OG7202N, OG7202P, OG7204N, OG7204P, OG7208N, OG7208P			
spare parts for	106648			
	GEV No.	101060	Ref. No.	—
	magnet unit standard L 39mm D1 ø 15.4mm D2 ø 11mm suitable for PEL20-21/JUNKERS/EGA			
	GEV No.	106191	Ref. No.	—
	bypass nozzle type PEL22 bore ø 0mm thread M6x0.5			
	GEV No.	106200	Ref. No.	—
	nut thread M9x1 suitable for PEL 24/25S			
accessories for	106648			
	GEV No.	100908	Ref. No.	—
	union screw thread M10x1 for pipe ø 4mm Qty 1 pcs			
	GEV No.	100909	Ref. No.	—
	union screw thread M10x1 for pipe ø 6mm Qty 1 pcs			
	GEV No.	101246	Ref. No.	—
	olive for pipe ø 4mm Qty 1 pcs			
	GEV No.	101278	Ref. No.	—
	olive for pipe ø 10mm Qty 1 pcs			
	GEV No.	101286	Ref. No.	—
	olive ID ø 6mm Qty 1 pcs			

Table continues overleaf



Зип Общепит

SABAF





vsezip.ru





+7(812)907-08-81

1





image not available

accessories for 106648			
	GEV No.	101300	Ref. No. —
union nut thread M16x1.5 tube ø 10mm			
	GEV No.	101450	Ref. No. —
olive for pipe ø 8mm L 12.7mm Qty 1 pcs ED ø 10mm			
	GEV No.	101451	Ref. No. —
union nut thread M16x1.5 tube ø 8mm			
	GEV No.	110079	Ref. No. —
knob dial plate gas thermostat 1-8 silver			
	GEV No.	110081	Ref. No. —
knob ø 70mm shaft ø 8x6.5mm shaft flat universal			

GEV No. 106729		Ref. No.		TH17 TH17 (nozzle 0,54mm)
description gas thermostat SABAF t.max. 300°C gas inlet pipe flange bypass nozzle ø 0.54mm gas outlet 3/8" ET (tube ø 10mm) thermocouple connection M8x1 capillary pipe 1200mm probe ø 4mm probe L 140mm shaft ø 6x4.6mm shaft L 22/13mm				
accessories for 106729				
	GEV No.	101278	Ref. No.	—
olive for pipe ø 10mm Qty 1 pcs				
	GEV No.	101478	Ref. No.	—
union nut thread 3/8" for pipe ø 10mm				
	GEV No.	101751	Ref. No.	—
bracket				

COPRECI

			
1			
GEV No. 109201		Ref. No. TH201/S	
description gas thermostat COPRECI type MT7200 gas inlet pipe flange ø21mm bypass nozzle ø 0.74+0.51mm gas outlet M16x1.5 (tube ø 10mm) pilot connection closed thermocouple connection M8x1 capillary pipe 835mm probe ø 4.5mm probe L 92mm shaft ø 7x5mm shaft L 41.5/20mm shaft flat lower with knob pipe input ø 8mm			
spare parts for 109201			
	GEV No.	101040	Ref. No. —
magnet unit high temperature L 35mm D1 ø 15.4mm D2 ø 11mm suitable for PEL20-21/JUNKERS/EGA			
	GEV No.	101060	Ref. No. —
magnet unit standard L 39mm D1 ø 15.4mm D2 ø 11mm suitable for PEL20-21/JUNKERS/EGA			
	GEV No.	101376	Ref. No. —
gasket ID ø 8mm ED ø 12mm H 3/5mm			
	GEV No.	101537	Ref. No. —
gasket ID ø 8mm ED ø 11.5mm H 3mm Qty 1 pcs			
	GEV No.	101538	Ref. No. —
clamp			
	GEV No.	107431	Ref. No. —
gasket set ID ø 8mm ED ø 11.5mm H 3mm Qty 7 pcs			

		1		
GEV No. 101819		Ref. No.		TH17 TH17 (nozzle 0,5mm) TH17/S
description gas thermostat SABAF t.max. 300°C gas inlet pipe flange bypass nozzle ø 0.5mm gas outlet 3/8" ET (tube ø 10mm) thermocouple connection M8x1 capillary pipe 1200mm probe ø 4mm probe L 140mm shaft ø 6x4.6mm shaft L 22/13mm				
spare parts for 101819				
	GEV No.	101376	Ref. No.	—
gasket ID ø 8mm ED ø 12mm H 3/5mm				
accessories for 101819				
	GEV No.	101278	Ref. No.	—
olive for pipe ø 10mm Qty 1 pcs				
	GEV No.	101478	Ref. No.	—
union nut thread 3/8" for pipe ø 10mm				
	GEV No.	101751	Ref. No.	—
bracket				

1 gas components

Зип-Общепит

vsezip.ru

+7(812)987-08-81



1

GEV No.	107809	Ref. No.	TH16/S
description	gas thermostat SABAF t.max. 300°C gas inlet pipe flange ø16mm bypass nozzle ø 0.5mm gas outlet 3/8" ET (tube ø 10mm) thermocouple connection M8x1 pilot connection capillary pipe 2120mm probe ø 4mm probe L 140mm shaft ø 6x4.6mm shaft L 22/13mm shaft flat lower		



1

GEV No.	106012	Ref. No.	VA57
description	gas valve type VK4115V 220-240V 50/60Hz gas inlet flange 32x32mm gas outlet flange 32x32mm thermocouple connection pilot connection pressure range 15-60mbar max 60mbar operator type HONEYWELL flange 32x32mm		

gas valves and ignition boxes



gas control valves

DUNGS



1

GEV No.	106050	Ref. No.	OVA04
description	gas valve 230V 50/60Hz gas inlet 1/2" gas outlet 1/2" DUNGS type GB 055 243 443		

accessories for	106012			
	GEV No.	102845	Ref. No.	—
	gas connection angled 1/2" flange 32x32mm hole distance 24x24mm Tandem			
	GEV No.	102846	Ref. No.	—
	gas connection straight 1/2" flange 32x32mm hole distance 24x24mm suitable for Tandem			



1

GEV No.	106051	Ref. No.	OVA03
description	gas valve 230V 50/60Hz gas inlet 1/2" gas outlet 1/2" DUNGS type GB-WND 055 243 442		

SIT
NOVASIT



1

GEV No.	107239	Ref. No.	VA20
description	gas valve SIT series Novasit 820 0.17VHz gas inlet 1/2" gas outlet 1/2" thermocouple connection M9x1 pilot connection M10x1 ignition pressure 3-5mbar pressure range 3-30mbar pressure regulator connection blind equiv. no. 0820303 supply Operator millivolt		





For models:	DF4, DF7, J10, J5, OG7106, OG7502			
spare parts for	107239			
	GEV No.	100110	Ref. No.	PI08
	pilot burner SIT type 190 series 3 flames nozzle ømm gas connectionmm			
	GEV No.	101065	Ref. No.	—
	magnet unit with cable L 44mm D1 ø 30mm D2 ø 20mm suitable for NOVASIT			
	GEV No.	101305	Ref. No.	—
	gas connection straight 1/2" flange 45x45mm ELETTROSIT/V4400/4600/4605 suitable for SIT/HONEYWELL hole distance 36x36mm			
	GEV No.	101306	Ref. No.	—
	gas connection angled flange 45x45mm hole distance 36x36mm 1/2" ELETTROSIT/V4400/4600/4605 screw with O-ring suitable for SIT/HONEYWELL			
	GEV No.	101307	Ref. No.	—
	gas connection straight flange 45x45mm hole distance 36x36mm 3/4" ELETTROSIT/V4400/4600/4605 screw with O-ring suitable for SIT/HONEYWELL			

Table continues overleaf



Зип.Общепит
ignition parts





pilot burners
vsezip.ru

160 series

+7(812)987-08-81



1

spare parts for 107239			
	GEV No.	101308	Ref. No. —
gas connection angled flange 45x45mm hole distance 36x36mm 3/4" ELETTROSIT/V4400/4600/4605 screw with O-ring suitable for SIT HONEYWELL			
	GEV No.	101312	Ref. No. —
microswitch			
	GEV No.	101799	Ref. No. —
knob adapter shaft ø 10x8mm shaft L 18mm catch lower suitable for ZANUSSI shaft flat upper			
	GEV No.	102116	Ref. No. TC41
thermopile ROBERTSHAW L 900mm probe ø 9mm probe L 57mm 250-750mV screw connection 7/16"			

ignition boxes

miscellaneous



1















GEV No.	107679	Ref. No.	OIG13
description	ignition box type		
spare parts for	107679		
	GEV No.	579004	Ref. No. —
data cable L 1800mm 6-pole for combi-steamer SCC, CM plug type RJ45/YY			



1

GEV No.	107191 ¹	Ref. No.	OIG05
description	ignition box type with connection cable		
accessories for	107191		
	GEV No.	579004	Ref. No. —
data cable L 1800mm 6-pole for combi-steamer SCC, CM plug type RJ45/YY			

¹with connection cable

GEV No.	100105	Ref. No.	PI27
description	pilot burner SIT type 160 series 3 flames nozzle ømm gas connectionmm		
For models:	CS4N, CS4P		
spare parts for	100105		
	GEV No.	100907	Ref. No. —
screw connection thread M10x1 Qty 1 pcs type SEF 1 ømm for thermocouple			
accessories for	100105		
	GEV No.	100202	Ref. No. —
pilot burner nozzle natural gas code 41 Qty 1 pcs nozzle ø 0.41mm			
	GEV No.	100203	Ref. No. —
pilot burner nozzle LPG code 25 Qty 1 pcs nozzle ø 0.25mm			
	GEV No.	100701	Ref. No. IIG08
ignition electrode connection M4 Qty 1 pcs			
	GEV No.	100801	Ref. No. —
gasket for pilot burner Qty 1 pcs			
	GEV No.	100869	Ref. No. —
pilot burner nozzle natural gas code 51 Qty 1 pcs suitable for 160 series nozzle ø 0.51mm			
	GEV No.	100906	Ref. No. —
screw connection thread M10x1 for ignition electrode brass Qty 1 pcs WS 10			
	GEV No.	100908	Ref. No. —
union screw thread M10x1 for pipe ø 4mm Qty 1 pcs			
	GEV No.	100909	Ref. No. —
union screw thread M10x1 for pipe ø 6mm Qty 1 pcs			
	GEV No.	101282	Ref. No. —
olive for pipe ø 4mm L 7.4mm Qty 1 pcs			
	GEV No.	101287	Ref. No. —
olive for pipe ø 6mm Qty 1 pcs			
	GEV No.	102110	Ref. No. —
pilot tube copper pipe ø 4mm thickness 1mm L 3000mm			
	GEV No.	102111	Ref. No. —
pilot tube copper pipe ø 6mm thickness 1mm L 3000mm			
	GEV No.	107650	Ref. No. JE56
pilot burner nozzle SIT LPG code 30 Qty 1 pcs			

1 gas components

Зип-Общепит













vsezip.ru

+7(812)987-08-81

190 series



1

GEV No.	100110	Ref. No.	PI08
description	pilot burner SIT type 190 series 3 flames nozzle ømm gas connectionmm		
For models:	DF4, DF7, OG7502		
accessories for	100110		
	GEV No.	100202	Ref. No. —
	pilot burner nozzle natural gas code 41 Qty 1 pcs nozzle ø 0.41mm		
	GEV No.	100203	Ref. No. —
	pilot burner nozzle LPG code 25 Qty 1 pcs nozzle ø 0.25mm		
	GEV No.	100701	Ref. No. IIG08
	ignition electrode connection M4 Qty 1 pcs		
	GEV No.	100906	Ref. No. —
	screw connection thread M10x1 for ignition electrode brass Qty 1 pcs WS 10		
	GEV No.	100907	Ref. No. —
	screw connection thread M10x1 Qty 1 pcs type SEF 1 ømm for thermocouple		
	GEV No.	100908	Ref. No. —
	union screw thread M10x1 for pipe ø 4mm Qty 1 pcs		
	GEV No.	100909	Ref. No. —
	union screw thread M10x1 for pipe ø 6mm Qty 1 pcs		
	GEV No.	101282	Ref. No. —
	olive for pipe ø 4mm L 7.4mm Qty 1 pcs		
	GEV No.	101287	Ref. No. —
	olive for pipe ø 6mm Qty 1 pcs		
	GEV No.	102110	Ref. No. —
	pilot tube copper pipe ø 4mm thickness 1mm L 3000mm		
	GEV No.	102111	Ref. No. —
	pilot tube copper pipe ø 6mm thickness 1mm L 3000mm		
	GEV No.	107650	Ref. No. JE56
	pilot burner nozzle SIT LPG code 30 Qty 1 pcs		

pilot burners

1

GEV No.	107817	Ref. No.	PI30
description	pilot burner 3 natural/liquid gas nozzle nozzle ømm gas pressure-bar code gas connection M10x1mm		

ROBERTSHAW

pilot burners

universal series - type 5



1

GEV No.	106088	Ref. No.	PI14
description	pilot burner ROBERTSHAW type 5CHL-1 2 flames code for pipe ø		

universal series - type 6

Width of caps:
 6CH10 = 1" (25,4mm)
 6CH14 = 1½" (38,1mm)
 6CH24 = 2½" (63,5mm)
 6CH30 = 3" (76,2mm)



1

GEV No.	106117	Ref. No.	PI125 PI25
description	pilot burner ROBERTSHAW type 6CH24-1 3 flames natural gas code 26 for pipe ø 1/4" CCT gas connection 1/4" CCTmm nozzle ømm		
For models:	J10, J5, OG7106, OG7202N, OG7202P, OG7204N, OG7204P, OG7208N, OG7208P		



Зип-Общепит

vsezip.ru

+7(812)987-08-81

producer-specific pilot burners

LINCAT

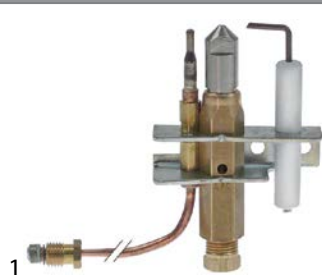

GEV No.	107815	Ref. No.	PI18
description	pilot burner 1 LPG nozzle nozzle \varnothing mm code gas connection M10x1mm		

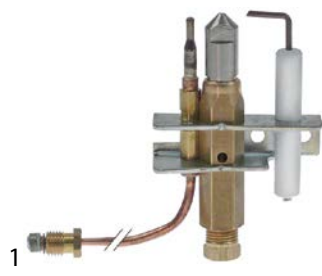

GEV No.	107816	Ref. No.	PI17
description	pilot burner 1 natural gas nozzle nozzle \varnothing mm code gas connection M10x1mm		



GEV No.	107817	Ref. No.	PI30
description	pilot burner 3 natural/liquid gas nozzle nozzle \varnothing mm gas pressure-bar code gas connection M10x1mm		

electrodes



GEV No.	106829	Ref. No.	OGA26
description	gasket for ignition electrode ID \varnothing 10mm hole \varnothing 4.5mm L 27mm W 17mm		



GEV No.	550897	Ref. No.	OGA23
description	gasket ignition electrode graphite thickness 2.5mm hole distance 27mm		



GEV No.	100701	Ref. No.	IIG08	
description	ignition electrode connection M4 Qty 1 pcs			
accessories for	100701			
	GEV No.	100906	Ref. No.	—
	screw connection thread M10x1 for ignition electrode brass Qty 1 pcs WS 10			

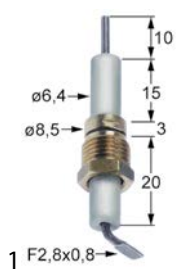

GEV No.	107281	Ref. No.	IG15
description	ignition electrode D1 \varnothing 6.4mm D2 \varnothing 8.5mm L1 10mm BL1 15mm BL2 3mm BL3 20mm connection male faston 2.8mm M10x1		
For models:	DF4, DF7		

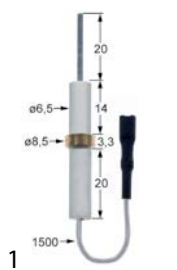

GEV No.	107818	Ref. No.	IG17
description	ignition electrode D1 \varnothing 6.5mm cable length 1500mm connection F2.8 D2 \varnothing 8.5mm L1 20mm BL1 14mm BL2 3.3mm BL3 20mm		



GEV No.	107819	Ref. No.	IG05
description	ignition electrode D1 \varnothing 6x7mm connection F2.8 L1 10mm L2 3mm BL1 14.5mm BL2 15mm BL3 14mm		



Зип Общепит

vsezip.ru

+7(812)987-08-81



GEV No.	107891	Ref. No.	IG03
description	ignition electrode D1 ø 7mm D2 ø 8.5mm connection male faston 2.8mm BL1 28mm BL2 3mm BL3 22mm		



GEV No.	102645	Ref. No.	IG14
description	ignition electrode flange length 19mm flange width 12mm D1 ø 6.3mm D2 ø 6.3mm L1 11mm L2 15mm BL1 16mm BL2 12mm connection male faston 2.8mm		
For models:	J10, J5, OG7202N, OG7202P, OG7204N, OG7204P, OG7208N, OG7208P		



GEV No.	107811	Ref. No.	IG30
description	ignition electrode flange length 20mm flange width 12mm D1 ø 6.5mm D2 ø 6.5mm L1 14mm L2 14mm L4 10mm BL1 16mm BL2 12mm connection F 2.8		



GEV No.	107812	Ref. No.	IG16
description	ignition electrode flange length 20mm flange width 12mm D1 ø 6.5mm D2 ø 6.5mm L1 4mm L2 16mm BL1 12mm BL2 16mm		
For models:	SLR6, SLR9		



GEV No.	102879	Ref. No.	OIG08
description	ignition electrode flange length 26mm flange width 16mm D1 ø 9mm L1 9mm L2 73mm BL1 82mm BL2 14mm connection F 4.8x0.8mm cable length 400mm mounting distance 19mm with flange		



GEV No.	103326	Ref. No.	OEL31
description	ignition electrode flange length 30mm flange width 17.5mm D1 ø 9mm L1 60mm L2 18mm BL1 27mm BL2 29mm fixing dimensions M4mm flange SCC_WE, CM_P 61-101/201G		



GEV No.	103333	Ref. No.	OIG09
description	ignition electrode flange length 30mm flange width 17mm D1 ø 9mm L1 37mm L2 10mm BL1 15mm BL2 25mm fixing dimensions M4mm with flange with earthing contact		



Зип Общепит

vsezip.ru

+7(812)987-08-81

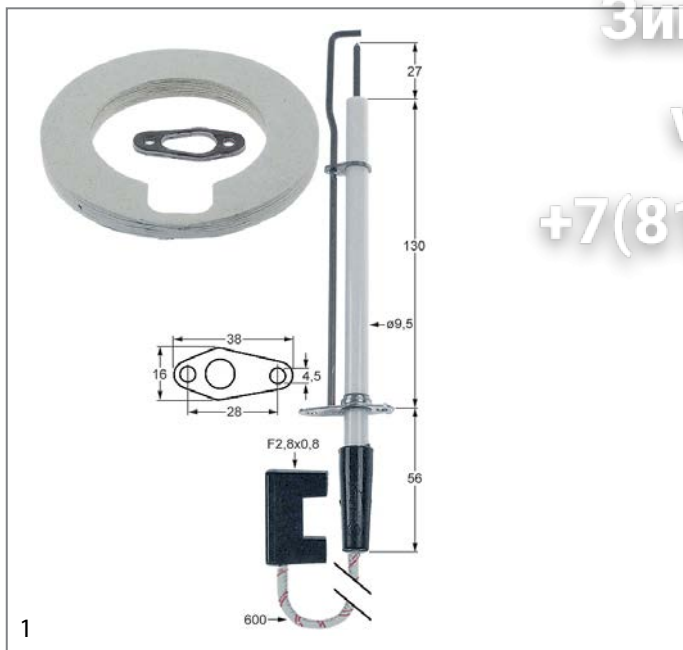

GEV No.	102884	Ref. No.	OIG06
description	ignition electrode flange length 38mm flange width 16mm D1 ø 9.5mm L1 27mm BL1 130mm BL2 56mm connection F 2.8x0.8mm cable length 600mm fixing dimensions ø4.5mm mounting distance 28mm with flange with earthing contact		



GEV No.	107814	Ref. No.	IG46
description	ignition electrode flange length 38mm flange width 17mm D1 ø 9.5mm D2 ø 9.5mm L1 45mm L2 5mm BL1 24mm BL2 5mm BL3 50mm connection ø 6mm		



GEV No.	107813	Ref. No.	IG43
description	ignition electrode flange length 38mm flange width 17mm D1 ø 9.5mm D2 ø 9.5mm L1 9mm L2 44.5mm BL1 24mm BL2 41mm connection ø 4mm		

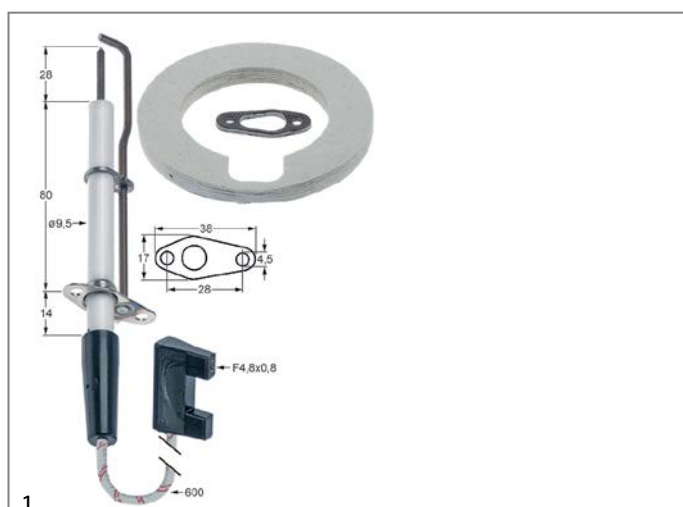

GEV No.	102883	Ref. No.	OIG07
description	ignition electrode flange length 38mm flange width 17mm D1 ø 9.5mm L1 28mm BL1 80mm BL2 14mm connection F 4.8x0.8mm cable length 600mm fixing dimensions ø4.5mm mounting distance 28mm with flange with earthing contact		

Зип Общепит

GEV No.	100037	Ref. No.	IG06
description	ignition cable cable length 900mm connection F2.8mm / F2.8mm		
For models:	J10		

+7(812)987-08-81

piezoelectric igniters

mounting diameter 22mm



GEV No.	103304	Ref. No.	OIG12
description	ignition electrode with accessories flange length 38mm flange width 16mm D1 ø 9mm BL1 54mm BL2 144mm cable length 575mm		



GEV No.	102647	Ref. No.	IG12
description	piezoelectric igniter body plastic blowing mounting ø 22mm connection F2.8x0.8 cable lengthmm		
For models:	SLR9		

ignition cables

pre-assembled cables

GEV No.	100190	Ref. No.	IG18
description	ignition cable cable length 1200mm connection F2.8mm / F2.8mm		
For models:	SLR6, SLR9		

GEV No.	102184	Ref. No.	IG11
description	ignition cable cable length 1500mm connection ø2.4mm / lug M4		

GEV No.	103306	Ref. No.	IG44
description	ignition cable cable length 445mm connection F4.8/ø4mm silicone ED ø 5mm		

GEV No.	100036	Ref. No.	IG39
description	ignition cable cable length 500mm connection F2.8mm / F2.8mm		

GEV No.	103305	Ref. No.	IG45
description	ignition cable cable length 645mm connection F6.3mm / ø6.5mm ED ø 5mmmm		



GEV No.	102639	Ref. No.	IG38
description	piezoelectric igniter body plastic blowing mounting ø 22mm connection male faston 2.8mm cable lengthmm		
For models:	OG7202N, OG7202P, OG7204N, OG7204P, OG7208N, OG7208P, OG7502		



GEV No.	100013	Ref. No.	IG35
description	piezoelectric igniter body plastic blowing mounting ø 22mm connection ø2.4mm cable lengthmm		
accessories for	100013		

GEV No.	100023	Ref. No.	—
description	female bullet size 2.3mm 0.5-1.5mm ² CuZn t.max. 125°C Qty 20 pcs		

miscellaneous



GEV No.	102635	Ref. No.	SI13
description	piezoelectric igniter		



Зип Общепит

vsezip.ru

+7(812)987-08-81



1

GEV No.	100006	Ref. No.	IG19
description	piezoelectric igniter suitable for ELETROSIT body plastic blowing connection $\varnothing 2.4\text{mm}$ $\varnothing 14\text{mm}$		

ignition switches



1

GEV No.	301014	Ref. No.	SW72
description	momentary rocker switch mounting measurements 30x11mm black 1NO 250V 16A connection male faston 6.3mm ambient temperature max. 85/125°C protection IP40 mounting $\varnothing\text{mm}$ male faston 6.3mm		

thermocouples

plug-in thermocouples

plug-in thermocouples standard

with barrel socket $\varnothing 5\text{mm}$ - type Junkers with aluminised tip

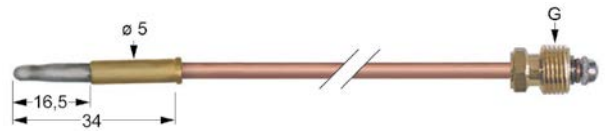

1

GEV No.	102205	Ref. No.	PI48	
description	thermocouple M8x1 L 750mm plug connection $\varnothing 5.0\text{mm}$			
accessories for	102205			
	GEV No.	101260	Ref. No.	—
	thermocouple fitting thread M8x1 Qty 1 pcs			

with barrel socket $\varnothing 6\text{mm}$

SIT

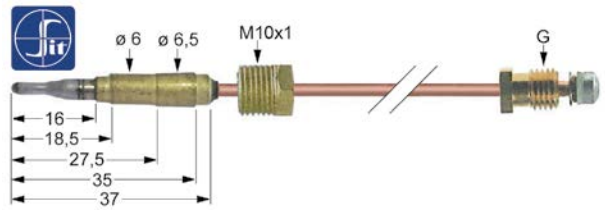

1

GEV No.	102944	Ref. No.	TC51
description	thermocouple M9x1 L 1500mm M10x1		

with barrel socket $\varnothing 6.5\text{mm}$

thermocouples SIT

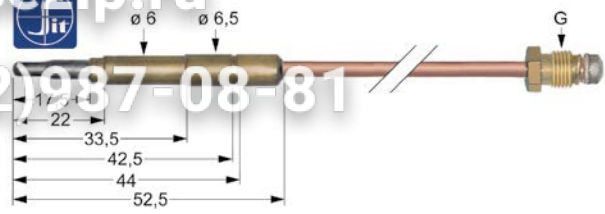

1

GEV No.	107614	Ref. No.	TC23
description	thermocouple SIT M9x1 L 1500mm plug connection $\varnothing 6.0(6.5)\text{mm}$		

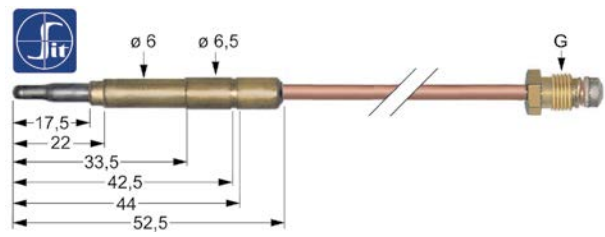

1

GEV No.	107609	Ref. No.	TC13
description	thermocouple SIT M9x1 L 600mm plug connection $\varnothing 6.0(6.5)\text{mm}$		
For models:	CS4N, CS4P		

threaded thermocouples (miscellaneous)





1

GEV No.	102577	Ref. No.	TC04	
description	thermocouple L 1200mm plug connection $\varnothing 6.0\text{mm}$			
For models:	OG7302			
accessories for	102577			
	GEV No.	101261	Ref. No.	TC24
	thermocouple fitting thread M9x1 Qty 1 pcs			



1

GEV No.	102576	Ref. No.	TC03	
description	thermocouple L 900mm plug connection $\varnothing 6.0\text{mm}$			
For models:	OG7202N, OG7202P, OG7204N, OG7204P, OG7208N, OG7208P			
accessories for	102576			
	GEV No.	101262	Ref. No.	TC09
	thermocouple fitting thread M10x1 Qty 1 pcs			



1

GEV No.	102579	Ref. No.	TC14
description	thermocouple M8x1 L 360mm plug connection $\varnothing 6.0\text{mm}$		
For models:	CG4, CG6, HT3, HT6N, HT6P, HT9, SLR6, SLR9		

1 gas components

Зип-Общепит

vsezip.ru

+7(812)987-08-81

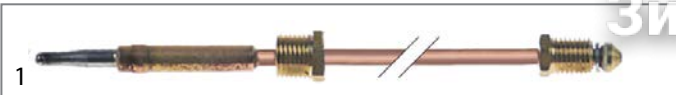

GEV No.	102593	Ref. No.	TC15
description	thermocouple M8x1 L 600mm plug connection ø6.0mm		
For models:	GR3, GR7, HT3, HT6N, HT6P, HT9, SLR6, SLR9		

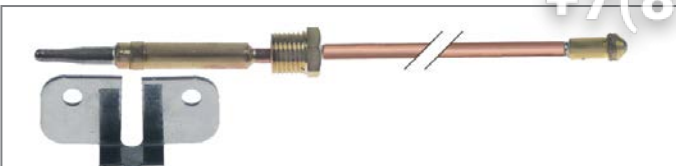

GEV No.	102575	Ref. No.	GRTC03
description	thermocouple M8x1 L 900mm plug connection ø6.0mm		



GEV No.	102578	Ref. No.	TC26
description	thermocouple M9x1 L 1000mm plug connection ø6.0mm		



GEV No.	102634	Ref. No.	TC40
description	thermocouple M9x1 L 400mm plug connection ø6.0mm		
For models:	OG7106, OG7502		

plug-in thermocouples with interruption

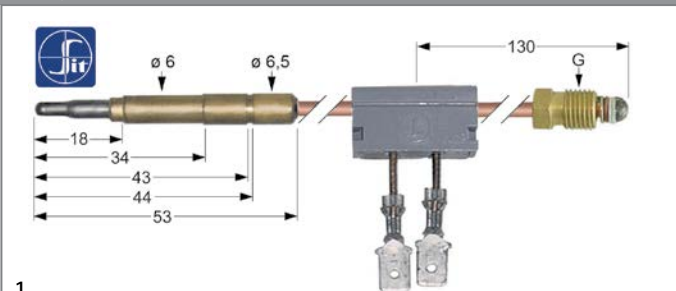

GEV No.	107177	Ref. No.	TC18
description	thermocouple SIT with interrupter M9x1 L 600mm plug connection ø6.0mm F 6.3mm		



GEV No.	102650	Ref. No.	TC38
description	thermocouple with interrupter M9x1 L 1000mm plug connection ø6.0(6.5)mm		
For models:	DF4		



GEV No.	102648	Ref. No.	TC39
description	thermocouple with interrupter M9x1 L 400mm plug connection ø6.0(6.5)mm plug/soldering connection		
For models:	DF7		

threaded thermocouples

threaded thermocouples standard

with socket with thread M8x1

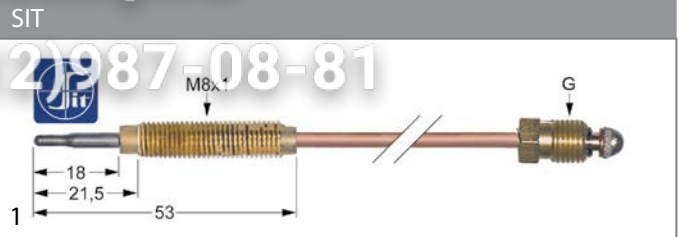

GEV No.	107636	Ref. No.	TC28
description	thermocouple SIT M9x1 L 600mm M8x1		
accessories for	107636		



GEV No.	102067	Ref. No.	—
description	nut thread M8x1 H 3mm brass Qty 1 pcs type SEF 1		

threaded thermocouples (miscellaneous)



GEV No.	102638	Ref. No.	TC33 TC49+TC07
description	thermocouple M8x1 L 1400mm M6x0.5		
For models:	SLR6, SLR9		



GEV No.	102572	Ref. No.	TC35
description	thermocouple M8x1 L 450mm M8x1		
accessories for	102572		



GEV No.	102630	Ref. No.	TC37
description	spacer bush with plain washer for thermocouple ø 8mm suitable for TC35/36 Qty 1 pcs		

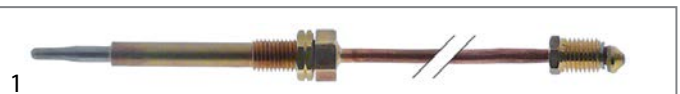

GEV No.	102594	Ref. No.	TC36
description	thermocouple M8x1 L 700mm M8x1		
accessories for	102594		



GEV No.	102630	Ref. No.	TC37
description	spacer bush with plain washer for thermocouple ø 8mm suitable for TC35/36 Qty 1 pcs		



GEV No.	102652	Ref. No.	TC34
description	thermocouple M8x1 L 750mm M8x1		



Зип-Общепит

vsezip.ru

+7(812)987-08-81

			
GEV No.	103351	Ref. No.	TC50
description	thermocouple M8x1 L 750mm M8x1		

threaded thermocouples with interruption

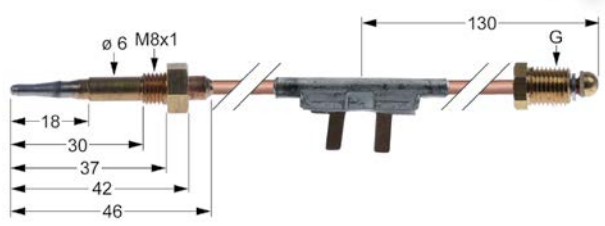
			
GEV No.	102651	Ref. No.	TC19
description	thermocouple with interrupter M9x1 L 1000mm M8x1 plug/soldering connection		
For models:	J10, J5		

producer-specific thermocouples

			
GEV No.	107821	Ref. No.	TC01
description	thermocouple L 600mm M12x1 M9x1		

thermopiles

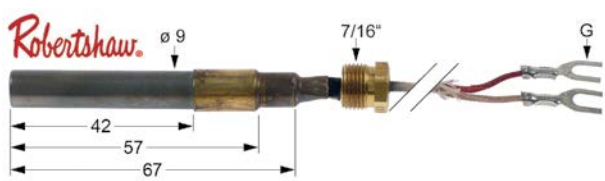
			
GEV No.	102116	Ref. No.	TC41
description	thermopile ROBERTSHAW L 900mm probe ø 9mm probe L 57mm 250-750mV screw connection 7/16"		
For models:	OG7502		

White Rodgers

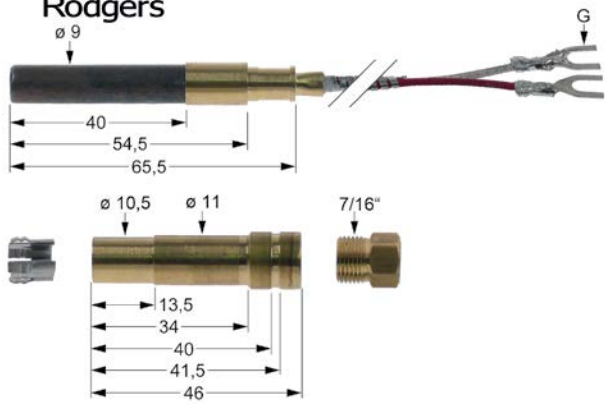
			
GEV No.	103243	Ref. No.	TC20
description	thermopile with PG9 adapter WHITE RODGERS L 36" - 915mm probe ø 9mm probe L 40mm 250-750mV screw connection 7/16" connection spate terminals		
For models:	DF4, DF7, J10, J5		

accessories

screws

			
GEV No.	102636	Ref. No.	TC05
description	thermocouple fitting brass Qty 1 pcs for thermocouple suitable for LINCAT		
For models:	OG7202N, OG7202P, OG7204N, OG7204P, OG7208N, OG7208P		

			
GEV No.	101262	Ref. No.	TC09
description	thermocouple fitting thread M10x1 Qty 1 pcs		

			
GEV No.	102566	Ref. No.	TC07
description	thermocouple fitting thread M8x1 Qty 10 pcs		

			
GEV No.	101261	Ref. No.	TC24
description	thermocouple fitting thread M9x1 Qty 1 pcs		
For models:	OG7202N, OG7202P, OG7204N, OG7204P, OG7208N, OG7208P, OG7302		

interrupters

			
GEV No.	101753	Ref. No.	IN23
description	interrupter brass		

1 gas components

Зип Общепит

vsezip.ru

+7(812)987-08-81

1 gas components

			
1			
GEV No.	101265	Ref. No.	IN08
description	interrupter thread M9x1		
For models:	OG7106		

miscellaneous			
			
1			
GEV No.	102637	Ref. No.	TC06
description	sleeve for thermocouple L 25mm ø 6.5mm Qty 1 pcs		
For models:	OG7202N, OG7202P, OG7204N, OG7204P, OG7208N, OG7208P		

			
1			
GEV No.	102630	Ref. No.	TC37
description	spacer bush with plain washer for thermocouple ø 8mm suitable for TC35/36 Qty 1 pcs		

gas burners

hob burners



producer-specific hob burners

LINCAT

			
1			
GEV No.	103057	Ref. No.	BU80
description	burner ø 94mm 5kW complete		

			
1			
GEV No.	103037	Ref. No.	BU36
description	burner cap ø 95mm		
For models:	HT3, HT6N, HT6P, HT9, SLR6, SLR9		

			
1			
GEV No.	103054	Ref. No.	BU100
description	burner cap ø 95mm H 15mm		

			
1			
GEV No.	103044	Ref. No.	BU35
description	burner head ø 100mm for burner cap ø 95mm nozzle mounting M6x0.75		
For models:	HT3, HT6N, HT6P, HT9, SLR6, SLR9		
accessories for	103044		
	GEV No.	109092	Ref. No.
			GA25
			
	gasket for burner head suitable for BU35		

			
1			
GEV No.	109092	Ref. No.	GA25
description	gasket for burner head suitable for BU35		

			
1			
GEV No.	104511	Ref. No.	BU111
description	gasket ø 72mm ID ø 45mm for burner head H 1.2mm perforation ø 5mm		

bar burners

bar burners

			
1			
GEV No.	109091	Ref. No.	BU27
description	bar burner 1-row L 330mm W 72mm ømm H 25mm		

			
1			
GEV No.	103050	Ref. No.	BU66
description	bar burner 1-row L 380mm Wmm ø 40mm Hmm		



Зип-Общепит
forced air burners

vsezip.ru

+7(812)987-08-81



1

GEV No.	109184	Ref. No.	OGA20
description	insulation for burner ø 97.5mm ID ø 62.5mm thickness 9.5mm		

ceramic burners



1

GEV No.	103036	Ref. No.	BU13
description	burner L 415mm W 123mm firing range 395x90mm salamander grill 3.1kW		
For models:	OG7302		



1

GEV No.	101673	Ref. No.	BU03
description	ceramic burner L 500mm W 163mm firing range 460x119mm		



1

GEV No.	101645	Ref. No.	BU69	
description	ceramic burner L 585mm W 163mm firing range 540x119mm			
accessories for	101645			
	GEV No.	106671	Ref. No.	JE15
	gas injector thread 12-28 UNF code 240 bore ø 1.3mm L 12mm			



1

GEV No.	108152	Ref. No.	OBL01
description	blower for burner combi-steamer SCC_WE, CM_P 61-202 230V 110W hole distance 50mm NRG118/0800-3612-030203		

accessories

gaskets



1

GEV No.	104283	Ref. No.	OGA32
description	gasket L 100mm W 100mm hole ø 64mm		

gas nozzles

main nozzles

gas nozzles 1/8"



1

GEV No.	106689	Ref. No.	JE51
description	gas injector thread 1/8" bore ø 1.5mm code 150		

gas nozzles M6x0.75



1

GEV No.	106662	Ref. No.	JE22
description	gas injector thread M6x0.75 WS 7 bore ø 0.9mm		



1

GEV No.	106485	Ref. No.	JE39
description	gas injector thread M6x0.75 WS 7 bore ø 1.6mm		

gas nozzles M12x1



1

GEV No.	100293	Ref. No.	JE103
description	gas injector thread M12x1 WS 14 bore ø 2.20mm		

gas nozzles (other)



1

GEV No.	106691	Ref. No.	JE47
description	gas injector code 340 bore ø 1.58mm L 12mm LPG		



1

GEV No.	106671	Ref. No.	JE15
description	gas injector thread 12-28 UNF code 240 bore ø 1.3mm L 12mm		
For models:	J10, J5, OG7302		



1

GEV No.	106690	Ref. No.	JE45
description	gas injector thread 12-28 UNF code 310 bore ø 1.55mm L 12mm LPG		
For models:	OG7202N, OG7204N, OG7208N		



1

GEV No.	106687	Ref. No.	JE14
description	gas injector thread 12-28 UNF code 520 bore ø 2mm L 12mm natural gas		
For models:	J10, J5		

pilot burner nozzles

pilot burner nozzles ROBERTSHAW



1

GEV No.	106105	Ref. No.	JE32
description	pilot burner nozzle LPG code 16 suitable for ROBERTSHAW		
For models:	J10, OG7106		

Зип Общепит

vsezip.ru

+7(812)987-08-81



GEV No.	106108	Ref. No.	JE110
description	pilot burner nozzle natural gas code 22 suitable for ROBERTSHAW		



1

GEV No.	100277	Ref. No.	JE31
description	pilot burner nozzle natural gas code 26 suitable for ROBERTSHAW		
For models:	J10, OG7106		

pilot burner nozzles SIT

160 series



1

GEV No.	107650	Ref. No.	JE56
description	pilot burner nozzle SIT LPG code 30 Qty 1 pcs		
For models:	OG7502		

pilot burner nozzles (other)

LINCAT



1

GEV No.	106672	Ref. No.	JE87
description	gas injector code 35 L 8mm		
For models:	OG7106		



1

GEV No.	106688	Ref. No.	JE105
description	gas injector natural gas code 41 bore ø 0.41mm thread 10-32 UNF Qty 1 pcs		



bypass nozzles

3ип Общелит
gas ball valves

bypass nozzles SABAF



GEV No.	106661	Ref. No.	JE117
description	bypass nozzle bore ø 0.54mm thread M4x0.5 SABAF		



GEV No.	106660	Ref. No.	JE116
description	bypass nozzle bore ø 0.85mm thread M4x0.5 SABAF		

auxiliary gas parts

gas pressure regulators

Standard pressure according to country:
Germany 50mbar
France 37mbar
Italy 30mbar
Spain 37/50mbar
UK 20mbar



GEV No.	250098	Ref. No.	PG10
description	gas pressure regulator RV48LM connection 3/4" - 3/4" countries UK output pressure 10-20mbar		
description	low pressure gas regulator type RV48LM - 1-2kPa, 4.8m³/h inlet 3/4", outlet 3/4"		



GEV No.	106693	Ref. No.	PG10
description	gas pressure regulator RV48LM countries UK input pressure max. 0.1bar output pressure 12.5-30mbar gas inlet 1/2" gas outlet 1/2"		
description	low pressure gas regulator type RV48LM - 1.25-3kPa, 4.8m³/h inlet 1/2", outlet 1/2"		

with DIN-DVGW approval



GEV No.	520288	Ref. No.	TA97
description	ball valve straight lever handle inlet 1" IT outlet 1" IT DN25 L 86mm approval DVGW gas technology operating p. 1bar		



GEV No.	520286	Ref. No.	TA29
description	ball valve straight lever handle inlet 1/2" IT outlet 1/2" IT DN15 L 61mm approval DVGW gas technology operating p. 1bar		
For models:	J10, OG7502		

equipment-specific units

for display coolers

housing and bezels

miscellaneous



GEV No.	692852	Ref. No.	DI29
description	cover transparent for lamp L 630mm W 140mm H 25mm plastic for type 750		
For models:	C6A-75, C6H-75, C6R-105L, C6R-105R, D3H-75, D3R-100, D5H-75, D5R-100, SCH785, SCR785		



GEV No.	692853	Ref. No.	DI30
description	cover transparent for lamp L 880mm W 140mm H 25mm plastic for type 1000		
For models:	C6A-100, C6H-100, C6R-130L, C6R-130R, D5H-100, D5R-125, SCH1085, SCR1085		

for pour machines

drain taps

drain taps



1

GEV No.	527557	Ref. No.	SL15 SL27 SL34
description	outlet tap complete pipe lengthmm thread 3/4" ET black/chrome suitable for COFFEE QUEEN		

for pressure steamers

valves and tank inlets



1

GEV No.	699188	Ref. No.	TA98
description	ball valve L 70mm W 22.5mm H 76.5mm 3-way 3/8"		



1

GEV No.	699187	Ref. No.	FL29
description	inlet tap L 370mm 1/2"		

for deep fryers

spouts



1

GEV No.	696730	Ref. No.	TU68
description	drain pipe for fryer ø 33.6mm 1" L 135mm		
For models:	OE7112		

Зип Общепит

vsezip.ru

+7(812)987-08-81



1

GEV No.	696731	Ref. No.	TU64
description	drain pipe ø 33.6mm 1" L 180mm		
For models:	OE7105		

for convection ovens/combi-steamers

spare parts and accessories



1

GEV No.	108152	Ref. No.	OBL01
description	blower for burner combi-steamer SCC_WE, CM_P 61-202 230V 110W hole distance 50mm NRG118/0800-3612-030203		



1

GEV No.	694998	Ref. No.	ODR18
description	container L 160mm W 135mm H 66mm suitable for combi-steamer SCC Linie 61-202		



1

GEV No.	694996	Ref. No.	OCO28 OPI14
description	sleeve with clip ø 61/73mm suitable for combi-steamer SCC_WE, CM_P 61/62/101		



Зип Общепит

vsezip.ru

7(812)987-08-81

housing and bezels



1

GEV No.	699801	Ref. No.	CPU08
description	cover for drain assembly L 325mm W 162mm H 92mm		



GEV No.	693329	Ref. No.	OFI03
description	filter insert L 213mm W 50mm ømm H 90mm		

glass panels



1

GEV No.	692856	Ref. No.	OGL03
description	door glass for combi-steamer SCC/CM202 L 1340mm mounting pos. inner W 680mm thickness 6mm		



1

GEV No.	694937	Ref. No.	ODO28
description	glass panel for door inside combi-steamer CPC-Linie 61 L 573mm W 495mm thickness 7mm		



1

GEV No.	694492	Ref. No.	OGL02
description	glass panel L 485mm W 508mm thickness 6mm mounting pos. inner for combi-steamer		

air filters



1

GEV No.	691620	Ref. No.	OFI05
description	filter L 220mm W 50mm ømm H 150mm SCC Line		

cleaning system

pumps

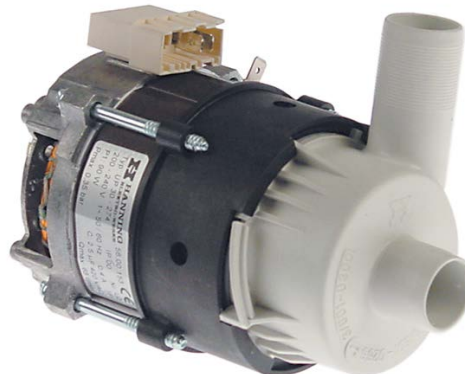

1

GEV No.	500578	Ref. No.	OPU06
description	pump inlet ø 24mm outlet ø 24mm type UP30-274 230V 50/60Hz 1 phase 0.09kW 0.12HP L 145mm rotation direction left capacitor 2.5µF HANNING		

spare parts for 500578

	GEV No.	501345	Ref. No.	—
	O-ring EPDM thickness 3mm ID ø 58mm Qty 1 pcs			



1

GEV No.	500579	Ref. No.	OPU03
description	pump inlet ø 24mm outlet ø 24mm type UP30-275 230V 50/60Hz 1 phase 0.09kW 0.12HP L 145mm rotation direction left capacitor 2.5µF HANNING		

spare parts for 500579

	GEV No.	501345	Ref. No.	—
	O-ring EPDM thickness 3mm ID ø 58mm Qty 1 pcs			

cleaning arms



1

GEV No.	541433	Ref. No.	OCL02
----------------	--------	-----------------	-------

description	cleaning arm CleanJet suitable for RATIONAL _101-_202
--------------------	---



1

GEV No.	541432	Ref. No.	OCL03
----------------	--------	-----------------	-------

description	cleaning arm CleanJet suitable for RATIONAL _61
--------------------	---

hoses



1

GEV No.	694491	Ref. No.	OHA21
----------------	--------	-----------------	-------

description	supply tube for hose reel
--------------------	---------------------------

hoses



1

GEV No.	530793	Ref. No.	OHO13
----------------	--------	-----------------	-------

description	formed hose ID \varnothing 22mm ED \varnothing 28mm L 640mm for combi-steamer SCC, CM201/202 since 04/2004
--------------------	--



1

GEV No.	692102	Ref. No.	OHO07
----------------	--------	-----------------	-------

description	hose ID \varnothing 50mm ED \varnothing 60mm L 50mm
--------------------	---

Зип-Общепит

service kits



1

GEV No.	699811	Ref. No.	OBU14
----------------	--------	-----------------	-------

description	service kit for bulb socket RATIONAL
--------------------	--------------------------------------

drip water trays



1

GEV No.	699800	Ref. No.	ODR08
----------------	--------	-----------------	-------

description	drip tray plastic L 745mm W 47mm H 20mm
--------------------	---

door mechanics

miscellaneous



1

GEV No.	694934	Ref. No.	ODO26
----------------	--------	-----------------	-------

description	cover for door latch suitable for combi-steamer CPC-Linie 201/202 aluminium L 96.5mm W 65.5mm
--------------------	---

miscellaneous



1

GEV No.	694433	Ref. No.	OVA05
----------------	--------	-----------------	-------

description	air valve for combi-steamer bore \varnothing 2mm L 18mm plastic \varnothing 20mm
--------------------	--

accessories for	694433
------------------------	--------



GEV No.	694402	Ref. No.	—
----------------	--------	-----------------	---

description	valve body for air valve hose \varnothing 10mm
--------------------	--



1

GEV No.	699809	Ref. No.	OHA20
----------------	--------	-----------------	-------

description	clamp for spray gun L 24mm
--------------------	----------------------------



Зип Общелит

vsezip.ru

+7(812)987-08-81



1

GEV No.	694786	Ref. No.	OHO21 OHO22 OPI12
description	conversion kit for ventilation for combi-steamer		



1

GEV No.	520917	Ref. No.	OGA34
description	gasket for heat exchanger D1 ø 104mm D2 ø 132mm		



1

GEV No.	694650	Ref. No.	ODR17
description	drain pipe for combi-steamer L 555mm plastic		

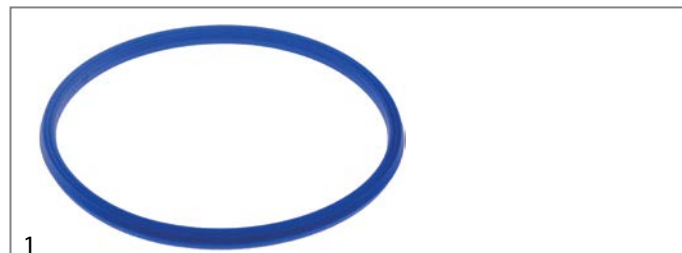

1

GEV No.	694320	Ref. No.	OGA03
description	gasket for lid ø 145mm		



1

GEV No.	694391	Ref. No.	ODR14
description	drain pipe with sleeve for drip pan L 560mm PE		



1

GEV No.	512184	Ref. No.	OCO10
description	hose connector plastic thread 3/4" Qty 1 pcs connection distance 60mm T-shape		



1

GEV No.	524459	Ref. No.	ODR07
description	drip rail L 540mm plastic W 63mm		
accessories for	524459		
	GEV No.	Ref. No.	ODR11
	697931		
description	mounting clip plastic W 20mm Qty 5 pcs		



1

GEV No.	697931	Ref. No.	ODR11
description	mounting clip plastic W 20mm Qty 5 pcs		



1

GEV No.	694651	Ref. No.	OSI03
description	filter for combi-steamer ø 97mm hole ø 6mm H 17.5mm		



1

GEV No.	694322	Ref. No.	ODR12
description	sleeve for drip pan D1 ø 15mm D2 ø 20mm L 62mm		



1

GEV No.	694657	Ref. No.	OSI04
description	thread bolt straight L 44mm SS thread M6 ø 6mm		

for heated display cases

housing and bezels

covers



GEV No.	692852	Ref. No.	DI29
description	cover transparent for lamp L 630mm W 140mm H 25mm plastic for type 750		
For models:	C6A-75, C6H-75, C6R-105L, C6R-105R, D3H-75, D3R-100, D5H-75, D5R-100, SCH785, SCR785		



GEV No.	692853	Ref. No.	DI30
description	cover transparent for lamp L 880mm W 140mm H 25mm plastic for type 1000		
For models:	C6A-100, C6H-100, C6R-130L, C6R-130R, D5H-100, D5R-125, SCH1085, SCR1085		

knobs

producer-specific knobs

LINCAT



GEV No.	113027	Ref. No.	KN182
description	knob 1-6 ø 55mm black		
For models:	BM3W, BM4W, BM6W, BM7W, BS3W, BS4W, BS7W, ECG6, GS3, GS4, GS4E, GS6, GS6T, GS6TE, GS7, GS7E, GS9, PB33, PB66		



GEV No.	113028	Ref. No.	KN178 KN263
description	knob 1-6 t.max.°C ø 55mm shaft ø 6x4.6mm shaft flat upper black		
For models:	BM3, BM4, BM6, BM7, BS3, BS4, BS7, CS4, CS4G, CS6		

Зип Общепит

vsezip.ru

+7(812)987-08-81

GEV No.	113007	Ref. No.	KN230
description	knob gas thermostat t.max. 250°C 170-250°C ø 70-80mm shaft ø 8mm black		



GEV No.	111649	Ref. No.	OKN06
description	knob ø 69mm shaft ø 5mm silver		

handles and hand wheels

mushroom cap handles



GEV No.	111782	Ref. No.	KN10
description	mushroom cap handle thread M6 handle ø 25mm L 17mm plastic black		
For models:	CS4, CS4N, CS4P, CS6, DF33, DF36, DF39, DF4, DF46, DF49, DF612, DF618, DF66, DF66ST, DF7, GBM2, GBM3, J10, J12, J18, J5, J6, J9, LCS, LDF, LDF2, LPB, PB33, PB66		

bracket handles



GEV No.	701558	Ref. No.	HA92
description	pull handle L 175mm H 62mm mounting distance 145mm thread M8		
For models:	ECO7, SLR6, SLR9, V6, V6D, V6F, V7		



GEV No.	701557	Ref. No.	HA68
description	pull handle L 200mm H 45mm mounting distance 132.5mm thread M8		
For models:	ECO76		





Зип Общепит

vsezip.ru

+7(812)987-08-81

 <p>1</p>	
GEV No.	701632
Ref. No.	HA77
description	pull handle L 227mm H 50mm mounting distance 170mm thread M8 black suitable for LINCAT
For models:	OE7010, OE7104, OE7105, OE7112, OE7113, OG7106



 <p>1</p>	
GEV No.	693577
Ref. No.	ODO11
description	D-lock W 29mm H 17mm spring length 50mm spring thickness 3mm
 <p>1</p>	
GEV No.	693579
Ref. No.	OCA11
description	door catch H 10.5mm L 42mm W 13mm M5

locks

handle latches

producer-specific

LINCAT

 <p>1</p>	
GEV No.	693578
Ref. No.	ODO22
description	bracket for door catch L 66mm W 23.5mm H 19mm mounting distance 46mm
accessories for	693578
 <p>1</p>	
GEV No.	693579
Ref. No.	OCA11
description	door catch H 10.5mm L 42mm W 13mm M5

hinges

door bearing



 <p>1</p>	
GEV No.	693587
Ref. No.	ODO32
description	hinge mounting pos. bottom right

fittings for catering equipment

outlet taps

universal

 <p>1</p>	
GEV No.	514506
Ref. No.	VA05
description	outlet tap stainless steel W 38mm H 40mm thread 3/4" IT

 <p>1</p>	
GEV No.	693576
Ref. No.	ODO14
description	catch L 83mm ø 41mm clamp length 43mm BL 45mm
spare parts for	693576
 <p>1</p>	
GEV No.	693577
Ref. No.	ODO11
description	D-lock W 29mm H 17mm spring length 50mm spring thickness 3mm

 <p>1</p>	
GEV No.	693580
Ref. No.	OLO02
description	cover for catch

 <p>1</p>	
GEV No.	693582
Ref. No.	ODO24
description	cover for door latch L 97mm W 10.5mm mounting distance 71mm H 65mm

producer-specific

LINCAT

 <p>1</p>	
GEV No.	514434 ¹
Ref. No.	DS24
description	ball valve thread 1/2" ET
For models:	BM3W, BM4W, BM6W, BM7W, BS3W, BS4W, BS7W, DF33, DF36, DF39, DF4, DF46, DF49, DF612, DF618, DF66, DF66ST, DF7, ECG6, J12, J18, J6, J9, PB33, PB66

¹pipe connection ø16mm

dispenser tap

complete



1

GEV No.	527590	Ref. No.	SL27
description	outlet tap complete inlet 3/4" blue		
For models:	EB3, EB4, EB6, EB6T		
spare parts for	527590		
	GEV No.	527591	Ref. No. SL28
	tap head blue		



1

GEV No.	527557	Ref. No.	SL15 SL27 SL34
description	outlet tap complete pipe lengthmm thread 3/4" ET black/chrome suitable for COFFEE QUEEN		

tap heads



1

GEV No.	527592	Ref. No.	— SL22
description	tap head black		

Зип Общепит

vsezip.ru

+7(812)987-08-81



1

GEV No.	527591	Ref. No.	SL28
description	tap head blue		

filters

device filters



1

GEV No.	698609	Ref. No.	OFI09
description	filter insert L 180mm W 140mm H 22mm plastic suitable for RATIONAL		

equipment feet and end caps

equipment feet

with screw mounting

universal



1

GEV No.	700866	Ref. No.	LE37
description	equipment foot tube ø 64mm thread M10 thread L 18mm H 135-190mm stainless steel Qty 1 pcs		
For models:	OA7920, OA7934, OE7105, OE7112		



Зип Общежит

screw-in feet

vsezip.ru

+7(812)987-08-81



1

GEV No.	700867	Ref. No.	LE42
description	equipment foot tube ø 64mm thread M12 thread L 23mm H 135-215mm SS size 2 1/2" Qty 1 pcs		
For models:	OE7010, OE7503, OG7502		



1

GEV No.	699192	Ref. No.	LE38
description	equipment foot tube ø 31mm thread 3/8" UNC thread L 25mm H 55-84mm Qty 1 pcs		
For models:	OA7919, OA7936, OE7012, OE7206, OE7209, OE7210		



1

GEV No.	701560	Ref. No.	FE29
description	equipment foot tube ø 50.5mm thread M12 thread L 16mm H 158-200mm		
For models:	ESLR9, HCL3, HCL4, HCL6, HCL7, HCL9, J10, J5, SLR6, SLR9		



1

GEV No.	701637	Ref. No.	FE40
description	equipment foot tube ø 52mm thread M10 thread L 36mm H 150-190mm SS Qty 1 pcs		

GEV No.	699190	Ref. No.	FE10
description	equipment foot thread M8 thread L 24mm ø 28.5mm H 16mm		
For models:	CC3, CC4, CC6, CC7, CN3, CN4, CN6, CN7, CT1, ECO76, ECO8, ECO9, G1A, GG1, HB2, HB3, HB4, HC3, HC4, HC6, HC7, J12, J18, J6, J9, LD2, LD3, LPO, LPW, LPW-LR, UMO50, UMSO50, UMSO50D		



1

GEV No.	699189	Ref. No.	FE28
description	equipment foot thread M8 thread L 32mm ø 26mm H 9.5mm Qty 1 pcs		

bolting feet



1

GEV No.	692157	Ref. No.	FE35 FE37
description	equipment foot ø 19mm H 12mm bore ø 5mm Qty 1 pcs		
For models:	AS3, AS4, BM3, BM3W, BM4, BM4W, BM6, BM6W, BM7, BM7W, BS3, BS3W, BS4, BS4W, BS7, BS7W, CG4, CS4, CS4G, CS4N, CS4P, CS6, DF33, DF36, DF39, DF4, DF46, DF49, DF612, DF618, DF66, DF66ST, DF7, ECC6, GS3, GS4, GS4E, GS6, GS6T, GS6TE, GS7, GS7E, GS9, HT3, HT6, HT7, J12, J18, J6, J9...(Other models you can see in the webshop)		



1

GEV No.	699191	Ref. No.	FE01
description	equipment foot ø 29.2mm H 39.5mm bore ø 6.2mm Qty 1 pcs		
For models:	EB3, EB4, EB6, EB6T, FDB4, FPB5		

miscellaneous

with fixing plate

ø100mm



1

GEV No.	701634	Ref. No.	CA150
description	swivel castor ø 100mm plate size 105x80mm hole distance 80x60mm H 125mm wheel width 32mm Qty 1 pcs		

ø125mm



1

GEV No.	701633	Ref. No.	CA145
description	swivel castor ø 125mm bearing ball bearing plate size 105x80mm hole distance 80x60mm H 155mm wheel width 32mm Qty 1 pcs		



1

GEV No.	701635	Ref. No.	CA184
description	swivel castor without brake ø 125mm plate fixing housing stainless steel bearing ball bearing plate size 100x86mm hole distance 78x60mm wheel body polypropylene H 160mm wheel width 31.5mm		

with bolt hole

ø125mm



1

GEV No.	710028	Ref. No.	CA113
description	swivel castor ø 125mm bolt hole ø12.0mm bolt hole ø 12mm H 155mm wheel width 36.5mm		
For models:	OA7905, OE7113		

Зип Общепит

vsezip.ru

+7(812)987-08-81



GEV No.	710029	Ref. No.	CA112
description	swivel castor with brake ø 125mm bolt hole ø12.0mm bolt hole ø 12mm H 155mm wheel width 36.5mm		
For models:	OA7905, OE7113		

baskets

fryer baskets

LINCAT



1

GEV No.	970985	Ref. No.	BA96
description	fryer basket W1 100mm L1 310mm H1 100mm L2 470mm H2 160mm H3 213mm chrome-plated steel rubber with holder		



1

GEV No.	970973	Ref. No.	BA122
description	fryer basket W1 110mm L1 340mm H1 150mm L2 620mm H2 192mm H3 330mm chrome-plated steel plastic-coated steel with holder W2 85mm		



1

GEV No.	970977	Ref. No.	BA156
description	fryer basket W1 120mm L1 240mm H1 88mm L2 395mm H2 162mm H3 238mm chrome-plated steel with holder		



1

GEV No.	970979	Ref. No.	BA159
description	fryer basket W1 133mm L1 337mm H1 144mm L2 610mm H2 197mm H3 335mm chrome-plated steel rubber with holder		



1

GEV No.	970987	Ref. No.	BA83
description	fryer basket W1 140mm L1 337mm H1 145mm L2 598mm H2 185mm H3 305mm chrome-plated steel rubber with holder		
For models:	OE7105, OG7106		

Зип Общепит
vsezip.ru
+7(812)987-08-81

			
1			
GEV No.	970984	Ref. No.	BA93
description	fryer basket W1 160mm L1 295mm H1 100mm L2 460mm H2 160mm H3 220mm chrome-plated steel rubber with holder		

			
1			
GEV No.	970988	Ref. No.	BA82
description	fryer basket W1 220mm L1 340mm H1 145mm L2 615mm H2 200mm H3 297mm chrome-plated steel rubber with holder		
For models:	OE7104, OE7112, OE7113		

			
1			
GEV No.	970972	Ref. No.	BA113
description	fryer basket W1 160mm L1 310mm H1 102mm L2 490mm H2 162mm H3 213mm chrome-plated steel with holder		

			
1			
GEV No.	970976	Ref. No.	BA155
description	fryer basket W1 197mm L1 218mm H1 85mm L2 395mm H2 165mm H3 220mm chrome-plated steel with holder		

			
1			
GEV No.	970986	Ref. No.	BA94
description	fryer basket W1 200mm L1 260mm H1 100mm L2 415mm H2 167mm H3 218mm chrome-plated steel rubber with holder		

			
1			
GEV No.	970691	Ref. No.	BA92
description	fryer basket W1 200mm L1 280mm H1 100mm		

			
1			
GEV No.	970989	Ref. No.	BA98
description	fryer basket W1 200mm L1 297mm H1 150mm L2 560mm H2 220mm H3 280mm chrome-plated steel rubber with holder		
For models:	J10, J5		

			
1			
GEV No.	970690	Ref. No.	BA91
description	fryer basket W1 200mm L1 310mm H1 100mm		
For models:	DF33, DF36, DF39, DF46, DF49, DF612, DF618, DF66, J12, J18, J6, J9		

pasta baskets

LINCAT

			
1			
GEV No.	970967	Ref. No.	BA116
description	pasta basket H1 101mm W1 102mm L1 155mm size 1/4 L2 210mm H3 220mm stainless steel		

			
1			
GEV No.	970969	Ref. No.	BA115
description	pasta basket H1 101mm W1 102mm L1 155mm size 1/4 L2 210mm H3 220mm stainless steel		

			
1			
GEV No.	970968	Ref. No.	BA114
description	pasta basket H1 103mm W1 101mm L1 310mm size 1/2 size L2 540mm H2 153mm H3 210mm stainless steel		

Зип Общепит

vsezip.ru

+7(812)987-08-81



1

GEV No.	970966	Ref. No.	BA112
description	pasta basket H1 103mm W1 202mm L1 310mm L2 540mm H2 153mm H3 210mm stainless steel		
For models:	PB33, PB66		



1

GEV No.	970970	Ref. No.	OA7923
description	pasta basket H1 225mm W1 216mm L1 300mm L2 525mm H2 278mm H3 330mm stainless steel		



1

GEV No.	970975	Ref. No.	OA7925 OA8925
description	pasta basket H1 215mm W1 145mm L1 164mm H3 375mm stainless steel		



1

GEV No.	970978	Ref. No.	BA157
description	pasta basket H1 79mm W1 205mm L1 217mm L2 365mm H2 122mm H3 190mm with holder		

miscellaneous



1

GEV No.	970974	Ref. No.	OA7922 OA8922
description	pasta basket H1 217mm W1 298mm L1 327mm H2 250mm H3 357mm stainless steel		

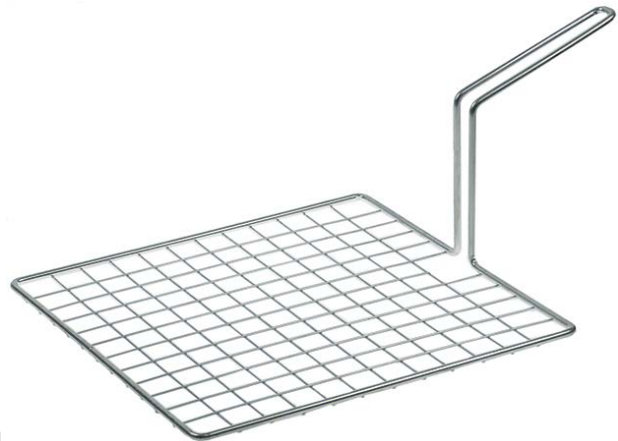

1

GEV No.	692896	Ref. No.	BA41
description	grate L 320mm W 320mm H 187mm with handle		



1

GEV No.	970971	Ref. No.	OA7924 OA8924
description	pasta basket H1 218mm W1 142mm L1 288mm L2 510mm H2 300mm H3 350mm stainless steel		

gaskets

gaskets for heated units

door seals

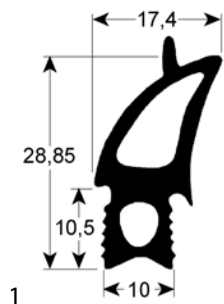

GEV No.	900290	Ref. No.	OSE06
description	door seal profile 2730 W 465mm L 520mm external size Qty 1		

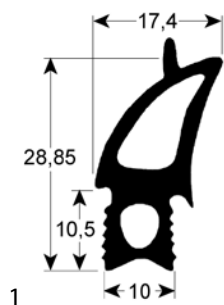

GEV No.	900262	Ref. No.	OSE10
description	door seal profile 2730 W 470mm L 1475mm outer plug size Qty 1		

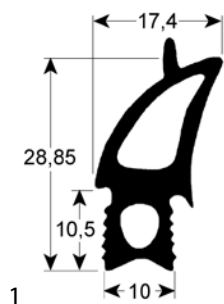

GEV No.	900291	Ref. No.	OSE02
description	door seal profile 2730 W 470mm L 785mm outer plug size Qty 1		

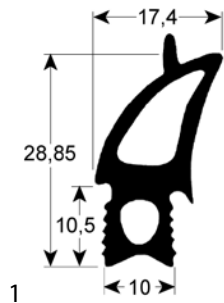

GEV No.	900574	Ref. No.	OSE13
description	door seal profile 2730 W 675mm L 1475mm outer plug size		

Зип Общепит

vsezip.ru

+7(812)987-08-81



GEV No.	900573	Ref. No.	OSE12
description	door seal profile 2730 W 675mm L 760mm outer plug size		

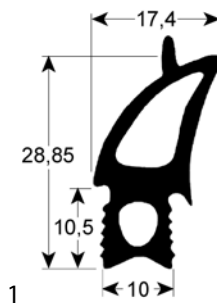

GEV No.	900292	Ref. No.	OSE03
description	door seal profile 2730 W 685mm L 780mm outer plug size		

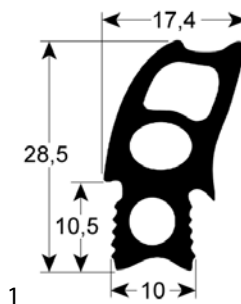

GEV No.	901403	Ref. No.	OSE08
description	door seal profile 2731 W 470mm L 500mm outer plug size Qty 1		

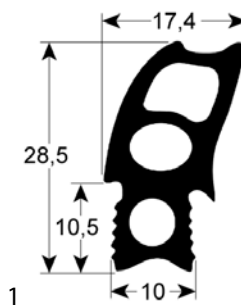

GEV No.	901405	Ref. No.	OSE09
description	door seal profile 2731 W 470mm L 760mm outer plug size		

Зип Общепит
vsezip.ru
+7(812)987 08 01

GEV No.	901438	Ref. No.	OSE04
description	door seal profile 2732 W 485mm L 1495mm external size Qty 1		

GEV No.	901439	Ref. No.	OSE05
description	door seal profile 2732 W 680mm L 1495mm outer plug size		

GEV No.	902322	Ref. No.	SE42
description	door seal profile 2991 W 535mm L 705mm external size Qty 1		

GEV No.	902323	Ref. No.	SE38
description	door seal profile 2991 W 590mm L 710mm external size Qty 1		

door seals with fixing hook

GEV No.	901163	Ref. No.	SE25
description	door seal L 1000mm with mounting clip Qty supplied by meter		

GEV No.	902321	Ref. No.	SE22
description	door seal L 420mm W 10mm		

GEV No.	902317	Ref. No.	SE05
description	door seal L 470mm W 430mm 4-sided with mounting clip		
For models:	ECO9		

GEV No.	902320	Ref. No.	SE23
description	door seal L 475mm W 9mm with mounting clip		

GEV No.	902318	Ref. No.	SE27
description	door seal L 510mm W 10mm with mounting clip		

GEV No.	902319	Ref. No.	SE17
description	door seal L 530mm W 12mm		

GEV No.	902316	Ref. No.	SE76
description	door seal L 560mm W 400mm 4-sided with mounting clip		
For models:	ECO8		

door gaskets (wire reinforced)

GEV No.	902324	Ref. No.	SE75
description	door seal wire reinforced L 1380mm ø 7.5mm		



Зип Общежит

vsezip.ru

+7(812)987-08-81

gaskets for tray rack trolleys

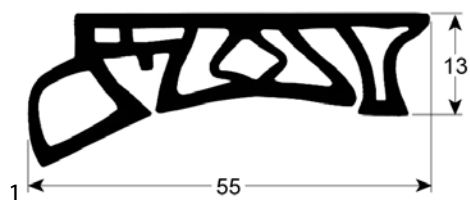

GEV No.	900566	Ref. No.	OGA25
description	tray rack trolley gasket profile 4095 L 575mm Qty 1		

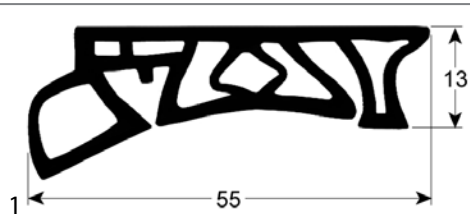

GEV No.	900255	Ref. No.	OGA30
description	tray rack trolley gasket profile 4095 L 780mm Qty 1		

O-rings

silicone

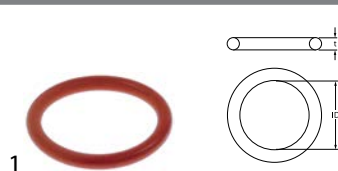

GEV No.	532727	Ref. No.	OGA38
description	O-ring silicone thickness 3.5mm ID ø 26mm Qty 5 pcs for model SCC, CM		

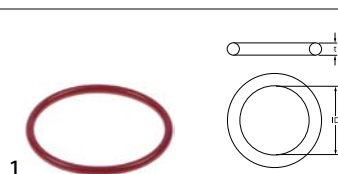

GEV No.	532728	Ref. No.	OGA37
description	O-ring silicone thickness 3.5mm ID ø 46mm Qty 5 pcs for model SCC, CM		

sealing cords

round



GEV No.	694917	Ref. No.	SE30
description	sealing cord L 106.5m for pizza oven ø 9mm		

shaft gaskets

miscellaneous



GEV No.	511685	Ref. No.	OGA29
description	shaft seal kit ID ø 15mm ED ø 27mm shaft seal flange mounting gauge with mountign material		



GEV No.	511682	Ref. No.	OGA09
description	shaft seal kit ID ø 17mm ED ø 29mm shaft seal flange mounting gauge with mountign material		

special gaskets

for combi-steamers



GEV No.	560599	Ref. No.	OGA16
description	gasket ED ø 132mm ID ø 105mm thickness 2mm CPC-Linie CM 61-202/G		



GEV No.	560597	Ref. No.	OGA40
description	gasket ED ø 140mm ID ø 128mm SCC Line		



GEV No.	560596	Ref. No.	OGA39
description	gasket ED ø 60mm ID ø 50mm SCC, SCC_WE, CM,CM_P since 04/2004		

Зип Общепит

vsezip.ru

+7(812)987-08-81



1

GEV No.	699803	Ref. No.	OGA24
description	gasket L 139mm W 130mm silicone thickness 4mm		



1

GEV No.	560613	Ref. No.	OGA33
description	gasket L 43mm W 67mm thickness 4mm SCC, CM61-202 since 06/2007 for combi-steamer		

miscellaneous

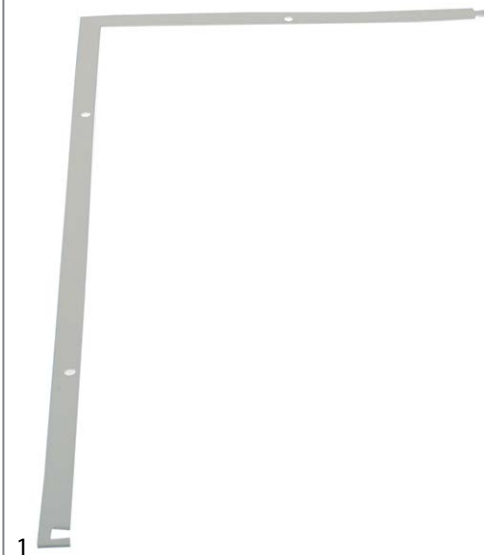

1

GEV No.	512473	Ref. No.	GA38
description	gasket suitable for LINCAT equiv. no. GA38 for tank L 398mm W 221mm without screws		



1

GEV No.	510658	Ref. No.	GA39
description	gasket suitable for LINCAT equiv. no. GA39 for tank L 303mm external weith 233mm Qty 1m with screws EB4		

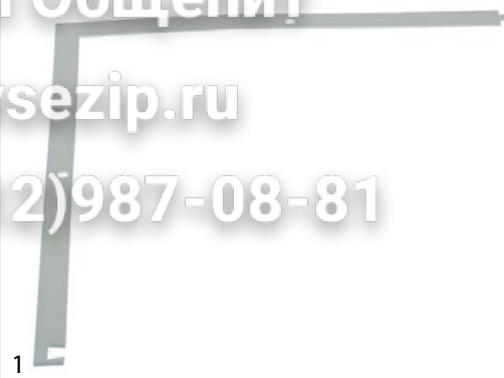

1

GEV No.	512393	Ref. No.	GA40
description	gasket suitable for LINCAT equiv. no. GA40 for tank L 233mm external weith 233mm without screws		
For models:	EB3, EB4, EB6, EB6T		



1

GEV No.	510660	Ref. No.	GA44
description	gasket suitable for LINCAT equiv. no. GA44 L 68mm W 50mm Qty 1m hole distance 57mm		
For models:	DF33, DF36, DF39, ECG6, J6, J9, PB33		



1

GEV No.	510661	Ref. No.	GA45
description	gasket suitable for LINCAT equiv. no. GA45 L 59mm W 30mm Qty 1m thickness 1.5mm hole distance 50mm		
For models:	DF33, DF36, DF39, ECG6, J12, J18, J6, J9, PB33		



1

GEV No.	550895	Ref. No.	OGA07
description	gasket suitable for RATIONAL equiv. no. 51101308 L 179mm W 90mm electrode thickness 3mm		



refrigeration cycle components

Зип Общежит
vsezip.ru
+7(812)987-08-81

valves

Schrader valves

Schrader valves (complete)



1	GEV No.	750101	Ref. No.	VA16
	description	Schrader valve complete connection 1/4" SAE L 130mm		
	For models:	FDB4, FPB5, SCR1085, SCR785		

filter driers

miscellaneous



1	GEV No.	750734	Ref. No.	G/DR02
	description	dryer size 10g ø 16mm L 115mm connection 2,5/6,2mm		
	For models:	FDB4, FPB5		



1	GEV No.	750616	Ref. No.	DR26
	description	dryer size 15g ø 19mm L 121mm connection 2,7/6,5mm type XH20P Qty 1 pcs		
	For models:	SCR1085, SCR785		

for saladettes



1	GEV No.	750733	Ref. No.	G/CD01
	description	evaporator L 240mm W 125mm D 45mm total length 260mm		
	For models:	FDB4, FPB5		

transmission technology and ball bearings

drive belts

toothed belts



1	GEV No.	697828	Ref. No.	BE14
	description	toothed belt profile XL L 400mm H 2mm teeth 80 rubber with textile insertion CODE B191009 W 6mm type 160XL		

springs

compression springs



1	GEV No.	693591	Ref. No.	OSP04
	description	compression spring ø 14mm L 27mm wire gauge ø 1.5mm		







hose reels and spray guns

spray guns



1

GEV No.	540302	Ref. No.	OHA01
description	spray gun for appliances 1/2" ET L 135mm type RATIONAL		
spare parts for	540302		
	GEV No.	517056	Ref. No. —
	O-ring EPDM thickness 2mm ID ø 6.5mm Qty 1 pcs		
	GEV No.	532535	Ref. No. —
	O-ring EPDM thickness 5mm ID ø 10mm Qty 1 pcs		
	GEV No.	548016	Ref. No. —
	compression spring ø 10mm L 17mm wire gauge ø 0.9mm for hand spray		
	GEV No.	548017	Ref. No. —
	pressure bolt for hand spray		



1

GEV No.	540664	Ref. No.	OHA10
description	spray gun for appliances 1/2" (12.83mm) L 165mm		
spare parts for	540664		
	GEV No.	699809	Ref. No. OHA20
	clamp for spray gun L 24mm		

3zip.Общепит

hose reels

appliance hose reels







1

GEV No.	541444	Ref. No.	OHA13
description	hose reel without spray gun hose length 1.5m		



1

GEV No.	540661	Ref. No.	OHA12
description	hose reel without spray gun hose length 1m		
accessories for	540661		
	GEV No.	540664	Ref. No. OHA10
	spray gun for appliances 1/2" (12.83mm) L 165mm		
	GEV No.	560630	Ref. No. —
	clamping washer nominal-ø 4mm ED ø 11.5mm SS thickness 0.2mm		
	GEV No.	694491	Ref. No. OHA21
	supply tube for hose reel		
	GEV No.	699802	Ref. No. —
	cover for spray gun D1 ø 90/145mm L 145mm H 68mm		



1

GEV No.	540483	Ref. No.	OHA02
description	hose reel without spray gun hose length 2.1m		



spare parts and accessories

hoses

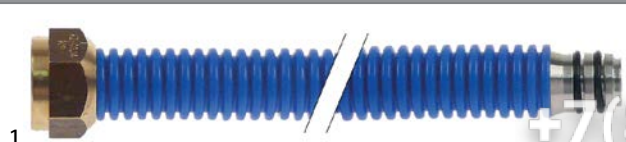



GEV No.	520915	Ref. No.	OHO24
description	connection hose for hose reel connections ø14.6mm / 3/4" length 0.7m		

hoses

supply hoses

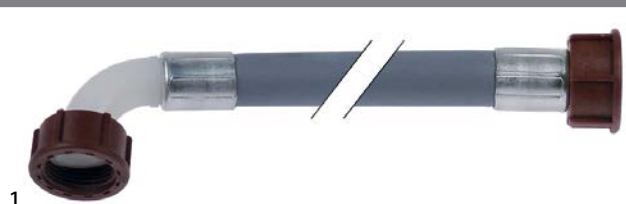
PVC supply hoses



GEV No.	520010	Ref. No.	PI12
description	supply hose PVC straight-curved DN13 connections 3/4" L 1500mm operating p. 10bar burst p. 32bar t.max. 90°C blue approval VDE flat seal		
For models:	ECO76		
accessories for	520010		
	GEV No.	520053	Ref. No. —
	screen connection 3/4" D1 ø 26mm D2 ø 15mm Qty 10 pcs rubber thickness 8mm		
	GEV No.	520054	Ref. No. —
	flat gasket rubber ED ø 23.5mm ID ø 14mm thickness 2.3mm Qty 10 pcs		

industrial hoses

silicone hoses

without fabric

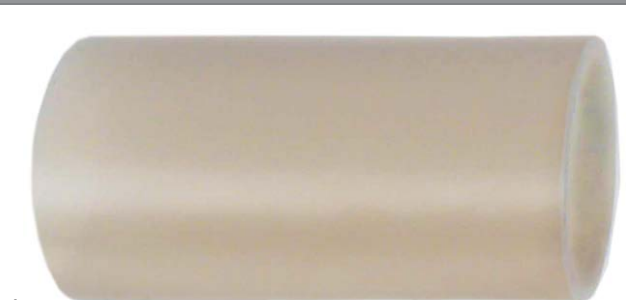

GEV No.	530067	Ref. No.	OHO14
description	silicone hose ID ø 50mm ED ø 56mm L 0.13m thickness 3mm t.max. 200°C		

Зип Общежит

formed hoses

straight

vsezip.ru

+7(812)987-08-81



GEV No.	530067	Ref. No.	OHO14
description	silicone hose ID ø 50mm ED ø 56mm L 0.13m thickness 3mm t.max. 200°C		

form L



GEV No.	530716	Ref. No.	OHO18
description	formed hose ID ø 18/23mm ED ø 25/28mm L 170mm Qty 1 L-shape for combi-steamer ø ø22(19)mm thickness 3mm		



GEV No.	530717	Ref. No.	OHO12
description	formed hose ID ø 19/22mm ED ø 25/28mm L 225mm L-shape for combi-steamer thickness 3.5mm		



GEV No.	530793	Ref. No.	OHO13
description	formed hose ID ø 22mm ED ø 28mm L 640mm for combi-steamer SCC, CM201/202 since 04/2004		



GEV No.	694323	Ref. No.	ODR16
description	formed hose ID ø 23mm ED ø 28mm L 480mm combi-steamer for drain		

Зип.Общепит
fittings, hose and pipe connectors

hose connectors
producer-specific

+7(812)987-08-81



1

GEV No.	694324	Ref. No.	OHO08
description	formed hose ID ø 23mm ED ø 28mm L 480mm for combi-steamer		

form U

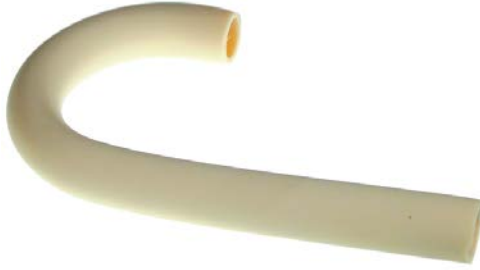

1

GEV No.	530715	Ref. No.	OHO11
description	formed hose L 450mm ID ø 22mm ED ø 29mm for combi-steamer U-shape		

miscellaneous



1

GEV No.	524453	Ref. No.	OHO16
description	formed hose ext. ø 29 D1 ø 23mm D2 ø 23mm L 340mm white Qty 1		



1

GEV No.	530066	Ref. No.	OHO06
description	formed hose ID ø 24mm ED ø 30mm L 380mm		



1

GEV No.	512183	Ref. No.	OHA22
description	hose connector for hose reel T-shape plastic ø 20/12mm 3/4"		

valves and tank inlets

ball valves

universal

mini ball valves



1

GEV No.	520956	Ref. No.	DV02
description	ball valve DN8 total length 54mm chrome-plated brass		
For models:	EB3F, EB4F, EB6, EB6T		



1

GEV No.	520957	Ref. No.	VA19
description	ball valve connection 1/2" IT - tube ø15mm DN8 total length 52mm chrome-plated brass		
For models:	GBM2, GBM3, OG7302		

producer-specific

LINCAT



1

GEV No.	514188	Ref. No.	TA101/A TA74
description	ball valve connection 1" IT - 1" IT total length 81mm handle length 116mm		
For models:	OE7104		



shut-off valves

producer-specific

LINCAT



1

GEV No.	514187	Ref. No.	CO167
description	shut-off valve connection 1/2" 1/2" cold/warm total length 50mm		

Зип Общепит

for cold drinks

vsezip.ru

+7(812)987-08-81



1

GEV No.	530478	Ref. No.	FC02
description	filter type AP2-C405-SG capacity 4000l flow rate 114l/h operation p max 8.6bar water temperature max. 38°C for filter head AP2 ø 13/22mm H 240mm activated carbon filtration for beverage vending machine		

water filters

CUNO

filters

for hot drinks



1

GEV No.	530078	Ref. No.	FC02
description	water filter CUNO type FC02 capacity 4000l flow rate 120l/h operation p max 8.6bar operation pressure max 25-120psi water temperature 40-100°C ø 57mm H 250mm for filter head AP2		

miscellaneous

connection heads



1

GEV No.	530079	Ref. No.	CF1
description	filter head		

filters



1

GEV No.	530077	Ref. No.	CFC01
description	water filter flow rate 2l/min operation p max 7bar water temperature 38°C ø 67mm H 230mm		

measuring equipment

thermometers

built-in thermometers

ø60mm



1

GEV No.	542345	Ref. No.	DT5
description	thermometer mounting ø 60mm t.max. 500°C 0 up to +500°C probe ø 8mm probe L 101mm capillary pipe 1070mm		

fastening material

washers

washers

miscellaneous



1

GEV No.	560401	Ref. No.	CO113
description	plain washer ID ø 5mm ED ø 8mm thickness 1mm copper Qty 1 pcs		
For models:	CG4, CG6, ECO9, J10, OG7202N, OG7202P, OG7204N, OG7204P, OG7208N, OG7208P		

+7(812)987-08-81

consumables

fuses

fine fuses

ø6.3x32mm 250V



1

GEV No.	358792	Ref. No.	OFU02
description	fine fuse size ø6.3x32mm 10A slow-acting rated 250V Qty 10 pcs		



1

GEV No.	358791	Ref. No.	OFU01
description	fine fuse size ø6.3x32mm 6.3A slow-acting rated 250V Qty 10 pcs		

Зип Общепит

G

vsezip.ru

+7(812)987-08-81

A			
alarm devices	30	gas ball valves	65
appliance hose reels	82	gas burners	62
axial fans	40	gas control valves	52
		gas nozzles	63
B		gas pressure regulators	65
ball valves	84	gas taps	48
bar burners	62	gas thermostats	49
bi-metal thermostats	14, 14	gaskets for heated units	77
bottom heaters	10	gaskets for tray rack trolleys	79
C		H	
cables	46	halogen lamp	27
cam switches	24	heating elements	3
castors and bumper angles	74	heating elements for bain maries	3
ceramic burners	63	heating elements for contact grills	7
compressors	40	heating elements for convection	11
condensators & interference suppression filters	46	heating elements for fryers	3
connection cables	47	heating elements for griddles	6
consumables	86	heating elements for heated cabinets	9
contactors	30	heating elements for large hobs	7
control thermostats	14	heating elements for ovens	3
cooling fans	42	heating elements for pizza ovens	8
cross flow fans	42	heating elements for salamanders/toasters	8
		hob burners	62
D		hose connectors	84
door gaskets (wire reinforced)	78	hose reels	82
door seals	77	hoses	83
door seals with fixing hook	78	hot air fans	43
drain pumps	45	hot air motors	42
		hot plates	13
E		I	
earthing cables	47	ignition boxes	53
electric accessories	46	ignition cables	58
electrodes	38	ignition switches	59
electronic controllers	33	immersion heating elements	10
energy regulators	13	indicator lights	26
evaporators	81	indicator lights (complete)	26
		industrial hoses	83
F		infrared lamps	27
fans	40		
fastening material	86	L	
filter driers	81	lamp accessories	30
filters	46	lamps	26
fine fuses	86	light bulbs	27
float switches	24	linear lamps	27
flow sensors	39		
fluorescent lamps	28, 28	M	
forced air burners	63	magnetic switches	25
formed hoses	83	measuring equipment	86
fuses	46, 86	microswitches	23

microwave lamps	28	transformers	32
miscellaneous	47		
motors	44		
O			
O-rings	79		
oven lamps	28	valves and tank inlets	84
P		wash and rinse pumps	45
piezoelectric igniters	58	washers	86
pilot burners	53	water filters	85
power supply cables	46		
pressure switches	38		
probes	33		
protection hoses	47		
pumps	45		
push/momentary push switches	23		
PVC supply hoses	83		
Q			
quartz heating elements	10		
R			
radial fans	44		
radiation heaters	13		
refrigeration cycle components	81		
refrigeration fans	42		
refrigeration motors universal	42		
relays	32		
rocker/momentary rocker switches	22		
S			
safety bi-metal thermostats	14		
safety thermostats	18		
Schrader valves	81		
sealing cords	79		
shaft gaskets	79		
shut-off valves	85		
silicone cable	47		
silicone hoses	83		
solenoid valves	36		
solid state relays	32		
spiral cables	47		
spray guns	82		
spray guns with external thread	82		
starter	28		
supply hoses	83		
switches and momentary switches	22		
T			
terminals	47		
thermocouples	59		
thermostats	14		