



Зип Ощепит

vsezip.ru

Spare Parts for

+7(812)987-08781 **Combi Ovens**



Spare parts suitable for

ALTOSHAAM

2017

Find the complete and up-to-date range of products in our GEV Webshop



heating elements

heating cables

miscellaneous



GEV No.	580139	Ref. No.	4878
description	heating cable kit		



GEV No.	420280	Ref. No.	4881 CB-3045
description	heating cable kit L 210Ft~64008mm for heated cabinet		



GEV No.	580006	Ref. No.	4880
description	heating cable L 134Ft~40843mm		

heating cartridges



GEV No.	419035	Ref. No.	CB-3538
description	heating cartridge 230W 240V ø 12.5mm L 112mm thread 5/8"-18UNF cable length 150mm		

Зип-Общепит

washers

vsezip.ru

+7(812)987-08-81

GEV No.	560112	Ref. No.	WS-22295
description	plain washer ID ø 5.3mm ED ø 10mm thickness 1mm SS Qty 20 pcs DIN 125A for thread M5		



GEV No.	560113	Ref. No.	WS-22297
description	plain washer ID ø 6.4mm ED ø 12mm thickness 1.6mm SS Qty 20 pcs DIN 125A for thread M6		

thermostats

bi-metal thermostats

safety bi-metal thermostats



GEV No.	390991	Ref. No.	TT-3859
description	bi-metal safety thermostat hole distance 23.5mm switch-off temp. 150°C 1CO 1-pole 16A 250V connection F6.3 screw		

control and safety thermostats

EGO

safety thermostats

55.32_ series



GEV No.	375474	Ref. No.	TT-33325
description	safety thermostat t.max. 340°C switch-off temp. 340°C 2-pole 1NC/1CO 1x20/1x0.5A probe ø 4mm probe L 120mm capillary pipe 1300mm capillary pipe isolated 900mm gland nut probe		



Зип Общепит

vsezip.ru

+7(812)987-08-81

INVENSYS / ROBERTSHAW

control thermostats



GEV No.	390992	Ref. No.	TT-3978
description	thermostat t.max. 121.111°C temperature range 15.55-121.11°C 1-pole 1NO 16A probe ø 5mm probe L 400mm capillary pipe 850mm capillary pipe isolatedmm gland nut shaft ø 6x4.6mm shaft L 21mm shaft position lower rotation 315° 60-250°F		



GEV No.	390875	Ref. No.	TT-3498
description	thermostat t.max. 232.2°C temperature range 37.77-232.22°C 1-pole 1NO 30A probe ø 5mm probe L 280mm capillary pipe 900mm capillary pipe isolatedmm gland nut shaft L 24mm rotation 315° 100-450°F t.max. 450°F		



GEV No.	580075	Ref. No.	TT3057 TT3058
description	thermostat t.max. 93°C temperature range 15-93°C 1-pole 1NO 15A probe ø 5mm probe L 400mm capillary pipe 1000mm capillary pipe isolatedmm gland nut shaft ø 6x4.6mm shaft L 22mm operating temperature range 60-200°F		



GEV No.	390993	Ref. No.	TT-33432
description	thermostat t.max. 93°C temperature range 15-93°C 1-pole 1NO 15A probe ø 5mm probe L 400mm capillary pipe 2100mm capillary pipe isolatedmm gland nut shaft ø 6x4.6mm shaft L 22mm operating temperature range 60-200°F		

various

control thermostats

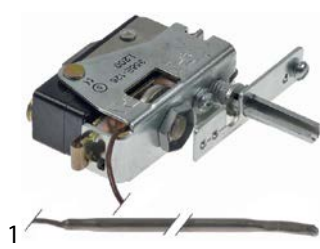

GEV No.	390994	Ref. No.	TT-33626
description	thermostat t.max. 121.11°C temperature range adjustable°C 1-pole 1NO 16A probe ø 4mm probe L 250mm capillary pipe 2140mm capillary pipe isolatedmm gland nut shaft ø 6x4.6mm shaft L 21mm shaft position° shaft position right rotation°		
For models:	750-S-HD		



GEV No.	580008	Ref. No.	TT3329
description	thermostat temperature range 37.77-162.78°C probe ø 5mm probe L 300mm capillary pipe 950mm shaft ø 6x4.6mm shaft L 23mm operating temperature range 100-325°F		

switches and momentary switches

rocker/momentary rocker switches

28x13.5mm



GEV No.	348099	Ref. No.	SW-3409
description	rocker switch mounting measurements 27.4x12.4mm black 1CO 250V 10A with neutral position connection male faston 6.3mm ambient temperature max. 85°C protection IP40		



Зип Общепит

vsezip.ru

+7(812)987-08-81

lamps

30x22mm



1

GEV No.	301004	Ref. No.	SW-3387
description	rocker switch mounting measurements 30x22mm black 2CO 230V 16A connection male faston 6.3mm ambient temperature max. 125/55°C protection IP40		
accessories for	301004		
	GEV No.	301036	Ref. No.
	protective cover internal size 30x22mm for rocker switch mounting measurementsmm		



1

GEV No.	346377	Ref. No.	SW-34788
description	rocker switch mounting measurements 30x22mm black 2CO 230V 16A 0-1 connection male faston 6.3mm ambient temperature max. 125/55°C protection IP40		
accessories for	346377		
	GEV No.	301036	Ref. No.
	protective cover internal size 30x22mm for rocker switch mounting measurementsmm		

37x21mm



1

GEV No.	347969	Ref. No.	SW-34769
description	rocker switch mounting measurements 37x21mm black 2NO 250V 10A 0-1 connection male faston 6.3mm ambient temperature max. 85°C protection IP44		



1

GEV No.	348153 ¹	Ref. No.	5010847
description	rocker switch mounting measurements 37x21mm black 2NO 250V 10A 0-1 connection male faston 6.3mm ambient temperature max. 85°C protection IP44 mounting frame inclusive		

¹with accessories

toggle switches

M12x0.75



1

GEV No.	348151	Ref. No.	SW-3040
description	toggle switch 2NO 250V screw		



GEV No.	348154	Ref. No.	SW-3041
description	toggle switch thread M10x0.75 1NO 120-240V 12/20A ON-OFF screw		

indicator lights

indicator lights (complete)

ø12mm

with plug-in socket



1

GEV No.	580014	Ref. No.	LI3025 LI3027
description	indicator light ø 12mm 230V red		

30x13mm



1

GEV No.	346547	Ref. No.	LI-3516
description	indicator light mounting measurements 27.4x12.4mm 230V red connection male faston 6.3mm temp.-resist. 120°C		

screw-on/push-on fit

halogen lamp

for socket G4 / G6.35 / G9



1

GEV No.	357193	Ref. No.	LP-34213
description	halogen lamp socket G4 12V 20W temp.-resist. 300°C OSRAM HALOSTAR OVEN		



Зип Общепит

vsezip.ru

+7(812)987-08-81

oven lamps

universal oven lamps

55x70mm



1

GEV No.	359297	Ref. No.	CV-26607
----------------	--------	-----------------	----------

description frame L 95mm W 81mm mounting distance 68/83mm thickness 6mm

accessories for 359297

	GEV No.	359299	Ref. No.	GS-26609
description gasket L 91mm W 77mm hole ø 3mm for oven lamp				



1

GEV No.	359299	Ref. No.	GS-26609
----------------	--------	-----------------	----------

description gasket L 91mm W 77mm hole ø 3mm for oven lamp

lamps

halogen lamps

for socket G4 / G6.35 / G9



1

GEV No.	357193	Ref. No.	LP-34213
----------------	--------	-----------------	----------

description halogen lamp socket G4 12V 20W temp.-resist. 300°C OSRAM HALOSTAR OVEN

timers

electric timers



1

GEV No.	580007	Ref. No.	TR3318
----------------	--------	-----------------	--------

description timer 240V operation time 12h

HARTLAND

power contactors



1

GEV No.	381284	Ref. No.	CN-3062
----------------	--------	-----------------	---------

description power contactor resistive load 40A 208/240VAC 30A/10HP (AC3/240V) 30A/7.46kW main contacts 3NO auxiliary contacts connection screw clamp/male faston 6.3mm type HCCY3XU02CY

SPRECHER+SCHUH

power contactors



1

GEV No.	381396	Ref. No.	CN-3654
----------------	--------	-----------------	---------

description power contactor resistive load 32A 220VAC (AC3/400V) 20A/11kW main contacts 3NO auxiliary contacts 1NC connection screw type CA7-23-01

solid state relays

CRYDOM



1

GEV No.	403662	Ref. No.	RL-3736
----------------	--------	-----------------	---------

description solid state relay CRYDOM 1 phase 25A 240V 90-280VAC L 57mm W 44.6mm screw connection type A2425







Зип Общепит

vsezip.ru

+7(812)987-08-81



miscellaneous

			
1			
GEV No.	403789	Ref. No.	RL-3583
description	solid state relay TELEDYNE 25A 12-280V 4-30VDC L 58mm W 44mm screw type S24D25		

			
1			
GEV No.	372018	Ref. No.	VA-34300
description	solenoid valve single straight 230VAC inlet 3/4" outlet 14mm DN10 EATON (INVENSYS) flow regulating valve outlet flow regulating valve inlet white		
spare parts for	372018		
	GEV No.	371122	Ref. No. —
	solenoid valve filter ø 19mm H 10mm suitable for MÜLLER		
	GEV No.	371131	Ref. No. —
	solenoid coil 230VAC		

probes

producer-specific probes

			
1			
GEV No.	379800	Ref. No.	5002100
description	temperature probe thermocouple K (NiCr-Ni) cable silicone probe -50 up to 1150°C cable -50 up to +180°C connection 2-wire thread M5 probe ø4x20mm cable length 3m		
accessories for	379800		
	GEV No.	521012	Ref. No. —
	gasket graphite ED ø 15mm ID ø 5mm thickness 1.2mm Qty 1 pcs		

			
1			
GEV No.	378507	Ref. No.	PR-33751
description	temperature probe thread M5 cable length 3m		

solenoid valves

solenoid valves (water)

ROBERTSHAW/INVENSYS



medium temperature: 90°C 90°C 60°C
 ambient temperature: 60°C 25°C 60°C
 duty cycle: 40% 100% 100%

			
1			
GEV No.	372022	Ref. No.	VA-34045
description	solenoid valve double straight 230VAC inlet 3/4" outlet 14mm DN10 EATON (INVENSYS)		

fans

axial fans

import

			
1			
GEV No.	601080 ¹	Ref. No.	FA-3568
description	axial fan L 119mm W 119mm H 38mm 230VAC 50/60Hz 23/20W bearing ball bearing connection male faston 2.8mm metal ADDA fan wheel ø 110mm temp.-resist. 70°C		
accessories for	601080		
	GEV No.	550898	Ref. No. —
	connecting cable cable length 2000mm connection F 2.8 connection distance 7.9mm for axial flow fan		
	GEV No.	692519	Ref. No. —
	guard L 120mm W 120mm plastic		

¹with ball bearings



ignition parts

pilot burners

HONEYWELL

pilot burners



1

GEV No. 102490 **Ref. No.** BN-33371

description pilot burner 1 flame

spare parts and accessories



Image not available

1

GEV No. 580002 **Ref. No.** HD2575

description counterpart

knobs

universal knobs



1

GEV No. 110124 **Ref. No.** KN3468

description knob thermostat t.max. 350°C t.max.°F 100-350°C°F ø 50mm shaft ø 6x4.6mm shaft flat upper black temperature range 100-350°C rotation 270°

accessories for 110124



GEV No. 110135 **Ref. No.** —

rosette knob up to ø 52mm

Зип-Общепит
producer specific knobs

ALTO-SHAAM
vsezip.ru



1

GEV No. 110124 **Ref. No.** KN3468

description knob thermostat t.max. 350°C t.max.°F 100-350°C°F ø 50mm shaft ø 6x4.6mm shaft flat upper black temperature range 100-350°C rotation 270°

accessories for 110124



GEV No. 110135 **Ref. No.** —
rosette knob up to ø 52mm



1

GEV No. 111491 **Ref. No.** KN-3474

description knob thermostat t.max. 90°C t.max.°F 15-90°C°F ø 48mm shaft ø 6x4.6mm shaft flat lower

For models: 750-S-HD



1

GEV No. 580011 **Ref. No.** KN3469

description knob thermostat t.max.°C t.max. 200°F°C 60-200°F ø 49mm shaft ø 6x4.6mm shaft flat lower

For models: 750-S-HD

locks

edgmount latches

magnetic locks

CHG

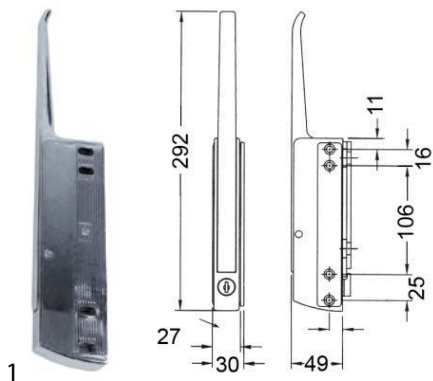

GEV No.	690208	Ref. No.	HD2007
description	magnetic lock L 168mm mounting distance 105/147mm non lockable refrigeration units R25		

hinges

edgmount hinges

CHG

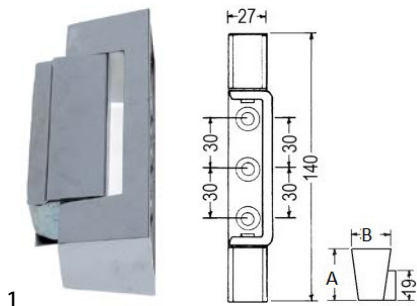

GEV No.	690294	Ref. No.	HG-2014
description	edgmount hinge L 140mm mounting distance 30/30mm hinging left/right without lift L1 33mm L2 30mm series R42		
spare parts for	690294		
	GEV No.	Ref. No.	—
	690292		
	spring for R42 (140mm)		

miscellaneous



GEV No.	710031	Ref. No.	CS-25675
description	swivel castor with swivel brake ø 90mm square pipes housing chrome-plated sheet steel capacitykg spigot hight 56mm spigot-ø 35x35mm bearing slide bearing wheel body tread H 190mm wheel width 32mm Qty 1 pcs		

gaskets for heated units

door seals

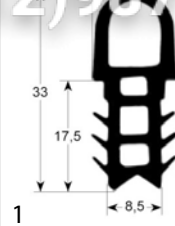

GEV No.	901675	Ref. No.	GS-25550
description	door seal profile 2060 W 420mm L 475mm external size Qty 1		

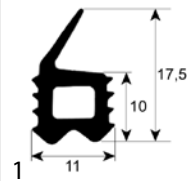

GEV No.	901312	Ref. No.	GS-23790
description	door seal profile 2708 W 385mm L 545mm external size		

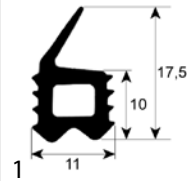

GEV No.	901313	Ref. No.	GS-23794
description	door seal profile 2708 W 500mm L 730mm external size		

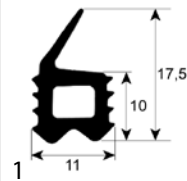

GEV No.	901132	Ref. No.	GS22903 GS-23778
description	door seal profile 2708 W 545mm L 590mm external size		
For models:	750-S-HD		

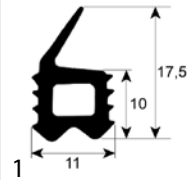

GEV No.	901314	Ref. No.	GS-23796
description	door seal profile 2708 W 560mm L 780mm external size		



Зип-Общепит
fastening material

vsezip.ru

+7(812)987-08-81

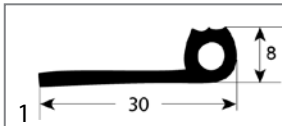

GEV No.	580013	Ref. No.	GS2398
description	door seal profile 2949 L 3000mm Qty 1		

fittings, hose and pipe connectors

hose connectors

nickel-plated brass



GEV No.	512440	Ref. No.	PB-26512
description	T-piece with probe connection nickel-plated brass thread 3/4" hose \varnothing 16mm		

measuring equipment

thermometers

built-in thermometers

\varnothing 41mm



GEV No.	541894	Ref. No.	TH-33713
description	thermometer mounting \varnothing 41mm t.max. 105°C 0-105°C probe \varnothing 9.5mm probe L 65mm capillary pipe 900mm		

\varnothing 52mm



GEV No.	580016	Ref. No.	GU-33384
description	thermometer mounting \varnothing 52mm t.max. 175°C +40 up to +175°C probe \varnothing 11mm probe L 67mm capillary pipe 1800mm		

screws

hexagonal screws



GEV No.	560084	Ref. No.	SC-26060
description	hexagonal screw thread M5 thread L 16mm SS WS 8 Qty 20 pcs DIN 933 / ISO 4017		



GEV No.	560088	Ref. No.	SC-22924
description	hexagonal screw thread M6 thread L 20mm SS WS 10 Qty 20 pcs DIN 933 / ISO 4017		

nuts

hexagonal nuts

DIN 934 / ISO 4032/8673



GEV No.	511212	Ref. No.	NU-22291
description	hexagonal nut thread M6 H 5mm WS 10 SS DIN/ISO DIN 934 / ISO 4032/8673 Qty 1 pcs		

washers

spring rings



GEV No.	560122	Ref. No.	WS-22301
description	lock washer ID \varnothing 5.2mm ED \varnothing 9mm SS DIN127 Qty 20 pcs for thread M5		



GEV No.	560123	Ref. No.	WS-22302
description	lock washer ID \varnothing 6.3mm ED \varnothing 11mm SS DIN127 Qty 20 pcs for thread M6		



washers

DIN 125A



1

GEV No.	560112	Ref. No.	WS-22295
description	plain washer ID ø 5.3mm ED ø 10mm thickness 1mm SS Qty 20 pcs DIN 125A for thread M5		

Зип Общепит



vsezip.ru

+7(812)987-08-91

GEV No.	560113	Ref. No.	WS-22297
description	plain washer ID ø 6.1mm ED ø 12mm thickness 1.6mm SS Qty 20 pcs DIN 125A for thread M6		

