



Зип Ощепит

vsezip.ru

Spare Parts for

+7(812)987-08781 **Combi Ovens**



Spare parts suitable for

BONNET

2017

Find the complete and up-to-date range of products in our GEV Webshop



heating elements

immersion heating elements

with compression flange 50 x 26mm

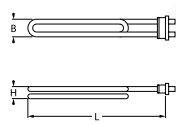



GEV No.	418932	Ref. No.	71244E
description	heating element 2000W 240V heating circuits 1 flange 50x26mm L 350mm W 30mm Hmm compression flange connection male faston 6.3mm tube ø 6.3mm immersion heater		

heating elements for convection

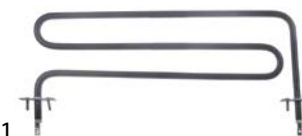

GEV No.	418925	Ref. No.	71844E BAAN309621
description	heating element 1500W 230V heating circuits 1 L 293mm W 106mm L1 32mm L2 261mm W2 83mm flange length 50mm flange width 26mm connection length 63mm connection male faston 6.3mm tube ø 8.5mm hole ø 6.2mm W1 23mm convection heating element convection oven INCOLOY windings 2		
accessories for	418925		
	GEV No.	520588	Ref. No. —
	gasket L 46mm W 22mm hole distance 24.5mm silicone for heating element		



GEV No.	418933	Ref. No.	71240E
description	heating element 2000W 240V heating circuits 1 L 390mm W 134mm W2 100mm flange length 50mm flange width 20mm connection length 50mm connection M4 tube ø 10mm thread M4 W1 34mm rectangular flange convection heating element convection oven		

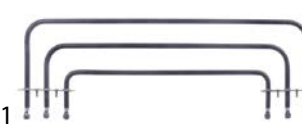

GEV No.	418917	Ref. No.	309252 71241E BAAN71241E
description	heating element 3000W 240V heating circuits 3 L 570mm W 140mm W2 110mm flange length 110mm flange width 20mm hole distance 40mm connection length 55mm connection M4 tube ø 10mm thread M4 W1 30mm rectangular flange convection heating element convection oven		

Зип Общепит

vsezip.ru

+7(812)987-08-81

GEV No.	418918	Ref. No.	71242E BAAN309253
description	heating element 2000W 240V heating circuits 3 L 570mm W 140mm W2 110mm flange length 110mm flange width 20mm hole distance 40mm connection length 55mm connection M4 tube ø 10mm thread M4 W1 30mm rectangular flange convection heating element convection oven		

accessories

sealing washers

O-rings



GEV No.	510408	Ref. No.	2001827H
description	O-ring EPDM thickness 5.34mm ID ø 47mm Qty 1 pcs		



GEV No.	510409	Ref. No.	318044 905588 966001 BAAN1323306 BAAN311999
description	O-ring EPDM thickness 5.34mm ID ø 56.52mm Qty 1 pcs		

energy regulators

EGO

1-circuit



GEV No.	380015	Ref. No.	1800602 301200 70486E 72113E BAAN167036 BAAN304497
description	energy regulator 230V 13A single-circuit turn direction right shaft ø 6x4.6mm shaft L 23mm mounting thread M4 power release 6-100% no. 50.57021.010		



thermostats

bi-metal thermostats

bi-metal thermostats



GEV No.	375927	Ref. No.	301045
description	bi-metal thermostat hole distance 23.5mm switch-off temp. 50°C 1NO 10A connection F6.3		

control and safety thermostats

EGO

control thermostats

55.10/19_series



GEV No.	375002	Ref. No.	7471032 BAAN1209939 BAAN310615
description	thermostat t.max. 320°C temperature range 55-320°C 1-pole 1NO 16A probe ø 3.1mm probe L 226mm capillary pipe 870mm capillary pipe isolated 850mm gland nut shaft L 23mm shaft position upper rotation 270°		

safety thermostats

55.13_series



GEV No.	375830	Ref. No.	905866 905886
description	safety thermostat switch-off temp. 365°C 1-pole 1NC 16A probe ø 3mm probe L 160mm capillary pipe 1730mm capillary pipe isolated 1710mm gland nut probe		

Зип Общежит

vsezip.ru

+7(812)987-08-81



GEV No.	390801	Ref. No.	71280E
description	thermostat switch-off temp. 140°C 1-pole 16A probe ø 6mm probe L 78mm capillary pipe 1500mm capillary pipe isolatedmm gland nut probe connection male faston 6.3mm		

55.32_series



GEV No.	375984	Ref. No.	301061 BAAN171095 BAAN304480
description	safety thermostat switch-off temp. 225°C 3-pole 3NC 20A probe ø 6mm probe L 94mm capillary pipe 900mm capillary pipe isolated 670mm gland nut M10x1 probe SS		



GEV No.	375706	Ref. No.	301049 BAAN169338 BAAN304476
description	safety thermostat switch-off temp. 400°C 3-pole 3NC 20A probe ø 3.9mm probe L 228mm capillary pipe 1190mm capillary pipe isolatedmm gland nut probe SS		



56._ series

E-G-O

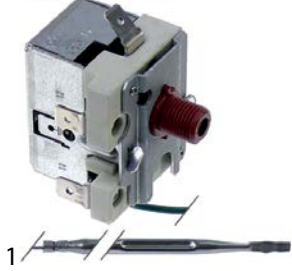

1

GEV No.	375442	Ref. No.	301039 301066 BAAN172196 BAAN304485
description	safety thermostat capillary pipe 1760mm probe ø 4mm 1-pole probe L 100mm 16A capillary pipe isolated 1600mm gland nut switch-off temp. 320°C probe M10x1		
accessories for	375442		
	GEV No.	101860	Ref. No. —
	nut thread M10x1 H 4mm WS 14 chrome-plated brass Qty 1 pcs		

control thermostats with operation switch

55.34_ series

E-G-O

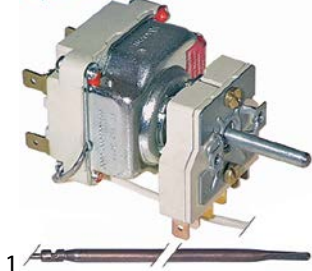

1

GEV No.	375246	Ref. No.	301034
description	thermostat t.max. 645°C temperature range 100-615/645°C 2-pole 2NO 16A probe ø 4mm probe L 230mm capillary pipe 1100mm capillary pipe isolated 600mm gland nut shaft ø 6x4.6mm shaft L 25mm shaft position lower rotation 270° outer switch 2NO probe material copper		

accessories

gland nut accessories

ducts



1

GEV No.	550148	Ref. No.	91373062 BAAN1323396 BAAN312763
description	gland duct ET M12x0.75 IT M9x1 probe ø max. 6.5mm WS 17 silicone		

Зип-Общепит

connecting bows

vsezip.ru

+7(812)987-08-01

1

GEV No.	550060	Ref. No.	300177
description	connecting bow long for thermostat Qty 1 pcs		

switches and momentary switches

rocker/momentary rocker switches

30x22mm



1

GEV No.	301202 ¹	Ref. No.	905913
description	rocker switch mounting measurements 30x22mm black 2NO 230V 20A 0-1 connection male faston 6.3mm ambient temperature max. 125/55°C protection IP65 with rubber collar		

¹non-illuminated

microswitches

lever actuated



1

GEV No.	345257	Ref. No.	300688 3755E BAAN305693
description	microswitch with lever 250V 16A 1CO connection male faston 6.3mm L 29mm L1 33mm ambient temperature max. 120°C mounting distance 22mm actuating force: 130g lever length 31.5mm		

pin-plunger actuated

M10



1



GEV No.	345032	Ref. No.	303621
description	microswitch with plunger thread M10x1 thread L 12mm 250V 16A 1CO connection male faston 6.3mm stroke 7mm mounting distance 22mm L 28mm ambient temperature max. 125°C type SP9603 actuating force: 180g		



Зип Общежит

vsezip.ru

+7(812)987-08-81

M12			
			
1			
GEV No.	345350	Ref. No.	1700340 BAAN1320656 BAAN302929
description	microswitch with plunger mounting distance 22mm thread M12x0.75 thread L 16mm 250V 16A 1CO connection male faston 6.3mm stroke 4mm ambient temperature max. 125°C type EF83161.3 actuating force: 66g		
accessories for	345350		
	GEV No.	345351	Ref. No. —
description	nut thread M12x0.75 H 1.6mm WS 14 chrome-plated brass Qty 1 pcs		

7-position cam switches			
			
1			
GEV No.	300106	Ref. No.	300010 BAAN166926 BAAN304345
description	cam switch 7 operating positions 1NO/2CO sequence 0-1-2-3-4-5-6 32A shaft ø 6x4.6mm shaft L 23mm connection screw 7-position shaft flat upper		

system switches (ROLD)

			
1			
GEV No.	345536	Ref. No.	900162
description	element holder mounting ø 16mm flat black		

			
1			
GEV No.	345606	Ref. No.	2001544H
description	momentary switch unit 2CO 250V 16A connection male faston 6.3mm		

			
1			
GEV No.	345538	Ref. No.	900163
description	push button ø 11.9mm black		

			
1			
GEV No.	345651	Ref. No.	900053 BAAN1323148 BAAN311603
description	switch 2CO 250V 16A connection male faston 6.3mm		

magnetic switches

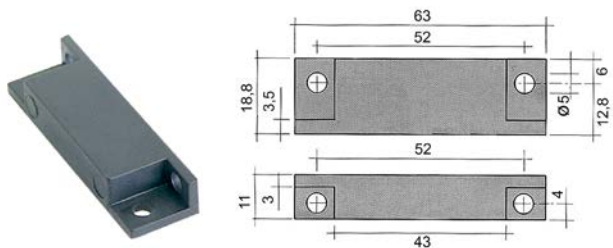
accessories			
magnets			
			
1			
GEV No.	345336	Ref. No.	2001868H BAAN1321497 BAAN307903
description	magnet ø 4.8mm L 63mm H 11mm W 18.8mm hole distance 51mm M4		

encoders and potentiometers

			
1			
GEV No.	300265	Ref. No.	309411 BAAN172230 BAAN701367
description	potentiometer		



lamps

indicator lights



indicator lights 3-piece (housing, lens and bulb)

lamps

neon light bulbs



1

GEV No.	359585	Ref. No.	74540008
description	neon light bulb socket E10 230V green ø 10mm L 28mm		
accessories for	359585		
	GEV No.	359060	Ref. No. —
	lamp socket mounting measurements ø16.2mm socket E10 connection screw		
	GEV No.	359685	Ref. No. —
	lamp socket mounting measurements ø16.2mm socket E10		

indicator lights (complete)

ø 6mm



1

GEV No.	359005	Ref. No.	2002147H
description	indicator light ø 6mm 230V yellow cable length 400mm		

ø12mm

with plug-in socket



1

GEV No.	359925	Ref. No.	308334 BAAN167305 BAAN304818
description	indicator light ø 12mm 400V green connection 2-wire cable length 700mm temp.-resist. 150°C		

ø13mm

with plug-in socket



1

GEV No.	359143	Ref. No.	904300 904360 BAAN1323249 BAAN311747
description	indicator light ø 13mm yellow 230V connection male faston 6.3mm temp.-resist. 120°C Qty 1 pcs		

Зип-Общепит

30x22mm



1



GEV No.	359156	Ref. No.	S175P15
description	indicator light mounting measurements 30x22mm 230V yellow connection male faston 6.3mm temp.-resist. 125/55°C type RL2		

screw-on/push-on fit

neon light bulbs



1

GEV No.	359585	Ref. No.	74540008
description	neon light bulb socket E10 230V green ø 10mm L 28mm		
accessories for	359585		
	GEV No.	359060	Ref. No. —
	lamp socket mounting measurements ø16.2mm socket E10 connection screw		
	GEV No.	359685	Ref. No. —
	lamp socket mounting measurements ø16.2mm socket E10		

light bulbs

for ovens



1

GEV No.	359610	Ref. No.	70597E
description	light bulb t.max. 300°C socket E14 15W 230V ø 22mm L 47mm lens L 20mm for oven lamp type Philips		



1

GEV No.	357153	Ref. No.	70598E
description	light bulb t.max. 300°C socket E14 25W 230V ø 25mm L 55mm lens L 30mm for oven type		



1

GEV No.	359614	Ref. No.	308463
description	light bulb t.max. 300°C socket E27 230V 40W ø 45mm L 71mm lens L 44mm Qty 1 pcs		



Зип Общежит

vsezip.ru

+7(812)987-08-81

halogen lamp			
for socket G4 / G6.35 / G9			
			
1 500°C			
GEV No.	359599	Ref. No.	308477 BAAN172222 BAAN304831
description	halogen lamp socket G4 12V 20W temp.-resist. 500°C		

halogen lamps			
for socket G4 / G6.35 / G9			
			
1 500°C			
GEV No.	359599	Ref. No.	308477 BAAN172222 BAAN304831
description	halogen lamp socket G4 12V 20W temp.-resist. 500°C		

fluorescent lamps

fluorescent lamps			
G23			
			
1			
GEV No.	359933	Ref. No.	309597 71819E BAAN309597 BAAN71819E
description	fluorescent lamp socket G23 L 237mm 11W 230V		

sockets

G4 / G5,3 / G6,35			
			
1			
GEV No.	359646	Ref. No.	147328
description	lamp socket socket G4/G5.3/G6.35 24V ø 17mm H 15mm connection cable 130mm mounting distance 26mm for halogen lamp holder length 31mm cable length 130mm		

oven lamps

lamps			
light bulbs			
			
1			
GEV No.	359610	Ref. No.	70597E
description	light bulb t.max. 300°C socket E14 15W 230V ø 22mm L 47mm lens L 20mm for oven lamp type Philips		

alarm devices

buzzers			
			
1			
GEV No.	350050	Ref. No.	305106
description	buzzer 230VAC connection male faston 6.3mm screw mounting thread M4 60dB		

			
1			
GEV No.	357153	Ref. No.	70598E
description	light bulb t.max. 300°C socket E14 25W 230V ø 25mm L 55mm lens L 30mm for oven type		

contactors

SIEMENS

power contactors			
			
1			
GEV No.	380957	Ref. No.	2001138H
description	power contactor resistive load 22A 24VAC (AC3/400V) 12A/5.5kW main contacts 3NO auxiliary contacts 1NO connection screw connection type 3RT10-17-1AB01 50/60Hz		

			
1			
GEV No.	359614	Ref. No.	308463
description	light bulb t.max. 300°C socket E27 230V 40W ø 45mm L 71mm lens L 44mm Qty 1 pcs		



TELEMECANIQUE (Schneider Electric)

Зип Общепит

power contactors



1

GEV No.	380617	Ref. No.	1700468
description	power contactor resistive load 25A 24VAC (AC3/400V) 9A/4kW main contacts 3NO auxiliary contacts 1NO/1NC connection screw connection type LC1D09B7		



1

GEV No.	380976	Ref. No.	1700732 300698
description	power contactor resistive load 32A 230VAC (AC3/400V) 18A/7.5kW main contacts 3NO auxiliary contacts 1NO/1NC connection screw connection		



1

GEV No.	380979	Ref. No.	300697 300699 300760 5875E 900130 905239 905241 905686 906759 910566 BAAN1322995 BAAN169330 BAAN304436 BAANS084P20
description	power contactor resistive load 40A 230VAC (AC3/400V) 25A/11kW main contacts 3NO auxiliary contacts 1NO/1NC connection screw connection type LC1D25P7		



1

GEV No.	380980	Ref. No.	300700
description	power contactor resistive load 50A 230VAC (AC3/400V) 32A/15kW main contacts 3NO auxiliary contacts 1NO/1NC connection screw connection type LC1D32P7		

vsezip.ru

+7(812)987-08-81

relays

power relays

with bracket mounting



1

GEV No.	380312	Ref. No.	2001867H 2001887H
description	power relays FINDER 230VAC 10A 3CO connection male faston 4.8mm bracket mounting dimensions 52x32.2x36.5mm manuf. no. 60.63.8.230.0000		



1

GEV No.	380139	Ref. No.	2001873H
description	power relays FINDER 230VAC 16A 2CO connection F6.3 bracket mounting dimensions 68x38.2x35.8mm manuf. no. 62.82.8.230.0000		





Зип.Общепит transformers

open transformers with plug connection

+7(812)987-08-81

			
1			
GEV No.	380403	Ref. No.	2001258H 2001873H 900073 BAAN1323154 BAAN311608
description	power relays FINDER 230VAC 16A 3CO connection F6.3 bracket mounting manuf. no. 62.83.8.230.0500		

			
1			
GEV No.	400956	Ref. No.	308479
description	transformer primary 230VAC secondary 12VAC 20VA connection male faston 6.3mm 50/60Hz type T602012/E temperature restriction 150°C ambient temperature max. 80°C		

			
2			
GEV No.	380702	Ref. No.	2002044H
description	power relays FINDER 230VAC 16A 3NO connection male faston 6.3mm flange dimensions 36x38x68mm manuf. no. 62.83.8.230.0300 230V		





electronic controllers

EVCO - EVERY CONTROL



universal controllers

built-in version

			
1			
GEV No.	380185	Ref. No.	2001929h 300283 BAAN1027526 BAAN171090 BAAN304383
description	power relays Italiana Relè 230VAC 30A 1NO connection F6.3 bracket mounting dimensions 36.5x32.2x51.8mm manuf. no. A10-230AC-FA		

			
1			
GEV No.	378131	Ref. No.	651225 S225P20
description	electronic controller EVERY CONTROL EVK411M mounting measurements 71x29mm 12V voltage AC/DC NTC/PTC/Pt100/Pt1000 relay outputs 1 CO-16A(8) NTC/PTC/Pt100/Pt1000/TC(J,K)/mV/mA yes protection IP65 dependent on probe°C display 3½ digits		
accessories for	378131		
	GEV No.	Ref. No.	—
	379050		temperature probe Pt100 cable Vetrotex probe -200 up to +600°C cable -50 up to +350°C probe ø6x100mm cable length 2.7m without screw connection 3-wire
	GEV No.	Ref. No.	—
	379160		temperature probe NTC 10kOhm cable thermoplastic probe -40 up to +110°C cable -40 up to +110°C probe ø6x14mm cable length 1.5m without screw connection 2-wire
	GEV No.	Ref. No.	—
	379781		temperature probe PTC 1kOhm cable thermoplastic probe -50 up to +150°C cable -40 up to +110°C probe ø6x14mm cable length 1.5m without screw connection 2-wire
	GEV No.	Ref. No.	—
	379944		temperature probe Pt1000 cable Vetrotex probe -70 up to +500°C cable -50 up to +350°C connection 2-wire thread probe ø6x180mm cable length 1.7m

relay sockets

			
1			
GEV No.	380137	Ref. No.	5937E
description	relay socket 8-pole connection plug-in connection round 8-pole dimensions 65x28x40mm 380V voltage AC 10A Italiana Relè manuf. no. ZVE8		
accessories for	380137		
	GEV No.	Ref. No.	—
	380805		support bracket



solenoid valves

solenoid valves (water)

ELBI



GEV No.	373020	Ref. No.	241447
description	solenoid valve double angled 230VAC inlet 3/4" outlet 14mm input 10l/min DN10 t.max. 90°C duty cycle 100% ELBI flow regulating valve inlet white		

ROBERTSHAW/INVENSYS

medium temperature: 90°C 90°C 60°C
 ambient temperature: 60°C 25°C 60°C
 duty cycle: 40% 100% 100%



GEV No.	372017	Ref. No.	144937 BAAN171061 BAAN302233
description	solenoid valve single straight 230VAC inlet 3/4" outlet 11.5mm DN10 EATON (INVENSYS)		

TP



GEV No.	370021	Ref. No.	1700434 3697E BAAN1320666 BAAN302969
description	solenoid valve double straight 230VAC inlet 3/4" outlet 11.5mm DN10 TP flow regulating valve inlet white		

spare parts for 370021

	GEV No.	371013	Ref. No.	—
solenoid coil TP 230VAC 50/60Hz				

accessories for 370021

	GEV No.	371220	Ref. No.	—
reducer TP flow rate 3l/min red tolerance ±15%				
	GEV No.	371221	Ref. No.	—
reducer TP flow rate 5.5l/min yellow tolerance ±15%				
	GEV No.	371222	Ref. No.	—
reducer TP flow rate 6l/min grey tolerance ±15%				

Зип-Общепит

	GEV No.	371223	Ref. No.	—
reducer TP flow rate 10l/min white tolerance ±15%				
	GEV No.	371224	Ref. No.	—
reducer TP flow rate 12l/min bronze tolerance ±15%				
	GEV No.	371225	Ref. No.	—
reducer TP flow rate 16l/min light brown tolerance ±15%				
	GEV No.	371226	Ref. No.	—
reducer TP flow rate 20l/min red tolerance ±15%				
	GEV No.	371230	Ref. No.	—
reducer TP flow rate 0.25l/min red tolerance ±25%				
	GEV No.	371231	Ref. No.	—
reducer TP flow rate 0.35l/min violet tolerance ±25%				
	GEV No.	371232	Ref. No.	—
reducer TP flow rate 0.5l/min orange tolerance ±25%				
	GEV No.	371233	Ref. No.	—
reducer TP flow rate 0.8l/min white tolerance ±25%				
	GEV No.	371234	Ref. No.	—
reducer TP flow rate 1l/min light blue tolerance ±25%				
	GEV No.	371235	Ref. No.	—
reducer TP flow rate 1.2l/min brown tolerance ±25%				
	GEV No.	371236	Ref. No.	—
reducer TP flow rate 1.5l/min light brown tolerance ±25%				
	GEV No.	371237	Ref. No.	—
reducer TP flow rate 2.5l/min yellow tolerance ±25%				
	GEV No.	371238	Ref. No.	—
reducer TP flow rate 3.4l/min dark green tolerance ±25%				
	GEV No.	371239	Ref. No.	—
reducer TP flow rate 5l/min black tolerance ±25%				
	GEV No.	371240	Ref. No.	—
reducer TP flow rate 8l/min blue tolerance ±20%				

	GEV No.	370017	Ref. No.	634084
description	solenoid valve single straight 230VAC inlet 3/4" outlet 11.5mm DN10 TP p max 10bar			
spare parts for	370017			
	GEV No.	371013	Ref. No.	—
solenoid coil TP 230VAC 50/60Hz				

Table continues overleaf

electric components



Зип-Общепит

vsezip.ru

+7(812)987-08-81

accessories for 370017		GEV No.	Ref. No.	
	reducer TP flow rate 3l/min red tolerance ±15%	371220		—
	reducer TP flow rate 5.5l/min yellow tolerance ±15%	371221		—
	reducer TP flow rate 6l/min grey tolerance ±15%	371222		—
	reducer TP flow rate 10l/min white tolerance ±15%	371223		—
	reducer TP flow rate 12l/min bronze tolerance ±15%	371224		—
	reducer TP flow rate 16l/min light brown tolerance ±15%	371225		—
	reducer TP flow rate 20l/min red tolerance ±15%	371226		—
	reducer TP flow rate 0.25l/min red tolerance ±25%	371230		—
	reducer TP flow rate 0.35l/min violet tolerance ±25%	371231		—
	reducer TP flow rate 0.5l/min orange tolerance ±25%	371232		—
	reducer TP flow rate 0.8l/min white tolerance ±25%	371233		—
	reducer TP flow rate 1l/min light blue tolerance ±25%	371234		—
	reducer TP flow rate 1.2l/min brown tolerance ±25%	371235		—
	reducer TP flow rate 1.5l/min light brown tolerance ±25%	371236		—
	reducer TP flow rate 2.5l/min yellow tolerance ±25%	371237		—
	reducer TP flow rate 3.4l/min dark green tolerance ±25%	371238		—
	reducer TP flow rate 5l/min black tolerance ±25%	371239		—
	reducer TP flow rate 8l/min blue tolerance ±20%	371240		—





GEV No.	Ref. No.	
370018	904693	
description solenoid valve single straight 230VAC inlet 3/4" outlet 14mm DN10 TP		
spare parts for 370018		
	GEV No. 371013	Ref. No. —
solenoid coil TP 230VAC 50/60Hz		
accessories for 370018		
	GEV No. 371220	Ref. No. —
reducer TP flow rate 3l/min red tolerance ±15%		
	GEV No. 371221	Ref. No. —
reducer TP flow rate 5.5l/min yellow tolerance ±15%		
	GEV No. 371222	Ref. No. —
reducer TP flow rate 6l/min grey tolerance ±15%		
	GEV No. 371223	Ref. No. —
reducer TP flow rate 10l/min white tolerance ±15%		
	GEV No. 371224	Ref. No. —
reducer TP flow rate 12l/min bronze tolerance ±15%		
	GEV No. 371225	Ref. No. —
reducer TP flow rate 16l/min light brown tolerance ±15%		
	GEV No. 371226	Ref. No. —
reducer TP flow rate 20l/min red tolerance ±15%		
	GEV No. 371230	Ref. No. —
reducer TP flow rate 0.25l/min red tolerance ±25%		
	GEV No. 371231	Ref. No. —
reducer TP flow rate 0.35l/min violet tolerance ±25%		
	GEV No. 371232	Ref. No. —
reducer TP flow rate 0.5l/min orange tolerance ±25%		
	GEV No. 371233	Ref. No. —
reducer TP flow rate 0.8l/min white tolerance ±25%		
	GEV No. 371234	Ref. No. —
reducer TP flow rate 1l/min light blue tolerance ±25%		
	GEV No. 371235	Ref. No. —
reducer TP flow rate 1.2l/min brown tolerance ±25%		
	GEV No. 371236	Ref. No. —
reducer TP flow rate 1.5l/min light brown tolerance ±25%		
	GEV No. 371237	Ref. No. —
reducer TP flow rate 2.5l/min yellow tolerance ±25%		

Table continues overleaf



Зип-Общепит
vsezip.ru

+7(812)987-08-81

accessories for		370018		
GEV No.	Ref. No.			
	371238	Ref. No.	—	
reducer TP flow rate 3.4l/min dark green tolerance ±25%				
	371239	Ref. No.	—	
reducer TP flow rate 5l/min black tolerance ±25%				
	371240	Ref. No.	—	
reducer TP flow rate 8l/min blue tolerance ±20%				



GEV No.	Ref. No.			
370025	314345	3664E	BAAN305607	

description solenoid valve triple straight 230VAC inlet 3/4" outlet 11.5mm DN10 TP

spare parts for		370025		
GEV No.	Ref. No.			
	371013	Ref. No.	—	
solenoid coil TP 230VAC 50/60Hz				

accessories for		370025		
GEV No.	Ref. No.			
	371220	Ref. No.	—	
reducer TP flow rate 3l/min red tolerance ±15%				
	371221	Ref. No.	—	
reducer TP flow rate 5.5l/min yellow tolerance ±15%				
	371222	Ref. No.	—	
reducer TP flow rate 6l/min grey tolerance ±15%				
	371223	Ref. No.	—	
reducer TP flow rate 10l/min white tolerance ±15%				
	371224	Ref. No.	—	
reducer TP flow rate 12l/min bronze tolerance ±15%				
	371225	Ref. No.	—	
reducer TP flow rate 16l/min light brown tolerance ±15%				
	371226	Ref. No.	—	
reducer TP flow rate 20l/min red tolerance ±15%				
	371230	Ref. No.	—	
reducer TP flow rate 0.25l/min red tolerance ±25%				
	371231	Ref. No.	—	
reducer TP flow rate 0.35l/min violet tolerance ±25%				
	371232	Ref. No.	—	
reducer TP flow rate 0.5l/min orange tolerance ±25%				
	371233	Ref. No.	—	
reducer TP flow rate 0.8l/min white tolerance ±25%				

accessories for		370025		
GEV No.	Ref. No.			
	371234	Ref. No.	—	
reducer TP flow rate 1l/min light blue tolerance ±25%				
	371235	Ref. No.	—	
reducer TP flow rate 1.2l/min brown tolerance ±25%				
	371236	Ref. No.	—	
reducer TP flow rate 1.5l/min light brown tolerance ±25%				
	371237	Ref. No.	—	
reducer TP flow rate 2.5l/min yellow tolerance ±25%				
	371238	Ref. No.	—	
reducer TP flow rate 3.4l/min dark green tolerance ±25%				
	371239	Ref. No.	—	
reducer TP flow rate 5l/min black tolerance ±25%				
	371240	Ref. No.	—	
reducer TP flow rate 8l/min blue tolerance ±20%				



GEV No.	Ref. No.			
370020	914123			

description solenoid valve double angled 230VAC inlet 3/4" outlet 14mm DN10 TP

spare parts for		370020		
GEV No.	Ref. No.			
	371013	Ref. No.	—	
solenoid coil TP 230VAC 50/60Hz				

accessories for		370020		
GEV No.	Ref. No.			
	371220	Ref. No.	—	
reducer TP flow rate 3l/min red tolerance ±15%				
	371221	Ref. No.	—	
reducer TP flow rate 5.5l/min yellow tolerance ±15%				
	371222	Ref. No.	—	
reducer TP flow rate 6l/min grey tolerance ±15%				
	371223	Ref. No.	—	
reducer TP flow rate 10l/min white tolerance ±15%				
	371224	Ref. No.	—	
reducer TP flow rate 12l/min bronze tolerance ±15%				
	371225	Ref. No.	—	
reducer TP flow rate 16l/min light brown tolerance ±15%				
	371226	Ref. No.	—	
reducer TP flow rate 20l/min red tolerance ±15%				











Table continues overleaf























Зип-Общепит

vsezip.ru

+7(812)987-08-81

accessories for		370020	
GEV No.	Ref. No.	GEV No.	Ref. No.
	371230	—	—
reducer TP flow rate 0.25l/min red tolerance ±25%			
	371231	—	—
reducer TP flow rate 0.35l/min violet tolerance ±25%			
	371232	—	—
reducer TP flow rate 0.5l/min orange tolerance ±25%			
	371233	—	—
reducer TP flow rate 0.8l/min white tolerance ±25%			
	371234	—	—
reducer TP flow rate 1l/min light blue tolerance ±25%			
	371235	—	—
reducer TP flow rate 1.2l/min brown tolerance ±25%			
	371236	—	—
reducer TP flow rate 1.5l/min light brown tolerance ±25%			
	371237	—	—
reducer TP flow rate 2.5l/min yellow tolerance ±25%			
	371238	—	—
reducer TP flow rate 3.4l/min dark green tolerance ±25%			
	371239	—	—
reducer TP flow rate 5l/min black tolerance ±25%			
	371240	—	—
reducer TP flow rate 8l/min blue tolerance ±20%			

accessories for		370015	
GEV No.	Ref. No.	GEV No.	Ref. No.
	371225	—	—
reducer TP flow rate 16l/min light brown tolerance ±15%			
	371226	—	—
reducer TP flow rate 2l/min red tolerance ±15%			
	371230	—	—
reducer TP flow rate 0.25l/min red tolerance ±25%			
	371231	—	—
reducer TP flow rate 0.35l/min violet tolerance ±25%			
	371232	—	—
reducer TP flow rate 0.5l/min orange tolerance ±25%			
	371233	—	—
reducer TP flow rate 0.8l/min white tolerance ±25%			
	371234	—	—
reducer TP flow rate 1l/min light blue tolerance ±25%			
	371235	—	—
reducer TP flow rate 1.2l/min brown tolerance ±25%			
	371236	—	—
reducer TP flow rate 1.5l/min light brown tolerance ±25%			
	371237	—	—
reducer TP flow rate 2.5l/min yellow tolerance ±25%			
	371238	—	—
reducer TP flow rate 3.4l/min dark green tolerance ±25%			
	371239	—	—
reducer TP flow rate 5l/min black tolerance ±25%			
	371240	—	—
reducer TP flow rate 8l/min blue tolerance ±20%			

 			
1			
GEV No.	370015	Ref. No.	634085
description	solenoid valve single angled 230VAC inlet 3/4" outlet 11.5mm DN10 TP		
accessories for	370015		
	GEV No. 371220	Ref. No.	—
reducer TP flow rate 3l/min red tolerance ±15%			
	GEV No. 371221	Ref. No.	—
reducer TP flow rate 5.5l/min yellow tolerance ±15%			
	GEV No. 371222	Ref. No.	—
reducer TP flow rate 6l/min grey tolerance ±15%			
	GEV No. 371223	Ref. No.	—
reducer TP flow rate 10l/min white tolerance ±15%			
	GEV No. 371224	Ref. No.	—
reducer TP flow rate 12l/min bronze tolerance ±15%			





 			
1			
GEV No.	370016	Ref. No.	23458 BAAN1322350 BAAN303848
description	solenoid valve single angled 230VAC inlet 3/4" outlet 14mm DN10 TP		
spare parts for	370016		
	GEV No. 371013	Ref. No.	—
solenoid coil TP 230VAC 50/60Hz			
accessories for	370016		
	GEV No. 371220	Ref. No.	—
reducer TP flow rate 3l/min red tolerance ±15%			

Table continues overleaf

1 electric components



Зип-Общепит

vsezip.ru

+7(812)987-08-81



accessories for		370016	
GEV No.	371221	Ref. No.	—
	reducer TP flow rate 5.5l/min yellow tolerance ±15%		
	reducer TP flow rate 6l/min grey tolerance ±15%		
	reducer TP flow rate 10l/min white tolerance ±15%		
	reducer TP flow rate 12l/min bronze tolerance ±15%		
	reducer TP flow rate 16l/min light brown tolerance ±15%		
	reducer TP flow rate 20l/min red tolerance ±15%		
	reducer TP flow rate 20l/min red tolerance ±15%		
	reducer TP flow rate 20l/min red tolerance ±15%		
	reducer TP flow rate 0.25l/min red tolerance ±25%		
	reducer TP flow rate 0.35l/min violet tolerance ±25%		
	reducer TP flow rate 0.5l/min orange tolerance ±25%		
	reducer TP flow rate 0.8l/min white tolerance ±25%		
	reducer TP flow rate 1l/min light blue tolerance ±25%		
	reducer TP flow rate 1.2l/min brown tolerance ±25%		
	reducer TP flow rate 1.5l/min light brown tolerance ±25%		
	reducer TP flow rate 2.5l/min yellow tolerance ±25%		
	reducer TP flow rate 3.4l/min dark green tolerance ±25%		
	reducer TP flow rate 5l/min black tolerance ±25%		
	reducer TP flow rate 8l/min blue tolerance ±20%		
	solenoid valve filter ø 19.5mm H 16mm		

GEV No.	370024	Ref. No.	634089
description	solenoid valve triple angled 230VAC inlet 3/4" outlet 14mm DN10 TP		
spare parts for	370024		
	GEV No.	371013	Ref. No. —
solenoid coil TP 230VAC 50/60Hz			
accessories for	370024		
	GEV No.	371220	Ref. No. —
reducer TP flow rate 3l/min red tolerance ±15%			
	GEV No.	371221	Ref. No. —
reducer TP flow rate 5.5l/min yellow tolerance ±15%			
	GEV No.	371222	Ref. No. —
reducer TP flow rate 6l/min grey tolerance ±15%			
	GEV No.	371223	Ref. No. —
reducer TP flow rate 10l/min white tolerance ±15%			
	GEV No.	371224	Ref. No. —
reducer TP flow rate 12l/min bronze tolerance ±15%			
	GEV No.	371225	Ref. No. —
reducer TP flow rate 16l/min light brown tolerance ±15%			
	GEV No.	371226	Ref. No. —
reducer TP flow rate 20l/min red tolerance ±15%			
	GEV No.	371230	Ref. No. —
reducer TP flow rate 0.25l/min red tolerance ±25%			
	GEV No.	371231	Ref. No. —
reducer TP flow rate 0.35l/min violet tolerance ±25%			
	GEV No.	371232	Ref. No. —
reducer TP flow rate 0.5l/min orange tolerance ±25%			
	GEV No.	371233	Ref. No. —
reducer TP flow rate 0.8l/min white tolerance ±25%			
	GEV No.	371234	Ref. No. —
reducer TP flow rate 1l/min light blue tolerance ±25%			
	GEV No.	371235	Ref. No. —
reducer TP flow rate 1.2l/min brown tolerance ±25%			
	GEV No.	371236	Ref. No. —
reducer TP flow rate 1.5l/min light brown tolerance ±25%			
	GEV No.	371237	Ref. No. —
reducer TP flow rate 2.5l/min yellow tolerance ±25%			



Table continues overleaf



Зип-Общепит

vsezip.ru

+7(812)987-08-81

accessories for		370024	
GEV No.	371238	Ref. No.	—
	reducer TP flow rate 3.4l/min dark green tolerance ±25%		
GEV No.	371239	Ref. No.	—
	reducer TP flow rate 5l/min black tolerance ±25%		
GEV No.	371240	Ref. No.	—
	reducer TP flow rate 8l/min blue tolerance ±20%		

solenoid valves with reducers

			
1			
GEV No.	370255	Ref. No.	914135
description	solenoid valve triple angled 230VAC inlet 3/4" outlet 11.5mm plastic		

			
1			
GEV No.	370250	Ref. No.	147723
description	solenoid valve triple straight 230VAC inlet 3/4" outlet 11.5mm t.max. 90°C TP plastic output B 0.25l/min flow regulating valve outlet B red		

ball valves electric



			
1			
GEV No.	401190	Ref. No.	314359
description	ball valve inlet 3/4" IT outlet 3/4" IT IP42 230V L 68mm 50/60Hz closed off-current mode of operation electric connection cable 300mm 3.5W duty cycle 50%		

axial fans

			
1			
GEV No.	601030 ¹	Ref. No.	780002656
description	axial fan L 119mm W 119mm H 38mm 230VAC 50Hz 18W bearing ball bearing manuf. no. 4656Z metal connection male faston 2.8mm ebm-papst fan wheel ø 110mm temp.-resist. 75°C		
accessories for	601030		
GEV No.	550898	Ref. No.	—
	connecting cable cable length 2000mm connection F 2.8 connection distance 7.9mm for axial flow fan		
GEV No.	692497	Ref. No.	—
	guard ø 105mm mounting distance 150mm for axial fan ebm-papst-mm		

¹with ball bearings

import

			
1			
GEV No.	601080 ¹	Ref. No.	304194 780002656 906107 BAAN167195 BAAN312100
description	axial fan L 119mm W 119mm H 38mm 230VAC 50/60Hz 23/20W bearing ball bearing connection male faston 2.8mm metal ADDA fan wheel ø 110mm temp.-resist. 70°C		
accessories for	601080		
GEV No.	550898	Ref. No.	—
	connecting cable cable length 2000mm connection F 2.8 connection distance 7.9mm for axial flow fan		
GEV No.	692519	Ref. No.	—
	guard L 120mm W 120mm plastic		

¹with ball bearings



Зип.Общепит pumps

vsezip.ru

pumps

+7(812)987-08-81

cross flow fans

COPREL

with standard coil



1

GEV No.	602060	Ref. No.	304229
description	cross flow fan COPREL FFR roller ϕ 60mm roller length 240mm laminated core thickness 20mm motor position right 230V/50-60Hz 33W universal bearing silicone connection male faston 6.3mm airflow 149m ³ /h -10 up to +60°C		

hot air motors



1

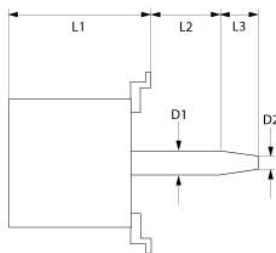

GEV No.	500812	Ref. No.	71251E
description	fan motor 220-240/380-415V 3 phase 50Hz 0.26kW 1440rpm speeds 1 D1 ϕ 17mm D2 ϕ 13.5mm		



1

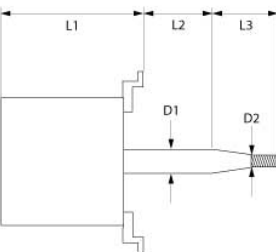

GEV No.	499206	Ref. No.	304267 BAAN1050261 BAAN1051644
description	fan motor 230/400V 3 phase 50/60Hz 0.12kW 1400/1700rpm speeds 2 L1 145mm L2 30mm L3 25mm D1 ϕ 17mm D2 ϕ 14mm M6 1.2/0.7A suitable capacitor 16 μ F/450V Cos(fi) 0.53 type 1079TH		

wash and rinse pumps



1

GEV No.	499284	Ref. No.	314361
description	pump inlet ϕ 28mm outlet ϕ 26mm type UP60-321 Ru. 220-240V 50Hz 1 phase 0.27kW L 190mm rotation direction right capacitor 5 μ F HANNING		

spare parts for 499284



GEV No.	365017	Ref. No.	2000001 304269
----------------	--------	-----------------	-------------------

operating capacitor capacity 5 μ F 450V tolerance 5% 50/60Hz ambient temperature max. -25 to +85°C ϕ 28mm L 54mm M8 plastic connection male faston 6.3mm 16.10.08 protection

GEV No.	507558	Ref. No.	—
----------------	--------	-----------------	---

mechanical shaft seal for shaft ϕ 7mm height counter ring 5mm ID ϕ 6.75mm ED ϕ 20mm mounting ϕ counter ring 18.5/slide ring 20mm

GEV No.	532644	Ref. No.	—
----------------	--------	-----------------	---

O-ring EPDM thickness 3mm ID ϕ 78mm Qty 1 pcs

drain pumps

ASKOLL



1

GEV No.	500346	Ref. No.	2001518H
description	drain pump inlet ϕ 30mm outlet ϕ 22mm 230V 40W 50Hz ASKOLL type M231 XP with holder		



booster pumps II

Зип Общепит

vsezip.ru

+7(812)987-08-81

accessories



1

GEV No.	365017	Ref. No.	2000001 304269
description	operating capacitor capacity 5µF 450V tolerance 5% 50/60Hz ambient temperature max. -25 to +85°C ø 28mm L 54mm M8 plastic connection male faston 6.3mm 16.10.08 protection		



1

GEV No.	365012	Ref. No.	2000059
description	operating capacitor capacity 6.3µF 450V tolerance 5% 50Hz ambient temperature max. -25 to +85°C ø 30mm L 61mm M8 plastic connection male faston 6.3mm protection		

condensators & interference suppression filters

operating capacitors

plastic



1

GEV No.	365021	Ref. No.	2001118H 304259
description	operating capacitor capacity 16µF 425V tolerance 5% 50/60Hz ambient temperature max. -25 to +85°C ø 35mm L 73mm single M8 plastic connection male faston 6.3mm 416.10.99 protection		



1

GEV No.	365019	Ref. No.	2001119H
description	operating capacitor capacity 20µF 400V tolerance 5% 50/60Hz ambient temperature max. -25 to +85°C ø 39.5mm L 70mm M8 plastic connection male faston 6.3mm 16.10.25. protection		



GEV No.	365017	Ref. No.	2000001 304269
description	operating capacitor capacity 5µF 450V tolerance 5% 50/60Hz ambient temperature max. -25 to +85°C ø 28mm L 54mm M8 plastic connection male faston 6.3mm 16.10.08 protection		



1

GEV No.	365012	Ref. No.	2000059
description	operating capacitor capacity 6.3µF 450V tolerance 5% 50Hz ambient temperature max. -25 to +85°C ø 30mm L 61mm M8 plastic connection male faston 6.3mm protection		



1

GEV No.	365013	Ref. No.	3709E
description	operating capacitor capacity 8µF 400V tolerance 5% 50Hz ambient temperature max. -25 to +85°C ø 31.5mm L 55mm M8 plastic connection male faston 6.3mm protection		

metal



1

GEV No.	365139	Ref. No.	5843E
description	operating capacitor capacity 10µF 450V tolerance 5% 60Hz ambient temperature max. -25 up to +70°C ø 40mm L 83mm M8 aluminium connection male faston 6.3mm C.87.8BF2 MKP protection		

Зип Общепит
gas thermostats

PEL
2551 series

+7(812)987-08-81

fuses

fine fuses

			
1			
GEV No.	358666	Ref. No.	309316
description	fine fuse size ø5x20mm 0.315A fast-acting rated 250V Qty 10 pcs		

			
1			
GEV No.	358530	Ref. No.	2001921H
description	fine fuse size ø5x20mm 0.8A fast-acting rated 250V Qty 10 pcs		

			
1			
GEV No.	358677	Ref. No.	2001981H 2002146H
description	fine fuse size ø5x20mm 4A fast-acting rated 250V Qty 10 pcs		

			
1			
GEV No.	358752	Ref. No.	3090506
description	fine fuse size ø6.3x32mm 10A fast-acting rated 500V Qty 10 pcs		

electric accessories

terminals

connection terminals with screw/faston connections

			
1			
GEV No.	550411	Ref. No.	2001039H 306090 306157 5876E 906154
description	power terminal block 6-pole max. 40A max 450V connection ø6mm ² / F6.3 temp.-resist. 150°C cross section 6mm ²		

1			
GEV No.	101172	Ref. No.	310137
description	gas thermostat PEL type 255T 100-300°C gas inlet M16x1.5 (tube ø 10mm) bypass nozzle ø 0.35mm gas outlet M16x1.5 (tube ø 10/8mm) thermocouple connection M9x1 pilot connection M10x1 capillary pipe 1200mm probe ø 6mm probe L 100mm shaft ø 8x6.5mm shaft L 21/15mm shaft flat upper		

spare parts for	101172		
------------------------	--------	--	--

	GEV No.	100259	Ref. No.	—
	bypass nozzle type PEL22 bore ø 0.35mm thread M6x0.5			

	GEV No.	101060	Ref. No.	7473048 BAAN310651
	magnet unit standard L 39mm D1 ø 15.4mm D2 ø 11mm suitable for PEL20-21/JUNKERS/EGA			

	GEV No.	106200	Ref. No.	—
	nut thread M9x1 suitable for PEL 24/255			

accessories for	101172		
------------------------	--------	--	--

	GEV No.	100908	Ref. No.	—
	union screw thread M10x1 for pipe ø 4mm Qty 1 pcs			

	GEV No.	100909	Ref. No.	—
	union screw thread M10x1 for pipe ø 6mm Qty 1 pcs			

	GEV No.	101246	Ref. No.	—
	olive for pipe ø 4mm Qty 1 pcs			

	GEV No.	101278	Ref. No.	—
	olive for pipe ø 10mm Qty 1 pcs			

	GEV No.	101286	Ref. No.	—
	olive ID ø 6mm Qty 1 pcs			

	GEV No.	101300	Ref. No.	—
	union nut thread M16x1.5 tube ø 10mm			

	GEV No.	101450	Ref. No.	—
	olive for pipe ø 8mm L 12.7mm Qty 1 pcs ED ø 10mm			

	GEV No.	101451	Ref. No.	—
	union nut thread M16x1.5 tube ø 8mm			

	GEV No.	110079	Ref. No.	—
	knob dial plate gas thermostat 1-8 silver			

	GEV No.	110081	Ref. No.	171475
	knob ø 70mm shaft ø 8x6.5mm shaft flat universal			



gas valves and ignition boxes

Зип-Общепит









gas control valves

SIT

ELETTROSIT



1

GEV No.	101127	Ref. No.	7472025 BAAN1209942 BAAN310630
description	gas valve SIT type ELETTROSIT 230V gas inlet 3/4" gas outlet 3/4" thermocouple connection M9x1 pilot connection M10x1 lateral equiv. no. 0.810.175		
spare parts for	101127		
	GEV No.	101312	Ref. No. —
	microswitch		
	GEV No.	101352	Ref. No. —
	solenoid coil 230V 50Hz suitable for ELETTROSIT		
accessories for	101127		
	GEV No.	100006	Ref. No. —
	piezoelectric igniter suitable for ELETTROSIT body plastic blowing connection $\varnothing 2.4\text{mm}$ $\varnothing 14\text{mm}$		
	GEV No.	100904	Ref. No. —
	locking screw M10x1 for pipe $\varnothing 4\text{mm}$ Qty 1 pcs		
	GEV No.	100905	Ref. No. —
	locking screw M10x1 for pipe $\varnothing 6\text{mm}$ Qty 1 pcs		
	GEV No.	101301	Ref. No. —
	gas connection thread 1/2" straight ELETTROSIT screw with O-ring		
	GEV No.	101303	Ref. No. —
	gas connection straight thread 3/4" ELETTROSIT		
	GEV No.	101309	Ref. No. —
	extension		

accessories



1

GEV No.	101313	Ref. No.	2020037
description	solenoid coil 230V 50Hz		
accessories for	101313		
	GEV No.	550896	Ref. No. —
	gasket with screw gas valves NOVASIT		

TANDEM



1









GEV No.	101189	Ref. No.	310305 BAAN829205 BAAN847641
description	gas valve 230V 50Hz gas inlet 1/2" gas outlet 1/2" pilot connection M10x1 level slow ignition ignition times pressure range 3-50mbar power supply for modulator equiv. no. 0.830.040 suitable for Tandem		
spare parts for	101189		
	GEV No.	101379	Ref. No. —
	solenoid coil 230V 50Hz suitable for Tandem		
accessories for	101189		
	GEV No.	100904	Ref. No. —
	locking screw M10x1 for pipe $\varnothing 4\text{mm}$ Qty 1 pcs		
	GEV No.	100905	Ref. No. —
	locking screw M10x1 for pipe $\varnothing 6\text{mm}$ Qty 1 pcs		
	GEV No.	101274	Ref. No. —
	olive for pipe $\varnothing 16\text{mm}$ Qty 1 pcs		
	GEV No.	101275	Ref. No. —
	union screw thread 1/2" for pipe $\varnothing 16\text{mm}$ Qty 1 pcs		
	GEV No.	101925	Ref. No. —
	plug with O-ring thread M10x1 for pilot burner suitable for NOVASIT		
	GEV No.	102845	Ref. No. —
	gas connection angled 1/2" flange 32x32mm hole distance 24x24mm Tandem		
	GEV No.	102846	Ref. No. —
	gas connection straight 1/2" flange 32x32mm hole distance 24x24mm suitable for Tandem		

Table continues overleaf

Зип-Общепит
vsezip.ru
+7(812)987-08-81

accessories for	101189		
	GEV No.	102847	Ref. No.
			—
	O-ring		





GEV No.	107831	Ref. No.	310196
description	gas valve 230V 50Hz gas inlet 1/2" gas outlet 1/2" pilot connection M10x1 pressure range 3-50mbar type Tandem 830 SIT equiv. no. 0.830.030		

spare parts for	107831		
	GEV No.	101379	Ref. No.
			—
	solenoid coil 230V 50Hz suitable for Tandem		

accessories for	107831		
------------------------	--------	--	--

	GEV No.	100904	Ref. No.
			—
	locking screw M10x1 for pipe ø 4mm Qty 1 pcs		

	GEV No.	100905	Ref. No.
			—
	locking screw M10x1 for pipe ø 6mm Qty 1 pcs		

	GEV No.	101274	Ref. No.
			—
	olive for pipe ø 16mm Qty 1 pcs		

	GEV No.	101275	Ref. No.
			—
	union screw thread 1/2" for pipe ø 16mm Qty 1 pcs		

	GEV No.	101925	Ref. No.
			—
	plug with O-ring thread M10x1 for pilot burner suitable for NOVASIT		

	GEV No.	102845	Ref. No.
			—
	gas connection angled 1/2" flange 32x32mm hole distance 24x24mm Tandem		

	GEV No.	102846	Ref. No.
			—
	gas connection straight 1/2" flange 32x32mm hole distance 24x24mm suitable for Tandem		

	GEV No.	102847	Ref. No.
			—
	O-ring		

SIT			
100 series			
	1		
GEV No.	107519	Ref. No.	310324 BAAN1064197 BAAN1067290
description	ignition box SIT type 579DBC electrodes 2 waiting time 3s safety time 5s 220/240V 12VA 50/60Hz		

ignition parts









pilot burners			
SIT			
100 series			
	1		
GEV No.	106906	Ref. No.	2020124 7434003
description	pilot burner SIT type 100 series 3 flames nozzle ø 0.2mm gas connection 6mm		
spare parts for	106906		
	GEV No.	100245	Ref. No.
			—
	pilot burner nozzle LPG code 20 bore ø 0.2mm Qty 1 pcs thread M8x0.75		
	GEV No.	100855	Ref. No.
			—
	pilot burner bracket triple		
	GEV No.	100885	Ref. No.
			—
	air mixing sleeve for pilot burner Qty 1 pcs		
	GEV No.	100916	Ref. No.
			—
	compression spring for pilot burner Qty 1 pcs		
	GEV No.	100917	Ref. No.
			—
	gasket for pilot burner Qty 1 pcs aluminium		
	GEV No.	100918	Ref. No.
			—
	screw for pilot burner		
	GEV No.	107162	Ref. No.
			—
	pilot burner cap SIT 3 flames Hmm Lmm Qty 1 pcs		
	GEV No.	107701	Ref. No.
			—
	pilot burner bottom part SIT 100 series nozzle ø 0.2mm		

Table continues overleaf



Зип Общежит

electrodes

vsezip.ru

+7(812)987-08-81

accessories for		106906	
	GEV No.	100245	Ref. No. —
	pilot burner nozzle LPG code 20 bore \varnothing 0.2mm Qty 1 pcs thread M8x0.75		
	GEV No.	100246	Ref. No. —
	pilot burner nozzle natural gas bore \varnothing 0.35mm Qty 1 pcs thread M8x0.75		
	GEV No.	100904	Ref. No. —
	locking screw M10x1 for pipe \varnothing 4mm Qty 1 pcs		
	GEV No.	100905	Ref. No. —
	locking screw M10x1 for pipe \varnothing 6mm Qty 1 pcs		
	GEV No.	102110	Ref. No. —
	pilot tube copper pipe \varnothing 4mm thickness 1mm L 3000mm		
	GEV No.	102111	Ref. No. —
	pilot tube copper pipe \varnothing 6mm thickness 1mm L 3000mm		
	GEV No.	107171	Ref. No. —
	pilot burner nozzle SIT natural/liquid gas bore \varnothing 0.25mm Qty 1 pcs		
	GEV No.	107700	Ref. No. —
	pilot burner bottom part SIT 100 series nozzle \varnothing 0.25mm		
	GEV No.	107702	Ref. No. —
	pilot burner bottom part SIT 100 series nozzle \varnothing 0.35mm		

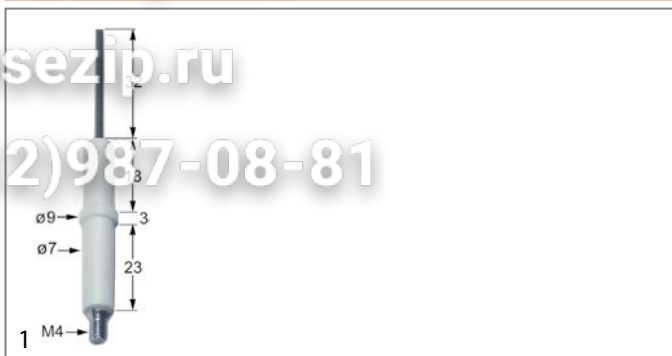

GEV No.	100701	Ref. No.	308480 BAAN824045 BAAN838031
description	ignition electrode connection M4 Qty 1 pcs		
accessories for	100701		
	GEV No.	100906	Ref. No. 317980 BAAN829766 BAAN838033
	screw connection thread M10x1 for ignition electrode brass Qty 1 pcs WS 10		

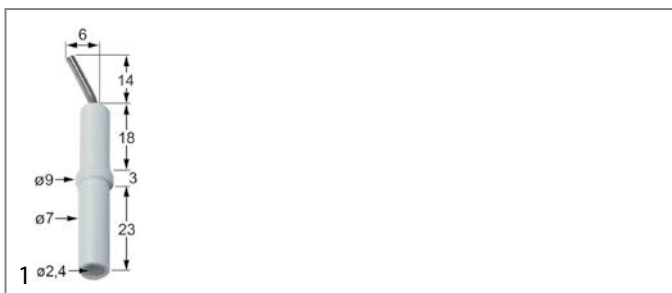

GEV No.	100707	Ref. No.	7455048
description	ignition electrode D1 \varnothing 7mm D2 \varnothing 9mm connection \varnothing 2.4mm L1 14mm L2 6mm BL1 18mm BL2 3mm BL3 23mm to clip Qty 1 pcs		



GEV No.	100906	Ref. No.	317980 BAAN829766 BAAN838033
description	screw connection thread M10x1 for ignition electrode brass Qty 1 pcs WS 10		

accessories

ignition electrodes



GEV No.	100707	Ref. No.	7455048
description	ignition electrode D1 \varnothing 7mm D2 \varnothing 9mm connection \varnothing 2.4mm L1 14mm L2 6mm BL1 18mm BL2 3mm BL3 23mm to clip Qty 1 pcs		

ignition cables

pre-assembled cables



GEV No.	100176	Ref. No.	307997
description	ignition cable cable length 1000mm connection \varnothing 2.4mm / \varnothing 4mm permanent temperature 200°C		

2 gas components

ignition units



1

GEV No.	102388	Ref. No.	308466 680782 BAAN308466
description	ignition unit outputs 4 230VAC dimensions 111x23x34mm mounting distance 100mm inlet F6.3x0.8 outlet F2.8x0.8 type WAC-T4 0.6VA 50/60Hz		

thermocouples

thermocouple sets universal

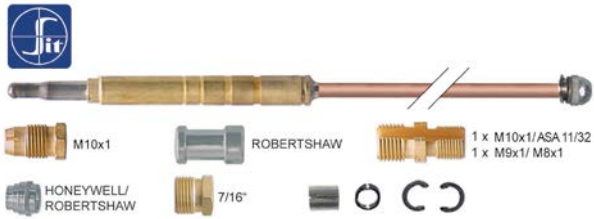

1

GEV No.	107648	Ref. No.	7473055
description	thermocouple set SIT 11-piece L 1200mm		



1

GEV No.	102286	Ref. No.	634321
description	thermocouple set 8-piece L 900mm flexible		

plug-in thermocouples

plug-in thermocouples standard

with barrel socket $\phi 6(6.5)$ mm

thermocouples SIT

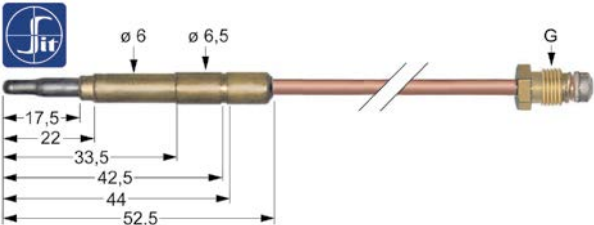

1

GEV No.	102682	Ref. No.	310276 7473056 BAAN310657 BAAN840079
description	thermocouple SIT aluminized tip M9x1 L 850mm plug connection $\phi 6.0(6.5)$ mm		

Зип Общепит

vsezip.ru

+7(812)987-08-81

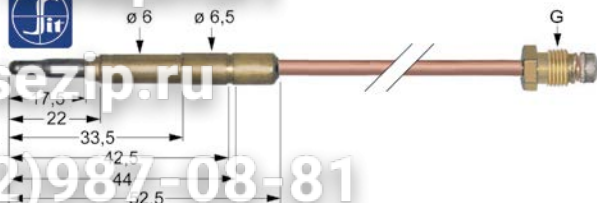

1

GEV No.	107613	Ref. No.	310277 7473029 BAAN310646 BAAN838026
description	thermocouple SIT M9x1 L 1200mm plug connection $\phi 6.0(6.5)$ mm		

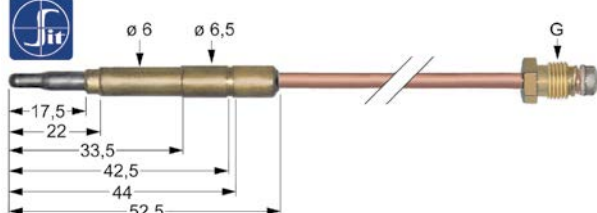

1

GEV No.	107614	Ref. No.	7473034
description	thermocouple SIT M9x1 L 1500mm plug connection $\phi 6.0(6.5)$ mm		

threaded thermocouples

threaded thermocouples standard

with socket with thread M8x1

SIT

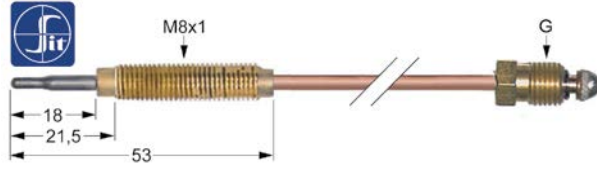

1

GEV No.	107634	Ref. No.	310193	
description	thermocouple SIT M8x1 L 1500mm M8x1			
accessories for	107634			
	GEV No.	102067	Ref. No.	—
	nut thread M8x1 H 3mm brass Qty 1 pcs type SEF 1			

extensions



1

GEV No.	102811	Ref. No.	7492000
description	thermocouple extension thread M9x1 - M9x1 L 600mm		



Зип Общежит
vsezip.ru
+7(812)987-08-81

accessories

interrupters



1

GEV No.	101265	Ref. No.	605680 905680
description	interrupter thread M9x1		

gas nozzles

pilot burner nozzles

pilot burner nozzles SIT

100 series



1

GEV No.	102973	Ref. No.	7433158
description	pilot burner nozzle natural gas bore ø 0.45mm Qty 1 pcs		

160 series



1

GEV No.	107172	Ref. No.	310274 BAAN834138 BAAN838035
description	pilot burner nozzle SIT LPG code 25 Qty 1 pcs		



1

GEV No.	107650	Ref. No.	311171
description	pilot burner nozzle SIT LPG code 30 Qty 1 pcs		



1

GEV No.	107174	Ref. No.	310273 BAAN829765 BAAN838038
description	pilot burner nozzle SIT natural gas code 41 Qty 1 pcs		

screw connections

union screws



1

GEV No.	100906	Ref. No.	317980 BAAN829766 BAAN838033
description	screw connection thread M10x1 for ignition electrode brass Qty 1 pcs WS 10		



1

GEV No.	100907	Ref. No.	317979 BAAN829767 BAAN838027
description	screw connection thread M10x1 Qty 1 pcs type SEF 1 ømm for thermocouple		

for ice-cube maker

hoses

formed hoses

straight

silicone hoses



1

GEV No.	530063	Ref. No.	71289E
description	silicone hose ID ø 18mm ED ø 25mm L 1m t.max. 200°C transparent		

brewing units

filter holder gaskets

O-rings



1

GEV No.	510409	Ref. No.	318044 905588 966001 BAAN1323306 BAAN311999
description	O-ring EPDM thickness 5.34mm ID ø 56.52mm Qty 1 pcs		

2 gas components

Зип.Общепит

door catches

vsezip.ru

+7(812)987-08-81

knobs

producer-specific knobs

BONNET



1

GEV No.	110081	Ref. No.	171475
description	knob ø 70mm shaft ø 8x6.5mm shaft flat universal		

locks

edgemount latches

handle latches

CAFF/FERMOD

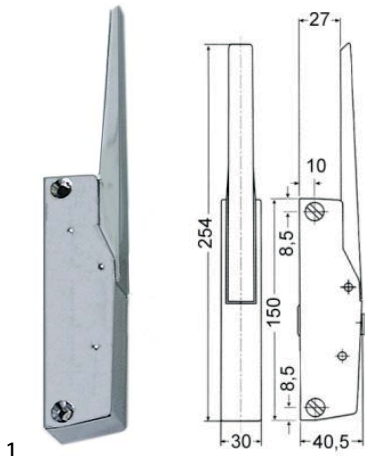

1

GEV No.	690412	Ref. No.	21433E 384634 BAAN1322230 BAAN303576
description	handle latch L 150mm mounting distance 133mm non lockable G 790 total length 254mm handle length 105mm		

accessories for	690412			
	GEV No.	690418	Ref. No.	—
	door catch L 36mm W 19mm H 29mm mounting distance 12mm zinc-coated steel for refrigeration units			
	GEV No.	690419	Ref. No.	—
	door catch L 52mm W 20mm H 30mm mounting distance 26-37mm zamak for refrigeration units			
	GEV No.	700061	Ref. No.	—
	door catch L 58mm W 20mm H 35mm mounting distance 42mm chrome-plated brass for headed units			
	GEV No.	700435	Ref. No.	—
	door catch L 58mm W 20mm H 35mm mounting distance 42mm zamak for refrigeration units			

shelves and shelf rails

grates

universal

without upstand

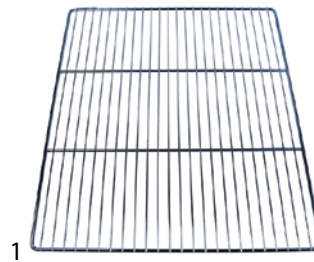

1

GEV No.	970123	Ref. No.	635022	
description	grate W 650mm D 530mm GN 2/1 stainless steel wire gauge frame 7.8mm lengthwise wires gauge 3.8mm crossing wires 2 suitable for refrigerator			
accessories for	970123			
	GEV No.	690330	Ref. No.	—
	rack L 1000mm W 22mm H 4mm aperture 3x8mm hole distance 12.5mm stainless steel			
	GEV No.	694700	Ref. No.	—
	shelf support L 31/28mm W 22mm H 18mm SS Qty 12 pcs			
	GEV No.	694701	Ref. No.	—
	shelf support L 31/28mm W 22mm H 17mm SS with hook Qty 12 pcs			

gaskets

gaskets for heated units

window seals

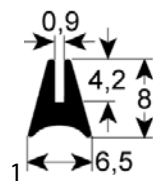

1

GEV No.	901306	Ref. No.	366122
description	window gasket profile 1515 Qty supplied by meter		



Зип Общепит

vsezip.ru

+7(812)987-08-81

GEV No.	901513	Ref. No.	71209E
description	window gasket profile 1615 suitable for BOURGEOIS Qty supplied by meter		

GEV No.	532000	Ref. No.	366185
description	O-ring EPDM thickness 7mm ID ø 57mm Qty 1 pcs		

door seals

GEV No.	901424	Ref. No.	71204E 71206E BAAN309220 BAAN309222
description	door seal profile 2711 L 2600mm Qty 1		

special gaskets

miscellaneous

GEV No.	511600	Ref. No.	71860E
description	gasket ED ø 80mm		

GEV No.	518126	Ref. No.	71876E
description	door seal profile 2980 L 2820mm		

transmission technology and ball bearings

ball bearings

deep-groove ball bearings 2RS

GEV No.	523522	Ref. No.	21090500
description	deep-groove ball bearing type 6004-2RS shaft ø 20mm ED ø 42mm W 12mm with sealing discs deep-groove ball bearing DIN 625-1		

O-rings

EPDM

ø5.34mm

GEV No.	510408	Ref. No.	2001827H
description	O-ring EPDM thickness 5.34mm ID ø 47mm Qty 1 pcs		

dosing pumps

accessories

container filters with non-return valve

GEV No.	361058	Ref. No.	2000034
description	container filter with non-return valve SS hose ø 4x6mm ø 20mm L 56mm		

GEV No.	510409	Ref. No.	318044 905588 966001 BAAN1323306 BAAN311999
description	O-ring EPDM thickness 5.34mm ID ø 56.52mm Qty 1 pcs		

mechanical components, equipment accessories



hoses

supply hoses

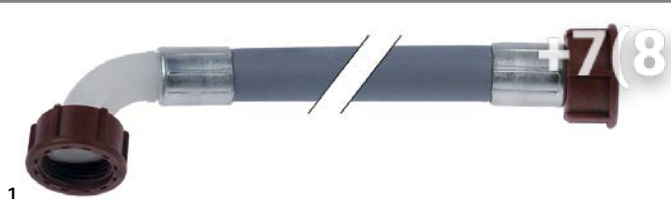
PVC supply hoses



1

GEV No.	520010	Ref. No.	2001753H 42551
description	supply hose PVC straight-curved DN13 connections 3/4" L 1500mm operating p. 10bar burst p. 32bar t.max. 90°C blue approval VDE flat seal		
accessories for	520010		
	GEV No.	520053	Ref. No. —
	screen connection 3/4" D1 ø 26mm D2 ø 15mm Qty 10 pcs rubber thickness 8mm		
	GEV No.	520054	Ref. No. —
	flat gasket rubber ED ø 23.5mm ID ø 14mm thickness 2.3mm Qty 10 pcs		



1

GEV No.	520011	Ref. No.	2001738H
description	supply hose PVC straight-curved DN13 connections 3/4" L 2000mm operating p. 10bar burst p. 32bar t.max. 90°C approval VDE flat seal		

industrial hoses

Niplaflex hoses



1

GEV No.	530561	Ref. No.	2001726H
description	pressure hose ID ø 10mm ED ø 17mm L 5m thickness 3.5mm operating p. 10bar burst p. 30bar t.max. 110°C		

PVC hoses

PVC hoses without fabric



1

GEV No.	520029	Ref. No.	2001747H
description	PVC hose ID ø 6mm ED ø 9mm L 10m thickness 1.5mm t.max. 60°C transparent		

Зип-Общепит

silicone hoses

without fabric



1

GEV No.	530063	Ref. No.	71289E
description	silicone hose ID ø 18mm ED ø 25mm L 1m t.max. 200°C transparent		

with fabric

with monofilament braid

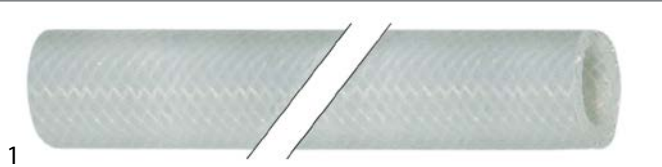

1

GEV No.	530542	Ref. No.	71265E
description	silicone hose with monofilament braid ID ø 10mm ED ø 17mm L 5m thickness 3.5mm operating p. 4bar burst pressure at 95°C non definedbar burst pressure 130°C non definedbar t.max. 200°C Qty 5m		

valves and tank inlets

ball valves

ball valves electric



1

GEV No.	401190	Ref. No.	314359
description	ball valve inlet 3/4" IT outlet 3/4" IT IP42 230V L 68mm 50/60Hz closed off-current mode of operation electric connection cable 300mm 3.5W duty cycle 50%		

water cycle components

supply filters



1

GEV No.	520261	Ref. No.	91297387
description	supply filter thread 1/2" IT - 1/2" IT total length 58mm red brass mesh opening 0.4mm		



ancillary products

Зип-Общепит consumables

vsezip.ru

+7(812)987-08-81

clamps

hose clamps

DIN 3017 - W2



1

GEV No. 520114 **Ref. No.** 917110

description hose clamp ø 20-32mm width 9mm Qty 10 pcs DIN 3017

fastening material

nuts

hexagonal nuts

DIN 985



1

GEV No. 560141 **Ref. No.** 389540
BAAN1050326

description hexagonal nut thread M5 H 5.4mm SS WS 8 Qty 20 pcs DIN/ISO DIN 985 self-locking

fasteners

clamps

hose clamps

DIN 3017 - W2



1

GEV No. 520114 **Ref. No.** 917110

description hose clamp ø 20-32mm width 9mm Qty 10 pcs DIN 3017

fuses

fine fuses



1

GEV No. 358666 **Ref. No.** 309316

description fine fuse size ø5x20mm 0.315A fast-acting rated 250V Qty 10 pcs



1

GEV No. 358530 **Ref. No.** 2001921H

description fine fuse size ø5x20mm 0.8A fast-acting rated 250V Qty 10 pcs



1

GEV No. 358677 **Ref. No.** 2001981H
2002146H

description fine fuse size ø5x20mm 4A fast-acting rated 250V Qty 10 pcs

ø6.3x32mm 500V



1

GEV No. 358752 **Ref. No.** 3090506

description fine fuse size ø6.3x32mm 10A fast-acting rated 500V Qty 10 pcs

Зип Общепит

vsezip.ru

+7(812)987-08-81

Зип Общепит

vsezip.ru

+7(812)987-08-81

A			
alarm devices	7	hexagonal nuts	27
axial fans	15	hose clamps	27, 27
		hoses	26
		hot air motors	16
B			
ball valves	26	ignition boxes	20
ball valves electric	15, 26	ignition cables	21
bi-metal thermostats	3, 3	ignition units	22
booster pumps II	17	immersion heating elements	2
		indicator lights	6
		indicator lights (complete)	6
		industrial hoses	26
C		L	
cam switches	5	lamps	6
clamps	27, 27	light bulbs	6
condensators & interference suppression filters	17		
consumables	27	M	
contactors	7	magnetic switches	5
container filters	25	microswitches	4
control thermostats	3		
cross flow fans	16	N	
		neon light bulbs	6, 6
		Niplaflex hoses	26
		nuts	27
D		O	
door catches	24	operating capacitors	17
door seals	25	O-rings	25
dosing pumps	25	oven lamps	7
drain pumps	16		
		P	
		pilot burners	20
		pumps	16
		PVC hoses	26
		PVC supply hoses	26
E		R	
edgemount latches	24	relays	8
electric accessories	18	rocker/momentary rocker switches	4
electronic controllers	9		
energy regulators	2	S	
		safety thermostats	3
		shelves and shelf rails	24
		silicone hoses	26
		solenoid valves	10
		supply filters	26, 26
		supply hoses	26
		switches and momentary switches	4
		system switches (ROLD)	5
F			
fans	15		
fasteners	27		
fastening material	27		
fine fuses	27		
fluorescent lamps	7, 7		
fuses	18, 27		
G			
gas control valves	19		
gas nozzles	23		
gas thermostats	18		
gaskets for heated units	24		
grates	24		
H			
halogen lamp	7		
handle latches	24		
heating elements	2		
heating elements for convection	2		

Зип Общепит**vsezip.ru****+7(812)987-08-81****T**

terminals	18
thermocouples	22
thermostats	23
transformers	29

V

valves and tank inlets	26
------------------------	----

W

wash and rinse pumps	16
water cycle components	26
window seals	24