

Зип Общепит

vsezip.ru

+7(812)987-08-81

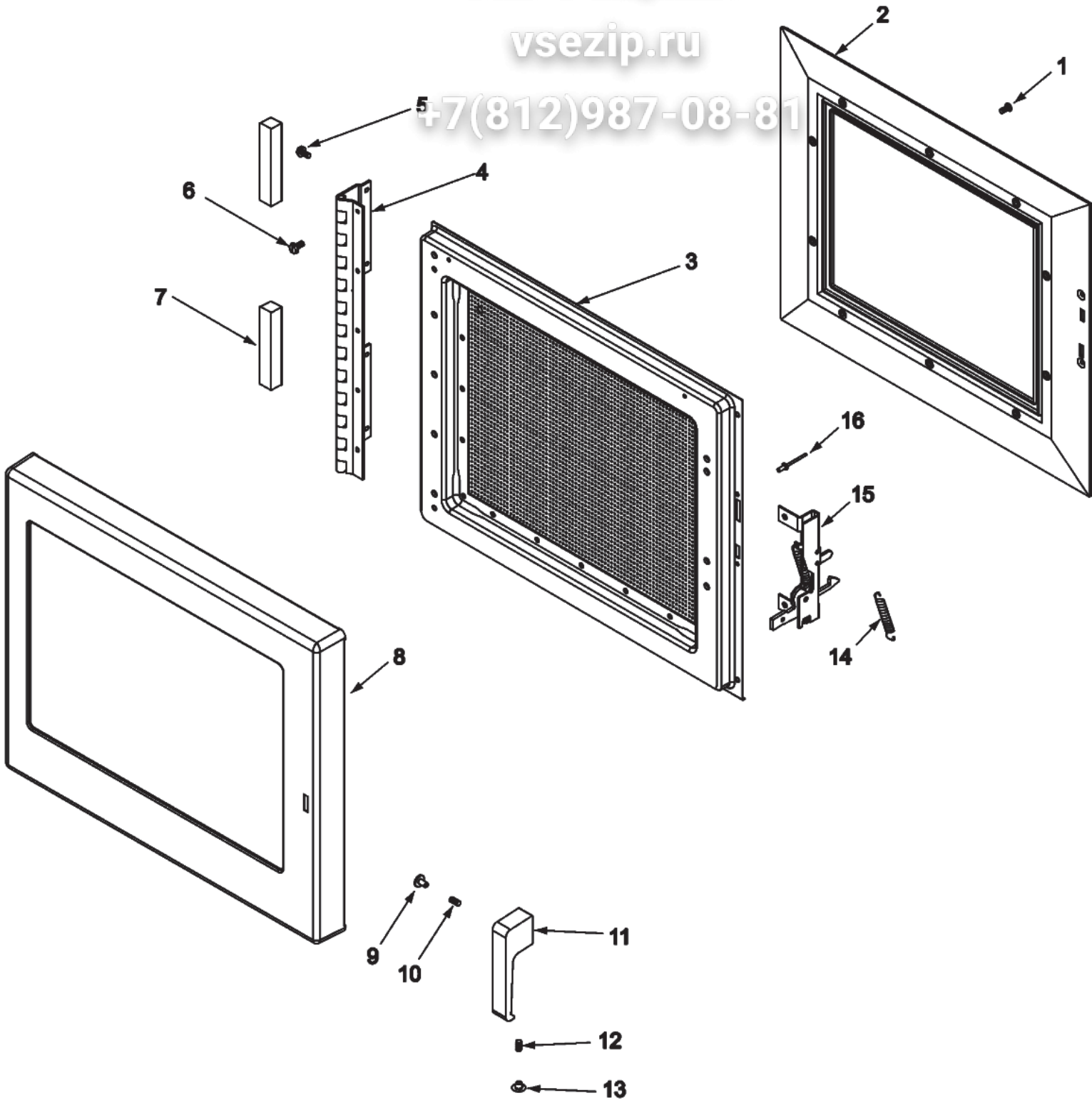

Зип Общепит

vsezip.ru

+7(812)987-08-81

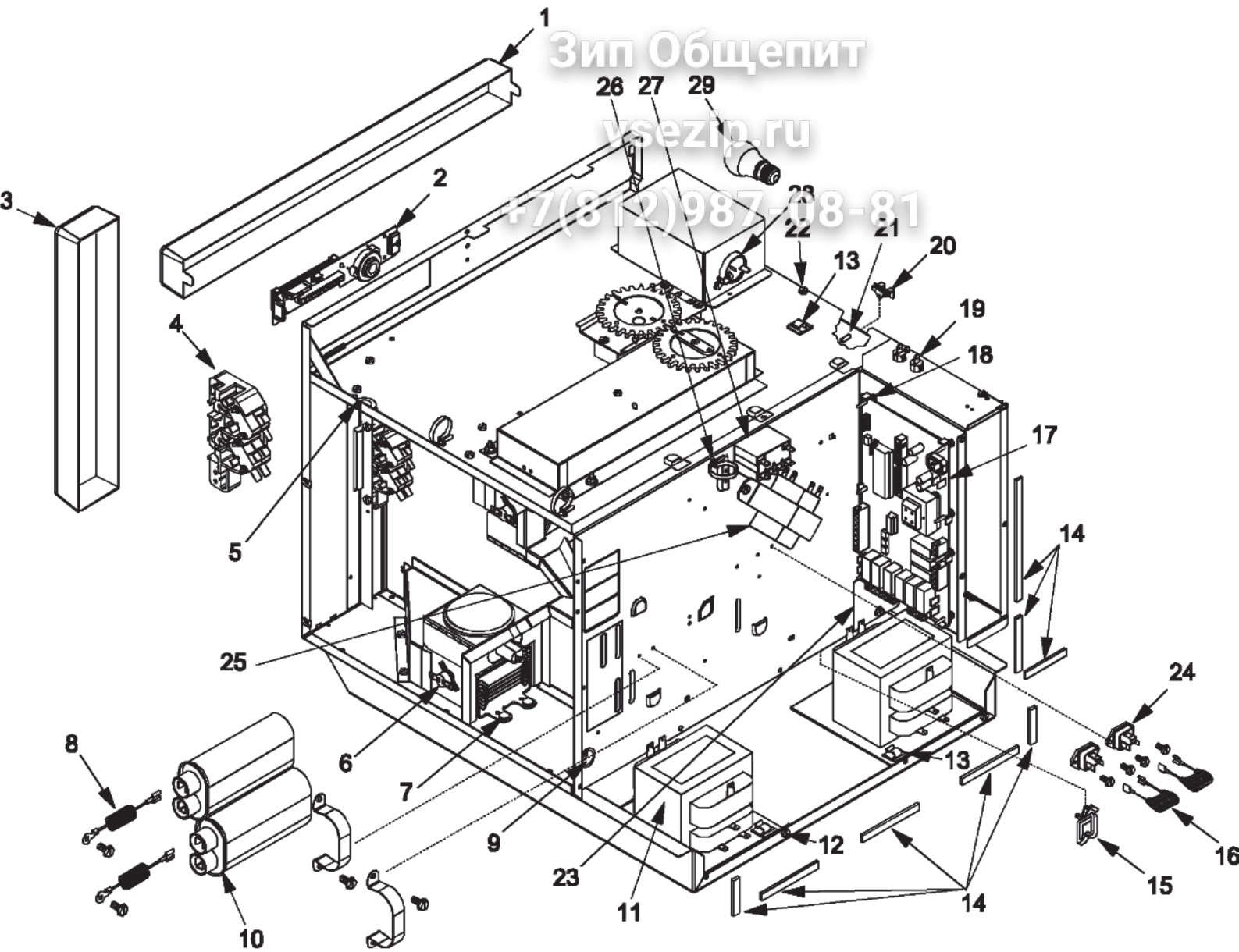

Зип Общепит

vsezip.ru

+7(812)937-08-81

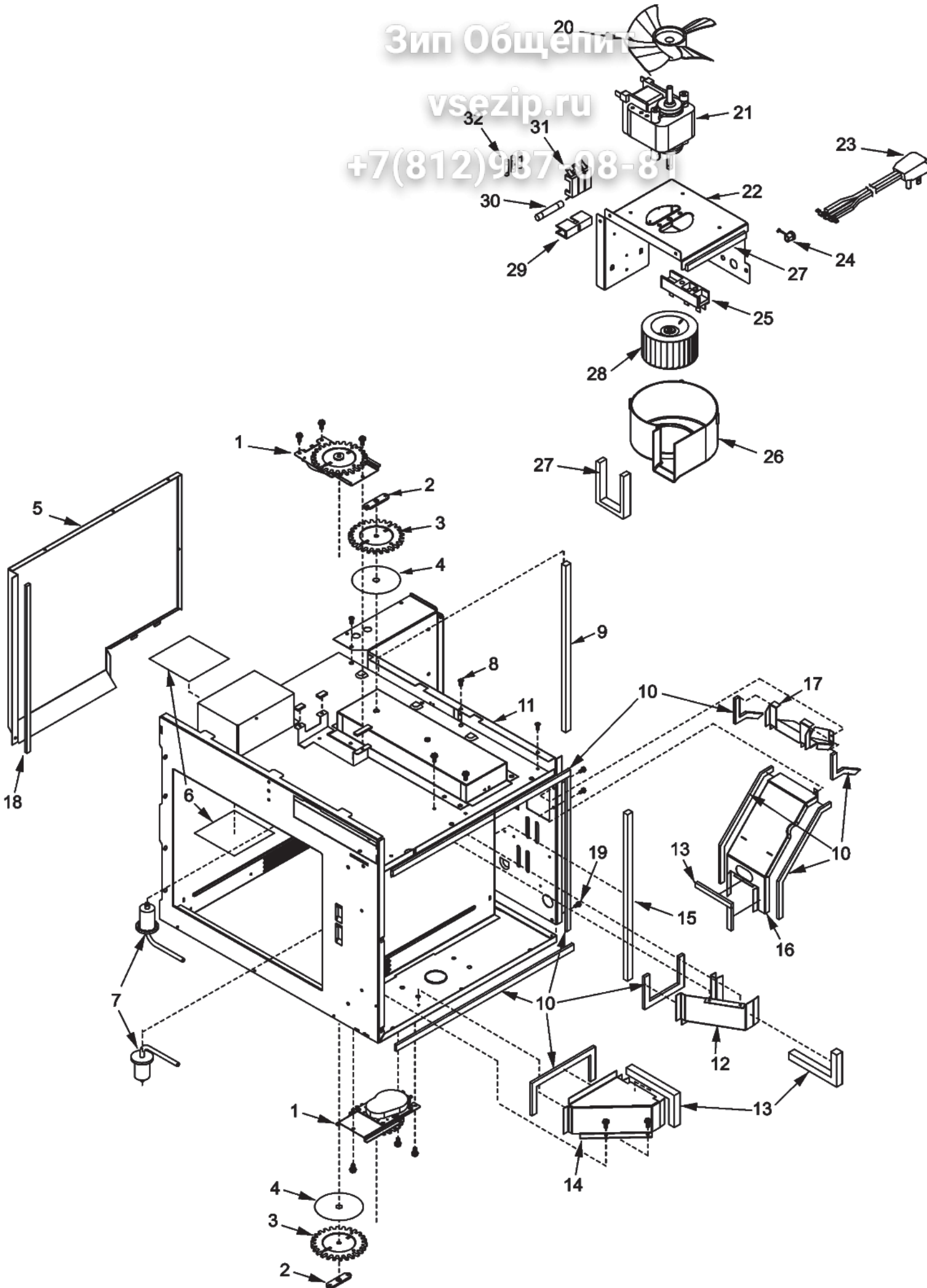

Зип Ощепит

vsezip.ru

+7(812)987-08-81

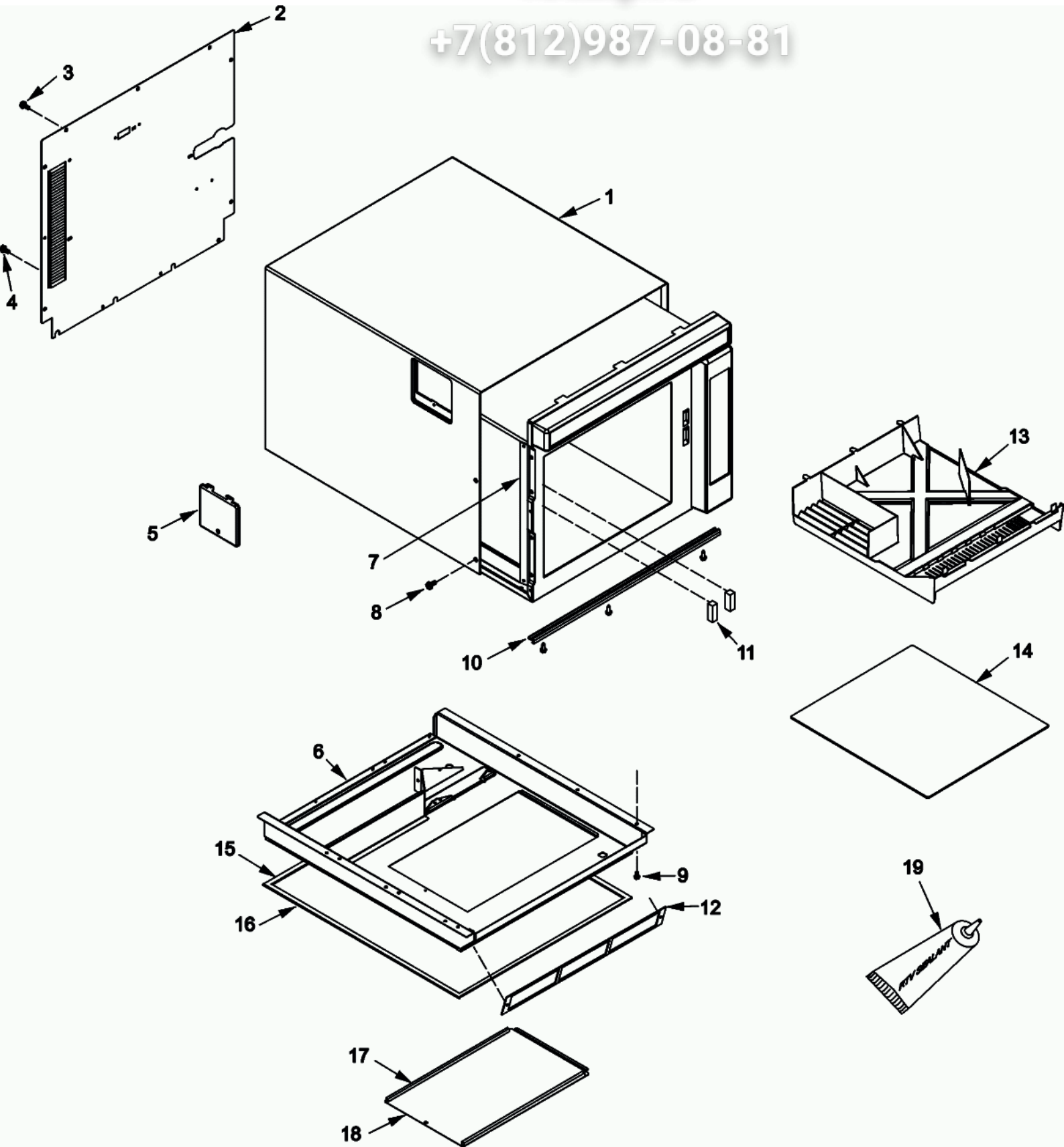

Seite	Pos	Kreditor Artikel Nr.	GB
001	001	20001136	NON-MAGNETIC Y-DRIVE BIT
001	001	R0193574	MAGNETIC Y-DRIVE BIT
001	002	59002015	INNER DOOR ASSY (NO SCREWS)
001	003	59002013	WELD, DOOR RING
001	004	59004034	HINGE, DOOR
001	005	12990526	SCREW-SM/HEX RoHS
001	006	12990525	SCREW-SM/HEX RoHS
001	007	A3263904	GASKET
001	008	R0156918	OUTER DOOR/LENS RETAINER ASSY
001	009	12360703	PLUG-HOLE
001	010	13046901	SCREW-SET/CONE RoHS
001	011	12490901	HANDLE-DOOR
001	012	M0208342	SCREW, SET
001	013	59002165	PLUG BUTTON WHITE
001	014	C8893502	SPRING-DOOR LATCH
001	015	12002757	KIT, LATCH- RC CHASSIS
001	016	A4539601	RIVET, POP
002	001	59001859	TOUCH PANEL ASSY- TOP
002	001	M0231704	SCREW, TF
002	002	13042201	SCREW
002	002	59002084	BOARD, DISPLAY
002	003	M0231704	SCREW, TF
002	003	59001860	TOUCH PANEL ASSY- SIDE
002	004	12002636	KIT, INTERLOCK SWITCH
002	004	12990523	SCREW-SM/HEX RoHS
002	005	59002007	GROMMET, RUBBER
002	006	B5684130	THERMAL CUTOUT
002	006	M0229916	SCREW-TC
002	007	59004010	MAGNETRON
002	008	M0216515	SCREW
002	008	13091701	DIODE
002	009	A3293506	BUSHING - SNAP
002	010	59001160	CAPACITOR- .69
002	010	12990522	SCREW-SM/HEX RoHS
002	010	A4055405	STRAP-CAPACITOR
002	011	59001626	TRANSFORMER, HV
002	012	12990526	SCREW-SM/HEX RoHS
002	013	M0104106	CLIP-CORD
002	015	B5667304	CLIP-WIRE
002	016	59002017	SNUBBER ASSY
002	017	59004070	BOARD, HV-RC
002	018	M0590602	SUPPORT
002	019	M0325401	BUSHING-TERMINAL
002	020	B5795315	CUTOUT - THERMAL
002	020	13041801	SCREW-TC/PAN RoHS
002	021	M0308801	CAP-SCREW
002	022	12992302	SCREW-TF/HEX RoHS
002	023	10847601	PLATE-PARTITION
002	023	M0200316	SCREW
002	024	M0216515	SCREW
002	024	R0157373	KIT, TRIAC
002	025	12990522	SCREW-SM/HEX RoHS
002	025	59001630	TRANSFORMER, AUTO
002	026	M0322202	TIE-WIRE
002	027	12492202	RELAY
002	028	B8371401	RECEPTACLE-LAMP
002	028	M0231704	SCREW, TF
002	029	10664502	LAMP-41W
003	001	R0130263	MOTOR, ANTENNA (230V)
003	001	M0231704	SCREW, TF
003	002	12570202	RETAINER, GEAR SHAFT
003	003	12570101	GEAR-SPUR
003	004	10903002	WASHER-SPUR GEAR
003	005	10781901	DUCT-EXHAUST
003	006	B8367701	WINDOW-OVEN LIGHT
003	007	R0130262	KIT, ANTENNA
003	008	M0200316	SCREW
003	009	10966601	GASKET-NEOPRENE
003	010	59004077	GASKET, PER FT

Seite	Pos	Kredtor Artikel Nr.	GB
003	012	12990525	SCREW-SM/HEX RoHS
003	012	10989201	DUCT-TOP EXHAUST
003	013	59002162	GASKET, PER FT
003	014	10989301	DUCT-BTM EXHAUST
003	014	12990525	SCREW-SM/HEX RoHS
003	015	59002162	GASKET, PER FT
003	016	10989401	DIVIDER-BTM FLOW
003	017	R0156986	REAR DIVIDER DUCT WITH GASKET
003	017	M0216515	SCREW
003	019	M0200316	SCREW
003	020	B5706704	BLADE, FAN
003	021	12002065	KIT, BLOWER MOTOR
003	022	12567707	BRACKET, BLOWER
003	022	M0216515	SCREW
003	023	59002112	POWER CORD
003	024	M0370003	RELIEF-STRAIN
003	025	B5677203	BLOCK-TERMINAL
003	025	M0234117	SCREW
003	026	12990523	SCREW-SM/HEX RoHS
003	026	12552001	SCROLL, BLOWER
003	027	59002162	GASKET, PER FT
003	028	C3670809	WHEEL-BLOWER
003	029	10091101	BLOCK-FUSE
003	030	M0805205	FUSE-30A
003	031	59001682	BLOCK, FUSE- 3 POLE
003	031	M0234117	SCREW
003	032	M0805102	FUSE-15A
004	001	10908901Q	WRAPPER- STAINLESS
004	002	R0156970	PANEL, ACCESS- REAR
004	003	12990525	SCREW-SM/HEX RoHS
004	004	12990526	SCREW-SM/HEX RoHS
004	005	M0288213	CLIP
004	005	10785608	COVER-LIGHT
004	005	13042002	SCREW-TF/OVAL RoHS
004	006	59001130	BASEPAN & GASKET ASSY
004	007	12189003	BRKT-HINGE SUPPORT
004	007	M0231704	SCREW, TF
004	008	13042002	SCREW-TF/OVAL RoHS
004	009	M0220417	SCREW
004	010	13042002	SCREW-TF/OVAL RoHS
004	010	10909001	TRIM
004	011	3010003001	STANDOFF-POLY
004	012	10853102	GRILLE-AIR INLET
004	012	13042901	SCREW-THUMB RoHS
004	012	M0274066	WASHER-NYLON
004	013	59004008	ANTENNA SHIELD
004	014	R0156942	KIT, CERAMIC TRAY W/SEALER
004	015	R0000413	GASKET, BASEPAN - 90 in (228 cm)
004	016	R0000413	GASKET, BASEPAN - 90 in (228 cm)
004	018	M0216703	SCREW
004	018	10782402	BOTTOM ACCESS-E CT
004	019	59002167	SEALER
		R0193574	MAGNETIC Y-DRIVE BIT
		20001136	NON-MAGNETIC Y-DRIVE BIT
		R0130265	KIT, HARNESS- HVB/DISPLAY
		13018201	HARNESS-INTERLOCK
		12543401	HARNESS-OVEN LT
		12598201	HARNESS, LOWER ANTENNA MOTOR
		13095301	HARNESS OVEN
		12696001	HARNESS, HI VOLT
		12002483	KIT, CAVITY- 2 TUBE "S" CHASSIS
		12001916	NLA- KIT, FUSE- 15 AMP

Зип-Общепит

vsezip.ru

+7(812)987-08-81

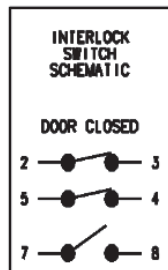
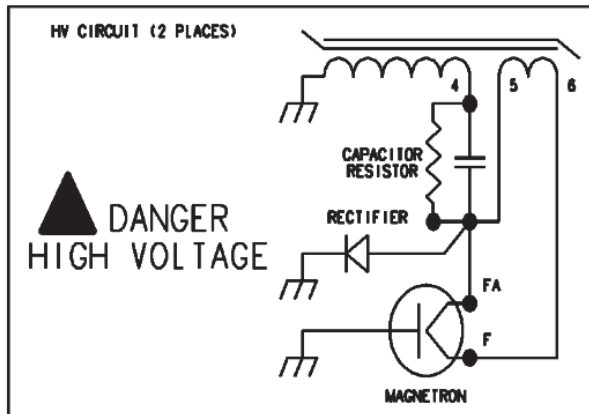
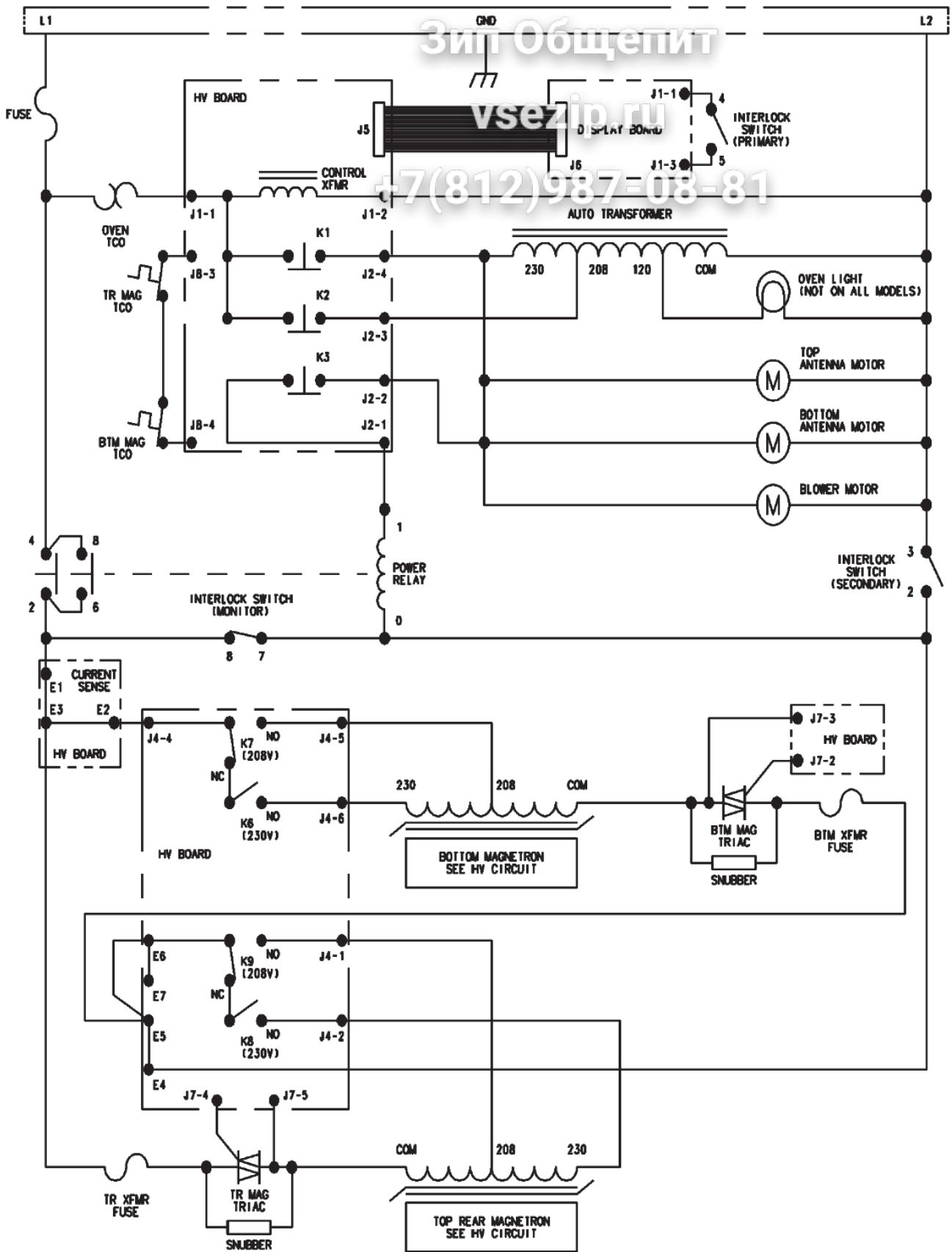

Зип Общепит

vsezip.ru

7(812)987-08-81