

Зип Общепит

vsezip.ru

ANTENNA

+7(812)987-08-81

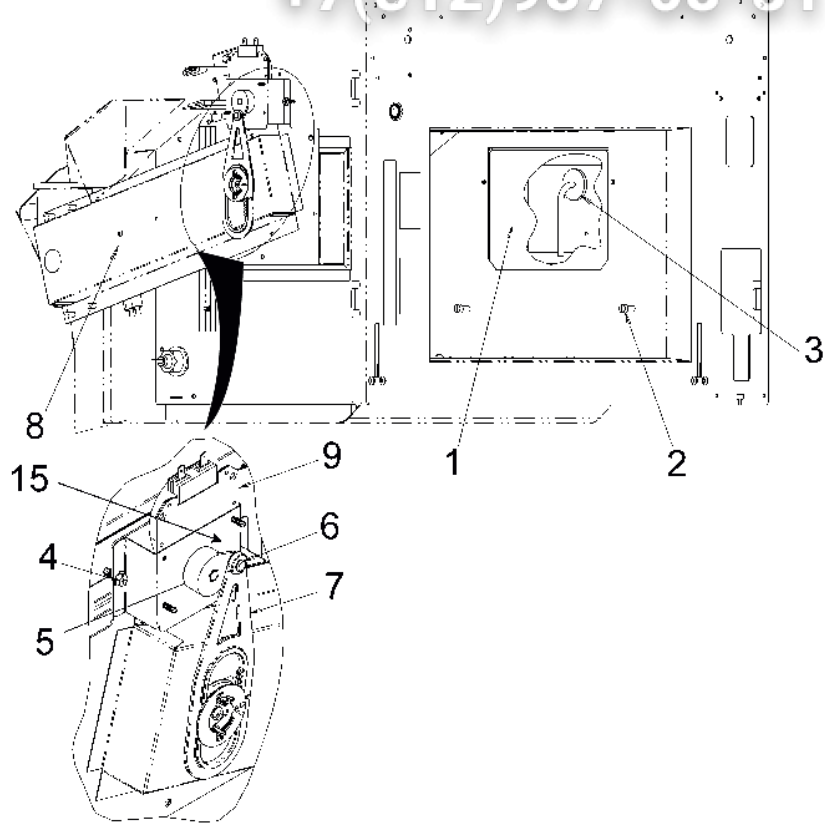

BASEPAN

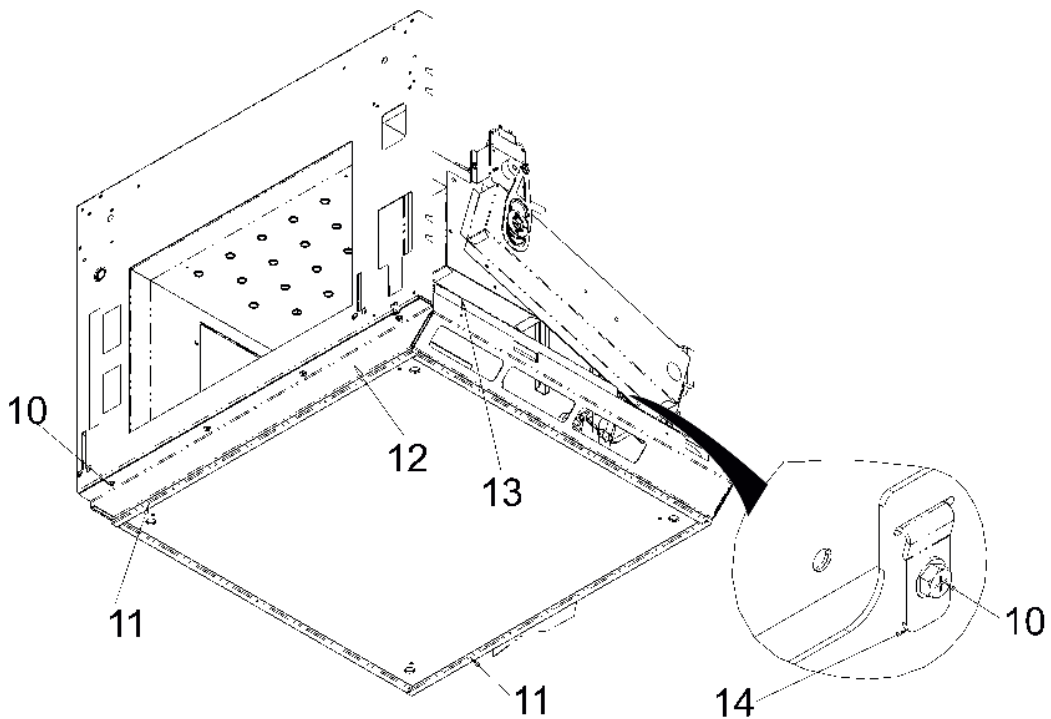

Зип Общепит

DOOR ASSEMBLY

+7(812)987-08881

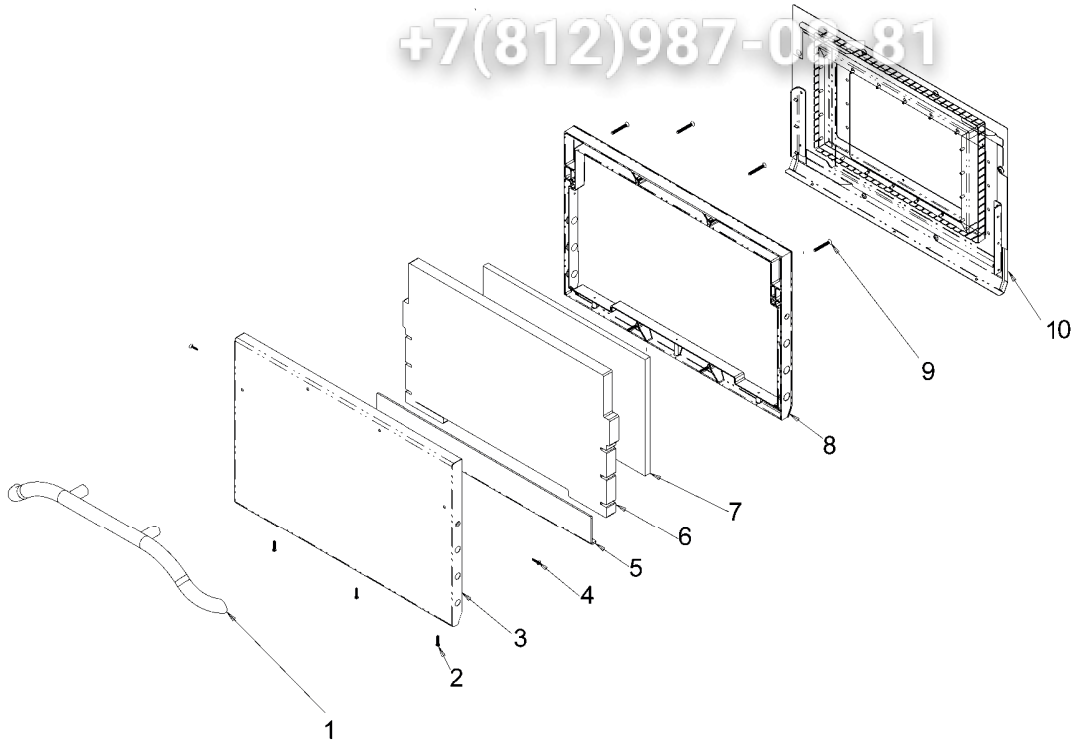

CONTROL ASSEMBLY

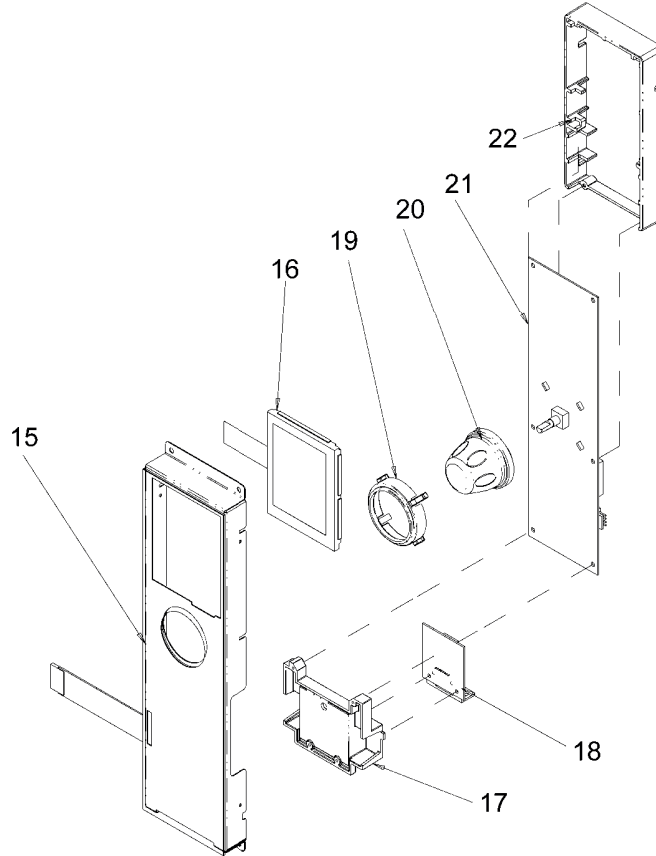

ELECTRICAL, SWITCHES, CONVECTION BLOWER

Зир Общепит
vsezip.ru
+7(812)987-08-81

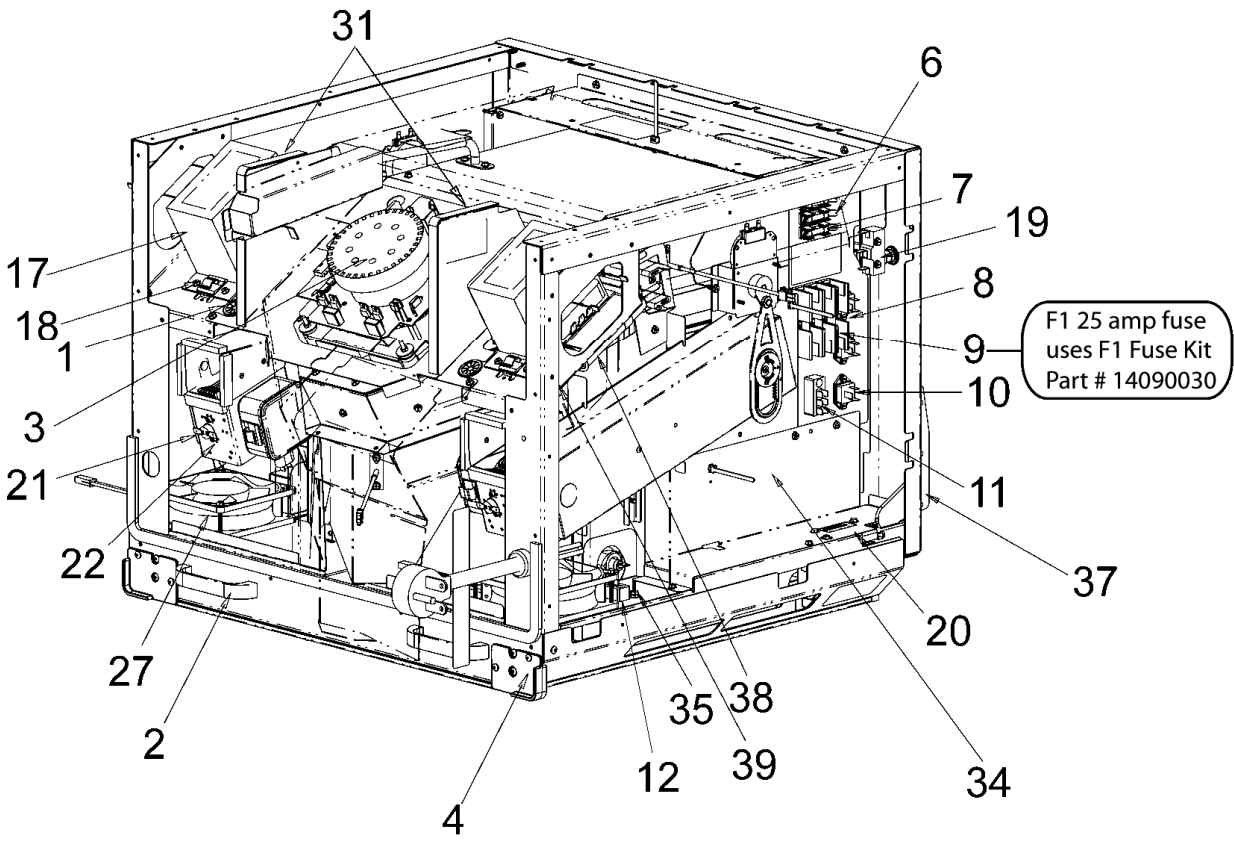
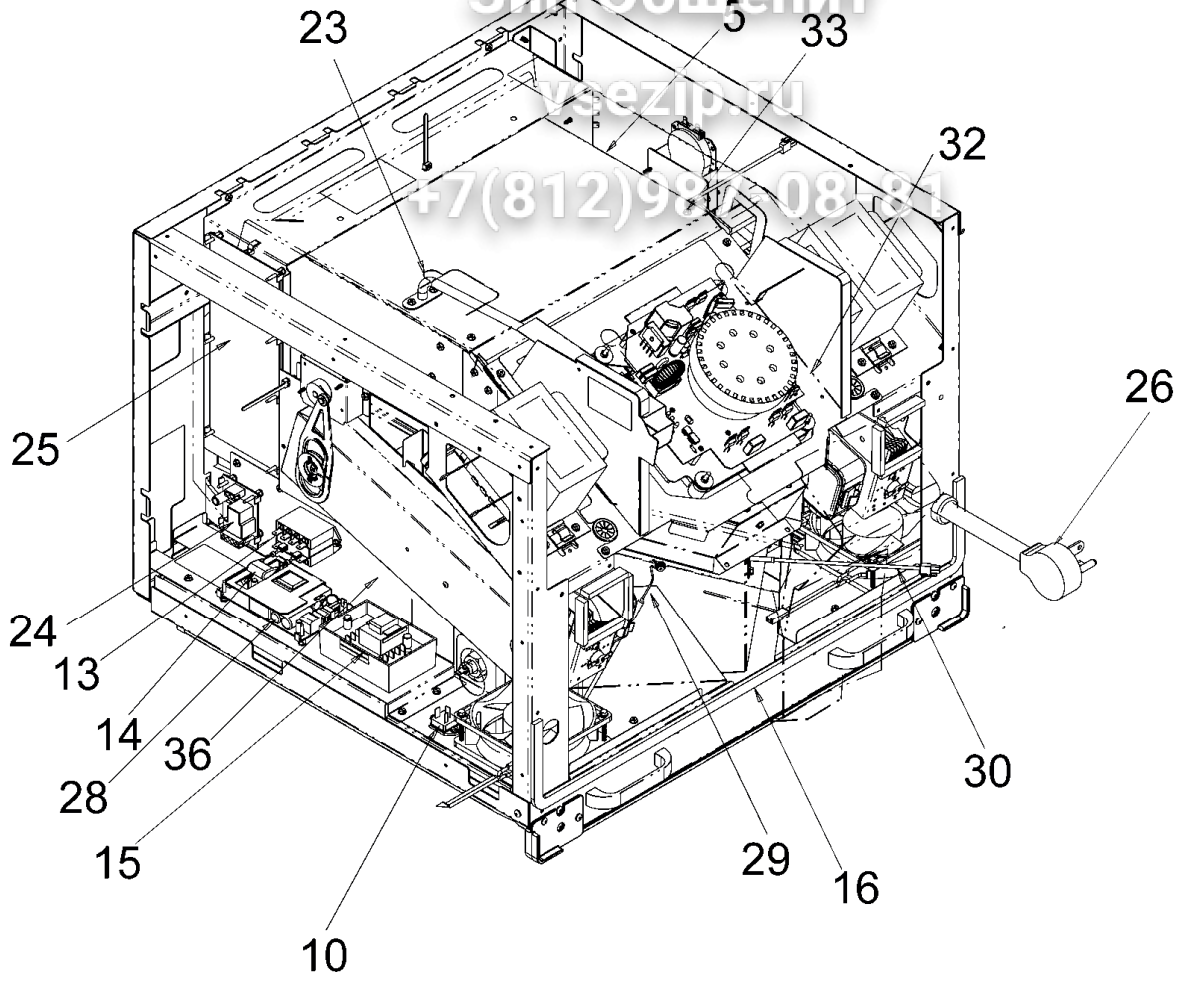

Зип Общепит

HEATERSip.ru

+7(812)987-08-81

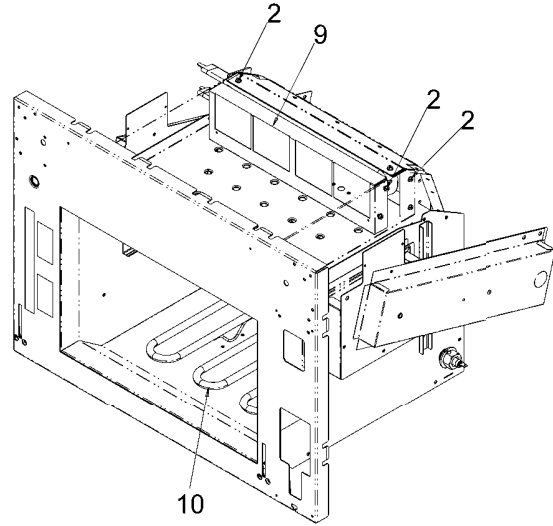
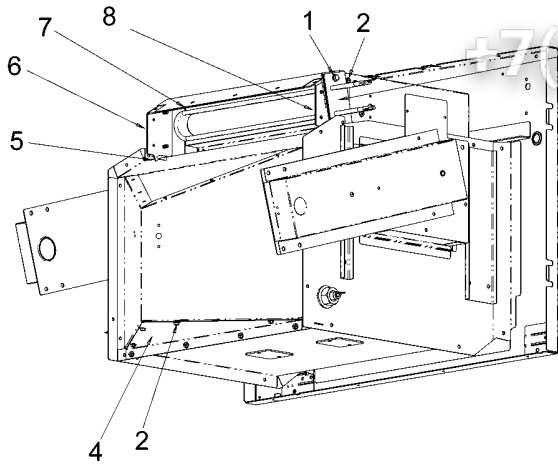

FAN BOX

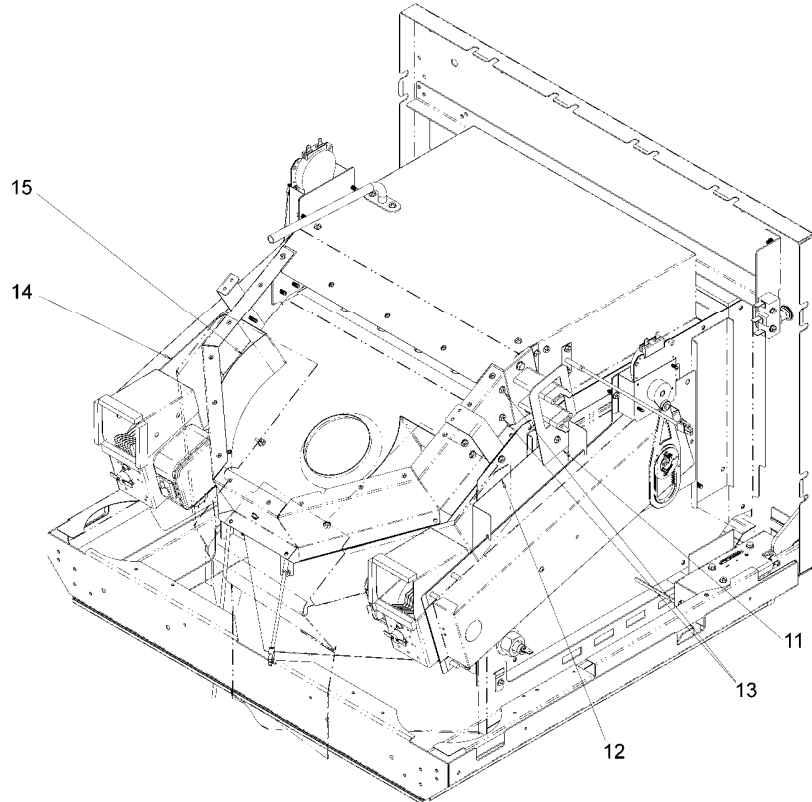

OUTERCASE

Зип Общепит

vsezip.ru

+7 (812) 987-08-81

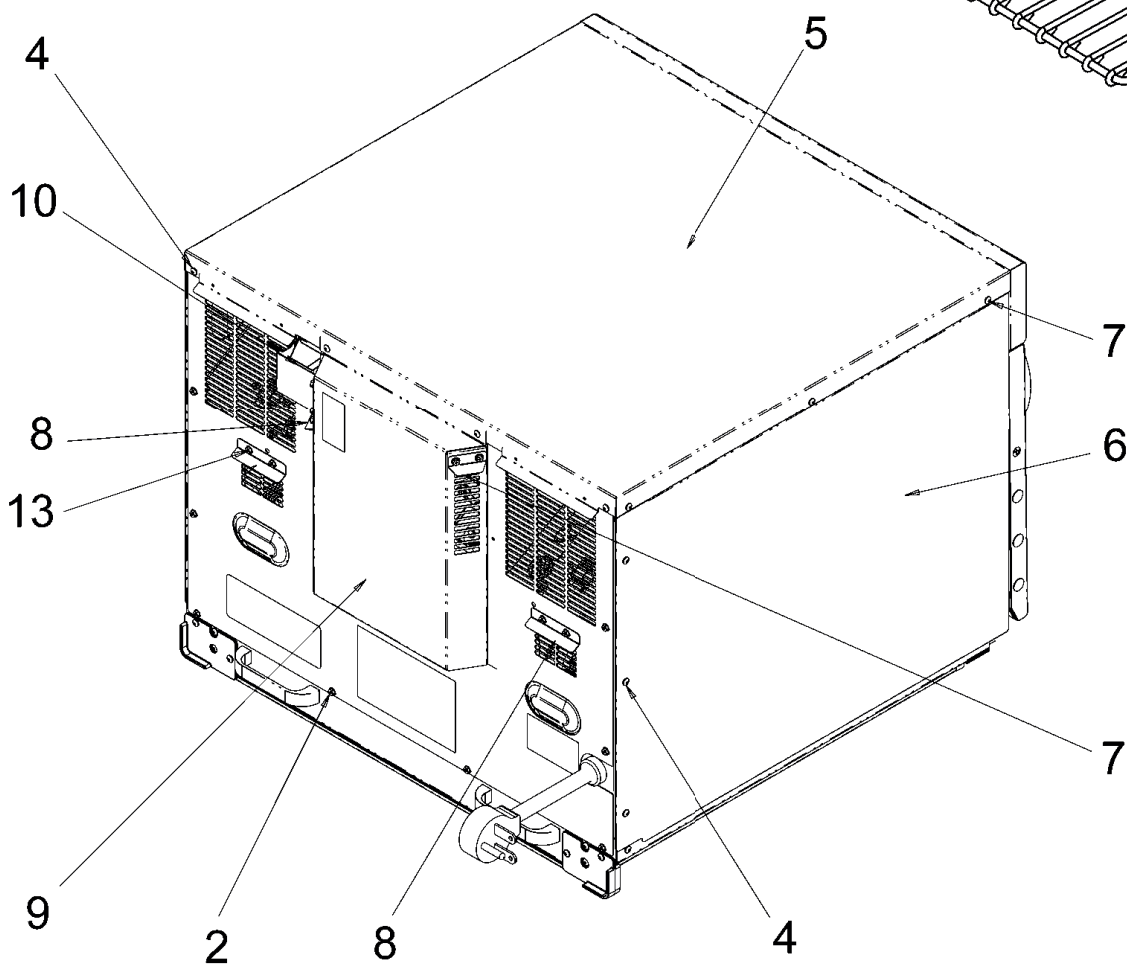
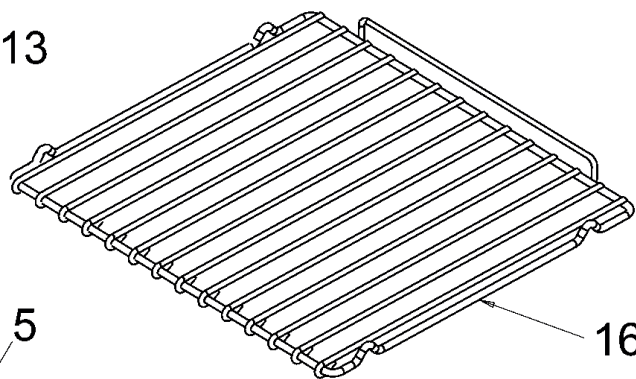
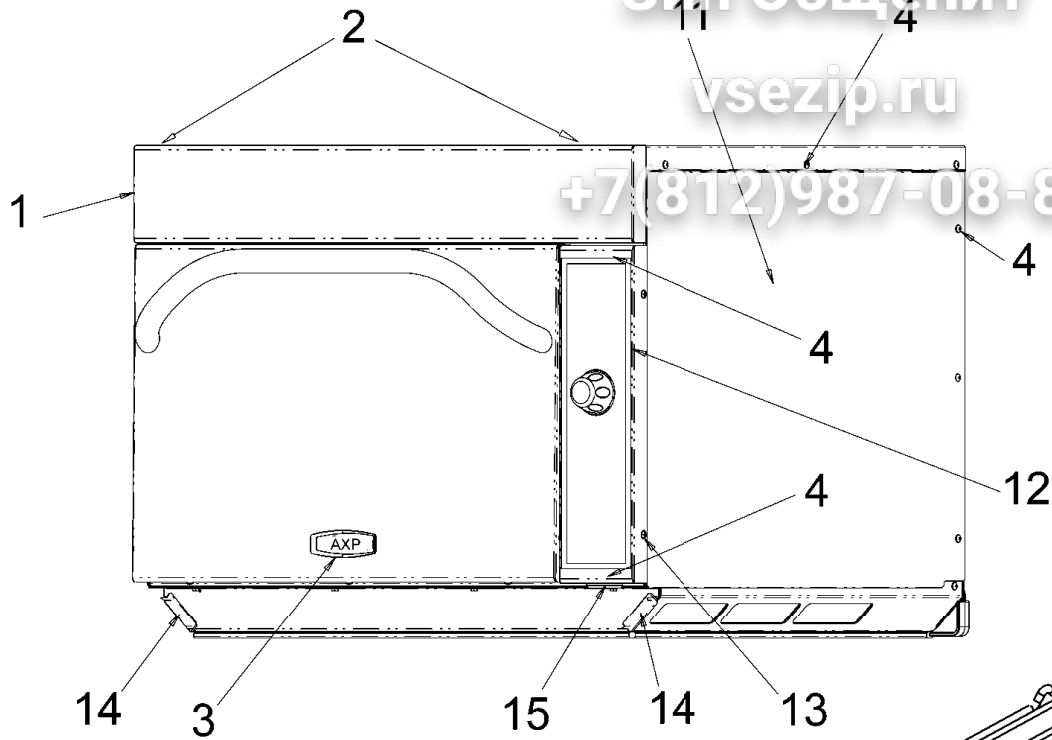

SCHEMATIC

Зип Общепит

vsezip.ru

+7(812)987-08-81

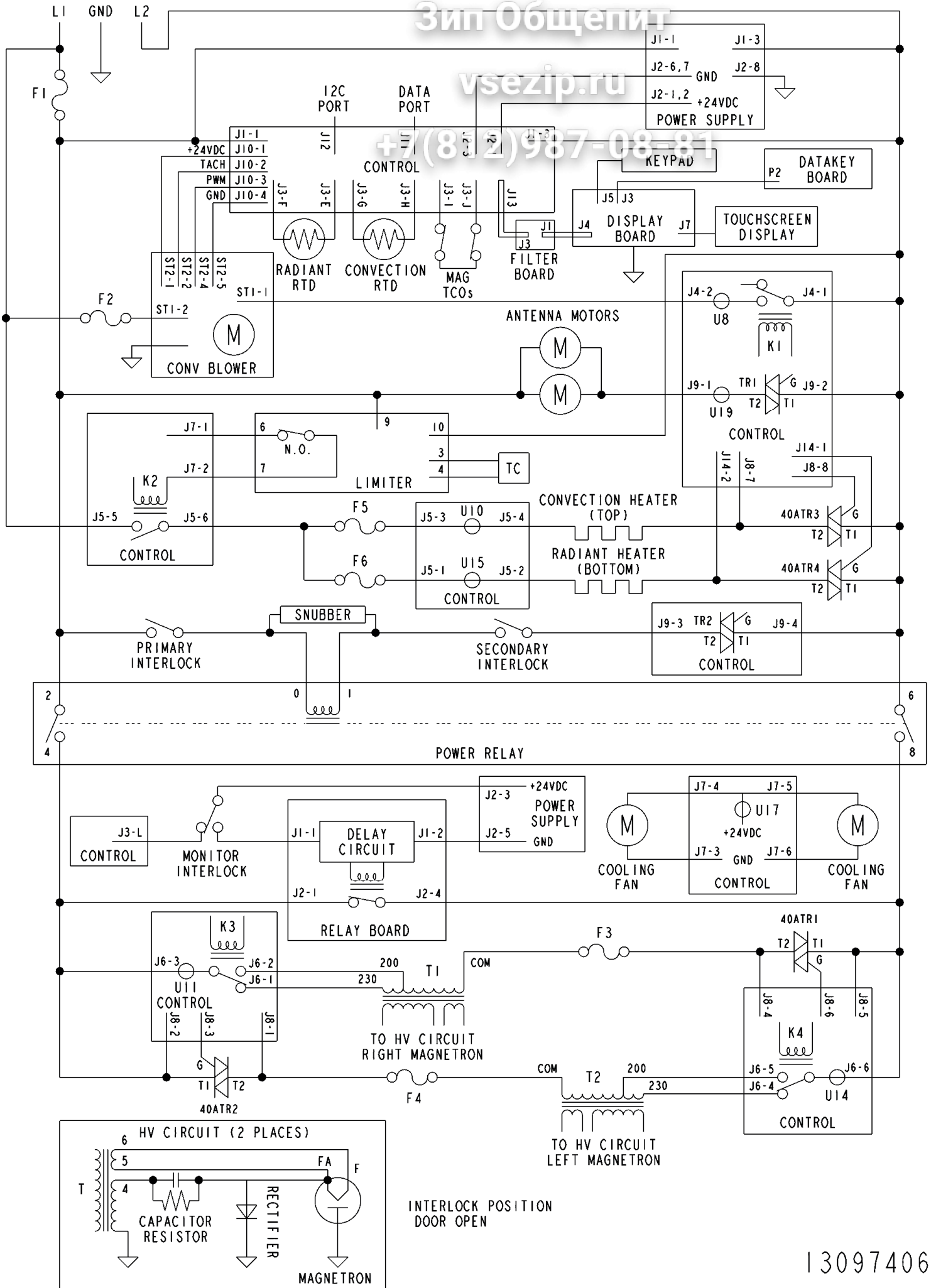

13097406

Seite	Pos	Kredtor Artikel Nr.	GB
001	001	14080004	KIT, STIRRER COVER
001	002	13079101	SCREW-MACH/SHLD RoHS
001	003	14080002	KIT, ANTENNA & STIRRER COVER- AXP
001	004	12991605	SCREW
001	005	12002872	KIT, CAM (FOR ANTENNA MOTOR)
001	006	13083701	RIVET, NYLON
001	007	12002867	KIT, GEAR & RACK
001	008	14080001	KIT, TUNING STUB - AXP
001	009	12002873	KIT, STIRRER MOTOR
001	010	12991605	SCREW
001	011	R0000413	GASKET, BASEPAN - 90 in (228 cm)
001	012	59004037	BASEPAN & GASKET ASSY
001	013	13097801	INSUL-HINGE
001	014	13072801	KEY-CAVITY EXPANSION
001	015	21006802	BRKT-ANTENNA MOTOR
002	001	59002142	HANDLE, DOOR
002	002	13041504	SCREW-TR/PAN RoHS
002	003	14080015	KIT, OUTER DOOR
002	004	13083601	SCREW-HI LO/FLAT RoHS
002	005	13096101	INSUL-OUTER DOOR
002	006	13074301	INSUL-DOOR
002	007	13094201	INSUL-DOOR CHOKE
002	008	13074201	SPACER-DOOR
002	009	13047403	SCREW-TC/FLAT RoHS
002	010	14080014	KIT, INNER DOOR
002	015	59002149	TOUCH PANEL ASSY
002	016	12002877	KIT, DISPLAY TOUCH SCREEN
002	017	59002119	HOLDER, DATA KEY
002	018	59002095	BOARD,DATA KEY
002	019	13079401	COLLAR, KNOB
002	020	13078901	KNOB, CONTROL
002	021	14080008	KIT, DISPLAY & FILTER BOARDS
002	022	59002115	HOLDER, CONTROL
003	001	M0571003	BUSHING-SNAP
003	002	13095701	HANDLE, BASEPAN
003	003	59002076	CONVECTION MOTOR ASSY
003	004	13086601	BARRIER, RECIRCULATION
003	005	13084601	INSUL-TOP/SIDES CAVITY
003	006	59001682	BLOCK, FUSE- 3 POLE
003	007	M0805105	FUSE-12A
003	008	10091101	BLOCK-FUSE
003	009	M0805201	FUSE-25A
003	009	14090030	KIT, F1 FUSE- AXP & MXP
003	010	59002026	TRIAC (40A)
003	011	B5677215	BLOCK, TERMINAL
003	012	B5677214	BLOCK - TERMINAL
003	013	59001981	RELAY
003	014	59002017	SNUBBER ASSY
003	015	59002133	LIMITER, ELECTRONIC
003	016	A3030330	GASKET, PER FT
003	017	59002124	TRANSFORMER, HV
003	018	M0104106	CLIP-CORD
003	019	59002121	SWITCH, PRIMARY INTERLOCK
003	020	59002122	INTERLOCK SWITCH ASSY
003	021	B5684130	THERMAL CUTOUT
003	022	59001484	MAGNETRON
003	023	13078001	VENT, CAVITY STEAM
003	024	59002117	BOARD, RELAY MONITOR
003	025	59002114	BOARD, MAIN CONTROL
003	026	59004001	POWER CORD
003	027	59002132	MOTOR, FAN (24V DC)
003	028	59002118	BOARD, POWER SUPPLY (24V DC)
003	029	59002131	THERMOCOUPLE
003	030	59001709	SENSOR, TEMP
003	031	M0275058	TAPE-FOAM (ROLL)
003	032	13081001	INSUL RETAINER WELD
003	033	12990524	SCREW-SM/HEX RoHS
003	034	13082802	PLATE-LH FRNT PARTITION
003	035	M0293511	STUD 6

Seite	Pos	Kredtor Artikel Nr.	GB
003	036	13097601	PLATE-RH FRNT PARTITION
003	037	59002141	HINGE
003	038	59001168	CAPACITOR- 1.00
003	039	59002123	DIODE
004	001	12992403	SCREW-TR/HEX
004	002	12991609	SCREW-TC/HEX
004	003	59002125	ELEMENT, CONVECTION-TOP
004	004	13072301	BOTTOM-RETURN PLENUM
004	005	13077701	GASKET-PLENUM NOZZLE
004	006	13076501	PLATE-PLENUM RH
004	007	13076401	PLATE-PLENUM TOP
004	008	13076601	PLATE-PLENUM LH
004	009	13076301	CONVERTER - CATALYTIC
004	010	12002874	KIT, BOTTOM ELEMENT
004	011	13096701	RETAINER-INSUL
004	012	13087602	DUCT-LH
004	013	12991609	SCREW-TC/HEX
004	014	13087101	DUCT-RH
004	015	13077901	GASKET-PLENUM RETURN
005	001	13098502	ESCUTCHEON- TOP
005	002	12991605	SCREW
005	003	13079803	NAMEPLATE-AXP
005	004	13074001	SCREW-TC/PAN TORX RoHS
005	005	59002136	OUTER PANEL, TOP
005	006	59002137	OUTER PANEL, RIGHT SIDE
005	007	13086001	CAP-SUMP DRIP
005	008	13082601	CAP-MAG DRIP
005	009	13081902	BACK, OUTERCASE
005	010	13086801	HOOD-EXHAUST
005	011	59002138	OUTER PANEL, LEFT SIDE
005	012	13079701	ESCUTCHEON, SIDE
005	013	13042001	SCREW-TF/OVAL RoHS
005	014	59002139	FILTER, AIR
005	015	59002092	PLUG, DATA KEY
005	016	59002140	RACK, OVEN
006	001	13097406	SCHEMATIC
006	002	13097202	HARNESS, MAIN
006	003	13017713	WIRE, JUMPER - MAG FA TO CAP
006	004	13087301	HARNESS, CTRL BD TO FLTR BD
006	005	13087401	HARNESS-DATA KEY
006	006	12696201	HARNESS, HV

WIRING DIAGRAM

