

NP90-07

PENTOLE DA LITRI 100 E 150 - RISCALDAMENTO DIRETTO ELETTRICO  
 ELECTRIC DIRECT HEATED BOILING PANS  
 MARMITES ELECTRIQUES CHAUFFE DIRECTE  
 DIREKTBEHEIZT ELEKTRISCH KOCHKESSEL

Зип Общепит



vsezip.ru

+7(812)987-08-81

Mod.

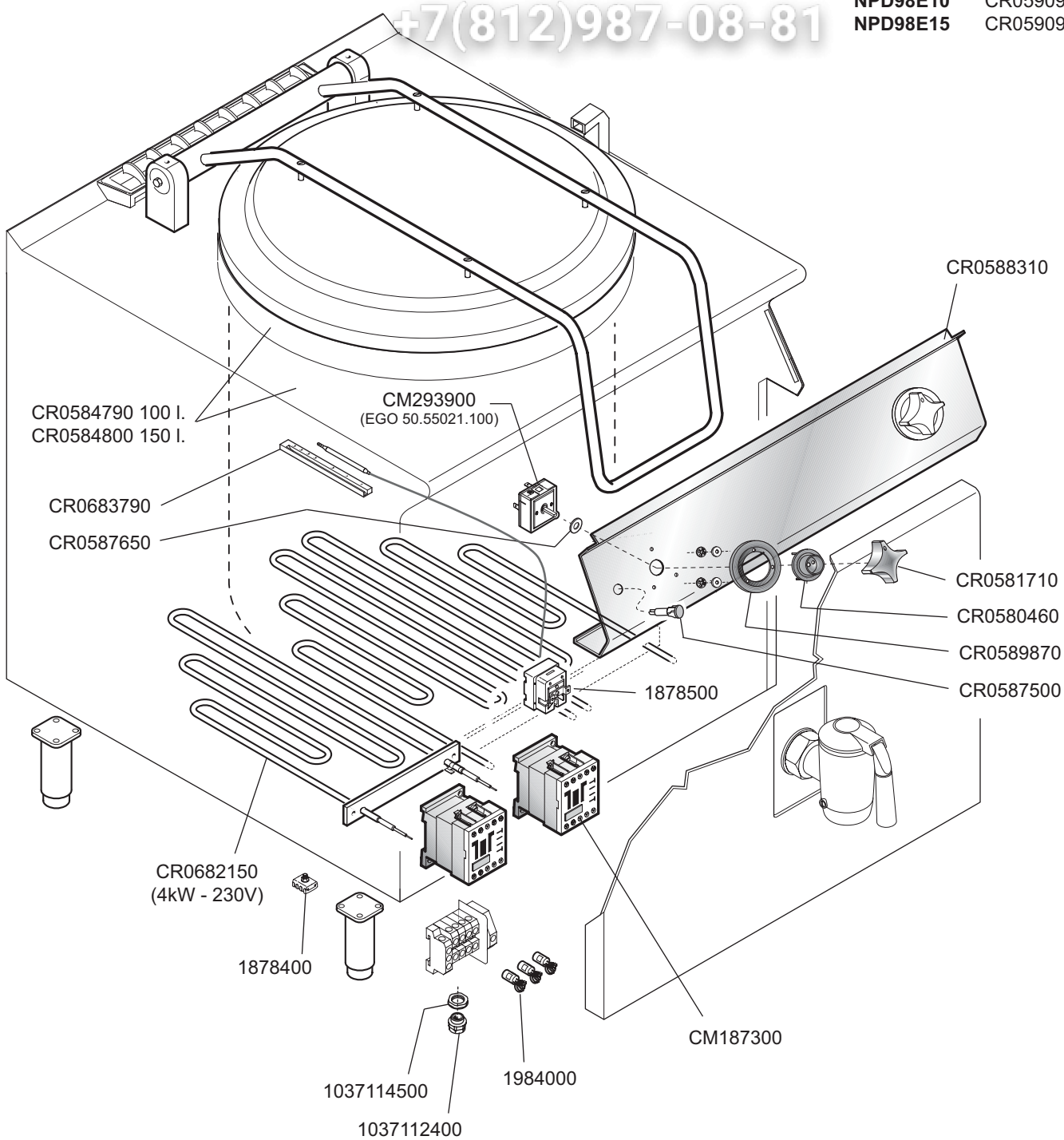
NPD98E10 CR0590930  
 NPD98E15 CR0590940



 MARENO INDUSTRIE ALI spa Mareno di Piave (TV)	ELABORATO:	APPROVATO:	GRUPPO:	DENOMINAZIONE:		
			Serie NP90	Impianto elettrico		
	DATA:	DATA:	PARTICOLARE:	REV. N.	DEL	DISEGNO N.
	25 Feb 2008	25 Feb 2008	Disegno esploso per ricambi	▼	▼	▼
SOST. DIS.				Z00	0208	3.P.90.15

NP90-07

PENTOLE - 100, 140 E 150 LITRI

GAS AND ELECTRIC HEATED BOILING PANS - 100, 140 AND 150 LITERS

PLUMES À GAZ ET ÉLECTRIQUES - 100, 140 ET 150 LITRES

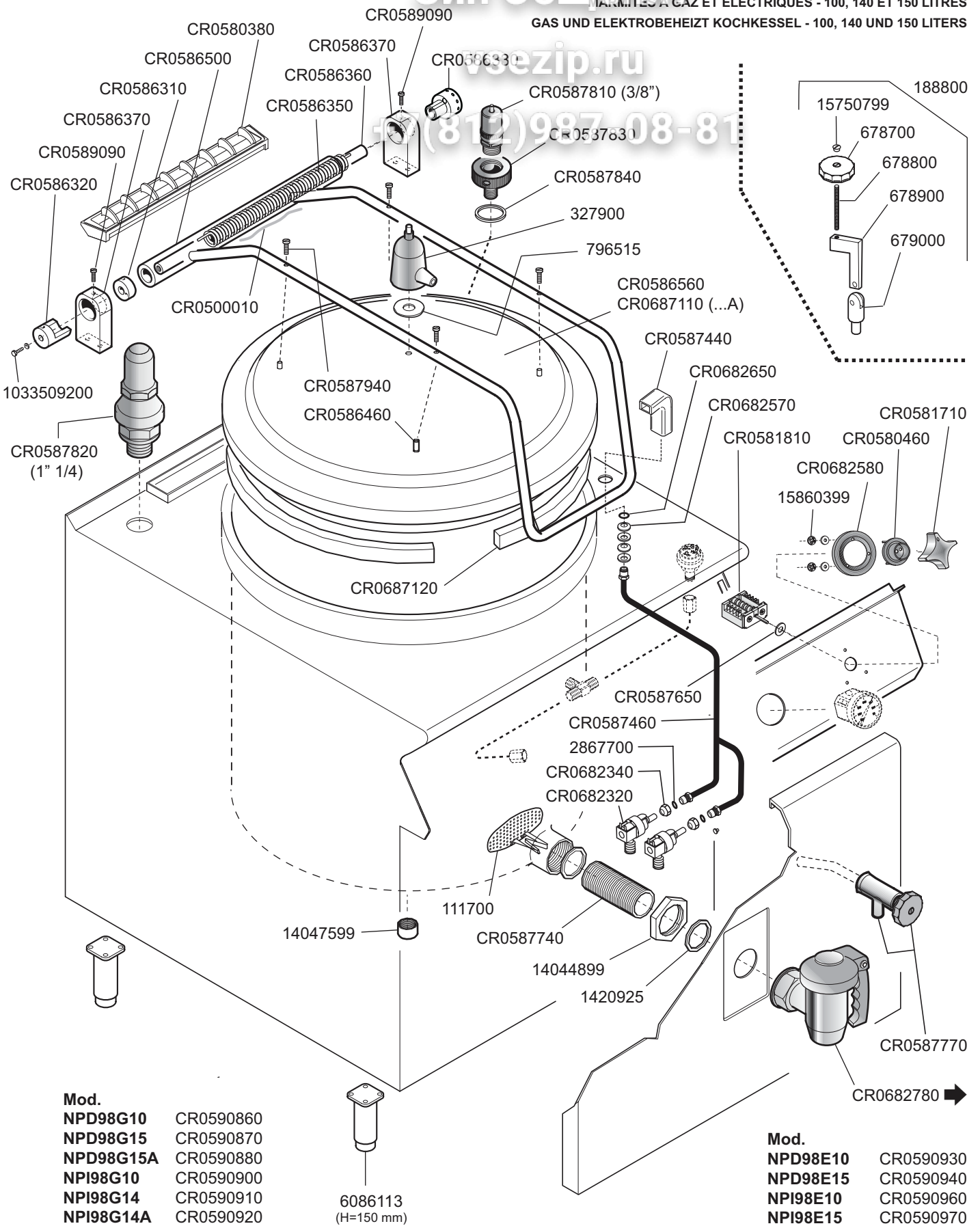

GAS UND ELEKTROBEHEIZT KOCHKESSEL - 100, 140 UND 150 LITERS

Зип Обществу  
vsezip.ru  
(812) 987-08-81



- Mod.**
- NPD98G10 CR0590860
  - NPD98G15 CR0590870
  - NPD98G15A CR0590880
  - NPI98G10 CR0590900
  - NPI98G14 CR0590910
  - NPI98G14A CR0590920

- Mod.**
- NPD98E10 CR0590930
  - NPD98E15 CR0590940
  - NPI98E10 CR0590960
  - NPI98E15 CR0590970

 MARENO INDUSTRIE ALI spa Mareno di Piave (TV)	ELABORATO:	APPROVATO:	GRUPPO:	DENOMINAZIONE:		
			Serie NP90	Impianto idraulico e mobile - Particolari comuni		
	DATA:	DATA:	PARTICOLARE:	REV. N.	DEL	DISEGNO N.
	25 Feb 2008	25 Feb 2008	Disegno esploso per ricambi	Z00	0708	3.P90.14
SOST. DIS.						

**2" CON - 100, 140, 150 Lit.**  
**Cod. CM128900** (01301019)  
 (Serie Protagonista 90 - 1999/2008)  
 Serial No. < MA020167179

**A**

36204851  
 34003013  
 1420925  
 77122400 - Grasso/Grease 36206760  
 (KLUBER Non Trop PLB DR (Cod. art. 572411) tubo da 100g)

**2" OR - 100, 140, 150 Lit.**  
**Cod. CM128900** (01301019)  
 (Serie Protagonista 90 - 2009)  
 Serial No. < MA020167179

**B**

77122600 (34003012)  
 77122800 (31004866)  
 77121900 OR 34044795 (n. 3 pz.)  
 77122300 - Grasso/Grease 36206780  
 (LOXEAL 4 silicónico al PTFE (Cod. art. 804004) tubo da 100g)

**2" OR - 100, 140, 150 Lit.**  
**Cod. CR0682780** (01321009)  
 (Serie N-Protagonista 90 - 2008)  
 Serial No. < MA020167179



**C**

77122700 (31004855)  
 77122600 (34003012)  
 77121900 OR 34044795 (n. 3 pz.)  
 77122300 - Grasso/Grease 36206780  
 (LOXEAL 4 silicónico al PTFE (Cod. art. 804004) tubo da 100g)

**2" CON - 100, 140, 150 Lit.**  
**Cod. CR0682780** (01322009)  
 (Serie N-Protagonista 90 - 2009)  
 Serial No. > MA020167013

**D**

77122700 (31004855)  
 77122600 (34003012)  
 77122400 - Grasso/Grease 36206760  
 (KLUBER Non Trop PLB DR (Cod. art. 572411) tubo da 100g)

 MARENO INDUSTRIE ALI spa Mareno di Piave (TV)	ELABORATO:	APPROVATO:	GRUPPO:	DENOMINAZIONE:		
			N-Cottura NP90 - 2008	Rubinetto di scarico da 2"		
	DATA:	DATA:	PARTICOLARE:	REV. N.	DEL	DISEGNO N.
	15 Ott 2009	15 Ott 2009	Disegno esplosivo per ricambi 	Z00	0110	3.P90.14/2
	SOST. DIS.					