



Зип Ощепит

vsezip.ru

Spare Parts for

Ovens & Combi Ovens



Spare parts suitable for

FOINOX

2018

Find the complete and up-to-date range of products in our GEV Webshop



heating elements

heating elements for ovens





GEV No.	418759	Ref. No.	10645
description	heating element 1800W 230V heating circuits 1 L 360mm W 390mm L1 95mm L2 265mm W1 165mm W2 60mm flange length 100mm flange width 23mm hole distance 86mm bridge length 485mm hole ø 3.3mm tube ø 6.3mm connection male faston 6.3mm connection length 10mm windings 4 rectangular flange dry heating element mounting thread M4		

immersion heating elements

3 hole flange ø47.5mm



GEV No.	418136	Ref. No.	3434
description	heating element 4360W 240V mounting ø 47.5mm heating circuits 3 L 310mm W 31mm H 35mm number of thermostat sleeves 1 thermostat sleeves ø 7mm length thermostat sleeves 200mm thermostat sleeve clinging tube ø 6.3mm hole distance 62mm hole ø 8mm connection M4 3 hole flange immersion heater		
For models:	FM06EB, FM06EDG, FM10EB, FM10EDG, FM20EB, FM20EDG		
spare parts for	418136		
	GEV No.	510408	Ref. No. —
	O-ring EPDM thickness 5.34mm ID ø 47mm Qty 1 pcs		
accessories for	418136		
	GEV No.	510408	Ref. No. —
	O-ring EPDM thickness 5.34mm ID ø 47mm Qty 1 pcs		
	GEV No.	510562	Ref. No. —
	O-ring silicone thickness 5.34mm ID ø 47mm Qty 1 pcs		

with expansion flange 70 x 18mm



GEV No.	417781	Ref. No.	10621
description	heating element 2000W 230V heating circuits 1 flange 70x18mm L 210mm W 60mm connection male faston 6.3mm tube ø 8.2mm immersion heater expansion flange connection length 34mm		

Зип Общепит



GEV No.	418137	Ref. No.	10622
description	heating element 3000W 230V heating circuits 1 flange 70x18mm L 220mm W 65mm Hmm connection male faston 6.3mm tube ø 8.5mm immersion heater expansion flange connection length 34mm		
For models:	FM200EA, FM200EAP, FM200EB, FM201EA, FM201EAP, FM201EB		



GEV No.	418138	Ref. No.	10620
description	heating element 6000W 230V heating circuits 1 flange 70x18mm L 445mm W 68mm connection male faston 6.3mm tube ø 8.5mm immersion heater expansion flange connection length 34mm		
For models:	FM401EA, FM401EAP, FM401EB		

heating elements for convection



GEV No.	418129	Ref. No.	10638 40400038
description	heating element 16000W 230V heating circuits 3 ID ø 337mm ED ø 358mm L 450mm H 100mm L1 84mm W1 108mm H1 15mm H2 85mm flange length 142mm flange width 25mm hole distance 64mm connection M4 tube ø 8.5mm convection heating element hole ø 6mm rectangular flange		
For models:	FC201EA, FC201EAP, FC201EB, FM201EA, FM201EAP, FM201EB, MM201EA, MM201EAP, MM201EB		



GEV No.	418133	Ref. No.	0022
description	heating element 2000W 220V heating circuits 1 ID ø 187mm ED ø 200mm L 215mm H 25mm L1 15mm W1 60mm H1 5mm H2 20mm flange length 100mm flange width 22mm hole distance 86mm connection male faston 6.3mm connection length 37mm tube ø 6.5mm convection heating element hole ø 5mm rectangular flange		
For models:	FE1-2, FE2-3		



Зип Общепит

vsezip.ru

+7(812)987-08-81



1

GEV No.	416412	Ref. No.	0159
description	heating element 2500W 230V heating circuits 1 ID ø 188mm ED ø 200mm L 215mm H 30mm W1 3mm W1 53mm H1 5mm H2 25mm flange length 100mm flange width 22mm hole distance 86mm connection male faston 6.3mm		



1

GEV No.	418134	Ref. No.	0508
description	heating element 3300W 240V heating circuits 1 ID ø 185mm ED ø 200mm L 215mm H 30mm W1 60mm H1 5mm H2 25mm flange length 100mm flange width 22mm hole distance 85mm connection male faston 6.3mm connection length 22mm tube ø 6.5mm connection heating element hole ø 5mm rectangular flange		
For models:	FC06E, FC06EA, FC06EDG, FC12E, FC12EA, FC12EDG		

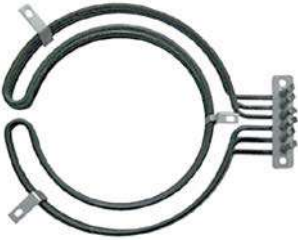

1

GEV No.	415855	Ref. No.	10601
description	heating element 3900W 230V heating circuits 3 ID ø 176mm ED ø 244mm L 282mm H 43mm W1 38mm W1 61mm H1 13mm H2 30mm flange length 92mm flange width 22mm hole distance 78mm connection male faston 6.3mm connection length 60mm tube ø 6.3mm convection heating element hole ø 6.3mm rectangular flange		



1

GEV No.	418131	Ref. No.	1023
description	heating element 6000W 230V heating circuits 3 ID ø 217mm ED ø 231mm L 271mm H 90mm W1 41mm W1 103mm H1 24mm H2 66mm flange length 140mm flange width 22mm hole distance 63mm tube ø 6.3mm convection heating element hole ø 5mm rectangular flange		



1

GEV No.	418132	Ref. No.	3016 3016A
description	heating element 7350W 230V heating circuits 3 ID ø 250mm ED ø 265mm L 277mm H 75mm W1 17mm W1 102mm H1 12mm H2 67mm flange length 143mm flange width 25mm hole distance 7mm connection M4 tube ø 6.5mm convection heating element hole ø 63mm rectangular flange		
For models:	FC06SE, FC06SEA, FC06SEEDG, FM06EB, FM06EDG, FP05E, FP05EDG, MM06EA, MM06EAP, MM06EB		



1





GEV No.	418753	Ref. No.	10628
description	heating element 8000W 230V heating circuits 3 ID ø 287mm ED ø 300mm L 345mm H 90mm W1 39mm W1 120mm H2 67mm flange length 142mm flange width 25mm hole distance 12.7mm connection M4 connection length 67mm tube ø 6.5mm convection heating element hole ø 7mm rectangular flange		



1

GEV No.	418135	Ref. No.	1126
description	heating element 920W 230V heating circuits 1 ID ø 200mm ED ø 215mm L 255mm H 40mm thread 1/4" connection male faston 6.3mm 2 hole fixing mounting distance 24mm tube ø 8.5mm convection heating element		

For models:	FC06E, FC06EA, FC06EDG, FC12E, FC12EA, FC12EDG		
accessories for	418135		

	GEV No.	361182	Ref. No.	—
	nut thread 1/4" H 5mm nickel-plated brass WS 17 Qty 1 pcs			
	GEV No.	510417	Ref. No.	—
	flat gasket fibre ED ø 20mm ID ø 14mm thickness 2mm Qty 1 pcs			
	GEV No.	520228	Ref. No.	—
	tooth lock washer ID ø 15.3mm ED ø 24mm steel Qty 1 pcs for thread M14			
	GEV No.	550262	Ref. No.	—
	flat gasket copper ED ø 20mm ID ø 14mm thickness 2mm			



Зип Общепит

vsezip.ru

812)987-08-81



GEV No.	390068	Ref. No.	0283 0596 3529
description	thermostat t.max. 269°C temperature range 55-269°C 1-pole 1CO 16A probe ø 3.1mm probe L 219mm capillary pipe 1280mm capillary pipe isolated 1270mm gland nut shaft ø 6x4.6mm shaft L 23mm shaft position upper° rotation 318°		
For models:	FC05E, FC05EU, FC05G, FC05GU, FC06E, FC06EA, FC06EDG, FC06G, FC06GA, FC06GDG, FC06SE, FC06SEA, FC06SEDG, FC12E, FC12EA, FC12EDG, FC12G, FC12GA, FC12GDG, FC12SE, FC12SEA, FC12SEDG, FC200EB, FC200GB, FC201EB, FC201GB, FC20E, FC20EA, FC20EDG, FC20G, FC20GA, FC20GDG, FC401EB, FC401GB, FDE10, FDE15, FDE55, FDG10, FDG15, FDG55, FM200EB, FM200GB, FM201EB, FM201GB, FM401EB, FM401GB, FP05E, FP05EDG, FP05G, FP05GDG... (Other models you can see in the webshop)		



GEV No.	375002	Ref. No.	0026
description	thermostat t.max. 320°C temperature range 55-320°C 1-pole 1NO 16A probe ø 3.1mm probe L 226mm capillary pipe 870mm capillary pipe isolated 850mm gland nut shaft L 23mm shaft position upper rotation 270°		
For models:	FE1-2, FE2-3		



GEV No.	418139	Ref. No.	1466
description	heating element 3500W 240V heating circuits 1 L 620mm W 120mm L1 33mm L2 587mm W2 90mm flange length 70mm flange width 22mm hole distance 56mm connection length 100mm connection M4 tube ø 8.5mm hole ø 6mm W1 30mm rectangular flange convection heating element windings 2		
For models:	FC12SE, FC12SEA, FC12SEDG, FC20E, FC20EA, FC20EDG, FM10EB, FM10EDG, FM20EB, FM20EDG, FP10E, FP10EDG, MM10EA, MM10EAP, MM10EB, MM20EA, MM20EAP, MM20EB		

energy regulators

EGO

1-circuit



GEV No.	380015	Ref. No.	0280
description	energy regulator 230V 13A single-circuit turn direction right shaft ø 6x4.6mm shaft L 23mm mounting thread M4 power release 6-100% no. 50.57021.010		
For models:	FC05E, FC05EU, FC05G, FC05GU, FC06E, FC06EA, FC06EDG, FC06G, FC06GA, FC06GDG, FC06SE, FC06SEA, FC06SEDG, FC12E, FC12EA, FC12EDG, FC12G, FC12GA, FC12GDG, FC12SE, FC12SEA, FC12SEDG, FC200EB, FC200GB, FC201EB, FC20E, FC20EA, FC20EDG, FC20G, FC20GA, FC20GDG, FC401EB, FDE10, FDE15, FDE55, FDG10, FDG15, FDG55, FM06EB, FM06GB, FM10EB, FM10GB, FM20EB, FM20GB, FP05E, FP05EDG, FP05G, FP05GDG, FP10E, FP10EDG... (Other models you can see in the webshop)		

thermostats

control and safety thermostats

EGO

control thermostats

55.10/19_series



GEV No.	375647	Ref. No.	10005
description	thermostat t.max. 110°C temperature range 31-110°C 1-pole 1NO 16A probe ø 6mm probe L 133mm capillary pipe 870mm capillary pipe isolated gland nut shaft ø 6x4.6mm shaft L 23mm shaft position upper rotation 318°		
For models:	MM2/3EB		



Зип Общепит

vsezip.ru

+7(812)987-08-81

electric components

safety thermostats



55.10/19_ series



1



GEV No.	375250	Ref. No.	0599 3528
description	safety thermostat capillary pipe 870mm probe ø 6mm 1-pole probe L 129mm 16A capillary pipe isolatedmm gland nut switch-off temp. 130°C probe SS		
For models:	FM06EDG, FM06GB, FM10EDG, FM10GB, FM201EA, FM201EAP, FM201EB, FM201GB, FM20EDG, FM20GB, FM401EB, FM401GB		
spare parts for	375250		
	GEV No.	551083	Ref. No. —
	cap for safety thermostat thread M8x1		

55.32_ series

1

GEV No.	375649	Ref. No.	3019 3023
description	safety thermostat switch-off temp. 160°C 3-pole 20A probe ø 6mm probe L 87mm capillary pipe 890mm capillary pipe isolated 880mm gland nut probe SS		
For models:	FM06EB, FM06GDG, FM10EB, FM10GDG, FM20EB, FM20GDG		

1

GEV No.	375380	Ref. No.	3023+0830
description	safety thermostat switch-off temp. 160°C 3-pole 20A probe ø 6mm probe L 89mm capillary pipe 900mm capillary pipe isolated 900mm gland nut probe SS		

control thermostats

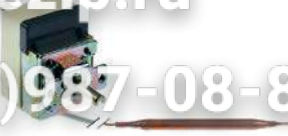

1

GEV No.	375645	Ref. No.	10008
description	thermostat t.max. 120°C temperature range 30-120°C 1-pole 1CO 16A probe ø 6mm probe L 110mm capillary pipe 1600mm capillary pipe isolated 1550mm gland nut shaft ø 6x4.6mm shaft L 22mm shaft position upper rotation 270° probe material copper 250V		

switches and momentary switches

push/momentary push switches

28.5x77.5mm



1

GEV No.	346365	Ref. No.	10044
description	switch combination momentary/latching mounting measurements 28.5x77.5mm black 2CO/2CO 250V 16A with indicator connection male faston 6.3mm ambient temperature max. 85°C protection IP40		
For models:	MM06EB, MM06GB, MM10EB, MM10GB, MM20EB, MM20GB		



1

GEV No.	346363	Ref. No.	10043
description	switch combination with indicator mounting measurements 28.5x77.5mm black 2CO/2CO 250V 16A connection male faston 6.3mm ambient temperature max. 85°C protection IP40		
For models:	FM06EB, FM06GB, FM10EB, FM10GB, FM20EB, FM20GB		

microswitches

pin-plunger actuated

M10



1

GEV No.	345032	Ref. No.	1519
description	microswitch with plunger thread M10x1 thread L 12mm 250V 16A 1CO connection male faston 6.3mm stroke 7mm mounting distance 22mm L 28mm ambient temperature max. 125°C type SP9603 actuating force: 180g		



system switches (ROLD)

Зип Общепит

vsezip.ru

+7(812)987-08-81



1

GEV No.	345721	Ref. No.	3471
description	blank cap holder		



1

GEV No.	345537	Ref. No.	10313
description	element holder mounting measurements 20.6x16.4mm light grey arched for push buttons 13x17mm		
For models:	FC05G, FC05GU, FC200EA, FC200EAP, FC200EB, FC200GA, FC200GAP, FC200GB, FC201EB, FC201GA, FC201GAP, FC201GB, FC401EB, FC401GA, FC401GAP, FC401GB, FDE10, FDE155, FDE155DG, FDE55, FDE55DG, FDG10, FDG155, FDG155DG, FDG55, FDG55DG, FM200EA, FM200EAP, FM200EB, FM200GA, FM200GAP, FM200GB, FM201EA, FM201EAP, FM201EB, FM201GA, FM201GAP, FM201GB, FM401EA, FM401EAP, FM401EB, FM401GA, FM401GAP, FM401GB, MM200EA, MM200EAP, MM200EB, MM200GA, MM200GAP, MM200GB...(Other models you can see in the webshop)		



1

GEV No.	345131	Ref. No.	3475
description	element holder mounting measurements 28.5x28.5mm grey single element holder		



1

GEV No.	346201	Ref. No.	3468
description	element holder mounting measurements 28.5x77.5mm grey three-fold element holder		



1

GEV No.	345606	Ref. No.	3474
description	momentary switch unit 2CO 250V 16A connection male faston 6.3mm		
For models:	FC05G, FC05GU, FC200EA, FC200EAP, FC200EB, FC200GA, FC200GAP, FC200GB, FC201EB, FC201GA, FC201GAP, FC201GB, FC401EB, FC401GA, FC401GAP, FC401GB, FDG10, FDG155, FDG55, FM10GB, FM200EA, FM200EAP, FM200EB, FM200GA, FM200GAP, FM200GB, FM201EA, FM201EAP, FM201EB, FM201GA, FM201GAP, FM201GB, FM401EA, FM401EAP, FM401EB, FM401GA, FM401GAP, FM401GB, MM06GB, MM10GB, MM2/3EB, MM200EA, MM200EAP, MM200EB, MM200GA, MM200GAP, MM200GB, MM201EA, MM201EAP, MM201EB...(Other models you can see in the webshop)		



1

GEV No.	345538	Ref. No.	3480
description	push button ø 11.9mm black		



1

GEV No.	345133	Ref. No.	3470
description	push button ø 23mm grey		
For models:	MM2/3EB		



1

GEV No.	346211	Ref. No.	3469
description	push button ø 23mm grey with lens		



1

GEV No.	345539	Ref. No.	10312
description	push button size 17x13mm grey		
For models:	FC05G, FC05GU, FC200EA, FC200EAP, FC200EB, FC200GA, FC200GAP, FC200GB, FC201EB, FC201GA, FC201GAP, FC201GB, FC401EB, FC401GA, FC401GAP, FC401GB, FDE10, FDE155, FDE155DG, FDE55, FDE55DG, FDG10, FDG155, FDG155DG, FDG55, FDG55DG, FM200EA, FM200EAP, FM200EB, FM200GA, FM200GAP, FM200GB, FM201EA, FM201EAP, FM201EB, FM201GA, FM201GAP, FM201GB, FM401EA, FM401EAP, FM401EB, FM401GA, FM401GAP, FM401GB, MM200EA, MM200EAP, MM200EB, MM200GA, MM200GAP, MM200GB...(Other models you can see in the webshop)		



1

GEV No.	346364	Ref. No.	3472
description	rotary disc red/white disc ø 20.6mm		



Зип Общепит

vsezip.ru

7(812)987-08-81



1

GEV No.	345605	Ref. No.	3473
description	switch 2CO 250V 16A connection male faston 6.3mm		
For models:	FC05G, FC05GU, FC06E, FC06EA, FC06EDG, FC06G, FC06GA, FC06GDG, FC06SE, FC06SEA, FC06SEDG, FC12E, FC12EA, FC12EDG, FC12G, FC12GA, FC12GDG, FC12SE, FC12SEA, FC12SEDG, FC200EA, FC200EAP, FC200EB, FC200GB, FC201EB, FC201GB, FC20E, FC20EA, FC20EDG, FC20G, FC20GA, FC20GDG, FC401EB, FC401GB, FDE10, FDE155, FDE155DG, FDE55, FDG10, FDG155, FDG155DG, FDG55, FDG55DG, FM06EB, FM06GB, FM10EB, FM10GB, FM200EA, FM200EAP, FM200EB...(Other models you can see in the webshop)		



10 operating positions

GEV No.	301205	Ref. No.	10027
description	cam switch 10 operating positions 5NO/1CO sequence 0-1-2-3-4-5-6-7-8-9 16A shaft ø 6x4.6mm shaft L 23mm connection male faston 6.3mm ceramic		

cam switches

4 operating positions



1

GEV No.	300010	Ref. No.	0281
description	cam switch 4 operating positions 2NO/2CO sequence 0-1-2-3 16A shaft ø 6x4.6mm shaft L 23mm connection male faston 6.3mm ceramic		
For models:	FC05E, FC05EU, FC05G, FC05GU, FC06E, FC06EA, FC06EDG, FC06G, FC06GA, FC06GDG, FC06SE, FC06SEA, FC06SEDG, FC12E, FC12EA, FC12EDG, FC12G, FC12GA, FC12GDG, FC12SE, FC12SEA, FC12SEDG, FC200EB, FC200GB, FC201EB, FC201GB, FC20E, FC20EA, FC20EDG, FC20G, FC20GA, FC20GDG, FC401EB, FDE10, FDE155, FDE55, FDG10, FDG155, FDG55, FM200GB, FP05E, FP05EDG, FP05G, FP05GDG, FP10E, FP10EDG, FP10G, FP10GDG		

operation switches



1

GEV No.	300153	Ref. No.	0038
description	cam switch 3 operating positions operation switch 16A sequence 0-1-2 shaft ø 6x4.6mm shaft L 23mm connection male faston 6.3mm plastic ambient temperature max. 240°C		
For models:	FE1-2, FE2-3		

magnetic switches

37x16mm

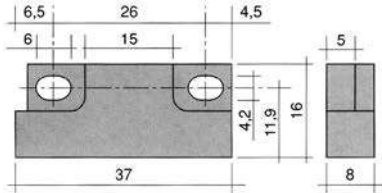
1

GEV No.	345600	Ref. No.	70201
description	magnetic switch L 37mm W 16mm 1NO 250V 0.2A P max. 50W connection cable length 960mm		
accessories for	345600		
	GEV No.	Ref. No.	—
	519049	magnet ømm L 63mm H 10.7mm W 18.8mm hole distance 52mm M2 hole ø 2mm	

5 operating positions

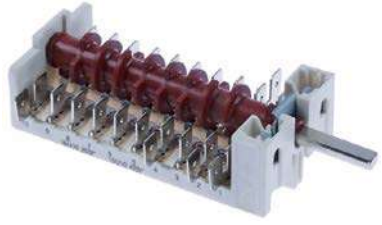

1

GEV No.	347652	Ref. No.	3018
description	cam switch 5 operating positions 5NO/2CO sequence 0-1-2-3-4 16A shaft ø 6x4.6mm shaft L 23mm connection male faston 6.3mm plastic		
For models:	FM06EB, FM06GB, FM10EB, FM10GB, FM200EA, FM200EAP, FM200EB, FM200GA, FM200GAP, FM201EA, FM201EAP, FM201EB, FM201GA, FM201GAP, FM201GB, FM20EB, FM20GB, FM401EA, FM401EAP, FM401EB, FM401GA, FM401GAP, FM401GB, MM06EB, MM06GB, MM10EB, MM10GB, MM2/3EB, MM200EB, MM200GB, MM201EB, MM201GB, MM20EB, MM20GB, MM401GB		

M10x0.75



1

GEV No.	348024	Ref. No.	10419
description	magnetic switch 1NO 250V 1A P max. 10W connection Faston 6.3mm cable length 2000mm		



Зип Общепит

screw on / push on fit

light bulbs
for ovensvsezip.ru
+7(812)987-08-81

accessories

magnets



GEV No.	348007	Ref. No.	10420
description	magnet ø 23mm Lmm H 10mm Wmm ID ø 4.5mm ED ø 23mm M3 hole ø 4.5mm		

light bulbs

for ovens



GEV No.	359610	Ref. No.	35.0003.01
description	light bulb t.max. 300°C socket E14 15W 230V ø 22mm L 47mm lens L 20mm for oven lamp type Philips		
For models:	FC05E, FC05EU, FC05G, FC05GU, FC06E, FC06EA, FC06EDG, FC06G, FC06GA, FC06GDG, FC06SE, FC06SEA, FC06SEDG, FC12E, FC12EA, FC12EDG, FC12G, FC12GA, FC12GDG, FC12SE, FC12SEA, FC12SEDG, FC20E, FC20EA, FC20EDG, FC20G, FC20GA, FC20GDG, FE1-2, FE2-3, FP05E, FP05EDG, FP05G, FP05GDG, FP10E, FP10EDG, FP10G, FP10GDG		

lamps

indicator lights

indicator lights (complete)

ø10mm

with plug-in socket



GEV No.	359139	Ref. No.	0631
description	indicator light ø 10mm green 230V connection male faston 6.3mm Qty 1 pcs		
For models:	FC200EB, FC200GB, FC201EB, FC201GB, FC401EB, FC401GB, FDE10, FDE155, FDE55, FDG10, FDG155, FDG55, FM06EB, FM06GB, FM10EB, FM10GB, FM200GB, FM201EB, FM201GB, FM20EB, FM20GB, FM401EB, FM401GB, MM200EB, MM200GB, MM201EB, MM201GB, MM401GB		



GEV No.	359740	Ref. No.	10341
description	light bulb t.max. 300°C socket E14 15W 230V ø 22mm L 48mm lens L 20mm for oven lamp IMPORT 70 1000		



GEV No.	359138	Ref. No.	0591
description	indicator light ø 10mm red 230V connection male faston 6.3mm Qty 1 pcs		
For models:	FC05E, FC05EU, FC05G, FC05GU, FC06E, FC06EA, FC06EDG, FC06G, FC06GA, FC06GDG, FC06SE, FC06SEA, FC06SEDG, FC12E, FC12EA, FC12EDG, FC12G, FC12GA, FC12GDG, FC12SE, FC12SEA, FC12SEDG, FC20E, FC20EA, FC20EDG, FC20G, FC20GA, FC20GDG, FE1-2, FE2-3, FM06EB, FM06GB, FM10EB, FM10GB, FM200EB, FM200GB, FM201EB, FM201GB, FM20EB, FM20GB, FM401EB, FM401GB, FP05E, FP05EDG, FP05G, FP05GDG, FP10E, FP10EDG, FP10G, FP10GDG		



GEV No.	359612	Ref. No.	3546
description	light bulb t.max. 300°C socket E14 25W 230V ø 25mm L 56mm lens L 30mm for oven lamp type Philips		
For models:	FM06EB, FM06EDG, FM06GB, FM06GDG, FM10EB, FM10EDG, FM10GB, FM10GDG, FM20EB, FM20EDG, FM20GB, FM20GDG, MM06EA, MM06EAP, MM06EB, MM06GA, MM06GAP, MM06GB, MM10EA, MM10EAP, MM10EB, MM10GA, MM10GAP, MM10GB, MM2/3EA, MM2/3EB, MM20EA, MM20EAP, MM20EB, MM20GA, MM20GAP, MM20GB		



GEV No.	359140	Ref. No.	0592
description	indicator light ø 10mm yellow 230V connection male faston 6.3mm Qty 1 pcs		
For models:	FC05E, FC05EU, FC05G, FC05GU, FC06E, FC06EA, FC06EDG, FC06G, FC06GA, FC06GDG, FC06SE, FC06SEA, FC06SEDG, FC12E, FC12EA, FC12EDG, FC12G, FC12GA, FC12GDG, FC12SE, FC12SEA, FC12SEDG, FC200EB, FC200GB, FC201EB, FC201GB, FC20E, FC20EA, FC20EDG, FC20G, FC20GA, FC20GDG, FC401EB, FC401GB, FDE10, FDE155, FDE155DG, FDE55, FDE55DG, FDG10, FDG155, FDG155DG, FDG55, FDG55DG, FE1-2, FE2-3, FM06EB, FM06GB, FM10EB, FM10GB...(Other models you can see in the webshop)		

halogen lamp

for socket G4 / G6.35 / G9



GEV No.	359599	Ref. No.	10307
description	halogen lamp socket G4 12V 20W temp.-resist. 500°C 250 2000		
For models:	FC200EA, FC200EAP, FC200EB, FC200GA, FC200GAP, FC200GB, FC201EA, FC201EAP, FC201EB, FC201GA, FC201GAP, FC201GB, FC401EA, FC401EAP, FC401EB, FC401GA, FC401GAP, FC401GB, FDE10, FDE155, FDE155DG, FDE55, FDE55DG, FDG10, FDG155, FDG155DG, FDG55, FDG55DG, FM200EA, FM200EAP, FM200EB, FM200GA, FM200GAP, FM200GB, FM201EA, FM201EAP, FM201EB, FM201GA, FM201GAP, FM201GB, FM401EA, FM401EAP, FM401EB, FM401GA, FM401GAP, FM401GB, MM200EA, MM200EAP, MM200EB, MM200GA...(Other models you can see in the webshop)		



oven lamps

Зип Общежит
mounting diameter 35.5mm

vsezip.ru

+7(812)987-08-81

universal oven lamps

mounting diameter 35.5mm



GEV No.	359701	Ref. No.	35.0002.01
description	lamp socket socket E14 220-230V mounting ø 35.5mm connection male faston 6.3mm 15W		
For models:	FC05E, FC05G, FC05GU, FE1-2		
accessories for	359701		
	GEV No.	359705	Ref. No. —
	oven lamp glass thr.ø 33.5mm ø 52mm hard glas temp.-resist. 350°C		
	GEV No.	359709	Ref. No. —
	oven lamp glass thr.ø 33.5mm ø 42mm hard glas temp.-resist. 350°C		
	GEV No.	359721	Ref. No. 0812.01
	gasket silicone ED ø 48mm ID ø 39.5mm thickness 5mm Qty 1 pcs		
	GEV No.	359942	Ref. No. —
	oven lamp glass thr.ø 33.5mm H 39mm ø 40mm hard glas temp.-resist. 350°C		



GEV No.	359661	Ref. No.	35000101
description	oven lamp glass thread 32.1 ø 58mm hard glas temp.-resist. 350°C		
accessories for	359661		
	GEV No.	359700	Ref. No. —
	gasket for pizza oven fibre glass ID ø 32.5mm ED ø 55mm thickness 5mm		
	GEV No.	360782	Ref. No. —
	gasket for bulb socket fibre glass ID ø 35mm ED ø 45mm thickness 5mm		



GEV No.	359721	Ref. No.	0812.01
description	gasket silicone ED ø 48mm ID ø 39.5mm thickness 5mm Qty 1 pcs		
For models:	FC05E, FC05EU, FC05G, FC05GU, FC06E, FC06EA, FC06EDG, FC06G, FC06GA, FC06GDG, FC06SE, FC06SEA, FC06SEDG, FC12E, FC12EA, FC12EDG, FC12G, FC12GA, FC12GDG, FC12SE, FC12SEA, FC12SEDG, FC200EA, FC200EAP, FC200EB, FC200GA, FC200GAP, FC200GB, FC201EA, FC201EAP, FC201EB, FC201GA, FC201GAP, FC201GB, FC401EA, FC401EAP, FC401EB, FC401GA, FC401GAP, FC401GB, FE1-2, FE2-3, FM200EA, FM200EAP, FM200EB, FM200GA, FM200GAP, FM200GB, FM201EA, FM201EAP...(Other models you can see in the webshop)		



GEV No.	359703	Ref. No.	10340
description	oven lamp mounting ø 47.8mm 230V 15W socket E14 temp.-resist. 300°C connection male faston 6.3mm hard glas		
spare parts for	359703		
	GEV No.	359610	Ref. No. 35.0003.01
	light bulb t.max. 300°C socket E14 15W 230V ø 22mm L 47mm lens L 20mm for oven lamp type Philips		
	GEV No.	359725	Ref. No. —
	oven lamp glass thread ø 44mm H 43mm ø 54mm hard glas temp.-resist. 350°C		

55x70mm



GEV No.	359297	Ref. No.	10306
description	frame L 95mm W 81mm mounting distance 68/83mm thickness 6mm		
For models:	FC05G, FC05GU		
accessories for	359297		
	GEV No.	359299	Ref. No. 10304
	gasket L 91mm W 77mm hole ø 3mm for oven lamp		



GEV No.	359299	Ref. No.	10304
description	gasket L 91mm W 77mm hole ø 3mm for oven lamp		
For models:	FC05G, FC05GU		



GEV No.	359296	Ref. No.	10305
description	lamp glass L 74mm W 58mm thickness 3mm		
For models:	FC05G, FC05GU		

1 electric components



55x100mm



1	GEV No.	359698	Ref. No.	3542
description	lamp socket L 100mm W 55mm socket E14 connection male faston 6.3mm			
For models:	FM06EB, FM06EDG, FM06GB, FM06GDG, FM10EB, FM10EDG, FM10GB, FM10GDG, FM20EB, FM20EDG, FM20GB, FM20GDG, MM06EA, MM06EAP, MM06EB, MM06GA, MM06GAP, MM06GB, MM10EA, MM10EAP, MM10EB, MM10GA, MM10GAP, MM10GB, MM2/3EA, MM2/3EB, MM20EA, MM20EAP, MM20EB, MM20GA, MM20GAP, MM20GB			
spare parts for	359698			
	GEV No.	358119	Ref. No.	—
	frame L 118mm W 72mm mounting distance 143mm for bulb socket			
	GEV No.	358122	Ref. No.	—
	gasket L 112mm W 68mm silicone thickness 3mm for bulb socket			
	GEV No.	358123	Ref. No.	—
	lamp glass L 112mm W 68mm			
	GEV No.	359612	Ref. No.	3546
	light bulb t.max. 300°C socket E14 25W 230V ø 25mm L 56mm lens L 30mm for oven lamp type Philips			
	GEV No.	359714	Ref. No.	3543
	gasket silicone L 140mm W 75mm for bulb socket			
	GEV No.	359715	Ref. No.	3544
	lamp glass L 110mm W 65mm thickness 5mm			
	GEV No.	359716	Ref. No.	1265A 3545
	frame for bulb socket			
accessories for	359698			
	GEV No.	359612	Ref. No.	3546
	light bulb t.max. 300°C socket E14 25W 230V ø 25mm L 56mm lens L 30mm for oven lamp type Philips			
	GEV No.	359938	Ref. No.	—
	borosilicate glass L 115mm W 69mm			

1



GEV No.	359716	Ref. No.	1265A 3545
description	frame for bulb socket		
For models:	FC20E, FC20EA, FC20EDG, FC20G, FC20GA, FC20GDG, FM06EB, FM06EDG, FM06GB, FM06GDG, FM10EB, FM10EDG, FM10GB, FM10GDG, FM20EB, FM20EDG, FM20GB, FM20GDG, MM06EA, MM06EAP, MM06EB, MM06GA, MM06GAP, MM06GB, MM10EA, MM10EAP, MM10EB, MM10GA, MM10GAP, MM10GB, MM2/3EA, MM2/3EB, MM20EA, MM20EAP, MM20EB, MM20GA, MM20GAP, MM20GB		

Зип Общепит

vsezip.ru

+7(812)987-08-81

1

GEV No.	359714	Ref. No.	3543
description	gasket silicone L 140mm W 75mm for bulb socket		
For models:	FC20E, FC20EA, FC20EDG, FC20G, FC20GA, FC20GDG, FM06EB, FM06EDG, FM06GB, FM06GDG, FM10EB, FM10EDG, FM10GB, FM10GDG, FM20EB, FM20EDG, FM20GB, FM20GDG, MM06EA, MM06EAP, MM06EB, MM06GA, MM06GAP, MM06GB, MM10EA, MM10EAP, MM10EB, MM10GA, MM10GAP, MM10GB, MM2/3EA, MM2/3EB, MM20EA, MM20EAP, MM20EB, MM20GA, MM20GAP, MM20GB		

1



GEV No.	359715	Ref. No.	3544
description	lamp glass L 110mm W 65mm thickness 5mm		
For models:	FC20E, FC20EA, FC20EDG, FC20G, FC20GA, FC20GDG, FM06EB, FM06EDG, FM06GB, FM06GDG, FM10EB, FM10EDG, FM10GB, FM10GDG, FM20EB, FM20EDG, FM20GB, FM20GDG, MM06EA, MM06EAP, MM06EB, MM06GA, MM06GAP, MM06GB, MM10EA, MM10EAP, MM10EB, MM10GA, MM10GAP, MM10GB, MM2/3EB, MM20EA, MM20EAP, MM20EB, MM20GB		

1





GEV No.	359698	Ref. No.	3542	
description	lamp socket L 100mm W 55mm socket E14 connection male faston 6.3mm			
For models:	FM06EB, FM06EDG, FM06GB, FM06GDG, FM10EB, FM10EDG, FM10GB, FM10GDG, FM20EB, FM20EDG, FM20GB, FM20GDG, MM06EA, MM06EAP, MM06EB, MM06GA, MM06GAP, MM06GB, MM10EA, MM10EAP, MM10EB, MM10GA, MM10GAP, MM10GB, MM2/3EA, MM2/3EB, MM20EA, MM20EAP, MM20EB, MM20GA, MM20GAP, MM20GB			
spare parts for	359698			
	GEV No.	358119	Ref. No.	—
	frame L 118mm W 72mm mounting distance 143mm for bulb socket			
	GEV No.	358122	Ref. No.	—
	gasket L 112mm W 68mm silicone thickness 3mm for bulb socket			
	GEV No.	358123	Ref. No.	—
	lamp glass L 112mm W 68mm			
	GEV No.	359612	Ref. No.	3546
	light bulb t.max. 300°C socket E14 25W 230V ø 25mm L 56mm lens L 30mm for oven lamp type Philips			
	GEV No.	359714	Ref. No.	3543
	gasket silicone L 140mm W 75mm for bulb socket			
	GEV No.	359715	Ref. No.	3544
	lamp glass L 110mm W 65mm thickness 5mm			

Table continues overleaf

Зип Общепит
Lamps

vsezip.ru



+7(812)987-08-81

spare parts for 359698				
	GEV No.	359716	Ref. No.	1265A 3545
frame for bulb socket				
accessories for 359698				
	GEV No.	359612	Ref. No.	3546
light bulb t.max. 300°C socket E14 25W 230V ø 25mm L 56mm lens L 30mm for oven lamp type Philips				
	GEV No.	359938	Ref. No.	—
borosilicate glass L 115mm W 69mm				

light bulbs				
	GEV No.	359610	Ref. No.	35.0003.01
description light bulb t.max. 300°C socket E14 15W 230V ø 22mm L 47mm lens L 20mm for oven lamp type Philips				
For models: FC05E, FC05EU, FC05G, FC05GU, FC06E, FC06EA, FC06EDG, FC06G, FC06GA, FC06GDG, FC06SE, FC06SEA, FC06SEDG, FC12E, FC12EA, FC12EDG, FC12G, FC12GA, FC12GDG, FC12SE, FC12SEA, FC12SEDG, FC20E, FC20EA, FC20EDG, FC20G, FC20GA, FC20GDG, FE1-2, FE2-3, FP05E, FP05EDG, FP05G, FP05GDG, FP10E, FP10EDG, FP10G, FP10GDG				

producer-specific oven lamps

FOINOX

	1			
GEV No.	359297	Ref. No.	10306	
description frame L 95mm W 81mm mounting distance 68/83mm thickness 6mm				
For models: FC05G, FC05GU				
accessories for 359297				
	GEV No.	359299	Ref. No.	10304
gasket L 91mm W 77mm hole ø 3mm for oven lamp				

	1			
GEV No.	359299	Ref. No.	10304	
description gasket L 91mm W 77mm hole ø 3mm for oven lamp				
For models: FC05G, FC05GU				

	1			
GEV No.	359296	Ref. No.	10305	
description lamp glass L 74mm W 58mm thickness 3mm				
For models: FC05G, FC05GU				

	1			
GEV No.	359839	Ref. No.	10867	
description lamp socket socket G4 for halogen lamp				

	1			
GEV No.	359740	Ref. No.	10341	
description light bulb t.max. 300°C socket E14 15W 230V ø 22mm L 48mm lens L 20mm for oven lamp IMPORT 70 1000				

	1			
GEV No.	359612	Ref. No.	3546	
description light bulb t.max. 300°C socket E14 25W 230V ø 25mm L 56mm lens L 30mm for oven lamp type Philips				
For models: FM06EB, FM06EDG, FM06GB, FM06GDG, FM10EB, FM10EDG, FM10GB, FM10GDG, FM20EB, FM20EDG, FM20GB, FM20GDG, MM06EA, MM06EAP, MM06EB, MM06GA, MM06GAP, MM06GB, MM10EA, MM10EAP, MM10EB, MM10GA, MM10GAP, MM10GB, MM2/3EA, MM2/3EB, MM20EA, MM20EAP, MM20EB, MM20GA, MM20GAP, MM20GB				

halogen lamps

for socket G4 / G6.35 / G9

	1 500°C			
GEV No.	359599	Ref. No.	10307	
description halogen lamp socket G4 12V 20W temp.-resist. 500°C 250 2000				
For models: FC200EA, FC200EAP, FC200EB, FC200GA, FC200GAP, FC200GB, FC201EA, FC201EAP, FC201EB, FC201GA, FC201GAP, FC201GB, FC401EA, FC401EAP, FC401EB, FC401GA, FC401GAP, FC401GB, FDE15, FDE155DG, FDE55, FDE55DG, FDG10, FDG155, FDG155DG, FDG55, FDG55DG, FM200EA, FM200EAP, FM200EB, FM200GA, FM200GAP, FM200GB, FM201EA, FM201EAP, FM201EB, FM201GA, FM201GAP, FM201GB, FM401EA, FM401EAP, FM401EB, FM401GA, FM401GAP, FM401GB, MM200EA, MM200EAP, MM200EB, MM200GA... (Other models you can see in the webshop)				

1 electric components



Зип-Общепит

mechanical timers

sockets

G4 / G5,3 / G6,35



1

GEV No.	359646	Ref. No.	10308
description	lamp socket socket G4/G5.3/G6.35 24V ø 17mm H 15mm connection cable 130mm mounting distance 26mm for halogen lamp holder length 31mm cable length 130mm		
For models:	FC200EA, FC200EAP, FC200EB, FC200GA, FC200GAP, FC200GB, FC201EA, FC201EAP, FC201EB, FC201GA, FC201GAP, FC201GB, FC401EA, FC401EAP, FC401EB, FC401GA, FC401GAP, FC401GB, FDE10, FDE155, FDE155DG, FDE55, FDE55DG, FDG10, FDG155, FDG155DG, FDG55, FDG55DG, FM200EA, FM200EAP, FM200EB, FM200GA, FM200GAP, FM200GB, FM201EA, FM201EAP, FM201EB, FM201GA, FM201GAP, FM201GB, FM401EA, FM401EAP, FM401EB, FM401GA, FM401GAP, FM401GB, MM200EA, MM200EAP, MM200EB, MM200GA... (Other models you can see in the webshop)		

timers

programme timers





1

GEV No.	360339	Ref. No.	10039 10042
description	timer FIBER P25 engines 1 chambers 1 operation time 20s 230V shaft ø 6x4.6mm shaft L 20mm manuf. no. P255J01C1N4 motor type M51BJ0R6400		
For models:	FC200EA, FC200EAP, FC200EB, FC200GA, FC200GAP, FC200GB, FC201EA, FC201EAP, FC201EB, FC201GA, FC201GAP, FC201GB, FC401EA, FC401EAP, FC401EB, FC401GA, FC401GAP, FC401GB, FM200EA, FM200EAP, FM200EB, FM200GA, FM200GAP, FM200GB, FM201EA, FM201EAP, FM201EB, FM201GA, FM201GAP, FM201GB, FM401EA, FM401EAP, FM401EB, FM401GA, FM401GAP, FM401GB, MM200EA, MM200EAP, MM200EB, MM200GA, MM200GAP, MM200GB, MM201EA, MM201EAP, MM201EB, MM201GA, MM201GAP, MM201GB, MM401EA, MM401EAP, MM401GA... (Other models you can see in the webshop)		
spare parts for	360339		
	GEV No.	360673	Ref. No. —
	motor kit pinion ø 6.8mm teeth 15 230V voltage AC 50/60Hz turn direction clockwise motor ø 48mm H 18.5mm motor type UDS-40NE1RNZ165 cable length 150mm with holder		

vsezip.ru

+7(812)987-08-81

1

GEV No.	350003	Ref. No.	0039
description	timer M2 with bell 2-pole operation time 120min impulse mechanical 2NO at 250V 16A permanent position no shaft ø 6x4.6mm shaft 6x4.6mm shaft L 23mm mounting distance 28mm connection lateral		
For models:	FC05E, FC05EU, FC05G, FC05GU, FC06E, FC06EA, FC06EDG, FC06G, FC06GA, FC06GDG, FC06SE, FC06SEA, FC06SEEDG, FC12E, FC12EA, FC12EDG, FC12G, FC12GA, FC12GDG, FC12SE, FC12SEA, FC12SEEDG, FC20E, FC20EA, FC20EDG, FC20G, FC20GA, FC20GDG, FDE10, FDE155, FDE55, FDG10, FDG155, FDG55, FP05E, FP05EDG, FP05G, FP05GDG, FP10E, FP10EDG, FP10G, FP10GDG		
accessories for	350003		
	GEV No.	110366	Ref. No. —
	knob switch zero mark t.max. °C ø 44mm shaft ø 6x4.6mm shaft flat upper black		
	GEV No.	111199	Ref. No. —
	dial plate graduation 120min permanent position no rotation 0-330° ø 60mm timers knob ø 45mm		

1

GEV No.	350008	Ref. No.	0050 3433 0050
description	timer M2 with bell 2-pole operation time 120min impulse mechanical 2NO at 250V 16A permanent position yes shaft ø 6x4.6mm shaft 6x4.6mm shaft L 24mm mounting distance 28mm connection lateral		
For models:	FC05G, FC05GU, FC200EB, FC200GB, FC201EB, FC201GB, FC401EB, FC401GB, FE1-2, FE2-3, FM06EB, FM06GB, FM10EB, FM10GB, FM200EB, FM200GB, FM201EB, FM201GB, FM20EB, FM20GB, FM401EB, FM401GB, MM06EB, MM06GB, MM10EB, MM10GB, MM2/3EB, MM200EB, MM200GB, MM201EB, MM201GB, MM20EB, MM20GB, MM401GB		

alarm devices

buzzers



1

GEV No.	350050	Ref. No.	1553
description	buzzer 230VAC connection male faston 6.3mm screw mounting thread M4 60dB		
For models:	FC05G, FC05GU		



contactors

SIEMENS

power contactors



1

GEV No.	380645	Ref. No.	10004
description	power contactor 230VAC with auxiliary contacts		



1

GEV No.	381387	Ref. No.	10001
description	power contactor resistive load 22A 230VAC (AC3/400V) 4kW main contacts 3NO auxiliary contacts 1NO connection screw connection type 3RT2016-1AP01		

overload switches



1

GEV No.	381002	Ref. No.	10003
description	overload switch setting range 1.8-2.5A		

motor protection circuit breakers



1

GEV No.	382000	Ref. No.	10012
description	motor protection circuit breaker type 3RU1116-1EBO setting range 2.8-4A (AC3/400V) 1.5kW		

Зип Общепит

power contactors



1

GEV No.	381227	Ref. No.	10071
description	power contactor resistive load 25A 240VAC (AC3/400V) 14A/5.5kW main contacts 3NO auxiliary contacts 1NO connection screw connection type J7KN-14D-10		

relays

power relays

with male contacts

female contact 2.0mm

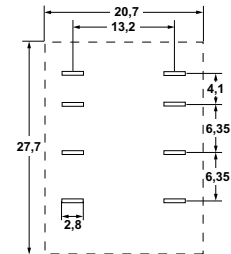

1

GEV No.	380377	Ref. No.	10507	
description	power relays FINDER 220-240VAC 10A 2CO connection F2 plug-in connection manuf. no. 55.32.8.230.0000 94.92.3 250V			
For models:	FM200EA, FM200EAP, FM200EB, FM200GA, FM200GAP, FM200GB, FM201EA, FM201EAP, FM201EB, FM201GA, FM201GAP, FM201GB, FM401EA, FM401EAP, FM401EB, FM401GA, FM401GAP, FM401GB, MM200EB, MM200GB, MM201EB, MM401GB			
accessories for	380377			
	GEV No.	380341	Ref. No.	—
	relay socket 4-pole contacts 12 300V voltage AC 6A Italiana Relè manuf. no. ZMD4			
	GEV No.	380378	Ref. No.	10509
	relay socket 2-pole 55/85 dimensions 70.5x30x27mm 250V voltage AC 10A FINDER manuf. no. 94.72			
	GEV No.	380384	Ref. No.	—
	relay socket 2-pole contacts male faston 2.8mm 250V voltage AC 10A W 23mm for			
	GEV No.	380399	Ref. No.	—
	relay socket 4-pole dimensions 76.2x27x86.1mm 250V voltage AC 1A FINDER manuf. no. 94.94.3			

electric components



relay sockets

Зип-Общепит

level relays

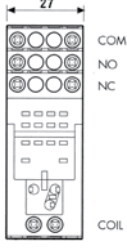

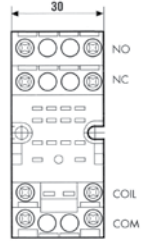

1

GEV No.	380937	Ref. No.	10505
description	relay socket 2-pole 55.32 connection male faston 2.8mm contacts 2CO dimensions 27x77mm 300V voltage AC 12A FINDER manuf. no. 94.82.3SMA		

1

GEV No.	380378	Ref. No.	10509
description	relay socket 2-pole 55/85 dimensions 70.5x30x27mm 250V voltage AC 10A FINDER manuf. no. 94.72		
For models:	FM200EA, FM200EAP, FM200EB, FM200GA, FM200GAP, FM200GB, FM201EA, FM201EAP, FM201EB, FM201GA, FM201GAP, FM201GB, FM401EA, FM401EAP, FM401EB, FM401GA, FM401GAP, FM401GB, MM200EB, MM200GB, MM201EB, MM201GB, MM401GB		
accessories for	380378		
	GEV No.	380804	Ref. No. —
	support bracket		



1

GEV No.	380638	Ref. No.	10503
description	relay socket 8-pole dimensions 51x41x23mm 250V 10A FINDER manuf. no. 90.26		
For models:	MM06EB, MM06GB, MM10EB, MM10GB, MM2/3EB, MM20EB, MM20GB		

GICAR
vsezip.ru

+7(812)987-08-81





GEV No.	401224	Ref. No.	10532
description	level relay 230V connection F6.3 type RL30/3ES/F/G		
For models:	FM200EB, FM200GB, FM201EB		

time relays

time relays



GEV No.	380329	Ref. No.	10508
description	time relay FIBER 85.02.8.240 time range 0.05s - 100h 230-240VAC 10A mounting measurements 20.6x27.7mm 2CO connection 2.0		
For models:	FM200EA, FM200EAP, FM200EB, FM200GA, FM200GAP, FM200GB, FM201EA, FM201EAP, FM201EB, FM201GA, FM201GAP, FM201GB, FM401EA, FM401EAP, FM401EB, FM401GA, FM401GAP, FM401GB, MM200EB, MM200GB, MM201EB, MM201GB, MM401GB		
accessories for	380329		
	GEV No.	380378	Ref. No. 10509
	relay socket 2-pole 55/85 dimensions 70.5x30x27mm 250V voltage AC 10A FINDER manuf. no. 94.72		
	GEV No.	380803	Ref. No. —
	relay socket 2-pole dimensions 76.2x27x86.1mm 250V voltage AC 10A FINDER manuf. no. 94.92.3		



GEV No.	380639	Ref. No.	10501
description	time relay TECNOLOGIC RTR12DS06S time range 6s 230VAC 5A mounting measurements 34x34mm 1CO connection plug-in connection round 8-pole		
For models:	MM06EB, MM06GB, MM10EB, MM10GB, MM2/3EB, MM20EB, MM20GB		
accessories for	380639		
	GEV No.	380638	Ref. No. 10503
	relay socket 8-pole dimensions 51x41x23mm 250V 10A FINDER manuf. no. 90.26		



Зип Общепит

vsezip.ru

+7(812)987-08-81



1

GEV No.	380640	Ref. No.	10502
description	time relay TECNOLOGIC RTR12DS60S time range 60s 230VAC 5A 1CO connection plug-in connection round 8-pole		
For models:	MM06EB, MM06GB, MM10EB, MM10GB, MM2/3EB, MM20EB, MM20GB		
accessories for	380640		
	GEV No.	380638	Ref. No.
			10503
	relay socket 8-pole dimensions 51x41x23mm 250V 10A FINDER manuf. no. 90.26		



1

GEV No.	379054	Ref. No.	1551
description	transformer primary 230VAC secondary 12VAC 3VA secondary 0.25A H 40mm L 45mm W 50mm connection screw 50/60Hz type 153/M		
For models:	FC06E, FC06EA, FC06EDG, FC06G, FC06GA, FC06GDG, FC06SE, FC06SEA, FC06SEDG, FC12E, FC12EA, FC12EDG, FC12G, FC12GA, FC12GDG, FC12SE, FC12SEA, FC12SEDG, FC200EB, FC200GB, FC201EB, FC201GB, FC20E, FC20EA, FC20EDG, FC20G, FC20GA, FC20GDG, FC401EB, FC401GB, FM06EB, FM06GB, FM10EB, FM10GB, FM200EB, FM200GB, FM201EB, FM201GB, FM20EB, FM20GB, FM401EB, FM401GB, FP05E, FP05EDG, FP05G, FP05GDG, FP10E, FP10EDG, FP10G, FP10GDG...(Other models you can see in the webshop)		

transformers

open transformers

with clamp terminal



1

GEV No.	401229	Ref. No.	10323 10324
description	transformer primary 230V secondary 12V 63VA		
For models:	FC200EA, FC200EAP, FC200EB, FC200GA, FC200GAP, FC200GB, FDG55, FDG55DG, MM200EA, MM200EAP, MM200EB, MM200GA, MM200GAP, MM200GB		

encapsulated transformers

PMA



1

GEV No.	379196	Ref. No.	0635
description	transformer primary 230VAC secondary 12VAC 10VA secondary 0.8A connection screw 50Hz		
For models:	FC06E, FC06EA, FC06EDG, FC06G, FC06GA, FC06GDG, FC06SE, FC06SEA, FC06SEDG, FC12E, FC12EA, FC12EDG, FC12G, FC12GA, FC12GDG, FC12SE, FC12SEA, FC12SEDG, FC20E, FC20EA, FC20EDG, FC20G, FC20GA, FC20GDG, FM200EA, FM200EAP, FM200GA, FM200GAP, FM201EA, FM201EAP, FM201GA, FM201GAP, FM401EA, FM401EAP, FM401GA, FM401GAP, FP05E, FP05EDG, FP05G, FP05GDG, FP10E, FP10EDG, FP10G, FP10GDG		

electronic controllers

EVCO - EVERY CONTROL

universal controllers

built-in version



1

GEV No.	378131	Ref. No.	1549
description	electronic controller EVERY CONTROL EVK411M mounting measurements 71x29mm 12V voltage AC/DC NTC/PTC/Pt100/Pt1000 relay outputs 1 CO-16A(8) NTC/PTC/Pt100/Pt1000/TC(J,K)/mV/mA yes protection IP65 dependent on probe°C display 3½ digits		
For models:	FC06E, FC06EA, FC06EDG, FC06G, FC06GA, FC06GDG, FC06SE, FC06SEA, FC06SEDG, FC12E, FC12EA, FC12EDG, FC12G, FC12GA, FC12GDG, FC12SE, FC12SEA, FC12SEDG, FC200EB, FC200GB, FC201EB, FC201GB, FC20E, FC20EA, FC20EDG, FC20G, FC20GA, FC20GDG, FC401EB, FC401GB, FM06EB, FM06GB, FM10EB, FM10GB, FM200EB, FM200GB, FM201EB, FM201GB, FM20EB, FM20GB, FM401EB, FM401GB, FP05E, FP05EDG, FP05G, FP05GDG, FP10E, FP10EDG, FP10G, FP10GDG...(Other models you can see in the webshop)		
accessories for	378131		
	GEV No.	379050	Ref. No.
			0634
	temperature probe Pt100 cable Vetrotex probe -200 up to +600°C cable -50 up to +350°C probe ø6x100mm cable length 2.7m without screw connection 3-wire		
	GEV No.	379160	Ref. No.
			—
	temperature probe NTC 10kOhm cable thermoplastic probe -40 up to +110°C cable -40 up to +110°C probe ø6x14mm cable length 1.5m without screw connection 2-wire		
	GEV No.	379781	Ref. No.
			—
	temperature probe PTC 1kOhm cable thermoplastic probe -50 up to +150°C cable -40 up to +110°C probe ø6x14mm cable length 1.5m without screw connection 2-wire		
	GEV No.	379944	Ref. No.
			—
	temperature probe Pt1000 cable Vetrotex probe -70 up to +500°C cable -50 up to +350°C connection 2-wire thread probe ø6x180mm cable length 1.7m		



SHANGFANG

accessories



1

GEV No.	379054	Ref. No.	1551
description	transformer primary 230VAC secondary 12VAC 3VA secondary 0.25A H 40mm L 45mm W 50mm connection screw 50/60Hz type 153/M		
For models:	FC06E, FC06EA, FC06EDG, FC06G, FC06GA, FC06GDG, FC06SE, FC06SEA, FC06SEDG, FC12E, FC12EA, FC12EDG, FC12G, FC12GA, FC12GDG, FC12SE, FC12SEA, FC12SEDG, FC200EB, FC200GB, FC201EB, FC201GB, FC20E, FC20EA, FC20EDG, FC20G, FC20GA, FC20GDG, FC401EB, FC401GB, FM06EB, FM06GB, FM10EB, FM10GB, FM200EB, FM200GB, FM201EB, FM201GB, FM20EB, FM20GB, FM401EB, FM401GB, FP05E, FP05EDG, FP05G, FP05GDG, FP10E, FP10EDG, FP10G, FP10GDG...(Other models you can see in the webshop)		

probes

universal probes

temperature probes



1

GEV No.	379050 ¹	Ref. No.	0634
description	temperature probe Pt100 cable Vetrotex probe -200 up to +600°C cable -50 up to +350°C probe ø6x100mm cable length 2.7m without screw connection 3-wire		

¹3-wire

producer-specific probes

probes



1

GEV No.	402154	Ref. No.	10411
description	temperature probe Pt100 cable silicone probe -100 up to 450°C cable -50 up to +180°C connection 3-wire thread 1/8" probe ø6x35mm cable length 1.5m		

core probes



1

GEV No.	379945	Ref. No.	10402
description	core temperature probe Pt100 cable PTFE probe -40 up to +250°C cable -40 up to +250°C connection plug probe ø3.5x100mm thread cable length 0.5m handle ø 10mm handle length 80mm		
For models:	FC06E, FC06EA, FC06EDG, FC12E, FC12EA, FC12EDG, FC12G, FC12GA, FC12GDG, FC12SE, FC12SEA, FC12SEDG, FC20E, FC20EA, FC20EDG, FC20G, FC20GA, FC20GDG, FM10EB, FM10GB, FM20EB, FM20GB, FP10E, FP10EDG, FP10G, FP10GDG, MM06EA, MM06EAP, MM06EB, MM06GA, MM06GAP, MM10EA, MM10EAP, MM10EB, MM10GA, MM10GAP, MM20EA, MM20EAP, MM20EB, MM20GA, MM20GAP, MM20GB		

Зип Общепит

vsezip.ru

+7(812)987-08-81



1

GEV No.	379946	Ref. No.	10401
description	core temperature probe Pt100 cable PTFE probe -40 up to +250°C cable -40 up to +250°C connection plug probe ø3.5x100mm thread cable length 0.7m handle ø 10mm handle length 80mm		
For models:	FC06G, FC06GA, FC06GDG, FC06SE, FC06SEA, FC06SEDG, FM06EB, FM06GB, FP05E, FP05EDG, FP05G, FP05GDG, MM2/3EA		



1

GEV No.	379947	Ref. No.	10405 10406
description	core temperature probe Pt100 cable PTFE probe -40 up to +250°C cable -40 up to +250°C connection plug probe ø3.5x100mm thread cable length 1.2m handle ø 10mm handle length 80mm		
For models:	FC200EA, FC200EAP, FC200EB, FC200GA, FC200GAP, FC200GB, FC201EA, FC201EAP, FC201EB, FC201GA, FC201GAP, FC201GB, FC401EA, FC401EAP, FC401EB, FC401GA, FC401GAP, FC401GB, FM200EA, FM200EAP, FM200EB, FM200GA, FM200GAP, FM200GB, FM201EA, FM201EAP, FM201EB, FM201GA, FM201GAP, FM201GB, FM401EA, FM401EAP, FM401EB, FM401GA, FM401GAP, FM401GB, MM200EA, MM200EAP, MM200EB, MM200GA, MM200GAP, MM200GB, MM201EA, MM201EAP, MM201EB, MM201GA, MM201GAP, MM201GB, MM401EA, MM401EAP...(Other models you can see in the webshop)		

electronics

EPROMs

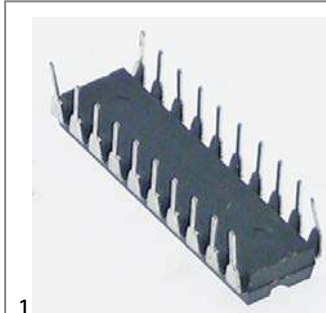

1

GEV No.	403201	Ref. No.	10547
description	EPROM type FOCABO 59		



solenoid valves

solenoid valves (water)

Зип Общепит

vsezip.ru

+7(812)987-08-81

RPE



1

GEV No.	374021	Ref. No.	1363
description	solenoid valve double straight 230VAC inlet 3/4" outlet 10mm DN10 RPE		
For models:	FC201EA, FC201EAP, FC201EB, FC201GA, FC201GAP, FC201GB, FC20E, FC20EA, FC20EDG, FC20G, FC20GA, FC20GDG, FC401EA, FC401EAP, FC401EB, FC401GA, FC401GAP, FC401GB, FM06EB, FM06EDG, FM06GB, FM06GDG, FM10EB, FM10EDG, FM10GB, FM10GDG, FM20EB, FM20EDG, FM20GB, FM20GDG, MM201EA, MM201EAP, MM201EB, MM201GA, MM201GAP, MM201GB, MM401EA, MM401EAP, MM401GA, MM401GAP, MM401GB		



GEV No.	371268	Ref. No.	0290 0295
description	reducer flow rate 0.32-0.42l/min green		
For models:	FM06GB, FM06GDG, FM10EB, FM10EDG, FM10GDG, FM20EB, FM20EDG, FM20GB, FM20GDG		

solenoid valves with reducers

4-fold



1

GEV No.	374111	Ref. No.	13003
description	solenoid valve 4-fold straight 230VAC inlet 3/4" outlet 10.5 duty cycle 100% RPE type H pressure range 0.2-10bar		



2

GEV No.	374017	Ref. No.	0282
description	solenoid valve single straight 230VAC inlet 3/4" outlet 10mm input 6l/min DN10 RPE polyamide flow regulating valve inlet white membranes NBR pressure range 0.2-10bar		
For models:	FC05E, FC05EU, FC05G, FC05GU, FC06E, FC06EA, FC06EDG, FC06G, FC06GA, FC06GDG, FC06SE, FC06SEA, FC06SEEDG, FC12E, FC12EA, FC12EDG, FC12G, FC12GA, FC12GDG, FC12SE, FC12SEA, FC12SEEDG, FC200EA, FC200EAP, FC200EB, FC200GA, FC200GAP, FC200GB, FC201EA, FC201EAP, FC201EB, FC201GA, FC201GAP, FC201GB, FC401EA, FC401EAP, FC401EB, FC401GA, FC401GAP, FC401GB, FDE10, FDE155, FDE155DG, FDE55, FDE55DG, FDG10, FDG155, FDG155DG, FDG55, FDG55DG...(Other models you can see in the webshop)		

various



1

GEV No.	371267	Ref. No.	0291
description	reducer flow rate 3l/min black		
For models:	FC20E, FC20EA, FC20EDG, FC20G, FC20GA, FC20GDG, FM06EB, FM06EDG, FM06GB, FM06GDG, FM10EB, FM10EDG, FM10GB, FM10GDG, FM200EA, FM200EAP, FM200EB, FM200GA, FM200GAP, FM200GB, FM201EA, FM201EAP, FM201EB, FM201GA, FM201GAP, FM201GB, FM20EB, FM20EDG, FM20GB, FM20GDG, FM401EA, FM401EAP, FM401EB, FM401GA, FM401GAP, FM401GB		

reducers

outlet side



1

GEV No.	371269	Ref. No.	13001
description	reducer flow rate 0.07-0.14l/min brown		
For models:	MM06EA, MM06EAP, MM06GA, MM06GAP, MM06GB, MM10EA, MM10EAP, MM10GA, MM10GAP, MM10GB, MM20EA, MM20EAP, MM20EB, MM20GA, MM20GAP, MM20GB		



1

GEV No.	371266	Ref. No.	0289
description	reducer flow rate 0.2l/min red		
For models:	FC05G, FC05GU, FC200EA, FC200EAP, FC200EB, FC200GA, FC200GAP, FC200GB, FC201EA, FC201EAP, FC201EB, FC201GA, FC201GAP, FC201GB, FC20E, FC20EA, FC20EDG, FC20G, FC20GA, FC20GDG, FC401EA, FC401EAP, FC401EB, FC401GA, FC401GAP, FC401GB, FDE10, FDE155, FDE155DG, FDE55, FDE55DG, FDG10, FDG155, FDG155DG, FDG55, FDG55DG, FM06EB, FM06EDG, FM06GB, FM06GDG, FM10EB, FM10EDG, FM10GB, FM10GDG, FM200EA, FM200EAP, FM200EB, FM200GA, FM200GAP, FM200GB...(Other models you can see in the webshop)		

metal

CEME

solenoid valves



1

GEV No.	370348	Ref. No.	11022
description	solenoid valve 2-ways 230VAC connection 1/2" L 60mm t.max. 90°C membranes NBR p max 10bar p min 0.25bar brass		

electric components



Зип.Общепит fans

vsezip.ru import

+7(812)987-08-81

ball valves electric



1

GEV No.	401233	Ref. No.	10036
description	ball valve inlet 1/2" IT outlet 1/2" IT 230V 50/60Hz mode of operation electric W 60mm H 99mm cable 4-pole 2.5W 4-pole duty cycle 50%		
For models:	FM200EA, FM200EAP, FM200EB, FM200GA, FM200GAP, FM200GB, FM201EA, FM201EAP, FM201EB, FM201GB, FM401EA, FM401EAP, FM401EB, FM401GB		

electrodes



1

GEV No.	401225	Ref. No.	3680
description	level electrode M12 ET - 1/8" ET total length 124/127/139mm probe L 91/95/104mm insulated probe length 42mm set 3-piece connection male faston 6.3mm ø 2.5mm		
For models:	FM06EB, FM06EDG		



1

GEV No.	401226	Ref. No.	3681
description	level electrode M12x1 total length 150/160/171mm probe L 117/127/138mm insulated probe length 20mm set 3-piece connection male faston 6.3mm ø 2.5mm		
For models:	FM10EB, FM10EDG, FM20EB, FM20EDG		





1

GEV No.	401228	Ref. No.	3572
description	level electrode total length 175mm connection male faston 6.3mm ø 2.5mm		
For models:	FM10GB, FM200EA, FM200EAP, FM200EB, FM200GA, FM200GAP, FM200GB, FM201EA, FM201EAP, FM201EB, FM201GA, FM201GAP, FM201GB, FM401EA, FM401EAP, FM401GA, FM401GAP, FM401GB		

axial fans



1

GEV No.	601080 ¹	Ref. No.	10724
description	axial fan L 119mm W 119mm H 38mm 230VAC 50/60Hz 23/20W bearing ball bearing connection male faston 2.8mm metal ADDA fan wheel ø 110mm temp.-resist. 70°C		
For models:	FC200EA, FC200EAP, FC200EB, FC200GA, FC200GAP, FC200GB, FC201EA, FC201EAP, FC201EB, FC201GA, FC201GAP, FC201GB, FC401EA, FC401EAP, FC401EB, FC401GA, FC401GAP, FC401GB, FM200EA, FM200EAP, FM200EB, FM200GA, FM200GAP, FM200GB, FM201EA, FM201EAP, FM201EB, FM201GA, FM201GAP, FM201GB, FM401EA, FM401EAP, FM401EB, FM401GA, FM401GAP, FM401GB, MM200EA, MM200EAP, MM200EB, MM200GA, MM200GAP, MM200GB, MM201EA, MM201EAP, MM201EB, MM201GA, MM201GAP, MM201GB, MM401EA, MM401EAP...(Other models you can see in the webshop)		
accessories for	601080		
		GEV No.	550898
		Ref. No.	—
	connecting cable cable length 2000mm connection F 2.8 connection distance 7.9mm for axial flow fan		
		GEV No.	692519
		Ref. No.	—
	guard L 120mm W 120mm plastic		

¹with ball bearings



1

GEV No.	601130 ¹	Ref. No.	10721
description	axial fan L 80mm W 80mm H 25mm 230VAC 50/60Hz 13/14W bearing ball bearing connection male faston 2.8mm metal ADDA fan wheel ø 75mm temp.-resist. 70°C airflow 30.6m³/h		
accessories for	601130		
		GEV No.	550898
		Ref. No.	—
	connecting cable cable length 2000mm connection F 2.8 connection distance 7.9mm for axial flow fan		

¹with ball bearings

Зип Общепит

vsezip.ru

+7(812)9870881



1

GEV No.	601081 ¹	Ref. No.	10720
description	axial fan L 80mm W 80mm H 38mm 230VAC 50/60Hz 14/13.5W bearing ball bearing connection male faston 2.8mm metal ADDA fan wheel ø 75mm temp.-resist. 70°C		
For models:	FC200EA, FC200EAP, FC200EB, FC200GA, FC200GAP, FC200GB, FC201EA, FC201EAP, FC201EB, FC201GA, FC201GAP, FC201GB, FC401EA, FC401EAP, FC401EB, FC401GA, FC401GAP, FC401GB, FDE10, FDE155, FDE155DG, FDE55, FDE55DG, FDG10, FDG155, FDG155DG, FDG55, FDG55DG, FM200EA, FM200EAP, FM200EB, FM200GA, FM200GAP, FM200GB, FM201EA, FM201EAP, FM201EB, FM201GA, FM201GAP, FM201GB, FM401EA, FM401EAP, FM401EB, FM401GA, FM401GAP, FM401GB, MM2/3EA, MM2/3EB, MM200EA, MM200EAP.. (Other models you can see in the webshop)		
accessories for	601081		
	GEV No.	691102	Ref. No. —
	guard ø 75mm mounting distance 71mm for axial fan 80mm		

¹with ball bearings

hot air motors



1

GEV No.	601362	Ref. No.	1720
description			
accessories for	601362		
	GEV No.	365017	Ref. No. —
	operating capacitor capacity 5µF 450V tolerance 5% 50/60Hz ambient temperature max. -25 to +85°C ø 28mm L 54mm M8 plastic connection male faston 6.3mm 16.10.08 protection		
	GEV No.	694600	Ref. No. —
	bush for hot air motors ø 25mm H 10mm seat ø 8.5mm		
	GEV No.	694601	Ref. No. —
	spring for hot air motors ø 22mm H 18mm ID ø 19mm		



GEV No.	550757	Ref. No.	0693
description	counterflange for fan motor ED ø 48mm int. ø 1 24mm int. ø 2 15mm thickness 5mm brass		



GEV No.	550859	Ref. No.	0691
description	counterflange for fan motor ED ø 60mm int. ø 1 34mm int. ø 2 25mm thickness 6mm brass		



1

GEV No.	601046	Ref. No.	0840 0840B
description	fan motor 220/380V 3 phase 50/60Hz 0.75kW 1350/1650rpm speeds 1 L1 185mm L2 42mm L3 47mm D1 ø 24mm D2 ø 20mm M12L IT 1.9/3.3A Cos(φ) 0.83 at 50Hz 200-240/346-415V at 60Hz 200-277/346-480V at 50Hz 1350rpm at 60Hz 1650rpm type ST80/4 no. 661512		



1

GEV No.	601354	Ref. No.	1100C
description	fan motor 220-240V 1 phase 50Hz 0.11kW 2760rpm speeds 1 L1 130mm L2 32mm L3 30mm L4 18mm D1 ø 7/8mm D2 ø 9mm M4R IT 0.9A at 50Hz 230V at 50Hz 2760rpm suitable capacitor 4µF type LM63 shaft flat length 17mm		
accessories for	601354		
	GEV No.	365031	Ref. No. 1103
	operating capacitor capacity 4µF 450V tolerance 5% 50/60Hz ambient temperature max. -25 to +85°C ø 31mm L 58mm M8 plastic connection male faston 6.3mm protection		
	GEV No.	601061	Ref. No. —
	fan wheel D1 ø 160mm H1 60mm blades 15 D2 ø 18mm D3 ø 18mm H2 35mm		

Зип Общепит

vsezip.ru

+7(812)987-08-81



1

GEV No.	601043	Ref. No.	0764
description	fan motor 220-240V 1 phase 50Hz 0.37/0.07kW 0.1/0.5HP 1400/2700rpm speeds 2 L1 123mm L2 107mm L3 15mm D1 ø 15mm D2 ø 12mm M10L ET 2/0.7A suitable capacitor 20µF/250V at 50Hz 1400/2700rpm type 1057		
For models:	FC06G, FC06GA, FC06GDG, FC06SE, FC06SEA, FC06SEDG, FM06EB, FM06EDG, FM06GB, FM06GDB, FP05E, FP05EDG, FP05G, FP05GDB, MM06EA, MM06EAP, MM06EB, MM06GA, MM06GAP, MM06GB		
accessories for	601043		
	GEV No.	365019	Ref. No. 0775
	operating capacitor capacity 20µF 400V tolerance 5% 50/60Hz ambient temperature max. -25 to +85°C ø 39.5mm L 70mm M8 plastic connection male faston 6.3mm 16.10.25. protection		



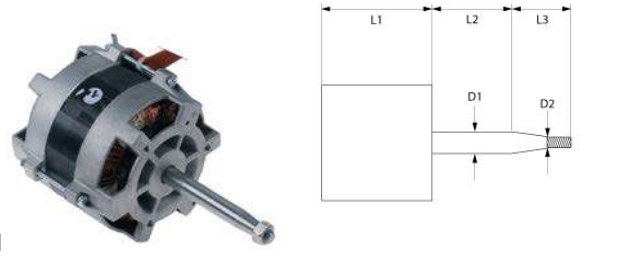

1

GEV No.	601067	Ref. No.	15007
description	fan wheel D1 ø 150mm H1 38mm blades 36 D2 ø 6mm D3 ø 6mm H2 14mm		
For models:	MM2/3EA, MM2/3EB		



1

GEV No.	601166	Ref. No.	10705
description	fan motor 220-240V 1 phase 50Hz 0.37kW 2700rpm speeds 1 L1 123mm L2 77mm L3 30mm D1 ø 15mm D2 ø 12mm M10L ET 2A suitable capacitor 12.5µF/450V at 50Hz 2700rpm type 1057.2157		
For models:	FC05G, FC05GU		
spare parts for	601166		
	GEV No.	365014	Ref. No. 0932
	operating capacitor capacity 12.5µF 450V tolerance 5%Hz ambient temperature max. -25 to +85°C ø 35mm L 70mm M8 plastic connection male faston 6.3mm 45S.C3DS.12.5 protection		
accessories for	601166		
	GEV No.	601165	Ref. No. 1118
	fan wheel D1 ø 160mm H1 60mm blades 15 D2 ø 16mm D3 ø 16mm H2 29mm		



1

GEV No.	601165	Ref. No.	1118
description	fan wheel D1 ø 160mm H1 60mm blades 15 D2 ø 16mm D3 ø 16mm H2 29mm		
For models:	FC05G, FC05GU		



1

GEV No.	514507	Ref. No.	1104
description	fan wheel blades 15 D1 ø 160mm D2 ø 11mm D3 ø 16mm H1 60mm H2 18mm		



1

GEV No.	601060	Ref. No.	0758
description	fan wheel D1 ø 180mm H1 60mm blades 16 D2 ø 11mm D3 ø 16mm H2 30mm		
For models:	FC06G, FC06GA, FC06GDG, FC06SE, FC06SEA, FC06SEDG, FM06EB, FM06EDG, FM06GB, FM06GDB, FP05E, FP05EDG, FP05G, FP05GDB, MM06EA, MM06EAP, MM06EB, MM06GA, MM06GAP, MM06GB		



1

GEV No.	601872	Ref. No.	15093
description	fan wheel D1 ø 200mm H1 43mm blades 45 D2 ø 8.3mm D3 ø 8.3mm H2 25mm		

Зип Общепит

vsezip.ru

+7(812)987-08-81

 <p>1</p>			
GEV No.	601064	Ref. No.	15016
description	fan wheel D1 \varnothing 220mm H1 78mm blades 20 D2 \varnothing 11.5mm D3 \varnothing 16.5mm H2 30mm		

 <p>1</p>			
GEV No.	601224	Ref. No.	3196
description	fan wheel D1 \varnothing 300mm H1 100mm blades 24 D2 \varnothing 19.5mm D3 \varnothing 23mm H2 46mm		
For models:	FC201EA, FC201EAP, FC201EB, FC201GA, FC201GAP, FC201GB, FM10EB, FM10EDG, FM10GB, FM10GDG, FM201EA, FM201EAP, FM201EB, FM201GA, FM201GAP, FM201GB, MM10EA, MM10EAP, MM10EB, MM10GA, MM10GAP, MM10GB, MM201EA, MM201EAP, MM201EB, MM201GA, MM201GAP, MM201GB		

 <p>1</p>			
GEV No.	601063	Ref. No.	0759
description	fan wheel D1 \varnothing 350mm H1 100mm blades 24 D2 \varnothing 19.5mm D3 \varnothing 23mm H2 46mm		
For models:	FC12G, FC12GA, FC12GDG, FC12SE, FC12SEA, FC12SEDG, FC200EA, FC200EAP, FC200EB, FC200GA, FC200GAP, FC200GB, FC20E, FC20EA, FC20EDG, FC20G, FC20GA, FC20GDG, FC401EA, FC401EAP, FC401EB, FC401GA, FC401GAP, FC401GB, FM200EA, FM200EAP, FM200EB, FM200GA, FM200GAP, FM200GB, FM20EB, FM20EDG, FM20GB, FM20GDG, FM401EA, FM401EAP, FM401EB, FM401GA, FM401GAP, FM401GB, FP10E, FP10EDG, FP10G, FP10GDG, MM200EA, MM200EAP, MM200EB, MM200GA, MM200GAP, MM200GB...(Other models you can see in the webshop)		

 <p>1</p>			
GEV No.	691810	Ref. No.	0692
description	flange for fan motor ED \varnothing 48mm int. \varnothing 1 19.5mm int. \varnothing 2 15mm thickness 3.5mm brass		

 <p>1</p>			
GEV No.	550858	Ref. No.	0690
description	flange for fan motor ED \varnothing 60mm int. \varnothing 1 28.5mm int. \varnothing 2 25mm thickness 4mm brass		

 <p>1</p>			
GEV No.	550853	Ref. No.	0688
description	gasket for fan motor ID \varnothing 24mm ED \varnothing 29mm thickness 3mm		
For models:	FC200EA, FC200EAP, FC200EB, FC200GA, FC200GAP, FC200GB, FC201EA, FC201EAP, FC201EB, FC201GA, FC201GAP, FC201GB, FC401EA, FC401EAP, FC401EB, FC401GA, FC401GAP, FC401GB, FDE10, FDE15S, FDE15SDG, FDE55, FDE55DG, FDG10, FDG15S, FDG15SDG, FDG55, FDG55DG, FM200EA, FM200EAP, FM200EB, FM200GA, FM200GAP, FM200GB, FM201EA, FM201EAP, FM201EB, FM201GA, FM201GAP, FM201GB, FM401EA, FM401EAP, FM401EB, FM401GA, FM401GAP, FM401GB, MM200EA, MM200EAP, MM200EB, MM200GA...(Other models you can see in the webshop)		

 <p>1</p>			
GEV No.	511171	Ref. No.	0689
description	shaft seal ID \varnothing 14.5mm ED \varnothing 20mm thickness 3mm		

Зип.Общепит.

condensators & interference sup-
pression filters

vsezip.ru

operating capacitors

+7(812)987-08-81

hot air fans

miscellaneous



1

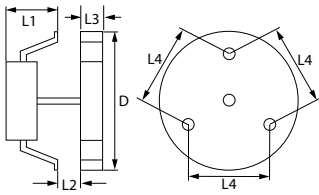

GEV No.	601125	Ref. No.	0016 0016A 10731
description	hot air fan 220-240V 45W 50/60Hz L1 70mm L2 11mm L3 25mm L4 87mm fan wheel ø 150mm FIME type C30R0479CLF		
For models:	FC06E, FC06EA, FC06EDG, FC12E, FC12EA, FC12EDG, FE1-2, FE2-3		
accessories for	601125		
	GEV No.	550879	Ref. No. —
	insulation ø 130mm thickness 3mm hole ø 18mm for hot air fan		

plastic



1

GEV No.	365014	Ref. No.	0932
description	operating capacitor capacity 12.5µF 450V tolerance 5%Hz ambient temperature max. -25 to +85°C ø 35mm L 70mm M8 plastic connection male faston 6.3mm 45S.C3DS.12.5 protection		



1

GEV No.	365019	Ref. No.	0775
description	operating capacitor capacity 20µF 400V tolerance 5% 50/60Hz ambient temperature max. -25 to +85°C ø 39.5mm L 70mm M8 plastic connection male faston 6.3mm 16.10.25. protection		



1

GEV No.	365031	Ref. No.	1103
description	operating capacitor capacity 4µF 450V tolerance 5% 50/60Hz ambient temperature max. -25 to +85°C ø 31mm L 58mm M8 plastic connection male faston 6.3mm protection		

pumps

drain pumps

ASKOLL



1

GEV No.	500565	Ref. No.	3363
description	drain pump 30W		

electric accessories

cables

ribbon cables

group 1



1

GEV No.	400228	Ref. No.	70528
description	ribbon cable 16-pole L 600mm plug type FC-16P raster size 2.54mm		

terminals

porcelain clamps



1

GEV No.	550112	Ref. No.	10360
description	porcelain terminal block 2-pole 2.5mm ² max. 10A max 250V t.max. 200°C L 22mm W 17mm H 15mm mounting distancemm Qty 1 pcs		



Зип-Общепит

vsezip.ru

+7(812)987-08-81

various



1

GEV No.	693955	Ref. No.	10220
description	terminal grounding cable		
For models:	FC05G, FC05GU		

gas valves and ignition boxes

gas control valves

HONEYWELL



1

GEV No.	101186	Ref. No.	11017	
description	gas valve type VK4105C 220-240V 50/60Hz gas inlet flange 32x32mm gas outlet flange 32x32mm thermocouple connection pilot connection pressure range 15-60mbar max 60mbar operator type pressure controller type V5360E 1226 1 HONEYWELL hole distance 24mm flange 32x32mm			
accessories for	101186			
	GEV No.	102845	Ref. No.	—
	gas connection angled 1/2" flange 32x32mm hole distance 24x24mm Tandem			
	GEV No.	102846	Ref. No.	—
	gas connection straight 1/2" flange 32x32mm hole distance 24x24mm suitable for Tandem			

ELETTROSIT



1

GEV No.	101127	Ref. No.	0766	
description	gas valve SIT type ELETTROSIT 230V gas inlet 3/4" gas outlet 3/4" thermocouple connection M9x1 pilot connection M10x1 lateral equiv. no. 0.810.175			
For models:	FC06G, FC06GA, FC06GDG, FC12G, FC12GA, FC12GDG, FC20G, FC20GA, FC20GDG, FP05G, FP05GDG, FP10G, FP10GDG			
spare parts for	101127			
	GEV No.	101312	Ref. No.	1119
	microswitch			
	GEV No.	101352	Ref. No.	—
	solenoid coil 230V 50Hz suitable for ELETTROSIT			
accessories for	101127			
	GEV No.	100006	Ref. No.	—
	piezoelectric igniter suitable for ELETTROSIT body plastic blowing connection ø2.4mm ø 14mm			
	GEV No.	100904	Ref. No.	—
	locking screw M10x1 for pipe ø 4mm Qty 1 pcs			
	GEV No.	100905	Ref. No.	0830
	locking screw M10x1 for pipe ø 6mm Qty 1 pcs			
	GEV No.	101301	Ref. No.	—
	gas connection thread 1/2" straight ELETTROSIT screw with O-ring			
	GEV No.	101303	Ref. No.	—
	gas connection straight thread 3/4" ELETTROSIT			
	GEV No.	101309	Ref. No.	—
	extension			













Зип-Общепит

NOVASIT



1

GEV No.	101162	Ref. No.	3015
description	gas valve SIT series Novasit 820 230V 50Hz gas inlet 1/2" gas outlet 1/2" thermocouple connection M9x1 pilot connection M10x1 ignition pressure 3-5mbar pressure range 3-30mbar pressure regulator connection blind equiv. no. 0.820.010		
For models:	FM20GB, FM20GDG, MM20GA, MM20GAP, MM20GB		
spare parts for	101162		
	GEV No.	101065	Ref. No. —
	magnet unit with cable L 44mm D1 ø 30mm D2 ø 20mm suitable for NOVASIT		
	GEV No.	101313	Ref. No. —
	solenoid coil 230V 50Hz		
accessories for	101162		
	GEV No.	100006	Ref. No. —
	piezoelectric igniter suitable for ELETTROSIT body plastic blowing connection ø2.4mm ø 14mm		
	GEV No.	101305	Ref. No. —
	gas connection straight 1/2" flange 45x45mm ELETTROSIT/V4400/4600/4605 suitable for SIT/HONEYWELL hole distance 36x36mm		
	GEV No.	101306	Ref. No. —
	gas connection angled flange 45x45mm hole distance 36x36mm 1/2" ELETTROSIT/V4400/4600/4605 screw with O-ring suitable for SIT/HONEYWELL		
	GEV No.	101307	Ref. No. —
	gas connection straight flange 45x45mm hole distance 36x36mm 3/4" ELETTROSIT/V4400/4600/4605 screw with O-ring suitable for SIT/HONEYWELL		
	GEV No.	101308	Ref. No. —
	gas connection angled flange 45x45mm hole distance 36x36mm 3/4" ELETTROSIT/V4400/4600/4605 screw with O-ring suitable for SIT/HONEYWELL		
	GEV No.	101312	Ref. No. 1119
	microswitch		
	GEV No.	101314	Ref. No. —
	solenoid coil 24V 50Hz		
	GEV No.	101317	Ref. No. —
	plug with cable L 1000mm suitable for NOVASIT		
	GEV No.	101318	Ref. No. —
	cover cap for solenoid coil suitable for NOVASIT		

accessories

vsezip.ru

+7(812)987-08-81

1

GEV No.	100105	Ref. No.	0830
description	locking screw M10x1 for pipe ø 6mm Qty 1 pcs		



1

GEV No.	101312	Ref. No.	1119
description	microswitch		

SIGMA



1

GEV No.	107498	Ref. No.	11009
description	gas valve type Sigma 230V 50Hz gas inlet 1/2" gas outlet 1/2" pressure range 2-50mbar		
spare parts for	107498		
	GEV No.	106214	Ref. No. —
	solenoid coil 230V 50Hz Sigma		
accessories for	107498		
	GEV No.	107222	Ref. No. —
	plug for solenoid valve 3-pole cable length 1070mm		



Зип Общепит

honeywell

vsezip.ru

+7(812)987-08-81

TANDEM



1

GEV No.	101984	Ref. No.	11002
description	gas valve 230V 50Hz gas inlet 1/2" gas outlet 1/2" pilot connection level slow ignition ignition times pressure range 2-50mbar power supply for modulator 230VAC rectified Tandem equiv. no. 0.836.010		
For models:	FC200GA, FC200GAP, FC200GB, FC201GA, FC201GAP, FC201GB, FC401GA, FC401GAP, FC401GB, FDG10, FDG155, FDG155DG, FDG55, FDG55DG, FM06GB, FM06GDG, FM10GB, FM10GDG, FM200GA, FM200GAP, FM200GB, FM201GA, FM201GAP, FM201GB, FM401GA, FM401GAP, FM401GB, MM06GA, MM06GAP, MM06GB, MM10GA, MM10GAP, MM10GB, MM200GA, MM200GAP, MM200GB, MM201GA, MM201GAP, MM201GB, MM401GA, MM401GAP, MM401GB		
accessories for	101984		
	GEV No.	101274	Ref. No. —
	olive for pipe ø 16mm Qty 1 pcs		
	GEV No.	101275	Ref. No. —
	union screw thread 1/2" for pipe ø 16mm Qty 1 pcs		
	GEV No.	101925	Ref. No. —
	plug with O-ring thread M10x1 for pilot burner suitable for NOVASIT		
	GEV No.	102845	Ref. No. —
	gas connection angled 1/2" flange 32x32mm hole distance 24x24mm Tandem		
	GEV No.	102846	Ref. No. —
	gas connection straight 1/2" flange 32x32mm hole distance 24x24mm suitable for Tandem		
	GEV No.	102847	Ref. No. —
	O-ring		



1

GEV No.	102367	Ref. No.	11016
description	ignition box HONEYWELL type S4565A 2092 1 electrodes 3 waiting times safety time 10s 220-240V 4VA 50/60Hz		
For models:	FC05G, FC05GU		

SIT



1

GEV No.	102309	Ref. No.	11010
description	ignition box SIT type 537ABC electrodes 3 waiting time 1.5s safety time 10s 230V 10VA 50-60Hz protection IP44		

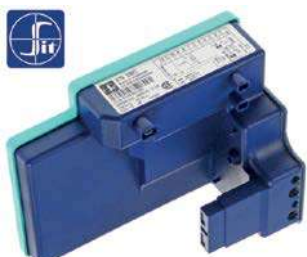

1

GEV No.	107497	Ref. No.	11147
description	ignition box SIT type 579DBC electrodes 1 waiting time 1s safety time 5s 220/240V 12VA 50/60Hz		

ignition boxes

HONEYWELL





1

GEV No.	101165	Ref. No.	11003 11020
description	ignition box HONEYWELL type S4560A 1008 equiv. no. S4560A 1008 electrodes 1 waiting time 0s safety time 10s 220-240V 10VA 50Hz		
spare parts for	101165		
	GEV No.	358696	Ref. No. —
	fine fuse size ø5x20mm 4A medium lag rated 250V Qty 10 pcs		

2 gas components

Зип-Общепит

accessories for 106906

GEV No.	107171	Ref. No.	—
			
pilot burner nozzle SIT natural/liquid gas bore \varnothing 0.25mm Qty 1 pcs			
GEV No.	107700	Ref. No.	—
			
pilot burner bottom part SIT 100 series nozzle \varnothing 0.25mm			
GEV No.	107702	Ref. No.	—
			
pilot burner bottom part SIT 100 series nozzle \varnothing 0.35mm			

accessories

ignition electrodes

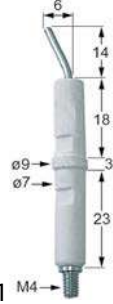
			
GEV No.	100706	Ref. No.	0832
description ignition electrode connection M4 Qty 1 pcs			
For models: FC06G, FC06GA, FC06GDG, FC12G, FC12GA, FC12GDG, FC20G, FC20GA, FC20GDG, FM06GB, FM20GB, FM20GDG, FP05G, FP05GDG, FP10G, FP10GDG, MM20GB			

electrodes















			
GEV No.	100706	Ref. No.	0832
description ignition electrode connection M4 Qty 1 pcs			
For models: FC06G, FC06GA, FC06GDG, FC12G, FC12GA, FC12GDG, FC20G, FC20GA, FC20GDG, FM06GB, FM20GB, FM20GDG, FP05G, FP05GDG, FP10G, FP10GDG, MM20GB			

ignition parts

pilot burners

SIT

100 series

			
1			
GEV No.	106906	Ref. No.	0836
description pilot burner SIT type 100 series 3 flames nozzle \varnothing 0.2mm gas connection 6mm			
For models: FC06G, FC06GA, FC06GDG, FC12G, FC12GA, FC12GDG, FC20G, FC20GA, FC20GDG, FM06GB, FM20GB, FP05G, FP05GDG, FP10G, FP10GDG, MM20GB			
spare parts for 106906			
GEV No.	100245	Ref. No.	—
 pilot burner nozzle LPG code 20 bore \varnothing 0.2mm Qty 1 pcs thread M8x0.75			
GEV No.	100855	Ref. No.	—
 pilot burner bracket triple			
GEV No.	100885	Ref. No.	—
 air mixing sleeve for pilot burner Qty 1 pcs			
GEV No.	100916	Ref. No.	—
 compression spring for pilot burner Qty 1 pcs			
GEV No.	100917	Ref. No.	—
 gasket for pilot burner Qty 1 pcs aluminium ID \varnothing 8.5mm ED \varnothing 11mm thickness 1.2mm			
GEV No.	100918	Ref. No.	—
 screw for pilot burner			
GEV No.	107162	Ref. No.	—
 pilot burner cap SIT 3 flames Hmm Lmm Qty 1 pcs			
accessories for 106906			
GEV No.	100245	Ref. No.	—
 pilot burner nozzle LPG code 20 bore \varnothing 0.2mm Qty 1 pcs thread M8x0.75			
GEV No.	100246	Ref. No.	—
 pilot burner nozzle natural gas bore \varnothing 0.35mm Qty 1 pcs thread M8x0.75			
GEV No.	100904	Ref. No.	—
 locking screw M10x1 for pipe \varnothing 4mm Qty 1 pcs			
GEV No.	100905	Ref. No.	0830
 locking screw M10x1 for pipe \varnothing 6mm Qty 1 pcs			
GEV No.	102110	Ref. No.	—
 pilot tube copper pipe \varnothing 4mm thickness 1mm L 3000mm			
GEV No.	102111	Ref. No.	—
 pilot tube copper pipe \varnothing 6mm thickness 1mm L 3000mm			



Зип-Общепит
thermocouples

vsezip.ru

+7(812)987-08-81

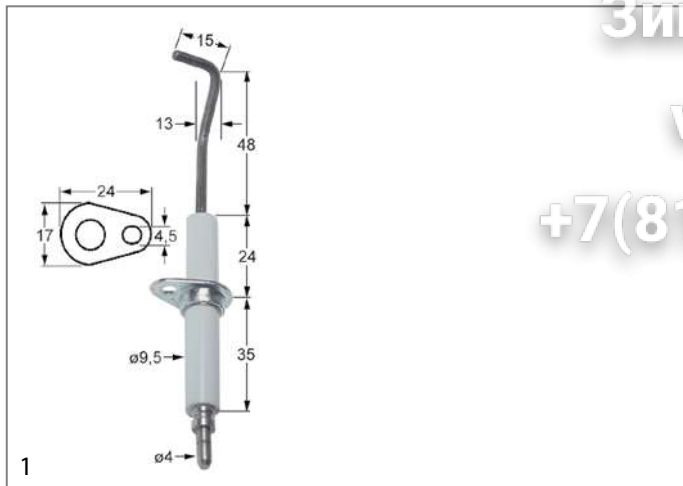

GEV No.	102342	Ref. No.	11001 11007
description	ignition electrode flange length 24mm flange width 17mm D1 ø 9.5mm L1 48mm L2 13mm L3 15mm BL1 24mm BL2 35mm fixing dimensions ø4.5mm with flange connection ø 4mm		
For models:	FC05G, FC05GU, FC200GA, FC200GAP, FC200GB, FC201GA, FC201GAP, FC201GB, FC401GA, FC401GAP, FC401GB, FDG10, FDG155, FDG155DG, FDG55, FDG55DG, FM06GDG, FM10GB, FM10GDG, FM200GA, FM200GAP, FM200GB, FM201GA, FM201GAP, FM201GB, FM401GA, FM401GAP, FM401GB, MM06GA, MM06GAP, MM06GB, MM10GA, MM10GAP, MM10GB, MM200GA, MM200GAP, MM200GB, MM201GA, MM201GAP, MM201GB, MM20GA, MM20GAP, MM401GB		

ignition cables

pre-assembled cables

GEV No.	100026	Ref. No.	3958
description	ignition cable cable length 1000mm connection ø4mm / F6.3mm		

GEV No.	102155	Ref. No.	3973
description	ignition cable cable length 900mm connection ø4mm / F2.8mm		
For models:	FM10GB, MM06GA, MM06GAP, MM06GB, MM10GA, MM10GAP, MM10GB, MM20GA, MM20GAP		

ignition units

GEV No.	101002	Ref. No.	0825
description	ignition unit outputs 2 230VAC dimensions 88x23x34mm mounting distance 73mm inlet F6.3x0.8 outlet F2.8x0.8 0.6VA 50/60Hz		
For models:	FC06G, FC06GA, FC06GDG, FC12G, FC12GA, FC12GDG, FC20G, FC20GA, FC20GDG, FM06GB, FM20GB, FM20GDG, FP05G, FP05GDG, FP10G, FP10GDG		

plug-in thermocouples

plug-in thermocouples standard

with barrel socket ø6(6.5)mm

thermocouples SIT

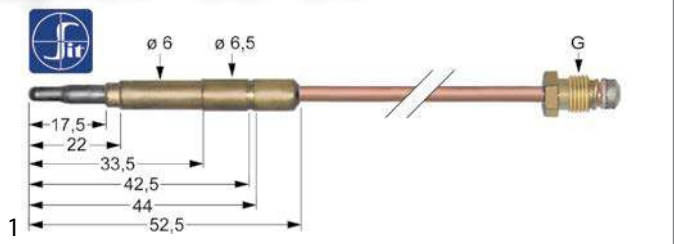

GEV No.	107612	Ref. No.	1668
description	thermocouple SIT M9x1 L 1000mm plug connection ø6.0(6.5)mm		
For models:	FC06G, FC06GA, FC06GDG, FC12G, FC12GA, FC12GDG, FC20G, FC20GA, FC20GDG, FM06GB, FP05G, FP05GDG, FP10G, FP10GDG		

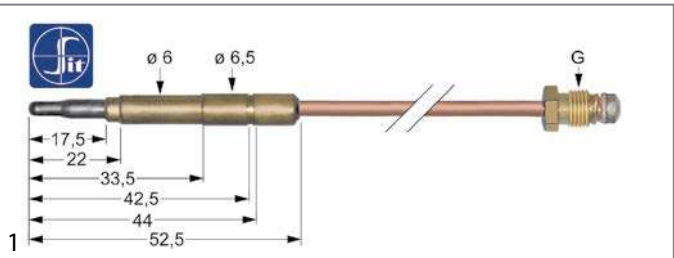

GEV No.	107614	Ref. No.	1556
description	thermocouple SIT M9x1 L 1500mm plug connection ø6.0(6.5)mm		

plug-in thermocouples with interruption

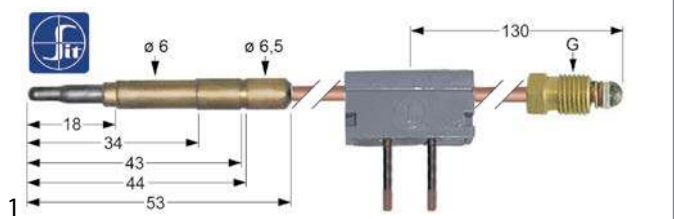

GEV No.	107164	Ref. No.	0831
description	thermocouple SIT with interrupter M9x1 L 1000mm plug connection ø6.0(6.5)mm soldering connection		

gas burners

bar burners

bar burners



GEV No.	105788	Ref. No.	0767A
description	bar burner 1-row ø 50mm Wmm Hmm L 483mm flange width 71mm convection oven flange ø 75mm		

gas components



3ип Общепит
screw connections

olives

vsezip.ru

+7(812)987-08-81

1			
GEV No.	105790	Ref. No.	3131
description	bar burner ø 50mm Wmm Hmm L 325mm flange width 57mm flange length 57mm convection oven		
For models:	FM06GB, FM06GDG, FM10GB, FM10GDG, FM200GA, FM200GAP, FM200GB, FM201GA, FM201GAP, FM201GB, FM20GB, FM20GDG		

1					
GEV No.	101256	Ref. No.	0665		
description	olive for pipe ø 16mm Qty 1 pcs				
For models:	FC05G, FC05GU				
accessories for	101256				
		GEV No.	101253	Ref. No.	—
	union nut thread M24x1.5 PEL for pipe ø 16mm				

1			
GEV No.	105791	Ref. No.	11031 11032
description	bar burner ø 50mm Wmm Hmm L 375mm flange width 57mm flange length 57mm convection oven		
For models:	FM401GA, FM401GAP, FM401GB		

union screws					
1					
GEV No.	100905	Ref. No.	0830		
description	locking screw M10x1 for pipe ø 6mm Qty 1 pcs				

1			
GEV No.	105789	Ref. No.	11030 1361
description	bar burner ø 50mm Wmm Hmm L 618mm flange width 71mm convection oven flange ø 75mm		
For models:	FC200GA, FC200GAP, FC200GB, FC201GA, FC201GAP, FC201GB, FC20G, FC20GA, FC20GDG, FC401GA, FC401GAP, FC401GB, FM200GA, FM200GAP, FM200GB, FM201GA, FM201GAP, FM201GB, FM20GDG, FM401GA, FM401GAP, FM401GB, MM200GB, MM201GA, MM201GAP, MM201GB, MM20GA, MM20GAP, MM20GB, MM401GA, MM401GAP, MM401GB		

equipmentspecific units
for convection ovens/combi-steamers

glass panels					
1					
GEV No.	694355	Ref. No.	15146		
description	glass panel L 745mm W 355mm thickness 4mm				

gas nozzles

main nozzles

gas nozzles M10x1

1			
GEV No.	106287	Ref. No.	2142
description	gas injector thread M10x1 WS 11 bore ø 2.2mm inner peaked		



knobs

producer-specific knobs

FOINOX



1

GEV No.	111410	Ref. No.	15075
description	knob zero mark ø 50mm shaft ø 6x4.6mm shaft flat upper black		

handles and hand wheels

mushroom cap handles



1

GEV No.	111411	Ref. No.	0382
description	mushroom cap handle thread M6 handle ø 26mm ø 17mm L 17mm plastic black matt		
For models:	FC05G, FC05GU		

locks

handle latches



universal

outside fixing



locks



1

GEV No.	694065	Ref. No.	90199
description	door handle for headed units L 145mm W 40mm H 62mm spring length 33mm outer black		
spare parts for	694065		
	GEV No.	514390	Ref. No.
			15057
	spring for door handle ø 6mm L 54mm W 27.5mm		
	GEV No.	694734	Ref. No.
			—
	door handle L 165mm W 40mm H 25mm black		
	GEV No.	694735	Ref. No.
			—
	cap ø 32mm black		

Зип-Общепит

accessories for	694065		
	GEV No.	694066	Ref. No.
			3772
	door catch with spigot 2-stage L 28mm W 14mm H 15mm H1 16mm total length 51mm thread M8 thread L 23mm stainless steel		
	GEV No.	694067	Ref. No.
			—
	door catch with spigot 1-stage L 26mm total length 51mm thread M8		

producer-specific

HIOS/FOINOX



1





GEV No.	694066	Ref. No.	3772
description	door catch with spigot 2-stage L 28mm W 14mm H 15mm H1 16mm total length 51mm thread M8 thread L 23mm stainless steel		



1

GEV No.	694065	Ref. No.	90199
description	door handle for headed units L 145mm W 40mm H 62mm spring length 33mm outer black		

spare parts for 694065

	GEV No.	514390	Ref. No.
			15057
	spring for door handle ø 6mm L 54mm W 27.5mm		
	GEV No.	694734	Ref. No.
			—
	door handle L 165mm W 40mm H 25mm black		
	GEV No.	694735	Ref. No.
			—
	cap ø 32mm black		
accessories for	694065		
	GEV No.	694066	Ref. No.
			3772
	door catch with spigot 2-stage L 28mm W 14mm H 15mm H1 16mm total length 51mm thread M8 thread L 23mm stainless steel		
	GEV No.	694067	Ref. No.
			—
	door catch with spigot 1-stage L 26mm total length 51mm thread M8		



1

GEV No.	514390	Ref. No.	15057
description	spring for door handle ø 6mm L 54mm W 27.5mm		

edgemoat latches

handle latches

CAFF/FERMOD

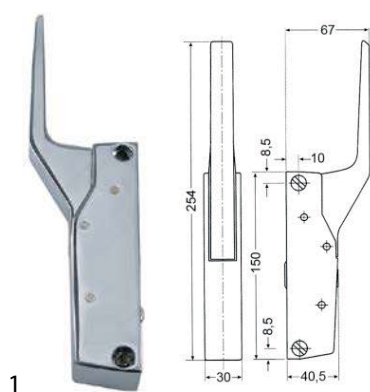

GEV No.	700060	Ref. No.	1496
description	handle latch L 150mm mounting distance 133mm non lockable heated units G 791		
accessories for	700060		
	GEV No.	700061	Ref. No. 1500
	door catch L 58mm W 20mm H 35mm mounting distance 42mm chrome-plated brass for headed units		
	GEV No.	700062	Ref. No. —
	handle protection heated units		

door catches



GEV No.	700061	Ref. No.	1500
description	door catch L 58mm W 20mm H 35mm mounting distance 42mm chrome-plated brass for headed units		
For models:	FC06E, FC06EA, FC06EDG, FC06G, FC06GA, FC06GDG, FC06SE, FC06SEA, FC06SEDG, FC12E, FC12EA, FC12EDG, FC12G, FC12GA, FC12GDG, FC12SE, FC12SEA, FC12SEDG, FC20E, FC20EA, FC20EDG, FC20G, FC20GA, FC20GDG, FM06EB, FM06EDG, FM06GB, FM06GDG, FM10EB, FM10EDG, FM10GDG, FM20EB, FM20EDG, FM20GB, FM20GDG, FP05E, FP05EDG, FP05G, FP05GDG, FP10E, FP10EDG, FP10G, FP10GDG		
accessories for	700061		
	GEV No.	690414	Ref. No. —
	handle latch L 150mm mounting distance 133mm non lockable refrigeration units G 791		

3in1 Общепит

snap locks

universal vsezip.ru

+7(812)987-08-81



GEV No.	690864	Ref. No.	0285
description	door catch L 38mm W 13mm H 21mm mounting distance 28mm zamak with spigot		
For models:	FC05E, FC05EU, FC05G, FC05GU		



GEV No.	690596	Ref. No.	0285+0285B
description	snap lock L 60mm W 15mm H 36mm mounting distance 48/28mm spring thickness 1.5mm complete with door catch zamak		



GEV No.	690863	Ref. No.	0285B
description	snap lock L 60mm W 16mm mounting distance 48mm spring thickness 1.5mm without door catch zamak		



GEV No.	690903	Ref. No.	0117B
description	snap lock L 69mm W 13mm H 20mm mounting distance 57mm complete with door catch nickel-plated brass		
For models:	FE1-2, FE2-3		

espagnolette locks

producer-specific

HIOS/FOINOX



GEV No.	514317	Ref. No.	3754
description	disc ID ø 11mm ED ø 17mm H 3mm brass		
For models:	FC06E, FC06EA, FC06EDG, FC06G, FC06GA, FC06GDG, FC06SE, FC06SEA, FC06SEDG, FC12E, FC12EA, FC12EDG, FC12G, FC12GA, FC12GDG, FC12SE, FC12SEA, FC12SEDG, FC200EA, FC200EAP, FC200EB, FC200GA, FC200GAP, FC200GB, FC201EA, FC201EAP, FC201EB, FC201GA, FC201GAP, FC201GB, FC20E, FC20EA, FC20EDG, FC20G, FC20GA, FC20GDG, FC401EA, FC401EAP, FC401EB, FC401GA, FC401GAP, FC401GB, FDE10, FDE155, FDE155DG, FDE55, FDE55DG, FDG10, FDG155, FDG155DG...(Other models you can see in the webshop)		



Зип-Общепит

vsezip.ru

+7(812)987-08-81

1			
GEV No.	514321	Ref. No.	3738.1
description	door catch with roller L 35mm W 26mm H 32mm mounting distance 20mm rollerø 10mm		
For models:	FC06E, FC06EA, FC06EDG, FC06G, FC06GA, FC06GDG, FC06SE, FC06SEA, FC06SEDG, FC12E, FC12EA, FC12EDG, FC12G, FC12GA, FC12GDG, FC12SE, FC12SEA, FC12SEDG, FC200EA, FC200EAP, FC200EB, FC200GA, FC200GAP, FC200GB, FC201EA, FC201EAP, FC201EB, FC201GA, FC201GAP, FC201GB, FC20E, FC20EA, FC20EDG, FC20G, FC20GA, FC20GDG, FC401EA, FC401EAP, FC401EB, FC401GA, FC401GAP, FC401GB, FDE10, FDE155, FDE155DG, FDE55, FDE55DG, FDG10, FDG155, FDG155DG...(Other models you can see in the webshop)		

1			
GEV No.	690827	Ref. No.	3775
description	latch block L 40mm brass hole ø 20mm dimensions 30x30mm		

1			
GEV No.	690862	Ref. No.	3747
description	latch gear opening to the right shaft intake ø 8x8mm L 170mm W 40mm H 29mm		
For models:	FC06E, FC06EA, FC06EDG, FC06G, FC06GA, FC06GDG, FC06SE, FC06SEA, FC06SEDG, FC12E, FC12EA, FC12EDG, FC12G, FC12GA, FC12GDG, FC12SE, FC12SEA, FC12SEDG, FC200EA, FC200EAP, FC200EB, FC200GA, FC200GAP, FC200GB, FC201EA, FC201EAP, FC201EB, FC201GA, FC201GAP, FC201GB, FC20E, FC20EA, FC20EDG, FC401EA, FC401EAP, FC401EB, FC401GA, FC401GAP, FC401GB, FDE10, FDE155, FDE155DG, FDE55, FDE55DG, FDG10, FDG155, FDG155DG, FDG55, FDG55DG, FM06EB...(Other models you can see in the webshop)		

accessories for	690862			
	GEV No.	514317	Ref. No.	3754
description	disc ID ø 11mm ED ø 17mm H 3mm brass			
	GEV No.	514321	Ref. No.	3738.1
description	door catch with roller L 35mm W 26mm H 32mm mounting distance 20mm rollerø 10mm			
	GEV No.	690826	Ref. No.	3910
description	striker bolt L1 60mm L2 64mm D1 ø 20mm D2 ø 10mm			
	GEV No.	690827	Ref. No.	3775
description	latch block L 40mm brass hole ø 20mm dimensions 30x30mm			
	GEV No.	690828	Ref. No.	3734
description	bush L 20mm brass ID ø 10mm ED ø 15mm			
	GEV No.	690829	Ref. No.	3736.1
description	bush H 8mm ID ø 8mm ED ø 26mm			
	GEV No.	691637	Ref. No.	3780
description	roll pin ø 3mm L 20mm			
	GEV No.	691653	Ref. No.	40328
description	striker bolt L1 60mm L2 240mm D1 ø 20mm D2 ø 10mm			

accessories for	690862			
	GEV No.	691654	Ref. No.	40332
description	striker bolt L1 60mm L2 113mm D1 ø 20mm D2 ø 10mm			
	GEV No.	691655	Ref. No.	3909
description	striker bolt L1 60mm L2 105mm D1 ø 20mm D2 ø 10mm			
	GEV No.	691656	Ref. No.	3795
description	striker bolt L1 60mm L2 315mm D1 ø 20mm D2 ø 10mm			
	GEV No.	691657	Ref. No.	3796
description	striker bolt L1 60mm L2 283mm D1 ø 20mm D2 ø 10mm			
	GEV No.	691658	Ref. No.	40329
description	striker bolt L1 60mm L2 570mm D1 ø 20mm D2 ø 10mm			

1			
GEV No.	691637	Ref. No.	3780
description	roll pin ø 3mm L 20mm		

1			
GEV No.	691653	Ref. No.	40328
description	striker bolt L1 60mm L2 240mm D1 ø 20mm D2 ø 10mm		

hinges

oven hinges

1			
GEV No.	700390	Ref. No.	15062
description	oven hinge mounting distance 142mm mounting distance 2mm lug mountingmm lever lengthmm groove distance 12mm spring thickness 3mm mounting ear position spring length 116mm L 170mm mounting pos. left/right W 22mm		

door bearing

1			
GEV No.	514306	Ref. No.	0045D
description	hinge bearing mounting pos. bottom left without bolt		
For models:	FE1-2, FE2-3		

mechanical components, equipment accessories

Зип Общепит

vsezip.ru

+7(812)987-08-81



GEV No.	514310	Ref. No.	0321.05
description	hinge bearing mounting pos. bottom left without bolt		
For models:	FC06E, FC06EA, FC06EDG, FC06G, FC06GA, FC06GDG, FC06SE, FC06SEA, FC06SEDG, FC12E, FC12EA, FC12EDG, FC12G, FC12GA, FC12GDG, FC12SE, FC12SEA, FC12SEDG, FC20E, FC20EA, FC20EDG, FC20G, FC20GA, FC20GDG, FM06EB, FM06EDG, FM06GB, FM06GDG, FM10EB, FM10EDG, FM10GB, FM10GDG, FM20EB, FM20EDG, FM20GB, FM20GDG, FP05E, FP05EDG, FP05G, FP05GDG, FP10E, FP10EDG, FP10G, FP10GDG, MM06EA, MM06EAP, MM06EB, MM06GA, MM06GAP, MM06GB...(Other models you can see in the webshop)		



GEV No.	514313	Ref. No.	12025
description	hinge bearing mounting pos. lower without bolt		
For models:	FC200EA, FC200EAP, FC200EB, FC200GA, FC200GAP, FC200GB, FC201EA, FC201EAP, FC201EB, FC201GA, FC201GAP, FC201GB, FC401EA, FC401EAP, FC401EB, FC401GA, FC401GAP, FC401GB, FDE10, FDE15, FDE15SDG, FDE55, FDE55DG, FDG10, FDG15, FDG15SDG, FDG55, FDG55DG, FM200EA, FM200EAP, FM200EB, FM200GA, FM200GAP, FM200GB, FM201EA, FM201EAP, FM201EB, FM201GA, FM201GAP, FM201GB, FM401EA, FM401EAP, FM401EB, FM401GA, FM401GAP, FM401GB, MM200EA, MM200EAP, MM200EB, MM200GA...(Other models you can see in the webshop)		



GEV No.	514315	Ref. No.	30082
description	hinge bearing mounting pos. lower without bolt		
For models:	MM2/3EA, MM2/3EB		



GEV No.	514309	Ref. No.	0322C
description	hinge bearing mounting pos. upper left without bolt		
For models:	FC06E, FC06EA, FC06EDG, FC06G, FC06GA, FC06GDG, FC06SE, FC06SEA, FC06SEDG, FC12E, FC12EA, FC12EDG, FC12G, FC12GA, FC12GDG, FC12SE, FC12SEA, FC12SEDG, FM06EB, FM06EDG, FM06GB, FM06GDG, FM10EB, FM10EDG, FM10GB, FM10GDG, FP05G, FP05GDG, FP10E, FP10EDG, FP10G, FP10GDG, MM06EA, MM06EAP, MM06EB, MM06GA, MM06GAP, MM06GB, MM10EA, MM10EAP, MM10EB, MM10GA, MM10GAP, MM10GB, MM20EA, MM20EAP, MM20EB, MM20GB		



GEV No.	514311	Ref. No.	15.0007.01
description	hinge bearing mounting pos. upper left without bolt		
For models:	FC20E, FC20EA, FC20EDG, FC20G, FC20GA, FC20GDG, FM20EB, FM20EDG, FM20GB, FM20GDG, MM20GA, MM20GAP		



GEV No.	514314	Ref. No.	30083
description	hinge bearing mounting pos. upper left without bolt		
For models:	MM2/3EA, MM2/3EB		

DERBY RUOTE

with fixing plate

chrome-plated steel



GEV No.	701286 ¹	Ref. No.	15034
description	swivel castor with swivel brake ø 125mm plate fixing housing chrome-plated sheet steel plate size 95x70mm hole distance 70x50mm capacity 100kg bearing cup-and-cone bearing wheel body polypropylene tread TPE tyres H 162mm wheel width 30mm Qty 1 pcs		
accessories for	701286		
	GEV No.	701287	Ref. No. —
	swivel castor ø 125mm plate fixing housing chrome-plated sheet steel plate size 95x70mm hole distance 70x50mm capacity 100kg bearing cup-and-cone bearing wheel body polypropylene tread TPE tyres H 162mm wheel width 30mm Qty 1 pcs		

¹with swivel brake

gaskets

gaskets for heated units

window seals

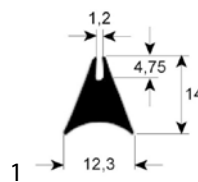

GEV No.	900058	Ref. No.	1441+1441 1444_25MT 1444_6MT
description	window gasket profile 1620 Qty supplied by meter		



Зип Общепит

vsezip.ru

+7(812)987-08-81

GEV No.	900463	Ref. No.	30093
description	window gasket profile 1650 L 1110mm Qty 1		
For models:	MM2/3EA, MM2/3EB		

GEV No.	900881	Ref. No.	30093
description	window gasket profile 1650 Qty supplied by meter		

GEV No.	900469	Ref. No.	14017
description	window gasket profile 1880 L 1385mm Qty 1		
For models:	FC200EA, FC200EAP, FC200EB, FC200GA, FC200GAP, FC200GB, FC201EA, FC201EAP, FC201EB, FC201GA, FC201GAP, FC201GB, FC401EA, FC401EAP, FC401EB, FC401GA, FC401GAP, FC401GB, FM200EA, FM200EAP, FM200EB, FM200GA, FM200GAP, FM200GB, FM201EA, FM201EAP, FM201EB, FM201GA, FM201GAP, FM201GB, FM401EA, FM401EAP, FM401EB, FM401GA, FM401GAP, FM401GB, MM200EA, MM200EAP, MM200EB, MM200GA, MM200GAP, MM200GB, MM201EA, MM201EAP, MM201EB, MM201GA, MM201GAP, MM201GB, MM401EA, MM401EAP...(Other models you can see in the webshop)		

GEV No.	900470	Ref. No.	14018
description	window gasket profile 1880 L 520mm Qty 1		
For models:	FC200EA, FC200EAP, FC200EB, FC200GA, FC200GAP, FC200GB, FM200EA, FM200EAP, FM200EB, FM200GA, FM200GAP, FM200GB, MM200EA, MM200EAP, MM200EB, MM200GA, MM200GAP, MM200GB		
accessories for	900470		
	GEV No.	Ref. No.	14019
	window gasket profile 1880 L 680mm Qty 1		

GEV No.	900471	Ref. No.	14019
description	window gasket profile 1880 L 680mm Qty 1		
For models:	FC201EA, FC201EAP, FC201EB, FC201GA, FC201GAP, FC201GB, FC401EA, FC401EAP, FC401EB, FC401GA, FC401GAP, FC401GB, FM201EA, FM201EAP, FM201EB, FM201GA, FM201GAP, FM201GB, FM401EA, FM401EAP, FM401EB, FM401GA, FM401GAP, FM401GB, MM201EA, MM201EAP, MM201EB, MM201GA, MM201GAP, MM201GB, MM401EA, MM401EAP, MM401GA, MM401GAP, MM401GB		
accessories for	900471		
	GEV No.	Ref. No.	14018
	window gasket profile 1880 L 520mm Qty 1		

GEV No.	900882	Ref. No.	14002
description	window gasket profile 1880 Qty supplied by meter		

door seals

GEV No.	900462	Ref. No.	30098
description	door seal profile 2400 L 410mm Qty 1		
For models:	MM2/3EA, MM2/3EB		

GEV No.	901324	Ref. No.	1442
description	door seal profile 2400 L 620mm external size		



Зип Общепит

vsezip.ru

+7(812)987-08-81

GEV No. 900883 Ref. No. 1093
description door seal profile 2400 Qty supplied by meter

GEV No. 900934 Ref. No. 0271B
description door seal profile 2400 Qty supplied by meter

GEV No. 900474 Ref. No. 14014
description door seal profile 2400 W 685mm L 805mm external size Qty 1

GEV No. 900466 Ref. No. 0324
description door seal profile 2400 W 700mm L 915mm external size Qty 1
For models: FC12E, FC12EA, FC12EDG, FC12G, FC12GA, FC12GDG, FC12SE, FC12SEA, FC12SEDG, FP10E, FP10EDG, FP10G, FP10GDG

GEV No. 900348 Ref. No. 0324-15MT, 0324-6MT, 1093-15MT, 1093-6MT, 3351-15MT, 3351-6MT, 3352-15MT
description door seal profile 2402 Qty supplied by meter

GEV No. 900059 Ref. No. 14011-25MT, 14011-6MT, 14012-25MT, 14012-6MT, 14020-25MT, 14020-6MT, 14021-25MT, 14021-6MT, 14028-25MT, 14028-6MT, 14029-25MT, 14029-6MT
description door seal profile 2410 Qty supplied by meter

GEV No. 900478 Ref. No. 14020	
description door seal profile 2415 L 1465mm mounting pos. left/right Qty 1	
For models: FC201EA, FC201EAP, FC201EB, FC201GA, FC201GAP, FC201GB, FC401EA, FC401EAP, FC401EB, FC401GA, FC401GAP, FC401GB, FM201EA, FM201EAP, FM201EB, FM201GA, FM201GAP, FM201GB, FM401EA, FM401EAP, FM401EB, FM401GA, FM401GAP, FM401GB, MM201EA, MM201EAP, MM201EB, MM201GA, MM201GAP, MM201GB, MM401EA, MM401EAP, MM401GA, MM401GAP, MM401GB	
accessories for 900478	
	GEV No. 900479 Ref. No. 14021
description door seal profile 2415 L 635mm mounting pos. upper/lower Qty 1	



Зип Общепит

vsezip.ru

+7(812)987-08-81

GEV No.	901302	Ref. No.	14029
description	door seal profile 2415 L 543mm mounting pos. left/right Qty 1		
accessories for	901302		
	GEV No.	901300	Ref. No. 14028
	door seal profile 2415 L 675mm mounting pos. upper/lower Qty 1		

GEV No.	902166	Ref. No.	14082
description	door seal profile 2749 W 660mm L 1450mm external size suitable for FOINOX		

GEV No.	900476	Ref. No.	14012
description	door seal profile 2415 L 695mm mounting pos. upper/lower Qty 1		
accessories for	900476		
	GEV No.	900477	Ref. No. 14011 14012 14013 14014 14021 14028
	door seal profile 2415 L 805mm mounting pos. left/right Qty 1		

door seals with fixing hook

GEV No.	900810	Ref. No.	0162
description	door seal L 360mm W 290mm with 8 mounting clips external size		

GEV No.	900307	Ref. No.	14070
description	door seal L 480mm W 380mm type ECG Speedy external size		

GEV No.	900477	Ref. No.	14011 14012 14013 14014 14021 14028
description	door seal profile 2415 L 805mm mounting pos. left/right Qty 1		
For models:	FC200EA, FC200EAP, FC200EB, FC200GA, FC200GAP, FC200GB, FM200EA, FM200EAP, FM200EB, FM200GA, FM200GAP, FM200GB, MM200EA, MM200EAP, MM200EB, MM200GA, MM200GAP, MM200GB		
accessories for	900477		
	GEV No.	900476	Ref. No. 14012
	door seal profile 2415 L 695mm mounting pos. upper/lower Qty 1		

GEV No.	901342	Ref. No.	14073
description	door seal L 620mm W 270mm with 10 mounting clips plug size		

mechanical components, equipment accessories

Зип.Общепит
valves and tank inlets

ball valves
ball valves electric

+7(812)987-08-81

sealing washers

silicone gaskets



1

GEV No.	359721	Ref. No.	0812.01
description	gasket silicone ED ø 48mm ID ø 39.5mm thickness 5mm Qty 1 pcs		
For models:	FC05E, FC05EU, FC05G, FC05GU, FC06E, FC06EA, FC06EDG, FC06G, FC06GA, FC06GDG, FC06SE, FC06SEA, FC06SEDG, FC12E, FC12EA, FC12EDG, FC12G, FC12GA, FC12GDG, FC12SE, FC12SEA, FC12SEDG, FC200EA, FC200EAP, FC200EB, FC200GA, FC200GAP, FC200GB, FC201EA, FC201EAP, FC201EB, FC201GA, FC201GAP, FC201GB, FC401EA, FC401EAP, FC401EB, FC401GA, FC401GAP, FC401GB, FE1-2, FE2-3, FM200EA, FM200EAP, FM200EB, FM200GA, FM200GAP, FM200GB, FM201EA, FM201EAP...(Other models you can see in the webshop)		

ball valves

ball valves electric



1

GEV No.	401233	Ref. No.	10036
description	ball valve inlet 1/2" IT outlet 1/2" IT 230V 50/60Hz mode of operation electric W 60mm H 99mm cable 4-pole 2.5W 4-pole duty cycle 50%		
For models:	FM200EA, FM200EAP, FM200EB, FM200GA, FM200GAP, FM200GB, FM201EA, FM201EAP, FM201EB, FM201GB, FM401EA, FM401EAP, FM401EB, FM401GB		

shaft gaskets

shaft gaskets



1

GEV No.	511171	Ref. No.	0689
description	shaft seal ID ø 14.5mm ED ø 20mm thickness 3mm		

measuring equipment

thermometers

built-in thermometers

ø52mm



1

GEV No.	541077	Ref. No.	0593 0594
description	thermometer mounting ø 52mm t.max. 350°C +50 up to +350°C probe ø 6mm probe L 30mm capillary pipe 1000mm built-in depth 28mm		
For models:	FC05G, FC05GU		

hose reels and spray guns

spray guns



1

GEV No.	691048	Ref. No.	1518.01
description	spray gun for appliances 1/2" ET L 225mm type STAR		
spare parts for	691048		
	GEV No.	507309	Ref. No. —
	O-ring EPDM thickness 2.62mm ID ø 17.13mm Qty 1 pcs		
	GEV No.	510322	Ref. No. —
	O-ring EPDM thickness 1.78mm ID ø 17.17mm Qty 1 pcs		
	GEV No.	524055	Ref. No. —
	flat gasket rubber ED ø 18mm ID ø 12mm thickness 2mm Qty 1 pcs		
	GEV No.	528485	Ref. No. —
	O-ring EPDM thickness 1.78mm ID ø 6.07mm Qty 1 pcs		
	GEV No.	528494	Ref. No. —
	gasket rubber ED ø 13mm ID ø 4mm thickness 4mm Qty 1 pcs		

fastening material

screws

hexagonal screws



1

GEV No.	560083	Ref. No.	17120
description	hexagonal screw thread M5 thread L 10mm SS WS 8 Qty 20 pcs DIN 933 / ISO 4017		



fasteners

roll pins



1

GEV No.	691637	Ref. No.	3780
description	roll pin ø 3mm L 20mm		

Зип Общепит

vsezip.ru

+7(812)987-08-81

Зип Общепит

vsezip.ru

+7(812)987-08-81

A		I	
alarm devices	12	ignition boxes	25
axial fans	18	ignition cables	27
B		ignition units	27
ball valves	36	immersion heating elements	2
ball valves electric	18, 36	indicator lights	8
bar burners	27	indicator lights (complete)	8
C		L	
cables	22	lamps	8
cam switches	7	light bulbs	8
castors and bumper angles	32	M	
condensators & interference suppression filters	22	magnetic switches	7
contactors	13	measuring equipment	36
control thermostats	4	mechanical timers	12
D		microswitches	5
door catches	30	O	
door seals	33	operating capacitors	22
door seals with fixing hook	35	oven hinges	31
drain pumps	22	oven lamps	9
E		P	
edgemount latches	30	pilot burners	26
electric accessories	22	probes	16
electrodes	18	programme timers	12
electronic controllers	15	pumps	22
energy regulators	4	push/momentary push switches	5
espagnolette locks	30	R	
F		relays	13
fans	18	ribbon cables	22
fasteners	37	roll pins	37
fastening material	36	S	
G		safety thermostats	5
gas burners	27	screws	36
gas control valves	23	sealing washers	36
gas nozzles	28	shaft gaskets	36
gaskets for heated units	32	snap locks	30
GEV	2	solenoid valves	17
H		spray guns	36
halogen lamp	8	spray guns with external thread	36
handle latches	30	switches and momentary switches	5
heating elements	2	system switches (ROLD)	6
heating elements for convection	2	T	
heating elements for ovens	2	temperature probes	16
hexagonal screws	36	terminals	22
hot air fans	22	thermocouples	27
hot air motors	19	thermostats	4

time relays	14
timers	12
transformers	15

U

universal probes	16
------------------	----

V

valves and tank inlets	36
------------------------	----

W

window seals	32
--------------	----

Зип Общепит**vsezip.ru****+7(812)987-08-81**