

Зип Общепит

vsezip.ru

+7(812)987-08-81

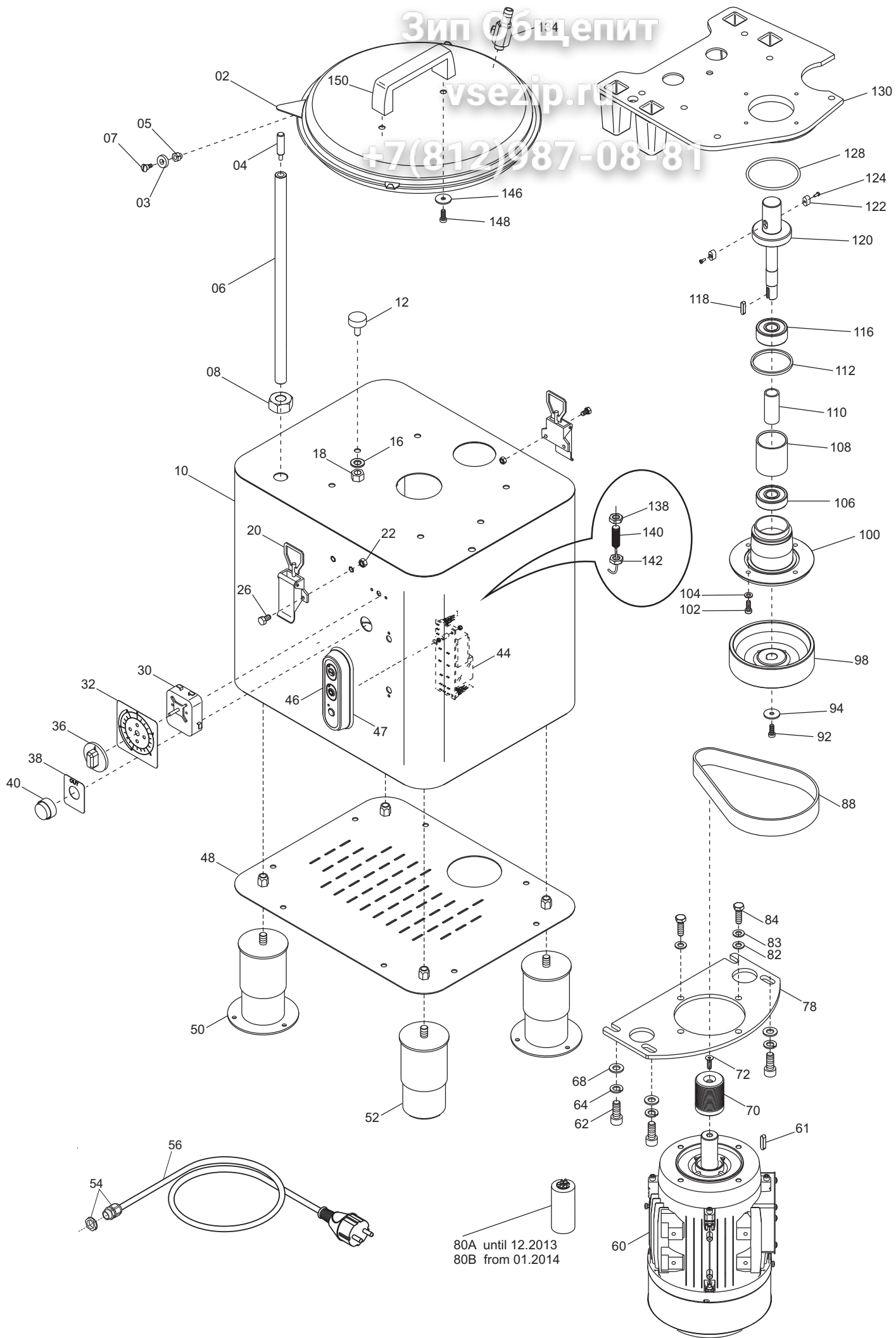

80A until 12.2013
80B from 01.2014

Зип Общепит

vsezip.ru

+7(812)987-08-81

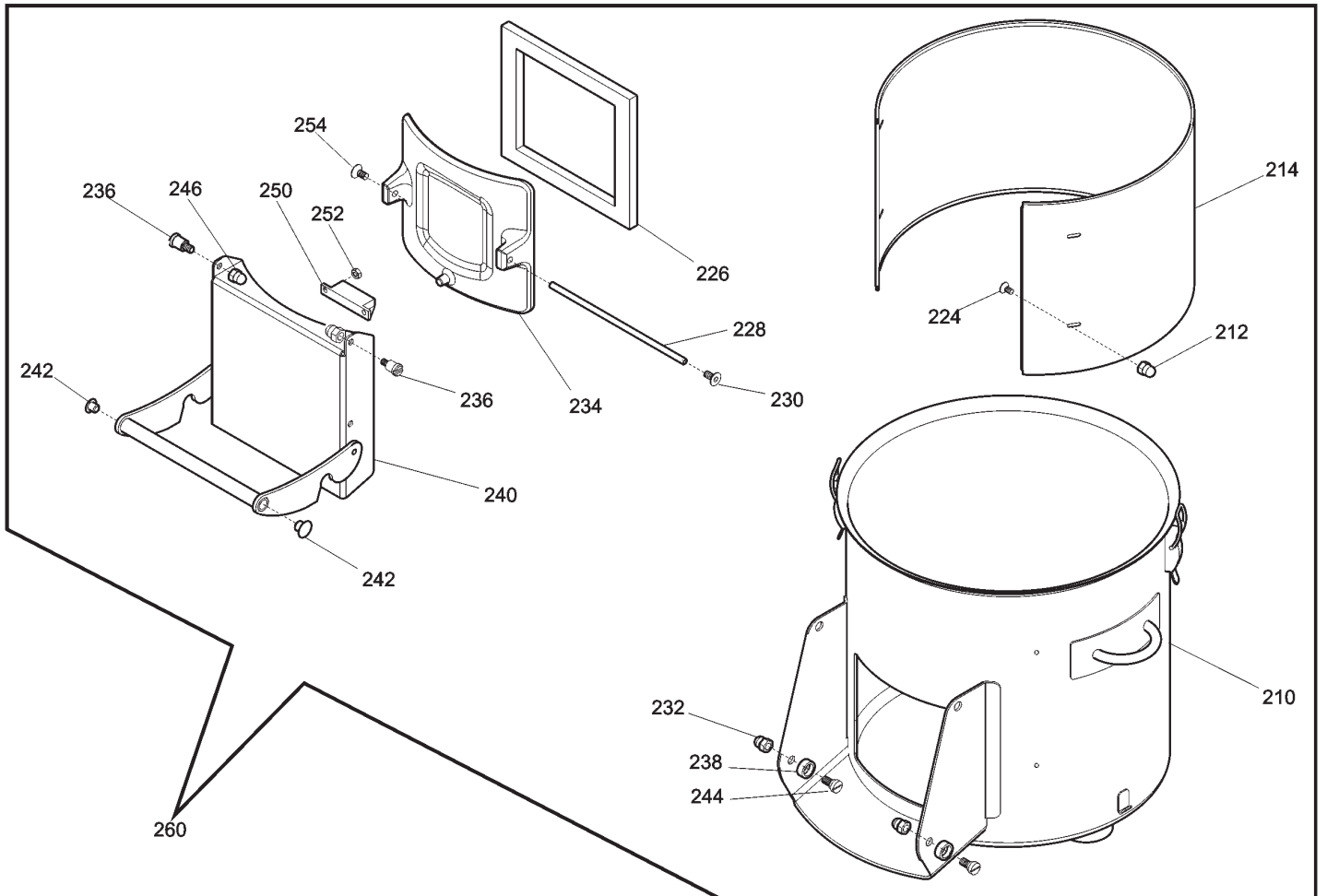
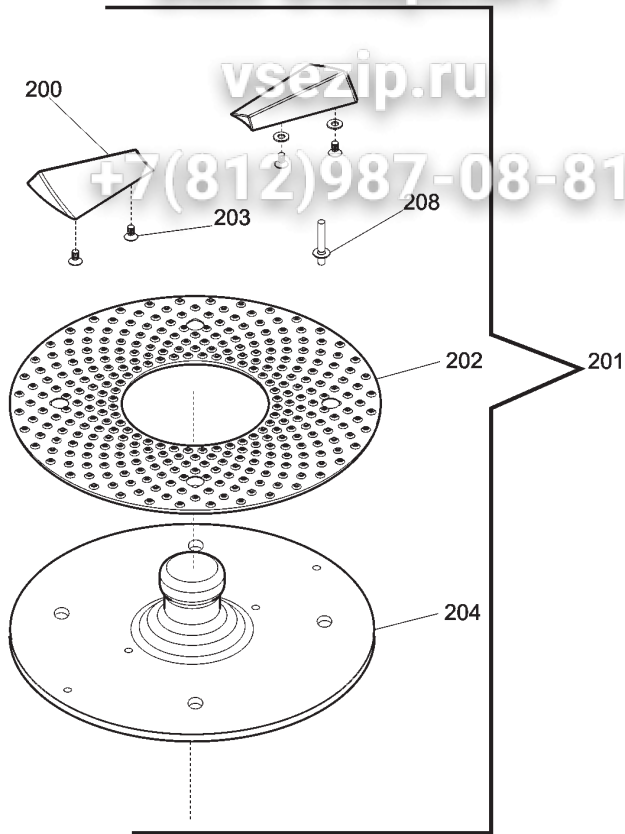

Зип Ощепит

02	COPERCHIO ACCIAIO SALDATO PPJ20SC		IV5890621E
03	MAGNETE IP67		IV5820520IP
04	SCREW-TYPE MAGNET M10 FOR PPJ20SC		IV5820510
06	ASTA SUPP. MICRO PPJ SC 20		IV75ASM18
08	DADO ALTO M16 X ASTA MICRO PPJ		IV75DM16A
10	CARCASSA ACCIAIO PPJ20SC		IV2486608
12	ANTI-VIBRANT FEET, POTATO PEELER		IV4600600
16	WASHER 08 x 24 INOX		IV77R08X24
18	NUT M 08		IV77D08
20	CONTAINER LOCKING _ PPJ		IV7700020
22	NUT M 05		IV77D05
26	SCREW M5 PPJ		IV77VE05X10
30	TIMER 1-PHASE _ PPJ 10/20 CE/NON CE	★	IV5966010
36	KNOB FOR TIMER PPJ		IV5966011
40	START-OUT BUTTON _ PPJ		IV5940601
44B	CIRCUIT BOARD 220-380 3-PHASE	★	19411008
44A	ELEKTRONISCHE PLATINE 220Volts	★	19411007
46	ELEKTRON. SCHALTER FUER AUFSCH.	★	19702004
47	GUMMI FUER EIN/AUS SCHALTER		19563034
48	COPERTURA INF. PPJ20SC		IV2486620
50	FLANGED FOOT for potatopeeler		IV4630600
52	PIEDINI NON FLANGIATI PLP		IV4630605
54	PRESSACAVO PG 11		IV5890302
56	CAVO ALIMENTAZIONE MN PG		IV5503006

vsezip.ru

+7(812)987-08-81

Зип Общепит

60B	MOTOR FUER KARTOFFELSCHALER PPJ20	V5030603
60A	MOTORE MEC90L 230V/50MN PPJ 20	V5056602
61	GRANO M6X08	V7530608
70	PULLEY MEC 90/100 D.33	V1320620
78	MOTOR SUPPORT FLANGE _ PPJ 10 SC	V2400659
80	CONDENSATORE 35 MF PER PPJ MONOFASE	V5820035P
88	BELT 508 - PPJ 20 SC	V7000605
92	SCREW M6 X 18	V77VEI06X18
94	WASHER M6 X 20	V77R06X20
98	PULLEY FOR POTATO PEELER	V1020615
100	BEARING HOLDER FOR PP	V1080605
102	SCREW M6 X 12 PLP	V77VEI06X12
104	WASHER M6	V77R06
106	BALL BEARING 6303 2RS _ PPJ	V7300600
108	BEARING SPACER _ PPJ	V2080610
110	SPACER, BALL BEARINGS	V2080615
112	CONTAINER SHAFT GASKET FOR PP	V4100610
116	BALL BEARING 62303 2RS _ PPJ	V7300605
118	FIXING KEY _ PPJ	V76C5X5X20
120	SHAFT - POTATO PEELER	V2080600
122	KEY 7 X 8 X 15 FOR PPJ	V77C7X8X15
128	SHAFT GASKET FOR PP	V7200600
130	MOTOR FLANGE PPJ SC	V1020610
134	WATER INLET PPJ	V7800600
140	SCREW-TYPE MAGNET M10 FOR TC MAGNUM	V5820510
150	MANIGLIA VASCHETTA GRATT.TCG DKT	29561652

Зип Общепит

200	RIALZO PIATTELLO BRILLANT. PPJ 20	IV1086325
201	PEELING DISC POTATO PEELER PPJ20	IV98406220
202	PEELING DISC FOR PPJ 20	IV2226510
203	VITE SVASATA 6 X 16 PLP	IV77TSEI6X16
204	PIATTELLO BRILLANTATO PPJ 20	IV1086100
205	VITE SVASATA 6 X 12 PLP	IV77TSEI6X12
210	CONTAINER _ PPJ 20	IV2226610
214	SIDE ABRASIVE SURFACE _ PPJ20	IV2426695
216	COPERCHIO ACCIAIO SALDATO PPJ 20	IV2096600
226	DOOR GASKET PPJ20	IV4130610
228	PIN - LOCK DOOR PPJ	IV2080635
234	INSIDE DOOR FRAME FOR PPJ	IV1020640
236	DOOR SCREW FOR PPJ	IV2080645
238	NEEDLE-ROLLER - DOOR PPJ	IV2080655
240	DOOR ASSEMBLY FOR POTATO PEELER	IV9800680
242	HANDLE CAP FOR PPJ	IV4210600
244	SCREW - DOOR PPJ	IV2080650
246	BLIND NUT M 6	IV77DC06
250	MAGNETIC SWITCH	LF1050103
260	CONTAINER ASSEMBLY PPJ20	IV9800676