



Зип Общепит

vsezip.ru

+7(812)987-08-81



GAS COMPONENTS



ELECTRIC COMPONENTS



WATER TECHNOLOGY



MECHANICAL COMPONENTS



TOOLS

Spare parts suitable for

OEM

Find the complete and up-to-date range of products in our GEV Webshop

Зип Общепит

vsezip.ru

+7(812)987-08-82

Manufacturer catalogue

The most important spare parts and accessories arranged clearly for every manufacturer



Complete product range and all appliance data always up to date in the GEV Webshop



Alphabetical Index at the end of the catalogue

GEV Webshop

www.gev-online.co.uk

www.gev-online.com



Add to Favourites



Sign In with email address and usual password



Easy-order – place several items in your basket at the same time









Quick Item search – no login needed



heating elements

Зип Общепит heating elements for pizza ovens

heating elements for coffee machine



| | | | |
|---|--|-----------------|-----------------------|
|  | | | |
| GEV No. | 415193 | Ref. No. | EE003 |
| description | heating element 3000W 230V heating circuits 3 mounting ø 42mm hole distance 74mm L 310mm W 35mm H 43mm L1 35mm L2 45mm L3 230mm H1 13mm hole ø 10mm connection M4 immersion heater 2 hole flange | | |
| accessories for | 415193 | | |
|  | GEV No. | 521103 | Ref. No. — |
| | nut thread M4 H 3mm WS 7 brass Qty 20 pcs | | |
|  | GEV No. | 521104 | Ref. No. — |
| | washer ID ø 4.3mm ED ø 8mm thickness 0.5mm brass Qty 20 pcs for thread M4 | | |
|  | GEV No. | 521125 | Ref. No. AD036 |
| | flat gasket rubber ED ø 52mm ID ø 42.5mm thickness 4mm Qty 1 pcs | | |
|  | GEV No. | 560111 | Ref. No. — |
| | plain washer ID ø 4.3mm ED ø 9mm thickness 0.8mm SS Qty 20 pcs DIN 125A for thread M4 | | |
|  | GEV No. | 560131 | Ref. No. — |
| | hexagonal nut thread M4 H 3.2mm WS 7 SS DIN/ISO DIN 934 / ISO 4032/8673 Qty 20 pcs | | |

| | | | |
|---|--|-----------------|-------------------|
|  | | | |
| GEV No. | 415194 | Ref. No. | EE005 |
| description | heating element 4500W 230V heating circuits 3 mounting ø 42mm hole distance 74mm L 318mm W 32mm H 44mm L1 35mm L2 45mm L3 235mm H1 29mm H2 15mm hole ø 9mm tube ø 8.5mm connection M4 immersion heater 2 hole flange | | |
| accessories for | 415194 | | |
|  | GEV No. | 521103 | Ref. No. — |
| | nut thread M4 H 3mm WS 7 brass Qty 20 pcs | | |
|  | GEV No. | 521104 | Ref. No. — |
| | washer ID ø 4.3mm ED ø 8mm thickness 0.5mm brass Qty 20 pcs for thread M4 | | |
|  | GEV No. | 560111 | Ref. No. — |
| | plain washer ID ø 4.3mm ED ø 9mm thickness 0.8mm SS Qty 20 pcs DIN 125A for thread M4 | | |
|  | GEV No. | 560131 | Ref. No. — |
| | hexagonal nut thread M4 H 3.2mm WS 7 SS DIN/ISO DIN 934 / ISO 4032/8673 Qty 20 pcs | | |

| | | | |
|--|--|-----------------|---------|
|  | | | |
| GEV No. | 416461 | Ref. No. | EE15700 |
| description | heating element 1000W 230V L 473mm W 275mm thread 1/4" mounting distance 262mm connection length 40mm connection cable tube ø 8.5mm cable length 490mm heating circuits 1 dry heating element 2 hole fixing pizza oven | | |

| | | | |
|--|---|-----------------|---------|
|  | | | |
| GEV No. | 416470 | Ref. No. | EE10400 |
| description | heating element 1100W 230V L 580mm W 160mm thread 3/8" mounting distance 151mm connection length 104mm tube ø 8.5mm heating circuits 1 dry heating element pizza oven | | |
| For models: | 109, 111, 66, 69, 77, 96, 99 | | |

| | | | |
|--|--|-----------------|---------|
|  | | | |
| GEV No. | 416466 | Ref. No. | EE10800 |
| description | heating element 1100W 230V L 880mm W 120mm thread 3/8" mounting distance 111mm connection length 104mm connection M5 tube ø 8.5mm dry heating element 2 hole fixing pizza oven | | |
| For models: | 109, 111, 23, 66, 69, 77, 96, 99 | | |

| | | | |
|--|---|-----------------|-------------------|
|  | | | |
| GEV No. | 416472 | Ref. No. | EE10600 |
| description | heating element 1100W 400V L 580mm W 165mm thread 3/8" mounting distance 157mm connection length 90mm connection male faston 6.3mm tube ø 8.5mm heating circuits 1 dry heating element 2 hole fixing | | |
| For models: | 96, R-109-1, R-109-2, R-109-3, R-111-1, R-111-2, R-111-3, R-66-1, R-66-2, R-66-3, R-69-1, R-69-2, R-69-3, R-77-1, R-77-2, R-77-3, R-96-1, R-96-2, R-96-3, R-99-1, R-99-2, R-99-3, RE-109-1, RE-109-2, RE-109-3, RE-111-1, RE-111-2, RE-111-3, RE-66-1, RE-66-2, RE-66-3, RE-69-1, RE-69-2, RE-69-3, RE-77-1, RE-77-2, RE-77-3, RE-96-1, RE-96-2, RE-96-3, RE-99-1, RE-99-2, RE-99-3, S-109-1, S-109-2, S-109-3, S-111-1, S-111-2, S-111-3, S-66-1...(Other models you can see in the webshop) | | |
| accessories for | 416472 | | |
|  | GEV No. | 361183 | Ref. No. — |
| | nut thread 3/8" H 6mm nickel-plated brass WS 20 Qty 1 pcs | | |
|  | GEV No. | 521137 | Ref. No. — |
| | flat gasket fibre ED ø 20mm ID ø 18mm thickness 1.5mm for thread 3/8" Qty 1 pcs | | |



electric components





Зип Общепит

vsezip.ru

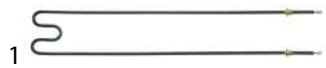

+7(812)9870818

| | | |
|---|---|-------------------------|
|  | GEV No. 416468 | Ref. No. EE11000 |
| description | heating element 1100W 400V L 884mm W 125mm thread 3/8" mounting distance 117mm connection length 86mm connection male faston 6.3mm tube ø 8.5mm heating circuits 1 dry heating element 2 hole fixing | |
| For models: | 69, R-109-1, R-109-2, R-109-3, R-111-1, R-111-2, R-111-3, R-66-1, R-66-2, R-66-3, R-69-1, R-69-2, R-69-3, R-77-1, R-77-2, R-77-3, R-96-1, R-96-2, R-96-3, R-99-1, R-99-2, R-99-3, RE-109-1, RE-109-2, RE-109-3, RE-111-1, RE-111-2, RE-111-3, RE-66-1, RE-66-2, RE-66-3, RE-69-1, RE-69-2, RE-69-3, RE-77-1, RE-77-2, RE-77-3, RE-96-1, RE-96-2, RE-96-3, RE-99-1, RE-99-2, RE-99-3, S-109-1, S-109-2, S-109-3, S-111-1, S-111-2, S-111-3, S-66-1...(Other models you can see in the webshop) | |
| accessories for | 416468 | |
|  | GEV No. 361183 | Ref. No. — |
| | nut thread 3/8" H 6mm nickel-plated brass WS 20 Qty 1 pcs | |
|  | GEV No. 521137 | Ref. No. — |
| | flat gasket fibre ED ø 20mm ID ø 18mm thickness 1.5mm for thread 3/8" Qty 1 pcs | |

| | | |
|---|---|----------------------------------|
|  | GEV No. 420435 | Ref. No. EE247 EE24700 |
| description | heating element 1300W 230V L 568mm W 158mm mounting distance 148mm connection F6.3 tube ø 8.5mm heating circuits 1 | |
| For models: | R-109-1, R-109-2, R-109-3, R-111-1, R-111-2, R-111-3, R-66-1, R-66-2, R-66-3, R-69-1, R-69-2, R-69-3, R-77-1, R-77-2, R-77-3, R-96-1, R-96-2, R-96-3, R-99-1, R-99-2, R-99-3, RE-109-1, RE-109-2, RE-109-3, RE-111-1, RE-111-2, RE-111-3, RE-66-1, RE-66-2, RE-66-3, RE-69-1, RE-69-2, RE-69-3, RE-77-1, RE-77-2, RE-77-3, RE-96-1, RE-96-2, RE-96-3, RE-99-1, RE-99-2, RE-99-3, S-109-1, S-109-2, S-109-3, S-111-1, S-111-2, S-111-3, S-66-1, S-66-2...(Other models you can see in the webshop) | |

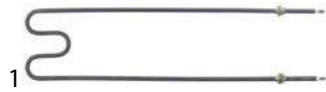
| | | |
|---|--|-------------------------|
|  | GEV No. 416473 | Ref. No. EE11300 |
| description | heating element 1300W 230V L 880mm W 163mm thread 3/8" mounting distance 153mm connection length 93mm connection M5 tube ø 10mm heating circuits 1 dry heating element 2 hole fixing | |
| For models: | 109, 111, 66, 69, 77, 96, 99 | |
| accessories for | 416473 | |
|  | GEV No. 361183 | Ref. No. — |
| | nut thread 3/8" H 6mm nickel-plated brass WS 20 Qty 1 pcs | |
|  | GEV No. 521137 | Ref. No. — |
| | flat gasket fibre ED ø 20mm ID ø 18mm thickness 1.5mm for thread 3/8" Qty 1 pcs | |

| | | |
|---|---|-------------------------|
|  | GEV No. 420436 | Ref. No. EE12800 |
| description | heating element 1300W 400V L 570mm W 162mm mounting distance 152mm connection F6.3 tube ø 10mm heating circuits 1 | |
| For models: | R-109-1, R-109-2, R-109-3, R-111-1, R-111-2, R-111-3, R-66-1, R-66-2, R-66-3, R-69-1, R-69-2, R-69-3, R-77-1, R-77-2, R-77-3, R-96-1, R-96-2, R-96-3, R-99-1, R-99-2, R-99-3, RE-109-1, RE-109-2, RE-109-3, RE-111-1, RE-111-2, RE-111-3, RE-66-1, RE-66-2, RE-66-3, RE-69-1, RE-69-2, RE-69-3, RE-77-1, RE-77-2, RE-77-3, RE-96-1, RE-96-2, RE-96-3, RE-99-1, RE-99-2, RE-99-3, S-109-1, S-109-2, S-109-3, S-111-1, S-111-2, S-111-3, S-66-1, S-66-2...(Other models you can see in the webshop) | |

| | | |
|--|---|-------------------------|
|  | GEV No. 416475 | Ref. No. EE11500 |
| description | heating element 1300W 230V L 880mm W 160mm thread 3/8" mounting distance 155mm connection length 109mm tube ø 10mm heating circuits 1 dry heating element 2 hole fixing | |
| For models: | 99 | |
| spare parts for | 416475 | |
|  | GEV No. 521137 | Ref. No. — |
| | flat gasket fibre ED ø 20mm ID ø 18mm thickness 1.5mm for thread 3/8" Qty 1 pcs | |
| accessories for | 416475 | |
|  | GEV No. 361183 | Ref. No. — |
| | nut thread 3/8" H 6mm nickel-plated brass WS 20 Qty 1 pcs | |

| | | |
|--|------------------------------|-------------------------|
|  | GEV No. 416474 | Ref. No. EE08400 |
| description | heating element 1600W 230V | |
| For models: | 109, 111, 66, 69, 77, 96, 99 | |

| | | |
|---|---|-------------------------|
|  | GEV No. 417540 | Ref. No. EE24400 |
| description | heating element 1600W 230V L 895mm W 200mm thread 1/4" (tube ø 8mm) tube ø 8.5mm heating circuits 1 | |

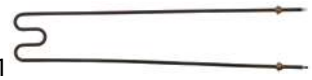
| | | |
|--|---|-------------------------|
|  | GEV No. 416476 | Ref. No. EE11400 |
| description | heating element 1600W 400V L 880mm W 155mm thread 3/8" mounting distance 145mm connection length 103mm tube ø 10mm heating circuits 1 dry heating element pizza oven | |
| For models: | 99, R-109-1, R-109-2, R-109-3, R-111-1, R-111-2, R-111-3, R-66-1, R-66-2, R-66-3, R-69-1, R-69-2, R-69-3, R-77-1, R-77-2, R-77-3, R-96-1, R-96-2, R-96-3, R-99-1, R-99-2, R-99-3, RE-109-1, RE-109-2, RE-109-3, RE-111-1, RE-111-2, RE-111-3, RE-66-1, RE-66-2, RE-66-3, RE-69-1, RE-69-2, RE-69-3, RE-77-1, RE-77-2, RE-77-3, RE-96-1, RE-96-2, RE-96-3, RE-99-1, RE-99-2, RE-99-3, S-109-1, S-109-2, S-109-3, S-111-1, S-111-2, S-111-3, S-66-1...(Other models you can see in the webshop) | |







Зип Общепит

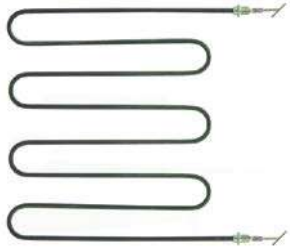



vsezip.ru

+7(812)987-08-81



| | | | |
|---|---|-----------------|-------------------|
| GEV No. | 416462 | Ref. No. | EE07000 |
| description | heating element 1650W 230V L 470mm W 450mm thread 1/4" mounting distance 442mm connection length 40mm connection cable tube ø 8.5mm cable length 480mm heating circuits 1 dry heating element 2 hole fixing | | |
| spare parts for | 416462 | | |
|  | GEV No. | 510417 | Ref. No. — |
| | flat gasket fibre ED ø 20mm ID ø 14mm thickness 2mm Qty 1 pcs | | |
| accessories for | 416462 | | |
|  | GEV No. | 361182 | Ref. No. — |
| | nut thread 1/4" H 5mm nickel-plated brass WS 17 Qty 1 pcs | | |
|  | GEV No. | 520228 | Ref. No. — |
| | tooth lock washer ID ø 15.3mm ED ø 24mm steel Qty 1 pcs for thread M14 | | |
|  | GEV No. | 550262 | Ref. No. — |
| | flat gasket copper ED ø 20mm ID ø 14mm thickness 2mm | | |



| | | | |
|---|--|-----------------|--------------------|
| GEV No. | 416464 | Ref. No. | EE17700 EE28200 |
| description | heating element 2000W 230V L 600mm W 572mm thread 1/4" mounting distance 563mm connection length 45mm tube ø 8.6mm cable length 643mm heating circuits 1 dry heating element 2 hole fixing | | |
| accessories for | 416464 | | |
|  | GEV No. | 361182 | Ref. No. — |
| | nut thread 1/4" H 5mm nickel-plated brass WS 17 Qty 1 pcs | | |
|  | GEV No. | 510417 | Ref. No. — |
| | flat gasket fibre ED ø 20mm ID ø 14mm thickness 2mm Qty 1 pcs | | |
|  | GEV No. | 520228 | Ref. No. — |
| | tooth lock washer ID ø 15.3mm ED ø 24mm steel Qty 1 pcs for thread M14 | | |
|  | GEV No. | 550262 | Ref. No. — |
| | flat gasket copper ED ø 20mm ID ø 14mm thickness 2mm | | |

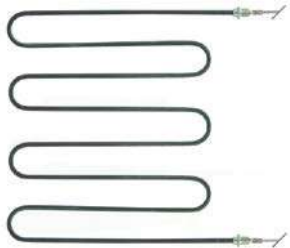

| | | | |
|--------------------|---|-----------------|---------|
| GEV No. | 416463 | Ref. No. | EE23000 |
| description | heating element 1700W 230V mounting pos. upper pizza oven | | |

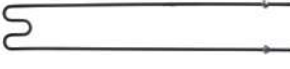

| | | | |
|--------------------|---|-----------------|---------|
| GEV No. | 418889 | Ref. No. | EE24800 |
| description | heating element 2000W 230V L 880mm W 160mm thread 3/8" mounting distance 150mm connection length 105mm connection male faston 6.3mm tube ø 10mm heating circuits 1 dry heating element pizza oven | | |
| For models: | R-109-1, R-109-2, R-109-3, R-111-1, R-111-2, R-111-3, R-66-1, R-66-2, R-66-3, R-69-1, R-69-2, R-69-3, R-77-1, R-77-2, R-77-3, R-96-1, R-96-2, R-96-3, R-99-1, R-99-2, R-99-3, RE-109-1, RE-109-2, RE-109-3, RE-111-1, RE-111-2, RE-111-3, RE-66-1, RE-66-2, RE-66-3, RE-69-1, RE-69-2, RE-69-3, RE-77-1, RE-77-2, RE-77-3, RE-96-1, RE-96-2, RE-96-3, RE-99-1, RE-99-2, RE-99-3, S-109-1, S-109-2, S-109-3, S-111-1, S-111-2, S-111-3, S-66-1, S-66-2...(Other models you can see in the webshop) | | |



| | | | |
|--------------------|---|-----------------|---------|
| GEV No. | 418888 | Ref. No. | EE15000 |
| description | heating element 1900W 400V L 880mm W 160mm thread 3/8" mounting distance 150mm connection length 105mm connection male faston 6.3mm tube ø 10mm heating circuits 1 dry heating element pizza oven | | |
| For models: | R-109-1, R-109-2, R-109-3, R-111-1, R-111-2, R-111-3, R-66-1, R-66-2, R-66-3, R-69-1, R-69-2, R-69-3, R-77-1, R-77-2, R-77-3, R-96-1, R-96-2, R-96-3, R-99-1, R-99-2, R-99-3, RE-109-1, RE-109-2, RE-109-3, RE-111-1, RE-111-2, RE-111-3, RE-66-1, RE-66-2, RE-66-3, RE-69-1, RE-69-2, RE-69-3, RE-77-1, RE-77-2, RE-77-3, RE-96-1, RE-96-2, RE-96-3, RE-99-1, RE-99-2, RE-99-3, S-109-1, S-109-2, S-109-3, S-111-1, S-111-2, S-111-3, S-66-1, S-66-2...(Other models you can see in the webshop) | | |

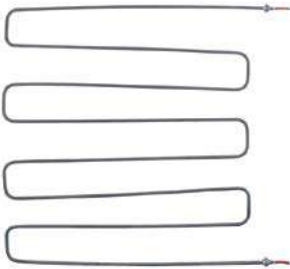

| | | | |
|--------------------|--|-----------------|---------|
| GEV No. | 420437 | Ref. No. | EE28100 |
| description | heating element 3000W 230V L 672mm W 657mm mounting distance 647mm tube ø 8.5mm heating circuits 1 | | |







Зип Общепит

vsezip.ru

7(812)987-08-81



| | | | |
|---|--|-----------------|-------------------|
| GEV No. | 415804 | Ref. No. | N/A |
| description | heating element 500W 400V L 515mm W 105mm thread 1/4" mounting distance 100mm connection length 24mm tube ø 8.5mm cable length 1000mm heating circuits 1 dry heating element 2 hole fixing | | |
| accessories for | 415804 | | |
|  | GEV No. | 510417 | Ref. No. — |
| | flat gasket fibre ED ø 20mm ID ø 14mm thickness 2mm Qty 1 pcs | | |
|  | GEV No. | 520228 | Ref. No. — |
| | tooth lock washer ID ø 15.3mm ED ø 24mm steel Qty 1 pcs for thread M14 | | |
|  | GEV No. | 550262 | Ref. No. — |
| | flat gasket copper ED ø 20mm ID ø 14mm thickness 2mm | | |



| | | | |
|--------------------|---|-----------------|------------------|
| GEV No. | 418640 | Ref. No. | EE054 EE05400 |
| description | heating element 600W 230V L 530mm W 106mm thread 1/4" mounting distance 98mm connection length 47mm connection cable tube ø 8.5mm cable length 980mm heating circuits 1 dry heating element 2 hole fixing | | |
| For models: | MF 4 | | |







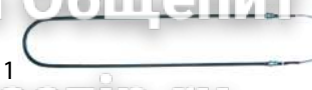

| | | | |
|---|--|-----------------|-------------------|
| GEV No. | 415943 | Ref. No. | EE13300 |
| description | heating element 600W 230V L 575mm W 127mm thread 1/4" mounting distance 119mm connection length 50mm tube ø 8.5mm cable length 1180mm heating circuits 1 dry heating element 2 hole fixing | | |
| accessories for | 415943 | | |
|  | GEV No. | 361182 | Ref. No. — |
| | nut thread 1/4" H 5mm nickel-plated brass WS 17 Qty 1 pcs | | |
|  | GEV No. | 510417 | Ref. No. — |
| | flat gasket fibre ED ø 20mm ID ø 14mm thickness 2mm Qty 1 pcs | | |
|  | GEV No. | 520228 | Ref. No. — |
| | tooth lock washer ID ø 15.3mm ED ø 24mm steel Qty 1 pcs for thread M14 | | |
|  | GEV No. | 550262 | Ref. No. — |
| | flat gasket copper ED ø 20mm ID ø 14mm thickness 2mm | | |







| | | | |
|--------------------|--|-----------------|---------|
| GEV No. | 415945 | Ref. No. | EE13500 |
| description | heating element 600W 400V L 575mm W 131mm thread 1/4" mounting distance 125mm connection length 34mm tube ø 8.5mm cable length 1200mm heating circuits 1 dry heating element 2 hole fixing | | |



| | | | |
|---|--|-----------------|-------------------|
| GEV No. | 415944 | Ref. No. | EE13200 |
| description | heating element 700W 230V L 580mm W 122mm thread 1/4" mounting distance 109mm connection length 45mm tube ø 8.5mm cable length 1210mm heating circuits 1 dry heating element 2 hole fixing | | |
| spare parts for | 415944 | | |
|  | GEV No. | 510417 | Ref. No. — |
| | flat gasket fibre ED ø 20mm ID ø 14mm thickness 2mm Qty 1 pcs | | |
| accessories for | 415944 | | |
|  | GEV No. | 361182 | Ref. No. — |
| | nut thread 1/4" H 5mm nickel-plated brass WS 17 Qty 1 pcs | | |
|  | GEV No. | 520228 | Ref. No. — |
| | tooth lock washer ID ø 15.3mm ED ø 24mm steel Qty 1 pcs for thread M14 | | |
|  | GEV No. | 521012 | Ref. No. — |
| | gasket graphite ED ø 15mm ID ø 5mm thickness 1.2mm Qty 1 pcs | | |
|  | GEV No. | 550262 | Ref. No. — |
| | flat gasket copper ED ø 20mm ID ø 14mm thickness 2mm | | |



| | | | |
|---|---|-----------------|-------------------|
| GEV No. | 415946 | Ref. No. | EE13400 |
| description | heating element 700W 400V L 575mm W 120mm thread 1/4" mounting distance 112mm connection length 28mm connection cable tube ø 8.5mm cable length 1180mm heating circuits 1 dry heating element 2 hole fixing | | |
| spare parts for | 415946 | | |
|  | GEV No. | 510417 | Ref. No. — |
| | flat gasket fibre ED ø 20mm ID ø 14mm thickness 2mm Qty 1 pcs | | |
| accessories for | 415946 | | |
|  | GEV No. | 361182 | Ref. No. — |
| | nut thread 1/4" H 5mm nickel-plated brass WS 17 Qty 1 pcs | | |
|  | GEV No. | 520228 | Ref. No. — |
| | tooth lock washer ID ø 15.3mm ED ø 24mm steel Qty 1 pcs for thread M14 | | |
|  | GEV No. | 550262 | Ref. No. — |
| | flat gasket copper ED ø 20mm ID ø 14mm thickness 2mm | | |



| | | | |
|---|--|-----------------|-------------------|
| GEV No. | 416469 | Ref. No. | EE10500 |
| description | heating element 900W 230V L 583mm W 167mm thread 3/8" mounting distance 158mm connection length 90mm connection M5 tube ø 8.7mm heating circuits 1 dry heating element 2 hole fixing | | |
| For models: | 109, 111, 66, 69, 77, 96, 99 | | |
| accessories for | 416469 | | |
|  | GEV No. | 361183 | Ref. No. — |
| | nut thread 3/8" H 6mm nickel-plated brass WS 20 Qty 1 pcs | | |

Table continues overleaf







Зип Общепит heating elements for pizza presses

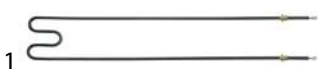

vsezip.ru

+7(812)987-08-81

| | | | |
|---|---|--------|-----------------|
| accessories for | 416469 | | |
|  | GEV No. | 521137 | Ref. No. |
| | | | — |
| | flat gasket fibre ED ø 20mm ID ø 18mm thickness 1.5mm for thread 3/8" Qty 1 pcs | | |

| | | | |
|---|---|-----------------|---------|
|  | 1 | | |
| GEV No. | 416465 | Ref. No. | EE10900 |
| description | heating element 900W 230V L 875mm W 125mm thread 3/8" mounting distance 120mm connection length 70mm connection M5 tube ø 8.5mm heating circuits 1 dry heating element 2 hole fixing pizza oven | | |
| For models: | 109, 111, 66, 69, 77, 96, 99 | | |

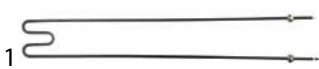
| | | | |
|---|---|-----------------|-----------------|
|  | 1 | | |
| GEV No. | 416471 | Ref. No. | EE10700 |
| description | heating element 900W 400V L 580mm W 160mm thread 3/8" mounting distance 152mm connection length 86mm connection male faston 6.3mm tube ø 8.5mm heating circuits 1 dry heating element 2 hole fixing | | |
| For models: | 96 | | |
| accessories for | 416471 | | |
|  | GEV No. | 361183 | Ref. No. |
| | | | — |
| | nut thread 3/8" H 6mm nickel-plated brass WS 20 Qty 1 pcs | | |
|  | GEV No. | 521137 | Ref. No. |
| | | | — |
| | flat gasket fibre ED ø 20mm ID ø 18mm thickness 1.5mm for thread 3/8" Qty 1 pcs | | |

| | | | |
|---|---|-----------------|-----------------|
|  | 1 | | |
| GEV No. | 416467 | Ref. No. | EE11100 |
| description | heating element 900W 400V L 979mm W 120mm thread 3/8" mounting distance 112mm connection length 89mm connection male faston 6.3mm tube ø 8.5mm heating circuits 1 dry heating element 2 hole fixing | | |
| For models: | 69 | | |
| spare parts for | 416467 | | |
|  | GEV No. | 521137 | Ref. No. |
| | | | — |
| | flat gasket fibre ED ø 20mm ID ø 18mm thickness 1.5mm for thread 3/8" Qty 1 pcs | | |
| accessories for | 416467 | | |
|  | GEV No. | 361183 | Ref. No. |
| | | | — |
| | nut thread 3/8" H 6mm nickel-plated brass WS 20 Qty 1 pcs | | |

| | | | |
|--|--|-----------------|---------|
|  | 1 | | |
| GEV No. | 416477 | Ref. No. | EE02800 |
| description | heating element 1500W 230V L 364mm W 235mm connection M5 connection length 23mm L1 180mm L2 184mm W1 103mm W2 29mm dry heating element tube ø 8.5mm windings 5 | | |
| For models: | PF33MT | | |

| | | | |
|--|--|-----------------|---------|
|  | 1 | | |
| GEV No. | 416478 | Ref. No. | EE18100 |
| description | heating element 1500W 400V L 369mm W 235mm heating circuits 1 connection M5 connection length 22mm L1 108mm L2 261mm W1 97mm W2 26mm dry heating element tube ø 8.5mm windings 5 | | |
| For models: | PF33MT | | |

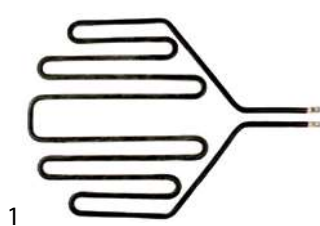
| | | | |
|---|---|-----------------|--------------------|
|  | 1 | | |
| GEV No. | 416479 | Ref. No. | EE03000 EE16300 |
| description | heating element 3000W 230V L 493mm W 355mm connection M5 connection length 30mm L1 115mm L2 355mm W1 162mm W2 31mm dry heating element tube ø 10mm windings 5 | | |
| For models: | PF45HT, PF45MT-E | | |

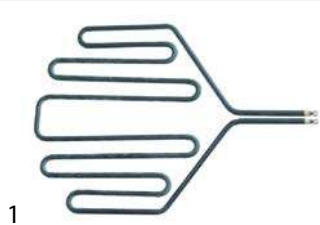
| | | | |
|--|--|-----------------|---------|
|  | 1 | | |
| GEV No. | 416480 | Ref. No. | EE16200 |
| description | heating element 3000W 400V L 490mm W 332mm connection male faston connection length 25mm L1 125mm L2 365mm W1 153mm W2 26mm dry heating element tube ø 10mm windings 5 | | |
| For models: | PF45HT, PF45MTE, PF45MT-E | | |

1 electric components





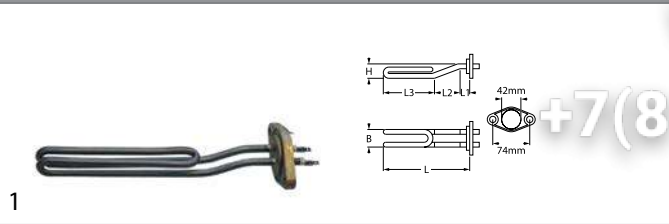

immersion heating elements

Зип Общепит
accessories

2 hole flange 74mm



| | | | |
|--------------------|--|-----------------|-------|
| GEV No. | 415191 | Ref. No. | EE002 |
| description | heating element 2300W 220V heating circuits 1 mounting \varnothing 42mm L 240mm W 29mm H 27mm L1 35mm L2 35mm L3 170mm tube \varnothing 8.5mm hole distance 74mm hole \varnothing 8mm connection M4 immersion heater 2 hole flange H1 8mm H2 23mm flange length 94mm flange width 58mm | | |

| | | | | |
|--|---|--------|-----------------|---|
| accessories for | 415191 | | | |
|  | GEV No. | 521103 | Ref. No. | — |
| | nut thread M4 H 3mm WS 7 brass Qty 20 pcs | | | |
|  | GEV No. | 521104 | Ref. No. | — |
| | washer ID \varnothing 4.3mm ED \varnothing 8mm thickness 0.5mm brass Qty 20 pcs for thread M4 | | | |
|  | GEV No. | 560111 | Ref. No. | — |
| | plain washer ID \varnothing 4.3mm ED \varnothing 9mm thickness 0.8mm SS Qty 20 pcs DIN 125A for thread M4 | | | |
|  | GEV No. | 560131 | Ref. No. | — |
| | hexagonal nut thread M4 H 3.2mm WS 7 SS DIN/ISO DIN 934 / ISO 4032/8673 Qty 20 pcs | | | |

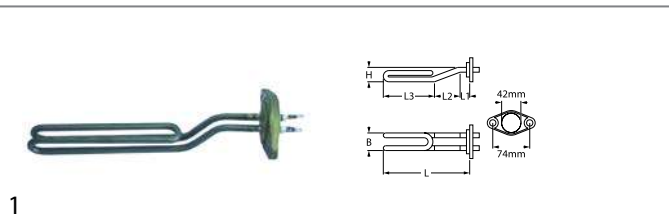



| | | | |
|--------------------|--|-----------------|-------|
| GEV No. | 415192 | Ref. No. | EE010 |
| description | heating element 3000W 220V heating circuits 1 mounting \varnothing 42mm L 225mm W 29mm H 39mm L1 20mm L2 35mm L3 170mm hole distance 74mm hole \varnothing 9mm connection male faston 6.3mm immersion heater 2 hole flange | | |

1"



| | | | |
|--------------------|---|-----------------|-------|
| GEV No. | 415195 | Ref. No. | EE001 |
| description | heating element 2500W 230V heating circuits 1 thread 1" L 200mm W 20mm H 20mm tube \varnothing 8.5mm connection male faston 6.3mm immersion heater flange with thread | | |

| | | | | |
|---|---|--------|-----------------|---|
| accessories for | 415195 | | | |
|  | GEV No. | 510404 | Ref. No. | — |
| | flat gasket fibre ED \varnothing 44mm ID \varnothing 34mm thickness 2mm Qty 1 pcs | | | |
|  | GEV No. | 510422 | Ref. No. | — |
| | gasket copper ED \varnothing 37.7mm ID \varnothing 32.5mm thickness 2.7mm for thread 1" | | | |
|  | GEV No. | 520233 | Ref. No. | — |
| | nut thread 1" H 6mm brass WS 47 Qty 1 pcs | | | |

sealing washers



| | | | |
|--------------------|--|-----------------|-------|
| GEV No. | 521125 | Ref. No. | AD036 |
| description | flat gasket rubber ED \varnothing 52mm ID \varnothing 42.5mm thickness 4mm Qty 1 pcs | | |

thermostats

control and safety thermostats

EGO

control thermostats

55.10/19_ series



| | | | |
|--------------------|--|-----------------|--------------------|
| GEV No. | 375309 | Ref. No. | ED036R0 ED04800 |
| description | thermostat t.max. 180°C temperature range 95-180°C 1-pole 1NO 16A probe \varnothing 6mm probe L 130mm capillary pipe 1500mm capillary pipe isolated 1100mm gland nut shaft L 23mm shaft position upper rotation 270° | | |
| For models: | PF33MT, PF45HT | | |



| | | | |
|--------------------|---|-----------------|---------|
| GEV No. | 375313 | Ref. No. | ED00700 |
| description | thermostat t.max. 358°C temperature range 60-358°C 1-pole 1NO 16A probe \varnothing 3.03mm probe L 178mm capillary pipe 870mm capillary pipe isolated 870mm gland nut shaft L 23mm shaft position upper rotation 270° | | |

Зип Общежит

vsezip.ru

+7(812)987-08-81



| | | | |
|--------------------|--|-----------------|---------|
| GEV No. | 376004 | Ref. No. | ED05800 |
| description | thermostat t.max. 422°C temperature range 65-422°C 1-pole 1CO 16A probe ø 4mm probe L 230mm capillary pipe 900mm capillary pipe isolated 630mm gland nut shaft L 23mm shaft position upper | | |



| | | | |
|--------------------|--|-----------------|---------|
| GEV No. | 375065 | Ref. No. | ED05500 |
| description | safety thermostat switch-off temp. 500°C 3-pole 3NC 20A probe ø 4mm probe L 308mm capillary pipe 890mm capillary pipe isolated-mm gland nut probe SS | | |

safety thermostats

55.10/19_ series



| | | | |
|--------------------|--|-----------------|---------|
| GEV No. | 375311 | Ref. No. | ED04900 |
| description | safety thermostat switch-off temp. 250°C 1-pole 16A probe ø 6mm probe L 87mm capillary pipe 1470mm capillary pipe isolated 1460mm gland nut probe SS | | |
| For models: | PF33MT, PF45HT, PF45MTE, PF45MT-E | | |

IMIT / TEMPOMATIC / ARTHERMO

control thermostats





| | | | |
|--------------------|---|-----------------|-------|
| GEV No. | 390186 | Ref. No. | ED002 |
| description | thermostat t.max. 52°C temperature range fixed 52°C 1-pole 1CO 16A probe ø 6.5mm probe L 95mm capillary pipe 1000mm capillary pipe isolated 1000mm gland nut shaft Lmm contacts 1CO | | |

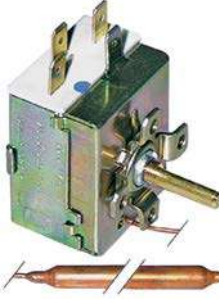

| | | | |
|--------------------|---|-----------------|---------|
| GEV No. | 375191 | Ref. No. | ED02300 |
| description | safety thermostat switch-off temp. 500°C 1-pole 16A probe ø 3.9mm probe L 230mm capillary pipe 870mm capillary pipe isolated 660mm gland nut probe | | |
| For models: | R-109-1, R-109-2, R-109-3, R-111-1, R-111-2, R-111-3, R-66-1, R-66-2, R-66-3, R-69-1, R-69-2, R-69-3, R-77-1, R-77-2, R-77-3, R-96-1, R-96-2, R-96-3, R-99-1, R-99-2, R-99-3, RE-109-1, RE-109-2, RE-109-3, RE-111-1, RE-111-2, RE-111-3, RE-66-1, RE-66-2, RE-66-3, RE-69-1, RE-69-2, RE-69-3, RE-77-1, RE-77-2, RE-77-3, RE-96-1, RE-96-2, RE-96-3, RE-99-1, RE-99-2, RE-99-3, S-109-1, S-109-2, S-109-3, S-111-1, S-111-2, S-111-3, S-66-1, S-66-2...(Other models you can see in the webshop) | | |



| | | | |
|---|--|-----------------|-------------------|
| GEV No. | 390006 | Ref. No. | ED001 ED00100 |
| description | thermostat t.max. 86°C temperature range 0-86°C 1-pole 1CO 16A probe ø 6.5mm probe L 95mm capillary pipe 1500mm capillary pipe isolatedmm gland nut shaft ø 6x4.6mm shaft L 19mm rotation 270° | | |
| accessories for | 390006 | | |
|  | GEV No. | 110100 | Ref. No. — |
| | knob thermostat t.max. 90°C 0-90°C ø 42mm shaft ø 6x4.6mm shaft flat -135° black | | |
|  | GEV No. | 110105 | Ref. No. — |
| | rosette knob ø 42mm ø 56mm zero mark | | |



3ип.Общепит switches and momentary switches

vsezip.ru

30x11mm

+7(812)987-08-81

INVENSYS / ROBERTSHAW

control thermostats



| | | | |
|--------------------|---|-----------------|----------|
| GEV No. | 390636 | Ref. No. | P8905-03 |
| description | thermostat t.max. 204°C temperature range 93-204°C 1-pole 1NO 0.67A probe ø 9.5mm probe L 123mm capillary pipe 915mm capillary pipe isolatedmm gland nut 1/4" NPT shaft ø 6x4.6mm shaft L 21mm shaft position lower rotation 315° probe material nickel-plated probe thread 1/4" US | | |



| | | | |
|--------------------|---|-----------------|----------|
| GEV No. | 390771 | Ref. No. | P5047585 |
| description | thermostat temperature range 121-190°C 1-pole probe ø 8mm probe L 260mm capillary pipe 1200mm shaft ø 6x4.6mm shaft L 25mm shaft position lower rotation 315° operating temperature range 200-375°F | | |

control thermostats with actual value



| | | | |
|--------------------|---|-----------------|---------|
| GEV No. | 379039 | Ref. No. | ED02200 |
| description | thermostat t.max. 500°C temperature range 0-500°C 1CO 5A probe ø 8mm probe L 150mm capillary pipe 1100mm mounting ø 60mm front measurements 72x72mm | | |
| For models: | 109, 111, 22, 23, 32, 33 220V, 33 380V, 34 220V, 34 380V, 66, 69, 77, 96, 99, SG22, SG23, SG33 | | |

rocker/momentary rocker switches

| | | | |
|--------------------|--|-----------------|---------|
| GEV No. | 301013 | Ref. No. | EF02300 |
| description | rocker switch mounting measurements 30x11mm black 1CO 250V 16A connection male faston 6.3mm ambient temperature max. 85/125°C protection IP40 | | |
| For models: | 22, 23, 32, 33 220V, 33 380V, 34 220V, 34 380V, R-109-1, R-109-2, R-109-3, R-111-1, R-111-2, R-111-3, R-66-1, R-66-2, R-66-3, R-69-1, R-69-2, R-69-3, R-77-1, R-77-2, R-77-3, R-96-1, R-96-2, R-96-3, R-99-1, R-99-2, R-99-3, S-109-1, S-109-2, S-109-3, S-111-1, S-111-2, S-111-3, S-66-1, S-66-2, S-66-3, S-69-1, S-69-2, S-69-3, S-77-1, S-77-2, S-77-3, S-96-1, S-96-2, S-96-3, S-99-1, S-99-2, S-99-3, SG22...(Other models you can see in the webshop) | | |

30x22mm

| | | | |
|--------------------|---|-----------------|---------|
| GEV No. | 345512 | Ref. No. | EF00400 |
| description | rocker switch mounting measurements 30x22mm orange 2NO 400V 16A illuminated 0-I connection male faston 6.3mm ambient temperature max. 85/125°C protection IP40 | | |
| For models: | 109, 111, 22, 23, 32, 33 220V, 33 380V, 34 220V, 34 380V, 66, 69, 77, 96, 99, PF33MT, PF45MTE, PF45MT-E, R-109-1, R-109-2, R-109-3, R-111-1, R-111-2, R-111-3, R-66-1, R-66-2, R-66-3, R-69-1, R-69-2, R-69-3, R-77-1, R-77-2, R-77-3, R-96-1, R-96-2, R-96-3, R-99-1, R-99-2, R-99-3, S-109-1, S-109-2, S-109-3, S-111-1, S-111-2, S-111-3, S-66-1, S-66-2, S-66-3, S-69-1, S-69-2, S-69-3...(Other models you can see in the webshop) | | |

| | | | |
|------------------------|---|-----------------|---------|
| GEV No. | 301004 | Ref. No. | EF02400 |
| description | rocker switch mounting measurements 30x22mm black 2CO 250V 16A connection male faston 6.3mm ambient temperature max. 125/55°C protection IP40 | | |
| accessories for | 301004 | | |
| | GEV No. | Ref. No. | — |
| | protective cover internal size 30x22mm for rocker switch mounting measurementsmm | | |

push/momentary push switches

ø16mm

| | | | |
|--------------------|--|-----------------|----------------------|
| GEV No. | 101029 | Ref. No. | EF04800+EF04900+5000 |
| description | momentary push switch mounting ø 16mm white 1NO 250V 16A connection male faston 6.3mm protection IP40 ambient temperature max. 150°C | | |



Зип-Общепит

vsezip.ru

+7(812)987-08-81

miscellaneous



| | | | |
|--------------------|---|-----------------|--------------------|
| 1 | | | |
| GEV No. | 346475 | Ref. No. | EF04400 EF08300 |
| description | momentary push switch green illuminated display 220V connection male faston 6.3mm ambient temperature max. 125/85°C protection IP40 | | |
| For models: | PF33MT | | |

roller 90°



| | | | |
|--------------------|--|-----------------|---------|
| 1 | | | |
| GEV No. | 347096 | Ref. No. | EG03700 |
| description | microswitch with roller plunger 250V 20A 1CO connection screw L1 49mm ambient temperature max. 125°C thread L 14.5mm thread M12x1 mounting distance 25mm actuating force: 370g type Z15G1318 | | |
| For models: | PF33MT | | |

microswitches

pin-plunger actuated

M10



| | | | |
|--------------------|---|-----------------|------------------|
| 1 | | | |
| GEV No. | 345032 | Ref. No. | EG001 EG00100 |
| description | microswitch with plunger thread M10x1 thread L 12mm 250V 16A 1CO connection male faston 6.3mm stroke 7mm mounting distance 22mm L 28mm ambient temperature max. 125°C type SP9603 actuating force: 180g | | |
| For models: | PF33MT | | |

M12



| | | | |
|--------------------|---|-----------------|---------|
| 1 | | | |
| GEV No. | 345694 | Ref. No. | EG03100 |
| description | microswitch with plunger mounting distance 25mm thread M12x1 thread L 14mm 250V 16A 1CO connection screw stroke 4mm L 49mm ambient temperature max. 125°C type MS10 actuating force: 350g | | |
| For models: | PF33MT | | |

roller actuated

roller 0°



| | | | |
|--------------------|---|-----------------|---------|
| 1 | | | |
| GEV No. | 345693 | Ref. No. | EG03200 |
| description | microswitch with roller plunger 230V 16A 1CO connection screw ambient temperature max. 125°C thread L 14mm thread M10 | | |
| For models: | PF33MT, PF45HT | | |

position switches

PIZZATO

FA series



| | | | |
|--------------------|-------------------|-----------------|--------------------|
| 1 | | | |
| GEV No. | 345697 | Ref. No. | EG04100 EG04410 |
| description | position switch | | |
| For models: | PF45MTE, PF45MT-E | | |



| | | | |
|--------------------|--|-----------------|---------|
| 1 | | | |
| GEV No. | 345696 | Ref. No. | EG04010 |
| description | position switch cast aluminum 1NO/1NC 400V 3A L 86mm W 30mm H 16mm protection IP67 actuating force: 1000g screw connection mounting distance 20mm thr.ø M12mm cable 1800 thread L 15mm | | |
| For models: | PF45MTE, PF45MT-E | | |

cam switches

on/off

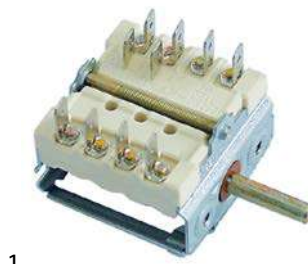

| | | | |
|--------------------|--|-----------------|---------|
| 1 | | | |
| GEV No. | 300139 | Ref. No. | EH01800 |
| description | cam switch ON-OFF connection male faston | | |



rotary switches

BREMAS

A1600 series



1

| | | | |
|---|--|-----------------|----------------------------|
| GEV No. | 345762 | Ref. No. | EH00900 EH00900+AC06200 |
| description | rotary switch 3 1-0-2 sets of contacts 6 type CS0167085 400V 16A shaft \varnothing 5x5mm shaft L 23mm shaft square connection screw | | |
| For models: | 109, 111, 22, 23, 32, 33 380V, 34 380V, 66, 69, 77, 96, 99, R-109-1, R-109-2, R-109-3, R-111-1, R-111-2, R-111-3, R-66-1, R-66-2, R-66-3, R-69-1, R-69-2, R-69-3, R-77-1, R-77-2, R-77-3, R-96-1, R-96-2, R-96-3, R-99-1, R-99-2, R-99-3, S-109-1, S-109-2, S-109-3, S-111-1, S-111-2, S-111-3, S-66-1, S-66-2, S-66-3, S-69-1, S-69-2, S-69-3, S-77-1, S-77-2, S-77-3, S-96-1, S-96-2...(Other models you can see in the webshop) | | |
| accessories for | 345762 | | |
|  | GEV No. | 110932 | Ref. No. AC06200 |
| | knob switch zero mark t.max.°C \varnothing 42mm shaft \varnothing 6x4.6mm shaft flat upper black | | |



1

| | | | |
|--------------------|--|-----------------|-----------|
| GEV No. | 348174 | Ref. No. | OMEH00900 |
| description | rotary switch sets of contacts 6 3 1-0-2 type CA0167085V 400V 16A shaft \varnothing 5x5mm shaft L 23mm shaft square connection screw | | |

A2500 series



1

| | | | |
|--------------------|--|-----------------|---------|
| GEV No. | 346105 | Ref. No. | EH00600 |
| description | rotary switch 2 0-1 sets of contacts 3 type CA0250003V 690V 32A shaft \varnothing 5x5mm shaft L 23mm shaft square connection screw | | |
| For models: | PF45HT | | |

miscellaneous



1

| | | | |
|--------------------|--|-----------------|------------------|
| GEV No. | 300223 | Ref. No. | EH010 EH01000 |
| description | rotary switch 3 1-0-2 500V 25A shaft \varnothing 5x5mm shaft square connection screw ambient temperature max. 75°C | | |

Зип Общежит

magnetic switches

M12x1

vsezip.ru

+7(812)987-08-81



| | | | |
|--------------------|--|-----------------|---------|
| GEV No. | 345698 | Ref. No. | EN06800 |
| description | magnetic switch thread M12x1 1NC 24-240V AC/DCV 0.005-0.2A connection cable cable length 2000mm L 42mm | | |
| For models: | PF45MTE, PF45MT-E | | |

miscellaneous



1

| | | | |
|--------------------|-----------------------|-----------------|------------------|
| GEV No. | 692022 | Ref. No. | EF057 EF05700 |
| description | emergency stop switch | | |

control equipment

MOELLER/EATON

push buttons - signal lamps



1

| | | | |
|---|--|-----------------|---|
| GEV No. | 345705 | Ref. No. | EF05400 EF10000 EF10010 |
| description | push button mounting measurements \varnothing 22mm black tipping | | |
| For models: | PF33MT, PF45MT-E | | |
| accessories for | 345705 | | |
|  | GEV No. | 345707 | Ref. No. EF04010 EF09600 EF09610 |
| | contact block 1NC/1NO | | |

switch blocks



1

| | | | |
|--------------------|-----------------------|-----------------|-------------------------------|
| GEV No. | 345707 | Ref. No. | EF04010 EF09600 EF09610 |
| description | contact block 1NC/1NO | | |
| For models: | PF45MT-E | | |





Зип-Общепит

vsezip.ru

812)987-08-81

| | | | |
|--|-------------------|-----------------|--------------------------------|
|  <p>1</p> | | | |
| GEV No. | 345706 | Ref. No. | EFC4510 EFC9800 EFC09810 |
| description | contact block 1NO | | |
| For models: | PF33MT | | |

| | | | |
|--|-------------------------|-----------------|------------|
|  <p>1</p> | | | |
| GEV No. | 346292 | Ref. No. | 50MAA78015 |
| description | contact block screw 1NO | | |
| For models: | PF33MT | | |

| | | | |
|--|-----------------------------|-----------------|------------|
|  <p>1</p> | | | |
| GEV No. | 346293 | Ref. No. | 50MAA78014 |
| description | contact block holder triple | | |
| For models: | PF33MT | | |

| | | | |
|--|--|-----------------|---------|
| indicator lamp for socket type SRZ / SDK / SDY / SFK | | | |
|  <p>1</p> | | | |
| GEV No. | 359132 | Ref. No. | EL00300 |
| description | indicator lamp green 250V connection male faston 6.3mm protection IP54 ambient temperature max. 85°C | | |

| | | | |
|--|--|-----------------|---------|
| indicator lights (complete) | | | |
| 30x11mm | | | |
|  <p>1</p> | | | |
| GEV No. | 359159 | Ref. No. | EL01200 |
| description | indicator light mounting measurements 30x11mm 230V yellow connection male faston 6.3mm temp.-resist. 125°C | | |

| | | | |
|--|---|-----------------|---------|
|  <p>1</p> | | | |
| GEV No. | 359268 | Ref. No. | EL03500 |
| description | indicator light mounting measurements 30x11mm 400V yellow | | |
| For models: | PF33MT, PF45HT | | |

miscellaneous

| | | | |
|---|---------------|-----------------|------------------|
|  <p>Image not available</p> <p>1</p> | | | |
| GEV No. | 692026 | Ref. No. | EF058 EF05800 |
| description | contact block | | |

screw-on/push-on fit

| | | | |
|---|--|-----------------|---------|
| halogen lamp | | | |
| for socket E14 / E27 | | | |
|  <p>1</p> | | | |
| GEV No. | 359728 | Ref. No. | EL06600 |
| description | halogen lamp socket E14 230V 40W ø 25mm lens L 54mm L 80mm temp.-resist. 300°C Qty 1 | | |

lamps

indicator lights

indicator lights 2-piece (lens and indicator lamp)

indicator light lenses

ø10mm (type SRZ-2)

| | | | |
|--|--|-----------------|---------|
|  <p>1</p> | | | |
| GEV No. | 359358 | Ref. No. | EL00200 |
| description | indicator light housings mounting measurements ø10mm orange square | | |

| | | | |
|---|---|-----------------|------------------|
| for socket G4 / G6.35 / G9 | | | |
|  <p>1</p> | | | |
| GEV No. | 359074 | Ref. No. | EL062 EL06200 |
| description | halogen lamp socket G6.35 12V 35W temp.-resist. 500°C | | |
| For models: | R-109-1, R-109-2, R-109-3, R-111-1, R-111-2, R-111-3, R-66-1, R-66-2, R-66-3, R-69-1, R-69-2, R-69-3, R-77-1, R-77-2, R-77-3, R-96-1, R-96-2, R-96-3, R-99-1, R-99-2, R-99-3, RE-109-1, RE-109-2, RE-109-3, RE-111-1, RE-111-2, RE-111-3, RE-66-1, RE-66-2, RE-66-3, RE-69-1, RE-69-2, RE-69-3, RE-77-1, RE-77-2, RE-77-3, RE-96-1, RE-96-2, RE-96-3, RE-99-1, RE-99-2, RE-99-3, S-109-1, S-109-2, S-109-3, S-111-1, S-111-2, S-111-3, S-66-1, S-66-2...(Other models you can see in the webshop) | | |



electric components



Зип Общепит

vsezip.ru

+7(812)987-08-81

| | | | |
|---|--|-----------------|---------|
|  | | | |
| 1 | | | |
| GEV No. | 359946 | Ref. No. | EL07400 |
| description | halogen lamp socket G9 230V 40W temp.-resist. 300°C | | |
|  | | | |
| 1 | | | |
| GEV No. | 359370 | Ref. No. | EL04000 |
| description | halogen lamp socket G6.35 12V 50W temp.-resist. 300°C ø 10mm L 44mm clear | | |
| For models: | 109, 111, 22, 23, 32, 33 220V, 33 380V, 34 220V, 34 380V, 66, 69, 77, 96, 99, SG22, SG23, SG33 | | |

| | | | |
|--|---|-----------------|---------|
|  | | | |
| 1 | | | |
| GEV No. | 359700 | Ref. No. | AL26600 |
| description | gasket for pizza oven fibre glass ID ø 32.5mm ED ø 55mm thickness 5mm | | |
| For models: | R-109-1, R-109-2, R-109-3, R-111-1, R-111-2, R-111-3, R-66-1, R-66-2, R-66-3, R-69-1, R-69-2, R-69-3, R-77-1, R-77-2, R-77-3, R-96-1, R-96-2, R-96-3, R-99-1, R-99-2, R-99-3, RE-109-1, RE-109-2, RE-109-3, RE-111-1, RE-111-2, RE-111-3, RE-66-1, RE-66-2, RE-66-3, RE-69-1, RE-69-2, RE-69-3, RE-77-1, RE-77-2, RE-77-3, RE-96-1, RE-96-2, RE-96-3, RE-99-1, RE-99-2, RE-99-3, S-109-1, S-109-2, S-109-3, S-111-1, S-111-2, S-111-3, S-66-1, S-66-2...(Other models you can see in the webshop) | | |

oven lamps

universal oven lamps

mounting diameter 35.5mm

| | | | |
|---|--|-----------------|---------|
|  | | | |
| 1 | | | |
| GEV No. | 359427 | Ref. No. | EL073R0 |
| description | lamp socket socket G9 mounting ø 35.5mm connection male faston 6.3mm | | |



producer-specific oven lamps



OEM

| | | | |
|--|---|-----------------|---------|
|  | | | |
| 1 | | | |
| GEV No. | 359700 | Ref. No. | AL26600 |
| description | gasket for pizza oven fibre glass ID ø 32.5mm ED ø 55mm thickness 5mm | | |
| For models: | R-109-1, R-109-2, R-109-3, R-111-1, R-111-2, R-111-3, R-66-1, R-66-2, R-66-3, R-69-1, R-69-2, R-69-3, R-77-1, R-77-2, R-77-3, R-96-1, R-96-2, R-96-3, R-99-1, R-99-2, R-99-3, RE-109-1, RE-109-2, RE-109-3, RE-111-1, RE-111-2, RE-111-3, RE-66-1, RE-66-2, RE-66-3, RE-69-1, RE-69-2, RE-69-3, RE-77-1, RE-77-2, RE-77-3, RE-96-1, RE-96-2, RE-96-3, RE-99-1, RE-99-2, RE-99-3, S-109-1, S-109-2, S-109-3, S-111-1, S-111-2, S-111-3, S-66-1, S-66-2...(Other models you can see in the webshop) | | |

| | | | |
|---|---|-----------------|---------|
|  | | | |
| 1 | | | |
| GEV No. | 359709 | Ref. No. | AL19500 |
| description | oven lamp glass thr.ø 33.5mm ø 42mm hard glas temp.-resist. 350°C | | |

| | | | |
|--|---|-----------------|---------|
|  | | | |
| 1 | | | |
| GEV No. | 359639 | Ref. No. | EL06900 |
| description | lamp socket socket E14 with grip fixing | | |

| | | | |
|---|---|-----------------|-------------------------|
|  | | | |
| 1 | | | |
| GEV No. | 359661 | Ref. No. | AL201 AL20100 |
| description | oven lamp glass thread 32.1 ø 58mm hard glas temp.-resist. 350°C | | |
| For models: | R-109-1, R-109-2, R-109-3, R-111-1, R-111-2, R-111-3, R-66-1, R-66-2, R-66-3, R-69-1, R-69-2, R-69-3, R-77-1, R-77-2, R-77-3, R-96-1, R-96-2, R-96-3, R-99-1, R-99-2, R-99-3, RE-109-1, RE-109-2, RE-109-3, RE-111-1, RE-111-2, RE-111-3, RE-66-1, RE-66-2, RE-66-3, RE-69-1, RE-69-2, RE-69-3, RE-77-1, RE-77-2, RE-77-3, RE-96-1, RE-96-2, RE-96-3, RE-99-1, RE-99-2, RE-99-3, S-109-1, S-109-2, S-109-3, S-111-1, S-111-2, S-111-3, S-66-1, S-66-2...(Other models you can see in the webshop) | | |
| accessories for | 359661 | | |
|  | GEV No. | 359700 | Ref. No. AL26600 |
| | gasket for pizza oven fibre glass ID ø 32.5mm ED ø 55mm thickness 5mm | | |

| | | | |
|--|---|-----------------|-------------------------|
|  | | | |
| 1 | | | |
| GEV No. | 359661 | Ref. No. | AL201 AL20100 |
| description | oven lamp glass thread 32.1 ø 58mm hard glas temp.-resist. 350°C | | |
| For models: | R-109-1, R-109-2, R-109-3, R-111-1, R-111-2, R-111-3, R-66-1, R-66-2, R-66-3, R-69-1, R-69-2, R-69-3, R-77-1, R-77-2, R-77-3, R-96-1, R-96-2, R-96-3, R-99-1, R-99-2, R-99-3, RE-109-1, RE-109-2, RE-109-3, RE-111-1, RE-111-2, RE-111-3, RE-66-1, RE-66-2, RE-66-3, RE-69-1, RE-69-2, RE-69-3, RE-77-1, RE-77-2, RE-77-3, RE-96-1, RE-96-2, RE-96-3, RE-99-1, RE-99-2, RE-99-3, S-109-1, S-109-2, S-109-3, S-111-1, S-111-2, S-111-3, S-66-1, S-66-2...(Other models you can see in the webshop) | | |
| accessories for | 359661 | | |
|  | GEV No. | 359700 | Ref. No. AL26600 |
| | gasket for pizza oven fibre glass ID ø 32.5mm ED ø 55mm thickness 5mm | | |

Зип Общепит



vsezip.ru

7(812)987-08-81



| | | | |
|---|---|-----------------|---------|
|  | | | |
| 1 | | | |
| GEV No. | 698562 | Ref. No. | QAT2200 |
| description | reflector L 120mm W 108mm ø 120mm H 33mm for pizza oven | | |
| For models: | R-109-1, R-109-2, R-109-3, R-111-1, R-111-2, R-111-3, R-66-1, R-66-2, R-66-3, R-69-1, R-69-2, R-69-3, R-77-1, R-77-2, R-77-3, R-96-1, R-96-2, R-96-3, R-99-1, R-99-2, R-99-3, RE-109-1, RE-109-2, RE-109-3, RE-111-1, RE-111-2, RE-111-3, RE-66-1, RE-66-2, RE-66-3, RE-69-1, RE-69-2, RE-69-3, RE-77-1, RE-77-2, RE-77-3, RE-96-1, RE-96-2, RE-96-3, RE-99-1, RE-99-2, RE-99-3, S-109-1, S-109-2, S-109-3, S-111-1, S-111-2, S-111-3, S-66-1, S-66-2...(Other models you can see in the webshop) | | |

| | | | |
|---|---|-----------------|--------------------|
|  | | | |
| 1 | | | |
| GEV No. | 698561 | Ref. No. | HAT6400 HAT6410 |
| description | bracket H 40mm L 178mm W 98mm for lamp | | |
| For models: | R-109-1, R-109-2, R-109-3, R-111-1, R-111-2, R-111-3, R-66-1, R-66-2, R-66-3, R-69-1, R-69-2, R-69-3, R-77-1, R-77-2, R-77-3, R-96-1, R-96-2, R-96-3, R-99-1, R-99-2, R-99-3, RE-109-1, RE-109-2, RE-109-3, RE-111-1, RE-111-2, RE-111-3, RE-66-1, RE-66-2, RE-66-3, RE-69-1, RE-69-2, RE-69-3, RE-77-1, RE-77-2, RE-77-3, RE-96-1, RE-96-2, RE-96-3, RE-99-1, RE-99-2, RE-99-3, S-109-1, S-109-2, S-109-3, S-111-1, S-111-2, S-111-3, S-66-1, S-66-2...(Other models you can see in the webshop) | | |

| | | | |
|---|---|-----------------|---------|
|  | | | |
| 1 | | | |
| GEV No. | 359700 | Ref. No. | AL26600 |
| description | gasket for pizza oven fibre glass ID ø 32.5mm ED ø 55mm thickness 5mm | | |
| For models: | R-109-1, R-109-2, R-109-3, R-111-1, R-111-2, R-111-3, R-66-1, R-66-2, R-66-3, R-69-1, R-69-2, R-69-3, R-77-1, R-77-2, R-77-3, R-96-1, R-96-2, R-96-3, R-99-1, R-99-2, R-99-3, RE-109-1, RE-109-2, RE-109-3, RE-111-1, RE-111-2, RE-111-3, RE-66-1, RE-66-2, RE-66-3, RE-69-1, RE-69-2, RE-69-3, RE-77-1, RE-77-2, RE-77-3, RE-96-1, RE-96-2, RE-96-3, RE-99-1, RE-99-2, RE-99-3, S-109-1, S-109-2, S-109-3, S-111-1, S-111-2, S-111-3, S-66-1, S-66-2...(Other models you can see in the webshop) | | |

| | | | |
|---|---|-----------------|-------------------------|
|  | | | |
| 1 | | | |
| GEV No. | 359320 | Ref. No. | EI03100 EL05600 |
| description | lamp socket 24V socket G6.35 cable length 280mm connection male faston 6.3mm ø 16mm H 10mm mounting distance 26mm holder length 32mm Qty 1 pcs | | |
| For models: | 109, 111, 22, 23, 32, 33 220V, 33 380V, 34 220V, 34 380V, 66, 69, 77, 96, 99, R-109-1, R-109-2, R-109-3, R-111-1, R-111-2, R-111-3, R-66-1, R-66-2, R-66-3, R-69-1, R-69-2, R-69-3, R-77-1, R-77-2, R-77-3, R-96-1, R-96-2, R-96-3, R-99-1, R-99-2, R-99-3, RE-109-1, RE-109-2, RE-109-3, RE-111-1, RE-111-2, RE-111-3, RE-66-1, RE-66-2, RE-66-3, RE-69-1, RE-69-2, RE-69-3, RE-77-1, RE-77-2, RE-77-3...(Other models you can see in the webshop) | | |
| accessories for | 359320 | | |
|  | GEV No. | 359370 | Ref. No. EL04000 |
| | halogen lamp socket G6.35 12V 50W temp.-resist. 300°C ø 10mm L 44mm clear | | |

| | | | |
|---|--|-----------------|------------------|
|  | | | |
| 1 | | | |
| GEV No. | 359661 | Ref. No. | AL201 AL20100 |
| description | oven lamp glass thread 32.1 ø 58mm hard glas temp.-resist. 350°C | | |

| | | | |
|---|---|-----------------|-------------------------|
|  | | | |
| 1 | | | |
| GEV No. | 359661 | Ref. No. | AL201 AL20100 |
| description | oven lamp glass thread 32.1 ø 58mm hard glas temp.-resist. 350°C | | |
| For models: | R-109-1, R-109-2, R-109-3, R-111-1, R-111-2, R-111-3, R-66-1, R-66-2, R-66-3, R-69-1, R-69-2, R-69-3, R-77-1, R-77-2, R-77-3, R-96-1, R-96-2, R-96-3, R-99-1, R-99-2, R-99-3, RE-109-1, RE-109-2, RE-109-3, RE-111-1, RE-111-2, RE-111-3, RE-66-1, RE-66-2, RE-66-3, RE-69-1, RE-69-2, RE-69-3, RE-77-1, RE-77-2, RE-77-3, RE-96-1, RE-96-2, RE-96-3, RE-99-1, RE-99-2, RE-99-3, S-109-1, S-109-2, S-109-3, S-111-1, S-111-2, S-111-3, S-66-1, S-66-2...(Other models you can see in the webshop) | | |
| accessories for | 359661 | | |
|  | GEV No. | 359700 | Ref. No. AL26600 |
| | gasket for pizza oven fibre glass ID ø 32.5mm ED ø 55mm thickness 5mm | | |

| | | | |
|--|---|-----------------|---------|
|  | | | |
| 1 | | | |
| GEV No. | 698562 | Ref. No. | QAT2200 |
| description | reflector L 120mm W 108mm ø 120mm H 33mm for pizza oven | | |
| For models: | R-109-1, R-109-2, R-109-3, R-111-1, R-111-2, R-111-3, R-66-1, R-66-2, R-66-3, R-69-1, R-69-2, R-69-3, R-77-1, R-77-2, R-77-3, R-96-1, R-96-2, R-96-3, R-99-1, R-99-2, R-99-3, RE-109-1, RE-109-2, RE-109-3, RE-111-1, RE-111-2, RE-111-3, RE-66-1, RE-66-2, RE-66-3, RE-69-1, RE-69-2, RE-69-3, RE-77-1, RE-77-2, RE-77-3, RE-96-1, RE-96-2, RE-96-3, RE-99-1, RE-99-2, RE-99-3, S-109-1, S-109-2, S-109-3, S-111-1, S-111-2, S-111-3, S-66-1, S-66-2...(Other models you can see in the webshop) | | |

| | | | |
|--|------------------|-----------------|---------|
|  | | | |
| 1 | | | |
| GEV No. | 359324 | Ref. No. | HAT0110 |
| description | frame for lamp | | |
| For models: | SG22, SG23, SG33 | | |

| | | | |
|--|------------------|-----------------|---------|
|  | | | |
| 1 | | | |
| GEV No. | 359325 | Ref. No. | AL03220 |
| description | gasket | | |
| For models: | SG22, SG23, SG33 | | |

1 electric components



Зип Общепит
vsezip.ru
7(812)987 08 81

| | | | |
|---|--|-----------------|------------------------------|
|  | | | |
| 1 | | | |
| GEV No. | 359323 | Ref. No. | AL04000 AL04000 + AL03220 |
| description | lamp glass with gasket L 154mm W 63mm thickness 8mm | | |
| For models: | 22, 23, 32, 33 220V, 33 380V, 34 220V, 34 380V, SG22, SG23, SG33 | | |

| | | | |
|--|--|-----------------|------------------------------|
|  | | | |
| 1 | | | |
| GEV No. | 359323 | Ref. No. | AL04000 AL04000 + AL03220 |
| description | lamp glass with gasket L 154mm W 63mm thickness 8mm | | |
| For models: | 22, 23, 32, 33 220V, 33 380V, 34 220V, 34 380V, SG22, SG23, SG33 | | |

| | | | |
|---|-----------------------------|-----------------|---------|
|  | | | |
| 1 | | | |
| GEV No. | 359322 | Ref. No. | HAT5910 |
| description | lamp holder for bulb socket | | |
| For models: | SG22, SG23, SG33 | | |

| | | | |
|--|---|-----------------|---------|
|  | | | |
| 1 | | | |
| GEV No. | 359639 | Ref. No. | EL06900 |
| description | lamp socket socket E14 with grip fixing | | |

| | | | |
|---|---|-----------------|----------------------------------|
|  | | | |
| 1 | | | |
| GEV No. | 359320 | Ref. No. | EL03100 EL05600 |
| description | lamp socket 24V socket G6.35 cable length 280mm connection male faston 6.3mm ø 16mm H 10mm mounting distance 26mm holder length 32mm Qty 1 pcs | | |
| For models: | 109, 111, 22, 23, 32, 33 220V, 33 380V, 34 220V, 34 380V, 66, 69, 77, 96, 99, R-109-1, R-109-2, R-109-3, R-111-1, R-111-2, R-111-3, R-66-1, R-66-2, R-66-3, R-69-1, R-69-2, R-69-3, R-77-1, R-77-2, R-77-3, R-96-1, R-96-2, R-96-3, R-99-1, R-99-2, R-99-3, RE-109-1, RE-109-2, RE-109-3, RE-111-1, RE-111-2, RE-111-3, RE-66-1, RE-66-2, RE-66-3, RE-69-1, RE-69-2, RE-69-3, RE-77-1, RE-77-2, RE-77-3...(Other models you can see in the webshop) | | |
| accessories for | 359320 | | |
|  | GEV No. | 359370 | Ref. No. EL04000 |
|  | GEV No. | 359661 | Ref. No. AL201 AL20100 |
| oven lamp glass thread 32.1 ø 58mm hard glas temp.-resist. 350°C | | | |

| | | | |
|---|--|-----------------|---------|
| lamps | | | |
| halogen lamps | | | |
| for socket E14 / E27 | | | |
|  | | | |
| 1 | | | |
| GEV No. | 359728 | Ref. No. | EL06600 |
| description | halogen lamp socket E14 230V 40W ø 25mm lens L 54mm L 80mm temp.-resist. 300°C Qty 1 | | |

| | | | |
|---|---|-----------------|------------------|
| for socket G4 / G6.35 / G9 | | | |
|  | | | |
| 1 500°C | | | |
| GEV No. | 359074 | Ref. No. | EL062 EL06200 |
| description | halogen lamp socket G6.35 12V 35W temp.-resist. 500°C | | |
| For models: | R-109-1, R-109-2, R-109-3, R-111-1, R-111-2, R-111-3, R-66-1, R-66-2, R-66-3, R-69-1, R-69-2, R-69-3, R-77-1, R-77-2, R-77-3, R-96-1, R-96-2, R-96-3, R-99-1, R-99-2, R-99-3, RE-109-1, RE-109-2, RE-109-3, RE-111-1, RE-111-2, RE-111-3, RE-66-1, RE-66-2, RE-66-3, RE-69-1, RE-69-2, RE-69-3, RE-77-1, RE-77-2, RE-77-3, RE-96-1, RE-96-2, RE-96-3, RE-99-1, RE-99-2, RE-99-3, S-109-1, S-109-2, S-109-3, S-111-1, S-111-2, S-111-3, S-66-1, S-66-2...(Other models you can see in the webshop) | | |

| | | | |
|---|------------------|-----------------|---------|
|  | | | |
| 1 | | | |
| GEV No. | 359325 | Ref. No. | AL03220 |
| description | gasket | | |
| For models: | SG22, SG23, SG33 | | |

| | | | |
|---|---|-----------------|---------|
|  | | | |
| 1 | | | |
| GEV No. | 359946 | Ref. No. | EL07400 |
| description | halogen lamp socket G9 230V 40W temp.-resist. 300°C | | |



timers

Зип.Общепит

contactors

vsezip.ru

+7(812)987-08-81

programme timers

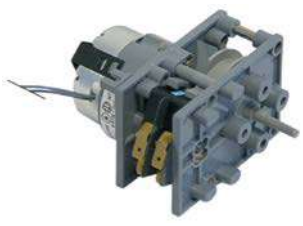

1

| | | | |
|---|--|-----------------|-------------------|
| GEV No. | 360035 | Ref. No. | EC016 |
| description | timer CDC 4902F engines 1 chambers 2 operation time 120s 230V shaft ø 6x4.6mm shaft L 17mm manuf. no. 4902F1 / 3322050 motor type M48L ATS | | |
| spare parts for | 360035 | | |
|  | GEV No. | 360083 | Ref. No. — |
| | motor CDC pinion ø 4.9mm teeth 10 230V turn direction left motor ø 47mm H 19.3mm motor type M48L ATS for timer | | |



1

| | | | |
|---|--|-----------------|-------------------|
| GEV No. | 360040 | Ref. No. | EC030 |
| description | timer CDC 9003F engines 1 chambers 3 operation time 6min 230V shaft ø 6x4.6mm shaft L 21mm manuf. no. 9003F3 / PRCIH5 motor type M48R ATS | | |
| spare parts for | 360040 | | |
|  | GEV No. | 360118 | Ref. No. — |
| | motor CDC pinion ø 4.9mm teeth 10 230V voltage AC 50/60Hz turn direction right motor ø 47mm H 19.3mm motor type M48R ATS for timer cable length 260mm 1.9/2.5W | | |
| accessories for | 360040 | | |
|  | GEV No. | 110197 | Ref. No. — |
| | knob switch zero mark ø 42mm shaft ø 6x4.6mm shaft flat adjustable black | | |

ISKRA (FANAL)

power contactors



1

| | | | |
|--------------------|--|-----------------|--------------------|
| GEV No. | 380204 | Ref. No. | EN00500 EN08200 |
| description | power contactor resistive load 25A 230VAC (AC3/400V) 9A/4kW main contacts 3NO auxiliary contacts 1NO connection screw connection type Fanal DSL9 10 type ISKRA KNL9 10 | | |

LOVATO

power contactors



1

| | | | |
|--------------------|---|-----------------|---------|
| GEV No. | 380914 | Ref. No. | EN13900 |
| description | power contactor resistive load 20A 230VAC (AC3/400V) 9A/4kW main contacts 6NO auxiliary contacts 2NC connection screw connection type 11BGR0901A230 | | |
| For models: | PF45MT-E | | |



1

| | | | |
|---|---|-----------------|--------------------|
| GEV No. | 380855 | Ref. No. | EN00500 EN08200 |
| description | power contactor resistive load 25A 230VAC (AC3/400V) 4.2kW main contacts 3NO auxiliary contacts 1NO | | |
| For models: | 109, 111, 22, 23, 32, 33 380V, 34 380V, 66, 69, 77, 96, 99, PF45HT, PF45MTE, PF45MT-E, R-109-1, R-109-2, R-109-3, R-111-1, R-111-2, R-111-3, R-66-1, R-66-2, R-66-3, R-69-1, R-69-2, R-69-3, R-77-1, R-77-2, R-77-3, R-96-1, R-96-2, R-96-3, R-99-1, R-99-2, R-99-3, S-109-1, S-109-2, S-109-3, S-111-1, S-111-2, S-111-3, S-66-1, S-66-2, S-66-3, S-69-1, S-69-2, S-69-3, S-77-1, S-77-2...(Other models you can see in the webshop) | | |
| accessories for | 380855 | | |
|  | GEV No. | 380055 | Ref. No. — |
| | RC circuit voltage AC/DC suitable for BF09-32 rated 240V | | |

Table continues overleaf

electric components



Зип-Общепит

With Male Contacts

female contact 2.0mm

vsezip.ru

+7(812)987-08-81

| | | | |
|------------------------|---|-----------------|---|
| accessories for | 380855 | | |
| GEV No. | 380118 | Ref. No. | — |
| description | auxiliary contact contacts 1NO/1NC AC1 10A for contactors BF series connection screw type G480/11 | | |

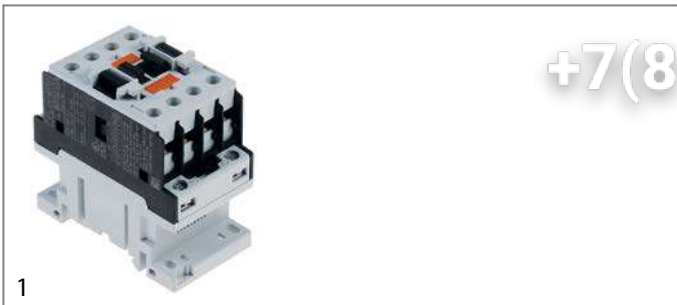

| | | | |
|--------------------|--|-----------------|--------------------|
| GEV No. | 380714 | Ref. No. | EN08200 EN17000 |
| description | power contactor resistive load 25A 230VAC (AC3/400V) 9A/4.2kW main contacts 3NO auxiliary contacts 1NO connection screw connection type BF0910A230 | | |

auxiliary contacts



| | | | |
|--------------------|---|-----------------|---------|
| GEV No. | 380057 | Ref. No. | EN13100 |
| description | auxiliary contact contacts 1NO/1NC AC1 10A for contactors BG series connection screw type BGX1011 | | |
| For models: | PF45MT-E | | |

relays

power relays

with bracket mounting



| | | | |
|--------------------|---|-----------------|---------|
| GEV No. | 380139 | Ref. No. | EN12500 |
| description | power relays FINDER 230VAC 16A 2CO connection F6.3 bracket mounting dimensions 68x38.2x35.8mm manuf. no. 62.82.8.230.0000 | | |

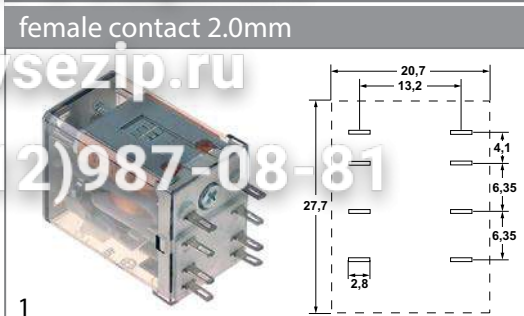

| | | | |
|------------------------|--|-----------------|---------|
| GEV No. | 380377 | Ref. No. | EN01600 |
| description | power relays FINDER 220-240VAC 10A 2CO connection F2 plug-in connection manuf. no. 55.32.8.230.0000 94.92.3 250V | | |
| For models: | PF45HT, PF45MTE, PF45MT-E | | |
| accessories for | 380377 | | |
| GEV No. | 380341 | Ref. No. | — |
| description | relay socket 4-pole contacts 12 300V voltage AC 6A Italiana Relè manuf. no. ZMD4 | | |
| GEV No. | 380378 | Ref. No. | EN01700 |
| description | relay socket 2-pole 55/85 dimensions 70.5x30x27mm 250V voltage AC 10A FINDER manuf. no. 94.72 | | |
| GEV No. | 380384 | Ref. No. | — |
| description | relay socket 2-pole contacts male faston 2.8mm 250V voltage AC 10A W 23mm for | | |
| GEV No. | 380399 | Ref. No. | — |
| description | relay socket 4-pole dimensions 76.2x27x86.1mm 250V voltage AC 1A FINDER manuf. no. 94.94.3 | | |

relay sockets

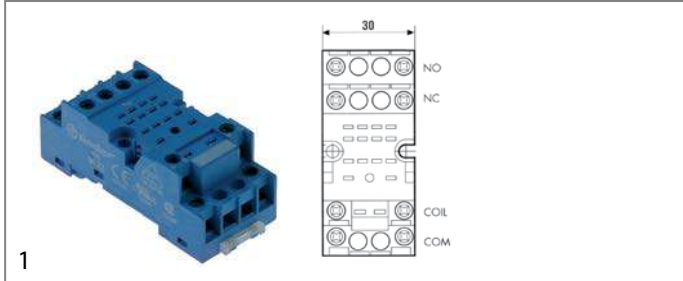



| | | | |
|------------------------|---|-----------------|---------|
| GEV No. | 380378 | Ref. No. | EN01700 |
| description | relay socket 2-pole 55/85 dimensions 70.5x30x27mm 250V voltage AC 10A FINDER manuf. no. 94.72 | | |
| For models: | PF45HT, PF45MTE, PF45MT-E | | |
| accessories for | 380378 | | |
| GEV No. | 380804 | Ref. No. | — |
| description | support bracket | | |



Зип Общепит
encapsulated transformers

PMA
vsezip.ru

+7(812)987-08-81

| | | | |
|---|--|-----------------|-------------------|
|  | | | |
| 1 | | | |
| GEV No. | 380137 | Ref. No. | EC02700 |
| description | relay socket 8-pole connection plug-in connection round 8-pole dimensions 65x28x40mm 380V voltage AC 10A Italiana Relè manuf. no. ZVE8 | | |
| For models: | PF33MT, PF45HT | | |
| accessories for | 380137 | | |
|  | GEV No. | 380805 | Ref. No. — |
| support bracket | | | |

| | | | |
|--|---|-----------------|---------|
|  | | | |
| 1 | | | |
| GEV No. | 379054 | Ref. No. | EH03200 |
| description | transformer primary 230VAC secondary 12VAC 3VA secondary 0.25A H 40mm L 45mm W 50mm connection screw 50/60Hz type 153/M | | |
| For models: | PF45MTE | | |

time relays

time relays

| | | | |
|--|---|-----------------|---------|
|  | | | |
| 1 | | | |
| GEV No. | 360693 | Ref. No. | EC03900 |
| description | time relay CDC Sc.741 time range 3s-60min 48-230V mounting measurements 35x35mm connection P.35.002 | | |
| For models: | PF33MT, PF45HT | | |

transformers

toroidal core transformers







| | | | |
|---|---|-----------------|-------------------------------|
|  | | | |
| 1 | | | |
| GEV No. | 101028 | Ref. No. | EH03300 EH04500 EH04510 |
| description | transformer primary 0-230VAC secondary 0-12VAC 50VA H 30mm L 80mm W 80mm connection grip connection 50/60Hz type 147340F for ignition | | |
| For models: | R-109-1, R-109-2, R-109-3, R-111-1, R-111-2, R-111-3, R-66-1, R-66-2, R-66-3, R-69-1, R-69-2, R-69-3, R-77-1, R-77-2, R-77-3, R-96-1, R-96-2, R-96-3, R-99-1, R-99-2, R-99-3, RE-109-1, RE-109-2, RE-109-3, RE-111-1, RE-111-2, RE-111-3, RE-66-1, RE-66-2, RE-66-3, RE-69-1, RE-69-2, RE-69-3, RE-77-1, RE-77-2, RE-77-3, RE-96-1, RE-96-2, RE-96-3, RE-99-1, RE-99-2, RE-99-3, S-109-1, S-109-2, S-109-3, S-111-1, S-111-2, S-111-3, S-66-1, S-66-2...(Other models you can see in the webshop) | | |

electronic controllers

ELIWELL

universal controllers

built-in version

| | | | |
|---|--|-----------------|-------------------|
|  | | | |
| 1 | | | |
| GEV No. | 379568 | Ref. No. | ED051 ED077 |
| description | electronic controller ELIWELL type ICPlus915 model ICP22JI750000 mounting measurements 71x29mm 230V voltage AC Pt100/TC (J,K) relay outputs 2 CO-8A(4) CO-8A(4) Pt100/TC (J,K,S) DI front measurements 78x37mm built-in depth 60mm mode of operation cooking protection IPx0 accuracy 1% built-in version defr. funct. no -150 to 1350°C display 3½ digits | | |
| accessories for | 379568 | | |
|  | GEV No. | 378065 | Ref. No. — |
| | alarm device AKO type AKO-520641 mounting measurements 214x214mm 230V voltage AC relay outputs 1 CO-8A(4) up to 4 front measurements 222x222mm yes yes | | |
|  | GEV No. | 378074 | Ref. No. — |
| | temperature probe thermocouple J (Fe-CuNi) cable Vetrotex probe -50 up to +750°C cable -50 up to +350°C probe ø3x100mm cable length 3m without screw connection 2-wire | | |
|  | GEV No. | 378075 | Ref. No. — |
| | temperature probe thermocouple K (NiCr-Ni) cable Vetrotex probe -50 up to 1150°C cable -50 up to +350°C probe ø4.5x150mm cable length 3m without screw connection 2-wire | | |
|  | GEV No. | 379050 | Ref. No. — |
| | temperature probe Pt100 cable Vetrotex probe -200 up to +600°C cable -50 up to +350°C probe ø6x100mm cable length 2.7m without screw connection 3-wire | | |
|  | GEV No. | 379062 | Ref. No. — |
| | temperature probe thermocouple J (Fe-CuNi) cable Vetrotex probe -50 up to +750°C cable -50 up to +350°C probe ø6x50mm cable length 3m without screw connection 2-wire | | |



Зип.Общепит

probes

refrigeration controllers

built-in version



| | | | |
|--------------------|--|-----------------|--------------------|
| 1 | | | |
| GEV No. | 379018 | Ref. No. | ED05100 ED07700 |
| description | electronic controller ELIWELL type EWPC902T thermocouple J | | |
| For models: | PF45MT-E, R-109-1, R-109-2, R-109-3, R-111-1, R-111-2, R-111-3, R-66-1, R-66-2, R-66-3, R-69-1, R-69-2, R-69-3, R-77-1, R-77-2, R-77-3, R-96-1, R-96-2, R-96-3, R-99-1, R-99-2, R-99-3, S-109-1, S-109-2, S-109-3, S-111-1, S-111-2, S-111-3, S-66-1, S-66-2, S-66-3, S-69-1, S-69-2, S-69-3, S-77-1, S-77-2, S-77-3, S-96-1, S-96-2, S-96-3, S-99-1, S-99-2, S-99-3 | | |

PIXSYS

universal controllers

built-in version



| | | | |
|--------------------|---|-----------------|---------|
| 1 | | | |
| GEV No. | 379857 | Ref. No. | ED01800 |
| description | electronic controller PIXSYS type ATR150-2AB mounting measurements 66.5x66.5mm 24/230V voltage AC PTC/Pt100/TC(J/K/S) relay outputs 1 relay defr. funct. no display 4 digits TempIn1 yes 8A | | |
| For models: | 22, 23, 32, 33, 34 | | |

SHANGFANG

accessories



| | | | |
|--------------------|---|-----------------|---------|
| 1 | | | |
| GEV No. | 379054 | Ref. No. | EH03200 |
| description | transformer primary 230VAC secondary 12VAC 3VA secondary 0.25A H 40mm L 45mm W 50mm connection screw 50/60Hz type 153/M | | |
| For models: | PF45MTE | | |

producer-specific probes

vsezip.ru

probes

+7(812)987-08-81



Image not available

| | | | |
|--------------------|---------------------|-----------------|---------|
| 1 | | | |
| GEV No. | 379457 | Ref. No. | EO23200 |
| description | extension for probe | | |
| For models: | PF45MTE | | |



| | | | |
|--------------------|--|-----------------|---------|
| 1 | | | |
| GEV No. | 378457 | Ref. No. | ED08320 |
| description | temperature probe Pt1000 cable silicone probe -100 up to 450°C cable -50 up to +180°C connection plug thread probe ø3x280mm cable length 1.95m | | |



Image not available

| | | | |
|--------------------|--|-----------------|---------|
| 1 | | | |
| GEV No. | 379000 | Ref. No. | ED07100 |
| description | temperature probe thermocouple J (Fe-CuNi) cable red/blue cable length 0.7m probe ø 2mm probe L 2000mm | | |



| | | | |
|--------------------|--|-----------------|--------------------|
| 1 | | | |
| GEV No. | 379451 | Ref. No. | ED01900 ED06500 |
| description | temperature probe thermocouple J cable silicone probe -50 up to 1150°C cable -50 up to +180°C connection 2-wire thread probe ø2x250mm cable length 1.5m | | |
| For models: | 109, 111, 66, 69, 77, 96, 99, R-109-1, R-109-2, R-109-3, R-111-1, R-111-2, R-111-3, R-66-1, R-66-2, R-66-3, R-69-1, R-69-2, R-69-3, R-77-1, R-77-2, R-77-3, R-96-1, R-96-2, R-96-3, R-99-1, R-99-2, R-99-3, RE-109-1, RE-109-2, RE-109-3, RE-111-1, RE-111-2, RE-111-3, RE-66-1, RE-66-2, RE-66-3, RE-69-1, RE-69-2, RE-69-3, RE-77-1, RE-77-2, RE-77-3, RE-96-1, RE-96-2, RE-96-3, RE-99-1, RE-99-2, RE-99-3, S-109-1...(Other models you can see in the webshop) | | |



| | | | |
|--------------------|--|-----------------|--------------------|
| 1 | | | |
| GEV No. | 379454 | Ref. No. | ED05200 ED06600 |
| description | temperature probe thermocouple K (NiCr-Ni) cable silicone probe -50 up to 1150°C cable -50 up to +180°C connection male faston thread probe ø2x250mm cable length 2.5m | | |
| For models: | PF45MTE, PF45MT-E | | |



electronics

Зип-Общепит

Телефон

vsezip.ru

+7(812)987-08-81

PCBs



1

| | | | |
|--------------------|---|-----------------|-------------------------------|
| GEV No. | 403457 | Ref. No. | HE185 HE18500 OMHE23400 |
| description | main PCB pizza oven 430DS L 91mm W 84mm suitable for OEM 230V | | |



1

| | | | |
|--------------------|--------------------|-----------------|---------|
| GEV No. | 400576 | Ref. No. | HE05600 |
| description | Triac | | |
| For models: | 22, 23, 32, 33, 34 | | |



1

| | | | |
|--------------------|--------|-----------------|--------------------|
| GEV No. | 401631 | Ref. No. | SR8H000 SR8H510 |
| description | PCB | | |

central units



1

| | | | |
|--------------------|------------------|-----------------|------------|
| GEV No. | 401092 | Ref. No. | 50PAA78246 |
| description | control box 400V | | |



1

| | | | |
|--------------------|--------|-----------------|---------|
| GEV No. | 401939 | Ref. No. | HE12400 |
| description | PCB | | |

keypads

membrane keypads



1

| | | | |
|--------------------|---------------------------|-----------------|----------|
| GEV No. | 401420 | Ref. No. | 96.00364 |
| description | membrane keypad 6 buttons | | |



Image not available

1

| | | | |
|--------------------|--------|-----------------|------------------|
| GEV No. | 692023 | Ref. No. | R3H00 R3H0000 |
| description | PCB | | |

solenoid valves

solenoid valves (gas)

ASCO



1

| | | | |
|--------------------|--|-----------------|---------|
| GEV No. | 101378 | Ref. No. | EB01800 |
| description | solenoid valve 2-ways 230VAC connection 1/2" L 58mm Asco p max 0.14bar slide-on receptacle DIN gas | | |
| For models: | SG22, SG23, SG33 | | |

electric components



Зип.Общепит

motors
vsezip.ru
universal

+7(812)987-08-81

electric components

pressure switches

for warewashing

ø 58mm with male faston 6.3mm

with connection horizontal



| | | | |
|--------------------|---|-----------------|-------|
| GEV No. | 541011 | Ref. No. | EI002 |
| description | pressure control pressure range 110/70mbar connection 6mm ø 58mm pressure connection horizontal warewashing | | |



| | | | |
|--------------------|--|-----------------|-------|
| GEV No. | 541010 | Ref. No. | EI001 |
| description | pressure control pressure range 50/30mbar connection 6mm ø 58mm pressure connection horizontal warewashing | | |

fans

axial fans

import



| | | | |
|--------------------|--|-----------------|---------|
| GEV No. | 601080 ¹ | Ref. No. | ES22700 |
| description | axial fan L 119mm W 119mm H 38mm 230VAC 50/60Hz 23/20W bearing ball bearing connection male faston 2.8mm metal ADDA fan wheel ø 110mm temp.-resist. 70°C | | |

| | | | | |
|------------------------|--|--------|-----------------|---|
| accessories for | 601080 | | | |
| | GEV No. | 550898 | Ref. No. | — |
| | connecting cable cable length 2000mm connection F 2.8 connection distance 7.9mm for axial flow fan | | | |
| | GEV No. | 692519 | Ref. No. | — |
| | guard L 120mm W 120mm plastic | | | |

¹with ball bearings

motors



| | | | |
|--------------------|---|-----------------|---------|
| GEV No. | 501371 | Ref. No. | ES11200 |
| description | motor 250W 230/400V 50Hz 3 phase shaft ø 11mm flange ø 140mm 1400rpm type 63 BA.M.E. flange B5 0.25kW | | |
| For models: | PF33MT | | |

pumps

wash and rinse pumps

FIR

pumps



| | | | |
|--------------------|--|-----------------|-------|
| GEV No. | 500037 | Ref. No. | EA009 |
| description | pump inlet ø 28mm outlet ø 26mm type 2211.1410 230V 50Hz 1 phase 0.074kW 0.1HP L 190mm rotation direction left capacitor 5µF FIR | | |







| | | | | |
|------------------------|--|--------|-----------------|---|
| spare parts for | 500037 | | | |
| | GEV No. | 365017 | Ref. No. | — |
| | operating capacitor capacity 5µF 450V tolerance 5% 50/60Hz ambient temperature max. -25 to +85°C ø 28mm L 54mm M8 plastic connection male faston 6.3mm 16.10.08 protection | | | |
| | GEV No. | 510384 | Ref. No. | — |
| | pump cover inlet ø 28mm outlet ø 26mm ø 100mm ID ø 76mm | | | |
| | GEV No. | 510695 | Ref. No. | — |
| | mechanical shaft seal height counter ring 5.5mm ID ø 11mm | | | |
| | GEV No. | 521203 | Ref. No. | — |
| | impellor ø 72mm H 18mm thread M7 shaft ø 11mm shaft length 32mm blades 3 | | | |
| | GEV No. | 521703 | Ref. No. | — |
| | pump cover gasket EPDM thickness 2.5mm ID ø 75mm Qty 1 pcs | | | |



Зип Общепит
vsezip.ru
+7(812)987-0987



1

| | | | |
|---|--|-----------------|-------------------|
| GEV No. | 500038 | Ref. No. | EA003 |
| description | pump inlet ø 45mm outlet ø 40mm type 3911.1425 230V 50Hz 1 phase 0.55kW 0.75HP L 205mm rotation direction right capacitor 10µF FIR | | |
| spare parts for | 500038 | | |
|  | GEV No. | 365015 | Ref. No. — |
| | operating capacitor capacity 10µF 400V tolerance 5%Hz ambient temperature max. -25 to +85°C ø 35.5mm L 59mm M8 plastic connection male faston 6.3mm protection | | |
|  | GEV No. | 510508 | Ref. No. — |
| | pump cover FIR inlet ø 45mm outlet ø 40mm pump type PU 0.5/3911 turn direction right ø 160mm ID ø 125mm inner height 25mm | | |
|  | GEV No. | 510610 | Ref. No. — |
| | impellor ø 95.5mm H 23mm shaft intake ø 9/8mm rotation direction right seat ø 16mm blades 6 | | |
|  | GEV No. | 510692 | Ref. No. — |
| | mechanical shaft seal for shaft ø 11mm slide ring ext. ø 24mm slide ring H 13mm counter ring mounting ø 26mm height counter ring 8mm counter ring int. ø 14mm | | |
|  | GEV No. | 521702 | Ref. No. — |
| | pump cover gasket thickness 3.5x4.5mm Qty 1 pcs | | |
| accessories for | 500038 | | |
|  | GEV No. | 551286 | Ref. No. — |
| | adapter L 120mm 4-pole for Meiko pump suitable for 500038 plug type dependent on equipment | | |

fuses

fine fuses

fine fuse holders



1

| | | | |
|--------------------|--------------------|-----------------|---------|
| GEV No. | 550537 | Ref. No. | HE05800 |
| description | fuse holder | | |
| For models: | 22, 23, 32, 33, 34 | | |

| | | | |
|--------------------|---|-----------------|---------|
| GEV No. | 358383 | Ref. No. | HE05800 |
| description | fuse holder suitable fuse ø5.20mm ø 13.1mm 10A rated 250V connection soldering connection | | |

gas taps

PEL

21N series



1

| | | | |
|---|--|-----------------|-------------------|
| GEV No. | 101894 | Ref. No. | GA11600 |
| description | gas tap PEL type 21N gas inlet M16x1.5 (tube ø 10mm) bypass nozzle ø 0mm gas outlet M16x1.5 (tube ø 10/8mm) thermocouple connection pilot connection closed shaft ø 8x6.5mm shaft L 23/15mm shaft flat upper | | |
| spare parts for | 101894 | | |
|  | GEV No. | 100551 | Ref. No. — |
| | bypass nozzle type PEL20/21 bore ø 0.6mm thread M5x0.5 | | |
|  | GEV No. | 101205 | Ref. No. — |
| | gas tap front part shaft ø 8x6.5mm shaft L 22/15mm shaft flat upper/lower suitable for PEL20 | | |
| accessories for | 101894 | | |
|  | GEV No. | 101278 | Ref. No. — |
| | olive for pipe ø 10mm Qty 1 pcs | | |
|  | GEV No. | 101300 | Ref. No. — |
| | union nut thread M16x1.5 tube ø 10mm | | |
|  | GEV No. | 101450 | Ref. No. — |
| | olive for pipe ø 8mm L 12.7mm Qty 1 pcs ED ø 10mm | | |
|  | GEV No. | 101451 | Ref. No. — |
| | union nut thread M16x1.5 tube ø 8mm | | |
|  | GEV No. | 110081 | Ref. No. — |
| | knob ø 70mm shaft ø 8x6.5mm shaft flat universal | | |
|  | GEV No. | 110083 | Ref. No. — |
| | knob dial plate gas tap without ignition flame silver | | |

22S/O series

| | | | |
|---|---|-----------------|-------------------|
|  | | | |
| GEV No. | 101086 | Ref. No. | GA0530U |
| description | gas tap PEL type 22S/O gas inlet M20x1.5 (tube ø 12mm) bypass nozzle ø 0.35mm gas outlet M20x1.5 (tube ø 12/10mm) thermocouple connection M9x1 pilot connection M10x1 shaft ø 10x8mm shaft L 25/17mm shaft flat lower | | |
| For models: | SG22, SG23, SG33 | | |
| spare parts for | 101086 | | |
|  | GEV No. | 100259 | Ref. No. — |
| | bypass nozzle type PEL22 bore ø 0.35mm thread M6x0.5 | | |
|  | GEV No. | 101058 | Ref. No. — |
| | magnet unit L 39mm D1 ø 15.4mm D2 ø 13.5mm suitable for PEL22/EGA24197 standard | | |
|  | GEV No. | 101201 | Ref. No. — |
| | gas tap front part shaft ø 10x8mm shaft L 25/17mm shaft flat upper/lower suitable for PEL22 | | |
|  | GEV No. | 101231 | Ref. No. — |
| | thermocouple nut T1: M9x1 T2: M18x1 | | |
|  | GEV No. | 101240 | Ref. No. — |
| | gas connection thread M20x1.5 tube ø 12/10mm for PEL gas taps with gasket and screws horizontal | | |
|  | GEV No. | 101460 | Ref. No. — |
| | O-ring ø 12.37mm D1 ø 2.62mm suitable for PEL22 | | |
|  | GEV No. | 101461 | Ref. No. — |
| | screw kit suitable for PEL22 Qty 4 pcs | | |
| accessories for | 101086 | | |
|  | GEV No. | 100908 | Ref. No. — |
| | union screw thread M10x1 for pipe ø 4mm Qty 1 pcs | | |
|  | GEV No. | 100909 | Ref. No. — |
| | union screw thread M10x1 for pipe ø 6mm Qty 1 pcs | | |
|  | GEV No. | 101241 | Ref. No. — |
| | gas connection thread M20x1.5 tube ø 12/10mm for PEL gas taps vertical | | |
|  | GEV No. | 101246 | Ref. No. — |
| | olive for pipe ø 4mm Qty 1 pcs | | |
|  | GEV No. | 101248 | Ref. No. — |
| | olive for pipe ø 12mm Qty 1 pcs suitable for PEL | | |
|  | GEV No. | 101249 | Ref. No. — |
| | olive for pipe ø 10mm Qty 1 pcs | | |
|  | GEV No. | 101250 | Ref. No. — |
| | union nut thread M20x1.5 for pipe ø 10mm | | |
|  | GEV No. | 101251 | Ref. No. — |
| | union nut thread M20x1.5 for pipe ø 12mm | | |
|  | GEV No. | 101286 | Ref. No. — |
| | olive ID ø 6mm Qty 1 pcs | | |

Зип-Общепит

vsezip.ru

+7(812)987-08-81

| | | | |
|--------------------|---|-----------------|---|
| GEV No. | 110080 | Ref. No. | — |
| description | knob ø 70mm shaft ø 10x8mm shaft flat universal | | |
| GEV No. | 112206 | Ref. No. | — |
| description | knob dial plate silver gas tap PEL21/22/23 t.max.°C ED ø 63mm ID ø 45.5mm | | |















| | | | |
|---|--|-----------------|-------------------|
|  | | | |
| GEV No. | 101510 | Ref. No. | GA053 |
| description | gas tap PEL type 22S/O gas inlet M20x1.5 (tube ø 12mm) bypass nozzle ø 0mm gas outlet M20x1.5 (tube ø 12/10mm) thermocouple connection M9x1 pilot connection M10x1 shaft ø 10x8mm shaft L 25/17mm shaft flat lower | | |
| spare parts for | 101510 | | |
|  | GEV No. | 101058 | Ref. No. — |
| | magnet unit L 39mm D1 ø 15.4mm D2 ø 13.5mm suitable for PEL22/EGA24197 standard | | |
|  | GEV No. | 101201 | Ref. No. — |
| | gas tap front part shaft ø 10x8mm shaft L 25/17mm shaft flat upper/lower suitable for PEL22 | | |
|  | GEV No. | 101231 | Ref. No. — |
| | thermocouple nut T1: M9x1 T2: M18x1 | | |
|  | GEV No. | 101240 | Ref. No. — |
| | gas connection thread M20x1.5 tube ø 12/10mm for PEL gas taps with gasket and screws horizontal | | |
|  | GEV No. | 101460 | Ref. No. — |
| | O-ring ø 12.37mm D1 ø 2.62mm suitable for PEL22 | | |
|  | GEV No. | 101461 | Ref. No. — |
| | screw kit suitable for PEL22 Qty 4 pcs | | |
| accessories for | 101510 | | |
|  | GEV No. | 100908 | Ref. No. — |
| | union screw thread M10x1 for pipe ø 4mm Qty 1 pcs | | |
|  | GEV No. | 100909 | Ref. No. — |
| | union screw thread M10x1 for pipe ø 6mm Qty 1 pcs | | |
|  | GEV No. | 101241 | Ref. No. — |
| | gas connection thread M20x1.5 tube ø 12/10mm for PEL gas taps vertical | | |
|  | GEV No. | 101246 | Ref. No. — |
| | olive for pipe ø 4mm Qty 1 pcs | | |
|  | GEV No. | 101248 | Ref. No. — |
| | olive for pipe ø 12mm Qty 1 pcs suitable for PEL | | |
|  | GEV No. | 101249 | Ref. No. — |
| | olive for pipe ø 10mm Qty 1 pcs | | |
|  | GEV No. | 101250 | Ref. No. — |
| | union nut thread M20x1.5 for pipe ø 10mm | | |

Table continues overleaf



| accessories for | | 101510 | |
|---|----------|----------|---|
| GEV No. | Ref. No. | Ref. No. | — |
|  | 101251 | Ref. No. | — |
| union nut thread M20x1.5 for pipe ø 12mm | | | |
|  | 101286 | Ref. No. | — |
| olive ID ø 6mm Qty 1 pcs | | | |
|  | 110080 | Ref. No. | — |
| knob ø 70mm shaft ø 10x8mm shaft flat universal | | | |
|  | 112206 | Ref. No. | — |
| knob dial plate silver gas tap PEL21/22/23 t.max.°C ED ø 63mm ID ø 45.5mm | | | |

23S/O series



| GEV No. | Ref. No. | Ref. No. | GA05800 |
|--|----------|----------|---------|
| description | | | |
| gas tap PEL type 23S/O gas inlet M28x1.5 (tube ø 20mm) bypass nozzle ø 0.35mm gas outlet M24x1.5 (tube ø 16/12mm) thermocouple connection M10x1 pilot connection M10x1 shaft ø 10x8mm shaft L 25/17mm shaft flat lower | | | |
| spare parts for | | | |
|  | 100455 | Ref. No. | — |
| bypass nozzle type PEL23/24 bore ø 0.35mm thread M8x0.5 | | | |
|  | 101059 | Ref. No. | — |
| magnet unit T1: M10x1 T2: M22x1 L 46mm ø 18mm suitable for PEL23S M10x1 | | | |
|  | 101204 | Ref. No. | — |
| gas tap front part shaft ø 10x8mm shaft L 25/17mm shaft flat upper/lower suitable for PEL23S | | | |
|  | 101244 | Ref. No. | — |
| gas connection thread M24x1.5 tube ø 12/16mm horizontal for PEL gas taps | | | |
|  | 101463 | Ref. No. | — |
| screw suitable for PEL23S Qty 4 pcs | | | |
|  | 528455 | Ref. No. | — |
| O-ring Viton thickness 2.62mm ID ø 18.72mm Qty 1 pcs | | | |
| accessories for | | 106033 | |
|  | 101252 | Ref. No. | — |
| union nut thread M24x1.5 for pipe ø 12mm | | | |
|  | 101253 | Ref. No. | — |
| union nut thread M24x1.5 PEL for pipe ø 16mm | | | |
|  | 101254 | Ref. No. | — |
| union nut thread M28x1.5 tube ø 20mm | | | |
|  | 101255 | Ref. No. | — |
| olive for pipe ø 12mm Qty 1 pcs | | | |
|  | 101256 | Ref. No. | — |
| olive for pipe ø 16mm Qty 1 pcs | | | |

| accessories for | | 106033 | |
|---|----------|----------|---|
| GEV No. | Ref. No. | Ref. No. | — |
|  | 101257 | Ref. No. | — |
| olive for pipe ø 20mm Qty 1 pcs | | | |

gas valves and ignition boxes
gas solenoid valves

ASCO



| GEV No. | Ref. No. | Ref. No. | EB01800 |
|--|----------|----------|---------|
| description | | | |
| solenoid valve 2-ways 230VAC connection 1/2" L 58mm Asco p max 0.14bar slide-on receptacle DIN gas | | | |
| For models: | | | |
| SG22, SG23, SG33 | | | |

ignition parts

pilot burners

POLIDORO

pilot burners



| GEV No. | Ref. No. | Ref. No. | GA11100 |
|--|----------|----------|---------|
| description | | | |
| pilot burner POLIDORO 2 flames code gas connection 6mm | | | |

electrodes



| GEV No. | Ref. No. | Ref. No. | GA01400 GA01410 |
|--|----------|----------|--------------------|
| description | | | |
| ignition electrode flange length 23mm flange width 15mm D1 ø 7mm L1 28mm L2 18mm L3 23mm L4 14mm BL1 21mm BL2 28mm fixing dimensions ø5x4mm with flange connection ø 4mm | | | |
| For models: | | | |
| SG22, SG23 | | | |

Зип.Общепит

gas burners

bar burners

vsezip.ru

bar burners

+7(812)987-08-81



1

| | | | |
|--------------------|---|-----------------|---------|
| GEV No. | 102491 | Ref. No. | GA29900 |
| description | ignition electrode flange length 40mm flange width 19mm D1 ø 9.4mm L1 52mm BL1 50mm BL2 60mm connection male faston 2.8mm | | |

ignition units



1

| | | | |
|--------------------|-------------------------|-----------------|---------|
| GEV No. | 101026 | Ref. No. | EH02100 |
| description | ignition unit outputs 4 | | |
| For models: | SG22, SG23, SG33 | | |

ignition switches



1

| | | | |
|--------------------|--|-----------------|----------------------|
| GEV No. | 101029 | Ref. No. | EF04800+EF04900+5000 |
| description | momentary push switch mounting ø 16mm white 1NO 250V 16A connection male faston 6.3mm protection IP40 ambient temperature max. 150°C | | |

thermocouples

plug-in thermocouples

plug-in thermocouples standard

with barrel socket ø6(6.5)mm

thermocouples SIT

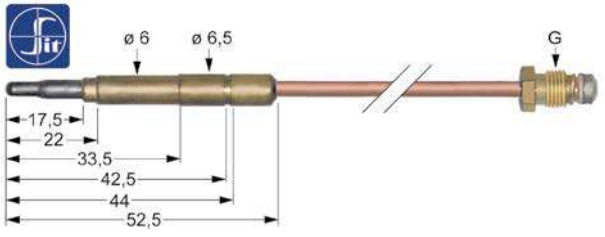

1

| | | | |
|--------------------|--|-----------------|---------|
| GEV No. | 107612 | Ref. No. | GA24100 |
| description | thermocouple SIT M9x1 L 1000mm plug connection ø6.0(6.5)mm | | |

1

| | | | |
|--------------------|---|-----------------|---------|
| GEV No. | 105234 | Ref. No. | GA00800 |
| description | bar burner ø 25mm Wmm Hmm L 1047mm pizza oven | | |
| For models: | SG33 | | |



1

| | | | |
|--------------------|--|-----------------|------------------|
| GEV No. | 105116 | Ref. No. | GA007 GA00700 |
| description | bar burner ø 25mm Wmm Hmm L 740mm pizza oven | | |
| For models: | SG22, SG23 | | |



1

| | | | |
|--------------------|---|-----------------|---------|
| GEV No. | 105199 | Ref. No. | GA07200 |
| description | bar burner ø 50mm Wmm Hmm L 520mm flange width 57mm flange length 57mm pizza oven | | |
| For models: | SG22 | | |



1

| | | | |
|--------------------|---|-----------------|---------|
| GEV No. | 105201 | Ref. No. | GA07100 |
| description | bar burner ø 50mm Wmm Hmm L 800mm flange width 57mm flange length 57mm pizza oven | | |
| For models: | SG23, SG33 | | |



ceramic burners

3ip Общепит
for dough mixers

vsezip.ru

+7(812)987-08-81

accessories

burner grids



1

| | | | |
|--------------------|---------------------------|-----------------|---------|
| GEV No. | 101511 | Ref. No. | KB61110 |
| description | burner grid L 41mm W 16mm | | |
| For models: | SG22, SG23, SG33 | | |

sealing strips



1

| | | | |
|--------------------|--|-----------------|--------------------|
| GEV No. | 101513 | Ref. No. | AL13600 AL13610 |
| description | sealing strip L 230/310mm W 20mm thickness 3mm fibre glass | | |
| For models: | SG22 | | |



1

| | | | |
|--------------------|--|-----------------|--------------------------------|
| GEV No. | 101512 | Ref. No. | 52.00066 AL13500 AL13510 |
| description | sealing strip L 550mm W 20mm thickness 3mm fibre glass | | |
| For models: | SG23, SG33 | | |

ceramic plates

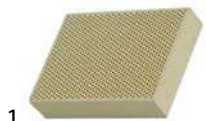

1

| | | | |
|--------------------|------------------------------------|-----------------|---------|
| GEV No. | 101514 | Ref. No. | GA02600 |
| description | ceramic plate L 68mm W 48mm H 13mm | | |
| For models: | SG22, SG23, SG33 | | |

equipment-specific units

for vegetable slicers

ejector discs

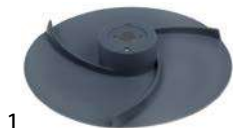

1

| | | | |
|--------------------|---|-----------------|------------|
| GEV No. | 699110 | Ref. No. | 50SCA78300 |
| description | ejector disc flat H 10mm ø 200mm seat ø 50mm shaft diameter 19mm hole distance 39mm | | |

drive shafts



1

| | | | |
|--------------------|---|-----------------|---------------------------------|
| GEV No. | 692036 | Ref. No. | AOEMKE100 KE10000 KE10020 |
| description | drive shaft D1 ø 29mm for dough hook ø 20mm with flange L 140mm thread M10 D2 ø 100mm | | |
| For models: | R201M/T | | |

spacer rings



1

| | | | |
|--------------------|------------------------------------|-----------------|--------------------|
| GEV No. | 692028 | Ref. No. | AE03100 AE03120 |
| description | spacer bush ø 27mm ID ø 21mm H 7mm | | |



1

| | | | |
|--------------------|---|-----------------|--------------------|
| GEV No. | 692031 | Ref. No. | AE14700 AE14720 |
| description | spacer bush ø 30mm D1 ø 25mm ID ø 21mm H 10.6mm | | |



1

| | | | |
|--------------------|---|-----------------|------|
| GEV No. | 697990 | Ref. No. | AE75 |
| description | spacer ring ø 35mm ID ø 31mm H 11mm zinc-coated steel | | |



1

| | | | |
|--------------------|---|-----------------|------|
| GEV No. | 697991 | Ref. No. | AE76 |
| description | spacer ring ø 37mm ID ø 30.5mm H 20mm zinc-coated steel | | |

dough hooks

with mounting groove



1

| | | | |
|--------------------|---|-----------------|---------------|
| GEV No. | 697312 | Ref. No. | AH095 AH10 |
| description | dough hook shaft \varnothing 30mm usable height 435mm | | |

bearing blocks



1

| | | | |
|--------------------|---------------|-----------------|---------|
| GEV No. | 692038 | Ref. No. | KE16510 |
| description | bearing block | | |



1

| | | | |
|--------------------|--|-----------------|--------------------|
| GEV No. | 692032 | Ref. No. | KE02600 KE02620 |
| description | bearing block mounting pos. upper int. \varnothing 1 42mm int. \varnothing 2 47mm H 60mm | | |

for dough dividers



1

| | | | |
|--------------------|---|-----------------|------|
| GEV No. | 690884 | Ref. No. | AH23 |
| description | divider funnel portions of 120-160g \varnothing 135mm L 160mm mounting distance 180mm | | |

Зип Общепит

vsezip.ru

+7(812)987-08-81



1

| | | | |
|--------------------|---|-----------------|------|
| GEV No. | 690885 | Ref. No. | AH24 |
| description | divider funnel portions of 150-190g \varnothing 135mm L 160mm mounting distance 180mm | | |



1

| | | | |
|--------------------|---|-----------------|------|
| GEV No. | 690886 | Ref. No. | AH25 |
| description | divider funnel portions of 180-220g \varnothing 135mm L 160mm mounting distance 180mm | | |



1

| | | | |
|--------------------|---|-----------------|------|
| GEV No. | 690887 | Ref. No. | AH26 |
| description | divider funnel portions of 210-260g \varnothing 135mm L 160mm mounting distance 180mm | | |



Зип Общежит
for dough roller

rollers
vsezip.ru

+7(812)987-08-81



| | | | |
|--------------------|---|-----------------|------|
| GEV No. | 690888 | Ref. No. | AH44 |
| description | divider funnel portions of 240-280g ø 135mm L 160mm mounting distance 180mm | | |

Image not available

| | | | |
|--------------------|-----------------------------------|-----------------|------|
| GEV No. | 690881 | Ref. No. | AH27 |
| description | divider funnel portions of 50-70g | | |

Image not available

| | | | |
|--------------------|--|-----------------|------|
| GEV No. | 690882 | Ref. No. | AH21 |
| description | divider funnel portions of 60-100g ø 135mm L 160mm mounting distance 180mm | | |

Image not available

| | | | |
|--------------------|--|-----------------|------|
| GEV No. | 690883 | Ref. No. | AH22 |
| description | divider funnel portions of 90-130g ø 135mm L 160mm mounting distance 180mm | | |



| | | | |
|--------------------|--|-----------------|------------------|
| GEV No. | 692014 | Ref. No. | RC05200 KF073 |
| description | roller for dough rolling machine L 300mm ø 49mm mounting pos. bottom at the back | | |



| | | | |
|--------------------|---|-----------------|------------------|
| GEV No. | 692015 | Ref. No. | KF072 RC048R0 |
| description | roller for dough rolling machine L 306mm ø 49mm mounting pos. bottom in the front | | |

Image not available

| | | | |
|--------------------|--|-----------------|------------------|
| GEV No. | 692016 | Ref. No. | KF074 KF07400 |
| description | roller for dough rolling machine mounting pos. upper at the back | | |

Image not available

| | | | |
|--------------------|---|-----------------|------------------|
| GEV No. | 692017 | Ref. No. | KF071 KF07100 |
| description | roller for dough rolling machine mounting pos. upper in the front | | |

holders



1

| | | | |
|--------------------|---|-----------------|--------------------|
| GEV No. | 692002 | Ref. No. | R3K10R0 RC058R0 |
| description | lever hole \varnothing 10mm H 20mm hole distance 31mm | | |

couplings



1

| | | | |
|---|--|-----------------|-----------------|
| GEV No. | 692012 | Ref. No. | KF07600 |
| description | coupling \varnothing 35mm ID \varnothing 25mm H 14mm | | |
| accessories for | 692012 | | |
|  | GEV No. | 692011 | Ref. No. |
| | | | KF07500 |
| | coupling \varnothing 41.5mm ID \varnothing 25mm H 12mm | | |



1

| | | | |
|---|--|-----------------|-----------------|
| GEV No. | 692011 | Ref. No. | KF07500 |
| description | coupling \varnothing 41.5mm ID \varnothing 25mm H 12mm | | |
| accessories for | 692011 | | |
|  | GEV No. | 692012 | Ref. No. |
| | | | KF07600 |
| | coupling \varnothing 35mm ID \varnothing 25mm H 14mm | | |

pinions

rear mounting



1

| | | | |
|--------------------|--------|-----------------|---------|
| GEV No. | 692009 | Ref. No. | KF07820 |
| description | pinion | | |

Зип Общепит

vsezip.ru

+7(812)987-08-81



1

| | | | |
|--------------------|--|-----------------|---------|
| GEV No. | 692008 | Ref. No. | KF07720 |
| description | pinion \varnothing 47.5mm H 34mm mounting pos. rear ID \varnothing 25mm for dough roller | | |



1

| | | | |
|--------------------|--|-----------------|---------|
| GEV No. | 697109 | Ref. No. | RC057R0 |
| description | pinion \varnothing 47.5mm H 35mm mounting pos. rear ID \varnothing 25mm for dough roller | | |

front mounting



1

| | | | |
|--------------------|---|-----------------|---------|
| GEV No. | 697108 | Ref. No. | RC056R0 |
| description | pinion \varnothing 47.5mm H 35mm mounting pos. front ID \varnothing 14mm for dough roller | | |

springs



1

| | | | |
|--------------------|--|-----------------|------------------|
| GEV No. | 693920 | Ref. No. | MC114 RC055R0 |
| description | spring for pinion \varnothing 49mm thickness 1.5mm Qty 2 pcs | | |

roller covers

upper



1

| | | | |
|--------------------|---|-----------------|---------|
| GEV No. | 697342 | Ref. No. | RC418R0 |
| description | hand protection mounting pos. upper P30 | | |



Зип Общепит

vsezip.ru

+7(812)987-08-81

side parts



1

| | | | |
|--------------------|--|-----------------|---------|
| GEV No. | 692024 | Ref. No. | KD05020 |
| description | side panel mounting pos. right W 39mm L 125mm H 100mm F/30 | | |



1

| | | | |
|--------------------|--|-----------------|-------|
| GEV No. | 692025 | Ref. No. | KF061 |
| description | side panel mounting pos. left W 25mm L 122mm H 80mm F/30 | | |

spindles



1

| | | | |
|--------------------|------------------------|-----------------|------------------|
| GEV No. | 692005 | Ref. No. | KF062 KF06200 |
| description | spindle ø 24mm L 160mm | | |

spindles

eccentric



1

| | | | |
|--------------------|--|-----------------|-------|
| GEV No. | 692019 | Ref. No. | KF063 |
| description | spindle ø 25mm L 380mm mounting pos. bottom in the front eccentric for dough rolling machine | | |





Image not available

1

| | | | |
|--------------------|---|-----------------|------------------|
| GEV No. | 692021 | Ref. No. | KF064 KF06400 |
| description | spindle ø 25mm mounting pos. upper in the front eccentric for dough rolling machine | | |



1

| | | | |
|--------------------|---|-----------------|------------------|
| GEV No. | 692018 | Ref. No. | KF069 KF06900 |
| description | spindle ø 25mm L 350mm mounting pos. bottom at the back cylindrical for dough rolling machine | | |



Image not available

1

| | | | |
|--------------------|--|-----------------|------------------|
| GEV No. | 692020 | Ref. No. | KF068 KF06800 |
| description | spindle ø 25mm mounting pos. upper at the back cylindrical for dough rolling machine | | |

miscellaneous





Image not available

1

| | | | |
|--------------------|--------|-----------------|-------|
| GEV No. | 692007 | Ref. No. | AD174 |
| description | lid | | |



1

| | | | |
|--------------------|-----------------------------------|-----------------|-------|
| GEV No. | 693921 | Ref. No. | AD174 |
| description | lid for side part ø 30.5mm H 11mm | | |
| For models: | PF45MTE | | |

for display coolers

funnels



Image not available

1

| | | | |
|--------------------|---|-----------------|------|
| GEV No. | 690884 | Ref. No. | AH23 |
| description | divider funnel portions of 120-160g ø 135mm L 160mm mounting distance 180mm | | |

Зип Общепит

vsezip.ru

+7(812)987-08-81



1

| | | | |
|--------------------|---|-----------------|------|
| GEV No. | 690885 | Ref. No. | AH24 |
| description | divider funnel portions of 150-190g ø 135mm L 160mm mounting distance 180mm | | |



1

| | | | |
|--------------------|---|-----------------|------|
| GEV No. | 690888 | Ref. No. | AH44 |
| description | divider funnel portions of 240-280g ø 135mm L 160mm mounting distance 180mm | | |



1

| | | | |
|--------------------|---|-----------------|------|
| GEV No. | 690886 | Ref. No. | AH25 |
| description | divider funnel portions of 180-220g ø 135mm L 160mm mounting distance 180mm | | |



1

| | | | |
|--------------------|-----------------------------------|-----------------|------|
| GEV No. | 690881 | Ref. No. | AH27 |
| description | divider funnel portions of 50-70g | | |



1

| | | | |
|--------------------|--|-----------------|------|
| GEV No. | 690882 | Ref. No. | AH21 |
| description | divider funnel portions of 60-100g ø 135mm L 160mm mounting distance 180mm | | |



1

| | | | |
|--------------------|---|-----------------|------|
| GEV No. | 690887 | Ref. No. | AH26 |
| description | divider funnel portions of 210-260g ø 135mm L 160mm mounting distance 180mm | | |



1

| | | | |
|--------------------|--|-----------------|------|
| GEV No. | 690883 | Ref. No. | AH22 |
| description | divider funnel portions of 90-130g ø 135mm L 160mm mounting distance 180mm | | |

for convection ovens/combi-steamers

3zip Общепит for pizza ovens

glass panels



1

| | | | |
|--------------------|---|-----------------|--------------------|
| GEV No. | 700162 | Ref. No. | AL01100 AL27600 |
| description | glass panel L 410mm W 131mm thickness 4mm rectangular | | |
| For models: | R-109-1, R-109-2, R-109-3, R-111-1, R-111-2, R-111-3, R-66-1, R-66-2, R-66-3, R-69-1, R-69-2, R-69-3, R-77-1, R-77-2, R-77-3, R-96-1, R-96-2, R-96-3, R-99-1, R-99-2, R-99-3, RE-109-1, RE-109-2, RE-109-3, RE-111-1, RE-111-2, RE-111-3, RE-66-1, RE-66-2, RE-66-3, RE-69-1, RE-69-2, RE-69-3, RE-77-1, RE-77-2, RE-77-3, RE-96-1, RE-96-2, RE-96-3, RE-99-1, RE-99-2, RE-99-3, S-109-1, S-109-2, S-109-3, S-111-1, S-111-2, S-111-3, S-66-1, S-66-2...(Other models you can see in the webshop) | | |

doors



1

| | | | |
|--------------------|---|-----------------|---------|
| GEV No. | 694291 | Ref. No. | E4M2000 |
| description | stop bolt ø 11.5mm L 25mm thread M8 WS 15 | | |

door mechanics

bolts



1

| | | | |
|--------------------|---|-----------------|---------|
| GEV No. | 694291 | Ref. No. | E4M2000 |
| description | stop bolt ø 11.5mm L 25mm thread M8 WS 15 | | |

for tilting bratt pans

miscellaneous



1

| | | | |
|--------------------|--|-----------------|------------|
| GEV No. | 523510 | Ref. No. | 50IBA71269 |
| description | deep-groove ball bearing type 6202-2RS shaft ø 15mm ED ø 35mm W 11mm with sealing discs deep-groove ball bearing DIN 625-1 | | |

glass panels

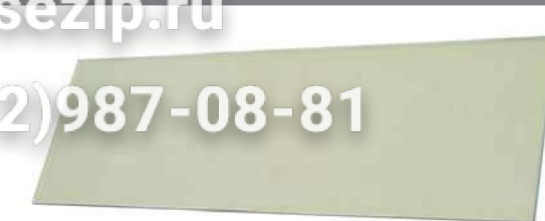

1

| | | | |
|--------------------|---|-----------------|--------------------|
| GEV No. | 700162 | Ref. No. | AL01100 AL27600 |
| description | glass panel L 410mm W 131mm thickness 4mm rectangular | | |
| For models: | R-109-1, R-109-2, R-109-3, R-111-1, R-111-2, R-111-3, R-66-1, R-66-2, R-66-3, R-69-1, R-69-2, R-69-3, R-77-1, R-77-2, R-77-3, R-96-1, R-96-2, R-96-3, R-99-1, R-99-2, R-99-3, RE-109-1, RE-109-2, RE-109-3, RE-111-1, RE-111-2, RE-111-3, RE-66-1, RE-66-2, RE-66-3, RE-69-1, RE-69-2, RE-69-3, RE-77-1, RE-77-2, RE-77-3, RE-96-1, RE-96-2, RE-96-3, RE-99-1, RE-99-2, RE-99-3, S-109-1, S-109-2, S-109-3, S-111-1, S-111-2, S-111-3, S-66-1, S-66-2...(Other models you can see in the webshop) | | |



1

| | | | |
|--------------------|--|-----------------|---------|
| GEV No. | 700163 | Ref. No. | AL01100 |
| description | glass panel L 410mm W 133mm thickness 5mm rectangular | | |
| For models: | 109, 111, 22, 23, 32, 33 220V, 33 380V, 34 220V, 34 380V, 66, 69, 77, 96, 99, SG22, SG23, SG33 | | |

firebricks



1

| | | | |
|--------------------|---|-----------------|---------|
| GEV No. | 850007 | Ref. No. | AL15500 |
| description | firebrick L 495mm W 315mm H 14mm delivery freight forwarding company only | | |



1

| | | | |
|--------------------|---|-----------------|---------|
| GEV No. | 850008 | Ref. No. | AL14400 |
| description | firebrick L 515mm W 495mm H 19mm delivery freight forwarding company only | | |

Зип Общепит

vsezip.ru

+7(812)987-08-81

1



| | | | |
|--------------------|---|-----------------|---------|
| GEV No. | 850009 | Ref. No. | AL15100 |
| description | firebrick L 622mm W 606mm H 25mm delivery freight forwarding company only | | |
| For models: | 22, 66, R-109-1, R-109-2, R-109-3, R-111-1, R-111-2, R-111-3, R-66-1, R-66-2, R-66-3, R-69-1, R-69-2, R-69-3, R-77-1, R-77-2, R-77-3, R-96-1, R-96-2, R-96-3, R-99-1, R-99-2, R-99-3, RE-109-1, RE-109-2, RE-109-3, RE-111-1, RE-111-2, RE-111-3, RE-66-1, RE-66-2, RE-66-3, RE-69-1, RE-69-2, RE-69-3, RE-77-1, RE-77-2, RE-77-3, RE-96-1, RE-96-2, RE-96-3, RE-99-1, RE-99-2, RE-99-3, S-109-1, S-109-2, S-109-3, S-111-1, S-111-2, S-111-3...(Other models you can see in the webshop) | | |

1



| | | | |
|--------------------|--|-----------------|---------|
| GEV No. | 850013 | Ref. No. | AL17900 |
| description | firebrick L 913mm W 455mm H 19mm delivery freight forwarding company only | | |
| For models: | 33 220V, 33 380V, 99, R-109-1, R-109-2, R-109-3, R-111-1, R-111-2, R-111-3, R-66-1, R-66-2, R-66-3, R-69-1, R-69-2, R-69-3, R-77-1, R-77-2, R-77-3, R-96-1, R-96-2, R-96-3, R-99-1, R-99-2, R-99-3, RE-109-1, RE-109-2, RE-109-3, RE-111-1, RE-111-2, RE-111-3, RE-66-1, RE-66-2, RE-66-3, RE-69-1, RE-69-2, RE-69-3, RE-77-1, RE-77-2, RE-77-3, RE-96-1, RE-96-2, RE-96-3, RE-99-1, RE-99-2, RE-99-3, S-109-1, S-109-2, S-109-3, S-111-1, S-111-2...(Other models you can see in the webshop) | | |

1



| | | | |
|--------------------|---|-----------------|---------|
| GEV No. | 850012 | Ref. No. | AL18200 |
| description | firebrick L 913mm W 606mm H 19mm delivery freight forwarding company only | | |
| For models: | 23, 32, 69, 96, R-109-1, R-109-2, R-109-3, R-111-1, R-111-2, R-111-3, R-66-1, R-66-2, R-66-3, R-69-1, R-69-2, R-69-3, R-77-1, R-77-2, R-77-3, R-96-1, R-96-2, R-96-3, R-99-1, R-99-2, R-99-3, RE-109-1, RE-109-2, RE-109-3, RE-111-1, RE-111-2, RE-111-3, RE-66-1, RE-66-2, RE-66-3, RE-69-1, RE-69-2, RE-69-3, RE-77-1, RE-77-2, RE-77-3, RE-96-1, RE-96-2, RE-96-3, RE-99-1, RE-99-2, RE-99-3, S-109-1, S-109-2, S-109-3, S-111-1...(Other models you can see in the webshop) | | |

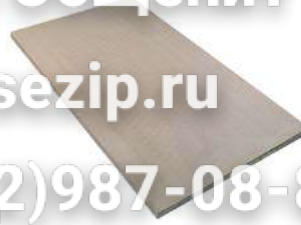

| | | | |
|--------------------|---|-----------------|---------|
| GEV No. | 850006 | Ref. No. | AL14500 |
| description | firebrick L 913mm W 606mm H 25mm delivery freight forwarding company only | | |

miscellaneous



1

| | | | |
|--------------------|--------------------------------|-----------------|---------|
| GEV No. | 698558 | Ref. No. | E1K0300 |
| description | bush L 20.5mm ø 16mm ID ø 10mm | | |



1

| | | | |
|--------------------|---|-----------------|---------|
| GEV No. | 698560 | Ref. No. | E1K0200 |
| description | hinge L 40mm W 50mm H 73mm mounting pos. left | | |



1

| | | | |
|--------------------|--|-----------------|------------------|
| GEV No. | 698559 | Ref. No. | E1K01 E1K0100 |
| description | hinge L 40mm W 50mm H 73mm mounting pos. right | | |



for dishwashers

door mechanics

locks



1

| | | | |
|--------------------|------------------|-----------------|-------|
| GEV No. | 506157 | Ref. No. | AC046 |
| description | door catch catch | | |

washing and rinsing systems



1

| | | | |
|--------------------|--------|-----------------|---------|
| GEV No. | 510194 | Ref. No. | DB031R0 |
| description | swirl | | |

knobs

universal knobs



1

| | | | |
|--------------------|--|-----------------|---------|
| GEV No. | 111985 | Ref. No. | AC00600 |
| description | knob switch zero mark t.max.°C ø 42mm shaft ø 6x4.6mm shaft flat lower black | | |



1

| | | | |
|--------------------|--|-----------------|---------|
| GEV No. | 110932 | Ref. No. | AC06200 |
| description | knob switch zero mark t.max.°C ø 42mm shaft ø 6x4.6mm shaft flat upper black | | |
| For models: | 109, 111, 22, 23, 32, 33 380V, 34 380V, 66, 69, 77, 96, 99, PF33MT, PF45HT, R-109-1, R-109-2, R-109-3, R-111-1, R-111-2, R-111-3, R-66-1, R-66-2, R-66-3, R-69-1, R-69-2, R-69-3, R-77-1, R-77-2, R-77-3, R-96-1, R-96-2, R-96-3, R-99-1, R-99-2, R-99-3, S-109-1, S-109-2, S-109-3, S-111-1, S-111-2, S-111-3, S-66-1, S-66-2, S-66-3, S-69-1, S-69-2, S-69-3, S-77-1, S-77-2, S-77-3...(Other models you can see in the webshop) | | |

product specific knobs

OEM

vsezip.ru

+7(812)987-08-81



1

| | | | |
|--------------------|---|-----------------|---------|
| GEV No. | 110162 | Ref. No. | AC05100 |
| description | knob potentiometer ø 18.5mm shaft ø 6mm black | | |
| For models: | 22, 23, 32, 33, 34, PF33MT, PF45HT | | |



1

| | | | |
|--------------------|--|-----------------|---------|
| GEV No. | 111985 | Ref. No. | AC00600 |
| description | knob switch zero mark t.max.°C ø 42mm shaft ø 6x4.6mm shaft flat lower black | | |



1

| | | | |
|--------------------|--|-----------------|---------|
| GEV No. | 110932 | Ref. No. | AC06200 |
| description | knob switch zero mark t.max.°C ø 42mm shaft ø 6x4.6mm shaft flat upper black | | |
| For models: | 109, 111, 22, 23, 32, 33 380V, 34 380V, 66, 69, 77, 96, 99, PF33MT, PF45HT, R-109-1, R-109-2, R-109-3, R-111-1, R-111-2, R-111-3, R-66-1, R-66-2, R-66-3, R-69-1, R-69-2, R-69-3, R-77-1, R-77-2, R-77-3, R-96-1, R-96-2, R-96-3, R-99-1, R-99-2, R-99-3, S-109-1, S-109-2, S-109-3, S-111-1, S-111-2, S-111-3, S-66-1, S-66-2, S-66-3, S-69-1, S-69-2, S-69-3, S-77-1, S-77-2, S-77-3...(Other models you can see in the webshop) | | |

miscellaneous



1

| | | | |
|--------------------|---------------------------|-----------------|---------|
| GEV No. | 110205 | Ref. No. | AC04000 |
| description | knob ø 27mm shaft ø 5x5mm | | |
| For models: | PF45HT | | |

handles and hand wheels

cylindrical handles

fixed



1

| | | | |
|--------------------|--|-----------------|---------|
| GEV No. | 690158 | Ref. No. | AC06600 |
| description | cylindrical handle thread M8 ø 29mm L 112mm | | |
| For models: | 22, 23, 32, 33 220V, 33 380V, 34 220V, 34 380V, R-109-1, R-109-2, R-109-3, R-111-1, R-111-2, R-111-3, R-66-1, R-66-2, R-66-3, R-69-1, R-69-2, R-69-3, R-77-1, R-77-2, R-77-3, R-96-1, R-96-2, R-96-3, R-99-1, R-99-2, R-99-3, RE-109-1, RE-109-2, RE-109-3, RE-111-1, RE-111-2, RE-111-3, RE-66-1, RE-66-2, RE-66-3, RE-69-1, RE-69-2, RE-69-3, RE-77-1, RE-77-2, RE-77-3, RE-96-1, RE-96-2, RE-96-3, RE-99-1, RE-99-2, RE-99-3, S-109-1...(Other models you can see in the webshop) | | |

handle bars

consoles



1

| | | | |
|--------------------|------------------------|-----------------|----------|
| GEV No. | 690116 | Ref. No. | HDTV0300 |
| description | console for handle rod | | |

door handles

door handles



1

| | | | |
|--------------------|--------|-----------------|---------|
| GEV No. | 690112 | Ref. No. | H9N6020 |
| description | handle | | |



1

| | | | |
|--------------------|--------|-----------------|---------|
| GEV No. | 691257 | Ref. No. | HDM0010 |
| description | handle | | |

Зип.Общепит

miscellaneous

vsezip.ru

+7(812)987-08-81

| | | | |
|--------------------|-----------------------------------|-----------------|---------|
| GEV No. | 690055 | Ref. No. | H9N5020 |
| description | handle holder mounting pos. right | | |

accessories

miscellaneous



1

| | | | |
|--------------------|--|-----------------|---------|
| GEV No. | 690149 | Ref. No. | AC07100 |
| description | hand protection for door handle | | |
| For models: | 22, 23, 32, 33 220V, 33 380V, 34 220V, 34 380V, R-109-1, R-109-2, R-109-3, R-111-1, R-111-2, R-111-3, R-66-1, R-66-2, R-66-3, R-69-1, R-69-2, R-69-3, R-77-1, R-77-2, R-77-3, R-96-1, R-96-2, R-96-3, R-99-1, R-99-2, R-99-3, RE-109-1, RE-109-2, RE-109-3, RE-111-1, RE-111-2, RE-111-3, RE-66-1, RE-66-2, RE-66-3, RE-69-1, RE-69-2, RE-69-3, RE-77-1, RE-77-2, RE-77-3, RE-96-1, RE-96-2, RE-96-3, RE-99-1, RE-99-2, RE-99-3, S-109-1...(Other models you can see in the webshop) | | |

baskets

warewashing baskets

steel wire baskets round

mix baskets

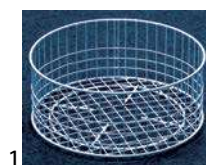

1

| | | | |
|--------------------|--|-----------------|-------|
| GEV No. | 970579 | Ref. No. | AB013 |
| description | mix basket ED ø 360mm H 140mm seat ø 280mm | | |



gaskets

sealing washers

rubber gaskets



1

| | | | |
|--------------------|--|-----------------|-------|
| GEV No. | 521125 | Ref. No. | AD036 |
| description | flat gasket rubber ED ø 52mm ID ø 42.5mm thickness 4mm Qty 1 pcs | | |

shaft gaskets

shaft gaskets



1

| | | | |
|--------------------|--|-----------------|------------|
| GEV No. | 516246 | Ref. No. | 50IAA71178 |
| description | shaft seal ID ø 17mm ED ø 35mm thickness 7mm | | |

special gaskets

miscellaneous



1

| | | | |
|--------------------|---|-----------------|---------|
| GEV No. | 693441 | Ref. No. | AL27810 |
| description | gasket L 430mm W 155mm glass fibre | | |
| For models: | R-109-1, R-109-2, R-109-3, R-111-1, R-111-2, R-111-3, R-66-1, R-66-2, R-66-3, R-69-1, R-69-2, R-69-3, R-77-1, R-77-2, R-77-3, R-96-1, R-96-2, R-96-3, R-99-1, R-99-2, R-99-3, RE-109-1, RE-109-2, RE-109-3, RE-111-1, RE-111-2, RE-111-3, RE-66-1, RE-66-2, RE-66-3, RE-69-1, RE-69-2, RE-69-3, RE-77-1, RE-77-2, RE-77-3, RE-96-1, RE-96-2, RE-96-3, RE-99-1, RE-99-2, RE-99-3, S-109-1, S-109-2, S-109-3, S-111-1, S-111-2, S-111-3, S-66-1, S-66-2...(Other models you can see in the webshop) | | |

transmission technology and ball bearings

ball bearings

deep-groove ball bearings 2RS



1

| | | | |
|--------------------|--|-----------------|------------------|
| GEV No. | 523522 | Ref. No. | AB047 AB04700 |
| description | deep-groove ball bearing type 6004-2RS shaft ø 20mm ED ø 42mm W 12mm with sealing discs deep-groove ball bearing DIN 625-1 | | |
| For models: | PF45MT-E | | |



1

| | | | |
|--------------------|--|-----------------|------------|
| GEV No. | 523510 | Ref. No. | 50IBA71269 |
| description | deep-groove ball bearing type 6202-2RS shaft ø 15mm ED ø 35mm W 11mm with sealing discs deep-groove ball bearing DIN 625-1 | | |



1

| | | | |
|--------------------|--|-----------------|---------|
| GEV No. | 523512 | Ref. No. | AB04800 |
| description | deep-groove ball bearing type 6204-2RS shaft ø 20mm ED ø 47mm W 14mm with sealing discs deep-groove ball bearing DIN 625-1 | | |
| For models: | PF45MTE, PF45MT-E | | |

deep-groove ball bearings 2Z



1

| | | | |
|--------------------|--|-----------------|------------------|
| GEV No. | 523508 | Ref. No. | AB119 AB11900 |
| description | deep-groove ball bearing shaft ø 10mm ED ø 30mm W 9mm type 6200-2Z DIN 625-1 | | |

+7(812)987-08-81

vsezip.ru

Зип Общепит

vsezip.ru

+7(812)987-08-81

| | | | |
|---|---|-----------------|--------------------------------|
|  | | | |
| 1 | | | |
| GEV No. | 692000 | Ref. No. | 50IBA71268 AB117 AB11700 |
| description | deep-groove ball bearing shaft \varnothing 15mm ED \varnothing 35mm W 11mm type 6202-2Z DIN 625-1 | | |

| | | | |
|---|---|-----------------|--------------------|
|  | | | |
| 1 | | | |
| GEV No. | 692033 | Ref. No. | AB10900 AB11400 |
| description | deep-groove ball bearing shaft \varnothing 25mm ED \varnothing 47mm W 12mm type 6005-2Z DIN 625-1 | | |

thrust ball bearings

| | | | |
|--|--|-----------------|--------------------------|
|  | | | |
| 1 | | | |
| GEV No. | 523536 | Ref. No. | 50IBA71241 50IBA78008 |
| description | thrust ball bearing shaft \varnothing 20mm ED \varnothing 40mm W 14mm type 51204 DIN 711 | | |

drive belts

high-performance V-belts, cogged

| | | | |
|---|--|-----------------|------------------|
|  | | | |
| 1 | | | |
| GEV No. | 691963 | Ref. No. | AD184 AD18400 |
| description | V-belt belt width 13mm L 1050mm H 8mm CODE AX40 profile AX/X13 | | |
| For models: | PF45MT-E | | |

| | | | |
|---|---|-----------------|------------------|
|  | | | |
| 1 | | | |
| GEV No. | 697781 | Ref. No. | AD088 AD08800 |
| description | V-belt belt width 13mm L 890mm H 8mm CODE AX35 profile AX/X13 | | |

| | | | |
|--|--|-----------------|---------|
|  | | | |
| 1 | | | |
| GEV No. | 697786 | Ref. No. | AD11800 |
| description | toothed belt profile H L 762mm Hmm teeth 60 splitting rubber with textile insertion CODE H300 W 25mm | | |

chains

roller chains 08B-2 double

| | | | |
|--|--|-----------------|----------------------------------|
|  | | | |
| 1 | | | |
| GEV No. | 698398 | Ref. No. | KE03410 |
| description | chain DIN/ISO 08 B-2 splitting 1/2" / 12.7mm links 48 internal width 7.75mm roller \varnothing 8.51mm double | | |
| accessories for | 698398 | | |
|  | GEV No. | 698399 | Ref. No. KE041 KE04100 |
| connector double DIN/ISO 08 B-2 splitting 1/2" links 1 | | | |

connectors

| | | | |
|---|--|-----------------|------------------|
|  | | | |
| 1 | | | |
| GEV No. | 698399 | Ref. No. | KE041 KE04100 |
| description | connector double DIN/ISO 08 B-2 splitting 1/2" links 1 | | |

springs

torsion springs

| | | | |
|--|--|-----------------|---------|
|  | | | |
| 1 | | | |
| GEV No. | 698557 | Ref. No. | MD10700 |
| description | spring \varnothing 19.2mm L2 33.3mm wire gauge \varnothing 3mm L1 48mm | | |



Зип Общепит
fastening material
vsezip.ru
+7(812)987-08-81

| | | | |
|---|---|-----------------|---------|
|  | | | |
| 1 | | | |
| GEV No. | 692094 | Ref. No. | MD04900 |
| description | torsion spring ø 17mm L2 32mm wire gauge ø 2.5mm L1: 45mm L3mm Qty 1 pcs | | |
| For models: | R-109-1, R-109-2, R-109-3, R-111-1, R-111-2, R-111-3, R-66-1, R-66-2, R-66-3, R-69-1, R-69-2, R-69-3, R-77-1, R-77-2, R-77-3, R-96-1, R-96-2, R-96-3, R-99-1, R-99-2, R-99-3, RE-109-1, RE-109-2, RE-109-3, RE-111-1, RE-111-2, RE-111-3, RE-66-1, RE-66-2, RE-66-3, RE-69-1, RE-69-2, RE-69-3, RE-77-1, RE-77-2, RE-77-3, RE-96-1, RE-96-2, RE-96-3, RE-99-1, RE-99-2, RE-99-3, S-109-1, S-109-2, S-109-3, S-111-1, S-111-2, S-111-3, S-66-1, S-66-2...(Other models you can see in the webshop) | | |

| | | | |
|---|--|-----------------|------------------|
|  | | | |
| 1 | | | |
| GEV No. | 700872 | Ref. No. | KD019 KD01900 |
| description | torsion spring ø 31mm mounting pos. left | | |
| For models: | PF45MT-E | | |

| | | | |
|---|---|-----------------|------------------|
|  | | | |
| 1 | | | |
| GEV No. | 700871 | Ref. No. | KD018 KD01800 |
| description | torsion spring ø 31mm mounting pos. right | | |
| For models: | PF45MT-E | | |

measuring equipment

thermometers

built-in thermometers

ø60mm

| | | | |
|---|--|-----------------|---------|
|  | | | |
| 1 | | | |
| GEV No. | 541879 | Ref. No. | ED07500 |
| description | thermometer mounting ø 60mm 0 up to +500°C probe ø 8mm probe L 155mm capillary pipe 1000mm | | |

| | | | |
|---|---|-----------------|--------------------|
| screws | | | |
| countersunk screws | | | |
|  | | | |
| 1 | | | |
| GEV No. | 692037 | Ref. No. | MB15700 MB22000 |
| description | countersunk screw thread M10 L 20mm WS 6 SS DIN 7991/ISO 10642 Qty 1 pcs intake hexagonal | | |

| | | | |
|---|---|-----------------|---------|
| nuts | | | |
| knurled nuts | | | |
|  | | | |
| 1 | | | |
| GEV No. | 691258 | Ref. No. | HST0320 |
| description | knurled nut thread M6 ø 19mm H 15mm chrome-plated steel | | |

| | | | |
|---|---|-----------------|------------|
| hexagonal nuts | | | |
| DIN 934 / ISO 4032/8673 | | | |
|  | | | |
| 1 | | | |
| GEV No. | 505200 | Ref. No. | 50BBA76593 |
| description | nut thread M12x1.75 H 10mm WS 19 SS DIN/ISO DIN 934 / ISO 4032/8673 Qty 1 pcs | | |

| | | | |
|---|--------|-----------------|---------|
| washers | | | |
| washers | | | |
| miscellaneous | | | |
|  | | | |
| 1 | | | |
| GEV No. | 692034 | Ref. No. | AE14200 |
| description | disc | | |

| | | | |
|---|-----------------------------|-----------------|------------------|
| fasteners | | | |
| slot nuts | | | |
|  | | | |
| 1 | | | |
| GEV No. | 692006 | Ref. No. | MD048 MD04800 |
| description | slot nut W 5mm H 5mm L 20mm | | |

Зип Общепит

vseZip.ru

Image not available

+7(812)987-08-81



| | | | | |
|--|----------------|--------|-----------------|---------|
| 1 | GEV No. | 692035 | Ref. No. | MD06100 |
| description slot nut W 6mm H 6mm L 25mm | | | | |



| | | | | |
|--|----------------|--------|-----------------|------|
| 1 | GEV No. | 560285 | Ref. No. | MD41 |
| description slot nut W 8mm H 7mm L 30mm | | | | |

retaining rings

DIN 471



| | | | | |
|--|----------------|--------|-----------------|-------|
| 1 | GEV No. | 691403 | Ref. No. | MC033 |
| description retaining ring shaft ø 19mm thickness 1.2mm stainless steel DIN 471 | | | | |

DIN 472



| | | | | |
|---|----------------|--------|-----------------|------------|
| 1 | GEV No. | 698003 | Ref. No. | 50BHA76670 |
| description retaining ring bore ø 35mm thickness 1.5mm steel DIN 472 | | | | |



| | | | | |
|---|----------------|--------|-----------------|---------|
| 1 | GEV No. | 692029 | Ref. No. | MC03500 |
| description retaining ring bore ø 47mm thickness 1.8mm steel DIN 472 | | | | |
| For models: PF45MTE, PF45MT-E | | | | |



| | | | | |
|---|----------------|--------|-----------------|------------------|
| 1 | GEV No. | 523103 | Ref. No. | MC043 MC04300 |
| description retaining ring bore ø 52mm thickness 2mm steel DIN 472 | | | | |

miscellaneous



| | | | | |
|-----------------------------------|----------------|--------|-----------------|------------------|
| 1 | GEV No. | 692003 | Ref. No. | MC062 MC06200 |
| description retaining ring | | | | |
| For models: PF33MT | | | | |

| | | | | |
|-----------------------------------|----------------|--------|-----------------|------------------|
| 1 | GEV No. | 692004 | Ref. No. | MC115 MC11500 |
| description retaining ring | | | | |

roll pins



| | | | | |
|--|----------------|--------|-----------------|---------|
| 1 | GEV No. | 692013 | Ref. No. | MD09700 |
| description roll pin ø 3mm L 16mm | | | | |

consumables

fuses

fine fuses

fine fuse holders



| | | | | |
|---------------------------------------|----------------|--------|-----------------|---------|
| 1 | GEV No. | 550537 | Ref. No. | HE05800 |
| description fuse holder | | | | |
| For models: 22, 23, 32, 33, 34 | | | | |

Зип Общепит

vsezip.ru

+7(812)987-08-81

| | | | |
|-------------------------------------|--------|----------------------------------|----|
| A | | M | |
| axial fans | 22 | magnetic switches | 12 |
| B | | measuring equipment | 39 |
| bar burners | 26 | microswitches | 11 |
| C | | motors | 22 |
| cam switches | 11 | N | |
| ceramic burners | 27 | nuts | 39 |
| consumables | 40 | O | |
| contactors | 17 | oven lamps | 14 |
| control equipment | 12 | P | |
| control thermostats | 8, 9 | pilot burners | 25 |
| countersunk screws | 39 | position switches | 11 |
| E | | pressure switches | 22 |
| electronic controllers | 19 | probes | 20 |
| F | | programme timers | 17 |
| fans | 22 | pumps | 22 |
| fasteners | 39 | push/momentary push switches | 10 |
| fastening material | 39 | R | |
| fine fuses | 40 | relays | 18 |
| fuses | 23, 40 | retaining rings | 40 |
| G | | rocker/momentary rocker switches | 10 |
| gas burners | 26 | roll pins | 40 |
| gas solenoid valves | 25 | rotary switches | 12 |
| gas taps | 23 | S | |
| H | | safety thermostats | 9 |
| halogen lamp | 13 | screws | 39 |
| heating elements | 3 | sealing washers | 37 |
| heating elements for coffee machine | 3 | shaft gaskets | 37 |
| heating elements for pizza ovens | 3 | slot nuts | 39 |
| heating elements for pizza presses | 7 | solenoid valves | 21 |
| hexagonal nuts | 39 | switches and momentary switches | 10 |
| I | | T | |
| ignition switches | 26 | thermocouples | 26 |
| ignition units | 26 | thermostats | 8 |
| immersion heating elements | 8 | time relays | 19 |
| indicator lights | 13 | timers | 17 |
| indicator lights (complete) | 13 | transformers | 19 |
| K | | W | |
| knurled nuts | 39 | wash and rinse pumps | 22 |
| L | | washers | 39 |
| lamps | 13 | | |