



Зип Общепит

vsezip.ru

+7(812)987-08-81



**GAS COMPONENTS**



**ELECTRIC COMPONENTS**



**WATER TECHNOLOGY**



**MECHANICAL COMPONENTS**



**TOOLS**

Spare parts suitable for

**ANGELO-PO**

Find the complete and up-to-date range of products in our GEV Webshop

Зип Общепит

vsezip.ru

+7(812)987-08-82

# Manufacturer catalogue

The most important spare parts and accessories arranged clearly for every manufacturer



**Complete product range and all appliance data always up to date in the GEV Webshop**



**Alphabetical Index at the end of the catalogue**

## GEV Webshop

[www.gev-online.co.uk](http://www.gev-online.co.uk)

[www.gev-online.com](http://www.gev-online.com)



**Add to Favourites**



**Sign In with email address and usual password**



**Easy-order – place several items in your basket at the same time**



**Quick Item search – no login needed**



heating elements

heating elements for ovens

Зип Общепит

vsezip.ru

+7(812)987-08-81

electric components

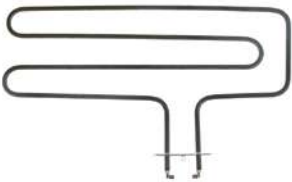

1

<b>GEV No.</b>	418596	<b>Ref. No.</b>	32G1590 32G1591
<b>description</b>	heating element 2600W 230V L 265mm W 510mm L1 93mm W2 62mm flange length 100mm flange width 22mm hole distance 86mm hole ø 5mm		
<b>For models:</b>	1G1FA0E, 1G1FA0EV, 1G1PE1E, 1G1PE1EV, 1G1PE2E, 1G1PE2EV, 2G1PE1E, 2G1PE1EV, 2G1PE2E, 2G1PE2EV, 31GE, 31TCE, 32TCE		



1

<b>GEV No.</b>	415169	<b>Ref. No.</b>	32G0950 32G0951 32G1601
<b>description</b>	heating element 2700W 380V L 450mm W 590mm L1 115mm L2 335mm W1 370mm W2 60mm flange length 100mm flange width 22mm hole distance 86mm hole ø 5mm tube ø 6.5mm connection male faston 6.3mm heating circuits 1 rectangular flange dry heating element		
<b>For models:</b>	08WFA4E, 08WFAAE, 10WTPGE, 12WFA6E, 12WFAAE, 191FAAE, 191FAE, 191FAG, 191PE4E, 1A1PE4E, 1A1PEFTE, 1A1FBE, 1D1PE4E, 1D1FBE, 6043590, 71E, 71GE, 71GEGG, FS30E		

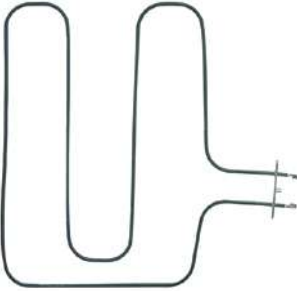

1

<b>GEV No.</b>	416677	<b>Ref. No.</b>	32G0151 32G1350 32G1351
<b>description</b>	heating element 2600W 400V L 460mm W 505mm L1 115mm L2 340mm W1 150mm W2 60mm flange length 100mm flange width 22mm hole distance 86mm hole ø 5mm tube ø 6.3mm connection male faston 6.3mm heating circuits 1 rectangular flange oven		
<b>For models:</b>	31GE, 31TCE, 32TCE		

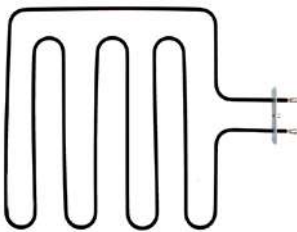

1

<b>GEV No.</b>	418641	<b>Ref. No.</b>	32G3250
<b>description</b>	heating element 2700W 400V heating circuits 1 L 465mm W 385mm L1 100mm L2 365mm W1 162mm W2 61mm flange length 100mm flange width 22mm hole distance 86mm hole ø 5mm tube ø 6.5mm connection male faston 6.3mm connection length 45mm mounting pos. upper rectangular flange dry heating element		
<b>For models:</b>	1G1FA0E, 1G1FA0EV, 1G1PE1E, 1G1PE1EV, 1G1PE2E, 1G1PE2EV, 2G1FA0E, 2G1PE1E, 2G1PE1EV, 2G1PE2E, 2G1PE2EV		

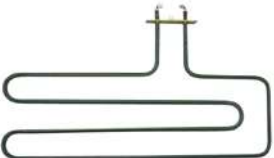

1

<b>GEV No.</b>	415673	<b>Ref. No.</b>	32G1621 32G1630
<b>description</b>	heating element 2600W 415V L 251mm W 510mm L1 89mm L2 162mm W1 287mm W2 63mm flange length 100mm flange width 22mm hole distance 86mm hole ø 5mm tube ø 8.7mm connection length 31mm connection male faston 6.3mm heating circuits 1 rectangular flange dry heating element oven		
<b>For models:</b>	1G1FA0E, 1G1FA0EV, 1G1PE1E, 1G1PE1EV, 1G1PE2E, 1G1PE2EV, 2G1FA0E, 2G1PE1E, 2G1PE1EV, 2G1PE2E, 2G1PE2EV, 31GE, 31TCE, 32TCE		

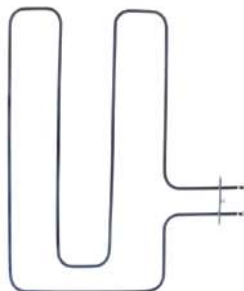



1

<b>GEV No.</b>	418837	<b>Ref. No.</b>	32G1220
<b>description</b>	heating element 2940W 230V L 455mm W 590mm L1 115mm L2 340mm W1 370mm W2 60mm flange length 100mm flange width 22mm hole distance 86mm hole ø 5mm tube ø 6.3mm connection length 55mm heating circuits 1 oven		
<b>For models:</b>	71E, FS30E		





Зип Общепит  
vsezip.ru  
8(2)987-08-81

			
<b>GEV No.</b>	416676	<b>Ref. No.</b>	32G0160
<b>description</b>	heating element 800W 230V heating circuits 1 L 405mm W 122mm H 16mm L1 42mm L2 363mm W1 30mm W2 62mm flange length 100mm flange width 22mm hole distance 86mm hole ø 4mm tube ø 6.3mm connection male faston 6.3mm rectangular flange dry heating element		

			
<b>GEV No.</b>	415171	<b>Ref. No.</b>	32G0080
<b>description</b>	heating element 900W 230V heating circuits 1 L 430mm W 122mm H 28mm L1 55mm L2 375mm W1 30mm W2 62mm flange length 100mm flange width 22mm hole distance 86mm hole ø 4mm tube ø 6.3mm connection male faston 6.3mm rectangular flange dry heating element		





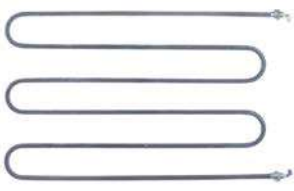

### heating elements for bain maries

			
<b>GEV No.</b>	416683	<b>Ref. No.</b>	32G2220
<b>description</b>	heating element 1000W 230V heating circuits 1 L 480mm W 35mm flange length 70mm flange width 22mm hole distance 56mm connection length 28mm connection M4 tube ø 8.5mm rectangular flange hole ø 5.5mm dry heating element		
<b>For models:</b>	04WBMEV, 090BM1E, 0A0BME, 0B0BME, 0D0BME, 190BM2E, 1A0BME, 1D0BME, 6040110, 6042680		

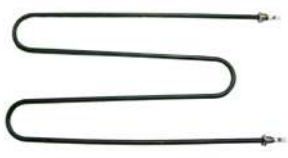
			
<b>GEV No.</b>	416682	<b>Ref. No.</b>	32G0280
<b>description</b>	heating element 1450W 230V L 378mm W 252mm connection male faston 6.3mm tube ø 8.5mm 2 hole fixing thread 1/4" dry heating element water bath mounting distance 245mm		
<b>For models:</b>	030EBM, 031EBM, 0G0BME, 1G0BME		

			
<b>GEV No.</b>	418688	<b>Ref. No.</b>	32G1730
<b>description</b>	heating element 1500W 230V L 470mm W 305mm tube ø 8.5mm thread 1/4" bain marie mounting distance 297mm		
<b>For models:</b>	ACBM, ACBM218, ANBM, ANBM218, ANBM75, SE14VB, SE21VB, SI14VB, SI21VB, SL14CVB, SL14NVB, SL21CVB, SL21NVB, SL7NVB, TBM, TBM218		

			
<b>GEV No.</b>	415173	<b>Ref. No.</b>	32G0070 32G0071
<b>description</b>	heating element 1600W 230V L 585mm W 200mm connection M6 tube ø 8.5mm 2 hole fixing thread M14x1.5 immersion heater mounting distance 184mm		
<b>For models:</b>	070BME, 071BME, 090BME, 091BME		
<b>accessories for</b>	415173		
	<b>GEV No.</b>	510417	<b>Ref. No.</b> —
flat gasket fibre ED ø 20mm ID ø 14mm thickness 2mm Qty 1 pcs			
	<b>GEV No.</b>	520228	<b>Ref. No.</b> —
tooth lock washer ID ø 15.3mm ED ø 24mm steel Qty 1 pcs for thread M14			
	<b>GEV No.</b>	520230	<b>Ref. No.</b> —
nut thread M14x1.5 H 5mm WS 19 zinc-coated steel Qty 1 pcs			
	<b>GEV No.</b>	521101	<b>Ref. No.</b> —
nut thread M14x1.5 H 5mm WS 19 SS Qty 1 pcs			
	<b>GEV No.</b>	550262	<b>Ref. No.</b> —
flat gasket copper ED ø 20mm ID ø 14mm thickness 2mm			

			
<b>GEV No.</b>	415181	<b>Ref. No.</b>	32G1250
<b>description</b>	heating element 2000W 230V heating circuits 1 L 458mm W 208mm connection male faston 6.3mm tube ø 8.5mm 2 hole fixing thread M14x1 immersion heater mounting distance 200mm		
<b>For models:</b>	030BME, 031BME		
<b>accessories for</b>	415181		
	<b>GEV No.</b>	510417	<b>Ref. No.</b> —
flat gasket fibre ED ø 20mm ID ø 14mm thickness 2mm Qty 1 pcs			
	<b>GEV No.</b>	520228	<b>Ref. No.</b> —
tooth lock washer ID ø 15.3mm ED ø 24mm steel Qty 1 pcs for thread M14			
	<b>GEV No.</b>	521133	<b>Ref. No.</b> —
nut thread M14x1.5 H 6mm WS 19 zinc-coated steel Qty 1 pcs			
	<b>GEV No.</b>	550261	<b>Ref. No.</b> —
nut thread M14x1 H 4mm WS 19 SS Qty 1 pcs			
	<b>GEV No.</b>	550262	<b>Ref. No.</b> —
flat gasket copper ED ø 20mm ID ø 14mm thickness 2mm			





Зип Общепит  
heating elements for fryers

vsezip.ru  
miscellaneous

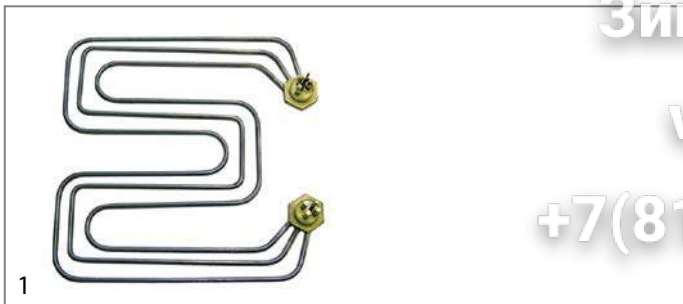

+7(812)987-08-81



<b>GEV No.</b>	415175	<b>Ref. No.</b>	32G0650
<b>description</b>	heating element 4800W 220V heating circuits 3 L 410mm W 417mm connection M3 tube ø 8.5mm flange with thread thread 1¼" immersion heater H1 10mm H 19mm		
<b>accessories for</b>	415175		
	<b>GEV No.</b>	510405	<b>Ref. No.</b> N/A
	flat gasket fibre ED ø 56mm ID ø 42mm thickness 2mm for thread 1¼" Qty 1 pcs		
	<b>GEV No.</b>	520232	<b>Ref. No.</b> —
	nut thread 1¼" H 5mm nickel-plated brass WS 47 Qty 1 pcs		
	<b>GEV No.</b>	527169	<b>Ref. No.</b> —
	hexagonal nut thread M3 H 2.8mm WS 5.5 brass Qty 1 pcs		
	<b>GEV No.</b>	528021	<b>Ref. No.</b> —
	flat gasket PTFE ED ø 53mm ID ø 42.5mm thickness 3mm Qty 1 pcs equiv. no. 12001/02286 suitable for Astoria/Aurora/Brasilia/Wega		
	<b>GEV No.</b>	560110	<b>Ref. No.</b> —
	plain washer ID ø 3.2mm ED ø 7mm thickness 0.5mm SS Qty 20 pcs DIN 125A for thread M3		
	<b>GEV No.</b>	560130	<b>Ref. No.</b> —
	hexagonal nut thread M3 H 2.4mm WS 5.5 SS DIN/ISO DIN 934 / ISO 4032/8673 Qty 20 pcs		

<b>GEV No.</b>	415172	<b>Ref. No.</b>	32G0090
<b>description</b>	heating element 800W 230V L 405mm W 50mm connection male faston 6.3mm tube ø 8.5mm 2 hole fixing thread M12x1 dry heating element mounting distance 42mm		
<b>For models:</b>	0G0BME-VERS.032008, 1G0BME-VERS.032008		
<b>spare parts for</b>	415172		
	<b>GEV No.</b>	510417	<b>Ref. No.</b> —
	flat gasket fibre ED ø 20mm ID ø 14mm thickness 2mm Qty 1 pcs		
<b>accessories for</b>	415172		
	<b>GEV No.</b>	520229	<b>Ref. No.</b> —
	nut thread M12x1 H 4mm WS 16 zinc-coated steel Qty 1 pcs		
	<b>GEV No.</b>	521110	<b>Ref. No.</b> —
	flat gasket fibre ED ø 20mm ID ø 13mm thickness 2mm Qty 1 pcs		

<b>GEV No.</b>	419049	<b>Ref. No.</b>	32G2610
<b>description</b>	heating element 7200W 230V L 300mm W 155mm		
<b>For models:</b>	04WFR3ED, 08WFR4ED, 091FR3E, 091FR3ED, 0A1FR3E, 0A1FR3ED, 0D1FR3E, 0D1FR3ED, 0G0FR3E, 0G0FR3ED, 191FR4E, 191FR4ED, 1A1FR4E, 1A1FR4ED, 1D1FR4E, 1D1FR4ED, 1G0FR4E, 6043840, 6043970		
<b>accessories for</b>	419049		
	<b>GEV No.</b>	510219	<b>Ref. No.</b> 60A0980
	O-ring set Qty 2 pcs		

<b>GEV No.</b>	416589	<b>Ref. No.</b>	32G2400
<b>description</b>	heating element 18000W 400V heating circuits 3 mounting pos. left L 395mm W 270mm H 32mm flange length 20mm flange ø 53.5mm thermostat sleeves ø 7mm length thermostat sleeves 315mm number of thermostat sleeves 1 thermostat sleeve clinging L1 15mm L2 380mm W1 34mm W2 41mm tube ø 8.5mm cable length 2000mm rotation flange immersion heater fryer connection length 110mm		
<b>For models:</b>	091FR1E, 091FR1EA, 091FR1ED, 0A1FR1E, 0A1FR1ED, 0D1FR1E, 0D1FR1ED, 191FR2E, 191FR2ED, 1A1FR2E, 1A1FR2ED, 1D1FR2ED		
<b>accessories for</b>	416589		
	<b>GEV No.</b>	510219	<b>Ref. No.</b> 60A0980
	O-ring set Qty 2 pcs		
	<b>GEV No.</b>	550494	<b>Ref. No.</b> 3152150 3152151
	O-ring Viton thickness 3.53mm ID ø 47.22mm Qty 1 pcs		

electric components



Зип-Общепит

vsezip.ru

+7(812)987-08-81

2 hole fixing

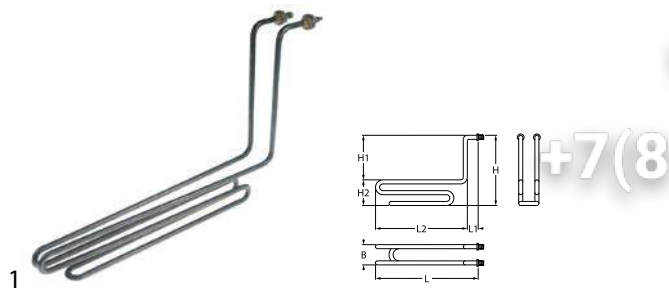

<b>GEV No.</b>	418597	<b>Ref. No.</b>	32G0060
<b>description</b>	heating element 2500W 230V heating circuits 1 L 460mm W 33mm H 275mm L1 45mm L2 415mm H1 220mm H2 55mm thread 1/4" tube ø 8.5mm windings 3		

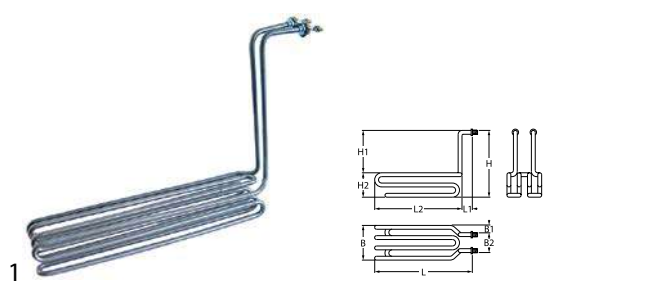

<b>GEV No.</b>	416588	<b>Ref. No.</b>	32G0100 32G1181
<b>description</b>	heating element 4700W 400V heating circuits 1 L 480mm W 90mm H 230mm L1 60mm L2 420mm W1 40mm W2 25mm H1 415mm H2 65mm thread 1/4" mounting distance 35mm tube ø 8.5mm 2 hole fixing connection M6 fryer windings 6		

**For models:** 70FE, 70FE1, 70FE1B, 71FE, 71FE2, 71FE2B

**accessories for** 416588

	<b>GEV No.</b>	560113	<b>Ref. No.</b>	3121480
	plain washer ID ø 6.4mm ED ø 12mm thickness 1.6mm SS Qty 20 pcs DIN 125A for thread M6			
	<b>GEV No.</b>	560133	<b>Ref. No.</b>	—
	hexagonal nut thread M6 H 5mm WS 10 SS DIN/ISO DIN 934 / ISO 4032/8673 Qty 20 pcs			

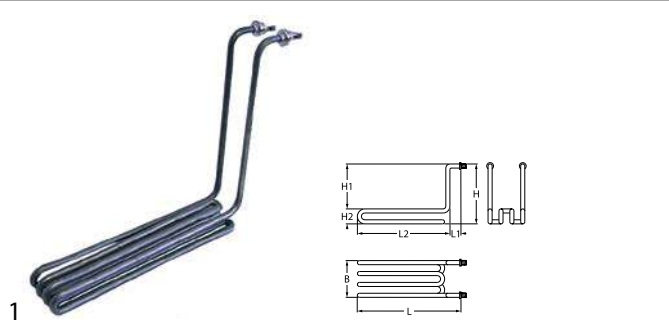

<b>GEV No.</b>	415180	<b>Ref. No.</b>	32G1241
<b>description</b>	heating element 2050W 230V heating circuits 1 L 305mm W 53mm H 245mm L1 30mm L2 275mm H1 210mm H2 35mm thread 1/4" mounting distance 22mm tube ø 8.5mm 2 hole fixing connection male faston 6.3mm fryer heaters windings 4		

**For models:** 030FE1, 030FE1B, 091FE28, 091FE28B, 30FES2, 30FES2B, 70FES2, 70FES2B

**accessories for** 415180

	<b>GEV No.</b>	361182	<b>Ref. No.</b>	3117580
	nut thread 1/4" H 5mm nickel-plated brass WS 17 Qty 1 pcs			
	<b>GEV No.</b>	510417	<b>Ref. No.</b>	—
	flat gasket fibre ED ø 20mm ID ø 14mm thickness 2mm Qty 1 pcs			

<b>GEV No.</b>	520228	<b>Ref. No.</b>	—
tooth lock washer ID ø 15.3mm ED ø 24mm steel Qty 1 pcs for thread M 14			
<b>GEV No.</b>	550262	<b>Ref. No.</b>	—
flat gasket copper ED ø 20mm ID ø 14mm thickness 2mm			

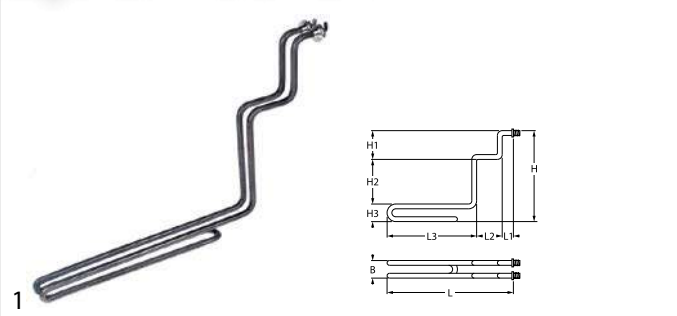

<b>GEV No.</b>	418760	<b>Ref. No.</b>	32G0130
<b>description</b>	heating element 1750W 230V L 415mm W 35mm H 260mm 2 hole fixing connection 6.3x0.8 heating circuits 1 L1 30mm L2 70mm L3 315mm H1 30mm H2 135mm H3 24mm tube ø 8.5mm thread M13 mounting distance 23mm connection length 7.5mm		

heating elements for griddles



<b>GEV No.</b>	416678	<b>Ref. No.</b>	32G1040
<b>description</b>	heating element 1700W 400V heating circuits 1 L 445mm W 75mm H 83mm tube ø 8.8mm connection male faston 6.3mm connection length 23mm griddle connection distance 66mm dry heating element		

**For models:** 031FTE04, 031FTE06



<b>GEV No.</b>	415179	<b>Ref. No.</b>	32G1260 32G1262
<b>description</b>	heating element 1750W 230V heating circuits 1 L 445mm W 82mm H 50mm tube ø 8.5mm connection M4 griddle connection distance 80mm dry heating element		

**For models:** 030FTE, 030FTE04, 031FTE, 031FTE04, 031FTE06



<b>GEV No.</b>	418481	<b>Ref. No.</b>	32G2371
<b>description</b>	heating element 2200W 230V heating circuits 1 L 615mm W 83.5mm H 89mm tube ø 8.5mm connection male faston 6.3mm connection length 21mm connection distance 75mm dry heating element		

**For models:** 090FT1E, 090FT2E, 090FT4E, 090FT5E, 090FT7E, 091FT1E, 091FT2E, 091FT4E, 091FT5E, 091FT7E, 0A0FT1E, 0A0FT2E, 0A0FT4E, 0A0FT5E, 0D0FT1E, 0D0FT2E, 0D0FT4E, 0D0FT5E, 190FT15E, 190FT1E, 190FT2E, 190FT3E, 190FT42E, 190FT4E, 190FT5E, 190FT6E, 190FT72E, 190FT7E, 191FT1E, 191FT2E, 191FT3E, 191FT4E, 191FT6E, 191FT7E, 1A0FT1E, 1A0FT2E, 1A0FT3E, 1A0FT4E, 1A0FT6E, 1A1PEFTE, 1D0FT1E, 1D0FT2E, 1D0FT3E, 1D0FT4E, 1D0FT6E



Зип Общежит

heating elements for tilting bratt pan

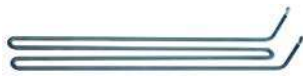

<b>GEV No.</b>	416680	<b>Ref. No.</b>	32G2370
<b>description</b>	heating element 2200W 230V heating circuits 1 L 615mm W 86mm H 92mm tube ø 8.5mm connection male faston 6.3mm griddle connection distance 84mm dry heating element		
<b>For models:</b>	0A0FT1E, 0A0FT2E, 0A0FT4E, 0A0FT5E, 0D0FT1E, 0D0FT2E, 0D0FT4E, 0D0FT5E, 1A0FT1E, 1A0FT2E, 1A0FT3E, 1A0FT4E, 1A0FT6E, 1D0FT1E, 1D0FT2E, 1D0FT3E, 1D0FT4E, 1D0FT6E		



<b>GEV No.</b>	416525	<b>Ref. No.</b>	32G1920 32G1921
<b>description</b>	heating element 1500W 230V L 415mm W 82mm H 50mm connection M4 dry heating element heating circuits 1 tube ø 8.5mm connection distance 65mm		
<b>For models:</b>	31RE		



<b>GEV No.</b>	416679	<b>Ref. No.</b>	32G1870
<b>description</b>	heating element 2200W 400V heating circuits 1 L 572mm W 81mm H 85mm tube ø 8.5mm connection male faston 6.3mm griddle connection distance 75mm dry heating element		
<b>For models:</b>	070FTE04, 070FTE05, 071FTE04, 071FTE06, 090FTE04, 090FTE05, 091FTE04, 091FTE06		



<b>GEV No.</b>	416596	<b>Ref. No.</b>	32G0251
<b>description</b>	heating element 1750W 230V L 500mm W 81mm H 50mm connection M4 dry heating element heating circuits 1 tube ø 8.5mm L1 18mm W1 10mm W2 47mm connection distance 73mm		
<b>For models:</b>	71ARE, 91ARE		

heating elements for refrigeration

heating elements for defrosting

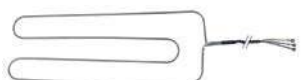

<b>GEV No.</b>	418600	<b>Ref. No.</b>	32G1021
<b>description</b>	heating element 160W 220V L 540mm W 170mm tube ø 4.5mm defrosting		
<b>For models:</b>	K16APGPZ, K16XPZAP, SA16AGB, SA16GB		



<b>GEV No.</b>	416597	<b>Ref. No.</b>	32G2481
<b>description</b>	heating element 2000W 230V L 530mm W 93mm H 70mm connection M4 dry heating element heating circuits 1 tube ø 8.5mm connection distance 83mm		
<b>For models:</b>	191BR1E, 191BR2E, 191BR2EA, 1A1BR1E, 1A1BR2E, 1A1BR2EA, 1D1BR1E, 1D1BR2E, 1D1BR2EA, 291BR1E, 291BR2E, 291BR2EA, 2A1BR1E, 2A1BR2E, 2A1BR2EA, 2D1BR1E, 2D1BR2E, 2D1BR2EA		



<b>GEV No.</b>	418609	<b>Ref. No.</b>	32G0350
<b>description</b>	heating element 2x110W 2x115V L 620mm cable length 2000mm tube ø 8.5mm defrosting		
<b>For models:</b>	65NB, 6BEABA, 6BEABB, 6BEABM, 6BEABZ, 6BEBBA, 6BEBBB, 6BEBBM, 6BEBBZ, 6BECBA, 6BECBB, 6BECBM, 6BECBZ, 6BMABA, 6BMABB, 6BMABM, 6BMABZ, 6MBBBA, 6MBBBB, 6MBBBM, 6MBBBZ, 6BMCBA, 6BMCBB, 6BMCBM, 6BMCBZ, 6RA, 6RA2, 6RA2A, 6RA2M, 6RA2Z, 6RA4, 6RA4A, 6RA4M, 6RA4Z, 6RAA, 6RAM, 6RAZ, 6RB, 6RB11, 6RB11A, 6RB11M, 6RB11Z, 6RB2, 6RB2A, 6RB2M, 6RB2Z, 6RB4, 6RB4A, 6RB4M, 6RB4Z...(Other models you can see in the webshop)		

heating elements for pasta cookers



<b>GEV No.</b>	415020	<b>Ref. No.</b>	32G0230 32G0380
<b>description</b>	heating element 4500W 230V mounting ø 57.5mm heating circuits 3 L 355mm W 35mm H 47mm number of thermostat sleeves 1 thermostat sleeves ø 7mm length thermostat sleeves 295mm thermostat sleeve upper tube ø 8.5mm hole distance 70mm hole ø 10mm connection length 25mm connection male faston 6.3mm 3 hole flange immersion heater		
<b>For models:</b>	0G1CP1EC, F60P, F60PR, F60T, L100, L40S, L60, L80		



<b>GEV No.</b>	418594	<b>Ref. No.</b>	32G1970
<b>description</b>	heating element 400W 220V L 480mm W 140mm H 80mm cable length 1000mm tube ø 8.5mm defrosting		
<b>For models:</b>	S60B, S60B-2, S60BE, S60BX, S60BX-2		









<b>GEV No.</b>	418602	<b>Ref. No.</b>	32G3270
<b>description</b>	heating element 4500W 400V heating circuits 3 L 315mm W 36mm H 48mm thermostat sleeves ø 7.5mm length thermostat sleeves 285mm hole distance 72mm mounting ø 57.5mm number of thermostat sleeves 1 thermostat sleeve eccentric, non clinging		
<b>For models:</b>	0G1CP1E, 0G1CP1EC, 0G1CP1E-VERS.2004, 1G1PI1E, 6043850, 6043980		
<b>accessories for</b>	418602		
	<b>GEV No.</b>	510409	<b>Ref. No.</b>
			3150430 3151960 37Q5260
	O-ring EPDM thickness 5.34mm ID ø 56.52mm Qty 1 pcs		





Зип-Общепит



vsezip.ru



+7(812)987-08-81

			
<b>GEV No.</b>	415182	<b>Ref. No.</b>	32G1300 32G1301 32G1930
<b>description</b>	heating element 4540W 230V heating circuits 3 L 325mm V 30mm H 48mm round flange connection M4 tube ø 8.5mm thermostat sleeves ø 7.5mm length thermostat sleeves 300mm mounting ø 57.5mm number of thermostat sleeves 1 thermostat sleeve eccentric, clinging pasta cooker		
<b>For models:</b>	30CPSE, 70CPE, 90CPE		
<b>spare parts for</b>	415182		
	<b>GEV No.</b>	510409	<b>Ref. No.</b> 3150430 3151960 37Q5260
	O-ring EPDM thickness 5.34mm ID ø 56.52mm Qty 1 pcs		
<b>accessories for</b>	415182		
	<b>GEV No.</b>	521103	<b>Ref. No.</b> N/A
	nut thread M4 H 3mm WS 7 brass Qty 20 pcs		
	<b>GEV No.</b>	521104	<b>Ref. No.</b> —
	washer ID ø 4.3mm ED ø 8mm thickness 0.5mm brass Qty 20 pcs for thread M4		
	<b>GEV No.</b>	550002	<b>Ref. No.</b> 3113780
	tension strap H 10mm L 21mm W 10mm hole ø 6.5mm for heating element		
	<b>GEV No.</b>	560111	<b>Ref. No.</b> —
	plain washer ID ø 4.3mm ED ø 9mm thickness 0.8mm SS Qty 20 pcs DIN 125A for thread M4		
	<b>GEV No.</b>	560131	<b>Ref. No.</b> —
	hexagonal nut thread M4 H 3.2mm WS 7 SS DIN/ISO DIN 934 / ISO 4032/8673 Qty 20 pcs		

			
<b>GEV No.</b>	416681	<b>Ref. No.</b>	32G2310
<b>description</b>	heating element 6000W 400V heating circuits 3 L 485mm W 37mm H 40mm 3 hole flange connection M4 tube ø 8.5mm thermostat sleeves ø 7mm length thermostat sleeves 445mm hole distance 70mm mounting ø 57.5mm hole ø 10mm number of thermostat sleeves 1 connection length 30mm thermostat sleeve upper pasta cooker		
<b>For models:</b>	04WCP1EM, 091CP1E, 0A1CP1E, 0D1CP1E, 6040090, 6040310		
<b>spare parts for</b>	416681		
	<b>GEV No.</b>	510409	<b>Ref. No.</b> 3150430 3151960 37Q5260
	O-ring EPDM thickness 5.34mm ID ø 56.52mm Qty 1 pcs		

## heating elements for chargrills

			
<b>GEV No.</b>	415148	<b>Ref. No.</b>	32G0140
<b>description</b>	heating element 750W 230V L 519mm W 35mm H 105mm 2 hole fixing mounting distance 26mm connection male faston 6.3mm L1 30mm L2 489mm tube ø 8.5mm dry heating element thread 1/4"		
<b>accessories for</b>	415148		
	<b>GEV No.</b>	361182	<b>Ref. No.</b> 3117580
	nut thread 1/4" H 5mm nickel-plated brass WS 17 Qty 1 pcs		

	<b>GEV No.</b>	510417	<b>Ref. No.</b>	—
	flat gasket fibre ED ø 20mm ID ø 14mm thickness 2mm Qty 1 pcs			
	<b>GEV No.</b>	520228	<b>Ref. No.</b>	—
	tooth lock washer ID ø 15.3mm ED ø 24mm steel Qty 1 pcs for thread M17			
	<b>GEV No.</b>	550262	<b>Ref. No.</b>	—
	flat gasket copper ED ø 20mm ID ø 14mm thickness 2mm			

## heating elements for salamanders/toast-

			
<b>GEV No.</b>	415758	<b>Ref. No.</b>	32G1441 32G1580
<b>description</b>	heating element 1300W 230V heating circuits 1 L 238mm W 132mm H 72mm connection distance 124mm tube ø 8.5mm cable length 900mm dry heating element connection length 20mm		
<b>For models:</b>	60SME		

## heating elements for heating bridges

			
<b>GEV No.</b>	418202	<b>Ref. No.</b>	3003800
<b>description</b>	heating element 500W 220V heating circuits 1 L 485mm Wmm lug length 40mm lug width 18mm connection M5 tube ø 6.3mm rectangular flange hole ø M4mm dry heating element		

## heating cables

## connection on both sides

## with male fastons

			
<b>GEV No.</b>	418761	<b>Ref. No.</b>	32G2420
<b>description</b>	heating cable 25W 230V L 5000mm ø 4mm		
<b>For models:</b>	40CP-OPR01, 40CPX-OPR01, AF1B, AF1B-OPR01, AF1N, AF1N-OPR01, AF2B, AF2B-OPR01, AF2N, AF2N-OPR01, CX120, CX120B, CX120NN, CX130B, CX140, CX140B, CX140BN, CX140BR, CX140CP, CX140NN, CX140PV, CX140R, CX150B, CX150BN, CX150BR, CX150CP, CX150R, CX55, CX55B, CX60B, CX65, CX652, CX65B, CX65BR, CX65NB, CX65NCP, CX65NN, CX65PV, CX65R, CX70B, CX70BR, CX70NB, CX70NN, CX70R, FG2B, FSD1B, FSD1N, FSD2B, FSD2N, FSD2N2...(Other models you can see in the webshop)		

			
<b>GEV No.</b>	420382	<b>Ref. No.</b>	32G3290
<b>description</b>	heating cable 31W 230V L 5000mm for blast chiller connection male faston		
<b>For models:</b>	DS31, DS31A, DS31C, DS31M, DS51, DS51A, DS51C, DS51M, IS51, IS51A, IS51AR, IS51C, IS51CR, IS51M, IS51MR, IS51R, IS51W, IS51WA, IS51WC, IS51WM, SM03LT7, SM03LT7A, SM03LT7M, SM1L7, SM1L7A, SM1L7FCV, SM1L7M, SM1LT7, SM1LT7A, SM1LT7M		





Зип Общепит

heating cartridges

vsezip.ru

+7(812)987-0871

<b>GEV No.</b>	420383	<b>Ref. No.</b>	32G2280
<b>description</b>	heating cable 45W 230V L 6000mm for blast chiller connection male faston		
<b>For models:</b>	IS101L, IS101LR, IS101LW, IS101S, IS101SR, IS101SW, SM2L, SM2LR, SM2LW, SM2S, SM2SR, SM2SW		

<b>GEV No.</b>	420384	<b>Ref. No.</b>	32G3500
<b>description</b>	heating cable 53W 230V L 6800mm for blast chiller connection male faston		
<b>For models:</b>	IS102S, IS102SR, IS102SR-0NR01, IS102SW, IS72S, IS72SR, IS72SW		

<b>GEV No.</b>	418755	<b>Ref. No.</b>	32G1820
<b>description</b>	heating cable 80W 220V $\phi$ 3mm connection male faston 6.3mm cable length 5250mm		
<b>For models:</b>	135BN, 135BNX, 135CPX, 135NN, 135NNX, 40CP, 40CPX, 55B, 65, 65B, 65BA, 65BX, 65BX-2, 65BXE, 65BXR, 65NB, 65NBX, 65PVX, 65X, 65X-2, 65XR, SP120BN, SP120NN, SP135BN, SP135CP, SP135NN, SP55, SP55B, SP65, SP65B, SP65NB		

<b>connection on both sides (metal braided)</b>			
<b>GEV No.</b>	419170	<b>Ref. No.</b>	32G0240
<b>description</b>	heating cable 100W 230V L1 (unheated) 600mm L2 (heated) 6600mm $\phi$ 4mm Qty 1		
<b>For models:</b>	6BEA11A, 6BEA11B, 6BEA11M, 6BEA11Z, 6BEA2A, 6BEA2B, 6BEA2M, 6BEA2Z, 6BEA3A, 6BEA3B, 6BEA3M, 6BEA3Z, 6BEA4A, 6BEA4B, 6BEA4M, 6BEA4Z, 6BEA5A, 6BEA5B, 6BEA5M, 6BEA5Z, 6BEA6A, 6BEA6B, 6BEA6M, 6BEA6Z, 6BEA7A, 6BEA7B, 6BEA7M, 6BEA7Z, 6BEA8A, 6BEA8B, 6BEA8M, 6BEA8Z, 6BEA9A, 6BEA9B, 6BEA9M, 6BEA9Z, 6BEA10A, 6BEA10B, 6BEA10M, 6BEA10Z, 6BEA11A, 6BEA11B, 6BEA11M, 6BEA11Z, 6BEA12A, 6BEA12B, 6BEA12M, 6BEA12Z, 6BEA13A, 6BEA13B, 6BEA13M, 6BEA13Z, 6BEA14A, 6BEA14B, 6BEA14M, 6BEA14Z, 6BEA15A, 6BEA15B, 6BEA15M, 6BEA15Z, 6BEA16A, 6BEA16B, 6BEA16M, 6BEA16Z, 6BEA17A, 6BEA17B, 6BEA17M, 6BEA17Z, 6BEA18A, 6BEA18B, 6BEA18M, 6BEA18Z, 6BEA19A, 6BEA19B, 6BEA19M, 6BEA19Z, 6BEA20A, 6BEA20B, 6BEA20M, 6BEA20Z, 6BEA21A, 6BEA21B, 6BEA21M, 6BEA21Z, 6BEA22A, 6BEA22B, 6BEA22M, 6BEA22Z, 6BEA23A, 6BEA23B, 6BEA23M, 6BEA23Z, 6BEA24A, 6BEA24B, 6BEA24M, 6BEA24Z, 6BEA25A, 6BEA25B, 6BEA25M, 6BEA25Z, 6BEA26A, 6BEA26B, 6BEA26M, 6BEA26Z, 6BEA27A, 6BEA27B, 6BEA27M, 6BEA27Z, 6BEA28A, 6BEA28B, 6BEA28M, 6BEA28Z, 6BEA29A, 6BEA29B, 6BEA29M, 6BEA29Z, 6BEA30A, 6BEA30B, 6BEA30M, 6BEA30Z, 6BEA31A, 6BEA31B, 6BEA31M, 6BEA31Z, 6BEA32A, 6BEA32B, 6BEA32M, 6BEA32Z, 6BEA33A, 6BEA33B, 6BEA33M, 6BEA33Z, 6BEA34A, 6BEA34B, 6BEA34M, 6BEA34Z, 6BEA35A, 6BEA35B, 6BEA35M, 6BEA35Z, 6BEA36A, 6BEA36B, 6BEA36M, 6BEA36Z, 6BEA37A, 6BEA37B, 6BEA37M, 6BEA37Z, 6BEA38A, 6BEA38B, 6BEA38M, 6BEA38Z, 6BEA39A, 6BEA39B, 6BEA39M, 6BEA39Z, 6BEA40A, 6BEA40B, 6BEA40M, 6BEA40Z, 6BEB11M, 6BEB11Z, 6BEB22A, 6BEB22B, 6BEB22M, 6BEB22Z, 6BEB23A, 6BEB23B, 6BEB23M, 6BEB23Z, 6BEB24A, 6BEB24B, 6BEB24M, 6BEB24Z, 6BEB25A, 6BEB25B, 6BEB25M, 6BEB25Z, 6BEB26A, 6BEB26B, 6BEB26M, 6BEB26Z, 6BEB27A, 6BEB27B, 6BEB27M, 6BEB27Z, 6BEB28A, 6BEB28B, 6BEB28M, 6BEB28Z, 6BEB29A, 6BEB29B, 6BEB29M, 6BEB29Z, 6BEB30A, 6BEB30B, 6BEB30M, 6BEB30Z, 6BEB31A, 6BEB31B, 6BEB31M, 6BEB31Z, 6BEB32A, 6BEB32B, 6BEB32M, 6BEB32Z, 6BEB33A, 6BEB33B, 6BEB33M, 6BEB33Z, 6BEB34A, 6BEB34B, 6BEB34M, 6BEB34Z, 6BEB35A, 6BEB35B, 6BEB35M, 6BEB35Z, 6BEB36A, 6BEB36B, 6BEB36M, 6BEB36Z, 6BEB37A, 6BEB37B, 6BEB37M, 6BEB37Z, 6BEB38A, 6BEB38B, 6BEB38M, 6BEB38Z, 6BEB39A, 6BEB39B, 6BEB39M, 6BEB39Z, 6BEB40A, 6BEB40B, 6BEB40M, 6BEB40Z, 6BEB41A, 6BEB41B, 6BEB41M, 6BEB41Z, 6BEB42A, 6BEB42B, 6BEB42M, 6BEB42Z, 6BEB43A, 6BEB43B, 6BEB43M, 6BEB43Z, 6BEB44A, 6BEB44B, 6BEB44M, 6BEB44Z, 6BEB45A, 6BEB45B, 6BEB45M, 6BEB45Z, 6BEB46A, 6BEB46B, 6BEB46M, 6BEB46Z, 6BEB47A, 6BEB47B, 6BEB47M, 6BEB47Z, 6BEB48A, 6BEB48B, 6BEB48M, 6BEB48Z, 6BEB49A, 6BEB49B, 6BEB49M, 6BEB49Z, 6BEB50A, 6BEB50B, 6BEB50M, 6BEB50Z, 6BEB51A, 6BEB51B, 6BEB51M, 6BEB51Z, 6BEB52A, 6BEB52B, 6BEB52M, 6BEB52Z, 6BEB53A, 6BEB53B, 6BEB53M, 6BEB53Z, 6BEB54A, 6BEB54B, 6BEB54M, 6BEB54Z, 6BEB55A, 6BEB55B, 6BEB55M, 6BEB55Z, 6BEB56A, 6BEB56B, 6BEB56M, 6BEB56Z, 6BEB57A, 6BEB57B, 6BEB57M, 6BEB57Z, 6BEB58A, 6BEB58B, 6BEB58M, 6BEB58Z, 6BEB59A, 6BEB59B, 6BEB59M, 6BEB59Z, 6BEB60A, 6BEB60B, 6BEB60M, 6BEB60Z, 6BEB61A, 6BEB61B, 6BEB61M, 6BEB61Z, 6BEB62A, 6BEB62B, 6BEB62M, 6BEB62Z, 6BEB63A, 6BEB63B, 6BEB63M, 6BEB63Z, 6BEB64A, 6BEB64B, 6BEB64M, 6BEB64Z, 6BEB65A, 6BEB65B, 6BEB65M, 6BEB65Z, 6BEB66A, 6BEB66B, 6BEB66M, 6BEB66Z, 6BEB67A, 6BEB67B, 6BEB67M, 6BEB67Z, 6BEB68A, 6BEB68B, 6BEB68M, 6BEB68Z, 6BEB69A, 6BEB69B, 6BEB69M, 6BEB69Z, 6BEB70A, 6BEB70B, 6BEB70M, 6BEB70Z, 6BEB71A, 6BEB71B, 6BEB71M, 6BEB71Z, 6BEB72A, 6BEB72B, 6BEB72M, 6BEB72Z, 6BEB73A, 6BEB73B, 6BEB73M, 6BEB73Z, 6BEB74A, 6BEB74B, 6BEB74M, 6BEB74Z, 6BEB75A, 6BEB75B, 6BEB75M, 6BEB75Z, 6BEB76A, 6BEB76B, 6BEB76M, 6BEB76Z, 6BEB77A, 6BEB77B, 6BEB77M, 6BEB77Z, 6BEB78A, 6BEB78B, 6BEB78M, 6BEB78Z, 6BEB79A, 6BEB79B, 6BEB79M, 6BEB79Z, 6BEB80A, 6BEB80B, 6BEB80M, 6BEB80Z, 6BEB81A, 6BEB81B, 6BEB81M, 6BEB81Z, 6BEB82A, 6BEB82B, 6BEB82M, 6BEB82Z, 6BEB83A, 6BEB83B, 6BEB83M, 6BEB83Z, 6BEB84A, 6BEB84B, 6BEB84M, 6BEB84Z, 6BEB85A, 6BEB85B, 6BEB85M, 6BEB85Z, 6BEB86A, 6BEB86B, 6BEB86M, 6BEB86Z, 6BEB87A, 6BEB87B, 6BEB87M, 6BEB87Z, 6BEB88A, 6BEB88B, 6BEB88M, 6BEB88Z, 6BEB89A, 6BEB89B, 6BEB89M, 6BEB89Z, 6BEB90A, 6BEB90B, 6BEB90M, 6BEB90Z, 6BEB91A, 6BEB91B, 6BEB91M, 6BEB91Z, 6BEB92A, 6BEB92B, 6BEB92M, 6BEB92Z, 6BEB93A, 6BEB93B, 6BEB93M, 6BEB93Z, 6BEB94A, 6BEB94B, 6BEB94M, 6BEB94Z, 6BEB95A, 6BEB95B, 6BEB95M, 6BEB95Z, 6BEB96A, 6BEB96B, 6BEB96M, 6BEB96Z, 6BEB97A, 6BEB97B, 6BEB97M, 6BEB97Z, 6BEB98A, 6BEB98B, 6BEB98M, 6BEB98Z, 6BEB99A, 6BEB99B, 6BEB99M, 6BEB99Z, 6BEB100A, 6BEB100B, 6BEB100M, 6BEB100Z, 6BEC11A, 6BEC11B...(Other models you can see in the webshop)		

<b>GEV No.</b>	419109	<b>Ref. No.</b>	32G1810
<b>description</b>	heating cable 150W 220V L1 (unheated) 2x1000mm L2 (heated) 5000mm $\phi$ 3.5mm L 7000mm connection male faston 6.3mm		
<b>For models:</b>	120B, 135, 135-4, 135B, 135BA, 135BX, 135BXE, 135BXR, 135PVX, 135X, 135X-3, 135X-4, 135XR, ISP202R, ISR201R, ISR202R, SP120, SP120B, SP135, SP135B		

<b>GEV No.</b>	418892	<b>Ref. No.</b>	32G3310	
<b>description</b>	heating cartridge 190W 230V $\phi$ 12mm L 240mm thread 3/8" cable length 2000mm immersion heater			
<b>For models:</b>	AF1N, AF1N-0PR01, AF2N, AF2N-0PR01, CX120, CX120NN, CX130, CX130NN, CX140, CX140BN, CX140BR, CX140CP, CX140NN, CX140PV, CX140R, CX150, CX150BN, CX150BR, CX150CP, CX150NN, CX150PV, CX150R, CX55, CX60, CX65, CX652, CX65BR, CX65NB, CX65NCP, CX65NN, CX65PV, CX65R, CX70, CX702, CX70BR, CX70NB, CX70NN, CX70PV, CX70R, FSD1N, FSD2N, FSD2N2, FSDR1B-0PR01, FSDR1N-0PR01, FSDR2B-0PR01, FSDR2B2-0PR01, FSDR2N, FSDR2N-0PR01, FSDR2N2-0PR01, FSE2N...(Other models you can see in the webshop)			
<b>accessories for</b>	418892			
	<b>GEV No.</b>	511472	<b>Ref. No.</b>	—
	nut thread 3/8" H 4mm brass WS 21 Qty 1 pcs			
	<b>GEV No.</b>	518393	<b>Ref. No.</b>	—
	flat gasket FIBER ED $\phi$ 24mm ID $\phi$ 17mm thickness 2mm Qty 1 pcs			

<b>GEV No.</b>	417747	<b>Ref. No.</b>	3134541
<b>description</b>	heating cartridge 150W 230V $\phi$ 10mm L 165mm connection female faston 6.3mm cable length 520mm		

heater battery

<b>GEV No.</b>	415122	<b>Ref. No.</b>	32G1990
<b>description</b>	heater battery mounting distance 185mm W 40mm H 35mm 2000W 230V temperature restriction 105°C heating circuits 2 connection cable cable length 340mm L 197mm for cross flow fan		

coil heating elements

<b>GEV No.</b>	419164	<b>Ref. No.</b>	32G2200
<b>description</b>	heating element 1500W 230V L 345mm W 95mm thread 3/8" connection M6 connection length 46mm dishwasher dry heating element heating circuits 1 2 hole fixing		
<b>For models:</b>	TA9C, TA9C-VERS.2006		

electric components



## immersion heating elements

## 3 hole flange ø38.5mm

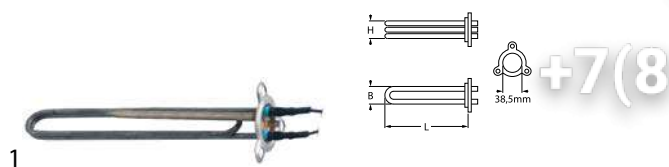

<b>GEV No.</b>	416277	<b>Ref. No.</b>	3030200
----------------	--------	-----------------	---------

**description** heating element 2800W 230V mounting ø 38.5mm heating circuits 1 L 302mm W 37mm H 28mm number of thermostat sleeves 1 thermostat sleeves ø 7mm length thermostat sleeves 199mm thermostat sleeve not clinging tube ø 6.4mm hole distance 57mm hole ø 10mm cable length 114mm 3 hole flange connection 26 immersion heater

**accessories for** 416277

<b>GEV No.</b>	532577	<b>Ref. No.</b>	—
----------------	--------	-----------------	---

 O-ring EPDM thickness 5.34mm ID ø 40.65mm Qty 1 pcs

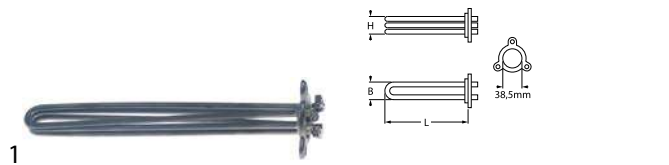

<b>GEV No.</b>	420037	<b>Ref. No.</b>	3104990
----------------	--------	-----------------	---------

**description** heating element 4000W 230V mounting ø 38.5mm heating circuits 3 L 300mm W 33mm H 27mm tube ø 6.4mm hole distance 57mm hole ø 10mm connection male faston 6.3mm vertical

**For models:** KD40, KD40PS, KD40-VERS.112009

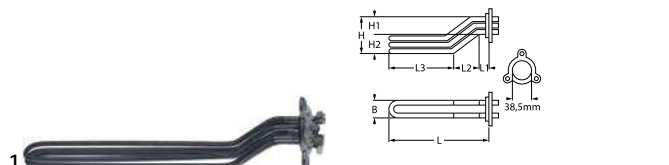

<b>GEV No.</b>	420061	<b>Ref. No.</b>	3075840
----------------	--------	-----------------	---------

**description** heating element 3500W 230V heating circuits 3 L 366mm W 35mm H 60mm L1 30mm L2 56mm L3 280mm H1 36mm H2 24mm hole distance 57mm hole ø 10mm tube ø 6.2mm connection male faston 6.3mm

**For models:** LF50EM

**accessories for** 420061

<b>GEV No.</b>	532577	<b>Ref. No.</b>	—
----------------	--------	-----------------	---

 O-ring EPDM thickness 5.34mm ID ø 40.65mm Qty 1 pcs

Зип Общепит

vsezip.ru

+7(812)987-08-81

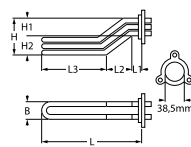

<b>GEV No.</b>	416267	<b>Ref. No.</b>	32G2140
----------------	--------	-----------------	---------

**description** heating element 4500W 230V mounting ø 38.5mm heating circuits 3 L 358mm W 32mm H 58mm L1 36mm L2 72mm L3 250mm H1 28mm H2 30mm hole distance 57mm hole ø 10mm tube ø 6.3mm connection male faston 6.3mm immersion heater 3 hole flange

**For models:** CS243D, CS243D-VERS.2006, CS243S, CS243VD, CS243VS, CS370AD, CS370AD-VERS.2006, CS370AS, CS370AS-VERS.2006, CS370AVD, CS370AVS, CS370D, CS370D-VERS.2006, CS370S, CS370S-VERS.2006, CS370VD, CS370VS, CS466AD, CS466AD-VERS.2006, CS466AS, CS466AS-VERS.2006, CS466AVD, CS466AVS, CS466D, CS466D-VERS.2006, CS466S, CS466S-VERS.2006, CS466VD, CS466VS, LF50E, LF50EMPS, LF50EM-VERS.122012, LF50E-VERS.122012, LF50E-VERS.2007, N303D, N303S, N303VD, N303VS, N354D, N354S, N354VD, N354VS, N506D, N506S, N506VD, N506VS, N607D, N607S, N607VD, N607VS

**accessories for** 416267

<b>GEV No.</b>	532577	<b>Ref. No.</b>	—
----------------	--------	-----------------	---

 O-ring EPDM thickness 5.34mm ID ø 40.65mm Qty 1 pcs

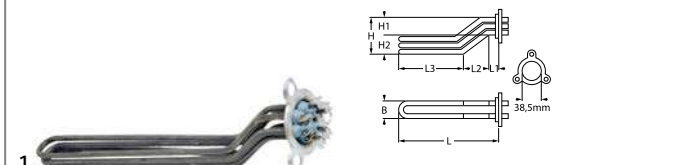

<b>GEV No.</b>	416268	<b>Ref. No.</b>	32G2180
----------------	--------	-----------------	---------

**description** heating element 6000W 230V mounting ø 38.5mm heating circuits 3 L 360mm W 34mm H 55mm L1 35mm L2 70mm L3 255mm H1 27mm H2 28mm hole distance 57mm hole ø 10mm tube ø 6.3mm connection male faston 6.3mm immersion heater 3 hole flange

**spare parts for** 416268

<b>GEV No.</b>	532577	<b>Ref. No.</b>	—
----------------	--------	-----------------	---

 O-ring EPDM thickness 5.34mm ID ø 40.65mm Qty 1 pcs



Зип Общежит

vsezip.ru

+7(812)987-08-81

3 hole flange ø38.5mm

<b>GEV No.</b>	416269	<b>Ref. No.</b>	32G2170
<b>description</b>	heating element 8000W 230V mounting ø 38.5mm heating circuits 3 L 545mm W 32mm H 60mm L1 38mm L2 55mm L3 447mm H1 27mm H2 33mm hole distance 57mm hole ø 10mm tube ø 6.3mm connection male faston 6.3mm immersion heater 3 hole flange		
<b>For models:</b>	C165D, C165S, C165VD, C165VS, C207D, C207D-VERS.2006, C207S, C207S-VERS.2006, C207VD, C207VS, C304AD, C304AD-VERS.2006, C304AS, C304AS-VERS.2006, C304AVD, C304AVS, C304D, C304D-VERS.2006, C304S, C304S-VERS.2006, C304VD, C304VS, C92D-VERS.2006, C92S-VERS.2006, CS243D, CS243D-VERS.2006, CS243S, CS243S-VERS.2006, CS243VD, CS243VS, CS370AD, CS370AD-VERS.2006, CS370AS, CS370AS-VERS.2006, CS370AVD, CS370AVS, CS370D, CS370D-VERS.2006, CS370S, CS370S-VERS.2006, CS370VD, CS370VS, CS466AD, CS466AD-VERS.2006, CS466AS, CS466AS-VERS.2006, CS466AVD, CS466AVS, CS466D, CS466D-VERS.2006... (Other models you can see in the webshop)		
<b>accessories for</b>	416269		
	<b>GEV No.</b>	<b>532577</b>	<b>Ref. No.</b>
			—
	O-ring EPDM thickness 5.34mm ID ø 40.65mm Qty 1 pcs		

3 hole flange ø47.5mm

<b>GEV No.</b>	415013	<b>Ref. No.</b>	32G0390 32G0790
<b>description</b>	heating element 2400W 230V mounting ø 47.5mm heating circuits 1 L 215mm W 40mm H 35mm number of thermostat sleeves 1 thermostat sleeves ø 6.5mm length thermostat sleeves 190mm thermostat sleeve eccentric, non clinging tube ø 6.5mm hole distance 64mm hole ø 8x10mm connection male faston 6.3mm 3 hole flange immersion heater		
<b>For models:</b>	L40, L45		
<b>accessories for</b>	415013		
	<b>GEV No.</b>	<b>510408</b>	<b>Ref. No.</b>
			3152650
	O-ring EPDM thickness 5.34mm ID ø 47mm Qty 1 pcs		
	<b>GEV No.</b>	<b>510562</b>	<b>Ref. No.</b>
			—
	O-ring silicone thickness 5.34mm ID ø 47mm Qty 1 pcs		

3 hole flange ø57.5mm

<b>GEV No.</b>	418249	<b>Ref. No.</b>	32G2150
<b>description</b>	heating element 10000W 230V mounting ø 57.5mm heating circuits 3 L 512mm W 50mm H 33mm number of thermostat sleeves 1 thermostat sleeves ø 8.5mm length thermostat sleeves 458mm thermostat sleeve eccentric, clinging tube ø 6.3mm hole distance 70mm hole ø 9mm connection length 30mm connection M4 3 hole flange immersion heater		
<b>For models:</b>	C304AD, C304AD-VERS.2006, C304AS, C304AS-VERS.2006, C304D, C304D-VERS.2006, C304S, C304S-VERS.2006, CS243D, CS243S, CS243VD, CS243VS, CS370AD, CS370AD-VERS.2006, CS370AS, CS370AS-VERS.2006, CS370AVD, CS370AVS, CS370D, CS370D-VERS.2006, CS370S, CS370S-VERS.2006, CS370VD, CS370VS, CS466AD, CS466AD-VERS.2006, CS466AS, CS466AS-VERS.2006, CS466AVD, CS466AVS, CS466D, CS466D-VERS.2006, CS466S, CS466S-VERS.2006, CS466VD, CS466VS, LC130-VERS.2001		

<b>GEV No.</b>	415023	<b>Ref. No.</b>	32G0840
<b>description</b>	heating element 12500W 230V mounting ø 57.5mm heating circuits 3 L 630mm W 36mm H 48mm number of thermostat sleeves 1 thermostat sleeves ø 7mm length thermostat sleeves 295mm thermostat sleeve eccentric, non clinging tube ø 8.5mm hole distance 76mm hole ø 8x10mm connection M5 3 hole flange immersion heater		
<b>spare parts for</b>	415023		
	<b>GEV No.</b>	<b>510409</b>	<b>Ref. No.</b>
			3150430 3151960 37Q5260
	O-ring EPDM thickness 5.34mm ID ø 56.52mm Qty 1 pcs		

<b>GEV No.</b>	419138	<b>Ref. No.</b>	32G2000 32G2340 32G2840
<b>description</b>	heating element 14000W 230V mounting ø 57.5mm heating circuits 3 L 515mm W 37mm H 50mm number of thermostat sleeves 1 thermostat sleeves ø 7.5mm length thermostat sleeves 450mm thermostat sleeve upper tube ø 10mm hole distance 72mm hole ø 8x10mm connection length 30mm connection M5 3 hole flange immersion heater		
<b>For models:</b>	C165D, C165S, C207D, C207D-VERS.2006, C207S, C207S-VERS.2006, C92D-VERS.2006, C92S-VERS.2006, CS243D-VERS.2006, CS243S-VERS.2006, LP124, LP124S-VERS.052006, LP124-VERS.052006		
<b>accessories for</b>	419138		
	<b>GEV No.</b>	<b>510409</b>	<b>Ref. No.</b>
			3150430 3151960 37Q5260
	O-ring EPDM thickness 5.34mm ID ø 56.52mm Qty 1 pcs		

electric components



Зип Общепит

vsezip.ru

+7(812)987-08-81

<b>GEV No.</b>	415020	<b>Ref. No.</b>	32G0230 32G0380
<b>description</b>	heating element 4500W 230V mounting $\varnothing$ 57.5mm heating circuits 3 L 355mm W 35mm H 47mm number of thermostat sleeves 1 thermostat sleeves $\varnothing$ 7mm length thermostat sleeves 295mm thermostat sleeve upper tube $\varnothing$ 8.5mm hole distance 70mm hole $\varnothing$ 10mm connection length 25mm connection male faston 6.3mm 3 hole flange immersion heater		
<b>For models:</b>	OG1CP1EC, F60P, F60PR, F60T, L100, L40S, L60, L80		

<b>GEV No.</b>	415021	<b>Ref. No.</b>	32G0400 32G0420 32G0520 32G0920	
<b>description</b>	heating element 6000W 230V mounting $\varnothing$ 57.5mm heating circuits 3 L 343mm W 37mm H 50mm number of thermostat sleeves 1 thermostat sleeves $\varnothing$ 7mm length thermostat sleeves 294mm thermostat sleeve not clinging tube $\varnothing$ 8.5mm hole distance 72mm hole $\varnothing$ 8mm connection M5 3 hole flange			
<b>For models:</b>	F60P, F60PR, F60T, F80P, F80PR, L100, L45, L60, L80			
<b>spare parts for</b>	415021			
	<b>GEV No.</b>	510409	<b>Ref. No.</b>	3150430 3151960 37Q5260
O-ring EPDM thickness 5.34mm ID $\varnothing$ 56.52mm Qty 1 pcs				
<b>accessories for</b>	415021			
	<b>GEV No.</b>	550002	<b>Ref. No.</b>	3113780
tension strap H 10mm L 21mm W 10mm hole $\varnothing$ 6.5mm for heating element				

<b>GEV No.</b>	418585	<b>Ref. No.</b>	32G2580
<b>description</b>	heating element 6000W 400V mounting $\varnothing$ 57.5mm heating circuits 3 L 324mm W 42mm H 30mm number of thermostat sleeves 1 thermostat sleeves $\varnothing$ 7mm length thermostat sleeves 280mm thermostat sleeve eccentric, clinging tube $\varnothing$ 8.5mm hole distance 74mm hole $\varnothing$ 8/10mm connection length 10mm connection M4 3 hole flange immersion heater		
<b>For models:</b>	LC100, LC100-VERS.2001, LC80, LF50, LP84S-VERS.052006, LP84-VERS.052006		

<b>GEV No.</b>	415022	<b>Ref. No.</b>	32G0850 32G2100 32G2720	
<b>description</b>	heating element 9000W 230/400V mounting $\varnothing$ 57.5mm heating circuits 3 L 475mm W 36mm H 43mm number of thermostat sleeves 1 thermostat sleeves $\varnothing$ 7mm length thermostat sleeves 300mm thermostat sleeve eccentric, non clinging tube $\varnothing$ 10mm hole distance 73mm hole $\varnothing$ 10mm connection length 30mm connection M5 3 hole flange immersion heater			
<b>spare parts for</b>	415022			
	<b>GEV No.</b>	510409	<b>Ref. No.</b>	3150430 3151960 37Q5260
O-ring EPDM thickness 5.34mm ID $\varnothing$ 56.52mm Qty 1 pcs				

<b>GEV No.</b>	418586	<b>Ref. No.</b>	32G2720
<b>description</b>	heating element 9000W 230V mounting $\varnothing$ 57.5mm heating circuits 3 L 515mm W 37mm H 46mm number of thermostat sleeves 1 thermostat sleeves $\varnothing$ 7mm length thermostat sleeves 440mm thermostat sleeve eccentric, clinging hole distance 73mm		
<b>For models:</b>	CS370AD-VERS.2006, CS370AS-VERS.2006, CS370D-VERS.2006, CS370S-VERS.2006, CS466AD-VERS.2006, CS466AS-VERS.2006, CS466D-VERS.2006, CS466S-VERS.2006, LC130, LP84, LP84S-VERS.052006, LP84-VERS.052006, N303D, N303S, N354D, N354S, N506S, N607D, N607S, N760D, N760S, N886D, N886S		

<b>with compression flange 50 x 26mm</b>				
<b>GEV No.</b>	416209	<b>Ref. No.</b>	32G2070	
<b>description</b>	heating element 2000W 230V heating circuits 1 compression flange flange 50x26mm L 180mm W 90mm H 24mm L1 55mm L2 125mm W1 28mm W2 35mm connection male faston 6.3mm tube $\varnothing$ 8.5mm connection length 28mm immersion heater			
<b>For models:</b>	LF50EM, LF50EMPS, LF50EMPS-VERS.122012, LF50EM-VERS.122012, LF50E-VERS.122012, LF50E-VERS.2007, LP70			
<b>accessories for</b>	416209			
	<b>GEV No.</b>	510387	<b>Ref. No.</b>	—
gasket L 46mm W 22mm $\varnothing$ mm EPDM for heating element for flange 50x26mm				



Зип Общежит

vsezip.ru

+7(812)987-08-81

with compression flange 62 x 26mm

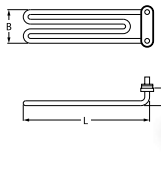
<b>GEV No.</b>	415268	<b>Ref. No.</b>	3030180
<b>description</b>	heating element 1850-2020W 230-240V heating circuits 1 expansion flange flange 62x26mm L 245mm W 40mm H 25mm tube ø 6.5mm connection male faston 6.3mm immersion heater		



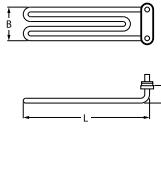

<b>GEV No.</b>	415270	<b>Ref. No.</b>	32g3360
<b>description</b>	heating element 2700W 230V heating circuits 1 compression flange flange 62x26mm L 335mm W 43mm H 25mm tube ø 6.3mm connection male faston 6.3mm immersion heater		
<b>For models:</b>	KD100, KD100A, KD100PSD, KD60, KD60E, KD60EAT, KD60M, KD60MA, KD60ME, KD60MPS, KD60MPSA, KD60PS, KD60PSD, KD6E-ATSD, KD85, KD85A, KD85E, KD85EA, KD85EAT, KD85EATS, KD85EPS, KD85EPSA, KD85PS, KD85PSA, KN1100, KN1100SD, KN11PSDD, KN50, KN50M, KN50MPS, KN50PS, KN50PSD, KN50PSDD, KN80, KN800, KN800PSD, KN80PS, LP70		

with expansion flange 70 x 18mm









<b>GEV No.</b>	418588	<b>Ref. No.</b>	32G0120
<b>description</b>	heating element 1000W 220V heating circuits 1 flange 70x18mm L 175mm W 83mm H 55mm connection male faston 6.3mm tube ø 8.3mm		



<b>GEV No.</b>	418598	<b>Ref. No.</b>	32G0190
<b>description</b>	heating element 1500W 220V heating circuits 1 flange 70x18mm L 175mm W 83mm H 55mm connection male faston 6.3mm immersion heater tube ø 8.5mm		

with round flange ø 47.5mm



<b>GEV No.</b>	415249	<b>Ref. No.</b>	32G0480	
<b>description</b>	heating element 1500W 220V heating circuits 1 mounting ø 47.5mm L 220mm W 36mm H 49mm round flange connection male faston 6.3mm immersion heater tube ø 6.5mm connection length 18mm thermostat sleeves ø 7.5mm number of thermostat sleeves 1 length thermostat sleeves 181mm thermostat sleeve not clinging			
<b>spare parts for</b>	415249			
	<b>GEV No.</b>	510408	<b>Ref. No.</b>	3152650
	O-ring EPDM thickness 5.34mm ID ø 47mm Qty 1 pcs			
<b>accessories for</b>	415249			
	<b>GEV No.</b>	510562	<b>Ref. No.</b>	—
	O-ring silicone thickness 5.34mm ID ø 47mm Qty 1 pcs			
	<b>GEV No.</b>	520235	<b>Ref. No.</b>	—
	3 hole flange hole distance 70.5mm perforation ø 6.5mm ID ø 53.5mm			
	<b>GEV No.</b>	520236	<b>Ref. No.</b>	—
	flange for heating element ID ø 50mm ED ø 90mm hole ø 6.5mm 3 holes			
	<b>GEV No.</b>	550002	<b>Ref. No.</b>	3113780
	tension strap H 10mm L 21mm W 10mm hole ø 6.5mm for heating element			
	<b>GEV No.</b>	550362	<b>Ref. No.</b>	—
	blind flange ø 64mm mounting ø 47.5mm			









<b>GEV No.</b>	415043	<b>Ref. No.</b>	32g0540	
<b>description</b>	heating element 2500W 230V heating circuits 1 mounting ø 47.5mm L 225mm W 41mm H 36mm round flange connection male faston 6.3mm immersion heater tube ø 6.5mm connection length 17mm thermostat sleeves ø 7mm number of thermostat sleeves 1 length thermostat sleeves 210mm thermostat sleeve eccentric, non clinging			
<b>For models:</b>	LT10R, LT20F, LT25F			
<b>spare parts for</b>	415043			
	<b>GEV No.</b>	510408	<b>Ref. No.</b>	3152650
	O-ring EPDM thickness 5.34mm ID ø 47mm Qty 1 pcs			
<b>accessories for</b>	415043			
	<b>GEV No.</b>	510408	<b>Ref. No.</b>	3152650
	O-ring EPDM thickness 5.34mm ID ø 47mm Qty 1 pcs			
	<b>GEV No.</b>	510562	<b>Ref. No.</b>	—
	O-ring silicone thickness 5.34mm ID ø 47mm Qty 1 pcs			
	<b>GEV No.</b>	520235	<b>Ref. No.</b>	—
	3 hole flange hole distance 70.5mm perforation ø 6.5mm ID ø 53.5mm			
	<b>GEV No.</b>	520236	<b>Ref. No.</b>	—
	flange for heating element ID ø 50mm ED ø 90mm hole ø 6.5mm 3 holes			
	<b>GEV No.</b>	550002	<b>Ref. No.</b>	3113780
	tension strap H 10mm L 21mm W 10mm hole ø 6.5mm for heating element			

Table continues overleaf

electric components



Зип Общежит

vsezip.ru



+7(812)987-08-81



<b>accessories for</b>	415043		
	GEV No.	550362	Ref. No.
			—
	blind flange ø 64mm mounting ø 47.5mm		

<b>1</b>			
<b>GEV No.</b>	415269	<b>Ref. No.</b>	32G3400
<b>description</b>	heating element 2700W 230V heating circuits 3 mounting ø 47.5mm L 257mm W 28mm H 45mm round flange connection male faston 6.3mm immersion heater tube ø 6.3mm H1 11mm H2 34mm connection length 28mm		
<b>For models:</b>	KD100, KD100A, KD100PSD, KD130, KD130A, KD130E, KD130EAT, LP151		

<b>accessories for</b>	415269		
	GEV No.	510408	Ref. No.
			3152650
	O-ring EPDM thickness 5.34mm ID ø 47mm Qty 1 pcs		
	GEV No.	510562	Ref. No.
			—
	O-ring silicone thickness 5.34mm ID ø 47mm Qty 1 pcs		
	GEV No.	520235	Ref. No.
			—
	3 hole flange hole distance 70.5mm perforation ø 6.5mm ID ø 53.5mm		
	GEV No.	520236	Ref. No.
			—
	flange for heating element ID ø 50mm ED ø 90mm hole ø 6.5mm 3 holes		
	GEV No.	550002	Ref. No.
			3113780
	tension strap H 10mm L 21mm W 10mm hole ø 6.5mm for heating element		
	GEV No.	550362	Ref. No.
			—
	blind flange ø 64mm mounting ø 47.5mm		

<b>1</b>			
<b>GEV No.</b>	415263	<b>Ref. No.</b>	32G3390
<b>description</b>	heating element 4500W 230V heating circuits 3 mounting ø 47.5mm L 375mm W 38mm H 46mm round flange connection male faston 6.3mm immersion heater tube ø 6.3mm thermostat sleeves ø 7mm number of thermostat sleeves 1 length thermostat sleeves 240mm thermostat sleeve not clinging		
<b>accessories for</b>	415263		
	GEV No.	510408	Ref. No.
			3152650
	O-ring EPDM thickness 5.34mm ID ø 47mm Qty 1 pcs		
	GEV No.	520235	Ref. No.
			—
	3 hole flange hole distance 70.5mm perforation ø 6.5mm ID ø 53.5mm		
	GEV No.	520236	Ref. No.
			—
	flange for heating element ID ø 50mm ED ø 90mm hole ø 6.5mm 3 holes		
	GEV No.	521012	Ref. No.
			—
	gasket graphite ED ø 15mm ID ø 5mm thickness 1.2mm Qty 1 pcs		
	GEV No.	550002	Ref. No.
			3113780
	tension strap H 10mm L 21mm W 10mm hole ø 6.5mm for heating element		
	GEV No.	550362	Ref. No.
			—
	blind flange ø 64mm mounting ø 47.5mm		







<b>1</b>			
<b>GEV No.</b>	415019	<b>Ref. No.</b>	32G0220
<b>description</b>	heating element 3000W 230V heating circuits 3 mounting ø 57.5mm L 338mm W 37mm H 41mm round flange connection male faston 6.3mm immersion heater tube ø 8.5mm connection length 27mm thermostat sleeves ø 7mm number of thermostat sleeves 1 length thermostat sleeves 300mm thermostat sleeve not clinging with 3 hole flange & O-ring		
<b>accessories for</b>	415019		
	GEV No.	550002	Ref. No.
			3113780
	tension strap H 10mm L 21mm W 10mm hole ø 6.5mm for heating element		



<b>1</b>			
<b>GEV No.</b>	416598	<b>Ref. No.</b>	32G1931
<b>description</b>	heating element 4540W 400V heating circuits 3 L 312mm W 55mm H 48mm tube ø 8.5mm thermostat sleeves ø 7mm length thermostat sleeves 290mm number of thermostat sleeves 1 connection M4 immersion heater round flange mounting ø 57.5mm		
<b>For models:</b>	31PIE6		
<b>accessories for</b>	416598		
	GEV No.	550002	Ref. No.
			3113780
	tension strap H 10mm L 21mm W 10mm hole ø 6.5mm for heating element		



<b>1</b>			
<b>GEV No.</b>	415264	<b>Ref. No.</b>	3037760
<b>description</b>	heating element 6000W 230V heating circuits 3 mounting ø 57.5mm L 480mm W 33mm H 42mm round flange connection M5 immersion heater tube ø 8.5mm connection length 19mm thermostat sleeves ø 7.5mm number of thermostat sleeves 1 length thermostat sleeves 268mm thermostat sleeve not clinging		
<b>For models:</b>	KD85, KD85A, KD85E, KD85EA, KD85EAT, KD85EATS, KD85EPS, KD85EPSA, KD85PS, KD85PSA, KN1100, KN1100SD, KN11PSDD, KN800, KN800PSD, LP151, LP202, LP202HC, LP302, LP302HC, N100D, N100S, N100VD, N100VS, N38D, N38S, N42D, N42S, N42VD, N42VS, N50D, N50S, N50VD, N50VS, N66D, N66S, N66VD, N66VS, N70D, N70S, N70VD, N70VS, N85D, N85S, N85VD, N85VS		
<b>spare parts for</b>	415264		
	GEV No.	510409	Ref. No.
			3150430 3151960 37Q5260
	O-ring EPDM thickness 5.34mm ID ø 56.52mm Qty 1 pcs		
<b>accessories for</b>	415264		
	GEV No.	550002	Ref. No.
			3113780
	tension strap H 10mm L 21mm W 10mm hole ø 6.5mm for heating element		









Зип Общепит  
vsezip.ru  
(812)9818888



			
<b>GEV No.</b>	415183	<b>Ref. No.</b>	32G0770
<b>description</b>	heating element 7000W 220V heating circuits 3 L 415mm W 41mm H 70mm tube ø 8.5mm connection M4 immersion heater round flange L1 265mm L2 150mm H1 25mm H2 55mm mounting ø 57.5mm		
<b>accessories for</b>	415183		
	<b>GEV No.</b>	521103	<b>Ref. No.</b> N/A
	nut thread M4 H 3mm WS 7 brass Qty 20 pcs		
	<b>GEV No.</b>	521104	<b>Ref. No.</b> —
	washer ID ø 4.3mm ED ø 8mm thickness 0.5mm brass Qty 20 pcs for thread M4		
	<b>GEV No.</b>	550002	<b>Ref. No.</b> 3113780
	tension strap H 10mm L 21mm W 10mm hole ø 6.5mm for heating element		
	<b>GEV No.</b>	560111	<b>Ref. No.</b> —
	plain washer ID ø 4.3mm ED ø 9mm thickness 0.8mm SS Qty 20 pcs DIN 125A for thread M4		
	<b>GEV No.</b>	560131	<b>Ref. No.</b> —
	hexagonal nut thread M4 H 3.2mm WS 7 SS DIN/ISO DIN 934 / ISO 4032/8673 Qty 20 pcs		

			
<b>GEV No.</b>	416599	<b>Ref. No.</b>	32G1031 32G1160
<b>description</b>	heating element 7000W 240V heating circuits 3 L 405mm W 42mm H 70mm tube ø 8.5mm thermostat sleeves ø 7mm length thermostat sleeves 51mm number of thermostat sleeves 1 thermostat sleeve eccentric sensor screw connection M9x1 connection M4 immersion heater round flange kettle L1 250mm L2 155mm H1 30mm H2 40mm mounting ø 57.5mm		
<b>For models:</b>	71PIE15, 71PIE15A, 91PIE15, 91PIE15A		
<b>accessories for</b>	416599		
	<b>GEV No.</b>	550002	<b>Ref. No.</b> 3113780
	tension strap H 10mm L 21mm W 10mm hole ø 6.5mm for heating element		

			
<b>GEV No.</b>	416600	<b>Ref. No.</b>	32G2330
<b>description</b>	heating element 7000W 400V heating circuits 3 L 415mm W 41mm H 84mm tube ø 8.5mm thermostat sleeves ø 6.5mm length thermostat sleeves 51mm number of thermostat sleeves 1 thermostat sleeve not clinging connection M4 connection length 12mm immersion heater round flange kettle L1 265mm L2 150mm H1 32mm H2 52mm mounting ø 57.5mm		
<b>For models:</b>	191PI2E, 191PI2EA, 1A1PI2E, 1A1PI2EA, 1D1PI2E, 1D1PI2EA		
<b>accessories for</b>	416600		
	<b>GEV No.</b>	550002	<b>Ref. No.</b> 3113780
	tension strap H 10mm L 21mm W 10mm hole ø 6.5mm for heating element		

			
<b>GEV No.</b>	415265	<b>Ref. No.</b>	32G3410
<b>description</b>	heating element 9000W 230V heating circuits 3 mounting ø 57.5mm L 470mm W 35mm H 41mm round flange connection M5 immersion heater tube ø 8.5mm connection length upper centre not clinging number of thermostat sleeves ø 7.5mm number of thermostat sleeves 1 length thermostat sleeves 29.5mm		
<b>For models:</b>	KD100, KD100A, KD100PSD, KD130, KD130A, KD130E, KD130EAT, LP202, LP202HC, LP302, LP302HC, LP402, LP402HC, LP402V, LPG300, N100D, N100S, N100VD, N100VS, N38D, N38S, N42D, N42S, N42VD, N42VS, N50D, N50S, N50VD, N50VS, N66D, N66S, N66VD, N66VS, N70D, N70S, N70VD, N70VS, N85D, N85S, N85VD, N85VS		
<b>spare parts for</b>	415265		
	<b>GEV No.</b>	510409	<b>Ref. No.</b> 3150430 3151960 37Q5260
	O-ring EPDM thickness 5.34mm ID ø 56.52mm Qty 1 pcs		
<b>accessories for</b>	415265		
	<b>GEV No.</b>	550002	<b>Ref. No.</b> 3113780
	tension strap H 10mm L 21mm W 10mm hole ø 6.5mm for heating element		

			
<b>GEV No.</b>	415011	<b>Ref. No.</b>	32g0500
<b>description</b>	heating element 3000W 230V heating circuits 1 thread 1¼" L 285mm W 24mm H 20mm tube ø 6.5mm connection M4 immersion heater connection length 26mm flange with thread WS 54		
<b>accessories for</b>	415011		
	<b>GEV No.</b>	510405	<b>Ref. No.</b> N/A
	flat gasket fibre ED ø 56mm ID ø 42mm thickness 2mm for thread 1¼" Qty 1 pcs		
	<b>GEV No.</b>	520232	<b>Ref. No.</b> —
	nut thread 1¼" H 5mm nickel-plated brass WS 47 Qty 1 pcs		
	<b>GEV No.</b>	528021	<b>Ref. No.</b> —
	flat gasket PTFE ED ø 53mm ID ø 42.5mm thickness 3mm Qty 1 pcs equiv. no. 12001/02286 suitable for Astoria/Aurora/Brasilia/Wega		

			
<b>GEV No.</b>	417167	<b>Ref. No.</b>	32G0170
<b>description</b>	heating element 4500W 230V heating circuits 3 thread 2" L 300mm W 37mm H 37mm tube ø 8.5mm connection M4 immersion heater connection length 65mm		
<b>spare parts for</b>	417167		
	<b>GEV No.</b>	510407	<b>Ref. No.</b> —
	flat gasket fibre ED ø 78mm ID ø 60mm thickness 2mm for heating element for thread 2" Qty 1 pcs		

electric components



Зип Общепит



vsezip.ru

812)987-08-81

			
<b>GEV No.</b>	416261	<b>Ref. No.</b>	32G2590
<b>description</b>	heating element 3000W 230V heating circuits 1 L 358mm W 32mm H 34mm H2 37mm thread M10x1 mounting distance 25mm tube ø 6.5mm connection male faston 6.3mm 2 hole fixing immersion heater		
<b>For models:</b>	LC100, LC100-VERS.2001, LC130, LC130-VERS.2001, LC80, LF50, LF50E		
<b>accessories for</b>	416261		
	<b>GEV No.</b>	510416	<b>Ref. No.</b> —
	flat gasket fibre ED ø 19mm ID ø 10.5mm thickness 1.5mm for thread M10 Qty 1 pcs		
	<b>GEV No.</b>	510893	<b>Ref. No.</b> —
	O-ring EPDM thickness 2.62mm ID ø 9.92mm Qty 1 pcs		
	<b>GEV No.</b>	520231	<b>Ref. No.</b> —
	nut thread M10x1 H 6mm WS 14 zinc-coated steel Qty 1 pcs		
	<b>GEV No.</b>	521129	<b>Ref. No.</b> —
	nut thread M10 H 6mm SS WS 17 Qty 1 pcs DIN/ISO DIN 439		

			
<b>GEV No.</b>	418103	<b>Ref. No.</b>	32G1711
<b>description</b>	heating element 24000W 400V heating circuits 3 ID ø 518mm ED ø 535mm L 590mm H 143mm L1 38mm W1 104mm H1 120mm H2 23mm flange length 142mm flange width 25mm hole distance 125mm connection M6 tube ø 8.5mm convection heating element hole ø 6mm rectangular flange		
<b>For models:</b>	FC1221E, FC241E, FCV241E, FCV241EDM, FCV241EDS, FCV401EDM, FM1221E1, FM1221E1-VERS.2006, FM1221E2, FM1221E2-VERS.2006, FM1221E3, FM1221E3-VERS.2006, FM2021E1, FM2021E2, FM2021E2-VERS.2006, FM2021E3, FM2021E3-VERS.2006		
<b>accessories for</b>	418103		
	<b>GEV No.</b>	699165	<b>Ref. No.</b> 3332550
	gasket L 142mm W 25mm D1 ø 6.5mm D2 ø 12mm hole distance 17mm 9 holes graphite thickness 2mm		

## heating elements for convection

			
<b>GEV No.</b>	418102	<b>Ref. No.</b>	32G1701
<b>description</b>	heating element 16400W 230V heating circuits 3 ID ø 441mm ED ø 458mm L 492mm H 143mm L1 34mm W1 104mm H1 128mm H2 115mm flange length 142mm flange width 25mm hole distance 63mm connection M6x1 tube ø 8.5mm convection heating element hole ø 6mm rectangular flange		
<b>For models:</b>	BX101E, BX101E-VERS.122013, FC101E, FC101E, FCV101E, FCV101EDM, FCV101EDM-UL, FCV101EDS, FCV101EDS-UL, FCV101E-UL, FCV141E, FCV141EDM, FCV141EDS, FCV72EDM-UL, FCV72EDS-UL, FCV72E-UL, FM1011E1, FM1011E1-VERS.2006, FM1011E2, FM1011E2-VERS.2006, FM1011E3, FM1011E3-VERS.2006, FM2011E2-VERS.2006, FM2011E3-VERS.2006, FM721E1, FM721E1-VERS.2006, FM721E2, FM721E2-VERS.2006, FM721E3, FM721E3-VERS.2006, FX101E1, FX101E1R, FX101E2, FX101E2C, FX101E2R, FX101E3, FX101E3C, FX101E3R, FX10E2CR, FX10E3CR, FX201E2, FX201E2P, FX201E3, FX201E3P		
<b>accessories for</b>	418102		
	<b>GEV No.</b>	699165	<b>Ref. No.</b> 3332550
	gasket L 142mm W 25mm D1 ø 6.5mm D2 ø 12mm hole distance 17mm 9 holes graphite thickness 2mm		

			
<b>GEV No.</b>	419175	<b>Ref. No.</b>	32G1550
<b>description</b>	heating element 2400W 230V heating circuits 1 ID ø 190mm ED ø 210mm 2 hole fixing connection M4 tube ø 8.5mm thread 1/4" heated cabinet		
<b>For models:</b>	A12A1E, A12B1E, A12B2E, A12M1E, A12Z1E, A12Z2E, A14A1E, A14B1E, A14B2E, A14M1E, A14Z1E, A14Z2E, A16A1E, A16B1E, A16B2E, A16M1E, A16Z1E, A16Z2E, A18A1E, A18B1E, A18B2E, A18M1E, A18Z1E, A18Z2E, A20A1E, A20B1E, A20B2E, A20M1E, A20Z1E, A20Z2E, ACBM, ACBM218, ACPN, ACPN218, AJ12AE, AJ12ME, AJ14AE, AJ14ME, AJ16AE, AJ16ME, SL14CPN, SL14CVB, SL21CPN, SL21CVB		

			
<b>GEV No.</b>	418099	<b>Ref. No.</b>	32G0430
<b>description</b>	heating element 2800W 230V heating circuits 1 ID ø 217mm ED ø 230mm L 249mm H 72mm L1 11mm W1 68mm H1 11mm H2 41mm flange length 142mm flange width 25mm hole distance 63mm connection male faston 6.3mm connection length 73mm tube ø 6.3mm convection heating element hole ø 6mm rectangular flange		
<b>For models:</b>	FCV3EM		





Зип Общепит

vsezip.ru

+7(812)987-08-20



1

<b>GEV No.</b>	418100	<b>Ref. No.</b>	32G1940
<b>description</b>	heating element 4150W 230V heating circuits 3 ID $\varnothing$ 214mm ED $\varnothing$ 226mm L 248mm H 70mm L1 15mm W1 103mm H1 5mm H2 65mm flange length 142mm flange width 25mm hole distance 62mm connection male faston 6.3mm tube $\varnothing$ 6.3mm convection heating element hole $\varnothing$ 6mm rectangular flange		
<b>For models:</b>	FCV4E, FCV4EDS, FCV4EM, FM423E1, FM423E2		



<b>GEV No.</b>	415737	<b>Ref. No.</b>	32G1280
<b>description</b>	heating element 2500W 250V heating circuits 1 L 655mm W 120mm L1 30mm L2 625mm W2 200mm flange length 70mm flange width 22mm hole distance 56mm connection length 100mm connection M4 tube $\varnothing$ 6.3mm hole $\varnothing$ 5.5mm W1 30mm rectangular flange convection heating element windings 2		



1

<b>GEV No.</b>	418101	<b>Ref. No.</b>	32G1691
<b>description</b>	heating element 8700W 230V heating circuits 3 ID $\varnothing$ 317mm ED $\varnothing$ 333mm L 375mm H 100mm L1 42mm W1 105mm H1 82mm H2 18mm flange length 142mm flange width 25mm hole distance 63mm connection M6 connection length 26mm tube $\varnothing$ 8.5mm convection heating element hole $\varnothing$ 6mm rectangular flange		
<b>For models:</b>	FC611E, FC61E, FCV61E, FCV61EDM, FCV61EDM-UL, FCV61EDS, FCV61EDS-UL, FCV61E-UL, FM611E1, FM611E1-VERS.2006, FM611E2, FM611E2-VERS.2006, FM611E3, FM611E3-VERS.2006		
<b>accessories for</b>	418101		
	<b>GEV No.</b>	699165	<b>Ref. No.</b> 3332550
	gasket L 142mm W 25mm D1 $\varnothing$ 6.5mm D2 $\varnothing$ 12mm hole distance 17mm 9 holes graphite thickness 2mm		



1

<b>GEV No.</b>	419222	<b>Ref. No.</b>	3115001
<b>description</b>	heating element 27000/29000W 400/415V L 590mm W 545mm H 140mm heating circuits 3 cable lengthmm		
<b>For models:</b>	BX122E, BX122E-VERS.122013, FX122E1, FX122E2, FX122E2C, FX122E2T, FX122E2T-VERS.032014, FX122E3, FX122E3C, FX122E3T, FX122E3T-VERS.022014, FX12E3CT, FX12E3CT-VERS.022014, FX202E2, FX202E2-VERS.032014, FX202E3, FX202E3-VERS.022014		



1

<b>GEV No.</b>	415736	<b>Ref. No.</b>	32G1360
<b>description</b>	heating element 3500W 230V heating circuits 1 L 655mm W 125mm L1 30mm L2 625mm W2 88mm flange length 70mm flange width 22mm hole distance 56mm connection length 97mm connection M4 tube $\varnothing$ 6.25mm hole $\varnothing$ 5mm W1 30mm rectangular flange convection heating element windings 2 mounting distance 58mm		



1

<b>GEV No.</b>	419261	<b>Ref. No.</b>	3116030
<b>description</b>	heating element 9500/10400W 230/240V heating circuits 3 ID $\varnothing$ 320mm ED $\varnothing$ 337mm L 380mm H 148mm L1 40mm W1 105mm H1 20mm H2 120mm flange length 142mm flange width 25mm hole distance 18mm connection M6x1 connection length 85mm tube $\varnothing$ 8.5mm convection heating element flange combi-steamer		
<b>For models:</b>	BX61E, BX61E-VERS.122013, FX61E1, FX61E1R, FX61E2, FX61E2C, FX61E2CR, FX61E2CR-VERS.032014, FX61E2C-VERS.032014, FX61E2R, FX61E2R-VERS.032014, FX61E2-VERS.032014, FX61E3, FX61E3C, FX61E3CR, FX61E3CR-VERS.022014, FX61E3C-VERS.022014, FX61E3R, FX61E3R-VERS.022014, FX61E3-VERS.022014		

radiation heaters

1-circuit



1

<b>GEV No.</b>	490025	<b>Ref. No.</b>	3080080
<b>description</b>	radiation heater $\varnothing$ 200mm 1700W 230V heating circuits 1 energy regulation with temperature signalization with heating coil connections 2+2 connection type male faston 6.3mm EGO		
<b>For models:</b>	OG0PEVTR, 1G0PEVTR, 6VTR, 6VTR2		



Зип Общепит

vsezip.ru

+7(812)987-08-81

## 2-circuit



1	<b>GEV No.</b>	490139	<b>Ref. No.</b>	3080070
<b>description</b>	radiation heater ø 250mm 2500W 230V heating circuits 2 energy regulation with temperature signalization partial power 1000W with ribbon heater connections 3+2 connection type male faston 6.3mm EGO			



1	<b>GEV No.</b>	490071 <sup>1</sup>	<b>Ref. No.</b>	32G1210 32G1211
<b>description</b>	hot plate dimensions 300x300mm 4000W 230V with spill ring connection 4 screw clamps protector yes square			
<b>For models:</b>	070E, 071E, 08WPE4V, 090E, 090PE4, 091E, 190PE4, 71E			

<sup>1</sup>incl. protector

## hot plates

## square &amp; rectangular

## with radiused edge



1	<b>GEV No.</b>	490068 <sup>1</sup>	<b>Ref. No.</b>	32G2860
<b>description</b>	hot plate dimensions 220x220mm 2600W 400V with spill ring connection 4 screw clamps protector yes square			
<b>For models:</b>	0G0PE2, 0G1PE2, 1G0PE2, 1G1PE2, 1G1PE2E, 1G1PE2EV, 2G0PE2, 2G1PE2E, 2G1PE2EV			

<sup>1</sup>incl. protector

1	<b>GEV No.</b>	490074 <sup>1</sup>	<b>Ref. No.</b>	32G0940 32G1080
<b>description</b>	hot plate dimensions 300x300mm 4000W 400V with spill ring connection 4 screw clamps protector yes square			
<b>For models:</b>	04WPE4V, 070E, 071E, 08WPE4V, 090E, 090PE4, 091E, 0A0PE4, 0D0PE4, 190PE4, 191PE4E, 1A0PE4, 1A1PE4E, 1A1PE4E, 1D0PE4, 1D1PE4E, 71E			

<sup>1</sup>incl. protector

1	<b>GEV No.</b>	490056 <sup>1</sup>	<b>Ref. No.</b>	32G1201
<b>description</b>	hot plate dimensions 300x300mm 3000W 230V with spill ring connection 4 screw clamps protector yes square			
<b>For models:</b>	070E, 071E, 090E, 091E, 71E			

<sup>1</sup>incl. protector

## round

## with radiused edge

## for domestic and commercial kitchens



1	<b>GEV No.</b>	490016	<b>Ref. No.</b>	32G0030
<b>description</b>	hot plate ø 180mm 2000W 230V connection 4 screw clamps with 8mm spill ring			
<b>For models:</b>	030E, 031E, 0G0PE1, 1G0PE1, 1G1PE1E, 1G1PE1EV, 2G0PE1, 2G1PE1E, 2G1PE1EV, 31TCE, 32TCE			



1	<b>GEV No.</b>	490073	<b>Ref. No.</b>	32G0930 32G1090
<b>description</b>	hot plate dimensions 300x300mm 3000W 400V with spill ring connection 4 screw clamps protector no square			
<b>For models:</b>	070E, 071E, 090E, 091E, 71E			





1	<b>GEV No.</b>	490017	<b>Ref. No.</b>	32G0290 32G1320
<b>description</b>	hot plate ø 180mm 2000W 400V connection 4 screw clamps with 8mm spill ring			
<b>For models:</b>	030E, 031E, 0G0PE1, 1G0PE1, 1G1PE1E, 1G1PE1EV, 2G0PE1, 2G1PE1E, 2G1PE1EV, 31TCE, 32TCE			



Зип Общепит  
accessories

knobs  
vsezip.ru

77(812)987-08-81

			
1			
<b>GEV No.</b>	490020	<b>Ref. No.</b>	32G0020
<b>description</b>	hot plate ø 220mm 2600W 230V connection 4 screw clamps with 8mm spill ring		
<b>For models:</b>	030E, 031E, 0G0PE1, 1G0PE1, 1G1PE1E, 1G1PE1EV, 2G0PE1, 2G1PE1E, 2G1PE1EV, 31TCE, 32TCE		
<b>accessories for</b>	490020		
	<b>GEV No.</b>	550796	<b>Ref. No.</b> —
	fixing plate for hot plate ø220mm		

			
1			
<b>GEV No.</b>	490021	<b>Ref. No.</b>	32G0300 32G1330
<b>description</b>	hot plate ø 220mm 2600W 400V connection 4 screw clamps with 8mm spill ring		
<b>For models:</b>	030E, 031E, 0G0PE1, 1G0PE1, 1G1PE1E, 1G1PE1EV, 2G0PE1, 2G1PE1E, 2G1PE1EV, 31TCE, 32TCE		

energy regulators



EGO

1-circuit

			
1			
<b>GEV No.</b>	380015	<b>Ref. No.</b>	32Z0170 32Z0171
<b>description</b>	energy regulator 230V 13A single-circuit turn direction right shaft ø 6x4.6mm shaft L 23mm mounting thread M4 power release 6-100% no. 50.57021.010		
<b>For models:</b>	06WBR3E, 08WGREV, 090SPE, 0G0SPE, 0G1BR3E, 190GRE, 191BR1E, 191BR2E, 191BR2EA, 1A1BR1E, 1A1BR2E, 1A1BR2EA, 1D1BR1E, 1D1BR2E, 1D1BR2EA, 1G0GRE, 1G1BR3E, 291BR1E, 291BR2E, 291BR2EA, 291PI3E, 2A1BR1E, 2A1BR2E, 2A1BR2EA, 2A1PI3E, 2D1BR1E, 2D1BR2E, 2D1BR2EA, FC1011E, FC1011G, FC1221E, FC1221G, FC611E, FC611G, FMS, FMSX		

2-circuit

			
1			
<b>GEV No.</b>	380027	<b>Ref. No.</b>	3008300
<b>description</b>	energy regulator EGO 230V 13A dual circuit turn direction right shaft ø 6x4.6mm shaft L 23mm mounting thread M4 power release 6-70% no. 50.55021.100		
<b>For models:</b>	04WVT3RV, 090VTR, 0G0PEVTR, 190VTR, 1G0PEVTR, 6042520, 6042530, 6043590, 6VTR2		



			
1			
<b>GEV No.</b>	110117	<b>Ref. No.</b>	36M0750
<b>description</b>	knob energy regulator 1-3 t.max.°C ø 60mm shaft ø 6x4.6mm shaft flat upper black		
<b>spare parts for</b>	110117		
	<b>GEV No.</b>	112495	<b>Ref. No.</b> —
	knob spring L 10.5mm W 8.5mm Qty 1 pcs		

thermostats

bi-metal thermostats

safety bi-metal thermostats

			
1			
<b>GEV No.</b>	390480	<b>Ref. No.</b>	32V7250
<b>description</b>	bi-metal safety thermostat hole distance 23.8mm switch-off temp. 105°C 1NC 1-pole 16A connection F6.3 2 hole fixing		

			
1			
<b>GEV No.</b>	390233	<b>Ref. No.</b>	32V7250 32Z8270
<b>description</b>	bi-metal safety thermostat hole distance 24mm switch-off temp. 110°C 1NC 1-pole 16A connection F6.3 2 hole fixing without holder		
<b>accessories for</b>	390233		
	<b>GEV No.</b>	504736	<b>Ref. No.</b> —
	bracket for contact thermostat		
	<b>GEV No.</b>	550388	<b>Ref. No.</b> —
	bracket for contact thermostat mounting distance 24.5mm mounting ø 3.8		

bi-metal thermostats

			
1			
<b>GEV No.</b>	375927	<b>Ref. No.</b>	3093940
<b>description</b>	bi-metal thermostat hole distance 23.5mm switch-off temp. 50°C 1NO 10A connection F6.3		
<b>For models:</b>	04WPEBV, 08WPEBV, 08WTPEV, 090PEB, 091FR7G, 091PEB, 190PEB, 190TPE, 191PEB, 191TPE, 6BM, 6BR, 6CP, 6FR, 6FTL, 6FTR, 6PC, 6VTR		



Зип Общепит

vsezip.ru

+7(812)987-08-81

			
1			
<b>GEV No.</b>	390439	<b>Ref. No.</b>	3008880
<b>description</b>	bi-metal thermostat hole distance 23.5mm switch-off temp. 70°C 1NC 10A 250V connection F6.3		
<b>For models:</b>	04WPE4V, 08WPE4V, 090PE4, 091FR1I, 091FR7G, 190PE4, 191FR2I, 191FR4ED, 191PE4E, 6BM, 6BR, 6CP, 6FR, 6FTL, 6FTR, 6PC, 6VTR		

## control and safety thermostats

## EGO

## control thermostats

## 51.\_ series



1			
<b>GEV No.</b>	390033	<b>Ref. No.</b>	32Z0410
<b>description</b>	thermostat t.max. 93°C temperature range 30-93°C 1-pole 1NO 15A probe Ø 20/23.5mm probe L 11mm capillary pipe 900mm capillary pipe isolated 800mm gland nut shaft Ø 6x4.6mm shaft L 25mm shaft position upper rotation 270° outer switch 2NO probe material SS with knob probe		
<b>For models:</b>	030BME, 030EBM, 031BME, 031EBM, 0G0BME, 1G0BME, A12A1E, A12B1E, A12B2E, A12M1E, A12Z1E, A12Z2E, A14A1E, A14B1E, A14B2E, A14M1E, A14Z1E, A14Z2E, A16A1E, A16B1E, A16B2E, A16M1E, A16Z1E, A16Z2E, A18A1E, A18B1E, A18B2E, A18M1E, A18Z1E, A18Z2E, A20A1E, A20B1E, A20B2E, A20M1E, A20Z1E, A20Z2E, ACBM, ACBM218, ACPN, ACPN218, AJ12AE, AJ12ME, AJ14AE, AJ14ME, AJ16AE, AJ16ME, AJ18AE, AJ18ME, AJ20AE, AJ20ME...(Other models you can see in the webshop)		
<b>accessories for</b>	390033		
	<b>GEV No.</b>	510167	<b>Ref. No.</b> 3150270 315Q270
	gasket for thermostat ED Ø 41mm ID Ø 18mm Qty ANGELO PO/ ZANUSSI pcs equiv. no. 3150270/66717		

## 55.10/19\_ series



1			
<b>GEV No.</b>	375345	<b>Ref. No.</b>	32Z9380
<b>description</b>	thermostat t.max. 150°C temperature range fixed 150°C 1-pole 1NO 16A probe Ø 6mm probe L 74mm capillary pipe 900mm capillary pipe isolated 900mm gland nut shaft Lmm shaft position° shaft position		
<b>For models:</b>	04WBMEV, 090BM1E, 0A0BME, 0B0BME, 0D0BME, 6040110, 6042680		



1			
<b>GEV No.</b>	375844	<b>Ref. No.</b>	32Z2940
<b>description</b>	thermostat t.max. 182°C temperature range 100-180°C 1-pole 1NO 16A probe Ø 11mm probe L 28mm capillary pipe 850mm capillary pipe isolated 800mm gland nut shaft Ø 6x4.6mm shaft L 23mm shaft position upper rotation 270° screw-in probe probe thread M14x1		

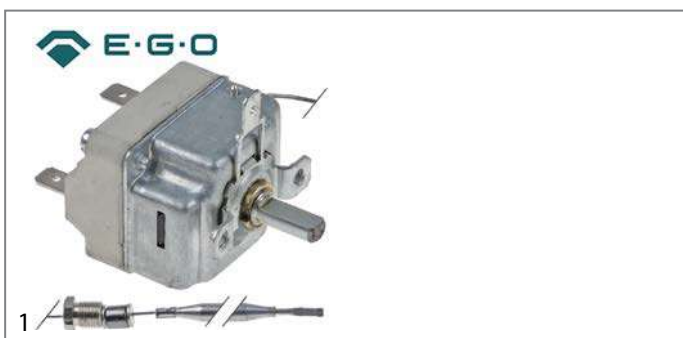

1			
<b>GEV No.</b>	375395	<b>Ref. No.</b>	32V4540
<b>description</b>	thermostat t.max. 182°C temperature range 95-180°C 1-pole 1NO 16A probe Ø 6mm probe L 133mm capillary pipe 870mm capillary pipe isolated 520mm gland nut M9x1 shaft Ø 6x4.6mm shaft L 13mm shaft position upper rotation 270° 250V		
<b>For models:</b>	0M0FR1E, 1M0FR2E		



1			
<b>GEV No.</b>	375922	<b>Ref. No.</b>	3168460
<b>description</b>	thermostat t.max. 185°C temperature range 101-185°C 1-pole 1NO 16A probe Ø 6mm probe L 133mm capillary pipe 870mm capillary pipe isolated 520mm gland nut M10x1 shaft Ø 6x4.6mm shaft L 23mm shaft position upper		
<b>For models:</b>	091FR1I, 091FR1I-VERS.032012, 191FR2I, 191FR2I-VERS.032012		



Зип Общепит

vsezip.ru

+7(812)987-08-81



<b>GEV No.</b>	375631	<b>Ref. No.</b>	32Z5820
<b>description</b>	thermostat t.max. 249°C temperature range 55-249°C 1-pole 1NO 16A probe ø 3.1mm probe L 226mm capillary pipe 1270mm capillary pipe isolated 850mm gland nut 3/8"-M8x1 shaft ø 6x4.6mm shaft L 23mm shaft position upper rotation 318°		
<b>For models:</b>	FC101, FC1011E, FC1011G, FC101E, FC1221E, FC1221G, FC241, FC241E, FC241G, FC61, FC611E, FC611G, FC61E, FCV101, FCV101-CSA, FCV101E, FCV101E-UL, FCV141, FCV141-CSA, FCV141E, FCV241, FCV241E, FCV241E-UL, FCV241G, FCV241G-CSA, FCV3EM, FCV4EM, FCV61, FCV61-CSA, FCV61E, FCV61E-UL, FCV72E-UL		



<b>GEV No.</b>	375643	<b>Ref. No.</b>	32Z2371
<b>description</b>	thermostat t.max. 330°C temperature range fixed 330°C 1-pole 1NC 16A probe ø 3mm probe L 219mm capillary pipe 900mm capillary pipe isolated 900mm gland nut		
<b>For models:</b>	030EBM, 031EBM, 0G0BME, 0G0BME-VERS.032008, 1G0BME, 1G0BME-VERS.032008		



<b>GEV No.</b>	390068	<b>Ref. No.</b>	32Z0610
<b>description</b>	thermostat t.max. 269°C temperature range 55-269°C 1-pole 1CO 16A probe ø 3.1mm probe L 219mm capillary pipe 1280mm capillary pipe isolated 1270mm gland nut shaft ø 6x4.6mm shaft L 23mm shaft position upper° rotation 318°		



<b>GEV No.</b>	390037	<b>Ref. No.</b>	32Z0180
<b>description</b>	thermostat t.max. 54°C temperature range fixed 54°C 1-pole 1NC 16A probe ø 20/23.5mm probe L 11mm capillary pipe 900mm capillary pipe isolated 850mm gland nut		



<b>GEV No.</b>	375437	<b>Ref. No.</b>	32Z0210
<b>description</b>	thermostat t.max. 324°C temperature range 66-324°C 1-pole 1NO 16A probe ø 4mm probe L 124mm capillary pipe 1470mm capillary pipe isolatedmm gland nut shaft ø 6x4.6mm shaft L 23mm shaft position upper rotation 270°		



<b>GEV No.</b>	375845	<b>Ref. No.</b>	32Z2160
<b>description</b>	thermostat t.max. 54°C temperature range fixed 54°C 1-pole CO probe ø 20/23.5mm probe L 11mm capillary pipe 1600mm capillary pipe isolatedmm gland nut with knob probe		

Зип Общепит

vsezip.ru

+7(812)987-08-81



<b>GEV No.</b>	375215	<b>Ref. No.</b>	32Z2430
<b>description</b>	thermostat t.max. 65°C temperature range fixed 65°C 1-pole 1CO 16A probe ø 6mm probe L 130mm capillary pipe 900mm capillary pipe isolated 900mm gland nut shaft Lmm shaft position		
<b>For models:</b>	F60PR, F60T, F80P, F80PR, L100, L40, L40S, L60, L80		



<b>GEV No.</b>	390040	<b>Ref. No.</b>	32V0200
<b>description</b>	thermostat t.max. 90°C temperature range 30-90°C 1-pole 1CO 16A probe ø 6mm probe L 130mm capillary pipe 2040mm capillary pipe isolated 1940mm gland nut shaft ø ø6x4.6mm shaft L 23mm shaft position upper rotation 270° probe material SS		
<b>For models:</b>	F60P, F60PR, F60T, F80P, F80PR, L45		



<b>GEV No.</b>	390003	<b>Ref. No.</b>	32Z0450
<b>description</b>	thermostat t.max. 90°C temperature range 30-90°C 1-pole 1CO 16A probe ø 15mm probe L 22.5mm capillary pipe 1700mm capillary pipe isolatedmm gland nut shaft ø ø6x4.6mm shaft L 16mm shaft position upper° shaft position rotation 270° with knob probe		
<b>accessories for</b>	390003		
	<b>GEV No.</b>	510165	<b>Ref. No.</b> —
gasket for thermostat ED ø 27mm ID ø 11mm thickness 8.5mm			



<b>GEV No.</b>	390032	<b>Ref. No.</b>	32Z0160 32Z5880
<b>description</b>	thermostat t.max. 90°C temperature range 30-90°C 1-pole 1CO 16A probe ø 6mm probe L 130mm capillary pipe 2500mm capillary pipe isolatedmm gland nut M10x1 shaft ø ø6x4.6mm shaft L 23mm shaft position upper rotation 270° probe material SS		
<b>For models:</b>	FC101, FC1011E, FC1011G, FC101E, FC1221E, FC1221G, FC241, FC241E, FC241G, FC61, FC611E, FC611G, FC61E, FCV101, FCV101-CSA, FCV101E, FCV101E-UL, FCV141, FCV141-CSA, FCV141E, FCV241, FCV241E, FCV241E-UL, FCV241G, FCV3EM, FCV401DM, FCV401EDM, FCV401EDM-UL, FCV4EM, FCV61, FCV61-CSA, FCV61E, FCV61E-UL, FCV72E-UL, L100, L40, L40S, L60, L80		



<b>GEV No.</b>	375632	<b>Ref. No.</b>	32Z5880
<b>description</b>	thermostat t.max. 90°C temperature range 30-90°C 1-pole 1CO 16A probe ø 6mm probe L 130mm capillary pipe 1300mm capillary pipe isolated 850mm gland nut M10x1 shaft ø ø6x4.6mm shaft L 23mm shaft position upper rotation 270°		

55.34\_ series



<b>GEV No.</b>	375343	<b>Ref. No.</b>	32Z9210
<b>description</b>	thermostat t.max. 160°C temperature range fixed 160°C 3-pole 3NC 16A probe ø 6mm probe L 74mm capillary pipe 900mm capillary pipe isolated 900mm gland nut		
<b>For models:</b>	190BM2E, 1A0BME, 1D0BME		



Зип Общепит

vsezip.ru

+7(812)987-08-81



<b>GEV No.</b>	375038	<b>Ref. No.</b>	32Z2560
<b>description</b>	thermostat t.max. 300°C temperature range 50-300°C 3-pole 3NO 16A probe ø 6mm probe L 79mm capillary pipe 1740mm capillary pipe isolated 800mm gland nut shaft ø 6x4.6mm shaft L 23mm shaft position upper rotation 270°		
<b>For models:</b>	191FAAE, 191FAE, 191PE4E, 1A1PE4E, 1A1PEFTE, 1A1FBE, 1D1PE4E, 1D1FBE, 71E, 71GE, 71GEGG, FS30E		
<b>accessories for</b>	375038		
	<b>GEV No.</b>	110123	<b>Ref. No.</b> —
	knob thermostat t.max. 300°C ø 50mm shaft ø 6x4.6mm shaft flat upper black temperature range 50-300°C rotation 270°		



<b>GEV No.</b>	375836	<b>Ref. No.</b>	3001550
<b>description</b>	thermostat t.max. 95°C temperature range fixed 95°C 3-pole 1CO/2NC 16A probe ø 3.1mm probe L 226mm capillary pipe 880mm capillary pipe isolated 880mm gland nut		
<b>For models:</b>	08WGREV, 190GRE, 1G0GRE, 1G1PE1E, 1G1PE1EV, 1G1PE2E, 1G1PE2EV, 2G1PE1E, 2G1PE1EV, 2G1PE2E, 2G1PE2EV		





<b>GEV No.</b>	375991	<b>Ref. No.</b>	3110640
<b>description</b>	thermostat t.max. 560°C temperature range fixed 560°C 3-pole 3NC 16A probe ø 3.9mm probe L 225mm capillary pipe 1150mm capillary pipe isolated 600mm gland nut		
<b>For models:</b>	04WPBEV, 08WPBEV, 08WTPBEV, 090PEB, 091PEB, 190PEB, 190TPE, 191PEB, 191TPE, 6042610, 6042630, 6044340, 6044350		

safety thermostats

55.10/19\_ series



<b>GEV No.</b>	375166	<b>Ref. No.</b>	31Z7990 32Z3340 32Z8000
<b>description</b>	safety thermostat switch-off temp. 230°C 1-pole 0.5A probe ø 11mm probe L 16.5mm capillary pipe 850mm capillary pipe isolated 850mm gland nut probe screw-in probe probe thread M14x1		
<b>For models:</b>	30F, 30FS, 70F, 71F		
<b>accessories for</b>	375166		
	<b>GEV No.</b>	521133	<b>Ref. No.</b> —
	nut thread M14x1.5 H 6mm WS 19 zinc-coated steel Qty 1 pcs		
	<b>GEV No.</b>	532520	<b>Ref. No.</b> 3150390
	O-ring silicone thickness 2.62mm ID ø 15.08mm Qty 1 pcs		
	<b>GEV No.</b>	550261	<b>Ref. No.</b> —
	nut thread M14x1 H 4mm WS 19 SS Qty 1 pcs		



<b>GEV No.</b>	375411	<b>Ref. No.</b>	32z0130
<b>description</b>	thermostat t.max. 93°C temperature range 30-93°C 3-pole 3NO 16A probe ø 6mm probe L 129mm capillary pipe 1480mm capillary pipe isolated 1100mm gland nut M10x1 shaft ø 6x4.6mm shaft L 23mm shaft position upper rotation 270°		



Зип Общепит

vsezip.ru

+7(812)987-08-81

55.32\_series



1

<b>GEV No.</b>	375308	<b>Ref. No.</b>	32Z9620 32Z9621
<b>description</b>	safety thermostat switch-off temp. 135°C 3-pole 0.5A probe ø 11mm probe L 27.5mm capillary pipe 1000mm capillary pipe isolated 960mm gland nut probe screw-in probe probe thread M14x1		
<b>For models:</b>	191PI1G, 191PI1GA, 191PI2G, 191PI2GA, 1A1PI1G, 1A1PI1GA, 1D1PI1G, 1D1PI1GA, 1G1PI1G, 291PD3G, 291PI3G, 31PI6, 71PI10, 71PI10A, 91PI10, 91PI10A		



1

<b>GEV No.</b>	375208	<b>Ref. No.</b>	32V398
<b>description</b>	safety thermostat switch-off temp. 139°C 3-pole 2x20/1x0.5A probe ø 6mm probe L 77mm capillary pipe 890mm capillary pipe isolated-mm gland nut M9x1 probe SS		



1

<b>GEV No.</b>	375209	<b>Ref. No.</b>	32V3980 32Z2011
<b>description</b>	safety thermostat switch-off temp. 140°C 3-pole 20A probe ø 6mm probe L 89mm capillary pipe 900mm capillary pipe isolated 900mm gland nut probe SS		
<b>For models:</b>	191CP1GA, 1A1CP1GA, 1A1PI2G, 1A1PI2GA, 1D1CP1GA, 1D1PI2G, 1D1PI2GA, 291PD3G, 291PI3G, 2A1PD3G, 2A1PI3G, 2D1PI3G, F60P, F60PR, F60T, F80P, F80PR, L100, L40, L40S, L45, L60, L80		



1

<b>GEV No.</b>	375622	<b>Ref. No.</b>	32V0320
<b>description</b>	safety thermostat switch-off temp. 147°C 1-pole 20A probe ø 6mm probe L 89mm capillary pipe 900mm capillary pipe isolated 800mm gland nut probe		
<b>For models:</b>	291PI3E, 2A1PI3E, MCF20E, MCF40E		



1

<b>GEV No.</b>	390166	<b>Ref. No.</b>	32Z2710
<b>description</b>	safety thermostat switch-off temp. 150°C 3-pole 20A probe ø 6mm probe L 87mm capillary pipe 1490mm capillary pipe isolated 1250mm gland nut M9x1 probe SS		
<b>For models:</b>	04WCP1EM, 0A1CP1E, 0D1CP1E, 0G1CP1E, 191PI2E, 191PI2EA, 1A1PI2E, 1A1PI2EA, 1D1PI2E, 1D1PI2EA, 1G1PI1E, 30CPSE, 31PIE6, 70CPE, 71PIE15, 71PIE15A, 90CPE, 91PIE15, 91PIE15A		



1

<b>GEV No.</b>	375528	<b>Ref. No.</b>	32V0460
<b>description</b>	safety thermostat switch-off temp. 200°C 1-pole 0.5A probe ø 6mm probe L 79mm capillary pipe 900mm capillary pipe isolated 900mm gland nut probe SS		
<b>For models:</b>	090BM1G, 0A0BMG, 0D0BMG, 190BM2G, 1A0BMG, 1D0BMG		





Зип Общепит

vsezip.ru

+7(812)987-08-81



<b>GEV No.</b>	375290	<b>Ref. No.</b>	32Z3631
<b>description</b>	safety thermostat switch-off temp. 240°C 3-pole 20A probe ø 6mm probe L 87mm capillary pipe 2000mm capillary pipe isolated 1800mm gland nut probe SS		
<b>For models:</b>	030FE, 030FE1, 030FE1B, 091FE28, 091FE28B, 30FES, 30FES2, 30FES2B, 70FE, 70FE1, 70FE1B, 70FES, 70FES2, 70FES2B, 71FE, 71FE2, 71FE2B		



<b>GEV No.</b>	391040	<b>Ref. No.</b>	32V6561
<b>description</b>	safety thermostat switch-off temp. 270°C 3-pole 3NC 16A probe ø 6mm probe L 79mm capillary pipe 2050mm capillary pipe isolated 1700mm probe no to be sold in France probe material SS		
<b>For models:</b>	04WFR3ED, 08WFR4ED, 091FR1E, 091FR1EA, 091FR1ED, 091FR1EX, 091FR3E, 091FR3ED, 091FR7G, 091FR7GS, 091FR7G-VERS.052012, 091FR7GX, 0A1FR1E, 0A1FR1ED, 0A1FR3E, 0A1FR3ED, 0D1FR1E, 0D1FR1ED, 0D1FR3E, 0D1FR3ED, 0G0FR3E, 0G0FR3ED, 191FR2E, 191FR2ED, 191FR4E, 1A1FR2E, 1A1FR2ED, 1A1FR4E, 1A1FR4ED, 1D1FR2ED, 1D1FR4E, 1D1FR4ED, 1G0FR4E, 6043840, 6043970		



<b>GEV No.</b>	375841	<b>Ref. No.</b>	32V4630 32Z0200 32Z7980
<b>description</b>	safety thermostat switch-off temp. 248°C 3-pole probe ø 6mm probe L 87mm capillary pipe 1500mm capillary pipe isolatedmm gland nut probe SS		
<b>For models:</b>	0M0FR1E, 1M0FR2E		



<b>GEV No.</b>	375840	<b>Ref. No.</b>	32V6560
<b>description</b>	safety thermostat switch-off temp. 270°C 3-pole 3NC 20A probe ø 6mm probe L 79mm capillary pipe 2000mm capillary pipe isolated-mm gland nut probe SS		
<b>For models:</b>	04WFR3ED, 08WFR4ED, 091FR1E, 091FR1ED, 091FR3E, 091FR3ED, 0A1FR1E, 0A1FR1ED, 0A1FR3E, 0A1FR3ED, 0D1FR1E, 0D1FR1ED, 0D1FR3E, 0D1FR3ED, 0G0FR3E, 0G0FR3ED, 191FR2E, 191FR2ED, 191FR4E, 191FR4ED, 1A1FR2E, 1A1FR2ED, 1A1FR4E, 1A1FR4ED, 1D1FR2ED, 1D1FR4E, 1D1FR4ED, 1G0FR4E		



<b>GEV No.</b>	375292	<b>Ref. No.</b>	32V0970
<b>description</b>	safety thermostat switch-off temp. 253°C 3-pole 20A probe ø 6mm probe L 79mm capillary pipe 2000mm capillary pipe isolated 1800mm gland nut probe		
<b>For models:</b>	0A1FR1E, 0A1FR1ED, 0D1FR1E, 0D1FR1ED, 1A1FR2E, 1A1FR2ED, 1D1FR2ED		



<b>GEV No.</b>	375286	<b>Ref. No.</b>	32Z5381 32Z5610
<b>description</b>	safety thermostat switch-off temp. 285°C 1-pole 0.5A probe ø 4mm probe L 120mm capillary pipe 1500mm capillary pipe isolated 1500mm gland nut probe		
<b>For models:</b>	06WFR3GD, 091FR1G, 091FR1GD, 091FR3G, 091FR3GD, 0A1FR1G, 0A1FR1GD, 0A1FR1GD-VERS.2004, 0A1FR1G-VERS.2004, 0A1FR3G, 0A1FR3GD, 0B1FR1G, 0B1FR1GD, 0D1FR1G, 0D1FR1GD, 0D1FR1GD-VERS.2004, 0D1FR1G-VERS.2004, 0D1FR3G, 0D1FR3GD, 0G1FR3G, 0G1FR3GD, 10WFR4GD, 191FR2G, 191FR2GD, 191FR4G, 191FR4GD, 1A1FR2G, 1A1FR2GD, 1A1FR2GD-VERS.2004, 1A1FR2G-VERS.2004, 1A1FR4G, 1A1FR4GD, 1D1FR2G, 1D1FR2GD, 1D1FR2GD-VERS.2004, 1D1FR2G-VERS.2004, 1D1FR4G, 1D1FR4GD, 1G1FR4G, 1G1FR4GD, 30F1, 30F1B, 30FS2, 30FS2B, 70F1, 70F1B, 71F2, 71F2B, 90F110B, 91F210...(Other models you can see in the webshop)		

Зип Общепит

vsezip.ru

+7(812)987-08-81



<b>GEV No.</b>	375943	<b>Ref. No.</b>	32Z5612
<b>description</b>	safety thermostat switch-off temp. 299°C 1-pole 20A probe ø 4mm probe L 123mm capillary pipe 1500mm capillary pipe isolated 1400mm gland nut probe		
<b>For models:</b>	06WFR3GD, 091FR1G, 091FR1GD, 091FR1I, 091FR1IA, 091FR1ID, 091FR1ID-VERS.052012, 091FR1I-VERS.032012, 091FR3G, 091FR3GD, 0A1FR1G, 0A1FR1GD, 0A1FR1GD-VERS.2004, 0A1FR1G-VERS.2004, 0A1FR3G, 0A1FR3GD, 0B1FR1G, 0B1FR1GD, 0D1FR1G, 0D1FR1GD, 0D1FR1GD-VERS.2004, 0D1FR1G-VERS.2004, 0D1FR3G, 0D1FR3GD, 0G1FR3G, 0G1FR3GD, 10WFR4GD, 191FR2G, 191FR2GD, 191FR2I, 191FR2ID, 191FR2ID-VERS.092012, 191FR2I-VERS.032012, 191FR4G, 191FR4GD, 1A1FR2G, 1A1FR2GD, 1A1FR2GD-VERS.2004, 1A1FR2G-VERS.2004, 1A1FR4G, 1A1FR4GD, 1D1FR2G, 1D1FR2GD, 1D1FR2GD-VERS.2004, 1D1FR2G-VERS.2004, 1D1FR4G, 1D1FR4GD, 1G1FR4G, 1G1FR4GD, 30F1...(Other models you can see in the webshop)		



<b>GEV No.</b>	375307	<b>Ref. No.</b>	32Z9201 32Z9202
<b>description</b>	safety thermostat switch-off temp. 365°C 3-pole 20A probe ø 4mm probe L 120mm capillary pipe 1300mm capillary pipe isolated 1250mm gland nut probe SS		
<b>For models:</b>	031FTE04, 031FTE06, 06WBR3E, 06WFT1EV, 06WFT2EV, 06WFT3EV, 06WFT4EV, 06WFT6EV, 06WFT7EV, 070FTE04, 070FTE05, 071FTE04, 071FTE06, 08WFA4E, 08WFAAE, 08WFT1EV, 08WFT2EV, 08WFT3EV, 08WFT4EV, 08WFT6EV, 08WFT7EV, 090FT1E, 090FT2E, 090FT4E, 090FT5E, 090FT7E, 090FTE04, 090FTE05, 091FT1E, 091FT2E, 091FT4E, 091FT5E, 091FT7E, 091FTE04, 091FTE06, 0A0FT1E, 0A0FT2E, 0A0FT4E, 0A0FT5E, 0D0FT1E, 0D0FT2E, 0D0FT4E, 0D0FT5E, 0G0FT1E, 0G0FT2E, 0G0FT4E, 0G0FT5E, 0G0FT7E, 0G1BR3E, 0G1FT2E...(Other models you can see in the webshop)		



<b>GEV No.</b>	375220	<b>Ref. No.</b>	32Z6790
<b>description</b>	safety thermostat switch-off temp. 330°C 3-pole 20A probe ø 11mm probe L 18.5mm capillary pipe 900mm capillary pipe isolated 900mm gland nut probe screw-in probe probe thread M14x1		
<b>For models:</b>	FCV4E, FCV4EDS		



<b>GEV No.</b>	375474	<b>Ref. No.</b>	3111950 32Z5511
<b>description</b>	safety thermostat t.max. 340°C switch-off temp. 340°C 2-pole 1NC/1CO 1x20/1x0.5A probe ø 4mm probe L 120mm capillary pipe 1300mm capillary pipe isolated 900mm gland nut probe		
<b>For models:</b>	FC101, FC1011E, FC1011G, FC101E, FC1221E, FC1221G, FC241, FC241E, FC241G, FC61, FC611E, FC611G, FC61E, FCV101, FCV101DM, FCV101DS, FCV101E, FCV101EDM, FCV101EDS, FCV141, FCV141DM, FCV141DS, FCV141E, FCV141EDM, FCV141EDS, FCV241, FCV241DM, FCV241DS, FCV241E, FCV241EDM, FCV241EDS, FCV241G, FCV241G-CSA, FCV241GDM, FCV241GDS, FCV3EM, FCV401DM, FCV401EDM, FCV4EM, FCV61, FCV61DM, FCV61DS, FCV61E, FCV61EDM, FCV61EDS, FM1011E1, FM1011E1-VERS.2006, FM1011E2, FM1011E2-VERS.2006, FM1011E3...(Other models you can see in the webshop)		



<b>GEV No.</b>	375344	<b>Ref. No.</b>	32Z1400
<b>description</b>	safety thermostat switch-off temp. 360°C 1-pole 0.5A probe ø 4mm probe L 120mm capillary pipe 1500mm capillary pipe isolated 1500mm gland nut probe		
<b>For models:</b>	031FT04, 031FT06, 070FT04, 070FT05, 071FT04, 071FT06, 08WFT-4GV, 08WFT6GV, 090FT04, 090FT05, 090FT4G, 090FT5G, 091FT04, 091FT06, 0A0FT1G, 0A0FT2G, 0A0FT4G, 0A0FT5G, 0B0FT1G, 0B0FT2G, 0B0FT4G, 0B0FT5G, 0D0FT1G, 0D0FT2G, 0D0FT4G, 0D0FT5G, 0G0FT4G, 0G0FT4G-VERS.032008, 0G0FT5G, 0G0FT5G-VERS.032008, 0G1BR3G, 190FT15G, 190FT42G, 190FT4G, 190FT6G, 1A0FT1G, 1A0FT2G, 1A0FT3G, 1A0FT4G, 1A0FT6G, 1B0FT4G, 1B0FT6G, 1D0FT1G, 1D0FT2G, 1D0FT3G, 1D0FT4G, 1D0FT6G, 1G0FT4G, 1G0FT4G-VERS.032008, 1G0FT6G...(Other models you can see in the webshop)		



Зип Общепит

vsezip.ru

+7(812)987-08-81



<b>GEV No.</b>	375438	<b>Ref. No.</b>	3014260 3014261
<b>description</b>	thermostat switch-off temp. 156°C 3-pole 20A probe ø 6mm probe L 87mm capillary pipe 1490mm capillary pipe isolated 1350mm gland nut shaft ø 6x4.6mm probe		
<b>For models:</b>	04WCP1EM, 091CP1E, 0A1CP1E, 0D1CP1E, 0G1CP1E, 0G1CP1EC, 0G1CP1E-VERS.2004, 10CP1EA, 12CP1EA, 18CP2EA, 6040090, 6040310, 6043250, 6043470, 6043850, 6043980, PIER06HD, PIER15HD		



<b>GEV No.</b>	375288	<b>Ref. No.</b>	32Z6630
<b>description</b>	thermostat capillary pipe isolatedmm gland nut shaft ø 6x4.6mm screw-in probe		
<b>For models:</b>	030FE1B, 091FE28B, 091FR1G, 091FR3G, 0A1FR1G, 0A1FR1G-VERS.2004, 0A1FR3G, 0A1FR3GD, 0B1FR1G, 0D1FR1G, 0D1FR1G-VERS.2004, 0D1FR3G, 0D1FR3GD, 0G1FR3G, 191FR2G, 191FR4G, 1A1FR2G, 1A1FR2G-VERS.2004, 1A1FR4G, 1A1FR4GD, 1D1FR2G, 1D1FR2G-VERS.2004, 1D1FR4G, 1D1FR4GD, 1G1FR4G, 30F1B, 30FES2B, 30FS2B, 70F1B, 70FE1B, 70FES2, 70FES2B, 71F2B, 71FE2B, 90F110B, 91F210B, 91F223B		





control thermostats with operation switch

51.\_series



<b>GEV No.</b>	375346	<b>Ref. No.</b>	32Z9270
<b>description</b>	thermostat t.max. 110°C temperature range 30-110°C 1-pole 1NO 15A probe ø 6mm probe L 130mm capillary pipe 900mm capillary pipe isolated 900mm shaft ø 6x4.6mm shaft L 23mm shaft position upper rotation 318° outer switch 2NO		



<b>GEV No.</b>	375289	<b>Ref. No.</b>	32Z2480
<b>description</b>	thermostat t.max. 180°C temperature range 100-180°C 1-pole 1NO 16A probe ø 11mm probe L 10mm capillary pipe 850mm capillary pipe isolated 850mm gland nut outer switch 2NO probe thread M14x1		
<b>For models:</b>	030FE, 30FES, 70FE, 70FES, 71FE		
<b>spare parts for</b>	375289		
	GEV No.	300200	Ref. No. —
	operation switch 2 operating positions 2NO 16A sequence 0-1 shaft ø 6x4.6mm shaft L 23mm connection male faston 6.3mm operation switch ceramic		
	GEV No.	550060	Ref. No. —
	connecting bow long for thermostat Qty 1 pcs		
<b>accessories for</b>	375289		
	GEV No.	361182	Ref. No. 3117580
	nut thread 1/4" H 5mm nickel-plated brass WS 17 Qty 1 pcs		
	GEV No.	532520	Ref. No. 3150390
	O-ring silicone thickness 2.62mm ID ø 15.08mm Qty 1 pcs		



<b>GEV No.</b>	390069	<b>Ref. No.</b>	32Z0500
<b>description</b>	thermostat t.max. 265°C temperature range 45-265°C 1-pole 1NO 15A probe ø 3mm probe L 219mm capillary pipe 900mm capillary pipe isolatedmm shaft ø 6x4.6mm shaft L 23mm shaft position upper rotation 270° outer switch 2NO		







Зип Общепит

vsezip.ru

+7(812)987-08-81





<b>GEV No.</b>	390765	<b>Ref. No.</b>	32Z5970
<b>description</b>	thermostat t.max. 110°C temperature range 30-110°C 3-pole 3NO 16A probe ø 6mm probe L 131mm capillary pipe 1160mm gland nut shaft ø 6x4.6mm shaft L 23mm shaft position upper rotation 310°		
<b>For models:</b>	ACBM, ACBM218, ANBM, ANBM218, ANBM75, SE14VB, SE21VB, SI14VB, SI21VB, SL14CVB, SL14NVB, SL21CVB, SL21NVB, SL7NVB, TBM, TBM218		



<b>GEV No.</b>	375269	<b>Ref. No.</b>	32Z3790
<b>description</b>	thermostat t.max. 300°C temperature range 100-300°C 3-pole 3NO 16A probe ø 6mm probe L 75mm capillary pipe 1150mm capillary pipe isolated 1150mm gland nut shaft L 23mm rotation 270° outer switch 4NO		
<b>For models:</b>	030FTE, 030FTE06, 031FTE, 031FTE06, 031FTE08		
<b>spare parts for</b>	375269		
	<b>GEV No.</b>	300080	<b>Ref. No.</b> —
	cam switch 2 operating positions 4NO 16A sequence 0-1 shaft ø 6x4.6mm shaft L 23mm connection screw operation switch ceramic ambient temperature max. 150°C		
	<b>GEV No.</b>	375453	<b>Ref. No.</b> —
	thermostat t.max. 308°C temperature range 100-300°C 3-pole 3NO 16A probe ø 6mm probe L 75mm capillary pipe 1150mm capillary pipe isolatedmm gland nut shaft ø 6x4.6mm shaft L 23mm rotation 270° probe material SS		



<b>GEV No.</b>	375274	<b>Ref. No.</b>	32Z7400
<b>description</b>	thermostat t.max. 260°C temperature range 100-260°C 3-pole 3NO 16A probe ø 6mm probe L 75mm capillary pipe 1150mm capillary pipe isolated 1150mm gland nut rotation 270°		
<b>For models:</b>	031FTE04, 031FTE06, 06WFT1EV, 06WFT2EV, 06WFT3EV, 06WFT4EV, 06WFT6EV, 06WFT7EV, 070FTE04, 070FTE05, 071FTE04, 071FTE06, 08WFT1EV, 08WFT2EV, 08WFT3EV, 08WFT4EV, 08WFT6EV, 08WFT7EV, 090FT1E, 090FT2E, 090FT4E, 090FT5E, 090FT7E, 090FTE04, 090FTE05, 091FT1E, 091FT2E, 091FT4E, 091FT5E, 091FT7E, 091FTE04, 091FTE06, 0A0FT1E, 0A0FT2E, 0A0FT4E, 0A0FT5E, 0D0FT1E, 0D0FT2E, 0D0FT4E, 0D0FT5E, 0G0FT1E, 0G0FT2E, 0G0FT4E, 0G0FT5E, 0G0FT7E, 0G1FT2E, 0G1FT4E, 0G1FT5E, 0G1FT7E, 190FT15E...(Other models you can see in the webshop)		
<b>spare parts for</b>	375274		
	<b>GEV No.</b>	300200	<b>Ref. No.</b> —
	operation switch 2 operating positions 2NO 16A sequence 0-1 shaft ø 6x4.6mm shaft L 23mm connection male faston 6.3mm operation switch ceramic		
	<b>GEV No.</b>	375813	<b>Ref. No.</b> —
	thermostat t.max. 260°C temperature range 100-260°C 3-pole 3NO 16A probe ø 6mm probe L 75mm capillary pipe 1150mm capillary pipe isolated 1150mm gland nut shaft ø 6x4.6mm shaft L 23mm shaft position upper rotation 270°		
	<b>GEV No.</b>	550060	<b>Ref. No.</b> —
	connecting bow long for thermostat Qty 1 pcs		



<b>GEV No.</b>	375299	<b>Ref. No.</b>	32V0660 32V0661
<b>description</b>	thermostat t.max. 330°C temperature range 60-330°C 2-pole 2NO 16A probe ø 4mm probe L 128mm capillary pipe 1500mm capillary pipe isolated 1450mm gland nut shaft ø 6x4.6mm shaft L 23mm shaft position upper rotation 270° outer switch 2NO		
<b>For models:</b>	191BR1E, 191BR1G, 191BR1GA, 191BR2E, 191BR2EA, 191BR2G, 191BR2GA, 1A1BR1E, 1A1BR1G, 1A1BR1GA, 1A1BR2E, 1A1BR2EA, 1A1BR2G, 1A1BR2GA, 1D1BR1E, 1D1BR1G, 1D1BR1GA, 1D1BR2E, 1D1BR2EA, 1D1BR2G, 1D1BR2GA, 291BR1E, 291BR1G, 291BR1GA, 291BR2E, 291BR2EA, 291BR2G, 291BR2GA, 2A1BR1E, 2A1BR1G, 2A1BR1GA, 2A1BR2E, 2A1BR2EA, 2A1BR2G, 2A1BR2GA, 2D1BR1E, 2D1BR1G, 2D1BR1GA, 2D1BR2E, 2D1BR2EA, 2D1BR2G, 2D1BR2GA		
<b>spare parts for</b>	375299		
	<b>GEV No.</b>	300200	<b>Ref. No.</b> —
	operation switch 2 operating positions 2NO 16A sequence 0-1 shaft ø 6x4.6mm shaft L 23mm connection male faston 6.3mm operation switch ceramic		
	<b>GEV No.</b>	550060	<b>Ref. No.</b> —
	connecting bow long for thermostat Qty 1 pcs		

electric components



IMIT / TEMPOMATIC / ARTHERMO

control thermostats



<b>GEV No.</b>	390193	<b>Ref. No.</b>	32V1920
<b>description</b>	thermostat t.max. 56°C temperature range 0-90°C 1-pole 1CO 16A probe ø 6.5mm probe L 95mm capillary pipe 1500mm capillary pipe isolated 1500mm gland nut shaft ømm shaft Lmm shaft position rotation 270° probe material copper		
<b>For models:</b>	LC100, LC100-VERS.2001, LC130, LC130-VERS.2001, LC80		



<b>GEV No.</b>	390421	<b>Ref. No.</b>	32Z7200
<b>description</b>	thermostat t.max. 85°C temperature range 0-90°C 1-pole 1CO 16A probe ø 6.5mm probe L 95mm capillary pipe 1500mm capillary pipe isolated 1450mm gland nut shaft ømm shaft Lmm shaft position rotation 270° probe material copper		
<b>For models:</b>	LT10R, LT20F, LT25F		

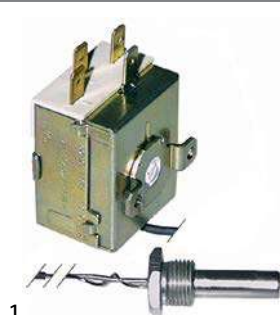

<b>GEV No.</b>	390310	<b>Ref. No.</b>	32V2630
<b>description</b>	thermostat t.max. 85°C temperature range fixed 55°C 1-pole 1CO 16A probe ø 9.5mm probe L 37mm capillary pipe 600mm capillary pipe isolated 540mm gland nut shaft ømm shaft Lmm shaft position rotation° screw-in probe probe thread 3/8" probe material SS		
<b>For models:</b>	LF50, LF50E, LF50EM, LF50EMPS, LF50E-VERS.2007		

<b>accessories for</b>	390310			
	<b>GEV No.</b>	506024	<b>Ref. No.</b>	—
	nut thread 3/8" H 6mm SS WS 22 Qty 1 pcs			
	<b>GEV No.</b>	529349	<b>Ref. No.</b>	—
	flat gasket FIBER ED ø 22mm ID ø 16.5mm thickness 2mm for thread 3/8" Qty 1 pcs			

Зип Общепит

vsezip.ru

+7(812)987-08-81



<b>GEV No.</b>	390006	<b>Ref. No.</b>	32V1910 32Z8840
<b>description</b>	thermostat t.max. 86°C temperature range 0-86°C 1-pole 1CO 16A probe ø 6.5mm probe L 95mm capillary pipe 1500mm capillary pipe isolatedmm gland nut shaft ø 6x4.6mm shaft L 19mm rotation 270°		
<b>For models:</b>	C207D-VERS.2006, C207S-VERS.2006, C207VD-VERS.2006, C207VS-VERS.2006, C304AD-VERS.2006, C304AS-VERS.2006, C304AVD-VERS.2006, C304AVS-VERS.2006, C304D-VERS.2006, C304S-VERS.2006, C304VD-VERS.2006, C304VS-VERS.2006, C92D-VERS.2006, C92S-VERS.2006, C92VD-VERS.2006, C92VS-VERS.2006, CS243D-VERS.2006, CS243S-VERS.2006, CS243VD-VERS.2006, CS243VS-VERS.2006, CS370AD-VERS.2006, CS370AS-VERS.2006, CS370AVD-VERS.2006, CS370AVS-VERS.2006, CS370D-VERS.2006, CS370S-VERS.2006, CS370VD-VERS.2006, CS370VS-VERS.2006, CS466AD-VERS.2006, CS466AS-VERS.2006, CS466AVD-VERS.2006, CS466AVS-VERS.2006, CS466D-VERS.2006, CS466S-VERS.2006, CS466VD-VERS.2006, CS466VS-VERS.2006, LC100, LC100-VERS.2001, LC130, LC130-VERS.2001, LC80, LF50		

<b>accessories for</b>	390006			
	<b>GEV No.</b>	110100	<b>Ref. No.</b>	36M2830
	knob thermostat t.max. 90°C 0-90°C ø 42mm shaft ø 6x4.6mm shaft flat -135° black			
	<b>GEV No.</b>	110105	<b>Ref. No.</b>	—
	rosette knob ø 42mm ø 56mm zero mark			



<b>GEV No.</b>	390704	<b>Ref. No.</b>	32Z8840
<b>description</b>	thermostat t.max. 86°C temperature range 0-86°C 1-pole 1CO 16A probe ø 6.5mm probe L 98mm capillary pipe 1020mm capillary pipe isolated 950mm gland nut shaft ø 6x4.6mm shaft L 19mm shaft position +135° rotation 270° probe material copper 250V		
<b>For models:</b>	C165D, C165S, C165VD, C165VS, C207D, C207S, C207VD, C207VS, C304AD, C304AD-VERS.2006, C304AS, C304AS-VERS.2006, C304AVD, C304AVD-VERS.2006, C304AVS, C304AVS-VERS.2006, C304D, C304D-VERS.2006, C304S, C304S-VERS.2006, C304VD, C304VD-VERS.2006, C304VS, C304VS-VERS.2006, CS243D, CS243D-VERS.2006, CS243S, CS243S-VERS.2006, CS243VD, CS243VD-VERS.2006, CS243VS, CS243VS-VERS.2006, CS370AD, CS370AD-VERS.2006, CS370AS, CS370AS-VERS.2006, CS370AVD, CS370AVD-VERS.2006, CS370AVS, CS370AVS-VERS.2006, CS370D, CS370D-VERS.2006, CS370S, CS370S-VERS.2006, CS370VD, CS370VD-VERS.2006, CS370VS, CS370VS-VERS.2006, CS466AD, CS466AD-VERS.2006...(Other models you can see in the webshop)		



Зип Общепит

vsezip.ru

+7(812)987-08-81



<b>GEV No.</b>	390460	<b>Ref. No.</b>	32V7240
<b>description</b>	thermostat t.max. 90°C temperature range 30-90°C 1-pole 1CO 16A probe ø 6.5mm probe L 95mm capillary pipe 2000mm capillary pipe isolated 1950mm gland nut shaft ømm shaft Lmm shaft position rotation 270° probe material copper		

safety thermostats



<b>GEV No.</b>	390023	<b>Ref. No.</b>	32Z8530 32Z8830
<b>description</b>	safety thermostat switch-off temp. 90-110°C 1-pole 16A probe ø 6.5mm probe L 90mm capillary pipe 1000mm capillary pipe isolated mm gland nut probe		
<b>For models:</b>	C165D, C165S, C207D, C207D-VERS.2006, C207S, C207S-VERS.2006, C207VD-VERS.2006, C207VS-VERS.2006, C304AD, C304AD-VERS.2006, C304AS, C304AS-VERS.2006, C304AVD-VERS.2006, C304A-VS-VERS.2006, C304D, C304D-VERS.2006, C304S, C304S-VERS.2006, C304VD-VERS.2006, C304VS-VERS.2006, C92D-VERS.2006, C92S-VERS.2006, C92VD-VERS.2006, C92VS-VERS.2006, CS243D, CS243S, CS243VD, CS243VS, CS370AD, CS370AS, CS370AVD, CS370AVS, CS370D, CS370S, CS370VD, CS370VS, CS466AD, CS466AS, CS466AVD, CS466AVS, CS466D, CS466S, CS466VD, CS466VS, LC100, LC100-VERS.2001, LC130, LC130-VERS.2001, LC80, LF50...(Other models you can see in the webshop)		

PRODIGY / FIRT

control thermostats



<b>GEV No.</b>	390723	<b>Ref. No.</b>	32Z0190
<b>description</b>	thermostat PRODIGY temperature range -35 up to +35°C probe ø 6mm probe L 110mm capillary pipe 1500mm type TR/711-N		
<b>accessories for</b>	390723		
	<b>GEV No.</b>	110305	<b>Ref. No.</b> —
	knob thermostat t.max. 35°C temperature range -35 up to +35°C ø 45mm shaft ø 6x4.6mm shaft flat inclined rotation 270° white		

RANGE

safety thermostats



<b>GEV No.</b>	375832	<b>Ref. No.</b>	3040550
<b>description</b>	safety thermostat t.max. 70°C temperature range 0-70°C 1-pole 1NO 16A probe ø 8mm probe L 60mm capillary pipe 870mm capillary pipe isolatedmm gland nut shaft ømm shaft Lmm shaft position rotation° probe material copper switch-off temp. 70°C		
<b>For models:</b>	PG22C, PG23C, PG23CW, PG24CW, PG30C, PG31CW, PG42C, PG43CW, PG60C, PG61CW, PG80C, PG80C-VERS.200911, PG81CW, PG81CW-VERS.200911, PGC132, PGC134W, PGC210, PGC212W		

various

control thermostats



<b>GEV No.</b>	375287	<b>Ref. No.</b>	6300359
<b>description</b>	thermostat t.max. 190°C temperature range 160-190°C probe ø 16mm probe L 93mm probe thread 1/2"		
<b>For models:</b>	030FE1, 30F1, 30FES2, 30FS2, 70F1, 70FE1, 70FES2, 71F2, 71FE2, 91F210		

control thermostats with operation switch



<b>GEV No.</b>	375951	<b>Ref. No.</b>	6300738
<b>description</b>	thermostat t.max. 187°C 1-pole 1NO probe ø 6mm probe L 132mm capillary pipe 900mm capillary pipe isolated 480mm shaft ø 4.5x6mm shaft L 23mm outer switch 42.02900.000 with thermowell		
<b>For models:</b>	030FE1B, 091FE28B, 091FR1G, 091FR3G, 0A1FR1G, 0A1FR1G-VERS.2004, 0A1FR3G, 0A1FR3GD, 0B1FR1G, 0D1FR1G, 0D1FR1G-VERS.2004, 0D1FR3G, 0D1FR3GD, 0G1FR3G, 191FR2G, 191FR4G, 1A1FR2G, 1A1FR2G-VERS.2004, 1A1FR4G, 1A1FR4GD, 1D1FR2G, 1D1FR2G-VERS.2004, 1D1FR4G, 1D1FR4GD, 1G1FR4G, 30F1B, 30FES2B, 30FS2B, 70F1B, 70FE1B, 70FES2, 70FES2B, 71F2B, 71FE2B, 90F110B, 91F210B, 91F223B		
<b>spare parts for</b>	375951		
	<b>GEV No.</b>	301115	<b>Ref. No.</b> 3168540
	cam switch 2 operating positions 2NO sequence 0-1 16A shaft ø 6x4.6mm shaft L 23mm connection male faston 6.3mm		
	<b>GEV No.</b>	375922	<b>Ref. No.</b> 3168460
	thermostat t.max. 185°C temperature range 101-185°C 1-pole 1NO 16A probe ø 6mm probe L 133mm capillary pipe 870mm capillary pipe isolated 520mm gland nut M10x1 shaft ø 6x4.6mm shaft L 23mm shaft position upper		

Зип Общепит refrigeration thermostats

universal without housing vsezip.ru

+7(812)987-08-81



<b>GEV No.</b>	375267	<b>Ref. No.</b>	32Z3550 32Z3551
<b>description</b>	thermostat t.max. 290°C temperature range 50-290°C 3-pole 3NO probe ø 3mm probe L 219mm capillary pipe 1200mm capillary pipe isolated 1200mm shaft position lower rotation 270°		
<b>For models:</b>	1G1FA0E, 1G1FA0EV, 1G1PE1E, 1G1PE1EV, 1G1PE2E, 1G1PE2EV, 2G1FA0E, 2G1PE1E, 2G1PE1EV, 2G1PE2E, 2G1PE2EV, 31GE, 31TCE, 32TCE		



<b>GEV No.</b>	375265	<b>Ref. No.</b>	32W0030
<b>description</b>	thermostat t.max. 300°C temperature range 50-300°C 3-pole 3NO 16A probe ø 6mm probe L 79mm capillary pipe 1740mm capillary pipe isolated 800mm shaft ø 6x4.6mm rotation 270°		

<b>spare parts for</b>	375265			
	<b>GEV No.</b>	375038	<b>Ref. No.</b>	32Z2560
	thermostat t.max. 300°C temperature range 50-300°C 3-pole 3NO 16A probe ø 6mm probe L 79mm capillary pipe 1740mm capillary pipe isolated 800mm gland nut shaft ø 6x4.6mm shaft L 23mm shaft position upper rotation 270°			
	<b>GEV No.</b>	550059	<b>Ref. No.</b>	—
	connecting bow short for switch Qty 1 pcs			

safety thermostats



<b>GEV No.</b>	390194	<b>Ref. No.</b>	32V7260
<b>description</b>	safety thermostat switch-off temp. 90-110°C 1-pole 16A probe ø 6.5mm probe L 87mm capillary pipe 1500mm capillary pipe isolated 1497mm connection male faston 6.3mm adjustable		



<b>GEV No.</b>	390534	<b>Ref. No.</b>	32Z1090 32Z2590 32Z6310 32Z7110	
<b>description</b>	thermostat temperature range -35 up to +35°C probe ø6x110mm capillary pipe 1800mm PRODIGY			
<b>For models:</b>	120, 120B, 120NN, 120PV, 135, 135-4, 135B, 135BA, 135BN, 135BNX, 135BX, 135BXE, 135BXR, 135CPX, 135NN, 135NNX, 135PVX, 135X, 135X-3, 135X-4, 135XR, 40CP, 40CPX, 55, 55B, 55PV, 65, 65B, 65BA, 65BX, 65BX-2, 65BXE, 65BXR, 65NB, 65NBX, 65NN, 65NNX, 65PVX, 65X, 65X-2, 65XR, 6BMA11A, 6BMA11B, 6BMA11M, 6BMA2A, 6BMA2B, 6BMA2M, 6BMA3A, 6BMA3B, 6BMA3M...(Other models you can see in the webshop)			
<b>accessories for</b>	390534			
	<b>GEV No.</b>	110305	<b>Ref. No.</b>	—
	knob thermostat t.max. 35°C temperature range -35 up to +35°C ø 45mm shaft ø 6x4.6mm shaft flat inclined rotation 270° white			

RANCO

K22 series



<b>GEV No.</b>	390202	<b>Ref. No.</b>	32Z7450
<b>description</b>	thermostat RANCO type K22L2025 probe ømm probe Lmm capillary pipe 1500mm temperature range +1°C up to +11°C		
<b>For models:</b>	PGA20, PGA30, PGA40, PGA60, PGA80, PGW20, PGW30, PGW40, PGW60, PGW80		



<b>GEV No.</b>	390207	<b>Ref. No.</b>	32Z3890
<b>description</b>	thermostat RANCO type K22L2030 probe ø 2mm probe Lmm capillary pipe 2000mm temperature range -13 up to -4°C		
<b>For models:</b>	PGA20, PGA30, PGA40, PGA60, PGA80, PGW20, PGW30, PGW40, PGW60, PGW80		







Зип Общепит

vsezip.ru

+7(812)987-08-81

			
<b>GEV No.</b>	390209	<b>Ref. No.</b>	32V2280 32V4360
<b>description</b>	thermostat RANCO type K22L1020 probe ø 9mm probe L 40mm capillary pipe 2000mm temperature range -20.5 up to -1.5°C		
<b>For models:</b>	PG22C, PG23C, PG23CW, PG24CW, PG30C, PG31CW		

			
<b>GEV No.</b>	390254	<b>Ref. No.</b>	32V4270
<b>description</b>	thermostat RANCO type K50P1135 probe ømm probe Lmm capillary pipe 2500mm T cold 1.5°C		

			
<b>GEV No.</b>	390737	<b>Ref. No.</b>	32V4400
<b>description</b>	thermostat RANCO type K22-L1074 probe ø 9mm probe L 42mm capillary pipe 1450mm temperature range -19 up to -1°C		
<b>For models:</b>	PG42C, PG43CW, PG60C, PG61CW, PG80C, PG80C-VERS.200911, PG81CW, PG81CW-VERS.200911, PGC132, PGC132-VERS.200911, PGC134W, PGC134W-VERS.200911, PGC210, PGC210-VERS.200911, PGC212W, PGC212W-VERS.200911		

			
<b>GEV No.</b>	390581	<b>Ref. No.</b>	3111590
<b>description</b>	thermostat RANCO type K50-S3595 probe ø 2mm probe Lmm capillary pipe 2000mm		
<b>For models:</b>	PG23C, PG24CW, PG30C, PG31CW		

K52 series

			
<b>GEV No.</b>	390214	<b>Ref. No.</b>	32Z0920
<b>description</b>	thermostat RANCO type K52L4512 probe ø 11mm probe L 30mm capillary pipe 2100mm temperature range -6.4 up to +3.2°C		
<b>For models:</b>	40, 40EV, 40EVP, 40PL, 40PV, 40X, 40XPV		

K50 series

			
<b>GEV No.</b>	390208	<b>Ref. No.</b>	3034730
<b>description</b>	thermostat RANCO type K50L3006 probe ømm probe Lmm capillary pipe 2000mm temperature range +1.5 up to +4°C		
<b>For models:</b>	PG22C, PG23C, PG23CW, PG24CW, PG30C, PG31CW, PG42C, PG43CW, PG60C, PG61CW, PG80C, PG80C-VERS.200911, PG81CW, PG81CW-VERS.200911, PGC132, PGC132-VERS.200911, PGC134W, PGC134W-VERS.200911, PGC210, PGC210-VERS.200911, PGC212W, PGC212W-VERS.200911		

K55 series

			
<b>GEV No.</b>	390252	<b>Ref. No.</b>	32Z7580
<b>description</b>	thermostat RANCO type K55L5070 capillary pipe 2500mm temperature range -22 up to -7°C		
<b>For models:</b>	40B, S125B, S125B-4, S125BX, S125BX-4, S60B, S60B-2, S60BX, S60BX-2		

			
<b>GEV No.</b>	390278	<b>Ref. No.</b>	32Z6360
<b>description</b>	thermostat RANCO type K50L3207 probe ømm probe Lmm capillary pipe 1500mm temperature range -10 up to -2°C		
<b>For models:</b>	BRPR, BRPR218, BRPR21C, BRPRV, BRVR, BRVR218, BRVR21C, BRVRV, TPR, TPR218, TPR21C, TPRV, TVR, TVR218, TVR21C, TVRV		



Зип.Общепит

vsezip.ru

+7(812)987-08-81

## K60 series

RANCO



1

<b>GEV No.</b>	390598	<b>Ref. No.</b>	32Z4730
<b>description</b>	thermostat RANCO type K60-L2045 probe ø 2mm probe Lmm capillary pipe 2000mm		

## accessories

## probe clips

## clamps

## for thermostat



1

<b>GEV No.</b>	691171	<b>Ref. No.</b>	35T3540
<b>description</b>	probe clip for probe ø 9mm Qty 1 pcs L 30mm W 20mm		
<b>For models:</b>	030FE, 030FE1, 030FE1B, 031FT04, 031FT06, 031FTE04, 031FTE06, 06WBR3E, 06WFT1EV, 06WFT2EV, 06WFT3EV, 06WFT4EV, 06WFT6EV, 06WFT7EV, 070FTE04, 070FTE05, 071FTE04, 071FTE06, 090FT1G, 090FT2G, 090FT4G, 090FT5G, 090FT7G, 090FTE04, 090FTE05, 091FE28, 091FE28B, 091FTE04, 091FTE06, 0A0FT1E, 0A0FT1G, 0A0FT2E, 0A0FT2G, 0A0FT4E, 0A0FT4G, 0A0FT5E, 0A0FT5G, 0B0FT1G, 0B0FT2G, 0B0FT4G, 0B0FT5G, 0D0FT1E, 0D0FT1G, 0D0FT2E, 0D0FT2G, 0D0FT4E, 0D0FT4G, 0D0FT5E, 0D0FT5G, 0G0FT1E...(Other models you can see in the webshop)		



1

<b>GEV No.</b>	691170	<b>Ref. No.</b>	35S0540
<b>description</b>	probe clip for probe ø 9mm Qty 1 pcs L 38mm W 20mm		
<b>For models:</b>	030FE, 030FE1, 030FE1B, 091FE28, 091FE28B, 0G1BR3E, 1G1BR3E, 30FES, 70FE, 70FES, 71FE		

## miscellaneous



1

<b>GEV No.</b>	691175	<b>Ref. No.</b>	35S5040
<b>description</b>	probe clip for probe ø 4mm for pipe ø 9mm		
<b>For models:</b>	030FE1, 030FE1B, 091FE28, 091FE28B, 30FES2, 30FES2B, 70FES2, 70FES2B		

## gland duct accessories

## ducts

1

<b>GEV No.</b>	560623	<b>Ref. No.</b>	3003400
<b>description</b>	gland duct ET M16 IT M10x1 WS 19 L 18mm		
<b>For models:</b>	FM1011E2-VERS.2006, FM1011E3, FM1011E3-VERS.2006, FM1011G2-VERS.2006, FM1011G3, FM1011G3-VERS.2006, FM1221E2-VERS.2006, FM1221E3, FM1221E3-VERS.2006, FM1221G2-VERS.2006, FM1221G3, FM1221G3-VERS.2006, FM2011E2-VERS.2006, FM2011E3-VERS.2006, FM2011G2-VERS.2006, FM2011G3-VERS.2006, FM2021E2-VERS.2006, FM2021E3, FM2021E3-VERS.2006, FM2021G2-VERS.2006, FM2021G3, FM2021G3-VERS.2006, FM423E2, FM611E2-VERS.2006, FM611E3, FM611E3-VERS.2006, FM611G2-VERS.2006, FM611G3, FM611G3-VERS.2006, FM721E2-VERS.2006, FM721E3, FM721E3-VERS.2006, FM721G2-VERS.2006, FM721G3, FM721G3-VERS.2006, FX101E2, FX101E2C, FX101E2C-VERS.032014, FX101E2R, FX101E2R-VERS.032014, FX101E2-VERS.032014, FX101E3, FX101E3C, FX101E3C-VERS.022014, FX101E3R, FX101E3R-VERS.022014, FX101E3-VERS.022014, FX101G2, FX101G2C, FX101G2C-VERS.032014...(Other models you can see in the webshop)		

## miscellaneous



1

<b>GEV No.</b>	691191	<b>Ref. No.</b>	36D6970
<b>description</b>	connecting piece for thermostat		
<b>For models:</b>	030FE1, 30F1, 30FES2, 30FS2		



1

<b>GEV No.</b>	691154	<b>Ref. No.</b>	37Q3270
<b>description</b>	cover cap temperature limiter		
<b>For models:</b>	04WCP1EM, 04WFR3ED, 06WFR3GD, 08WFA4E, 08WFAAE, 08WFR4ED, 08WFT1EV, 08WFT2EV, 08WFT3EV, 08WFT4EV, 08WFT6EV, 08WFT7EV, 091CP1E, 091FR1E, 091FR1EA, 091FR1ED, 091FR1G, 091FR1GD, 091FR3E, 091FR3ED, 091FR3G, 091FR3GD, 091FT1E, 091FT2E, 091FT4E, 091FT5E, 091FT7E, 0A1CP1E, 0A1FR1E, 0A1FR1ED, 0A1FR1G, 0A1FR1GD, 0A1FR1GD-VERS.2004, 0A1FR1G-VERS.2004, 0A1FR3G, 0A1FR3GD, 0B1FR1G, 0B1FR1GD, 0D1CP1E, 0D1FR1E, 0D1FR1ED, 0D1FR1G, 0D1FR1GD, 0D1FR1GD-VERS.2004, 0D1FR1G-VERS.2004, 0D1FR3G, 0D1FR3GD, 0G1BR3E, 0G1CP1E, 0G1CP1EC...(Other models you can see in the webshop)		



switches and momentary switches

rocker/momentary rocker switches

25.5x25mm



<b>GEV No.</b>	345280 <sup>1</sup>	<b>Ref. No.</b>	32W6010
<b>description</b>	rocker switch mounting measurements 25.5x25mm green 2CO 250V 16A illuminated connection male faston 6.3mm ambient temperature max. 85°C protection IP40		

<sup>1</sup>illuminated



<b>GEV No.</b>	345278 <sup>1</sup>	<b>Ref. No.</b>	32W0990 32W3970
<b>description</b>	rocker switch mounting measurements 25.5x25mm green 2NO 250V 16A illuminated 0-1 connection male faston 6.3mm protection IP40		
<b>For models:</b>	3G6SA, 3G6SA2, 3G6SA4, 40-OPR01, 40B-OPR01, 40BX-OPR01, 40CP-OPR01, 40CPX-OPR01, 40EV-OPR01, 40PV-OPR01, 40X-OPR01, 4G6SB, 4G6SB2, 4G6SB4, 4G6SB6, 6BR15V, 6BR15VC, 6BR19V, 6BR19VC, 6ERA-OPR01, 6ERA2-OPR01, 6ERA2A-OPR01, 6ERA2M-OPR01, 6ERAA-OPR01, 6ERAB-OPR01, 6ERABA-OPR01, 6ERABM-OPR01, 6ERAM-OPR01, 6ERB-OPR01, 6ERB2-OPR01, 6ERB2A-OPR01, 6ERB2M-OPR01, 6ERB4-OPR01, 6ERB4A-OPR01, 6ERB4M-OPR01, 6ERBA-OPR01, 6ERBB-OPR01, 6ERBBA-OPR01, 6ERBBM-OPR01, 6ERBM-OPR01, 6ERC-OPR01, 6ERC2-OPR01, 6ERC2A-OPR01, 6ERC2M-OPR01, 6ERC4-OPR01, 6ERC4A-OPR01, 6ERC4M-OPR01, 6ERCA-OPR01, 6ERCB-OPR01, 6ERCBM-OPR01... (Other models you can see in the webshop)		

<sup>1</sup>illuminated

30x22mm

labelled



<b>GEV No.</b>	300125	<b>Ref. No.</b>	32W0860 32W2331 32W2990
<b>description</b>	rocker switch mounting measurements 30x22mm green 2NO 230V 16A 0-1 connection male faston 6.3mm ambient temperature max. 125/55°C protection IP65 with cover cap		
<b>For models:</b>	120, 120B, 120NN, 120PV, 135, 135-4, 135A, 135B, 135BA, 135BN, 135BNX, 135BX, 135BXE, 135BXR, 135CPX, 135NN, 135NNX, 135PVX, 135X, 135X-3, 135X-4, 135XE, 135XR, 40, 40B, 40CP, 40CPX, 40EV, 40EVP, 40PL, 40PV, 40X, 40XPV, 55, 55B, 55PV, 65, 65A, 65B, 65BA, 65BX, 65BX-2, 65BXE, 65BXR, 65NB, 65NBX, 65NN, 65NNX, 65PVX, 65X... (Other models you can see in the webshop)		

**accessories for**



<b>GEV No.</b>	301036	<b>Ref. No.</b>	—
protective cover internal size 30x22mm for rocker switch mounting measurementsmm			



<b>GEV No.</b>	301164	<b>Ref. No.</b>	32W0631
<b>description</b>	rocker switch mounting measurements 30x22mm green 2NO 250V 16A illuminated connection male faston 6.3mm ambient temperature max. 85°C protection IP65 with cover cap		
<b>For models:</b>	1G1FA0EV, 1G1FA0GV, 1G1PE1EV, 1G1PE2EV, 2091SCP, 2G1FA0GV, 2G1PE1EV, 2G1PE2EV, 31GE, 31TC, 31TCE, 32TC, 32TCE, FX101E1, FX101E1R, FX101E2, FX101E2C, FX101E2R, FX101E3, FX101E3C, FX101E3C-VERS.022014, FX101E3R, FX101G1, FX101G1R, FX101G2, FX101G2C, FX101G2R, FX101G3, FX101G3C, FX101G3C-VERS.022014, FX101G3R, FX10E2CR, FX10E3CR, FX10E3CR-VERS.022014, FX10G2CR, FX10G3CR, FX10G3CR-VERS.022014, FX122E1, FX122E2, FX122E2C, FX122E3, FX122E3C, FX122G1, FX122G2, FX122G2C, FX122G3, FX122G3C, FX12E3CT, FX12E3CT-VERS.022014, FX12G3CT... (Other models you can see in the webshop)		

**accessories for**



<b>GEV No.</b>	301036	<b>Ref. No.</b>	—
protective cover internal size 30x22mm for rocker switch mounting measurementsmm			



<b>GEV No.</b>	345275	<b>Ref. No.</b>	32W3190
<b>description</b>	rocker switch mounting measurements 30x22mm white 1CO/indicator light 230V 16A 1-2 connection male faston 6.3mm ambient temperature max. 125/55°C protection IP65 with cover cap		
<b>For models:</b>	120, 120NN, 120PV, 135, 135-4, 135BN, 135BNX, 135CPX, 135NN, 135NNX, 135PVX, 135X, 135X-3, 135X-4, 135XR, 55, 55PV, 65, 65NB, 65NBX, 65NN, 65NNX, 65PVX, 65X, 65X-2, 65XR, 6BMA11A, 6BMA11B, 6BMA11M, 6BMA11Z, 6BMA2A, 6BMA2B, 6BMA2M, 6BMA2Z, 6BMA3A, 6BMA3B, 6BMA3M, 6BMA3Z, 6BMAA, 6BMAB, 6BMAM, 6BMAZ, 6BMB11A, 6BMB11B, 6BMB11M, 6BMB11Z, 6BMB22A, 6BMB22B, 6BMB22M, 6BMB22Z... (Other models you can see in the webshop)		

push/momentary push switches

19x13mm



<b>GEV No.</b>	347431	<b>Ref. No.</b>	3126050
<b>description</b>	momentary push switch mounting measurements 19x13mm red 1NO 250V 16A connection male faston 6.3mm ambient temperature max. 105/55°C protection IP40		
<b>For models:</b>	090FAA, 091FR11, 091FR11-VERS.032012, 091FR7G, 091FR7G-VERS.052012, 10CP1GA, 12CP1GA, 18CP2GA, 190FAA, 191FR21, 191FR21-VERS.032012		





Зип Общепит  
vsezip.ru  
7(812)9804800

			
1			
<b>GEV No.</b>	301054	<b>Ref. No.</b>	3062550 6300676
<b>description</b>	momentary push switch mounting measurements 19x13mm red 1NO 250V 16A connection male faston 6.3mm ambient temperature max. 105/55°C protection IP65 with cover cap		
<b>For models:</b>	090BM1G, 090FAVA, 090FT1G, 090FT2G, 090FT4G, 090FT5G, 090FT7G, 090GRG, 091CP1G, 190BM2G, 190FAB, 190FT15G, 190FT1G, 190FT2G, 190FT3G, 190FT42G, 190FT4G, 190FT6G, 190FT72G, 190FT7G, 190GRG, 190TP0, 191CP1G, 191CP1GA, 191CP2G, 191FAAG, 191FABG, 191FADG, 191FAG, 191PD1G, 191PD2G, 191PI1G, 191PI1GA, 191PI2G, 191PI2GA, 191TPG, 291FAG, 291FAGF, 291PD3G, 291PI3G, 291TPCG, 391FAG, G1FAGS, G1FAGST		

			
2			
<b>GEV No.</b>	301713	<b>Ref. No.</b>	6300674
<b>description</b>	push switch mounting measurements 19x13mm blue 1NO 250V 16A connection male faston 6.3mm ambient temperature max. 85°C protection IP65 with cover cap		
<b>For models:</b>	191BR1E, 191BR1G, 191BR1GA, 191BR2E, 191BR2EA, 191BR2G, 191BR2GA, 291BR1E, 291BR1G, 291BR1GA, 291BR2E, 291BR2EA, 291BR2G, 291BR2GA		

## 28.5x28.5mm

			
1			
<b>GEV No.</b>	346916	<b>Ref. No.</b>	32V2050
<b>description</b>	momentary push switch mounting measurements 28.5x28.5mm grey 1NO 250V 16A connection male faston 6.3mm ambient temperature max. 125/55°C protection IP40		
<b>For models:</b>	LF50, LF50E, LF50EM, LF50E-VERS.2007		

			
1			
<b>GEV No.</b>	346915	<b>Ref. No.</b>	32V2030
<b>description</b>	push switch mounting measurements 28.5x28.5mm grey 1CO 250V 16A connection male faston 6.3mm ambient temperature max. 125/55°C protection IP40		
<b>For models:</b>	LF50, LF50E, LF50EM, LF50E-VERS.2007		

			
1			
<b>GEV No.</b>	346914	<b>Ref. No.</b>	32V2040
<b>description</b>	push switch mounting measurements 28.5x28.5mm weak 2CO 250V 16A connection male faston 6.3mm ambient temperature max. 150°C protection IP40		
<b>For models:</b>	LF50, LF50E, LF50EM, LF50E-VERS.2007		

			
1			
<b>GEV No.</b>	345587	<b>Ref. No.</b>	32V2050
<b>description</b>	momentary push switch mounting measurements 28.5x28.5mm yellow 1NO 250V 16A connection male faston 6.3mm ambient temperature max. 125°C protection IP40		

			
1			
<b>GEV No.</b>	345589	<b>Ref. No.</b>	32V2030 32V2070
<b>description</b>	push switch mounting measurements 28.5x28.5mm yellow 2CO 250V 16A connection male faston 6.3mm ambient temperature max. 85/125°C protection IP40		

## ø22mm

			
1			
<b>GEV No.</b>	699002	<b>Ref. No.</b>	32W2030
<b>description</b>	momentary push switch mounting ø 22mm black/white 1NO/1NC/indicator light 230V 6A 0-1 connection screw ambient temperature max. 70°C protection IP40		
<b>For models:</b>	TG12, TG12X, TG12XE		

## ø25mm

			
1			
<b>GEV No.</b>	301322	<b>Ref. No.</b>	3203760
<b>description</b>	push switch mounting ø 25mm silver 1NO/1NC 250V 5A stainless steel connection male faston 2.8mm		
<b>For models:</b>	B151H, B151M, FX201E2, FX201E2P, FX201E2P-VERS.032014, FX201E2-VERS.032014, FX201E3, FX201E3P, FX201E3P-VERS.022014, FX201E3-VERS.022014, FX201G2, FX201G2P, FX201G2P-VERS.032014, FX201G2-VERS.032014, FX201G3P, FX201G3-VERS.022014, FX202E2, FX202E2-VERS.032014, FX202E3, FX202E3-230V-3-50Hz-60Hz, FX202E3-230V-3-50Hz-60Hz-VERS.022014, FX202E3-VERS.022014, FX202G2, FX202G2-VERS.032014, FX202G3, FX202G3-VERS.022014		

## 2 hole fixing

			
1			
<b>GEV No.</b>	346906	<b>Ref. No.</b>	32W0280
<b>description</b>	switch combination 2CO/2CO/2NO		





Зип Общепит  
vsezip.ru  
+7(812)987-0885

			
1			
<b>GEV No.</b>	346905	<b>Ref. No.</b>	32W0830
<b>description</b>	switch combination 2CO/2CO/2NO 250V 16A connection male faston 6.3mm ambient temperature max. 85°C protection IP 40		

			
1			
<b>GEV No.</b>	345257	<b>Ref. No.</b>	32W4240
<b>description</b>	microswitch with lever 250V 16A 1CO connection male faston 6.3mm L 29mm L1 33mm ambient temperature max. 120°C mounting distance 22mm actuating force: 130g lever length 31.5mm		

<b>miscellaneous</b>			
			
1			
<b>GEV No.</b>	346910	<b>Ref. No.</b>	32W0410
<b>description</b>	momentary push switch green 1NO/1NC/indicator light 600V 10A connection screw ambient temperature max. 85°C protection IP40		

			
1			
<b>GEV No.</b>	345255	<b>Ref. No.</b>	32W1320
<b>description</b>	microswitch with lever 250V 16A 1CO connection male faston 6.3mm L 35mm L1 28mm ambient temperature max. 125°C mounting distance 22mm actuating force: 136g lever length 27mm		
<b>For models:</b>	120, 120B, 120NN, 120PV, 135, 135-4, 135A, 135B, 135BA, 135BN, 135BNX, 135BX, 135BXE, 135BXR, 135CPX, 135NN, 135NNX, 135PVX, 135X, 135X-3, 135X-4, 135XE, 135XR, 40, 40CP, 40CPX, 40PV, 40X, 40XPV, 55, 55B, 55PV, 65, 65A, 65B, 65BA, 65BX, 65BX-2, 65BXE, 65BXR, 65NB, 65NBX, 65NN, 65NNX, 65PVX, 65X, 65X-2, 65XE, 65XR, S125... (Other models you can see in the webshop)		

			
1			
<b>GEV No.</b>	346911	<b>Ref. No.</b>	32W1430
<b>description</b>	momentary push switch green 2NO 300V 3A connection screw ambient temperature max. 125/55°C protection IP40		

			
1			
<b>GEV No.</b>	345459	<b>Ref. No.</b>	32W1180
<b>description</b>	microswitch with lever 250V 15A 1NC connection male faston 6.3mm ambient temperature max. 85°C mounting distance 15-25mm ROLD lever length 66mm series RM		

			
1			
<b>GEV No.</b>	348228	<b>Ref. No.</b>	32W4140
<b>description</b>	push switch mounting ø 12mm black 2NO/1NC 250V 16A connection male faston 6.3mm		
<b>For models:</b>	KD100, KD100A, KD100PSD, KD85, KD85A, KD85PS, KD85PSA, KN1100, KN1100SD, KN11PSDD, KN35, KN37, KN37PS, KN800, KN800PSD		

			
1			
<b>GEV No.</b>	346909	<b>Ref. No.</b>	32W0010
<b>description</b>	microswitch with lever 250V 16A 1CO connection male faston 6.3mm ambient temperature max. 125°C mounting distance 13mm lever length 50mm		

<b>accessories</b>			
<b>push buttons</b>			
			
1			
<b>GEV No.</b>	346912	<b>Ref. No.</b>	32W1420
<b>description</b>	push button black		

			
1			
<b>GEV No.</b>	346907	<b>Ref. No.</b>	32W0020
<b>description</b>	microswitch with lever 250V 16A 1CO connection male faston ambient temperature max. 85°C		

<b>microswitches</b>			
<b>lever actuated</b>			
			
1			
<b>GEV No.</b>	345254	<b>Ref. No.</b>	32W1320
<b>description</b>	microswitch with lever 250V 16A 1CO connection male faston 6.3mm ambient temperature max. 120°C mounting distance 22mm actuating force: 60g lever length 58mm		

			
1			
<b>GEV No.</b>	346904	<b>Ref. No.</b>	32W3700
<b>description</b>	microswitch with lever 250V 16A 1NO connection male faston ambient temperature max. male faston 6.3mm°C		
<b>For models:</b>	0M0FR1E, 1M0FR2E		



Зип Общепит

vsezip.ru

+7(812)987-08-81

## pin-plunger actuated

M10



1

<b>GEV No.</b>	347216	<b>Ref. No.</b>	32W1660 32W3340
<b>description</b>	microswitch with plunger thread M10x0.75 thread L 14mm 250V 10A 1CO connection male faston 6.3mm stroke 7.5mm mounting distance 22mm L 28mm ambient temperature max. 125°C type NR6K5 actuating force: 260g		
<b>For models:</b>	030FE, 030FE1, 030FE1B, 04WFR3ED, 08WFR4ED, 091FE28, 091FE28B, 091FR3E, 091FR3ED, 0A1FR3E, 0A1FR3ED, 0D1FR3E, 0D1FR3ED, 0G0FR3E, 0G0FR3ED, 10CP1EA, 10CP1GA, 10CP1IA, 12CP1EA, 12CP1GA, 12CP1IA, 18CP2EA, 18CP2GA, 18CP2IA, 191BR1E, 191BR1G, 191BR2E, 191BR2G, 191FR4E, 191FR4ED, 1A1FR4E, 1A1FR4ED, 1D1FR4E, 1D1FR4ED, 1G0FR4E, 291BR1E, 291BR1G, 291BR2E, 291BR2G, 30FES, 30FES2, 30FES2B, 6043840, 6043970, 70FE, 70FE1, 70FE1B, 70FES, 70FES2, 70FES2B...(Other models you can see in the webshop)		

M12



1

<b>GEV No.</b>	345350	<b>Ref. No.</b>	32W3020
<b>description</b>	microswitch with plunger mounting distance 22mm thread M12x0.75 thread L 16mm 250V 16A 1CO connection male faston 6.3mm stroke 4mm ambient temperature max. 125°C type EF83161.3 actuating force: 66g		
<b>For models:</b>	FC101, FC101E, FC241, FC241E, FC241G, FC61, FC61E, FCV101, FCV101DM, FCV101DS, FCV101E, FCV101EDM, FCV101EDS, FCV141, FCV141DM, FCV141DS, FCV141E, FCV141EDM, FCV141EDS, FCV241, FCV241DM, FCV241DS, FCV241E, FCV241EDM, FCV241EDS, FCV241G, FCV241GDM, FCV241GDS, FCV401DM, FCV401EDM, FCV61, FCV61DM, FCV61DS, FCV61E, FCV61EDM, FCV61EDS		
<b>accessories for</b>	345350		
	<b>GEV No.</b>	345351	<b>Ref. No.</b> —
	nut thread M12x0.75 H 1.6mm WS 14 chrome-plated brass Qty 1 pcs		



1

<b>GEV No.</b>	345360	<b>Ref. No.</b>	32W1410
<b>description</b>	microswitch with plunger mounting distance 25.4mm thread M12x1 thread L 15mm 250V 10A 1CO connection screw stroke 5mm ambient temperature max. 125°C type Highly D5000 actuating force: 200g		
<b>For models:</b>	65NN, SP65NN		



1

<b>GEV No.</b>	345679	<b>Ref. No.</b>	32W0960
<b>description</b>	microswitch with plunger mounting distance 25mm thread M12x1 thread L 9mm 250V 5A 1CO connection male faston 6.3mm stroke 5mm ambient temperature max. 125°C type MF12 actuating force: 680g		
<b>For models:</b>	31RE, 71AR		

## with push button

## switches with snap-fit



1

<b>GEV No.</b>	347027	<b>Ref. No.</b>	32W3770
<b>description</b>	microswitch with push button 250V 1A 1CO connection male faston 2.8mm L 26x12mm ambient temperature max. 85°C type XKA-304B1AAJ11 actuating force: 50g		
<b>For models:</b>	CX120, CX120B, CX120NN, CX130, CX130B, CX130NN, CX140, CX140B, CX140BN, CX140BR, CX140CP, CX140NN, CX140PV, CX140R, CX150, CX150B, CX150BN, CX150BR, CX150CP, CX150NN, CX150PV, CX150R, CX55, CX55B, CX60, CX60B, CX65, CX652, CX65B, CX65BR, CX65NB, CX65NCP, CX65NN, CX65PV, CX65R, CX70, CX702, CX70B, CX70BR, CX70NB, CX70NN, CX70PV, CX70R, FG2B, FSD1B, FSD1N, FSD2B, FSD2N, FSD2N2, FSDR2B...(Other models you can see in the webshop)		



1

<b>GEV No.</b>	348008	<b>Ref. No.</b>	3096020
<b>description</b>	microswitch with push button 250V 2.5A 1NO/1NC connection male faston 2.8mm/6.3mm L 27mm L1 22mm ambient temperature max. 104°C actuating force: 180g		

## roller actuated

## roller 0°



1

<b>GEV No.</b>	345639	<b>Ref. No.</b>	32W1040
<b>description</b>	microswitch with roller plunger 230V 16A 1CO connection solder/screw connection L1 49mm ambient temperature max. 125°C thread L 14mm thread M10 mounting distance 25mm actuating force: 300g type MS15-1		



Зип Общепит

vsezip.ru

+7(812)9870881

roller 90°



<b>GEV No.</b>	347096	<b>Ref. No.</b>	32W4150
<b>description</b>	microswitch with roller plunger 250V 20A 1CO connection screw L1 49mm ambient temperature max. 125°C thread L 14.5mm thread M12x1 mounting distance 25mm actuating force: 370g type Z15G1318		
<b>For models:</b>	KD100, KD100A, KD100PSD, KD130, KD130A, KD130E, KD130EAT, KN1100, KN1100SD, KN11PSDD, KN800, KN800PSD		

non-standard



<b>GEV No.</b>	346183	<b>Ref. No.</b>	33Q5620 6300496
<b>description</b>	microswitch connection male faston		
<b>For models:</b>	FC101, FC101E, FC241, FC241E, FC241G, FC61, FC61E, FCV101, FCV101DM, FCV101DS, FCV101E, FCV101EDM, FCV101EDS, FCV141, FCV141DM, FCV141DM-CSA, FCV141DS, FCV141E, FCV141EDM, FCV141EDS, FCV241, FCV241DM, FCV241DS, FCV241E, FCV241EDM, FCV241EDS, FCV241G, FCV241GDM, FCV241GDS, FCV401DM, FCV401EDM, FCV61, FCV61DM, FCV61DS, FCV61E, FCV61EDM, FCV61EDS		

accessories



<b>GEV No.</b>	691143	<b>Ref. No.</b>	36D8360
<b>description</b>	bolt for microswitch		
<b>For models:</b>	FC101, FC101E, FC241, FC61, FC61E, FCV101, FCV101-CSA, FCV101DM, FCV101DM-CSA, FCV101DS, FCV101DS-CSA, FCV101E, FCV101EDM, FCV101EDM-CSA, FCV101EDS, FCV101EDS-CSA, FCV101E-UL, FCV141, FCV141-CSA, FCV141DM, FCV141DM-CSA, FCV141DS, FCV141DS-CSA, FCV141E, FCV141EDM, FCV141EDS, FCV241, FCV241DM, FCV241DS, FCV401DM, FCV401DM-CSA, FCV401EDM, FCV401EDM-CSA, FCV61, FCV61-CSA, FCV61DM, FCV61DM-CSA, FCV61DS, FCV61DS-CSA, FCV61E, FCV61EDM, FCV61EDM-CSA, FCV61EDS, FCV61EDS-CSA, FCV61E-UL, FCV72EDM-CSA, FCV72EDS-CSA, FCV72E-UL		



<b>GEV No.</b>	691140	<b>Ref. No.</b>	33Q5610
<b>description</b>	bush for microswitch thread M16x1.5		
<b>For models:</b>	FC101, FC101E, FC241, FC241E, FC241G, FC61, FC61E, FCV101, FCV101-CSA, FCV101DM, FCV101DM-CSA, FCV101DS, FCV101DS-CSA, FCV101E, FCV101EDM, FCV101EDM-CSA, FCV101EDS, FCV101EDS-CSA, FCV101E-UL, FCV141, FCV141-CSA, FCV141DM, FCV141DM-CSA, FCV141DS, FCV141DS-CSA, FCV141E, FCV141EDM, FCV141EDS, FCV241, FCV241DM, FCV241DS, FCV241E, FCV241EDM, FCV241EDM-CSA, FCV241EDS, FCV241EDS-CSA, FCV241E-UL, FCV241G, FCV241G-CSA, FCV241GDM, FCV241GDM-CSA, FCV241GDS, FCV241GDS-CSA, FCV401DM, FCV401DM-CSA, FCV401EDM, FCV401EDM-CSA, FCV61, FCV61-CSA, FCV61DM...(Other models you can see in the webshop)		



<b>GEV No.</b>	691139	<b>Ref. No.</b>	33Q4120 33Q5610
<b>description</b>	connecting plate for microswitch		
<b>For models:</b>	FC101, FC101E, FC241E, FC241G, FC61, FC61E, FCV101, FCV101-CSA, FCV101DM, FCV101DM-CSA, FCV101DS, FCV101DS-CSA, FCV101E, FCV101EDM, FCV101EDM-CSA, FCV101EDS, FCV101EDS-CSA, FCV101E-UL, FCV141, FCV141-CSA, FCV141DM, FCV141DS, FCV141DS-CSA, FCV141E, FCV141EDM, FCV141EDS, FCV241E, FCV241EDM, FCV241EDM-CSA, FCV241EDS, FCV241EDS-CSA, FCV241E-UL, FCV241G, FCV241G-CSA, FCV241GDM, FCV241GDM-CSA, FCV241GDS, FCV241GDS-CSA, FCV401DM, FCV401DM-CSA, FCV401EDM, FCV401EDM-CSA, FCV61, FCV61-CSA, FCV61DM, FCV61DM-CSA, FCV61DS, FCV61DS-CSA, FCV61E, FCV61EDM...(Other models you can see in the webshop)		



<b>GEV No.</b>	516249	<b>Ref. No.</b>	36G1720
<b>description</b>	hexagonal screw thread M5 WS 8		
<b>For models:</b>	LT10R, LT20F, LT25F		



<b>GEV No.</b>	691138	<b>Ref. No.</b>	35Q2360
<b>description</b>	housing for microswitch		
<b>For models:</b>	FC101, FC101E, FC241, FC241E, FC241G, FC61, FC61E, FCV101, FCV101-CSA, FCV101DM, FCV101DM-CSA, FCV101DS, FCV101DS-CSA, FCV101E, FCV101EDM, FCV101EDM-CSA, FCV101EDS, FCV101EDS-CSA, FCV101E-UL, FCV141, FCV141-CSA, FCV141DM, FCV141DM-CSA, FCV141DS, FCV141DS-CSA, FCV141E, FCV141EDM, FCV141EDS, FCV241, FCV241DM, FCV241DS, FCV241E, FCV241EDM, FCV241EDM-CSA, FCV241EDS, FCV241EDS-CSA, FCV241E-UL, FCV241G, FCV241GDM, FCV241GDM-CSA, FCV241GDS, FCV241GDS-CSA, FCV401DM, FCV401DM-CSA, FCV401EDM, FCV401EDM-CSA, FCV61, FCV61-CSA, FCV61DM, FCV61DM-CSA...(Other models you can see in the webshop)		



<b>GEV No.</b>	691142	<b>Ref. No.</b>	36G6040 36G6041
<b>description</b>	pin for microswitch		
<b>For models:</b>	FC101, FC101E, FC241, FC241E, FC241G, FC61, FC61E, FCV101, FCV101-CSA, FCV101DM, FCV101DM-CSA, FCV101DS, FCV101DS-CSA, FCV101E, FCV101EDM, FCV101EDM-CSA, FCV101EDS, FCV101EDS-CSA, FCV101E-UL, FCV141, FCV141-CSA, FCV141DM, FCV141DM-CSA, FCV141DS, FCV141DS-CSA, FCV141E, FCV141EDM, FCV141EDS, FCV241, FCV241DM, FCV241DS, FCV241E, FCV241EDM, FCV241EDM-CSA, FCV241EDS, FCV241EDS-CSA, FCV241E-UL, FCV241G, FCV241G-CSA, FCV241GDM, FCV241GDM-CSA, FCV241GDS, FCV241GDS-CSA, FCV401DM, FCV401DM-CSA, FCV401EDM, FCV401EDM-CSA, FCV61, FCV61-CSA, FCV61DM...(Other models you can see in the webshop)		



Зип Общепит

vsezip.ru

812)987-0881

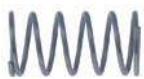
			
<b>GEV No.</b>	691141	<b>Ref. No.</b>	36G7140
<b>description</b>	spring for microswitch		
<b>For models:</b>	1A1BR1E, 1A1BR1G, 1A1BR1GA, 1A1BR2E, 1A1BR2EA, 1A1BR2G, 1A1BR2GA, 1D1BR1E, 1D1BR1G, 1D1BR1GA, 1D1BR2E, 1D1BR2EA, 1D1BR2G, 1D1BR2GA, 2A1BR1G, 2A1BR1GA, 2A1BR2G, 2A1BR2GA, 2D1BR1G, 2D1BR1GA, 2D1BR2G, 2D1BR2GA, FC101, FC101E, FC241, FC241E, FC241G, FC61, FC61E, FCV101, FCV101-CSA, FCV101DM, FCV101DM-CSA, FCV101DS, FCV101DS-CSA, FCV101E, FCV101EDM, FCV101EDM-UL, FCV101EDS, FCV101EDS-UL, FCV101E-UL, FCV141, FCV141-CSA, FCV141DM, FCV141DM-CSA, FCV141DS, FCV141DS-CSA, FCV141E, FCV141EDM, FCV141EDS...(Other models you can see in the webshop)		

			
<b>GEV No.</b>	346317	<b>Ref. No.</b>	32W1630
<b>description</b>	push button ø 23mm white		
<b>For models:</b>	LT25F		

## position switches

## PIZZATO

## FR series

			
<b>GEV No.</b>	345337	<b>Ref. No.</b>	32W3251
<b>description</b>	position switch plastic 1NO/1NC 400V 3A L 83mm W 31mm H 31mm protection IP67 actuating force: 900g screw connection PG11 mounting distance 20mm		
<b>For models:</b>	091FR1E, 091FR1EA, 091FR1ED, 091FR1EX, 0A1FR1E, 0A1FR1ED, 0D1FR1E, 0D1FR1ED, 191BR1GA, 191BR2EA, 191BR2GA, 191FR2E, 191FR2ED, 1A1BR1E, 1A1BR1G, 1A1BR1GA, 1A1BR2E, 1A1BR2EA, 1A1BR2G, 1A1BR2GA, 1A1FR2E, 1A1FR2ED, 1D1BR1E, 1D1BR1G, 1D1BR1GA, 1D1BR2E, 1D1BR2EA, 1D1BR2G, 1D1BR2GA, 1D1FR2ED, 1G1BR1E, 291BR1GA, 291BR2EA, 291BR2GA, 2A1BR1E, 2A1BR1G, 2A1BR1GA, 2A1BR2E, 2A1BR2EA, 2A1BR2G, 2A1BR2GA, 2D1BR1E, 2D1BR1G, 2D1BR1GA, 2D1BR2E, 2D1BR2EA, 2D1BR2G, 2D1BR2GA, 71ARE, 71RA...(Other models you can see in the webshop)		

			
<b>GEV No.</b>	346221	<b>Ref. No.</b>	32W4260
<b>description</b>	push button size 23x23mm green ON-OFF with lens		
<b>For models:</b>	KD100, KD100A, KD100PSD, KD130, KD130A, KD37, KD37PS, KD37-VERS.112009, KD40, KD40LUX, KD40PS, KD40-VERS.112009, KD60, KD60M, KD60MA, KD60MPS, KD60MPSA, KD60PS, KD60PSD, KD85, KD85A, KD85PS, KD85PSA, KN1100, KN1100SD, KN11PSDD, KN35, KN37, KN37PS, KN40, KN40PS, KN40PSD, KN50, KN50M, KN50MPS, KN50PS, KN50PSD, KN50PSDD, KN80, KN800, KN800PSD, KN80PS, N100D, N100S, N100VD, N100VS, N38D, N38S, N38VD, N38VS...(Other models you can see in the webshop)		

			
<b>GEV No.</b>	346222	<b>Ref. No.</b>	3063320
<b>description</b>	push button size 23x23mm green START		
<b>For models:</b>	KD37, KD37PS, KD37-VERS.112009, KD40, KD40LUX, KD40PS, KD40-VERS.112009, KD60, KD60M, KD60MA, KD60MPS, KD60MPSA, KD60PS, KD60PSD, KD85, KD85A, KN35, KN37, KN37PS, KN40, KN40PS, KN40PSD, KN50, KN50M, KN50MPS, KN50PS, KN50PSD, KN50PSDD, KN80, KN80PS		

## system switches (ROLD)

			
<b>GEV No.</b>	345130	<b>Ref. No.</b>	3040850
<b>description</b>	momentary switch unit 1NO 250V 16A connection male faston 6.3mm		

			
<b>GEV No.</b>	346251	<b>Ref. No.</b>	33Q6440
<b>description</b>	rotary disc orange/green disc ø 20.6mm		
<b>For models:</b>	KD100, KD100A, KD100PSD, KD130, KD130A, KD37, KD37PS, KD37-VERS.112009, KD40, KD40LUX, KD40PS, KD40-VERS.112009, KD60, KD60M, KD60MA, KD60MPS, KD60MPSA, KD60PS, KD60PSD, KD85, KD85A, KD85PS, KD85PSA, KN1100, KN1100SD, KN11PSDD, KN35, KN37, KN37PS, KN40, KN40PS, KN40PSD, KN50, KN50M, KN50MPS, KN50PS, KN50PSD, KN50PSDD, KN80, KN800, KN800PSD, KN80PS, N100D, N100S, N100VD, N100VS, N38D, N38S, N38VD, N38VS...(Other models you can see in the webshop)		

			
<b>GEV No.</b>	347193	<b>Ref. No.</b>	3040850
<b>description</b>	momentary switch unit 1NO 250V 16A connection male faston 6.3mm		





Зип Общепит  
vsezip.ru  
+7(812)987-08-81



1

<b>GEV No.</b>	345720	<b>Ref. No.</b>	32W4150
<b>description</b>	switch 2NO 250V 16A connection male faston 6.3mm		
<b>For models:</b>	KD100, KD100A, KD100PSD, KD130, KD130A, KD37, KD37PS, KD37-VERS.112009, KD40, KD40LUX, KD40PS, KD40-VERS.112009, KD60, KD60M, KD60MA, KD60MPS, KD60MP5A, KD60PS, KD60PSD, KD85, KD85A, KD85PS, KD85PSA, KN1100, KN1100SD, KN11PSDD, KN35, KN37, KN37PS, KN40, KN40PS, KN40PSD, KN50, KN50M, KN50MPS, KN50PS, KN50PSD, KN50PSDD, KN80, KN800, KN800PSD, KN80PS, N100D, N100S, N100VD, N100VS, N38D, N38S, N38VD, N38VS...(Other models you can see in the webshop)		



1

<b>GEV No.</b>	300088	<b>Ref. No.</b>	32W3830
<b>description</b>	cam switch 2 operating positions 4NO sequence 0-1 16A shaft ø 6x4.6mm shaft L 23mm connection male faston 6.3mm ceramic		
<b>For models:</b>	0M0BR1E, 0M0FR1E, 0M0FT1E, 0M0FT2E, 0M0FT4E, 0M0FT5E, 0M0GR1E, 0M0GR2E, 1M0FR2E, 1M0FT1E, 1M0FT2E, 1M0FT3E, 1M0FT4E, 1M0FT5E, 1M0FT6E, 2M0FT1E, 2M0FT2E, 2M0FT3E, 2M0FT4E, 2M0FT5E, 2M0FT6E		

float switches



1

<b>GEV No.</b>	403292	<b>Ref. No.</b>	6300787
<b>description</b>	float switch 1NO ø 12mm mounting ø 8mm 24V 0.2A plug cable length 880mm 1-pole		
<b>For models:</b>	FX101E3, FX101E3C, FX101E3C-VERS.022014, FX101E3R, FX101E3R-VERS.022014, FX101E3-VERS.022014, FX101G3, FX101G3C, FX101G3C-VERS.022014, FX101G3R, FX101G3R-VERS.022014, FX101G3-VERS.022014, FX10E3CR, FX10E3CR-VERS.022014, FX10G3CR, FX10G3CR-VERS.022014, FX122E3, FX122E3C, FX122E3T, FX122E3T-VERS.022014, FX122G3, FX122G3C, FX122G3T, FX122G3T-VERS.022014, FX12E3CT, FX12E3CT-VERS.022014, FX12G3CT, FX12G3CT-VERS.022014, FX201E3, FX201E3P, FX201E3P-VERS.022014, FX201E3-VERS.022014, FX201G3P, FX201G3-VERS.022014, FX202E3, FX202E3-230V-3-50Hz-60Hz, FX202E3-230V-3-50Hz-60Hz-VERS.022014, FX202E3-VERS.022014, FX202G3, FX202G3-VERS.022014, FX61E3, FX61E3C, FX61E3CR, FX61E3CR-VERS.022014, FX61E3C-VERS.022014, FX61E3R, FX61E3R-VERS.022014, FX61E3-VERS.022014, FX61G3, FX61G3C...(Other models you can see in the webshop)		



1

<b>GEV No.</b>	300020	<b>Ref. No.</b>	32W0490 32W3610
<b>description</b>	cam switch 4 operating positions 2NO sequence 0-1-0-1 16A shaft ø 6x4.6mm shaft L 23mm connection screw ceramic		
<b>For models:</b>	04WFR3ED, 06WFR3GD, 08WFR4ED, 091FR1ED, 091FR1GD, 091FR3ED, 091FR3GD, 0A1FR1ED, 0A1FR1GD, 0A1FR1GD-VERS.2004, 0B1FR1GD, 0D1FR1ED, 0D1FR1GD, 0D1FR1GD-VERS.2004, 0G0FR3ED, 0G1FR3GD, 10WFR4GD, 191FR2ED, 191FR2GD, 191FR4ED, 191FR4GD, 1A1FR2ED, 1A1FR2GD, 1A1FR2GD-VERS.2004, 1A1PI2G, 1A1PI2GA, 1D1FR2ED, 1D1FR2GD, 1D1FR2GD-VERS.2004, 1D1PI2G, 1D1PI2GA, 1G1FR4GD, 291PI3G, 2A1PI3G, 2D1PI3G, FC101, FC101E, FC241, FC241E, FC241G, FC61, FC61E, L100, L80		
<b>accessories for</b>	300020		
		<b>GEV No.</b>	110135 <b>Ref. No.</b> —
			rosette knob up to ø 52mm
		<b>GEV No.</b>	110231 <b>Ref. No.</b> —
			knob switch 0-1-0-1 t.max.°C ø 50mm shaft ø 6x4.6mm shaft flat upper black

cam switches

on/off



1

<b>GEV No.</b>	301115	<b>Ref. No.</b>	3168540
<b>description</b>	cam switch 2 operating positions 2NO sequence 0-1 16A shaft ø 6x4.6mm shaft L 23mm connection male faston 6.3mm		
<b>For models:</b>	091FR1I, 091FR1I-VERS.032012, 191FR2I, 191FR2I-VERS.032012, 6043840, 6043970		

5-position



1

<b>GEV No.</b>	300147	<b>Ref. No.</b>	32W0510
<b>description</b>	cam switch 5 operating positions 1NO/2CO sequence 0-1-2-3-4 16A shaft ø 6x4.6mm shaft L 23mm connection screw 5-position		

Зип Общепит

vsezip.ru

+7(812)987-08-81



1

<b>GEV No.</b>	300149	<b>Ref. No.</b>	32W1050
<b>description</b>	cam switch 5 operating positions 2NO/2CO sequence 0-1-2-3-4 32A shaft ø 6x4.6mm shaft L 23mm connection screw 5-position ceramic		
<b>For models:</b>	04WPE4V, 070E, 071E, 08WPE4V, 090E, 090PE4, 091E, 0A0PE4, 0D0PE4, 190PE4, 191PE4E, 1A0PE4, 1A1PE4E, 1A1PEFTE, 1D0PE4, 1D1PE4E, 30CPSE, 70CPE, 71E, 71PIE15, 71PIE15A, 90CPE, 91PIE15, 91PIE15A		

accessories for 300025			
<b>GEV No.</b>	112213	<b>Ref. No.</b>	—
<b>description</b>	knob dial plate silver switch 7-position t.max.°C ED ø 63mm ID ø 41.5mm		
<b>GEV No.</b>	112311	<b>Ref. No.</b>	—
<b>description</b>	knob adapter shaft ø 6.40mm L 0mm with spring		



1

<b>GEV No.</b>	300105	<b>Ref. No.</b>	32W3260
<b>description</b>	cam switch 5 operating positions 3NO/1CO sequence 0-1-2-3-4 32A shaft ø 6x4.6mm shaft L 23mm connection screw 5-position ceramic		
<b>For models:</b>	0A1CP1E, 0D1CP1E, 0G1CP1E, 0G1CP1E-VERS.2004, 191PI2E, 191PI2EA, 1A1PI2E, 1A1PI2EA, 1D1PI2E, 1D1PI2EA, 1G1PI1E, 31PIE6		



1

<b>GEV No.</b>	300106	<b>Ref. No.</b>	32W2920
<b>description</b>	cam switch 7 operating positions 1NO/2CO sequence 0-1-2-3-4-5-6 32A shaft ø 6x4.6mm shaft L 23mm connection screw 7-position shaft flat upper		
<b>For models:</b>	60SME		

3 operating positions



1

<b>GEV No.</b>	345171	<b>Ref. No.</b>	3041660
<b>description</b>	cam switch 3 operating positions 3NO sequence 0-1-2 16A shaft ø 6x4.6mm shaft L 26mm connection male faston 6.3mm ceramic		
<b>For models:</b>	FC1011E, FC1011G, FC1221E, FC1221G, FC611E, FC611G		
<b>accessories for</b>	345171		



<b>GEV No.</b>	112340	<b>Ref. No.</b>	—
<b>description</b>	knob switch zero mark t.max.°C temperature range°C ø 40mm shaft ø 6x4.6mm shaft flat left black		



1

<b>GEV No.</b>	300133	<b>Ref. No.</b>	32w0520
<b>description</b>	cam switch 5-position sequence 0-1-2-3-4 shaft ø 6x4.6mm connection screw clamp 3-pole		

7-position



1

<b>GEV No.</b>	300025	<b>Ref. No.</b>	32W0760 32W1840
<b>description</b>	cam switch 7 operating positions 1NO/2CO sequence 0-1-2-3-4-5-6 16A shaft ø 6x4.6mm shaft L 23mm connection screw 7-position ceramic		
<b>For models:</b>	030E, 031E, 0G0PE1, 0G0PE2, 0G1PE2, 1G0PE1, 1G0PE2, 1G1PE1E, 1G1PE1EV, 1G1PE2, 1G1PE2E, 1G1PE2EV, 2G0PE1, 2G0PE2, 2G1PE1E, 2G1PE1EV, 2G1PE2E, 2G1PE2EV, 31TCE, 32TCE		
<b>accessories for</b>	300025		
	<b>GEV No.</b>	112172	<b>Ref. No.</b> —
knob universal ø 70mm black without adaptor/dial plate			

4 operating positions



1

<b>GEV No.</b>	345996	<b>Ref. No.</b>	32W1440
<b>description</b>	cam switch		
<b>For models:</b>	191FAAE, 191FAE, 191PE4E, 1A1PE4E, 1A1PEFTE, 1A1FBE, 1D1PE4E, 1D1FBE, 71E, 71GE, 71GEGG, FS30E		



Зип Общепит

vsezip.ru

+7(812)987-08-81



1

<b>GEV No.</b>	300010	<b>Ref. No.</b>	32Z0540
<b>description</b>	cam switch 4 operating positions 2NO/2CO sequence 0-1-2-3 16A shaft ø 6x4.6mm shaft L 23mm connection male faston 6.3mm ceramic		



1

<b>GEV No.</b>	300122	<b>Ref. No.</b>	32W0980
<b>description</b>	operation switch sequence 0-1-2-3 shaft ø 6x4.6mm connection male faston 2-pole		
<b>For models:</b>	F60P, F60PR, F60T, F80P, F80PR, L100, L40, L40S, L45, L60, L80		



1

<b>GEV No.</b>	301144	<b>Ref. No.</b>	3162280
<b>description</b>	cam switch 4 operating positions 6NO sequence 0-1-2-3 16A shaft ø 6x4.6mm shaft L 23mm connection male faston 6.3mm plastic		
<b>For models:</b>	04WCP1EM, 06WCP1GM, 091CP1E, 091CP1G, 0G1CP1EC, 0G1CP1E-VERS.2004, 0G1CP1G-VERS.2004, 191CP1G, 191CP2G, 1G1CP1G-VERS.2004, 1G1CP2G-VERS.2004, 6040090, 6040310, 6043850, 6043980		

rotary switches

BRETER

rotary switches



1

<b>GEV No.</b>	346917	<b>Ref. No.</b>	32W2420
<b>description</b>	rotary switch 2 0-1 sets of contacts 4 400V 20A shaft ø 5x5mm shaft square with knob connection screw		

operation switches



1

<b>GEV No.</b>	301153	<b>Ref. No.</b>	32W2550
<b>description</b>	cam switch 2 operating positions 2NO 16A sequence 0-1 shaft ø 6x4.6mm shaft L 23mm connection male faston 6.3mm ceramic		
<b>For models:</b>	030FE1, 091FE28, 30F1, 30FES2, 30FS2, 70F1, 70FE, 70FE1, 70FES2, 71F2, 71FE2, 91F210		

LOVATO



1

<b>GEV No.</b>	346178	<b>Ref. No.</b>	32W1200
<b>description</b>	rotary switch 2 0-1 sets of contacts 2 type GN209479U 690V 20A shaft ø 6x6mm shaft L 23.5mm shaft square connection screw		



1

<b>GEV No.</b>	300215	<b>Ref. No.</b>	32W0080
<b>description</b>	cam switch 2 operating positions sequence 0-1 3-pole ambient temperature max. 318°C		



Зип-Общепит

65x20mm

vsezip.ru

+7(812)987-08-81

## magnetic switches

37x16mm

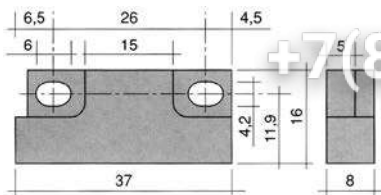

1

<b>GEV No.</b>	345600	<b>Ref. No.</b>	32V5740 32W2160
<b>description</b>	magnetic switch L 37mm W 16mm 1NO 250V 0.2A P max. 50W connection cable cable length 960mm		
<b>For models:</b>	BX101E, BX101E-VERS.122013, BX101G, BX101G-VERS.122013, BX122E, BX122E-VERS.122013, BX122G, BX122G-VERS.122013, BX61E, BX61E-VERS.122013, BX61G, BX61G-VERS.122013, BX82E, BX82E-VERS.122013, BX82G, BX82G-VERS.122013, FM1011E1, FM1011E1-VERS.2006, FM1011E2, FM1011E2-VERS.2006, FM1011E3, FM1011E3-VERS.2006, FM1011G1, FM1011G1-VERS.2006, FM1011G2, FM1011G2-VERS.2006, FM1011G3, FM1011G3-VERS.2006, FM1221E1, FM1221E1-VERS.2006, FM1221E2, FM1221E2-VERS.2006, FM1221E3, FM1221E3-VERS.2006, FM1221G1, FM1221G1-VERS.2006, FM1221G2, FM1221G2-VERS.2006, FM1221G3, FM1221G3-VERS.2006, FM2011E2-VERS.2006, FM2011E3-VERS.2006, FM2011G2-VERS.2006, FM2011G3-VERS.2006, FM2021E1, FM2021E2, FM2021E2-VERS.2006, FM2021E3, FM2021E3-VERS.2006, FM2021G1...(Other models you can see in the webshop)		
<b>accessories for</b>	345600		
	<b>GEV No.</b>	519049	<b>Ref. No.</b> 3023650 32W0870 32W1680
	magnet ømm L 63mm H 10.7mm W 18.8mm hole distance 52mm M2 hole ø 2mm		

51x16mm



1

<b>GEV No.</b>	348168	<b>Ref. No.</b>	3022950
<b>description</b>	magnetic switch L 51mm W 16mm 1NO 240V 2A P max. 12W cable length 350mm		
<b>For models:</b>	DK112, DK351M, DK352, DK552, DP10, DP25		

1

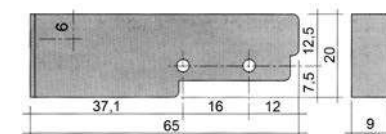

<b>GEV No.</b>	345116	<b>Ref. No.</b>	32W1210
<b>description</b>	magnetic switch L 65mm W 20mm 1NO 250V 0.4A P max. 100W connection cable cable length 3000mm		
<b>accessories for</b>	345116		
	<b>GEV No.</b>	345399	<b>Ref. No.</b> —
	magnet ø 3.3mm L 40mm H 8mm W 13mm hole distance 30mm M3		

M10x0.75



1

<b>GEV No.</b>	348024	<b>Ref. No.</b>	32W1890 32W3460
<b>description</b>	magnetic switch 1NO 250V 1A P max. 10W connection Faston 6.3mm cable length 2000mm		



1

<b>GEV No.</b>	345632	<b>Ref. No.</b>	32W3200 32W3240 32Z8650
<b>description</b>	magnetic switch thread M10x0.75 1NO 250V 0.5A P max. 50W connection cable cable length 2000mm type 102		
<b>For models:</b>	C165D, C165S, C165VD, C165VS, C207D, C207D-VERS.2006, C207S, C207S-VERS.2006, C207VD, C207VD-VERS.2006, C207VS, C207VS-VERS.2006, C304AD, C304AD-VERS.2006, C304AS, C304AS-VERS.2006, C304AVD, C304AVD-VERS.2006, C304AVS, C304AVS-VERS.2006, C304D, C304D-VERS.2006, C304S, C304S-VERS.2006, C304VD, C304VD-VERS.2006, C304VS, C304VS-VERS.2006, C92D-VERS.2006, C92S-VERS.2006, C92VD-VERS.2006, C92VS-VERS.2006, CS243D, CS243D-VERS.2006, CS243S, CS243S-VERS.2006, CS243VD, CS243VD-VERS.2006, CS243VS, CS243VS-VERS.2006, CS370AD, CS370AD-VERS.2006, CS370AS, CS370AS-VERS.2006, CS370AVD, CS370AVD-VERS.2006, CS370AVS, CS370AVS-VERS.2006, CS370D, CS370D-VERS.2006...(Other models you can see in the webshop)		
<b>accessories for</b>	345632		
	<b>GEV No.</b>	100779	<b>Ref. No.</b> —
	nut thread M10x0.75 H 3mm WS 14 SS Qty 2 pcs		



Зип Общепит

vsezip.ru

+7(812)987-08-81

accessories

magnets



1			
<b>GEV No.</b>	691178	<b>Ref. No.</b>	3008810 3112370
<b>description</b>	magnet $\varnothing$ 22mm Lmm H 7mm Wmm ED $\varnothing$ 22mm M5		
<b>For models:</b>	FC1011E, FC1011G, FC1221E, FC1221G, FC611E, FC611G, FM1011E1, FM1011E1-VERS.2006, FM1011E2, FM1011E2-VERS.2006, FM1011E3, FM1011E3-VERS.2006, FM1011G1, FM1011G1-VERS.2006, FM1011G2, FM1011G2-VERS.2006, FM1011G3, FM1011G3-VERS.2006, FM1221E1, FM1221E1-VERS.2006, FM1221E2, FM1221E2-VERS.2006, FM1221E3, FM1221E3-VERS.2006, FM1221G1, FM1221G1-VERS.2006, FM1221G2, FM1221G2-VERS.2006, FM1221G3, FM1221G3-VERS.2006, FM2011E2-VERS.2006, FM2011E3-VERS.2006, FM2011G2-VERS.2006, FM2011G3-VERS.2006, FM2021E1, FM2021E2, FM2021E2-VERS.2006, FM2021E3, FM2021E3-VERS.2006, FM2021G1, FM2021G2, FM2021G2-VERS.2006, FM2021G3, FM2021G3-VERS.2006, FM611E1, FM611E1-VERS.2006, FM611E2, FM611E2-VERS.2006, FM611E3, FM611E3-VERS.2006... (Other models you can see in the webshop)		

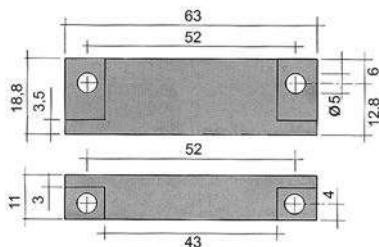

1			
<b>GEV No.</b>	345336	<b>Ref. No.</b>	3210010
<b>description</b>	magnet $\varnothing$ 4.8mm L 63mm H 11mm W 18.8mm hole distance 51mm M4		
<b>For models:</b>	LP151, LP202, LP202HC, LP302, LP302HC, LP402, LP402HC, LP402V, LPG300		

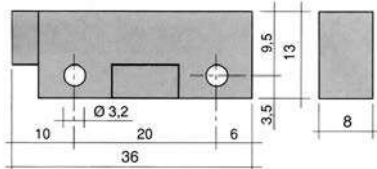

1			
<b>GEV No.</b>	345398	<b>Ref. No.</b>	32V0080
<b>description</b>	magnet $\varnothing$ mm L 36mm H 8mm W 13mm hole distance 20mm M3 hole $\varnothing$ 3mm		

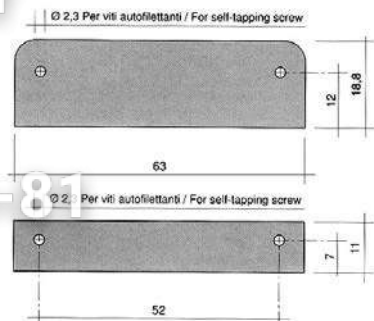

1			
<b>GEV No.</b>	519049	<b>Ref. No.</b>	3023650 32W0870 32W1680
<b>description</b>	magnet $\varnothing$ mm L 63mm H 10.7mm W 18.8mm hole distance 52mm M2 hole $\varnothing$ 2mm		
<b>For models:</b>	C165D, C165S, C165VD, C165VS, C207D, C207D-VERS.2006, C207S, C207S-VERS.2006, C207VD, C207VD-VERS.2006, C207VS, C207VS-VERS.2006, C304AD, C304AD-VERS.2006, C304AS, C304AS-VERS.2006, C304AVD, C304AVD-VERS.2006, C304AVS, C304AVS-VERS.2006, C304D, C304D-VERS.2006, C304S, C304S-VERS.2006, C304VD, C304VD-VERS.2006, C304VS, C304VS-VERS.2006, C92D-VERS.2006, C92S-VERS.2006, C92VD-VERS.2006, C92VS-VERS.2006, CS243D, CS243D-VERS.2006, CS243S, CS243S-VERS.2006, CS243VD, CS243VD-VERS.2006, CS243VS, CS243VS-VERS.2006, CS370AD, CS370AD-VERS.2006, CS370AS, CS370AS-VERS.2006, CS370AVD, CS370AVD-VERS.2006, CS370AVS, CS370AVS-VERS.2006, CS370D, CS370D-VERS.2006... (Other models you can see in the webshop)		
<b>accessories for</b>	519049		
	<b>GEV No.</b>	560095	<b>Ref. No.</b> —
	sheet metal screws $\varnothing$ 2.9mm L 9.5mm SS Qty 20 pcs DIN 7981/ISO 7049 head $\varnothing$ 5.6mm oval head		

control equipment

BRETER

switches (complete)



1			
<b>GEV No.</b>	345718	<b>Ref. No.</b>	32W1640
<b>description</b>	momentary push switch black 1NC/1NO		
<b>For models:</b>	71AR, 71ARE, 71RA, 91AR, 91ARE, 91RA		



1			
<b>GEV No.</b>	345717	<b>Ref. No.</b>	32W1650
<b>description</b>	momentary push switch green 1NC/1NO		
<b>For models:</b>	71AR, 71ARE, 71RA, 91AR, 91ARE, 91RA		



## ELFIN

## switches (complete)



1

<b>GEV No.</b>	347947	<b>Ref. No.</b>	32Z8470
<b>description</b>	rotary selector mounting measurements ø22mm 2NO/2NC sequence 0-1-2 black		
<b>For models:</b>	C207D, C207S, C207VD, C207VS, C304AD, C304AS, C304AVD, C304AVS, C304D, C304S, C304VD, C304VS, CS243D, CS243S, CS243VD, CS243VS, CS370AD, CS370AS, CS370AVD, CS370AVS, CS370D, CS370S, CS370VD, CS370VS, CS466AD, CS466AS, CS466AVD, CS466AVS, CS466D, CS466S, CS466VD, CS466VS, N303D, N303S, N303VD, N303VS, N354D, N354S, N354VD, N354VS, N506D, N506S, N506VD, N506VS, N607D, N607S, N607VD, N607VS, N760D, N760S...(Other models you can see in the webshop)		

## LOVATO



1

<b>GEV No.</b>	301171	<b>Ref. No.</b>	32W3330
<b>description</b>	contact block LAVATO 8 LM2T-C10 1NC max 690V 10A		
<b>For models:</b>	10CP1EA, 10CP1GA, 10CP1IA, 12CP1EA, 12CP1GA, 12CP1IA, 18CP2EA, 18CP2GA, 18CP2IA, 191BR1GA, 191BR2EA, 191BR2GA, 1A1BR1GA, 1A1BR2EA, 1A1BR2GA, 1D1BR1GA, 1D1BR2EA, 1D1BR2GA, 2091SCP, 291BR1GA, 291BR2EA, 291BR2GA, 2A1BR1GA, 2A1BR2EA, 2A1BR2GA, 2D1BR1GA, 2D1BR2EA, 2D1BR2GA, BRE21HD, BRE31HD, PIER06HD, PIER10HD, PIER15HD		



1

<b>GEV No.</b>	301170	<b>Ref. No.</b>	32W3320
<b>description</b>	contact block LAVATO 8 LM2T-C10 1NO max 690V 10A		
<b>For models:</b>	10CP1EA, 10CP1GA, 10CP1IA, 12CP1EA, 12CP1GA, 12CP1IA, 18CP2EA, 18CP2GA, 18CP2IA, 191BR1GA, 191BR2EA, 191BR2GA, 1A1BR1GA, 1A1BR2EA, 1A1BR2GA, 1D1BR1GA, 1D1BR2EA, 1D1BR2GA, 291BR1GA, 291BR2EA, 291BR2GA, 2A1BR1GA, 2A1BR2EA, 2A1BR2GA, 2D1BR1GA, 2D1BR2EA, 2D1BR2GA, BRE21HD, BRE31HD, PIER06HD, PIER10HD, PIER15HD		

## Зип, Общепит

plastic series

## switch block brackets



1

<b>GEV No.</b>	301169	<b>Ref. No.</b>	32W3310
<b>description</b>	contact block holder		
<b>For models:</b>	10CP1EA, 10CP1GA, 10CP1IA, 12CP1EA, 12CP1GA, 12CP1IA, 18CP2EA, 18CP2GA, 18CP2IA, 191BR1GA, 191BR2EA, 191BR2GA, 1A1BR1GA, 1A1BR2EA, 1A1BR2GA, 1D1BR1GA, 1D1BR2EA, 1D1BR2GA, 291BR1GA, 291BR2EA, 291BR2GA, 2A1BR1GA, 2A1BR2EA, 2A1BR2GA, 2D1BR1GA, 2D1BR2EA, 2D1BR2GA, BRE21HD, BRE31HD, PIER06HD, PIER10HD, PIER15HD		

## metal series

## push buttons



1

<b>GEV No.</b>	301197	<b>Ref. No.</b>	37Q4030 37Q7600
<b>description</b>	protective cover transparent ED ø 34mm H 16mm for push-button		
<b>For models:</b>	10CP1EA, 10CP1GA, 10CP1IA, 12CP1EA, 12CP1GA, 12CP1IA, 18CP2EA, 18CP2GA, 18CP2IA, 191BR1GA, 191BR2EA, 191BR2GA, 1A1BR1GA, 1A1BR2EA, 1A1BR2GA, 1D1BR1GA, 1D1BR2EA, 1D1BR2GA, 291BR1GA, 291BR2EA, 291BR2GA, 2A1BR1GA, 2A1BR2EA, 2A1BR2GA, 2D1BR1GA, 2D1BR2EA, 2D1BR2GA, 71AR, 71ARE, 71RA, 91AR, 91ARE, 91RA, BRE21HD, BRE31HD, PIER06HD, PIER10HD, PIER15HD		



1

<b>GEV No.</b>	301196	<b>Ref. No.</b>	32W3300
<b>description</b>	push button mounting measurements ø22mm black arrow		
<b>For models:</b>	10CP1EA, 10CP1GA, 10CP1IA, 12CP1EA, 12CP1GA, 12CP1IA, 18CP2EA, 18CP2GA, 18CP2IA, 191BR1GA, 191BR2EA, 191BR2GA, 1A1BR1GA, 1A1BR2EA, 1A1BR2GA, 1D1BR1GA, 1D1BR2EA, 1D1BR2GA, 291BR1GA, 291BR2EA, 291BR2GA, 2A1BR1GA, 2A1BR2EA, 2A1BR2GA, 2D1BR1GA, 2D1BR2EA, 2D1BR2GA, BRE21HD, BRE31HD, PIER06HD, PIER10HD, PIER15HD		



TELEMECANIQUE (EFA)

3ип Общежит encoders and potentiometers

vsezip.ru

+7(812)987-08-81

XA2 series

switches (complete)



1

<b>GEV No.</b>	345592	<b>Ref. No.</b>	32W2150
<b>description</b>	rotary selector mounting measurements ø22mm 1NC/1NO complete sequence 0-1-2		
<b>For models:</b>	LC100, LC100-VERS.2001, LC130, LC130-VERS.2001, LC80		



1

<b>GEV No.</b>	345591	<b>Ref. No.</b>	32Z8670
<b>description</b>	rotary selector mounting measurements ø22mm complete		
<b>For models:</b>	C165D, C165S, C165VD, C165VS, C207D, C207S, C207VD, C207VS, C304AD, C304AS, C304AVD, C304AVS, C304D, C304S, C304VD, C304VS, CS243D, CS243S, CS243VD, CS243VS, CS370AD, CS370AS, CS370AVD, CS370AVS, CS370D, CS370S, CS370VD, CS370VS, CS466AD, CS466AS, CS466AVD, CS466AVS, CS466D, CS466S, CS466VD, CS466VS, LC100, LC100-VERS.2001, LC130, LC130-VERS.2001, LC80, LP124, LP124S-VERS.052006, LP124V, LP124V-VERS.052006, LP124VS-VERS.052006, LP124V-VERS.052006, LP84, LP84S-VERS.052006, LP84V...(Other models you can see in the webshop)		

miscellaneous



1

<b>GEV No.</b>	349001	<b>Ref. No.</b>	32W1700
<b>description</b>	indicator lamp mounting measurements ø22mm yellow		
<b>For models:</b>	C165D, C165S, C165VD, C165VS, C207D, C207S, C207VD, C207VS, C304AD, C304AS, C304AVD, C304AVS, C304D, C304S, C304VD, C304VS, CS243D, CS243S, CS243VD, CS243VS, CS370AD, CS370AS, CS370AVD, CS370AVS, CS370D, CS370S, CS370VD, CS370VS, CS466AD, CS466AS, CS466AVD, CS466AVS, CS466D, CS466S, CS466VD, CS466VS, LP124, LP124V, LP84, LP84V		



1

<b>GEV No.</b>	402322	<b>Ref. No.</b>	3051070
<b>description</b>	encoder		
<b>For models:</b>	BX101E, BX101G, BX122E, BX122G, BX61E, BX61G, BX82E, BX82G, FM1011E1-VERS.2006, FM1011E2-VERS.2006, FM1011E3-VERS.2006, FM1011G1-VERS.2006, FM1011G2-VERS.2006, FM1011G3-VERS.2006, FM1221E1-VERS.2006, FM1221E2-VERS.2006, FM1221E3-VERS.2006, FM1221G1-VERS.2006, FM1221G2-VERS.2006, FM1221G3-VERS.2006, FM2011E2-VERS.2006, FM2011E3-VERS.2006, FM2011G2-VERS.2006, FM2011G3-VERS.2006, FM2021E2-VERS.2006, FM2021E3-VERS.2006, FM2021G2-VERS.2006, FM2021G3-VERS.2006, FM423E1, FM423E2, FM611E1-VERS.2006, FM611E2-VERS.2006, FM611E3-VERS.2006, FM611G1-VERS.2006, FM611G2-VERS.2006, FM611G3-VERS.2006, FM721E1-VERS.2006, FM721E2-VERS.2006, FM721E3-VERS.2006, FM721G1-VERS.2006, FM721G2-VERS.2006, FM721G3-VERS.2006		



1

<b>GEV No.</b>	300272	<b>Ref. No.</b>	3104220 6300966
<b>description</b>	encoder shaft ø 6x4.6mm for combi-steamer		
<b>For models:</b>	BX101E-VERS.122013, BX101G-VERS.122013, BX122E-VERS.122013, BX122G-VERS.122013, BX61E-VERS.122013, BX61G-VERS.122013, BX82E-VERS.122013, BX82G-VERS.122013, FX101E1, FX101E1R, FX101E2, FX101E2C, FX101E2C-VERS.032014, FX101E2R, FX101E2R-VERS.032014, FX101E2-VERS.032014, FX101E3, FX101E3C, FX101E3C-VERS.022014, FX101E3R, FX101E3R-VERS.022014, FX101E3-VERS.022014, FX101G1, FX101G1R, FX101G2, FX101G2C, FX101G2C-VERS.032014, FX101G2R, FX101G2R-VERS.032014, FX101G2-VERS.032014, FX101G3, FX101G3C, FX101G3C-VERS.022014, FX101G3R, FX101G3R-VERS.022014, FX101G3-VERS.022014, FX10E2CR, FX10E2CR-VERS.032014, FX10E3CR, FX10E3CR-VERS.022014, FX10G2CR, FX10G2CR-VERS.032014, FX10G3CR, FX10G3CR-VERS.022014, FX122E1, FX122E2, FX122E2C, FX122E2T, FX122E2T-VERS.032014, FX122E3...(Other models you can see in the webshop)		



1

<b>GEV No.</b>	300230	<b>Ref. No.</b>	32V5580
<b>description</b>	potentiometer		
<b>For models:</b>	FM1011E1, FM1011E2, FM1011E3, FM1011G1, FM1011G2, FM1011G3, FM1221E1, FM1221E2, FM1221E3, FM1221G1, FM1221G2, FM1221G3, FM2021E1, FM2021E2, FM2021E3, FM2021G1, FM2021G2, FM2021G3, FM611E1, FM611E2, FM611E3, FM611G1, FM611G2, FM611G3, FM721E1, FM721E2, FM721E3, FM721G1, FM721G2, FM721G3, FS611		

electric components



## lamps

## indicator lights

## indicator lights 2-piece (lens and indicator lamp)

indicator lamps for socket type SRZ / SDK / SDY / SEK



<b>GEV No.</b>	359130	<b>Ref. No.</b>	32W4220
<b>description</b>	indicator lamp 230V clear connection male faston 6.3mm ø 8mm		
<b>For models:</b>	KD100, KD100A, KD100PSD, KD37, KD37PS, KD37-VERS.112009, KD40, KD40LUX, KD40PS, KD40-VERS.112009, KD60, KD60M, KD60MA, KD60MPS, KD60MPSA, KD60PS, KD60PSD, KD85, KD85A, KD85PS, KD85PSA, KN1100, KN1100SD, KN1100SDD, KN35, KN37, KN37PS, KN40, KN40PS, KN40PSD, KN50, KN50M, KN50MPS, KN50PS, KN50PSD, KN50PSDD, KN80, KN800, KN800PSD, KN80PS		

## indicator lights (complete)

ø 6mm



<b>GEV No.</b>	359004	<b>Ref. No.</b>	32W0101
<b>description</b>	indicator light ø 6mm 230V green cable length 400mm temp.-resist. 106°C		
<b>For models:</b>	FC101, FC1011E, FC1011G, FC101E, FC1221E, FC1221G, FC241, FC241E, FC241G, FC61, FC611E, FC611G, FC61E, FMS, FMSX		



<b>GEV No.</b>	359009	<b>Ref. No.</b>	32W0450
<b>description</b>	indicator light ø 6mm 230V red cable length 400mm with series resistor		
<b>For models:</b>	FC101, FC1011E, FC1011G, FC101E, FC1221E, FC1221G, FC241, FC241E, FC241G, FC61, FC611E, FC611G, FC61E		



<b>GEV No.</b>	359005	<b>Ref. No.</b>	32W2250
<b>description</b>	indicator light ø 6mm 230V yellow cable length 400mm		
<b>For models:</b>	FC101, FC1011E, FC1011G, FC101E, FC1221E, FC1221G, FC241, FC241E, FC241G, FC61, FC611E, FC611G, FC61E, FMS, FMSX		

ø 9mm



<b>GEV No.</b>	345597	<b>Ref. No.</b>	32W2140
<b>description</b>	indicator light ø 9mm 400V green connection male faston 6.3mm temp.-resist. 85°C		
<b>For models:</b>	LC100, LC100-VERS.2001, LC130, LC130-VERS.2001, LC80, LF50, LF50E, LF50EM, LF50EMPS, LF50E-VERS.2007		

Зип-Общепит

<b>GEV No.</b>	345598	<b>Ref. No.</b>	32W2130
<b>description</b>	indicator light ø 9mm 400V yellow connection male faston 6.3mm temp.-resist. 85°C		
<b>For models:</b>	LC100, LC100-VERS.2001, LC130, LC130-VERS.2001, LC80, LF50, LF50E, LF50EM, LF50EMPS, LF50E-VERS.2007		

ø10mm

with screw socket



<b>GEV No.</b>	359995	<b>Ref. No.</b>	32W3280
<b>description</b>	indicator light ø 10mm 230V clear connection male faston 6.3mm		
<b>For models:</b>	P5		



<b>GEV No.</b>	359378	<b>Ref. No.</b>	3106710 32W1330 32W1331
<b>description</b>	indicator light ø 10mm 230V green connection male faston 6.3mm socket screw base		
<b>For models:</b>	030BME, 030E, 030EBM, 030FE, 030FE1, 030FE1B, 030FTE, 030FTER, 031BME, 031E, 031EBM, 031FTE, 031FTER, 031FTERL, 04WB-MEV, 04WCP1EM, 04WFR3ED, 04WPE4V, 04WVT3RV, 06WBR3E, 06WCP1GM, 06WFR3GD, 06WFT1EV, 06WFT2EV, 06WFT3EV, 06WFT4EV, 06WFT6EV, 06WFT7EV, 070BME, 070E, 070FTE, 070FTER, 071BME, 071E, 071FTE, 071FTER, 071FTERL, 08WCP1GM, 08WFA4E, 08WFAAE, 08WFR4ED, 08WFT1EV, 08WFT2EV, 08WFT3EV, 08WFT4EV, 08WFT6EV, 08WFT7EV, 08WGREV, 08WPE4V, 090BM1E...(Other models you can see in the webshop)		



<b>GEV No.</b>	359380	<b>Ref. No.</b>	32W1340
<b>description</b>	indicator light ø 10mm 230V red connection male faston 6.3mm socket screw base		



<b>GEV No.</b>	359379	<b>Ref. No.</b>	3106730 32W0790 32W0791
<b>description</b>	indicator light ø 10mm 230V yellow connection male faston 6.3mm socket screw base		
<b>For models:</b>	030BME, 030EBM, 030FE, 030FE1, 030FE1B, 030FTE, 030FTER, 031BME, 031EBM, 031FTE, 031FTER, 031FTERL, 04WBMEV, 04WCP1EM, 04WFR3ED, 06WBR3E, 06WFR3GD, 06WFT1EV, 06WFT2EV, 06WFT3EV, 06WFT4EV, 06WFT6EV, 06WFT7EV, 070BME, 070FTE, 070FTER, 071BME, 071FTE, 071FTER, 071FTERL, 08WFA4E, 08WFAAE, 08WFR4ED, 08WFT1EV, 08WFT2EV, 08WFT3EV, 08WFT4EV, 08WFT6EV, 08WFT7EV, 090BM1E, 090BME, 090FT1E, 090FT2E, 090FT4E, 090FT5E, 090FT7E, 090FTE, 090FTER, 091BME, 091CP1E...(Other models you can see in the webshop)		





Зип Общепит

vsezip.ru

+7(812)987-08-81

			
1			
<b>GEV No.</b>	359527	<b>Ref. No.</b>	32W1562
<b>description</b>	indicator light ø 10mm 400V green connection male faston 6.3mm socket screw base		
<b>For models:</b>	031FTE04, 031FTE06, 070E, 070FTE04, 070FTE05, 071E, 071FTE04, 071FTE06, 08WFAAE, 090E, 090FTE04, 090FTE05, 091E, 091FTE04, 091FTE06, 0A0FT1E, 0A0FT2E, 0A0FT4E, 0A0FT5E, 0A0PE4, 0A1CP1E, 0D0FT1E, 0D0FT2E, 0D0FT4E, 0D0FT5E, 0D0PE4, 0D1CP1E, 0G0FT1E, 0G0FT2E, 0G0FT4E, 0G0FT5E, 0G0PE1, 0G0PE2, 0G1CP1E, 10WTPGE, 12WFAAA, 12WFAAE, 190BM2E, 191PI2E, 191PI2EA, 1A0BME, 1A0FT1E, 1A0FT2E, 1A0FT3E, 1A0FT4E, 1A0FT6E, 1A0PE4, 1A1PE4E, 1A1PEFTE, 1A1PI2E...(Other models you can see in the webshop)		

			
1			
<b>GEV No.</b>	360483	<b>Ref. No.</b>	6300652
<b>description</b>	indicator light ø 10mm 230V green connection male faston 6.3mm cable length 90mm with series resistor for 230V ordinary operation socket screw base		
<b>For models:</b>	031FTE04, 031FTE06, 070E, 070FTE04, 070FTE05, 071E, 071FTE04, 071FTE06, 090E, 090FTE04, 090FTE05, 091E, 091FTE04, 091FTE06, 0A0FT1E, 0A0FT2E, 0A0FT4E, 0A0FT5E, 0A0PE4, 0A1CP1E, 0D0FT1E, 0D0FT2E, 0D0FT4E, 0D0FT5E, 0D0PE4, 0D1CP1E, 0G0FT1E, 0G0FT2E, 0G0FT4E, 0G0FT5E, 0G0FT7E, 0G0PE1, 0G0PE2, 0G1CP1E, 0G1PE2, 10WTPGE, 12WFAAA, 190BM2E, 191PI2E, 191PI2EA, 1A0BME, 1A0FT1E, 1A0FT2E, 1A0FT3E, 1A0FT4E, 1A0FT6E, 1A0PE4, 1A1PE4E, 1A1PEFTE, 1A1PI2E...(Other models you can see in the webshop)		

			
1			
<b>GEV No.</b>	346881	<b>Ref. No.</b>	3106720 32W1341 6300653
<b>description</b>	indicator light ø 10mm 230V red connection male faston 6.3mm		

			
1			
<b>GEV No.</b>	346883	<b>Ref. No.</b>	3106730 32W1551 6300651
<b>description</b>	indicator light ø 10mm 230V yellow connection male faston 6.3mm		
<b>For models:</b>	031FTE04, 031FTE06, 070FTE04, 070FTE05, 071FTE04, 071FTE06, 090FTE04, 090FTE05, 091FTE04, 091FTE06, 0A0FT1E, 0A0FT2E, 0A0FT4E, 0A0FT5E, 0D0FT1E, 0D0FT2E, 0D0FT4E, 0D0FT5E, 0G0FT1E, 0G0FT2E, 0G0FT4E, 0G0FT5E, 0G0FT7E, 10WTPGE, 12WFAAA, 190BM2E, 1A0BME, 1A0FT1E, 1A0FT2E, 1A0FT3E, 1A0FT4E, 1A0FT6E, 1A1PE4E, 1A1PEFTE, 1A1FBE, 1D0BME, 1D0FT1E, 1D0FT2E, 1D0FT3E, 1D0FT4E, 1D0FT6E, 1D1PE4E, 1D1FBE, 1G0FT1E, 1G0FT2E, 1G0FT3E, 1G0FT4E, 1G0FT7E, 1G1FA0E, 1G1FA0EV...(Other models you can see in the webshop)		

			
1			
<b>GEV No.</b>	359889	<b>Ref. No.</b>	32W2080
<b>description</b>	indicator light ø 10mm 230V red connection cable		
<b>For models:</b>	AFC30MS, AFC30S, AFC35, AFT30MS, AFT30S, AFT30VMS, AFT30VS, AFT33MS, AFT33S, AFT35, AFT35VS		

			
1			
<b>GEV No.</b>	359019	<b>Ref. No.</b>	32W1560 32W1561
<b>description</b>	indicator light ø 10mm green 400V connection male faston 6.3mm Qty 1 pcs		
<b>For models:</b>	031FTE04, 031FTE06, 070E, 070FTE04, 070FTE05, 071E, 071FTE04, 071FTE06, 08WFAAE, 090E, 090FTE04, 090FTE05, 091E, 091FTE04, 091FTE06, 0A0FT1E, 0A0FT2E, 0A0FT4E, 0A0FT5E, 0A0PE4, 0A1CP1E, 0D0FT1E, 0D0FT2E, 0D0FT4E, 0D0FT5E, 0D0PE4, 0D1CP1E, 0G0FT1E, 0G0FT2E, 0G0FT4E, 0G0FT5E, 0G0PE1, 0G0PE2, 0G1CP1E, 10WTPGE, 12WFAAA, 12WFAAE, 1A0BME, 1A0FT1E, 1A0FT2E, 1A0FT3E, 1A0FT4E, 1A0FT6E, 1A0PE4, 1A1PE4E, 1A1PEFTE, 1A1PI2E, 1A1PI2EA, 1A1FBE, 1D0BME...(Other models you can see in the webshop)		

			
1			
<b>GEV No.</b>	359020	<b>Ref. No.</b>	32W1550 32W1551
<b>description</b>	indicator light ø 10mm red 400V connection male faston 6.3mm Qty 1 pcs		
<b>For models:</b>	0A1CP1E, 0D1CP1E, 0G1CP1E, 191PI2E, 191PI2EA, 1A1PI2E, 1A1PI2EA, 1D1PI2E, 1D1PI2EA, 1G1PI2E		

			
1			
<b>GEV No.</b>	359140	<b>Ref. No.</b>	32W0790
<b>description</b>	indicator light ø 10mm yellow 230V connection male faston 6.3mm Qty 1 pcs		

			
1			
<b>GEV No.</b>	359334	<b>Ref. No.</b>	32W2440
<b>description</b>	indicator light ø 10mm yellow 24V connection male faston 6.3mm Qty 1 pcs		

			
1			
<b>GEV No.</b>	359034	<b>Ref. No.</b>	32W2240 32W2241
<b>description</b>	indicator light ø 10mm yellow 400V connection male faston 6.3mm Qty 1 pcs		
<b>For models:</b>	031FTE04, 031FTE06, 070FTE04, 070FTE05, 071FTE04, 071FTE06, 08WFAAE, 090FTE04, 090FTE05, 091FTE04, 091FTE06, 0A0FT1E, 0A0FT2E, 0A0FT4E, 0A0FT5E, 0D0FT1E, 0D0FT2E, 0D0FT4E, 0D0FT5E, 0G0FT1E, 0G0FT2E, 0G0FT4E, 0G0FT5E, 10WTPGE, 12WFAAA, 12WFAAE, 190BM2E, 1A0BME, 1A0FT1E, 1A0FT2E, 1A0FT3E, 1A0FT4E, 1A0FT6E, 1A1PE4E, 1A1PEFTE, 1A1FBE, 1D0BME, 1D0FT1E, 1D0FT2E, 1D0FT3E, 1D0FT4E, 1D0FT6E, 1D1PE4E, 1D1FBE, 1G0FT1E, 1G0FT2E, 1G0FT3E, 1G0FT4E, 1G1FA0E, 1G1FA0EV...(Other models you can see in the webshop)		

electric components



Зип-Общепит

vsezip.ru

+7(812)987-08-81

electric components

ø12mm

with screw socket



1

<b>GEV No.</b>	359023	<b>Ref. No.</b>	32W1380
<b>description</b>	indicator light ø 12mm 24V green connection male faston 6.3mm		

28.5x28.5mm

lamps (complete)



1

<b>GEV No.</b>	359355	<b>Ref. No.</b>	32W1250
<b>description</b>	indicator light mounting measurements 28.5x28.5mm 230V blue		



1

<b>GEV No.</b>	359352	<b>Ref. No.</b>	32W1220
<b>description</b>	indicator light mounting measurements 28.5x28.5mm 230V clear		



1

<b>GEV No.</b>	359353	<b>Ref. No.</b>	32W1230
<b>description</b>	indicator light mounting measurements 28.5x28.5mm 230V green		



1

<b>GEV No.</b>	359356	<b>Ref. No.</b>	N/A
<b>description</b>	indicator light mounting measurements 28.5x28.5mm 230V red		

30x11mm



1

<b>GEV No.</b>	359158	<b>Ref. No.</b>	32W0550
<b>description</b>	indicator light mounting measurements 30x11mm 230V red connection male faston 6.3mm temp.-resist. 125°C		

30x22mm



1

<b>GEV No.</b>	359155	<b>Ref. No.</b>	32W0680
<b>description</b>	indicator light mounting measurements 30x22mm 230V red connection male faston 6.3mm temp.-resist. 125°C type RL2		



1

<b>GEV No.</b>	359156	<b>Ref. No.</b>	32W0270 32W0640
<b>description</b>	indicator light mounting measurements 30x22mm 230V yellow connection male faston 6.3mm temp.-resist. 125/55°C type RL2		

33x10mm



1

<b>GEV No.</b>	359451	<b>Ref. No.</b>	32W0720
<b>description</b>	indicator light mounting measurements 33.1x10.3mm 400V yellow connection male faston 6.3mm		

34x10mm



1

<b>GEV No.</b>	359899	<b>Ref. No.</b>	32W0650
<b>description</b>	indicator light mounting measurements 34x10mm 380V red connection male faston 6.3mm temp.-resist. 120°C		

screw-on/push-on fit

light bulbs

for ovens



1

<b>GEV No.</b>	359610	<b>Ref. No.</b>	32W0780
<b>description</b>	light bulb t.max. 300°C socket E14 15W 230V ø 22mm L 47mm lens L 20mm for oven lamp type Philips		



Зип Общепит

vsezip.ru

47(812)987-08-81

**PHILIPS**



1

<b>GEV No.</b>	359612	<b>Ref. No.</b>	32W0210
<b>description</b>	light bulb t.max. 300°C socket E14 25W 230V ø 25mm L 56mm. lens L 30mm for oven lamp type Philips		
<b>For models:</b>	FC101, FC1011E, FC1011G, FC101E, FC1221E, FC1221G, FC241, FC241E, FC241G, FC61, FC611E, FC611G, FC61E, FCV101, FCV101-CSA, FCV101DM, FCV101DM-CSA, FCV101DS, FCV101DS-CSA, FCV101E, FCV101EDM, FCV101EDM-UL, FCV101EDS, FCV101EDS-UL, FCV101E-UL, FCV141, FCV141-CSA, FCV141DM, FCV141DM-CSA, FCV141DS, FCV141DS-CSA, FCV141E, FCV141EDM, FCV141EDS, FCV241, FCV241DM, FCV241DS, FCV241E, FCV241EDM, FCV241EDM-UL, FCV241EDS, FCV241EDS-UL, FCV241E-UL, FCV241G, FCV241G-CSA, FCV241GDM, FCV241GDM-CSA, FCV241GDS, FCV241GDS-CSA, FCV3EM...(Other models you can see in the webshop)		

**PHILIPS**



1

<b>GEV No.</b>	359595	<b>Ref. No.</b>	32W3790
<b>description</b>	light bulb socket E14 15W 230-240V ø 25mm L 56mm lens L 30mm Qty 1 pcs		
<b>For models:</b>	AF1B, AF1B-OPR01, AF1N, AF1N-OPR01, AF2B, AF2B-OPR01, AF2N, AF2N-OPR01, AGL6B, CX120, CX120B, CX120NN, CX130, CX130B, CX130NN, CX140, CX140B, CX140BN, CX140BR, CX140CP, CX140NN, CX140R, CX150, CX150B, CX150BN, CX150BR, CX150CP, CX150NN, CX150R, CX55, CX55B, CX60, CX60B, CX65, CX652, CX65B, CX65BR, CX65NB, CX65NCP, CX65NN, CX65R, CX70, CX702, CX70B, CX70BR, CX70NB, CX70NN, CX70R, FG2B, FSD1B...(Other models you can see in the webshop)		



1



<b>GEV No.</b>	359614	<b>Ref. No.</b>	32W2350
<b>description</b>	light bulb t.max. 300°C socket E27 230V 40W ø 45mm L 71mm lens L 44mm Qty 1 pcs		

oven lamps

universal oven lamps  
mounting diameter 35.5mm



1

<b>GEV No.</b>	357162	<b>Ref. No.</b>	3008760	
<b>description</b>	oven lamp mounting ø 35.5mm 12V 20W socket G4 temp.-resist. 300°C connection cable 450mm hard glas			
<b>spare parts for</b>	357162			
	<b>GEV No.</b>	359599	<b>Ref. No.</b>	3019710 3030660
	halogen lamp socket G4 12V 20W temp.-resist. 500°C			
	<b>GEV No.</b>	359762	<b>Ref. No.</b>	—
	lamp socket socket G4 mounting ø 35.5mm connection cable 450mm			
	<b>GEV No.</b>	359942	<b>Ref. No.</b>	—
	oven lamp glass thr.ø 33.5mm ø 41mm hard glas temp.-resist. 350°C			

halogen lamp  
for socket G4 / G6.35 / G9

**OSRAM**







1

<b>GEV No.</b>	357193	<b>Ref. No.</b>	3030661
<b>description</b>	halogen lamp socket G4 12V 20W temp.-resist. 300°C OSRAM HALOSTAR OVEN		
<b>For models:</b>	BX101E, BX101E-VERS.122013, BX101G, BX101G-VERS.122013, BX122E, BX122E-VERS.122013, BX122G, BX122G-VERS.122013, BX61E, BX61E-VERS.122013, BX61G, BX61G-VERS.122013, BX82E, BX82E-VERS.122013, BX82G, BX82G-VERS.122013, FM1011E1, FM1011E2, FM1011E3, FM1011G1, FM1011G2, FM1011G3, FM1221E1, FM1221E2, FM1221E3, FM1221G1, FM1221G2, FM1221G3, FM611E2, FM611E3, FM611G1, FM611G2, FM611G3, FM721E1, FM721E2, FM721E3, FM721G1, FM721G2, FM721G3, FX101E1, FX101E1R, FX101E2, FX101E2C, FX101E2C-VERS.032014, FX101E2R, FX101E2R-VERS.032014, FX101E2-VERS.032014, FX101E3, FX101E3C, FX101E3C-VERS.022014...(Other models you can see in the webshop)		



1

<b>GEV No.</b>	360759	<b>Ref. No.</b>	3019720	
<b>description</b>	oven lamp mounting ø 35.5mm 12V 20W socket G4 temp.-resist. 350°C connection cable 450mm hard glas			
<b>For models:</b>	FPZ14E, FPZ16E, FPZ24E, FPZ2635E, FPZ26E, FPZ4G, FPZ6G			
<b>spare parts for</b>	360759			
	<b>GEV No.</b>	357192	<b>Ref. No.</b>	—
	halogen lamp socket G4 12V 20W temp.-resist.°C OSRAM HALOSTAR STARLITE			
	<b>GEV No.</b>	357264	<b>Ref. No.</b>	—
	lamp socket socket G4 mounting ø 35.5mm connection cable 450mm			
	<b>GEV No.</b>	359033	<b>Ref. No.</b>	3019730
	oven lamp glass thr.ø 33.5mm H 36mm ø 41mm hard glas temp.-resist. 350°C			



1



<b>GEV No.</b>	359599	<b>Ref. No.</b>	3019710 3030660
<b>description</b>	halogen lamp socket G4 12V 20W temp.-resist. 500°C		
<b>For models:</b>	BX101E, BX101E-VERS.122013, BX101G, BX101G-VERS.122013, BX122E, BX122E-VERS.122013, BX122G, BX122G-VERS.122013, BX61E, BX61E-VERS.122013, BX61G, BX61G-VERS.122013, BX82E, BX82E-VERS.122013, BX82G, BX82G-VERS.122013, FM1011E1, FM1011E2, FM1011E3, FM1011G1, FM1011G2, FM1011G3, FM1221E1, FM1221E2, FM1221E3, FM1221G1, FM1221G2, FM1221G3, FM611E2, FM611E3, FM611G1, FM611G2, FM611G3, FM721E1, FM721E2, FM721E3, FM721G1, FM721G2, FM721G3, FPZ14E, FPZ16E, FPZ24E, FPZ2635E, FPZ26E, FPZ4G, FPZ6G, FX101E1, FX101E1R, FX101E2, FX101E2C...(Other models you can see in the webshop)		









Зип Общепит

vsezip.ru



77(812)987-08-81

	<b>1</b>			
<b>GEV No.</b>	359718	<b>Ref. No.</b>	32W0740	
<b>description</b>	oven lamp mounting $\phi$ 35.5mm 230V 15W socket E14 temp.-resist. 300°C connection male faston 6.3mm hard glas			
<b>spare parts for</b>	359718			
	<b>GEV No.</b>	359701	<b>Ref. No.</b>	32W0746 32W2561
	lamp socket socket E14 220-230V mounting $\phi$ 35.5mm connection male faston 6.3mm 15W			
	<b>GEV No.</b>	359740	<b>Ref. No.</b>	—
	light bulb t.max. 300°C socket E14 15W 230V $\phi$ 22mm L 48mm lens L 20mm for oven lamp IMPORT			

	<b>1</b>			
<b>GEV No.</b>	359701	<b>Ref. No.</b>	32W0746 32W2561	
<b>description</b>	lamp socket socket E14 220-230V mounting $\phi$ 35.5mm connection male faston 6.3mm 15W			
<b>For models:</b>	FC101, FC101E, FC241, FC241E, FC241G, FC61, FC61E, FCV101, FCV101-CSA, FCV101DM, FCV101DM-CSA, FCV101DS, FCV101DS-CSA, FCV101E, FCV101EDM, FCV101EDM-UL, FCV101EDS, FCV101EDS-UL, FCV101E-UL, FCV141, FCV141-CSA, FCV141DM, FCV141DM-CSA, FCV141DS, FCV141DS-CSA, FCV141E, FCV141EDM, FCV141EDS, FCV241, FCV241DM, FCV241DS, FCV241E, FCV241EDM, FCV241EDM-UL, FCV241EDS, FCV241E-UL, FCV241G, FCV241GDM, FCV241GDM-CSA, FCV241GDS, FCV241GDS-CSA, FCV401DM, FCV401DM-CSA, FCV401EDM, FCV401EDM-UL, FCV61, FCV61-CSA, FCV61DM, FCV61DM-CSA, FCV61DS...(Other models you can see in the webshop)			
<b>accessories for</b>	359701			
	<b>GEV No.</b>	359705	<b>Ref. No.</b>	32W3080
	oven lamp glass thr. $\phi$ 33.5mm $\phi$ 52mm hard glas temp.-resist. 350°C			
	<b>GEV No.</b>	359709	<b>Ref. No.</b>	—
	oven lamp glass thr. $\phi$ 33.5mm $\phi$ 42mm hard glas temp.-resist. 350°C			
	<b>GEV No.</b>	359721	<b>Ref. No.</b>	—
	gasket silicone ED $\phi$ 48mm ID $\phi$ 39.5mm thickness 5mm Qty 1 pcs			
	<b>GEV No.</b>	359942	<b>Ref. No.</b>	—
	oven lamp glass thr. $\phi$ 33.5mm $\phi$ 41mm hard glas temp.-resist. 350°C			

	<b>1</b>		
<b>GEV No.</b>	359033	<b>Ref. No.</b>	3019730
<b>description</b>	oven lamp glass thr. $\phi$ 33.5mm H 36mm $\phi$ 41mm hard glas temp.-resist. 350°C		
<b>For models:</b>	FPZ14E, FPZ16E, FPZ24E, FPZ2635E, FPZ26E, FPZ4G, FPZ6G		

	<b>1</b>			
<b>GEV No.</b>	359705	<b>Ref. No.</b>	32W3080	
<b>description</b>	oven lamp glass thr. $\phi$ 33.5mm $\phi$ 52mm hard glas temp.-resist. 350°C			
<b>accessories for</b>	359705			
	<b>GEV No.</b>	359610	<b>Ref. No.</b>	32W0780
	light bulb t.max. 300°C socket E14 15W 230V $\phi$ 22mm L 47mm lens L 20mm for oven lamp type Philips			
	<b>GEV No.</b>	359700	<b>Ref. No.</b>	—
	gasket for pizza oven fibre glass ID $\phi$ 32.5mm ED $\phi$ 55mm thickness 5mm			
	<b>GEV No.</b>	359721	<b>Ref. No.</b>	—
	gasket silicone ED $\phi$ 48mm ID $\phi$ 39.5mm thickness 5mm Qty 1 pcs			
	<b>GEV No.</b>	359837	<b>Ref. No.</b>	—
	gasket ID $\phi$ 33mm ED $\phi$ 46mm thickness 1mm graphite			
	<b>GEV No.</b>	359838	<b>Ref. No.</b>	—
	gasket ID $\phi$ 33mm ED $\phi$ 45mm			

	<b>1</b>			
<b>GEV No.</b>	359661	<b>Ref. No.</b>	32X3080	
<b>description</b>	oven lamp glass thread 32.1 $\phi$ 58mm hard glas temp.-resist. 350°C			
<b>accessories for</b>	359661			
	<b>GEV No.</b>	359700	<b>Ref. No.</b>	—
	gasket for pizza oven fibre glass ID $\phi$ 32.5mm ED $\phi$ 55mm thickness 5mm			

55x70mm

	<b>1</b>		
<b>GEV No.</b>	358147	<b>Ref. No.</b>	3036970
<b>description</b>	gasket L 75mm W 65mm thickness 1mm for oven lamp		
<b>For models:</b>	FC1011E, FC1011G, FC1221E, FC1221G, FC611E, FC611G, FCV3EM, FCV4E, FCV4EDS, FCV4EM, FM1011E1, FM1011E1-VERS.2006, FM1011E2, FM1011E2-VERS.2006, FM1011E3, FM1011E3-VERS.2006, FM1011G1, FM1011G1-VERS.2006, FM1011G2, FM1011G2-VERS.2006, FM1011G3, FM1011G3-VERS.2006, FM1221E1, FM1221E1-VERS.2006, FM1221E2, FM1221E2-VERS.2006, FM1221E3, FM1221E3-VERS.2006, FM1221G1, FM1221G1-VERS.2006, FM1221G2, FM1221G2-VERS.2006, FM1221G3, FM1221G3-VERS.2006, FM2011E2-VERS.2006, FM2011E3-VERS.2006, FM2011G2-VERS.2006, FM2011G3-VERS.2006, FM2021E1, FM2021E2, FM2021E2-VERS.2006, FM2021E3-VERS.2006, FM2021G1, FM2021G2, FM2021G2-VERS.2006, FM2021G3, FM2021G3-VERS.2006, FM423E1, FM423E2, FM611E1...(Other models you can see in the webshop)		





Зип Общепит

vsezip.ru





(812)987-08-81

			
1			
<b>GEV No.</b>	359299	<b>Ref. No.</b>	37Q4107 37Q4106
<b>description</b>	gasket L 91mm W 77mm hole ø 3mm for oven lamp		
<b>For models:</b>	FCV3EM, FCV4E, FCV4EDS, FCV4EM		

			
1			
<b>GEV No.</b>	359296	<b>Ref. No.</b>	37M9910 37M9911
<b>description</b>	lamp glass L 74mm W 58mm thickness 3mm		
<b>For models:</b>	FCV3EM, FCV4E, FCV4EDS, FCV4EM		

producer-specific oven lamps			
ANGELO PO			
			
1			
<b>GEV No.</b>	359339	<b>Ref. No.</b>	37Q7840
<b>description</b>	gasket ID ø 65mm ED ø 80mm thickness 1mm		
<b>For models:</b>	FC101, FC101E, FC241, FC241E, FC241G, FC61, FC61E, FCV101, FCV101-CSA, FCV101DM, FCV101DM-CSA, FCV101DS, FCV101DS-CSA, FCV101E, FCV101EDM, FCV101EDM-UL, FCV101EDS, FCV101EDS-UL, FCV101E-UL, FCV141, FCV141-CSA, FCV141DM, FCV141DM-CSA, FCV141DS, FCV141DS-CSA, FCV141E, FCV141EDM, FCV141EDS, FCV241, FCV241DM, FCV241DS, FCV241E, FCV241EDM, FCV241EDM-UL, FCV241EDS, FCV241EDS-UL, FCV241E-UL, FCV241G, FCV241G-CSA, FCV241GDM, FCV241GDM-CSA, FCV241GDS, FCV241GDS-CSA, FCV401DM, FCV401DM-CSA, FCV401EDM, FCV401EDM-UL, FCV4E, FCV4EDS, FCV61...(Other models you can see in the webshop)		

			
1			
<b>GEV No.</b>	359340	<b>Ref. No.</b>	3036650 37M6210
<b>description</b>	glass panel round ø 78mm thickness 3mm		
<b>For models:</b>	031FT04, 031FT06, 070FT04, 070FT05, 071FT04, 071FT06, 090FT04, 090FT05, 091FT04, 091FT06, 0A0FT1G, 0A0FT2G, 0A0FT4G, 0A0FT5G, 0D0FT1G, 0D0FT2G, 0D0FT4G, 0D0FT5G, 1A0FT1G, 1A0FT2G, 1A0FT3G, 1A0FT4G, 1A0FT6G, 1D0FT1G, 1D0FT2G, 1D0FT3G, 1D0FT4G, 1D0FT6G, FC101, FC101E, FC241, FC241E, FC241G, FC61, FC61E, FCV101, FCV101-CSA, FCV101DM, FCV101DM-CSA, FCV101DS, FCV101DS-CSA, FCV101E, FCV101EDM, FCV101EDM-UL, FCV101EDS, FCV101EDS-UL, FCV101E-UL, FCV141, FCV141-CSA, FCV141DM...(Other models you can see in the webshop)		

			
1			
<b>GEV No.</b>	359701	<b>Ref. No.</b>	32W0746 32W2561
<b>description</b>	lamp socket socket E14 220-230V mounting ø 35.5mm connection male faston 6.3mm 15W		
<b>For models:</b>	FC101, FC101E, FC241, FC241E, FC241G, FC61, FC61E, FCV101, FCV101-CSA, FCV101DM, FCV101DM-CSA, FCV101DS, FCV101DS-CSA, FCV101E, FCV101EDM, FCV101EDM-UL, FCV101EDS, FCV101EDS-UL, FCV101E-UL, FCV141, FCV141-CSA, FCV141DM, FCV141DM-CSA, FCV141DS, FCV141DS-CSA, FCV141E, FCV141EDM, FCV141EDS, FCV241, FCV241DM, FCV241DS, FCV241E, FCV241EDM, FCV241EDM-UL, FCV241EDS, FCV241E-UL, FCV241G, FCV241GDM, FCV241GDM-CSA, FCV241GDS, FCV241GDS-CSA, FCV401DM, FCV401DM-CSA, FCV401EDM, FCV401EDM-UL, FCV61, FCV61-CSA, FCV61DM, FCV61DM-CSA, FCV61DS...(Other models you can see in the webshop)		
<b>accessories for</b>	359701		
	<b>GEV No.</b>	359705	<b>Ref. No.</b> 32W3080
	<b>GEV No.</b>	359709	<b>Ref. No.</b> —
	<b>GEV No.</b>	359721	<b>Ref. No.</b> —
	<b>GEV No.</b>	359942	<b>Ref. No.</b> —

			
1			
<b>GEV No.</b>	357179	<b>Ref. No.</b>	3159800 3278370 35E3360
<b>description</b>	frame for oven lamp L 97mm W 97mm thickness 6mm mounting distance 78mm ø 55mm		
<b>For models:</b>	BX101E, BX101E-VERS.122013, BX101G, BX101G-VERS.122013, BX122E, BX122E-VERS.122013, BX122G, BX122G-VERS.122013, BX61E, BX61E-VERS.122013, BX61G, BX61G-VERS.122013, BX82E, BX82E-VERS.122013, BX82G, BX82G-VERS.122013, FC101E, FC101G, FC1221E, FC1221G, FC61E, FC61G, FCV3EM, FCV4E, FCV4EDS, FCV4EM, FM1011E1, FM1011E1-VERS.2006, FM1011E2, FM1011E2-VERS.2006, FM1011E3, FM1011E3-VERS.2006, FM1011G1, FM1011G1-VERS.2006, FM1011G2, FM1011G2-VERS.2006, FM1011G3, FM1011G3-VERS.2006, FM1221E1, FM1221E1-VERS.2006, FM1221E2, FM1221E2-VERS.2006, FM1221E3, FM1221E3-VERS.2006, FM1221G1, FM1221G1-VERS.2006, FM1221G2, FM1221G2-VERS.2006, FM1221G3, FM1221G3-VERS.2006...(Other models you can see in the webshop)		

electric components



Зип-Общепит

accessories for 359295			
GEV No.	551336	Ref. No.	36E3170
gasket for lamp L 92mm W 92mm thickness 2.3mm			



GEV No.	551336	Ref. No.	36E3170
description gasket for lamp L 92mm W 92mm thickness 2.3mm			
For models: BX101E, BX101E-VERS.122013, BX101G, BX101G-VERS.122013, BX122E, BX122E-VERS.122013, BX122G, BX122G-VERS.122013, BX61E, BX61E-VERS.122013, BX61G, BX61G-VERS.122013, BX82E, BX82E-VERS.122013, BX82G, BX82G-VERS.122013, FC1011E, FC1011G, FC1221E, FC1221G, FC611E, FC611G, FCV3EM, FCV4E, FCV4EDS, FCV4EM, FM1011E1, FM1011E1-VERS.2006, FM1011E2, FM1011E2-VERS.2006, FM1011E3, FM1011E3-VERS.2006, FM1011G1, FM1011G1-VERS.2006, FM1011G2, FM1011G2-VERS.2006, FM1011G3, FM1011G3-VERS.2006, FM1221E1, FM1221E1-VERS.2006, FM1221E2, FM1221E2-VERS.2006, FM1221E3, FM1221E3-VERS.2006, FM1221G1, FM1221G1-VERS.2006, FM1221G2, FM1221G2-VERS.2006, FM1221G3, FM1221G3-VERS.2006...(Other models you can see in the webshop)			

1			
GEV No.	357262	Ref. No.	3097180
description lamp socket socket E14 mounting measurements 55x70mm connection male faston 6.3mm Qty 1 pcs			
For models: FC1011E, FC1011G, FC1221E, FC1221G, FC611E, FC611G, FCV3EM, FCV4E, FCV4EDS, FCV4EM, FM423E1, FM423E2			
accessories for 357262			

1			
GEV No.	357179	Ref. No.	3159800 3278370 35E3360
description frame for oven lamp L 97mm W 97mm thickness 6mm mounting distance 78mm ø 55mm			
For models: FC1011E, FC1011G, FC1221E, FC1221G, FC611E, FC611G, FCV3EM, FCV4E, FCV4EDS, FCV4EM, FM423E1, FM423E2			



GEV No.	357180	Ref. No.	3036960 3036961 3036962 3036963
description lamp glass L 73.6mm W 64mm thickness 4mm			
For models: BX101E, BX101E-VERS.122013, BX101G, BX101G-VERS.122013, BX122E, BX122E-VERS.122013, BX122G, BX122G-VERS.122013, BX61E, BX61E-VERS.122013, BX61G, BX61G-VERS.122013, BX82E, BX82E-VERS.122013, BX82G, BX82G-VERS.122013, FC1011E, FC1011G, FC1221E, FC1221G, FC611E, FC611G, FCV3EM, FCV4E, FCV4EDS, FCV4EM, FM1011E1, FM1011E1-VERS.2006, FM1011E2, FM1011E2-VERS.2006, FM1011E3, FM1011E3-VERS.2006, FM1011G1, FM1011G1-VERS.2006, FM1011G2, FM1011G2-VERS.2006, FM1011G3, FM1011G3-VERS.2006, FM1221E1, FM1221E1-VERS.2006, FM1221E2, FM1221E2-VERS.2006, FM1221E3, FM1221E3-VERS.2006, FM1221G1, FM1221G1-VERS.2006, FM1221G2, FM1221G2-VERS.2006, FM1221G3, FM1221G3-VERS.2006...(Other models you can see in the webshop)			

1			
GEV No.	357180	Ref. No.	3036960 3036961 3036962 3036963
description lamp glass L 73.6mm W 64mm thickness 4mm			

1			
GEV No.	358147	Ref. No.	3036970
description gasket L 75mm W 65mm thickness 1mm for oven lamp			

1			
GEV No.	551336	Ref. No.	36E3170
description gasket for lamp L 92mm W 92mm thickness 2.3mm			

## lamps

## light bulbs

1			
GEV No.	359610	Ref. No.	32W0780
description light bulb t.max. 300°C socket E14 15W 230V ø 22mm L 47mm lens L 20mm for oven lamp type Philips			

1			
GEV No.	359612	Ref. No.	32W0210
description light bulb t.max. 300°C socket E14 25W 230V ø 25mm L 56mm lens L 30mm for oven lamp type Philips			
For models: FC101, FC101E, FC1011G, FC101E, FC1221E, FC1221G, FC241, FC241E, FC241G, FC61, FC611E, FC611G, FC61E, FCV101, FCV101-CSA, FCV101DM, FCV101DM-CSA, FCV101DS, FCV101DS-CSA, FCV101E, FCV101EDM, FCV101EDM-UL, FCV101EDS, FCV101EDS-UL, FCV101E-UL, FCV141, FCV141-CSA, FCV141DM, FCV141DM-CSA, FCV141DS, FCV141DS-CSA, FCV141E, FCV141EDM, FCV141EDS, FCV241, FCV241DM, FCV241DS, FCV241E, FCV241EDM, FCV241EDM-UL, FCV241EDS, FCV241EDS-UL, FCV241E-UL, FCV241G, FCV241G-CSA, FCV241GDM, FCV241GDM-CSA, FCV241GDS, FCV241GDS-CSA, FCV3EM...(Other models you can see in the webshop)			



GEV No.	359295	Ref. No.	32V5570								
description lamp socket for halogen lamp 12V 20W socket G4 mounting measurements 55 x 70mm cable length 135mm											
For models: BX101E, BX101E-VERS.122013, BX101G, BX101G-VERS.122013, BX122E, BX122E-VERS.122013, BX122G, BX122G-VERS.122013, BX61E, BX61E-VERS.122013, BX61G, BX61G-VERS.122013, BX82E, BX82E-VERS.122013, BX82G, BX82G-VERS.122013, FM1011E1, FM1011E1-VERS.2006, FM1011E2, FM1011E2-VERS.2006, FM1011E3, FM1011E3-VERS.2006, FM1011G1, FM1011G1-VERS.2006, FM1011G2, FM1011G2-VERS.2006, FM1011G3, FM1011G3-VERS.2006, FM1221E1, FM1221E1-VERS.2006, FM1221E2, FM1221E2-VERS.2006, FM1221E3, FM1221E3-VERS.2006, FM1221G1, FM1221G1-VERS.2006, FM1221G2, FM1221G2-VERS.2006, FM1221G3, FM1221G3-VERS.2006, FM2011E2-VERS.2006, FM2011E3-VERS.2006, FM2011G2-VERS.2006, FM2011G3-VERS.2006, FM2021E1, FM2021E2, FM2021E2-VERS.2006, FM2021E3, FM2021E3-VERS.2006, FM2021G1...(Other models you can see in the webshop)											
spare parts for 359295											
<table border="1"> <tr> <td>GEV No.</td> <td>359599</td> <td>Ref. No.</td> <td>3019710 3030660</td> </tr> <tr> <td colspan="4">description halogen lamp socket G4 12V 20W temp.-resist. 500°C</td> </tr> </table>				GEV No.	359599	Ref. No.	3019710 3030660	description halogen lamp socket G4 12V 20W temp.-resist. 500°C			
GEV No.	359599	Ref. No.	3019710 3030660								
description halogen lamp socket G4 12V 20W temp.-resist. 500°C											
accessories for 359295											
<table border="1"> <tr> <td>GEV No.</td> <td>359296</td> <td>Ref. No.</td> <td>37M9910 37M9911</td> </tr> <tr> <td colspan="4">description lamp glass L 74mm W 58mm thickness 3mm</td> </tr> </table>				GEV No.	359296	Ref. No.	37M9910 37M9911	description lamp glass L 74mm W 58mm thickness 3mm			
GEV No.	359296	Ref. No.	37M9910 37M9911								
description lamp glass L 74mm W 58mm thickness 3mm											

Зип.Общепит  
timers

programme timers  
vsezip.ru

77(812)987-08-81

			
1			
<b>GEV No.</b>	359614	<b>Ref. No.</b>	32W2350
<b>description</b>	light bulb t.max. 300°C socket E27 230V 40W ø 45mm L 71mm lens L 44mm Qty 1 pcs		

halogen lamps  
for socket G4 / G6.35 / G9

			
1			
<b>GEV No.</b>	357193	<b>Ref. No.</b>	3030661
<b>description</b>	halogen lamp socket G4 12V 20W temp.-resist. 300°C OSRAM HALOSTAR OVEN		
<b>For models:</b>	BX101E, BX101E-VERS.122013, BX101G, BX101G-VERS.122013, BX122E, BX122E-VERS.122013, BX122G, BX122G-VERS.122013, BX61E, BX61E-VERS.122013, BX61G, BX61G-VERS.122013, BX82E, BX82E-VERS.122013, BX82G, BX82G-VERS.122013, FM1011E1, FM1011E2, FM1011E3, FM1011G1, FM1011G2, FM1011G3, FM1221E1, FM1221E2, FM1221E3, FM1221G1, FM1221G2, FM1221G3, FM611E2, FM611E3, FM611G1, FM611G2, FM611G3, FM721E1, FM721E2, FM721E3, FM721G1, FM721G2, FM721G3, FX101E1, FX101E1R, FX101E2, FX101E2C, FX101E2C-VERS.032014, FX101E2R, FX101E2R-VERS.032014, FX101E2-VERS.032014, FX101E3, FX101E3C, FX101E3C-VERS.022014...(Other models you can see in the webshop)		

			
1			
<b>GEV No.</b>	359599	<b>Ref. No.</b>	3019710 3030660
<b>description</b>	halogen lamp socket G4 12V 20W temp.-resist. 500°C		
<b>For models:</b>	BX101E, BX101E-VERS.122013, BX101G, BX101G-VERS.122013, BX122E, BX122E-VERS.122013, BX122G, BX122G-VERS.122013, BX61E, BX61E-VERS.122013, BX61G, BX61G-VERS.122013, BX82E, BX82E-VERS.122013, BX82G, BX82G-VERS.122013, FM1011E1, FM1011E2, FM1011E3, FM1011G1, FM1011G2, FM1011G3, FM1221E1, FM1221E2, FM1221E3, FM1221G1, FM1221G2, FM1221G3, FM611E2, FM611E3, FM611G1, FM611G2, FM611G3, FM721E1, FM721E2, FM721E3, FM721G1, FM721G2, FM721G3, FPZ14E, FPZ16E, FPZ24E, FPZ2635E, FPZ26E, FPZ4G, FPZ6G, FX101E1, FX101E1R, FX101E2, FX101E2C...(Other models you can see in the webshop)		

lamp accessories

			
1			
<b>GEV No.</b>	511436	<b>Ref. No.</b>	37Q7370
<b>description</b>	gasket for lamp		
<b>For models:</b>	135, 135-4, 135B, 135BN, 135BNX, 135BX, 135BXR, 135CPX, 135NN, 135NNX, 135X, 135X-3, 135X-4, 135XR, 65, 65B, 65BX, 65BX-2, 65BXR, 65NB, 65NBX, 65NN, 65NNX, 65X, 65X-2, 65XR, SP120, SP120B, SP120BN, SP120NN, SP135, SP135B, SP135BN, SP135CP, SP135NN, SP55, SP55B, SP65, SP65B, SP65NB, SP65NN		

			
1			
<b>GEV No.</b>	360380	<b>Ref. No.</b>	32Z0391
<b>description</b>	timer BIGATTI engines 1 chambers 1 operation time 3s 230V shaft ø 6x4.6mm shaft L 18mm manuf. no. 4023/3s. / 32Z0391 motor type 82354039		

			
1			
<b>GEV No.</b>	360382	<b>Ref. No.</b>	32Z5730
<b>description</b>	timer BIGATTI engines 1 chambers 1 operation time 6h 230V manuf. no. SA001 / 32Z5730 motor type 82394530		

			
1			
<b>GEV No.</b>	360645	<b>Ref. No.</b>	3289260
<b>description</b>	timer CDC 11901F engines 1 chambers 1 operation time 20S 230V 50/60Hz shaft ø 6x4mm shaft L 25mm manuf. no. 11901F1CEE000.0000		
<b>For models:</b>	FX201G3P, FX201G3-VERS.022014		

electric components

Зип Общепит

vsezip.ru

+7(812)987-08-81





1

<b>GEV No.</b>	360389	<b>Ref. No.</b>	32V7290
<b>description</b>	timer CDC 4904F engines 1 chambers 4 operation time 5min 230V shaft $\emptyset$ mm shaft Lmm manuf. no. 4904F3 / 10300122 motor type M48L ATS		
<b>For models:</b>	KD100, KD100A, KD100PSD, KD130, KD130A		
<b>spare parts for</b>	360389		
	<b>GEV No.</b>	360083	<b>Ref. No.</b> —
	motor CDC pinion $\emptyset$ 4.9mm teeth 10 230V turn direction left motor $\emptyset$ 47mm H 19.3mm motor type M48L ATS for timer		



1

<b>GEV No.</b>	360379	<b>Ref. No.</b>	32Z4760
<b>description</b>	timer CDC 9003F engines 1 chambers 3 operation time 240s 230V shaft $\emptyset$ 6x4.6mm shaft L 20mm manuf. no. 9003F1 / 32Z4760 motor type M48R ATS		
<b>spare parts for</b>	360379		
	<b>GEV No.</b>	360118	<b>Ref. No.</b> —
	motor CDC pinion $\emptyset$ 4.9mm teeth 10 230V voltage AC 50/60Hz turn direction right motor $\emptyset$ 47mm H 19.3mm motor type M48R ATS for timer cable length 260mm 1.9/2.5W		



1

<b>GEV No.</b>	360196	<b>Ref. No.</b>	32Z0780
<b>description</b>	timer CDC 4904F engines 1 chambers 4 operation time 60s 230V manuf. no. 4904F3 / 3322060 motor type M48L BTN		



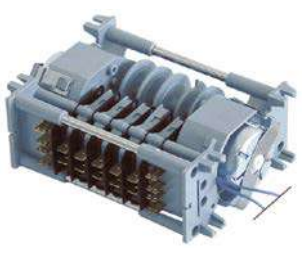

1

<b>GEV No.</b>	360381	<b>Ref. No.</b>	32Z5840
<b>description</b>	timer CDC engines 1 chambers 2 operation time 2h 230V shaft $\emptyset$ 6x4.6mm shaft L 19mm manuf. no. 4900/32Z5840		



1

<b>GEV No.</b>	360215	<b>Ref. No.</b>	32V1940
<b>description</b>	timer CDC 7805DV engines 2 chambers 5 operation time 6s / 3min 230V shaft $\emptyset$ mm shaft Lmm motor type M37RN/M37LN		
<b>For models:</b>	LC130, LC130-VERS.2001		
<b>spare parts for</b>	360215		
	<b>GEV No.</b>	360119	<b>Ref. No.</b> —
	motor CDC pinion $\emptyset$ 5.4mm teeth 12 230V turn direction right motor $\emptyset$ 37mm motor type M37RN for timer		
	<b>GEV No.</b>	360131	<b>Ref. No.</b> —
	motor CDC pinion $\emptyset$ 5.4mm teeth 12 230V turn direction left motor $\emptyset$ 37mm motor type M37LN for timer		



1

<b>GEV No.</b>	360386	<b>Ref. No.</b>	32Z0310
<b>description</b>	timer CRONEL engines 1 chambers 2 operation time 180s 230V shaft $\emptyset$ 6x4.6mm shaft L 18mm manuf. no. D9404 motor type 82340		



1

<b>GEV No.</b>	360077	<b>Ref. No.</b>	3030290
<b>description</b>	timer CROUZET engines 1 chambers 2 operation time 120s 230V shaft $\emptyset$ mm shaft Lmm manuf. no. 627/5261 motor type 82340		





Зип Общепит

vsezip.ru

+7(812)987-08-81





1

<b>GEV No.</b>	360289	<b>Ref. No.</b>	3030290
<b>description</b>	timer CROUZET engines 1 chambers 2 operation time 120s 230V shaft ømm shaft Lmm manuf. no. 627/5309 motor type 600		
<b>For models:</b>	KD37, KD40		



1

<b>GEV No.</b>	360334	<b>Ref. No.</b>	32Z9630
<b>description</b>	timer FIBER P04 engines 1 chambers 2 operation time 120min 230V shaft ø 6x4.6mm shaft L 20mm manuf. no. P045J02W401 motor type M51BJ0R6400 impulse electric		
<b>For models:</b>	FCV3EM, FCV4EM		
<b>spare parts for</b>	360334		
	<b>GEV No.</b>	360673	<b>Ref. No.</b> —
	motor kit pinion ø 6.8mm teeth 15 230V voltage AC 50/60Hz turn direction clockwise motor ø 48mm H 18.5mm motor type UDS-40NE1RNZ165 cable length 150mm with holder		





1

<b>GEV No.</b>	360436	<b>Ref. No.</b>	32V5780
<b>description</b>	timer FIBER P24 engines 1 chambers 1 operation time 20s 230V shaft ø 4x6.4mm shaft L 25mm manuf. no. P245J01C118 motor type M51BJ0R0000		
<b>For models:</b>	BX101E, BX101E-VERS.122013, BX101G, BX101G-VERS.122013, BX122E, BX122E-VERS.122013, BX122G, BX122G-VERS.122013, BX61E, BX61E-VERS.122013, BX61G, BX61G-VERS.122013, BX82E, BX82E-VERS.122013, BX82G, BX82G-VERS.122013, FM1011E1, FM1011E1-VERS.2006, FM1011E2, FM1011E2-VERS.2006, FM1011E3, FM1011E3-VERS.2006, FM1011G1, FM1011G1-VERS.2006, FM1011G2, FM1011G2-VERS.2006, FM1011G3, FM1011G3-VERS.2006, FM1221E1, FM1221E1-VERS.2006, FM1221E2, FM1221E2-VERS.2006, FM1221E3, FM1221E3-VERS.2006, FM1221G1, FM1221G1-VERS.2006, FM1221G2, FM1221G2-VERS.2006, FM1221G3, FM1221G3-VERS.2006, FM2011E2-VERS.2006, FM2011E3-VERS.2006, FM2011G2-VERS.2006, FM2011G3-VERS.2006, FM2021E1, FM2021E2, FM2021E2-VERS.2006, FM2021E3, FM2021E3-VERS.2006, FM2021G1...(Other models you can see in the webshop)		





1

<b>GEV No.</b>	360435	<b>Ref. No.</b>	32V7300
<b>description</b>	timer FIBER P25 engines 1 chambers 4 operation time 6min 230V 50Hz shaft ømm shaft Lmm motor type M51BJ0L6400		
<b>spare parts for</b>	360435		
	<b>GEV No.</b>	360674	<b>Ref. No.</b> —
	motor kit pinion ø 6.8mm teeth 15 230V voltage AC 50/60Hz turn direction counterclockwise motor ø 48mm H 18.5mm motor type UDS40NE1RNZ165 cable length 150mm with holder		





1

<b>GEV No.</b>	360234	<b>Ref. No.</b>	32V2060
<b>description</b>	timer FIBER P25 engines 2 chambers 4 operation time 6s / 3min 230V shaft ømm shaft Lmm manuf. no. P255J04JBC7 motor type M51B-J0R6400 / M51BJ0L6400		
<b>For models:</b>	LF50, LF50E, LF50EM		
<b>spare parts for</b>	360234		
	<b>GEV No.</b>	360673	<b>Ref. No.</b> —
	motor kit pinion ø 6.8mm teeth 15 230V voltage AC 50/60Hz turn direction clockwise motor ø 48mm H 18.5mm motor type UDS-40NE1RNZ165 cable length 150mm with holder		
	<b>GEV No.</b>	360674	<b>Ref. No.</b> —
	motor kit pinion ø 6.8mm teeth 15 230V voltage AC 50/60Hz turn direction counterclockwise motor ø 48mm H 18.5mm motor type UDS40NE1RNZ165 cable length 150mm with holder		



1

<b>GEV No.</b>	360245	<b>Ref. No.</b>	32Z2020
<b>description</b>	timer FIBER P25 engines 2 chambers 5 operation time 180s / 6min 230V shaft ømm shaft Lmm manuf. no. P255J05JZE6 motor type M51BJ0R6400 / M51BJ0L6400		
<b>For models:</b>	L40, L40S, L45, L60		
<b>spare parts for</b>	360245		
	<b>GEV No.</b>	360673	<b>Ref. No.</b> —
	motor kit pinion ø 6.8mm teeth 15 230V voltage AC 50/60Hz turn direction clockwise motor ø 48mm H 18.5mm motor type UDS-40NE1RNZ165 cable length 150mm with holder		
	<b>GEV No.</b>	360674	<b>Ref. No.</b> —
	motor kit pinion ø 6.8mm teeth 15 230V voltage AC 50/60Hz turn direction counterclockwise motor ø 48mm H 18.5mm motor type UDS40NE1RNZ165 cable length 150mm with holder		

Зип Общепит

vsezip.ru

+7(812)987-08-81





1

<b>GEV No.</b>	360392	<b>Ref. No.</b>	3175700
<b>description</b>	timer FIBER P25 engines 2 chambers 5 operation time 60s / 3min 230V shaft ømm shaft Lmm		



1

<b>GEV No.</b>	360232	<b>Ref. No.</b>	32V0530
<b>description</b>	timer FIBER P25 engines 2 chambers 5 operation time 6s / 9min 24V shaft ømm shaft Lmm manuf. no. P255205KEF0 motor type M51B20R6400 / M51B20L6400 voltage AC		
<b>spare parts for</b>	360232		
	<b>GEV No.</b>	360675	<b>Ref. No.</b> —
	motor kit pinion ø 6.8mm teeth 15 24V voltage AC 50/60Hz turn direction clockwise motor ø 48mm H 18.5mm motor type UDS-40NE1RNZ165 cable length 150mm with holder		
	<b>GEV No.</b>	360676	<b>Ref. No.</b> —
	motor kit pinion ø 6.8mm teeth 15 24V voltage AC 50/60Hz turn direction counterclockwise motor ø 48mm H 18.5mm motor type UDS40NE1RNZ165 cable length 150mm with holder		



1

<b>GEV No.</b>	360246	<b>Ref. No.</b>	32Z8110
<b>description</b>	timer FIBER P25 engines 2 chambers 5 operation time 80s / 5min 230V shaft ømm shaft Lmm manuf. no. P255J05KRH3 motor type M51BJ0R6400 / M51BJ0L6400 run-time 80/300s		
<b>For models:</b>	F80P, F80PR, L80		
<b>spare parts for</b>	360246		
	<b>GEV No.</b>	360673	<b>Ref. No.</b> —
	motor kit pinion ø 6.8mm teeth 15 230V voltage AC 50/60Hz turn direction clockwise motor ø 48mm H 18.5mm motor type UDS-40NE1RNZ165 cable length 150mm with holder		
	<b>GEV No.</b>	360674	<b>Ref. No.</b> —
	motor kit pinion ø 6.8mm teeth 15 230V voltage AC 50/60Hz turn direction counterclockwise motor ø 48mm H 18.5mm motor type UDS40NE1RNZ165 cable length 150mm with holder		



1

<b>GEV No.</b>	360051	<b>Ref. No.</b>	32Z3840
<b>description</b>	timer FIBER P36 engines 1 chambers 2 operation time 15min 230V shaft ømm shaft Lmm manuf. no. P365JR2J717 motor type M51B-J0R6400		
<b>For models:</b>	PGA20, PGA30, PGA40, PGA60, PGA80, PGW20, PGW30, PGW40, PGW60, PGW80		
<b>spare parts for</b>	360051		
	<b>GEV No.</b>	360673	<b>Ref. No.</b> —
	motor kit pinion ø 6.8mm teeth 15 230V voltage AC 50/60Hz turn direction clockwise motor ø 48mm H 18.5mm motor type UDS-40NE1RNZ165 cable length 150mm with holder		

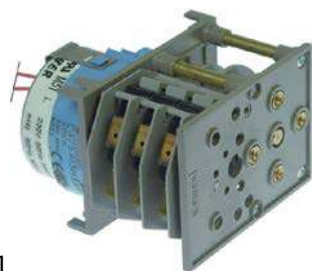

1

<b>GEV No.</b>	360369	<b>Ref. No.</b>	32Z5720
<b>description</b>	timer FIBER P37 engines 1 chambers 3 operation time 120s 230V shaft ømm shaft Lmm manuf. no. P375J03H340 motor type M51B-J0L***		
<b>For models:</b>	LT10R, LT20F, LT25F		
<b>spare parts for</b>	360369		
	<b>GEV No.</b>	360674	<b>Ref. No.</b> —
	motor kit pinion ø 6.8mm teeth 15 230V voltage AC 50/60Hz turn direction counterclockwise motor ø 48mm H 18.5mm motor type UDS40NE1RNZ165 cable length 150mm with holder		

mechanical timers



1



<b>GEV No.</b>	350003	<b>Ref. No.</b>	32Z0420 32Z2200
<b>description</b>	timer M2 with bell 2-pole operation time 120min impulse mechanical 2NO at 250V 16A permanent position no shaft ø 6x4.6mm shaft 6x4.6mm shaft L 23mm mounting distance 28mm connection lateral		
<b>For models:</b>	FC101, FC1011E, FC1011G, FC101E, FC1221E, FC1221G, FC241, FC241E, FC241G, FC61, FC611E, FC611G, FC61E		
<b>accessories for</b>	350003		
	<b>GEV No.</b>	110366	<b>Ref. No.</b> —
	knob switch zero mark t.max. °C°C ø 44mm shaft ø 6x4.6mm shaft flat upper black		

Table continues overleaf



Зип Общепит  
vsezip.ru

+7(812)987-08-81

accessories for	350003		
	GEV No.	111199	Ref. No.
			—
	dial plate graduation 120min permanent position no rotation 0-330° ø 60mm timers knob ø 45mm		

			
1			
GEV No.	360447	Ref. No.	32Z5540
description	timer T203 1-pole operation time 5min impulse mechanical 1NO at 250V 16(3)A permanent position no shaft ø 4x4.6mm shaft 6x4.6mm shaft L 16mm mounting distance 30mm connection rear ambient temperature max. 55°C		

			
1			
GEV No.	360384	Ref. No.	32Z5731
description	defrost timer CDC type 11901F defrosting interval 4x per 24h fan delaymin 230V		
For models:	135A, 135XE, 65A, 65XE, S125, S125-4, S125E, S125X, S125X-4, S60, S60-2, S60E, S60X, S60X-2, SA87		

defrost timers

BIGATTI

			
1			
GEV No.	360058	Ref. No.	32Z7100
description	defrost timer type SB3.82 defrosting interval 1-12x in 24h defrosting time 2-54min fan delay 0-15min 230V defr. funct. 1-12x per 24h		
For models:	40CP, 40CPX, 65NN, 65NNX, 6BMA11A, 6BMA11B, 6BMA11M, 6BMA2A, 6BMA2B, 6BMA2M, 6BMA3A, 6BMA3B, 6BMA3M, 6BMAA, 6BMAB, 6BMAM, 6BMB11A, 6BMB11B, 6BMB11M, 6BMB22A, 6BMB22B, 6BMB22M, 6BMB2A, 6BMB2B, 6BMB2M, 6BMB3A, 6BMB3B, 6BMB3M, 6BMB4A, 6BMB4B, 6BMB4M, 6BMBA, 6BMBA, 6BMBB, 6BMBM, 6BMC11A, 6BMC11B, 6BMC11M, 6BMC22A, 6BMC22B, 6BMC22M, 6BMC2A, 6BMC2B, 6BMC2M, 6BMC33A, 6BMC33B, 6BMC33M, 6BMC3A, 6BMC3B, 6BMC3M, 6BMC4A...(Other models you can see in the webshop)		

miscellaneous			
			
1			
GEV No.	360383	Ref. No.	32Z2452
description	defrost timer		

alarm devices

alarm units

			
1			
GEV No.	350056	Ref. No.	32Z5860
description	alarm device 220-240VAC ømm H 25mm wall-mounted version mounting distancemm 83dB protection IPx0		
For models:	FCV101, FCV101E, FCV141, FCV141E, FCV241, FCV241E, FCV241G, FCV241G-CSA, FCV3EM, FCV4EM, FCV61, FCV61E		

CDC

			
1			
GEV No.	360521	Ref. No.	32Z2420 32Z2421
description	defrost timer CDC type 11901F defrosting interval 4x per 24h defrosting time 12min fan delaymin 230V 50-60Hz defr. funct. every 6h		
For models:	120, 120NN, 120PV, 135, 135-4, 135BN, 135BNX, 135CPX, 135NN, 135NNX, 135PVX, 135X, 135X-3, 135X-4, 55, 55PV, 65, 65NN, 65NNX, 65PVX, 65X, 65X-2, SP65NN		

electric components



## contactors

## GENERAL ELECTRIC (AEG)

## power contactors



1

<b>GEV No.</b>	380262	<b>Ref. No.</b>	3100910 32V7170 32Z2080 32Z2083
<b>description</b>	power contactor resistive load 32A 230VAC (AC3/400V) 17A/7.5kW main contacts 3NO auxiliary contacts 1NC connection screw connection type AEG LS7K01A type GE CL02A 301 H 85mm		
<b>For models:</b>	030FE, 030FE1, 030FE1B, 04WFR3ED, 08WFR4ED, 091FE28, 091FE28B, 091FR3E, 091FR3ED, 0A1FR3E, 0A1FR3ED, 0D1FR3E, 0D1FR3ED, 0G0FR3E, 0G0FR3ED, 191FR4E, 191FR4ED, 1A1FR4E, 1A1FR4ED, 1D1FR4E, 1D1FR4ED, 1G0FR4E, 1G1BR1E, 30FES, 30FES2, 30FES2B, 31RE, 6043840, 6043970, 70FES, 70FES2, 70FES2B, 71AR, 71ARE, 91AR, FC101, FC101E, FC241E, FC241G, FC61, FC611E, FC61E, FCV101, FCV101DM, FCV101DS, FCV101E, FCV101EDM, FCV101EDS, FCV141, FCV141DM...(Other models you can see in the webshop)		



2

<b>GEV No.</b>	380265	<b>Ref. No.</b>	32Z2091
<b>description</b>	power contactor resistive load 60A 230VAC (AC3/400V) 32A/16kW main contacts 3NO auxiliary contacts 1NO connection screw connection type AEG LS15K 00A type GE CL04A 310 H 98mm L 87mm W 55mm		
<b>For models:</b>	04WCP1EM, 091CP1E, 091FR1E, 091FR1ED, 0A1FR1E, 0A1FR1ED, 0D1FR1E, 0D1FR1ED, 0G1BR3E, 191BR1E, 191BR2E, 191BR2EA, 191FR2E, 191FR2ED, 1A1BR1E, 1A1BR2E, 1A1BR2EA, 1A1FR2E, 1A1FR2ED, 1D1BR1E, 1D1BR2E, 1D1BR2EA, 1D1FR2ED, 1G1BR3E, 291BR1E, 291BR2E, 291BR2EA, 2A1BR1E, 2A1BR2E, 2A1BR2EA, 2D1BR1E, 2D1BR2E, 2D1BR2EA, 70FE1, 70FE1B, 71ARE, 71FE2, 71FE2B, 91ARE		

## Зип-Общепит

ISKRA (PULS)

## power contactors

vsezip.ru

+7(812)987-08-81



1

<b>GEV No.</b>	380415	<b>Ref. No.</b>	32Z4471
<b>description</b>	power contactor resistive load 16A 230VAC (AC3/400V) 8.5A/5.5kW main contacts 3NO auxiliary contacts 1NC connection male faston 6.3mm type Fanal DSL7 01 type ISKRA K07MF 01		



1

<b>GEV No.</b>	380212	<b>Ref. No.</b>	32V0980
<b>description</b>	power contactor resistive load 20A 230VAC (AC3/400V) 8.5A/5.5kW main contacts 3NO auxiliary contacts 1NC connection screw connection type Fanal K07M 01 type ISKRA DSL7 01		

## LOVATO

## power contactors



1

<b>GEV No.</b>	380711	<b>Ref. No.</b>	32Z3512 32Z4471
<b>description</b>	power contactor resistive load 20A 230VAC (AC3/400V) 9A/4kW main contacts 3NO auxiliary contacts 1NC connection male faston type 11BGF0901A230		
<b>For models:</b>	070FTE, 070FTE, 071BME, 071FTE, 071FTE, 071FTE, 071FTE, 090FTE, 090FTE, 091BME, 091FTE, 091FTE, 091FTE, 71ARE, 91ARE, FC1011E, FC1221E, FC241E, FCV141E, FCV141EDM, FCV141EDS, FCV241E, FCV241EDM, FCV241EDS, FCV401EDM, FCV61E, FM1011E1, FM1011E1-VERS.2006, FM1011E2, FM1011E2-VERS.2006, FM1011E3, FM1011E3-VERS.2006, FM1221E1, FM1221E1-VERS.2006, FM1221E2, FM1221E2-VERS.2006, FM1221E3, FM1221E3-VERS.2006, FM2011E2-VERS.2006, FM2011E3-VERS.2006, FM2021E1, FM2021E2, FM2021E2-VERS.2006, FM2021E3, FM2021E3-VERS.2006, FM611E3, FM721E1, FM721E1-VERS.2006, FM721E2, FM721E2-VERS.2006, FM721E3...		



Зип Общепит

vsezip.ru

+7(812)987-08-81



1

<b>GEV No.</b>	380704	<b>Ref. No.</b>	32V6550
<b>description</b>	power contactor resistive load 20A 230VAC (AC3/400V) 9A/4kW main contacts 3NO auxiliary contacts 1NC connection screw connection type 11BG0901A230		
<b>For models:</b>	08WGREV, 190GRE, 191BR2EA, 1A1BR2EA, 1D1BR2EA, 1G0GRE, 291BR1GA, 291BR2EA, 291BR2GA, 2A1BR1GA, 2A1BR2EA, 2A1BR2GA, 2D1BR1GA, 2D1BR2GA, FC1011E, FC1011G, FC1221E, FC1221G, FC611E, FC611G, FCV3EM, FM1011E3, FM1011E3-VERS.2006, FM1011G3, FM1011G3-VERS.2006, FM1221E3, FM1221E3-VERS.2006, FM1221G3, FM1221G3-VERS.2006, FM2021E3, FM2021G3, FM423E1, FM423E2, FM611E3, FM611E3-VERS.2006, FM611G3, FM611G3-VERS.2006, FM721E3, FM721E3-VERS.2006, FM721G3, FM721G3-VERS.2006, FX101E3, FX101E3C, FX101E3C-VERS.022014, FX101E3R, FX101E3R-VERS.022014, FX101E3-VERS.022014, FX101G3, FX101G3C, FX101G3C-VERS.022014...(Other models you can see in the webshop)		





1

<b>GEV No.</b>	380782	<b>Ref. No.</b>	32Z2090
<b>description</b>	power contactor resistive load 40A 230VAC (AC3/400V) 12.5kW main contacts 3NO connection screw connection		



1

<b>GEV No.</b>	380705	<b>Ref. No.</b>	32V1880
<b>description</b>	power contactor resistive load 20A 230VAC (AC3/400V) 9A/4kW main contacts 3NO auxiliary contacts 1NO connection screw connection type 11BG0910A230		
<b>accessories for</b>	380705		
		<b>GEV No.</b>	380057
		<b>Ref. No.</b>	—
	auxiliary contact contacts 1NO/1NC AC1 10A for contactors BG series connection screw type BGX1011		



1

<b>GEV No.</b>	380721	<b>Ref. No.</b>	3110890
<b>description</b>	power contactor resistive load 45A 230VAC (AC3/400V) 26A/13kW main contacts 3NO auxiliary contacts connection screw connection type BF2600A230		
<b>For models:</b>	091CP1E, 091FR1E, 091FR1EA, 091FR1ED, 091FR1EX, 0A1FR1E, 0A1FR1ED, 0D1FR1E, 0D1FR1ED, 191BR1E, 191BR2E, 191BR2EA, 191FR2E, 191FR2ED, 1A1FR2E, 1A1FR2ED, 1D1FR2ED, 291BR1E, 291BR2E, 291BR2EA, FX122E3, FX122E3C, FX122E3T, FX122E3T-VERS.022014, FX12E3CT, FX12E3CT-VERS.022014, FX201E3, FX201E3P, FX201E3P-VERS.022014, FX201E3-VERS.022014, FX202E3, FX202E3-VERS.022014		



1

<b>GEV No.</b>	380083	<b>Ref. No.</b>	3100940 32V5290
<b>description</b>	power contactor resistive load 25A 230VAC (AC3/400V) 9A/4.2kW main contacts 3NO auxiliary contacts 1NC connection screw connection type BF0901A230		
<b>For models:</b>	04WBMEV, 06WFT1EV, 06WFT2EV, 06WFT3EV, 06WFT4EV, 06WFT6EV, 06WFT7EV, 08WFT1EV, 08WFT2EV, 08WFT3EV, 08WFT4EV, 08WFT6EV, 08WFT7EV, 091FT1E, 091FT2E, 091FT4E, 091FT5E, 091FT7E, 0G1CP1EC, 0G1FT2E, 0G1FT4E, 0G1FT5E, 0G1FT7E, 191FT1E, 191FT2E, 191FT3E, 191FT4E, 191FT6E, 191FT7E, 1G1FT2E, 1G1FT4E, 1G1FT5E, 1G1FT6E, 1G1FT7E, BX101E, BX101E-VERS.122013, BX101G, BX101G-VERS.122013, BX122E, BX122E-VERS.122013, BX122G, BX122G-VERS.122013, BX61E, BX61E-VERS.122013, BX61G, BX61G-VERS.122013, BX82E, BX82E-VERS.122013, BX82G, BX82G-VERS.122013...(Other models you can see in the webshop)		



1

<b>GEV No.</b>	380722	<b>Ref. No.</b>	3100930 32Z3511
<b>description</b>	power contactor resistive load 56A 230VAC (AC3/400V) 32A/16kW main contacts 3NO auxiliary contacts connection screw connection type BF3200A230		
<b>For models:</b>	091FR1ED, 10CP1EA, 12CP1EA, 18CP2EA, BRE21HD, BRE31HD, BX101E, BX101E-VERS.122013, BX122E, BX122E-VERS.122013, BX61E, BX61E-VERS.122013, BX82E, BX82E-VERS.122013, FC1011E, FC101E, FC1221E, FC241E, FCV101E, FCV101EDM, FCV101EDS, FCV141E, FCV141EDM, FCV141EDS, FCV241E, FCV241EDM, FCV241EDS, FCV401EDM, FCV61E, FM1011E1, FM1011E1-VERS.2006, FM1011E2, FM1011E2-VERS.2006, FM1011E3, FM1011E3-VERS.2006, FM1221E1, FM1221E1-VERS.2006, FM1221E2, FM1221E2-VERS.2006, FM1221E3, FM1221E3-VERS.2006, FM2011E2-VERS.2006, FM2011E3-VERS.2006, FM2021E1, FM2021E2, FM2021E2-VERS.2006, FM2021E3, FM2021E3-VERS.2006, FM611E3, FM721E1...(Other models you can see in the webshop)		

electric components



## MOELLER/EATON

## power contactors



1

<b>GEV No.</b>	380171	<b>Ref. No.</b>	32Z4840
<b>description</b>	power contactor resistive load 20A 230VAC (AC3/400V) 9A/4kW main contacts 3NO auxiliary contacts 1NO connection screw connection type DILEM 10		
<b>For models:</b>	LCV, P10, P102, P10M, P20, P202, P5, Q3, Q3M, Q5, Q52, Q5M, Q8, Q82, TV1, TV1M, TV2L		

## SIEMENS

## power contactors



1

<b>GEV No.</b>	380646	<b>Ref. No.</b>	32Z9250
<b>description</b>	power contactor resistive load 40A 230VAC (AC3/400V) 17A/7.5kW main contacts 3NO auxiliary contacts connection screw connection type 3RT10-25-1AL20		
<b>For models:</b>	ART1L7, ART1L7A, ART1L7M, ART1LD, ART1LD7, ART1LD7A, ART1LD7M, ART1LDA, ART2LD, ART2SD, ART3SD, B1101S, B151H, B151M, BF101L, BF101S, BF51H, BF51M, D12Q1M, D12Q2, D12Q2M, DS51, DS51A, DS51C, DS51M, FS611, GR135BT, GR140TN4, GR65BT, GR65TN4, IA101L, IA101S, IA51, IA51A, IA51C, IA51M, IA72S, IS101L, IS101LW, IS101S, IS101SR, IS101SW, IS102S, IS102SR-0NR01, IS102SW, IS51, IS51A, IS51AR, IS51C, IS51CR...(Other models you can see in the webshop)		

## power contactors



1

<b>GEV No.</b>	380617	<b>Ref. No.</b>	32Z8680
<b>description</b>	power contactor resistive load 25A 24VAC (AC3/400V) 9A/4kW main contacts 3NO auxiliary contacts 1NO/1NC connection screw connection type LC1D09B7		
<b>For models:</b>	C165D, C165S, C165VD, C165VS, C207D, C207S, C207VD, C207VS, C304AD, C304AS, C304AVD, C304AVS, C304D, C304S, C304VD, C304VS, CS243D, CS243S, CS243VD, CS243VS, CS370AD, CS370AS, CS370AVD, CS370AVS, CS370D, CS370S, CS370VD, CS370VS, CS466AD, CS466AS, CS466AVD, CS466AVS, CS466D, CS466S, CS466VD, CS466VS, N303D, N303S, N303VD, N303VS, N354D, N354S, N354VD, N354VS, N506D, N506S, N506VD, N506VS, N607D, N607S...(Other models you can see in the webshop)		

## relays

## power relays

## with flange mounting



1

<b>GEV No.</b>	380817	<b>Ref. No.</b>	32Z7930
<b>description</b>	power relays Italiana Relè 230VAC 16A 2NO connection male faston 6.3mm screw mounting manuf. no. B1-2-230AC		
<b>For models:</b>	LT25F		

## with bracket mounting



1

<b>GEV No.</b>	380815	<b>Ref. No.</b>	32V0540
<b>description</b>	power relays 230VAC 16A 2NO connection male faston 6.3mm flange dimensions 36x38x68mm		
<b>For models:</b>	LC100, LC100-VERS.2001, LC130, LC130-VERS.2001, LC80, LF50, LF50E		



Зип Общепит  
plug in/print relays

vsezip.ru

+7(812)987-08-81



1

<b>GEV No.</b>	380139	<b>Ref. No.</b>	32V2950 32V7100 32Z2000
<b>description</b>	power relays FINDER 230VAC 16A 2CO connection F6.3 bracket mounting dimensions 68x38.2x35.8mm manuf. no. 62.82.8.230.0000		
<b>For models:</b>	F60P, F60PR, F60T, F80P, F80PR, KD100, KD100A, KD100PSD, KD37, KD40, KD85, KD85A, KD85PS, KD85PSA, KN35, KN37, KN37PS, KN40, KN40PS, KN40PSD, KN50, KN50M, KN50MPS, KN50PS, KN50PSD, KN50PSDD, KN80, KN80PS, L100, L40, L40S, L45, L60, L80, LC100, LC100-VERS.2001, LC130, LC130-VERS.2001, LC80, LP151		



1

<b>GEV No.</b>	380403	<b>Ref. No.</b>	32V2940
<b>description</b>	power relays FINDER 230VAC 16A 3CO connection F6.3 bracket mounting manuf. no. 62.83.8.230.0500		
<b>For models:</b>	LF50EM, LP124, LP124V, LP84V		







1

<b>GEV No.</b>	380185	<b>Ref. No.</b>	32V3720
<b>description</b>	power relays Italiana Relè 230VAC 30A 1NO connection F6.3 bracket mounting dimensions 36.5x32.2x51.8mm manuf. no. A10-230AC-FA		

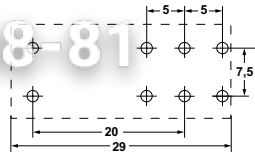

1



<b>GEV No.</b>	380333	<b>Ref. No.</b>	32V6630	
<b>description</b>	print relay 230VAC 2CO at 250V 8A connection pins raster size 5mm FINDER manuf. no. 40.52.8.230.0000 95.65/95.75			
<b>For models:</b>	191BR2EA, FM1221G1, FM1221G2, FM1221G3, FM2011G2-VERS.2006, FM2011G3-VERS.2006, FM2021G1, FM2021G2, FM2021G2-VERS.2006, FM2021G3, FM2021G3-VERS.2006			
<b>accessories for</b>	380333			
	<b>GEV No.</b>	380340	<b>Ref. No.</b>	—
	relay socket dimensions 62x36x15mm 250V voltage AC 10A Italiana Relè manuf. no. ZMEM/5			
	<b>GEV No.</b>	380505	<b>Ref. No.</b>	—
	relay socket 2CO 40.52 dimensions 81.9x15.5x75mm 250V voltage AC 10A FINDER manuf. no. 95.95.3			
	<b>GEV No.</b>	381181	<b>Ref. No.</b>	—
	relay socket 2-pole 40.51/40.52/40.61 connection screw clamp dimensions 15.8x78.6mm 250V voltage AC 10A FINDER manuf. no. 95.75			

transformers

open transformers

with clamp terminal



1

<b>GEV No.</b>	403905	<b>Ref. No.</b>	3117170
<b>description</b>	transformer primary 230V/50-60Hz secondary 12V 50VA connection screw connection type T1ULF		
<b>For models:</b>	10CP1EA, 10CP1GA, 10CP1IA, 12CP1EA, 12CP1GA, 12CP1IA, 18CP2EA, 18CP2GA, 18CP2IA, FX101E1, FX101E1R, FX101E2, FX101E2C, FX101E2C-VERS.032014, FX101E2R, FX101E2R-VERS.032014, FX101E2-VERS.032014, FX101E3, FX101E3C, FX101E3C-VERS.022014, FX101E3R, FX101E3R-VERS.022014, FX101E3-VERS.022014, FX101G1, FX101G1R, FX101G2, FX101G2C, FX101G2C-VERS.032014, FX101G2R, FX101G2R-VERS.032014, FX101G2-VERS.032014, FX101G3, FX101G3C, FX101G3C-VERS.022014, FX101G3R, FX101G3R-VERS.022014, FX101G3-VERS.022014, FX10E2CR, FX10E2CR-VERS.032014, FX10E3CR, FX10E3CR-VERS.022014, FX10G2CR, FX10G2CR-VERS.032014, FX10G3CR, FX10G3CR-VERS.022014, FX122E1, FX122E2, FX122E2C, FX122E2T, FX122E2T-VERS.032014...(Other models you can see in the webshop)		

1 electric components



electric components

Зип Обществит  
electronic controllers

vsezip.ru

refrigeration controllers

built-in version

+7(812)987-08-81

with plug connection



<b>GEV No.</b>	400956	<b>Ref. No.</b>	32V5770
<b>description</b>	transformer primary 230VAC secondary 12VAC 20VA connection male faston 6.3mm 50/60Hz type T602012/E temperature restriction 150°C ambient temperature max. 80°C		
<b>For models:</b>	B1101S, B151H, B151M, BF101L, BF101S, BF51H, BF51M, BX101E, BX101E-VERS.122013, BX101G, BX101G-VERS.122013, BX61E, BX61E-VERS.122013, BX61G, BX61G-VERS.122013, BX82E, BX82E-VERS.122013, BX82G, BX82G-VERS.122013, FM1011E1, FM1011E1-VERS.2006, FM1011E2, FM1011E2-VERS.2006, FM1011E3, FM1011E3-VERS.2006, FM1011G1, FM1011G1-VERS.2006, FM1011G2, FM1011G2-VERS.2006, FM1011G3, FM1011G3-VERS.2006, FM611E1, FM611E1-VERS.2006, FM611E2, FM611E2-VERS.2006, FM611E3, FM611E3-VERS.2006, FM611G1, FM611G1-VERS.2006, FM611G2, FM611G2-VERS.2006, FM611G3, FM611G3-VERS.2006, FM721E1, FM721E1-VERS.2006, FM721E2, FM721E2-VERS.2006, FM721E3, FM721E3-VERS.2006, FM721G1...(Other models you can see in the webshop)		

encapsulated transformers

PMA



<b>GEV No.</b>	379054	<b>Ref. No.</b>	32Z3470
<b>description</b>	transformer primary 230VAC secondary 12VAC 3VA secondary 0.25A H 40mm L 45mm W 50mm connection screw 50/60Hz type 153/M		
<b>For models:</b>	120, 120B, 120PV, 135, 135-4, 135B, 135BA, 135BN, 135BNX, 135BX, 135BXE, 135BXR, 135CPX, 135PVX, 135X, 135X-3, 135X-4, 135XR, 40CP, 40CPX, 55, 55B, 55PV, 65, 65B, 65BA, 65BX, 65BX-2, 65BXE, 65BXR, 65NB, 65NBX, 65PVX, 65X, 65X-2, 65XR, 6BMA11A, 6BMA11B, 6BMA11M, 6BMA11Z, 6BMA2A, 6BMA2B, 6BMA2M, 6BMA2Z, 6BMA3A, 6BMA3B, 6BMA3M, 6BMA3Z, 6BMAA, 6BMAB...(Other models you can see in the webshop)		

ELIWELL

built-in version



<b>GEV No.</b>	379114	<b>Ref. No.</b>	32Z3460
<b>description</b>	electronic controller ELIWELL type EWPC961 mounting measurements 71x29mm		



<b>GEV No.</b>	379102	<b>Ref. No.</b>	32Z3660
<b>description</b>	electronic controller ELIWELL type EWPC970 mounting measurements 71x29mm 12V relay outputs 8A		



<b>GEV No.</b>	379614	<b>Ref. No.</b>	32V7580
<b>description</b>	electronic controller ELIWELL type ID961 mounting measurements 71x29mm 230V voltage AC NTC/PTC front measurements 33x75mm protection IP65 1x NTC probe inclusive -50 up to +150°C display 3½ digit LCD 1999 Digits		
<b>For models:</b>	MX120, MX130, MX130NN, MX140, MX150, MX150NN, MX60, MX70		
<b>accessories for</b>	379614		

<b>GEV No.</b>	378194	<b>Ref. No.</b>	32V6000
<b>description</b>	temperature probe NTC 10kOhm cable PVC probe -20 up to +80°C cable -10 up to 100°C probe ø7x24.5mm cable length 1.5m without screw connection 2-wire		
<b>GEV No.</b>	379052	<b>Ref. No.</b>	—
<b>description</b>	temperature probe PTC 1kOhm cable silicone probe -50 up to +150°C cable -50 up to +180°C probe ø6x40mm cable length 1.5m without screw connection 2-wire		
<b>GEV No.</b>	379053	<b>Ref. No.</b>	—
<b>description</b>	temperature probe PTC 1kOhm cable PVC probe -50 up to +150°C cable -10 up to 100°C probe ø6x30mm cable length 3m without screw connection 2-wire		
<b>GEV No.</b>	379057	<b>Ref. No.</b>	—
<b>description</b>	temperature probe NTC 10kOhm cable PVC probe -20 up to +80°C cable -10 up to 100°C probe ø6x25mm cable length 3m 2-wire		
<b>GEV No.</b>	379064	<b>Ref. No.</b>	8223470
<b>description</b>	temperature probe PTC 1kOhm cable silicone probe -50 up to +150°C cable -50 up to +180°C probe ø6x40mm cable length 3m without screw connection 2-wire		

Table continues overleaf





Зип-Общепит  
refrigerator controllers

accessories for		379614	
GEV No.	379142	Ref. No.	—
	temperature probe PTC 1kOhm cable PVC probe -50 up to +150°C cable -10 up to 100°C probe ø6x30mm cable length 1.5m without screw connection 2-wire		
	temperature probe NTC 10kOhm cable thermoplastic probe -40 up to +110°C cable -40 up to +110°C probe ø6x14mm cable length 1.5m without screw connection 2-wire		
	temperature probe NTC 10kOhm cable thermoplastic probe -40 up to +110°C cable -40 up to +110°C probe ø6x14mm cable length 3m without screw connection 2-wire		32V6010
	temperature probe NTC 10kOhm cable silicone probe -40 up to +110°C cable -50 up to +180°C probe ø6x40mm cable length 3m 2-wire		32V3730
	temperature probe NTC 10kOhm cable silicone probe -40 up to +110°C cable -50 up to +180°C probe ø6x40mm cable length 1.5m without screw connection 2-wire		—
	temperature probe PTC 1kOhm cable thermoplastic probe -50 up to +150°C cable -40 up to +110°C probe ø6x14mm cable length 1.5m without screw connection 2-wire		—
	temperature probe PTC 1kOhm cable thermoplastic probe -50 up to +150°C cable -40 up to +110°C probe ø6x14mm cable length 3m 2-wire resistor 1kOhm		—

built-in version



1

GEV No.	379232	Ref. No.	32V6500
<b>description</b>	electronic controller		
<b>For models:</b>	CX70R		

EVCO - EVERY CONTROL

universal controllers

built-in version



1

GEV No.	379632	Ref. No.	32V0421
<b>description</b>	electronic controller EVERY CONTROL mounting measurements 135x66mm built-in depth 67mm 230V voltage AC with accessories -50 up to +100°C type ECS805P220D306 front measurements 142x70mm		
<b>For models:</b>	ART2LD, ART2SD, ART3SD		



1

GEV No.	381388	Ref. No.	32V2090
<b>description</b>	electronic controller ANGELO PO conversion kit mounting measurements 71x29mm 230V voltage AC NTC front measurements 33x75mm protection IP65 1x NTC probe inclusive -40 up to +99°C		
<b>For models:</b>	6SMA, 6SMA2, 6SMA2A, 6SMA2B, 6SMA2M, 6SMA2Z, 6SMA4Z, 6SMAA, 6SMAB, 6SMAM, 6SMAZ, 6SMB, 6SMB2, 6SMB2A, 6SMB2B, 6SMB2M, 6SMB2Z, 6SMB4, 6SMB4A, 6SMB4B, 6SMB4M, 6SMB4Z, 6SMB6Z, 6SMB6A, 6SMB6B, 6SMB6M, 6SMB6Z, 6SMC, 6SMC2, 6SMC2A, 6SMC2B, 6SMC2M, 6SMC2Z, 6SMC4, 6SMC4A, 6SMC4B, 6SMC4M, 6SMC4Z, 6SMC6, 6SMC6A, 6SMC6B, 6SMC6M, 6SMC6Z, 6SMC8Z, 6SMCA, 6SMCB, 6SMCM, 6SMCZ, PE1633, PE1633V...(Other models you can see in the webshop)		



1

GEV No.	379616	Ref. No.	32V5020
<b>description</b>	electronic controller EVERY CONTROL mounting measurements 71x29mm 12V voltage AC TC-K protection IP65 0-999°C type FK400A front measurements 33x75mm		
<b>For models:</b>	FPZ4G, FPZ6G		



1

GEV No.	379613	Ref. No.	32V2980
<b>description</b>	electronic controller ANGELO PO mounting measurements 71x29mm 12V voltage AC NTC front measurements 33x75mm protection IP65 2xNTC probe inclusive -40 up to +110°C		
<b>For models:</b>	135B, 135BN, 135BNX, 135BX, 135BXR, 65B, 65BX, 65BX-2, 65BXR, 65NB, 65NBX, SP65NB		

electric components

Зип Общепит

vsezip.ru

+7(812)987-08-81



<b>GEV No.</b>	379609	<b>Ref. No.</b>	32V6060
<b>description</b>	electronic controller ANGELO PO mounting measurements 71x29mm 12V voltage AC NTC relay outputs 1 relay front measurements 33x75mm protection IP65 2xNTC probe inclusive -40 up to +99°C compressor relay 16A		
<b>For models:</b>	CX130B, CX60B, FX150B, FX70B, MX120B, MX140B, MX55B, MX65B, S1200B, S1200B4, S1200BE, S600B, S600B2, S600BE		



<b>GEV No.</b>	378192	<b>Ref. No.</b>	32V6900
<b>description</b>	electronic controller EVERY CONTROL type EVK201 mounting measurements 71x29mm 230V voltage AC NTC relay outputs 1 relay 1CO NTC defr. funct. no -50 up to +150°C display 3½ digits compressor relay 10A		
<b>For models:</b>	6SMA, 6SMA2, 6SMA2A, 6SMA2B, 6SMA2M, 6SMA2Z, 6SMA4Z, 6SMAA, 6SMAB, 6SMAM, 6SMAZ, 6SMB, 6SMB2, 6SMB2A, 6SMB2B, 6SMB2M, 6SMB2Z, 6SMB4, 6SMB4A, 6SMB4B, 6SMB4M, 6SMB4Z, 6SMB6Z, 6SMBA, 6SMBB, 6SMBM, 6SMBZ, 6SMC, 6SMC2, 6SMC2A, 6SMC2B, 6SMC2M, 6SMC2Z, 6SMC4, 6SMC4A, 6SMC4B, 6SMC4M, 6SMC4Z, 6SMC6, 6SMC6A, 6SMC6B, 6SMC6M, 6SMC6Z, 6SMC8Z, 6SMCA, 6SMCB, 6SMCM, 6SMCZ, PE1633, PE1633V...(Other models you can see in the webshop)		



<b>GEV No.</b>	379608	<b>Ref. No.</b>	32V6080
<b>description</b>	electronic controller EVERY CONTROL mounting measurements 71x29mm 12V voltage AC NTC relay outputs 1 relay front measurements 33x75mm protection IP65 2xNTC probe inclusive -40 up to +99°C compressor relay 16A		
<b>For models:</b>	CX130B, CX150B, CX150BN, CX150BR, CX60B, CX70B, CX70BR		



<b>GEV No.</b>	378126	<b>Ref. No.</b>	3087950 3107290 3120900 32V6920 32V7490 32V7820 32V8590
<b>description</b>	electronic controller EVERY CONTROL type EVK201N7 mounting measurements 71x29mm 230V voltage AC NTC/PTC relay outputs 1 CO-16A(5) NTC/PTC front measurements 33x75mm built-in depth 59mm protection IP65 -40 up to +105°C display 3½ digits		
<b>For models:</b>	3G6SA, 3G6SA2, 3G6SA4, 4G6SB, 4G6SB2, 4G6SB4, 4G6SB6, 6BR15V, 6BR15VC, 6BR19V, 6BR19VC, 6MA, 6MA2, 6MA2A, 6MA2M, 6MAA, 6MAM, 6MB, 6MB11, 6MB11A, 6MB11M, 6MB2, 6MB2A, 6MB2M, 6MB4, 6MB4A, 6MB4M, 6MBA, 6MBM, 6MC, 6MC11, 6MC11A, 6MC11M, 6MC2, 6MC2A, 6MC2M, 6MC4, 6MC4A, 6MC4M, 6MCA, 6MCM, 6MJA, 6MJA2, 6MJA2A, 6MJA2M, 6MJAA, 6MJAM, 6MJB, 6MJB2, 6MJB2A...(Other models you can see in the webshop)		



<b>GEV No.</b>	378187	<b>Ref. No.</b>	32V6050
<b>description</b>	electronic controller EVERY CONTROL mounting measurements 71x29mm 230V voltage AC NTC/PTC relay outputs 1 CO -50 up to +150°C display 3½ digits		
<b>For models:</b>	CX130, CX130NN, CX60, FX150, FX150NN, FX70		

<b>accessories for</b>	378126	<b>GEV No.</b>	379053	<b>Ref. No.</b>	—
			temperature probe PTC 1kOhm cable PVC probe -50 up to +150°C cable -10 up to 100°C probe ø6x30mm cable length 3m without screw connection 2-wire		
		<b>GEV No.</b>	379064	<b>Ref. No.</b>	8223470
			temperature probe PTC 1kOhm cable silicone probe -50 up to +150°C cable -50 up to +180°C probe ø6x40mm cable length 3m without screw connection 2-wire		
		<b>GEV No.</b>	379161	<b>Ref. No.</b>	32V6010
			temperature probe NTC 10kOhm cable thermoplastic probe -40 up to +110°C cable -40 up to +110°C probe ø6x14mm cable length 3m without screw connection 2-wire		
		<b>GEV No.</b>	379782	<b>Ref. No.</b>	—
			temperature probe PTC 1kOhm cable thermoplastic probe -50 up to +150°C cable -40 up to +110°C probe ø6x14mm cable length 3m 2-wire resistor 1kOhm		



Зип Общепит

vsezip.ru

+7(812)987-08-81



71 x 29mm



1

<b>GEV No.</b>	378154	<b>Ref. No.</b>	3048060 3096600 3106300 3107300 3119780
<b>description</b>	electronic controller EVERY CONTROL type EVK203N7VXBS mounting measurements 71x29mm 230V voltage AC NTC/PTC relay outputs 3 NO-16A(5) CO-8A(4) NO-8A(4) NTC/PTC NTC/PTC DI front measurementsmm built-in depth 59mm protection IP65 yes -50 up to +150°C display 3½ digits		
<b>For models:</b>	6ERA-OPR01, 6ERA2-OPR01, 6ERA2A-OPR01, 6ERA2M-OPR01, 6ERAA-OPR01, 6ERAM-OPR01, 6ERB-OPR01, 6ERB2-OPR01, 6ERB2A-OPR01, 6ERB2M-OPR01, 6ERB4-OPR01, 6ERB4A-OPR01, 6ERB4M-OPR01, 6ERBA-OPR01, 6ERBM-OPR01, 6ERC-OPR01, 6ERC2-OPR01, 6ERC2A-OPR01, 6ERC2M-OPR01, 6ERC4-OPR01, 6ERC4A-OPR01, 6ERC4M-OPR01, 6ERCA-OPR01, 6ERCM-OPR01, BS11, BS11A, BS11M, BS16, BS16A, BS16M, BS21, BS21A, BS21M, BSR11, BSR11A, BSR11M, BSR16, BSR16A, BSR16M, BSR21, BSR21A, BSR21M, MD130, MD130BN, MD130NN, MD150, MD150A, MD150BN, MD150NCP, MD150NN...(Other models you can see in the webshop)		
<b>accessories for</b>	378154		
	<b>GEV No.</b>	379053	<b>Ref. No.</b> —
	temperature probe PTC 1kOhm cable PVC probe -50 up to +150°C cable -10 up to 100°C probe ø6x30mm cable length 3m without screw connection 2-wire		
	<b>GEV No.</b>	379064	<b>Ref. No.</b> 8223470
	temperature probe PTC 1kOhm cable silicone probe -50 up to +150°C cable -50 up to +180°C probe ø6x40mm cable length 3m without screw connection 2-wire		
	<b>GEV No.</b>	379161	<b>Ref. No.</b> 32V6010
	temperature probe NTC 10kOhm cable thermoplastic probe -40 up to +110°C cable -40 up to +110°C probe ø6x14mm cable length 3m without screw connection 2-wire		
	<b>GEV No.</b>	379782	<b>Ref. No.</b> —
	temperature probe PTC 1kOhm cable thermoplastic probe -50 up to +150°C cable -40 up to +110°C probe ø6x14mm cable length 3m 2-wire resistor 1kOhm		



<b>GEV No.</b>	378188	<b>Ref. No.</b>	32V6070 32V6270
<b>description</b>	electronic controller EVERY CONTROL type FK203B mounting measurements 71x29mm 12V voltage AC/DC NTC relay outputs 3 relays -40 up to +99°C DEF Relay 8A fan relay 8A compressor relay 10A		
<b>For models:</b>	CX130, CX130NN, CX150, CX150BN, CX150CP, CX150NN, CX150PV, CX150R, CX60, CX70, CX702, CX70PV		



1

<b>GEV No.</b>	378190	<b>Ref. No.</b>	32V6280
<b>description</b>	electronic controller EVERY CONTROL type FK203B mounting measurements 71x29mm 12V voltage AC/DC NTC relay outputs 3 relays -40 up to +99°C DEF Relay 8A fan relay 8A compressor relay 10A		
<b>For models:</b>	CX70NB, CX70NN		



1

<b>GEV No.</b>	378191	<b>Ref. No.</b>	32V6260
<b>description</b>	electronic controller EVERY CONTROL type FK203B mounting measurements 71x29mm 12V voltage AC/DC NTC relay outputs 3 relays -40 up to +99°C DEF Relay 8A fan relay 8A compressor relay 10A		



1

<b>GEV No.</b>	378193	<b>Ref. No.</b>	32V2920
<b>description</b>	electronic controller EVERY CONTROL type FK206A mounting measurements 71x29mm 12V voltage AC/DC NTC -40 up to +99°C		
<b>For models:</b>	6JA, 6JA2, 6JA2A, 6JA2M, 6JAA, 6JAM, 6JB, 6JB2, 6JB2A, 6JB2M, 6JB4A, 6JB4M, 6JBA, 6JBM		



1

<b>GEV No.</b>	378189	<b>Ref. No.</b>	32V6290 32V6300
<b>description</b>	electronic controller EVERY CONTROL type EVK213 mounting measurements 71x29mm 12V voltage AC/DC NTC/PTC relay outputs 3 relays -40 up to +105°C display 3½ digits DEF Relay 8A fan relay 8A compressor relay 16A		
<b>For models:</b>	CX150CP, CX70NB		

Зип-Общепит

accessories

vsezip.ru

+7(812)987-08-81



1	<b>GEV No.</b>	379615	<b>Ref. No.</b>	32V7490
<b>description</b>	electronic controller mounting measurements 71x29mm 230V voltage AC NTC relay outputs 1 relay front measurements 33x75mm protection IP65 1x NTC probe inclusive -40 up to +99°C compressor relay 16A			
<b>For models:</b>	40, 40-OPR01, 40PV, 40PV-OPR01, 40X, 40X-OPR01, 40XPV			



1	<b>GEV No.</b>	378197	<b>Ref. No.</b>	32V7460
<b>description</b>	printer EVERY CONTROL PM100AX9S201 mounting measurements 90x90mm			
<b>For models:</b>	ISP202R, ISR201R, ISR202R, SM14SR, SM7SR			

electronic thermometers

built-in version



1	<b>GEV No.</b>	379900	<b>Ref. No.</b>	32Z8250
<b>description</b>	thermometer EVERY CONTROL type TM103T N4 mounting measurements 58x25.5mm 24V voltage AC -40 up to +110°C measuring input NTC display 2½ digit front measurements 31x64mm protection IP54 accuracy 1%			
<b>For models:</b>	C165D, C165S, C165VD, C165VS, C207D, C207D-VERS.2006, C207S, C207S-VERS.2006, C207VD, C207VD-VERS.2006, C207VS, C207VS-VERS.2006, C304AD, C304AD-VERS.2006, C304AS, C304AS-VERS.2006, C304AVD, C304AVD-VERS.2006, C304AVS, C304AVS-VERS.2006, C304D, C304D-VERS.2006, C304S, C304S-VERS.2006, C304VD, C304VD-VERS.2006, C304VS, C304VS-VERS.2006, C92D-VERS.2006, C92S-VERS.2006, C92VD-VERS.2006, C92VS-VERS.2006, CS243D, CS243D-VERS.2006, CS243S, CS243S-VERS.2006, CS243VD, CS243VD-VERS.2006, CS243VS, CS243VS-VERS.2006, CS370AD, CS370AD-VERS.2006, CS370AS, CS370AS-VERS.2006, CS370AVD, CS370AVD-VERS.2006, CS370AVS, CS370AVS-VERS.2006, CS370D, CS370D-VERS.2006...(Other models you can see in the webshop)			

SHANGFANG

accessories



1	<b>GEV No.</b>	379054	<b>Ref. No.</b>	32Z3470
<b>description</b>	transformer primary 230VAC secondary 12VAC 3VA secondary 0.25A H 40mm L 45mm W 50mm connection screw 50/60Hz type 153/M			
<b>For models:</b>	120, 120B, 120PV, 135, 135-4, 135B, 135BA, 135BN, 135BNX, 135BX, 135BXE, 135BXR, 135CPX, 135PVX, 135X, 135X-3, 135X-4, 135XR, 40CP, 40CPX, 55, 55B, 55PV, 65, 65B, 65BA, 65BX, 65BX-2, 65BXE, 65BXR, 65NB, 65NBX, 65PVX, 65X, 65X-2, 65XR, 6BMA11A, 6BMA11B, 6BMA11M, 6BMA11Z, 6BMA2A, 6BMA2B, 6BMA2M, 6BMA2Z, 6BMA3A, 6BMA3B, 6BMA3M, 6BMA3Z, 6BMAA, 6BMAB...(Other models you can see in the webshop)			

probes  
universal probes

temperature probes



1	<b>GEV No.</b>	378194	<b>Ref. No.</b>	32V6000
<b>description</b>	temperature probe NTC 10kOhm cable PVC probe -20 up to +80°C cable -10 up to 100°C probe ø7x24.5mm cable length 1.5m without screw connection 2-wire			
<b>For models:</b>	6MA, 6MA2, 6MA2A, 6MA2M, 6MAA, 6MAM, 6MB, 6MB11, 6MB11A, 6MB11M, 6MB2, 6MB2A, 6MB2M, 6MB4, 6MB4A, 6MB4M, 6MBA, 6MBM, 6MC, 6MC11, 6MC11A, 6MC11M, 6MC2, 6MC2A, 6MC2M, 6MC4, 6MC4A, 6MC4M, 6MCA, 6MCM, 6MJA, 6MJA2, 6MJA2A, 6MJA2M, 6MJAA, 6MJAM, 6MJB, 6MJB2, 6MJB2A, 6MJB2M, 6MJB4, 6MJB4A, 6MJB4M, 6MJB4, 6MJBM, BP41P, BP41X, BP53G, BP53V, BP53X...(Other models you can see in the webshop)			





Зип Общепит

vsezip.ru

(812)9877093

			
<b>GEV No.</b>	379343	<b>Ref. No.</b>	32V3730
<b>description</b>	temperature probe NTC 10kOhm cable silicone probe -40 up to +110°C cable -50 up to +180°C probe ø6x40mm cable length 3m 2-wire		
<b>For models:</b>	6EA, 6EA11, 6EA11A, 6EA11M, 6EA13, 6EA13A, 6EA13M, 6EA2, 6EA2A, 6EA2M, 6EAA, 6EAB, 6EABA, 6EABM, 6EAM, 6EB, 6EB11, 6EB11A, 6EB11M, 6EB13, 6EB13A, 6EB13M, 6EB2, 6EB22, 6EB22A, 6EB22M, 6EB2A, 6EB2M, 6EB4, 6EB4A, 6EB4M, 6EBA, 6EBB, 6EBBA, 6EBBM, 6EBM, 6EC, 6EC11, 6EC11A, 6EC11M, 6EC13, 6EC13A, 6EC13M, 6EC2, 6EC22, 6EC22A, 6EC22M, 6EC2A, 6EC2M, 6EC4...(Other models you can see in the webshop)		

			
<b>GEV No.</b>	379932	<b>Ref. No.</b>	32Z6041
<b>description</b>	temperature probe Pt100 cable silicone probe -100 up to 450°C cable -50 up to +180°C connection 3-wire thread M10x1 probe ø3x130mm cable length 1.5m		
<b>For models:</b>	FCV101DM, FCV101DM-CSA, FCV101DS, FCV101DS-CSA, FCV101EDM, FCV101EDM-UL, FCV101EDS, FCV101EDS-UL, FCV141DM, FCV141DM-CSA, FCV141DS, FCV141DS-CSA, FCV141EDM, FCV141EDS, FCV241DM, FCV241DS, FCV241EDM, FCV241EDM-UL, FCV241EDS, FCV241EDS-UL, FCV241GDM, FCV241GDM-CSA, FCV241GDS, FCV241GDS-CSA, FCV401DM, FCV401DM-CSA, FCV401EDM, FCV401EDM-UL, FCV61DM, FCV61DM-CSA, FCV61DS, FCV61DS-CSA, FCV61EDM, FCV61EDM-UL, FCV61EDS, FCV61EDS-UL, FCV72EDM-UL, FCV72EDS-UL		

			
<b>GEV No.</b>	379161	<b>Ref. No.</b>	32V6010
<b>description</b>	temperature probe NTC 10kOhm cable thermoplastic probe -40 up to +110°C cable -40 up to +110°C probe ø6x14mm cable length 3m without screw connection 2-wire		
<b>For models:</b>	3G6SA, 3G6SA2, 3G6SA4, 40-OPR01, 40B-OPR01, 40BX-OPR01, 40CP, 40CP-OPR01, 40CPX, 40CPX-OPR01, 40EV-OPR01, 40PV-OPR01, 40X-OPR01, 4G6SB, 4G6SB2, 4G6SB4, 4G6SB6, 6BR15V, 6BR15VC, 6BR19V, 6BR19VC, 6EA, 6EA11, 6EA11A, 6EA11M, 6EA13, 6EA13A, 6EA13M, 6EA2, 6EA2A, 6EA2M, 6EAA, 6EAB, 6EABA, 6EABM, 6EAM, 6EB, 6EB11, 6EB11A, 6EB11M, 6EB13, 6EB13A, 6EB13M, 6EB2, 6EB22, 6EB22A, 6EB22M, 6EB2A, 6EB2M, 6EB4...(Other models you can see in the webshop)		

			
<b>GEV No.</b>	379934	<b>Ref. No.</b>	32Z6191
<b>description</b>	temperature probe Pt100 cable silicone probe -100 up to 450°C cable -50 up to +180°C connection 3-wire thread M10x1 probe ø3x65mm cable length 0.65m		
<b>For models:</b>	FCV101, FCV101-CSA, FCV101DM, FCV101DM-CSA, FCV101DS, FCV101DS-CSA, FCV101E, FCV101EDM, FCV101EDM-UL, FCV101EDS, FCV101EDS-UL, FCV101E-UL, FCV141, FCV141-CSA, FCV141DM, FCV141DM-CSA, FCV141DS, FCV141DS-CSA, FCV141E, FCV141EDM, FCV141EDS, FCV241, FCV241DM, FCV241DS, FCV241E, FCV241EDM, FCV241EDM-UL, FCV241EDS, FCV241EDS-UL, FCV241E-UL, FCV241G, FCV241G-CSA, FCV241GDM, FCV241GDM-CSA, FCV241GDS, FCV241GDS-CSA, FCV3EM, FCV401DM, FCV401DM-CSA, FCV401EDM, FCV401EDM-UL, FCV4E, FCV4EDS, FCV4EM, FCV61, FCV61-CSA, FCV61DM, FCV61DM-CSA, FCV61DS, FCV61DS-CSA...(Other models you can see in the webshop)		

			
<b>GEV No.</b>	379064	<b>Ref. No.</b>	8223470
<b>description</b>	temperature probe PTC 1kOhm cable silicone probe -50 up to +150°C cable -50 up to +180°C probe ø6x40mm cable length 3m without screw connection 2-wire		

			
<b>GEV No.</b>	379892	<b>Ref. No.</b>	32Z7410
<b>description</b>	temperature probe Pt100 cable Vetrotex probe -200 up to +600°C cable -50 up to +350°C connection 2-wire thread probe ø6x80mm cable length 1.5m		

			
<b>GEV No.</b>	379487	<b>Ref. No.</b>	32V0150
<b>description</b>	temperature probe PTC cable silicone probe -50 up to +150°C cable -50 up to +180°C probe ø6x30mm cable length 2.5m without screw connection 2-wire		
<b>For models:</b>	6BEA11A, 6BEA11B, 6BEA11M, 6BEA2A, 6BEA2B, 6BEA2M, 6BEA3A, 6BEA3B, 6BEA3M, 6BEAA, 6BEAB, 6BEABA, 6BEABB, 6BEABM, 6BEAM, 6BEB11A, 6BEB11B, 6BEB11M, 6BEB22A, 6BEB22B, 6BEB22M, 6BEB2A, 6BEB2B, 6BEB2M, 6BEB3A, 6BEB3B, 6BEB3M, 6BEB4A, 6BEB4B, 6BEB4M, 6BEBA, 6BEBB, 6BEBBA, 6BEBBB, 6BEBBM, 6BEBM, 6BEC11A, 6BEC11B, 6BEC11M, 6BEC22A, 6BEC22B, 6BEC22M, 6BEC2A, 6BEC2B, 6BEC2M, 6BEC33A, 6BEC33B, 6BEC33M, 6BEC3A, 6BEC3B...(Other models you can see in the webshop)		

			
<b>GEV No.</b>	379931	<b>Ref. No.</b>	32Z6780
<b>description</b>	temperature probe Pt100 cable Vetrotex probe -200 up to +600°C cable -50 up to +350°C connection 3-wire thread M10x1 probe ø4x85mm cable length 0.8m		
<b>For models:</b>	FCV4E, FCV4EDS		

producer-specific probes

probes

			
<b>GEV No.</b>	379652	<b>Ref. No.</b>	32Z3310
<b>description</b>	temperature probe Pt100 cable glass fibre probe -200 up to +600°C cable -50 up to +350°C connection 2-wire thread 1/4" probe ø6x40mm cable length 1.4m		



electric components

# Зип-Общепит

core probes

vsezip.ru

+7(812)987-08-81



<b>GEV No.</b>	379331	<b>Ref. No.</b>	32V5750
<b>description</b>	temperature probe Pt1000 cable PTFE probe -70 up to +500°C cable -40 up to +250°C connection 2-wire thread M10x1 probe ø3x60mm cable length 0.7m		
<b>For models:</b>	091FR1EX, 091FR1IA, 091FR1ID, 091FR1ID-VERS.052012, 10CP1EA, 10CP1GA, 10CP1IA, 12CP1EA, 12CP1GA, 12CP1IA, 18CP2EA, 18CP2GA, 18CP2IA, 191FR2ED, 191FR2ID, 191FR2ID-VERS.092012, BX101E, BX101E-VERS.122013, BX101G, BX101G-VERS.122013, BX122E, BX122E-VERS.122013, BX122G, BX122G-VERS.122013, BX61E, BX61E-VERS.122013, BX61G, BX61G-VERS.122013, BX82E, BX82E-VERS.122013, BX82G, BX82G-VERS.122013, FM1011E1, FM1011E1-VERS.2006, FM1011E2, FM1011E2-VERS.2006, FM1011E3, FM1011E3-VERS.2006, FM1011G1, FM1011G1-VERS.2006, FM1011G2, FM1011G2-VERS.2006, FM1011G3, FM1011G3-VERS.2006, FM1221E1, FM1221E1-VERS.2006, FM1221E2, FM1221E2-VERS.2006, FM1221E3, FM1221E3-VERS.2006...(Other models you can see in the webshop)		



<b>GEV No.</b>	378647	<b>Ref. No.</b>	32V5760
<b>description</b>	temperature probe Pt1000 cable Vetrotex probe -70 up to +500°C cable -50 up to +350°C connection 2-wire thread M10x1 probe ø3x100mm cable length 1m		
<b>For models:</b>	091FR1EA, 091FR1ED, 091FR7GS, 091FR7GX, 191FR2ED, FM1011E1, FM1011E1-VERS.2006, FM1011E2, FM1011E2-VERS.2006, FM1011E3, FM1011E3-VERS.2006, FM1011G1, FM1011G1-VERS.2006, FM1011G2, FM1011G2-VERS.2006, FM1011G3, FM1011G3-VERS.2006, FM1221E1, FM1221E1-VERS.2006, FM1221E2, FM1221E2-VERS.2006, FM1221E3, FM1221E3-VERS.2006, FM1221G1, FM1221G1-VERS.2006, FM1221G2, FM1221G2-VERS.2006, FM1221G3, FM1221G3-VERS.2006, FM2011E2-VERS.2006, FM2011E3-VERS.2006, FM2011G2-VERS.2006, FM2011G3-VERS.2006, FM2021E1, FM2021E2, FM2021E2-VERS.2006, FM2021E3, FM2021E3-VERS.2006, FM2021G1, FM2021G2, FM2021G2-VERS.2006, FM2021G3, FM2021G3-VERS.2006, FM611E1, FM611E1-VERS.2006, FM611E2, FM611E2-VERS.2006, FM611E3, FM611E3-VERS.2006, FM611G1...(Other models you can see in the webshop)		



<b>GEV No.</b>	379789	<b>Ref. No.</b>	3104950
<b>description</b>	temperature probe thermocouple J (Fe-CuNi) cable glass fibre probe -50 up to +750°C cable -50 up to +350°C connection male faston 2.8mm thread probe ø4x40mm cable length 1m		
<b>For models:</b>	04WPBEV, 08WPBEV, 08WTPVEV, 090PEB, 091PEB, 190PEB, 190TPE, 191PEB, 191TPE		

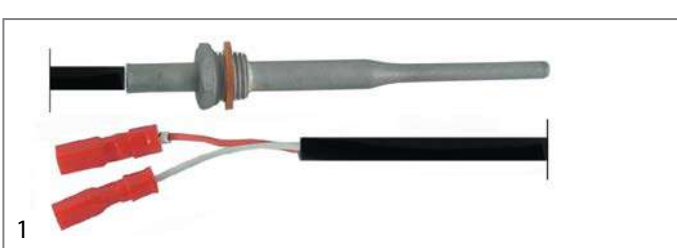

<b>GEV No.</b>	379910	<b>Ref. No.</b>	32V0030
<b>description</b>	temperature probe thermocouple J (Fe-CuNi) cable silicone probe -50 up to 1150°C cable -50 up to +180°C connection male faston 2.8mm thread M10x1 probe ø4/6x72mm cable length 0.6m		
<b>For models:</b>	04WFR3ED, 06WFR3GD, 091FR1ED, 091FR1GD, 091FR3ED, 091FR3GD, 0A1FR1ED, 0A1FR1GD, 0A1FR1GD-VERS.2004, 0A1FR3ED, 0A1FR3GD, 0B1FR1GD, 0D1FR1ED, 0D1FR1GD, 0D1FR1GD-VERS.2004, 0D1FR3ED, 0D1FR3GD, 0G0FR3ED, 0G1FR3GD, 10WFR4GD, 191FR2ED, 191FR2G, 191FR2GD, 191FR4ED, 191FR4GD, 1A1FR2ED, 1A1FR2GD, 1A1FR2GD-VERS.2004, 1A1FR4ED, 1A1FR4GD, 1D1FR2ED, 1D1FR2GD, 1D1FR2GD-VERS.2004, 1D1FR4ED, 1D1FR4GD, 1G1FR4GD, 6FR		

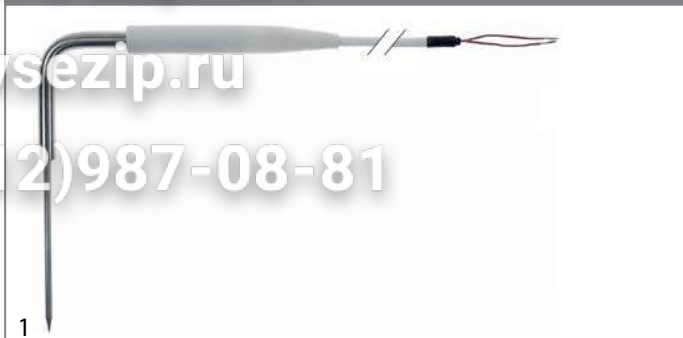

<b>GEV No.</b>	378550	<b>Ref. No.</b>	32V8360
<b>description</b>	core temperature probe NTC 10kOhm cable silicone probe -40 up to +120°C cable -50 up to +180°C connection 2-wire probe ø4.5x100mm thread cable length 3.8m handle ø 16mm handle length 120mm		
<b>For models:</b>	DS31, DS31A, DS31C, DS31M, DS315H, DS51, DS51A, DS51C, DS51M		



<b>GEV No.</b>	379933	<b>Ref. No.</b>	32Z1982 32Z1983
<b>description</b>	core temperature probe Pt100 cable PTFE probe -40 up to +250°C cable -40 up to +250°C connection 3-wire probe ø2.5x100mm thread cable length 2.75m handle ø 15mm handle length 90mm		
<b>For models:</b>	FCV101DM, FCV101DM-CSA, FCV101DS, FCV101DS-CSA, FCV101EDM, FCV101EDM-UL, FCV101EDS, FCV101EDS-UL, FCV141DM, FCV141DM-CSA, FCV141DS, FCV141DS-CSA, FCV141EDM, FCV141EDS, FCV241DM, FCV241DS, FCV241EDM, FCV241EDM-UL, FCV241EDS, FCV241EDS-UL, FCV241GDM, FCV241GDS, FCV241GDS-CSA, FCV401DM, FCV401DM-CSA, FCV401EDM, FCV401EDM-UL, FCV4EDS, FCV61DM, FCV61DM-CSA, FCV61DS, FCV61DS-CSA, FCV61EDM, FCV61EDM-UL, FCV61EDS, FCV61EDS-UL, FCV72EDM-UL, FCV72EDS-UL		



<b>GEV No.</b>	379891	<b>Ref. No.</b>	32Z6830
<b>description</b>	core temperature probe Pt100 cable silicone probe -40 up to +120°C cable -50 up to +180°C connection 3-wire probe ø3.5-5.5x100mm thread cable length 1.85m handle ø 12mm handle length 100mm		

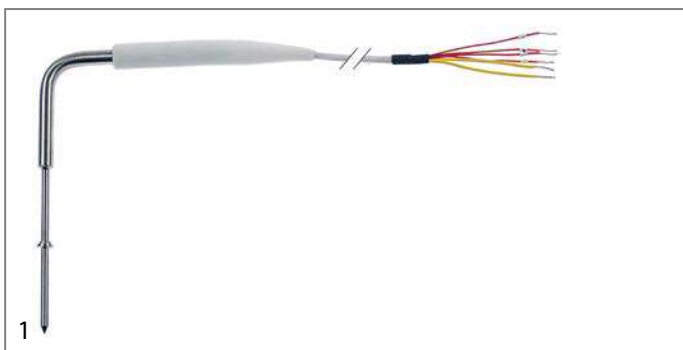

<b>GEV No.</b>	378402 <sup>1</sup>	<b>Ref. No.</b>	32V7960
<b>description</b>	core temperature probe Pt100 cable silicone probe -40 up to +120°C cable -50 up to +180°C connection 5-wire probe ø5x175mm thread cable length 3.5m handle ø 16mm handle length 125mm		
<b>For models:</b>	FS611, IA101L, IA101S, IA51, IA51A, IA51C, IA51M, IA72S, IS101L, IS101LR, IS101LW, IS101S, IS101SR, IS101SW, IS102S, IS102SR, IS102SR-ONR01, IS102SW, IS51, IS51A, IS51AR, IS51C, IS51CR, IS51H, IS51HW, IS51M, IS51MR, IS51R, IS51W, IS51WA, IS51WC, IS51WM, IS72S, IS72SR, IS72SW, ISFEB, ISFEB-OPR01, ISFEN, ISFEN-OPR01, ISP202R, ISR201R, ISR202R		

<sup>1</sup>multipoint probe



Зип Общепит

vsezip.ru

+7(812)987-08-81

electric components



<b>GEV No.</b>	379890	<b>Ref. No.</b>	32Z6010
<b>description</b>	core temperature probe Pt100 cable SS corrugated hose probe -40 up to +250°C cable -40 up to +250°C connection 2-wire probe ø4x-100mm thread M16x1.5 cable length 1.6m handle ø 8.5mm handle length 100mm		



<b>GEV No.</b>	403452	<b>Ref. No.</b>	6300643
<b>description</b>	core temperature probe Pt1000 cable PTFE probe -40 up to +250°C cable -40 up to +250°C connection 2-wire probe ø3x100mm thread cable length 3.2m handle ø 13mm handle length 60mm		
<b>For models:</b>	FM1011E2-VERS.2006, FM1011G2-VERS.2006, FM1221E2-VERS.2006, FM1221G2-VERS.2006, FM2011E2-VERS.2006, FM2011G2-VERS.2006, FM611E2-VERS.2006, FM611G2-VERS.2006, FM721E2-VERS.2006, FM721G2-VERS.2006		



<b>GEV No.</b>	401966	<b>Ref. No.</b>	6300644
<b>description</b>	core temperature probe Pt1000 cable PTFE probe -40 up to +250°C cable -40 up to +250°C connection 3-wire probe ø3x100mm thread cable length 1.5m handle ø 13mm handle length 75mm		
<b>For models:</b>	FM1011E3-VERS.2006, FM1011G3-VERS.2006, FM1221E3-VERS.2006, FM1221G3-VERS.2006, FM2011E3-VERS.2006, FM2011G3-VERS.2006, FM2021E3-VERS.2006, FM2021G3-VERS.2006, FM611E3-VERS.2006, FM611G3-VERS.2006, FM721E3-VERS.2006, FM721G3-VERS.2006		



<b>GEV No.</b>	378264	<b>Ref. No.</b>	3159510 3159511 3200361
<b>description</b>	core temperature probe Pt1000 cable PTFE probe -40 up to +250°C cable -40 up to +250°C connection 5-wire probe ø3x100mm thread cable length 2.7m handle ø 13mm handle length 75mm		
<b>For models:</b>	FM1011E3, FM1011G3, FM1221E3, FM1221G3, FM2021E3, FM2021G3, FM611E3, FM611G3, FM721E3, FM721G3		



<b>GEV No.</b>	379588	<b>Ref. No.</b>	3139610 32V5940
<b>description</b>	core temperature probe Pt1000 cable thermoplastic probe -40 up to +250°C cable -40 up to +110°C connection 2-wire probe ø3x110mm thread cable length 3.1m handle ø 13mm handle length 70mm		
<b>For models:</b>	FM1011E2, FM1011G2, FM1221E2, FM1221G2, FM2021E2, FM2021G2, FM423E2, FM611E2, FM611G2, FM721E2, FM721G2, FX101E2, FX101E2C, FX101E2C-VERS.032014, FX101E2R, FX101E2R-VERS.032014, FX101E2-VERS.032014, FX101G2, FX101G2C, FX101G2C-VERS.032014, FX101G2R, FX101G2R-VERS.032014, FX101G2-VERS.032014, FX10E2CR, FX10E2CR-VERS.032014, FX10G2CR, FX10G2CR-VERS.032014, FX122E2, FX122E2C, FX122E2T, FX122E2T-VERS.032014, FX122G2, FX122G2C, FX122G2T, FX122G2T-VERS.032014, FX201E2, FX201E2P, FX201E2P-VERS.032014, FX201E2-VERS.032014, FX201G2, FX201G2P, FX201G2P-VERS.032014, FX201G2-VERS.032014, FX202E2, FX202E2-VERS.032014, FX202G2, FX202G2-VERS.032014, FX61E2, FX61E2C, FX61E2CR...(Other models you can see in the webshop)		



<b>GEV No.</b>	381511	<b>Ref. No.</b>	72378
<b>description</b>	core temperature probe Pt1000 connection 6-wire probe ø3.2x-100mm cable length 3.1m handle ø 13mm handle length 70mm combi-steamer		

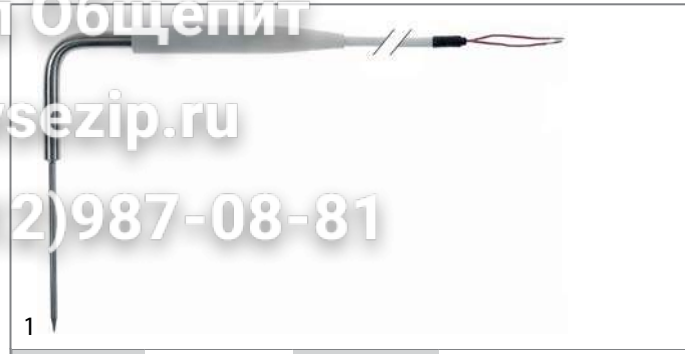

<b>GEV No.</b>	378186	<b>Ref. No.</b>	32V0010 32V0441 32V8600
<b>description</b>	core temperature probe PTC 1kOhm cable silicone probe -40 up to +120°C cable -50 up to +180°C connection 2-wire probe ø4x90mm thread cable length 3.8m handle ø 15mm handle length 120mm L1 175mm L2 190mm		
<b>For models:</b>	ART1LD, ART1LD7, ART1LD7A, ART1LD7M, ART1LDA, ART2LD, ART2SD, ART3SD, SM14SR, SM1L, SM1L7, SM1L7A, SM1L7FCV, SM1L7M, SM1LA, SM1LAR, SM1LAT, SM1LAW, SM1LR, SM1LT, SM1LT7, SM1LT7A, SM1LT7M, SM1LW, SM2L, SM2LR, SM2LW, SM2S, SM2SR, SM2SW, SM3S, SM3SR, SM4SR, SM7SR		

accessories

screw connections



<b>GEV No.</b>	401967	<b>Ref. No.</b>	3004870
<b>description</b>	screw connection for core temperature probe		
<b>For models:</b>	FM1011E2, FM1011E2-VERS.2006, FM1011E3, FM1011E3-VERS.2006, FM1011G2, FM1011G2-VERS.2006, FM1011G3, FM1011G3-VERS.2006, FM1221E2, FM1221E2-VERS.2006, FM1221E3, FM1221E3-VERS.2006, FM1221G2, FM1221G2-VERS.2006, FM1221G3, FM1221G3-VERS.2006, FM2011E2-VERS.2006, FM2011E3-VERS.2006, FM2011G2-VERS.2006, FM2011G3-VERS.2006, FM2021E2, FM2021E2-VERS.2006, FM2021E3, FM2021E3-VERS.2006, FM2021G2, FM2021G2-VERS.2006, FM2021G3, FM2021G3-VERS.2006, FM611E2, FM611E2-VERS.2006, FM611E3, FM611E3-VERS.2006, FM611G2, FM611G2-VERS.2006, FM611G3, FM611G3-VERS.2006, FM721E2, FM721E2-VERS.2006, FM721E3, FM721E3-VERS.2006, FM721G2, FM721G2-VERS.2006, FM721G3, FM721G3-VERS.2006, FX101E2, FX101E2C, FX101E3, FX101E3C, FX101E3R, FX101G2...(Other models you can see in the webshop)		

miscellaneous



<b>GEV No.</b>	519385	<b>Ref. No.</b>	3150220
<b>description</b>	gasket for core temperature probe ED ø 8mm ID ø 4mm thickness 5mm		
<b>For models:</b>	FCV101DM, FCV101DM-CSA, FCV101DS, FCV101DS-CSA, FCV101EDM, FCV101EDM-UL, FCV101EDS, FCV101EDS-UL, FCV141DM, FCV141DM-CSA, FCV141DS, FCV141DS-CSA, FCV141EDM, FCV141EDS, FCV241DM, FCV241DS, FCV241EDM, FCV241EDM-UL, FCV241EDS, FCV241EDS-UL, FCV241GDM, FCV241GDM-CSA, FCV241GDS, FCV241GDS-CSA, FCV401DM, FCV401DM-CSA, FCV401EDM, FCV401EDM-UL, FCV4EDS, FCV61DM, FCV61DM-CSA, FCV61DS, FCV61DS-CSA, FCV61EDM, FCV61EDM-UL, FCV61EDS, FCV61EDS-UL, FCV72EDM-UL, FCV72EDS-UL, FM1011E2, FM1011E3, FM1011G2, FM1011G3, FM1221E2, FM1221E3, FM1221G2, FM1221G3, FM2021E2, FM2021E3, FM2021G2...(Other models you can see in the webshop)		

Зип Общепит

vsezip.ru

+7(812)98708-81



1

<b>GEV No.</b>	691159	<b>Ref. No.</b>	35Q6360
<b>description</b>	protective plate for probe		
<b>For models:</b>	FC101, FC101E, FC241, FC241E, FC241G, FC61, FC61E, FCV101, FCV101-CSA, FCV101DM, FCV101DM-CSA, FCV101DS, FCV101DS-CSA, FCV101E, FCV101EDM, FCV101EDM-UL, FCV101EDS, FCV101EDS-UL, FCV101E-UL, FCV141, FCV141-CSA, FCV141DM, FCV141DM-CSA, FCV141DS, FCV141DS-CSA, FCV141E, FCV141EDM, FCV141EDS, FCV241, FCV241DM, FCV241DS, FCV241E, FCV241EDM, FCV241EDM-UL, FCV241EDS, FCV241EDS-UL, FCV241E-UL, FCV241G, FCV241G-CSA, FCV241GDM, FCV241GDM-CSA, FCV241GDS, FCV241GDS-CSA, FCV401DM, FCV401DM-CSA, FCV401EDM, FCV401EDM-UL, FCV4E, FCV4EDS, FCV61...(Other models you can see in the webshop)		



1

<b>GEV No.</b>	403687	<b>Ref. No.</b>	3034260 32V4350
<b>description</b>	electronic timer for ice maker Simag mounting measurements 90x70mm 230		
<b>For models:</b>	PG22C, PG23C, PG23CW, PG24CW, PG30C, PG31CW, PG42C, PG43CW, PG60C, PG61CW, PG80C, PG81CW, PGC132, PGC134W, PGC210, PGC212W		

## electronics

### PCBs

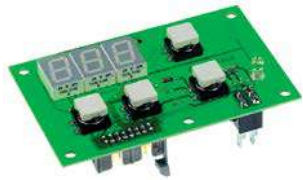

1

<b>GEV No.</b>	400677	<b>Ref. No.</b>	32V0780
<b>description</b>	control PCB fryer 091FR1 ED		
<b>For models:</b>	04WFR3ED, 06WFR3GD, 08WFR4ED, 091FR1ED, 091FR1GD, 091FR3ED, 091FR3GD, 0A1FR1ED, 0A1FR1GD, 0A1FR1GD-VERS.2004, 0A1FR3ED, 0A1FR3GD, 0B1FR1GD, 0D1FR1ED, 0D1FR1GD, 0D1FR1GD-VERS.2004, 0D1FR3ED, 0D1FR3GD, 0G0FR3ED, 0G1FR3GD, 10WFR4GD, 191FR2ED, 191FR2GD, 191FR4ED, 191FR4GD, 1A1FR2ED, 1A1FR2GD, 1A1FR2GD-VERS.2004, 1A1FR4ED, 1A1FR4GD, 1D1FR2ED, 1D1FR2GD, 1D1FR2GD-VERS.2004, 1D1FR4ED, 1D1FR4GD, 1G1FR4GD		

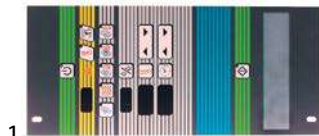

1

<b>GEV No.</b>	401183	<b>Ref. No.</b>	32Z6621 32V6622
<b>description</b>	keypad PCB		
<b>For models:</b>	FCV4E		



1

<b>GEV No.</b>	401184	<b>Ref. No.</b>	32Z1081 32Z1082
<b>description</b>	keypad PCB		
<b>For models:</b>	FCV4EDS		

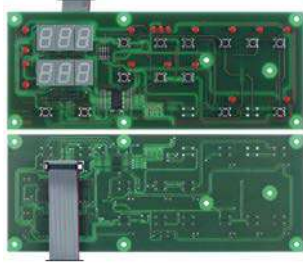

1

<b>GEV No.</b>	403729	<b>Ref. No.</b>	32V3060
<b>description</b>	control PCB L 203mm W 80mm		
<b>For models:</b>	SM2L, SM2LR, SM2LW, SM2S, SM2SR, SM2SW, SM3S, SM3SR, SM4SR, SM7SR		



1

<b>GEV No.</b>	401748	<b>Ref. No.</b>	3049200
<b>description</b>	keypad PCB		
<b>For models:</b>	IS101LR, IS101SR, IS102SR, IS102SR-ONR01, IS51AR, IS51CR, IS51MR, IS51R, IS72SR		





Зип Общепит

vsezip.ru

+7(812)987-08-81

electric components



1

<b>GEV No.</b>	401750	<b>Ref. No.</b>	32Z8940
<b>description</b>	keypad PCB		
<b>For models:</b>	SM2L, SM2LR, SM2LW, SM2S, SM2SR, SM2SW, SM3S, SM3SR, SM4SR		



1

<b>GEV No.</b>	401749	<b>Ref. No.</b>	32Z9640
<b>description</b>	PCB		
<b>For models:</b>	SM1L, SM1LA, SM1LAR, SM1LAW, SM1LR, SM1LW, SM2L, SM2LR, SM2LW, SM2S, SM2SR, SM2SW, SM3S, SM3SR, SM4SR		



1

<b>GEV No.</b>	401751	<b>Ref. No.</b>	32Z8240
<b>description</b>	keypad PCB		
<b>For models:</b>	SM1L, SM1LA, SM1LAR, SM1LAW, SM1LR, SM1LW		



1

<b>GEV No.</b>	402866	<b>Ref. No.</b>	32V5360 32V5361
<b>description</b>	PCB combi-steamer FM1011 suitable for ANGELO PO		
<b>For models:</b>	FM1011E1, FM1011E1-VERS.2006, FM1011E2, FM1011E2-VERS.2006, FM1011E3, FM1011G1, FM1011G1-VERS.2006, FM1011G2, FM1011G2-VERS.2006, FM1011G3, FM1221E1, FM1221E1-VERS.2006, FM1221E2, FM1221E2-VERS.2006, FM1221E3, FM1221G1, FM1221G1-VERS.2006, FM1221G2, FM1221G2-VERS.2006, FM1221G3, FM2011E2-VERS.2006, FM2011G2-VERS.2006, FM2021E1, FM2021E2, FM2021E2-VERS.2006, FM2021G1, FM2021G2, FM2021G2-VERS.2006, FM611E1, FM611E1-VERS.2006, FM611E2, FM611E2-VERS.2006, FM611E3, FM611G1, FM611G1-VERS.2006, FM611G2, FM611G2-VERS.2006, FM611G3, FM721E1, FM721E1-VERS.2006, FM721E2, FM721E2-VERS.2006, FM721G1, FM721G1-VERS.2006, FM721G2, FM721G2-VERS.2006		





1

<b>GEV No.</b>	402867	<b>Ref. No.</b>	3018770 3018771
<b>description</b>	keypad PCB combi-steamer FM1011 L 275mm W 100mm suitable for ANGELO PO buttons 12		
<b>For models:</b>	FM1011E1, FM1011E2, FM1011E3, FM1011G1, FM1011G2, FM1011G3, FM1221E1, FM1221E2, FM1221E3, FM1221G1, FM1221G2, FM1221G3, FM2021E1, FM2021E2, FM2021E3, FM2021G1, FM2021G2, FM2021G3, FM611E1, FM611E2, FM611E3, FM611G1, FM611G2, FM611G3, FM721E1, FM721E2, FM721E3, FM721G1, FM721G2, FM721G3		



1

<b>GEV No.</b>	402675	<b>Ref. No.</b>	3104130
<b>description</b>	PCB dishwasher KD60 L 185mm W 30mm buttons 4		
<b>For models:</b>	KD40EPSD, KD40LEPS, KD40LUXE, KD60E, KD60EAT, KD60ME, KD85E, KD85EA, KD85EAT, KD85EPS, KD85EPSA, LP70		
<b>accessories for</b>	402675		
	<b>GEV No.</b>	400066	<b>Ref. No.</b> 3099170
	ribbon cable 10-pole L 1000mm plug type FC-10P raster size 2.54mm		



1

<b>GEV No.</b>	401218	<b>Ref. No.</b>	32Z6210 32Z6211
<b>description</b>	PCB		
<b>For models:</b>	FCV101, FCV101E, FCV141, FCV141E, FCV241, FCV241E, FCV241G, FCV3EM, FCV4EM, FCV61, FCV61E		



Зип Общепит

vsezip.ru

+7(812)987-08-81



1

<b>GEV No.</b>	401029	<b>Ref. No.</b>	3026600 3114850
<b>description</b>	PCB dishwasher LF 50 L 122mm W 80mm Qty 1 pcs		
<b>For models:</b>	LF50EM, LF50EMPS, LF50E-VERS.2007		

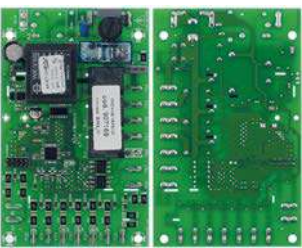

1

<b>GEV No.</b>	403255	<b>Ref. No.</b>	3207870
<b>description</b>	PCB dishwasher N700/NE1300/S026/S030 L 135mm W 82mm		
<b>For models:</b>	LF50EM, LF50EMPS, LF50EMPS-VERS.122012, LF50EM-VERS.122012, LF50E-VERS.122012, LF50E-VERS.2007		

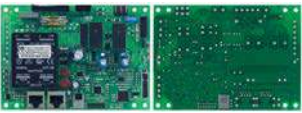

1

<b>GEV No.</b>	404028	<b>Ref. No.</b>	6300751
<b>description</b>	PCB for combi-steamer ANGELO PO L 140mm W 100mm		
<b>For models:</b>	BX101G, BX101G-VERS.122013, BX122G, BX122G-VERS.122013, BX61G, BX61G-VERS.122013, BX82G, BX82G-VERS.122013, FX101G1, FX101G1R, FX101G2, FX101G2C, FX101G2C-VERS.032014, FX101G2R, FX101G2R-VERS.032014, FX101G2-VERS.032014, FX101G3, FX101G3C, FX101G3C-VERS.022014, FX101G3R, FX101G3R-VERS.022014, FX101G3-VERS.022014, FX10G2CR, FX10G2CR-VERS.032014, FX10G3CR, FX10G3CR-VERS.022014, FX122G1, FX122G2, FX122G2C, FX122G2T, FX122G2T-VERS.032014, FX122G3, FX122G3C, FX122G3T, FX122G3T-VERS.022014, FX12G3CT, FX12G3CT-VERS.022014, FX201G2, FX201G2P, FX201G2P-VERS.032014, FX201G2-VERS.032014, FX201G3P, FX201G3-VERS.022014, FX202G2, FX202G2-VERS.032014, FX202G3, FX202G3-VERS.022014, FX61G1, FX61G1R, FX61G2...(Other models you can see in the webshop)		



1

<b>GEV No.</b>	400678	<b>Ref. No.</b>	32Z9090
<b>description</b>	PCB fryer 091FR1 ED 230V		
<b>For models:</b>	04WFR3ED, 06WFR3GD, 08WFR4ED, 091FR1ED, 091FR1GD, 091FR3ED, 091FR3GD, 0A1FR1ED, 0A1FR1GD, 0A1FR1GD-VERS.2004, 0A1FR3ED, 0A1FR3GD, 0B1FR1GD, 0D1FR1ED, 0D1FR1GD, 0D1FR1GD-VERS.2004, 0D1FR3ED, 0D1FR3GD, 0G0FR3ED, 0G1FR3GD, 10WFR4GD, 191FR2ED, 191FR2GD, 191FR4ED, 191FR4GD, 1A1FR2ED, 1A1FR2GD, 1A1FR2GD-VERS.2004, 1A1FR4ED, 1A1FR4GD, 1D1FR2ED, 1D1FR2GD, 1D1FR2GD-VERS.2004, 1D1FR4ED, 1D1FR4GD, 1G1FR4GD		





1

<b>GEV No.</b>	402978	<b>Ref. No.</b>	3184480
<b>description</b>	PCB L 73mm W 73mm timer		
<b>For models:</b>	PG22C, PG23C, PG23CW, PG24CW, PG30C, PG31CW, PG42C, PG43CW, PG60C, PG61CW		



1

<b>GEV No.</b>	400955	<b>Ref. No.</b>	3019810	
<b>description</b>	PCB slicer 230/400V			
<b>For models:</b>	STV			
<b>accessories for</b>	400955			
	<b>GEV No.</b>	401357	<b>Ref. No.</b>	—
	momentary push switch mounting measurements ø22mm 1NO/1NC/indicator light 400V 4A indicator lamp 24V 0-1 connection screw ambient temperature max. 125/55°C protection IP40			
	<b>GEV No.</b>	401709	<b>Ref. No.</b>	—
	protective cover external size 57x32mm internal size 47x22mm matt finish rubber H 27.5mm			



1

<b>GEV No.</b>	403575	<b>Ref. No.</b>	32Z7090
<b>description</b>	PCB slicer L 128mm W 43mm 230-400V		
<b>For models:</b>	AFC30MS, AFC30S, AFC35, AFT30S, AFT30VMS, AFT30VS, AFT33S, AFT35, AFT35VS		



1

<b>GEV No.</b>	400954	<b>Ref. No.</b>	3069870
<b>description</b>	PCB slicer/cutter 50/60Hz 230V		
<b>For models:</b>	SC9VV, STV		



Зип Общепит  
vsezip.ru  
+7(812)987-08-81



1

<b>GEV No.</b>	401747	<b>Ref. No.</b>	32V8030
<b>description</b>	power PCB for blast chiller SERIE IM suitable for SAGI		
<b>For models:</b>	FS611, IS101L, IS101LW, IS101S, IS101SW, IS102S, IS102SR, IS102SW, IS51, IS51A, IS51C, IS51H, IS51HW, IS51M, IS51W, IS51WA, IS51WC, IS51WM, IS72S, IS72SW, ISFEB, ISFEB-OPR01, ISFEN, ISFEN-OPR01		



1

<b>GEV No.</b>	378403	<b>Ref. No.</b>	37N0480
<b>description</b>	front foil blast freezer 70 GL		
<b>For models:</b>	SM2L, SM2LR, SM2LW, SM2S, SM2SR, SM2SW, SM3S, SM3SR, SM4SR, SM7SR		

## keypads

### front foils



1

<b>GEV No.</b>	401180	<b>Ref. No.</b>	37M4201
<b>description</b>	front foil		
<b>For models:</b>	FC101, FC101E, FC241, FC241E, FC241G, FC61, FC61E		

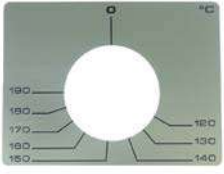

1

<b>GEV No.</b>	401639	<b>Ref. No.</b>	37M5670
<b>description</b>	front foil L 115mm W 87mm		

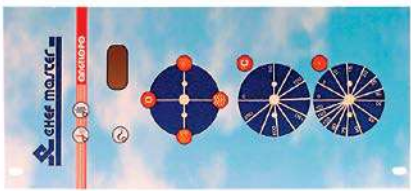

1

<b>GEV No.</b>	401181	<b>Ref. No.</b>	37M9220
<b>description</b>	front foil		
<b>For models:</b>	FCV3EM, FCV4EM		

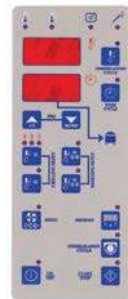

1

<b>GEV No.</b>	401956	<b>Ref. No.</b>	37N0470
<b>description</b>	keypad foil		
<b>For models:</b>	SM14SR, SM1L, SM1L7, SM1L7A, SM1L7FCV, SM1L7M, SM1LA, SM1LAR, SM1LAW, SM1LR, SM1LW		



1

<b>GEV No.</b>	401182	<b>Ref. No.</b>	37M5641
<b>description</b>	front foil		
<b>For models:</b>	FCV101, FCV101E, FCV141, FCV141E, FCV241, FCV241E, FCV241G, FCV61, FCV61E		



1

<b>GEV No.</b>	400676	<b>Ref. No.</b>	37M8560
<b>description</b>	keypad foil for fryer L 97mm W 60mm		
<b>For models:</b>	04WFR3ED, 06WFR3GD, 08WFR4ED, 091FR1ED, 091FR1GD, 091FR3ED, 091FR3GD, 0A1FR1ED, 0A1FR1GD, 0A1FR1GD-VERS.2004, 0A1FR3ED, 0A1FR3GD, 0B1FR1GD, 0D1FR1ED, 0D1FR1GD, 0D1FR1GD-VERS.2004, 0D1FR3ED, 0D1FR3GD, 0G0FR3ED, 0G1FR3GD, 10WFR4GD, 191FR2ED, 191FR2GD, 191FR4ED, 191FR4GD, 1A1FR2ED, 1A1FR2GD, 1A1FR2GD-VERS.2004, 1A1FR4ED, 1A1FR4GD, 1D1FR2ED, 1D1FR2GD, 1D1FR2GD-VERS.2004, 1D1FR4ED, 1D1FR4GD, 1G1FR4GD		



1

<b>GEV No.</b>	511927	<b>Ref. No.</b>	37M1610
<b>description</b>	keypad foil for potato peeler device silver L 175mm W 61mm buttons 3		
<b>For models:</b>	P10, P10M, P20		



Зип.Общепит  
solenoid valves

vsezip.ru  
straight

+7(812)987-08-81



<b>GEV No.</b>	401752	<b>Ref. No.</b>	37M7330
<b>description</b>	keypad foil SAGI suitable for for ice maker L 200mm W 60mm buttons 8		
<b>For models:</b>	SM1L, SM1LA, SM1LAR, SM1LAW, SM1LR, SM1LW		



<b>GEV No.</b>	403029	<b>Ref. No.</b>	37N5560
<b>description</b>	keypad foil suitable for ANGELO PO L 210mm buttons 6		
<b>For models:</b>	DS31, DS31A, DS31C, DS31M, DS51, DS51A, DS51C, DS51M, IA101L, IA101S, IA51, IA51A, IA51C, IA51M, IA72S, IS101L, IS101LR, IS101LW, IS101S, IS101SR, IS101SW, IS102S, IS102SR, IS102SW, IS51, IS51A, IS51AR, IS51C, IS51CR, IS51H, IS51HW, IS51M, IS51MR, IS51R, IS51W, IS51WA, IS51WC, IS51WM, IS72S, IS72SR, IS72SW, ISP202R, ISR201R, ISR202R		

membrane keypads



<b>GEV No.</b>	402027	<b>Ref. No.</b>	37M7340
<b>description</b>	membrane keypad for blast freezer buttons 8 suitable for SAGI L 200mm W 60mm		
<b>For models:</b>	SM2L, SM2LR, SM2LW, SM2S, SM2SR, SM2SW, SM3S, SM3SR, SM4SR		

keypad units



<b>GEV No.</b>	403002	<b>Ref. No.</b>	3018180	
<b>description</b>	keypad unit slicer buttons 2 MIRRA/SAN-DANIELE/YORK L 120mm W 48mm			
<b>For models:</b>	SC4, SC6, SC9VV, STV			
<b>accessories for</b>	403002			
	<b>GEV No.</b>	403004	<b>Ref. No.</b>	—
gasket for keypad housing L 122mm W 52mm				

solenoid valves (water)

LLBI

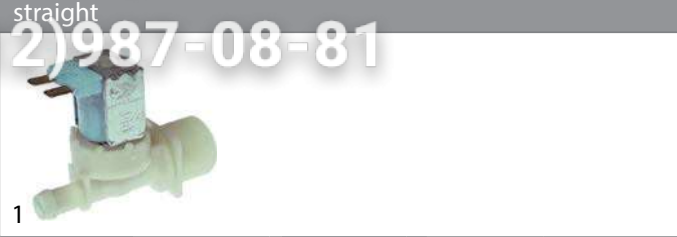

<b>GEV No.</b>	374053	<b>Ref. No.</b>	3032680
<b>description</b>	solenoid valve single straight 230VAC inlet 3/4" outlet 11.5mm t.max. 60°C ELBI plastic flow regulating valve outlet orange		
<b>For models:</b>	BX101E, BX101E-VERS.122013, BX101G, BX101G-VERS.122013, BX122E, BX122E-VERS.122013, BX122G, BX122G-VERS.122013, BX61E, BX61E-VERS.122013, BX61G, BX61G-VERS.122013, BX82E, BX82E-VERS.122013, BX82G, BX82G-VERS.122013, FM1011E1, FM1011E1-VERS.2006, FM1011E2, FM1011E2-VERS.2006, FM1011E3, FM1011E3-VERS.2006, FM1011G1, FM1011G1-VERS.2006, FM1011G2, FM1011G2-VERS.2006, FM1011G3, FM1011G3-VERS.2006, FM1221E1, FM1221E1-VERS.2006, FM1221E2, FM1221E2-VERS.2006, FM1221E3, FM1221E3-VERS.2006, FM1221G1, FM1221G1-VERS.2006, FM1221G2, FM1221G2-VERS.2006, FM1221G3, FM1221G3-VERS.2006, FM2021E1, FM2021E2, FM2021G1, FM2021G2, FM423E2, FM611E1, FM611E1-VERS.2006, FM611E2, FM611E2-VERS.2006, FM611E3...(Other models you can see in the webshop)		
<b>spare parts for</b>	374053		

	<b>GEV No.</b>	370467	<b>Ref. No.</b>	N/A
solenoid valve filter suitable for ELBI				



<b>GEV No.</b>	370431	<b>Ref. No.</b>	33D2780
<b>description</b>	solenoid valve single straight 230VAC inlet 3/4" outlet 11.5mm input/min output 2l/min DN10 t.max. 90°C ELBI plastic		
<b>For models:</b>	PGC132, PGC132-VERS.200911, PGC134W, PGC134W-VERS.200911, PGC210, PGC210-VERS.200911, PGC212W, PGC212W-VERS.200911		











Зип Общепит











vsezip.ru

+7(812)987-08-81

MÜLLER

medium temperature: 90°C  
duty cycle: 100%

 <p>1</p>			
<b>GEV No.</b>	370158	<b>Ref. No.</b>	33D1710 33D2410
<b>description</b>	solenoid valve double straight 230VAC inlet 3/4" outlet 11.5mm DN10 t.max. 90°C duty cycle 100% MÜLLER		
<b>For models:</b>	FC101, FC101E, FC241E, FC241G, FC61, FC61E, FCV101, FCV101-CSA, FCV101DM, FCV101DM-CSA, FCV101DS, FCV101DS-CSA, FCV101E, FCV101EDM, FCV101EDM-UL, FCV101EDS, FCV101EDS-UL, FCV101E-UL, FCV141, FCV141-CSA, FCV141DM, FCV141DM-CSA, FCV141DS, FCV141DS-CSA, FCV141E, FCV141EDM, FCV141EDS, FCV241E, FCV241EDM, FCV241EDM-UL, FCV241EDS, FCV241EDS-UL, FCV241E-UL, FCV241G, FCV241G-CSA, FCV241GDM, FCV241GDM-CSA, FCV241GDS, FCV241GDS-CSA, FCV401DM, FCV401DM-CSA, FCV401EDM, FCV401EDM-UL, FCV61, FCV61-CSA, FCV61DM, FCV61DM-CSA, FCV61DS, FCV61DS-CSA, FCV61E...(Other models you can see in the webshop)		
<b>spare parts for</b>	370158		
	<b>GEV No.</b>	370195	<b>Ref. No.</b> —
	solenoid valve body double straight inlet 3/4" outlet 11.5mm DN10 t.max. 90°C duty cycle 100% MÜLLER 230V		
	<b>GEV No.</b>	371002	<b>Ref. No.</b> —
	solenoid valve holder MÜLLER flange support		
	<b>GEV No.</b>	371009	<b>Ref. No.</b> —
	compression spring for solenoid coil		
	<b>GEV No.</b>	371011	<b>Ref. No.</b> —
	spare parts kit membrane with long star star hight 8mm MÜLLER		
	<b>GEV No.</b>	371017	<b>Ref. No.</b> —
	solenoid coil MÜLLER 230VAC connection male faston 6.3mm		
	<b>GEV No.</b>	371122	<b>Ref. No.</b> —
	solenoid valve filter ø 19mm H 10mm suitable for MÜLLER		
<b>accessories for</b>	370158		
	<b>GEV No.</b>	371010	<b>Ref. No.</b> —
	solenoid coil 230VAC connection with cable cable length 2000mm		
	<b>GEV No.</b>	371037	<b>Ref. No.</b> —
	solenoid coil 24VAC 50/60Hz connection male faston 6.3mm		
	<b>GEV No.</b>	371038	<b>Ref. No.</b> —
	solenoid coil 230VAC connection appliance plug		

<b>GEV No.</b>	370117	<b>Ref. No.</b>	33D2460
<b>description</b>	solenoid valve single straight 230VAC inlet 3/4" outlet 11.5mm DN10 t.max. 90°C duty cycle 100% MÜLLER		
<b>For models:</b>	FM1011E3, FM1011G3, FM1221E1, FM1221E2, FM1221E3, FM1221G1, FM1221G2, FM1221G3, FM611E3, FM611G3, FM721E1, FM721E2, FM721E3, FM721G1, FM721G2, FM721G3		
<b>spare parts for</b>	370117		
	<b>GEV No.</b>	370133	<b>Ref. No.</b> —
	solenoid valve body single straight inlet 3/4" outlet 11.5mm DN10 t.max. 90°C duty cycle 100% MÜLLER 230V		
	<b>GEV No.</b>	371002	<b>Ref. No.</b> —
	solenoid valve holder MÜLLER flange support		
	<b>GEV No.</b>	371009	<b>Ref. No.</b> —
	compression spring for solenoid coil		
	<b>GEV No.</b>	371011	<b>Ref. No.</b> —
	spare parts kit membrane with long star star hight 8mm MÜLLER		
	<b>GEV No.</b>	371017	<b>Ref. No.</b> —
	solenoid coil MÜLLER 230VAC connection male faston 6.3mm		
	<b>GEV No.</b>	371122	<b>Ref. No.</b> —
	solenoid valve filter ø 19mm H 10mm suitable for MÜLLER		
	<b>GEV No.</b>	501161	<b>Ref. No.</b> —
	tap head for solenoid valve holder for solenoid coils		
<b>accessories for</b>	370117		
	<b>GEV No.</b>	371010	<b>Ref. No.</b> —
	solenoid coil 230VAC connection with cable cable length 2000mm		
	<b>GEV No.</b>	371037	<b>Ref. No.</b> —
	solenoid coil 24VAC 50/60Hz connection male faston 6.3mm		
	<b>GEV No.</b>	371038	<b>Ref. No.</b> —
	solenoid coil 230VAC connection appliance plug		

1 electric components



Зип-Общепит

vsezip.ru

+7(812)987-08-81

## ROBERTSHAW/INVENSYS

medium temperature: 90°C 90°C 60°C  
 ambient temperature: 60°C 25°C 60°C  
 duty cycle: 40% 100% 100%

## spare parts and accessories

## reducers

## outlet side



1

<b>GEV No.</b>	371255	<b>Ref. No.</b>	N/A
<b>description</b>	reducer type EATON (INVENSYS) flow rate 5l/min pressure range 0 up to 10bar tolerance ±15/25% black		

## RPE



1

<b>GEV No.</b>	374017	<b>Ref. No.</b>	33D2310 33D3260
<b>description</b>	solenoid valve single straight 230VAC inlet 3/4" outlet 10mm input 6l/min DN10 RPE polyamide flow regulating valve inlet white membranes NBR pressure range 0.2-10bar		



1

<b>GEV No.</b>	374015	<b>Ref. No.</b>	33D3280
<b>description</b>	solenoid valve single angled 230VAC inlet 3/4" outlet 10mm input 10-12l/min DN10 RPE flow regulating valve inlet white		
<b>For models:</b>	KD100, KD100A, KD100PSD, KD130, KD130A, KD130E, KD130EAT, KD85, KD85A, KD85PS, KD85PSA, KN1100, KN1100SD, KN11PSDD, KN800, KN800PSD, LP151		

1

<b>GEV No.</b>	370021	<b>Ref. No.</b>	33D1640 33D1641 33D3250
<b>description</b>	solenoid valve double straight 230VAC inlet 3/4" outlet 11.5mm DN10 TP flow regulating valve inlet white		
<b>For models:</b>	FC101, FC101E, FC241, FC241E, FC241G, FC61, FC61E, FCV101, FCV101DM, FCV101DS, FCV101E, FCV101EDM, FCV101EDS, FCV141, FCV141DM, FCV141DS, FCV141E, FCV141EDM, FCV141EDS, FCV241, FCV241DM, FCV241DS, FCV241E, FCV241EDM, FCV241EDS, FCV241G, FCV241GDM, FCV241GDS, FCV3EM, FCV401DM, FCV401EDM, FCV4E, FCV4EDS, FCV4EM, FCV61, FCV61DM, FCV61DS, FCV61E, FCV61EDM, FCV61EDS, FM423E1, KD37, KD37PS, KD37-VERS.112009, KD40, KD40EPSD, KD40LEPS, KD40LSPS, KD40LUX, KD40LUXE...(Other models you can see in the webshop)		
<b>accessories for</b>	370021		
	<b>GEV No.</b>	371220	<b>Ref. No.</b> —
		reducer TP flow rate 3l/min red tolerance ±15%	
	<b>GEV No.</b>	371221	<b>Ref. No.</b> —
		reducer TP flow rate 5.5l/min yellow tolerance ±15%	
	<b>GEV No.</b>	371222	<b>Ref. No.</b> —
		reducer TP flow rate 6l/min grey tolerance ±15%	
	<b>GEV No.</b>	371223	<b>Ref. No.</b> —
		reducer TP flow rate 10l/min white tolerance ±15%	
	<b>GEV No.</b>	371224	<b>Ref. No.</b> —
		reducer TP flow rate 12l/min bronze tolerance ±15%	
	<b>GEV No.</b>	371225	<b>Ref. No.</b> —
		reducer TP flow rate 16l/min light brown tolerance ±15%	
	<b>GEV No.</b>	371226	<b>Ref. No.</b> —
		reducer TP flow rate 20l/min red tolerance ±15%	
	<b>GEV No.</b>	371230	<b>Ref. No.</b> —
		reducer TP flow rate 0.25l/min red tolerance ±25%	
	<b>GEV No.</b>	371231	<b>Ref. No.</b> —
		reducer TP flow rate 0.35l/min violet tolerance ±25%	
	<b>GEV No.</b>	371232	<b>Ref. No.</b> —
		reducer TP flow rate 0.5l/min orange tolerance ±25%	
	<b>GEV No.</b>	371233	<b>Ref. No.</b> —
		reducer TP flow rate 0.8l/min white tolerance ±25%	
	<b>GEV No.</b>	371234	<b>Ref. No.</b> —
		reducer TP flow rate 1l/min light blue tolerance ±25%	
	<b>GEV No.</b>	371235	<b>Ref. No.</b> —
		reducer TP flow rate 1.2l/min brown tolerance ±25%	

Table continues overleaf





Зип-Общепит

vsezip.ru

+7(812)987-08-81

accessories for		370021	
GEV No.	Ref. No.	GEV No.	Ref. No.
	371236	—	—
	371237	—	—
	371238	—	—
	371239	—	—
	371240	—	—

accessories for		370017	
GEV No.	Ref. No.	GEV No.	Ref. No.
	371232	—	—
	371233	—	—
	371234	—	—
	371235	—	—
	371236	—	—
	371237	—	—
	371238	—	—
	371239	—	—
	371240	—	—

  <b>1</b>			
GEV No.	Ref. No.	33D1370	33D2310
<b>description</b> solenoid valve single straight 230VAC inlet 3/4" outlet 11.5mm DN10 TP p max 10bar			
spare parts for		370017	
	GEV No. 371013	Ref. No.	—
accessories for 370017			
	GEV No. 371220	Ref. No.	—
	GEV No. 371221	Ref. No.	—
	GEV No. 371222	Ref. No.	—
	GEV No. 371223	Ref. No.	—
	GEV No. 371224	Ref. No.	—
	GEV No. 371225	Ref. No.	—
	GEV No. 371226	Ref. No.	—
	GEV No. 371230	Ref. No.	—
	GEV No. 371231	Ref. No.	—



  <b>1</b>			
GEV No.	Ref. No.	33D0290	
<b>description</b> solenoid valve double angled 230VAC inlet 3/4" outlet 11.5mm DN10 TP plastic			
spare parts for		370019	
	GEV No. 371013	Ref. No.	—
accessories for 370019			
	GEV No. 371220	Ref. No.	—
	GEV No. 371221	Ref. No.	—
	GEV No. 371222	Ref. No.	—
	GEV No. 371223	Ref. No.	—
	GEV No. 371224	Ref. No.	—

Table continues overleaf

1 electric components



Зип-Общепит

vsezip.ru

+7(812)987-08-81

accessories for		370019		
GEV No.	Ref. No.	Ref. No.	Ref. No.	Ref. No.
	371225			—
reducer TP flow rate 16l/min light brown tolerance ±15%				
	371226			—
reducer TP flow rate 20l/min red tolerance ±15%				
	371230			—
reducer TP flow rate 0.25l/min red tolerance ±25%				
	371231			—
reducer TP flow rate 0.35l/min violet tolerance ±25%				
	371232			—
reducer TP flow rate 0.5l/min orange tolerance ±25%				
	371233			—
reducer TP flow rate 0.8l/min white tolerance ±25%				
	371234			—
reducer TP flow rate 1l/min light blue tolerance ±25%				
	371235			—
reducer TP flow rate 1.2l/min brown tolerance ±25%				
	371236			—
reducer TP flow rate 1.5l/min light brown tolerance ±25%				
	371237			—
reducer TP flow rate 2.5l/min yellow tolerance ±25%				
	371238			—
reducer TP flow rate 3.4l/min dark green tolerance ±25%				
	371239			—
reducer TP flow rate 5l/min black tolerance ±25%				
	371240			—
reducer TP flow rate 8l/min blue tolerance ±20%				

accessories for		370015		
GEV No.	Ref. No.	Ref. No.	Ref. No.	Ref. No.
	371223			—
reducer TP flow rate 10l/min white tolerance ±15%				
	371224			—
reducer TP flow rate 12l/min bronze tolerance ±15%				
	371225			—
reducer TP flow rate 16l/min light brown tolerance ±15%				
	371226			—
reducer TP flow rate 20l/min red tolerance ±15%				
	371230			—
reducer TP flow rate 0.25l/min red tolerance ±25%				
	371231			—
reducer TP flow rate 0.35l/min violet tolerance ±25%				
	371232			—
reducer TP flow rate 0.5l/min orange tolerance ±25%				
	371233			—
reducer TP flow rate 0.8l/min white tolerance ±25%				
	371234			—
reducer TP flow rate 1l/min light blue tolerance ±25%				
	371235			—
reducer TP flow rate 1.2l/min brown tolerance ±25%				
	371236			—
reducer TP flow rate 1.5l/min light brown tolerance ±25%				
	371237			—
reducer TP flow rate 2.5l/min yellow tolerance ±25%				
	371238			—
reducer TP flow rate 3.4l/min dark green tolerance ±25%				
	371239			—
reducer TP flow rate 5l/min black tolerance ±25%				
	371240			—
reducer TP flow rate 8l/min blue tolerance ±20%				

<b>GEV No.</b>	370015	<b>Ref. No.</b>	33D1370 33D1371	
<b>description</b>	solenoid valve single angled 230VAC inlet 3/4" outlet 11.5mm DN10 TP			
<b>accessories for</b>		370015		
	GEV No.	371220	Ref. No.	—
reducer TP flow rate 3l/min red tolerance ±15%				
	GEV No.	371221	Ref. No.	—
reducer TP flow rate 5.5l/min yellow tolerance ±15%				
	GEV No.	371222	Ref. No.	—
reducer TP flow rate 6l/min grey tolerance ±15%				

<b>GEV No.</b>	370031	<b>Ref. No.</b>	N/A	
<b>description</b>	solenoid valve single angled 24VAC inlet 3/4" outlet 14mm DN10 TP			
<b>spare parts for</b>		370031		
	GEV No.	371035	Ref. No.	—
solenoid coil 24VAC				

Table continues overleaf





Зип Общепит

vsezip.ru

+7(812)987-08-81

accessories for 370031		GEV No.	371220	Ref. No.	—
	reducer TP flow rate 3l/min red tolerance ±15%	GEV No.	371221	Ref. No.	—
	reducer TP flow rate 5.5l/min yellow tolerance ±15%	GEV No.	371222	Ref. No.	—
	reducer TP flow rate 6l/min grey tolerance ±15%	GEV No.	371223	Ref. No.	—
	reducer TP flow rate 10l/min white tolerance ±15%	GEV No.	371224	Ref. No.	—
	reducer TP flow rate 12l/min bronze tolerance ±15%	GEV No.	371225	Ref. No.	—
	reducer TP flow rate 16l/min light brown tolerance ±15%	GEV No.	371226	Ref. No.	—
	reducer TP flow rate 20l/min red tolerance ±15%	GEV No.	371230	Ref. No.	—
	reducer TP flow rate 0.25l/min red tolerance ±25%	GEV No.	371231	Ref. No.	—
	reducer TP flow rate 0.35l/min violet tolerance ±25%	GEV No.	371232	Ref. No.	—
	reducer TP flow rate 0.5l/min orange tolerance ±25%	GEV No.	371233	Ref. No.	—
	reducer TP flow rate 0.8l/min white tolerance ±25%	GEV No.	371234	Ref. No.	—
	reducer TP flow rate 1l/min light blue tolerance ±25%	GEV No.	371235	Ref. No.	—
	reducer TP flow rate 1.2l/min brown tolerance ±25%	GEV No.	371236	Ref. No.	—
	reducer TP flow rate 1.5l/min light brown tolerance ±25%	GEV No.	371237	Ref. No.	—
	reducer TP flow rate 2.5l/min yellow tolerance ±25%	GEV No.	371238	Ref. No.	—
	reducer TP flow rate 3.4l/min dark green tolerance ±25%	GEV No.	371239	Ref. No.	—
	reducer TP flow rate 5l/min black tolerance ±25%	GEV No.	371240	Ref. No.	—
	reducer TP flow rate 8l/min blue tolerance ±20%				

solenoid valves with reducers			
			
1	GEV No.	370648	Ref. No. 3032670
description	solenoid valve double straight 220-240VAC inlet 3/4" input 10l/min DN10 TP outlet 11.5mm output A 3.4l/min flow regulating valve outlet A green		
For models:	10CP1EA, 10CP1GA, 10CP1IA, 12CP1EA, 12CP1GA, 12CP1IA, 18CP2EA, 18CP2GA, 18CP2IA, FC1011E, FC1011G, FC1221E, FC1221G, FC611E, FC611G, FM1011E2-VERS.2006, FM1011E3, FM1011E3-VERS.2006, FM1011G2-VERS.2006, FM1011G3, FM1011G3-VERS.2006, FM1221E2-VERS.2006, FM1221E3, FM1221E3-VERS.2006, FM1221G2-VERS.2006, FM1221G3, FM1221G3-VERS.2006, FM2011E2-VERS.2006, FM2011E3-VERS.2006, FM2011G2-VERS.2006, FM2011G3-VERS.2006, FM2021E1, FM2021E2, FM2021E2-VERS.2006, FM2021E3, FM2021E3-VERS.2006, FM2021G1, FM2021G2, FM2021G2-VERS.2006, FM2021G3, FM2021G3-VERS.2006, FM423E2, FM611E2-VERS.2006, FM611E3, FM611E3-VERS.2006, FM611G2-VERS.2006, FM611G3, FM611G3-VERS.2006, FM721E1-VERS.2006, FM721E2-VERS.2006...(Other models you can see in the webshop)		

metal			
ASCO			
spare parts and accessories			
power sockets			
			
1	GEV No.	371093	Ref. No. 32A2330
description	power socket plug type compact cable length 1100mm small		
For models:	0A1FR1G, 0A1FR1GD, 0A1FR1GD-VERS.2004, 0A1FR1G-VERS.2004, 0B1FR1G, 0B1FR1GD, 0D1FR1G, 0D1FR1GD, 0D1FR1GD-VERS.2004, 0D1FR1G-VERS.2004, 1A1BR1G, 1A1BR1GA, 1A1BR2G, 1A1BR2GA, 1A1FR2G, 1A1FR2GD, 1A1FR2GD-VERS.2004, 1A1FR2G-VERS.2004, 1D1BR1G, 1D1BR1GA, 1D1BR2G, 1D1BR2GA, 1D1FR2G, 1D1FR2GD, 1D1FR2GD-VERS.2004, 1D1FR2G-VERS.2004, 2A1BR1G, 2A1BR1GA, 2A1BR2G, 2A1BR2GA, 2D1BR1G, 2D1BR1GA, 2D1BR2G, 2D1BR2GA		



electric components





Зип Общепит

vsezip.ru

+7(812)987-08-81

SIRAI			
2-way			
L140-B series			
			
1			
<b>GEV No.</b>	370320	<b>Ref. No.</b>	33D1060
<b>description</b>	solenoid valve brass 2-ways 24VAC inlet 1/2" outlet 1/2" connection 1/2" L 41mm DN 10mm slide-on receptacle compact -10 up to +90°C SIRAI type series L140-B coil type Z610A membranes NBR (water) p max 12bar p min 0.35bar		
<b>For models:</b>	C165D, C165S, C207D, C207D-VERS.2006, C207S, C207S-VERS.2006, C207VD, C207VD-VERS.2006, C207VS, C207VS-VERS.2006, C304AD, C304AD-VERS.2006, C304AS, C304AS-VERS.2006, C304AVD, C304AVD-VERS.2006, C304AVS, C304AVS-VERS.2006, C304D, C304D-VERS.2006, C304S, C304S-VERS.2006, C304VD, C304VD-VERS.2006, C304VS, C304VS-VERS.2006, C92D-VERS.2006, C92S-VERS.2006, C92VD-VERS.2006, C92VS-VERS.2006, CS243D, CS243D-VERS.2006, CS243S, CS243S-VERS.2006, CS243VD, CS243VD-VERS.2006, CS243VS, CS243VS-VERS.2006, CS370AD, CS370AD-VERS.2006, CS370AS, CS370AS-VERS.2006, CS370AVD, CS370AVD-VERS.2006, CS370AVS, CS370AVS-VERS.2006, CS370D, CS370D-VERS.2006, CS370S, CS370S-VERS.2006...(Other models you can see in the webshop)		
<b>spare parts for</b>	370320		
	<b>GEV No.</b>	371070	<b>Ref. No.</b> N/A
	solenoid coil 24VAC 10VA SIRAI coil type Z610A seat ø 10mm		
<b>accessories for</b>	370320		
	<b>GEV No.</b>	371091	<b>Ref. No.</b> N/A
	power socket plug type DIN 43650B cable lengthmm small		

L180-B series			
			
1			
<b>GEV No.</b>	370391	<b>Ref. No.</b>	33D1050
<b>description</b>	solenoid valve 2-ways 24VAC connection 3/4" L 79mm DN 18mm -10 up to +90°C coil type Z610A membranes NBR (water) p max 12bar p min 0.35bar		
<b>For models:</b>	C165D, C165S, C207D, C207D-VERS.2006, C207S, C207S-VERS.2006, C207VD-VERS.2006, C207VS-VERS.2006, C304AD, C304AD-VERS.2006, C304AS, C304AS-VERS.2006, C304AVD-VERS.2006, C304AVS-VERS.2006, C304D, C304D-VERS.2006, C304S, C304S-VERS.2006, C304VD-VERS.2006, C304VS-VERS.2006, C92D-VERS.2006, C92S-VERS.2006, C92VD-VERS.2006, C92VS-VERS.2006, CS243D, CS243D-VERS.2006, CS243S, CS243S-VERS.2006, CS243VD, CS243VD-VERS.2006, CS243VS, CS243VS-VERS.2006, CS370AD, CS370AD-VERS.2006, CS370AS, CS370AS-VERS.2006, CS370AVD, CS370AVD-VERS.2006, CS370AVS, CS370AVS-VERS.2006, CS370D, CS370D-VERS.2006, CS370S, CS370S-VERS.2006, CS370VD, CS370VD-VERS.2006, CS370VS, CS370VS-VERS.2006, CS466AD, CS466AD-VERS.2006...(Other models you can see in the webshop)		
<b>accessories for</b>	370391		
	<b>GEV No.</b>	371091	<b>Ref. No.</b> N/A
	power socket plug type DIN 43650B cable lengthmm small		

			
1			
<b>GEV No.</b>	370329	<b>Ref. No.</b>	N/A
<b>description</b>	solenoid valve 2-ways 24VAC inlet 1/2" outlet 1/2" connection 1/2" L 66mm DN 13.5mm slide-on receptacle compact -10 up to +90°C SIRAI type series L180-B coil type Z610A membranes NBR (water) p max 12bar p min 0.35bar		
<b>spare parts for</b>	370329		
	<b>GEV No.</b>	371070	<b>Ref. No.</b> N/A
	solenoid coil 24VAC 10VA SIRAI coil type Z610A seat ø 10mm		
	<b>GEV No.</b>	371171	<b>Ref. No.</b> N/A
	membrane series L180-B membrane type NBR (water)		
<b>accessories for</b>	370329		
	<b>GEV No.</b>	371091	<b>Ref. No.</b> N/A
	power socket plug type DIN 43650B cable lengthmm small		



			
1			
<b>GEV No.</b>	370047	<b>Ref. No.</b>	33D0070 33D1460
<b>description</b>	solenoid valve brass 2-ways 230VAC inlet 1/2" outlet 1/2" connection 1/2" L 66mm DN 13.5mm slide-on receptacle compact -10 up to +90°C SIRAI type series L180-B coil type Z610A membranes NBR (water) p max 12bar p min 0.35bar 50/60Hz		
<b>spare parts for</b>	370047		
	<b>GEV No.</b>	371085	<b>Ref. No.</b> —
	solenoid coil 230VAC 4VA SIRAI coil type ZB10A seat ø 10mm 50/60Hz		
	<b>GEV No.</b>	371171	<b>Ref. No.</b> N/A
	membrane series L180-B membrane type NBR (water)		
<b>accessories for</b>	370047		
	<b>GEV No.</b>	371091	<b>Ref. No.</b> N/A
	power socket plug type DIN 43650B cable lengthmm small		





Зип Общепит



vsezip.ru

+7(812)987-08-81

solenoid valves steam (water)			
2-way			
L145-R series			
 <p>1</p>			
<b>GEV No.</b>	370085	<b>Ref. No.</b>	33D1420
<b>description</b>	solenoid valve 230VAC connection 1" L 105mm DN 18.5mm slide-on receptacle DIN -60 up to +170°C SIRAI type series L145-R coil type Z534A membranes PTFE (steam) p max 8bar p min 0.4bar		
<b>spare parts for</b>	370085		
	<b>GEV No.</b>	371067	<b>Ref. No.</b> N/A
solenoid coil 230VAC 14VA SIRAI coil type Z534A seat ø 12mm			
	<b>GEV No.</b>	371166	<b>Ref. No.</b> —
membrane connection 1" series L145-R membrane type PTFE			
<b>accessories for</b>	370085		
	<b>GEV No.</b>	371090	<b>Ref. No.</b> N/A
power socket plug type DIN 43650A screw			

 <p>1</p>			
<b>GEV No.</b>	370318	<b>Ref. No.</b>	33D0570
<b>description</b>	solenoid valve 2-ways 24VAC inlet 1/2" outlet 1/2" connection 1/2" L 66mm DN 10mm slide-on receptacle compact -60 up to +170°C SIRAI type series L145-R coil type Z614A membranes PTFE (steam) p max 8bar p min 0.4bar		
<b>spare parts for</b>	370318		
	<b>GEV No.</b>	371158	<b>Ref. No.</b> N/A
solenoid coil 24VAC 10VA SIRAI coil type Z614A seat ø 10mm			
	<b>GEV No.</b>	371164	<b>Ref. No.</b> N/A
membrane connection 3/8"-1/2" series L145-R membrane type PTFE			
<b>accessories for</b>	370318		
	<b>GEV No.</b>	371091	<b>Ref. No.</b> N/A
power socket plug type DIN 43650B cable lengthmm small			

 <p>1</p>			
<b>GEV No.</b>	370326	<b>Ref. No.</b>	33D0560
<b>description</b>	solenoid valve 2-ways 230VAC connection 1" L 105mm DN 22mm slide-on receptacle DIN -10 up to 140°C SIRAI type series L153-D coil type Z914A membranes EPDM (steam/water) p max 8bar p min 0.1bar		
<b>spare parts for</b>	370326		
	<b>GEV No.</b>	371161	<b>Ref. No.</b> N/A
solenoid coil 230VAC 27VA SIRAI coil type Z923A seat ø 16mm 50Hz			

spare parts and accessories			
solenoid coils			
 <p>1</p>			
<b>GEV No.</b>	371071	<b>Ref. No.</b>	32Z5470
<b>description</b>	solenoid coil 230VAC 10VA SIRAI coil type Z610A seat ø 10mm H 33mm L 33mm W 25mm 50/60Hz		
<b>accessories for</b>	371071		
	<b>GEV No.</b>	371091	<b>Ref. No.</b> N/A
power socket plug type DIN 43650B cable lengthmm small			

 <p>1</p>			
<b>GEV No.</b>	371067	<b>Ref. No.</b>	N/A
<b>description</b>	solenoid coil 230VAC 14VA SIRAI coil type Z534A seat ø 12mm		

 <p>1</p>			
<b>GEV No.</b>	371161	<b>Ref. No.</b>	N/A
<b>description</b>	solenoid coil 230VAC 27VA SIRAI coil type Z923A seat ø 16mm 50Hz		

electric components



Зип Общепит  
vsezip.ru  
7(812)987-08-81



<b>GEV No.</b>	371070	<b>Ref. No.</b>	N/A	
<b>description</b>	solenoid coil 24VAC 10VA SIRAI coil type Z610A seat ø 10mm			
<b>accessories for</b>	371070			
	<b>GEV No.</b>	371091	<b>Ref. No.</b>	N/A
	power socket plug type DIN 43650B cable lengthmm small			



<b>GEV No.</b>	371158	<b>Ref. No.</b>	N/A	
<b>description</b>	solenoid coil 24VAC 10VA SIRAI coil type Z614A seat ø 10mm			
<b>accessories for</b>	371158			
	<b>GEV No.</b>	371091	<b>Ref. No.</b>	N/A
	power socket plug type DIN 43650B cable lengthmm small			



<b>GEV No.</b>	371099	<b>Ref. No.</b>	N/A	
<b>description</b>	solenoid coil 24VDC 5.5VA SIRAI coil type ZB10A seat ø 10mm			
<b>accessories for</b>	371099			
	<b>GEV No.</b>	371091	<b>Ref. No.</b>	N/A
	power socket plug type DIN 43650B cable lengthmm small			

membranes



<b>GEV No.</b>	371163	<b>Ref. No.</b>	N/A
<b>description</b>	membrane connection 1/2" series L140-B membrane type NBR (water)		



<b>GEV No.</b>	371172	<b>Ref. No.</b>	N/A
<b>description</b>	membrane connection 3/4" series L180-B membrane type NBR (water)		



<b>GEV No.</b>	371164	<b>Ref. No.</b>	N/A
<b>description</b>	membrane connection 3/8"-1/2" series L145-R membrane type PTFE		



<b>GEV No.</b>	371170	<b>Ref. No.</b>	N/A
<b>description</b>	membrane series L180-B membrane type NBR (water)		



<b>GEV No.</b>	371171	<b>Ref. No.</b>	N/A
<b>description</b>	membrane series L180-B membrane type NBR (water)		

solenoid valves (gas)

BRAHMA

solenoid valves



<b>GEV No.</b>	101948 <sup>1</sup>	<b>Ref. No.</b>	33A1650	
<b>description</b>	solenoid valve 230VAC DN 15mm connection 1/2" L 72mm BRAHMA coil type 18811003 p max 0.5bar reg. no. 63AQ0626			
<b>For models:</b>	1A1PI2G, 1A1PI2GA, 1D1PI2G, 1D1PI2GA, 291PI3G, 2A1PI3G, 2D1PI3G			
<b>spare parts for</b>	101948			
	<b>GEV No.</b>	101968	<b>Ref. No.</b>	—
	solenoid valve 230VAC 20VA seat ø 17mm coil type 13902001 BRAHMA			

<sup>1</sup>aluminium housing

spare parts and accessories

solenoid coils



<b>GEV No.</b>	106242	<b>Ref. No.</b>	32V3640
<b>description</b>	solenoid coil 230VAC 20VA seat ø 17mm		
<b>For models:</b>	1A1PI2G, 1A1PI2GA, 1D1PI2G, 1D1PI2GA, 291PI3G, 2A1PI3G, 2D1PI3G		



solenoid valves (refrigeration)

Зип.Общепит pressure switches

vsezip.ru

+7(812)987-08-81

CASTEL

spare parts and accessories



<b>GEV No.</b>	371090	<b>Ref. No.</b>	N/A
<b>description</b>	power socket plug type DIN 43650A screw		

PARKER

valves



<b>GEV No.</b>	370611	<b>Ref. No.</b>	33A0510
<b>description</b>	solenoid valve 2-way 230V 1.9 tube $\phi$ 6mm coil type ZB09 50/60Hz		
<b>For models:</b>	120, 120NN, 120PV, 135, 135-4, 135BN, 135BNX, 135CPX, 135NN, 135NNX, 135PVX, 135X, 135X-3, 135X-4, 40CP, 40CPX, 55, 55PV, 65, 65NB, 65NBX, 65NN, 65NNX, 65PVX, 65X, 65X-2, 6BEA11A, 6BEA11B, 6BEA11M, 6BEA11Z, 6BEA2A, 6BEA2B, 6BEA2M, 6BEA2Z, 6BEA3A, 6BEA3B, 6BEA3M, 6BEA3Z, 6BEA4, 6BEA4B, 6BEA4M, 6BEA4Z, 6BEB11A, 6BEB11B, 6BEB11M, 6BEB11Z, 6BEB22A, 6BEB22B, 6BEB22M, 6BEB22Z...(Other models you can see in the webshop)		

Solenoid valve - accessories

filters



<b>GEV No.</b>	370467	<b>Ref. No.</b>	N/A
<b>description</b>	solenoid valve filter suitable for ELBI		



<b>GEV No.</b>	371091	<b>Ref. No.</b>	N/A
<b>description</b>	power socket plug type DIN 43650B cable lengthmm small		

for warewashing

$\phi$  58mm with male faston 6.3mm

with connection horizontal



<b>GEV No.</b>	541192	<b>Ref. No.</b>	32Z7190
<b>description</b>	pressure control		
<b>For models:</b>	LT10R, LT20F, LT25F		



<b>GEV No.</b>	541011	<b>Ref. No.</b>	32Z4690
<b>description</b>	pressure control pressure range 110/70mbar connection 6mm $\phi$ 58mm pressure connection horizontal warewashing		



<b>GEV No.</b>	541331	<b>Ref. No.</b>	32Z0860
<b>description</b>	pressure control pressure range 225/70mbar connection 6mm $\phi$ 58mm pressure connection horizontal warewashing		
<b>For models:</b>	L100, L80, LCV		



<b>GEV No.</b>	541314	<b>Ref. No.</b>	32V7060
<b>description</b>	pressure control pressure range 46/26mbar connection 6mm $\phi$ 58mm pressure connection horizontal warewashing pressure connection $\phi$ 6mm		
<b>For models:</b>	KD100, KD100A, KD100PSD, KD130A, KD130E, KD130EAT, KD37, KD37PS, KD37-VERS.112009, KD40, KD40EPSD, KD40LEPS, KD40LSPS, KD40LUX, KD40LUXE, KD40PS, KD40-VERS.112009, KD60, KD60E, KD60EAT, KD60M, KD60MA, KD60ME, KD60MPS, KD60MPSA, KD60PS, KD60PSD, KD6EATSD, KD85A, KD85EA, KD85EAT, KD85EATS, KD85EPSA, KD85PSA, KN1100, KN1100SD, KN11PSDD, KN35, KN37, KN37PS, KN40, KN40PS, KN40PSD, KN50, KN50M, KN50MPS, KN50PS, KN50PSD, KN50PSDD, KN80...(Other models you can see in the webshop)		

electric components





Зип Общепит

vsezip.ru

7(812)987 08 81

			
1			
<b>GEV No.</b>	541010	<b>Ref. No.</b>	32Z1700
<b>description</b>	pressure control pressure range 50/30mbar connection 6mm ø 58mm pressure connection horizontal warewashing		

			
1			
<b>GEV No.</b>	541194	<b>Ref. No.</b>	32Z2170
<b>description</b>	pressure control pressure range 50/32mbar connection male faston 6.3mm ø 58mm pressure connection horizontal warewashing pressure connection ø 6mm		

			
1			
<b>GEV No.</b>	541140	<b>Ref. No.</b>	32V7060 32Z2170
<b>description</b>	pressure control pressure range 55/30mbar connection 6mm ø 58mm pressure connection horizontal warewashing		

			
1			
<b>GEV No.</b>	541012	<b>Ref. No.</b>	32Z0280
<b>description</b>	pressure control pressure range 68/40mbar connection 6mm ø 58mm pressure connection horizontal warewashing pressure connection ø 6mm		

			
1			
<b>GEV No.</b>	541330	<b>Ref. No.</b>	32Z4740 32Z4741
<b>description</b>	pressure control pressure range 70/30mbar connection 6mm ø 58mm pressure connection horizontal warewashing pressure connection ø 6mm		
<b>For models:</b>	F60P, F60PR, F60T, F80P, F80PR, L40, L40S, L45, L60, LCV		

			
1			
<b>GEV No.</b>	541311	<b>Ref. No.</b>	32Z0070
<b>description</b>	pressure control pressure range 76/38mbar connection 6mm ø 58mm pressure connection horizontal warewashing pressure connection ø 6mm		

			
1			
<b>GEV No.</b>	541312	<b>Ref. No.</b>	32V7080
<b>description</b>	pressure control pressure range 86/59mbar connection 6mm ø 58mm pressure connection horizontal warewashing pressure connection ø 6mm		
<b>For models:</b>	KD100, KD100A, KD100PSD, KD40EPSD, KD40LEPS, KD40LUXE, LP151		

			
1			
<b>GEV No.</b>	541168	<b>Ref. No.</b>	32V1870 32Z8880
<b>description</b>	pressure control pressure range 90/35mbar connection 6mm ø 58mm pressure connection horizontal warewashing pressure connection ø 6mm		
<b>For models:</b>	C165D, C165S, C165VD, C165VS, C207D, C207S, C207VD, C207VD-VERS.2006, C207VS, C207VS-VERS.2006, C304AD, C304AS, C304AVD, C304AVD-VERS.2006, C304AVS, C304AVS-VERS.2006, C304D, C304S, C304VD, C304VD-VERS.2006, C304VS, C304VS-VERS.2006, C92VD-VERS.2006, C92VS-VERS.2006, LC100, LC100-VERS.2001, LC130, LC130-VERS.2001, LC80, N303S, N303VD, N303VS, N354D, N354VD, N354VS, N506D, N506VD, N506VS, N607D, N607VD, N607VS, N760S, N760VD, N760VS, N886D, N886VD, N886VS		

			
1			
<b>GEV No.</b>	541017	<b>Ref. No.</b>	32Z8930
<b>description</b>	pressure control with mounting strap pressure range 40/20mbar connection 6mm ø 58mm pressure connection horizontal warewashing		
<b>For models:</b>	CS243S, CS243VS, CS370AS, CS370AVS, CS370S, CS370VS, CS466AS, CS466AVS, CS466VS, LF50, LF50E, LF50EM, LF50E-VERS.2007, N303D, N303S, N303VD, N303VS, N354D, N354S, N354VD, N354VS, N506D, N506S, N506VD, N506VS, N607D, N607S, N607VD, N607VS, N760D, N760S, N760VD, N760VS, N886D, N886S, N886VD, N886VS		



Зип Общепит

vsezip.ru

+7(812)987-08-81



1

<b>GEV No.</b>	541199	<b>Ref. No.</b>	6300569
<b>description</b>	pressure control pressure range 0.2-3.0mbar ø 74mm pressure connection ø 6.3mm		
<b>For models:</b>	FC1011G, FC1221G, FC611G, FM1011G1, FM1011G1-VERS.2006, FM1011G2, FM1011G2-VERS.2006, FM1011G3, FM1011G3-VERS.2006, FM1221G1, FM1221G1-VERS.2006, FM1221G2, FM1221G2-VERS.2006, FM1221G3, FM1221G3-VERS.2006, FM2011G2-VERS.2006, FM2011G3-VERS.2006, FM2021G1, FM2021G2, FM2021G2-VERS.2006, FM2021G3, FM2021G3-VERS.2006, FM611G1, FM611G1-VERS.2006, FM611G2, FM611G2-VERS.2006, FM611G3, FM611G3-VERS.2006, FM721G1, FM721G1-VERS.2006, FM721G2, FM721G2-VERS.2006, FM721G3, FM721G3-VERS.2006		



1

<b>GEV No.</b>	541575	<b>Ref. No.</b>	3004460 3004461
<b>description</b>	pressure control ø 45.5mm pressure range 400/200mbar 1CO pressure connection vertical convection oven connection male faston 6.3mm suitable for ANGELO PO 250V p max 1bar 6A pressure connection 1/8"		
<b>For models:</b>	FM1011E3, FM1011E3-VERS.2006, FM1011G3, FM1011G3-VERS.2006, FM1221E3, FM1221E3-VERS.2006, FM1221G3, FM1221G3-VERS.2006, FM2011E3-VERS.2006, FM2011G3-VERS.2006, FM2021E3, FM2021E3-VERS.2006, FM2021G3, FM2021G3-VERS.2006, FM611E3, FM611E3-VERS.2006, FM611G3, FM611G3-VERS.2006, FM721E3, FM721E3-VERS.2006, FM721G3, FM721G3-VERS.2006		

ø 79mm with coded plug



1

<b>GEV No.</b>	541332	<b>Ref. No.</b>	32Z2840
<b>description</b>	pressure control 2 pressure ranges pressure range 70/40 90/70mbar connection coded plug ø 78mm pressure connection horizontal warewashing pressure connection ø 6mm at 250V 16A		
<b>For models:</b>	F60PR, F60T, F80P, F80PR		

for pasta cookers



1

<b>GEV No.</b>	541980	<b>Ref. No.</b>	6300988
<b>description</b>	conversion kit for drain pump pressure range 300/245 385/300bar 0G1CP1G		

for combi-steamers



1

<b>GEV No.</b>	541806	<b>Ref. No.</b>	3041830 32Z5870 32Z5871 32Z5872
<b>description</b>	pressure control ø 38mm pressure range 0.2-3.0bar connection 1/8" 250V 10A GP600 pressure connection 1/8"		
<b>For models:</b>	BX101E, BX101E-VERS.122013, BX101G, BX101G-VERS.122013, BX122E, BX122E-VERS.122013, BX122G, BX122G-VERS.122013, BX61E, BX61E-VERS.122013, BX61G, BX61G-VERS.122013, BX82E, BX82E-VERS.122013, BX82G, BX82G-VERS.122013, FCV101, FCV101-CSA, FCV101DM, FCV101DM-CSA, FCV101DS, FCV101DS-CSA, FCV101E, FCV101EDM, FCV101EDM-UL, FCV101EDS, FCV101EDS-UL, FCV101E-UL, FCV141, FCV141-CSA, FCV141DM, FCV141DM-CSA, FCV141DS, FCV141DS-CSA, FCV141E, FCV141EDM, FCV141EDS, FCV241, FCV241DM, FCV241DS, FCV241E, FCV241EDM, FCV241EDM-UL, FCV241EDS, FCV241EDS-UL, FCV241E-UL, FCV241G, FCV241G-CSA, FCV241GDM, FCV241GDM-CSA...(Other models you can see in the webshop)		
<b>accessories for</b>	541806		
	<b>GEV No.</b>	541814	<b>Ref. No.</b> —
	protection cap for pressure switch EPDM XP600		



1

<b>GEV No.</b>	542229	<b>Ref. No.</b>	3160100 3253760
<b>description</b>	pressure control pressure range 350/265mbar connection 5.5		
<b>For models:</b>	04WCP1EM, 06WCP1GM, 08WCP1GM, 091CP1E, 091CP1G, 191CP1G, 191CP2G, 1G1CP1G-VERS.2004, 6040090, 6040310		



1

<b>GEV No.</b>	541482	<b>Ref. No.</b>	3017600
<b>description</b>	pressure control pressure range 385/325mbar connection 6mm		
<b>For models:</b>	04WCP1EM, 06WCP1GM, 08WCP1GM, 091CP1E, 091CP1G, 0G1CP1EC, 0G1CP1E-VERS.2004, 0G1CP1G-VERS.2004, 191CP1G, 191CP2G, 1G1CP1G-VERS.2004, 1G1CP2G-VERS.2004		



for boiling pans



1

<b>GEV No.</b>	541510	<b>Ref. No.</b>	32V1790
<b>description</b>	pressure control EGO		
<b>For models:</b>	1A1PI2G, 1A1PI2GA, 1D1PI2G, 1D1PI2GA, 291PI3E, 291PI3G, 2A1PI3E, 2A1PI3G, 2D1PI3G, MCF20E, MCF20V, MCF40E, MCF40V		

for refrigeration

RANCO

G60 series



1

<b>GEV No.</b>	541195	<b>Ref. No.</b>	32Z6350
<b>description</b>	pressure control RANCO G60H1129401		
<b>For models:</b>	120NN, 65NB, 65NBX, 65NN, 65NNX, SP65NB, SP65NN		

compressors

ACC/ZEL

R134A

HMBP monophase

*High/Medium evaporation temperature above -20/-15 °C*

1

<b>GEV No.</b>	605007	<b>Ref. No.</b>	34D6390
<b>description</b>	compressor coolant R134a type GL60TB 220-240V 50Hz HMBP fully hermetic 9.5kg 1/5HP power input 437W cylinder capacity 5.7cm <sup>3</sup> CSIR H 175.5mm 95W 128W 170W 222W 284W 355W 437W 528W test method ASHRAE ambient temperature max. 43°C		
<b>For models:</b>	40CP, 40CPX, 65A, 65XE, 6FMA11A, 6FMA11B, 6FMA11M, 6FMA11Z, 6FMA2A, 6FMA2B, 6FMA2M, 6FMA2Z, 6FMA4A, 6FMA4B, 6FMA4M, 6FMA4Z, 6FMAA, 6FMAB, 6FMAM, 6FMAZ, 6TRA, 6TRA2, 6TRA2A, 6TRA2M, 6TRA2Z, 6TRA4, 6TRA4A, 6TRA4M, 6TRA4Z, 6TRAA, 6TRAM, 6TRAZ, CX140CP, CX150CP, CX65NB, CX65NCP, CX65NN, CX70NB, CX70NN, FM1A, FM1A-11, FM1A-2, FM1A-4, S60, S60-2, S60E, S60X, S60X-2, SA87		

Зип Общепит

vsezip.ru

+7(812)987-08-81



1

<b>GEV No.</b>	605008	<b>Ref. No.</b>	34D6500
<b>description</b>	compressor coolant R134a type GL80TB 220-240V 50Hz HMBP fully hermetic 9.5kg 1/5HP power input 554W cylinder capacity 7.6cm <sup>3</sup> CSIR H 175.5mm 165W 215W 290W 390W 500W 615W 727W 840W test method ASHRAE ambient temperature max. 43°C		
<b>For models:</b>	55, 55PV, 6JB, 6JB2, 6JB2A, 6JB2M, 6JB4A, 6JB4M, 6JBA, 6JBM, 6SMB, 6SMB2, 6SMB2A, 6SMB2B, 6SMB2M, 6SMB2Z, 6SMB4, 6SMB4A, 6SMB4B, 6SMB4M, 6SMB4Z, 6SMB6Z, 6SMB6A, 6SMBB, 6SMBM, 6SMBZ, PE1633, PE1633V, PZ20, PZ2033A, PZ2033B, PZ2037A, PZ2037B		



1

<b>GEV No.</b>	605009	<b>Ref. No.</b>	34D6510
<b>description</b>	compressor coolant R134a type GL90TB 220-240V 50Hz HMBP fully hermetic 10.8kg 1/4HP power input 293W cylinder capacity 8.8cm <sup>3</sup> CSIR H 175.5mm 143W 194W 259W 339W 432W 539W 661W 796W test method ASHRAE		
<b>For models:</b>	6FMB11A, 6FMB11B, 6FMB11M, 6FMB11Z, 6FMB2A, 6FMB2B, 6FMB2M, 6FMB2Z, 6FMB4A, 6FMB4B, 6FMB4M, 6FMB4Z, 6FMB6A, 6FMB6B, 6FMB6M, 6FMB6Z, 6FMC11A, 6FMC11B, 6FMC11M, 6FMC11Z, 6FMC2A, 6FMC2B, 6FMC2M, 6FMC2Z, 6FMC4A, 6FMC4B, 6FMC4M, 6FMC4Z, 6FMC6A, 6FMC6B, 6FMC6M, 6FMC6Z, 6TRB, 6TRB11, 6TRB11A, 6TRB11M, 6TRB11Z, 6TRB2, 6TRB2A, 6TRB2M, 6TRB2Z, 6TRB4, 6TRB4A, 6TRB4M, 6TRB4Z, 6TRB6, 6TRB6A, 6TRB6M, 6TRB6Z, 6TRBA...(Other models you can see in the webshop)		





Зип Общепит

EMBRACE / ASTERA

vsezip.ru

R134A  
1HP multiphase

+7(812)987-08-81



1

<b>GEV No.</b>	605010	<b>Ref. No.</b>	34D6520 34D6760
<b>description</b>	compressor coolant R134a type GP12TB 220-240V 50Hz HMBP fully hermetic 11.2kg 3/8HP power input 661W cylinder capacity 12cm <sup>3</sup> CSIR H 203.6mmW 143W 194W 259W 339W 432W 539W 661W 796W test method ASHRAE ambient temperature max. 43°C		
<b>For models:</b>	120, 120NN, 120PV, 135, 135-4, 135A, 135NN, 135NNX, 135PVX, 135X, 135X-3, 135X-4, 135XE, 65NN, 65NNX, 65PVX, 6SMC, 6SMC2, 6SMC2A, 6SMC2B, 6SMC2M, 6SMC2Z, 6SMC4, 6SMC4A, 6SMC4B, 6SMC4M, 6SMC4Z, 6SMC6, 6SMC6A, 6SMC6B, 6SMC6M, 6SMC6Z, 6SMC8Z, 6SMCA, 6SMCB, 6SMCM, 6SMCZ, 6TRC, 6TRC11, 6TRC11A, 6TRC11M, 6TRC11Z, 6TRC2, 6TRC2A, 6TRC2M, 6TRC2Z, 6TRC4, 6TRC4A, 6TRC4M, 6TRC4Z...(Other models you can see in the webshop)		



1

<b>GEV No.</b>	605209	<b>Ref. No.</b>	34D5490
<b>description</b>	compressor coolant R134a type NEK6187Z-A 220-240V 50Hz HBP 11kg 1/3HP cylinder capacity 10cm <sup>3</sup> CSIR H 200mmWWW 365W 482W 624W 791W 983W 1201W test method EN 12900 ambient temperature max. 55°C		
<b>For models:</b>	6BEC11A, 6BEC11B, 6BEC11M, 6BEC11Z, 6BEC22A, 6BEC22B, 6BEC22M, 6BEC22Z, 6BEC2A, 6BEC2B, 6BEC2M, 6BEC2Z, 6BEC33A, 6BEC33B, 6BEC33M, 6BEC33Z, 6BEC3A, 6BEC3B, 6BEC3M, 6BEC3Z, 6BEC4A, 6BEC4B, 6BEC4M, 6BEC4Z, 6BEC6A, 6BEC6B, 6BEC6M, 6BEC6Z, 6BECA, 6BECB, 6BECM, 6BECZ, 6BMB11A, 6BMB11B, 6BMB11M, 6BMB11Z, 6BMB22A, 6BMB22B, 6BMB22M, 6BMB22Z, 6BMB2A, 6BMB2B, 6BMB2M, 6BMB2Z, 6BMB3A, 6BMB3B, 6BMB3M, 6BMB3Z, 6BMB4A, 6BMB4B...(Other models you can see in the webshop)		

CUBIGEL

accessories



1

<b>GEV No.</b>	380091	<b>Ref. No.</b>	32Z6920
<b>description</b>	start relay MTRP0027 120/240V voltage AC 8A 1NO		
<b>For models:</b>	135CPX, 55, 55PV, 6BEA11A, 6BEA11B, 6BEA11M, 6BEA2A, 6BEA2B, 6BEA2M, 6BEA3A, 6BEA3B, 6BEA3M, 6BEA, 6BEAB, 6BEAM, 6BEB11A, 6BEB11B, 6BEB11M, 6BEB22A, 6BEB22B, 6BEB22M, 6BEB2A, 6BEB2B, 6BEB2M, 6BEB3A, 6BEB3B, 6BEB3M, 6BEB4A, 6BEB4B, 6BEB4M, 6BEBA, 6BEBB, 6BEBM, 6BMA11A, 6BMA11B, 6BMA11M, 6BMA2A, 6BMA2B, 6BMA2M, 6BMA3A, 6BMA3B, 6BMA3M, 6BMAA, 6BMAB, 6BMAM, 6FMA11A, 6FMA11B, 6FMA11M, 6FMA2A, 6FMA2B...(Other models you can see in the webshop)		

accessories

starting relays

klixons



1

<b>GEV No.</b>	380094	<b>Ref. No.</b>	32Z1050
<b>description</b>	start relay 120/240V voltage AC 8A 1NO 1NO 1-pole		

overload protector (klixon)



1

<b>GEV No.</b>	390597	<b>Ref. No.</b>	32Z1030
<b>description</b>	overload protector for engine protective circuit breaker MRP77A-MN_3001 with cable t.max. 150°C reset automatic		

electric components



electric components

Зип.Общепит

axial fans  
vsezip.ru  
ebm-papst

+7(812)987-08-81



<b>1</b>	<b>GEV No.</b>	390599	<b>Ref. No.</b>	32Z6930
<b>description</b>	overload protector for engine protective curcuit breaker T0318/22 with cable t.max. 150°C reset automatic			
<b>For models:</b>	135CPX, 55, 55PV, 6BEA11A, 6BEA11B, 6BEA11M, 6BEA2A, 6BEA2B, 6BEA2M, 6BEA3A, 6BEA3B, 6BEA3M, 6BEAA, 6BEAB, 6BEAM, 6BEB11A, 6BEB11B, 6BEB11M, 6BEB22A, 6BEB22B, 6BEB22M, 6BEB2A, 6BEB2B, 6BEB2M, 6BEB3A, 6BEB3B, 6BEB3M, 6BEB4A, 6BEB4B, 6BEB4M, 6BEBA, 6BEBB, 6BEBM, 6BMA11A, 6BMA11B, 6BMA11M, 6BMA2A, 6BMA2B, 6BMA2M, 6BMA3A, 6BMA3B, 6BMA3M, 6BMAA, 6BMAB, 6BMAM, 6FMA11A, 6FMA11B, 6FMA11M, 6FMA2A, 6FMA2B...(Other models you can see in the webshop)			



<b>1</b>	<b>GEV No.</b>	601082 <sup>1</sup>	<b>Ref. No.</b>	3076620
<b>description</b>	axial fan L 92mm W 92mm H 25mm 230VAC 50/60Hz 9/11W bearing ball bearing manuf. no. 3956 metal connection male faston 2.8mm ebm-papst fan wheel ø 85mm temp.-resist. 80°C			
<b>For models:</b>	04WPEBV, 08WPEBV, 08WTPEV, 090PEB, 091FR1EX, 091FR1IA, 091FR7G, 091FR7GS, 091FR7GX, 190PEB, 190TPE, 6BM, 6BR, 6CP, 6FR, 6FTL, 6FTR, 6PC, 6VTR, 6VTR2			
<b>accessories for</b>	601082			
	<b>GEV No.</b>	691103	<b>Ref. No.</b>	—
	guard ø 90mm mounting distance 83mm for axial fan 92mm			

<sup>1</sup>with ball bearings

## evaporation and condensing trays

### condensing trays heated

universal

heating cartridges



<b>1</b>	<b>GEV No.</b>	418892	<b>Ref. No.</b>	32G3310
<b>description</b>	heating cartridge 300W 230V ø 12mm L 240mm thread 3/8" cable length 2000mm immersion heater			
<b>For models:</b>	AF1N, AF1N-0PR01, AF2N, AF2N-0PR01, CX120, CX120NN, CX130, CX130NN, CX140, CX140BN, CX140BR, CX140CP, CX140NN, CX140PV, CX140R, CX150, CX150BN, CX150BR, CX150CP, CX150NN, CX150PV, CX150R, CX55, CX60, CX65, CX652, CX65BR, CX65NB, CX65NCP, CX65NN, CX65PV, CX65R, CX70, CX702, CX70BR, CX70NB, CX70NN, CX70PV, CX70R, FSD1N, FSD2N, FSD2N2, FSDR1B-0PR01, FSDR1N-0PR01, FSDR2B-0PR01, FSDR2B2-0PR01, FSDR2N, FSDR2N-0PR01, FSDR2N2-0PR01, FSE2N...(Other models you can see in the webshop)			
<b>accessories for</b>	418892			
	<b>GEV No.</b>	511472	<b>Ref. No.</b>	—
	nut thread 3/8" H 4mm brass WS 21 Qty 1 pcs			
	<b>GEV No.</b>	518393	<b>Ref. No.</b>	—
	flat gasket FIBER ED ø 24mm ID ø 17mm thickness 2mm Qty 1 pcs			

## import



<b>1</b>	<b>GEV No.</b>	601604 <sup>1</sup>	<b>Ref. No.</b>	32M7130 32V5790
<b>description</b>	axial fan L 119mm W 119mm H 38mm 230VAC 50/60Hz 17/15W bearing slide bearing manuf. no. AA1282HS-AT connection cable 300mm fan wheel ø 110mm temp.-resist. 70°C input current 0.1A airflow 130m <sup>3</sup> /h 2600rpm			

<sup>1</sup>with slide bearings



Зип-Общепит

vsezip.ru

+7(812)9870881



1

<b>GEV No.</b>	601055 <sup>1</sup>	<b>Ref. No.</b>	3113740 3205930
<b>description</b>	axial fan L 92mm W 92mm H 25mm 230VAC 50/60Hz 14.5/14W bearing ball bearing connection male faston 2.8mm metal ADDA fan wheel ø 85mm temp.-resist. 70°C		
<b>For models:</b>	08WPBEV, 08WTPEV, 090PEB, 091FR11, 091FR11D, 091PEB, 10CP1EA, 10CP1IA, 12CP1EA, 12CP1IA, 18CP2EA, 18CP2IA, 190PEB, 190TPE, 191FR2I, 191FR2ID, 191PEB, 191TPE, 2091SCP, FX101E1, FX101E1R, FX101E2, FX101E2C, FX101E2C-VERS.032014, FX101E2R, FX101E2R-VERS.032014, FX101E2-VERS.032014, FX101E3, FX101E3C, FX101E3C-VERS.022014, FX101E3R, FX101E3R-VERS.022014, FX101E3-VERS.022014, FX101G1, FX101G1R, FX101G2, FX101G2C, FX101G2C-VERS.032014, FX101G2R, FX101G2R-VERS.032014, FX101G2-VERS.032014, FX101G3, FX101G3C, FX101G3C-VERS.022014, FX101G3R, FX101G3R-VERS.022014, FX101G3-VERS.022014, FX10E2CR, FX10E2CR-VERS.032014, FX10E3CR...(Other models you can see in the webshop)		
<b>accessories for</b>	601055		
	<b>GEV No.</b>	550898	<b>Ref. No.</b> —
	connecting cable cable length 2000mm connection F 2.8 connection distance 7.9mm for axial flow fan		
	<b>GEV No.</b>	691103	<b>Ref. No.</b> —
	guard ø 90mm mounting distance 83mm for axial fan 92mm		

<sup>1</sup>with ball bearings

refrigeration fans

refrigeration motors universal

ELCO

N series - multi fit



1

<b>GEV No.</b>	601427	<b>Ref. No.</b>	32M4041 32M6870
<b>description</b>	fan motor ELCO 10W 230V 50/60Hz bearing slide bearing L1 49mm L2 59mm L3 86.5mm W 83mm connection cable 500mm 1300/1550rpm 5 mounting options VNT10-20/028		
<b>For models:</b>	120, 120B, 120NN, 120PV, 135, 135-4, 135A, 135B, 135BA, 135BN, 135BNX, 135BX, 135BXE, 135BXR, 135CPX, 135NN, 135NNX, 135PVX, 135X, 135X-3, 135X-4, 135XE, 135XR, 3G6SA, 3G6SA2, 3G6SA4, 40B, 40CP, 40CPX, 4G6SB, 4G6SB2, 4G6SB4, 4G6SB6, 55, 55B, 55PV, 65, 65A, 65B, 65BA, 65BX, 65BX-2, 65BXE, 65BXR, 65NB, 65NBX, 65NN, 65NNX, 65PVX, 65X...(Other models you can see in the webshop)		
<b>spare parts for</b>	601427		
	<b>GEV No.</b>	560140	<b>Ref. No.</b> —
	hexagonal nut thread M4 H 4.8mm SS WS 7 Qty 20 pcs DIN/ISO DIN 985 self-locking		

<b>spare parts for</b>	601427		
	<b>GEV No.</b>	560332	<b>Ref. No.</b> —
	plain washer ID ø 4.3mm ED ø 9mm thickness 0.8mm SS Qty 1 pcs		
	<b>GEV No.</b>	560340	<b>Ref. No.</b> —
	hexagonal nut thread M4 H 3.2mm WS 7 SS DIN/ISO DIN 934 / ISO 4032/8673 Qty 1 pcs		
	<b>GEV No.</b>	601413	<b>Ref. No.</b> —
	fixing plate suitable for fanwheel ED ø 32mm shaft ø 7 mounting distance 26mm		

	1		
<b>GEV No.</b>	601430	<b>Ref. No.</b>	32M4351
<b>description</b>	fan motor ELCO 5W 230V 50/60Hz bearing slide bearing L1 48mm L2 52mm L3 79.5mm W 83mm connection cable 500mm 1300/1550rpm 5 mounting options VNT5-13/027		
<b>spare parts for</b>	601430		
	<b>GEV No.</b>	560140	<b>Ref. No.</b> —
	hexagonal nut thread M4 H 4.8mm SS WS 7 Qty 20 pcs DIN/ISO DIN 985 self-locking		
	<b>GEV No.</b>	560332	<b>Ref. No.</b> —
	plain washer ID ø 4.3mm ED ø 9mm thickness 0.8mm SS Qty 1 pcs		
	<b>GEV No.</b>	560340	<b>Ref. No.</b> —
	hexagonal nut thread M4 H 3.2mm WS 7 SS DIN/ISO DIN 934 / ISO 4032/8673 Qty 1 pcs		
	<b>GEV No.</b>	601413	<b>Ref. No.</b> —
	fixing plate suitable for fanwheel ED ø 32mm shaft ø 7 mounting distance 26mm		



electric components



## N series - standard



1

<b>GEV No.</b>	601708 <sup>1</sup>	<b>Ref. No.</b>	32M7020
<b>description</b>	fan motor ELCO 10W 230V 50/60Hz bearing slide bearing L3 82.5mm W 66mm connection Plug In cable lengthmm 1300/1550rpm VN10-20/1124		
<b>For models:</b>	3G6SA, 3G6SA2, 3G6SA4, 40B, 40B-OPR01, 40BX-OPR01, 40CP-OPR01, 40CPX-OPR01, 4G6SB, 4G6SB2, 4G6SB4, 4G6SB6, 6BR15V, 6BR15VC, 6BR19V, 6BR19VC, 6EA, 6EA11, 6EA11A, 6EA11M, 6EA13, 6EA13A, 6EA13M, 6EA2, 6EA2A, 6EA2M, 6EAA, 6EAB, 6EABA, 6EABM, 6EAM, 6EB, 6EB11, 6EB11A, 6EB11M, 6EB13, 6EB13A, 6EB13M, 6EB2, 6EB22, 6EB22A, 6EB22M, 6EB2A, 6EB2M, 6EB4, 6EB4A, 6EB4M, 6EBA, 6EBM, 6EC...(Other models you can see in the webshop)		
<b>spare parts for</b>	601708		
	<b>GEV No.</b>	601413	<b>Ref. No.</b> —
	fixing plate suitable for fanwheel ED ø 32mm shaft ø 7 mounting distance 26mm		
<b>accessories for</b>	601708		
	<b>GEV No.</b>	601892	<b>Ref. No.</b> —
	connector cable ELCO cable length 1500mm 0.75mm <sup>2</sup> protection IP42 for Plug-In		

<sup>1</sup>with coded connector

## RE series



1

<b>GEV No.</b>	602051	<b>Ref. No.</b>	32M7240
<b>description</b>	fan motor 18/62W 230V 50/60Hz 2600rpm		
<b>For models:</b>	AGL6B, B151H, BF51H, FSD2B-OPR01, FSD2B2-OPR01, FSDR2B-OPR01, FSDR2B2-OPR01, FSE2B-OPR01, FSE2B2-OPR01, FSER2B-OPR01, FSER2B2-OPR01, IS51H, XS51H		

## BT series - capacitor motors



1

<b>GEV No.</b>	601820 <sup>1</sup>	<b>Ref. No.</b>	32M4701
<b>description</b>	fan motor 35W 230V 50/60Hz L2 89mm L3 110mm W 82mm cable length 2150mm 1300/1550rpm ELCO incl. capacitor capacitor 2.5µF		
<b>For models:</b>	ART2LD, ART2SD, DS51, DS51A, DS51C, DS51M, GR135BT, GR1A, GR2A, IA101L, IA101S, IS101L, IS101S, IS51, IS51A, IS51C, IS51M, ISFEB, ISFEB-OPR01, ISFEN, ISFEN-OPR01, SM1L, SM1L7, SM1L7A, SM1L7FCV, SM1L7M, SM1LA, SM1LAM, SM1LAT, SM1LM, SM1LT, SM1LT7, SM1LT7A, SM1LT7M, SM2L, SM2S, SM3S		

<sup>1</sup>incl. capacitor

## Зип-Общепит

multi fit fan motors



1

<b>GEV No.</b>	601022	<b>Ref. No.</b>	32M0220 32M1060 32M4371
<b>description</b>	fan motor 10W 230V 50-60Hz L1 44mm L2 54mm L3 85mm W 84mm cable length 500mm 1300rpm YZF10-20-18/26 5 mounting options bearing slide bearing		
<b>For models:</b>	120, 120B, 120NN, 120PV, 135, 135BN, 135NN, 55, 55B, 55PV, 65, 65B, 65NB, 65NN, 6BEABA, 6BEABB, 6BEABM, 6BEABZ, BRPR, BRPR218, BRVR, BRVR218, PGA20, PGA30, PGA40, PGA60, PGA80, PGW20, PGW30, PGW40, PGW60, PGW80, S125X, S60B, S60BX, S60X, SA87, SP120, SP120B, SP120BN, SP120NN, SP135, SP135BN, SP135CP, SP135NN, SP55, SP55B, SP65, SP65B, SP65NB...(Other models you can see in the webshop)		



1

<b>GEV No.</b>	601020	<b>Ref. No.</b>	32M4350
<b>description</b>	fan motor 5W 230V 50-60Hz L1 44mm L2 48mm L3 79mm W 84mm cable length 500mm 1300rpm YZF5-13-18/26 5 mounting options bearing slide bearing		
<b>For models:</b>	135BN, 135NN, 40CP, 40CPX, 65, 65NB, 65NN, S125B, S125BX, S125X, S60B, S60X, SP120BN, SP120NN, SP135BN, SP135CP, SP135NN, SP55, SP55B, SP65, SP65NB, SP65NN		

Зип Общепит

vsezip.ru

+7(812)987-08-81

accessories

fan wheels

aluminium

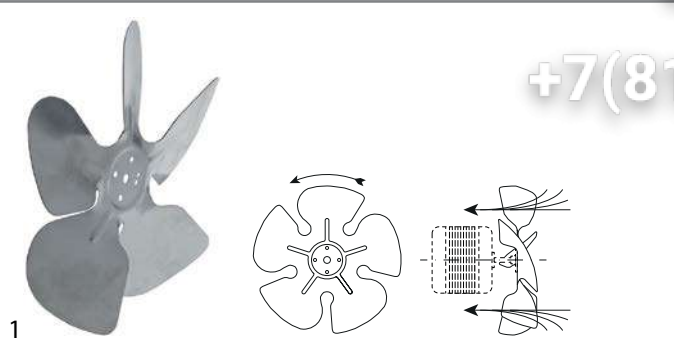

<b>GEV No.</b>	601070	<b>Ref. No.</b>	32M3280
<b>description</b>	fan wheel sucking ø 200mm fan wheel mounting 25.4mm blade angle 28° W 38mm aluminium		
<b>For models:</b>	135BN, 135BNX, 135CPX, 135NN, 135NNX, 3G6SA, 3G6SA2, 3G6SA4, 40B-OPR01, 40BX-OPR01, 40CP, 40CP-OPR01, 40CPX, 40CPX-OPR01, 4G6SB, 4G6SB2, 4G6SB4, 4G6SB6, 55B, 65, 65A, 65NB, 65NBX, 65NN, 65NNX, 65PVX, 65X, 65X-2, 65XE, 65XR, 6BR15V, 6BR15VC, 6BR19V, 6BR19VC, 6EA, 6EA11, 6EA11A, 6EA11M, 6EA13, 6EA13A, 6EA13M, 6EA2, 6EA2A, 6EA2M, 6EAA, 6EAM, 6JA, 6JA2, 6JA2A, 6JA2M...(Other models you can see in the webshop)		

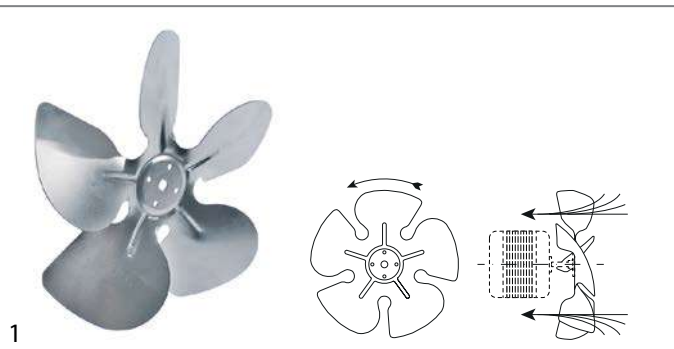

<b>GEV No.</b>	601282	<b>Ref. No.</b>	32M1550
<b>description</b>	fan wheel sucking ø 200mm fan wheel mounting 25.4mm blade angle 34° W 44mm aluminium		
<b>For models:</b>	135BN, 135BNX, 65B, 65BA, 65BX, 65BX-2, 65BXE, 65BXR, ART1L, ART1L7, ART1L7A, ART1L7M, ART1LA, CX120B, CX130, CX130B, CX130NN, CX60, CX60B, DA51, DA51A, DA51M, FX150, FX150B, FX150NN, FX70, FX70B, GD150B, ISFEB-OPR01, ISFEN-OPR01, MD130, MD130B, MD130BN, MD130NN, MD150, MD1504, MD150B, MD150B4, MD150BB, MD150BN, MD150BPV, MD150BR, MD150NCP, MD150NN, MD150PV, MD150R, MD60, MD60B, MD70, MD702...(Other models you can see in the webshop)		

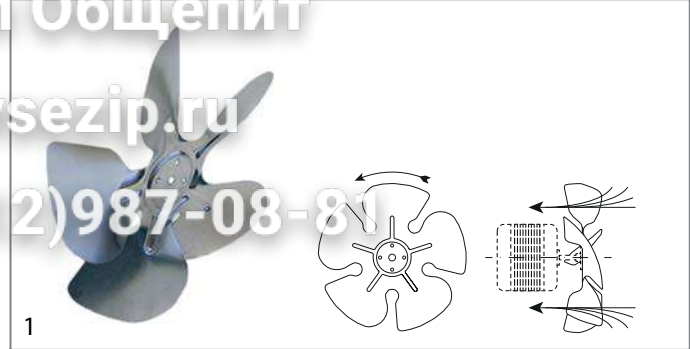

<b>GEV No.</b>	601072	<b>Ref. No.</b>	32M1080
<b>description</b>	fan wheel sucking ø 250mm fan wheel mounting 25.4mm blade angle 25° W 50mm aluminium		
<b>For models:</b>	120, 120B, 120NN, 120PV, 135, 135-4, 135A, 135B, 135BA, 135BN, 135BNX, 135BX, 135BXE, 135BXR, 135NN, 135NNX, 135PVX, 135X, 135X-3, 135X-4, 135XE, 135XR, 65B, 65BX, 65BX-2, 65NB, 65NBX, 65NN, 65NNX, 65PVX, AF1N, AF1N-OPR01, CX120, CX120NN, CX130, CX130B, CX140, CX140BN, CX140CP, CX140NN, CX140PV, CX150, CX150BN, CX150CP, CX150PV, CX55, CX55B, CX60B, CX65, CX652...(Other models you can see in the webshop)		

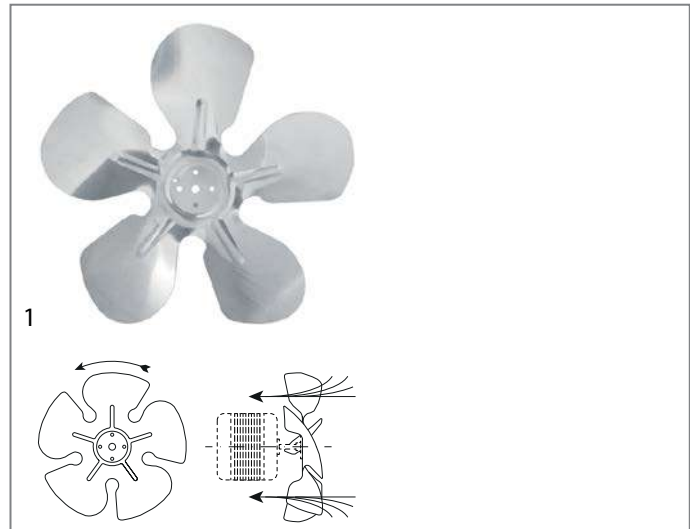

<b>GEV No.</b>	601387	<b>Ref. No.</b>	32M2260
<b>description</b>	fan wheel sucking ø 254mm fan wheel mounting 25.4mm blade angle 34° W 50mm aluminium		
<b>For models:</b>	135B, 135BX, AF2B, AF2B-OPR01, ART1LD, ART1LDA, BRPR, BRPR218, BRPR21C, BRPRV, BRVR, BRVR218, BRVR21C, BRVRV, CX120B, CX130B, CX140B, CX150B, D12Q1M, D12Q2, D12Q2M, FG2B, FSD2B, FSE2B, FSE2B2, GD150B, ISFEB, ISFEB-OPR01, ISFEN, ISFEN-OPR01, MD130B, MD150B, MD150B4, MD150BPV, MDE150B, MX120B, MX140B, PD130B, PD150B, PDG150B, S125B, S125B-4, S125BX, S125BX-4, SE14PRV, SE14PRW, SE14VRV, SE14VRW, SI14PRV, SI14PRW...(Other models you can see in the webshop)		

electric components



Зип-Общепит

vsezip.ru

+7(812)987-08-81

cold air circulating fans (complete)

ebm-papst

A2E series

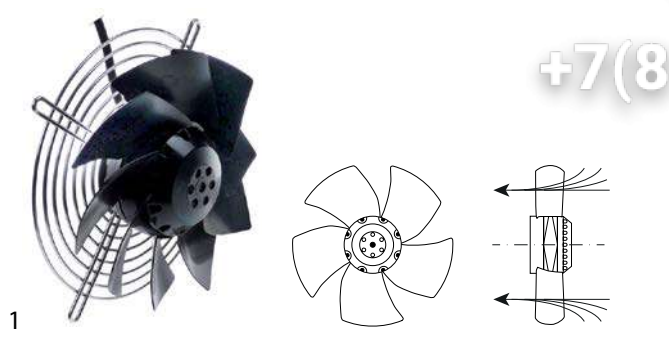

<b>GEV No.</b>	601663 <sup>1</sup>	<b>Ref. No.</b>	32M6610
<b>description</b>	fan A2E200-AI38-10 fan wheel ø 200mm blades 9 230V 50/60Hz 64W 2600rpm cable length 450mm ebm-papst sucking suitable capacitor 1.5µF with protective grid		
<b>For models:</b>	ART1L, ART1L7, ART1L7A, ART1L7M, ART1LA, ART2LD, ART2SD, ART3SD, DA51, DA51A, DA51M, DS31, DS31A, DS31C, DS31M, DS351H, SM03LT7, SM03LT7A, SM03LT7M		
<b>spare parts for</b>	601663		
	<b>GEV No.</b>	365171	<b>Ref. No.</b> —
	capacitor capacity 1.5µF 400V tolerance 5% 50/60Hz ambient temperature max. -40 up to +85°C ø 25mm L 50mm M8 plastic connection cable 250mm MLR25PRL		
	<b>GEV No.</b>	601958	<b>Ref. No.</b> —
	guard ø 210mm for fan hole distance 258mm		

<sup>1</sup>incl. capacitor and guard

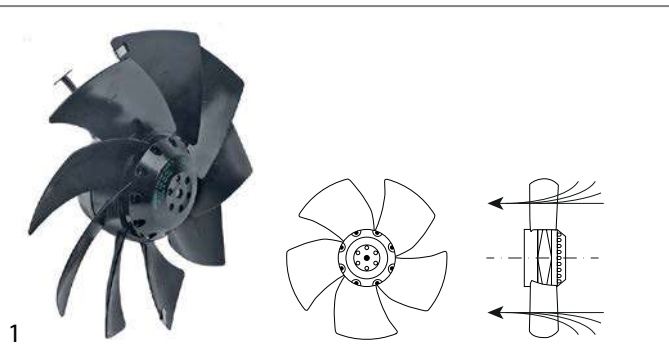

<b>GEV No.</b>	601964	<b>Ref. No.</b>	32M4720 32M6850
<b>description</b>	fan A2E250AM06-12 fan wheel ø 250mm blades 9 230V 50/60Hz 115/150W ø 250mm 2450rpm cable length 1400mm sucking suitable capacitor 3µF		
<b>For models:</b>	ART1LD, ART1LD7, ART1LD7A, ART1LD7M, ART1LDA, DS51, DS51A, DS51C, DS51M, IA101L, IA101S, IA51, IA51A, IA51C, IA51M, IA72S, IS101L, IS101LR, IS101LW, IS101S, IS101SR, IS101SW, IS51, IS51A, IS51AR, IS51C, IS51CR, IS51H, IS51HW, IS51M, IS51MR, IS51R, IS51W, IS51WA, IS51WC, IS51WM, IS72S, IS72SR, IS72SW, ISFEB, ISFEB-0PR01, ISFEN, ISFEN-0PR01, SM1LAM, SM1LAT, SM1LM, SM1LT, SM1LT7, SM1LT7A, SM1LT7M...(Other models you can see in the webshop)		
<b>spare parts for</b>	601964		
	<b>GEV No.</b>	365137	<b>Ref. No.</b> —
	capacitor capacity 3µF 450V tolerance 5% 50/60Hz ambient temperature max. -25 to +85°C ø 25mm L 56mm M8 plastic connection cable 250mm 416.17.77GF protection		



<b>GEV No.</b>	601810	<b>Ref. No.</b>	32M6220
<b>description</b>	fan 230V 50Hz ø 278mm suitable capacitor 4µF ECOFIT type 2VRE35 H 90mm fan wheel ø 250mm cable length 2000mm		
<b>For models:</b>	SM1L, SM1L7, SM1L7A, SM1L7FCV, SM1L7M, SM1LA, SM1LAR, SM1LAW, SM1LR, SM1LW, SM2L, SM2LR, SM2LW, SM2S, SM2SR, SM2SW, SM3S, SM3SR		

cross flow fans

COPREL

with standard coil



<b>GEV No.</b>	601032	<b>Ref. No.</b>	32M2090
<b>description</b>	cross flow fan COPREL TFL(FN) roller ø 60mm roller length 180mm laminated core thickness 15mm motor position left 230V/50Hz 19W bearing rubber connection male faston 6.3mm coil type airflow 107m <sup>3</sup> /h -10 up to +60°C refrigeration		



<b>GEV No.</b>	601452	<b>Ref. No.</b>	32M0050 32M0521 32M5920
<b>description</b>	cross flow fan TFL 180 roller ø 60mm roller length 180mm laminated core thickness 20mm motor position left 230V/50Hz 19W universal bearing silicone connection male faston 6.3mm airflow 100m <sup>3</sup> /h -30 up to +100°C 230V 50Hz		
<b>For models:</b>	120, 120NN, 120PV, 135CPX, 3G65A, 3G65A2, 3G65A4, 40, 40-0PR01, 40PL, 40PV, 40PV-0PR01, 40X, 40X-0PR01, 40XPV, 4G65B, 4G65B2, 4G65B4, 4G65B6, 55, 55PV, 6BEA11A, 6BEA11B, 6BEA11M, 6BEA11Z, 6BEA2A, 6BEA2B, 6BEA2M, 6BEA2Z, 6BEA3A, 6BEA3B, 6BEA3M, 6BEA3Z, 6BEAA, 6BEAB, 6BEAM, 6BEAZ, 6BEB11A, 6BEB11B, 6BEB11M, 6BEB11Z, 6BEB22A, 6BEB22B, 6BEB22M, 6BEB22Z, 6BEB2A, 6BEB2B, 6BEB2M, 6BEB2Z, 6BEB3A...(Other models you can see in the webshop)		



Зип Общепит

vsezip.ru

+7(812)987-08-81

double fans



<b>GEV No.</b>	601026	<b>Ref. No.</b>	32M1220 32M2210
<b>description</b>	cross flow fan COPREL TFD(FD) roller ø 60mm roller length 2x180mm laminated core thickness 35mm motor position centre 230V/50-60Hz 42W refrigeration bearing rubber connection male faston 6.3mm coil type airflow 255m³/h -10 up to +60°C		

accessories for cross flow fans

heater battery



<b>GEV No.</b>	415122	<b>Ref. No.</b>	32G1990
<b>description</b>	heater battery mounting distance 185mm W 40mm H 35mm 2000W 230V temperature restriction 105°C heating circuits 2 connection cable cable length 340mm L 197mm for cross flow fan		

hot air motors



<b>GEV No.</b>	550688	<b>Ref. No.</b>	31S1490 31S1490
<b>description</b>	bushing for fan motor		
<b>For models:</b>	FC101, FC101E, FC241, FC241E, FC241G, FC61, FC61E, FCV101, FCV101-CSA, FCV101DM, FCV101DM-CSA, FCV101DS, FCV101DS-CSA, FCV101E, FCV101EDM, FCV101EDM-UL, FCV101EDS, FCV101EDS-UL, FCV101E-UL, FCV141, FCV141-CSA, FCV141DM, FCV141DM-CSA, FCV141DS, FCV141DS-CSA, FCV141E, FCV141EDM, FCV141EDS, FCV241, FCV241DM, FCV241DS, FCV241E, FCV241EDM, FCV241EDM-UL, FCV241EDS, FCV241EDS-UL, FCV241E-UL, FCV241G, FCV241G-CSA, FCV241GDM, FCV241GDM-CSA, FCV241GDS, FCV241GDS-CSA, FCV401DM, FCV401DM-CSA, FCV401EDM, FCV401EDM-UL, FCV61, FCV61-CSA, FCV61DM...(Other models you can see in the webshop)		

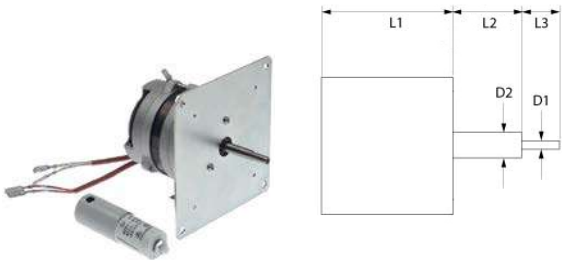

<b>GEV No.</b>	601104	<b>Ref. No.</b>	32M4301
<b>description</b>	fan motor 220-240V 1 phase 50/60Hz 0.045/0.0765kW 2800/3400rpm speeds 1 L1 97mm L2 41mm L3 19mm D1 ø 8mm D2 ø 10mm 0.35A suitable capacitor 2µF/400V power input 45W at 50Hz 2800/3400rpm		
<b>For models:</b>	1G1FA0EV, 1G1FA0GV, 1G1PE1EV, 1G1PE2EV, 2G1FA0GV, 2G1PE1EV, 2G1PE2EV, 31GE, 31TC, 31TCE, 32TC, 32TCE		



<b>GEV No.</b>	601210	<b>Ref. No.</b>	32M4260
<b>description</b>	fan motor 220-240V 1 phase 50Hz 0.075kW 2800rpm speeds 1 L1 120mm L2 38mm L3 36mm D1 ø 12mm D2 ø 8mm M5R IT 0.55A suitable capacitor 2.5µF/400V at 50Hz 2800rpm type 1074		
<b>For models:</b>	FCV3EM, FCV4E, FCV4EDS, FCV4EM, FM423E1, FM423E2		

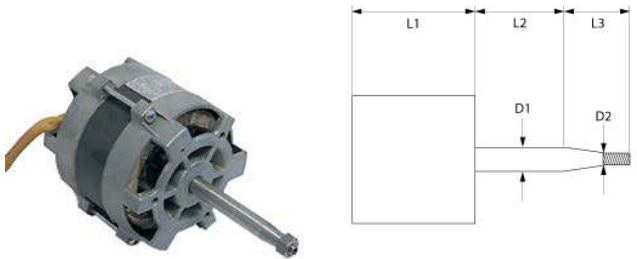

<b>GEV No.</b>	601043	<b>Ref. No.</b>	32M1500
<b>description</b>	fan motor 220-240V 1 phase 50Hz 0.37/0.07kW 0.1/0.5HP 1400/2700rpm speeds 2 L1 123mm L2 107mm L3 15mm D1 ø 15mm D2 ø 12mm M10L ET 2/0.7A suitable capacitor 20µF/250V at 50Hz 1400/2700rpm type 1057		

<b>accessories for</b>	601043	<b>GEV No.</b>	365019	<b>Ref. No.</b>	—
<b>description</b>	operating capacitor capacity 20µF 400V tolerance 5% 50/60Hz ambient temperature max. -25 to +85°C ø 39.5mm L 70mm M8 plastic connection male faston 6.3mm 16.10.25. protection				

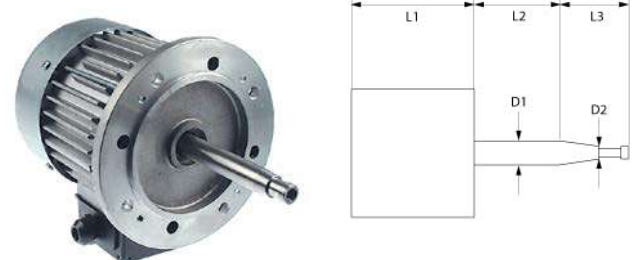

<b>GEV No.</b>	601211	<b>Ref. No.</b>	32M3820
<b>description</b>	fan motor 230/400-415V 3 phase 50/60Hz 0.25kW 1400/1600rpm speeds 1 L1 175mm L2 70mm L3 27mm D1 ø 17mm D2 ø 12mm M8R IT 1.4/0.8A at 50Hz 1400rpm at 60Hz 1600rpm type 1046.4530		
<b>For models:</b>	FC101, FC101E, FC241, FC241E, FC241G, FC61, FC61E, FCV101, FCV101DS, FCV101E, FCV101EDS, FCV141, FCV141DS, FCV141E, FCV141EDS, FCV241, FCV241DS, FCV241E, FCV241EDS, FCV241G, FCV241GDS, FCV61, FCV61DS, FCV61E, FCV61EDS		

<b>accessories for</b>	601211	<b>GEV No.</b>	550690	<b>Ref. No.</b>	3150900
<b>description</b>	shaft sealing for fan motor				



Зип Общепит

vsezip.ru

+7(812)987-08-81

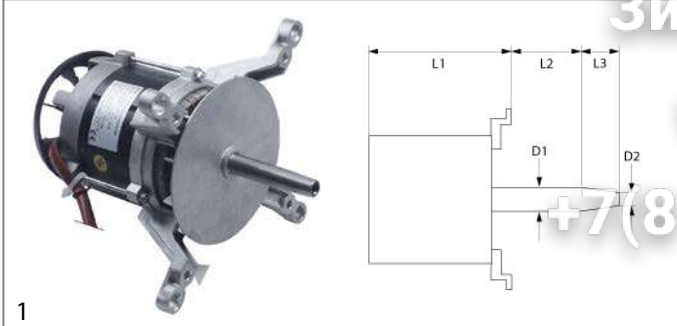

<b>GEV No.</b>	601713	<b>Ref. No.</b>	32M6722
<b>description</b>	fan motor 230/400V 1 phase 50/60Hz 0.55kW 0.75HP 1400rpm speeds 1 L1 200mm L2 53mm L3 32mm D1 ø 18mm D2 ø 15mm M10x1 suitable capacitor 31.5µF Cos(φ) 0.72 at 50Hz 1400rpm at 60Hz 1700rpm type 3065A4051		
<b>For models:</b>	FC1011E, FC1011G, FC1221E, FC1221G, FC611E, FC611G, FM1011E1, FM1011E1-VERS.2006, FM1011E2, FM1011E2-VERS.2006, FM1011E3, FM1011G1, FM1011G1-VERS.2006, FM1011G2, FM1011G2-VERS.2006, FM1011G3, FM1221E1, FM1221E1-VERS.2006, FM1221E2, FM1221E2-VERS.2006, FM1221E3, FM1221G1, FM1221G2, FM1221G3, FM2011E2-VERS.2006, FM2011G2-VERS.2006, FM2021E1, FM2021E2, FM2021E2-VERS.2006, FM2021E3, FM2021G1, FM2021G2, FM2021G3, FM611E1, FM611E1-VERS.2006, FM611E2, FM611E2-VERS.2006, FM611E3, FM611G1, FM611G1-VERS.2006, FM611G2, FM611G2-VERS.2006, FM611G3, FM721E1, FM721E1-VERS.2006, FM721E2, FM721E2-VERS.2006, FM721E3, FM721G1, FM721G1-VERS.2006...(Other models you can see in the webshop)		

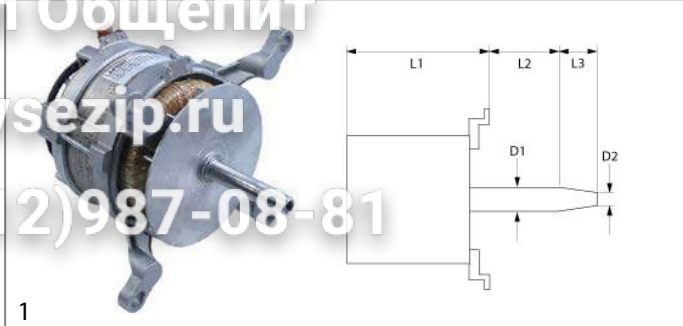

<b>GEV No.</b>	601598	<b>Ref. No.</b>	3001182
<b>description</b>	fan motor 230V 1 phase 50Hz 0.22/0.55kW 960/1430rpm speeds 2 L1 175mm L2 52mm L3 32mm D1 ø 15mm D2 ø 18mm M10R IT 1.7/3.7A suitable capacitor 36/25 Cos(φ) 0.96 at 50Hz 960/1430rpm type LM/ FB 100L		
<b>For models:</b>	FM1011G1, FM1011G2, FM1011G3, FM1011G3-VERS.2006, FM2011G3-VERS.2006, FM611G1, FM611G2, FM611G3, FM611G3-VERS.2006, FM721G1, FM721G2, FM721G3, FM721G3-VERS.2006		



<b>GEV No.</b>	602175	<b>Ref. No.</b>	3103750
<b>description</b>	fan motor 230/400V 3 phase 50/60Hz 0.7kW 1400/1700rpm L1 150mm L2 80mm L3 32mm D1 ø 18mm D2 ø 15mm M8 suitable capacitor 3µF400V type 3042P4050		
<b>For models:</b>	BX101E, BX101E-VERS.122013, BX101G, BX101G-VERS.122013, BX61E, BX61E-VERS.122013, BX61G, BX61G-VERS.122013, BX82E, BX82E-VERS.122013, BX82G, BX82G-VERS.122013, FX101E1, FX101E1R, FX101E2, FX101E2C, FX101E2C-VERS.032014, FX101E2R, FX101E2R-VERS.032014, FX101E2-VERS.032014, FX101E3, FX101E3C, FX101E3C-VERS.022014, FX101E3R, FX101E3R-VERS.022014, FX101E3-VERS.022014, FX101G3, FX101G3C, FX101G3C-VERS.022014, FX101G3R, FX101G3R-VERS.022014, FX101G3-VERS.022014, FX10E2CR, FX10E2CR-VERS.032014, FX10E3CR, FX10E3CR-VERS.022014, FX10G3CR, FX10G3CR-VERS.022014, FX201E2, FX201E2P, FX201E2P-VERS.032014, FX201E2-VERS.032014, FX201E3, FX201E3P, FX201E3P-VERS.022014, FX201E3-VERS.022014, FX201G2P, FX201G2P-VERS.032014, FX201G3P, FX201G3-VERS.022014...(Other models you can see in the webshop)		

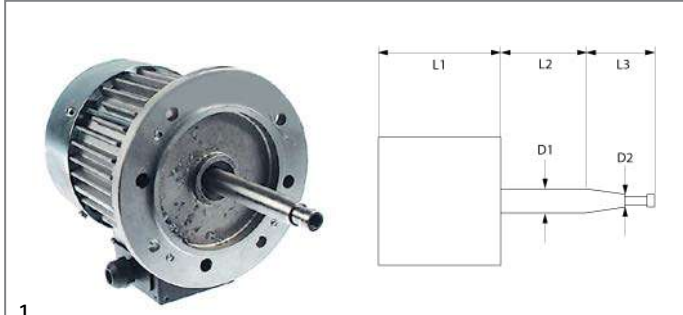

<b>GEV No.</b>	601212	<b>Ref. No.</b>	32M3880
<b>description</b>	fan motor 380-400-415V 3 phase 50Hz 0.04/0.33HP 700/1400rpm speeds 2 L1 180mm L2 70mm L3 27mm D1 ø 17mm D2 ø 12mm M8R IT 0.4/0.9A at 50Hz 700/1400rpm type 1046/4-8		
<b>For models:</b>	FCV101DM, FCV101EDM, FCV141DM, FCV141EDM, FCV241DM, FCV241EDM, FCV241GDM, FCV401EDM, FCV61DM, FCV61EDM		



<b>GEV No.</b>	602173	<b>Ref. No.</b>	32M6760 32M6761
<b>description</b>	fan wheel blades 12 D1 ø 365mm D2 ø 14mm D3 ø 18mm H1 140mm H2 23mm		
<b>For models:</b>	FC1221E, FC1221G, FM1221E1, FM1221E1-VERS.2006, FM1221E2, FM1221E2-VERS.2006, FM1221E3, FM1221E3-VERS.2006, FM1221G1, FM1221G1-VERS.2006, FM1221G2, FM1221G2-VERS.2006, FM1221G3, FM1221G3-VERS.2006, FM2021E1, FM2021E2, FM2021E2-VERS.2006, FM2021E3, FM2021E3-VERS.2006, FM2021G1, FM2021G2, FM2021G2-VERS.2006, FM2021G3, FM2021G3-VERS.2006		



Зип Общепит

vsezip.ru

+7(812)987-08-81

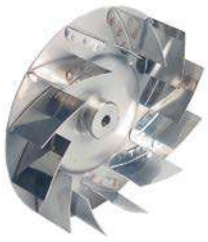

1

<b>GEV No.</b>	601109	<b>Ref. No.</b>	32M0370
<b>description</b>	fan wheel D1 ø 160mm H1 35mm blades 12 D2 ø 8mm D3 ø 8mm H2 15mm		
<b>For models:</b>	1G1FA0EV, 1G1FA0GV, 1G1PE1EV, 1G1PE2EV, 2G1FA0GV, 2G1PE1EV, 2G1PE2EV, 31GE, 31TC, 31TCE, 32TC, 32TCE		



1

<b>GEV No.</b>	514449	<b>Ref. No.</b>	32M6741
<b>description</b>	fan wheel D1 ø 283mm H1 140mm blades 8 D2 ø 15mm D3 ø 18mm		
<b>For models:</b>	FC611E, FC611G, FM611E1, FM611E1-VERS.2006, FM611E2, FM611E2-VERS.2006, FM611E3, FM611E3-VERS.2006, FM611G1, FM611G1-VERS.2006, FM611G2, FM611G2-VERS.2006, FM611G3, FM611G3-VERS.2006		



1

<b>GEV No.</b>	601221	<b>Ref. No.</b>	32M4270 32M4271
<b>description</b>	fan wheel D1 ø 180mm H1 60mm blades 12 D2 ø 9mm D3 ø 12.5mm H2 35mm		
<b>For models:</b>	FCV3EM, FCV4E, FCV4EDS, FCV4EM, FM423E1, FM423E2		



1

<b>GEV No.</b>	601208	<b>Ref. No.</b>	32M2561
<b>description</b>	fan wheel D1 ø 335mm H1 135mm blades 12 D2 ø 12mm D3 ø 18mm H2 56mm		
<b>For models:</b>	FC101, FC101E, FCV101, FCV101-CSA, FCV101DM, FCV101DM-CSA, FCV101DS, FCV101DS-CSA, FCV101E, FCV101EDM, FCV101EDM-UL, FCV101EDS, FCV101EDS-UL, FCV101E-UL, FCV141, FCV141-CSA, FCV141DM, FCV141DM-CSA, FCV141DS, FCV141DS-CSA, FCV141E, FCV141EDM, FCV141EDS, FCV72EDM-UL, FCV72EDS-UL, FCV72E-UL		



1

<b>GEV No.</b>	601060	<b>Ref. No.</b>	32M1570
<b>description</b>	fan wheel D1 ø 180mm H1 60mm blades 16 D2 ø 11mm D3 ø 16mm H2 30mm		



1

<b>GEV No.</b>	601209	<b>Ref. No.</b>	32M3992
<b>description</b>	fan wheel D1 ø 400mm H1 135mm blades 20 D2 ø 12mm D3 ø 18mm H2 54mm		
<b>For models:</b>	FC241E, FC241G, FCV241E, FCV241EDM, FCV241EDM-UL, FCV241EDS, FCV241EDS-UL, FCV241E-UL, FCV241G, FCV241G-CSA, FCV241GDM, FCV241GDM-CSA, FCV241GDS, FCV241GDS-CSA, FCV401EDM, FCV401EDM-UL		



1

<b>GEV No.</b>	601207	<b>Ref. No.</b>	32M3811 32M3812
<b>description</b>	fan wheel D1 ø 280mm H1 135mm blades 12 D2 ø 12mm D3 ø 18mm H2 55mm		
<b>For models:</b>	FC61, FC61E, FCV61, FCV61-CSA, FCV61DM, FCV61DM-CSA, FCV61DS, FCV61DS-CSA, FCV61E, FCV61EDM, FCV61EDM-UL, FCV61EDS, FCV61EDS-UL, FCV61E-UL		



Зип Общепит  
vsezip.ru  
+7(812)987-08-81

	<b>GEV No.</b> 550687	<b>Ref. No.</b> 33Q6320
<b>description</b>	flange for fan motor	
<b>For models:</b>	FCV3EM, FCV4E, FCV4EDS, FCV4EM	

	<b>GEV No.</b> 552005	<b>Ref. No.</b> 36E3160
<b>description</b>	flange for fan motor ED ø 56mm int. ø 1 38mm int. ø 2 20mm thickness 8mm brass	
<b>For models:</b>	BX101E, BX101E-VERS.122013, BX101G, BX101G-VERS.122013, BX122E, BX122E-VERS.122013, BX122G, BX122G-VERS.122013, BX61E, BX61E-VERS.122013, BX61G, BX61G-VERS.122013, BX82E, BX82E-VERS.122013, BX82G, BX82G-VERS.122013, FC1011E, FC1011G, FC1221E, FC1221G, FC611E, FC611G, FM1011E1, FM1011E1-VERS.2006, FM1011E2, FM1011E2-VERS.2006, FM1011E3, FM1011E3-VERS.2006, FM1011G1, FM1011G1-VERS.2006, FM1011G2, FM1011G2-VERS.2006, FM1011G3, FM1011G3-VERS.2006, FM1221E1, FM1221E1-VERS.2006, FM1221E2, FM1221E2-VERS.2006, FM1221E3, FM1221E3-VERS.2006, FM1221G1, FM1221G1-VERS.2006, FM1221G2, FM1221G2-VERS.2006, FM1221G3, FM1221G3-VERS.2006, FM2011E2-VERS.2006, FM2011E3-VERS.2006, FM2011G2-VERS.2006, FM2011G3-VERS.2006...(Other models you can see in the webshop)	

	<b>GEV No.</b> 552006	<b>Ref. No.</b> 33Q5381
<b>description</b>	flange for fan motor ED ø 57.5mm int. ø 1 35mm int. ø 2 23mm thickness 2mm	
<b>For models:</b>	FC101, FC101E, FC241, FC241E, FC241G, FC61, FC61E, FCV101, FCV101-CSA, FCV101DM, FCV101DM-CSA, FCV101DS, FCV101DS-CSA, FCV101E, FCV101EDM, FCV101EDM-UL, FCV101EDS, FCV101EDS-UL, FCV101E-UL, FCV141, FCV141-CSA, FCV141DM, FCV141DM-CSA, FCV141DS, FCV141DS-CSA, FCV141E, FCV141EDM, FCV141EDS, FCV241, FCV241DM, FCV241DS, FCV241E, FCV241EDM, FCV241EDM-UL, FCV241EDS, FCV241EDS-UL, FCV241E-UL, FCV241G, FCV241G-CSA, FCV241GDM, FCV241GDM-CSA, FCV241GDS, FCV241GDS-CSA, FCV401DM, FCV401DM-CSA, FCV401EDM, FCV401EDM-UL, FCV61, FCV61-CSA, FCV61DM...(Other models you can see in the webshop)	

	<b>GEV No.</b> 697866	<b>Ref. No.</b> 33Q5690
<b>description</b>	flange for fan motor ED ø 58mm int. ø 1 38.8mm int. ø 2 19/23mm brass	
<b>For models:</b>	FC101, FC101E, FC241, FC241E, FC241G, FC61, FC61E, FCV101, FCV101-CSA, FCV101DM, FCV101DM-CSA, FCV101DS, FCV101DS-CSA, FCV101E, FCV101EDM, FCV101EDM-UL, FCV101EDS, FCV101EDS-UL, FCV101E-UL, FCV141, FCV141-CSA, FCV141DM, FCV141DM-CSA, FCV141DS, FCV141DS-CSA, FCV141E, FCV141EDM, FCV141EDS, FCV241, FCV241DM, FCV241DS, FCV241E, FCV241EDM, FCV241EDM-UL, FCV241EDS, FCV241EDS-UL, FCV241E-UL, FCV241G, FCV241G-CSA, FCV241GDM, FCV241GDM-CSA, FCV241GDS, FCV241GDS-CSA, FCV401DM, FCV401DM-CSA, FCV401EDM, FCV401EDM-UL, FCV61, FCV61-CSA, FCV61DM...(Other models you can see in the webshop)	

	<b>GEV No.</b> 550686	<b>Ref. No.</b> 37Q0250
<b>description</b>	gasket for fan motor ID ø 22mm ED ø 58mm thickness 1mm with 3 screw holes	
<b>For models:</b>	BX101E, BX101E-VERS.122013, BX101G, BX101G-VERS.122013, BX122E, BX122E-VERS.122013, BX122G, BX122G-VERS.122013, BX61E, BX61E-VERS.122013, BX61G, BX61G-VERS.122013, BX82E, BX82E-VERS.122013, BX82G, BX82G-VERS.122013, FC1011E, FC1011G, FC1221E, FC1221G, FC611E, FC611G, FCV3EM, FCV4E, FCV4EDS, FCV4EM, FM1011E1, FM1011E1-VERS.2006, FM1011E2, FM1011E2-VERS.2006, FM1011E3, FM1011E3-VERS.2006, FM1011G1, FM1011G1-VERS.2006, FM1011G2, FM1011G2-VERS.2006, FM1011G3, FM1011G3-VERS.2006, FM1221E1, FM1221E1-VERS.2006, FM1221E2, FM1221E2-VERS.2006, FM1221E3, FM1221E3-VERS.2006, FM1221G1, FM1221G1-VERS.2006, FM1221G2, FM1221G2-VERS.2006, FM1221G3, FM1221G3-VERS.2006...(Other models you can see in the webshop)	

	<b>GEV No.</b> 550689	<b>Ref. No.</b> 37Q3011
<b>description</b>	gasket for fan motor ID ø 40mm ED ø 58mm thickness 1mm with 3 screw holes	
<b>For models:</b>	FC101, FC101E, FC241, FC241E, FC241G, FC61, FC61E, FCV101, FCV101-CSA, FCV101DM, FCV101DM-CSA, FCV101DS, FCV101DS-CSA, FCV101E, FCV101EDM, FCV101EDM-UL, FCV101EDS, FCV101EDS-UL, FCV101E-UL, FCV141, FCV141-CSA, FCV141DM, FCV141DM-CSA, FCV141DS, FCV141DS-CSA, FCV141E, FCV141EDM, FCV141EDS, FCV241, FCV241DM, FCV241DS, FCV241E, FCV241EDM, FCV241EDM-UL, FCV241EDS, FCV241EDS-UL, FCV241E-UL, FCV241G, FCV241G-CSA, FCV241GDM, FCV241GDM-CSA, FCV241GDS, FCV241GDS-CSA, FCV3EM, FCV401DM, FCV401DM-CSA, FCV401EDM, FCV401EDM-UL, FCV4E, FCV4EDS...(Other models you can see in the webshop)	

	<b>GEV No.</b> 550690	<b>Ref. No.</b> 3150900
<b>description</b>	shaft sealing for fan motor	
<b>For models:</b>	FC101, FC101E, FC241, FC241E, FC241G, FC61, FC61E, FCV101, FCV101-CSA, FCV101DM, FCV101DM-CSA, FCV101DS, FCV101DS-CSA, FCV101E, FCV101EDM, FCV101EDM-UL, FCV101EDS, FCV101EDS-UL, FCV101E-UL, FCV141, FCV141-CSA, FCV141DM, FCV141DM-CSA, FCV141DS, FCV141DS-CSA, FCV141E, FCV141EDM, FCV141EDS, FCV241, FCV241DM, FCV241DS, FCV241E, FCV241EDM, FCV241EDM-UL, FCV241EDS, FCV241EDS-UL, FCV241E-UL, FCV241G, FCV241G-CSA, FCV241GDM, FCV241GDM-CSA, FCV241GDS, FCV241GDS-CSA, FCV401DM, FCV401DM-CSA, FCV401EDM, FCV401EDM-UL, FCV61, FCV61-CSA, FCV61DM...(Other models you can see in the webshop)	

hot air fans



3 in 1 zip Общепит

miscellaneous

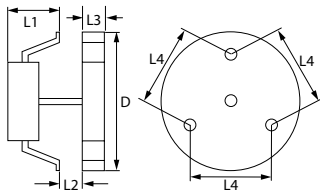

1



<b>GEV No.</b>	601011	<b>Ref. No.</b>	32M0360 32M2320 32M2420 32M5690
<b>description</b>	hot air fan 220-240V 40W 50/60Hz L1 65mm L2 15mm L3 25mm L4 87mm fan wheel ø 150mm FIME type C25R8023CLH		
<b>For models:</b>	A12A1E, A12B1E, A12B2E, A12M1E, A12Z1E, A12Z2E, A14A1E, A14B1E, A14B2E, A14M1E, A14Z1E, A14Z2E, A16A1E, A16B1E, A16B2E, A16M1E, A16Z1E, A16Z2E, A18A1E, A18B1E, A18B2E, A18M1E, A18Z1E, A18Z2E, A20A1E, A20B1E, A20B2E, A20M1E, A20Z1E, A20Z2E, ACBM, ACBM218, ACPN, ACPN218, AJ12AE, AJ12ME, AJ14AE, AJ14ME, AJ16AE, AJ16ME, AJ18AE, AJ18ME, AJ20AE, AJ20ME, SL14CPN, SL14CVB, SL21CPN, SL21CVB		
<b>accessories for</b>	601011		
	<b>GEV No.</b>	550879	<b>Ref. No.</b> —
	insulation ø 130mm thickness 3mm hole ø 20mm for hot air fan		
	<b>GEV No.</b>	601260	<b>Ref. No.</b> —
	nut thread M6L IT for hot air fan		

accessories

fan wheels for hot air fans



1

<b>GEV No.</b>	601710	<b>Ref. No.</b>	32M2510
<b>description</b>	fan wheel ø 225mm shaft intake ø 7mm aluminium blades 5		
<b>For models:</b>	120, 120NN, 135A, 135BN, 135BNX, 135CPX, 135XE, 40B, 40CP, 40CPX, 55B, 65, 65A, 65BA, 65BXE, 65NB, 65NBX, 65NN, 65NNX, 65PVX, 65X, 65X-2, 65XE, 6BEA11A, 6BEA11B, 6BEA11M, 6BEA11Z, 6BEA2A, 6BEA2B, 6BEA2M, 6BEA2Z, 6BEA3A, 6BEA3B, 6BEA3M, 6BEA3Z, 6BEAA, 6BEAB, 6BEABA, 6BEABB, 6BEABM, 6BEABZ, 6BEAM, 6BEAZ, 6BEB11A, 6BEB11B, 6BEB11M, 6BEB11Z, 6BEB22A, 6BEB22B, 6BEB22M...(Other models you can see in the webshop)		



1

<b>GEV No.</b>	601870	<b>Ref. No.</b>	32V6840
<b>description</b>	radial fan 230/240V voltage AC 50/60Hz H1 180mm L1 175mm D1 ø 75mm W1 80mm W2 50mm H2 50mm W3 83mm H3 83mm		
<b>For models:</b>	FC1221G, FM1221G1, FM1221G1-VERS.2006, FM1221G2, FM1221G2-VERS.2006, FM1221G3, FM1221G3-VERS.2006, FM2021G1, FM2021G2, FM2021G2-VERS.2006, FM2021G3, FM2021G3-VERS.2006		



1

<b>GEV No.</b>	601599	<b>Ref. No.</b>	32V5830
<b>description</b>	radial fan 230V voltage AC 50Hz 60W H1 175mm L1 205mm D1 ø 109mm W1 135mm W2 58mm H2 58mm convection oven		
<b>For models:</b>	FC1011G, FC611G, FM1011G1, FM1011G1-VERS.2006, FM1011G2, FM1011G2-VERS.2006, FM1011G3, FM1011G3-VERS.2006, FM2011G2-VERS.2006, FM2011G3-VERS.2006, FM611G1, FM611G1-VERS.2006, FM611G2, FM611G2-VERS.2006, FM611G3, FM611G3-VERS.2006, FM721G1, FM721G1-VERS.2006, FM721G2, FM721G2-VERS.2006, FM721G3, FM721G3-VERS.2006		

accessories universal



1

<b>GEV No.</b>	801197	<b>Ref. No.</b>	3018670 6003060
<b>description</b>	puller for fan wheel seat ø 27-33mm thread M16x1.5 WS 17		
<b>For models:</b>	FM1011E1, FM1011E2, FM1011E3, FM1011G1, FM1011G2, FM1011G3, FM1221E1, FM1221E2, FM1221E3, FM1221G1, FM1221G2, FM1221G3, FM611E1, FM611E2, FM611E3, FM611G1, FM611G2, FM611G3		
<b>spare parts for</b>	801197		
	<b>GEV No.</b>	801198	<b>Ref. No.</b> 3019160
	screw for puller thread M16x1.5 L 63mm WS 17		



## pumps

## wash and rinse pumps

ALBA (C&amp;A)

pumps



1

<b>GEV No.</b>	500180	<b>Ref. No.</b>	32M2950
<b>description</b>	pump inlet $\varnothing$ 28mm outlet $\varnothing$ 28mm type C7670 230V 50Hz 1 phase 0.11kW 0.15HP L 190mm rotation direction right capacitor 6.3 $\mu$ F ALBA PUMPS (C&A)		
<b>For models:</b>	LT10R		
<b>spare parts for</b>	500180		
	<b>GEV No.</b>	365012	<b>Ref. No.</b> —
	operating capacitor capacity 6.3 $\mu$ F 450V tolerance 5% 50Hz ambient temperature max. -25 to +85°C $\varnothing$ 30mm L 61mm M8 plastic connection male faston 6.3mm protection		
	<b>GEV No.</b>	510692	<b>Ref. No.</b> —
	mechanical shaft seal for shaft $\varnothing$ 11mm slide ring ext. $\varnothing$ 24mm slide ring H 13mm counter ring mounting $\varnothing$ 26mm height counter ring 8mm counter ring int. $\varnothing$ 14mm		
	<b>GEV No.</b>	521222	<b>Ref. No.</b> —
	impellor $\varnothing$ 72mm H 19mm thread M7L shaft $\varnothing$ 11mm shaft length 29mm blades 3		
	<b>GEV No.</b>	521518	<b>Ref. No.</b> —
	pump cover ALBA PUMPS (C&A) inlet $\varnothing$ 28mm outlet $\varnothing$ 28mm turn direction right $\varnothing$ 93mm ID $\varnothing$ 76mm inner height 31mm		
	<b>GEV No.</b>	532490	<b>Ref. No.</b> —
	O-ring EPDM thickness 2.62mm ID $\varnothing$ 72.69mm Qty 1 pcs		





Зип Общепит

vsezip.ru

+7(812)987-08-81



1

<b>GEV No.</b>	500181	<b>Ref. No.</b>	32M2940
<b>description</b>	pump inlet $\varnothing$ 45mm outlet $\varnothing$ 40mm type C7675 230V 50Hz 1 phase 0.29kW 0.4HP L 175mm rotation direction right capacitor 10 $\mu$ F ALBA PUMPS (C&A)		
<b>For models:</b>	LT20F, LT25F		
<b>spare parts for</b>	500181		
	<b>GEV No.</b>	365015	<b>Ref. No.</b> —
	operating capacitor capacity 10 $\mu$ F 400V tolerance 5%Hz ambient temperature max. -25 to +85°C $\varnothing$ 35.5mm L 59mm M8 plastic connection male faston 6.3mm protection		
	<b>GEV No.</b>	509018	<b>Ref. No.</b> —
	O-ring EPDM thickness 3.53mm ID $\varnothing$ 107.5mm Qty 1 pcs		
	<b>GEV No.</b>	509028	<b>Ref. No.</b> —
	impellor $\varnothing$ 87mm H 21mm rotation direction right thread M7L shaft $\varnothing$ 12mm		
	<b>GEV No.</b>	510693	<b>Ref. No.</b> 3036790 3152080
	mechanical shaft seal for shaft $\varnothing$ 12mm slide ring ext. $\varnothing$ 24mm slide ring H 15.5mm slide ring int. $\varnothing$ 11mm counter ring mounting $\varnothing$ 24mm height counter ring 8mm counter ring int. $\varnothing$ 13.5mm		
	<b>GEV No.</b>	521528	<b>Ref. No.</b> 36G8080
	pump cover ALBA PUMPS (C&A) inlet $\varnothing$ 45mm outlet $\varnothing$ 40mm turn direction right $\varnothing$ 129mm ID $\varnothing$ 105mm inner height 19mm		



Зип Общепит

vsezip.ru



+7(812)987-08-81

FIR

pumps







1

<b>GEV No.</b>	500010	<b>Ref. No.</b>	32M2140
<b>description</b>	pump inlet ø 45mm outlet ø 40mm type 2292.1506 230V 50Hz 1 phase 0.55kW 0.75HP L 238mm rotation direction right capacitor 12.5µF FIR		
<b>For models:</b>	L40, L40S		
<b>spare parts for</b>	500010		
	<b>GEV No.</b>	365014	<b>Ref. No.</b> 32Z1310
	operating capacitor capacity 12.5µF 450V tolerance 5%Hz ambient temperature max. -25 to +85°C ø 35mm L 70mm M8 plastic connection male faston 6.3mm 45S.C3DS.12.5 protection		
	<b>GEV No.</b>	510600	<b>Ref. No.</b> 32G0260
	impellor ø 102mm H 29mm shaft intake ø 9/8mm rotation direction right blades 6		
	<b>GEV No.</b>	510692	<b>Ref. No.</b> —
	mechanical shaft seal for shaft ø 11mm slide ring ext. ø 24mm slide ring H 13mm counter ring mounting ø 26mm height counter ring 8mm counter ring int. ø 14mm		
	<b>GEV No.</b>	521023	<b>Ref. No.</b> —
	fanwheel cover ED ø 150mm H 70mm for wash pump		
	<b>GEV No.</b>	521506	<b>Ref. No.</b> —
	pump cover FIR inlet ø 45mm outlet ø 40mm turn direction right ø 160mm ID ø 125mm inner height 25mm		
	<b>GEV No.</b>	521702	<b>Ref. No.</b> —
	pump cover gasket thickness 3.5x4.5mm Qty 1 pcs		



1

<b>GEV No.</b>	500023	<b>Ref. No.</b>	32M3660
<b>description</b>	pump inlet ø 63mm outlet ø 47mm type 1225.2725 230/400V 50Hz 3 phase 1.1kW 1.5HP L 335mm rotation direction right FIR		
<b>spare parts for</b>	500023		
	<b>GEV No.</b>	510602	<b>Ref. No.</b> —
	impellor ø 110mm H 34mm rotation direction right thread M8L shaft ø 28mm seat ø 12.2mm blades 6		
	<b>GEV No.</b>	510693	<b>Ref. No.</b> 3036790 3152080
	mechanical shaft seal for shaft ø 12mm slide ring ext. ø 24mm slide ring H 15.5mm slide ring int. ø 11mm counter ring mounting ø 24mm height counter ring 8mm counter ring int. ø 13.5mm		
	<b>GEV No.</b>	521513	<b>Ref. No.</b> 36D8510
	pump cover FIR inlet ø 63mm outlet ø 47mm turn direction right ID ø 150mm inner height 32mm		
	<b>GEV No.</b>	524416	<b>Ref. No.</b> —
	pump cover gasket thickness 4x4mm Qty 1 pcs		



1

<b>GEV No.</b>	500742	<b>Ref. No.</b>	32M1590
<b>description</b>	pump inlet ø 63mm outlet ø 47mm type 1226.2602 230/400V 50Hz 3 phase 1.5kW 2HP L 333mm rotation direction left FIR		
<b>For models:</b>	L80		





Зиг-Общепит

vsezip

+7(812)987-08-81



1

<b>GEV No.</b>	500323	<b>Ref. No.</b>	32M1480
<b>description</b>	pump inlet ø 63mm outlet ø 47mm type 1227.2721 230/400V 50Hz 3 phase 2kW 2.7HP L 335mm rotation direction right FIR		
<b>For models:</b>	L100		
<b>spare parts for</b>	500323		
	<b>GEV No.</b>	510599	<b>Ref. No.</b> —
	impellor ø 123mm H 34mm M8L		
	<b>GEV No.</b>	510693	<b>Ref. No.</b> 3036790 3152080
	mechanical shaft seal for shaft ø 12mm slide ring ext. ø 24mm slide ring H 15.5mm slide ring int. ø 11mm counter ring mounting ø 24mm height counter ring 8mm counter ring int. ø 13.5mm		
	<b>GEV No.</b>	521513	<b>Ref. No.</b> 36D8510
	pump cover FIR inlet ø 63mm outlet ø 47mm turn direction right ID ø 150mm inner height 32mm		
	<b>GEV No.</b>	524416	<b>Ref. No.</b> —
	pump cover gasket thickness 4x4mm Qty 1 pcs		

<b>GEV No.</b>	510693	<b>Ref. No.</b>	3036790 3152080
	mechanical shaft seal for shaft ø 12mm slide ring ext. ø 24mm slide ring H 15.5mm slide ring int. ø 11mm counter ring mounting ø 24mm height counter ring 8mm counter ring int. ø 13.5mm		
<b>GEV No.</b>	521513	<b>Ref. No.</b>	36D8510
	pump cover FIR inlet ø 63mm outlet ø 47mm turn direction right ID ø 150mm inner height 32mm		
	<b>GEV No.</b>	524416	<b>Ref. No.</b> —
	pump cover gasket thickness 4x4mm Qty 1 pcs		



1

<b>GEV No.</b>	500111	<b>Ref. No.</b>	32M4820
<b>description</b>	pump inlet ø 63mm outlet ø 53mm type 1241.2500 230/400V 50Hz 3 phase 1.1kW 1.5HP L 330mm rotation direction left FIR		
<b>For models:</b>	C304AD, C304AD-VERS.2006, C304AS, C304AS-VERS.2006, C304AVD, C304AVD-VERS.2006, C304AVS, C304AVS-VERS.2006, C304D, C304D-VERS.2006, C304S, C304S-VERS.2006, C304VD, C304VD-VERS.2006, C304VS, C304VS-VERS.2006, CS243S-VERS.2006, CS370AD, CS370AD-VERS.2006, CS370AS, CS370AS-VERS.2006, CS370AVD, CS370AVD-VERS.2006, CS370AVS, CS370AVS-VERS.2006, CS370D, CS370D-VERS.2006, CS370S, CS370S-VERS.2006, CS370VD, CS370VD-VERS.2006, CS370VS, CS370VS-VERS.2006, CS466AD, CS466AD-VERS.2006, CS466AS, CS466AS-VERS.2006, CS466AVD, CS466AVD-VERS.2006, CS466AVS, CS466AVS-VERS.2006, CS466D, CS466D-VERS.2006, CS466S, CS466S-VERS.2006, CS466VD, CS466VD-VERS.2006, CS466VS, CS466VS-VERS.2006		
<b>spare parts for</b>	500111		
	<b>GEV No.</b>	510531	<b>Ref. No.</b> —
	pump cover FIR inlet ø 63mm outlet ø 53mm auxiliary pressure connection M16x1.5mm supporting pressure open turn direction left ø 185mm ID ø 150mm inner height 37mm		
	<b>GEV No.</b>	510612	<b>Ref. No.</b> —
	impellor ø 110mm H 34mm M8R		
	<b>GEV No.</b>	510693	<b>Ref. No.</b> 3036790 3152080
	mechanical shaft seal for shaft ø 12mm slide ring ext. ø 24mm slide ring H 15.5mm slide ring int. ø 11mm counter ring mounting ø 24mm height counter ring 8mm counter ring int. ø 13.5mm		
	<b>GEV No.</b>	524416	<b>Ref. No.</b> —
	pump cover gasket thickness 4x4mm Qty 1 pcs		



1

<b>GEV No.</b>	500117	<b>Ref. No.</b>	32M0020
<b>description</b>	pump inlet ø 63mm outlet ø 47mm type 4225.22725 230/400V 50Hz 3 phase 1.4kW 2HP L 280mm rotation direction right FIR		
<b>For models:</b>	L80		
<b>spare parts for</b>	500117		
	<b>GEV No.</b>	510602	<b>Ref. No.</b> —
	impellor ø 110mm H 34mm rotation direction right thread M8L shaft ø 28mm seat ø 12.2mm blades 6		



Зип Общепит



vsezip.ru

+7(812)987-08-81

LGB





1



<b>GEV No.</b>	500094	<b>Ref. No.</b>	32M2920
<b>description</b>	pump inlet ø 28mm outlet ø 26mm type ZF131SX 230V 50Hz 1 phase 0.2kW 0.15HP L 195mm rotation direction left capacitor 6.3µF LGB		
<b>For models:</b>	F60PR, F60T, F80P, F80PR		
<b>spare parts for</b>	500094		
	<b>GEV No.</b>	365012	<b>Ref. No.</b> —
	operating capacitor capacity 6.3µF 450V tolerance 5% 50Hz ambient temperature max. -25 to +85°C ø 30mm L 61mm M8 plastic connection male faston 6.3mm protection		
	<b>GEV No.</b>	502266	<b>Ref. No.</b> —
	pump cover inlet ø 28mm outlet ø 26mm		
	<b>GEV No.</b>	510703	<b>Ref. No.</b> —
	mechanical shaft seal for shaft ø 13mm slide ring H 13mm height counter ring 5.5mm ED ø 26mm		
	<b>GEV No.</b>	521085	<b>Ref. No.</b> —
	impellor ø 72mm H 17mm thread M7L shaft ø 13mm shaft length 12mm blades 3		
	<b>GEV No.</b>	528800	<b>Ref. No.</b> —
	O-ring EPDM thickness 2.62mm ID ø 75.87mm Qty 1 pcs		

1



<b>GEV No.</b>	500508	<b>Ref. No.</b>	32M2910 32M4760
<b>description</b>	pump inlet ø 45mm outlet ø 38mm type ZF320VSX 230V 50Hz 1 phase 0.75kW 1HP L 230mm rotation direction right capacitor 12.5µF LGB		
<b>For models:</b>	F60P, F60PR, F60T, F80P, F80PR, L45		
<b>spare parts for</b>	500508		
	<b>GEV No.</b>	365014	<b>Ref. No.</b> 32Z1310
	operating capacitor capacity 12.5µF 450V tolerance 5%Hz ambient temperature max. -25 to +85°C ø 35mm L 70mm M8 plastic connection male faston 6.3mm 45S.C3DS.12.5 protection		
	<b>GEV No.</b>	510702	<b>Ref. No.</b> 3152680
	mechanical shaft seal height counter ring 5.5mm ID ø 12mm		
	<b>GEV No.</b>	521247	<b>Ref. No.</b> —
	impellor ø 90mm H 27mm rotation direction right thread M8L blades 6		
	<b>GEV No.</b>	521542	<b>Ref. No.</b> —
	pump cover LGB inlet ø 45mm outlet ø 40mm auxiliary pressure connection 13mm supporting pressure open ø 150mm ID ø 120mm inner high 25mm		
	<b>GEV No.</b>	521714	<b>Ref. No.</b> —
	pump cover gasket thickness 4x4mm Qty 1 pcs		

1



<b>GEV No.</b>	500984	<b>Ref. No.</b>	32M5770
<b>description</b>	pump inlet ø 45mm outlet ø 39mm type ZF270VSX 230V 50Hz 1 phase 0.4kW L 209mm rotation direction right capacitor 10µF LGB		
<b>For models:</b>	LF50, LF50E, LF50EM, LF50EMPS, LF50EMPS-VERS.122012, LF50EM-VERS.122012, LF50E-VERS.122012, LF50E-VERS.2007, LP70		



Зип Общепит

vsezip.ru

+7(812)987-08-81





1

<b>GEV No.</b>	500377	<b>Ref. No.</b>	32M4830
<b>description</b>	pump inlet ø 61mm outlet ø 52mm type ZF800DX 230/400V 50Hz 3 phase 2kW 2.72HP L 330mm rotation direction left LGB		
<b>For models:</b>	C165D, C165S, C165VD, C165VS, C207D, C207D-VERS.2006, C207S, C207S-VERS.2006, C207VD, C207VD-VERS.2006, C207VS, C207VS-VERS.2006, C304AD, C304AD-VERS.2006, C304AS, C304AS-VERS.2006, C304AVD, C304AVD-VERS.2006, C304AVS, C304AVS-VERS.2006, C304D, C304D-VERS.2006, C304S, C304S-VERS.2006, C304VD, C304VD-VERS.2006, C304VS, C304VS-VERS.2006, C92D-VERS.2006, C92S-VERS.2006, C92VD-VERS.2006, C92VS-VERS.2006, CS243D, CS243D-VERS.2006, CS243S, CS243S-VERS.2006, CS243VD, CS243VD-VERS.2006, CS243VS, CS243VS-VERS.2006, CS370AD, CS370AD-VERS.2006, CS370AS, CS370AS-VERS.2006, CS370AVD, CS370AVD-VERS.2006, CS370AVS, CS370AVS-VERS.2006, CS370D, CS370D-VERS.2006...(Other models you can see in the webshop)		
<b>spare parts for</b>	500377		
	<b>GEV No.</b>	510551	<b>Ref. No.</b> 3FL1123
	pump cover gasket ID ø 158.3mm pump type 1214/1293/1225/2243/1226/1204/3473/1241 thickness 3.53mm EPDM Qty 1 pcs		
	<b>GEV No.</b>	510694	<b>Ref. No.</b> —
	mechanical shaft seal for shaft ø 13mm height counter ring 8mm ID ø 11.5mm H 16mm mounting ø 24/26mm int. ø 1 14mm		
	<b>GEV No.</b>	521276	<b>Ref. No.</b> —
	impellor ø 120mm H 39mm pump type ZF800DX shaft intake ø 12mm rotation direction left thread M8R pump for ZF800DX blades 6		
	<b>GEV No.</b>	521516	<b>Ref. No.</b> —
	pump cover LGB inlet ø 62mm outlet ø 52mm auxiliary pressure connection 12mm supporting pressure closed turn direction left ø 190mm ID ø 150mm inner height 40mm		



1

<b>GEV No.</b>	500376	<b>Ref. No.</b>	32M6180
<b>description</b>	pump inlet ø 62mm outlet ø 50mm type AM5225SX 230V 50Hz 1 phase 0.9kW 1.2HP L 300mm rotation direction right capacitor 16µF LGB		
<b>For models:</b>	LC80		
<b>spare parts for</b>	500376		
	<b>GEV No.</b>	365021	<b>Ref. No.</b> 32Z6080
	operating capacitor capacity 16µF 425V tolerance 5% 50/60Hz ambient temperature max. -25 to +85°C ø 35mm L 73mm single M8 plastic connection male faston 6.3mm 416.10.99 protection		
	<b>GEV No.</b>	510551	<b>Ref. No.</b> 3FL1123
	pump cover gasket ID ø 158.3mm pump type 1214/1293/1225/2243/1226/1204/3473/1241 thickness 3.53mm EPDM Qty 1 pcs		
	<b>GEV No.</b>	510694	<b>Ref. No.</b> —
	mechanical shaft seal for shaft ø 13mm height counter ring 8mm ID ø 11.5mm H 16mm mounting ø 24/26mm int. ø 1 14mm		
	<b>GEV No.</b>	512029	<b>Ref. No.</b> —
	impellor ø 103mm H 26mm thread M8L shaft ø 19mm shaft length 15mm seat ø 8.2mm		
	<b>GEV No.</b>	521536	<b>Ref. No.</b> —
	pump cover ALBA / LGB inlet ø 62mm outlet ø 50mm auxiliary pressure connection 12mm supporting pressure closed turn direction right ø 180mm ID ø 150mm inner height 38mm		









Зип Общепит





vsezip.ru

+7(812)9810888







1

<b>GEV No.</b>	500379	<b>Ref. No.</b>	32M5740
<b>description</b>	pump inlet ø 62mm outlet ø 50mm type ZF650SX 230/400V 50Hz 3 phase 1.35kW 1.8HP L 335mm rotation direction right LGB		
<b>For models:</b>	LC100, N354D, N354S, N354VD, N354VS, N506D, N506S, N506VD, N506VS, N607D, N607S, N607VD, N607VS, N760D, N760S, N760VD, N760VS, N886D, N886S, N886VD, N886VS		
<b>spare parts for</b>	500379		
	GEV No.	510551	Ref. No. 3FL1123
	pump cover gasket ID ø 158.3mm pump type 1214/1293/1225/2243/1226/1204/3473/1241 thickness 3.53mm EPDM Qty 1 pcs		
	GEV No.	510694	Ref. No. —
	mechanical shaft seal for shaft ø 13mm height counter ring 8mm ID ø 11.5mm H 16mm mounting ø 24/26mm int. ø 1 14mm		
	GEV No.	521240	Ref. No. —
	impellor ø 110mm H 32mm rotation direction left thread M8L shaft ø 20mm shaft length 10mm seat ø 8.2mm blades 6		
	GEV No.	521536	Ref. No. —
	pump cover ALBA / LGB inlet ø 62mm outlet ø 50mm auxiliary pressure connection 12mm supporting pressure closed turn direction right ø 180mm ID ø 150mm inner height 38mm		

<b>spare parts for</b>	499257		
	GEV No.	509007	Ref. No. —
	impellor ø 85mm H 20mm rotation direction left thread M10R shaft ø 2mm shaft length 7.5mm blades 12		
	GEV No.	510693	Ref. No. 3036790 3152080
	mechanical shaft seal for shaft ø 12mm slide ring ext. ø 24mm slide ring H 15.5mm slide ring int. ø 11mm counter ring mounting ø 24mm height counter ring 8mm counter ring int. ø 13.5mm		
	GEV No.	521167	Ref. No. 3101190
	pump cover OLYMPIA inlet ø 1"mm outlet ø 30/30mm ID ø 94mm		
	GEV No.	521723	Ref. No. 3116490
	pump cover gasket EPDM thickness 2mm ID ø 90mm Qty 1 pcs		



1

<b>GEV No.</b>	500958	<b>Ref. No.</b>	3034630
<b>description</b>	pump inlet ø 33mm outlet ø 30/28mm type T45 230V 50Hz 1 phase 0.33kW 0.45HP L 215mm rotation direction left capacitor 8µF OLYMPIA		
<b>For models:</b>	KD40, KD40LSPS, KD40LUX		
<b>spare parts for</b>	500958		
	GEV No.	365013	Ref. No. 3222490
	operating capacitor capacity 8µF 400V tolerance 5%Hz ambient temperature max. -25 to +85°C ø 31.5mm L 55mm M8 plastic connection male faston 6.3mm protection		
	GEV No.	510693	Ref. No. 3036790 3152080
	mechanical shaft seal for shaft ø 12mm slide ring ext. ø 24mm slide ring H 15.5mm slide ring int. ø 11mm counter ring mounting ø 24mm height counter ring 8mm counter ring int. ø 13.5mm		
	GEV No.	521257	Ref. No. —
	impellor ø 80mm H 12mm rotation direction left thread M10R shaft ø 12mm shaft length 7.5mm blades 6		
	GEV No.	521551	Ref. No. —
	pump cover OLYMPIA inlet ø 33mm outlet ø 30mm outlet 2 ø 28 turn direction left ø 103mm ID ø 93mm inner height 30mm		
	GEV No.	521723	Ref. No. 3116490
	pump cover gasket EPDM thickness 2mm ID ø 90mm Qty 1 pcs		

OLYMPIA

pumps



1

<b>GEV No.</b>	499257	<b>Ref. No.</b>	3037780
<b>description</b>	pump inlet ø 1" IT outlet ø 30mm type L63.T45F_2V 230V 50Hz 1 phase 0.33kW L 230mm rotation direction left capacitor 8µF OLYMPIA		
<b>For models:</b>	KD40		
<b>spare parts for</b>	499257		
	GEV No.	365013	Ref. No. 3222490
	operating capacitor capacity 8µF 400V tolerance 5%Hz ambient temperature max. -25 to +85°C ø 31.5mm L 55mm M8 plastic connection male faston 6.3mm protection		

Зип.Общепит  
booster pumps

vsezip.ru

+7(812)987-08-81



1

<b>GEV No.</b>	500529	<b>Ref. No.</b>	3234970
<b>description</b>	pump inlet $\varnothing$ 60mm outlet $\varnothing$ 48mm type T12 230V 50Hz 1 phase 0.88kW 1.2HP L 270mm rotation direction right capacitor 16 $\mu$ F auxiliary pressure connection 10mm supporting pressure open OLYMPIA		
<b>For models:</b>	KN80, KN800, KN800PSD, KN80PS		
<b>spare parts for</b>	500529		
	<b>GEV No.</b>	365021	<b>Ref. No.</b> 32Z6080
	operating capacitor capacity 16 $\mu$ F 425V tolerance 5% 50/60Hz ambient temperature max. -25 to +85°C $\varnothing$ 35mm L 73mm single M8 plastic connection male faston 6.3mm 416.10.99 protection		
	<b>GEV No.</b>	510693	<b>Ref. No.</b> 3036790 3152080
	mechanical shaft seal for shaft $\varnothing$ 12mm slide ring ext. $\varnothing$ 24mm slide ring H 15.5mm slide ring int. $\varnothing$ 11mm counter ring mounting $\varnothing$ 24mm height counter ring 8mm counter ring int. $\varnothing$ 13.5mm		
	<b>GEV No.</b>	521010	<b>Ref. No.</b> —
	impeller $\varnothing$ 98mm H 12mm M10L blades 8		
	<b>GEV No.</b>	521559	<b>Ref. No.</b> —
	pump cover OLYMPIA inlet $\varnothing$ 60mm outlet $\varnothing$ 48mm outlet 2 $\varnothing$ 31 auxiliary pressure connection 10mm supporting pressure open turn direction right $\varnothing$ 170mm ID $\varnothing$ 150mm inner height 22mm		
	<b>GEV No.</b>	521727	<b>Ref. No.</b> —
	pump cover gasket EPDM thickness 1.78mm ID $\varnothing$ 145mm Qty 1 pcs		



1

<b>GEV No.</b>	500358	<b>Ref. No.</b>	3057760
<b>description</b>	pump inlet $\varnothing$ 3/8" outlet $\varnothing$ 3/8" type PS46 230V 50Hz 0.45kW $\varnothing$ 100mm L 200mm capacitor 10 $\mu$ F LGB		
<b>For models:</b>	KD100A, KD130A, KD60MA, KD60MPSA, KD85A, KD85PSA, LP151, LP70		
<b>spare parts for</b>	500358		
	<b>GEV No.</b>	510713	<b>Ref. No.</b> —
	slide ring for shaft $\varnothing$ 12mm ED $\varnothing$ 24mm H 16mm		
	<b>GEV No.</b>	510723	<b>Ref. No.</b> —
	counter ring H 8mm ED $\varnothing$ 26mm ID $\varnothing$ 13.5mm for mechanical shaft seal		
	<b>GEV No.</b>	698400	<b>Ref. No.</b> —
	pump cover gasket pump type PS46 thickness 2mm ID $\varnothing$ 66mm Qty 1 pcs		
<b>accessories for</b>	500358		
	<b>GEV No.</b>	365015	<b>Ref. No.</b> —
	operating capacitor capacity 10 $\mu$ F 400V tolerance 5% ambient temperature max. -25 to +85°C $\varnothing$ 35.5mm L 59mm M8 plastic connection male faston 6.3mm protection		
	<b>GEV No.</b>	511279	<b>Ref. No.</b> —
	hose connector brass straight thread 3/8" hose $\varnothing$ 12mm Qty 1 pcs		
	<b>GEV No.</b>	520202	<b>Ref. No.</b> —
	hose connector nickel-plated brass straight thread 3/8" hose $\varnothing$ 12mm Qty 1 pcs		
	<b>GEV No.</b>	520677	<b>Ref. No.</b> —
	hose connector brass straight thread 3/8" hose $\varnothing$ 13mm Qty 1 pcs		

drain pumps

GRE



1

<b>GEV No.</b>	500051	<b>Ref. No.</b>	32M4430
<b>description</b>	drain pump inlet $\varnothing$ 22/30mm outlet $\varnothing$ 22mm 100W 230V 50Hz GRE		
<b>For models:</b>	PGA20, PGA30, PGA40, PGA60, PGA80, PGW20, PGW30, PGW40, PGW60, PGW80		



Зип Общепит pumps for ice machines

vsezip.ru

+7(812)987-08-81



1

<b>GEV No.</b>	500980	<b>Ref. No.</b>	32M5220
<b>description</b>	drain pump inlet ø 30mm outlet ø 21mm 100W 230V 50Hz GRE		
<b>For models:</b>	F60T, F80P		



1

<b>GEV No.</b>	501420	<b>Ref. No.</b>	32M6430
<b>description</b>	pump GRE 100W 230V 50Hz inlet ø 25mm outlet ø 22mm L 150mm total length 230mm for ice-cube maker		
<b>For models:</b>	PG80C, PG81CW, PGC132, PGC132-VERS.200911, PGC134W, PGC134W-VERS.200911, PGC210, PGC210-VERS.200911, PGC212W, PGC212W-VERS.200911		
<b>spare parts for</b>	501420		
	<b>GEV No.</b>	695417	<b>Ref. No.</b> —
	insulation for pump		

miscellaneous



1

<b>GEV No.</b>	500201	<b>Ref. No.</b>	N/A
<b>description</b>	drain pump inlet ø 24mm outlet ø 22mm 230V 100W		



1

<b>GEV No.</b>	500047	<b>Ref. No.</b>	32M6310
<b>description</b>	pump REBO type MH30F1 30W 230V 50Hz outlet ø 12.7mm L 135mm rotation direction left		
<b>For models:</b>	PG22C, PG23C, PG23CW, PG24CW, PG30C, PG31CW, PG42C, PG43CW, PG60C, PG61CW		

vibration pumps



1

<b>GEV No.</b>	520159	<b>Ref. No.</b>	3007950
<b>description</b>	hose connector nickel-plated brass straight thread 1/8" hose ø 6mm Qty 1 pcs WS 12 total length 32mm thread L 7.5mm grommet ø 6mm grommet length 19.5mm		
<b>For models:</b>	FM1011E3, FM1011G3, FM1221E3, FM1221G3, FM2021E3, FM2021G3, FM423E2, FM611E3, FM611G3, FM721E3, FM721G3		

condensators & interference suppression filters

starting capacitors



1

<b>GEV No.</b>	500972	<b>Ref. No.</b>	32M7000 32M7001
<b>description</b>	vibration pump 230V 47W 50Hz inlet ø 7 outlet ø 1/8" IT CEME type E507		
<b>For models:</b>	FM1011E3, FM1011E3-VERS.2006, FM1011G3, FM1011G3-VERS.2006, FM1221E3, FM1221E3-VERS.2006, FM1221G3-VERS.2006, FM2011E3-VERS.2006, FM2011G3-VERS.2006, FM2021E3, FM2021E3-VERS.2006, FM2021G3, FM2021G3-VERS.2006, FM611E3, FM611E3-VERS.2006, FM611G3, FM611G3-VERS.2006, FM721E3, FM721E3-VERS.2006, FM721G3, FM721G3-VERS.2006		

starting capacitors



1

<b>GEV No.</b>	365095	<b>Ref. No.</b>	32V1490
<b>description</b>	starting capacitor 43µF 330V 50/60Hz duty cycle 3 60A1D-330043NXET ø 36mm L 80mm M8 plastic connection cable 350mm 04P.5523CM		
<b>For models:</b>	120, 120NN, 120PV, 135A, 135XE, 40, 40CP, 40CPX, 40EV, 40EVP, 40PV, 40X, 40XPV, 55, 55PV, 65A, 65XE, 6FMA11A, 6FMA11B, 6FMA11M, 6FMA11Z, 6FMA2A, 6FMA2B, 6FMA2M, 6FMA2Z, 6FMA4A, 6FMA4B, 6FMA4M, 6FMA4Z, 6FMAA, 6FMAB, 6FMAM, 6FMAZ, 6FMB11A, 6FMB11B, 6FMB11M, 6FMB11Z, 6FMB2A, 6FMB2B, 6FMB2M, 6FMB2Z, 6FMB4A, 6FMB4B, 6FMB4M, 6FMB4Z, 6FMBA, 6FMBB, 6FMBM, 6FMBZ, 6FMC11A...(Other models you can see in the webshop)		

operating capacitors

plastic



<b>GEV No.</b>	365014	<b>Ref. No.</b>	32Z1310
<b>description</b>	operating capacitor capacity 12.5µF 450V tolerance 5%Hz ambient temperature max. -25 to +85°C ø 35mm L 70mm M8 plastic connection male faston 6.3mm 45S.C3DS.12.5 protection		
<b>For models:</b>	L40, L40S		



<b>GEV No.</b>	365021	<b>Ref. No.</b>	32Z6080
<b>description</b>	operating capacitor capacity 16µF 425V tolerance 5% 50/60Hz ambient temperature max. -25 to +85°C ø 35mm L 73mm single M8 plastic connection male faston 6.3mm 416.10.99 protection		
<b>For models:</b>	FC101, FC241, FC61, FCV101, FCV101DS, FCV141, FCV141DS, FCV141DS-CSA, FCV241, FCV241DS, FCV61, FCV61DS		



<b>GEV No.</b>	365224	<b>Ref. No.</b>	32V6440
<b>description</b>	operating capacitor capacity 25µF 420V tolerance 5% 50/60Hz ø 45mm L 75mm M8 plastic connection male faston 6.3mm		
<b>For models:</b>	FM1011G3, FM1011G3-VERS.2006, FM2011G3-VERS.2006, FM611G3, FM611G3-VERS.2006, FM721G3, FM721G3-VERS.2006, FX61G1, FX61G1R, FX61G2, FX61G2C, FX61G2CR, FX61G2R		



<b>GEV No.</b>	365225	<b>Ref. No.</b>	32V5980
<b>description</b>	operating capacitor capacity 35µF 420V tolerance 5% 50/60Hz ambient temperature max. -25 to +85°C ø 45mm L 95mm M8 plastic connection male faston 6.3mm protection		
<b>For models:</b>	FC1011G, FC611G, FM1011G1-VERS.2006, FM1011G2-VERS.2006, FM1011G3-VERS.2006, FM1221G1, FM1221G1-VERS.2006, FM1221G2, FM1221G2-VERS.2006, FM1221G3-VERS.2006, FM2011G2-VERS.2006, FM2011G3-VERS.2006, FM2021G2-VERS.2006, FM2021G3-VERS.2006, FM611G1-VERS.2006, FM611G2-VERS.2006, FM611G3-VERS.2006, FX101G1, FX101G1R, FX101G2, FX101G2C, FX101G2R, FX10G2CR, FX82G1, FX82G2, FX82G2C		

Зип Общепит

vsezip.ru

+7(812)987-08-81



<b>GEV No.</b>	365022	<b>Ref. No.</b>	32V6540
<b>description</b>	operating capacitor capacity 40µF 400V tolerance 5%Hz ambient temperature max. -25 to +85°C ø 45mm L 95mm M8 plastic connection male faston 6.3mm protection		
<b>For models:</b>	BX101G, BX101G-VERS.122013, BX82G, BX82G-VERS.122013, FM1011G1, FM1011G2, FM1011G3, FM611G1, FM611G2, FM611G3, FM721G1, FM721G1-VERS.2006, FM721G2, FM721G2-VERS.2006, FM721G3, FM721G3-VERS.2006, FX101G1, FX101G1R, FX101G2, FX101G2C, FX101G2C-VERS.032014, FX101G2R, FX101G2R-VERS.032014, FX101G2-VERS.032014, FX10G2CR, FX10G2CR-VERS.032014, FX201G2, FX201G2P, FX201G2P-VERS.032014, FX201G2-VERS.032014, FX202G2, FX202G2-VERS.032014, FX82G1, FX82G2, FX82G2C, FX82G2T, FX82G2T-VERS.032014		



<b>GEV No.</b>	365013	<b>Ref. No.</b>	32Z2490
<b>description</b>	operating capacitor capacity 8µF 400V tolerance 5%Hz ambient temperature max. -25 to +85°C ø 31.5mm L 55mm M8 plastic connection male faston 6.3mm protection		
<b>For models:</b>	71AR		

filters

interference suppression filters



<b>GEV No.</b>	365065	<b>Ref. No.</b>	32Z6100
<b>description</b>	interference suppression filter 1000Ohm capacity 1µF		
<b>For models:</b>	FCV101DM, FCV101DS, FCV101EDM, FCV101EDS, FCV141DM, FCV141DS, FCV141EDM, FCV141EDS, FCV241DM, FCV241DS, FCV241EDM, FCV241EDS, FCV241GDM, FCV241GDS, FCV401DM, FCV401EDM, FCV4E, FCV4EDS, FCV61DM, FCV61DM-CSA, FCV61DS, FCV61EDM, FCV61EDM-UL, FCV61EDS		



fuses

Зип Общепит electric accessories

vsezip.ru

+7(812)987-08-81

fine fuses

1



<b>GEV No.</b>	358668	<b>Ref. No.</b>	3201540
<b>description</b>	fine fuse size $\varnothing$ 5x20mm 0.5A fast-acting rated 250V Qty 10 pcs		
<b>For models:</b>	04WFR3ED, 08WFR4ED, 08WGREV, 091FR3ED, 0A1FR1ED, 0A1FR3ED, 0D1FR1ED, 0D1FR3ED, 0G0FR3ED, 10CP1EA, 10CP1GA, 10CP1IA, 12CP1EA, 12CP1GA, 12CP1IA, 18CP2EA, 18CP2GA, 18CP2IA, 191FR4ED, 1A1FR2ED, 1A1FR4ED, 1D1FR2ED, 1D1FR4ED, 71RA, 91RA, FC101, FC101E, FC1011G, FC101E, FC1221E, FC1221G, FC241, FC241E, FC241G, FC61, FC61E, FC611G, FC61E, FCV101, FCV101DM, FCV101DS, FCV101E, FCV101EDM, FCV101EDS, FCV141, FCV141DM, FCV141DS, FCV141E, FCV141EDM, FCV141EDS...(Other models you can see in the webshop)		

2



<b>GEV No.</b>	358671	<b>Ref. No.</b>	3200020
<b>description</b>	fine fuse size $\varnothing$ 5x20mm 1A fast-acting rated 250V Qty 10 pcs		
<b>For models:</b>	06WBR3E, 0G1BR3E, 191BR1E, 191BR1GA, 191BR2E, 191BR2EA, 191BR2GA, 1A1BR1E, 1A1BR1GA, 1A1BR2E, 1A1BR2EA, 1A1BR2GA, 1D1BR1E, 1D1BR1GA, 1D1BR2E, 1D1BR2EA, 1D1BR2GA, 1G1BR3E, 291BR1E, 291BR1GA, 291BR2E, 291BR2EA, 291BR2GA, 2A1BR1E, 2A1BR1GA, 2A1BR2E, 2A1BR2EA, 2A1BR2GA, 2D1BR1E, 2D1BR1GA, 2D1BR2E, 2D1BR2EA, 2D1BR2GA, 71ARE, 91ARE, FCV401DM, FCV401EDM		

1



<b>GEV No.</b>	358031	<b>Ref. No.</b>	32V6210
<b>description</b>	fine fuse size $\varnothing$ 10x38mm 10A rated 500V type Gg fast-acting Qty 1 pcs		
<b>For models:</b>	BX101E, BX101E-VERS.122013, BX122E, BX122E-VERS.122013, BX61E, BX61E-VERS.122013, BX82E, BX82E-VERS.122013, FC1011E, FC1221E, FC611E, FM1011E1, FM1011E1-VERS.2006, FM1011E2, FM1011E2-VERS.2006, FM1011E3, FM1011E3-VERS.2006, FM1221E1, FM1221E1-VERS.2006, FM1221E2, FM1221E2-VERS.2006, FM1221E3-VERS.2006, FM2011E2-VERS.2006, FM2011E3-VERS.2006, FM2021E1, FM2021E2, FM2021E2-VERS.2006, FM2021E3, FM2021E3-VERS.2006, FM611E1, FM611E1-VERS.2006, FM611E2, FM611E2-VERS.2006, FM611E3, FM611E3-VERS.2006, FM721E1, FM721E1-VERS.2006, FM721E2, FM721E2-VERS.2006, FM721E3, FM721E3-VERS.2006, FX101E1, FX101E1R, FX101E2, FX101E2C, FX101E2C-VERS.032014, FX101E2R, FX101E2R-VERS.032014, FX101E2-VERS.032014, FX101E3...(Other models you can see in the webshop)		

cables earthing cables

1



<b>GEV No.</b>	100171	<b>Ref. No.</b>	32A2400 32A2401
<b>description</b>	earthing cable connection F2.8mm / lug M5 cable length 1200mm		
<b>For models:</b>	1A1FA1G, 1A1FA2G, 1A1FA4G, 1A1FA5G, 1A1FAAG, 1A1FABG, 1A1FAS2G, 1A1FASG, 1A1TP0G, 1A1TP0G-VERS.2002, 1B1FAS2G, 1B1FASG, 1D1FA1G, 1D1FA2G, 1D1FA4G, 1D1FA5G, 1D1FAAG, 1D1FABG, 1D1FAS2G, 1D1FASG, 1D1TP0G, 1D1TP0G-VERS.2002, 1G1BR1G, 2A1FA1G, 2A1FA4G, 2A1FAAG, 2A1FAS2G, 2A1FASG, 2A1TP3G, 2A1TP6G, 2A1TPCG, 2A1TPSG, 2D1FA1G, 2D1FA4G, 2D1FAAG, 2D1FAS2G, 2D1FASG, 2D1TP3G, 2D1TP6G, 2D1TPCG, 2D1TPSG, 3A1FA1G, 3A1FA4G, 3A1FAAG, 3A1FASG, 3D1FA1G, 3D1FA4G, 3D1FAAG, 3D1FASG, 60SM		

1



<b>GEV No.</b>	104684	<b>Ref. No.</b>	3113500
<b>description</b>	earthing cable connection F2.8mm / lug M5 cable length 350mm 1.5mm <sup>2</sup>		
<b>For models:</b>	BX101G, BX101G-VERS.122013, BX122G, BX122G-VERS.122013, BX61G, BX61G-VERS.122013, BX82G, BX82G-VERS.122013, FC1011G, FC611G, FM1011G1, FM1011G1-VERS.2006, FM1011G2, FM1011G2-VERS.2006, FM1011G3, FM1011G3-VERS.2006, FM2011G2-VERS.2006, FM2011G3-VERS.2006, FM611G1, FM611G1-VERS.2006, FM611G2, FM611G2-VERS.2006, FM611G3, FM611G3-VERS.2006, FM721G1, FM721G1-VERS.2006, FM721G2, FM721G2-VERS.2006, FM721G3, FM721G3-VERS.2006, FX101G1, FX101G1R, FX101G2, FX101G2C, FX101G2C-VERS.032014, FX101G2R, FX101G2R-VERS.032014, FX101G2-VERS.032014, FX101G3, FX101G3C, FX101G3C-VERS.022014, FX101G3R, FX101G3R-VERS.022014, FX101G3-VERS.022014, FX10G2CR, FX10G2CR-VERS.032014, FX10G3CR, FX10G3CR-VERS.022014, FX122G1, FX122G2...(Other models you can see in the webshop)		

1



<b>GEV No.</b>	100173	<b>Ref. No.</b>	32A0441
<b>description</b>	earthing cable connection F2.8mm / lug M5 cable length 620mm		
<b>For models:</b>	031FT04, 031FT06, 070FT04, 070FT05, 071FT04, 071FT06, 090BM1G, 090FT04, 090FT05, 091FT04, 091FT06, 0A0FT1G, 0A0FT2G, 0A0FT4G, 0A0FT5G, 0A0GRG, 0B0FT1G, 0B0FT2G, 0B0FT4G, 0B0FT5G, 0D0FT1G, 0D0FT2G, 0D0FT4G, 0D0FT5G, 0D0GRG, 0G0FT1G, 0G0FT2G, 0G0FT4G, 0G0FT5G, 190BM2G, 1A0FT1G, 1A0FT2G, 1A0FT3G, 1A0FT4G, 1A0FT6G, 1A0GRG, 1B0FT1G, 1B0FT2G, 1B0FT3G, 1B0FT4G, 1B0FT6G, 1D0FT1G, 1D0FT2G, 1D0FT3G, 1D0FT4G, 1D0FT6G, 1D0GRG, 1G0FT1G, 1G0FT2G, 1G0FT3G...(Other models you can see in the webshop)		

1



<b>GEV No.</b>	100183	<b>Ref. No.</b>	32A2530
<b>description</b>	earthing cable connection F2.8mm / lug M5 cable length 900mm		
<b>For models:</b>	08WCP1GM, 0A0BMG, 0A0FAVA, 0A1CP1G, 0B1CP1G, 0D0BMG, 0D0FAVA, 0D1CP1G, 0G1CP1G, 10WTPGE, 10WTPGV, 1A0BMG, 1A0FA2, 1A0FA5, 1A0FAB, 1A0FAS2, 1A0TP0, 1A1CP1G, 1A1CP2G, 1A1FA2G, 1A1FA5G, 1A1FABG, 1A1FAS2G, 1A1FASG, 1A1PD1G, 1A1PD2G, 1A1PI1G, 1A1PI1GA, 1A1TP0G, 1A1TP0G-VERS.2002, 1B0FAS2, 1B0TP0, 1B1FAS2G, 1D0BMG, 1D0FA2, 1D0FA5, 1D0FAB, 1D0FAS2, 1D0TP0, 1D1CP1G, 1D1CP2G, 1D1FA2G, 1D1FA5G, 1D1FABG, 1D1FAS2G, 1D1PD1G, 1D1PD2G, 1D1PI1G, 1D1PI1GA, 1D1TP0G...(Other models you can see in the webshop)		

electric components



<b>GEV No.</b>	104798	<b>Ref. No.</b>	3113480
<b>description</b>	earthing cable connection F2.8mm/lug M6 cable length 600mm 1.5mm <sup>2</sup>		
<b>For models:</b>	FM1221G1, FM1221G1-VERS.2006, FM1221G2, FM1221G2-VERS.2006, FM1221G3, FM1221G3-VERS.2006, FM2021G1, FM2021G2, FM2021G2-VERS.2006, FM2021G3, FM2021G3-VERS.2006, FM721G1, FM721G2, FM721G3		

## ribbon cables

## group 1



<b>GEV No.</b>	400066	<b>Ref. No.</b>	3099170
<b>description</b>	ribbon cable 10-pole L 1000mm plug type FC-10P raster size 2.54mm		
<b>For models:</b>	KD85E, KD85EA, KD85EAT, KD85EPS, KD85EPSA, LP70		



<b>GEV No.</b>	403293	<b>Ref. No.</b>	32A2290
<b>description</b>	ribbon cable 16-pole L 1500mm plug type 2 row coded plug: number of poles 16		
<b>For models:</b>	06WFR3GD, 08WFR4ED, 091FR1GD, 091FR3GD, 0A1FR1ED, 0A1FR1GD, 0A1FR1GD-VERS.2004, 0A1FR3GD, 0B1FR1GD, 0D1FR1ED, 0D1FR1GD, 0D1FR1GD-VERS.2004, 0D1FR3GD, 0G0FR3ED, 0G1FR3GD, 10WFR4GD, 191FR2GD, 191FR4GD, 1A1FR2ED, 1A1FR2GD, 1A1FR2GD-VERS.2004, 1D1FR2ED, 1D1FR2GD, 1D1FR2GD-VERS.2004, 1G1FR4GD		

## connection cables



<b>GEV No.</b>	579007	<b>Ref. No.</b>	3116170
<b>description</b>	data cable L 1000mm 8-pole for combi-steamer suitable for ANGELO PO plug type RJ45		
<b>For models:</b>	BX122G, BX122G-VERS.122013, BX82G, BX82G-VERS.122013, FX101E1, FX101E1R, FX101E2, FX101E2C, FX101E2C-VERS.032014, FX101E2R, FX101E2R-VERS.032014, FX101E2-VERS.032014, FX101E3, FX101E3C, FX101E3C-VERS.022014, FX101E3R, FX101E3R-VERS.022014, FX101E3-VERS.022014, FX101G1, FX101G1R, FX101G2, FX101G2C, FX101G2C-VERS.032014, FX101G2R, FX101G2R-VERS.032014, FX101G2-VERS.032014, FX101G3, FX101G3C, FX101G3C-VERS.022014, FX101G3R, FX101G3R-VERS.022014, FX101G3-VERS.022014, FX10E2CR, FX10E2CR-VERS.032014, FX10E3CR, FX10E3CR-VERS.022014, FX10G2CR, FX10G2CR-VERS.032014, FX10G3CR, FX10G3CR-VERS.022014, FX122E1, FX122E2, FX122E2C, FX122E2T, FX122E2T-VERS.032014, FX122E3, FX122E3C, FX122E3T, FX122E3T-VERS.022014, FX122G1...(Other models you can see in the webshop)		

## terminals and connectors

insulated  
plug connectors

<b>GEV No.</b>	550326	<b>Ref. No.</b>	32D0080
<b>description</b>	connection terminal 12-pole connection male faston 6.3mm temp.-resist. 140°C		
<b>For models:</b>	0A1FR3G, 0A1FR3GD, 0D1FR3G, 0D1FR3GD, 0G1FR3G, 0G1FR3GD, 191BR1G, 191BR1GA, 191BR2G, 191BR2GA, 1A1BR1G, 1A1BR1GA, 1A1BR2G, 1A1BR2GA, 1A1FR4G, 1A1FR4GD, 1D1BR1G, 1D1BR1GA, 1D1BR2G, 1D1BR2GA, 1D1FR4G, 1D1FR4GD, 1G1FR4G, 1G1FR4GD, 291BR1G, 291BR1GA, 291BR2G, 291BR2GA, 2A1BR1G, 2A1BR1GA, 2A1BR2G, 2A1BR2GA, 2D1BR1G, 2D1BR1GA, 2D1BR2G, 2D1BR2GA		

## plug connectors



<b>GEV No.</b>	550952	<b>Ref. No.</b>	32D0420
<b>description</b>	connecting piece 2-pole		



<b>GEV No.</b>	550171	<b>Ref. No.</b>	32D0140
<b>description</b>	plug connector 10-pole STV 2/10		

## terminals

## porcelain clamps



<b>GEV No.</b>	550112	<b>Ref. No.</b>	3000060
<b>description</b>	porcelain terminal block 2-pole 2.5mm <sup>2</sup> max. 10A max 250V t.max. 200°C L 22mm W 17mm H 15mm mounting distancemm Qty 1 pcs		



Зип Общепит

vsezip.ru

+7(812)987-08-81

terminal blocks



1			
<b>GEV No.</b>	550232	<b>Ref. No.</b>	32D1450
<b>description</b>	lustre terminal 12-pole cross section 2.5mm <sup>2</sup> max. 32A max 450V temp.-resist. 150°C		
<b>For models:</b>	031FT04, 031FT06, 04WBMEV, 04WCP1EM, 04WFR3ED, 04WPE4V, 04WPEBV, 04WVT3RV, 06WBR3E, 06WFT1EV, 06WFT2EV, 06WFT3EV, 06WFT4EV, 06WFT6EV, 06WFT7EV, 070FT04, 070FT05, 071FT04, 071FT06, 08WFR4ED, 08WFT1EV, 08WFT2EV, 08WFT3EV, 08WFT4EV, 08WFT4GV, 08WFT6EV, 08WFT6GV, 08WFT7EV, 08WPE4V, 08WPEBV, 08WTPEV, 090BM1G, 090FT04, 090FT05, 090FT1G, 090FT2G, 090FT4G, 090FT5G, 090FT7G, 090GRG, 090PE4, 090VTR, 091CP1E, 091CP1G, 091FR1EA, 091FR1EX, 091FR3E, 091FR3ED, 091FT04, 091FT06...(Other models you can see in the webshop)		

connection terminals with screw/faston connections



1			
<b>GEV No.</b>	550278	<b>Ref. No.</b>	32D0171
<b>description</b>	power terminal block 3-pole max. 40A max 400V connection ø6mm <sup>2</sup> / F6.3 temp.-resist. 150°C cross section 6mm <sup>2</sup>		



1			
<b>GEV No.</b>	550349	<b>Ref. No.</b>	32D1800
<b>description</b>	power terminal block 4-pole max. 40A max 400V connection ø6mm <sup>2</sup> / F6.3 temp.-resist. 150°C cross section 6mm <sup>2</sup>		



1			
<b>GEV No.</b>	550411	<b>Ref. No.</b>	32D0250 32D0251
<b>description</b>	power terminal block 6-pole max. 40A max 450V connection ø6mm <sup>2</sup> / F6.3 temp.-resist. 150°C cross section 6mm <sup>2</sup>		

connection terminals with screw connection



<b>GEV No.</b>	550507	<b>Ref. No.</b>	32D1800
<b>description</b>	power terminal block 4-pole max. 40A max 400V connection M6/M6 temp.-resist. 150°C		

connection terminals with strain relief



1			
<b>GEV No.</b>	550951	<b>Ref. No.</b>	32D0380
<b>description</b>	power terminal block 3-pole cross section 2.5mm <sup>2</sup> with strain relief		
<b>For models:</b>	030BME, 030EBM, 031BME, 031EBM, 090FAA, 090FAVA, 090GRG, 0M0BME, 0M0SP1E, 190FAA, 190FAB, 190GRG, 190TP0, 191FAAG, 191FABG, 191FADG, 191FAG, 191PD2G, 191PI1G, 191PI1GA, 191PI2G, 191PI2GA, 191TPG, 1G1FA0GV, 1M0BME, 291FAG, 291TPCG, 2G1FA0GV, 30F1, 30F1B, 30F52, 30F52B, 31TC, 32TC, 391FAG, 70F1, 70F1B, 71F2, 71F2B, 91F223B, G1FAGS, G1FAGST		

plug-in terminal blocks



1			
<b>GEV No.</b>	550950	<b>Ref. No.</b>	32D0240
<b>description</b>	plug-in terminal block 16-pole max. 16A max 380V		

rail-mounted terminals

miscellaneous



1			
<b>GEV No.</b>	550947	<b>Ref. No.</b>	32D0470
<b>description</b>	rail-mounted terminal profile C		
<b>For models:</b>	030E, 030FE, 030FE1, 030FE1B, 030FTE, 030FTE, 031E, 031FTE, 031FTE, 031FTE, 070BME, 070E, 070FTE, 070FTE, 071BME, 071E, 071FTE, 071FTE, 071FTE, 090BME, 090E, 090FTE, 090FTE, 091BME, 091E, 091FE28, 091FE28B, 091FTE, 091FTE, 091FTE, 091FTE, 30CPSE, 30FES, 30FES2, 30FES2B, 31GE, 31PIE6, 31RE, 70CPE, 70FE, 70FE1, 70FE1B, 70FES, 70FES2, 70FES2B, 71PIE15, 71PIE15A, 90CPE, 91PIE15, 91PIE15A, FS30E		











Зип-Общепит

vsezip.ru

+7(812)987-08-81

			
<b>1</b>			
<b>GEV No.</b>	103179	<b>Ref. No.</b>	33D3180
<b>description</b>	gas tap PEL type 20S gas inlet pipe flange ø21mm bypass nozzle ø 0mm gas outlet M16x1.5 (tube ø 10/8mm) thermocouple connection M9x1 pilot connection shaft ø 8x6.5mm shaft L 22/15mm shaft flat lower without ignition flame connection		
<b>For models:</b>	G1FAGS, G1FAGST		

<b>accessories for</b>	101095		
	<b>GEV No.</b>	101450	<b>Ref. No.</b> —
	olive for pipe ø 8mm L 12.7mm Qty 1 pcs ED ø 10mm		
	<b>GEV No.</b>	101451	<b>Ref. No.</b> —
	union nut thread M16x1.5 tube ø 8mm		
	<b>GEV No.</b>	110081	<b>Ref. No.</b> 36M0770
	knob ø 70mm shaft ø 8x6.5mm shaft flat universal		
	<b>GEV No.</b>	112206	<b>Ref. No.</b> —
	knob dial plate silver gas tap PEL21/22/23 t.max.°C ED ø 63mm ID ø 45.5mm		

<b>21S series</b>			
			
<b>1</b>			
<b>GEV No.</b>	101095	<b>Ref. No.</b>	33D1170
<b>description</b>	gas tap PEL type 21S gas inlet M16x1.5 (tube ø 10mm) bypass nozzle ø 0.35mm gas outlet M16x1.5 (tube ø 10/8mm) thermocouple connection M8x1 pilot connection M10x1 shaft ø 8x6.5mm shaft L 22/15mm shaft flat lower		
<b>For models:</b>	030, 031, 032, 31, 31GE, 31TC, 32, 32TC, 32TP, 32TPV, 32V, 605M		
<b>spare parts for</b>	101095		
	<b>GEV No.</b>	100408	<b>Ref. No.</b> 33T3630
	bypass nozzle type PEL20/21 bore ø 0.35mm thread M5x0.5		
	<b>GEV No.</b>	101060	<b>Ref. No.</b> 32Z1520
	magnet unit standard L 39mm D1 ø 15.4mm D2 ø 11mm suitable for PEL20-21/JUNKERS/EGA		
	<b>GEV No.</b>	101206	<b>Ref. No.</b> —
	gas tap front part shaft ø 8x6.5mm shaft L 22/15mm shaft flat upper/lower suitable for PEL21		
	<b>GEV No.</b>	101230	<b>Ref. No.</b> —
	thermocouple nut T1: M8x1 T2: M18x1 aluminium		
<b>accessories for</b>	101095		
	<b>GEV No.</b>	100908	<b>Ref. No.</b> 36Q1000
	union screw thread M10x1 for pipe ø 4mm Qty 1 pcs		
	<b>GEV No.</b>	100909	<b>Ref. No.</b> 36Q0060
	union screw thread M10x1 for pipe ø 6mm Qty 1 pcs		
	<b>GEV No.</b>	101246	<b>Ref. No.</b> —
	olive for pipe ø 4mm Qty 1 pcs		
	<b>GEV No.</b>	101278	<b>Ref. No.</b> 36Q0080
	olive for pipe ø 10mm Qty 1 pcs		
	<b>GEV No.</b>	101286	<b>Ref. No.</b> 36Q0020
	olive ID ø 6mm Qty 1 pcs		
	<b>GEV No.</b>	101300	<b>Ref. No.</b> 36Q0830
	union nut thread M16x1.5 tube ø 10mm		

			
<b>1</b>			
<b>GEV No.</b>	109515	<b>Ref. No.</b>	3064310
<b>description</b>	gas tap PEL type 21S gas inlet pipe flange ø21mm bypass nozzle ø 0mm gas outlet M16x1.5 (tube ø 10/8mm) thermocouple connection M8x1 pilot connection M10x1 shaft ø 8x6.5mm shaft L 22/15mm shaft flat upper		
<b>For models:</b>	04WFAAV, 08WFA4E, 08WFA4G, 08WFAAE, 08WFAAG, 08WFAAV, 090FAA, 0G0FA0, 0G1CP1G-VERS.2004, 12WFA6E, 12WFA6G, 12WFAAA, 12WFAAE, 12WFAAG, 12WFAAN, 190FA, 190FAA, 190FAB, 190FAD, 191FAAE, 191FAAG, 191FABG, 191FADG, 191FAE, 191FAG, 1G0FA0, 1G0FA0B, 1G0GRG, 1G0TPO, 1G1CP1G-VERS.2004, 1G1CP2G-VERS.2004, 1G1FA0E, 1G1FA0EV, 1G1FA0G, 1G1FA0GV, 1G1FABG, 1G1FAPG, 1G1TPOG, 290FA, 291FAG, 291FAGF, 291TPCG, 2G0FA0, 2G0FA0A, 2G0FA0B, 2G1FA0E, 2G1FA0G, 2G1FA0GV, 2G1FABG, 2G1FACG...(Other models you can see in the webshop)		
<b>spare parts for</b>	109515		
	<b>GEV No.</b>	101060	<b>Ref. No.</b> 32Z1520
	magnet unit standard L 39mm D1 ø 15.4mm D2 ø 11mm suitable for PEL20-21/JUNKERS/EGA		
	<b>GEV No.</b>	101206	<b>Ref. No.</b> —
	gas tap front part shaft ø 8x6.5mm shaft L 22/15mm shaft flat upper/lower suitable for PEL21		
	<b>GEV No.</b>	101230	<b>Ref. No.</b> —
	thermocouple nut T1: M8x1 T2: M18x1 aluminium		
<b>accessories for</b>	109515		
	<b>GEV No.</b>	100908	<b>Ref. No.</b> 36Q1000
	union screw thread M10x1 for pipe ø 4mm Qty 1 pcs		
	<b>GEV No.</b>	100909	<b>Ref. No.</b> 36Q0060
	union screw thread M10x1 for pipe ø 6mm Qty 1 pcs		
	<b>GEV No.</b>	101246	<b>Ref. No.</b> —
	olive for pipe ø 4mm Qty 1 pcs		
	<b>GEV No.</b>	101278	<b>Ref. No.</b> 36Q0080
	olive for pipe ø 10mm Qty 1 pcs		
	<b>GEV No.</b>	101286	<b>Ref. No.</b> 36Q0020
	olive ID ø 6mm Qty 1 pcs		

Table continues overleaf















1 gas components





Зип-Общепит

vsezip.ru

+7(812)987-08-81

1

<b>GEV No.</b>	106234	<b>Ref. No.</b>	33A0090
<b>description</b>	gas tap PEL type 22N/O gas inlet M20x1.5 (tube ø 12mm) bypass nozzle ø 0.35mm gas outlet M20x1.5 (flanged tube ø 12/10mm) thermocouple connection pilot connection M10x1 shaft ø 10x8mm shaft L 28/13mm shaft flat lower		
<b>spare parts for</b>	106234		
	<b>GEV No.</b>	100259	<b>Ref. No.</b> 33T1180
	bypass nozzle type PEL22 bore ø 0.35mm thread M6x0.5		
	<b>GEV No.</b>	101203	<b>Ref. No.</b> —
	gas tap front part shaft ø 9x10mm shaft L 28/13mm shaft flat upper/lower suitable for PEL22		
	<b>GEV No.</b>	101240	<b>Ref. No.</b> —
	gas connection thread M20x1.5 tube ø 12/10mm for PEL gas taps with gasket and screws horizontal		
	<b>GEV No.</b>	101331	<b>Ref. No.</b> —
	adapter suitable for PEL22 for flanged cable 10/12mm		
	<b>GEV No.</b>	101460	<b>Ref. No.</b> —
	O-ring ø 12.37mm D1 ø 2.62mm suitable for PEL22		
	<b>GEV No.</b>	101461	<b>Ref. No.</b> —
	screw kit suitable for PEL22 Qty 4 pcs		
<b>accessories for</b>	106234		
	<b>GEV No.</b>	100908	<b>Ref. No.</b> 36Q1000
	union screw thread M10x1 for pipe ø 4mm Qty 1 pcs		
	<b>GEV No.</b>	100909	<b>Ref. No.</b> 36Q0060
	union screw thread M10x1 for pipe ø 6mm Qty 1 pcs		
	<b>GEV No.</b>	101246	<b>Ref. No.</b> —
	olive for pipe ø 4mm Qty 1 pcs		
	<b>GEV No.</b>	101248	<b>Ref. No.</b> 36Q0030
	olive for pipe ø 12mm Qty 1 pcs suitable for PEL		
	<b>GEV No.</b>	101249	<b>Ref. No.</b> 36Q1700
	olive for pipe ø 10mm Qty 1 pcs		
	<b>GEV No.</b>	101250	<b>Ref. No.</b> 36Q0610
	union nut thread M20x1.5 for pipe ø 10mm		
	<b>GEV No.</b>	101251	<b>Ref. No.</b> 36Q0050
	union nut thread M20x1.5 for pipe ø 12mm		
	<b>GEV No.</b>	101286	<b>Ref. No.</b> 36Q0020
	olive ID ø 6mm Qty 1 pcs		

<b>accessories for</b>	109515		
	<b>GEV No.</b>	101300	<b>Ref. No.</b> 36Q0830
	union nut thread M16x1.5 tube ø 10mm		
	<b>GEV No.</b>	101450	<b>Ref. No.</b> —
	olive for pipe ø 8mm L 12.7mm Qty 1 pcs ED ø 10mm		
	<b>GEV No.</b>	101451	<b>Ref. No.</b> —
	union nut thread M16x1.5 tube ø 8mm		
	<b>GEV No.</b>	110078	<b>Ref. No.</b> —
	knob without symbol ø 70mm shaft ø 6x4.6mm shaft flat universal		
	<b>GEV No.</b>	112206	<b>Ref. No.</b> —
	knob dial plate silver gas tap PEL21/22/23 t.max.°C ED ø 63mm ID ø 45.5mm		

	1		
<b>GEV No.</b>	106231	<b>Ref. No.</b>	33D1930
<b>description</b>	gas tap PEL type 21S gas inlet pipe flange ø21mm bypass nozzle ø 1.05mm gas outlet M16x1.5 (tube ø 10/8mm) thermocouple connection M8x1 pilot connection M10x1 shaft ø 8x6.5mm shaft L 22/15mm shaft flat lower		
<b>For models:</b>	0A0FA1, 0A0FA4, 0A0FAA, 0D0FA1, 0D0FA4, 0D0FAA, 0G0FA0, 0G1CP1G, 0G1CP1G-VERS.2004, 1A0FA1, 1A0FA2, 1A0FA4, 1A0FA5, 1A0FAA, 1A0FAB, 1A1FA1G, 1A1FA2G, 1A1FA4G, 1A1FA5G, 1A1FAAG, 1A1FABG, 1D0FA1, 1D0FA2, 1D0FA4, 1D0FA5, 1D0FAA, 1D0FAB, 1D1FA1G, 1D1FA2G, 1D1FA4G, 1D1FA5G, 1D1FAAG, 1D1FABG, 1G0FA0, 1G0GRG, 1G0TP0, 1G1CP1G, 1G1CP1G-VERS.2004, 1G1CP2G, 1G1CP2G-VERS.2004, 1G1FA0E, 1G1FA0EV, 1G1FA0G, 1G1FA0GV, 1G1FAPG, 1G1TP0G, 2A0FA1, 2A0FA4, 2A0FAA, 2A1FA1G...(Other models you can see in the webshop)		
<b>spare parts for</b>	106231		
	<b>GEV No.</b>	100557	<b>Ref. No.</b> 33T3670
	bypass nozzle type PEL20/21 bore ø 1.05mm thread M5x0.5		
	<b>GEV No.</b>	101060	<b>Ref. No.</b> 32Z1520
	magnet unit standard L 39mm D1 ø 15.4mm D2 ø 11mm suitable for PEL20-21/JUNKERS/EGA		
	<b>GEV No.</b>	101230	<b>Ref. No.</b> —
	thermocouple nut T1: M8x1 T2: M18x1 aluminium		
	<b>GEV No.</b>	101880	<b>Ref. No.</b> —
	gasket Viton ED ø 14mm ID ø 9mm thickness 7.7mm Qty 1 pcs		
<b>accessories for</b>	106231		
	<b>GEV No.</b>	101277	<b>Ref. No.</b> 36Q1630
	olive ID ø 8mm Qty 1 pcs		
	<b>GEV No.</b>	101278	<b>Ref. No.</b> 36Q0080
	olive for pipe ø 10mm Qty 1 pcs		
	<b>GEV No.</b>	101300	<b>Ref. No.</b> 36Q0830
	union nut thread M16x1.5 tube ø 10mm		
	<b>GEV No.</b>	101451	<b>Ref. No.</b> —
	union nut thread M16x1.5 tube ø 8mm		



Зип Общежит

225/O series

vsezip.ru

+7(812)987-08-81

1

	<b>GEV No.</b>	106233	<b>Ref. No.</b>	33A1110
<b>description</b>	gas tap PEL type 22N/O gas inlet M20x1.5 (tube ø 12mm) bypass nozzle ø 0.35mm gas outlet M20x1.5 (tube ø 12/10mm) thermocouple connection pilot connection M10x1 shaft ø 10x8mm shaft L 28/13mm shaft flat lower			
<b>spare parts for</b>	106233			
	<b>GEV No.</b>	100259	<b>Ref. No.</b>	33T1180
	bypass nozzle type PEL22 bore ø 0.35mm thread M6x0.5			
	<b>GEV No.</b>	101203	<b>Ref. No.</b>	—
	gas tap front part shaft ø 9x10mm shaft L 28/13mm shaft flat upper/lower suitable for PEL22			
	<b>GEV No.</b>	101240	<b>Ref. No.</b>	—
	gas connection thread M20x1.5 tube ø 12/10mm for PEL gas taps with gasket and screws horizontal			
	<b>GEV No.</b>	101460	<b>Ref. No.</b>	—
	O-ring ø 12.37mm D1 ø 2.62mm suitable for PEL22			
	<b>GEV No.</b>	101461	<b>Ref. No.</b>	—
	screw kit suitable for PEL22 Qty 4 pcs			
<b>accessories for</b>	106233			
	<b>GEV No.</b>	100908	<b>Ref. No.</b>	36Q1000
	union screw thread M10x1 for pipe ø 4mm Qty 1 pcs			
	<b>GEV No.</b>	100909	<b>Ref. No.</b>	36Q0060
	union screw thread M10x1 for pipe ø 6mm Qty 1 pcs			
	<b>GEV No.</b>	101246	<b>Ref. No.</b>	—
	olive for pipe ø 4mm Qty 1 pcs			
	<b>GEV No.</b>	101248	<b>Ref. No.</b>	36Q0030
	olive for pipe ø 12mm Qty 1 pcs suitable for PEL			
	<b>GEV No.</b>	101249	<b>Ref. No.</b>	36Q1700
	olive for pipe ø 10mm Qty 1 pcs			
	<b>GEV No.</b>	101250	<b>Ref. No.</b>	36Q0610
	union nut thread M20x1.5 for pipe ø 10mm			
	<b>GEV No.</b>	101251	<b>Ref. No.</b>	36Q0050
	union nut thread M20x1.5 for pipe ø 12mm			
	<b>GEV No.</b>	101286	<b>Ref. No.</b>	36Q0020
	olive ID ø 6mm Qty 1 pcs			

	<b>GEV No.</b>	101085	<b>Ref. No.</b>	33A0100 33A1040
<b>description</b>	gas tap PEL type 22S/O gas inlet M20x1.5 (tube ø 12mm) bypass nozzle ø 0.35mm gas outlet M20x1.5 (flanged tube ø 12/10mm) thermocouple connection M8x1 pilot connection M10x1 shaft ø 10x9mm shaft L 28/13mm shaft flat upper			
<b>For models:</b>	031TP, 070D, 070DGG, 070FT, 070FTR, 0712D, 0712VA, 071D, 071DGG, 071FT, 071FTR, 071FTRL, 071TP, 072D, 072DGG, 090, 090FT, 090FTR, 090GG, 091, 091FT, 091FTR, 091FTRL, 091GG, 091TP, 092, 092GG, 092VA, 092VAGG, 30CPS, 31PD6, 31PI6, 31TP, 32TP, 32TPV, 70CP, 712D, 712VA, 71CP, 71CP2, 71D, 71DGG, 71GE, 71GEGG, 71PD10, 71PD15, 71PI10, 71PI10A, 71TP, 72D...(Other models you can see in the webshop)			
<b>spare parts for</b>	101085			
	<b>GEV No.</b>	100259	<b>Ref. No.</b>	33T1180
	bypass nozzle type PEL22 bore ø 0.35mm thread M6x0.5			
	<b>GEV No.</b>	101058	<b>Ref. No.</b>	32Z1460
	magnet unit L 39mm D1 ø 15.4mm D2 ø 13.5mm suitable for PEL22/EGA24197 standard			
	<b>GEV No.</b>	101203	<b>Ref. No.</b>	—
	gas tap front part shaft ø 9x10mm shaft L 28/13mm shaft flat upper/lower suitable for PEL22			
	<b>GEV No.</b>	101230	<b>Ref. No.</b>	—
	thermocouple nut T1: M8x1 T2: M18x1 aluminium			
	<b>GEV No.</b>	101240	<b>Ref. No.</b>	—
	gas connection thread M20x1.5 tube ø 12/10mm for PEL gas taps with gasket and screws horizontal			
	<b>GEV No.</b>	101460	<b>Ref. No.</b>	—
	O-ring ø 12.37mm D1 ø 2.62mm suitable for PEL22			
	<b>GEV No.</b>	101461	<b>Ref. No.</b>	—
	screw kit suitable for PEL22 Qty 4 pcs			
<b>accessories for</b>	101085			
	<b>GEV No.</b>	100908	<b>Ref. No.</b>	36Q1000
	union screw thread M10x1 for pipe ø 4mm Qty 1 pcs			
	<b>GEV No.</b>	100909	<b>Ref. No.</b>	36Q0060
	union screw thread M10x1 for pipe ø 6mm Qty 1 pcs			
	<b>GEV No.</b>	101241	<b>Ref. No.</b>	—
	gas connection thread M20x1.5 tube ø 12/10mm for PEL gas taps vertical			
	<b>GEV No.</b>	101246	<b>Ref. No.</b>	—
	olive for pipe ø 4mm Qty 1 pcs			
	<b>GEV No.</b>	101248	<b>Ref. No.</b>	36Q0030
	olive for pipe ø 12mm Qty 1 pcs suitable for PEL			
	<b>GEV No.</b>	101249	<b>Ref. No.</b>	36Q1700
	olive for pipe ø 10mm Qty 1 pcs			





Table continues overleaf

1 gas components

Зип-Общепит

vsezip.ru

+7(812)987-08-81

accessories for		101085		
	GEV No.	101250	Ref. No.	36Q0610
	union nut thread M20x1.5 for pipe ø 10mm			
	GEV No.	101251	Ref. No.	36Q0050
	union nut thread M20x1.5 for pipe ø 12mm			
	GEV No.	101286	Ref. No.	36Q0020
	olive ID ø 6mm Qty 1 pcs			
	GEV No.	101331	Ref. No.	—
	adapter suitable for PEL22 for flanged cable 10/12mm			
	GEV No.	110140	Ref. No.	36M2390 36M5140
	knob switch zero mark ø 67mm shaft ø 10x9mm shaft flat upper black			

22S/V series



1

GEV No.	101457	Ref. No.	33A0580	
<b>description</b>	gas tap alternatives to JUNKERS type CH110 gas inlet M20x1.5 (tube ø 12mm) bypass nozzle ø 0.35mm gas outlet M20x1.5 (tube ø 12/10mm) thermocouple connection M8x1 pilot connection M10x1 shaft ø 10mm shaft L 25mm shaft flat with pipe outlet			
<b>spare parts for</b>	101457			
	GEV No.	100259	Ref. No.	33T1180
	bypass nozzle type PEL22 bore ø 0.35mm thread M6x0.5			
	GEV No.	100908	Ref. No.	36Q1000
	union screw thread M10x1 for pipe ø 4mm Qty 1 pcs			
	GEV No.	101058	Ref. No.	32Z1460
	magnet unit L 39mm D1 ø 15.4mm D2 ø 13.5mm suitable for PEL22/EGA24197 standard			
	GEV No.	101200	Ref. No.	—
	gas tap front part shaft ø 10mm shaft L 25mm shaft flat suitable for 22S/O			
	GEV No.	101230	Ref. No.	—
	thermocouple nut T1: M8x1 T2: M18x1 aluminium			
	GEV No.	101241	Ref. No.	—
	gas connection thread M20x1.5 tube ø 12/10mm for PEL gas taps vertical			
	GEV No.	101246	Ref. No.	—
	olive for pipe ø 4mm Qty 1 pcs			
	GEV No.	101460	Ref. No.	—
	O-ring ø 12.37mm D1 ø 2.62mm suitable for PEL22			
	GEV No.	101461	Ref. No.	—
	screw kit suitable for PEL22 Qty 4 pcs			

accessories for		101457		
	GEV No.	100945	Ref. No.	—
	roll pin ø 3.2mm L 10mm			
	GEV No.	101218	Ref. No.	—
	shaft extension L 25mm JUNKERS			
	GEV No.	101219	Ref. No.	—
	shaft extension L 25mm JUNKERS			
	GEV No.	101231	Ref. No.	—
	thermocouple nut T1: M9x1 T2: M18x1			
	GEV No.	101248	Ref. No.	36Q0030
	olive for pipe ø 12mm Qty 1 pcs suitable for PEL			
	GEV No.	101249	Ref. No.	36Q1700
	olive for pipe ø 10mm Qty 1 pcs			
	GEV No.	101250	Ref. No.	36Q0610
	union nut thread M20x1.5 for pipe ø 10mm			
	GEV No.	101251	Ref. No.	36Q0050
	union nut thread M20x1.5 for pipe ø 12mm			
	GEV No.	101290	Ref. No.	—
	thermocouple nut T1: M10x1 T2: M18x1 suitable for PEL20/21			
	GEV No.	110064	Ref. No.	36M0660
	knob			
	GEV No.	110066	Ref. No.	—
	knob screw			
	GEV No.	550396	Ref. No.	—
	shaft extension L 25mm JUNKERS			

1		33D1990 33D1991		
<b>GEV No.</b>	101661	<b>Ref. No.</b>		
<b>description</b>	gas tap PEL type 22S/V gas inlet pipe flange ø21mm bypass nozzle ø 0.35mm gas outlet M20x1.5 (tube ø 12/10mm) thermocouple connection M8x1 pilot connection M10x1 shaft ø 10x8.5mm shaft L 28/13mm shaft flat upper			
<b>For models:</b>	06WCP1GM, 08WCP1GM, 08WGRGV, 090FAVA, 090GRG, 091CP1G, 0A0FAS, 0A0FAVA, 0A0GRG, 0A1CP1G, 0B0FAS, 0B1CP1G, 0D0FAS, 0D0FAVA, 0D0GRG, 0D1CP1G, 10WTPGE, 10WTPGV, 190FAB, 190GRG, 190TPO, 191CP1G, 191CP2G, 191FABG, 191PD2G, 191PI1G, 191PI1GA, 191PI2G, 191PI2GA, 191TPG, 1A0FA2, 1A0FA5, 1A0FAB, 1A0FAS, 1A0FAS2, 1A0GRG, 1A0TPO, 1A1CP1G, 1A1CP2G, 1A1FA2G, 1A1FA5G, 1A1FABG, 1A1FAS2G, 1A1FASG, 1A1PD1G, 1A1PD2G, 1A1PI1G, 1A1PI1GA, 1A1TPOG, 1A1TPOG-VERS.2002...(Other models you can see in the webshop)			
<b>spare parts for</b>	101661			
	GEV No.	100259	Ref. No.	33T1180
	bypass nozzle type PEL22 bore ø 0.35mm thread M6x0.5			

















Table continues overleaf



Зип Общежит

vsezip.ru

+7(812)987-08-81

spare parts for		101661	
	GEV No.	101058	Ref. No. 32Z1460
	magnet unit L 39mm D1 ø 15.4mm D2 ø 13.5mm suitable for PEL22/ EGA24197 standard		
	GEV No.	101203	Ref. No. —
	gas tap front part shaft ø 9x10mm shaft L 28/13mm shaft flat upper/lower suitable for PEL22		
	GEV No.	101230	Ref. No. —
	thermocouple nut T1: M8x1 T2: M18x1 aluminium		
	GEV No.	101237	Ref. No. —
	flange thread M20x1.5 tube ø 21mm suitable for PEL22		
	GEV No.	101241	Ref. No. —
	gas connection thread M20x1.5 tube ø 12/10mm for PEL gas taps vertical		
	GEV No.	101460	Ref. No. —
	O-ring ø 12.37mm D1 ø 2.62mm suitable for PEL22		
	GEV No.	101461	Ref. No. —
	screw kit suitable for PEL22 Qty 4 pcs		
	GEV No.	101536	Ref. No. —
	gasket D1 ø 17mm D2 ø 11.5mm thickness 4.7mm		
accessories for		101661	
	GEV No.	100908	Ref. No. 36Q1000
	union screw thread M10x1 for pipe ø 4mm Qty 1 pcs		
	GEV No.	100909	Ref. No. 36Q0060
	union screw thread M10x1 for pipe ø 6mm Qty 1 pcs		
	GEV No.	101246	Ref. No. —
	olive for pipe ø 4mm Qty 1 pcs		
	GEV No.	101248	Ref. No. 36Q0030
	olive for pipe ø 12mm Qty 1 pcs suitable for PEL		
	GEV No.	101249	Ref. No. 36Q1700
	olive for pipe ø 10mm Qty 1 pcs		
	GEV No.	101250	Ref. No. 36Q0610
	union nut thread M20x1.5 for pipe ø 10mm		
	GEV No.	101251	Ref. No. 36Q0050
	union nut thread M20x1.5 for pipe ø 12mm		
	GEV No.	101286	Ref. No. 36Q0020
	olive ID ø 6mm Qty 1 pcs		

235/O		33A1530	
	GEV No.	109107	Ref. No. 33A1530
	description gas tap PEL type 235/O gas inlet M28x1.5 (tube ø 20mm) bypass nozzle ø 0mm gas outlet M24x1.5 (tube ø 16mm) thermocouple connection M9x1 pilot connection M10x1 shaft ø 10x8mm shaft L 35/19mm shaft flat upper		
	For models: 191CP1GA, 1A1CP1GA, 1A1PI2G, 1A1PI2GA, 1D1CP1GA, 1D1PI2G, 1D1PI2GA, 291PD3G, 291PI3G, 2A1PD3G, 2A1PI3G, 2D1PI3G, MCF20, MCF40		

alternatives to JUNKERS









	GEV No.	101457	Ref. No. 33A0580
	description gas tap alternatives to JUNKERS type CH110 gas inlet M20x1.5 (tube ø 12mm) bypass nozzle ø 0.35mm gas outlet M20x1.5 (tube ø 12/10mm) thermocouple connection M8x1 pilot connection M10x1 shaft ø 10mm shaft L 25mm shaft flat with pipe outlet		
	spare parts for 101457		
	GEV No.	100259	Ref. No. 33T1180
	bypass nozzle type PEL22 bore ø 0.35mm thread M6x0.5		
	GEV No.	100908	Ref. No. 36Q1000
	union screw thread M10x1 for pipe ø 4mm Qty 1 pcs		
	GEV No.	101058	Ref. No. 32Z1460
	magnet unit L 39mm D1 ø 15.4mm D2 ø 13.5mm suitable for PEL22/ EGA24197 standard		
	GEV No.	101200	Ref. No. —
	gas tap front part shaft ø 10mm shaft L 25mm shaft flat suitable for 225/O		
	GEV No.	101230	Ref. No. —
	thermocouple nut T1: M8x1 T2: M18x1 aluminium		
	GEV No.	101241	Ref. No. —
	gas connection thread M20x1.5 tube ø 12/10mm for PEL gas taps vertical		
	GEV No.	101246	Ref. No. —
	olive for pipe ø 4mm Qty 1 pcs		
	GEV No.	101460	Ref. No. —
	O-ring ø 12.37mm D1 ø 2.62mm suitable for PEL22		
	GEV No.	101461	Ref. No. —
	screw kit suitable for PEL22 Qty 4 pcs		

Table continues overleaf

1 gas components



Зип Общепит

vsezip.ru

+7(812)987-08-81

accessories for		101457		
	GEV No.	100945	Ref. No.	—
	roll pin ø 3.2mm L 10mm			
	GEV No.	101218	Ref. No.	—
	shaft extension JUNKERS			
	GEV No.	101219	Ref. No.	—
	shaft extension L 25mm JUNKERS			
	GEV No.	101231	Ref. No.	—
	thermocouple nut T1: M9x1 T2: M18x1			
	GEV No.	101248	Ref. No.	36Q0030
	olive for pipe ø 12mm Qty 1 pcs suitable for PEL			
	GEV No.	101249	Ref. No.	36Q1700
	olive for pipe ø 10mm Qty 1 pcs			
	GEV No.	101250	Ref. No.	36Q0610
	union nut thread M20x1.5 for pipe ø 10mm			
	GEV No.	101251	Ref. No.	36Q0050
	union nut thread M20x1.5 for pipe ø 12mm			
	GEV No.	101290	Ref. No.	—
	thermocouple nut T1: M10x1 T2: M18x1 suitable for PEL20/21			
	GEV No.	110064	Ref. No.	36M0660
	knob			
	GEV No.	110066	Ref. No.	—
	knob screw			
	GEV No.	550396	Ref. No.	—
	shaft extension L 25mm JUNKERS			

	<b>GEV No.</b>	103310	<b>Ref. No.</b>	3041750
	<b>description</b>	gas thermostat type 630 Eurosit series 110-190°C		
	<b>For models:</b>	0G0FR5G, 0G1FR7G, 1G0FR6G, 1G1FR8G		



<b>GEV No.</b>	101413	<b>Ref. No.</b>	33A0491 6300478	
<b>description</b>	gas thermostat type 630 Eurosit series t.max. 100°C 30-100°C gas inlet 3/8" gas outlet 3/8" thermocouple connection M9x1 pilot connection M10x1 probe ø 5mm probe L 122mm capillary pipe 1050mm SIT			
<b>For models:</b>	0A0BMG, 0D0BMG, 1A0BMG, 1D0BMG			
<b>accessories for</b>	101413			
	GEV No.	100904	Ref. No.	—
	locking screw M10x1 for pipe ø 4mm Qty 1 pcs			
	GEV No.	100905	Ref. No.	—
	locking screw M10x1 for pipe ø 6mm Qty 1 pcs			
	GEV No.	101273	Ref. No.	—
	olive for pipe ø 12mm L 9.5mm brass Qty 1 pcs suitable for universal			
	GEV No.	101276	Ref. No.	36Q0710
	union screw thread 3/8" tube ø 12mm Qty 1 pcs			
	GEV No.	101333	Ref. No.	36R0010
	plug thread 3/8" with O-ring			

## gas thermostats

SIT

630 Eurosit series



<b>GEV No.</b>	107688	<b>Ref. No.</b>	3315970
<b>description</b>	gas thermostat 100-340°C gas inlet 3/8" gas outlet 3/8" thermocouple connection M9x1 pilot connection M10x1 probe ø 4mm probe L 72mm capillary pipe 1050mm		



Зип Общепит

vsezip.ru

+7(812)987-08-81



1

<b>GEV No.</b>	101915	<b>Ref. No.</b>	33A0941
<b>description</b>	gas thermostat type 630 Eurosit series t.max. 320°C 80-320°C gas inlet 3/8" gas outlet 3/8" thermocouple connection M9x1 pilot connection M10x1 probe ø 4mm probe L 72mm capillary pipe 1050mm SIT		
<b>For models:</b>	1A1FAS2G, 1A1FASG, 1A1TP0G, 1D1FAS2G, 1D1FASG, 1D1TP0G, 2A1FAS2G, 2A1FASG, 2A1TPSG, 2D1FAS2G, 2D1FASG, 2D1TPSG, 3A1FASG, 3D1FASG		
<b>accessories for</b>	101915		
	<b>GEV No.</b>	100825	<b>Ref. No.</b> 33Q3480
	gas tap spindle shaft ø 8x6.5mm shaft L 22/14mm suitable for EUROSIT		
	<b>GEV No.</b>	100904	<b>Ref. No.</b> —
	locking screw M10x1 for pipe ø 4mm Qty 1 pcs		
	<b>GEV No.</b>	100905	<b>Ref. No.</b> —
	locking screw M10x1 for pipe ø 6mm Qty 1 pcs		
	<b>GEV No.</b>	100949	<b>Ref. No.</b> 3152280
	gasket suitable for 630 Eurosit series		
	<b>GEV No.</b>	101273	<b>Ref. No.</b> —
	olive for pipe ø 12mm L 9.5mm brass Qty 1 pcs suitable for universal		
	<b>GEV No.</b>	101276	<b>Ref. No.</b> 36Q0710
	union screw thread 3/8" tube ø 12mm Qty 1 pcs		
	<b>GEV No.</b>	101333	<b>Ref. No.</b> 36R0010
	plug thread 3/8" with O-ring		
	<b>GEV No.</b>	101390	<b>Ref. No.</b> —
	gas tap spindle shaft ø 6x4.6mm shaft L 32/15mm gas tap with ignition flame suitable for ZANUSSI, MARENO for gas thermostat EUROSIT		
	<b>GEV No.</b>	101392	<b>Ref. No.</b> 33A0920
	adapter suitable for 630 Eurosit series		
	<b>GEV No.</b>	110357	<b>Ref. No.</b> —
	gas tap spindle shaft ø 8x6.5mm shaft L 36/12mm suitable for 630 Eurosit series		
	<b>GEV No.</b>	110358	<b>Ref. No.</b> —
	adapter shaft ø 10x8mm shaft L 29/18mm suitable for 630 Eurosit series		



1

<b>GEV No.</b>	106164	<b>Ref. No.</b>	3041720 6018970
<b>description</b>	gas thermostat type 630 Eurosit series t.max. 340°C 100-340°C gas inlet 3/8" gas outlet 3/8" thermocouple connection M9x1 pilot connection M10x1 probe ø 4mm probe L 72mm capillary pipe 1050mm pressure regulator 13-18mbar ambient temperature max. 0-120°C		
<b>For models:</b>	08WFA4G, 08WFAAG, 08WFT1GV, 08WFT2GV, 08WFT3GV, 08WFT-7GV, 090FT1G, 090FT2G, 090FT4G, 090FT5G, 090FT7G, 0G0FT1G-VERS.032008, 0G0FT2G-VERS.032008, 0G0FT7G, 0G1BR3G, 12WFA6G, 12WFAAG, 190FT15G, 190FT1G, 190FT2G, 190FT3G, 190FT42G, 190FT4G, 190FT6G, 190FT72G, 190FT7G, 191FAAG, 191FABG, 191FADG, 191FAG, 191TPG, 1A1FA1G, 1A1FA2G, 1A1FA4G, 1A1FA5G, 1A1FAAG, 1A1FABG, 1A1TP0G-VERS.2002, 1B1FAS2G, 1B1FASG, 1D1FA1G, 1D1FA2G, 1D1FA4G, 1D1FA5G, 1D1FAAG, 1D1FABG, 1D1TP0G-VERS.2002, 1G0FT1G-VERS.032008, 1G0FT2G-VERS.032008, 1G0FT3G-VERS.032008...(Other models you can see in the webshop)		
<b>accessories for</b>	106164		
	<b>GEV No.</b>	100904	<b>Ref. No.</b> —
	locking screw M10x1 for pipe ø 4mm Qty 1 pcs		
	<b>GEV No.</b>	100905	<b>Ref. No.</b> —
	locking screw M10x1 for pipe ø 6mm Qty 1 pcs		
	<b>GEV No.</b>	101273	<b>Ref. No.</b> —
	olive for pipe ø 12mm L 9.5mm brass Qty 1 pcs suitable for universal		
	<b>GEV No.</b>	101276	<b>Ref. No.</b> 36Q0710
	union screw thread 3/8" tube ø 12mm Qty 1 pcs		
	<b>GEV No.</b>	101333	<b>Ref. No.</b> 36R0010
	plug thread 3/8" with O-ring		

Зип Общепит

vsezip.ru

+7(812)987-08-81



<b>GEV No.</b>	101125	<b>Ref. No.</b>	33A0570 33A0571
<b>description</b>	gas thermostat type 630 Eurosit series t.max. 340°C 100-340°C gas inlet 3/8" gas outlet 3/8" thermocouple connection M9x1 pilot connection M10x1 probe ø 4mm probe L 72mm capillary pipe 1050mm SIT		
<b>For models:</b>	08WFAAG, 0G1BR3G, 12WFAAG, 1A1FA1G, 1A1FA2G, 1A1FA4G, 1A1FA5G, 1A1FAAG, 1A1FABG, 1A1TP0G-VERS.2002, 1B1FAS2G, 1B1FASG, 1D1FA1G, 1D1FA2G, 1D1FA4G, 1D1FA5G, 1D1FAAG, 1D1FABG, 1D1TP0G-VERS.2002, 1G1BR3G, 2A1FA1G, 2A1FA4G, 2A1FAAG, 2A1TP3G, 2A1TP6G, 2A1TPCG, 2D1FA1G, 2D1FA4G, 2D1FAAG, 2D1TP3G, 2D1TP6G, 2D1TPCG, 3A1FA1G, 3A1FA4G, 3A1FAAG, 3D1FA1G, 3D1FA4G, 3D1FAAG		
<b>accessories for</b>	101125		
	<b>GEV No.</b>	100825	<b>Ref. No.</b> 33Q3480
gas tap spindle shaft ø 8x6.5mm shaft L 22/14mm suitable for EUROSIT			
	<b>GEV No.</b>	100904	<b>Ref. No.</b> —
locking screw M10x1 for pipe ø 4mm Qty 1 pcs			
	<b>GEV No.</b>	100905	<b>Ref. No.</b> —
locking screw M10x1 for pipe ø 6mm Qty 1 pcs			
	<b>GEV No.</b>	100949	<b>Ref. No.</b> 3152280
gasket suitable for 630 Eurosit series			
	<b>GEV No.</b>	101273	<b>Ref. No.</b> —
olive for pipe ø 12mm L 9.5mm brass Qty 1 pcs suitable for universal			
	<b>GEV No.</b>	101276	<b>Ref. No.</b> 36Q0710
union screw thread 3/8" tube ø 12mm Qty 1 pcs			
	<b>GEV No.</b>	101333	<b>Ref. No.</b> 36R0010
plug thread 3/8" with O-ring			
	<b>GEV No.</b>	101390	<b>Ref. No.</b> —
gas tap spindle shaft ø 6x4.6mm shaft L 32/15mm gas tap with ignition flame suitable for ZANUSSI, MARENO for gas thermostat EUROSIT			
	<b>GEV No.</b>	101392	<b>Ref. No.</b> 33A0920
adapter suitable for 630 Eurosit series			
	<b>GEV No.</b>	110357	<b>Ref. No.</b> —
gas tap spindle shaft ø 8x6.5mm shaft L 36/12mm suitable for 630 Eurosit series			
	<b>GEV No.</b>	110358	<b>Ref. No.</b> —
adapter shaft ø 10x8mm shaft L 29/18mm suitable for 630 Eurosit series			



<b>GEV No.</b>	101971	<b>Ref. No.</b>	6300479
<b>description</b>	gas thermostat type 630 Eurosit series t.max. 340°C 100-340°C SIT		
<b>spare parts for</b>	101971		
	<b>GEV No.</b>	100825	<b>Ref. No.</b> 33Q3480
gas tap spindle shaft ø 8x6.5mm shaft L 22/14mm suitable for EUROSIT			
	<b>GEV No.</b>	101392	<b>Ref. No.</b> 33A0920
adapter suitable for 630 Eurosit series			
<b>accessories for</b>	101971		
	<b>GEV No.</b>	100825	<b>Ref. No.</b> 33Q3480
gas tap spindle shaft ø 8x6.5mm shaft L 22/14mm suitable for EUROSIT			
	<b>GEV No.</b>	100904	<b>Ref. No.</b> —
locking screw M10x1 for pipe ø 4mm Qty 1 pcs			
	<b>GEV No.</b>	100905	<b>Ref. No.</b> —
locking screw M10x1 for pipe ø 6mm Qty 1 pcs			
	<b>GEV No.</b>	100949	<b>Ref. No.</b> 3152280
gasket suitable for 630 Eurosit series			
	<b>GEV No.</b>	101273	<b>Ref. No.</b> —
olive for pipe ø 12mm L 9.5mm brass Qty 1 pcs suitable for universal			
	<b>GEV No.</b>	101276	<b>Ref. No.</b> 36Q0710
union screw thread 3/8" tube ø 12mm Qty 1 pcs			
	<b>GEV No.</b>	101333	<b>Ref. No.</b> 36R0010
plug thread 3/8" with O-ring			
	<b>GEV No.</b>	101390	<b>Ref. No.</b> —
gas tap spindle shaft ø 6x4.6mm shaft L 32/15mm gas tap with ignition flame suitable for ZANUSSI, MARENO for gas thermostat EUROSIT			
	<b>GEV No.</b>	101392	<b>Ref. No.</b> 33A0920
adapter suitable for 630 Eurosit series			
	<b>GEV No.</b>	110357	<b>Ref. No.</b> —
gas tap spindle shaft ø 8x6.5mm shaft L 36/12mm suitable for 630 Eurosit series			
	<b>GEV No.</b>	110358	<b>Ref. No.</b> —
adapter shaft ø 10x8mm shaft L 29/18mm suitable for 630 Eurosit series			





Зип-Общепит

vsezip.ru

+7(812)987-08-81



<b>GEV No.</b>	107846	<b>Ref. No.</b>	6300641
<b>description</b>	gas thermostat type EUROSIT 80-320°C gas inlet 3/8" gas outlet 3/8" thermocouple connection M9x1 pilot connection M10x1 probe L 72mm capillary pipe 980mm SIT		
<b>For models:</b>	1A1FAS2G, 1A1FASG, 1A1TP0G, 1D1FAS2G, 1D1FASG, 1D1TP0G, 2A1FAS2G, 2A1FASG, 2A1TPSG, 2D1FAS2G, 2D1FASG, 2D1TPSG, 3A1FASG, 3D1FASG		

<b>accessories for</b>	106241		
	<b>GEV No.</b>	101269	<b>Ref. No.</b> —
	<b>description</b>	gas connection thread 1/2" angled with O-ring MINISIT 710	
	<b>GEV No.</b>	101270	<b>Ref. No.</b> —
	<b>description</b>	screw connection IT 3/8" ET 3/8" L 28mm	
	<b>GEV No.</b>	101272	<b>Ref. No.</b> —
	<b>description</b>	screw connection IT 1/2" ET 3/8" L 57mm	
	<b>GEV No.</b>	101273	<b>Ref. No.</b> —
	<b>description</b>	olive for pipe ø 12mm L 9,5mm brass Qty 1 pcs suitable for universal	
	<b>GEV No.</b>	101274	<b>Ref. No.</b> —
	<b>description</b>	olive for pipe ø 16mm Qty 1 pcs	
	<b>GEV No.</b>	101275	<b>Ref. No.</b> —
	<b>description</b>	union screw thread 1/2" for pipe ø 16mm Qty 1 pcs	
	<b>GEV No.</b>	101276	<b>Ref. No.</b> 36Q0710
	<b>description</b>	union screw thread 3/8" tube ø 12mm Qty 1 pcs	
	<b>GEV No.</b>	110068	<b>Ref. No.</b> 36M0950
	<b>description</b>	knob suitable for Minisit ø 37mm	

### 710 Minisit series



<b>GEV No.</b>	106241	<b>Ref. No.</b>	6000380
<b>description</b>	gas thermostat SIT type MINISIT 710 t.max. 190°C 50-190°C pressure controller yes		
<b>spare parts for</b>	106241		
	<b>GEV No.</b>	101053	<b>Ref. No.</b> 32Z1490
	<b>description</b>	magnet unit T1: M9x1 T2: M24x1 L 45mm ø 17mm suitable for Minisit	
<b>accessories for</b>	106241		
	<b>GEV No.</b>	100809	<b>Ref. No.</b> —
	<b>description</b>	O-ring EPDM thickness 2mm ID ø 21mm Qty 1 pcs	
	<b>GEV No.</b>	100904	<b>Ref. No.</b> —
	<b>description</b>	locking screw M10x1 for pipe ø 4mm Qty 1 pcs	
	<b>GEV No.</b>	100905	<b>Ref. No.</b> —
	<b>description</b>	locking screw M10x1 for pipe ø 6mm Qty 1 pcs	
	<b>GEV No.</b>	101054	<b>Ref. No.</b> —
	<b>description</b>	magnet unit T1: M10x1 T2: M24x1 L 45mm ø 17mm suitable for Minisit	
	<b>GEV No.</b>	101136	<b>Ref. No.</b> —
	<b>description</b>	piezoelectric igniter suitable for Minisit with cover cap ømm connection F6.3x0.8	
	<b>GEV No.</b>	101137	<b>Ref. No.</b> —
	<b>description</b>	cover cap without piezoelectric igniter	
	<b>GEV No.</b>	101267	<b>Ref. No.</b> —
	<b>description</b>	reducer IT 3/8" ET 1/2" L 21mm	
	<b>GEV No.</b>	101268	<b>Ref. No.</b> —
	<b>description</b>	gas connection thread 3/8" angled with O-ring MINISIT 710	





<b>GEV No.</b>	106239	<b>Ref. No.</b>	33A1031
<b>description</b>	gas thermostat SIT type MINISIT 710 t.max. 340°C 100-340°C gas inlet 1/2" gas outlet 3/8" thermocouple connection M9x1 pilot connection M10x1 probe ø 4mm probe L 72mm capillary pipe 1050mm probe type type C1 pressure controller yes pressure regulator 3-18mbar gland nut		
<b>For models:</b>	031FT04, 031FT06, 070FT04, 070FT05, 071FT04, 071FT06, 090FT04, 090FT05, 091FT04, 091FT06, 1G1BR1G, 31R, 712D, 712VA, 71D, 71DGG, 71TP, 72D, 72DGG, 72TP, 72TPGG, 72VA, 72VAGG, 72VAS, 72VASGG, 73D, 73DGG, 73VA, 73VAD, 73VADGG, 73VAGG, FS30		
<b>spare parts for</b>	106239		
	<b>GEV No.</b>	101053	<b>Ref. No.</b> 32Z1490
	<b>description</b>	magnet unit T1: M9x1 T2: M24x1 L 45mm ø 17mm suitable for Minisit	
	<b>GEV No.</b>	102107	<b>Ref. No.</b> —
	<b>description</b>	probe 100-340°C probe ø 4mm probe L 72mm capillary pipe 1050mm t.max. 340°C oven/grill probe type type C1 suitable for MINISIT 710	
<b>accessories for</b>	106239		
	<b>GEV No.</b>	100809	<b>Ref. No.</b> —
	<b>description</b>	O-ring EPDM thickness 2mm ID ø 21mm Qty 1 pcs	
	<b>GEV No.</b>	100904	<b>Ref. No.</b> —
	<b>description</b>	locking screw M10x1 for pipe ø 4mm Qty 1 pcs	

Table continues overleaf

1 gas components

Зип-Общепит



vsezip.ru

+7(812)987-08-81

accessories for		106239	
	GEV No.	100905	Ref. No. —
locking screw M10x1 for pipe ø 6mm Qty 1 pcs			
	GEV No.	101137	Ref. No. —
cover cap without piezoelectric igniter			
	GEV No.	101267	Ref. No. —
reducer IT 3/8" ET 1/2" L 21mm			
	GEV No.	101268	Ref. No. —
gas connection thread 3/8" angled with O-ring MINISIT 710			
	GEV No.	101269	Ref. No. —
gas connection thread 1/2" angled with O-ring MINISIT 710			
	GEV No.	101270	Ref. No. —
screw connection IT 3/8" ET 3/8" L 28mm			
	GEV No.	101272	Ref. No. —
screw connection IT 1/2" ET 3/8" L 57mm			
	GEV No.	101273	Ref. No. —
olive for pipe ø 12mm L 9.5mm brass Qty 1 pcs suitable for universal			
	GEV No.	101274	Ref. No. —
olive for pipe ø 16mm Qty 1 pcs			
	GEV No.	101275	Ref. No. —
union screw thread 1/2" for pipe ø 16mm Qty 1 pcs			
	GEV No.	101276	Ref. No. 36Q0710
union screw thread 3/8" tube ø 12mm Qty 1 pcs			
	GEV No.	110068	Ref. No. 36M0950
knob suitable for Minisit ø 37mm			

accessories for		106240	
	GEV No.	100905	Ref. No. —
locking screw M10x1 for pipe ø 6mm Qty 1 pcs			
	GEV No.	101137	Ref. No. —
cover cap without piezoelectric igniter			
	GEV No.	101273	Ref. No. —
olive for pipe ø 12mm L 9.5mm brass Qty 1 pcs suitable for universal			
	GEV No.	101276	Ref. No. 36Q0710
union screw thread 3/8" tube ø 12mm Qty 1 pcs			
	GEV No.	101505	Ref. No. —
gas connection thread 3/8" angled without O-ring MINISIT 710			
	GEV No.	101516	Ref. No. —
flat-headed bolt thread M4 thread L 16mm SS DIN 7985/ISO 7045 Qty 1 pcs			
	GEV No.	110068	Ref. No. 36M0950
knob suitable for Minisit ø 37mm			

accessories for		106240	
	GEV No.	100904	Ref. No. —
locking screw M10x1 for pipe ø 4mm Qty 1 pcs			
	GEV No.	101267	Ref. No. —
reducer IT 3/8" ET 1/2" L 21mm			
	GEV No.	101268	Ref. No. —
gas connection thread 3/8" angled with O-ring MINISIT 710			
	GEV No.	101269	Ref. No. —
gas connection thread 1/2" angled with O-ring MINISIT 710			
	GEV No.	101270	Ref. No. —
screw connection IT 3/8" ET 3/8" L 28mm			
	GEV No.	101272	Ref. No. —
screw connection IT 1/2" ET 3/8" L 57mm			
	GEV No.	101273	Ref. No. —
olive for pipe ø 12mm L 9.5mm brass Qty 1 pcs suitable for universal			
	GEV No.	101274	Ref. No. —
olive for pipe ø 16mm Qty 1 pcs			
	GEV No.	101275	Ref. No. —
union screw thread 1/2" for pipe ø 16mm Qty 1 pcs			
	GEV No.	101276	Ref. No. 36Q0710
union screw thread 3/8" tube ø 12mm Qty 1 pcs			

			
1			
<b>GEV No.</b>	106240	<b>Ref. No.</b>	33A1910 6000370
<b>description</b>	gas thermostat SIT type MINISIT 710 t.max. 340°C 100-340°C pressure controller yes		
<b>For models:</b>	0M0FT1G, 0M0FT2G, 0M0FT4G, 0M0FT5G, 1M0FT1G, 1M0FT2G, 1M0FT3G, 1M0FT4G, 1M0FT5G, 1M0FT6G, 2M0FT1G, 2M0FT2G, 2M0FT3G, 2M0FT4G, 2M0FT5G, 2M0FT6G		
<b>spare parts for</b>	106240		
	GEV No.	100068	Ref. No. —
pilot burner 2 flames gas connection 6mm			
	GEV No.	100809	Ref. No. —
O-ring EPDM thickness 2mm ID ø 21mm Qty 1 pcs			



Зип-Общепит

vsezip.ru

+7(812)987-08-81



<b>GEV No.</b>	101910 <sup>1</sup>	<b>Ref. No.</b>	33A1130
<b>description</b>	gas thermostat SIT type MINISIT 710 t.max. 90°C 20-90°C gas inlet 1/2" gas outlet 3/8" thermocouple connection M9x1 pilot connection M10x1 probe ø 10.5mm probe L 19mm capillary pipe 1050mm probe type type F2 pressure controller yes pressure regulator 3-18mbar gland nut probe thread 1/4"		
<b>For models:</b>	070BM, 071BM, 090BM, 091BM		
<b>spare parts for</b>	101910		
	GEV No.	101053	Ref. No. 32Z1490
	magnet unit T1: M9x1 T2: M24x1 L 45mm ø 17mm suitable for Minisit		
	GEV No.	106223	Ref. No. —
	probe 20-90°C probe ø 11mm probe thread 1/4" probe L 19mm capillary pipe 1050mm t.max. 90°C bain marie probe type type F2		
<b>accessories for</b>	101910		
	GEV No.	100809	Ref. No. —
	O-ring EPDM thickness 2mm ID ø 21mm Qty 1 pcs		
	GEV No.	100904	Ref. No. —
	locking screw M10x1 for pipe ø 4mm Qty 1 pcs		
	GEV No.	100905	Ref. No. —
	locking screw M10x1 for pipe ø 6mm Qty 1 pcs		
	GEV No.	101054	Ref. No. —
	magnet unit T1: M10x1 T2: M24x1 L 45mm ø 17mm suitable for Minisit		
	GEV No.	101136	Ref. No. —
	piezoelectric igniter suitable for Minisit with cover cap ømm connection F6.3x0.8		
	GEV No.	101137	Ref. No. —
	cover cap without piezoelectric igniter		
	GEV No.	101267	Ref. No. —
	reducer IT 3/8" ET 1/2" L 21mm		
	GEV No.	101268	Ref. No. —
	gas connection thread 3/8" angled with O-ring MINISIT 710		
	GEV No.	101269	Ref. No. —
	gas connection thread 1/2" angled with O-ring MINISIT 710		
	GEV No.	101270	Ref. No. —
	screw connection IT 3/8" ET 3/8" L 28mm		
	GEV No.	101272	Ref. No. —
	screw connection IT 1/2" ET 3/8" L 57mm		
	GEV No.	101273	Ref. No. —
	olive for pipe ø 12mm L 9.5mm brass Qty 1 pcs suitable for universal		

<sup>1</sup>probe thread 1/4"

<b>accessories for</b>	101910		
	GEV No.	101274	Ref. No. —
	olive for pipe ø 16mm Qty 1 pcs		
	GEV No.	101275	Ref. No. —
	union screw thread 1/4" for pipe ø 16mm Qty 1 pcs		
	GEV No.	101276	Ref. No. 36Q0710
	union screw thread 3/8" tube ø 12mm Qty 1 pcs		
	GEV No.	110068	Ref. No. 36M0950
	knob suitable for Minisit ø 37mm		

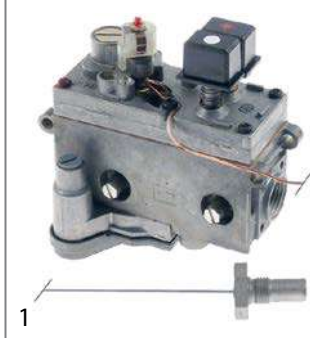

<b>GEV No.</b>	101114 <sup>1</sup>	<b>Ref. No.</b>	33A1370 6000480
<b>description</b>	gas thermostat with pressure controller SIT type MINISIT 710 t.max. 190°C 110-190°C gas inlet 1/2" gas outlet 3/8" thermocouple connection M9x1 pilot connection M10x1 probe ø 10.5mm probe L 26mm capillary pipe 1050mm probe type type F3 pressure controller yes pressure regulator 3-18mbar gland nut		
<b>For models:</b>	30F, 30FS, 70F, 71F		
<b>spare parts for</b>	101114		
	GEV No.	101053	Ref. No. 32Z1490
	magnet unit T1: M9x1 T2: M24x1 L 45mm ø 17mm suitable for Minisit		
	GEV No.	102104	Ref. No. —
	probe 110-190°C probe ø 11mm probe thread 1/4" probe L 26mm capillary pipe 1050mm t.max. 190°C fryer probe type type F3 suitable for MINISIT 710		
<b>accessories for</b>	101114		
	GEV No.	100809	Ref. No. —
	O-ring EPDM thickness 2mm ID ø 21mm Qty 1 pcs		
	GEV No.	100820	Ref. No. —
	gland duct ET M14x1.5 IT M10x0.75 probe ø max. 6.5mm WS 22		
	GEV No.	100904	Ref. No. —
	locking screw M10x1 for pipe ø 4mm Qty 1 pcs		
	GEV No.	100905	Ref. No. —
	locking screw M10x1 for pipe ø 6mm Qty 1 pcs		
	GEV No.	101054	Ref. No. —
	magnet unit T1: M10x1 T2: M24x1 L 45mm ø 17mm suitable for Minisit		
	GEV No.	101136	Ref. No. —
	piezoelectric igniter suitable for Minisit with cover cap ømm connection F6.3x0.8		
	GEV No.	101137	Ref. No. —
	cover cap without piezoelectric igniter		

<sup>1</sup>probe thread 1/4"  
Table continues overleaf

1 gas components

Зип-Общепит



vsezip.ru

+7(812)987-08-81

accessories for		101114	
	GEV No.	101267	Ref. No. —
reducer IT 3/8" ET 1/2" L 21mm			
	GEV No.	101268	Ref. No. —
gas connection thread 3/8" angled with O-ring MINISIT 710			
	GEV No.	101269	Ref. No. —
gas connection thread 1/2" angled with O-ring MINISIT 710			
	GEV No.	101270	Ref. No. —
screw connection IT 3/8" ET 3/8" L 28mm			
	GEV No.	101272	Ref. No. —
screw connection IT 1/2" ET 3/8" L 57mm			
	GEV No.	101273	Ref. No. —
olive for pipe ø 12mm L 9.5mm brass Qty 1 pcs suitable for universal			
	GEV No.	101274	Ref. No. —
olive for pipe ø 16mm Qty 1 pcs			
	GEV No.	101275	Ref. No. —
union screw thread 1/2" for pipe ø 16mm Qty 1 pcs			
	GEV No.	101276	Ref. No. 36Q0710
union screw thread 3/8" tube ø 12mm Qty 1 pcs			
	GEV No.	110068	Ref. No. 36M0950
knob suitable for Minisit ø 37mm			
	GEV No.	361182	Ref. No. 3117580
nut thread 1/4" H 5mm nickel-plated brass WS 17 Qty 1 pcs			
	GEV No.	532520	Ref. No. 3150390
O-ring silicone thickness 2.62mm ID ø 15.08mm Qty 1 pcs			



<b>GEV No.</b>	101432	<b>Ref. No.</b>	32Z0360 33A0800
<b>description</b>	gas thermostat with push button SIT type MINISIT 710 t.max. 90°C 30-90°C gas inlet 1/2" gas outlet 1/2" thermocouple connection M9x1 pilot connection M10x1 probe ø 8mm probe L 100mm capillary pipe 1050mm probe type type E2 pressure controller yes pressure regulator 3-18mbar gland nut		

spare parts for		101432	
	GEV No.	100809	Ref. No. —
O-ring EPDM thickness 2mm ID ø 21mm Qty 1 pcs			
	GEV No.	100905	Ref. No. —
locking screw M10x1 for pipe ø 6mm Qty 1 pcs			













spare parts for		101432	
	GEV No.	101053	Ref. No. 32Z1490
magnet unit T1: M9x1 T2: M24x1 L 45mm ø 17mm suitable for Minisit			
	GEV No.	101269	Ref. No. —
gas connection thread 1/2" angled with O-ring MINISIT 710			
	GEV No.	102117	Ref. No. —
probe 30-90°C probe ø 8mm probe L 100mm capillary pipe 1050mm t.max. 90°C bain marie probe type type E2 suitable for MINISIT 710			
	GEV No.	110068	Ref. No. 36M0950
knob suitable for Minisit ø 37mm			
accessories for		101432	
	GEV No.	100904	Ref. No. —
locking screw M10x1 for pipe ø 4mm Qty 1 pcs			
	GEV No.	101054	Ref. No. —
magnet unit T1: M10x1 T2: M24x1 L 45mm ø 17mm suitable for Minisit			
	GEV No.	101136	Ref. No. —
piezoelectric igniter suitable for Minisit with cover cap ømm connection F6.3x0.8			
	GEV No.	101137	Ref. No. —
cover cap without piezoelectric igniter			
	GEV No.	101267	Ref. No. —
reducer IT 3/8" ET 1/2" L 21mm			
	GEV No.	101268	Ref. No. —
gas connection thread 3/8" angled with O-ring MINISIT 710			
	GEV No.	101270	Ref. No. —
screw connection IT 3/8" ET 3/8" L 28mm			
	GEV No.	101272	Ref. No. —
screw connection IT 1/2" ET 3/8" L 57mm			
	GEV No.	101273	Ref. No. —
olive for pipe ø 12mm L 9.5mm brass Qty 1 pcs suitable for universal			
	GEV No.	101274	Ref. No. —
olive for pipe ø 16mm Qty 1 pcs			
	GEV No.	101275	Ref. No. —
union screw thread 1/2" for pipe ø 16mm Qty 1 pcs			
	GEV No.	101276	Ref. No. 36Q0710
union screw thread 3/8" tube ø 12mm Qty 1 pcs			







Зип-Общепит

vsezip.ru

+7(812)987-08-81

			
<b>GEV No.</b>	101131	<b>Ref. No.</b>	33A0300
<b>description</b>	gas thermostat without cap, button and angle SIT type MINISIT 710 t.max. 190°C 50-190°C gas inlet 1/2" gas outlet 3/8" thermocouple connection M9x1 pilot connection M10x1 probe ø 5mm probe L 98mm capillary pipe 1200mm probe type type A2 pressure controller no pressure regulator mbar gland nut		
<b>For models:</b>	B1101S, BF101L, BF101S, IS102S, IS102SR, IS102SR-0NR01, IS102SW, SM2L, SM2LW, SM2S, SM2SW, SM4SR, VS101L, XA72S, XS101L, XS101S, XS72S		
<b>spare parts for</b>	101131		
	<b>GEV No.</b>	101053	<b>Ref. No.</b> 32Z1490
	magnet unit T1: M9x1 T2: M24x1 L 45mm ø 17mm suitable for Minisit		
	<b>GEV No.</b>	102103	<b>Ref. No.</b> —
	probe 60-200°C probe ø 5mm probe L 98mm capillary pipe 1050mm t.max. 200°C fryer probe type type A2 suitable for MINISIT 710		
<b>accessories for</b>	101131		
	<b>GEV No.</b>	100809	<b>Ref. No.</b> —
	O-ring EPDM thickness 2mm ID ø 21mm Qty 1 pcs		
	<b>GEV No.</b>	100820	<b>Ref. No.</b> —
	gland duct ET M14x1.5 IT M10x0.75 probe ø max. 6.5mm WS 22		
	<b>GEV No.</b>	100904	<b>Ref. No.</b> —
	locking screw M10x1 for pipe ø 4mm Qty 1 pcs		
	<b>GEV No.</b>	100905	<b>Ref. No.</b> —
	locking screw M10x1 for pipe ø 6mm Qty 1 pcs		
	<b>GEV No.</b>	101054	<b>Ref. No.</b> —
	magnet unit T1: M10x1 T2: M24x1 L 45mm ø 17mm suitable for Minisit		
	<b>GEV No.</b>	101136	<b>Ref. No.</b> —
	piezoelectric igniter suitable for Minisit with cover cap ømm connection F6.3x0.8		
	<b>GEV No.</b>	101137	<b>Ref. No.</b> —
	cover cap without piezoelectric igniter		
	<b>GEV No.</b>	101267	<b>Ref. No.</b> —
	reducer IT 3/8" ET 1/2" L 21mm		
	<b>GEV No.</b>	101268	<b>Ref. No.</b> —
	gas connection thread 3/8" angled with O-ring MINISIT 710		
	<b>GEV No.</b>	101269	<b>Ref. No.</b> —
	gas connection thread 1/2" angled with O-ring MINISIT 710		
	<b>GEV No.</b>	101270	<b>Ref. No.</b> —
	screw connection IT 3/8" ET 3/8" L 28mm		
	<b>GEV No.</b>	101272	<b>Ref. No.</b> —
	screw connection IT 1/2" ET 3/8" L 57mm		

<b>accessories for</b>	101131		
	<b>GEV No.</b>	101273	<b>Ref. No.</b> —
	olive for pipe ø 12mm L 9.5mm brass Qty 1 pcs suitable for universal		
	<b>GEV No.</b>	101274	<b>Ref. No.</b> —
	olive for pipe ø 16mm Qty 1 pcs		
	<b>GEV No.</b>	101275	<b>Ref. No.</b> —
	union screw thread 1/2" for pipe ø 16mm Qty 1 pcs		
	<b>GEV No.</b>	101276	<b>Ref. No.</b> 36Q0710
	union screw thread 3/8" tube ø 12mm Qty 1 pcs		
	<b>GEV No.</b>	110068	<b>Ref. No.</b> 36M0950
	knob suitable for Minisit ø 37mm		

PEL

24ST series







			
<b>GEV No.</b>	106197	<b>Ref. No.</b>	33A1850
<b>description</b>	gas thermostat PEL type 24ST 120-280°C gas inlet pipe flange ø21mm bypass nozzle ø 0.35mm gas outlet M20x1.5 (tube ø 12/10mm) thermocouple connection M9x1 pilot connection M10x1 capillary pipe 1200mm probe ø 6mm probe L 120mm shaft ø 10x8mm shaft L 31/15mm shaft flat upper		
<b>For models:</b>	0A0FT4G, 0A0FT5G, 0B0FT1G, 0B0FT2G, 0B0FT4G, 0B0FT5G, 0D0FT4G, 0D0FT5G, 0G0FT4G, 0G0FT5G, 1A0FT4G, 1A0FT6G, 1B0FT4G, 1B0FT6G, 1D0FT4G, 1D0FT6G, 1G0FT4G, 1G0FT6G		
<b>spare parts for</b>	106197		
	<b>GEV No.</b>	100455	<b>Ref. No.</b> —
	bypass nozzle type PEL23/24 bore ø 0.35mm thread M8x0.5		
	<b>GEV No.</b>	101058	<b>Ref. No.</b> 32Z1460
	magnet unit L 39mm D1 ø 15.4mm D2 ø 13.5mm suitable for PEL22/ EGA24197 standard		
	<b>GEV No.</b>	106165	<b>Ref. No.</b> —
	gasket ø 27mm		
	<b>GEV No.</b>	106200	<b>Ref. No.</b> —
	nut thread M9x1 suitable for PEL 24/25S		
<b>accessories for</b>	106197		
	<b>GEV No.</b>	100908	<b>Ref. No.</b> 36Q1000
	union screw thread M10x1 for pipe ø 4mm Qty 1 pcs		
	<b>GEV No.</b>	100909	<b>Ref. No.</b> 36Q0060
	union screw thread M10x1 for pipe ø 6mm Qty 1 pcs		
	<b>GEV No.</b>	101246	<b>Ref. No.</b> —
	olive for pipe ø 4mm Qty 1 pcs		

Table continues overleaf

1 gas components

Зип-Общепит

vsezip.ru

+7(812)987-08-81

accessories for		106197		
GEV No.		Ref. No.		
	101248	36Q0030	olive for pipe ø 12mm Qty 1 pcs suitable for PEL	
	101249	36Q1700	olive for pipe ø 10mm Qty 1 pcs	
	101250	36Q0610	union nut thread M20x1.5 for pipe ø 10mm	
	101251	36Q0050	union nut thread M20x1.5 for pipe ø 12mm	
	101286	36Q0020	olive ID ø 6mm Qty 1 pcs	
	101331	—	adapter suitable for PEL22 for flanged cable 10/12mm	

accessories for		106198		
GEV No.		Ref. No.		
	101249	36Q1700	olive for pipe ø 10mm Qty 1 pcs	
	101250	36Q0610	union nut thread M20x1.5 for pipe ø 10mm	
	101251	36Q0050	union nut thread M20x1.5 for pipe ø 12mm	
	101286	36Q0020	olive ID ø 6mm Qty 1 pcs	
	101331	—	adapter suitable for PEL22 for flanged cable 10/12mm	









GEV No.	Ref. No.		
106198	33A1790	gas thermostat PEL type 24ST 140-340°C gas inlet pipe flange ø21mm bypass nozzle ø 0mm gas outlet M20x1.5 (tube ø 12/10mm) thermocouple connection M8x1 pilot connection M10x1 capillary pipe 1200mm probe ø 6mm probe L 100mm shaft ø 10x9mm shaft L 27/17mm shaft flat upper	
<b>For models:</b> 0A0FT1G, 0A0FT2G, 0D0FT1G, 0D0FT2G, 0G0FT1G, 0G0FT2G, 1A0FT1G, 1A0FT2G, 1A0FT3G, 1B0FT1G, 1B0FT2G, 1B0FT3G, 1D0FT1G, 1D0FT2G, 1D0FT3G, 1G0FT1G, 1G0FT2G, 1G0FT3G			
<b>spare parts for</b> 106198			
	100455	—	
	101058	32Z1460	
	101536	—	
	106199	—	
<b>accessories for</b> 106198			
	100908	36Q1000	
	100909	36Q0060	
	101246	—	
	101248	36Q0030	

GEV No.	Ref. No.		
101900	33A2840	gas thermostat PEL type 24ST up to 280°C gas inlet M20x1.5 (tube ø 12mm) bypass nozzle ø 0.8mm gas outlet M20x1.5 (tube ø 12/10mm) thermocouple connection M8x1 pilot connection M10x1 capillary pipe 1200mm probe ø 6mm probe L 120mm shaft ø 10x9mm shaft L 31/15mm shaft flat upper	
<b>For models:</b> 030FT, 030FTR, 031FT, 031FTR, 031FTRL, 31, 31TC, 31TP, 32, 32TC, 32TP, 32TPV, 32V			
<b>spare parts for</b> 101900			
	100497	33T4060	
	101058	32Z1460	
	106199	—	
<b>accessories for</b> 101900			
	100908	36Q1000	
	100909	36Q0060	
	101246	—	
	101248	36Q0030	
	101249	36Q1700	
	101250	36Q0610	
	101251	36Q0050	

Table continues overleaf



accessories for		101900		
	GEV No.	101286	Ref. No.	36Q0020
olive ID ø 6mm Qty 1 pcs				
	GEV No.	110079	Ref. No.	—
knob dial plate gas thermostat 1-8 silver				
	GEV No.	110080	Ref. No.	3FL1230
knob ø 70mm shaft ø 10x8mm shaft flat universal				

accessories for		101161		
	GEV No.	101461	Ref. No.	—
screw kit suitable for PEL22 Qty 4 pcs				
	GEV No.	110079	Ref. No.	—
knob dial plate gas thermostat 1-8 silver				
	GEV No.	110080	Ref. No.	3FL1230
knob ø 70mm shaft ø 10x8mm shaft flat universal				

24STS series

				
<b>GEV No.</b>	101161	<b>Ref. No.</b>	33A0060 6003911	
<b>description</b>	gas thermostat PEL type 24STS 120-320°C gas inlet M20x1.5 (tube ø 12/10mm) bypass nozzle ø 0.35mm gas outlet M20x1.5 (tube ø 12/10mm) thermocouple connection M9x1 pilot connection M10x1 capillary pipe 1200mm probe ø 6mm probe L 100mm shaft ø 10x8mm shaft L 27/17mm shaft flat upper			
<b>spare parts for</b>	101161			
	GEV No.	101058	Ref. No.	32Z1460
magnet unit L 39mm D1 ø 15.4mm D2 ø 13.5mm suitable for PEL22/EGA24197 standard				
<b>accessories for</b>	101161			
	GEV No.	101235	Ref. No.	—
gas connection thread M20x1.5 tube ø 12/10mm for PEL gas taps horizontal				
	GEV No.	101236	Ref. No.	—
gas connection thread M20x1.5 tube ø 12/10mm for PEL gas taps vertical				
	GEV No.	101240	Ref. No.	—
gas connection thread M20x1.5 tube ø 12/10mm for PEL gas taps with gasket and screws horizontal				
	GEV No.	101241	Ref. No.	—
gas connection thread M20x1.5 tube ø 12/10mm for PEL gas taps vertical				
	GEV No.	101248	Ref. No.	36Q0030
olive for pipe ø 12mm Qty 1 pcs suitable for PEL				
	GEV No.	101249	Ref. No.	36Q1700
olive for pipe ø 10mm Qty 1 pcs				
	GEV No.	101250	Ref. No.	36Q0610
union nut thread M20x1.5 for pipe ø 10mm				
	GEV No.	101251	Ref. No.	36Q0050
union nut thread M20x1.5 for pipe ø 12mm				
	GEV No.	101365	Ref. No.	—
gas connection thread M20x1.5 tube ø 12mm for PEL gas taps horizontal				
	GEV No.	101460	Ref. No.	—
O-ring ø 12.37mm D1 ø 2.62mm suitable for PEL22				



25ST series

				
<b>GEV No.</b>	101565	<b>Ref. No.</b>	33A0660	
<b>description</b>	gas thermostat PEL type 25ST up to 280°C gas inlet pipe flange ø 21mm bypass nozzle ø 0mm gas outlet M16x1.5 (tube ø 10/8mm) thermocouple connection M9x1 pilot connection M10x1 capillary pipe 1200mm probe ø 6mm probe L 122mm shaft ø 8x6.5mm shaft L 21/15mm shaft flat upper pipe input ø 9mm			
<b>For models:</b>	1G1FA0G, 1G1FA0GV, 1G1FABG, 1G1FAPG, 1G1TP0G, 2G1FA0G, 2G1FA0GV, 2G1FABG, 2G1FACG, 2G1FADG, 2G1FADGV, 2G1FAPG, 2G1TP3G, G1FAGS, G1FAGST			

gas valves and ignition boxes

gas control valves

HONEYWELL

				
<b>GEV No.</b>	106004	<b>Ref. No.</b>	32V5810	
<b>description</b>	gas valve type VK4105C 220-240V 50/60Hz gas inlet flange 32x32mm gas outlet flange 32x32mm thermocouple connection pilot connection pressure range 15-60mbar max 60mbar operator type pressure controller type V5306E 1234 1 suitable for HONEYWELL flange 32x32mm			
<b>For models:</b>	FCV61DS-CSA			
<b>accessories for</b>	106004			
	GEV No.	102845	Ref. No.	—
gas connection angled 1/2" flange 32x32mm hole distance 24x24mm Tandem				
	GEV No.	102846	Ref. No.	—
gas connection straight 1/2" flange 32x32mm hole distance 24x24mm suitable for Tandem				



SIT

ELETTROSIT



1

<b>GEV No.</b>	101993	<b>Ref. No.</b>	33A0590
<b>description</b>	gas valve SIT type ELETTROSIT 230V gas inlet 1/2" gas outlet 1/2" thermocouple connection M9x1 pilot connection M10x1 lateral equiv. no. 0.810.126		
<b>For models:</b>	30F1, 30F1B, 30FS2, 30FS2B, 70F1, 70F1B, 71AR, 71F2, 71F2B, 71RA, 90F110B, 91AR, 91F210, 91F210B, 91F223B, 91RA, FC101, FC61, FCV101, FCV101DM, FCV101DS, FCV241GDM, FCV241GDS, FCV401DM, FCV61, FCV61DM, FCV61DS		
<b>spare parts for</b>	101993		
	<b>GEV No.</b>	101312	<b>Ref. No.</b> 33A0020
microswitch			
	<b>GEV No.</b>	101352	<b>Ref. No.</b> —
solenoid coil 230V 50Hz suitable for ELETTROSIT			
<b>accessories for</b>	101993		
	<b>GEV No.</b>	100006	<b>Ref. No.</b> —
piezoelectric igniter suitable for ELETTROSIT body plastic blowing connection ø2.4mm ø 14mm			
	<b>GEV No.</b>	100904	<b>Ref. No.</b> —
locking screw M10x1 for pipe ø 4mm Qty 1 pcs			
	<b>GEV No.</b>	100905	<b>Ref. No.</b> —
locking screw M10x1 for pipe ø 6mm Qty 1 pcs			
	<b>GEV No.</b>	101301	<b>Ref. No.</b> —
gas connection thread 1/2" straight ELETTROSIT screw with O-ring			
	<b>GEV No.</b>	101303	<b>Ref. No.</b> —
gas connection straight thread 3/4" ELETTROSIT			
	<b>GEV No.</b>	101309	<b>Ref. No.</b> —
extension			
	<b>GEV No.</b>	103104	<b>Ref. No.</b> —
ignition switch			
	<b>GEV No.</b>	541504	<b>Ref. No.</b> 33Q5880
double nipple thread 1/2" - 1/2"			

Зип Общепит

vsezip.ru

+7(812)987-08-81



1

<b>GEV No.</b>	101127	<b>Ref. No.</b>	33A0530
<b>description</b>	gas valve SIT type ELETTROSIT 230V gas inlet 3/4" gas outlet 3/4" thermocouple connection M9x1 pilot connection M10x1 lateral equiv. no. 0.810.175		
<b>For models:</b>	FC241, FC241G, FCV141, FCV141DM, FCV141DS, FCV241, FCV241DM, FCV241DS, FCV241G		
<b>spare parts for</b>	101127		
	<b>GEV No.</b>	101312	<b>Ref. No.</b> 33A0020
microswitch			
	<b>GEV No.</b>	101352	<b>Ref. No.</b> —
solenoid coil 230V 50Hz suitable for ELETTROSIT			
<b>accessories for</b>	101127		
	<b>GEV No.</b>	100006	<b>Ref. No.</b> —
piezoelectric igniter suitable for ELETTROSIT body plastic blowing connection ø2.4mm ø 14mm			
	<b>GEV No.</b>	100904	<b>Ref. No.</b> —
locking screw M10x1 for pipe ø 4mm Qty 1 pcs			
	<b>GEV No.</b>	100905	<b>Ref. No.</b> —
locking screw M10x1 for pipe ø 6mm Qty 1 pcs			
	<b>GEV No.</b>	101301	<b>Ref. No.</b> —
gas connection thread 1/2" straight ELETTROSIT screw with O-ring			
	<b>GEV No.</b>	101303	<b>Ref. No.</b> —
gas connection straight thread 3/4" ELETTROSIT			
	<b>GEV No.</b>	101309	<b>Ref. No.</b> —
extension			





Зип-Общепит

vsezip.ru



+7(812)987-08-81

NOVASIT



1

<b>GEV No.</b>	101760	<b>Ref. No.</b>	33A1640
<b>description</b>	gas valve SIT series Novasit 820 220V 50Hz gas inlet 1/2" gas outlet 1/2" thermocouple connection M9x1 pilot connection M10x1 ignition pressure 3-5mbar pressure range 3-30mbar pressure regulator connection blind equiv. no. 0.820.060		
<b>For models:</b>	091FR1G, 091FR3G, 191FR2GD, 191FR4GD		
<b>spare parts for</b>	101760		
	<b>GEV No.</b>	101065	<b>Ref. No.</b> —
	magnet unit with cable L 44mm D1 ø 30mm D2 ø 20mm suitable for NOVASIT		
	<b>GEV No.</b>	101867	<b>Ref. No.</b> —
	solenoid coil 220V 60Hz		
<b>accessories for</b>	101760		
	<b>GEV No.</b>	100006	<b>Ref. No.</b> —
	piezoelectric igniter suitable for ELETTROSIT body plastic blowing connection ø2.4mm ø 14mm		
	<b>GEV No.</b>	100904	<b>Ref. No.</b> —
	locking screw M10x1 for pipe ø 4mm Qty 1 pcs		
	<b>GEV No.</b>	100905	<b>Ref. No.</b> —
	locking screw M10x1 for pipe ø 6mm Qty 1 pcs		
	<b>GEV No.</b>	101305	<b>Ref. No.</b> —
	gas connection straight 1/2" flange 45x45mm ELETTROSIT/V4400/4600/4605 suitable for SIT/HONEYWELL hole distance 36x36mm		
	<b>GEV No.</b>	101306	<b>Ref. No.</b> —
	gas connection angled flange 45x45mm hole distance 36x36mm 1/2" ELETTROSIT/V4400/4600/4605 screw with O-ring suitable for SIT/HONEYWELL		
	<b>GEV No.</b>	101307	<b>Ref. No.</b> —
	gas connection straight flange 45x45mm hole distance 36x36mm 3/4" ELETTROSIT/V4400/4600/4605 screw with O-ring suitable for SIT/HONEYWELL		
	<b>GEV No.</b>	101308	<b>Ref. No.</b> —
	gas connection angled flange 45x45mm hole distance 36x36mm 3/4" ELETTROSIT/V4400/4600/4605 screw with O-ring suitable for SIT/HONEYWELL		
	<b>GEV No.</b>	101312	<b>Ref. No.</b> 33A0020
	microswitch		
	<b>GEV No.</b>	101313	<b>Ref. No.</b> —
	solenoid coil 230V 50Hz		
	<b>GEV No.</b>	101314	<b>Ref. No.</b> —
	solenoid coil 24V 50Hz		
	<b>GEV No.</b>	101317	<b>Ref. No.</b> —
	plug with cable L 1000mm suitable for NOVASIT		

<b>accessories for</b>	101760		
	<b>GEV No.</b>	101318	<b>Ref. No.</b> —
	cover cap for solenoid coil suitable for NOVASIT		
	<b>GEV No.</b>	101503	<b>Ref. No.</b> —
	O-ring EPDM thickness 2mm ID ø 32mm Qty 1 pcs		



1









<b>GEV No.</b>	101162	<b>Ref. No.</b>	33A0460
<b>description</b>	gas valve SIT series Novasit 820 230V 50Hz gas inlet 1/2" gas outlet 1/2" thermocouple connection M9x1 pilot connection M10x1 ignition pressure 3-5mbar pressure range 3-30mbar pressure regulator connection blind equiv. no. 0.820.010		
<b>For models:</b>	06WFR3GD, 091FR1G, 091FR1GD, 091FR3G, 091FR3GD, 0A1FR1G, 0A1FR1GD, 0A1FR1GD-VERS.2004, 0A1FR1G-VERS.2004, 0A1FR3G, 0A1FR3GD, 0B1FR1G, 0B1FR1GD, 0D1FR1G, 0D1FR1GD, 0D1FR1GD-VERS.2004, 0D1FR1G-VERS.2004, 0D1FR3G, 0D1FR3GD, 0G1FR3G, 0G1FR3GD, 10WFR4GD, 191FR2G, 191FR2GD, 191FR4G, 191FR4GD, 1A1FR2G, 1A1FR2GD, 1A1FR2GD-VERS.2004, 1A1FR2G-VERS.2004, 1A1FR4G, 1A1FR4GD, 1D1FR2G, 1D1FR2GD, 1D1FR2GD-VERS.2004, 1D1FR2G-VERS.2004, 1D1FR4G, 1D1FR4GD, 1G1FR4G, 1G1FR4GD, FC101, FC241G, FC61, FCV101, FCV101DM, FCV101DS, FCV141, FCV141DM, FCV141DS, FCV241G...(Other models you can see in the webshop)		
<b>spare parts for</b>	101162		
	<b>GEV No.</b>	101065	<b>Ref. No.</b> —
	magnet unit with cable L 44mm D1 ø 30mm D2 ø 20mm suitable for NOVASIT		
	<b>GEV No.</b>	101313	<b>Ref. No.</b> —
	solenoid coil 230V 50Hz		
<b>accessories for</b>	101162		
	<b>GEV No.</b>	100006	<b>Ref. No.</b> —
	piezoelectric igniter suitable for ELETTROSIT body plastic blowing connection ø2.4mm ø 14mm		
	<b>GEV No.</b>	101305	<b>Ref. No.</b> —
	gas connection straight 1/2" flange 45x45mm ELETTROSIT/V4400/4600/4605 suitable for SIT/HONEYWELL hole distance 36x36mm		
	<b>GEV No.</b>	101306	<b>Ref. No.</b> —
	gas connection angled flange 45x45mm hole distance 36x36mm 1/2" ELETTROSIT/V4400/4600/4605 screw with O-ring suitable for SIT/HONEYWELL		
	<b>GEV No.</b>	101307	<b>Ref. No.</b> —
	gas connection straight flange 45x45mm hole distance 36x36mm 3/4" ELETTROSIT/V4400/4600/4605 screw with O-ring suitable for SIT/HONEYWELL		
	<b>GEV No.</b>	101308	<b>Ref. No.</b> —
	gas connection angled flange 45x45mm hole distance 36x36mm 3/4" ELETTROSIT/V4400/4600/4605 screw with O-ring suitable for SIT/HONEYWELL		
	<b>GEV No.</b>	101312	<b>Ref. No.</b> 33A0020
	microswitch		



Table continues overleaf





1 gas components

Зип-Общепит

vsezip.ru

+7(812)987-08-81

accessories for		101162	
GEV No.	101314	Ref. No.	—
	solenoid coil 24V 50Hz		
GEV No.	101317	Ref. No.	—
	plug with cable L 1000mm suitable for NOVASIT		
GEV No.	101318	Ref. No.	—
	cover cap for solenoid coil suitable for NOVASIT		

accessories for		101688	
GEV No.	101312	Ref. No.	33A0020
	microswitch		
GEV No.	101314	Ref. No.	—
	solenoid coil 24V 50Hz		
GEV No.	101317	Ref. No.	—
	plug with cable L 1000mm suitable for NOVASIT		
GEV No.	101318	Ref. No.	—
	cover cap for solenoid coil suitable for NOVASIT		
GEV No.	101503	Ref. No.	—
	O-ring EPDM thickness 2mm ID ø 32mm Qty 1 pcs		



GEV No.	101688	Ref. No.	33A0930
<b>description</b>	gas valve SIT series Novasit 824 230V 50Hz gas inlet 1/2" gas outlet 1/2" thermocouple connection M9x1 pilot connection M10x1 ignition pressurembar pressure range 2-50mbar pressure regulator connection equiv. no. 0.824.011		
<b>For models:</b>	191BR1G, 191BR1GA, 191BR2G, 191BR2GA, 1A1BR1G, 1A1BR1GA, 1A1BR2G, 1A1BR2GA, 1D1BR1G, 1D1BR1GA, 1D1BR2G, 1D1BR2GA, 291BR1G, 291BR1GA, 291BR2G, 291BR2GA, 2A1BR1G, 2A1BR1GA, 2A1BR2G, 2A1BR2GA, 2D1BR1G, 2D1BR1GA, 2D1BR2G, 2D1BR2GA		
<b>spare parts for</b>	101688		
GEV No.	101065	Ref. No.	—
	magnet unit with cable L 44mm D1 ø 30mm D2 ø 20mm suitable for NOVASIT		
GEV No.	101313	Ref. No.	—
	solenoid coil 230V 50Hz		
<b>accessories for</b>	101688		
GEV No.	100006	Ref. No.	—
	piezoelectric igniter suitable for ELETTROSIT body plastic blowing connection ø2.4mm ø 14mm		
GEV No.	100904	Ref. No.	—
	locking screw M10x1 for pipe ø 4mm Qty 1 pcs		
GEV No.	100905	Ref. No.	—
	locking screw M10x1 for pipe ø 6mm Qty 1 pcs		
GEV No.	101305	Ref. No.	—
	gas connection straight 1/2" flange 45x45mm ELETTROSIT/V4400/4600/4605 suitable for SIT/HONEYWELL hole distance 36x36mm		
GEV No.	101306	Ref. No.	—
	gas connection angled flange 45x45mm hole distance 36x36mm 1/2" ELETTROSIT/V4400/4600/4605 screw with O-ring suitable for SIT/HONEYWELL		
GEV No.	101307	Ref. No.	—
	gas connection straight flange 45x45mm hole distance 36x36mm 3/4" ELETTROSIT/V4400/4600/4605 screw with O-ring suitable for SIT/HONEYWELL		
GEV No.	101308	Ref. No.	—
	gas connection angled flange 45x45mm hole distance 36x36mm 3/4" ELETTROSIT/V4400/4600/4605 screw with O-ring suitable for SIT/HONEYWELL		

SIGMA



GEV No.	107893	Ref. No.	3041070
<b>description</b>	gas valve type 0840028 220V 60Hz gas inlet 3/4" gas outlet 3/4" pressure range 2-50mbar		
<b>For models:</b>	091FR11, 091FR11A, 091FR11D, 091FR11D-VERS.052012, 091FR11-VERS.032012, 091FR7G, 091FR7GS, 091FR7G-VERS.052012, 091FR7GX, 191FR21, 191FR21D, 191FR21D-VERS.092012, 191FR21-VERS.032012, FC1011G, FC1221G, FC611G, FM1011G1, FM1011G1-VERS.2006, FM1011G2, FM1011G2-VERS.2006, FM1011G3, FM1011G3-VERS.2006, FM2011G2-VERS.2006, FM2011G3-VERS.2006, FM2021G1, FM2021G2, FM2021G2-VERS.2006, FM2021G3, FM2021G3-VERS.2006, FM611G1, FM611G1-VERS.2006, FM611G2, FM611G2-VERS.2006, FM611G3, FM611G3-VERS.2006, FM721G1, FM721G1-VERS.2006, FM721G2, FM721G2-VERS.2006, FM721G3, FM721G3-VERS.2006		



Зип Общепит

vsezip.ru

+7(812)987-08-81





1

<b>GEV No.</b>	107894	<b>Ref. No.</b>	6300749
<b>description</b>	gas valve type 0848083 230V 50Hz gas inlet 3/4" gas outlet 3/4" pressure range 0.5-12mbar incl reducer 1/2" - 3/4"		
<b>For models:</b>	BX101G, BX101G-VERS.122013, BX122G, BX122G-VERS.122013, BX61G, BX61G-VERS.122013, BX82G, BX82G-VERS.122013, FX101G1, FX101G1R, FX101G2, FX101G2C, FX101G2C-VERS.032014, FX101G2R, FX101G2R-VERS.032014, FX101G2-VERS.032014, FX101G3, FX101G3C, FX101G3C-VERS.022014, FX101G3R, FX101G3R-VERS.022014, FX101G3-VERS.022014, FX10G2CR, FX10G2CR-VERS.032014, FX10G3CR, FX10G3CR-VERS.022014, FX122G1, FX122G2, FX122G2C, FX122G2T, FX122G2T-VERS.032014, FX122G3, FX122G3C, FX122G3T, FX122G3T-VERS.022014, FX12G3CT, FX12G3CT-VERS.022014, FX201G2, FX201G2P, FX201G2P-VERS.032014, FX201G2-VERS.032014, FX201G3P, FX201G3-VERS.022014, FX202G2, FX202G2-VERS.032014, FX202G3, FX202G3-VERS.022014, FX61G1, FX61G1R, FX61G2...(Other models you can see in the webshop)		





1

<b>GEV No.</b>	107241	<b>Ref. No.</b>	32V5800
<b>description</b>	gas valve type Sigma 230V 50Hz gas inlet 3/4" gas outlet 3/4" pressure range 2-50mbar		
<b>For models:</b>	FC1011G, FC611G, FM1011G1, FM1011G1-VERS.2006, FM1011G2, FM1011G2-VERS.2006, FM1011G3, FM1011G3-VERS.2006, FM2011G2, FM2011G2-VERS.2006, FM2011G3-VERS.2006, FM2021G1, FM2021G2, FM2021G2-VERS.2006, FM2021G3, FM2021G3-VERS.2006, FM611G1, FM611G1-VERS.2006, FM611G2, FM611G2-VERS.2006, FM611G3, FM611G3-VERS.2006, FM721G1, FM721G1-VERS.2006, FM721G2, FM721G2-VERS.2006, FM721G3, FM721G3-VERS.2006		
<b>spare parts for</b>	107241		
	<b>GEV No.</b>	106214	<b>Ref. No.</b> 3188170
	solenoid coil 230V 50Hz Sigma		
<b>accessories for</b>	107241		
	<b>GEV No.</b>	107222	<b>Ref. No.</b> —
	plug for solenoid valve 3-pole cable length 1070mm		



2

<b>GEV No.</b>	107547	<b>Ref. No.</b>	3011580
<b>description</b>	gas valve type Sigma 230V 50Hz gas inlet 3/4" ET gas outlet 3/4" ET pressure range 2-50mbar equiv. no. 0063AS4831		
<b>For models:</b>	091FR1I, 091FR1IA, 091FR1ID, 091FR1ID-VERS.052012, 091FR1I-VERS.032012, 091FR7G, 091FR7G, 091FR7G, 091FR7G-VERS.052012, 091FR7GX, 191FR2I, 191FR2ID, 191FR2ID-VERS.092012, 191FR2I-VERS.032012, FC1221G, FM1221G1, FM1221G1-VERS.2006, FM1221G2, FM1221G2-VERS.2006, FM1221G3, FM1221G3-VERS.2006		
<b>spare parts for</b>	107547		
	<b>GEV No.</b>	106214	<b>Ref. No.</b> 3188170
	solenoid coil 230V 50Hz Sigma		
<b>accessories for</b>	107547		
	<b>GEV No.</b>	107222	<b>Ref. No.</b> —
	plug for solenoid valve 3-pole cable length 1070mm		

ignition boxes

BRAHMA



1

<b>GEV No.</b>	107545	<b>Ref. No.</b>	3128260
<b>description</b>	ignition box BRAHMA type ECM113 electrodes 3 waiting time 1.5s safety time 3s 100-240V 15VA 50-60Hz		
<b>For models:</b>	091FR1I, 091FR1IA, 091FR1ID, 091FR1ID-VERS.052012, 091FR1I-VERS.032012, 091FR7G, 091FR7G, 091FR7G, 091FR7G-VERS.052012, 091FR7GX, 10CP11A, 12CP11A, 18CP21A, 191FR2I, 191FR2ID, 191FR2ID-VERS.092012, 191FR2I-VERS.032012		

miscellaneous



<b>GEV No.</b>	103221	<b>Ref. No.</b>	32V5850 32V5851
<b>description</b>	ignition box RV CONSTRUCTIONS ELECTRIQUES type 0526 waiting time 7s safety time 10s 230V 50/60Hz		
<b>For models:</b>	FC1011G, FC1221G, FC611G, FM1011G1, FM1011G1-VERS.2006, FM1011G2, FM1011G2-VERS.2006, FM1011G3, FM1011G3-VERS.2006, FM1221G1, FM1221G1-VERS.2006, FM1221G2, FM1221G2-VERS.2006, FM1221G3, FM1221G3-VERS.2006, FM2011G2-VERS.2006, FM2011G3-VERS.2006, FM2021G1, FM2021G2, FM2021G2-VERS.2006, FM2021G3, FM2021G3-VERS.2006, FM611G1, FM611G1-VERS.2006, FM611G2, FM611G2-VERS.2006, FM611G3, FM611G3-VERS.2006, FM721G1, FM721G1-VERS.2006, FM721G2, FM721G2-VERS.2006, FM721G3, FM721G3-VERS.2006		

safety valves

SIT

440 series



<b>GEV No.</b>	101101	<b>Ref. No.</b>	33A0430	
<b>description</b>	gas valve pressure range 50mbar gas inlet 3/4" gas outlet 3/4" pilot connection M10x1 (tube ø 6mm) thermocouple connection M9x1 type SIT D3			
<b>accessories for</b>	101101			
	<b>GEV No.</b>	100904	<b>Ref. No.</b>	—
	locking screw M10x1 for pipe ø 4mm Qty 1 pcs			
	<b>GEV No.</b>	100905	<b>Ref. No.</b>	—
	locking screw M10x1 for pipe ø 6mm Qty 1 pcs			

Зип-Общепит

gas solenoid valves

BRAHMA vsezip.ru



<b>GEV No.</b>	101948 <sup>1</sup>	<b>Ref. No.</b>	33A1650	
<b>description</b>	solenoid valve 230VAC DN 15mm connection 1/2" L 72mm BRAHMA coil type 18811003 p max 0.5bar reg. no. 63AQ0626			
<b>For models:</b>	1A1PI2G, 1A1PI2GA, 1D1PI2G, 1D1PI2GA, 291PI3G, 2A1PI3G, 2D1PI3G			
<b>spare parts for</b>	101948			
	<b>GEV No.</b>	101968	<b>Ref. No.</b>	—
	solenoid valve 230VAC 20VA seat ø 17mm coil type 13902001 BRAHMA			

<sup>1</sup>aluminium housing

ignition parts

pilot burners

SIT

100 series



<b>GEV No.</b>	106905	<b>Ref. No.</b>	33A0410 6000290	
<b>description</b>	pilot burner SIT type 100 series 2 flames nozzle ø 0.2mm gas connection 6mm			
<b>spare parts for</b>	106905			
	<b>GEV No.</b>	100245	<b>Ref. No.</b>	—
	pilot burner nozzle LPG code 20 bore ø 0.2mm Qty 1 pcs thread M8x0.75			
	<b>GEV No.</b>	100855	<b>Ref. No.</b>	33S0950
	pilot burner bracket triple			
	<b>GEV No.</b>	100885	<b>Ref. No.</b>	33A0970
	air mixing sleeve for pilot burner Qty 1 pcs			
	<b>GEV No.</b>	100916	<b>Ref. No.</b>	—
	compression spring for pilot burner Qty 1 pcs			
	<b>GEV No.</b>	100917	<b>Ref. No.</b>	—
	gasket for pilot burner Qty 1 pcs aluminium			











Table continues overleaf















Зип-Общепит

vsezip.ru

+7(812)987-08-81

spare parts for		106905	
	GEV No.	100918	Ref. No. —
screw for pilot burner			
	GEV No.	107161	Ref. No. —
pilot burner cap SIT 2 flames Hmm Lmm Qty 1 pcs			
	GEV No.	107701	Ref. No. —
pilot burner bottom part SIT 100 series nozzle 0.2mm			
accessories for		106905	
	GEV No.	100246	Ref. No. 33T0410
pilot burner nozzle natural gas bore 0.35mm Qty 1 pcs thread M8x0.75			
	GEV No.	100904	Ref. No. —
locking screw M10x1 for pipe 4mm Qty 1 pcs			
	GEV No.	100905	Ref. No. —
locking screw M10x1 for pipe 6mm Qty 1 pcs			
	GEV No.	102110	Ref. No. —
pilot tube copper pipe 4mm thickness 1mm L 3000mm			
	GEV No.	102111	Ref. No. —
pilot tube copper pipe 6mm thickness 1mm L 3000mm			
	GEV No.	107171	Ref. No. 33T0340
pilot burner nozzle SIT natural/liquid gas bore 0.25mm Qty 1 pcs			
	GEV No.	107700	Ref. No. 33A0960
pilot burner bottom part SIT 100 series nozzle 0.25mm			
	GEV No.	107702	Ref. No. 33A2900
pilot burner bottom part SIT 100 series nozzle 0.35mm			

			
1	GEV No.	106906	Ref. No. 6000350
description pilot burner SIT type 100 series 3 flames nozzle 0.2mm gas connection 6mm			
For models: 71AR, 91AR, FS30			
spare parts for		106906	
	GEV No.	100245	Ref. No. —
pilot burner nozzle LPG code 20 bore 0.2mm Qty 1 pcs thread M8x0.75			
	GEV No.	100855	Ref. No. 33S0950
pilot burner bracket triple			
	GEV No.	100885	Ref. No. 33A0970
air mixing sleeve for pilot burner Qty 1 pcs			
	GEV No.	100916	Ref. No. —
compression spring for pilot burner Qty 1 pcs			

spare parts for		106906	
	GEV No.	100917	Ref. No. —
gasket for pilot burner Qty 1 pcs aluminium			
	GEV No.	100918	Ref. No. —
screw for pilot burner			
	GEV No.	107162	Ref. No. 33A1080 33A1081
pilot burner cap SIT 3 flames Hmm Lmm Qty 1 pcs			
	GEV No.	107701	Ref. No. —
pilot burner bottom part SIT 100 series nozzle 0.2mm			
accessories for		106906	
	GEV No.	100245	Ref. No. —
pilot burner nozzle LPG code 20 bore 0.2mm Qty 1 pcs thread M8x0.75			
	GEV No.	100246	Ref. No. 33T0410
pilot burner nozzle natural gas bore 0.35mm Qty 1 pcs thread M8x0.75			
	GEV No.	100904	Ref. No. —
locking screw M10x1 for pipe 4mm Qty 1 pcs			
	GEV No.	100905	Ref. No. —
locking screw M10x1 for pipe 6mm Qty 1 pcs			
	GEV No.	102110	Ref. No. —
pilot tube copper pipe 4mm thickness 1mm L 3000mm			
	GEV No.	102111	Ref. No. —
pilot tube copper pipe 6mm thickness 1mm L 3000mm			
	GEV No.	107171	Ref. No. 33T0340
pilot burner nozzle SIT natural/liquid gas bore 0.25mm Qty 1 pcs			
	GEV No.	107700	Ref. No. 33A0960
pilot burner bottom part SIT 100 series nozzle 0.25mm			
	GEV No.	107702	Ref. No. 33A2900
pilot burner bottom part SIT 100 series nozzle 0.35mm			

accessories

pilot burner caps



<b>GEV No.</b>	100832	<b>Ref. No.</b>	33A1070
<b>description</b>	pilot burner cap 1 flame suitable for 100 series Hmm Lmm Qty 1 pcs		
<b>For models:</b>	030, 031, 032, 070D, 070DGG, 0712D, 0712VA, 071D, 071DGG, 072D, 072DGG, 090, 090GG, 091, 091GG, 092, 092GG, 092VA, 092VAGG, 0A0FAS, 0B0FAS, 0D0FAS, 1A0FAS, 1A0FAS2, 1A1FAS2G, 1A1FASG, 1B0FAS, 1B0FAS2, 1B1FAS2G, 1B1FASG, 1D0FAS, 1D0FAS2, 1D1FAS2G, 1D1FASG, 2A0FAS2, 2A1FAS2G, 2A1FASG, 2A1TPSG, 2D0FAS2, 2D1FAS2G, 2D1FASG, 2D1TPSG, 31, 31GE, 31TC, 32, 32TC, 32TP, 32TPV, 32V...(Other models you can see in the webshop)		



<b>GEV No.</b>	100835	<b>Ref. No.</b>	32Z2241
<b>description</b>	pilot burner cap 3 flames suitable for 100 series H 35mm L 48mm Qty 1 pcs W 52mm		
<b>For models:</b>	090BM1G, 0A0BMG, 0A1FR1G, 0A1FR1GD, 0B1FR1G, 0B1FR1GD, 0D0BMG, 0D1FR1G, 0D1FR1GD, 190BM2G, 1A0BMG, 1A1FR2G, 1A1FR2GD, 1D0BMG, 1D1FR2G, 1D1FR2GD, 30CPS, 30F, 30F1, 30F1B, 30FS, 30FS2, 30FS2B, 60SM, 70CP, 70F, 70F1, 70F1B, 71CP, 71CP2, 71F, 71F2, 71F2B, 90CP, 90F110B, 91CP, 91F210, 91F210B, 91F223B		



<b>GEV No.</b>	107162	<b>Ref. No.</b>	33A1080 33A1081
<b>description</b>	pilot burner cap SIT 3 flames Hmm Lmm Qty 1 pcs		
<b>For models:</b>	030FT, 030FTR, 031FT, 031FT04, 031FT06, 031FTR, 031FTRL, 031TP, 06WCP1GM, 06WFR3GD, 070BM, 070FT, 070FT04, 070FT05, 070FTR, 0712VA, 071BM, 071FT, 071FT04, 071FT06, 071FTR, 071FTRL, 071TP, 08WCP1GM, 08WFA4G, 08WFAAG, 08WFT1GV, 08WFT2GV, 08WFT3GV, 08WFT4GV, 08WFT6GV, 08WFT7GV, 090BM, 090FAVA, 090FT, 090FT04, 090FT05, 090FT1G, 090FT2G, 090FT4G, 090FT5G, 090FT7G, 090FTR, 091BM, 091CP1G, 091FR1G, 091FR1GD, 091FR3G, 091FR3GD, 091FT...(Other models you can see in the webshop)		



<b>GEV No.</b>	107166	<b>Ref. No.</b>	33A0380
<b>description</b>	pilot burner head SIT 1 flame Hmm Lmm Qty 1 pcs		



<b>GEV No.</b>	100998	<b>Ref. No.</b>	33A0200
<b>description</b>	pilot burner bottom part nozzle ø 0.21mm suitable for 100 series		
<b>For models:</b>	030, 031, 032, 31, 31GE, 31TC, 32, 32TC, 32TP, 32TPV, 32V		



<b>GEV No.</b>	107700	<b>Ref. No.</b>	33A0960
<b>description</b>	pilot burner bottom part SIT 100 series nozzle ø 0.25mm		
<b>For models:</b>	031FT04, 031FT06, 06WFR3GD, 070FT04, 070FT05, 071FT04, 071FT06, 08WCP1GM, 08WFT1GV, 08WFT2GV, 08WFT3GV, 08WFT4GV, 08WFT6GV, 08WFT7GV, 090FT04, 090FT05, 091FT04, 091FT06, 0A0FAVA, 0A1FR3G, 0A1FR3GD, 0D0FAVA, 0D1FR3G, 0D1FR3GD, 0G0FT1G, 0G0FT2G, 0G0FT4G, 0G0FT5G, 0G1CP1G, 0G1FR3G, 0G1FR3GD, 10WFR4GD, 1A1FR4G, 1A1FR4GD, 1D1FR4G, 1D1FR4GD, 1G0FT1G, 1G0FT2G, 1G0FT3G, 1G0FT4G, 1G0FT6G, 1G0TP0, 1G1BR1G, 1G1CP1G, 1G1CP2G, 1G1FA0G, 1G1FABG, 1G1FAPG, 1G1FR4G, 1G1FR4GD...(Other models you can see in the webshop)		

<b>spare parts for</b>	107700			
	<b>GEV No.</b>	100916	<b>Ref. No.</b>	—
	compression spring for pilot burner Qty 1 pcs			
	<b>GEV No.</b>	100917	<b>Ref. No.</b>	—
	gasket for pilot burner Qty 1 pcs aluminium			
	<b>GEV No.</b>	100918	<b>Ref. No.</b>	—
	screw for pilot burner			
	<b>GEV No.</b>	102742	<b>Ref. No.</b>	—
	pilot burner nozzle LPG code 25 bore ø 0.25mm Qty 1 pcs			











<b>accessories for</b>	107700			
	<b>GEV No.</b>	100245	<b>Ref. No.</b>	—
	pilot burner nozzle LPG code 20 bore ø 0.2mm Qty 1 pcs thread M8x0.75			
	<b>GEV No.</b>	100246	<b>Ref. No.</b>	33T0410
	pilot burner nozzle natural gas bore ø 0.35mm Qty 1 pcs thread M8x0.75			
	<b>GEV No.</b>	100904	<b>Ref. No.</b>	—
	locking screw M10x1 for pipe ø 4mm Qty 1 pcs			
	<b>GEV No.</b>	100905	<b>Ref. No.</b>	—
	locking screw M10x1 for pipe ø 6mm Qty 1 pcs			
	<b>GEV No.</b>	102110	<b>Ref. No.</b>	—
	pilot tube copper pipe ø 4mm thickness 1mm L 3000mm			
	<b>GEV No.</b>	102111	<b>Ref. No.</b>	—
	pilot tube copper pipe ø 6mm thickness 1mm L 3000mm			



Зип Общепит

vsezip.ru

+7(812)987-08-81





 <p>1</p>			
<b>GEV No.</b>	107702	<b>Ref. No.</b>	33A2900
<b>description</b>	pilot burner bottom part SIT 100 series nozzle $\varnothing$ 0.35mm		
<b>For models:</b>	030FT, 030FTR, 031FT, 031FTR, 031FTRL, 031TP, 070BM, 070D, 070DGG, 070FT, 070FTR, 0712D, 0712VA, 071BM, 071D, 071DGG, 071FT, 071FTR, 071FTRL, 071TP, 072D, 072DGG, 090, 090BM, 090FT, 090FTR, 090GG, 091, 091BM, 091FT, 091FTR, 091FTRL, 091GG, 091TP, 092, 092GG, 092VA, 092VAGG, 0A0BMG, 0A0FAS, 0A0FT1G, 0A0FT2G, 0A0FT4G, 0A0FT5G, 0A1FR1G, 0A1FR1GD, 0D0BMG, 0D0FAS, 0D0FT1G, 0D0FT2G...(Other models you can see in the webshop)		
<b>spare parts for</b>	107702		
	<b>GEV No.</b>	100246	<b>Ref. No.</b> 33T0410
	pilot burner nozzle natural gas bore $\varnothing$ 0.35mm Qty 1 pcs thread M8x0.75		
	<b>GEV No.</b>	100916	<b>Ref. No.</b> —
	compression spring for pilot burner Qty 1 pcs		
	<b>GEV No.</b>	100917	<b>Ref. No.</b> —
	gasket for pilot burner Qty 1 pcs aluminium		
	<b>GEV No.</b>	100918	<b>Ref. No.</b> —
	screw for pilot burner		
<b>accessories for</b>	107702		
	<b>GEV No.</b>	100245	<b>Ref. No.</b> —
	pilot burner nozzle LPG code 20 bore $\varnothing$ 0.2mm Qty 1 pcs thread M8x0.75		
	<b>GEV No.</b>	100904	<b>Ref. No.</b> —
	locking screw M10x1 for pipe $\varnothing$ 4mm Qty 1 pcs		
	<b>GEV No.</b>	100905	<b>Ref. No.</b> —
	locking screw M10x1 for pipe $\varnothing$ 6mm Qty 1 pcs		
	<b>GEV No.</b>	102110	<b>Ref. No.</b> —
	pilot tube copper pipe $\varnothing$ 4mm thickness 1mm L 3000mm		
	<b>GEV No.</b>	102111	<b>Ref. No.</b> —
	pilot tube copper pipe $\varnothing$ 6mm thickness 1mm L 3000mm		
	<b>GEV No.</b>	102742	<b>Ref. No.</b> —
	pilot burner nozzle LPG code 25 bore $\varnothing$ 0.25mm Qty 1 pcs		

 <p>1</p>			
<b>GEV No.</b>	100880	<b>Ref. No.</b>	33A0690
<b>description</b>	pilot burner bottom part SIT 100 series nozzle $\varnothing$ 0.4mm		

 <p>universal</p>			
<b>GEV No.</b>	100887	<b>Ref. No.</b>	33A0950
<b>description</b>	opposite support for pilot burner suitable for 100 series		
<b>For models:</b>	030, 030FT, 030FTR, 031, 031FT, 031FTR, 031FTRL, 031TP, 032, 06WCP1GM, 06WFR3GD, 070BM, 070D, 070DGG, 070FT, 070FT04, 070FT05, 070FTR, 0712D, 0712VA, 071BM, 071D, 071DGG, 071FT, 071FT04, 071FT06, 071FTR, 071FTRL, 071TP, 072D, 072DGG, 08WCP1GM, 08WFA4G, 08WFAAG, 08WFT1GV, 08WFT2GV, 08WFT3GV, 08WFT4GV, 08WFT6GV, 08WFT7GV, 090, 090BM, 090BM1G, 090FAVA, 090FT, 090FT04, 090FT05, 090FT1G...(Other models you can see in the webshop)		

 <p>1</p>			
<b>GEV No.</b>	100894	<b>Ref. No.</b>	33A1100
<b>description</b>	opposite support for pilot burner suitable for 100 series		

 <p>1</p>			
<b>GEV No.</b>	100886	<b>Ref. No.</b>	33A1000
<b>description</b>	pilot burner bracket suitable for 100 series 3-piece		
<b>For models:</b>	030FT, 030FTR, 031FT, 031FTR, 031FTRL, 070BM, 070FT, 070FTR, 0712VA, 071BM, 071FT, 071FTR, 071FTRL, 071TP, 08WFA4G, 08WFAAG, 08WFT1GV, 08WFT2GV, 08WFT3GV, 08WFT4GV, 08WFT6GV, 08WFT7GV, 090BM, 090FAVA, 090FT, 090FTR, 091BM, 091FT, 091FTR, 091FTRL, 091TP, 092VA, 092VAGG, 0A0FAVA, 0D0FAVA, 10WTPGE, 10WTPGV, 12WFA6G, 12WFAAG, 190FAB, 190TPO, 191BR1G, 191BR1GA, 191BR2G, 191BR2GA, 191FAAG, 191FABG, 191FADG, 191TPG, 1A0FA2...(Other models you can see in the webshop)		

 <p>1</p>			
<b>GEV No.</b>	100855	<b>Ref. No.</b>	33S0950
<b>description</b>	pilot burner bracket triple		
<b>accessories for</b>	100855		
	<b>GEV No.</b>	100855	<b>Ref. No.</b> 33S0950
	pilot burner bracket triple		
	<b>GEV No.</b>	100886	<b>Ref. No.</b> 33A1000
	pilot burner bracket suitable for 100 series 3-piece		
	<b>GEV No.</b>	100888	<b>Ref. No.</b> 33A0980
	screw bolt for pilot burner		

1 gas components





Зип Общепит  
vsezip.ru  
+7(812)987-08-81

			
1			
<b>GEV No.</b>	100888	<b>Ref. No.</b>	33A0980
<b>description</b>	screw bolt for pilot burner		
<b>For models:</b>	030FT, 030FTR, 031FT, 031FTR, 031FTRL, 070BM, 070FT, 070FT04, 070FT05, 070FTR, 0712VA, 071BM, 071FT, 071FT04, 071FT06, 071FTR, 071FTRL, 071TP, 090BM, 090FT, 090FTR, 091BM, 091FT, 091FTR, 091FTRL, 091TP, 30F, 30FS, 31, 31PD6, 31PI6, 31R, 31TC, 31TP, 32, 32TC, 32TP, 32TPV, 32V, 60SM, 70F, 712D, 712VA, 71AR, 71D, 71DGG, 71F, 71PD10, 71PD15, 71PI10...(Other models you can see in the webshop)		

<b>producer-specific</b>			
			
1			
<b>GEV No.</b>	100168	<b>Ref. No.</b>	35V9130
<b>description</b>	pilot burner bracket SIT type 100 series		
<b>For models:</b>	030, 031, 031TP, 032, 070D, 070DGG, 0712D, 0712VA, 071D, 071DGG, 072D, 072DGG, 090, 090GG, 091, 091GG, 092, 092GG, 092VA, 092VAGG, 0A0FAS, 0B0FAS, 0D0FAS, 1A0FAS, 1A0FAS2, 1A1FAS2G, 1A1FASG, 1B0FAS, 1B0FAS2, 1B1FAS2G, 1B1FASG, 1D0FAS, 1D0FAS2, 1D1FAS2G, 1D1FASG, 2A0FAS2, 2A1FAS2G, 2A1FASG, 2A1TPSG, 2D0FAS2, 2D1FAS2G, 2D1FASG, 2D1TPSG, 31, 31GE, 31TC, 31TP, 32, 32TC, 32TP...(Other models you can see in the webshop)		

			
1			
<b>GEV No.</b>	100169	<b>Ref. No.</b>	35S0690 35V9140
<b>description</b>	pilot burner bracket SIT type 100 series		
<b>For models:</b>	070D, 070DGG, 0712D, 0712VA, 071D, 071DGG, 072D, 072DGG, 090, 090GG, 091, 091GG, 092, 092GG, 092VA, 092VAGG, 0A0FAS, 0B0FAS, 0D0FAS, 1A0FAS, 1A0FAS2, 1A1FAS2G, 1A1FASG, 1B0FAS, 1B0FAS2, 1B1FAS2G, 1B1FASG, 1D0FAS, 1D0FAS2, 1D1FAS2G, 1D1FASG, 2A0FAS2, 2A1FAS2G, 2A1FASG, 2A1TPSG, 2D0FAS2, 2D1FAS2G, 2D1FASG, 2D1TPSG, 3A1FASG, 3D1FASG, 712D, 712VA, 71D, 71DGG, 71GE, 71GEGG, 72D, 72DGG, 72TP...(Other models you can see in the webshop)		

			
1			
<b>GEV No.</b>	100184	<b>Ref. No.</b>	35V2570
<b>description</b>	pilot burner bracket SIT type 100 series		
<b>For models:</b>	031FT04, 031FT06, 070FT04, 070FT05, 071FT04, 071FT06, 090FT04, 090FT05, 090FT1G, 090FT2G, 090FT4G, 090FT5G, 090FT7G, 091FT04, 091FT06, 0A0FT1G, 0A0FT2G, 0A0FT4G, 0A0FT5G, 0B0FT1G, 0B0FT2G, 0B0FT4G, 0B0FT5G, 0D0FT1G, 0D0FT2G, 0D0FT4G, 0D0FT5G, 0G0FT1G, 0G0FT1G-VERS.032008, 0G0FT2G, 0G0FT2G-VERS.032008, 0G0FT4G, 0G0FT4G-VERS.032008, 0G0FT5G, 0G0FT5G-VERS.032008, 0G0FT7G, 190FT15G, 190FT1G, 190FT2G, 190FT3G, 190FT42G, 190FT4G, 190FT6G, 190FT72G, 190FT7G, 1A0FT1G, 1A0FT2G, 1A0FT3G, 1A0FT4G, 1A0FT6G...(Other models you can see in the webshop)		

			
1			
<b>GEV No.</b>	100185	<b>Ref. No.</b>	35S5080
<b>description</b>	pilot burner bracket SIT type 100 series		
<b>For models:</b>	30CPS, 30F1, 30F1B, 30FS2, 30FS2B, 70CP, 70F1, 70F1B, 71CP, 71CP2, 71F2, 71F2B, 90CP, 90F110B, 91CP, 91F210, 91F210B, 91F223B		

			
1			
<b>GEV No.</b>	100188	<b>Ref. No.</b>	35R3540
<b>description</b>	pilot burner bracket SIT type 100 series		
<b>For models:</b>	0A1FR1G, 0A1FR1GD, 0B1FR1G, 0B1FR1GD, 0D1FR1G, 0D1FR1GD, 1A1FR2G, 1A1FR2GD, 1D1FR2G, 1D1FR2GD		

			
1			
<b>GEV No.</b>	100812	<b>Ref. No.</b>	35R0100
<b>description</b>	pilot burner bracket suitable for 100 series		
<b>For models:</b>	71PD10, 71PD15, 71PI10, 71PI10A, 91PI10, 91PI10A		

			
1			
<b>GEV No.</b>	100850	<b>Ref. No.</b>	35R1460
<b>description</b>	pilot burner bracket suitable for 100 series		
<b>For models:</b>	06WCP1GM, 08WCP1GM, 090BM1G, 091CP1G, 0A0BMG, 0D0BMG, 0G0FR5G, 0G1CP1G, 0G1CP1G-VERS.2004, 190BM2G, 191CP2G, 191PD2G, 191PI1G, 191PI1GA, 191PI2G, 191PI2GA, 1A0BMG, 1D0B-MG, 1G0FR6G, 1G0TP0, 1G1CP1G, 1G1CP1G-VERS.2004, 1G1CP2G, 1G1CP2G-VERS.2004, 1G1FA0G, 1G1FAPG, 1G1TP0G, 2G1FA0G, 2G1FADG, 2G1FADGV, 2G1FAPG, 2G1TP3G, G1FAGS, G1FAGST		

			
1			
<b>GEV No.</b>	102968	<b>Ref. No.</b>	35S0090
<b>description</b>	pilot burner bracket suitable for 100 series		







Зип-Общепит

vsezip.ru

+7(812)987-08-81

pilot burner nozzles			
			
<b>GEV No.</b>	100246	<b>Ref. No.</b>	33T0410
<b>description</b>	pilot burner nozzle natural gas bore $\varnothing$ 0.35mm Qty 1 pcs thread M8x0.75		
			
<b>GEV No.</b>	102972	<b>Ref. No.</b>	33T3130
<b>description</b>	pilot burner nozzle natural gas code 40 bore $\varnothing$ 0.4mm Qty 1 pcs		

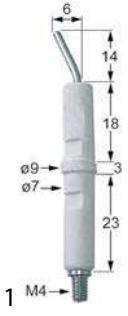
ignition electrodes			
			
<b>GEV No.</b>	100706	<b>Ref. No.</b>	32T0320
<b>description</b>	ignition electrode connection M4 Qty 1 pcs		
<b>For models:</b>	191CP1GA, 1A1CP1GA, 1A1PI2G, 1A1PI2GA, 1D1CP1GA, 1D1PI2G, 1D1PI2GA, 291PD3G, 291PI3G, 2A1PD3G, 2A1PI3G, 2D1PI3G		

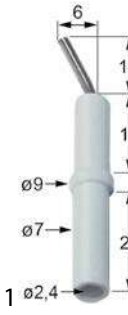
			
<b>GEV No.</b>	100707	<b>Ref. No.</b>	3232960
<b>description</b>	ignition electrode D1 $\varnothing$ 7mm D2 $\varnothing$ 9mm connection $\varnothing$ 2.4mm L1 14mm L2 6mm BL1 18mm BL2 3mm BL3 23mm to clip Qty 1 pcs		
<b>For models:</b>	06WCP1GM, 08WCP1GM, 08WFA4G, 08WFAAG, 090BM1G, 090FAVA, 090FT1G, 090FT2G, 090FT4G, 090FT5G, 090FT7G, 091CP1G, 091FR1G, 091FR1GD, 091FR3G, 091FR3GD, 0G0FT1G-VERS.032008, 0G0FT2G-VERS.032008, 0G0FT4G-VERS.032008, 0G0FT5G-VERS.032008, 0G0FT7G, 0G1CP1G-VERS.2004, 0G1FR3G, 0G1FR3GD, 0G1FR7G, 10WTPGE, 10WTPGV, 12WFA6G, 12WFAAG, 190BM2G, 190FAB, 190FT15G, 190FT1G, 190FT2G, 190FT3G, 190FT42G, 190FT4G, 190FT6G, 190FT72G, 190FT7G, 190TP0, 191BR1G, 191BR1GA, 191BR2G, 191BR2GA, 191CP2G, 191FAAG, 191FABG, 191FADG, 191FR2G...(Other models you can see in the webshop)		

			
<b>GEV No.</b>	100885	<b>Ref. No.</b>	33A0970
<b>description</b>	air mixing sleeve for pilot burner Qty 1 pcs		
<b>For models:</b>	030, 030FT, 030FTR, 031, 031FT, 031FT04, 031FT06, 031FTR, 031FTRL, 031TP, 032, 06WCP1GM, 06WFR3GD, 070BM, 070D, 070DGG, 070FT, 070FT04, 070FT05, 070FTR, 0712D, 0712VA, 071BM, 071D, 071DGG, 071FT, 071FT04, 071FT06, 071FTR, 071FTRL, 071TP, 072D, 072DGG, 08WCP1GM, 08WFA4G, 08WFAAG, 08WFT1GV, 08WFT2GV, 08WFT-3GV, 08WFT4GV, 08WFT6GV, 08WFT7GV, 090, 090BM, 090BM1G, 090FAVA, 090FT, 090FT04, 090FT05, 090FT1G...(Other models you can see in the webshop)		















160 series			
			
<b>GEV No.</b>	100109	<b>Ref. No.</b>	33A1630
<b>description</b>	pilot burner SIT type 160 series 1 flame nozzle $\varnothing$ mm gas connectionmm		
<b>For models:</b>	08WGRGV, 090GRG, 0A0GRG, 0D0GRG, 190GRG, 1A0GRG, 1D0GRG, 1G0GRG, 6042120-08WGRGV		
<b>spare parts for</b>	100109		
	<b>GEV No.</b>	100907	<b>Ref. No.</b> —
	screw connection thread M10x1 Qty 1 pcs type SEF 1 $\varnothing$ mm for thermocouple		
<b>accessories for</b>	100109		
	<b>GEV No.</b>	100202	<b>Ref. No.</b> —
	pilot burner nozzle natural gas code 41 Qty 1 pcs nozzle $\varnothing$ 0.41mm		
	<b>GEV No.</b>	100203	<b>Ref. No.</b> —
	pilot burner nozzle LPG code 25 Qty 1 pcs nozzle $\varnothing$ 0.25mm		
	<b>GEV No.</b>	100701	<b>Ref. No.</b> 32T0190
	ignition electrode connection M4 Qty 1 pcs		
	<b>GEV No.</b>	100801	<b>Ref. No.</b> —
	gasket for pilot burner Qty 1 pcs		
	<b>GEV No.</b>	100869	<b>Ref. No.</b> —
	pilot burner nozzle natural gas code 51 Qty 1 pcs suitable for 160 series nozzle $\varnothing$ 0.51mm		
	<b>GEV No.</b>	100906	<b>Ref. No.</b> 36Q1050
	screw connection thread M10x1 for ignition electrode brass Qty 1 pcs WS 10		
	<b>GEV No.</b>	100908	<b>Ref. No.</b> 36Q1000
	union screw thread M10x1 for pipe $\varnothing$ 4mm Qty 1 pcs		
	<b>GEV No.</b>	100909	<b>Ref. No.</b> 36Q0060
	union screw thread M10x1 for pipe $\varnothing$ 6mm Qty 1 pcs		
	<b>GEV No.</b>	101282	<b>Ref. No.</b> —
	olive for pipe $\varnothing$ 4mm L 7.4mm Qty 1 pcs		
	<b>GEV No.</b>	101287	<b>Ref. No.</b> 36Q0150
	olive for pipe $\varnothing$ 6mm Qty 1 pcs		

Table continues overleaf













Зип-Общепит

vsezip.ru

+7(812)987-08-81















<b>accessories for</b>	100109			
	GEV No.	102110	Ref. No.	—
	pilot tube copper pipe ø4mm thickness 1mm L 3000mm			
	GEV No.	102111	Ref. No.	—
	pilot tube copper pipe ø6mm thickness 1mm L 3000mm			
	GEV No.	107650	Ref. No.	33T3310
	pilot burner nozzle SIT LPG code 30 Qty 1 pcs			



<b>GEV No.</b>	100053	<b>Ref. No.</b>	33A0750	
<b>description</b>	pilot burner SIT type 160 series 2 flames nozzle ømm gas connectionmm			
<b>For models:</b>	1A1PD1G, 1A1PD2G, 1A1P1G, 1A1P1GA, 1D1PD1G, 1D1PD2G, 1D1P1G, 1D1P1GA			
<b>spare parts for</b>	100053			
	GEV No.	100907	Ref. No.	—
	screw connection thread M10x1 Qty 1 pcs type SEF 1 ømm for thermocouple			
<b>accessories for</b>	100053			
	GEV No.	100202	Ref. No.	—
	pilot burner nozzle natural gas code 41 Qty 1 pcs nozzle ø 0.41mm			
	GEV No.	100203	Ref. No.	—
	pilot burner nozzle LPG code 25 Qty 1 pcs nozzle ø 0.25mm			
	GEV No.	100701	Ref. No.	32T0190
	ignition electrode connection M4 Qty 1 pcs			
	GEV No.	100801	Ref. No.	—
	gasket for pilot burner Qty 1 pcs			
	GEV No.	100869	Ref. No.	—
	pilot burner nozzle natural gas code 51 Qty 1 pcs suitable for 160 series nozzle ø 0.51mm			
	GEV No.	100906	Ref. No.	36Q1050
	screw connection thread M10x1 for ignition electrode brass Qty 1 pcs WS 10			
	GEV No.	100908	Ref. No.	36Q1000
	union screw thread M10x1 for pipe ø4mm Qty 1 pcs			
	GEV No.	100909	Ref. No.	36Q0060
	union screw thread M10x1 for pipe ø6mm Qty 1 pcs			
	GEV No.	101282	Ref. No.	—
	olive for pipe ø4mm L 7.4mm Qty 1 pcs			
	GEV No.	101287	Ref. No.	36Q0150
	olive for pipe ø6mm Qty 1 pcs			
	GEV No.	102110	Ref. No.	—
	pilot tube copper pipe ø4mm thickness 1mm L 3000mm			
	GEV No.	102111	Ref. No.	—
	pilot tube copper pipe ø6mm thickness 1mm L 3000mm			

<b>accessories for</b>	100053			
	GEV No.	107650	Ref. No.	33T3310
	pilot burner nozzle SIT LPG code 30 Qty 1 pcs			



<b>GEV No.</b>	100054	<b>Ref. No.</b>	33A0880	
<b>description</b>	pilot burner SIT type 160 series 2 flames nozzle ømm gas connectionmm			
<b>For models:</b>	0A1CP1G, 0B1CP1G, 0D1CP1G, 191CP1G, 1A1CP1G, 1A1CP2G, 1D1CP1G, 1D1CP2G			
<b>spare parts for</b>	100054			
	GEV No.	100907	Ref. No.	—
	screw connection thread M10x1 Qty 1 pcs type SEF 1 ømm for thermocouple			
<b>accessories for</b>	100054			
	GEV No.	100202	Ref. No.	—
	pilot burner nozzle natural gas code 41 Qty 1 pcs nozzle ø 0.41mm			
	GEV No.	100203	Ref. No.	—
	pilot burner nozzle LPG code 25 Qty 1 pcs nozzle ø 0.25mm			
	GEV No.	100701	Ref. No.	32T0190
	ignition electrode connection M4 Qty 1 pcs			
	GEV No.	100801	Ref. No.	—
	gasket for pilot burner Qty 1 pcs			
	GEV No.	100869	Ref. No.	—
	pilot burner nozzle natural gas code 51 Qty 1 pcs suitable for 160 series nozzle ø 0.51mm			
	GEV No.	100906	Ref. No.	36Q1050
	screw connection thread M10x1 for ignition electrode brass Qty 1 pcs WS 10			
	GEV No.	100908	Ref. No.	36Q1000
	union screw thread M10x1 for pipe ø4mm Qty 1 pcs			
	GEV No.	100909	Ref. No.	36Q0060
	union screw thread M10x1 for pipe ø6mm Qty 1 pcs			
	GEV No.	101282	Ref. No.	—
	olive for pipe ø4mm L 7.4mm Qty 1 pcs			
	GEV No.	101287	Ref. No.	36Q0150
	olive for pipe ø6mm Qty 1 pcs			
	GEV No.	102110	Ref. No.	—
	pilot tube copper pipe ø4mm thickness 1mm L 3000mm			
	GEV No.	102111	Ref. No.	—
	pilot tube copper pipe ø6mm thickness 1mm L 3000mm			
	GEV No.	107650	Ref. No.	33T3310
	pilot burner nozzle SIT LPG code 30 Qty 1 pcs			



Зип Общежит

vsezip.ru

+7(812)987-08-81

JUNKERS			
CB 503 series			
pilot burners			
			
<b>GEV No.</b>	100058	<b>Ref. No.</b>	33A0470
<b>description</b>	pilot burner JUNKERS type CB503006 natural gas nozzle no.26 gas connection 4mm		
<b>spare parts for</b>	100058		
	<b>GEV No.</b>	100224	<b>Ref. No.</b> 33T0560
	pilot burner nozzle natural gas gas pressure 25mbar code 26 Qty 1 pcs suitable for JUNKERS CB503_		
	<b>GEV No.</b>	101281	<b>Ref. No.</b> —
	olive for pipe ø 4mm L 8.7mm Qty 1 pcs suitable for CB 502/503		
	<b>GEV No.</b>	101283	<b>Ref. No.</b> —
	union screw thread M10x1 for pipe ø 4mm Qty 1 pcs		
<b>accessories for</b>	100058		
	<b>GEV No.</b>	100220	<b>Ref. No.</b> 33T0540
	pilot burner nozzle LPG gas pressure 50mbar code 2 Qty 1 pcs suitable for JUNKERS CB503_		
	<b>GEV No.</b>	100221	<b>Ref. No.</b> —
	pilot burner nozzle LPG gas pressure 30mbar code 29 Qty 1 pcs suitable for JUNKERS CB50203_		
	<b>GEV No.</b>	100222	<b>Ref. No.</b> —
	pilot burner nozzle LPG gas pressure 50mbar code 5 Qty 1 pcs suitable for JUNKERS CB50203_		
	<b>GEV No.</b>	100223	<b>Ref. No.</b> —
	pilot burner nozzle natural gas gas pressure 20mbar code 3 Qty 1 pcs suitable for JUNKERS CB503_		
	<b>GEV No.</b>	100226	<b>Ref. No.</b> —
	pilot burner nozzle LPG gas pressure 50mbar code 15 suitable for JUNKERS		
	<b>GEV No.</b>	100227	<b>Ref. No.</b> —
	pilot burner nozzle natural gas gas pressure 25mbar code 6 Qty 1 pcs suitable for JUNKERS CB50203_		
	<b>GEV No.</b>	100228	<b>Ref. No.</b> —
	pilot burner nozzle town gas gas pressure 8mbar code 4 Qty 1 pcs suitable for JUNKERS CB50203_		
	<b>GEV No.</b>	100909	<b>Ref. No.</b> 36Q0060
	union screw thread M10x1 for pipe ø 6mm Qty 1 pcs		
	<b>GEV No.</b>	101287	<b>Ref. No.</b> 36Q0150
	olive for pipe ø 6mm Qty 1 pcs		
	<b>GEV No.</b>	102110	<b>Ref. No.</b> —
	pilot tube copper pipe ø 4mm thickness 1mm L 3000mm		
	<b>GEV No.</b>	102111	<b>Ref. No.</b> —
	pilot tube copper pipe ø 6mm thickness 1mm L 3000mm		















ANGELO PO			
pilot burners			
			
<b>GEV No.</b>	100187	<b>Ref. No.</b>	6000280
<b>description</b>	pilot burner SIT type 100 series 3 flames nozzle ø 0.25mm gas connectionmm		
<b>For models:</b>	30F, 30FS, 70F, 71F		
<b>spare parts for</b>	100187		
	<b>GEV No.</b>	100835	<b>Ref. No.</b> 32Z2241
	pilot burner cap 3 flames suitable for 100 series H 35mm L 48mm Qty 1 pcs W 52mm		
	<b>GEV No.</b>	100855	<b>Ref. No.</b> 33S0950
	pilot burner bracket triple		
	<b>GEV No.</b>	100882	<b>Ref. No.</b> —
	pilot burner bottom part PRO-GAS 100 series nozzle ø 0.25mm		
	<b>GEV No.</b>	100885	<b>Ref. No.</b> 33A0970
	air mixing sleeve for pilot burner Qty 1 pcs		
	<b>GEV No.</b>	100916	<b>Ref. No.</b> —
	compression spring for pilot burner Qty 1 pcs		
	<b>GEV No.</b>	100917	<b>Ref. No.</b> —
	gasket for pilot burner Qty 1 pcs aluminium		
	<b>GEV No.</b>	100918	<b>Ref. No.</b> —
	screw for pilot burner		
	<b>GEV No.</b>	102742	<b>Ref. No.</b> —
	pilot burner nozzle LPG code 25 bore ø 0.25mm Qty 1 pcs		
<b>accessories for</b>	100187		
	<b>GEV No.</b>	100245	<b>Ref. No.</b> —
	pilot burner nozzle LPG code 20 bore ø 0.2mm Qty 1 pcs thread M8x0.75		
	<b>GEV No.</b>	100246	<b>Ref. No.</b> 33T0410
	pilot burner nozzle natural gas bore ø 0.35mm Qty 1 pcs thread M8x0.75		
	<b>GEV No.</b>	100881	<b>Ref. No.</b> —
	pilot burner bottom part PRO-GAS 100 series nozzle ø 0.2mm		
	<b>GEV No.</b>	100883	<b>Ref. No.</b> —
	pilot burner bottom part PRO-GAS 100 series nozzle ø 0.35mm		
	<b>GEV No.</b>	100904	<b>Ref. No.</b> —
	locking screw M10x1 for pipe ø 4mm Qty 1 pcs		

Table continues overleaf

1 gas components

Зип-Общепит

vsezip.ru

+7(812)987-08-81

<b>accessories for</b>	100187			
	GEV No.	100905	Ref. No.	—
	locking screw M10x1 for pipe ø 6mm Qty 1 pcs			

Combi / Major series



<b>GEV No.</b>	100065	<b>Ref. No.</b>	6000170
----------------	--------	-----------------	---------

**description** pilot burner 1 flame gas connectionmm without nozzle

**spare parts for** 100065

	GEV No.	100831	Ref. No.	—
	pilot burner head Qty 1 pcs			

**accessories for** 100065

	GEV No.	100240	Ref. No.	33T0240
	pilot burner nozzle LPG code 39 gas pressure 30mbar brass			

	GEV No.	100241	Ref. No.	33T0050
	pilot burner nozzle natural gas code 13 gas pressure 25mbar bore ø 0.4mm Qty 1 pcs brass			

	GEV No.	100909	Ref. No.	36Q0060
	union screw thread M10x1 for pipe ø 6mm Qty 1 pcs			

	GEV No.	101282	Ref. No.	—
	olive for pipe ø 4mm L 7.4mm Qty 1 pcs			

	GEV No.	101283	Ref. No.	—
	union screw thread M10x1 for pipe ø 4mm Qty 1 pcs			

	GEV No.	101288	Ref. No.	—
	olive for pipe ø 6mm L 6mm aluminium Qty 1 pcs ED ø 8.5mm			









<b>GEV No.</b>	101777	<b>Ref. No.</b>	34A0010
----------------	--------	-----------------	---------

**description** pilot burner gas connectionmm without nozzle

**accessories for** 101777

	GEV No.	100240	Ref. No.	33T0240
	pilot burner nozzle LPG code 39 gas pressure 30mbar brass			

	GEV No.	100241	Ref. No.	33T0050
	pilot burner nozzle natural gas code 13 gas pressure 25mbar bore ø 0.4mm Qty 1 pcs brass			

<b>accessories for</b>	101777			
	GEV No.	100831	Ref. No.	—
	pilot burner head Qty 1 pcs			
	GEV No.	100909	Ref. No.	36Q0060
	union screw thread M10x1 for pipe ø 6mm Qty 1 pcs			
	GEV No.	101282	Ref. No.	—
	olive for pipe ø 4mm L 7.4mm Qty 1 pcs			
	GEV No.	101283	Ref. No.	—
	union screw thread M10x1 for pipe ø 4mm Qty 1 pcs			
	GEV No.	101288	Ref. No.	—
	olive for pipe ø 6mm L 6mm aluminium Qty 1 pcs ED ø 8.5mm			

new series



<b>GEV No.</b>	107541	<b>Ref. No.</b>	N/A
----------------	--------	-----------------	-----

**description** pilot burner 2 flames gas connection 4/6mm without nozzle

**accessories for** 107541

	GEV No.	100240	Ref. No.	33T0240
	pilot burner nozzle LPG code 39 gas pressure 30mbar brass			

	GEV No.	100241	Ref. No.	33T0050
	pilot burner nozzle natural gas code 13 gas pressure 25mbar bore ø 0.4mm Qty 1 pcs brass			

miscellaneous



<b>GEV No.</b>	104299	<b>Ref. No.</b>	3060930
----------------	--------	-----------------	---------

**description** pilot burner

**For models:** 190FA, 190FAD, 191FADG, 191FAE, 191FAG, 290FA, 291FAG, 291FAGF, 391FAG





electrodes

Зип Общепит

vsezip.ru

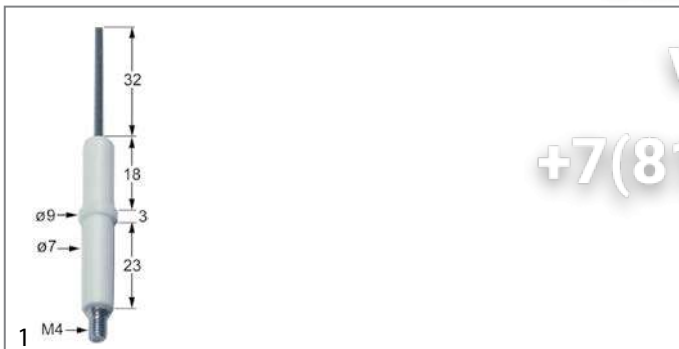
+7(812)987-08-81



<b>GEV No.</b>	100701	<b>Ref. No.</b>	32T0190
<b>description</b>	ignition electrode connection M4 Qty 1 pcs		
<b>For models:</b>	08WGRGV, 090GRG, 0A0GRG, 0A1CP1G, 0B1CP1G, 0D0GRG, 0D1CP1G, 190GRG, 191CP1G, 1A0GRG, 1A1CP1G, 1A1CP2G, 1A1PD1G, 1A1PD2G, 1A1PI1G, 1A1PI1GA, 1D0GRG, 1D1CP1G, 1D1CP2G, 1D1PD1G, 1D1PD2G, 1D1PI1G, 1D1PI1GA, 1G0GRG, 6042120-08WGRGV		
<b>accessories for</b>	100701		
	<b>GEV No.</b>	100906	<b>Ref. No.</b> 36Q1050
	screw connection thread M10x1 for ignition electrode brass Qty 1 pcs WS 10		

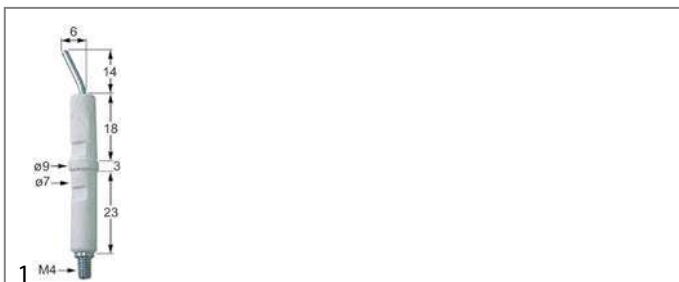

<b>GEV No.</b>	100706	<b>Ref. No.</b>	32T0320
<b>description</b>	ignition electrode connection M4 Qty 1 pcs		
<b>For models:</b>	191CP1GA, 1A1CP1GA, 1A1PI2G, 1A1PI2GA, 1D1CP1GA, 1D1PI2G, 1D1PI2GA, 291PD3G, 291PI3G, 2A1PD3G, 2A1PI3G, 2D1PI3G		

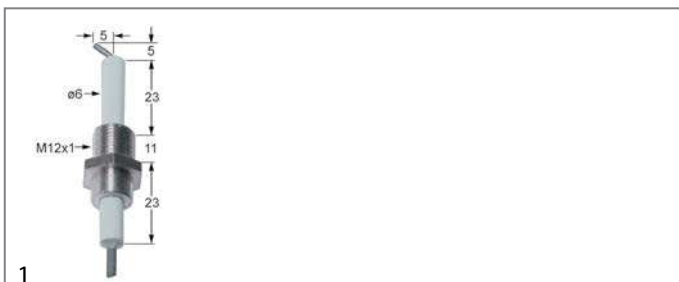

<b>GEV No.</b>	100712	<b>Ref. No.</b>	32T0080
<b>description</b>	ignition electrode D1 ø 6mm L1 5mm L2 5mm BL1 23mm BL2 11mm BL3 23mm connection F 2.8x0.8mm M12x1		

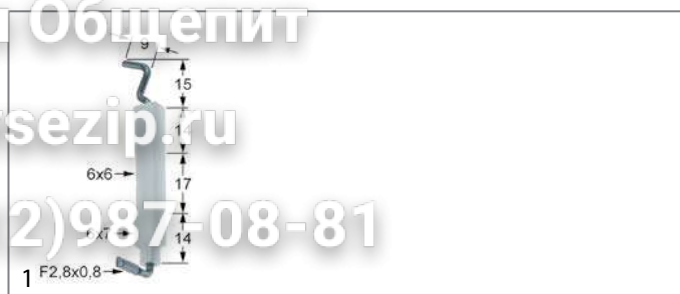

<b>GEV No.</b>	100736	<b>Ref. No.</b>	32T0141 32T0142
<b>description</b>	ignition electrode D1 ø 6x7mm connection F 2.8x0.8mm BL1 14mm BL2 16mm BL3 14mm		
<b>For models:</b>	030FT, 030FTR, 031FT, 031FT04, 031FT06, 031FTR, 031FTRL, 031TP, 06WCP1GM, 06WFR3GD, 070BM, 070FT, 070FT04, 070FT05, 070FTR, 0712VA, 071BM, 071FT, 071FT04, 071FT06, 071FTR, 071FTRL, 071TP, 08WCP1GM, 08WFAAG, 08WFT1GV, 08WFT2GV, 08WFT3GV, 08WFT4GV, 08WFT6GV, 08WFT7GV, 090BM, 090FAVA, 090FT, 090FT04, 090FT05, 090FT1G, 090FT2G, 090FT4G, 090FT5G, 090FT7G, 090FTR, 091BM, 091CP1G, 091FR1G, 091FR1GD, 091FR3G, 091FR3GD, 091FT, 091FT04...(Other models you can see in the webshop)		



<b>GEV No.</b>	100798	<b>Ref. No.</b>	32T0010 32T0060
<b>description</b>	ignition electrode D1 ø 6x7mm connection F 2.8x0.8mm D2 ø 6x6mm L1 15mm L2 10mm BL1 14mm BL2 17mm BL3 14mm to clip		
<b>For models:</b>	030FT, 030FTR, 031FT, 031FT04, 031FT06, 031FTR, 031FTRL, 031TP, 06WCP1GM, 06WFR3GD, 070BM, 070FT, 070FT04, 070FT05, 070FTR, 0712VA, 071BM, 071FT, 071FT04, 071FT06, 071FTR, 071FTRL, 071TP, 08WCP1GM, 08WFA4G, 08WFAAG, 08WFT1GV, 08WFT2GV, 08WFT3GV, 08WFT4GV, 08WFT6GV, 08WFT7GV, 090BM, 090BM1G, 090FAVA, 090FT, 090FT04, 090FT05, 090FT1G, 090FT2G, 090FT4G, 090FT5G, 090FT7G, 090FTR, 091BM, 091CP1G, 091FR1G, 091FR1GD, 091FR3G, 091FR3GD...(Other models you can see in the webshop)		



<b>GEV No.</b>	100708	<b>Ref. No.</b>	32T0140
<b>description</b>	ignition electrode D1 ø 6x7mm connection M4 D2 ø 6x6mm L1 11mm L2 5mm BL1 15mm BL2 16mm BL3 23mm		
<b>For models:</b>	71AR, 91AR, FS30		

1 gas components



Зип Общепит

vsezip.ru

+7(812)987-08-81



<b>GEV No.</b>	100707	<b>Ref. No.</b>	3232960
<b>description</b>	ignition electrode D1 ø 7mm D2 ø 9mm connection ø2.4mm L1 14mm L2 6mm BL1 18mm BL2 3mm BL3 23mm to clip Qty 1 pcs		
<b>For models:</b>	06WCP1GM, 08WCP1GM, 08WFA4G, 08WFAAG, 090BM1G, 090FAVA, 090FT1G, 090FT2G, 090FT4G, 090FT5G, 090FT7G, 091CP1G, 091FR1G, 091FR1GD, 091FR3G, 091FR3GD, 0G0FT1G-VERS.032008, 0G0FT2G-VERS.032008, 0G0FT4G-VERS.032008, 0G0FT5G-VERS.032008, 0G0FT7G, 0G1CP1G-VERS.2004, 0G1FR3G, 0G1FR3GD, 0G1FR7G, 10WTPGE, 10WTPGV, 12WFA6G, 12WFAAG, 190BM2G, 190FAB, 190FT15G, 190FT1G, 190FT2G, 190FT3G, 190FT42G, 190FT4G, 190FT6G, 190FT72G, 190FT7G, 190TP0, 191BR1G, 191BR1GA, 191BR2G, 191BR2GA, 191CP2G, 191FAAG, 191FABG, 191FADG, 191FR2G...(Other models you can see in the webshop)		



<b>GEV No.</b>	104800	<b>Ref. No.</b>	32V4670
<b>description</b>	ignition electrode flange length 55mm flange width 55mm D1 ø 9mm D2 ø 7mm L1 119mm L2 145mm BL1 60mm BL2 55mm		



<b>GEV No.</b>	106743	<b>Ref. No.</b>	6300568
<b>description</b>	ignition electrode flange length 55mm flange width 55mm D1 ø 9.3mm D2 ø 5.85mm L1 80mm BL1 80mm BL2 33.5mm BL3 29.5mm BL4 24.5mm with fixing flange with mounting material connection ø 4mm		
<b>For models:</b>	FC1221G, FM1221G1, FM1221G1-VERS.2006, FM1221G2, FM1221G2-VERS.2006, FM1221G3, FM1221G3-VERS.2006, FM2021G1, FM2021G2, FM2021G2-VERS.2006, FM2021G3, FM2021G3-VERS.2006, FM721G1, FM721G1-VERS.2006, FM721G2, FM721G2-VERS.2006, FM721G3, FM721G3-VERS.2006		



<b>GEV No.</b>	104683	<b>Ref. No.</b>	3106670 3106671
<b>description</b>	ignition electrode flange length 56mm flange width 22mm		
<b>For models:</b>	091FR11, 091FR11A, 091FR11D, 091FR11D-VERS.052012, 091FR11-VERS.032012, 091FR7G, 091FR7GX, 191FR21, 191FR21D, 191FR21D-VERS.092012, 191FR21-VERS.032012		

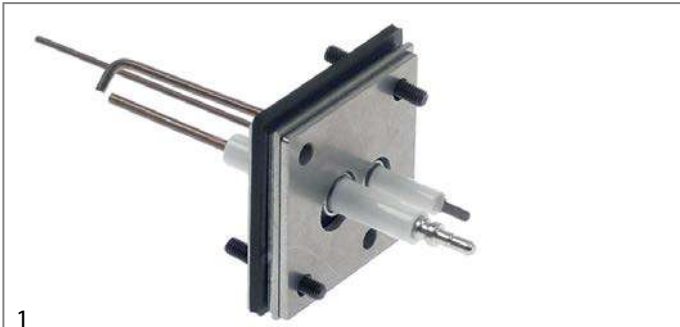

<b>GEV No.</b>	104801	<b>Ref. No.</b>	6300567
<b>description</b>	ignition electrode flange length 55mm flange width 55mm D1 ø 9mm D2 ø 7mm L1 118mm L2 145mm BL1 77mm BL2 65mm		
<b>For models:</b>	FC1011G, FC611G, FM1011G1, FM1011G1-VERS.2006, FM1011G2, FM1011G2-VERS.2006, FM1011G3, FM1011G3-VERS.2006, FM2011G2-VERS.2006, FM2011G3-VERS.2006, FM611G1, FM611G1-VERS.2006, FM611G2, FM611G2-VERS.2006, FM611G3, FM611G3-VERS.2006		



<b>GEV No.</b>	104799	<b>Ref. No.</b>	6300747
<b>description</b>	ignition electrode flange length 56mm flange width 22mm D1 ø 9x62mm D2 ø 9x62mm L1 130mm L2 140mm		
<b>For models:</b>	BX122G, BX122G-VERS.122013, BX82G, BX82G-VERS.122013, FX122G1, FX122G2, FX122G2C, FX122G2T, FX122G2T-VERS.032014, FX122G3, FX122G3C, FX122G3T, FX122G3T-VERS.022014, FX12G3CT, FX12G3CT-VERS.022014, FX202G2, FX202G2-VERS.032014, FX202G3, FX202G3-VERS.022014, FX82G1, FX82G2, FX82G2C, FX82G2T, FX82G2T-VERS.032014, FX82G3, FX82G3C, FX82G3CT, FX82G3CT-VERS.022014, FX82G3T, FX82G3T-VERS.022014		



Зип Общепит

vsezip.ru

+7(812)9800000

1 gas components



<b>GEV No.</b>	103287	<b>Ref. No.</b>	6300746
<b>description</b>	ignition electrode kit flange length 56mm flange width 22mm D1 ø 3mm D2 ø 9.5mm mounting distance 47mm		
<b>For models:</b>	BX101G, BX101G-VERS.122013, BX61G, BX61G-VERS.122013, FX101G1, FX101G1R, FX101G2, FX101G2C, FX101G2C-VERS.032014, FX101G2R, FX101G2R-VERS.032014, FX101G2-VERS.032014, FX101G3, FX101G3C, FX101G3C-VERS.022014, FX101G3R, FX101G3R-VERS.022014, FX101G3-VERS.022014, FX10G2CR, FX10G2CR-VERS.032014, FX10G3CR, FX10G3CR-VERS.022014, FX201G2, FX201G2P, FX201G2P-VERS.032014, FX201G2-VERS.032014, FX201G3P, FX201G3-VERS.022014, FX61G1, FX61G1R, FX61G2, FX61G2C, FX61G2CR, FX61G2CR-VERS.032014, FX61G2C-VERS.032014, FX61G2R, FX61G2R-VERS.032014, FX61G2-VERS.032014, FX61G3, FX61G3C, FX61G3CR, FX61G3CR-VERS.022014, FX61G3C-VERS.022014, FX61G3R, FX61G3R-VERS.022014, FX61G3-VERS.022014		



<b>GEV No.</b>	100906	<b>Ref. No.</b>	36Q1050
<b>description</b>	screw connection thread M10x1 for ignition electrode brass Qty 1 pcs WS 10		
<b>For models:</b>	08WGRGV, 090GRG, 0A0GRG, 0A1CP1G, 0B1CP1G, 0D0GRG, 0D1CP1G, 190GRG, 191CP1G, 1A0GRG, 1A1CP1G, 1A1CP2G, 1A1PD1G, 1A1PD2G, 1A1PI1G, 1A1PI1GA, 1D0GRG, 1D1CP1G, 1D1CP2G, 1D1PD1G, 1D1PD2G, 1D1PI1G, 1D1PI1GA, 1G0GRG, 6042120-08WGRGV		

**ignition cables**

**pre-assembled cables**



<b>GEV No.</b>	100190	<b>Ref. No.</b>	32A0061 32A0390
<b>description</b>	ignition cable cable length 1200mm connection F2.8mm / F2.8mm		
<b>For models:</b>	06WFR3GD, 071TP, 08WFAAG, 08WFT1GV, 08WFT2GV, 08WFT3GV, 08WFT4GV, 08WFT6GV, 08WFT7GV, 090FAVA, 091FR1G, 091FR1GD, 091FR3G, 091FR3GD, 091TP, 0A1FR1G, 0A1FR1GD, 0A1FR1GD-VERS.2004, 0A1FR1G-VERS.2004, 0A1FR3G, 0A1FR3GD, 0B1FR1G, 0B1FR1GD, 0D1FR1G, 0D1FR1GD, 0D1FR1GD-VERS.2004, 0D1FR1G-VERS.2004, 0D1FR3G, 0D1FR3GD, 0G1FR3G, 0G1FR3GD, 10WFR4GD, 12WFAAG, 190FAB, 191BR1G, 191BR1GA, 191BR2G, 191BR2GA, 191CP1GA, 191FABG, 191FR2G, 191FR2GD, 191FR4G, 191FR4GD, 1A1BR1G, 1A1BR1GA, 1A1BR2G, 1A1BR2GA, 1A1CP1GA, 1A1FR2G... (Other models you can see in the webshop)		



<b>GEV No.</b>	100179	<b>Ref. No.</b>	32A2540
<b>description</b>	ignition cable cable length 1200mm connection F2.8mm / ø2.4mm		
<b>For models:</b>	08WGRGV, 090GRG, 0A0BMG, 0A0FAVA, 0D0BMG, 0D0FAVA, 0G0FR5G, 0G1CP1G, 0G1CP1G-VERS.2004, 0G1FR7G, 190GRG, 1G1CP1G, 1G1CP1G-VERS.2004, 1A0FAZ, 1A0FA5, 1A0FAB, 1A0FAS2, 1A0TP0, 1A1FA2G, 1A1FASG, 1A1FABG, 1A1FAS2G, 1A1FASG, 1A1TP0G, 1A1TP0G-VERS.2002, 1B0FAS2, 1B0TP0, 1B1FAS2G, 1D0BMG, 1D0FA2, 1D0FA5, 1D0FAB, 1D0FAS2, 1D0TP0, 1D1FA2G, 1D1FASG, 1D1FABG, 1D1FAS2G, 1D1FASG, 1D1TP0G, 1D1TP0G-VERS.2002, 1G0FR6G, 1G1CP1G, 1G1CP1G-VERS.2004, 1G1CP2G, 1G1CP2G-VERS.2004, 1G1FR8G, 2A0FAS2, 2A1FAS2G, 2A1FASG...(Other models you can see in the webshop)		



<b>GEV No.</b>	102163	<b>Ref. No.</b>	32A3080
<b>description</b>	ignition cable cable length 1500mm connection F2.8mm / ø2.4mm		
<b>For models:</b>	08WFA4G, 12WFA6G, 190TP0, 191FAAG, 191FADG, 191FAG, 191PD2G, 191PI1G, 191PI1GA, 191PI2G, 191PI2GA, 191TPG, 1G1FA0G, 1G1FAPG, 1G1TP0G, 291FAG, 291TPCG, 2A1PI3G, 2D1PI3G, 2G1FA0G, 2G1FADG, 2G1FADGV, 2G1FAPG, 2G1TP3G, 391FAG		



<b>GEV No.</b>	100189	<b>Ref. No.</b>	3059160 32A1640
<b>description</b>	ignition cable cable length 150mm connection F2.8mm / lug M4		
<b>For models:</b>	090FT1G, 090FT2G, 090FT4G, 090FT5G, 090FT7G, 090GRG, 091CP1G, 091FR1G, 091FR1GD, 091FR3G, 091FR3GD, 0A1FR1G, 0A1FR1GD, 0A1FR1GD-VERS.2004, 0A1FR1G-VERS.2004, 0A1FR3G, 0A1FR3GD, 0B1FR1G, 0B1FR1GD, 0D1FR1G, 0D1FR1GD, 0D1FR1GD-VERS.2004, 0D1FR1G-VERS.2004, 0D1FR3G, 0D1FR3GD, 0G1FR3G, 0G1FR3GD, 10WTPGE, 191BR1G, 191BR1GA, 191BR2G, 191BR2GA, 1A1BR1G, 1A1BR1GA, 1A1BR2G, 1A1BR2GA, 1D1BR1G, 1D1BR1GA, 1D1BR2G, 1D1BR2GA, 1G1FR4G, 1G1FR4GD, 291BR1G, 291BR1GA, 291BR2G, 291BR2GA, 2A1BR1G, 2A1BR1GA, 2A1BR2G, 2A1BR2GA...(Other models you can see in the webshop)		



<b>GEV No.</b>	103353	<b>Ref. No.</b>	3113510
<b>description</b>	ignition cable cable length 350mm connection F2.8/F6.3		
<b>For models:</b>	FC1011G, FC611G, FM1011G1, FM1011G1-VERS.2006, FM1011G2, FM1011G2-VERS.2006, FM1011G3, FM1011G3-VERS.2006, FM2011G2-VERS.2006, FM2011G3-VERS.2006, FM611G1, FM611G1-VERS.2006, FM611G2, FM611G2-VERS.2006, FM611G3, FM611G3-VERS.2006, FM721G1, FM721G1-VERS.2006, FM721G2, FM721G2-VERS.2006, FM721G3, FM721G3-VERS.2006		



<b>GEV No.</b>	100036	<b>Ref. No.</b>	32A0040 32A0050
<b>description</b>	ignition cable cable length 500mm connection F2.8mm / F2.8mm		



<b>GEV No.</b>	103352	<b>Ref. No.</b>	3113490
<b>description</b>	ignition cable cable length 550mm connection F2.8mm / F6.3mm		
<b>For models:</b>	FM1221G1, FM1221G1-VERS.2006, FM1221G2, FM1221G2-VERS.2006, FM1221G3, FM1221G3-VERS.2006, FM2021G1, FM2021G2, FM2021G2-VERS.2006, FM2021G3, FM2021G3-VERS.2006, FM721G1, FM721G2, FM721G3, FX201G2, FX201G2P, FX201G2P-VERS.032014, FX201G2-VERS.032014, FX201G3P, FX201G3-VERS.022014, FX202G2, FX202G2-VERS.032014, FX202G3, FX202G3-VERS.022014		



<b>GEV No.</b>	102159	<b>Ref. No.</b>	32A0140
<b>description</b>	ignition cable cable length 600mm connection F2.8mm / F2.8mm		



<b>GEV No.</b>	100197	<b>Ref. No.</b>	32A0430
<b>description</b>	ignition cable cable length 600mm connection F2.8mm / ø2.4mm		
<b>For models:</b>	031FT04, 031FT06, 070FT04, 070FT05, 071FT04, 071FT06, 090FT04, 090FT05, 091FT04, 091FT06, 0A0FT1G, 0A0FT2G, 0A0FT4G, 0A0FT5G, 0B0FT1G, 0B0FT2G, 0B0FT4G, 0B0FT5G, 0D0FT1G, 0D0FT2G, 0D0FT4G, 0D0FT5G, 0G0FT1G, 0G0FT1G-VERS.032008, 0G0FT2G, 0G0FT2G-VERS.032008, 0G0FT4G, 0G0FT4G-VERS.032008, 0G0FT5G, 0G0FT5G-VERS.032008, 1A0FT1G, 1A0FT2G, 1A0FT3G, 1A0FT4G, 1A0FT6G, 1B0FT1G, 1B0FT2G, 1B0FT3G, 1B0FT4G, 1B0FT6G, 1D0FT1G, 1D0FT2G, 1D0FT3G, 1D0FT4G, 1D0FT6G, 1G0FT1G, 1G0FT1G-VERS.032008, 1G0FT2G, 1G0FT2G-VERS.032008, 1G0FT3G...(Other models you can see in the webshop)		



<b>GEV No.</b>	100025	<b>Ref. No.</b>	32A0051
<b>description</b>	ignition cable cable length 600mm connection ø4mm / F6.3mm		



<b>GEV No.</b>	107550	<b>Ref. No.</b>	3211850
<b>description</b>	ignition cable cable length 700mm connection ø4mm / F2.8mm with earthing cable		
<b>For models:</b>	091FR11, 091FR11A, 091FR11D, 091FR11D-VERS.052012, 091FR11-VERS.032012, 191FR21, 191FR21D, 191FR21D-VERS.092012, 191FR21-VERS.032012		



<b>GEV No.</b>	100037	<b>Ref. No.</b>	32A0010 32A0060 32A0210
<b>description</b>	ignition cable cable length 900mm connection F2.8mm / F2.8mm		
<b>For models:</b>	030FT, 030FTR, 031FT, 031FTR, 031FTRL, 031TP, 070BM, 070FT, 070FTR, 0712VA, 071BM, 071FT, 071FTR, 071FTRL, 090BM, 090BM1G, 090FT, 090FTR, 091BM, 091FT, 091FTR, 091FTRL, 092VA, 092VAGG, 135PVX, 190BM2G, 1G0TP0, 1G1TP0G, 2G1TP3G, 30CPS, 30F, 30FS, 31TP, 32TP, 32TPV, 70CP, 70F, 712D, 712VA, 71CP2, 71D, 71DGG, 71F, 71TP, 72D, 72DGG, 72TP, 72TPGG, 72VA, 72VAGG...(Other models you can see in the webshop)		



<b>GEV No.</b>	103307	<b>Ref. No.</b>	32A2541
<b>description</b>	ignition cable cable length 900mm connection F2.8mm / ø2.4mm		
<b>For models:</b>	06WCP1GM, 08WCP1GM, 08WGRGV, 090FAA, 090FT1G, 090FT2G, 090FT4G, 090FT5G, 090FT7G, 090GRG, 091CP1G, 0A0BMG, 0A0FAVA, 0D0BMG, 0D0FAVA, 0G0FR5G, 0G1CP1G, 0G1CP1G-VERS.2004, 0G1FR7G, 10WTPGV, 190FAA, 190FT15G, 190FT1G, 190FT2G, 190FT3G, 190FT42G, 190FT4G, 190FT6G, 190FT72G, 190FT7G, 190GRG, 191CP1G, 191CP2G, 1A0BMG, 1A0FA2, 1A0FA5, 1A0FAB, 1A0FAS2, 1A0TP0, 1A1FA2G, 1A1FA5G, 1A1FABG, 1A1FAS2G, 1A1FASG, 1A1TP0G, 1A1TP0G-VERS.2002, 1B0FAS2, 1B0TP0, 1B1FAS2G, 1D0BMG...(Other models you can see in the webshop)		



<b>GEV No.</b>	100016	<b>Ref. No.</b>	32A2550
<b>description</b>	ignition cable cable length 900mm connection ø2.4mm / ø2.4mm		
<b>For models:</b>	0A1CP1G, 0B1CP1G, 0D1CP1G, 0G1CP1G-VERS.2004, 0G1FR7G, 1A1CP1G, 1A1CP2G, 1A1PD1G, 1A1PD2G, 1A1PI1G, 1A1PI1GA, 1D1CP1G, 1D1CP2G, 1D1PD1G, 1D1PD2G, 1D1PI1G, 1D1PI1GA, 1G0FR6G, 1G1CP1G-VERS.2004, 1G1CP2G-VERS.2004, 1G1FR8G, 1G1PD1G, 1G1PI1G		

various





<b>GEV No.</b>	102986	<b>Ref. No.</b>	32A1600
<b>description</b>	ignition cable 10000hm		
<b>For models:</b>	FCV101DM, FCV101DS, FCV141DM, FCV141DS, FCV241DM, FCV241DS, FCV241GDM, FCV241GDS, FCV401DM, FCV61DM, FCV61DS		

piezoelectric igniters  
mounting diameter 18mm



<b>GEV No.</b>	100002	<b>Ref. No.</b>	32T0130
<b>description</b>	piezoelectric igniter body metal rotary mounting ø 18mm connection F2.8x0.8		
<b>For models:</b>	030FT, 030FTR, 031FT, 031FTR, 031FTRL, 031TP, 070BM, 070FT, 070FTR, 0712VA, 071BM, 071FT, 071FTR, 071FTRL, 071TP, 090BM, 090FT, 090FTR, 091BM, 091FT, 091FTR, 091FTRL, 091TP, 092VA, 092VAGG, 30CPS, 30F, 30FS, 31, 31PD6, 31PI6, 31R, 31TC, 31TP, 32, 32TC, 32TP, 32TPV, 32V, 60SM, 70CP, 70F, 712D, 712VA, 71CP, 71CP2, 71D, 71DGG, 71F, 71PD10...(Other models you can see in the webshop)		



<b>GEV No.</b>	100012	<b>Ref. No.</b>	32T0150
<b>description</b>	piezoelectric igniter body plastic blowing mounting ø 18mm connection ø2.4mm		
<b>For models:</b>	031FT04, 031FT06, 070FT04, 070FT05, 071FT04, 071FT06, 090FT04, 090FT05, 091FT04, 091FT06, 0A0BMG, 0A0FT1G, 0A0FT2G, 0A0FT4G, 0A0FT5G, 0A0GRG, 0A1CP1G, 0B0FT1G, 0B0FT2G, 0B0FT4G, 0B0FT5G, 0B1CP1G, 0D0BMG, 0D0FT1G, 0D0FT2G, 0D0FT4G, 0D0FT5G, 0D0GRG, 0D1CP1G, 0G0FT1G, 0G0FT2G, 0G0FT4G, 0G0FT5G, 0G1CP1G, 0M0FA1, 0M0FR1G, 0M0FT1G, 0M0FT2G, 0M0FT4G, 0M0FT5G, 0M0GL1G, 0M0GL2G, 1A0BMG, 1A0FA2, 1A0FA5, 1A0FAS2, 1A0FT1G, 1A0FT2G, 1A0FT3G, 1A0FT4G...(Other models you can see in the webshop)		
<b>spare parts for</b>	100012		
	<b>GEV No.</b>	101339	<b>Ref. No.</b> 37Q2100
			cover cap for piezoelectric igniter







Зип Общепит

ignition parts

vsezip.ru

+7(812)987-08-81

			
1			
<b>GEV No.</b>	100009	<b>Ref. No.</b>	3005500 3166990
<b>description</b>	piezoelectric igniter body plastic blowing mounting ø 18mm connection ø2.4mm front measurements 26mm M18x1.5		
<b>For models:</b>	031FT04, 031FT06, 070FT04, 070FT05, 071FT04, 071FT06, 090FT04, 090FT05, 091FT04, 091FT06, 0A0BMG, 0A0FAVA, 0A0FT1G, 0A0FT2G, 0A0FT4G, 0A0FT5G, 0A0GRG, 0A1CP1G, 0B0FT1G, 0B0FT2G, 0B0FT4G, 0B0FT5G, 0B1CP1G, 0D0BMG, 0D0FAVA, 0D0FT1G, 0D0FT2G, 0D0FT4G, 0D0FT5G, 0D0GRG, 0D1CP1G, 0G0FR5G, 0G0FT1G, 0G0FT1G-VERS.032008, 0G0FT2G, 0G0FT2G-VERS.032008, 0G0FT4G, 0G0FT4G-VERS.032008, 0G0FT5G, 0G0FT5G-VERS.032008, 0G0FT7G, 0G1BR3G, 0G1CP1G, 0G1CP1G-VERS.2004, 0G1FR7G, 0M0FA1, 0M0FR1G, 0M0FT1G, 0M0FT2G, 0M0FT4G...(Other models you can see in the webshop)		
<b>accessories for</b>	100009		
	<b>GEV No.</b>	101339	<b>Ref. No.</b> 37Q2100
	cover cap for piezoelectric igniter		
	<b>GEV No.</b>	106869	<b>Ref. No.</b> —
	cover cap for piezoelectric igniter ID ø 22mm ED ø 35mm H 25mm		
	<b>GEV No.</b>	107931	<b>Ref. No.</b> —
	cover cap for piezoelectric igniter ID ø 21mm ED ø 36mm		

<b>accessories</b>			
			
1			
<b>GEV No.</b>	101339	<b>Ref. No.</b>	37Q2100
<b>description</b>	cover cap for piezoelectric igniter		
<b>For models:</b>	0A0BMG, 0A0FAVA, 0A0FT1G, 0A0FT2G, 0A0FT4G, 0A0FT5G, 0A0GRG, 0A1CP1G, 0B0FT1G, 0B0FT2G, 0B0FT4G, 0B0FT5G, 0B1CP1G, 0D0BMG, 0D0FAVA, 0D0FT1G, 0D0FT2G, 0D0FT4G, 0D0FT5G, 0D0GRG, 0D1CP1G, 0G0FR5G, 0G0FT1G, 0G0FT1G-VERS.032008, 0G0FT2G, 0G0FT2G-VERS.032008, 0G0FT4G, 0G0FT4G-VERS.032008, 0G0FT5G, 0G0FT5G-VERS.032008, 0G0FT7G, 0G1BR3G, 0G1CP1G, 0G1CP1G-VERS.2004, 0G1FR7G, 191BR2EA, 1A0BMG, 1A0FA2, 1A0FA5, 1A0FAB, 1A0FAS2, 1A0FT1G, 1A0FT2G, 1A0FT3G, 1A0FT4G, 1A0FT6G, 1A0GRG, 1A0TP0, 1A1BR1E, 1A1BR2E...(Other models you can see in the webshop)		

			
1			
<b>GEV No.</b>	101730	<b>Ref. No.</b>	3191100
<b>description</b>	disc ID ø 18mm ED ø 31mm H 2mm		
<b>For models:</b>	0A0BMG, 0A0FAVA, 0A0FT1G, 0A0FT2G, 0A0FT4G, 0A0FT5G, 0A0GRG, 0A1CP1G, 0B0FT1G, 0B0FT2G, 0B0FT4G, 0B0FT5G, 0B1CP1G, 0D0BMG, 0D0FAVA, 0D0FT1G, 0D0FT2G, 0D0FT4G, 0D0FT5G, 0D0GRG, 0D1CP1G, 0G0FR5G, 0G0FT1G, 0G0FT2G, 0G0FT4G, 0G0FT5G, 0G1BR3G, 0G1CP1G, 0G1CP1G-VERS.2004, 0G1FR7G, 1A0BMG, 1A0FA2, 1A0FA5, 1A0FAB, 1A0FAS2, 1A0FT1G, 1A0FT2G, 1A0FT3G, 1A0FT4G, 1A0FT6G, 1A0GRG, 1A0TP0, 1A1CP1G, 1A1CP2G, 1A1FA1G, 1A1FA2G, 1A1FA4G, 1A1FA5G, 1A1FAAG, 1A1FABG...(Other models you can see in the webshop)		

			
1			
<b>GEV No.</b>	102485	<b>Ref. No.</b>	32T0040 32T0041 32T0050 32T0210
<b>description</b>	ignition unit outputs 2 220-240VAC 0.6VA 50-60Hz		
<b>For models:</b>	04WFAAV, 06WCP1GM, 06WFR3GD, 08WCP1GM, 08WFT1GV, 08WFT2GV, 08WFT3GV, 08WFT4GV, 08WFT6GV, 08WFT7GV, 08WGRGV, 090BM1G, 090FAA, 090FAVA, 090FT1G, 090FT2G, 090FT4G, 090FT5G, 090FT7G, 090GRG, 091CP1G, 091FR1G, 091FR1GD, 091FR3G, 091FR3GD, 0A1FR1G, 0A1FR1GD, 0A1FR1GD-VERS.2004, 0A1FR1G-VERS.2004, 0A1FR3G, 0A1FR3GD, 0B1FR1G, 0B1FR1GD, 0D1FR1G, 0D1FR1GD, 0D1FR1GD-VERS.2004, 0D1FR1G-VERS.2004, 0D1FR3G, 0D1FR3GD, 0G1FR3G, 0G1FR3GD, 10CP1GA, 10WFR4GD, 10WTPGV, 12CP1GA, 12WFA6G, 18CP2GA, 190BM2G, 190FAB, 190FT15G...(Other models you can see in the webshop)		

			
1			
<b>GEV No.</b>	103334	<b>Ref. No.</b>	3144130
<b>description</b>	ignition unit outputs 2 220-240VAC dimensions 83x42x32mm mounting distance 34mm inlet F2.8 outlet F2.8 type TSM 17VA 50/60Hz		
<b>For models:</b>	BX101G, BX101G-VERS.122013, BX122G, BX122G-VERS.122013, BX61G, BX61G-VERS.122013, BX82G, BX82G-VERS.122013, FX101G1R, FX101G2, FX101G2C, FX101G2C-VERS.032014, FX101G2R, FX101G2R-VERS.032014, FX101G2-VERS.032014, FX101G3, FX101G3C, FX101G3C-VERS.022014, FX101G3R, FX101G3R-VERS.022014, FX101G3-VERS.022014, FX10G2CR, FX10G2CR-VERS.032014, FX10G3CR, FX10G3CR-VERS.022014, FX122G1, FX122G2, FX122G2C, FX122G2T, FX122G2T-VERS.032014, FX122G3, FX122G3C, FX122G3T, FX122G3T-VERS.022014, FX12G3CT, FX12G3CT-VERS.022014, FX201G2, FX201G2P, FX201G2P-VERS.032014, FX201G2-VERS.032014, FX201G3P, FX201G3-VERS.022014, FX202G2, FX202G2-VERS.032014, FX202G3, FX202G3-VERS.022014, FX61G1, FX61G1R, FX61G2...(Other models you can see in the webshop)		

			
1			
<b>GEV No.</b>	101002	<b>Ref. No.</b>	3107650
<b>description</b>	ignition unit outputs 2 230VAC dimensions 88x23x34mm mounting distance 73mm inlet F6.3x0.8 outlet F2.8x0.8 0.6VA 50/60Hz		
<b>For models:</b>	091FR1ID-VERS.052012, 091FR11-VERS.032012, 091FR7G, 091FR7G5, 091FR7G-VERS.052012, 091FR7GX, 10CP11A, 12CP11A, 18CP21A, 191FR2ID-VERS.092012, 191FR21-VERS.032012		

			
1			
<b>GEV No.</b>	107548	<b>Ref. No.</b>	3134640
<b>description</b>	ignition unit outputs 4 220VAC dimensions 110x22x40mm mounting distance 100mm inlet F6.3x0.8 outlet F2.8x0.8 50-60Hz		
<b>For models:</b>	091FR11, 091FR11A, 091FR11D, 190FAA, 191FR21, 191FR21D		

1 gas components

Зип Общежит

vsezip.ru

7(812)987-08-81



1

<b>GEV No.</b>	102388	<b>Ref. No.</b>	32T0030
<b>description</b>	ignition unit outputs 4 230VAC dimensions 111x23x34mm mounting distance 100mm inlet F6.3x0.8 outlet F2.8x0.8 type WAC-T4 0.6VA 50/60Hz		



1

<b>GEV No.</b>	102389	<b>Ref. No.</b>	3015000
<b>description</b>	ignition unit outputs 6 230VAC dimensions 135x23x34mm mounting distance 123mm inlet F6.3x0.8 outlet F2.8x0.8 0.6VA 50/60Hz		
<b>For models:</b>	08WFA4E, 08WFA4G, 08WFAAE, 08WFAAG, 08WFAAV, 10WTPGE, 12WFA6E, 12WFA6G, 12WFAAA, 12WFAAE, 12WFAAG, 12WFAAN		



1

<b>GEV No.</b>	101004	<b>Ref. No.</b>	32T0070
<b>description</b>	ignition unit outputs 6 230VAC inlet F6.3x0.8 outlet F2.8x0.8 50Hz mounting ø 88mm		



1

<b>GEV No.</b>	101005	<b>Ref. No.</b>	32T0020
<b>description</b>	ignition unit outputs 8 230VAC dimensions 92x68x33mm mounting distance 88mm inlet F6.3x0.8 outlet F2.8x0.8 type BK 40086-00 0.6VA 50-60Hz		

thermocouples

plug-in thermocouples

plug-in thermocouples standard

with barrel socket ø6mm

type Junkers with aluminised tip

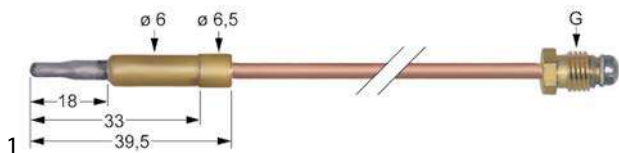

1

<b>GEV No.</b>	102229	<b>Ref. No.</b>	33A0360
<b>description</b>	thermocouple M10x1 L 1000mm plug connection ø6.0mm		

with barrel socket ø6(6.5)mm

thermocouples SIT

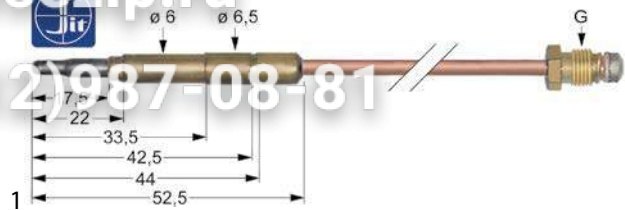

1

<b>GEV No.</b>	107621	<b>Ref. No.</b>	33A0370
<b>description</b>	thermocouple SIT M10x1 L 1500mm plug connection ø6.0(6.5)mm		

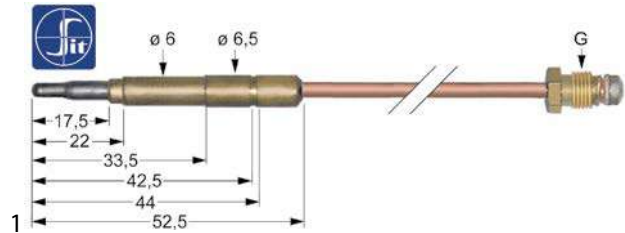

1

<b>GEV No.</b>	107605	<b>Ref. No.</b>	33A0520 33A0890
<b>description</b>	thermocouple SIT M8x1 L 1500mm plug connection ø6.0(6.5)mm		
<b>For models:</b>	071TP, 091TP, 1G1PD1G, 30CPS, 31, 31PD6, 31TC, 31TP, 32, 32TC, 32TP, 32TPV, 32V, 70CP, 71CP, 71CP2, 71PD10, 71PD15, 71TP, 72TP, 72TPGG, 90CP, 91CP		

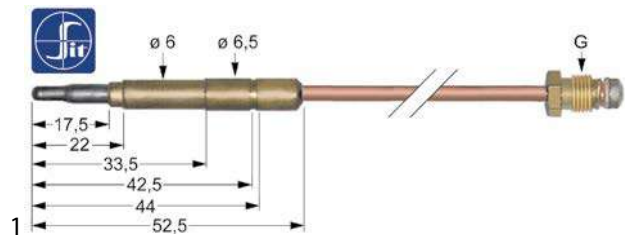

1

<b>GEV No.</b>	107600	<b>Ref. No.</b>	33A0390
<b>description</b>	thermocouple SIT M8x1 L 320mm plug connection ø6.0(6.5)mm		

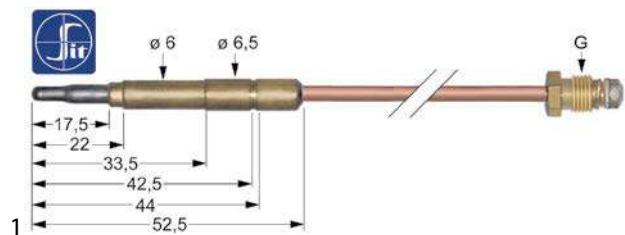

1

<b>GEV No.</b>	107601	<b>Ref. No.</b>	33A0400 33A1060
<b>description</b>	thermocouple SIT M8x1 L 600mm plug connection ø6.0(6.5)mm		
<b>For models:</b>	030, 030FT, 030FTR, 031, 031FT, 031FTR, 031FTRL, 031TP, 032, 070D, 070DGG, 070FT, 070FTR, 0712D, 0712VA, 071D, 071DGG, 071FT, 071FTR, 071FTRL, 072D, 072DGG, 090, 090FT, 090FTR, 090GG, 091, 091FT, 091FTR, 091FTRL, 091GG, 092, 092GG, 092VA, 092VAGG, 0A0FAS, 0B0FAS, 0D0FAS, 1A0FA2, 1A0FAS, 1A0FAB, 1A0FAS, 1A0FAS2, 1A1FA2G, 1A1FA5G, 1A1FABG, 1A1FAS2G, 1A1FASG, 1B0FAS, 1B0FAS2...(Other models you can see in the webshop)		



Зип Общежит

vsezip.ru

+7(812)987-08-81

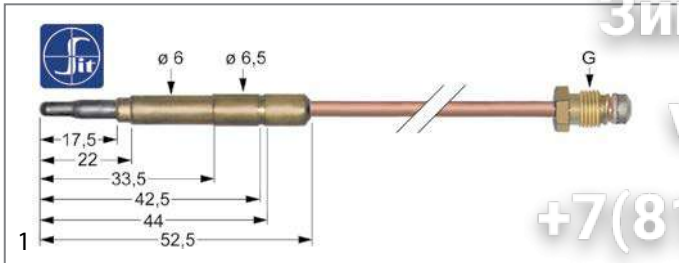

<b>GEV No.</b>	107612	<b>Ref. No.</b>	32A0310
<b>description</b>	thermocouple SIT M9x1 L 1000mm plug connection ø6.0(6.5)mm		

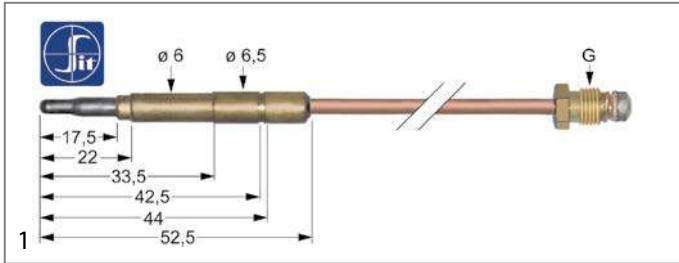

<b>GEV No.</b>	107614	<b>Ref. No.</b>	33A0320
<b>description</b>	thermocouple SIT M9x1 L 1500mm plug connection ø6.0(6.5)mm		

**For models:**  
 08WFA4G, 08WFAAG, 10WTPGE, 10WTPGV, 12WFA6G, 12WFAAG, 191FAAG, 191FABG, 191FADG, 191TPG, 1A1BR1G, 1A1BR1GA, 1A1BR2G, 1A1BR2GA, 1A1FA1G, 1A1FA2G, 1A1FA4G, 1A1FA5G, 1A1FAAG, 1A1FABG, 1A1TP0G-VERS.2002, 1B1FAS2G, 1B1FASG, 1D1BR1G, 1D1BR1GA, 1D1BR2G, 1D1BR2GA, 1D1FA1G, 1D1FA2G, 1D1FA4G, 1D1FA5G, 1D1FAAG, 1D1FABG, 1D1TP0G-VERS.2002, 1G1FA0G, 1G1FA0GV, 1G1FABG, 1G1FAPG, 1G1TP0G, 291FAG, 291TPCG, 2A1BR1G, 2A1BR1GA, 2A1BR2G, 2A1BR2GA, 2A1FA1G, 2A1FA4G, 2A1FAAG, 2A1TP3G, 2A1TP6G...(Other models you can see in the webshop)

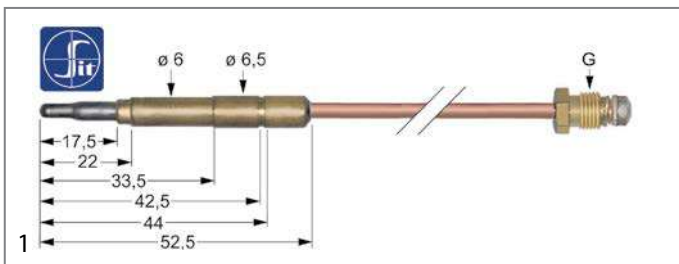

<b>GEV No.</b>	107609	<b>Ref. No.</b>	33A0310 33A0340
<b>description</b>	thermocouple SIT M9x1 L 600mm plug connection ø6.0(6.5)mm		

**For models:**  
 GR4A-ONR01, SM1L, SM1LA, SM1LAW, SM1LW, SM2L, SM2LR, SM2LW, SM2S, SM2SR, SM2SW, SM3S, SM3SR

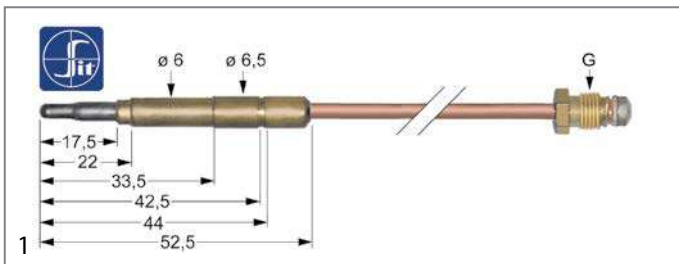

<b>GEV No.</b>	107611	<b>Ref. No.</b>	33A1140 33A1190
<b>description</b>	thermocouple SIT M9x1 L 850mm plug connection ø6.0(6.5)mm		

**For models:**  
 06WCP1GM, 070BM, 071BM, 08WCP1GM, 08WFT1GV, 08WFT2GV, 08WFT3GV, 08WFT7GV, 090BM, 091BM, 10WTPGE, 10WTPGV, 191BR1G, 191BR1GA, 191BR2G, 191BR2GA, 1A1FAS2G, 1A1FASG, 1A1PD1G, 1A1PD2G, 1A1PI1G, 1A1PI1GA, 1A1TP0G, 1D1FAS2G, 1D1FASG, 1D1PD1G, 1D1PD2G, 1D1PI1G, 1D1PI1GA, 1D1TP0G, 1G1BR1G, 291BR1G, 291BR1GA, 291BR2G, 291BR2GA, 2A1FAS2G, 2A1FASG, 2A1TPSG, 2D1FAS2G, 2D1FASG, 2D1TPSG, 31R, 3A1FASG, 3D1FASG, 6040560, 6042490, 6042500, 6043200, 712D, 712VA...(Other models you can see in the webshop)



<b>GEV No.</b>	102998	<b>Ref. No.</b>	33A0680
<b>description</b>	thermocouple M8x1 L 600mm plug connection ø6.0mm		

**For models:**  
 030, 030FT, 030FTR, 031, 031FT, 031FTR, 031FTRL, 031TP, 032, 04WFAAV, 070D, 070DGG, 070FT, 070FTR, 0712D, 0712VA, 071D, 071DGG, 071FT, 071FTR, 071FTRL, 072D, 072DGG, 08WFA4E, 08WFA4G, 08WFAAE, 08WFAAG, 08WFAAV, 08WGRGV, 090, 090FAA, 090FAVA, 090FT, 090FT1G, 090FT2G, 090FT7G, 090FTR, 090GG, 090GRG, 091, 091CP1G, 091FT, 091FTR, 091FTRL, 091GG, 092, 092GG, 092VA, 092VAGG, 0A0FA1...(Other models you can see in the webshop)

plug-in thermocouples with interruption

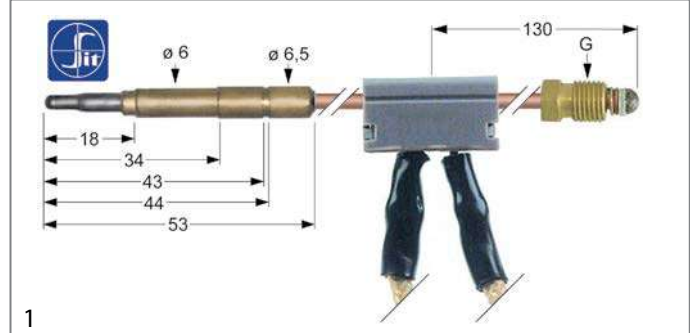

<b>GEV No.</b>	107863	<b>Ref. No.</b>	6021770
<b>description</b>	thermocouple SIT with interrupter M9x1 L 1000mm plug connection ø6.0(6.5)mm cable 820mm		

**For models:**  
 06WCP1GM, 06WFR3GD, 091CP1G, 091FR1G, 091FR1GD, 0G0FR5G, 0G1CP1G-VERS.2004, 0M0FR1G, 0M0FT4G, 0M0FT5G, 10CP1GA, 10WFR4GD, 12CP1GA, 18CP2GA, 191CP1G, 191CP2G, 191FR2G, 191FR2GD, 191PI1G, 191PI1GA, 191PI2G, 191PI2GA, 1A1FR2G, 1A1FR2GD, 1A1FR2GD-VERS.2004, 1A1FR2G-VERS.2004, 1A1FR4G, 1A1FR4GD, 1A1PI1G, 1A1PI1GA, 1D1FR2G, 1D1FR2GD, 1D1FR2GD-VERS.2004, 1D1FR2G-VERS.2004, 1D1FR4G, 1D1FR4GD, 1D1PI1G, 1D1PI1GA, 1G0FR6G, 1G1CP1G-VERS.2004, 1G1CP2G-VERS.2004, 1G1FR4G, 1G1FR4GD, 1G1PI1G, 1M0FR2G, 1M0FT4G, 1M0FT5G, 1M0FT6G, 291FAG, 2M0FT4G...(Other models you can see in the webshop)

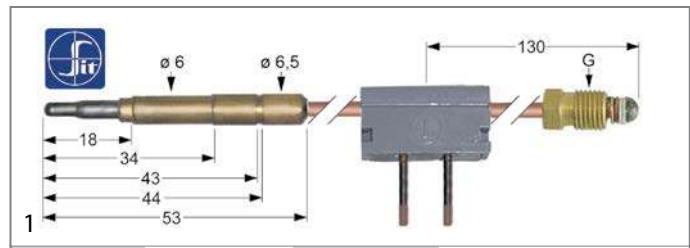

<b>GEV No.</b>	107164	<b>Ref. No.</b>	33A0900
<b>description</b>	thermocouple SIT with interrupter M9x1 L 1000mm plug connection ø6.0(6.5)mm soldering connection		

**For models:**  
 0M0FR1G, 0M0FT4G, 0M0FT5G, 191PI1G, 191PI1GA, 191PI2G, 191PI2GA, 1A1PI1G, 1A1PI1GA, 1D1PI1G, 1D1PI1GA, 1G1PI1G, 1M0FR2G, 1M0FT4G, 1M0FT5G, 1M0FT6G, 2M0FT4G, 2M0FT5G, 2M0FT6G, 30F, 30F1, 30F1B, 30FS, 30FS2, 30FS2B, 31PI6, 70F, 70F1, 70F1B, 71F, 71F2, 71F2B, 71PI10, 71PI10A, 90F110B, 91F210, 91F210B, 91F223B, 91PI10, 91PI10A, FC101, FC241, FC241G, FC61, FCV101, FCV101DM, FCV101DS, FCV141, FCV141DM, FCV141DS...(Other models you can see in the webshop)

1 gas components



Зип.Общепит

accessories

screws

vsezip.ru

+7(812)987-08-81

<b>GEV No.</b>	100920	<b>Ref. No.</b>	33Q2940
<b>description</b>	thermocouple fitting thread M8x1 / M9x1 Qty 1 pcs		
<b>For models:</b>	06WCP1GM, 08WCP1GM, 090FT1G, 090FT2G, 090FT7G, 091CP1G, 0A0FT4G, 0A0FT5G, 0B0FT1G, 0B0FT2G, 0B0FT4G, 0B0FT5G, 0D0FT4G, 0D0FT5G, 0G0FT4G, 0G0FT5G, 0G1CP1G-VERS.2004, 190FT1G, 190FT2G, 190FT3G, 190FT4G, 190FT6G, 190FT7G, 191CP1G, 191CP2G, 1A0FT4G, 1A0FT6G, 1A1PD2G, 1A1PI1G, 1A1PI1GA, 1B0FT4G, 1B0FT6G, 1D0FT4G, 1D0FT6G, 1D1PD2G, 1D1PI1G, 1D1PI1GA, 1G0FT4G, 1G0FT6G, 1G1CP1G-VERS.2004, 1G1CP2G-VERS.2004, 1G1PI1G, 31PI6, 71PI10, 71PI10A, 91PI10, 91PI10A, G1FAGS, G1FAGST		

miscellaneous



<b>GEV No.</b>	100950	<b>Ref. No.</b>	35T0680
<b>description</b>	fastening angle Qty 1 pcs		

gas burners

hob burners

producer-specific hob burners

ANGELO PO

Alpha (1), Delta (2), Gamma series



<b>GEV No.</b>	104792	<b>Ref. No.</b>	34A2040
<b>description</b>	burner cap ø 110mm		
<b>For models:</b>	0A0FA1, 0A0FA4, 0D0FA1, 0G0FA0, 1A0FA1, 1A0FA2, 1A1FA1G, 1A1FA2G, 1D0FA1, 1D0FA2, 1D1FA1G, 1D1FA2G, 1G0FA0, 1G1FA0E, 1G1FA0EV, 1G1FA0G, 1G1FA0GV, 1G1FAPG, 2A0FA1, 2A1FA1G, 2A1TP3G, 2D0FA1, 2D1FA1G, 2D1TP3G, 2G0FA0, 2G1FA0G, 2G1FAPG, 2G1TP3G, 3A1FA1G, 3D1FA1G, 6FA		



<b>GEV No.</b>	104790	<b>Ref. No.</b>	34A2060
<b>description</b>	burner cap ø 130mm 7.5kW		
<b>For models:</b>	0A0FA1, 0A0FA4, 0D0FA1, 0D0FA4, 1A0FA1, 1A0FA2, 1A0FA4, 1A0FA5, 1A1FA1G, 1A1FA2G, 1A1FA4G, 1A1FA5G, 1D0FA1, 1D0FA2, 1D0FA4, 1D0FA5, 1D1FA1G, 1D1FA2G, 1D1FA4G, 1D1FA5G, 2A0FA1, 2A0FA4, 2A1FA1G, 2A1FA4G, 2A1TP3G, 2A1TP6G, 2D0FA1, 2D0FA4, 2D1FA1G, 2D1FA4G, 2D1TP3G, 2D1TP6G, 3A1FA1G, 3A1FA4G, 3D1FA1G, 3D1FA4G		

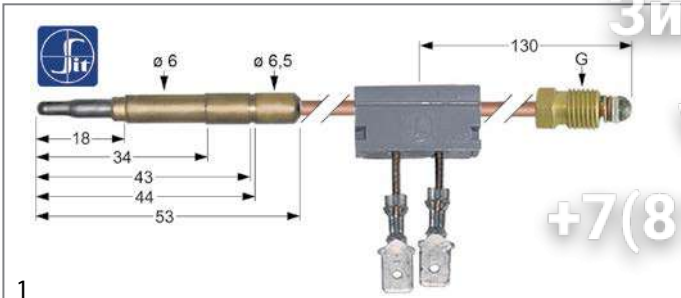

<b>GEV No.</b>	107177	<b>Ref. No.</b>	33A0140
<b>description</b>	thermocouple SIT with interrupter M9x1 L 600mm plug connection ø6.0mm F 6.3mm		
<b>For models:</b>	031FT04, 031FT06, 070FT04, 070FT05, 071FT04, 071FT06, 08WFT4GV, 08WFT6GV, 090BM1G, 090FT04, 090FT05, 090FT4G, 090FT5G, 091FR3G, 091FR3GD, 091FT04, 091FT06, 0A0BMG, 0A0FT1G, 0A0FT2G, 0A0FT4G, 0A0FT5G, 0A1FR1G, 0A1FR1GD, 0A1FR1GD-VERS.2004, 0A1FR1G-VERS.2004, 0A1FR3G, 0A1FR3GD, 0B0FT1G, 0B0FT2G, 0B0FT4G, 0B0FT5G, 0B1FR1G, 0B1FR1GD, 0D0BMG, 0D0FT1G, 0D0FT2G, 0D0FT4G, 0D0FT5G, 0D1FR1G, 0D1FR1GD, 0D1FR1GD-VERS.2004, 0D1FR1G-VERS.2004, 0D1FR3G, 0D1FR3GD, 0G0FR5G, 0G0FT4G, 0G0FT5G, 0G1BR3G, 0G1FR3G...(Other models you can see in the webshop)		

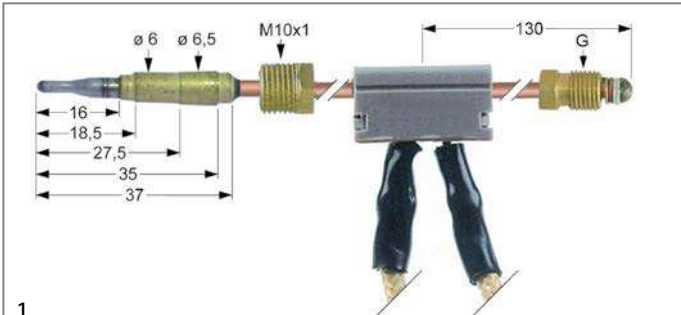

<b>GEV No.</b>	102252	<b>Ref. No.</b>	33A1410 6021780
<b>description</b>	thermocouple with interrupter M9x1 L 600mm plug connection ø6.0mm cable 650mm		
<b>For models:</b>	06WFR3GD, 090BM1G, 090FT4G, 090FT5G, 091FR1G, 091FR1GD, 091FR3G, 091FR3GD, 0A0BMG, 0A1FR1G, 0A1FR1GD, 0A1FR1GD-VERS.2004, 0A1FR1G-VERS.2004, 0B1FR1G, 0B1FR1GD, 0D0BMG, 0D1FR1G, 0D1FR1GD, 0D1FR1GD-VERS.2004, 0D1FR1G-VERS.2004, 0G0FT4G, 0G0FT4G-VERS.032008, 0G0FT5G, 0G0FT5G-VERS.032008, 0G1BR3G, 0G1FR3G, 0G1FR3GD, 0G1FR7G, 10WFR4GD, 190BM2G, 190FT15G, 190FT42G, 190FT4G, 190FT6G, 191FR2G, 191FR2GD, 191FR4G, 191FR4GD, 1A0BMG, 1A1FR2G, 1A1FR2GD, 1A1FR2GD-VERS.2004, 1A1FR2G-VERS.2004, 1A1FR4G, 1A1FR4GD, 1D0BMG, 1D1FR2G, 1D1FR2GD, 1D1FR2GD-VERS.2004, 1D1FR2G-VERS.2004...(Other models you can see in the webshop)		

extensions



<b>GEV No.</b>	102013	<b>Ref. No.</b>	33A0130 33A1270
<b>description</b>	thermocouple extension thread M9x1 L 500mm		
<b>For models:</b>	031FT04, 031FT06, 1A1BR1G, 1A1BR1GA, 1A1BR2G, 1A1BR2GA, 1D1BR1G, 1D1BR1GA, 1D1BR2G, 1D1BR2GA, 2A1BR1G, 2A1BR1GA, 2A1BR2G, 2A1BR2GA, 2D1BR1G, 2D1BR1GA, 2D1BR2G, 2D1BR2GA		
<b>accessories for</b>	102013		
	<b>GEV No.</b>	101261	<b>Ref. No.</b> —
	thermocouple fitting thread M9x1 Qty 1 pcs		



Зип Общепит

vsezip.ru

+7(812)987



<b>GEV No.</b>	104756	<b>Ref. No.</b>	34A2030 34A2032
<b>description</b>	burner head for burner cap ø 110mm new edition		
<b>For models:</b>	0A0FA1, 0A0FA4, 0D0FA1, 0G0FA0, 1A0FA1, 1A0FA2, 1A1FA1G, 1A1FA2G, 1D0FA1, 1D0FA2, 1D1FA1G, 1D1FA2G, 1G0FA0, 1G1FA0E, 1G1FA0EV, 1G1FA0G, 1G1FA0GV, 1G1FAPG, 2A0FA1, 2A1FA1G, 2A1TP3G, 2D0FA1, 2D1FA1G, 2D1TP3G, 2G0FA0, 2G1FA0G, 2G1FADG, 2G1FADGV, 2G1FAPG, 2G1TP3G, 3A1FA1G, 3D1FA1G		



<b>GEV No.</b>	104794	<b>Ref. No.</b>	34A2050 34A2051 34A2052
<b>description</b>	burner head for burner cap ø 130mm new edition		
<b>For models:</b>	0A0FA1, 0A0FA4, 0D0FA1, 0D0FA4, 1A0FA1, 1A0FA2, 1A0FA4, 1A0FA5, 1A1FA1G, 1A1FA2G, 1A1FA4G, 1A1FA5G, 1D0FA1, 1D0FA2, 1D0FA4, 1D0FA5, 1D1FA1G, 1D1FA2G, 1D1FA4G, 1D1FA5G, 2A0FA1, 2A0FA4, 2A1FA1G, 2A1FA4G, 2A1TP3G, 2A1TP6G, 2D0FA1, 2D0FA4, 2D1FA1G, 2D1FA4G, 2D1TP3G, 2D1TP6G, 3A1FA1G, 3A1FA4G, 3D1FA1G, 3D1FA4G		



<b>GEV No.</b>	104059	<b>Ref. No.</b>	3311911 34A2070 34A2071
<b>description</b>	burner lower part for burner cap ø 80/110mm		
<b>For models:</b>	08WFA4E, 090FAA, 0A0FA1, 0A0FA4, 0D0FA1, 0D0FA4, 0G0FA0, 12WFA6E, 190FA, 190FAA, 190FAB, 190FAD, 191FAAE, 191FAAG, 191FABG, 191FADG, 191FAE, 191FAG, 1A0FA1, 1A0FA2, 1A0FA4, 1A0FA5, 1A1FA1G, 1A1FA2G, 1A1FA4G, 1A1FA5G, 1D0FA1, 1D0FA2, 1D0FA4, 1D0FA5, 1D1FA1G, 1D1FA2G, 1D1FA4G, 1D1FA5G, 1G0FA0, 1G0FA0B, 1G1FA0E, 1G1FA0EV, 1G1FA0G, 1G1FA0GV, 1G1FABG, 1G1FAPG, 290FA, 291FAG, 291FAGF, 291TPCG, 2A0FA1, 2A0FA4, 2A1FA1G, 2A1FA4G...(Other models you can see in the webshop)		



<b>GEV No.</b>	104006	<b>Ref. No.</b>	34A2020
<b>description</b>	nozzle holder		
<b>For models:</b>	08WFA4E, 090FAA, 0A0FA1, 0A0FA4, 0D0FA1, 0D0FA4, 0G0FA0, 12WFA6E, 190FA, 190FAA, 190FAB, 190FAD, 191FAAE, 191FAAG, 191FABG, 191FADG, 191FAE, 191FAG, 1A0FA1, 1A0FA2, 1A0FA4, 1A0FA5, 1A1FA1G, 1A1FA2G, 1A1FA4G, 1A1FA5G, 1D0FA1, 1D0FA2, 1D0FA4, 1D0FA5, 1D1FA1G, 1D1FA2G, 1D1FA4G, 1D1FA5G, 1G0FA0, 1G0FA0B, 1G1FA0E, 1G1FA0EV, 1G1FA0G, 1G1FA0GV, 1G1FABG, 1G1FAPG, 290FA, 291FAG, 291FAGF, 291TPCG, 2A0FA1, 2A0FA4, 2A1FA1G, 2A1FA4G...(Other models you can see in the webshop)		



<b>GEV No.</b>	532541	<b>Ref. No.</b>	3152040
<b>description</b>	O-ring silicone thickness 1.78mm ID ø 47.35mm Qty 1 pcs		
<b>For models:</b>	04WFAAV, 08WFA4E, 08WFA4G, 08WFAAE, 08WFAAG, 08WFAAV, 090FAA, 0A0FA1, 0A0FA4, 0D0FA1, 0D0FA4, 0D0FAA, 0G0FA0, 12WFA6E, 12WFA6G, 12WFAAA, 12WFAAE, 12WFAAG, 12WFAAN, 190FA, 190FAA, 190FAB, 190FAD, 191FAAE, 191FAAG, 191FABG, 191FADG, 191FAE, 191FAG, 1A0FA1, 1A0FA2, 1A0FA4, 1A0FA5, 1A0FAA, 1A0FAB, 1A1FA1G, 1A1FA2G, 1A1FA4G, 1A1FA5G, 1A1FAAG, 1A1FABG, 1D0FA1, 1D0FA2, 1D0FA4, 1D0FA5, 1D0FAA, 1D0FAB, 1D1FA1G, 1D1FA2G...(Other models you can see in the webshop)		





<b>GEV No.</b>	104793	<b>Ref. No.</b>	34A2010
<b>description</b>	venturi ø 12mm		
<b>For models:</b>	0A0FA1, 0A0FA4, 0D0FA1, 0G0FA0, 1A0FA1, 1A0FA2, 1A1FA1G, 1A1FA2G, 1D0FA1, 1D0FA2, 1D1FA1G, 1D1FA2G, 1G0FA0, 1G0FA0B, 1G1FA0E, 1G1FA0EV, 1G1FA0G, 1G1FA0GV, 1G1FABG, 1G1FAPG, 2A0FA1, 2A1FA1G, 2A1TP3G, 2D0FA1, 2D1FA1G, 2D1TP3G, 2G0FA0, 2G0FA0B, 2G1FA0E, 2G1FA0G, 2G1FA0GV, 2G1FABG, 2G1FACG, 2G1FADG, 2G1FADGV, 2G1FAPG, 2G1TP3G, 3A1FA1G, 3D1FA1G, 6FA		



<b>GEV No.</b>	104005	<b>Ref. No.</b>	34A2000
<b>description</b>	venturi ø 14.5mm		
<b>For models:</b>	08WFA4E, 090FAA, 0A0FA1, 0A0FA4, 0D0FA1, 0D0FA4, 12WFA6E, 190FA, 190FAA, 190FAB, 190FAD, 191FAAE, 191FAAG, 191FABG, 191FADG, 191FAE, 191FAG, 1A0FA1, 1A0FA2, 1A0FA4, 1A0FA5, 1A1FA1G, 1A1FA2G, 1A1FA4G, 1A1FA5G, 1D0FA1, 1D0FA2, 1D0FA4, 1D0FA5, 1D1FA1G, 1D1FA2G, 1D1FA4G, 1D1FA5G, 290FA, 291FAG, 291FAGF, 291TPCG, 2A0FA1, 2A0FA4, 2A1FA1G, 2A1FA4G, 2A1TP3G, 2A1TP6G, 2D0FA1, 2D0FA4, 2D1FA1G, 2D1FA4G, 2D1TP3G, 2D1TP6G, 391FAG...(Other models you can see in the webshop)		

Serie Alpha (2), Delta (3), Omega (2)





<b>GEV No.</b>	104740	<b>Ref. No.</b>	3019390
<b>description</b>	burner cap ø 110mm 7kW		
<b>For models:</b>	04WFAAV, 08WFA4E, 08WFA4G, 08WFAAE, 08WFAAG, 08WFAAV, 090FAA, 0A0FAA, 0D0FAA, 0G0FA0, 12WFA6E, 12WFA6G, 12WFAAA, 12WFAAE, 12WFAAG, 12WFAAN, 190FA, 190FAA, 190FAB, 190FAD, 191FAAE, 191FAAG, 191FABG, 191FADG, 191FAE, 191FAG, 1A0FAA, 1A0FAB, 1A1FAAG, 1A1FABG, 1D0FAA, 1D0FAB, 1D1FABG, 1G0FA0, 1G0FA0B, 1G1FA0E, 1G1FA0EV, 1G1FA0G, 1G1FA0GV, 1G1FABG, 1G1FAPG, 290FA, 291FAG, 291FAGF, 291TPCG, 2A0FAA, 2A1FAAG, 2A1TPCG, 2D0FAA...(Other models you can see in the webshop)		
<b>accessories for</b>	104740		
	<b>GEV No.</b>	104739	<b>Ref. No.</b> 3019380
	<b>description</b>	burner head for burner cap ø 110mm 7kW	
	<b>GEV No.</b>	108142	<b>Ref. No.</b> 6013760 6013761 6013762
	<b>description</b>	venturi for burner cap ø 110mm suitable for burner 7kW	

1 gas components

Зип Общепит  
vsezip.ru  
+7(812)987 08 81



			
<b>1</b>			
<b>GEV No.</b>	104081	<b>Ref. No.</b>	3019370
<b>description</b>	burner cap ø 130mm 10kW		
<b>For models:</b>	04WFAAV, 08WFA4E, 08WFA4G, 08WFAAE, 08WFAAG, 08WFAAV, 090FAA, 0A0FAA, 0D0FAA, 12WFA6E, 12WFA6G, 12WFAAA, 12WFAAE, 12WFAAG, 12WFAAN, 190FA, 190FAA, 190FAB, 191FAAE, 191FAAG, 191FABG, 191FAE, 191FAG, 1A0FAA, 1A0FAB, 1A1FAAG, 1A1FABG, 1D0FAA, 1D0FAB, 1D1FAAG, 1D1FABG, 290FA, 291FAG, 291FAGF, 291TPCG, 2A0FAA, 2A1FAAG, 2A1TPCG, 2D0FAA, 2D1FAAG, 2D1TPCG, 391FAG, 3A1FAAG, 3D1FAAG		

			
<b>1</b>			
<b>GEV No.</b>	104298	<b>Ref. No.</b>	3057610
<b>description</b>	burner cap ø 80mm 4kW		
<b>For models:</b>	190FA, 190FAD, 191FADG, 191FAE, 191FAG, 1G0FA0, 1G1FA0E, 1G1FA0EV, 1G1FA0G, 1G1FA0GV, 290FA, 291FAG, 291FAGF, 2G0FA0, 2G0FA0A, 2G1FA0E, 2G1FA0G, 2G1FA0GV, 2G1FACG, 2G1FADG, 2G1FADGV, 391FAG, 6FA, 6FA1		
<b>accessories for</b>	104298		
	<b>GEV No.</b>	104297	<b>Ref. No.</b> 3057600
burner head for burner cap ø 80mm 4kW			
	<b>GEV No.</b>	108141	<b>Ref. No.</b> 6020730 6020731
venturi for burner cap ø 80mm suitable for burner 4kW			

			
<b>1</b>			
<b>GEV No.</b>	104739	<b>Ref. No.</b>	3019380
<b>description</b>	burner head for burner cap ø 110mm 7kW		
<b>For models:</b>	04WFAAV, 08WFA4E, 08WFA4G, 08WFAAE, 08WFAAG, 08WFAAV, 090FAA, 0A0FAA, 0D0FAA, 0G0FA0, 12WFA6E, 12WFA6G, 12WFAAA, 12WFAAE, 12WFAAG, 12WFAAN, 190FA, 190FAA, 190FAB, 190FAD, 191FAAE, 191FAAG, 191FABG, 191FADG, 191FAE, 191FAG, 1A0FAA, 1A0FAB, 1A1FAAG, 1A1FABG, 1D0FAA, 1D0FAB, 1D1FAAG, 1D1FABG, 1G0FA0, 1G0FA0B, 1G1FA0E, 1G1FA0EV, 1G1FA0G, 1G1FA0GV, 1G1FABG, 1G1FAPG, 290FA, 291FAG, 291FAGF, 291TPCG, 2A0FAA, 2A1FAAG, 2A1TPCG, 2D0FAA...(Other models you can see in the webshop)		
<b>accessories for</b>	104739		
	<b>GEV No.</b>	104740	<b>Ref. No.</b> 3019390
burner cap ø 110mm 7kW			
	<b>GEV No.</b>	108142	<b>Ref. No.</b> 6013760 6013761 6013762
venturi for burner cap ø 110mm suitable for burner 7kW			

			
<b>1</b>			
<b>GEV No.</b>	104097	<b>Ref. No.</b>	3019360
<b>description</b>	burner head for burner cap ø 130mm 10kW		
<b>For models:</b>	04WFAAV, 08WFA4E, 08WFA4G, 08WFAAE, 08WFAAG, 08WFAAV, 090FAA, 0A0FAA, 0D0FAA, 12WFA6E, 12WFA6G, 12WFAAA, 12WFAAE, 12WFAAG, 12WFAAN, 190FA, 190FAA, 190FAB, 191FAAE, 191FAAG, 191FABG, 191FAE, 191FAG, 1A0FAA, 1A0FAB, 1A1FAAG, 1A1FABG, 1D0FAA, 1D0FAB, 1D1FAAG, 1D1FABG, 290FA, 291FAG, 291FAGF, 291TPCG, 2A0FAA, 2A1FAAG, 2A1TPCG, 2D0FAA, 2D1FAAG, 2D1TPCG, 391FAG, 3A1FAAG, 3D1FAAG		
<b>accessories for</b>	104097		
	<b>GEV No.</b>	104007	<b>Ref. No.</b> 6014830 6014831 6014832
burner lower part for burner cap ø 130mm complete with venturi and nozzle holder			

			
<b>1</b>			
<b>GEV No.</b>	104297	<b>Ref. No.</b>	3057600
<b>description</b>	burner head for burner cap ø 80mm 4kW		
<b>For models:</b>	190FA, 190FAD, 191FADG, 191FAE, 191FAG, 1G0FA0, 1G1FA0E, 1G1FA0EV, 1G1FA0G, 1G1FA0GV, 290FA, 291FAG, 291FAGF, 2G0FA0, 2G0FA0A, 2G1FA0E, 2G1FA0G, 2G1FA0GV, 2G1FACG, 2G1FADG, 2G1FADGV, 391FAG, 6FA, 6FA1		
<b>accessories for</b>	104297		
	<b>GEV No.</b>	104298	<b>Ref. No.</b> 3057610
burner cap ø 80mm 4kW			
	<b>GEV No.</b>	108141	<b>Ref. No.</b> 6020730 6020731
venturi for burner cap ø 80mm suitable for burner 4kW			

			
<b>1</b>			
<b>GEV No.</b>	104007	<b>Ref. No.</b>	6014830 6014831 6014832
<b>description</b>	burner lower part for burner cap ø 130mm complete with venturi and nozzle holder		
<b>For models:</b>	04WFAAV, 08WFA4E, 08WFA4G, 08WFAAE, 08WFAAG, 08WFAAV, 090FAA, 0A0FAA, 0D0FAA, 12WFA6E, 12WFA6G, 12WFAAA, 12WFAAE, 12WFAAG, 12WFAAN, 190FA, 190FAA, 190FAB, 191FAAE, 191FAAG, 191FABG, 191FAE, 191FAG, 1A0FAA, 1A0FAB, 1A1FAAG, 1A1FABG, 1D0FAA, 1D0FAB, 1D1FAAG, 1D1FABG, 290FA, 291FAG, 291FAGF, 291TPCG, 2A0FAA, 2A1FAAG, 2A1TPCG, 2D0FAA, 2D1FAAG, 2D1TPCG, 391FAG, 3A1FAAG, 3D1FAAG		
<b>accessories for</b>	104007		
	<b>GEV No.</b>	104097	<b>Ref. No.</b> 3019360
burner head for burner cap ø 130mm 10kW			





Зип Общепит  
vsezip.ru  
7(812)987-08-81

			
1			
<b>GEV No.</b>	104059	<b>Ref. No.</b>	3311911 34A2070 34A2071
<b>description</b>	burner lower part for burner cap ø 80/110mm		
<b>For models:</b>	08WFA4E, 090FAA, 0A0FA1, 0A0FA4, 0D0FA1, 0D0FA4, 0G0FA0, 12WFA6E, 190FA, 190FAA, 190FAB, 190FAD, 191FAAE, 191FAAG, 191FABG, 191FADG, 191FAE, 191FAG, 1A0FA1, 1A0FA2, 1A0FA4, 1A0FA5, 1A1FA1G, 1A1FA2G, 1A1FA4G, 1A1FA5G, 1D0FA1, 1D0FA2, 1D0FA4, 1D0FA5, 1D1FA1G, 1D1FA2G, 1D1FA4G, 1D1FA5G, 1G0FA0, 1G0FA0B, 1G1FA0E, 1G1FA0EV, 1G1FA0G, 1G1FA0GV, 1G1FABG, 1G1FAPG, 290FA, 291FAG, 291FAGF, 291TPCG, 2A0FA1, 2A0FA4, 2A1FA1G, 2A1FA4G...(Other models you can see in the webshop)		

			
1			
<b>GEV No.</b>	104006	<b>Ref. No.</b>	34A2020
<b>description</b>	nozzle holder		
<b>For models:</b>	08WFA4E, 090FAA, 0A0FA1, 0A0FA4, 0D0FA1, 0D0FA4, 0G0FA0, 12WFA6E, 190FA, 190FAA, 190FAB, 190FAD, 191FAAE, 191FAAG, 191FABG, 191FADG, 191FAE, 191FAG, 1A0FA1, 1A0FA2, 1A0FA4, 1A0FA5, 1A1FA1G, 1A1FA2G, 1A1FA4G, 1A1FA5G, 1D0FA1, 1D0FA2, 1D0FA4, 1D0FA5, 1D1FA1G, 1D1FA2G, 1D1FA4G, 1D1FA5G, 1G0FA0, 1G0FA0B, 1G1FA0E, 1G1FA0EV, 1G1FA0G, 1G1FA0GV, 1G1FABG, 1G1FAPG, 290FA, 291FAG, 291FAGF, 291TPCG, 2A0FA1, 2A0FA4, 2A1FA1G, 2A1FA4G...(Other models you can see in the webshop)		

			
1			
<b>GEV No.</b>	532541	<b>Ref. No.</b>	3152040
<b>description</b>	O-ring silicone thickness 1.78mm ID ø 47.35mm Qty 1 pcs		
<b>For models:</b>	04WFAAV, 08WFA4E, 08WFA4G, 08WFAAE, 08WFAAG, 08WFAAV, 090FAA, 0A0FA1, 0A0FA4, 0A0FAA, 0D0FA1, 0D0FA4, 0D0FAA, 0G0FA0, 12WFA6E, 12WFA6G, 12WFAAA, 12WFAAE, 12WFAAG, 12WFAAN, 190FA, 190FAA, 190FAB, 190FAD, 191FAAE, 191FAAG, 191FABG, 191FADG, 191FAE, 191FAG, 1A0FA1, 1A0FA2, 1A0FA4, 1A0FA5, 1A0FAA, 1A0FAB, 1A1FA1G, 1A1FA2G, 1A1FA4G, 1A1FA5G, 1A1FAAG, 1A1FABG, 1D0FA1, 1D0FA2, 1D0FA4, 1D0FA5, 1D0FAB, 1D1FA1G, 1D1FA2G...(Other models you can see in the webshop)		



			
1			
<b>GEV No.</b>	108142	<b>Ref. No.</b>	6013760 6013761 6013762
<b>description</b>	venturi for burner cap ø 110mm suitable for burner 7kW		
<b>For models:</b>	04WFAAV, 08WFA4E, 08WFA4G, 08WFAAE, 08WFAAG, 08WFAAV, 090FAA, 0A0FAA, 0D0FAA, 12WFA6E, 12WFA6G, 12WFAAA, 12WFAAE, 12WFAAG, 12WFAAN, 190FA, 190FAA, 190FAB, 190FAD, 191FAAE, 191FAAG, 191FABG, 191FADG, 191FAE, 191FAG, 1A0FAA, 1A0FAB, 1A1FAAG, 1A1FABG, 1D0FAA, 1D0FAB, 1D1FAAG, 1D1FABG, 290FA, 291FAG, 291FAGF, 291TPCG, 2A0FAA, 2A1FAAG, 2A1TPCG, 2D0FAA, 2D1FAAG, 2D1TPCG, 391FAG, 3A1FAAG, 3D1FAAG		
<b>accessories for</b>	108142		
	<b>GEV No.</b>	104739	<b>Ref. No.</b> 3019380
burner head for burner cap ø 110mm 7kW			
	<b>GEV No.</b>	104740	<b>Ref. No.</b> 3019390
burner cap ø 110mm 7kW			

			
1			
<b>GEV No.</b>	108141	<b>Ref. No.</b>	6020730 6020731
<b>description</b>	venturi for burner cap ø 80mm suitable for burner 4kW		
<b>For models:</b>	190FA, 190FAD, 191FADG, 191FAE, 191FAG, 1G0FA0, 1G1FA0E, 1G1FA0EV, 1G1FA0G, 1G1FA0GV, 290FA, 291FAG, 291FAGF, 2G0FA0, 2G0FA0A, 2G1FA0E, 2G1FA0G, 2G1FA0GV, 2G1FACG, 2G1FADG, 2G1FADGV, 391FAG		
<b>accessories for</b>	108141		
	<b>GEV No.</b>	104297	<b>Ref. No.</b> 3057600
burner head for burner cap ø 80mm 4kW			
	<b>GEV No.</b>	104298	<b>Ref. No.</b> 3057610
burner cap ø 80mm 4kW			

			
1			
<b>GEV No.</b>	104058	<b>Ref. No.</b>	3057620
<b>description</b>	venturi ø 11mm		
<b>For models:</b>	190FA, 190FAD, 191FADG, 191FAE, 191FAG, 1G0FA0, 1G1FA0E, 1G1FA0EV, 1G1FA0G, 1G1FA0GV, 290FA, 291FAG, 291FAGF, 2G0FA0, 2G0FA0A, 2G1FA0E, 2G1FA0G, 2G1FA0GV, 2G1FACG, 2G1FADG, 2G1FADGV, 391FAG, 6FA, 6FA1		

			
1			
<b>GEV No.</b>	104005	<b>Ref. No.</b>	34A2000
<b>description</b>	venturi ø 14.5mm		
<b>For models:</b>	08WFA4E, 090FAA, 0A0FA1, 0A0FA4, 0D0FA1, 0D0FA4, 12WFA6E, 190FA, 190FAA, 190FAB, 190FAD, 191FAAE, 191FAAG, 191FABG, 191FADG, 191FAE, 191FAG, 1A0FA1, 1A0FA2, 1A0FA4, 1A0FA5, 1A1FA1G, 1A1FA2G, 1A1FA4G, 1A1FA5G, 1D0FA1, 1D0FA2, 1D0FA4, 1D0FA5, 1D1FA1G, 1D1FA2G, 1D1FA4G, 1D1FA5G, 290FA, 291FAG, 291FAGF, 291TPCG, 2A0FA1, 2A0FA4, 2A1FA1G, 2A1FA4G, 2A1TP3G, 2A1TP6G, 2D0FA1, 2D0FA4, 2D1FA1G, 2D1FA4G, 2D1TP3G, 2D1TP6G, 391FAG...(Other models you can see in the webshop)		

Combi, Junior (1), Major series

			
1			
<b>GEV No.</b>	103014	<b>Ref. No.</b>	34A0050
<b>description</b>	burner cap ø 110mm		
<b>accessories for</b>	103014		
	<b>GEV No.</b>	104018	<b>Ref. No.</b> 36D0070
burner holder for burner cap ø 60/90/110mm with nozzle holder gas inlet M20x1.5			
	<b>GEV No.</b>	104026	<b>Ref. No.</b> 34A0090
burner head for burner cap ø 110mm			

Зип Общепит

<b>GEV No.</b>	103010	<b>Ref. No.</b>	34A0070
----------------	--------	-----------------	---------

**description** burner cap ø 60mm

**accessories for** 103010

<b>GEV No.</b>	104017	<b>Ref. No.</b>	36D0060
----------------	--------	-----------------	---------

**description** burner holder with nozzle holder gas inlet 1/4"

<b>GEV No.</b>	104024	<b>Ref. No.</b>	34A0060
----------------	--------	-----------------	---------

**description** burner head for burner cap ø 60mm

<b>GEV No.</b>	103015	<b>Ref. No.</b>	34A1130 34A1131 34A1133
<b>description</b>	burner cap ø 110mm		
<b>For models:</b>	030, 031, 032, 0712D, 071D, 071DGG, 072D, 072DGG, 091, 091GG, 092, 092GG, 092VA, 092VAGG, 1A0FAS, 1B0FAS, 1B1FASG, 1D0FAS, 1D1FASG, 2A0FAS2, 2A1FAS2G, 2D0FAS2, 2D1FAS2G, 2D1FASG, 31, 31GE, 31TC, 32, 32TC, 32TP, 32TPV, 32V, 3D1FASG, 712D, 71D, 71DGG, 71GE, 71GEGG, 72D, 72DGG, 72VA, 72VAGG, 72VAS, 72VASGG, 73D, 73DGG, 73VA, 73VAD, 73VADGG, 73VAGG		
<b>accessories for</b>	103015		
<b>GEV No.</b>	104015	<b>Ref. No.</b>	34A1110
<b>description</b>	burner head for burner cap ø 110mm		
<b>GEV No.</b>	104018	<b>Ref. No.</b>	36D0070
<b>description</b>	burner holder for burner cap ø 60/90/110mm with nozzle holder gas inlet M20x1.5		

<b>GEV No.</b>	103056	<b>Ref. No.</b>	34A0540
<b>description</b>	burner cap ø 119mm with central hole		

<b>GEV No.</b>	103016	<b>Ref. No.</b>	34A1140 34A1141
<b>description</b>	burner cap ø 140mm		
<b>For models:</b>	070D, 070DGG, 0712D, 0712VA, 071D, 071DGG, 072D, 072DGG, 090, 090GG, 091, 091GG, 092, 092GG, 092VA, 092VAGG, 0A0FAS, 0B0FAS, 0D0FAS, 1A0FAS, 1A0FAS2, 1A1FAS2G, 1A1FASG, 1B0FAS, 1B0FAS2, 1B1FAS2G, 1B1FASG, 1D0FAS, 1D0FAS2, 1D1FAS2G, 1D1FASG, 2A0FAS2, 2A1FAS2G, 2A1FASG, 2A1TPSG, 2D0FAS2, 2D1FAS2G, 2D1FASG, 2D1TPSG, 3A1FASG, 3D1FASG, 712D, 712VA, 71D, 71DGG, 71GE, 71GEGG, 72D, 72DGG, 72TP...(Other models you can see in the webshop)		
<b>accessories for</b>	103016		
<b>GEV No.</b>	104016	<b>Ref. No.</b>	34A1090 34A6760
<b>description</b>	burner head for burner cap ø 140mm		
<b>GEV No.</b>	104019	<b>Ref. No.</b>	36D1230
<b>description</b>	burner holder for burner cap ø 140mm gas inlet M20x1.5		
<b>GEV No.</b>	104022	<b>Ref. No.</b>	34A1401
<b>description</b>	burner head ø 139.5mm seat ø 122.8mm for burner cap ø 140mm int. ø 192.8mm int. ø 285.2mm		
<b>GEV No.</b>	104023	<b>Ref. No.</b>	36D2771
<b>description</b>	burner holder seat ø 35mm with nozzle holder		

<b>GEV No.</b>	103013	<b>Ref. No.</b>	34A0740 34A1120 34A1121 34A1123
<b>description</b>	burner cap ø 90mm		
<b>For models:</b>	030, 031, 032, 070D, 070DGG, 0712D, 0712VA, 071D, 071DGG, 072D, 072DGG, 090, 090GG, 091, 091GG, 092, 092GG, 092VA, 092VAGG, 0A0FAS, 0B0FAS, 0D0FAS, 1A0FAS, 1A0FAS2, 1A1FAS2G, 1A1FASG, 1B0FAS, 1B0FAS2, 1B1FAS2G, 1B1FASG, 1D0FAS, 1D0FAS2, 1D1FAS2G, 1D1FASG, 2A0FAS2, 2A1FAS2G, 2A1FASG, 2A1TPSG, 2D0FAS2, 2D1FAS2G, 2D1FASG, 2D1TPSG, 31, 31GE, 31TC, 32, 32TC, 32TP, 32TPV, 32V...(Other models you can see in the webshop)		
<b>accessories for</b>	103013		
<b>GEV No.</b>	104014	<b>Ref. No.</b>	34A1100
<b>description</b>	burner head for burner cap ø 90mm		
<b>GEV No.</b>	104018	<b>Ref. No.</b>	36D0070
<b>description</b>	burner holder for burner cap ø 60/90/110mm with nozzle holder gas inlet M20x1.5		

<b>GEV No.</b>	103011	<b>Ref. No.</b>	34A0750 34A1580
<b>description</b>	burner cap ø 60mm		
<b>accessories for</b>	103011		
<b>GEV No.</b>	104013	<b>Ref. No.</b>	34A0570
<b>description</b>	burner head for burner cap ø 60mm		
<b>GEV No.</b>	104018	<b>Ref. No.</b>	36D0070
<b>description</b>	burner holder for burner cap ø 60/90/110mm with nozzle holder gas inlet M20x1.5		

<b>GEV No.</b>	103012	<b>Ref. No.</b>	34A0040
<b>description</b>	burner cap ø 90mm		
<b>accessories for</b>	103012		
<b>GEV No.</b>	104018	<b>Ref. No.</b>	36D0070
<b>description</b>	burner holder for burner cap ø 60/90/110mm with nozzle holder gas inlet M20x1.5		
<b>GEV No.</b>	104025	<b>Ref. No.</b>	34A0080
<b>description</b>	burner head for burner cap ø 90mm		

<b>GEV No.</b>	103013	<b>Ref. No.</b>	34A0740 34A1120 34A1121 34A1123
<b>description</b>	burner cap ø 90mm		
<b>For models:</b>	030, 031, 032, 070D, 070DGG, 0712D, 0712VA, 071D, 071DGG, 072D, 072DGG, 090, 090GG, 091, 091GG, 092, 092GG, 092VA, 092VAGG, 0A0FAS, 0B0FAS, 0D0FAS, 1A0FAS, 1A0FAS2, 1A1FAS2G, 1A1FASG, 1B0FAS, 1B0FAS2, 1B1FAS2G, 1B1FASG, 1D0FAS, 1D0FAS2, 1D1FAS2G, 1D1FASG, 2A0FAS2, 2A1FAS2G, 2A1FASG, 2A1TPSG, 2D0FAS2, 2D1FAS2G, 2D1FASG, 2D1TPSG, 31, 31GE, 31TC, 32, 32TC, 32TP, 32TPV, 32V...(Other models you can see in the webshop)		
<b>accessories for</b>	103013		
<b>GEV No.</b>	104014	<b>Ref. No.</b>	34A1100
<b>description</b>	burner head for burner cap ø 90mm		
<b>GEV No.</b>	104018	<b>Ref. No.</b>	36D0070
<b>description</b>	burner holder for burner cap ø 60/90/110mm with nozzle holder gas inlet M20x1.5		



Table continues overleaf









Зип Общепит  
vsezip.ru

+7(812)987-08-81

<b>accessories for</b> 103013			
	<b>GEV No.</b> 104020	<b>Ref. No.</b> 34A1380	
burner head for burner cap ø 90mm			
	<b>GEV No.</b> 104023	<b>Ref. No.</b> 36D2771	
burner holder seat ø 35mm with nozzle holder			

	<b>GEV No.</b> 103055	<b>Ref. No.</b> 34A0530	
description burner cap ø 95mm with central hole			

	<b>GEV No.</b> 104015	<b>Ref. No.</b> 34A1110	
description burner head for burner cap ø 110mm			



	<b>GEV No.</b> 104026	<b>Ref. No.</b> 34A0090	
description burner head for burner cap ø 110mm			
<b>accessories for</b> 104026			
	<b>GEV No.</b> 103014	<b>Ref. No.</b> 34A0050	
burner cap ø 110mm			
	<b>GEV No.</b> 104018	<b>Ref. No.</b> 36D0070	
burner holder for burner cap ø 60/90/110mm with nozzle holder gas inlet M20x1.5			



	<b>GEV No.</b> 104016	<b>Ref. No.</b> 34A1090 34A6760	
description burner head for burner cap ø 140mm			

	<b>GEV No.</b> 104013	<b>Ref. No.</b> 34A0570	
description burner head for burner cap ø 60mm			

	<b>GEV No.</b> 104024	<b>Ref. No.</b> 34A0060	
description burner head for burner cap ø 60mm			
<b>accessories for</b> 104024			
	<b>GEV No.</b> 104018	<b>Ref. No.</b> 36D0070	
burner holder for burner cap ø 60/90/110mm with nozzle holder gas inlet M20x1.5			

	<b>GEV No.</b> 104014	<b>Ref. No.</b> 34A1100	
description burner head for burner cap ø 90mm			
<b>accessories for</b> 104014			
	<b>GEV No.</b> 103013	<b>Ref. No.</b> 34A0740 34A1120 34A1121 34A1123	
burner cap ø 90mm			
	<b>GEV No.</b> 104018	<b>Ref. No.</b> 36D0070	
burner holder for burner cap ø 60/90/110mm with nozzle holder gas inlet M20x1.5			

	<b>GEV No.</b> 104025	<b>Ref. No.</b> 34A0080	
description burner head for burner cap ø 90mm			
<b>accessories for</b> 104025			
	<b>GEV No.</b> 103012	<b>Ref. No.</b> 34A0040	
burner cap ø 90mm			
	<b>GEV No.</b> 104018	<b>Ref. No.</b> 36D0070	
burner holder for burner cap ø 60/90/110mm with nozzle holder gas inlet M20x1.5			

	<b>GEV No.</b> 104019	<b>Ref. No.</b> 36D1230	
description burner holder for burner cap ø 140mm gas inlet M20x1.5			
<b>accessories for</b> 104019			
	<b>GEV No.</b> 103016	<b>Ref. No.</b> 34A1140 34A1141	
burner cap ø 140mm			

	<b>GEV No.</b> 103016	<b>Ref. No.</b> 34A1140 34A1141	
burner cap ø 140mm			

Table continues overleaf

Зип-Общепит

Delta, Omega 2, Omega, Senior series

vsezip.ru

+7(812)987-08-81

1 gas components

<b>accessories for</b>	104019		
	<b>GEV No.</b>	104016	<b>Ref. No.</b> 34A1090 34A6760
burner head for burner cap ø 140mm			

	1		
<b>GEV No.</b>	104018	<b>Ref. No.</b>	36D0070
<b>description</b> burner holder for burner cap ø 60/90/110mm with nozzle holder gas inlet M20x1.5			

<b>accessories for</b>	104018		
	<b>GEV No.</b>	103012	<b>Ref. No.</b> 34A0040
burner cap ø 90mm			

	<b>GEV No.</b>	103013	<b>Ref. No.</b> 34A0740 34A1120 34A1121 34A1123
burner cap ø 90mm			

	<b>GEV No.</b>	103014	<b>Ref. No.</b> 34A0050
burner cap ø 110mm			

	<b>GEV No.</b>	103015	<b>Ref. No.</b> 34A1130 34A1131 34A1133
burner cap ø 110mm			

	<b>GEV No.</b>	104014	<b>Ref. No.</b> 34A1100
burner head for burner cap ø 90mm			

	<b>GEV No.</b>	104025	<b>Ref. No.</b> 34A0080
burner head for burner cap ø 90mm			

	<b>GEV No.</b>	104026	<b>Ref. No.</b> 34A0090
burner head for burner cap ø 110mm			

	1		
<b>GEV No.</b>	104017	<b>Ref. No.</b>	36D0060
<b>description</b> burner holder with nozzle holder gas inlet 1/4"			

<b>accessories for</b>	104019		
	<b>GEV No.</b>	104019	<b>Ref. No.</b> 36D1230
burner holder for burner cap ø 140mm gas inlet M20x1.5			

	<b>GEV No.</b>	104022	<b>Ref. No.</b> 34A1401
burner head ø 139.5mm seat ø 122.8mm for burner cap ø 140mm int. ø 1 92.8mm int. ø 2 85.2mm			

	<b>GEV No.</b>	104023	<b>Ref. No.</b> 36D2771
burner holder seat ø 35mm with nozzle holder			

	<b>GEV No.</b>	103015	<b>Ref. No.</b> 34A1130 34A1131 34A1133
<b>description</b> burner cap ø 110mm			
<b>For models:</b> 030, 031, 032, 0712D, 071D, 071DGG, 072D, 072DGG, 091, 091GG, 092, 092GG, 092VA, 092VAGG, 1A0FAS, 1B0FAS, 1B1FASG, 1D0FAS, 1D1FASG, 2A0FAS2, 2A1FAS2G, 2D0FAS2, 2D1FAS2G, 2D1FASG, 31, 31GE, 31TC, 32, 32TC, 32TP, 32TPV, 32V, 3D1FASG, 712D, 71D, 71DGG, 71GE, 71GEGG, 72D, 72DGG, 72VA, 72VAGG, 72VAS, 72VASGG, 73D, 73DGG, 73VA, 73VAD, 73VADGG, 73VAGG			

<b>accessories for</b>	103015		
	<b>GEV No.</b>	104015	<b>Ref. No.</b> 34A1110
burner head for burner cap ø 110mm			

	<b>GEV No.</b>	104018	<b>Ref. No.</b> 36D0070
burner holder for burner cap ø 60/90/110mm with nozzle holder gas inlet M20x1.5			

	1		
<b>GEV No.</b>	103016	<b>Ref. No.</b>	34A1140 34A1141
<b>description</b> burner cap ø 140mm			

<b>For models:</b> 070D, 070DGG, 0712D, 0712VA, 071D, 071DGG, 072D, 072DGG, 090, 090GG, 091, 091GG, 092, 092GG, 092VA, 092VAGG, 0A0FAS, 0B0FAS, 0D0FAS, 1A0FAS, 1A0FAS2, 1A1FAS2G, 1A1FASG, 1B0FAS, 1B0FAS2, 1B1FAS2G, 1B1FASG, 1D0FAS, 1D0FAS2, 1D1FAS2G, 1D1FASG, 2A0FAS2, 2A1FAS2G, 2A1FASG, 2A1TPSG, 2D0FAS2, 2D1FAS2G, 2D1FASG, 2D1TPSG, 3A1FASG, 3D1FASG, 712D, 712VA, 71D, 71DGG, 71GE, 71GEGG, 72D, 72DGG, 72TP...(Other models you can see in the webshop)			
---	--	--	--

<b>accessories for</b>	103016		
	<b>GEV No.</b>	104016	<b>Ref. No.</b> 34A1090 34A6760
burner head for burner cap ø 140mm			

	<b>GEV No.</b>	104019	<b>Ref. No.</b> 36D1230
burner holder for burner cap ø 140mm gas inlet M20x1.5			

	<b>GEV No.</b>	104022	<b>Ref. No.</b> 34A1401
burner head ø 139.5mm seat ø 122.8mm for burner cap ø 140mm int. ø 1 92.8mm int. ø 2 85.2mm			

	<b>GEV No.</b>	104023	<b>Ref. No.</b> 36D2771
burner holder seat ø 35mm with nozzle holder			

	1		
<b>GEV No.</b>	103011	<b>Ref. No.</b>	34A0750 34A1580
<b>description</b> burner cap ø 60mm			

<b>accessories for</b>	103011		
	<b>GEV No.</b>	104013	<b>Ref. No.</b> 34A0570
burner head for burner cap ø 60mm			

	<b>GEV No.</b>	104013	<b>Ref. No.</b> 34A0570
burner head for burner cap ø 60mm			

Table continues overleaf







Зип Общепит



vsezip.ru

+7(812)987-08-81

accessories for 103011					
	<table border="1"> <tr> <th>GEV No.</th> <td>104018</td> <th>Ref. No.</th> <td>36D0070</td> </tr> </table> <p>burner holder for burner cap ø 60/90/110mm with nozzle holder gas inlet M20x1.5</p>	GEV No.	104018	Ref. No.	36D0070
GEV No.	104018	Ref. No.	36D0070		

 <p>1</p>							
<b>GEV No.</b>	103013	<b>Ref. No.</b>	34A0740 34A1120 34A1121 34A1123				
<b>description</b>	burner cap ø 90mm						
<b>For models:</b>	030, 031, 032, 070D, 070DGG, 0712D, 0712VA, 071D, 071DGG, 072D, 072DGG, 090, 090GG, 091, 091GG, 092, 092GG, 092VA, 092VAGG, 0A0FAS, 0B0FAS, 0D0FAS, 1A0FAS, 1A0FAS2, 1A1FAS2G, 1A1FASG, 1B0FAS, 1B0FAS2, 1B1FAS2G, 1B1FASG, 1D0FAS, 1D0FAS2, 1D1FAS2G, 1D1FASG, 2A0FAS2, 2A1FAS2G, 2A1FASG, 2A1TPSG, 2D0FAS2, 2D1FAS2G, 2D1FASG, 2D1TPSG, 31, 31GE, 31TC, 32, 32TC, 32TP, 32TPV, 32V...(Other models you can see in the webshop)						
accessories for 103013							
	<table border="1"> <tr> <th>GEV No.</th> <td>104014</td> <th>Ref. No.</th> <td>34A1100</td> </tr> </table> <p>burner head for burner cap ø 90mm</p>	GEV No.	104014	Ref. No.	34A1100		
GEV No.	104014	Ref. No.	34A1100				
	<table border="1"> <tr> <th>GEV No.</th> <td>104018</td> <th>Ref. No.</th> <td>36D0070</td> </tr> </table> <p>burner holder for burner cap ø 60/90/110mm with nozzle holder gas inlet M20x1.5</p>	GEV No.	104018	Ref. No.	36D0070		
GEV No.	104018	Ref. No.	36D0070				
	<table border="1"> <tr> <th>GEV No.</th> <td>104020</td> <th>Ref. No.</th> <td>34A1380</td> </tr> </table> <p>burner head for burner cap ø 90mm</p>	GEV No.	104020	Ref. No.	34A1380		
GEV No.	104020	Ref. No.	34A1380				
	<table border="1"> <tr> <th>GEV No.</th> <td>104023</td> <th>Ref. No.</th> <td>36D2771</td> </tr> </table> <p>burner holder seat ø 35mm with nozzle holder</p>	GEV No.	104023	Ref. No.	36D2771		
GEV No.	104023	Ref. No.	36D2771				

 <p>1</p>							
<b>GEV No.</b>	104021	<b>Ref. No.</b>	34A1390 34A1391				
<b>description</b>	burner head for burner cap ø 110mm						
<b>For models:</b>	030, 031, 032, 0712D, 071D, 071DGG, 072D, 072DGG, 091, 091GG, 092, 092GG, 092VA, 092VAGG, 1A0FAS, 1B0FAS, 1B1FASG, 1D0FAS, 1D1FASG, 2A0FAS2, 2A1FAS2G, 2D0FAS2, 2D1FAS2G, 2D1FASG, 31, 31GE, 31TC, 32, 32TC, 32TP, 32TPV, 32V, 3D1FASG, 712D, 71D, 71DGG, 71GE, 71GEGG, 72D, 72DGG, 72VA, 72VAGG, 72VAS, 72VASGG, 73D, 73DGG, 73VA, 73VAD, 73VADGG, 73VAGG						
accessories for 104021							
	<table border="1"> <tr> <th>GEV No.</th> <td>103015</td> <th>Ref. No.</th> <td>34A1130 34A1131 34A1133</td> </tr> </table> <p>burner cap ø 110mm</p>	GEV No.	103015	Ref. No.	34A1130 34A1131 34A1133		
GEV No.	103015	Ref. No.	34A1130 34A1131 34A1133				
	<table border="1"> <tr> <th>GEV No.</th> <td>104023</td> <th>Ref. No.</th> <td>36D2771</td> </tr> </table> <p>burner holder seat ø 35mm with nozzle holder</p>	GEV No.	104023	Ref. No.	36D2771		
GEV No.	104023	Ref. No.	36D2771				

 <p>1</p>							
<b>GEV No.</b>	103053	<b>Ref. No.</b>	34A1570				
<b>description</b>	burner head for burner cap ø 60mm						
accessories for 103053							
	<table border="1"> <tr> <th>GEV No.</th> <td>103011</td> <th>Ref. No.</th> <td>34A0750 34A1580</td> </tr> </table> <p>burner cap ø 60mm</p>	GEV No.	103011	Ref. No.	34A0750 34A1580		
GEV No.	103011	Ref. No.	34A0750 34A1580				

 <p>1</p>							
<b>GEV No.</b>	104020	<b>Ref. No.</b>	34A1380				
<b>description</b>	burner head for burner cap ø 90mm						
<b>For models:</b>	030, 031, 032, 070D, 070DGG, 0712D, 0712VA, 071D, 071DGG, 072D, 072DGG, 090, 090GG, 091, 091GG, 092, 092GG, 092VA, 092VAGG, 0A0FAS, 0B0FAS, 0D0FAS, 1A0FAS, 1A0FAS2, 1A1FAS2G, 1A1FASG, 1B0FAS, 1B0FAS2, 1B1FAS2G, 1B1FASG, 1D0FAS, 1D0FAS2, 1D1FAS2G, 1D1FASG, 2A0FAS2, 2A1FAS2G, 2A1FASG, 2A1TPSG, 2D0FAS2, 2D1FAS2G, 2D1FASG, 2D1TPSG, 31, 31GE, 31TC, 32, 32TC, 32TP, 32TPV, 32V...(Other models you can see in the webshop)						
accessories for 104020							
	<table border="1"> <tr> <th>GEV No.</th> <td>103013</td> <th>Ref. No.</th> <td>34A0740 34A1120 34A1121 34A1123</td> </tr> </table> <p>burner cap ø 90mm</p>	GEV No.	103013	Ref. No.	34A0740 34A1120 34A1121 34A1123		
GEV No.	103013	Ref. No.	34A0740 34A1120 34A1121 34A1123				
	<table border="1"> <tr> <th>GEV No.</th> <td>104023</td> <th>Ref. No.</th> <td>36D2771</td> </tr> </table> <p>burner holder seat ø 35mm with nozzle holder</p>	GEV No.	104023	Ref. No.	36D2771		
GEV No.	104023	Ref. No.	36D2771				

1 gas components

Зип-Общепит

solid top

vsezip.ru

+7(812)987-08-81



<b>GEV No.</b>	104022	<b>Ref. No.</b>	34A1401
<b>description</b>	burner head $\phi$ 139.5mm seat $\phi$ 122.8mm for burner cap $\phi$ 140mm int. $\phi$ 192.8mm int. $\phi$ 285.2mm		
<b>For models:</b>	070D, 070DGG, 0712D, 0712VA, 071D, 071DGG, 072D, 072DGG, 090, 090GG, 091, 091GG, 092, 092GG, 092VA, 092VAGG, 0A0FAS, 0B0FAS, 0D0FAS, 1A0FAS, 1A0FAS2, 1A1FAS2G, 1A1FASG, 1B0FAS, 1B0FAS2, 1B1FAS2G, 1B1FASG, 1D0FAS, 1D0FAS2, 1D1FAS2G, 1D1FASG, 2A0FAS2, 2A1FAS2G, 2A1FASG, 2A1TPSG, 2D0FAS2, 2D1FAS2G, 2D1FASG, 2D1TPSG, 3A1FASG, 3D1FASG, 712D, 712VA, 71D, 71DGG, 71GE, 71GEGG, 72D, 72DGG, 72TP...(Other models you can see in the webshop)		

<b>accessories for</b>	104022		
	<b>GEV No.</b>	103016	<b>Ref. No.</b>
			34A1140 34A1141
	burner cap $\phi$ 140mm		
	<b>GEV No.</b>	104023	<b>Ref. No.</b>
			36D2771
	burner holder seat $\phi$ 35mm with nozzle holder		



<b>GEV No.</b>	104023	<b>Ref. No.</b>	36D2771
<b>description</b>	burner holder seat $\phi$ 35mm with nozzle holder		
<b>For models:</b>	030, 031, 032, 070D, 070DGG, 0712D, 0712VA, 071D, 071DGG, 072D, 072DGG, 090, 090GG, 091, 091GG, 092, 092GG, 092VA, 092VAGG, 0A0FAS, 0B0FAS, 0D0FAS, 1A0FAS, 1A0FAS2, 1A1FAS2G, 1A1FASG, 1B0FAS, 1B0FAS2, 1B1FAS2G, 1B1FASG, 1D0FAS, 1D0FAS2, 1D1FAS2G, 1D1FASG, 2A0FAS2, 2A1FAS2G, 2A1FASG, 2A1TPSG, 2D0FAS2, 2D1FAS2G, 2D1FASG, 2D1TPSG, 31, 31GE, 31TC, 32, 32TC, 32TP, 32TPV, 32V...(Other models you can see in the webshop)		

<b>accessories for</b>	104023		
	<b>GEV No.</b>	103013	<b>Ref. No.</b>
			34A0740 34A1120 34A1121 34A1123
	burner cap $\phi$ 90mm		
	<b>GEV No.</b>	103015	<b>Ref. No.</b>
			34A1130 34A1131 34A1133
	burner cap $\phi$ 110mm		
	<b>GEV No.</b>	103016	<b>Ref. No.</b>
			34A1140 34A1141
	burner cap $\phi$ 140mm		
	<b>GEV No.</b>	104020	<b>Ref. No.</b>
			34A1380
	burner head for burner cap $\phi$ 90mm		
	<b>GEV No.</b>	104021	<b>Ref. No.</b>
			34A1390 34A1391
	burner head for burner cap $\phi$ 110mm		
	<b>GEV No.</b>	104022	<b>Ref. No.</b>
			34A1401
	burner head $\phi$ 139.5mm seat $\phi$ 122.8mm for burner cap $\phi$ 140mm int. $\phi$ 192.8mm int. $\phi$ 285.2mm		



<b>GEV No.</b>	105333	<b>Ref. No.</b>	34A0120
<b>description</b>	round burner $\phi$ 260mm for solid top		
<b>For models:</b>	071TP, 091TP, 71TP, 72TP, 72TPGG		

pan supports



<b>GEV No.</b>	210100	<b>Ref. No.</b>	36A0110
<b>description</b>	pan support W 312mm L 632mm		



<b>GEV No.</b>	210101	<b>Ref. No.</b>	36A2600
<b>description</b>	pan support W 315mm L 315mm for 700		
<b>For models:</b>	030, 031, 032, 31, 31GE, 31TC, 32, 32TC, 32TP, 32TPV, 32V		



<b>GEV No.</b>	210247	<b>Ref. No.</b>	36A4970 36A4971
<b>description</b>	pan support W 345mm L 585mm		
<b>For models:</b>	0G0FA0, 1G0FA0, 1G0FA0B, 1G1FA0E, 1G1FA0EV, 1G1FA0G, 1G1FA0GV, 1G1FABG, 1G1FAPG, 2G0FA0, 2G0FA0A, 2G0FA0B, 2G1FA0E, 2G1FA0G, 2G1FA0GV, 2G1FABG, 2G1FACG, 2G1FADG, 2G1FADGV, 2G1FAPG, 2G1TP3G		



Зип Общепит

vsezip.ru

(812) 987 08 81

1

<b>GEV No.</b>	210261	<b>Ref. No.</b>	36A2001 36A2002 6029680
<b>description</b>	pan support W 365mm L 395mm H 75mm		
<b>For models:</b>	04WFAAV, 08WFA4E, 08WFA4G, 08WFAAE, 08WFAAG, 08WFAAV, 090FAA, 0A0FA1, 0A0FA4, 0A0FAA, 0D0FA1, 0D0FA4, 0D0FAA, 12WFA6E, 12WFA6G, 12WFAAA, 12WFAAE, 12WFAAG, 12WFAAN, 190FA, 190FAA, 190FAB, 190FAD, 191FAAE, 191FAAG, 191FABG, 191FADG, 191FAE, 191FAG, 1A0FA1, 1A0FA2, 1A0FA4, 1A0FA5, 1A0FAA, 1A0FAB, 1A1FA1G, 1A1FA2G, 1A1FA4G, 1A1FA5G, 1A1FAAG, 1A1FABG, 1D0FA1, 1D0FA2, 1D0FA4, 1D0FA5, 1D0FAA, 1D0FAB, 1D1FA1G, 1D1FA2G, 1D1FA4G...(Other models you can see in the webshop)		

2

<b>GEV No.</b>	210179	<b>Ref. No.</b>	36A2610
<b>description</b>	pan support W 370mm L 370mm		
<b>For models:</b>	070DGG, 0712D, 0712VA, 071DGG, 072DGG, 090GG, 091GG, 092GG, 092VAGG, 0A0FAS, 0B0FAS, 0D0FAS, 1A0FAS, 1A0FAS2, 1A1FAS2G, 1A1FASG, 1B0FAS, 1B0FAS2, 1B1FAS2G, 1B1FASG, 1D0FAS, 1D0FAS2, 1D1FAS2G, 1D1FASG, 2A0FAS2, 2A1FAS2G, 2A1FASG, 2A1TPSG, 2D0FAS2, 2D1FAS2G, 2D1FASG, 2D1TPSG, 3A1FASG, 3D1FASG, 712D, 712VA, 71DGG, 71GEGG, 72DGG, 72TPGG, 72VAGG, 72VASGG, 73DGG, 73VADGG, 73VAGG		

reducers for pan supports

1

<b>GEV No.</b>	210005	<b>Ref. No.</b>	3012090 36A0491
<b>description</b>	reducer for pan support L 205mm W 205mm chrome-plated steel suitable for ANGELO PO		

1

<b>GEV No.</b>	210006	<b>Ref. No.</b>	36A2160 36A5450
<b>description</b>	reducer for pan support L 385mm W 190mm Qty 2 pcs		

1

<b>GEV No.</b>	103152	<b>Ref. No.</b>	36A0350
<b>description</b>	burner cap ø 125mm cast iron		
<b>For models:</b>	0712VA, 090FAVA, 092VA, 092VAGG, 0A0FAVA, 0D0FAVA, 190FAB, 191FABG, 1A0FA2, 1A0FA5, 1A0FAB, 1A0FAS2, 1A1FA2G, 1A1FA5G, 1A1FABG, 1A1FAS2G, 1B0FAS2, 1B1FAS2G, 1D0FA2, 1D0FA5, 1D0FAB, 1D0FAS2, 1D1FA2G, 1D1FA5G, 1D1FABG, 1D1FAS2G, 2A0FAS2, 2A1FAS2G, 2D0FAS2, 2D1FAS2G, 712VA, 72VA, 72VAGG, 72VAS, 72VASGG, 73VA, 73VAD, 73VADGG, 73VAGG		

miscellaneous

1

<b>GEV No.</b>	104324	<b>Ref. No.</b>	31V0240 31V0241
<b>description</b>	pin ø 7.4mm L 22mm WS 8 thread M5		
<b>For models:</b>	04WFAAV, 08WFA4E, 08WFA4G, 08WFAAE, 08WFAAG, 08WFAAV, 090FAA, 0A0FA1, 0A0FA4, 0A0FAA, 0D0FA1, 0D0FA4, 0D0FAA, 0G0FA0, 12WFA6E, 12WFA6G, 12WFAAA, 12WFAAE, 12WFAAG, 12WFAAN, 190FA, 190FAA, 190FAB, 190FAD, 191FAAE, 191FAAG, 191FABG, 191FADG, 191FAE, 191FAG, 1A0FA1, 1A0FA2, 1A0FA4, 1A0FA5, 1A0FAA, 1A0FAB, 1A1FA1G, 1A1FA2G, 1A1FA4G, 1A1FA5G, 1A1FAAG, 1A1FABG, 1D0FA1, 1D0FA2, 1D0FA4, 1D0FA5, 1D0FAA, 1D0FAB, 1D1FA1G, 1D1FA2G...(Other models you can see in the webshop)		

accessories

reducers for pan supports

1

<b>GEV No.</b>	210005	<b>Ref. No.</b>	3012090 36A0491
<b>description</b>	reducer for pan support L 205mm W 205mm chrome-plated steel suitable for ANGELO PO		

1

<b>GEV No.</b>	210006	<b>Ref. No.</b>	36A2160 36A5450
<b>description</b>	reducer for pan support L 385mm W 190mm Qty 2 pcs		

1 gas components

pan supports



1

<b>GEV No.</b>	210100	<b>Ref. No.</b>	36A0110
<b>description</b>	pan support W 312mm L 632mm		



1

<b>GEV No.</b>	210101	<b>Ref. No.</b>	36A2600
<b>description</b>	pan support W 315mm L 315mm for 700		
<b>For models:</b>	030, 031, 032, 31, 31GE, 31TC, 32, 32TC, 32TP, 32TPV, 32V		



1

<b>GEV No.</b>	210247	<b>Ref. No.</b>	36A4970 36A4971
<b>description</b>	pan support W 345mm L 585mm		
<b>For models:</b>	0G0FA0, 1G0FA0, 1G0FA0B, 1G1FA0E, 1G1FA0EV, 1G1FA0G, 1G1FA0GV, 1G1FABG, 1G1FAPG, 2G0FA0, 2G0FA0A, 2G0FA0B, 2G1FA0E, 2G1FA0G, 2G1FA0GV, 2G1FABG, 2G1FACG, 2G1FADG, 2G1FADGV, 2G1FAPG, 2G1TP3G		



1

<b>GEV No.</b>	210261	<b>Ref. No.</b>	36A2001 36A2002 6029680
<b>description</b>	pan support W 365mm L 395mm H 75mm		
<b>For models:</b>	04WFAAV, 08WFA4E, 08WFA4G, 08WFAAE, 08WFAAG, 08WFAAV, 090FAA, 0A0FA1, 0A0FA4, 0A0FAA, 0D0FA1, 0D0FA4, 0D0FAA, 12WFA6E, 12WFA6G, 12WFAAA, 12WFAAE, 12WFAAG, 12WFAAN, 190FA, 190FAA, 190FAB, 190FAD, 191FAAE, 191FAAG, 191FABG, 191FADG, 191FAE, 191FAG, 1A0FA1, 1A0FA2, 1A0FA4, 1A0FA5, 1A0FAA, 1A0FAB, 1A1FA1G, 1A1FA2G, 1A1FA4G, 1A1FA5G, 1A1FAAG, 1A1FABG, 1D0FA1, 1D0FA2, 1D0FA4, 1D0FA5, 1D0FAA, 1D0FAB, 1D1FA1G, 1D1FA2G, 1D1FA4G...(Other models you can see in the webshop)		

Зип Общепит

vsezip.ru

+7(812)987-08-81



1

<b>GEV No.</b>	210179	<b>Ref. No.</b>	36A2610
<b>description</b>	pan support W 370mm L 370mm		
<b>For models:</b>	070DGG, 0712D, 0712VA, 071DGG, 072DGG, 090GG, 091GG, 092GG, 092VAGG, 0A0FAS, 0B0FAS, 0D0FAS, 1A0FAS, 1A0FAS2, 1A1FAS2G, 1A1FASG, 1B0FAS, 1B0FAS2, 1B1FAS2G, 1B1FASG, 1D0FAS, 1D0FAS2, 1D1FAS2G, 1D1FASG, 2A0FAS2, 2A1FAS2G, 2A1FASG, 2A1TPSG, 2D0FAS2, 2D1FAS2G, 2D1FASG, 2D1TPSG, 3A1FASG, 3D1FASG, 712D, 712VA, 71DGG, 71GEGG, 72DGG, 72TPGG, 72VAGG, 72VASGG, 73DGG, 73VADGG, 73VAGG		

air mixers



1

<b>GEV No.</b>	102200	<b>Ref. No.</b>	36C1210
<b>description</b>	air mixing tube L 27mm D1 ø 24mm D2 ø 20mm ID ø 15mm thickness 2.6mm		
<b>For models:</b>	0A0GRG, 0D0GRG, 1A0GRG, 1D0GRG		

bar burners

bar burners



1

<b>GEV No.</b>	104760	<b>Ref. No.</b>	34A2520 34A2521
<b>description</b>	bar burner 2 row L 370mm W 200mm ømm H 45mm 6kW chargrill		
<b>For models:</b>	1G0GRG		



1

<b>GEV No.</b>	105345	<b>Ref. No.</b>	34A0350
<b>description</b>	bar burner 2 row L 525mm W 167mm ømm H 50mm pasta cooker		
<b>For models:</b>	0A1CP1G, 0B1CP1G, 0D1CP1G, 191CP1G, 1A1CP1G, 1A1CP2G, 1D1CP1G, 1D1CP2G		





Зип Общепит  
vsezip.ru

+7(812)987-08-81

			
1			
<b>GEV No.</b>	105373	<b>Ref. No.</b>	34A2080 34A2081 34A2082
<b>description</b>	bar burner 2 row L 560mm W 220mm ømm 9kW chargrill		
<b>For models:</b>	08WGRGV, 090GRG, 0A0GRG, 0D0GRG, 190GRG, 1A0GRG, 1D0GRG, 6042120-08WGRGV		

			
1			
<b>GEV No.</b>	105334	<b>Ref. No.</b>	34A0900
<b>description</b>	bar burner 4 row L 545mm W 300mm ømm 12kW solid top		
<b>For models:</b>	190TP0, 191TPG, 1A0TP0, 1A1FASG, 1A1TP0G, 1A1TP0G-VERS.2002, 1B0TP0, 1D0TP0, 1D1TP0G, 1D1TP0G-VERS.2002, 291TPCG, 2A1FASG, 2A1TP3G, 2A1TP6G, 2A1TPCG, 2A1TPSG, 2D1TP3G, 2D1TP6G, 2D1TPCG, 2D1TPSG, 3A1FASG		

			
1			
<b>GEV No.</b>	104163	<b>Ref. No.</b>	34A0580
<b>description</b>	bar burner 2 row L 600mm W 300mm ømm griddle		
<b>For models:</b>	071FT, 071FTR, 071FTRL, 091FT, 091FTR, 091FTRL		

			
1			
<b>GEV No.</b>	105369	<b>Ref. No.</b>	34A0730
<b>description</b>	bar burner 6 row L 445mm W 620mm ømm tilting bratt pan		
<b>For models:</b>	71RA, 91RA		

			
1			
<b>GEV No.</b>	105339	<b>Ref. No.</b>	34A0110
<b>description</b>	bar burner 3 row L 460mm W 280mm ømm H 90mm griddle		
<b>For models:</b>	031FT04, 031FT06, 08WFT1GV, 08WFT2GV, 08WFT3GV, 08WFT4GV, 08WFT6GV, 08WFT7GV, 0G0FT1G, 0G0FT1G-VERS.032008, 0G0FT2G, 0G0FT2G-VERS.032008, 0G0FT4G, 0G0FT4G-VERS.032008, 0G0FT5G, 0G0FT5G-VERS.032008, 0G0FT7G, 1G0FT1G, 1G0FT1G-VERS.032008, 1G0FT2G, 1G0FT2G-VERS.032008, 1G0FT3G, 1G0FT3G-VERS.032008, 1G0FT4G, 1G0FT4G-VERS.032008, 1G0FT6E, 1G0FT6G, 1G0FT6G-VERS.032008, 1G0FT7G, 6040560, 6042490, 6042500, 6043200		

			
1			
<b>GEV No.</b>	105335	<b>Ref. No.</b>	34A1520
<b>description</b>	bar burner angled L 605mm W 247mm ømm Hmm oven		
<b>For models:</b>	31, 31TC, 31TP, 32, 32TC, 32TP, 32TPV, 32V		

			
1			
<b>GEV No.</b>	105337	<b>Ref. No.</b>	34A1880
<b>description</b>	bar burner angled L 765mm W 345mm ømm Hmm oven		
<b>For models:</b>	191FAAG, 191FABG, 191FADG, 191TPG, 1A1FA1G, 1A1FA2G, 1A1FA4G, 1A1FASG, 1A1FAAG, 1A1FABG, 1A1FAS2G, 1A1FASG, 1A1TP0G, 1A1TP0G-VERS.2002, 1D1FA1G, 1D1FA2G, 1D1FA4G, 1D1FA5G, 1D1FAAG, 1D1FABG, 1D1FAS2G, 1D1FASG, 1D1TP0G, 1D1TP0G-VERS.2002, 291FAG, 291TPCG, 2A1FA1G, 2A1FA4G, 2A1FAAG, 2A1FAS2G, 2A1FASG, 2A1TP3G, 2A1TP6G, 2A1TPCG, 2A1TPSG, 2D1FA1G, 2D1FA4G, 2D1FAAG, 2D1FAS2G, 2D1FASG, 2D1TP3G, 2D1TP6G, 2D1TPCG, 2D1TPSG, 391FAG, 3A1FA1G, 3A1FA4G, 3A1FAAG, 3A1FASG, 3D1FA1G...(Other models you can see in the webshop)		

			
1			
<b>GEV No.</b>	105343	<b>Ref. No.</b>	34A1840 34A1841
<b>description</b>	bar burner 3 row L 585mm W 270mm ømm griddle		
<b>For models:</b>	070FT04, 070FT05, 071FT04, 071FT06, 090FT04, 090FT05, 090FT1G, 090FT2G, 090FT4G, 090FT5G, 090FT7G, 091FT04, 091FT06, 0A0FT1G, 0A0FT2G, 0A0FT4G, 0A0FT5G, 0B0FT1G, 0B0FT2G, 0B0FT4G, 0B0FT5G, 0D0FT1G, 0D0FT2G, 0D0FT4G, 0D0FT5G, 190FT15G, 190FT1G, 190FT2G, 190FT3G, 190FT42G, 190FT4G, 190FT6G, 190FT72G, 190FT7G, 1A0FT1G, 1A0FT2G, 1A0FT3G, 1A0FT4G, 1A0FT6G, 1B0FT1G, 1B0FT2G, 1B0FT3G, 1B0FT4G, 1B0FT6G, 1D0FT1G, 1D0FT2G, 1D0FT3G, 1D0FT4G, 1D0FT6G		

			
1			
<b>GEV No.</b>	105279	<b>Ref. No.</b>	34A1370
<b>description</b>	bar burner angled L 770mm W 345mm ømm Hmm oven		
<b>For models:</b>	71D, 71DGG, 71TP, 72D, 72DGG, 72TP, 72TPGG, 72VA, 72VAGG, 72VAS, 72VASGG, 73D, 73DGG, 73VA, 73VAD, 73VADGG, 73VAGG, FS30		

			
1			
<b>GEV No.</b>	105304	<b>Ref. No.</b>	34A1640 34A1641
<b>description</b>	bar burner ø 27mm Wmm Hmm L 425mm salamander grill		
<b>For models:</b>	60SM		

1 gas components

Зип Общепит



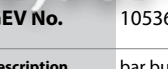

+7(812)987-08-81

1			
<b>GEV No.</b>	105347	<b>Ref. No.</b>	34A1510
<b>description</b>	bar burner ø 27mm Wmm Hmm L 440mm bain marie		
<b>For models:</b>	090BM1G, 0A0BMG, 0D0BMG		

1			
<b>GEV No.</b>	105367	<b>Ref. No.</b>	34A1790 34A1793
<b>description</b>	bar burner ømm tilting bratt pan		
<b>For models:</b>	1G1BR1G, 31R		

1			
<b>GEV No.</b>	107843	<b>Ref. No.</b>	34A0500
<b>description</b>	bar burner ø 50mm L 550mm flange width 57mm flange length 57mm 15kW combi-steamer		
<b>For models:</b>	FC241G, FCV241G, FCV241G-CSA, FCV241GDM, FCV241GDM-CSA, FCV241GDS, FCV241GDS-CSA, FCV401DM, FCV401DM-CSA		

1			
<b>GEV No.</b>	105368	<b>Ref. No.</b>	34A1480
<b>description</b>	bar burner ømm tilting bratt pan		
<b>For models:</b>	71AR, 91AR		

1			
<b>GEV No.</b>	105502	<b>Ref. No.</b>	34A1690 34A1690-2
<b>description</b>	bar burner ø 50mm Wmm Hmm L 424mm convection oven		
<b>For models:</b>	FC101, FCV101, FCV101-CSA, FCV101DM, FCV101DM-CSA, FCV101DS, FCV101DS-CSA		

1			
<b>GEV No.</b>	104136	<b>Ref. No.</b>	34A0230
<b>description</b>	bar burner ømm W 28mm H 42mm L 335mm flange width 35mm flange length 80mm kettle		
<b>For models:</b>	71PD10, 71PD15, 71PI10, 71PI10A, 91PI10, 91PI10A		

1			
<b>GEV No.</b>	105697	<b>Ref. No.</b>	34A2310
<b>description</b>	bar burner ø 50mm Wmm Hmm L 450mm with bolt M5x12 flange width 65mm flange length 71mm kettle		

1			
<b>GEV No.</b>	104162	<b>Ref. No.</b>	34A1461
<b>description</b>	bar burner T-shape L 560mm Wmm ø 40mm solid top		
<b>For models:</b>	070FT, 070FTR, 0712VA, 090FAVA, 090FT, 090FTR, 092VA, 092VAGG, 0A0FAVA, 0D0FAVA, 190FAB, 191FABG, 1A0FA2, 1A0FA5, 1A0FAB, 1A0FAS2, 1A1FA2G, 1A1FA5G, 1A1FABG, 1A1FAS2G, 1B0FAS2, 1B1FAS2G, 1D0FA2, 1D0FA5, 1D0FAB, 1D0FAS2, 1D1FA2G, 1D1FA5G, 1D1FABG, 1D1FAS2G, 2A0FAS2, 2A1FAS2G, 2D0FAS2, 2D1FAS2G, 712VA, 72VA, 72VAGG, 72VAS, 72VASGG, 73VA, 73VAD, 73VADGG, 73VAGG		

1			
<b>GEV No.</b>	105372	<b>Ref. No.</b>	34A1850
<b>description</b>	bar burner ømm kettle		
<b>For models:</b>	1G1PD1G, 1G1PI1G, 31PD6, 31PI6		

1			
<b>GEV No.</b>	105346	<b>Ref. No.</b>	34A1450
<b>description</b>	bar burner U-shape L 610mm W 205mm ømm Hmm bain marie		
<b>For models:</b>	070BM, 071BM, 090BM, 091BM		







Зип Общежит  
tube burners



vsezip.ru

+7(812)987-08-81



			
1			
<b>GEV No.</b>	105370	<b>Ref. No.</b>	34A1430 34A1431
<b>description</b>	burner ømm tilting bratt pan		
<b>For models:</b>	1A1BR1G, 1A1BR1GA, 1A1BR2G, 1A1BR2GA, 1D1BR1G, 1D1BR1GA, 1D1BR2G, 1D1BR2GA		

			
1			
<b>GEV No.</b>	105371	<b>Ref. No.</b>	34A1890 34A1891
<b>description</b>	burner ømm tilting bratt pan		
<b>For models:</b>	2A1BR1G, 2A1BR1GA, 2A1BR2G, 2A1BR2GA, 2D1BR1G, 2D1BR1GA, 2D1BR2G, 2D1BR2GA		

			
1			
<b>GEV No.</b>	211057	<b>Ref. No.</b>	3193150 36A5540
<b>description</b>	lava rock grid L 419mm W 282mm H 23.2mm suitable for ANGELO PO		
<b>For models:</b>	1G0GRG		

			
1			
<b>GEV No.</b>	211000	<b>Ref. No.</b>	36A4230 36A5290
<b>description</b>	lava rock grid L 600mm W 330mm H 22mm		
<b>For models:</b>	0A0GRG, 0D0GRG, 1A0GRG, 1D0GRG		
<b>accessories for</b>	211000		
	<b>GEV No.</b>	693000	<b>Ref. No.</b> 35Y2780
spring for lava rock grid			

lava rock grids

			
1			
<b>GEV No.</b>	211000	<b>Ref. No.</b>	36A4230 36A5290
<b>description</b>	lava rock grid L 600mm W 330mm H 22mm		
<b>For models:</b>	0A0GRG, 0D0GRG, 1A0GRG, 1D0GRG		
<b>accessories for</b>	211000		
	<b>GEV No.</b>	693000	<b>Ref. No.</b> 35Y2780
spring for lava rock grid			

			
1			
<b>GEV No.</b>	105401	<b>Ref. No.</b>	3007720 34A2120
<b>description</b>	burner L 300mm W 75mm H 42mm for fryer		
<b>For models:</b>	06WFR3GD, 091FR1G, 091FR1GD, 091FR11, 091FR11A, 091FR11D, 091FR11D-VERS.052012, 091FR11-VERS.032012, 091FR3G, 091FR3GD, 0A1FR1GD-VERS.2004, 0A1FR1G-VERS.2004, 0A1FR3G, 0A1FR3GD, 0D1FR1GD-VERS.2004, 0D1FR1G-VERS.2004, 0D1FR3G, 0D1FR3GD, 0G1FR3G, 0G1FR3GD, 10WFR4GD, 191FR2G, 191FR2GD, 191FR2I, 191FR2ID, 191FR2ID-VERS.092012, 191FR2I-VERS.032012, 191FR4G, 191FR4GD, 1A1FR2GD-VERS.2004, 1A1FR2G-VERS.2004, 1A1FR4G, 1A1FR4GD, 1D1FR2GD-VERS.2004, 1D1FR2G-VERS.2004, 1D1FR4G, 1D1FR4GD, 1G1FR4G, 1G1FR4GD		

			
1			
<b>GEV No.</b>	105344	<b>Ref. No.</b>	34A1670
<b>description</b>	tubular burner L 305mm W 55mm H 63mm for fryer/pasta cooker oval		
<b>For models:</b>	0A1FR1G, 0A1FR1GD, 0B1FR1G, 0B1FR1GD, 0D1FR1G, 0D1FR1GD, 1A1FR2G, 1A1FR2GD, 1D1FR2G, 1D1FR2GD, 30CPS, 30F1, 30F1B, 30FS2, 30FS2B, 70CP, 70F1, 70F1B, 71CP, 71CP2, 71F2, 71F2B, 90CP, 90F110B, 91CP, 91F210, 91F210B, 91F223B		

solid top burners

			
1			
<b>GEV No.</b>	105332	<b>Ref. No.</b>	34A1650
<b>description</b>	solid top burner ø 162mm H 117mm L 330mm		
<b>For models:</b>	031TP, 1G0TP0, 1G1TP0G, 2G1TP3G, 31TP, 32TP, 32TPV		



## forced air burners

Зип.Общепит

gas nozzles  
vsezip.ru

<b>GEV No.</b>	108153	<b>Ref. No.</b>	6300748
<b>description</b>	burner blower combi-steamer 230V 65W hole distance 50mm NRG118/0800-3612-030204		
<b>For models:</b>	BX101G, BX101G-VERS.122013, BX122G, BX122G-VERS.122013, BX61G, BX61G-VERS.122013, BX82G, BX82G-VERS.122013, FX101G1, FX101G1R, FX101G2, FX101G2C, FX101G2C-VERS.032014, FX101G2R, FX101G2R-VERS.032014, FX101G2-VERS.032014, FX101G3, FX101G3C, FX101G3C-VERS.022014, FX101G3R, FX101G3R-VERS.022014, FX101G3-VERS.022014, FX10G2CR, FX10G2CR-VERS.032014, FX10G3CR, FX10G3CR-VERS.022014, FX122G1, FX122G2, FX122G2C, FX122G2T, FX122G2T-VERS.032014, FX122G3, FX122G3C, FX122G3T, FX122G3T-VERS.022014, FX12G3CT, FX12G3CT-VERS.022014, FX201G2, FX201G2P, FX201G2P-VERS.032014, FX201G2-VERS.032014, FX201G3P, FX201G3-VERS.022014, FX202G2, FX202G2-VERS.032014, FX202G3, FX202G3-VERS.022014, FX61G1, FX61G1R, FX61G2...(Other models you can see in the webshop)		

## accessories

## gaskets



<b>GEV No.</b>	109208	<b>Ref. No.</b>	36E3770
<b>description</b>	gasket L 89mm W 89mm D1 ø 76mm thickness 1mm hole ø 6mm hole distance 69mm for burner chamber combi-steamer		
<b>For models:</b>	FC1011G, FC1221G, FC611G, FM1011G1, FM1011G1-VERS.2006, FM1011G2, FM1011G2-VERS.2006, FM1011G3, FM1011G3-VERS.2006, FM1221G1, FM1221G1-VERS.2006, FM1221G2, FM1221G2-VERS.2006, FM1221G3, FM1221G3-VERS.2006, FM2011G2-VERS.2006, FM2011G3-VERS.2006, FM2021G1, FM2021G2, FM2021G2-VERS.2006, FM2021G3, FM2021G3-VERS.2006, FM611G1, FM611G1-VERS.2006, FM611G2, FM611G2-VERS.2006, FM611G3, FM611G3-VERS.2006, FM721G1, FM721G1-VERS.2006, FM721G2, FM721G2-VERS.2006, FM721G3, FM721G3-VERS.2006		



<b>GEV No.</b>	109207	<b>Ref. No.</b>	36E3390
<b>description</b>	gasket L 89mm W 89mm ø 76mm thickness 3mm hole ø 4mm hole distance 69mm for burner chamber combi-steamer		
<b>For models:</b>	FC1011G, FC1221G, FC611G, FM1011G1, FM1011G1-VERS.2006, FM1011G2, FM1011G2-VERS.2006, FM1011G3, FM1011G3-VERS.2006, FM1221G1, FM1221G1-VERS.2006, FM1221G2, FM1221G2-VERS.2006, FM1221G3, FM1221G3-VERS.2006, FM2011G2-VERS.2006, FM2011G3-VERS.2006, FM2021G1, FM2021G2, FM2021G2-VERS.2006, FM2021G3, FM2021G3-VERS.2006, FM611G1, FM611G1-VERS.2006, FM611G2, FM611G2-VERS.2006, FM611G3, FM611G3-VERS.2006, FM721G1, FM721G1-VERS.2006, FM721G2, FM721G2-VERS.2006, FM721G3, FM721G3-VERS.2006		

## main nozzles

gas nozzles M6x0.75



<b>GEV No.</b>	102570	<b>Ref. No.</b>	33T3060
<b>description</b>	gas injector thread M6x0.75 WS 8 bore ø 1.15mm		



<b>GEV No.</b>	106744	<b>Ref. No.</b>	33T4490
<b>description</b>	gas injector thread M6x0.75 WS 8 bore ø 1.3mm		



<b>GEV No.</b>	102571	<b>Ref. No.</b>	3033010
<b>description</b>	gas injector thread M6x0.75 WS 8 bore ø 1.4mm		



<b>GEV No.</b>	106745	<b>Ref. No.</b>	3033000
<b>description</b>	gas injector thread M6x0.75 WS 8 bore ø 1.55mm		



<b>GEV No.</b>	102569	<b>Ref. No.</b>	33T4480
<b>description</b>	gas injector thread M6x0.75 WS 8 bore ø 1.5mm		



<b>GEV No.</b>	102564	<b>Ref. No.</b>	33T4230
<b>description</b>	gas injector thread M6x0.75 WS 8 bore ø 1.65mm		



<b>GEV No.</b>	102565	<b>Ref. No.</b>	33T4250
<b>description</b>	gas injector thread M6x0.75 WS 8 bore ø 1.75mm		



<b>GEV No.</b>	102961	<b>Ref. No.</b>	33T4240
<b>description</b>	gas injector thread M6x0.75 WS 8 bore ø 1.85mm		

+7(812)987-08-81



Зип Общепит

vsezip.ru

+7(812)987-08-81

			
1			
<b>GEV No.</b>	102567	<b>Ref. No.</b>	33T3050
<b>description</b>	gas injector thread M6x0.75 WS 8 bore ø 1mm		

			
1			
<b>GEV No.</b>	101974	<b>Ref. No.</b>	33T3910
<b>description</b>	gas injector thread M10x1 bore ø 1.35mm L 30mm WS 12		

gas nozzles M8x1			
			
1			
<b>GEV No.</b>	104737	<b>Ref. No.</b>	3032930
<b>description</b>	gas injector thread M8x1 WS 10 bore ø 0.5mm		
<b>For models:</b>	BX61E, BX61E-VERS.122013, BX61G, BX61G-VERS.122013, FC611E, FC611G, FM1221E1-VERS.2006, FM1221E2-VERS.2006, FM1221E3-VERS.2006, FM1221G1-VERS.2006, FM1221G2-VERS.2006, FM1221G3-VERS.2006, FM2011E2-VERS.2006, FM2011E3-VERS.2006, FM2011G2-VERS.2006, FM2011G3-VERS.2006, FM2021E2-VERS.2006, FM2021E3-VERS.2006, FM2021G2-VERS.2006, FM2021G3-VERS.2006, FM611E1, FM611E1-VERS.2006, FM611E2, FM611E2-VERS.2006, FM611E3, FM611E3-VERS.2006, FM611G1, FM611G1-VERS.2006, FM611G2, FM611G2-VERS.2006, FM611G3, FM611G3-VERS.2006, FX61E1, FX61E1R, FX61E2, FX61E2C, FX61E2CR, FX61E2CR-VERS.032014, FX61E2C-VERS.032014, FX61E2R, FX61E2R-VERS.032014, FX61E2-VERS.032014, FX61E3, FX61E3C, FX61E3CR, FX61E3CR-VERS.022014, FX61E3C-VERS.022014, FX61E3R, FX61E3R-VERS.022014, FX61E3-VERS.022014...(Other models you can see in the webshop)		

			
1			
<b>GEV No.</b>	101975	<b>Ref. No.</b>	33T3980
<b>description</b>	gas injector thread M10x1 bore ø 1.55mm L 30mm WS 12		

			
1			
<b>GEV No.</b>	100816	<b>Ref. No.</b>	33T3900
<b>description</b>	gas injector thread M10x1 bore ø 1.5mm WS 12		

			
1			
<b>GEV No.</b>	100153	<b>Ref. No.</b>	33T1700
<b>description</b>	gas injector thread M10x1 bore ø 1.6mm L 30mm WS 12		

			
1			
<b>GEV No.</b>	106402	<b>Ref. No.</b>	33T0710
<b>description</b>	gas injector thread M10x1 bore ø 1.75mm L 30mm WS 12		

			
1			
<b>GEV No.</b>	106407	<b>Ref. No.</b>	33T1750
<b>description</b>	gas injector thread M10x1 bore ø 1.85mm L 30mm WS 12		

			
1			
<b>GEV No.</b>	106403	<b>Ref. No.</b>	33T1920
<b>description</b>	gas injector thread M10x1 bore ø 1.9mm L 30mm WS 12		

			
1			
<b>GEV No.</b>	104736	<b>Ref. No.</b>	3032920
<b>description</b>	gas injector thread M8x1 WS 10 bore ø 1.85mm		
<b>For models:</b>	FC1011E, FC1011G, FC1221E, FC1221G, FC611E, FC611G, FM1011E1, FM1011E1-VERS.2006, FM1011E2, FM1011E2-VERS.2006, FM1011E3, FM1011E3-VERS.2006, FM1011G1, FM1011G1-VERS.2006, FM1011G2, FM1011G2-VERS.2006, FM1011G3, FM1011G3-VERS.2006, FM1221E1-VERS.2006, FM1221E2-VERS.2006, FM1221E3, FM1221E3-VERS.2006, FM1221G1-VERS.2006, FM1221G2-VERS.2006, FM1221G3, FM1221G3-VERS.2006, FM2011E2-VERS.2006, FM2011E3-VERS.2006, FM2011G2-VERS.2006, FM2011G3-VERS.2006, FM611E1, FM611E1-VERS.2006, FM611E2, FM611E2-VERS.2006, FM611E3, FM611E3-VERS.2006, FM611G1, FM611G1-VERS.2006, FM611G2, FM611G2-VERS.2006, FM611G3, FM611G3-VERS.2006, FM721E3, FM721G3		

gas nozzles M10x1			
			
1			
<b>GEV No.</b>	100670	<b>Ref. No.</b>	33T3880
<b>description</b>	gas injector thread M10x1 bore ø 0.9mm L 30mm WS 12		

			
1			
<b>GEV No.</b>	100676	<b>Ref. No.</b>	33T0690
<b>description</b>	gas injector thread M10x1 bore ø 1mm L 30mm WS 12		

			
1			
<b>GEV No.</b>	106400	<b>Ref. No.</b>	33T0650
<b>description</b>	gas injector thread M10x1 bore ø 1.1mm L 30mm WS 12		

			
1			
<b>GEV No.</b>	100673	<b>Ref. No.</b>	33T1990
<b>description</b>	gas injector thread M10x1 bore ø 2.05mm L 30mm WS 12		

1 gas components

Зип Общепит

vsezip.ru

+7(812)987-08-81

1			
<b>GEV No.</b>	106401	<b>Ref. No.</b>	33T0720
<b>description</b>	gas injector thread M10x1 bore $\varnothing$ 2.2mm L 30mm WS 12		

1			
<b>GEV No.</b>	101973	<b>Ref. No.</b>	33T3920
<b>description</b>	gas injector thread M10x1 bore $\varnothing$ 2.3mm L 30mm WS 12		

1			
<b>GEV No.</b>	107898	<b>Ref. No.</b>	33T0550
<b>description</b>	gas injector thread M10x1 bore $\varnothing$ 2.7mm L 30mm WS 12		

1			
<b>GEV No.</b>	106404	<b>Ref. No.</b>	33T0750
<b>description</b>	gas injector thread M10x1 bore $\varnothing$ 2.8mm L 30mm WS 12		

1			
<b>GEV No.</b>	106405	<b>Ref. No.</b>	33T3360
<b>description</b>	gas injector thread M10x1 bore $\varnothing$ 2mm L 30mm WS 12		

1			
<b>GEV No.</b>	106406	<b>Ref. No.</b>	33T2280
<b>description</b>	gas injector thread M10x1 bore $\varnothing$ 3.5mm L 30mm WS 12		

1			
<b>GEV No.</b>	101972	<b>Ref. No.</b>	33T4030
<b>description</b>	gas injector thread M10x1 bore $\varnothing$ 3.6mm L 30mm WS 12		

1			
<b>GEV No.</b>	106408	<b>Ref. No.</b>	33T3370
<b>description</b>	gas injector thread M10x1 bore $\varnothing$ 3mm L 30mm WS 12		

1			
<b>GEV No.</b>	106471	<b>Ref. No.</b>	33T1520
<b>description</b>	gas injector thread M10x1 WS 12 bore $\varnothing$ 0.7mm		

1			
<b>GEV No.</b>	106472	<b>Ref. No.</b>	33T1550
<b>description</b>	gas injector thread M10x1 WS 12 bore $\varnothing$ 0.85mm		

1			
<b>GEV No.</b>	106465	<b>Ref. No.</b>	33T1540
<b>description</b>	gas injector thread M10x1 WS 12 bore $\varnothing$ 0.8mm		

1			
<b>GEV No.</b>	106451	<b>Ref. No.</b>	33T1560
<b>description</b>	gas injector thread M10x1 WS 12 bore $\varnothing$ 0.9mm		

1			
<b>GEV No.</b>	106473	<b>Ref. No.</b>	33T1590
<b>description</b>	gas injector thread M10x1 WS 12 bore $\varnothing$ 1.05mm		

1			
<b>GEV No.</b>	106466	<b>Ref. No.</b>	33T1610
<b>description</b>	gas injector thread M10x1 WS 12 bore $\varnothing$ 1.15mm		

1			
<b>GEV No.</b>	106611	<b>Ref. No.</b>	33T1630
<b>description</b>	gas injector thread M10x1 WS 12 bore $\varnothing$ 1.25mm		



Зип Общепит

vsezip.ru

+7(812)987-08-81

 <p>1</p>	 <p>1</p>																
<table border="1"> <tr> <td><b>GEV No.</b></td> <td>106452</td> <td><b>Ref. No.</b></td> <td>33T3760</td> </tr> <tr> <td><b>description</b></td> <td colspan="3">gas injector thread M10x1 WS 12 bore ø 1.35mm</td> </tr> </table>	<b>GEV No.</b>	106452	<b>Ref. No.</b>	33T3760	<b>description</b>	gas injector thread M10x1 WS 12 bore ø 1.35mm			<table border="1"> <tr> <td><b>GEV No.</b></td> <td>106454</td> <td><b>Ref. No.</b></td> <td>33T1740</td> </tr> <tr> <td><b>description</b></td> <td colspan="3">gas injector thread M10x1 WS 12 bore ø 1.8mm</td> </tr> </table>	<b>GEV No.</b>	106454	<b>Ref. No.</b>	33T1740	<b>description</b>	gas injector thread M10x1 WS 12 bore ø 1.8mm		
<b>GEV No.</b>	106452	<b>Ref. No.</b>	33T3760														
<b>description</b>	gas injector thread M10x1 WS 12 bore ø 1.35mm																
<b>GEV No.</b>	106454	<b>Ref. No.</b>	33T1740														
<b>description</b>	gas injector thread M10x1 WS 12 bore ø 1.8mm																
 <p>1</p>	 <p>1</p>																
<table border="1"> <tr> <td><b>GEV No.</b></td> <td>106453</td> <td><b>Ref. No.</b></td> <td>33T1660</td> </tr> <tr> <td><b>description</b></td> <td colspan="3">gas injector thread M10x1 WS 12 bore ø 1.4mm</td> </tr> </table>	<b>GEV No.</b>	106453	<b>Ref. No.</b>	33T1660	<b>description</b>	gas injector thread M10x1 WS 12 bore ø 1.4mm			<table border="1"> <tr> <td><b>GEV No.</b></td> <td>106456</td> <td><b>Ref. No.</b></td> <td>33T1770</td> </tr> <tr> <td><b>description</b></td> <td colspan="3">gas injector thread M10x1 WS 12 bore ø 1.95mm</td> </tr> </table>	<b>GEV No.</b>	106456	<b>Ref. No.</b>	33T1770	<b>description</b>	gas injector thread M10x1 WS 12 bore ø 1.95mm		
<b>GEV No.</b>	106453	<b>Ref. No.</b>	33T1660														
<b>description</b>	gas injector thread M10x1 WS 12 bore ø 1.4mm																
<b>GEV No.</b>	106456	<b>Ref. No.</b>	33T1770														
<b>description</b>	gas injector thread M10x1 WS 12 bore ø 1.95mm																
 <p>1</p>	 <p>1</p>																
<table border="1"> <tr> <td><b>GEV No.</b></td> <td>101961</td> <td><b>Ref. No.</b></td> <td>33T3490</td> </tr> <tr> <td><b>description</b></td> <td colspan="3">gas injector thread M10x1 WS 12 bore ø 1.55mm</td> </tr> </table>	<b>GEV No.</b>	101961	<b>Ref. No.</b>	33T3490	<b>description</b>	gas injector thread M10x1 WS 12 bore ø 1.55mm			<table border="1"> <tr> <td><b>GEV No.</b></td> <td>106457</td> <td><b>Ref. No.</b></td> <td>33T1790</td> </tr> <tr> <td><b>description</b></td> <td colspan="3">gas injector thread M10x1 WS 12 bore ø 2.05mm</td> </tr> </table>	<b>GEV No.</b>	106457	<b>Ref. No.</b>	33T1790	<b>description</b>	gas injector thread M10x1 WS 12 bore ø 2.05mm		
<b>GEV No.</b>	101961	<b>Ref. No.</b>	33T3490														
<b>description</b>	gas injector thread M10x1 WS 12 bore ø 1.55mm																
<b>GEV No.</b>	106457	<b>Ref. No.</b>	33T1790														
<b>description</b>	gas injector thread M10x1 WS 12 bore ø 2.05mm																
 <p>1</p>	 <p>1</p>																
<table border="1"> <tr> <td><b>GEV No.</b></td> <td>106467</td> <td><b>Ref. No.</b></td> <td>33T0790</td> </tr> <tr> <td><b>description</b></td> <td colspan="3">gas injector thread M10x1 WS 12 bore ø 1.6mm</td> </tr> </table>	<b>GEV No.</b>	106467	<b>Ref. No.</b>	33T0790	<b>description</b>	gas injector thread M10x1 WS 12 bore ø 1.6mm			<table border="1"> <tr> <td><b>GEV No.</b></td> <td>106458</td> <td><b>Ref. No.</b></td> <td>33T1800</td> </tr> <tr> <td><b>description</b></td> <td colspan="3">gas injector thread M10x1 WS 12 bore ø 2.1mm</td> </tr> </table>	<b>GEV No.</b>	106458	<b>Ref. No.</b>	33T1800	<b>description</b>	gas injector thread M10x1 WS 12 bore ø 2.1mm		
<b>GEV No.</b>	106467	<b>Ref. No.</b>	33T0790														
<b>description</b>	gas injector thread M10x1 WS 12 bore ø 1.6mm																
<b>GEV No.</b>	106458	<b>Ref. No.</b>	33T1800														
<b>description</b>	gas injector thread M10x1 WS 12 bore ø 2.1mm																
 <p>1</p>	 <p>1</p>																
<table border="1"> <tr> <td><b>GEV No.</b></td> <td>106468</td> <td><b>Ref. No.</b></td> <td>33T1720</td> </tr> <tr> <td><b>description</b></td> <td colspan="3">gas injector thread M10x1 WS 12 bore ø 1.7mm</td> </tr> </table>	<b>GEV No.</b>	106468	<b>Ref. No.</b>	33T1720	<b>description</b>	gas injector thread M10x1 WS 12 bore ø 1.7mm			<table border="1"> <tr> <td><b>GEV No.</b></td> <td>106475</td> <td><b>Ref. No.</b></td> <td>33T1820</td> </tr> <tr> <td><b>description</b></td> <td colspan="3">gas injector thread M10x1 WS 12 bore ø 2.2mm</td> </tr> </table>	<b>GEV No.</b>	106475	<b>Ref. No.</b>	33T1820	<b>description</b>	gas injector thread M10x1 WS 12 bore ø 2.2mm		
<b>GEV No.</b>	106468	<b>Ref. No.</b>	33T1720														
<b>description</b>	gas injector thread M10x1 WS 12 bore ø 1.7mm																
<b>GEV No.</b>	106475	<b>Ref. No.</b>	33T1820														
<b>description</b>	gas injector thread M10x1 WS 12 bore ø 2.2mm																
 <p>1</p>	 <p>1</p>																
<table border="1"> <tr> <td><b>GEV No.</b></td> <td>106455</td> <td><b>Ref. No.</b></td> <td>33T1380</td> </tr> <tr> <td><b>description</b></td> <td colspan="3">gas injector thread M10x1 WS 12 bore ø 1.85mm</td> </tr> </table>	<b>GEV No.</b>	106455	<b>Ref. No.</b>	33T1380	<b>description</b>	gas injector thread M10x1 WS 12 bore ø 1.85mm			<table border="1"> <tr> <td><b>GEV No.</b></td> <td>106459</td> <td><b>Ref. No.</b></td> <td>33T1840</td> </tr> <tr> <td><b>description</b></td> <td colspan="3">gas injector thread M10x1 WS 12 bore ø 2.4mm</td> </tr> </table>	<b>GEV No.</b>	106459	<b>Ref. No.</b>	33T1840	<b>description</b>	gas injector thread M10x1 WS 12 bore ø 2.4mm		
<b>GEV No.</b>	106455	<b>Ref. No.</b>	33T1380														
<b>description</b>	gas injector thread M10x1 WS 12 bore ø 1.85mm																
<b>GEV No.</b>	106459	<b>Ref. No.</b>	33T1840														
<b>description</b>	gas injector thread M10x1 WS 12 bore ø 2.4mm																

Зип Общепит

vsezip.ru

+7(812)987-08-81



1

<b>GEV No.</b>	106469	<b>Ref. No.</b>	33T1950
<b>description</b>	gas injector thread M10x1 WS 12 bore $\varnothing$ 2.5mm		



1

<b>GEV No.</b>	106463	<b>Ref. No.</b>	33T1900
<b>description</b>	gas injector thread M10x1 WS 12 bore $\varnothing$ 3mm		



1

<b>GEV No.</b>	106460	<b>Ref. No.</b>	33T1860
<b>description</b>	gas injector thread M10x1 WS 12 bore $\varnothing$ 2.6mm		



1

<b>GEV No.</b>	101997	<b>Ref. No.</b>	33T4210
<b>description</b>	gas injector thread M10x1 WS 11 bore $\varnothing$ 1.4mm		



1

<b>GEV No.</b>	106461	<b>Ref. No.</b>	33T1880
<b>description</b>	gas injector thread M10x1 WS 12 bore $\varnothing$ 2.8mm		



1

<b>GEV No.</b>	100380	<b>Ref. No.</b>	33T0070
<b>description</b>	gas injector thread M10x1 WS 12 bore $\varnothing$ 0.7mm		



1

<b>GEV No.</b>	106462	<b>Ref. No.</b>	33T3750
<b>description</b>	gas injector thread M10x1 WS 12 bore $\varnothing$ 2.9mm		



1

<b>GEV No.</b>	100381	<b>Ref. No.</b>	33T0080
<b>description</b>	gas injector thread M10x1 WS 12 bore $\varnothing$ 0.85mm		



1

<b>GEV No.</b>	106474	<b>Ref. No.</b>	33T1780
<b>description</b>	gas injector thread M10x1 WS 12 bore $\varnothing$ 2mm		



1

<b>GEV No.</b>	100382	<b>Ref. No.</b>	33T0090
<b>description</b>	gas injector thread M10x1 WS 12 bore $\varnothing$ 1.05mm		



1

<b>GEV No.</b>	106464	<b>Ref. No.</b>	33T1930
<b>description</b>	gas injector thread M10x1 WS 12 bore $\varnothing$ 3.4mm		



1









<b>GEV No.</b>	100539	<b>Ref. No.</b>	33T0390
<b>description</b>	gas injector thread M10x1 WS 12 bore $\varnothing$ 1.15mm		



Зип Общепит

vsezip.ru

+7(812)987-08-81

 <p>1</p>	 <p>1</p>																
<table border="1"> <tr> <td><b>GEV No.</b></td> <td>100540</td> <td><b>Ref. No.</b></td> <td>33T1620</td> </tr> <tr> <td><b>description</b></td> <td colspan="3">gas injector thread M10x1 WS 12 bore <math>\varnothing</math> 1.2mm</td> </tr> </table>	<b>GEV No.</b>	100540	<b>Ref. No.</b>	33T1620	<b>description</b>	gas injector thread M10x1 WS 12 bore $\varnothing$ 1.2mm			<table border="1"> <tr> <td><b>GEV No.</b></td> <td>100537</td> <td><b>Ref. No.</b></td> <td>33T1580</td> </tr> <tr> <td><b>description</b></td> <td colspan="3">gas injector thread M10x1 WS 12 bore <math>\varnothing</math> 1mm</td> </tr> </table>	<b>GEV No.</b>	100537	<b>Ref. No.</b>	33T1580	<b>description</b>	gas injector thread M10x1 WS 12 bore $\varnothing$ 1mm		
<b>GEV No.</b>	100540	<b>Ref. No.</b>	33T1620														
<b>description</b>	gas injector thread M10x1 WS 12 bore $\varnothing$ 1.2mm																
<b>GEV No.</b>	100537	<b>Ref. No.</b>	33T1580														
<b>description</b>	gas injector thread M10x1 WS 12 bore $\varnothing$ 1mm																
 <p>1</p>	 <p>1</p>																
<table border="1"> <tr> <td><b>GEV No.</b></td> <td>100387</td> <td><b>Ref. No.</b></td> <td>33T1670</td> </tr> <tr> <td><b>description</b></td> <td colspan="3">gas injector thread M10x1 WS 12 bore <math>\varnothing</math> 1.45mm</td> </tr> </table>	<b>GEV No.</b>	100387	<b>Ref. No.</b>	33T1670	<b>description</b>	gas injector thread M10x1 WS 12 bore $\varnothing$ 1.45mm			<table border="1"> <tr> <td><b>GEV No.</b></td> <td>100386</td> <td><b>Ref. No.</b></td> <td>33T0160</td> </tr> <tr> <td><b>description</b></td> <td colspan="3">gas injector thread M10x1 WS 12 bore <math>\varnothing</math> 2.2mm</td> </tr> </table>	<b>GEV No.</b>	100386	<b>Ref. No.</b>	33T0160	<b>description</b>	gas injector thread M10x1 WS 12 bore $\varnothing$ 2.2mm		
<b>GEV No.</b>	100387	<b>Ref. No.</b>	33T1670														
<b>description</b>	gas injector thread M10x1 WS 12 bore $\varnothing$ 1.45mm																
<b>GEV No.</b>	100386	<b>Ref. No.</b>	33T0160														
<b>description</b>	gas injector thread M10x1 WS 12 bore $\varnothing$ 2.2mm																
 <p>1</p>	 <p>1</p>																
<table border="1"> <tr> <td><b>GEV No.</b></td> <td>102151</td> <td><b>Ref. No.</b></td> <td>33T0110</td> </tr> <tr> <td><b>description</b></td> <td colspan="3">gas injector thread M10x1 WS 12 bore <math>\varnothing</math> 1.4mm</td> </tr> </table>	<b>GEV No.</b>	102151	<b>Ref. No.</b>	33T0110	<b>description</b>	gas injector thread M10x1 WS 12 bore $\varnothing$ 1.4mm			<table border="1"> <tr> <td><b>GEV No.</b></td> <td>100388</td> <td><b>Ref. No.</b></td> <td>33T0170</td> </tr> <tr> <td><b>description</b></td> <td colspan="3">gas injector thread M10x1 WS 12 bore <math>\varnothing</math> 2.3mm</td> </tr> </table>	<b>GEV No.</b>	100388	<b>Ref. No.</b>	33T0170	<b>description</b>	gas injector thread M10x1 WS 12 bore $\varnothing$ 2.3mm		
<b>GEV No.</b>	102151	<b>Ref. No.</b>	33T0110														
<b>description</b>	gas injector thread M10x1 WS 12 bore $\varnothing$ 1.4mm																
<b>GEV No.</b>	100388	<b>Ref. No.</b>	33T0170														
<b>description</b>	gas injector thread M10x1 WS 12 bore $\varnothing$ 2.3mm																
 <p>1</p>	 <p>1</p>																
<table border="1"> <tr> <td><b>GEV No.</b></td> <td>100383</td> <td><b>Ref. No.</b></td> <td>33T0120</td> </tr> <tr> <td><b>description</b></td> <td colspan="3">gas injector thread M10x1 WS 12 bore <math>\varnothing</math> 1.6mm</td> </tr> </table>	<b>GEV No.</b>	100383	<b>Ref. No.</b>	33T0120	<b>description</b>	gas injector thread M10x1 WS 12 bore $\varnothing$ 1.6mm			<table border="1"> <tr> <td><b>GEV No.</b></td> <td>106430</td> <td><b>Ref. No.</b></td> <td>33T0190</td> </tr> <tr> <td><b>description</b></td> <td colspan="3">gas injector thread M10x1 WS 12 bore <math>\varnothing</math> 2.6mm</td> </tr> </table>	<b>GEV No.</b>	106430	<b>Ref. No.</b>	33T0190	<b>description</b>	gas injector thread M10x1 WS 12 bore $\varnothing$ 2.6mm		
<b>GEV No.</b>	100383	<b>Ref. No.</b>	33T0120														
<b>description</b>	gas injector thread M10x1 WS 12 bore $\varnothing$ 1.6mm																
<b>GEV No.</b>	106430	<b>Ref. No.</b>	33T0190														
<b>description</b>	gas injector thread M10x1 WS 12 bore $\varnothing$ 2.6mm																
 <p>1</p>	 <p>1</p>																
<table border="1"> <tr> <td><b>GEV No.</b></td> <td>100384</td> <td><b>Ref. No.</b></td> <td>33T0130</td> </tr> <tr> <td><b>description</b></td> <td colspan="3">gas injector thread M10x1 WS 12 bore <math>\varnothing</math> 1.8mm</td> </tr> </table>	<b>GEV No.</b>	100384	<b>Ref. No.</b>	33T0130	<b>description</b>	gas injector thread M10x1 WS 12 bore $\varnothing$ 1.8mm			<table border="1"> <tr> <td><b>GEV No.</b></td> <td>107466</td> <td><b>Ref. No.</b></td> <td>33T4640</td> </tr> <tr> <td><b>description</b></td> <td colspan="3">gas injector thread M10x1 WS 12 bore <math>\varnothing</math> 3.05mm</td> </tr> </table>	<b>GEV No.</b>	107466	<b>Ref. No.</b>	33T4640	<b>description</b>	gas injector thread M10x1 WS 12 bore $\varnothing$ 3.05mm		
<b>GEV No.</b>	100384	<b>Ref. No.</b>	33T0130														
<b>description</b>	gas injector thread M10x1 WS 12 bore $\varnothing$ 1.8mm																
<b>GEV No.</b>	107466	<b>Ref. No.</b>	33T4640														
<b>description</b>	gas injector thread M10x1 WS 12 bore $\varnothing$ 3.05mm																
 <p>1</p>	 <p>1</p>																
<table border="1"> <tr> <td><b>GEV No.</b></td> <td>100544</td> <td><b>Ref. No.</b></td> <td>33T1760</td> </tr> <tr> <td><b>description</b></td> <td colspan="3">gas injector thread M10x1 WS 12 bore <math>\varnothing</math> 1.9mm</td> </tr> </table>	<b>GEV No.</b>	100544	<b>Ref. No.</b>	33T1760	<b>description</b>	gas injector thread M10x1 WS 12 bore $\varnothing$ 1.9mm			<table border="1"> <tr> <td><b>GEV No.</b></td> <td>106431</td> <td><b>Ref. No.</b></td> <td>33T0510</td> </tr> <tr> <td><b>description</b></td> <td colspan="3">gas injector thread M10x1 WS 12 bore <math>\varnothing</math> 3.3mm</td> </tr> </table>	<b>GEV No.</b>	106431	<b>Ref. No.</b>	33T0510	<b>description</b>	gas injector thread M10x1 WS 12 bore $\varnothing$ 3.3mm		
<b>GEV No.</b>	100544	<b>Ref. No.</b>	33T1760														
<b>description</b>	gas injector thread M10x1 WS 12 bore $\varnothing$ 1.9mm																
<b>GEV No.</b>	106431	<b>Ref. No.</b>	33T0510														
<b>description</b>	gas injector thread M10x1 WS 12 bore $\varnothing$ 3.3mm																
<table border="1"> <tr> <td><b>For models:</b></td> <td colspan="3">91AR</td> </tr> </table>	<b>For models:</b>	91AR															
<b>For models:</b>	91AR																

Зип Общепит

vsezip.ru

+7(812)987-08-81

	<b>GEV No.</b> 106300	<b>Ref. No.</b> 33T2420
<b>description</b> gas injector thread M10x1 WS 12 bore ø 0.9mm L 31mm		

	<b>GEV No.</b> 106301	<b>Ref. No.</b> 33T0310
<b>description</b> gas injector thread M10x1 WS 12 bore ø 1.05mm L 31mm		

	<b>GEV No.</b> 106302	<b>Ref. No.</b> 33T2140
<b>description</b> gas injector thread M10x1 WS 12 bore ø 1.25mm L 31mm		

	<b>GEV No.</b> 106305	<b>Ref. No.</b> 33T3210
<b>description</b> gas injector thread M10x1 WS 12 bore ø 1.5mm L 31mm		

	<b>GEV No.</b> 102236	<b>Ref. No.</b> 33T1310
<b>description</b> gas injector thread M10x1 WS 12 bore ø 2.1mm		

	<b>GEV No.</b> 106303	<b>Ref. No.</b> 33T0320
<b>description</b> gas injector thread M10x1 WS 12 bore ø 2.3mm L 31mm		

**pilot burner nozzles**

**pilot burner nozzle AB**

	<b>GEV No.</b> 106237	<b>Ref. No.</b> 33T1510
<b>description</b> pilot burner nozzle natural/liquid gas code 25 bore ø 0.25mm Qty 1 pcs		

**pilot burner nozzles JUNKERS**

**CB 50203\_/503\_ series**

	<b>GEV No.</b> 100220	<b>Ref. No.</b> 33T0540
<b>description</b> pilot burner nozzle LPG gas pressure 50mbar code 2 Qty 1 pcs suitable for JUNKERS CB503_		

	<b>GEV No.</b> 100224	<b>Ref. No.</b> 33T0560
<b>description</b> pilot burner nozzle natural gas gas pressure 25mbar code 26 Qty 1 pcs suitable for JUNKERS CB503_		

**pilot burner nozzles SIT**

**100 series**

	<b>GEV No.</b> 100246	<b>Ref. No.</b> 33T0410
<b>description</b> pilot burner nozzle natural gas bore ø 0.35mm Qty 1 pcs thread M8x0.75		

	<b>GEV No.</b> 102972	<b>Ref. No.</b> 33T3130
<b>description</b> pilot burner nozzle natural gas code 40 bore ø 0.4mm Qty 1 pcs		

	<b>GEV No.</b> 107171	<b>Ref. No.</b> 33T0340
<b>description</b> pilot burner nozzle SIT natural/liquid gas bore ø 0.25mm Qty 1 pcs		

**160 series**

	<b>GEV No.</b> 107649	<b>Ref. No.</b> 33T4300
<b>description</b> pilot burner nozzle SIT LPG code 20 Qty 1 pcs		

	<b>GEV No.</b> 107650	<b>Ref. No.</b> 33T3310
<b>description</b> pilot burner nozzle SIT LPG code 30 Qty 1 pcs		

	<b>GEV No.</b> 107173	<b>Ref. No.</b> 33T4310
<b>description</b> pilot burner nozzle SIT natural gas code 35 Qty 1 pcs suitable for 160 series nozzle ø 0.35mm		





Зип Общепит

bypass nozzles

vsezip.ru

+7 (812) 987-08-81

			
1			
<b>GEV No.</b>	107174	<b>Ref. No.</b>	33T2870
<b>description</b>	pilot burner nozzle SIT natural gas code 41 Qty 1 pcs		

<b>bypass nozzles EGA</b>			
			
1			
<b>GEV No.</b>	100357	<b>Ref. No.</b>	33T2340
<b>description</b>	bypass nozzle EGA type 31248 series bore ø 0.7mm		

pilot burner nozzles (other)

ANGELO PO

			
1			
<b>GEV No.</b>	100253	<b>Ref. No.</b>	33T0040
<b>description</b>	pilot burner nozzle LPG code 2 gas pressure 50mbar Qty 1 pcs brass		

			
1			
<b>GEV No.</b>	100328	<b>Ref. No.</b>	33T2370
<b>description</b>	bypass nozzle EGA type 31248 series bore ø 0.8mm		

			
1			
<b>GEV No.</b>	100363	<b>Ref. No.</b>	33T2360
<b>description</b>	bypass nozzle EGA type 31248 series bore ø 1.5mm		

			
1			
<b>GEV No.</b>	106236	<b>Ref. No.</b>	33T2350
<b>description</b>	bypass nozzle EGA type 31248 series bore ø 1.7mm		

			
1			
<b>GEV No.</b>	100240	<b>Ref. No.</b>	33T0240
<b>description</b>	pilot burner nozzle LPG code 39 gas pressure 30mbar brass		

bypass nozzles PEL20/21

			
1			
<b>GEV No.</b>	100408	<b>Ref. No.</b>	33T3630
<b>description</b>	bypass nozzle type PEL20/21 bore ø 0.35mm thread M5x0.5		

<b>accessories for</b>	100240			
	<b>GEV No.</b>	100240	<b>Ref. No.</b>	33T0240
	pilot burner nozzle LPG code 39 gas pressure 30mbar brass			

			
1			
<b>GEV No.</b>	100553	<b>Ref. No.</b>	33T1450
<b>description</b>	bypass nozzle type PEL20/21 bore ø 0.4mm thread M5x0.5		

	<b>GEV No.</b>	100241	<b>Ref. No.</b>	33T0050
	pilot burner nozzle natural gas code 13 gas pressure 25mbar bore ø 0.4mm Qty 1 pcs brass			

			
1			
<b>GEV No.</b>	100550	<b>Ref. No.</b>	33T3530
<b>description</b>	bypass nozzle type PEL20/21 bore ø 0.55mm thread M5x0.5		

	<b>GEV No.</b>	100909	<b>Ref. No.</b>	36Q0060
	union screw thread M10x1 for pipe ø 6mm Qty 1 pcs			

			
1			
<b>GEV No.</b>	100548	<b>Ref. No.</b>	33T3640
<b>description</b>	bypass nozzle type PEL20/21 bore ø 0.65mm thread M5x0.5		

	<b>GEV No.</b>	101282	<b>Ref. No.</b>	—
	olive for pipe ø 4mm L 7.4mm Qty 1 pcs			

			
1			
<b>GEV No.</b>	100278	<b>Ref. No.</b>	33T2640
<b>description</b>	bypass nozzle type PEL20/21 bore ø 0.75mm thread M5x0.5		

	<b>GEV No.</b>	101283	<b>Ref. No.</b>	—
	union screw thread M10x1 for pipe ø 4mm Qty 1 pcs			

	<b>GEV No.</b>	101288	<b>Ref. No.</b>	—
	olive for pipe ø 6mm L 6mm aluminium Qty 1 pcs ED ø 8.5mm			

			
1			
<b>GEV No.</b>	100241	<b>Ref. No.</b>	33T0050
<b>description</b>	pilot burner nozzle natural gas code 13 gas pressure 25mbar bore ø 0.4mm Qty 1 pcs brass		

1 gas components

Зип Общепит

vsezip.ru

+7(812)987-08-81

1			
<b>GEV No.</b>	100552	<b>Ref. No.</b>	33T3650
<b>description</b>	bypass nozzle type PEL20/21 bore ø 0.7mm thread M5x0.5		

1			
<b>GEV No.</b>	100281	<b>Ref. No.</b>	33T1690
<b>description</b>	bypass nozzle type PEL22 bore ø 0.4mm thread M6x0.5		

1			
<b>GEV No.</b>	100527	<b>Ref. No.</b>	33T3660
<b>description</b>	bypass nozzle type PEL20/21 bore ø 0.85mm thread M5x0.5		

1			
<b>GEV No.</b>	100391	<b>Ref. No.</b>	33T2120
<b>description</b>	bypass nozzle type PEL22 bore ø 0.55mm thread M6x0.5		

1			
<b>GEV No.</b>	100555	<b>Ref. No.</b>	33T3540
<b>description</b>	bypass nozzle type PEL20/21 bore ø 0.8mm thread M5x0.5		

1			
<b>GEV No.</b>	100390	<b>Ref. No.</b>	33T1190
<b>description</b>	bypass nozzle type PEL22 bore ø 0.5mm thread M6x0.5		

1			
<b>GEV No.</b>	100556	<b>Ref. No.</b>	33T3810
<b>description</b>	bypass nozzle type PEL20/21 bore ø 0.95mm thread M5x0.5		

1			
<b>GEV No.</b>	100428	<b>Ref. No.</b>	33T1210
<b>description</b>	bypass nozzle type PEL22 bore ø 0.65mm thread M6x0.5		

1			
<b>GEV No.</b>	100557	<b>Ref. No.</b>	33T3670
<b>description</b>	bypass nozzle type PEL20/21 bore ø 1.05mm thread M5x0.5		

1			
<b>GEV No.</b>	100432	<b>Ref. No.</b>	33T2160
<b>description</b>	bypass nozzle type PEL22 bore ø 0.75mm thread M6x0.5		

1			
<b>GEV No.</b>	100530	<b>Ref. No.</b>	33T4260
<b>description</b>	bypass nozzle type PEL20/21 bore ø 1.1mm thread M5x0.5		

1			
<b>GEV No.</b>	100409	<b>Ref. No.</b>	33T3970
<b>description</b>	bypass nozzle type PEL22 bore ø 0.8mm thread M6x0.5		

1			
<b>GEV No.</b>	100532	<b>Ref. No.</b>	33T4270
<b>description</b>	bypass nozzle type PEL20/21 bore ø 1.2mm thread M5x0.5		

1			
<b>GEV No.</b>	100433	<b>Ref. No.</b>	33T3850
<b>description</b>	bypass nozzle type PEL22 bore ø 0.9mm thread M6x0.5		

1			
<b>GEV No.</b>	100533	<b>Ref. No.</b>	33T4290
<b>description</b>	bypass nozzle type PEL20/21 bore ø 1.3mm thread M5x0.5		

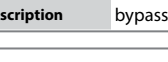
1			
<b>GEV No.</b>	100435	<b>Ref. No.</b>	33T2250
<b>description</b>	bypass nozzle type PEL22 bore ø 1.05mm thread M6x0.5		

<b>bypass nozzles PEL22</b>			
1			
<b>GEV No.</b>	100259	<b>Ref. No.</b>	33T1180
<b>description</b>	bypass nozzle type PEL22 bore ø 0.35mm thread M6x0.5		

1			
<b>GEV No.</b>	102974	<b>Ref. No.</b>	33T0590
<b>description</b>	bypass nozzle type PEL22 bore ø 1.25mm thread M6x0.5		



Зип Общепит gas nozzles sets

vsezip.ru

+7(812)987-08-81

bypass nozzles PEL23/24

	1
<b>GEV No.</b>	106235
<b>Ref. No.</b>	33T1480
<b>description</b>	bypass nozzle type PEL23/24 bore $\varnothing$ 0.4mm thread M8x0.5
	1
<b>GEV No.</b>	100448
<b>Ref. No.</b>	33T2500
<b>description</b>	bypass nozzle type PEL23/24 bore $\varnothing$ 0.5mm thread M8x0.5
	1
<b>GEV No.</b>	100494
<b>Ref. No.</b>	33T4050
<b>description</b>	bypass nozzle type PEL23/24 bore $\varnothing$ 0.75mm thread M8x0.5
	1
<b>GEV No.</b>	100497
<b>Ref. No.</b>	33T4060
<b>description</b>	bypass nozzle type PEL23/24 bore $\varnothing$ 0.8mm thread M8x0.5
	1
<b>GEV No.</b>	100598
<b>Ref. No.</b>	33T2490
<b>description</b>	bypass nozzle type PEL23/24 bore $\varnothing$ 0.95mm thread M8x0.5
	1
<b>GEV No.</b>	100597
<b>Ref. No.</b>	33T2690
<b>description</b>	bypass nozzle type PEL23/24 bore $\varnothing$ 0.9mm thread M8x0.5
	1
<b>GEV No.</b>	100628
<b>Ref. No.</b>	33T3280
<b>description</b>	bypass nozzle type PEL23/24 bore $\varnothing$ 1.05mm thread M8x0.5
	1
<b>GEV No.</b>	100667
<b>Ref. No.</b>	33T2720
<b>description</b>	bypass nozzle type PEL23/24 bore $\varnothing$ 1.35mm thread M8x0.5
	1
<b>GEV No.</b>	100677
<b>Ref. No.</b>	33T2660
<b>description</b>	bypass nozzle type PEL23/24 bore $\varnothing$ 1.45mm thread M8x0.5

	1
<b>GEV No.</b>	102171
<b>Ref. No.</b>	6018090
<b>description</b>	gas injector set
	1
<b>GEV No.</b>	102610
<b>Ref. No.</b>	6018330 60A0640
<b>description</b>	gas injector set LPG 2 flames ANGELO PO
	1
<b>GEV No.</b>	102622
<b>Ref. No.</b>	6012660
<b>description</b>	gas injector set LPG ANGELO PO
<b>For models:</b>	1A1FA1G, 1A1FA2G, 1A1FA4G, 1A1FA5G, 1A1TP0G-VERS.2002, 1D1FA1G, 1D1FA2G, 1D1FA4G, 1D1FA5G, 1D1TP0G-VERS.2002, 2A1FA1G, 2A1FA4G, 2A1TP3G, 2A1TP6G, 2D1FA1G, 2D1FA4G, 2D1TP3G, 2D1TP6G, 3A1FA1G, 3A1FA4G, 3D1FA1G, 3D1FA4G
	1
<b>GEV No.</b>	102613
<b>Ref. No.</b>	6018340 60A0650
<b>description</b>	gas injector set LPG for gas range 4 ANGELO PO

1 gas components

Зип Общепит

vsezip.ru

+7(812)987-08-81



1

<b>GEV No.</b>	102611	<b>Ref. No.</b>	6018360 60A0670
<b>description</b>	gas injector set LPG for gas range 4 with gas oven ANGELO PO		



1

<b>GEV No.</b>	102618	<b>Ref. No.</b>	6018250 60A0560
<b>description</b>	gas injector set LPG gas fryer 2 basins ANGELO PO		



1

<b>GEV No.</b>	102619	<b>Ref. No.</b>	6018430 60A0740
<b>description</b>	gas injector set LPG for solid top range with gas hob and gas oven ANGELO PO		



1

<b>GEV No.</b>	102625	<b>Ref. No.</b>	6018270 60A0580
<b>description</b>	gas injector set LPG gas fryer 2 basins ANGELO PO		



1

<b>GEV No.</b>	102626	<b>Ref. No.</b>	6018260 60A0570
<b>description</b>	gas injector set LPG gas fryer 1 basin ANGELO PO		



1

<b>GEV No.</b>	102617	<b>Ref. No.</b>	6018180 60A0490
<b>description</b>	gas injector set LPG gas pasta cooker 2 basins ANGELO PO		



1

<b>GEV No.</b>	102629	<b>Ref. No.</b>	6018240 60A0550
<b>description</b>	gas injector set LPG gas fryer 1 basin ANGELO PO		



1

<b>GEV No.</b>	102623	<b>Ref. No.</b>	6018190 60A0500
<b>description</b>	gas injector set LPG gas pasta cooker ANGELO PO		



Зип Общепит

vsezip.ru

+7(812)987-08-81



1

<b>GEV No.</b>	102624	<b>Ref. No.</b>	6018170 60A0480
<b>description</b>	gas injector set LPG gas pasta cooker ANGELO PO		

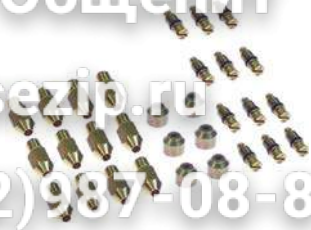

1

<b>GEV No.</b>	106808	<b>Ref. No.</b>	6025800
<b>description</b>	gas injector set natural gas ANGELO PO		



1

<b>GEV No.</b>	102621	<b>Ref. No.</b>	6012700
<b>description</b>	gas injector set LPG nominal power 5.5KW ANGELO PO		
<b>For models:</b>	0A0FA1, 0A0FA4, 0D0FA1, 0D0FA4, 1A0FA1, 1A0FA2, 1A0FA4, 1A0FA5, 1A1FA1G, 1A1FA2G, 1A1FA4G, 1A1FA5G, 1D0FA1, 1D0FA2, 1D0FA4, 1D0FA5, 1D1FA1G, 1D1FA2G, 1D1FA4G, 1D1FA5G, 2A0FA1, 2A0FA4, 2A1FA1G, 2A1FA4G, 2A1TP3G, 2A1TP6G, 2D0FA1, 2D0FA4, 2D1FA1G, 2D1FA4G, 2D1TP3G, 2D1TP6G, 3A1FA1G, 3A1FA4G, 3D1FA1G, 3D1FA4G		



1

<b>GEV No.</b>	106807	<b>Ref. No.</b>	6018060 60A0370
<b>description</b>	gas injector set natural gas ANGELO PO 0G0FT		



1

<b>GEV No.</b>	102620	<b>Ref. No.</b>	6012680
<b>description</b>	gas injector set LPG nominal power 7.5KW ANGELO PO		



1

<b>GEV No.</b>	102614	<b>Ref. No.</b>	6018290 60A0600
<b>description</b>	gas injector set natural gas for gas range 4 ANGELO PO		



1

<b>GEV No.</b>	102616	<b>Ref. No.</b>	6018410 60A0720
<b>description</b>	gas injector set LPG solid top range ANGELO PO		



1

<b>GEV No.</b>	102612	<b>Ref. No.</b>	6018320 60A0630
<b>description</b>	gas injector set natural gas for gas range 6 with gas oven ANGELO PO		



1

<b>GEV No.</b>	102615	<b>Ref. No.</b>	6018420 60A0730
<b>description</b>	gas injector set LPG solid top range with gas oven ANGELO PO		



1

<b>GEV No.</b>	106550	<b>Ref. No.</b>	6018370 60A0680
<b>description</b>	nozzle set LPG ANGELO PO		

1 gas components

## auxiliary gas parts

### screw connections

#### adapters



<b>GEV No.</b>	103097	<b>Ref. No.</b>	33Q2870
<b>description</b>	screw connection for thermostat		
<b>For models:</b>	1A1P11G, 1A1P11GA, 1D1P11G, 1D1P11GA, 1G1P11G, 31P16, 71P110, 71P110A, 91P110, 91P110A		

#### olives



<b>GEV No.</b>	103325	<b>Ref. No.</b>	3034890
<b>description</b>	olive for pipe $\varnothing$ 10mm D2 $\varnothing$ 9mm L 8mm		
<b>For models:</b>	08WFA4G, 090FT1G, 090FT2G, 090FT4G, 090FT5G, 090FT7G, 0G0FR5G, 0G0FT1G-VERS.032008, 0G0FT2G-VERS.032008, 0G0FT4G-VERS.032008, 0G0FT5G-VERS.032008, 0G0FT7G, 0G1FR7G, 12WFA6G, 190FT15G, 190FT1G, 190FT2G, 190FT3G, 190FT42G, 190FT4G, 190FT6G, 190FT72G, 190FT7G, 191FAAG, 191FABG, 191FADG, 191FAG, 191TPG, 1A1FAAG, 1A1FABG, 1D1FAAG, 1D1FABG, 1G0FR6G, 1G0FT1G-VERS.032008, 1G0FT2G-VERS.032008, 1G0FT3G-VERS.032008, 1G0FT4G-VERS.032008, 1G0FT6E, 1G0FT6G-VERS.032008, 1G0FT7G, 1G1BR1G, 1G1FR8G, 291FAG, 291FAGE, 291TPCG, 2A1FAAG, 2A1TPCG, 2D1FAAG, 2D1TPCG, 391FAG...(Other models you can see in the webshop)		







<b>GEV No.</b>	101249	<b>Ref. No.</b>	36Q1700
<b>description</b>	olive for pipe $\varnothing$ 10mm Qty 1 pcs		
<b>For models:</b>	06WCP1GM, 08WCP1GM, 08WGRGV, 090FAVA, 090GRG, 091CP1G, 091FR3G, 091FR3GD, 0A0BMG, 0A0FAS, 0A0FT1G, 0A0FT2G, 0A0FT4G, 0A0FT5G, 0A0GRG, 0A1CP1G, 0B0FAS, 0B0FT1G, 0B0FT2G, 0B0FT4G, 0B0FT5G, 0B1CP1G, 0D0BMG, 0D0FAS, 0D0FT1G, 0D0FT2G, 0D0FT4G, 0D0FT5G, 0D0GRG, 0D1CP1G, 0G0FR5G, 0G0FT1G, 0G0FT2G, 0G0FT4G, 0G0FT5G, 0G1BR3G, 10WTPGE, 10WTPGV, 190FAB, 190GRG, 190TP0, 191CP1G, 191CP2G, 191FABG, 191FR4G, 191FR4GD, 191PD2G, 191P11G, 191P11GA, 191P12G...(Other models you can see in the webshop)		
<b>accessories for</b>	101249		
	<b>GEV No.</b>	101250	<b>Ref. No.</b>
			36Q0610
	union nut thread M20x1.5 for pipe $\varnothing$ 10mm		

Зип-Общепит

vsezip.ru

+7(812)987-08-81

<b>GEV No.</b>	101278	<b>Ref. No.</b>	36Q0080
<b>description</b>	olive for pipe $\varnothing$ 10mm Qty 1 pcs		
<b>For models:</b>	030, 051, 032, 040, 0FAAV, 0WCP1GM, 06WFR3GD, 070BM, 070BME, 071BM, 071BME, 08WCP1GM, 08WFA4E, 08WFA4G, 08WFAAE, 08WFAAG, 08WFAAV, 08WFT1GV, 08WFT2GV, 08WFT3GV, 08WFT4GV, 08WFT6GV, 08WFT7GV, 08WGRGV, 090BM, 090BM1G, 090BME, 090FAA, 090FAVA, 090FT1G, 090FT2G, 090FT4G, 090FT5G, 090FT7G, 090GRG, 091BM, 091BME, 091CP1G, 091FR1EX, 091FR3G, 091FR3GD, 091FR7GS, 091FR7GX, 0A0BMG, 0A0FA1, 0A0FA4, 0A0FAA, 0A0FT1G, 0A0FT2G, 0A0FT4G, 0A0FT5G...(Other models you can see in the webshop)		
<b>accessories for</b>	101278		
	<b>GEV No.</b>	100943	<b>Ref. No.</b>
			—
	union nut thread M17x1 tube $\varnothing$ 10mm		
	<b>GEV No.</b>	101300	<b>Ref. No.</b>
			36Q0830
	union nut thread M16x1.5 tube $\varnothing$ 10mm		
	<b>GEV No.</b>	101478	<b>Ref. No.</b>
			—
	union nut thread 3/8" for pipe $\varnothing$ 10mm		

<b>GEV No.</b>	101248	<b>Ref. No.</b>	36Q0030
<b>description</b>	olive for pipe $\varnothing$ 12mm Qty 1 pcs suitable for PEL		
<b>For models:</b>	030FT, 030FTR, 031FT, 031FT04, 031FT06, 031FTR, 031FTRL, 031TP, 032, 070BM, 070D, 070DGG, 070FT, 070FT04, 070FT05, 070FTR, 0712D, 0712VA, 071BM, 071D, 071DGG, 071FT, 071FT04, 071FT06, 071FTR, 071FTRL, 071TP, 072D, 072DGG, 090, 090BM, 090FT, 090FT04, 090FT05, 090FT1G, 090FT2G, 090FT4G, 090FT5G, 090FT7G, 090FTR, 090GG, 090GRG, 091, 091BM, 091FR1G, 091FR1GD, 091FR11, 091FR11A, 091FR11D, 091FR11D-VERS.052012...(Other models you can see in the webshop)		
<b>accessories for</b>	101248		
	<b>GEV No.</b>	101251	<b>Ref. No.</b>
			36Q0050
	union nut thread M20x1.5 for pipe $\varnothing$ 12mm		

<b>GEV No.</b>	101428	<b>Ref. No.</b>	36Q0310
<b>description</b>	olive for pipe $\varnothing$ 14mm L 9mm Qty 1 pcs ED $\varnothing$ 16mm		
<b>For models:</b>	04WFAAV, 08WFAAE, 08WFAAG, 08WFAAV, 12WFAAE, 12WFAAG, 191BR1G, 191BR1GA, 191BR2G, 191BR2GA, 1A1BR1G, 1A1BR1GA, 1A1BR2G, 1A1BR2GA, 1D1BR1G, 1D1BR1GA, 1D1BR2G, 1D1BR2GA, 291BR1G, 291BR1GA, 291BR2G, 291BR2GA, 2A1BR1G, 2A1BR1GA, 2A1BR2G, 2A1BR2GA, 2D1BR1G, 2D1BR1GA, 2D1BR2G, 2D1BR2GA, FC241, FCV141, FCV141DM, FCV141DS, FCV241, FCV241DM, FCV241DS		





Зип Общепит

vsezip.ru



7(812)987-08-81



			
1			
<b>GEV No.</b>	100870	<b>Ref. No.</b>	36Q1040
<b>description</b>	olive for pipe ø 4mm Qty 1 pcs suitable for 160 series for pilot burner		
<b>For models:</b>	04WFAAV, 06WCP1GM, 06WFR3GD, 08WFA4E, 08WFA4G, 08WFA4E, 08WFA4E, 08WFAAG, 08WFAAV, 08WFT1GV, 08WFT2GV, 08WFT3GV, 08WFT4GV, 08WFT6GV, 08WFT7GV, 08WGRGV, 090BM1G, 090FAA, 090FAVA, 090FT1G, 090FT2G, 090FT4G, 090FT5G, 090FT7G, 090GRG, 091FR1G, 091FR1GD, 091FR3G, 091FR3GD, 0A0FA1, 0A0FA4, 0A0FAA, 0A0FT1G, 0A0FT2G, 0A0FT4G, 0A0FT5G, 0A0GRG, 0A1CP1G, 0B0FT1G, 0B0FT2G, 0B0FT4G, 0B0FT5G, 0B1CP1G, 0D0FA1, 0D0FA4, 0D0FAA, 0D0FT1G, 0D0FT2G, 0D0FT4G, 0D0FT5G, 0D0GRG...(Other models you can see in the webshop)		

			
1			
<b>GEV No.</b>	101286	<b>Ref. No.</b>	36Q0020
<b>description</b>	olive ID ø 6mm Qty 1 pcs		
<b>For models:</b>	04WFAAV, 08WFA4E, 08WFA4G, 08WFAAE, 08WFAAG, 08WFAAV, 090FAA, 0A0FA1, 0A0FA4, 0A0FAA, 0D0FA1, 0D0FA4, 0D0FAA, 0G0FA0, 12WFA6E, 12WFA6G, 12WFAAA, 12WFAAE, 12WFAAG, 12WFAAN, 190FA, 190FAA, 190FAB, 190FAD, 191FAAE, 191FAAG, 191FABG, 191FADG, 191FAE, 191FAG, 1A0FA1, 1A0FA2, 1A0FA4, 1A0FA5, 1A0FAA, 1A0FAB, 1A1FA1G, 1A1FA2G, 1A1FA4G, 1A1FA5G, 1A1FAAG, 1A1FABG, 1D0FA1, 1D0FA2, 1D0FA4, 1D0FA5, 1D0FAA, 1D0FAB, 1D1FA1G, 1D1FA2G...(Other models you can see in the webshop)		
<b>accessories for</b>	101286		
	<b>GEV No.</b>	100909	<b>Ref. No.</b> 36Q0060
union screw thread M10x1 for pipe ø 6mm Qty 1 pcs			
	<b>GEV No.</b>	101464	<b>Ref. No.</b> —
union nut thread M12x1 for pipe ø 6mm			

<b>T-pieces</b>			
			
1			
<b>GEV No.</b>	541502	<b>Ref. No.</b>	33Q0140
<b>description</b>	T-piece thread 3/8" ET - 3/8" ET - 3/8" ET brass		
<b>For models:</b>	1A1CP1G, 1D1CP1G, 1G1CP2G, 1G1PD1G, 1G1PI1E, 1G1PI1G, 31PD6, 31PI6, 31PIE6, 71CP, 71CP2, 71PD10, 71PD15, 71PI10, 71PI10A, 71PIE15, 71PIE15A, 71PV15, 71PV15A, 91CP, 91PI10, 91PI10A, 91PIE15, 91PIE15A		

			
1			
<b>GEV No.</b>	520666	<b>Ref. No.</b>	36Q0590
<b>description</b>	union nut thread 1/2" H 12mm		
<b>For models:</b>	091FR11, 091FR11A, 091FR11D, 091FR11D-VERS.052012, 091FR11-VERS.032012, 091FR7G, 091FR7GS, 091FR7G-VERS.052012, 091FR7GX, 0A1CP1E, 0A1CP1G, 0B1CP1G, 0D1CP1E, 0D1CP1G, 10CP11A, 12CP11A, 18CP21A, 191FR21, 191FR21D, 191FR21D-VERS.092012, 191FR21-VERS.032012, 1A1BR1E, 1A1BR1G, 1A1BR1GA, 1A1BR2E, 1A1BR2EA, 1A1BR2G, 1A1BR2GA, 1A1CP1G, 1A1CP2G, 1A1PD1G, 1A1PD2G, 1A1PI1G, 1A1PI1GA, 1A1PI2E, 1A1PI2EA, 1A1PI2V, 1A1PI-2VA, 1D1BR1E, 1D1BR1G, 1D1BR1GA, 1D1BR2E, 1D1BR2EA, 1D1BR2G, 1D1BR2GA, 1D1CP1G, 1D1CP2G, 1D1PD1G, 1D1PD2G, 1D1PI1G...(Other models you can see in the webshop)		

			
1			
<b>GEV No.</b>	101300	<b>Ref. No.</b>	36Q0830
<b>description</b>	union nut thread M16x1.5 tube ø 10mm		
<b>For models:</b>	030, 031, 032, 04WFAAV, 06WCP1GM, 06WFR3GD, 08WCP1GM, 08WFA4E, 08WFA4G, 08WFAAE, 08WFAAG, 08WFAAV, 08WFT1GV, 08WFT2GV, 08WFT3GV, 08WFT4GV, 08WFT6GV, 08WFT7GV, 08WGRGV, 090FAA, 090GRG, 091CP1G, 0A0BMG, 0A0FA1, 0A0FA4, 0A0FAA, 0A0GRG, 0D0BMG, 0D0FA1, 0D0FA4, 0D0FAA, 0D0GRG, 0G0FA0, 0G0FR5G, 0G1BR3G, 0G1CP1G, 0G1CP1G-VERS.2004, 0G1FR7G, 10WFR4GD, 12WFA6E, 12WFA6G, 12WFAAA, 12WFAAE, 12WFAAG, 12WFAAN, 190FA, 190FAA, 190FAB, 190FAD, 190GRG...(Other models you can see in the webshop)		
<b>accessories for</b>	101300		
	<b>GEV No.</b>	101278	<b>Ref. No.</b> 36Q0080
olive for pipe ø 10mm Qty 1 pcs			

			
1			
<b>GEV No.</b>	100944	<b>Ref. No.</b>	36Q0040
<b>description</b>	union nut thread M18x1.5 for pipe ø 12mm		
<b>accessories for</b>	100944		
	<b>GEV No.</b>	101273	<b>Ref. No.</b> —
olive for pipe ø 12mm L 9.5mm brass Qty 1 pcs suitable for universal			

1 gas components

Зип.Общепит

union screw

vsezip.ru

+7(812)987-08-81

gas components



1

<b>GEV No.</b>	101250	<b>Ref. No.</b>	36Q0610
<b>description</b>	union nut thread M20x1.5 for pipe ø 10mm		
<b>For models:</b>	04WFAAV, 06WCP1GM, 06WFR3GD, 08WCP1GM, 08WFA4E, 08WFA4G, 08WFAAE, 08WFAAG, 08WFAAV, 08WGRGV, 090FAA, 090FAVA, 090FT1G, 090FT2G, 090FT4G, 090FT5G, 090FT7G, 090GRG, 091CP1G, 091FR3G, 091FR3GD, 0A0FA1, 0A0FA4, 0A0FAA, 0A0FAS, 0A0FT1G, 0A0FT2G, 0A0FT4G, 0A0FT5G, 0A0GRG, 0A1CP1G, 0A1FR3G, 0A1FR3GD, 0B0FAS, 0B0FT1G, 0B0FT2G, 0B0FT4G, 0B0FT5G, 0B1CP1G, 0D0FA1, 0D0FA4, 0D0FAA, 0D0FAS, 0D0FT1G, 0D0FT2G, 0D0FT4G, 0D0FT5G, 0D0GRG, 0D1CP1G, 0D1FR3G...(Other models you can see in the webshop)		
<b>accessories for</b>	101250		
	<b>GEV No.</b>	101249	<b>Ref. No.</b> 36Q1700
	olive for pipe ø 10mm Qty 1 pcs		



1

<b>GEV No.</b>	101251	<b>Ref. No.</b>	36Q0050
<b>description</b>	union nut thread M20x1.5 for pipe ø 12mm		
<b>For models:</b>	030FT, 030FTR, 031FT, 031FTR, 031FTRL, 031TP, 032, 070D, 070DGG, 070FT, 070FTR, 0712D, 0712VA, 071BM, 071D, 071DGG, 071FT, 071FTR, 071FTRL, 071TP, 072D, 072DGG, 090, 090FT, 090FT1G, 090FT2G, 090FT4G, 090FT5G, 090FT7G, 090FTR, 090GG, 090GRG, 091, 091FR1G, 091FR1GD, 091FR1I, 091FR1IA, 091FR1ID, 091FR1ID-VERS.052012, 091FR1I-VERS.032012, 091FR3G, 091FR3GD, 091FR7G, 091FR7GS, 091FR7G-VERS.052012, 091FR7GX, 091FT, 091FTR, 091FTRL, 091GG...(Other models you can see in the webshop)		
<b>accessories for</b>	101251		
	<b>GEV No.</b>	101248	<b>Ref. No.</b> 36Q0030
	olive for pipe ø 12mm Qty 1 pcs suitable for PEL		



1

<b>GEV No.</b>	107892	<b>Ref. No.</b>	36Q0210
<b>description</b>	union nut thread M20x1.5 for pipe ø 14 WS 25		
<b>For models:</b>	04WFAAV, 08WFA4E, 08WFA4G, 08WFAAE, 08WFAAG, 08WFAAV, 12WFA6E, 12WFA6G, 12WFAAA, 12WFAAE, 12WFAAG, 12WFAAN, 191BR2G, 1A1BR1G, 1A1BR1GA, 1A1BR2G, 1A1BR2GA, 1D1BR1G, 1D1BR1GA, 1D1BR2G, 1D1BR2GA, 2A1BR1G, 2A1BR1GA, 2A1BR2G, 2A1BR2GA, 2D1BR1G, 2D1BR1GA, 2D1BR2G, 2D1BR2GA, 71AR, 71AR, 91AR, 91RA, FC241, FCV141, FCV141DM, FCV141DS, FCV241, FCV241DM, FCV241DS		



1

<b>GEV No.</b>	100906	<b>Ref. No.</b>	36Q1050
<b>description</b>	screw connection thread M10x1 for ignition electrode brass Qty 1 pcs WS 10		
<b>For models:</b>	08WGRGV, 090GRG, 0A0GRG, 0A1CP1G, 0B1CP1G, 0D0GRG, 0D1CP1G, 190GRG, 191CP1G, 1A0GRG, 1A1CP1G, 1A1CP2G, 1A1PD1G, 1A1PD2G, 1A1PI1G, 1A1PI1GA, 1D0GRG, 1D1CP1G, 1D1CP2G, 1D1PD1G, 1D1PD2G, 1D1PI1G, 1D1PI1GA, 1G0GRG, 6042120-08WGRGV		



1

<b>GEV No.</b>	101279	<b>Ref. No.</b>	3032790
<b>description</b>	union screw thread 3/8" for pipe ø 10mm Qty 1 pcs		
<b>For models:</b>	06WFR3GD, 08WFA4G, 090BM1G, 090FT1G, 090FT2G, 090FT4G, 090FT5G, 090FT7G, 091FR1EX, 091FR3G, 091FR3GD, 091FR7GS, 091FR7GX, 0A1FR3G, 0A1FR3GD, 0D1FR3G, 0D1FR3GD, 0G0FR5G, 0G0FT1G-VERS.032008, 0G0FT2G-VERS.032008, 0G0FT4G-VERS.032008, 0G0FT5G-VERS.032008, 0G0FT7G, 0G1FR3G, 0G1FR3GD, 0G1FR7G, 10WFR4GD, 12WFA6G, 190BM2G, 190FT15G, 190FT1G, 190FT2G, 190FT3G, 190FT42G, 190FT4G, 190FT6G, 190FT72G, 190FT7G, 191FAAG, 191FABG, 191FADG, 191FAG, 191FR4G, 191FR4GD, 191TPG, 1A1FAAG, 1A1FABG, 1A1FR4G, 1A1FR4GD, 1D1FAAG...(Other models you can see in the webshop)		



1

<b>GEV No.</b>	100908	<b>Ref. No.</b>	36Q1000
<b>description</b>	union screw thread M10x1 for pipe ø 4mm Qty 1 pcs		
<b>For models:</b>	04WFAAV, 06WCP1GM, 06WFR3GD, 08WFA4E, 08WFA4G, 08WFAAE, 08WFAAG, 08WFAAV, 08WFT1GV, 08WFT2GV, 08WFT3GV, 08WFT4GV, 08WFT6GV, 08WFT7GV, 08WGRGV, 090BM1G, 090FAA, 090FAVA, 090FT1G, 090FT2G, 090FT4G, 090FT5G, 090FT7G, 090GRG, 091FR1G, 091FR1GD, 091FR3G, 091FR3GD, 0A0FA1, 0A0FA4, 0A0FAA, 0A0FT1G, 0A0FT2G, 0A0FT4G, 0A0FT5G, 0A0GRG, 0A1CP1G, 0B0FT1G, 0B0FT2G, 0B0FT4G, 0B0FT5G, 0B1CP1G, 0D0FA1, 0D0FA4, 0D0FAA, 0D0FT1G, 0D0FT2G, 0D0FT4G, 0D0FT5G, 0D0GRG...(Other models you can see in the webshop)		

<b>accessories for</b>	100908		
	<b>GEV No.</b>	100897	<b>Ref. No.</b> —
	olive for pipe ø 4mm Qty 1 pcs for pilot burner		
	<b>GEV No.</b>	101246	<b>Ref. No.</b> —
	olive for pipe ø 4mm Qty 1 pcs		
	<b>GEV No.</b>	101280	<b>Ref. No.</b> —
	olive for pipe ø 4mm Qty 1 pcs		
	<b>GEV No.</b>	101282	<b>Ref. No.</b> —
	olive for pipe ø 4mm L 7.4mm Qty 1 pcs		





Зип Общепит

vsezip.ru

+7(812)987-08-81

			
1			
<b>GEV No.</b>	100909	<b>Ref. No.</b>	36Q0060
<b>description</b>	union screw thread M10x1 for pipe ø 6mm Qty 1 pcs		
<b>For models:</b>	04WFAAV, 08WFA4E, 08WFA4G, 08WFAAE, 08WFAAG, 08WFAAV, 090FAA, 0A0FA1, 0A0FA4, 0A0FAA, 0D0FA1, 0D0FA4, 0D0FAA, 0G0FA0, 12WFA6E, 12WFA6G, 12WFAAA, 12WFAAE, 12WFAAG, 12WFAAN, 190FA, 190FAA, 190FAB, 190FAD, 191FAAE, 191FAAG, 191FABG, 191FADG, 191FAE, 191FAG, 1A0FA1, 1A0FA2, 1A0FA4, 1A0FA5, 1A0FAA, 1A0FAB, 1A1FA1G, 1A1FA2G, 1A1FA4G, 1A1FA5G, 1A1FAAG, 1A1FABG, 1D0FA1, 1D0FA2, 1D0FA4, 1D0FA5, 1D0FAA, 1D0FAB, 1D1FA1G, 1D1FA2G...(Other models you can see in the webshop)		
<b>accessories for</b>	100909		
	<b>GEV No.</b>	100898	<b>Ref. No.</b> —
	olive for pipe ø 6mm Qty 1 pcs for pilot burner		
	<b>GEV No.</b>	101286	<b>Ref. No.</b> 36Q0020
	olive ID ø 6mm Qty 1 pcs		
	<b>GEV No.</b>	101287	<b>Ref. No.</b> 36Q0150
	olive for pipe ø 6mm Qty 1 pcs		
	<b>GEV No.</b>	101288	<b>Ref. No.</b> —
	olive for pipe ø 6mm L 6mm aluminium Qty 1 pcs ED ø 8.5mm		

			
1			
<b>GEV No.</b>	107551	<b>Ref. No.</b>	30Z2040
<b>description</b>	gas line tube ø 21mm L 745mm W 180mm H 70mm steel		
<b>For models:</b>	1A0FT1G, 1A0FT2G, 1A0FT3G, 1A0FT4G, 1A0FT6G, 1D0FT1G, 1D0FT2G, 1D0FT3G, 1D0FT4G, 1D0FT6G		

<b>universal</b>			
			
1			
<b>GEV No.</b>	107589	<b>Ref. No.</b>	3029620
<b>description</b>	gas line connection ø10mm L 1250mm ED ø 13mm SS flexible thickness 1mm connection length 30mm		
<b>For models:</b>	08WFT1GV, 08WFT2GV, 08WFT3GV, 08WFT4GV, 08WFT6GV, 08WFT7GV, 1G1FA0G, 1G1FABG, 1G1FAPG, 1G1TP0G, 2G1FA0G, 2G1FABG, 2G1FACG, 2G1FADG, 2G1FADGV, 2G1FAPG, 2G1TP3G		

			
1			
<b>GEV No.</b>	102990	<b>Ref. No.</b>	35Z6650
<b>description</b>	gas line connection ø10mm L 320mm ED ø 13mm SS with screw connection thickness 1mm connection length 30mm		
<b>For models:</b>	071FT, 071FTR, 071FTRL, 091FT, 091FTR, 091FTRL		

			
1			
<b>GEV No.</b>	102987	<b>Ref. No.</b>	3014320
<b>description</b>	gas line connection ø10mm L 400mm ED ø 13mm SS flexible thickness 1mm connection length 30mm		
<b>For models:</b>	04WFAAV, 08WFA4E, 08WFA4G, 08WFAAE, 08WFAAG, 08WFAAV, 08WFT1GV, 08WFT2GV, 08WFT3GV, 08WFT4GV, 08WFT6GV, 08WFT7GV, 08WGRGV, 090BM1G, 090FAA, 090FAVA, 090FT1G, 090FT2G, 090FT4G, 090FT5G, 090FT7G, 090GRG, 091FR3G, 091FR3GD, 0A0BMG, 0A0FAA, 0A0FT1G, 0A0FT2G, 0A0FT4G, 0A0FT5G, 0A0GRG, 0A1FR3G, 0A1FR3GD, 0B0FT1G, 0B0FT2G, 0B0FT4G, 0B0FT5G, 0D0BMG, 0D0FAA, 0D0FT1G, 0D0FT2G, 0D0FT4G, 0D0FT5G, 0D0GRG, 0D1FR3G, 0D1FR3GD, 0G0FA0, 0G0FR5G, 0G0FT1G, 0G0FT1G-VERS.032008...(Other models you can see in the webshop)		

			
1			
<b>GEV No.</b>	106655	<b>Ref. No.</b>	3029630
<b>description</b>	gas line connection ø10mm L 800mm ED ø 13mm SS flexible		
<b>For models:</b>	06WFR3GD, 08WCP1GM, 08WFA4G, 10WFR4GD, 12WFA6G, 191FAAG, 191FABG, 191FADG, 191FAG, 191FR4G, 191FR4GD, 191PD2G, 191PI1G, 191PI1GA, 191PI2G, 191PI2GA, 191TPG, 1A1FAAG, 1A1FABG, 1A1FR4G, 1A1FR4GD, 1A1PD1G, 1A1PD2G, 1A1PI1G, 1A1PI1GA, 1D1FAAG, 1D1FABG, 1D1FR4G, 1D1FR4GD, 1D1PD1G, 1D1PD2G, 1D1PI1G, 1D1PI1GA, 1G1BR1G, 1G1FR4G, 1G1FR4GD, 1G1PD1G, 1G1PI1G, 291FAG, 291FAGF, 291TPCG, 2A1FAAG, 2A1TPCG, 2D1FAAG, 2D1TPCG, 391FAG, 3A1FAAG, 3D1FAAG		

gas lines

main gas lines

producer-specific

			
1			
<b>GEV No.</b>	102991	<b>Ref. No.</b>	35Z4960
<b>description</b>	gas line tube ø 10mm L 300mm with screw connection		
<b>For models:</b>	070D, 070DGG, 0712D, 0712VA, 071D, 071DGG, 072D, 072DGG, 090, 090GG, 091, 091GG, 092, 092GG, 092VA, 092VAGG, 712D, 712VA, 71D, 71DGG, 71GE, 71GEGG, 72D, 72DGG, 72TP, 72TPGG, 72VA, 72VAGG, 72VAS, 72VASGG, 73D, 73DGG, 73VA, 73VAD, 73VADGG, 73VAGG		

Зип Общепит

vsezip.ru

+7(812)987-08-81

			
1			
<b>GEV No.</b>	102460	<b>Ref. No.</b>	3079320 32Z0640
<b>description</b>	gas line connection ø4mm L 750mm ED ø 12mm SS flexible thickness 0.75mm connection length 20mm		
<b>For models:</b>	06WCP1GM, 06WFR3GD, 08WFT1GV, 08WFT2GV, 08WFT3GV, 08WFT4GV, 08WFT6GV, 08WFT7GV, 090BM1G, 090FAVA, 091FR1G, 091FR1GD, 091FR3G, 091FR3GD, 0G1CP1G, 0G1CP1G-VERS.2004, 0G1FR3G, 0G1FR3GD, 0G1FR7G, 10WFR4GD, 190BM2G, 190FAB, 190TP0, 191CP1G, 191FABG, 191FR2G, 191FR2GD, 191PD2G, 191PI1G, 191PI1GA, 191PI2G, 191PI2GA, 191TPG, 1A1FR2GD-VERS.2004, 1A1FR2G-VERS.2004, 1A1PD1G, 1A1PD2G, 1A1PI1G, 1A1PI1GA, 1D1FR2GD-VERS.2004, 1D1FR2G-VERS.2004, 1D1PD1G, 1D1PD2G, 1D1PI1G, 1D1PI1GA, 1G0FT1G, 1G0FT2G, 1G0FT3G, 1G0FT4G, 1G0FT6G...(Other models you can see in the webshop)		

			
1			
<b>GEV No.</b>	102988	<b>Ref. No.</b>	35Z7410
<b>description</b>	pilot tube tube ø 5mm L 400mm		

pilot tubes			
producer-specific			
			
1			
<b>GEV No.</b>	106991	<b>Ref. No.</b>	3079290
<b>description</b>	pilot tube tube ø 4mm L 400mm aluminium flexible		
<b>For models:</b>	04WFAAV, 08WFA4E, 08WFA4G, 08WFAAE, 08WFAAG, 08WFAAV, 08WGRGV, 090BM1G, 090FT1G, 090FT2G, 090FT4G, 090FT5G, 090FT7G, 090GRG, 0G0FR5G, 0G0FT1G-VERS.032008, 0G0FT2G-VERS.032008, 0G0FT4G-VERS.032008, 0G0FT5G-VERS.032008, 0G0FT7G, 0G1BR3G, 12WFA6E, 12WFA6G, 12WFAAA, 12WFAAE, 12WFAAG, 12WFAAN, 190BM2G, 190FT15G, 190FT1G, 190FT2G, 190FT3G, 190FT42G, 190FT4G, 190FT6G, 190FT72G, 190FT7G, 190GRG, 191BR1G, 191BR1GA, 191BR2G, 191BR2GA, 1G0FR6G, 1G0FT1G-VERS.032008, 1G0FT2G-VERS.032008, 1G0FT3G-VERS.032008, 1G0FT4G-VERS.032008, 1G0FT6E, 1G0FT6G-VERS.032008, 1G0FT7G...(Other models you can see in the webshop)		

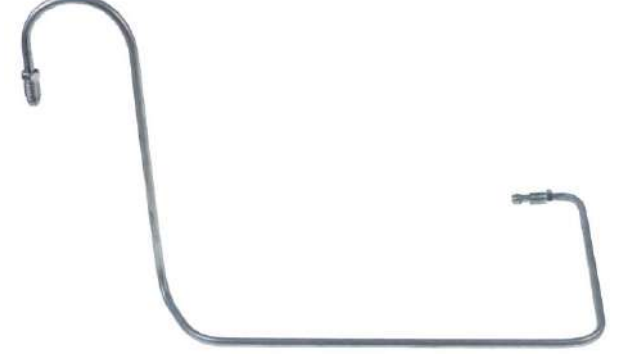
			
1			
<b>GEV No.</b>	102296	<b>Ref. No.</b>	35X4590
<b>description</b>	pilot tube tube ø 6mm T1: M10 T2: M10		
<b>For models:</b>	FC101, FC61, FCV101, FCV101-CSA, FCV101DM, FCV101DM-CSA, FCV101DS, FCV101DS-CSA, FCV61, FCV61-CSA, FCV61DM, FCV61DM-CSA, FCV61DS, FCV61DS-CSA		

			
1			
<b>GEV No.</b>	102989	<b>Ref. No.</b>	35Z7400
<b>description</b>	pilot tube tube ø 5mm L 130mm		
<b>For models:</b>	030, 031, 032, 31, 31GE, 31TC, 32, 32TC, 32TP, 32TPV, 32V		

consumables			
lava rocks / ceramic briquetts			
			
1			
<b>GEV No.</b>	211049	<b>Ref. No.</b>	37T1320
<b>description</b>	ceramic briquetts size 50x50x26mm Qty 40 pieces (2.4kg)		
<b>For models:</b>	08WGRGV, 090GRG, 0A0GRG, 0D0GRG, 190GRG, 1A0GRG, 1D0GRG, 1G0GRG, 6042120-08WGRGV		



## equipment-specific units

### for slicers

#### adjustment knobs



1

<b>GEV No.</b>	697796	<b>Ref. No.</b>	36M3680
<b>description</b>	adjusting knob $\varnothing$ 68mm shaft $\varnothing$ 18mm shaft L 73mm handle $\varnothing$ 68mm turn direction left		

#### eccentric disc for slice thickness



1

<b>GEV No.</b>	697508	<b>Ref. No.</b>	3FL0209
<b>description</b>	eccentrics for cutting thickness hole $\varnothing$ 18mm groove width 8mm ED $\varnothing$ 85mm thickness 24.5mm		

#### hand guard



1

<b>GEV No.</b>	698212	<b>Ref. No.</b>	35Q9820
<b>description</b>	hand protection		
<b>For models:</b>	AFT30MS, AFT30S, AFT33MS, AFT33S, AFT35		

#### blades

##### standard



1

<b>GEV No.</b>	697463	<b>Ref. No.</b>	36G8610
<b>description</b>	slicing machine blade ED $\varnothing$ 350mm seat $\varnothing$ 57mm 4 hole ID $\varnothing$ 280mm H 22.5mm 100Cr6 standard		
<b>For models:</b>	AFC35, AFT35, AFT35VS		

Зип Общепит

grindstones  
pair of grindstones



<b>GEV No.</b>	699007	<b>Ref. No.</b>	36G1030
<b>description</b>	grindstone 1 pair		



<b>GEV No.</b>	698340	<b>Ref. No.</b>	36G3950
<b>description</b>	pair of grindstones 1 pair		
<b>For models:</b>	AFC35, AFT33MS, AFT33S, AFT35, AFT35VS		

#### for bandsaws

##### saw blades

##### width 16mm



1

<b>GEV No.</b>	699003	<b>Ref. No.</b>	LF152020U16
<b>description</b>	saw blade L 2020mm W 16mm thickness 0.5mm tooth spacing 6mm		

#### for meat mincers

##### gear wheels



1

<b>GEV No.</b>	698205	<b>Ref. No.</b>	36G0390
<b>description</b>	gear wheel double $\varnothing$ 32/70mm shaft intake $\varnothing$ 15mm W 30mm teeth 18/41 splitting tooth width 14/11mm DIN/ISO Mod.12-22		

#### for cutters

##### drive shafts



1

<b>GEV No.</b>	694061	<b>Ref. No.</b>	36G7000
<b>description</b>	drive shaft $\varnothing$ 22mm stainless steel L 137mm CL3		
<b>For models:</b>	Q3, Q3M		

1

Зип-Общепит

vsezip.ru

+7(812)987-08-81

lids



1			
<b>GEV No.</b>	698209	<b>Ref. No.</b>	6000920
<b>description</b>	lid complete ø 215mm ID ø 210mm with magnet Q 3-5-8		
<b>For models:</b>	Q3, Q3M, Q5, Q52, Q5M, Q8, Q82		



1			
<b>GEV No.</b>	691664	<b>Ref. No.</b>	3031610
<b>description</b>	lid for cutter ø 225mm ID ø 204mm plastic with gasket C4-C6 edition since 08/2003		
<b>For models:</b>	SC4, SC6		



1			
<b>GEV No.</b>	694243	<b>Ref. No.</b>	36Z0665
<b>description</b>	lid ø 215mm ID ø 210mm plastic with magnet CL 3-5-8		

blades

spacer rings



1			
<b>GEV No.</b>	697106	<b>Ref. No.</b>	36G0650
<b>description</b>	spacer ring ED ø 63mm int. ø 1 39mm mounting distance 52mm hole ø 5.5mm plastic CL 3-5-8		
<b>For models:</b>	Q5, Q52, Q5M, Q8, Q82		

holders



1			
<b>GEV No.</b>	651037	<b>Ref. No.</b>	36G7010
<b>description</b>	blade holder ED ø 63mm int. ø 1 39mm int. ø 2 10mm H 81.5mm mounting distance 52mm thread M5 plastic CL 3-5-8		
<b>For models:</b>	Q3, Q3M, Q5, Q52, Q5M, Q8, Q82		

blades

blades smooth



1			
<b>GEV No.</b>	696177	<b>Ref. No.</b>	3017950
<b>description</b>	knife mounting pos. lower L 93mm seat ø 33mm mounting distance 46mm 4 hole hole ø 4.4mm thickness 2mm model C4-C6		
<b>For models:</b>	SC4, SC6		



1			
<b>GEV No.</b>	696173	<b>Ref. No.</b>	36G7030
<b>description</b>	knife mounting pos. upper seat ø 42mm mounting distance 52mm hole ø 5.5mm thickness 2mm model CL 3-5-8		
<b>For models:</b>	Q3, Q3M, Q5, Q52, Q5M, Q8, Q82		

for vegetable slicers

ejector discs



1			
<b>GEV No.</b>	699011	<b>Ref. No.</b>	36G6960
<b>description</b>	ejector disc H 7mm ø 195mm shaft diameter 22x27mm		
<b>For models:</b>	TV1, TV1M, TV2L		



Зип Общежит

vsezip.ru

+7(812)987-08-81

miscellaneous



1

<b>GEV No.</b>	692145	<b>Ref. No.</b>	36G6600
<b>description</b>	pulley disc ø 157mm disc width 31mm shaft intake ø 15mm overall width 30mm plastic for potato peeler device		
<b>For models:</b>	LCV, P10, P102, P10M, P20, P202, P5, TV1, TV1M, TV2L		

abrasive elements

grinding discs



1

<b>GEV No.</b>	696769	<b>Ref. No.</b>	3030900
<b>description</b>	peeling disk ø 383mm for potato peeler device C565		
<b>For models:</b>	MPK10, MPK10I, PK10, PK10I		

for potato peelers

drive shafts



1

<b>GEV No.</b>	692147	<b>Ref. No.</b>	36G6590
<b>description</b>	drive shaft for potato peeler device L 134mm		
<b>For models:</b>	P10, P102, P10M, P20, P202, P5		

miscellaneous



1

<b>GEV No.</b>	696412	<b>Ref. No.</b>	3600870
<b>description</b>	bottom plastic		
<b>For models:</b>	P10, P102, P10M, P20, P202, P5		

lids



1

<b>GEV No.</b>	696454	<b>Ref. No.</b>	36Z6501
<b>description</b>	lid for potato peeler device ø 430mm ID ø 380mm plastic mounting distance 220mm H 80mm		
<b>For models:</b>	LCV, P10, P102, P10M, P20, P202, P5		

<b>accessories for</b>	696454		
	<b>GEV No.</b>	901522	<b>Ref. No.</b>
			—
	lid gasket suitable for FIMAR for potato peeler device L 1280mm external height 12mm external width 12mm		



1

<b>GEV No.</b>	696408	<b>Ref. No.</b>	36G5950
<b>description</b>	bush for potato peeler device ED ø 20mm ID ø 16mm thickness 2mm L 19.4mm		
<b>For models:</b>	LCV, P10, P102, P10M, P20, P202, P5		



1

<b>GEV No.</b>	696407	<b>Ref. No.</b>	36D9660
<b>description</b>	deflector for potato peeler device plastic L 144mm W 38mm H 130mm thread 1/4"/M6		
<b>For models:</b>	P10, P102, P10M, P20, P202		



1

<b>GEV No.</b>	696406	<b>Ref. No.</b>	3190830
<b>description</b>	disc for potato peeler device ED ø 42mm ID ø 28.7mm thickness 4.5mm		
<b>For models:</b>	LCV, P10, P102, P10M, P20, P202, P5		

## for planetary mixers

### beaters



1

<b>GEV No.</b>	699393	<b>Ref. No.</b>	KA/W10731415
<b>description</b>	whisk shaft intake ø 12.7mm H 185mm suitable for KitchenAid		

## for fridges

### spare parts and accessories



1

<b>GEV No.</b>	691195	<b>Ref. No.</b>	36G5250
<b>description</b>	bracket for rack plastic		
<b>For models:</b>	135, 135BX, 135CPX, SP135, SP135B, SP135BN, SP135CP, SP135NN, SP65, SP65B, SP65NB		

Зип.Общепит

miscellaneous

vsezip.ru

+7(812)987-08-81



1

<b>GEV No.</b>	695580	<b>Ref. No.</b>	36D1250
<b>description</b>	frame L 1528mm W 55mm		
<b>For models:</b>	120, 120B, 120PV, 135, 135-4, 135A, 135B, 135BA, 135BX, 135BXE, 135BXR, 135CPX, 135PVX, 135X, 135X-3, 135X-4, 135XE, 135XR, SP120, SP120B, SP135, SP135B, SP135CP		

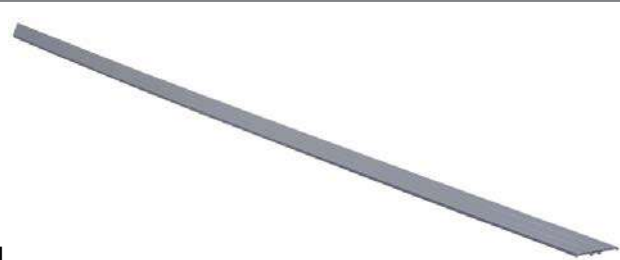

1

<b>GEV No.</b>	695581	<b>Ref. No.</b>	36D1290
<b>description</b>	frame L 1639mm W 55mm		
<b>For models:</b>	120, 120B, 120NN, 120PV, 135, 135-4, 135A, 135B, 135BA, 135BN, 135BNX, 135BX, 135BXE, 135BXR, 135CPX, 135NN, 135NNX, 135PVX, 135X, 135X-3, 135X-4, 135XE, 135XR, 55, 55B, 55PV, 65, 65A, 65B, 65BA, 65BX, 65BX-2, 65BXE, 65BXR, 65NB, 65NBX, 65NN, 65NNX, 65PVX, 65X, 65X-2, 65XE, 65XR, SP120, SP120B, SP120BN, SP120NN, SP135, SP135B, SP135BN...(Other models you can see in the webshop)		

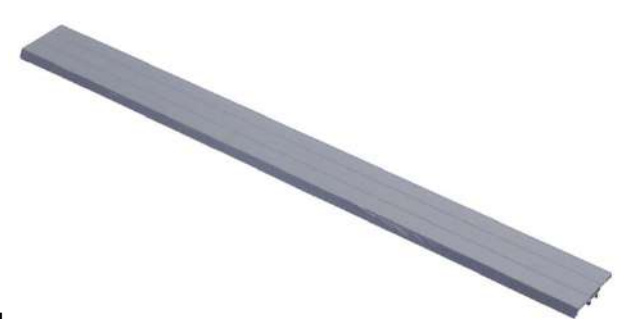

1

<b>GEV No.</b>	695579	<b>Ref. No.</b>	36D1260
<b>description</b>	frame L 621mm W 55mm		
<b>For models:</b>	135-4, 135CPX, 135X-3, 135X-4, 65BX-2, 65NB, 65NBX, 65NN, 65NNX, 65X-2, SP135CP, SP65NB, SP65NN		





3zip Общепит  
for refrigerated counters

lid hinges  
vsezip.ru

+7(812)987-08-81

			
1			
<b>GEV No.</b>	694636	<b>Ref. No.</b>	33Q6300
<b>description</b>	hose ID ø 21mm ED ø 27mm L 66mm ø 40mm thickness 3.5mm		
<b>For models:</b>	AF2B, AF2B-OPR01, AF2N, AF2N-OPR01, PGA20, PGA30, PGA40, PGA60, PGA80, PGW20, PGW30, PGW40, PGW60, PGW80, SM4SR		

			
1			
<b>GEV No.</b>	691099	<b>Ref. No.</b>	35G4630
<b>description</b>	hinge for lid mounting pos. left		
<b>For models:</b>	SA87		

			
1			
<b>GEV No.</b>	690689	<b>Ref. No.</b>	35X3460
<b>description</b>	spacer ring		
<b>For models:</b>	40EV, 40EVP, 40PV, 40XPV		

spare parts and accessories			
			
1			
<b>GEV No.</b>	691189	<b>Ref. No.</b>	36G8660
<b>description</b>	bush L 9mm ID ø 7mm ext. ø 10		
<b>For models:</b>	6BMA11A, 6BMA11B, 6BMA11M, 6BMA11Z, 6BMA2A, 6BMA2B, 6BMA2M, 6BMA2Z, 6BMA3A, 6BMA3B, 6BMA3M, 6BMA3Z, 6BMAA, 6BMAB, 6BMABA, 6BMABB, 6BMABM, 6BMABZ, 6BMAM, 6BMAZ, 6BMB11A, 6BMB11B, 6BMB11M, 6BMB11Z, 6BMB22A, 6BMB22B, 6BMB22M, 6BMB22Z, 6BMB2A, 6BMB2B, 6BMB2M, 6BMB2Z, 6BMB3A, 6BMB3B, 6BMB3M, 6BMB3Z, 6BMB4A, 6BMB4B, 6BMB4M, 6BMB4Z, 6BMB, 6BMBB, 6BMBBA, 6BMBBB, 6BMBBM, 6BMBBZ, 6BMBM, 6BMBZ, 6BMC11A, 6BMC11B...(Other models you can see in the webshop)		

			
1			
<b>GEV No.</b>	690691	<b>Ref. No.</b>	36C2440
<b>description</b>	spacer ring		
<b>For models:</b>	40EV, 40EVP, 40PV, 40XPV		

			
1			
<b>GEV No.</b>	698475	<b>Ref. No.</b>	3048360
<b>description</b>	drain pipe W 65mm H 145mm for refrigerated counters plastic Qty 1 pcs		
<b>For models:</b>	6EA, 6EA11, 6EA11A, 6EA11M, 6EA13, 6EA13A, 6EA13M, 6EA2, 6EA2A, 6EA2M, 6EAA, 6EAB, 6EABA, 6EABM, 6EAM, 6EB, 6EB11, 6EB11A, 6EB11M, 6EB13, 6EB13A, 6EB13M, 6EB2, 6EB22, 6EB22A, 6EB22M, 6EB2A, 6EB2M, 6EB4, 6EB4A, 6EB4M, 6EBA, 6EBB, 6EBBA, 6EBBM, 6EBM, 6EC, 6EC11, 6EC11A, 6EC11M, 6EC13, 6EC13A, 6EC13M, 6EC2, 6EC22, 6EC22A, 6EC22M, 6EC2A, 6EC2M, 6EC4...(Other models you can see in the webshop)		

			
1			
<b>GEV No.</b>	698476	<b>Ref. No.</b>	36E3990
<b>description</b>	thermostatic steam trap W 55mm H 45mm for fridge D1 ø 22mm D2 ø 16mm		
<b>For models:</b>	6EA, 6EA11, 6EA11A, 6EA11M, 6EA13, 6EA13A, 6EA13M, 6EA2, 6EA2A, 6EA2M, 6EAA, 6EAB, 6EABA, 6EABM, 6EAM, 6EB, 6EB11, 6EB11A, 6EB11M, 6EB13, 6EB13A, 6EB13M, 6EB2, 6EB22, 6EB22A, 6EB22M, 6EB2A, 6EB2M, 6EB4, 6EB4A, 6EB4M, 6EBA, 6EBB, 6EBBA, 6EBBM, 6EBM, 6EC, 6EC11, 6EC11A, 6EC11M, 6EC13, 6EC13A, 6EC13M, 6EC2, 6EC22, 6EC22A, 6EC22M, 6EC2A, 6EC2M, 6EC4...(Other models you can see in the webshop)		

Зип-Общепит

for ice-cube maker

ice chutes

vsezip.ru

slide grates

+7(812)987-08-81



1

<b>GEV No.</b>	694145	<b>Ref. No.</b>	3020430
<b>description</b>	slide grate for ice-cube maker L 250mm W 170mm H 25mm		
<b>For models:</b>	PG22C, PG23CW		



1

<b>GEV No.</b>	697867	<b>Ref. No.</b>	3300030
<b>description</b>	drain tray for condensation water plastic		
<b>For models:</b>	120B, 135, 135-4, 135A, 135B, 135BA, 135BN, 135BNX, 135BX, 135BXE, 135BXR, 135CPX, 135NN, 135NNX, 135PVX, 135X, 135X-3, 135X-4, 135XE, 135XR, 40CP, 40CPX, 55B, 65, 65A, 65B, 65BA, 65BX, 65BX-2, 65BXE, 65BXR, 65NB, 65NBX, 65NN, 65NNX, 65PVX, 65X, 65X-2, 65XE, 65XR, 6BEA11A, 6BEA11B, 6BEA11M, 6BEA11Z, 6BEA2A, 6BEA2B, 6BEA2M, 6BEA2Z, 6BEA3A, 6BEA3B...(Other models you can see in the webshop)		

## for freezer cabinets

## glass panels



1

<b>GEV No.</b>	700682	<b>Ref. No.</b>	37W0270
<b>description</b>	glass panel L 190mm W 310mm mounting pos. lateral		
<b>For models:</b>	AL1433V, AL1437V, AL1633V, AL1637V, AL2033V, AL2037V, AL2533V, AL2537V, AR143V, AR147V, AR163V, AR167V, AR203V, AR207V, AR253V, AR257V, BP53V, BP64V, BP83V, BP94V, BPZ163A, BPZ163B, BPZ163S, BPZ167A, BPZ167B, BPZ167S, BPZ203A, BPZ203B, BPZ203S, BPZ207A, BPZ207B, BPZ207S, BPZ253A, BPZ253B, BPZ257A, BPZ257B, PE1633V, PE2033V, PM1633V, PM2033V, PZ1633A, PZ1633B, PZ1637A, PZ1637B, PZ2033A, PZ2033B, PZ2037A, PZ2037B, PZ2533A, PZ2533B...(Other models you can see in the webshop)		

## for display coolers

## glass panels

## accessories



1

<b>GEV No.</b>	519386	<b>Ref. No.</b>	3190800
<b>description</b>	knurled nut for glass plate thread M4		
<b>For models:</b>	BRPRV, BRVRV, SE14PRV, SE14PRW, SE14VRV, SE14VRW, SI14PRV, SI14PRW, SI14VRV, SI14VRW, SL14RPRV, SL14RPRW, SL14RVRV, SL14RVRW, TPRV, TVRV		

## hoses

## miscellaneous



1

<b>GEV No.</b>	694636	<b>Ref. No.</b>	33Q6300
<b>description</b>	hose ID ø 21mm ED ø 27mm L 66mm ø 40mm thickness 3.5mm		
<b>For models:</b>	AF2B, AF2B-OPR01, AF2N, AF2N-OPR01, PGA20, PGA30, PGA40, PGA60, PGA80, PGW20, PGW30, PGW40, PGW60, PGW80, SM45R		

## for espresso machines

## brewing units

## filter holder gaskets

## O-rings



1

<b>GEV No.</b>	510409	<b>Ref. No.</b>	3150430 3151960 37Q5260
<b>description</b>	O-ring EPDM thickness 5.34mm ID ø 56.52mm Qty 1 pcs		
<b>For models:</b>	091CP1E, 0A1CP1E, 0G1CP1E, 0G1CP1EC, 0G1CP1E-VERS.2004, 191PI2E, 191PI2EA, 1A1PI2E, 1A1PI2EA, 1D1PI2E, 1D1PI2EA, 1G1PI1E, 30CPSE, 31PIE6, 6040090, 6040310, 6043850, 6043980, 70CPE, 71PIE15, 71PIE15A, 90CPE, 91PIE15, 91PIE15A, F60P, F60PR, F60T, F80P, F80PR, KD100, KD100A, KD100PSD, KD130, KD130A, KD130E, KD130EAT, KD60, KD60E, KD60EAT, KD60M, KD60MA, KD60ME, KD60MPS, KD60MPSA, KD60PS, KD60PSD, KD6EATSD, KD85, KD85A, KD85E...(Other models you can see in the webshop)		





screw connections

reducers



1

<b>GEV No.</b>	520700	<b>Ref. No.</b>	33Q5650
<b>description</b>	reducer thread 3/4" IT - 1/2" ET brass		
<b>For models:</b>	FCV101, FCV101-CSA, FCV101DM, FCV101DM-CSA, FCV101DS, FCV101DS-CSA, FCV101E, FCV101EDM, FCV101EDM-UL, FCV101EDS, FCV101EDS-UL, FCV101E-UL, FCV141, FCV141-CSA, FCV141DM, FCV141DM-CSA, FCV141DS, FCV141DS-CSA, FCV141E, FCV141EDM, FCV141EDS, FCV241, FCV241DM, FCV241DS, FCV241E, FCV241EDM, FCV241EDM-UL, FCV241EDS, FCV241EDS-UL, FCV241E-UL, FCV241G, FCV241G-CSA, FCV241GDM, FCV241GDM-CSA, FCV241GDS, FCV241GDS-CSA, FCV3EM, FCV401DM, FCV401DM-CSA, FCV401EDM, FCV401EDM-UL, FCV4E, FCV4EDS, FCV4EM, FCV61, FCV61-CSA, FCV61DM, FCV61DM-CSA, FCV61DS, FCV61DS-CSA...(Other models you can see in the webshop)		

for bain marie

housing and bezels



1

<b>GEV No.</b>	691183	<b>Ref. No.</b>	36D3430
<b>description</b>	end cap for control panel mounting pos. left		
<b>For models:</b>	030, 030BME, 030E, 030EBM, 030FE, 030FE1, 030FE1B, 030FT, 030FTE, 030FTER, 030FTR, 031, 031BME, 031E, 031EBM, 031FT, 031FT04, 031FT06, 031FTE, 031FTE04, 031FTE06, 031FTER, 031FTERL, 031FTR, 031FTRL, 031TP, 032, 070BM, 070BME, 070D, 070DGG, 070E, 070FT, 070FT04, 070FT05, 070FTE, 070FTE04, 070FTE05, 070FTER, 070FTR, 0712D, 0712VA, 071BM, 071BME, 071D, 071DGG, 071E, 071FT, 071FT04, 071FT06...(Other models you can see in the webshop)		



1

<b>GEV No.</b>	691184	<b>Ref. No.</b>	36D3420
<b>description</b>	end cap for control panel mounting pos. right		
<b>For models:</b>	030, 030BME, 030E, 030EBM, 030FE, 030FE1, 030FE1B, 030FT, 030FTE, 030FTER, 030FTR, 031, 031BME, 031E, 031EBM, 031FT, 031FT04, 031FT06, 031FTE, 031FTE04, 031FTE06, 031FTER, 031FTERL, 031FTR, 031FTRL, 031TP, 032, 070BM, 070BME, 070D, 070DGG, 070E, 070FT, 070FT04, 070FT05, 070FTE, 070FTE04, 070FTE05, 070FTER, 070FTR, 0712D, 0712VA, 071BM, 071BME, 071D, 071DGG, 071E, 071FT, 071FT04, 071FT06...(Other models you can see in the webshop)		

Зип Общепит

for deep fryers

vsezip.ru

+7(812)987-08-81

housing and bezels



1

<b>GEV No.</b>	691183	<b>Ref. No.</b>	36D3430
<b>description</b>	end cap for control panel mounting pos. left		
<b>For models:</b>	030, 030BME, 030E, 030EBM, 030FE, 030FE1, 030FE1B, 030FT, 030FTE, 030FTER, 030FTR, 031, 031BME, 031E, 031EBM, 031FT, 031FT04, 031FT06, 031FTE, 031FTE04, 031FTE06, 031FTER, 031FTERL, 031FTR, 031FTRL, 031TP, 032, 070BM, 070BME, 070D, 070DGG, 070E, 070FT, 070FT04, 070FT05, 070FTE, 070FTE04, 070FTE05, 070FTER, 070FTR, 0712D, 0712VA, 071BM, 071BME, 071D, 071DGG, 071E, 071FT, 071FT04, 071FT06...(Other models you can see in the webshop)		



1

<b>GEV No.</b>	691184	<b>Ref. No.</b>	36D3420
<b>description</b>	end cap for control panel mounting pos. right		
<b>For models:</b>	030, 030BME, 030E, 030EBM, 030FE, 030FE1, 030FE1B, 030FT, 030FTE, 030FTER, 030FTR, 031, 031BME, 031E, 031EBM, 031FT, 031FT04, 031FT06, 031FTE, 031FTE04, 031FTE06, 031FTER, 031FTERL, 031FTR, 031FTRL, 031TP, 032, 070BM, 070BME, 070D, 070DGG, 070E, 070FT, 070FT04, 070FT05, 070FTE, 070FTE04, 070FTE05, 070FTER, 070FTR, 0712D, 0712VA, 071BM, 071BME, 071D, 071DGG, 071E, 071FT, 071FT04, 071FT06...(Other models you can see in the webshop)		

glass panels



1

<b>GEV No.</b>	693397	<b>Ref. No.</b>	3070970 37N1420
<b>description</b>	glass panel L 29mm W 29mm thickness 3.5mm square		
<b>For models:</b>	06WCP1GM, 08WCP1GM, 08WFT1GV, 08WFT2GV, 08WFT3GV, 08WFT4GV, 08WFT6GV, 08WFT7GV, 090FT1G, 090FT2G, 090FT4G, 090FT5G, 090FT7G, 091CP1G, 091FR7G, 091FR7GS, 091FR7G-VERS.052012, 091FR7GX, 0A0FT1G, 0A0FT2G, 0A0FT4G, 0A0FT5G, 0A1CP1G, 0B0FT1G, 0B0FT2G, 0B0FT4G, 0B0FT5G, 0B1CP1G, 0D0FT1G, 0D0FT2G, 0D0FT4G, 0D0FT5G, 0D1CP1G, 0G0FT1G, 0G0FT1G-VERS.032008, 0G0FT2G, 0G0FT2G-VERS.032008, 0G0FT4G, 0G0FT4G-VERS.032008, 0G0FT5G, 0G0FT5G-VERS.032008, 0G0FT7G, 0G1CP1G, 0G1CP1G-VERS.2004, 0G1FR7G, 10CP1GA, 10CP1IA, 10WTPGE, 10WTPGV, 12CP1GA...(Other models you can see in the webshop)		

miscellaneous



1

<b>GEV No.</b>	691164	<b>Ref. No.</b>	36D6960
<b>description</b>	bar for spacer L 180mm thread M6x1		
<b>For models:</b>	030FE1, 030FE1B, 091FE28, 091FE28B, 30FES2, 30FES2B, 70FES2, 70FES2B		

1 

<b>GEV No.</b>	691163	<b>Ref. No.</b>	36D6950
<b>description</b>	bar for spacer L 270mm thread M6x1		
<b>For models:</b>	70FE1, 70FE1B, 71FE2, 71FE2B		

1 

<b>GEV No.</b>	541506	<b>Ref. No.</b>	33Q5730
<b>description</b>	screw connection complete thread 1"		
<b>For models:</b>	30CPS, 30CPSE, 70CP, 70CPE, 71CP, 71CP2, 90CP, 90CPE, 91CP		

1 

<b>GEV No.</b>	691121	<b>Ref. No.</b>	36D7150
<b>description</b>	support bracket for heating element		
<b>For models:</b>	030FE1, 030FE1B, 091FE28, 091FE28B, 30FES2, 30FES2B, 70FES2, 70FES2B		

## for grills



<b>GEV No.</b>	690425	<b>Ref. No.</b>	3600770
<b>description</b>	base plate L 105mm W 35mm H 7mm hole distance 76mm hole ø 12mm		
<b>For models:</b>	120, 120B, 120NN, 120PV, 135, 135-4, 135A, 135B, 135BA, 135BN, 135BNX, 135BX, 135BXE, 135BXR, 135CPX, 135NN, 135NNX, 135PVX, 135X, 135X-3, 135X-4, 135XE, 135XR, 55, 55B, 55PV, 65, 65A, 65B, 65BA, 65BX, 65BX-2, 65BXE, 65BXR, 65NB, 65NBX, 65NN, 65NNX, 65PVX, 65X, 65X-2, 65XE, 65XR, ART1LD, ART1LDA, ART2LD, ART2SD, ART3SD, S125, S125-4...(Other models you can see in the webshop)		

## Zip-Общепит

for griddles

spare parts and accessories

vsezip.ru

+7(812)987-08-81

1 

<b>GEV No.</b>	691169	<b>Ref. No.</b>	35T2260
<b>description</b>	hook for solid top		
<b>For models:</b>	031TP, 071TP, 091TP, 31TP, 32TP, 32TPV, 71TP, 72TP, 72TPGG		

1 

<b>GEV No.</b>	693000	<b>Ref. No.</b>	35Y2780
<b>description</b>	spring for lava rock grid		
<b>For models:</b>	08WGRGV, 090GRG, 0A0GRG, 0D0GRG, 190GRG, 1A0GRG, 1D0GRG, 1G0GRG		

## housing and bezels

1 

<b>GEV No.</b>	691183	<b>Ref. No.</b>	36D3430
<b>description</b>	end cap for control panel mounting pos. left		
<b>For models:</b>	030, 030BME, 030E, 030EBM, 030FE, 030FE1, 030FE1B, 030FT, 030FTE, 030FTER, 030FTR, 031, 031BME, 031E, 031EBM, 031FT, 031FT04, 031FT06, 031FTE, 031FTE04, 031FTE06, 031FTER, 031FTERL, 031FTR, 031FTRL, 031TP, 032, 070BM, 070BME, 070D, 070DGG, 070E, 070FT, 070FT04, 070FT05, 070FTE, 070FTE04, 070FTE05, 070FTER, 070FTR, 0712D, 0712VA, 071BM, 071BME, 071D, 071DGG, 071E, 071FT, 071FT04, 071FT06...(Other models you can see in the webshop)		

1 

<b>GEV No.</b>	691184	<b>Ref. No.</b>	36D3420
<b>description</b>	end cap for control panel mounting pos. right		
<b>For models:</b>	030, 030BME, 030E, 030EBM, 030FE, 030FE1, 030FE1B, 030FT, 030FTE, 030FTER, 030FTR, 031, 031BME, 031E, 031EBM, 031FT, 031FT04, 031FT06, 031FTE, 031FTE04, 031FTE06, 031FTER, 031FTERL, 031FTR, 031FTRL, 031TP, 032, 070BM, 070BME, 070D, 070DGG, 070E, 070FT, 070FT04, 070FT05, 070FTE, 070FTE04, 070FTE05, 070FTER, 070FTR, 0712D, 0712VA, 071BM, 071BME, 071D, 071DGG, 071E, 071FT, 071FT04, 071FT06...(Other models you can see in the webshop)		



sumps



1

<b>GEV No.</b>	691207	<b>Ref. No.</b>	35N2250
<b>description</b>	grease collecting tray L 540mm W 32mm H 15mm		
<b>For models:</b>	0A0FT1E, 0A0FT1G, 0A0FT2E, 0A0FT2G, 0A0FT4E, 0A0FT4G, 0A0FT5E, 0A0FT5G, 0B0FT1G, 0B0FT2G, 0B0FT4G, 0B0FT5G, 0D0FT1E, 0D0FT1G, 0D0FT2E, 0D0FT2G, 0D0FT4E, 0D0FT4G, 0D0FT5E, 0D0FT5G, 0G0FT1E, 0G0FT1G, 0G0FT1G-VERS.032008, 0G0FT2E, 0G0FT2G, 0G0FT2G-VERS.032008, 0G0FT4E, 0G0FT4G, 0G0FT4G-VERS.032008, 0G0FT5E, 0G0FT5G, 0G0FT5G-VERS.032008, 0G0FT7E, 0G0FT7G		

drain stoppers



1

<b>GEV No.</b>	691190	<b>Ref. No.</b>	3062770 3115040 36C0360
<b>description</b>	outflow plug PTFE L 52mm D1 ø 40mm D2 ø 33mm D3 ø 28mm		
<b>For models:</b>	031FT04, 031FT06, 031FTE04, 031FTE06, 06WFT1EV, 06WFT2EV, 06WFT3EV, 06WFT4EV, 06WFT6EV, 06WFT7EV, 070FT04, 070FT05, 070FTE04, 070FTE05, 071FT04, 071FT06, 071FTE04, 071FTE06, 08WFT1EV, 08WFT1GV, 08WFT2EV, 08WFT2GV, 08WFT3EV, 08WFT3GV, 08WFT4EV, 08WFT4GV, 08WFT6EV, 08WFT6GV, 08WFT7EV, 08WFT7GV, 08WGREV, 090FT04, 090FT05, 090FT1E, 090FT1G, 090FT2E, 090FT2G, 090FT4E, 090FT4G, 090FT5E, 090FT5G, 090FT7E, 090FT7G, 090FTE04, 090FTE05, 091FT04, 091FT06, 091FT1E, 091FT2E, 091FT5E...(Other models you can see in the webshop)		

3ип Общепит for convection ovens/combi-steamers

drain valves



1

<b>GEV No.</b>	696773	<b>Ref. No.</b>	6300833
<b>description</b>	drain fitting set for combi-steamer hose ø 8mm		
<b>For models:</b>	FX101E3, FX101E3C, FX101E3C-VERS.022014, FX101E3R, FX101E3R-VERS.022014, FX101E3-VERS.022014, FX101G3, FX101G3C, FX101G3C-VERS.022014, FX101G3R, FX101G3R-VERS.022014, FX101G3-VERS.022014, FX10E3CR, FX10E3CR-VERS.022014, FX10G3CR, FX10G3CR-VERS.022014, FX122E3, FX122E3C, FX122E3T, FX122E3T-VERS.022014, FX122G3, FX122G3C, FX122G3T, FX122G3T-VERS.022014, FX12E3CT, FX12E3CT-VERS.022014, FX12G3CT, FX12G3CT-VERS.022014, FX201E3, FX201E3P, FX201E3P-VERS.022014, FX201E3-VERS.022014, FX201G3P, FX201G3-VERS.022014, FX202E3, FX202E3-230V-3-50Hz-60Hz, FX202E3-230V-3-50Hz-60Hz-VERS.022014, FX202E3-VERS.022014, FX202G3, FX202G3-VERS.022014, FX61E3, FX61E3C, FX61E3CR, FX61E3CR-VERS.022014, FX61E3C-VERS.022014, FX61E3R, FX61E3R-VERS.022014, FX61E3-VERS.022014, FX61G3, FX61G3C...(Other models you can see in the webshop)		



1

<b>GEV No.</b>	696790	<b>Ref. No.</b>	30Z3011
<b>description</b>	drain pipe thread 1 1/2" IT angled 90° plastic ID ø 37mm ED ø 40mm for combi-steamer		
<b>For models:</b>	FC1011E, FC1011G, FC1221E, FC1221G, FC611E, FC611G, FM1011E1-VERS.2006, FM1011E2-VERS.2006, FM1011E3-VERS.2006, FM1011G1-VERS.2006, FM1011G2-VERS.2006, FM1011G3-VERS.2006, FM1221E1-VERS.2006, FM1221E2-VERS.2006, FM1221E3-VERS.2006, FM1221G1-VERS.2006, FM1221G2-VERS.2006, FM1221G3-VERS.2006, FM2011E2-VERS.2006, FM2011E3-VERS.2006, FM2011G2-VERS.2006, FM2011G3-VERS.2006, FM2021E2-VERS.2006, FM2021E3-VERS.2006, FM2021G2-VERS.2006, FM2021G3-VERS.2006, FM611E1-VERS.2006, FM611E2-VERS.2006, FM611E3-VERS.2006, FM611G1-VERS.2006, FM611G2-VERS.2006, FM611G3-VERS.2006, FM721E1-VERS.2006, FM721E2-VERS.2006, FM721E3-VERS.2006, FM721G1-VERS.2006, FM721G2-VERS.2006, FM721G3-VERS.2006		

Зип Общепит

vsezip.ru

+7(812)987-08-81



1

<b>GEV No.</b>	696788	<b>Ref. No.</b>	3120620 3215240
<b>description</b>	drain pipe thread 1 1/2" IT T-piece plastic ID ø 37mm ED ø 40mm for combi-steamer		
<b>For models:</b>	BX101E, BX101E-VERS.122013, BX101G, BX101G-VERS.122013, BX61E, BX61E-VERS.122013, BX61G, BX61G-VERS.122013, FX101E1, FX101E1R, FX101E2, FX101E2C, FX101E2C-VERS.032014, FX101E2R, FX101E2R-VERS.032014, FX101E2-VERS.032014, FX101E3, FX101E3C, FX101E3C-VERS.022014, FX101E3R, FX101E3R-VERS.022014, FX101E3-VERS.022014, FX101G1, FX101G1R, FX101G2, FX101G2C, FX101G2C-VERS.032014, FX101G2R, FX101G2R-VERS.032014, FX101G2-VERS.032014, FX101G3, FX101G3C, FX101G3C-VERS.022014, FX101G3R, FX101G3R-VERS.022014, FX101G3-VERS.022014, FX10E2CR, FX10E2CR-VERS.032014, FX10E3CR, FX10E3CR-VERS.022014, FX10G2CR, FX10G2CR-VERS.032014, FX10G3CR, FX10G3CR-VERS.022014, FX61E1, FX61E1R, FX61E2, FX61E2C, FX61E2CR, FX61E2CR-VERS.032014...(Other models you can see in the webshop)		



1

<b>GEV No.</b>	692880	<b>Ref. No.</b>	36A3400 36A3401
<b>description</b>	bush ID ø 34mm ED ø 60mm L 20mm thread 1 1/4" ET		
<b>For models:</b>	BX101E, BX101E-VERS.122013, BX101G, BX101G-VERS.122013, BX122E, BX122E-VERS.122013, BX122G, BX122G-VERS.122013, BX61E, BX61E-VERS.122013, BX61G, BX61G-VERS.122013, BX82E, BX82E-VERS.122013, BX82G, BX82G-VERS.122013, FC101, FC1011E, FC1011G, FC101E, FC1221E, FC1221G, FC241, FC241E, FC241G, FC61, FC611E, FC611G, FC61E, FCV101, FCV101-CSA, FCV101DM, FCV101DM-CSA, FCV101DS, FCV101DS-CSA, FCV101E, FCV101EDM, FCV101EDM-UL, FCV101EDS, FCV101EDS-UL, FCV101E-UL, FCV141, FCV141-CSA, FCV141DM, FCV141DM-CSA, FCV141DS, FCV141DS-CSA, FCV141E, FCV141EDM, FCV141EDS...(Other models you can see in the webshop)		

steam pipes



1

<b>GEV No.</b>	691639	<b>Ref. No.</b>	33Q6230
<b>description</b>	bush stainless steel L 31mm ID ø 33mm ED ø 35mm		
<b>For models:</b>	FC101, FC241, FC241G, FC61, FCV101, FCV101-CSA, FCV101DM, FCV101DM-CSA, FCV101DS, FCV101DS-CSA, FCV141, FCV141-CSA, FCV141DM, FCV141DM-CSA, FCV141DS, FCV141DS-CSA, FCV241, FCV241DM, FCV241DS, FCV241G, FCV241G-CSA, FCV241GDM, FCV241GDM-CSA, FCV241GDS, FCV241GDS-CSA, FCV401DM, FCV401DM-CSA, FCV61, FCV61-CSA, FCV61DM, FCV61DM-CSA, FCV61DS, FCV61DS-CSA		



1

<b>GEV No.</b>	540906	<b>Ref. No.</b>	33Q5980
<b>description</b>	steam nozzle plastic L 78.5mm ID ø 12.5mm ED ø 40mm		
<b>For models:</b>	FC101, FC1011E, FC1011G, FC101E, FC1221E, FC1221G, FC241, FC241E, FC241G, FC61, FC611E, FC611G, FC61E, FCV101, FCV101-CSA, FCV101DM, FCV101DM-CSA, FCV101DS, FCV101DS-CSA, FCV101E, FCV101EDM, FCV101EDM-UL, FCV101EDS, FCV101EDS-UL, FCV101E-UL, FCV141, FCV141-CSA, FCV141DM, FCV141DM-CSA, FCV141DS, FCV141DS-CSA, FCV141E, FCV141EDM, FCV141EDS, FCV241, FCV241DM, FCV241DS, FCV241E, FCV241EDM, FCV241EDM-UL, FCV241EDS, FCV241EDS-UL, FCV241E-UL, FCV241G, FCV241G-CSA, FCV241GDM, FCV241GDM-CSA, FCV241GDS, FCV241GDS-CSA, FCV61...(Other models you can see in the webshop)		

injection nozzles





1

<b>GEV No.</b>	692721	<b>Ref. No.</b>	33Q5441 33Q5442
<b>description</b>	injection nozzle bore ø 0.5mm D1 ø 12mm D2 ø 12mm L 60mm WS 17 brass for combi-steamer thread 1/8"		
<b>For models:</b>	FC61, FC61E, FCV61, FCV61-CSA, FCV61DM, FCV61DM-CSA, FCV61DS, FCV61DS-CSA, FCV61E, FCV61EDM, FCV61EDM-UL, FCV61EDS, FCV61EDS-UL, FCV61E-UL, FM611E1, FM611E2, FM611E3, FM611G1, FM611G2, FM611G3		



1

<b>GEV No.</b>	541487	<b>Ref. No.</b>	33Q5910 33Q5911
<b>description</b>	injection nozzle bore ø 7/0.6mm D1 ø 12mm D2 ø 12mm L 60mm WS 17 brass for combi-steamer thread 1/8"		
<b>For models:</b>	FC101, FC101E, FCV101, FCV101-CSA, FCV101DM, FCV101DM-CSA, FCV101DS, FCV101DS-CSA, FCV101E, FCV101EDM, FCV101EDM-UL, FCV101EDS, FCV101EDS-UL, FCV101E-UL, FCV401DM, FM1011E1, FM1011E2, FM1011E3, FM1011G1, FM1011G2, FM1011G3		
<b>accessories for</b>	541487		
	<b>GEV No.</b>	541508	<b>Ref. No.</b> 33D1680
	manometer ø 40mm pressure range 0-4bar connection thread 1/8"		





1



<b>GEV No.</b>	542427	<b>Ref. No.</b>	33Q6081
<b>description</b>	injection nozzle bore ø 7/0.7mm D1 ø 12mm D2 ø 12mm L 60mm WS 17 brass for combi-steamer thread 1/8"		
<b>For models:</b>	FC241E, FC241G, FCV141, FCV141-CSA, FCV141DM, FCV141DM-CSA, FCV141DS, FCV141DS-CSA, FCV141E, FCV141EDM, FCV141EDS, FCV241E, FCV241EDM, FCV241EDM-UL, FCV241EDS, FCV241EDS-UL, FCV241E-UL, FCV241G, FCV241G-CSA, FCV241GDM, FCV241GDM-CSA, FCV241GDS, FCV241GDS-CSA, FCV401EDM, FCV401EDM-UL, FCV72EDM-UL, FCV72EDS-UL, FCV72E-UL, FM1221E1, FM1221E2, FM1221E3, FM1221G1, FM1221G2, FM1221G3, FM721E1, FM721E2, FM721E3, FM721G1, FM721G2, FM721G3		





Зип Общепит  
 spare parts and accessories  
 vsezip.ru  
 +7(812)987-08-81

			
1			
<b>GEV No.</b>	542425	<b>Ref. No.</b>	33Q5920 33Q5921
<b>description</b>	injection nozzle bore $\varnothing$ 7/4.5mm D1 $\varnothing$ 12mm D2 $\varnothing$ 12mm L 60mm WS 17 brass for combi-steamer thread 1/8"		
<b>For models:</b>	FC101, FC101E, FC241, FC241E, FC241G, FC61, FC61E, FCV101, FCV101-CSA, FCV101DM, FCV101DM-CSA, FCV101DS, FCV101DS-CSA, FCV101E, FCV101EDM, FCV101EDM-UL, FCV101EDS, FCV101EDS-UL, FCV101E-UL, FCV141, FCV141-CSA, FCV141DM, FCV141DM-CSA, FCV141DS, FCV141DS-CSA, FCV141E, FCV141EDM, FCV141EDS, FCV241, FCV241DM, FCV241DS, FCV241E, FCV241EDM, FCV241EDM-UL, FCV241EDS, FCV241EDS-UL, FCV241E-UL, FCV241G, FCV241G-CSA, FCV241GDM, FCV241GDM-CSA, FCV241GDS, FCV241GDS-CSA, FCV401DM, FCV401DM-CSA, FCV401EDM, FCV401EDM-UL, FCV61, FCV61-CSA, FCV61DM...(Other models you can see in the webshop)		

			
1			
<b>GEV No.</b>	542429	<b>Ref. No.</b>	33T4450
<b>description</b>	nozzle bore $\varnothing$ 5/3.65mm L 24mm WS 12 brass thread M10x1		

			
1			
<b>GEV No.</b>	541507	<b>Ref. No.</b>	33T4110
<b>description</b>	nozzle cooling thread 1/8"		
<b>For models:</b>	FCV3EM, FCV4E, FCV4EDS, FCV4EM, FM423E1, FM423E2		
<b>accessories for</b>	541507		
	<b>GEV No.</b>	541488	<b>Ref. No.</b>
			33Q5591 33Q5592
	hose connector thread M14x1 ET - 1/8" IT angled		

			
1			
<b>GEV No.</b>	541509	<b>Ref. No.</b>	33T3720
<b>description</b>	nozzle cooling thread 1/8"		
<b>For models:</b>	FC101, FC101E, FC241, FC241E, FC241G, FC61, FC61E, FCV101, FCV101-CSA, FCV101DM, FCV101DM-CSA, FCV101DS, FCV101DS-CSA, FCV101E, FCV101EDM, FCV101EDM-UL, FCV101EDS, FCV101EDS-UL, FCV101E-UL, FCV141, FCV141-CSA, FCV141DM, FCV141DM-CSA, FCV141DS, FCV141DS-CSA, FCV141E, FCV141EDM, FCV141EDS, FCV241, FCV241DM, FCV241DS, FCV241E, FCV241EDM, FCV241EDM-UL, FCV241EDS, FCV241EDS-UL, FCV241E-UL, FCV241G, FCV241G-CSA, FCV241GDM, FCV241GDM-CSA, FCV241GDS, FCV241GDS-CSA, FCV401DM, FCV401DM-CSA, FCV401EDM, FCV401EDM-UL, FCV61, FCV61-CSA, FCV61DM...(Other models you can see in the webshop)		
<b>accessories for</b>	541509		
	<b>GEV No.</b>	541488	<b>Ref. No.</b>
			33Q5591 33Q5592
	hose connector thread M14x1 ET - 1/8" IT angled		

			
1			
<b>GEV No.</b>	108153	<b>Ref. No.</b>	6300748
<b>description</b>	burner blower combi-steamer 230V 65W hole distance 50mm NRG118/0800-3612-030204		
<b>For models:</b>	BX101G, BX101G-VERS.122013, BX122G, BX122G-VERS.122013, BX61G, BX61G-VERS.122013, BX82G, BX82G-VERS.122013, FX101G1, FX101G1R, FX101G2, FX101G2C, FX101G2C-VERS.032014, FX101G2R, FX101G2R-VERS.032014, FX101G2-VERS.032014, FX101G3, FX101G3C, FX101G3C-VERS.022014, FX101G3R, FX101G3R-VERS.022014, FX101G3-VERS.022014, FX10G2CR, FX10G2CR-VERS.032014, FX10G3CR, FX10G3CR-VERS.022014, FX122G1, FX122G2, FX122G2C, FX122G2T, FX122G2T-VERS.032014, FX122G3, FX122G3C, FX122G3T, FX122G3T-VERS.022014, FX12G3CT, FX12G3CT-VERS.022014, FX201G2, FX201G2P, FX201G2P-VERS.032014, FX201G2-VERS.032014, FX201G3P, FX201G3-VERS.022014, FX202G2, FX202G2-VERS.032014, FX202G3, FX202G3-VERS.022014, FX61G1, FX61G1R, FX61G2...(Other models you can see in the webshop)		

			
1			
<b>GEV No.</b>	542426	<b>Ref. No.</b>	3007200
<b>description</b>	connecting piece for combi-steamer L 22mm $\varnothing$ 13.5mm WS 14 1/8" ET - 1/8" IT		
<b>For models:</b>	FM1011E2-VERS.2006, FM1011E3, FM1011E3-VERS.2006, FM1011G2-VERS.2006, FM1011G3, FM1011G3-VERS.2006, FM1221E2-VERS.2006, FM1221E3, FM1221E3-VERS.2006, FM1221G2-VERS.2006, FM1221G3, FM1221G3-VERS.2006, FM2011E2-VERS.2006, FM2011E3-VERS.2006, FM2011G2-VERS.2006, FM2011G3-VERS.2006, FM2021E2-VERS.2006, FM2021E3, FM2021E3-VERS.2006, FM2021G2-VERS.2006, FM2021G3, FM2021G3-VERS.2006, FM423E2, FM611E2-VERS.2006, FM611E3, FM611E3-VERS.2006, FM611G2-VERS.2006, FM611G3, FM611G3-VERS.2006, FM721E2-VERS.2006, FM721E3, FM721E3-VERS.2006, FM721G2-VERS.2006, FM721G3, FM721G3-VERS.2006		

			
1			
<b>GEV No.</b>	551447	<b>Ref. No.</b>	3091170
<b>description</b>	connecting piece for combi-steamer stainless steel L 162mm $\varnothing$ 10mm		

			
1			
<b>GEV No.</b>	552007	<b>Ref. No.</b>	33Q5641
<b>description</b>	connecting piece incl reducer 1/2" - 3/4" L 48mm brass for combi-steamer		
<b>For models:</b>	FCV101, FCV101-CSA, FCV101DM, FCV101DM-CSA, FCV101DS, FCV101DS-CSA, FCV101E, FCV101EDM, FCV101EDM-UL, FCV101EDS, FCV101EDS-UL, FCV101E-UL, FCV141, FCV141-CSA, FCV141DM, FCV141DM-CSA, FCV141DS, FCV141DS-CSA, FCV141E, FCV141EDM, FCV141EDS, FCV241, FCV241DM, FCV241DS, FCV241E, FCV241EDM, FCV241EDM-UL, FCV241EDS, FCV241EDS-UL, FCV241E-UL, FCV241G, FCV241G-CSA, FCV241GDM, FCV241GDM-CSA, FCV241GDS, FCV241GDS-CSA, FCV3EM, FCV401DM, FCV401DM-CSA, FCV401EDM, FCV401EDM-UL, FCV4E, FCV4EDS, FCV4EM, FCV61, FCV61-CSA, FCV61DM, FCV61DM-CSA, FCV61DS, FCV61DS-CSA...(Other models you can see in the webshop)		

Зип Общепит

vsezip.ru

8(12)98448881



1			
<b>GEV No.</b>	551446	<b>Ref. No.</b>	3003760
<b>description</b>	connecting piece L 42mm WS 14 1/8" IT - 1/8" ET		
<b>For models:</b>	FM1011E2-VERS.2006, FM1011E3, FM1011E3-VERS.2006, FM1011G2-VERS.2006, FM1011G3, FM1011G3-VERS.2006, FM1221E2-VERS.2006, FM1221E3, FM1221E3-VERS.2006, FM1221G2-VERS.2006, FM1221G3-VERS.2006, FM2011E2-VERS.2006, FM2011E3-VERS.2006, FM2011G2-VERS.2006, FM2011G3-VERS.2006, FM2021E2-VERS.2006, FM2021E3, FM2021E3-VERS.2006, FM2021G2-VERS.2006, FM2021G3, FM2021G3-VERS.2006, FM611E2-VERS.2006, FM611E3, FM611E3-VERS.2006, FM611G2-VERS.2006, FM611G3, FM611G3-VERS.2006, FM721E2-VERS.2006, FM721E3, FM721E3-VERS.2006, FM721G2-VERS.2006, FM721G3, FM721G3-VERS.2006, FX201E3, FX201E3P, FX201E3P-VERS.022014, FX201E3-VERS.022014, FX201G3P, FX201G3-VERS.022014, FX202E3, FX202E3-230V-3-50Hz-60Hz, FX202E3-230V-3-50Hz-60Hz-VERS.022014, FX202E3-VERS.022014, FX202G3, FX202G3-VERS.022014		



1			
<b>GEV No.</b>	691742	<b>Ref. No.</b>	3120030
<b>description</b>	disc ext. ø 30		
<b>For models:</b>	FCV241G-CSA, FCV241GDM-CSA, FCV241GDS-CSA, L80		



1			
<b>GEV No.</b>	541503	<b>Ref. No.</b>	33Q0530
<b>description</b>	end cap for hot air oven thread 3/8"		
<b>For models:</b>	FC1011E, FC1011G, FC1221E, FC1221G, FC611E, FC611G, FCV101DM, FCV101DM-CSA, FCV101DS, FCV101DS-CSA, FCV101EDM, FCV101EDM-UL, FCV101EDS, FCV101EDS-UL, FCV141DM, FCV141DM-CSA, FCV141DS, FCV141DS-CSA, FCV141EDM, FCV141EDS, FCV241DM, FCV241DS, FCV241EDM, FCV241EDM-UL, FCV241EDS, FCV241EDS-UL, FCV241GDM, FCV241GDM-CSA, FCV241GDS, FCV241GDS-CSA, FCV401DM, FCV401DM-CSA, FCV61DM, FCV61DM-CSA, FCV61DS, FCV61DS-CSA, FCV61EDM, FCV61EDM-UL, FCV61EDS, FCV61EDS-UL, FCV72EDM-UL, FCV72EDS-UL, FM1011E1-VERS.2006, FM1011E2, FM1011E3, FM1011G1-VERS.2006, FM1011G2, FM1011G3, FM1221E1-VERS.2006, FM1221G1-VERS.2006...(Other models you can see in the webshop)		



1			
<b>GEV No.</b>	691192	<b>Ref. No.</b>	36D0360
<b>description</b>	flange		

<b>GEV No.</b>	521194	<b>Ref. No.</b>	36E2350
<b>description</b>	gas/let for heat exchanger combi-steamer ID ø 40mm hole distance 52mm thickness 3mm		
<b>For models:</b>	BX101G, BX101G-VERS.122013, BX61G, BX61G-VERS.122013, FC1011G, FM1011G1, FM1011G1-VERS.2006, FM1011G2, FM1011G2-VERS.2006, FM1011G3, FM1011G3-VERS.2006, FX101G1, FX101G1R, FX101G2, FX101G2C, FX101G2C-VERS.032014, FX101G2R, FX101G2R-VERS.032014, FX101G2-VERS.032014, FX101G3, FX101G3C, FX101G3C-VERS.022014, FX101G3R, FX101G3R-VERS.022014, FX101G3-VERS.022014, FX10G2CR, FX10G2CR-VERS.032014, FX10G3CR, FX10G3CR-VERS.022014, FX201G2, FX201G2P, FX201G2P-VERS.032014, FX201G2-VERS.032014, FX201G3P, FX201G3-VERS.022014, FX61G1, FX61G1R, FX61G2, FX61G2C, FX61G2CR, FX61G2CR-VERS.032014, FX61G2C-VERS.032014, FX61G2R, FX61G2R-VERS.032014, FX61G2-VERS.032014, FX61G3, FX61G3C, FX61G3CR, FX61G3CR-VERS.022014, FX61G3C-VERS.022014...(Other models you can see in the webshop)		



1			
<b>GEV No.</b>	691199	<b>Ref. No.</b>	36G5380
<b>description</b>	guide counterweight ø 37mm		
<b>For models:</b>	FC101, FC101E, FC241, FC241E, FC241G, FC61, FC61E, FCV101, FCV101-CSA, FCV101DM, FCV101DM-CSA, FCV101DS, FCV101DS-CSA, FCV101E, FCV101EDM, FCV101EDM-UL, FCV101EDS, FCV101EDS-UL, FCV101E-UL, FCV141, FCV141-CSA, FCV141DM, FCV141DM-CSA, FCV141DS, FCV141DS-CSA, FCV141E, FCV141EDM, FCV141EDS, FCV241, FCV241DM, FCV241DS, FCV241E, FCV241EDM, FCV241EDM-UL, FCV241EDS, FCV241EDS-UL, FCV241E-UL, FCV241G, FCV241G-CSA, FCV241GDM, FCV241GDM-CSA, FCV241GDS, FCV241GDS-CSA, FCV61, FCV61-CSA, FCV61DM, FCV61DM-CSA, FCV61DS, FCV61DS-CSA, FCV61E...(Other models you can see in the webshop)		



1			
<b>GEV No.</b>	691176	<b>Ref. No.</b>	35T0080
<b>description</b>	guide plate ø 60mm		





1			
<b>GEV No.</b>	691177	<b>Ref. No.</b>	35S8650
<b>description</b>	mounting ring for bulb socket		



Зип Общепит  
vsozip.ru  
7(812)987-08-81

			
1			
<b>GEV No.</b>	696791	<b>Ref. No.</b>	3011590 3253680
<b>description</b>	protective covering for igniter L 80mm 7/9 rubber		
<b>For models:</b>	091FR1I, 091FR1IA, 091FR1ID, 091FR1ID-VERS.052012, 091FR1I-VERS.032012, 091FR7G, 091FR7GS, 091FR7G-VERS.052012, 091FR7GX, 10CP1IA, 12CP1IA, 18CP2IA, 191FR2I, 191FR2ID, 191FR2ID-VERS.092012, 191FR2I-VERS.032012, BX101G, BX122G, BX61G, BX82G, FC1011G, FC1221G, FC611G, FM1011G1, FM1011G1-VERS.2006, FM1011G2, FM1011G2-VERS.2006, FM1011G3, FM1011G3-VERS.2006, FM1221G1, FM1221G1-VERS.2006, FM1221G2, FM1221G2-VERS.2006, FM1221G3, FM1221G3-VERS.2006, FM2011G2-VERS.2006, FM2011G3-VERS.2006, FM2021G1, FM2021G2, FM2021G2-VERS.2006, FM2021G3, FM2021G3-VERS.2006, FM611G1, FM611G1-VERS.2006, FM611G2, FM611G2-VERS.2006, FM611G3, FM611G3-VERS.2006, FM721G1, FM721G1-VERS.2006...(Other models you can see in the webshop)		

			
2			
<b>GEV No.</b>	541495	<b>Ref. No.</b>	33Q5630
<b>description</b>	reducer for hot air oven L 44mm WS 21 IT 3/8" ET M16x1.5		
<b>For models:</b>	FC101, FC101E, FC241, FC241E, FC241G, FC61, FC61E, FCV101, FCV101-CSA, FCV101DM, FCV101DM-CSA, FCV101DS, FCV101DS-CSA, FCV101E, FCV101EDM, FCV101EDM-UL, FCV101EDS, FCV101EDS-UL, FCV101E-UL, FCV141, FCV141-CSA, FCV141DM, FCV141DM-CSA, FCV141DS, FCV141DS-CSA, FCV141E, FCV141EDM, FCV141EDS, FCV241, FCV241DM, FCV241DS, FCV241E, FCV241EDM, FCV241EDM-UL, FCV241EDS, FCV241EDS-UL, FCV241E-UL, FCV241G, FCV241G-CSA, FCV241GDM, FCV241GDM-CSA, FCV241GDS, FCV241GDS-CSA, FCV401DM, FCV401DM-CSA, FCV401EDM, FCV401EDM-UL, FCV61, FCV61-CSA, FCV61DM...(Other models you can see in the webshop)		

			
1			
<b>GEV No.</b>	691167	<b>Ref. No.</b>	36D9150
<b>description</b>	ring ID ø 26mm ext. ø 30 thickness 1.5mm		

			
1			
<b>GEV No.</b>	541498	<b>Ref. No.</b>	33Q5410
<b>description</b>	screw connection WS 50 thread 1/4" ID ø 31mm		
<b>For models:</b>	FC101, FC101E, FC241, FC241E, FC241G, FC61, FC61E, FCV101, FCV101-CSA, FCV101DM, FCV101DM-CSA, FCV101DS, FCV101DS-CSA, FCV101E, FCV101EDM, FCV101EDM-UL, FCV101EDS, FCV101EDS-UL, FCV101E-UL, FCV141, FCV141-CSA, FCV141DM, FCV141DM-CSA, FCV141DS, FCV141DS-CSA, FCV141E, FCV141EDM, FCV141EDS, FCV241, FCV241DM, FCV241DS, FCV241E, FCV241EDM, FCV241EDM-UL, FCV241EDS, FCV241EDS-UL, FCV241E-UL, FCV241G, FCV241G-CSA, FCV241GDM, FCV241GDM-CSA, FCV241GDS, FCV241GDS-CSA, FCV401DM, FCV401DM-CSA, FCV401EDM, FCV401EDM-UL, FCV61, FCV61-CSA, FCV61DM, FCV61DM-CSA...(Other models you can see in the webshop)		
<b>accessories for</b>	541498		
	<b>GEV No.</b>	<b>Ref. No.</b>	
			3151450
			
	gasket suitable for ANGELO PO size 1/4"		

			
1			
<b>GEV No.</b>	091160	<b>Ref. No.</b>	36G0060
<b>description</b>	spring guide		

			
1			
<b>GEV No.</b>	551445	<b>Ref. No.</b>	3004791
<b>description</b>	water distributor for combi-steamer chrome-plated sheet steel L 92mm ø 35mm		
<b>For models:</b>	FM1011E1, FM1011E1-VERS.2006, FM1011E2, FM1011E2-VERS.2006, FM1011E3, FM1011E3-VERS.2006, FM1011G1, FM1011G1-VERS.2006, FM1011G2, FM1011G2-VERS.2006, FM1011G3, FM1011G3-VERS.2006, FM1221E1, FM1221E1-VERS.2006, FM1221E2, FM1221E2-VERS.2006, FM1221E3, FM1221E3-VERS.2006, FM1221G1, FM1221G1-VERS.2006, FM1221G2, FM1221G2-VERS.2006, FM1221G3, FM1221G3-VERS.2006, FM2011E2-VERS.2006, FM2011E3-VERS.2006, FM2011G2-VERS.2006, FM2011G3-VERS.2006, FM2021E1, FM2021E2, FM2021E2-VERS.2006, FM2021E3, FM2021E3-VERS.2006, FM2021G1, FM2021G2, FM2021G2-VERS.2006, FM2021G3, FM2021G3-VERS.2006, FM611E1, FM611E1-VERS.2006, FM611E2, FM611E2-VERS.2006, FM611E3, FM611E3-VERS.2006, FM611G1, FM611G1-VERS.2006, FM611G2, FM611G2-VERS.2006, FM611G3, FM611G3-VERS.2006...(Other models you can see in the webshop)		

			
1			
<b>GEV No.</b>	691165	<b>Ref. No.</b>	36G0190
<b>description</b>	wheel W 35mm ø 44mm		

			
1			
<b>GEV No.</b>	521197	<b>Ref. No.</b>	36E4290
<b>description</b>	Y-piece thread 1/8" IT - 1/8" IT - 1/8" IT stainless steel WS 13		
<b>For models:</b>	FM1011E3, FM1011G3, FM1221E3, FM1221G3, FM611E3, FM611G3, FM721E3, FM721G3		

<b>glass panels</b>			
			
1			
<b>GEV No.</b>	693397	<b>Ref. No.</b>	3070970 37N1420
<b>description</b>	glass panel L 29mm W 29mm thickness 3.5mm square		
<b>For models:</b>	06WCP1GM, 08WCP1GM, 08WFT1GV, 08WFT2GV, 08WFT3GV, 08WFT4GV, 08WFT6GV, 08WFT7GV, 090FT1G, 090FT2G, 090FT4G, 090FT5G, 090FT7G, 091CP1G, 091FR7G, 091FR7GS, 091FR7G-VERS.052012, 091FR7GX, 0A0FT1G, 0A0FT2G, 0A0FT4G, 0A0FT5G, 0A1CP1G, 0B0FT1G, 0B0FT2G, 0B0FT4G, 0B0FT5G, 0B1CP1G, 0D0FT1G, 0D0FT2G, 0D0FT4G, 0D0FT5G, 0D1CP1G, 0G0FT1G, 0G0FT1G-VERS.032008, 0G0FT2G, 0G0FT2G-VERS.032008, 0G0FT4G, 0G0FT4G-VERS.032008, 0G0FT5G, 0G0FT5G-VERS.032008, 0G0FT7G, 0G1CP1G, 0G1CP1G-VERS.2004, 0G1FR7G, 10CP1GA, 10CP1IA, 10WTPGE, 10WTPGV, 12CP1GA...(Other models you can see in the webshop)		

Зип Общежит

<b>GEV No.</b>	521196	<b>Ref. No.</b>	30Z2050
<b>description</b>	water pipe L 180mm W 120mm ø 11/12mm thread M16x1.5		
<b>For models:</b>	FC101, FC1011E, FC1011G, FC101E, FC1221E, FC1221G, FC241E, FC241G, FC61E, FC611E, FC611G, FC61E, FCV101, FCV101-CSA, FCV101DM, FCV101DM-CSA, FCV101DS, FCV101DS-CSA, FCV101E, FCV101EDM, FCV101EDM-UL, FCV101EDS, FCV101E-UL, FCV141, FCV141-CSA, FCV141DM, FCV141DM-CSA, FCV141DS, FCV141DS-CSA, FCV141E, FCV141EDM, FCV141EDS, FCV241E, FCV241EDM, FCV241EDM-UL, FCV241EDS, FCV241EDS-UL, FCV241E-UL, FCV241G, FCV241G-CSA, FCV241GDM, FCV241GDM-CSA, FCV241GDS, FCV241GDS-CSA, FCV401DM, FCV401DM-CSA, FCV401EDM, FCV401EDM-UL, FCV61, FCV61-CSA...(Other models you can see in the webshop)		

hoses

<b>GEV No.</b>	696792	<b>Ref. No.</b>	3067460
<b>description</b>	hose ID ø 32mm ED ø 40mm L 1000mm combi-steamer		
<b>For models:</b>	08WGREV, 091CP1E, 091CP1G, 10CP1EA, 10CP1GA, 10CP1IA, 12CP1EA, 12CP1GA, 12CP1IA, 18CP2EA, 18CP2GA, 18CP2IA, 191CP1G, 191CP2G, 6040090, 6040310, 6043850, 6043980, FMS, FMSX, PIER-06HD, PIER15HD		

service kits

<b>GEV No.</b>	696773	<b>Ref. No.</b>	6300833
<b>description</b>	drain fitting set for combi-steamer hose ø 8mm		
<b>For models:</b>	FX101E3, FX101E3C, FX101E3C-VERS.022014, FX101E3R, FX101E3R-VERS.022014, FX101E3-VERS.022014, FX101G3, FX101G3C, FX101G3C-VERS.022014, FX101G3R, FX101G3R-VERS.022014, FX101G3-VERS.022014, FX10E3CR, FX10E3CR-VERS.022014, FX10G3CR, FX10G3CR-VERS.022014, FX122E3, FX122E3C, FX122E3T, FX122E3T-VERS.022014, FX122G3, FX122G3C, FX122G3T, FX122G3T-VERS.022014, FX12E3CT, FX12E3CT-VERS.022014, FX12G3CT, FX12G3CT-VERS.022014, FX201E3, FX201E3P, FX201E3P-VERS.022014, FX201E3-VERS.022014, FX201G3P, FX201G3-VERS.022014, FX202E3, FX202E3-230V-3-50Hz-60Hz, FX202E3-230V-3-50Hz-60Hz-VERS.022014, FX202E3-VERS.022014, FX202G3, FX202G3-VERS.022014, FX61E3, FX61E3C, FX61E3CR, FX61E3CR-VERS.022014, FX61E3C-VERS.022014, FX61E3R, FX61E3R-VERS.022014, FX61E3-VERS.022014, FX61G3, FX61G3C...(Other models you can see in the webshop)		

<b>GEV No.</b>	691146	<b>Ref. No.</b>	3000770
<b>description</b>	glass panel L 515mm W 505mm thickness 6mm rectangular		
<b>For models:</b>	FM611E1, FM611E2, FM611E3, FM611G1, FM611G2, FM611G3		

<b>GEV No.</b>	691147	<b>Ref. No.</b>	3000760
<b>description</b>	glass panel L 720mm W 515mm thickness 6mm rectangular		
<b>For models:</b>	FM1011E1, FM1011E2, FM1011E3, FM1011G1, FM1011G2, FM1011G3		

cleaning system

nozzles

<b>GEV No.</b>	510626	<b>Ref. No.</b>	33T1120 33T1121
<b>description</b>	rinse jet ø 0.7/1.5mm thread 1/8" ET		
<b>For models:</b>	L100, L40, L40S, L60, L80		

screw connections

<b>GEV No.</b>	362028	<b>Ref. No.</b>	3041000
<b>description</b>	manifold 4+2 L 116mm plastic thread M10 IT		
<b>For models:</b>	FM1011E3-VERS.2006, FM1011G3-VERS.2006, FM1221E3-VERS.2006, FM1221G3-VERS.2006, FM2011E3-VERS.2006, FM2011G3-VERS.2006, FM611E3-VERS.2006, FM611G3-VERS.2006, FM721E3-VERS.2006, FM721G3-VERS.2006		

pipes

<b>GEV No.</b>	521196	<b>Ref. No.</b>	3120710
<b>description</b>	drain pipe L 568mm W 182mm ø 30mm for combi-steamer ID ø 21mm EPDM		
<b>For models:</b>	BX101E, BX101E-VERS.122013, BX122E, BX122E-VERS.122013, BX122G, BX122G-VERS.122013, BX61E, BX61E-VERS.122013, BX82E, BX82E-VERS.122013, BX82G, BX82G-VERS.122013, FM423E1, FM423E2, FX101E1, FX101E1R, FX101E2, FX101E2C, FX101E2C-VERS.032014, FX101E2R, FX101E2R-VERS.032014, FX101E2-VERS.032014, FX101E3, FX101E3C, FX101E3C-VERS.022014, FX101E3R, FX101E3R-VERS.022014, FX101E3-VERS.022014, FX101G1, FX101G1R, FX101G2, FX101G2C, FX101G2R, FX101G3, FX101G3C, FX101G3R, FX10E2CR, FX10E2CR-VERS.032014, FX10E3CR, FX10E3CR-VERS.022014, FX10G2CR, FX10G3CR, FX122E1, FX122E2, FX122E2C, FX122E2T, FX122E2T-VERS.032014, FX122E3, FX122E3C, FX122E3T...(Other models you can see in the webshop)		





door mechanics

holders



<b>GEV No.</b>	692858	<b>Ref. No.</b>	6300798
<b>description</b>	bracket for glass door combi-steamer		
<b>For models:</b>	FX101E1, FX101E2, FX101E2C, FX101E2C-VERS.032014, FX101E2-VERS.032014, FX101E3, FX101E3C, FX101E3C-VERS.022014, FX101E3R, FX101E3-VERS.022014, FX101G1, FX101G2, FX101G2C, FX101G2C-VERS.032014, FX101G2-VERS.032014, FX101G3, FX101G3C, FX101G3C-VERS.022014, FX101G3-VERS.022014, FX10E2CR-VERS.032014, FX122E1, FX122E2, FX122E2C, FX122E2T, FX122E2T-VERS.032014, FX122E3, FX122E3C, FX122E3T, FX122E3T-VERS.022014, FX122G1, FX122G3, FX122G3C, FX122G3T, FX122G3T-VERS.022014, FX12E3CT, FX12E3CT-VERS.022014, FX12G3CT, FX12G3CT-VERS.022014, FX61E1, FX61E2, FX61E2C, FX61E2C-VERS.032014, FX61E2-VERS.032014, FX61E3, FX61E3C, FX61E3C-VERS.022014, FX61E3-VERS.022014, FX61G1, FX61G2, FX61G2C... (Other models you can see in the webshop)		

locking mechanism



<b>GEV No.</b>	698503	<b>Ref. No.</b>	6300965
<b>description</b>	espagnolette lock complete		
<b>For models:</b>	FX201E2, FX201E2P, FX201E2P-VERS.032014, FX201E2-VERS.032014, FX201E3, FX201E3P, FX201E3P-VERS.022014, FX201E3-VERS.022014, FX201G2, FX201G2P, FX201G2P-VERS.032014, FX201G2-VERS.032014, FX201G3P, FX201G3-VERS.022014, FX202E2, FX202E2-VERS.032014, FX202E3, FX202E3-230V-3-50Hz-60Hz, FX202E3-230V-3-50Hz-60Hz-VERS.022014, FX202E3-VERS.022014, FX202G2, FX202G2-VERS.032014, FX202G3, FX202G3-VERS.022014		
<b>accessories for</b>	698503		
	<b>GEV No.</b>	690041	<b>Ref. No.</b> 3088460
	<b>GEV No.</b>	694409	<b>Ref. No.</b> —
	<b>GEV No.</b>	700604	<b>Ref. No.</b> —

accessories



<b>GEV No.</b>	696775	<b>Ref. No.</b>	36E2781
<b>description</b>	buffer for door ø 15mm silicone L 20mm		
<b>For models:</b>	BX101E, BX101E-VERS.122013, BX101G, BX101G-VERS.122013, BX122E, BX122E-VERS.122013, BX122G, BX122G-VERS.122013, BX61E, BX61E-VERS.122013, BX61G, BX61G-VERS.122013, BX82E, BX82E-VERS.122013, BX82G, BX82G-VERS.122013, FC1011E, FC1011G, FC1221E, FC1221G, FC611E, FC611G, FM1011E1, FM1011E1-VERS.2006, FM1011E2, FM1011E2-VERS.2006, FM1011E3, FM1011E3-VERS.2006, FM1011G1, FM1011G1-VERS.2006, FM1011G2, FM1011G2-VERS.2006, FM1011G3, FM1011G3-VERS.2006, FM1221E1, FM1221E1-VERS.2006, FM1221E2, FM1221E2-VERS.2006, FM1221E3, FM1221E3-VERS.2006, FM1221G1, FM1221G1-VERS.2006, FM1221G2, FM1221G2-VERS.2006, FM1221G3, FM1221G3-VERS.2006, FM2011E2-VERS.2006, FM2011E3-VERS.2006, FM2011G2-VERS.2006, FM2011G3-VERS.2006...(Other models you can see in the webshop)		

Зип Общепит



vsezip.ru

+7(812)987-08-81

<b>GEV No.</b>	696774	<b>Ref. No.</b>	3171920
<b>description</b>	washer for door handle ø13mm hole ø 20mm plastic		
<b>For models:</b>	FX101E1, FX101E2, FX101E2C, FX101E2C-VERS.032014, FX101E2-VERS.032014, FX101E3, FX101E3C, FX101E3C-VERS.022014, FX101E3R, FX101E3-VERS.022014, FX101G1, FX101G2, FX101G2C, FX101G2C-VERS.032014, FX101G2-VERS.032014, FX101G3, FX101G3C, FX101G3C-VERS.022014, FX101G3-VERS.022014, FX10E2CR-VERS.032014, FX122E1, FX122E2, FX122E2C, FX122E2T, FX122E2T-VERS.032014, FX122E3, FX122E3C, FX122E3T, FX122E3T-VERS.022014, FX122G1, FX122G3, FX122G3C, FX122G3T, FX122G3T-VERS.022014, FX12E3CT, FX12E3CT-VERS.022014, FX12G3CT, FX12G3CT-VERS.022014, FX61E1, FX61E2, FX61E2C, FX61E2C-VERS.032014, FX61E2-VERS.032014, FX61E3, FX61E3C, FX61E3C-VERS.022014, FX61E3-VERS.022014, FX61G1, FX61G2, FX61G2C... (Other models you can see in the webshop)		



<b>GEV No.</b>	692859	<b>Ref. No.</b>	3019510
<b>description</b>	fixing plate for catch W 42mm zinc-plated sheet steel L 93.5mm		
<b>For models:</b>	FC1011E, FC1011G, FC1221E, FC1221G, FC611E, FC611G, FM1011E1, FM1011E1-VERS.2006, FM1011E2, FM1011E2-VERS.2006, FM1011E3, FM1011E3-VERS.2006, FM1011G1, FM1011G1-VERS.2006, FM1011G2, FM1011G2-VERS.2006, FM1011G3, FM1011G3-VERS.2006, FM1221E1, FM1221E1-VERS.2006, FM1221E2, FM1221E2-VERS.2006, FM1221E3, FM1221E3-VERS.2006, FM1221G1, FM1221G1-VERS.2006, FM1221G2, FM1221G2-VERS.2006, FM1221G3, FM1221G3-VERS.2006, FM2011E2-VERS.2006, FM2011E3-VERS.2006, FM2011G2-VERS.2006, FM2011G3-VERS.2006, FM2021E1, FM2021E2, FM2021E2-VERS.2006, FM2021E3, FM2021E3-VERS.2006, FM2021G1, FM2021G2, FM2021G2-VERS.2006, FM2021G3, FM2021G3-VERS.2006, FM611E1, FM611E1-VERS.2006, FM611E2, FM611E2-VERS.2006, FM611E3, FM611E3-VERS.2006... (Other models you can see in the webshop)		

vibration pumps



<b>GEV No.</b>	500972	<b>Ref. No.</b>	32M7000 32M7001
<b>description</b>	vibration pump 230V 47W 50Hz inlet ø 7 outlet ø 1/8" IT CEME type E507		
<b>For models:</b>	FM1011E3, FM1011E3-VERS.2006, FM1011G3, FM1011G3-VERS.2006, FM1221E3, FM1221E3-VERS.2006, FM1221G3-VERS.2006, FM2011E3-VERS.2006, FM2011G3-VERS.2006, FM2021E3, FM2021E3-VERS.2006, FM2021G3, FM2021G3-VERS.2006, FM611E3, FM611E3-VERS.2006, FM611G3, FM611G3-VERS.2006, FM721E3, FM721E3-VERS.2006, FM721G3, FM721G3-VERS.2006		

Зип Общепит

vsezip.ru

7(812)987-08-81

## heat exchangers



<b>GEV No.</b>	521194	<b>Ref. No.</b>	36E2350
<b>description</b>	gasket for heat exchanger combi-steamer ID ø 40mm hole distance ø 52mm thickness 4mm		
<b>For models:</b>	BX101G, BX101G-VERS.122013, BX61G, BX61G-VERS.122013, FC1011G, FM1011G1, FM1011G1-VERS.2006, FM1011G2, FM1011G2-VERS.2006, FM1011G3, FM1011G3-VERS.2006, FX101G1, FX101G1R, FX101G2, FX101G2C, FX101G2C-VERS.032014, FX101G2R, FX101G2R-VERS.032014, FX101G2-VERS.032014, FX101G3, FX101G3C, FX101G3C-VERS.022014, FX101G3R, FX101G3R-VERS.022014, FX101G3-VERS.022014, FX10G2CR, FX10G2CR-VERS.032014, FX10G3CR, FX10G3CR-VERS.022014, FX201G2, FX201G2P, FX201G2P-VERS.032014, FX201G2-VERS.032014, FX201G3P, FX201G3-VERS.022014, FX61G1, FX61G1R, FX61G2, FX61G2C, FX61G2CR, FX61G2CR-VERS.032014, FX61G2C-VERS.032014, FX61G2R, FX61G2R-VERS.032014, FX61G2-VERS.032014, FX61G3, FX61G3C, FX61G3CR, FX61G3CR-VERS.022014, FX61G3C-VERS.022014...(Other models you can see in the webshop)		



<b>GEV No.</b>	521195	<b>Ref. No.</b>	36E3570
<b>description</b>	gasket for heat exchanger combi-steamer ID ø 52mm hole distance 63mm thickness 3mm		
<b>For models:</b>	BX122G, BX122G-VERS.122013, BX82G, BX82G-VERS.122013, FC1221G, FM1221G1, FM1221G1-VERS.2006, FM1221G2, FM1221G2-VERS.2006, FM1221G3, FM1221G3-VERS.2006, FM2021G1, FM2021G2, FM2021G2-VERS.2006, FM2021G3, FM2021G3-VERS.2006, FM721G1, FM721G1-VERS.2006, FM721G2, FM721G2-VERS.2006, FM721G3, FM721G3-VERS.2006, FX122G1, FX122G2, FX122G2C, FX122G2T, FX122G2T-VERS.032014, FX122G3, FX122G3C, FX122G3T, FX122G3T-VERS.022014, FX12G3CT, FX12G3CT-VERS.022014, FX202G2, FX202G2-VERS.032014, FX202G3, FX202G3-VERS.022014, FX82G1, FX82G2, FX82G2C, FX82G2T, FX82G2T-VERS.032014, FX82G3, FX82G3C, FX82G3CT, FX82G3CT-VERS.022014, FX82G3T, FX82G3T-VERS.022014		

## miscellaneous



<b>GEV No.</b>	691179	<b>Ref. No.</b>	33Q0730
<b>description</b>	bush thread M10x1 ø 5mm		
<b>For models:</b>	FCV101DM, FCV101DM-CSA, FCV101DS, FCV101DS-CSA, FCV101EDM, FCV101EDM-UL, FCV101EDS, FCV101EDS-UL, FCV141DM, FCV141DM-CSA, FCV141DS, FCV141DS-CSA, FCV141EDM, FCV141EDS, FCV241DM, FCV241DS, FCV241EDM, FCV241EDM-UL, FCV241EDS, FCV241EDS-UL, FCV241GDM, FCV241GDM-CSA, FCV241GDS, FCV241GDS-CSA, FCV401DM, FCV401DM-CSA, FCV401EDM, FCV401EDM-UL, FCV4EDS, FCV61DM, FCV61DM-CSA, FCV61DS, FCV61DS-CSA, FCV61EDM, FCV61EDM-UL, FCV61EDS, FCV61EDS-UL, FCV72EDM-UL, FCV72EDS-UL, FM101E2, FM101E3, FM101G2, FM101G3, FM1221E2, FM1221E3, FM1221G2, FM1221G3, FM2021E2, FM2021E3, FM2021G2...(Other models you can see in the webshop)		
<b>accessories for</b>	691179		
	<b>GEV No.</b>	519385	<b>Ref. No.</b> 3150220
	<b>GEV No.</b>	691180	<b>Ref. No.</b> 3120100



<b>GEV No.</b>	691123	<b>Ref. No.</b>	36E2060
<b>description</b>	duct for door opener		
<b>For models:</b>	FCV3EM, FCV4E, FCV4EDS, FCV4EM, FM423E1, FM423E2		



<b>GEV No.</b>	541486	<b>Ref. No.</b>	33Q5901
<b>description</b>	hose connector for manometer bore ø 0.4mm thread 1/8"		
<b>For models:</b>	FM423E1, FM423E2		
<b>accessories for</b>	541486		



<b>GEV No.</b>	541508	<b>Ref. No.</b>	33D1680
<b>description</b>	manometer ø 40mm pressure range 0-4bar connection thread 1/8"		



<b>GEV No.</b>	542121	<b>Ref. No.</b>	3032890
<b>description</b>	hose connector for manometer L 60mm WS 17 brass thread 1/8" ø 12mm T2: M8		
<b>For models:</b>	BX101E, BX101E-VERS.122013, BX101G, BX101G-VERS.122013, FC1011E, FC1011G, FC1221E, FC1221G, FC611E, FC611G, FM1011E1, FM1011E1-VERS.2006, FM1011E2, FM1011E2-VERS.2006, FM1011E3, FM1011E3-VERS.2006, FM1011G1, FM1011G1-VERS.2006, FM1011G2, FM1011G2-VERS.2006, FM1011G3, FM1011G3-VERS.2006, FM1221E1-VERS.2006, FM1221E2-VERS.2006, FM1221E3, FM1221E3-VERS.2006, FM1221G1-VERS.2006, FM1221G2-VERS.2006, FM1221G3, FM1221G3-VERS.2006, FM2011E2-VERS.2006, FM2011E3-VERS.2006, FM2011G2-VERS.2006, FM2011G3-VERS.2006, FM2021E1, FM2021E2, FM2021E2-VERS.2006, FM2021E3, FM2021E3-VERS.2006, FM2021G1, FM2021G2, FM2021G2-VERS.2006, FM2021G3, FM2021G3-VERS.2006, FM611E1, FM611E1-VERS.2006, FM611E2, FM611E2-VERS.2006, FM611E3, FM611E3-VERS.2006...(Other models you can see in the webshop)		



3ип Общежит  
for tilting bratt pans

drive shafts  
vsezip.ru

+7(812)987-08-81



1

<b>GEV No.</b>	697869	<b>Ref. No.</b>	3010750
<b>description</b>	mounting flange for fan steel		
<b>For models:</b>	FM1011G1, FM1011G2, FM1011G3, FM611G1, FM611G2, FM611G3, FM721G1, FM721G2, FM721G3		



Image not available

1

<b>GEV No.</b>	691180	<b>Ref. No.</b>	3120100
<b>description</b>	plain washer		
<b>For models:</b>	10CP1EA, 10CP1GA, 10CP1IA, 12CP1EA, 12CP1GA, 12CP1IA, 18CP2EA, 18CP2GA, 18CP2IA, C304AD, C304AS, C304AVD, C304AVS, CS370AD, CS370AS, CS370AVD, CS370AVS, CS466AD, CS466AS, CS466AVD, CS466AVS, FCV101DM, FCV101DM-CSA, FCV101DS, FCV101DS-CSA, FCV101EDM, FCV101EDM-UL, FCV101EDS, FCV101EDS-UL, FCV141DM, FCV141DM-CSA, FCV141DS, FCV141DS-CSA, FCV141EDM, FCV141EDS, FCV241DM, FCV241DS, FCV241EDM, FCV241EDM-UL, FCV241EDS, FCV241EDS-UL, FCV241GDM, FCV241GDM-CSA, FCV241GDS, FCV241GDS-CSA, FCV401DM, FCV401DM-CSA, FCV401EDM, FCV401EDM-UL, FCV4EDS...(Other models you can see in the webshop)		



1

<b>GEV No.</b>	697870	<b>Ref. No.</b>	3010670
<b>description</b>	protector for aspiration		
<b>For models:</b>	FM1011G1, FM1011G2, FM1011G3, FM1221G1, FM1221G2, FM1221G3, FM2021G1, FM2021G2, FM2021G3, FM611G1, FM611G2, FM611G3		



1

<b>GEV No.</b>	514043	<b>Ref. No.</b>	36G1290
<b>description</b>	spindle for tilting bratt pan seat $\phi$ 16mm		
<b>For models:</b>	1G1BR1E, 1G1BR1G, 31R, 31RE		

spare parts and accessories



1

<b>GEV No.</b>	693824	<b>Ref. No.</b>	36G6431
<b>description</b>	extension L 255mm thread M14x1.5 $\phi$ 25mm		



1

<b>GEV No.</b>	700735	<b>Ref. No.</b>	36E0870
<b>description</b>	spacer piece		
<b>For models:</b>	191BR1E, 191BR1G, 191BR1GA, 191BR2E, 191BR2EA, 191BR2G, 191BR2GA, 1A1BR1E, 1A1BR1G, 1A1BR1GA, 1A1BR2E, 1A1BR2EA, 1A1BR2G, 1A1BR2GA, 1D1BR1E, 1D1BR1G, 1D1BR1GA, 1D1BR2E, 1D1BR2EA, 1D1BR2G, 1D1BR2GA, 291BR1E, 291BR1G, 291BR1GA, 291BR2E, 291BR2EA, 291BR2G, 291BR2GA, 2A1BR1E, 2A1BR1G, 2A1BR1GA, 2A1BR2E, 2A1BR2EA, 2A1BR2G, 2A1BR2GA, 2D1BR1E, 2D1BR1G, 2D1BR1GA, 2D1BR2E, 2D1BR2EA, 2D1BR2G, 2D1BR2GA		



1

<b>GEV No.</b>	700734	<b>Ref. No.</b>	36E0440
<b>description</b>	thread bolt thread M5 D1 $\phi$ 18mm D2 $\phi$ 12mm		
<b>For models:</b>	191BR1E, 191BR1G, 191BR1GA, 191BR2E, 191BR2EA, 191BR2G, 191BR2GA, 1A1BR1E, 1A1BR1G, 1A1BR1GA, 1A1BR2E, 1A1BR2EA, 1A1BR2G, 1A1BR2GA, 1D1BR1E, 1D1BR1G, 1D1BR1GA, 1D1BR2E, 1D1BR2EA, 1D1BR2G, 1D1BR2GA, 291BR1E, 291BR1G, 291BR1GA, 291BR2E, 291BR2EA, 291BR2G, 291BR2GA, 2A1BR1E, 2A1BR1G, 2A1BR1GA, 2A1BR2E, 2A1BR2EA, 2A1BR2G, 2A1BR2GA, 2D1BR1E, 2D1BR1G, 2D1BR1GA, 2D1BR2E, 2D1BR2EA, 2D1BR2G, 2D1BR2GA		

housing and bezels



<b>GEV No.</b>	691183	<b>Ref. No.</b>	36D3430
<b>description</b>	end cap for control panel mounting pos. left		
<b>For models:</b>	030, 030BME, 030E, 030EBM, 030FE, 030FE1, 030FE1B, 030FT, 030FTE, 030FTER, 030FTR, 031, 031BME, 031E, 031EBM, 031FT, 031FT04, 031FT06, 031FTE, 031FTE04, 031FTE06, 031FTER, 031FTERL, 031FTR, 031FTRL, 031TP, 032, 070BM, 070BME, 070D, 070DGG, 070E, 070FT, 070FT04, 070FT05, 070FTE, 070FTE04, 070FTE05, 070FTER, 070FTR, 0712D, 0712VA, 071BM, 071BME, 071D, 071DGG, 071E, 071FT, 071FT04, 071FT06...(Other models you can see in the webshop)		



<b>GEV No.</b>	691184	<b>Ref. No.</b>	36D3420
<b>description</b>	end cap for control panel mounting pos. right		
<b>For models:</b>	030, 030BME, 030E, 030EBM, 030FE, 030FE1, 030FE1B, 030FT, 030FTE, 030FTER, 030FTR, 031, 031BME, 031E, 031EBM, 031FT, 031FT04, 031FT06, 031FTE, 031FTE04, 031FTE06, 031FTER, 031FTERL, 031FTR, 031FTRL, 031TP, 032, 070BM, 070BME, 070D, 070DGG, 070E, 070FT, 070FT04, 070FT05, 070FTE, 070FTE04, 070FTE05, 070FTER, 070FTR, 0712D, 0712VA, 071BM, 071BME, 071D, 071DGG, 071E, 071FT, 071FT04, 071FT06...(Other models you can see in the webshop)		

glass panels



<b>GEV No.</b>	693397	<b>Ref. No.</b>	3070970 37N1420
<b>description</b>	glass panel L 29mm W 29mm thickness 3.5mm square		
<b>For models:</b>	06WCP1GM, 08WCP1GM, 08WFT1GV, 08WFT2GV, 08WFT3GV, 08WFT4GV, 08WFT6GV, 08WFT7GV, 090FT1G, 090FT2G, 090FT4G, 090FT5G, 090FT7G, 091CP1G, 091FR7G, 091FR7GS, 091FR7G-VERS.052012, 091FR7GX, 0A0FT1G, 0A0FT2G, 0A0FT4G, 0A0FT5G, 0A1CP1G, 0B0FT1G, 0B0FT2G, 0B0FT4G, 0B0FT5G, 0B1CP1G, 0D0FT1G, 0D0FT2G, 0D0FT4G, 0D0FT5G, 0D1CP1G, 0G0FT1G, 0G0FT1G-VERS.032008, 0G0FT2G, 0G0FT2G-VERS.032008, 0G0FT4G, 0G0FT4G-VERS.032008, 0G0FT5G, 0G0FT5G-VERS.032008, 0G0FT7G, 0G1CP1G, 0G1CP1G-VERS.2004, 0G1FR7G, 10CP1GA, 10CP1IA, 10WTPGE, 10WTPGV, 12CP1GA...(Other models you can see in the webshop)		

spindles



<b>GEV No.</b>	514064	<b>Ref. No.</b>	36C0940
<b>description</b>	bearing block for tilting bratt pan ID ø 19/35mm ED ø 14mm		
<b>For models:</b>	1G1BR1E, 1G1BR1G, 31R, 31RE		

Зип, Общепит

<b>GEV No.</b>	514044	<b>Ref. No.</b>	36G8110
<b>description</b>	threaded rod thread M10x1.5 L 640mm ø 20mm		
<b>For models:</b>	191BR1E, 191BR1G, 191BR2E, 191BR2G, 1A1BR1E, 1A1BR1G, 1A1BR2E, 1A1BR2G, 1D1BR1E, 1D1BR1G, 1D1BR2E, 1D1BR2G, 291BR1E, 291BR1G, 291BR2E, 291BR2G, 2A1BR1E, 2A1BR2E, 2D1BR1E, 2D1BR2E		



<b>GEV No.</b>	693099	<b>Ref. No.</b>	36G6440
<b>description</b>	threaded rod thread M14x1 L 300mm ø 24mm		

<b>accessories for</b>	693099	<b>GEV No.</b>	693645	<b>Ref. No.</b>	36G6450
------------------------	--------	----------------	--------	-----------------	---------

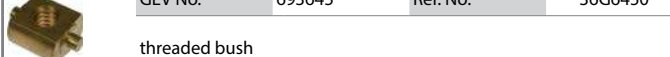

<b>description</b>	threaded bush				
--------------------	---------------	--	--	--	--

<b>accessories for</b>	693645	<b>GEV No.</b>	693824	<b>Ref. No.</b>	36G6431
------------------------	--------	----------------	--------	-----------------	---------



<b>description</b>	extension L 255mm thread M14x1.5 ø 25mm				
--------------------	---	--	--	--	--

<b>GEV No.</b>	514041	<b>Ref. No.</b>	36G1170
<b>description</b>	threaded rod thread M14x1.5 L 615mm ø 25mm		
<b>For models:</b>	31R, 31RE		

miscellaneous



<b>GEV No.</b>	514046	<b>Ref. No.</b>	36C2830
<b>description</b>	bracket for bearing		
<b>For models:</b>	191BR1E, 191BR1G, 191BR2E, 191BR2G, 1A1BR1E, 1A1BR1G, 1A1BR2E, 1A1BR2G, 1D1BR1E, 1D1BR1G, 1D1BR2E, 1D1BR2G, 291BR1E, 291BR1G, 291BR2E, 291BR2G, 2A1BR1E, 2A1BR1G, 2A1BR2E, 2A1BR2G, 2D1BR1E, 2D1BR1G, 2D1BR2E, 2D1BR2G		



<b>GEV No.</b>	691187	<b>Ref. No.</b>	36D9390
<b>description</b>	bushing ø 15/20mm for tilting bratt pan		
<b>For models:</b>	1G1BR1E, 1G1BR1G, 31R, 31RE		







cast plates



1

<b>GEV No.</b>	109719	<b>Ref. No.</b>	35D4340
<b>description</b>	cast plate L 530mm W 545mm		
<b>For models:</b>	08WFA4E, 08WFA4G, 08WFAAE, 08WFAAG, 10WTPGE, 12WFA6E, 12WFA6G, 12WFAAE, 12WFAAG, 1B1FAS2G, 1B1FASG, 1G1FA0EV, 1G1FA0GV, 1G1PE1EV, 1G1PE2EV, 2G1FA0GV, 2G1PE1EV, 2G1PE2EV, 31, 31GE, 31TC, 31TCE, 31TP, 32, 32TC, 32TCE, 32TP, 32TPV, 32V, 6043590, 712D, 712VA		

miscellaneous



1

<b>GEV No.</b>	698478	<b>Ref. No.</b>	3142670
<b>description</b>	coupling for oven for door L 80mm W 26mm intake 7.8 x 7.8		
<b>For models:</b>	FX201E2, FX201E2P, FX201E2P-VERS.032014, FX201E2-VERS.032014, FX201E3, FX201E3P, FX201E3P-VERS.022014, FX201E3-VERS.022014, FX201G2, FX201G2P, FX201G2P-VERS.032014, FX201G2-VERS.032014, FX201G3P, FX201G3-VERS.022014, FX202E2, FX202E2-VERS.032014, FX202E3, FX202E3-230V-3-50Hz-60Hz, FX202E3-230V-3-50Hz-60Hz-VERS.022014, FX202E3-VERS.022014, FX202G2, FX202G2-VERS.032014, FX202G3, FX202G3-VERS.022014		

for dishwashers

drain and intake components

ANGELO PO

drain /intake bodies



1

<b>GEV No.</b>	510681	<b>Ref. No.</b>	36G9130
<b>description</b>	body hose ø 32mm		
<b>For models:</b>	LC100-VERS.2001, LC130, LC130-VERS.2001		

Зип Общепит

vsezip.ru

+7(812)987-08-81

<b>GEV No.</b>	511440	<b>Ref. No.</b>	33Q2110 6000340
<b>description</b>	drain connection complete		
<b>For models:</b>	L40, L40S, L60		



1

<b>GEV No.</b>	517182	<b>Ref. No.</b>	3030150
<b>description</b>	drain connection thread 1" ID ø 27mm hose ø 30mm		
<b>For models:</b>	KD37, KD40, LP202, LP202HC, LP302, LP302HC, LP402, LP402HC, LP402V, LPG300		
<b>accessories for</b>	517182		
<b>GEV No.</b>	517180	<b>Ref. No.</b>	3030170
<b>description</b>	nut thread 1" H 5mm WS 36 SS Qty 1 pcs		
<b>GEV No.</b>	517181	<b>Ref. No.</b>	3030160
<b>description</b>	flat gasket rubber ED ø 44mm ID ø 32mm thickness 3mm Qty 1 pcs		



1

<b>GEV No.</b>	511914	<b>Ref. No.</b>	33M0170
<b>description</b>	drain fitting ED ø 110mm ID ø 80mm hose ø 28/45mm		
<b>For models:</b>	F60P, F60PR, F60T, F80P, F80PR, L45		
<b>spare parts for</b>	511914		
<b>GEV No.</b>	511915	<b>Ref. No.</b>	33M0180
<b>description</b>	flange for filter fixing		
<b>GEV No.</b>	519383	<b>Ref. No.</b>	3150290
<b>description</b>	gasket rubber ED ø 110mm ID ø 83mm thickness 3mm Qty 1 pcs		
<b>accessories for</b>	511914		
<b>GEV No.</b>	519383	<b>Ref. No.</b>	3150290
<b>description</b>	gasket rubber ED ø 110mm ID ø 83mm thickness 3mm Qty 1 pcs		





1

<b>GEV No.</b>	507574	<b>Ref. No.</b>	33Q2740
<b>description</b>	drain fitting thread 1 1/4" ED ø 54mm H 40mm ID ø 36/33mm		
<b>For models:</b>	C165D, C165S, C165VD, C165VS, C207D, C207D-VERS.2006, C207S, C207S-VERS.2006, C207VD, C207VD-VERS.2006, C207VS, C207VS-VERS.2006, C304AD, C304AD-VERS.2006, C304AS, C304AS-VERS.2006, C304AVD, C304AVD-VERS.2006, C304AVS, C304AVS-VERS.2006, C304D, C304D-VERS.2006, C304S, C304S-VERS.2006, C304VD, C304VD-VERS.2006, C304VS, C304VS-VERS.2006, C92D-VERS.2006, C92S-VERS.2006, C92VD-VERS.2006, C92VS-VERS.2006, CS243D, CS243D-VERS.2006, CS243S, CS243S-VERS.2006, CS243VD, CS243VD-VERS.2006, CS243VS, CS243VS-VERS.2006, CS370AD, CS370AD-VERS.2006, CS370AS, CS370AS-VERS.2006, CS370AVD, CS370AVD-VERS.2006, CS370AVS, CS370AVS-VERS.2006, CS370D, CS370D-VERS.2006...(Other models you can see in the webshop)		



2

<b>GEV No.</b>	519232	<b>Ref. No.</b>	33D3090 33Q2290
<b>description</b>	drain fitting thread 1 1/4" ED ø 54mm ID ø 35mm		
<b>For models:</b>	C165D, C165S, C165VD, C165VS, C207D, C207S, C207VD, C207VS, C304AD, C304AS, C304AVD, C304AVS, C304D, C304S, C304VD, C304VS, CS243D, CS243S, CS243VD, CS243VS, CS370AD, CS370AS, CS370AVD, CS370AVS, CS370D, CS370S, CS370VD, CS370VS, CS466AD, CS466AS, CS466AVD, CS466AVS, CS466D, CS466S, CS466VD, CS466VS, LC100-VERS.2001, LC130-VERS.2001, LF50E, LF50EM, LF50EMPS, LF50E-VERS.2007, LP124, LP124S-VERS.052006, LP124V, LP124-VERS.052006, LP124VS-VERS.052006, LP124V-VERS.052006, LP84, LP84S-VERS.052006...(Other models you can see in the webshop)		
<b>accessories for</b>	519232		
	<b>GEV No.</b>	519055	<b>Ref. No.</b> —
	locknut thread 1 1/4"		
	<b>GEV No.</b>	519179	<b>Ref. No.</b> 3151930
	O-ring EPDM thickness 3.53mm ID ø 41.28mm Qty 1 pcs		





1

<b>GEV No.</b>	503505	<b>Ref. No.</b>	33Q3050
<b>description</b>	drain fitting thread 1 1/2"		
<b>For models:</b>	L100, L40, L40S, L60, L80		
<b>accessories for</b>	503505		
	<b>GEV No.</b>	532114	<b>Ref. No.</b> 3150240
	O-ring EPDM thickness 3.53mm ID ø 50.8mm Qty 10 pcs		



1

<b>GEV No.</b>	517254	<b>Ref. No.</b>	33D3340
<b>description</b>	drain fitting thread 2 1/4" H 64mm ID ø 43mm		
<b>For models:</b>	KD100, KD100A, KD100PSD, LP151		
<b>accessories for</b>	517254		
	<b>GEV No.</b>	517205	<b>Ref. No.</b> —
	flat gasket rubber ED ø 75mm ID ø 58mm thickness 3mm Qty 1 pcs		
	<b>GEV No.</b>	517206	<b>Ref. No.</b> —
	nut thread 2"		



1

<b>GEV No.</b>	517181	<b>Ref. No.</b>	3030160
<b>description</b>	flat gasket rubber ED ø 44mm ID ø 32mm thickness 3mm Qty 1 pcs		
<b>For models:</b>	KD37, KD40, LP202, LP202HC, LP302, LP302HC, LP402, LP402HC, LP402V, N100D, N100S, N100VD, N100VS, N38D, N38S, N38VD, N38VS, N42D, N42S, N42VD, N42VS, N50D, N50S, N50VD, N50VS, N66D, N66S, N66VD, N66VS, N70D, N70S, N70VD, N70VS, N85D, N85S, N85VD, N85VS		



1

<b>GEV No.</b>	517180	<b>Ref. No.</b>	3030170
<b>description</b>	nut thread 1" H 5mm WS 36 SS Qty 1 pcs		
<b>For models:</b>	KD37, KD37PS, KD37-VERS.112009, KD40, LP202, LP202HC, LP302, LP302HC, LP402, LP402HC, LP402V, LPG300, N100D, N100S, N100VD, N100VS, N38D, N38S, N38VD, N38VS, N42D, N42S, N42VD, N42VS, N50D, N50S, N50VD, N50VS, N66D, N66S, N66VD, N66VS, N70D, N70S, N70VD, N70VS, N85D, N85S, N85VD, N85VS		





1

<b>GEV No.</b>	505505	<b>Ref. No.</b>	33Q2160
<b>description</b>	nut thread 1 1/4" WS 55 plastic		
<b>For models:</b>	C165D, C165S, C165VD, C165VS, C207D, C207D-VERS.2006, C207S, C207S-VERS.2006, C207VD, C207VD-VERS.2006, C207VS, C207VS-VERS.2006, C304AD, C304AD-VERS.2006, C304AS, C304AS-VERS.2006, C304AVD, C304AVD-VERS.2006, C304AVS, C304AVS-VERS.2006, C304D, C304D-VERS.2006, C304S, C304S-VERS.2006, C304VD, C304VD-VERS.2006, C304VS, C304VS-VERS.2006, C92D-VERS.2006, C92S-VERS.2006, C92VD-VERS.2006, C92VS-VERS.2006, CS243D, CS243D-VERS.2006, CS243S, CS243S-VERS.2006, CS243VD, CS243VD-VERS.2006, CS243VS, CS243VS-VERS.2006, CS370AD, CS370AD-VERS.2006, CS370AS, CS370AS-VERS.2006, CS370AVD, CS370AVD-VERS.2006, CS370AVS, CS370AVS-VERS.2006, CS370D, CS370D-VERS.2006...(Other models you can see in the webshop)		







Зип Общепит  
vsezip.ru  
+7(812)987-08-81

			
1			
<b>GEV No.</b>	510356	<b>Ref. No.</b>	33Q2320
<b>description</b>	nut thread 1 1/2"		
<b>accessories for</b>	510356		
	<b>GEV No.</b>	510876	<b>Ref. No.</b>
	flat gasket rubber ED ø 45mm ID ø 33mm thickness 3mm Qty 1 pcs		
	<b>GEV No.</b>	511298	<b>Ref. No.</b>
	hose connector hose ø 35mm		

			
1			
<b>GEV No.</b>	511309	<b>Ref. No.</b>	33Q0240
<b>description</b>	nut thread 1 1/2" ø 66mm H 9mm WS 51 brass Qty 1 pcs		
<b>For models:</b>	L100, L40, L40S, L60, L80		

			
1			
<b>GEV No.</b>	519179	<b>Ref. No.</b>	3151930
<b>description</b>	O-ring EPDM thickness 3.53mm ID ø 41.28mm Qty 1 pcs		
<b>For models:</b>	C165D, C165S, C165VD, C165VS, C207D, C207D-VERS.2006, C207S, C207S-VERS.2006, C207VD, C207VD-VERS.2006, C207VS, C207VS-VERS.2006, C304AD, C304AD-VERS.2006, C304AS, C304AS-VERS.2006, C304AVD, C304AVD-VERS.2006, C304AVS, C304AVS-VERS.2006, C304D, C304D-VERS.2006, C304S, C304S-VERS.2006, C304VD, C304VD-VERS.2006, C304VS, C304VS-VERS.2006, C92D-VERS.2006, C92S-VERS.2006, C92VD-VERS.2006, C92VS-VERS.2006, CS243D, CS243D-VERS.2006, CS243S, CS243S-VERS.2006, CS243VD, CS243VD-VERS.2006, CS243VS, CS243VS-VERS.2006, CS370AD, CS370AD-VERS.2006, CS370AS, CS370AS-VERS.2006, CS370AVD, CS370AVD-VERS.2006, CS370AVS, CS370AVS-VERS.2006, CS370D, CS370D-VERS.2006...(Other models you can see in the webshop)		

			
1			
<b>GEV No.</b>	532114	<b>Ref. No.</b>	3150240
<b>description</b>	O-ring EPDM thickness 3.53mm ID ø 50.8mm Qty 10 pcs		
<b>For models:</b>	L100, L40, L40S, L60, L80		

<b>filters</b>			
			
1			
<b>GEV No.</b>	504251	<b>Ref. No.</b>	30Q0490
<b>description</b>	drain filter ø 105mm H 80mm hole ø 40mm		
<b>For models:</b>	F60P, F60T, F80P, L45		

			
1			
<b>GEV No.</b>	519064	<b>Ref. No.</b>	30Q0300 30Q1510
<b>description</b>	chain filter ø 96mm H 81mm		
<b>For models:</b>	F60P, F60PR, F80PR, L45		

			
1			
<b>GEV No.</b>	519063	<b>Ref. No.</b>	30Q1330
<b>description</b>	filter H 75mm L 160mm W 75mm		
<b>For models:</b>	CS243D-VERS.2006, CS243S-VERS.2006, CS243VD-VERS.2006, CS243VS-VERS.2006, CS370AD-VERS.2006, CS370AS-VERS.2006, CS370AVD-VERS.2006, CS370AVS-VERS.2006, CS370D-VERS.2006, CS370S-VERS.2006, CS370VD-VERS.2006, CS370VS-VERS.2006, CS466AD-VERS.2006, CS466AS-VERS.2006, CS466AVD-VERS.2006, CS466AVS-VERS.2006, CS466D-VERS.2006, CS466S-VERS.2006, CS466VD-VERS.2006, CS466VS-VERS.2006, LF50, LF50E, LF50EM, LF50EMPS-VERS.122012, LF50EM-VERS.122012, LF50E-VERS.122012, LF50E-VERS.2007, LP70		

			
1			
<b>GEV No.</b>	511915	<b>Ref. No.</b>	33M0180
<b>description</b>	flange for filter fixing		
<b>For models:</b>	F60P, F60PR, F60T, F80P, F80PR, L45		

			
1			
<b>GEV No.</b>	507381	<b>Ref. No.</b>	30G0140
<b>description</b>	flat filter L 295mm W 195mm		
<b>For models:</b>	L100, L80		

			
1			
<b>GEV No.</b>	510002	<b>Ref. No.</b>	30Q3280
<b>description</b>	flat filter ø 50mm H 95mm L 383mm W 136mm		
<b>For models:</b>	KD100, KD100A, KD100PSD, LP151		

			
1			
<b>GEV No.</b>	519391	<b>Ref. No.</b>	35Q1030
<b>description</b>	intake filter ø 77mm H 100mm		



1

<b>GEV No.</b>	511439	<b>Ref. No.</b>	30G0150
<b>description</b>	rectangular filter H 42mm L 114mm W 104mm		
<b>For models:</b>	L100, L80		



1

<b>GEV No.</b>	511438	<b>Ref. No.</b>	30Q2120
<b>description</b>	rectangular filter H 70mm L 160mm W 145mm		



1

<b>GEV No.</b>	505268	<b>Ref. No.</b>	30Q1440
<b>description</b>	round filters $\varnothing$ 184mm H 103mm SS		
<b>For models:</b>	LC100		



1

<b>GEV No.</b>	516079	<b>Ref. No.</b>	35Q9940
<b>description</b>	round filters $\varnothing$ 508mm H 55mm		
<b>For models:</b>	LT10R, LT20F, LT25F		

### overflow pipes



1

<b>GEV No.</b>	517175	<b>Ref. No.</b>	3018870
<b>description</b>	overflow pipe L 107mm $\varnothing$ 28mm		
<b>For models:</b>	KD40		



1

<b>GEV No.</b>	519266	<b>Ref. No.</b>	33D2360
<b>description</b>	overflow pipe L 115mm		

Зип Общепит

vsezip.ru

+7(812)987-08-81



1

<b>GEV No.</b>	519378	<b>Ref. No.</b>	33D3080
<b>description</b>	overflow pipe L 115mm $\varnothing$ 28mm		
<b>For models:</b>	LF50E, LF50EM, LP70		



1

<b>GEV No.</b>	516252	<b>Ref. No.</b>	33D0390
<b>description</b>	overflow pipe L 120mm $\varnothing$ 29mm		
<b>For models:</b>	LT10R, LT20F, LT25F		



1

<b>GEV No.</b>	519387	<b>Ref. No.</b>	33D0341
<b>description</b>	overflow pipe L 185mm $\varnothing$ 36mm		
<b>For models:</b>	L40, L60		



1



<b>GEV No.</b>	517185	<b>Ref. No.</b>	33D3350
<b>description</b>	overflow pipe L 185mm $\varnothing$ 40mm		
<b>For models:</b>	KD100, KD100A, KD100PSD, KN50, KN50M, KN50MPS, KN50PS, KN50PSD, KN50PSDD, KN80, KN80PS, LP70		
<b>accessories for</b>	517185		



<b>GEV No.</b>	517189	<b>Ref. No.</b>	37Q5140
<b>description</b>	gasket $\varnothing$ 28mm D1 $\varnothing$ 40mm thickness 6mm		





Зип Общепит  
vsezip.ru  
+7(812)987-0881

			
1			
<b>GEV No.</b>	517186	<b>Ref. No.</b>	33D3360
<b>description</b>	overflow pipe L 210mm ø 40mm		
<b>For models:</b>	KD100, KD100A, KD100PSD, KD60, KD60E, KD60EAT, KD60M, KD60MA, KD60ME, KD6EATSD, KD85, KD85A, KD85E, KD85EA, KD85EAT, KD85EATS, KD85EPS, KD85EPSA, KD85PS, KD85PSA, KN1100, KN1100SD, KN11PSDD, KN800, KN800PSD, LP151		
<b>accessories for</b>	517186		
	<b>GEV No.</b>	517189	<b>Ref. No.</b> 37Q5140
	gasket ø 28mm D1 ø 40mm thickness 6mm		

			
1			
<b>GEV No.</b>	516081	<b>Ref. No.</b>	33D0140
<b>description</b>	overflow pipe L 223mm ø 30mm		
<b>For models:</b>	F60P, F60PR, F80PR, L45		

			
1			
<b>GEV No.</b>	510679	<b>Ref. No.</b>	33D2320
<b>description</b>	overflow pipe L 245mm ø 35mm		
<b>For models:</b>	LC100, LC80		

			
1			
<b>GEV No.</b>	517357	<b>Ref. No.</b>	3056130
<b>description</b>	overflow pipe L 420mm ø 44mm		
<b>For models:</b>	KD130, KD130A, KD130E, KD130EAT		
<b>accessories for</b>	517357		
	<b>GEV No.</b>	517189	<b>Ref. No.</b> 37Q5140
	gasket ø 28mm D1 ø 40mm thickness 6mm		

			
1			
<b>GEV No.</b>	519390	<b>Ref. No.</b>	33D2880
<b>description</b>	overflow pipe L 430mm ø 35mm		
<b>For models:</b>	C165D, C165S, C165VD, C165VS, C207D, C207S, C207VD, C207VD-VERS.2006, C207VS, C207VS-VERS.2006, C304AD, C304AS, C304AVD, C304AVD-VERS.2006, C304AVS, C304AVS-VERS.2006, C304D, C304S, C304VD, C304VD-VERS.2006, C304VS, C304VS-VERS.2006, C92VD-VERS.2006, C92VS-VERS.2006, CS243D, CS243S, CS243VD, CS243VD-VERS.2006, CS243VS, CS243VS-VERS.2006, CS370AD, CS370AS, CS370AVD, CS370AVD-VERS.2006, CS370AVS, CS370AVS-VERS.2006, CS370D, CS370S, CS370VD, CS370VD-VERS.2006, CS370VS, CS370VS-VERS.2006, CS466AD, CS466AD-VERS.2006, CS466AS, CS466AS-VERS.2006, CS466AVD, CS466AVD-VERS.2006, CS466AVS, CS466AVS-VERS.2006...(Other models you can see in the webshop)		

			
1			
<b>GEV No.</b>	519381	<b>Ref. No.</b>	33D0050
<b>description</b>	overflow pipe L 430mm ø 42mm		
<b>For models:</b>	L100, L80		

			
1			
<b>GEV No.</b>	517177	<b>Ref. No.</b>	3081150
<b>description</b>	overflow pipe L 96mm ø 28mm		
<b>For models:</b>	KD37		

containers

dosing containers

			
1			
<b>GEV No.</b>	361736	<b>Ref. No.</b>	36A4160
<b>description</b>	rinse aid container		
<b>For models:</b>	LF50, LF50E, LF50EM, LF50EM-VERS.122012, LF50E-VERS.122012, LF50E-VERS.2007		

			
1			
<b>GEV No.</b>	519380	<b>Ref. No.</b>	33D0660
<b>description</b>	rinse aid container		
<b>For models:</b>	F60P, F60PR, F60T, F80P, F80PR, L45		

boilers

boilers for dishwashers



1			
<b>GEV No.</b>	516163	<b>Ref. No.</b>	34A0700
<b>description</b>	boiler		
<b>For models:</b>	LT10R, LT20F, LT25F		



1			
<b>GEV No.</b>	517294	<b>Ref. No.</b>	3022510
<b>description</b>	boiler ø 113mm L 320mm		
<b>For models:</b>	KD37, KD37PS, KD37-VERS.112009, KN35, KN37PS		



1			
<b>GEV No.</b>	517295	<b>Ref. No.</b>	3023900
<b>description</b>	boiler ø 113mm L 370mm		
<b>For models:</b>	KD40, KD40PS, KD40-VERS.112009, KN40, KN40PS, KN40PSD		



1			
<b>GEV No.</b>	519022	<b>Ref. No.</b>	34A1950
<b>description</b>	boiler ø 150mm L 400mm		
<b>For models:</b>	LF50, LF50E, LF50EM		

Зип Общепит

vsezip.ru

+7(812)987-08-81



1			
<b>GEV No.</b>	517302	<b>Ref. No.</b>	34A2560
<b>description</b>	boiler with insulation ø 160mm L 500mm		
<b>For models:</b>	KD100, KD100A, KD100PSD, KD130, KD130A, KD85, KD85A, KD85E, KD85EA, KD85EAT, KD85EATS, KD85EPS, KD85EPSA, KD85PS, KD85PSA, KN1100, KN1100SD, KN11PSDD, KN800, KN800PSD, LP151		
<b>accessories for</b>	517302		
	<b>GEV No.</b>	517337	<b>Ref. No.</b>
			—
	insulating mat boiler ø 160mm		

spare parts and accessories



1			
<b>GEV No.</b>	691742	<b>Ref. No.</b>	3120030
<b>description</b>	disc ext. ø 30		
<b>For models:</b>	FCV241G-CSA, FCV241GDM-CSA, FCV241GDS-CSA, L80		

hood mechanics for dishwashers

bolts



1			
<b>GEV No.</b>	510595	<b>Ref. No.</b>	3100100
<b>description</b>	bolt thread M6x1 for hood handle		
<b>For models:</b>	L100, L80		

bushes



1			
<b>GEV No.</b>	512423	<b>Ref. No.</b>	N/A
<b>description</b>	bush for hood handle		



1			
<b>GEV No.</b>	519205	<b>Ref. No.</b>	36C3560
<b>description</b>	bush hood mechanics		
<b>For models:</b>	LC100, LC100-VERS.2001, LC130, LC130-VERS.2001, LC80		



Зип Общежит

vsezip.ru

+7(812)987-08-81

			
1			
<b>GEV No.</b>	524445	<b>Ref. No.</b>	35Z0770
<b>description</b>	bush L 22mm for handle rod ø 12mm		
<b>For models:</b>	L100, L80		

			
1			
<b>GEV No.</b>	524446	<b>Ref. No.</b>	35Z4410
<b>description</b>	bush L 35mm for handle rod ø 8mm		

spring holders

			
1			
<b>GEV No.</b>	519243	<b>Ref. No.</b>	36H0450
<b>description</b>	bush for spring holder hood mechanics		
<b>For models:</b>	LC100, LC100-VERS.2001, LC130, LC130-VERS.2001, LC80		

			
1			
<b>GEV No.</b>	516094	<b>Ref. No.</b>	36G0210
<b>description</b>	spring holder		
<b>For models:</b>	L100, L80		



guide bars



			
1			
<b>GEV No.</b>	517378	<b>Ref. No.</b>	3036440
<b>description</b>	guide bar L 650mm mounting pos. left for hood mechanics thickness 25mm		
<b>For models:</b>	KD100, KD100A, KD100PSD, KD130, KD130A, KD130E, KD130EAT		



			
1			
<b>GEV No.</b>	513019	<b>Ref. No.</b>	3036430
<b>description</b>	guide bar L 695mm mounting pos. right thickness 25mm		
<b>For models:</b>	KD100, KD100A, KD100PSD, KD130, KD130A, KD130E, KD130EAT		

			
<b>GEV No.</b>	510864	<b>Ref. No.</b>	N/A
<b>description</b>	bush for spring holder hood mechanics		

air traps



			
1			
<b>GEV No.</b>	510344	<b>Ref. No.</b>	33D0360
<b>description</b>	air trap		
<b>For models:</b>	L100, L40, L40S, L60, L80		
<b>accessories for</b>	510344		
	<b>GEV No.</b>	361182	<b>Ref. No.</b> 3117580
	nut thread 1/4" H 5mm nickel-plated brass WS 17 Qty 1 pcs		
	<b>GEV No.</b>	511512	<b>Ref. No.</b> 3150410
	O-ring EPDM thickness 2.62mm ID ø 18.72mm Qty 10 pcs		

			
1			
<b>GEV No.</b>	511450	<b>Ref. No.</b>	33M0220
<b>description</b>	air trap		
<b>For models:</b>	F60P, F60PR, F60T, F80P, F80PR, L45		
<b>accessories for</b>	511450		
	<b>GEV No.</b>	511197	<b>Ref. No.</b> 3151770
	gasket L 46mm W 33mm for air trap		

			
1			
<b>GEV No.</b>	516241	<b>Ref. No.</b>	3060029
<b>description</b>	air trap		
<b>accessories for</b>	516241		
	<b>GEV No.</b>	528485	<b>Ref. No.</b> —
	O-ring EPDM thickness 1.78mm ID ø 6.07mm Qty 1 pcs		



1

<b>GEV No.</b>	519263	<b>Ref. No.</b>	33M0510
<b>description</b>	air trap		
<b>For models:</b>	CS243D, CS243S, CS243VD, CS243VS, CS370AD, CS370AS, CS370AVD, CS370AVS, CS370D, CS370S, CS370VD, CS370VS, CS466AD, CS466AS, CS466AVD, CS466AVS, CS466D, CS466S, CS466VD, CS466VS, LF50, LF50E, LF50EM, LF50EMPS, LF50E-VERS.2007, LP70		
<b>accessories for</b>	519263		
	<b>GEV No.</b>	519057	<b>Ref. No.</b>
			—
	nut thread 3/8" WS 25 H 6mm brass		
	<b>GEV No.</b>	519114	<b>Ref. No.</b>
			3151890
	flat gasket rubber ED ø 25mm ID ø 16.5mm thickness 2mm Qty 1 pcs		





1

<b>GEV No.</b>	519319	<b>Ref. No.</b>	33D1390
<b>description</b>	air trap		
<b>For models:</b>	C165D, C165S, C165VD, C165VS, C207D, C207D-VERS.2006, C207S, C207S-VERS.2006, C207VD, C207VD-VERS.2006, C207VS, C207VS-VERS.2006, C304AD, C304AD-VERS.2006, C304AS, C304AS-VERS.2006, C304AVD, C304AVD-VERS.2006, C304AVS, C304AVS-VERS.2006, C304D, C304D-VERS.2006, C304S, C304S-VERS.2006, C304VD, C304VD-VERS.2006, C304VS, C304VS-VERS.2006, C92D-VERS.2006, C92S-VERS.2006, C92VD-VERS.2006, C92VS-VERS.2006, CS243D, CS243D-VERS.2006, CS243S, CS243S-VERS.2006, CS243VD, CS243VD-VERS.2006, CS243VS, CS243VS-VERS.2006, CS370AD, CS370AD-VERS.2006, CS370AS, CS370AS-VERS.2006, CS370AVD, CS370AVD-VERS.2006, CS370AVS, CS370AVS-VERS.2006, CS370D, CS370D-VERS.2006...(Other models you can see in the webshop)		
<b>accessories for</b>	519319		
	<b>GEV No.</b>	519057	<b>Ref. No.</b>
			—
	nut thread 3/8" WS 25 H 6mm brass		
	<b>GEV No.</b>	519114	<b>Ref. No.</b>
			3151890
	flat gasket rubber ED ø 25mm ID ø 16.5mm thickness 2mm Qty 1 pcs		



1

<b>GEV No.</b>	517168	<b>Ref. No.</b>	33D3330
<b>description</b>	air trap H 56mm		
<b>accessories for</b>	517168		
	<b>GEV No.</b>	517173	<b>Ref. No.</b>
			37Q5130
	flat gasket FIBER ED ø 14mm ID ø 8mm thickness 1.5mm Qty 1 pcs		
	<b>GEV No.</b>	517174	<b>Ref. No.</b>
			3110050 33Q6470
	nut thread M8 H 6.5mm WS 13 SS DIN/ISO DIN 934 / ISO 4032/8673 Qty 1 pcs		

Зип Общепит

vsezip.ru

+7(812)987-08-81



1

<b>GEV No.</b>	517308	<b>Ref. No.</b>	33D3320
<b>description</b>	air trap H 45mm		
<b>For models:</b>	KD100, KD100A, KD100PSD, KN35, KN37, KN37PS, KN40, KN40PS, KN40PSD, LP151		

## air trap accessories



1

<b>GEV No.</b>	511385	<b>Ref. No.</b>	35Z0050
<b>description</b>	flange L 46mm W 32mm for air trap		
<b>For models:</b>	F60P, F60PR, F60T, F80P, F80PR, L45		



1

<b>GEV No.</b>	511197	<b>Ref. No.</b>	3151770
<b>description</b>	gasket L 46mm W 33mm for air trap		
<b>For models:</b>	F60P, F60PR, F60T, F80P, F80PR, L45		

## mechanics for flight type dishwashers



1

<b>GEV No.</b>	691638	<b>Ref. No.</b>	36G7550
<b>description</b>	tappet		
<b>For models:</b>	C165D, C165S, C165VD, C165VS, C207D, C207D-VERS.2006, C207S, C207S-VERS.2006, C207VD, C207VD-VERS.2006, C207VS, C207VS-VERS.2006, C304AD, C304AD-VERS.2006, C304AS, C304AS-VERS.2006, C304AVD, C304AVD-VERS.2006, C304AVS, C304AVS-VERS.2006, C304D, C304D-VERS.2006, C304S, C304S-VERS.2006, C304VD, C304VD-VERS.2006, C304VS, C304VS-VERS.2006, C92D-VERS.2006, C92S-VERS.2006, C92VD-VERS.2006, C92VS-VERS.2006, CAD, CAS, CS243D, CS243D-VERS.2006, CS243S, CS243S, CS243VD, CS243VD-VERS.2006, CS243VS, CS243VS-VERS.2006, CS370AD, CS370AD-VERS.2006, CS370AS, CS370AS-VERS.2006, CS370AVD, CS370AVD-VERS.2006, CS370AVS, CS370AVS-VERS.2006, CS370D...(Other models you can see in the webshop)		



Зип Общежит

vsezip.ru

+7(812)987-08-81

backflow preventers

backflow preventers



1

<b>GEV No.</b>	504140	<b>Ref. No.</b>	33D0650 33D2100 33D2330
<b>description</b>	backflow preventer		



1

<b>GEV No.</b>	516101	<b>Ref. No.</b>	33D0650 33D2330
<b>description</b>	backflow preventer dishwasher hose ø 12mm		

**For models:** C165D, C165S, C207D, C207S, C304AD, C304AS, C304D, C304S, CS243D, CS243S, CS243VD, CS243VS, CS370AD, CS370AS, CS370A-VD, CS370AVS, CS370D, CS370S, CS370VD, CS370VS, CS466AD, CS466AS, CS466AVD, CS466AVS, CS466D, CS466S, CS466VD, CS466VS, F60P, KD100, KD100PSD, KD130, KD130E, KD37, KD40, KD40EPSD, KD40LEPS, KD40LSPS, KD40LUX, KD40LUXE, KD60, KD60M, KD60MPS, KD60PS, KD60PSD, KD85, KD85PS, L100, L45, L80...(Other models you can see in the webshop)

**spare parts for** 516101

<b>GEV No.</b>	506367	<b>Ref. No.</b>	—
<b>description</b>	flat gasket rubber ED ø 40mm ID ø 28mm thickness 1.8mm Qty 1 pcs		

miscellaneous



1

<b>GEV No.</b>	506160	<b>Ref. No.</b>	3120050
<b>description</b>	plain washer ID ø 8.6mm ED ø 16mm thickness 1.5mm SS Qty 1 pcs		

**For models:** 091FR1EX, 091FR7GS, 091FR7GX, BRE21HD, BRE31HD, FM1011E2-VERS.2006, FM1011E3-VERS.2006, FM1011G2-VERS.2006, FM1011G3-VERS.2006, FM1221E2-VERS.2006, FM1221E3-VERS.2006, FM1221G2-VERS.2006, FM1221G3-VERS.2006, FM611E2-VERS.2006, FM611E3-VERS.2006, FM611G2-VERS.2006, FM611G3-VERS.2006, FM721E3-VERS.2006, FM721G3-VERS.2006, FX101E2C, FX101E3C, FX101G2C, FX101G3C, FX10E2CR, FX10E3CR, FX10G2CR, FX10G3CR, FX122E2C, FX122E3, FX122E3C, FX122E3T, FX122E3T-VERS.022014, FX122G2C, FX122G3, FX122G3C, FX122G3T, FX122G3T-VERS.022014, FX12E3CT, FX12E3CT-VERS.022014, FX12G3CT, FX12G3CT-VERS.022014, FX61E2C, FX61E2CR, FX61E3CR, FX61G2C, FX61G2CR, FX61G3C, FX61G3CR, FX82E2C, FX82E3C...(Other models you can see in the webshop)

bolts



1

<b>GEV No.</b>	514283	<b>Ref. No.</b>	36D7060 36D7061 36D7062
<b>description</b>	bolt with flattening 7mm ø 10mm L 20mm for door		

**For models:** BX101E, BX101E-VERS.122013, BX101G, BX101G-VERS.122013, BX122E, BX122E-VERS.122013, BX122G, BX122G-VERS.122013, BX61E, BX61E-VERS.122013, BX61G, BX61G-VERS.122013, BX82E, BX82E-VERS.122013, BX82G, BX82G-VERS.122013, FC101, FC1011E, FC1011G, FC101E, FC1221E, FC1221G, FC241, FC241E, FC241G, FC61, FC611E, FC611G, FC61E, FCV101, FCV101-CSA, FCV101DM, FCV101DM-CSA, FCV101DS, FCV101DS-CSA, FCV101E, FCV101EDM, FCV101EDM-UL, FCV101EDS, FCV101EDS-UL, FCV141, FCV141-CSA, FCV141DM, FCV141DM-CSA, FCV141DS, FCV141DS-CSA, FCV141E, FCV141EDM, FCV141EDS, FCV241...(Other models you can see in the webshop)

springs

roller springs



1

<b>GEV No.</b>	519340	<b>Ref. No.</b>	36G8430
<b>description</b>	roller spring		

**For models:** LP124, LP124S-VERS.052006, LP124V, LP124-VERS.052006, LP124VS-VERS.052006, LP124V-VERS.052006

sliding plates



1

<b>GEV No.</b>	518584	<b>Ref. No.</b>	36M1230
<b>description</b>	sliding plate		

**For models:** LP124, LP124S-VERS.052006, LP124V, LP124-VERS.052006, LP124VS-VERS.052006, LP124V-VERS.052006

hinges



1

<b>GEV No.</b>	510594	<b>Ref. No.</b>	3190130
<b>description</b>	door bolt ø 8mm L 42mm		

**For models:** L40, L40S, L60

Зип Общепит

vsezip.ru

7(812)987-08-81



1

<b>GEV No.</b>	510593	<b>Ref. No.</b>	35S1930
<b>description</b>	door hinge		
<b>For models:</b>	L40, L40S, L60		
<b>accessories for</b>	510593		
	<b>GEV No.</b>	<b>Ref. No.</b>	
	510594	3190130	
	door bolt ø 8mm L 42mm		



1

<b>GEV No.</b>	516089	<b>Ref. No.</b>	36G7400
<b>description</b>	spring assisted hinge spring hinge		
<b>For models:</b>	LT10R, LT20F, LT25F		

## door shafts



1

<b>GEV No.</b>	695575	<b>Ref. No.</b>	3011520
<b>description</b>	door shaft ø 10mm L 458mm icemaker		
<b>For models:</b>	PG23C, PG24CW, PG30C, PG31CW		

## locks



1

<b>GEV No.</b>	510210	<b>Ref. No.</b>	36M0030
<b>description</b>	counterpart counterpart		
<b>For models:</b>	L40, L40S, L60		
<b>accessories for</b>	510210		
	<b>GEV No.</b>	<b>Ref. No.</b>	
	510209	36M0020	
	door catch		





1

<b>GEV No.</b>	510209	<b>Ref. No.</b>	36M0020
<b>description</b>	door catch		
<b>For models:</b>	L40, L40S, L60		
<b>accessories for</b>	510209		
	<b>GEV No.</b>	<b>Ref. No.</b>	
	510210	36M0030	
	counterpart counterpart		



1

<b>GEV No.</b>	517276	<b>Ref. No.</b>	3030100
<b>description</b>	door catch catch		
<b>accessories for</b>	517276		
	<b>GEV No.</b>	<b>Ref. No.</b>	
	517277	—	
	gasket for catch		
	<b>GEV No.</b>	<b>Ref. No.</b>	
	517278	—	
	counterpart door catch		



1

<b>GEV No.</b>	519247	<b>Ref. No.</b>	31W0061
<b>description</b>	door catch door locking catch		
<b>For models:</b>	F60P, F60PR, F60T, F80P, F80PR, L45, LF50, LF50E, LF50EM, LF50EMPS, LF50EMPS-VERS.122012, LF50EM-VERS.122012, LF50E-VERS.122012, LF50E-VERS.2007		
<b>accessories for</b>	519247		
	<b>GEV No.</b>	<b>Ref. No.</b>	
	519050	—	
	nut thread M12x1.75 H 4mm WS 16 SS Qty 1 pcs for snap lock		

## miscellaneous



1

<b>GEV No.</b>	504435	<b>Ref. No.</b>	3152010
<b>description</b>	flat gasket plastic ED ø 18mm ID ø 9.5mm thickness 2.5mm for door hinge Qty 1 pcs		





screw connections

Зип Общежит

curtains

vsezip.ru

7(812)987-08-81



1

<b>GEV No.</b>	519008	<b>Ref. No.</b>	N/A
<b>description</b>	locknut thread 2 1/4" Qty 1 pcs		



1

<b>GEV No.</b>	505506	<b>Ref. No.</b>	33Q0220
<b>description</b>	nut		



1

<b>GEV No.</b>	505505	<b>Ref. No.</b>	33Q2160
<b>description</b>	nut thread 1 1/4" WS 55 plastic		

**For models:** C165D, C165S, C165VD, C165VS, C207D, C207D-VERS.2006, C207S, C207S-VERS.2006, C207VD, C207VD-VERS.2006, C207VS, C207VS-VERS.2006, C304AD, C304AD-VERS.2006, C304AS, C304AS-VERS.2006, C304AVD, C304AVD-VERS.2006, C304AVS, C304AVS-VERS.2006, C304D, C304D-VERS.2006, C304S, C304S-VERS.2006, C304VD, C304VD-VERS.2006, C304VS, C304VS-VERS.2006, C92D-VERS.2006, C92S-VERS.2006, C92VD-VERS.2006, C92VS-VERS.2006, CS243D, CS243D-VERS.2006, CS243S, CS243S-VERS.2006, CS243VD, CS243VD-VERS.2006, CS243VS, CS243VS-VERS.2006, CS370AD, CS370AD-VERS.2006, CS370AS, CS370AS-VERS.2006, CS370AVD, CS370AVD-VERS.2006, CS370AVS, CS370AVS-VERS.2006, CS370D, CS370D-VERS.2006...(Other models you can see in the webshop)



1

<b>GEV No.</b>	506278	<b>Ref. No.</b>	33Q4700
<b>description</b>	nut thread M26x1.5 H 15mm WS 32 plastic Qty 1 pcs 12		
<b>For models:</b>	F60PR, F60T, F80P, F80PR		

curtains



1

<b>GEV No.</b>	533016	<b>Ref. No.</b>	36Z0720
<b>description</b>	curtain W 640mm H 410mm plastic thickness 1.5mm warewashing		

washing and rinsing systems



1

<b>GEV No.</b>	505508	<b>Ref. No.</b>	33Q0280
<b>description</b>	bearing for wash arm		



1

<b>GEV No.</b>	524877	<b>Ref. No.</b>	36D0740
<b>description</b>	bush for rinse arm ø 20mm ID ø 16mm H 8mm ED ø 26mm		
<b>For models:</b>	L100, L40, L40S, L60, L80		





1

<b>GEV No.</b>	510053	<b>Ref. No.</b>	36G8460
<b>description</b>	bush for rinse arm ø 24mm H 5.7mm		
<b>For models:</b>	LP124, LP124S-VERS.052006, LP124V, LP124-VERS.052006, LP124VS-VERS.052006, LP124V-VERS.052006, LP84, LP84S-VERS.052006, LP84V, LP84-VERS.052006, LP84VS-VERS.052006, LP84V-VERS.052006		





1

<b>GEV No.</b>	519088	<b>Ref. No.</b>	36G9110
<b>description</b>	bush for wash arm		

			
1			
<b>GEV No.</b>	519167	<b>Ref. No.</b>	33Q370 33Q3700
<b>description</b>	bush for wash arm		
<b>For models:</b>	LP124, LP124S-VERS.052006, LP124V, LP124-VERS.052006, LP124VS-VERS.052006, LP124V-VERS.052006, LP84, LP84S-VERS.052006, LP84V, LP84-VERS.052006, LP84VS-VERS.052006, LP84V-VERS.052006		
<b>accessories for</b>	519167		
	<b>GEV No.</b>	519087	<b>Ref. No.</b> 36G8720
locknut for wash arm			

			
1			
<b>GEV No.</b>	518075	<b>Ref. No.</b>	36Q0180
<b>description</b>	end cap thread 1/4" WS 14		
<b>For models:</b>	L100, L40, L40S, L60, L80		

			
1			
<b>GEV No.</b>	519047	<b>Ref. No.</b>	36U0740
<b>description</b>	flange		
<b>For models:</b>	LF50		

			
1			
<b>GEV No.</b>	517095	<b>Ref. No.</b>	3021600
<b>description</b>	flange ø 60mm		

			
1			
<b>GEV No.</b>	519122	<b>Ref. No.</b>	37Q4200
<b>description</b>	flat gasket for rinse arm		
<b>For models:</b>	C165D, C165S, C207D, C207S, C304AD, C304AS, C304D, C304S, CS243D, CS243S, CS243VD, CS243VS, CS370AD, CS370AS, CS370AVD, CS370AVS, CS370D, CS370S, CS370VD, CS370VS, CS466AD, CS466AS, CS466AVD, CS466AVS, CS466D, CS466S, CS466VD, CS466VS, LC100, LC100-VERS.2001, LC130, LC130-VERS.2001, LC80, N303D, N303S, N303VD, N303VS, N354D, N354S, N354VD, N354VS, N506D, N506S, N506VD, N506VS, N607D, N607S, N607VD, N607VS, N760D... (Other models you can see in the webshop)		

			
1			
<b>GEV No.</b>	691730	<b>Ref. No.</b>	33Q0510
<b>description</b>	knurled nut thread M10x1.5 ø 36mm H 3.5mm stainless steel		
<b>For models:</b>	L100, L40S, L60, L80		

			
1			
<b>GEV No.</b>	519006	<b>Ref. No.</b>	33Q4220
<b>description</b>	locknut		

			
1			
<b>GEV No.</b>	695590	<b>Ref. No.</b>	31Z0250
<b>description</b>	bush for wash arm		
<b>For models:</b>	KD100, KD100A, KD100PSD, KD37, KD37PS, KD37-VERS.112009, KD40PS, KD40-VERS.112009, KD85, KD85A, KD85PS, KD85PSA, KN35, KN37, KN37PS, KN40, KN40PS, KN40PSD		

			
1			
<b>GEV No.</b>	517341	<b>Ref. No.</b>	33Q6600
<b>description</b>	bush ID ø 16mm ED ø 48mm		
<b>For models:</b>	KD100, KD100A, KD100PSD, KD130, KD130A, KD130E, KD130EAT, KN1100, KN1100SD, KN11PSDD, LP151, N100D, N100S, N100VD, N100VS, N38D, N38S, N38VD, N38VS, N42D, N42S, N42VD, N42VS, N50D, N50S, N50VD, N50VS, N66D, N66S, N66VD, N66VS, N70D, N70S, N70VD, N70VS, N85D, N85S, N85VD, N85VS		

			
1			
<b>GEV No.</b>	541505	<b>Ref. No.</b>	33Q0740
<b>description</b>	connecting piece thread 1/2" ø 14mm		
<b>For models:</b>	L100, L40, L60, L80		







Зип-Общепит

vsezip.ru

+7(812)987-08-81

	
1	
<b>GEV No.</b>	519087
<b>Ref. No.</b>	36G8720
<b>description</b>	locknut for wash arm
<b>For models:</b>	LC100, LC100-VERS.2001, LC130, LC130-VERS.2001, LP124, LP124S-VERS.052006, LP124V, LP124-VERS.052006, LP124VS-VERS.052006, LP124V-VERS.052006, LP84, LP84S-VERS.052006, LP84V, LP84-VERS.052006, LP84VS-VERS.052006, LP84V-VERS.052006

	
1	
<b>GEV No.</b>	518075
<b>Ref. No.</b>	36Q0180
<b>description</b>	end cap thread 1/4" WS 14
<b>For models:</b>	
	
1	
<b>GEV No.</b>	524877
<b>Ref. No.</b>	36D0740
<b>description</b>	push for rinse arm ø 2mm ID ø 16mm H 8mm ED ø 26mm
<b>For models:</b>	
	
1	
<b>GEV No.</b>	691730
<b>Ref. No.</b>	33Q0510
<b>description</b>	knurled nut thread M10x1.5 ø 36mm H 3.5mm stainless steel
<b>For models:</b>	

	
1	
<b>GEV No.</b>	510183
<b>Ref. No.</b>	33T0270
<b>description</b>	opposite support for rinse jet



	
1	
<b>GEV No.</b>	505502
<b>Ref. No.</b>	36D0720
<b>description</b>	rinse arm shaft
<b>For models:</b>	L100, L40, L40S, L60, L80

	
1	
<b>GEV No.</b>	510181
<b>Ref. No.</b>	33T0280
<b>description</b>	opposite support for wash jet

	
1	
<b>GEV No.</b>	517332
<b>Ref. No.</b>	33Q0420
<b>description</b>	rinse arm shaft
<b>For models:</b>	L100, L40, L60, L80

	
1	
<b>GEV No.</b>	532536
<b>Ref. No.</b>	3152400
<b>description</b>	O-ring for rinse jet
<b>For models:</b>	C207D-VERS.2006, C207S-VERS.2006, C207VD-VERS.2006, C207VS-VERS.2006, C304AD-VERS.2006, C304AS-VERS.2006, C304AVD-VERS.2006, C304AVS-VERS.2006, C304D-VERS.2006, C304S-VERS.2006, C304VD-VERS.2006, C304VS-VERS.2006, C92D-VERS.2006, C92S-VERS.2006, C92VD-VERS.2006, C92VS-VERS.2006, CS243D-VERS.2006, CS243S-VERS.2006, CS243VD-VERS.2006, CS243VS-VERS.2006, CS370AD-VERS.2006, CS370AS-VERS.2006, CS370AVD-VERS.2006, CS370AVS-VERS.2006, CS370D-VERS.2006, CS370S-VERS.2006, CS370VD-VERS.2006, CS370VS-VERS.2006, CS466AD-VERS.2006, CS466AS-VERS.2006, CS466AVD-VERS.2006, CS466AVS-VERS.2006, CS466D-VERS.2006, CS466S-VERS.2006, CS466VD-VERS.2006, CS466VS-VERS.2006, LC100, LC100-VERS.2001, LC130, LC130-VERS.2001, LC80, LF50, LF50E, LF50EM, LF50EMPS

	
1	
<b>GEV No.</b>	510626
<b>Ref. No.</b>	33T1120 33T1121
<b>description</b>	rinse jet ø 0.7/1.5mm thread 1/8" ET
<b>For models:</b>	L100, L40, L40S, L60, L80

	
1	
<b>GEV No.</b>	505516
<b>Ref. No.</b>	30Z0240 6001920
<b>description</b>	rinse arm L 495mm nozzles 4 complete
<b>For models:</b>	L100, L40, L40S, L60, L80
<b>spare parts for</b>	505516
	<b>GEV No.</b> 505502 <b>Ref. No.</b> 36D0720
	rinse arm shaft
	<b>GEV No.</b> 510626 <b>Ref. No.</b> 33T1120 33T1121
	rinse jet ø 0.7/1.5mm thread 1/8" ET

	
1	
<b>GEV No.</b>	519201
<b>Ref. No.</b>	36G9080
<b>description</b>	rinse pipe
<b>For models:</b>	LC80, LF50

Зип Общепит



vsezip.ru



7(812)987 08 81

			
1			
<b>GEV No.</b>	517333	<b>Ref. No.</b>	33Q5070
<b>description</b>	sleeve thread M16x1 ø 25mm stainless steel		
<b>For models:</b>	L40, L40S, L60		

			
1			
<b>GEV No.</b>	505510	<b>Ref. No.</b>	33Q1400
<b>description</b>	wash arm boss		

			
1			
<b>GEV No.</b>	519085	<b>Ref. No.</b>	33Q3710
<b>description</b>	Thumb screw ø 34mm thread M6		
<b>For models:</b>	LC100, LC100-VERS.2001, LC130, LC130-VERS.2001, LC80, LF50, LF50E, LF50EM, LF50EMPS, LF50EMPS-VERS.122012, LF50EM-VERS.122012, LF50E-VERS.122012, LF50E-VERS.2007, LP124, LP124V, LP84, LP84V		

			
1			
<b>GEV No.</b>	511911	<b>Ref. No.</b>	36D7750
<b>description</b>	wash arm support		
<b>accessories for</b>	511911		
	<b>GEV No.</b>	510884	<b>Ref. No.</b>
			—
	gasket		

			
1			
<b>GEV No.</b>	524804	<b>Ref. No.</b>	3036730
<b>description</b>	Thumb screw thread M5 thread L 7mm ø 30mm H 5mm SS Qty 1 pcs		
<b>For models:</b>	KD100, KD100A, KD100PSD, KD130, KD130A, KD130E, KD130EAT, KD40EPSD, KD40LEPS, KD40LUXE, KD60, KD60E, KD60EAT, KD60M, KD60MA, KD60ME, KD60MPS, KD60MPSA, KD60PS, KD60PSD, KD6E-ATSD, KD85, KD85A, KD85E, KD85EA, KD85EAT, KD85EATS, KD85EPS, KD85EPSA, KD85PS, KD85PSA, KN1100, KN1100SD, KN11PSDD, KN80, KN80PS, LP151, LP202, LP202HC, LP302, LP302HC, LP402, LP402HC, LP402V, LP70		
<b>accessories for</b>	524804		
	<b>GEV No.</b>	505277	<b>Ref. No.</b>
			3036720 33q6400
	rinse arm shaft warewashing ø 14mm H 38mm thread 1/4"		

			
1			
<b>GEV No.</b>	511912	<b>Ref. No.</b>	33M0820
<b>description</b>	wash arm support		
<b>accessories for</b>	511912		
	<b>GEV No.</b>	510884	<b>Ref. No.</b>
			—
	gasket		

			
1			
<b>GEV No.</b>	510338	<b>Ref. No.</b>	N/A
<b>description</b>	union nut dosing pump thread 1/2" ø 32mm H 15mm for dosing pump		

			
1			
<b>GEV No.</b>	511561	<b>Ref. No.</b>	3021590
<b>description</b>	wash arm support mounting pos. lower H 103mm		
<b>For models:</b>	KD40		

			
1			
<b>GEV No.</b>	505507	<b>Ref. No.</b>	33Q1380
<b>description</b>	wash arm bearing		

			
1			
<b>GEV No.</b>	504779	<b>Ref. No.</b>	33Q3380
<b>description</b>	wash arm support ø 43mm H 36.5mm M4		
<b>For models:</b>	L100, L40, L40S, L60, L80		



Зип Общепит  
vsezip.ru  
17(812)987-08-81



1

<b>GEV No.</b>	519388	<b>Ref. No.</b>	33T0970
<b>description</b>	wash jet		



1

<b>GEV No.</b>	519389	<b>Ref. No.</b>	33T0260
<b>description</b>	wash jet		



1

<b>GEV No.</b>	110117	<b>Ref. No.</b>	36M0750
<b>description</b>	knob energy regulator 1-3 t.max.°C ø 60mm shaft ø 6x4.6mm shaft flat upper black		
<b>spare parts for</b>	110117		
	<b>GEV No.</b>	112495	<b>Ref. No.</b> —
	knob spring L 10.5mm W 8.5mm Qty 1 pcs		

for vacuum packers

PTFE tapes



1

<b>GEV No.</b>	692155	<b>Ref. No.</b>	304184
<b>description</b>	PTFE tape W 50mm Qty 1m		



1

<b>GEV No.</b>	110111	<b>Ref. No.</b>	36M0590
<b>description</b>	knob switch 5-position ø 60mm shaft ø 6x4.6mm shaft flat upper black		



1

<b>GEV No.</b>	110116	<b>Ref. No.</b>	3110114 3110117
<b>description</b>	knob thermostat t.max. 110°C ø 60mm shaft ø 6x4.6mm shaft flat upper black temperature range 30-110°C rotation 270°		

knobs

universal knobs



1

<b>GEV No.</b>	111934	<b>Ref. No.</b>	36M0700
<b>description</b>	knob thermostat t.max. 90°C ø 50mm shaft ø 6x4.6mm shaft flat upper black temperature range 30-90°C rotation 270°		
<b>For models:</b>	L100, L40, L40S, L60, L80		
<b>accessories for</b>	111934		
	<b>GEV No.</b>	110135	<b>Ref. No.</b> —
	rosette knob up to ø 52mm		



1

<b>GEV No.</b>	110114	<b>Ref. No.</b>	36M0610
<b>description</b>	knob thermostat t.max. 300°C ø 60mm shaft ø 6x4.6mm shaft flat upper black temperature range 50-300°C rotation 270°		

producer-specific knobs

ANGELO PO



<b>GEV No.</b>	110899	<b>Ref. No.</b>	6300489
<b>description</b>	knob gas tap with ignition flame t.max.°C°C ø 77mm shaft ø 10x9mm shaft flat upper red		
<b>For models:</b>	0A0FAS, 0A0FAVA, 0A0GRG, 0A1CP1G, 0B0FAS, 0B1CP1G, 0D0FAS, 0D0FAVA, 0D0GRG, 0D1CP1G, 1A0FA2, 1A0FA5, 1A0FAB, 1A0FAS, 1A0FAS2, 1A0GRG, 1A0TP0, 1A1CP1G, 1A1CP2G, 1A1FA2G, 1A1FASG, 1A1FABG, 1A1FAS2G, 1A1FASG, 1A1PD1G, 1A1PD2G, 1A1PI1G, 1A1PI1GA, 1A1TP0G, 1A1TP0G-VERS.2002, 1B0FAS, 1B0FAS2, 1B0TP0, 1B1FAS2G, 1B1FASG, 1D0FA2, 1D0FA5, 1D0FAB, 1D0FAS, 1D0FAS2, 1D0GRG, 1D0TP0, 1D1CP1G, 1D1CP2G, 1D1FA2G, 1D1FA5G, 1D1FABG, 1D1FAS2G, 1D1FASG, 1D1PD1G...(Other models you can see in the webshop)		



<b>GEV No.</b>	112192	<b>Ref. No.</b>	6300518 6300521
<b>description</b>	knob gas tap with ignition flame t.max.°C°C ø 77mm shaft ø 8x6.5mm shaft flat upper red		
<b>For models:</b>	0A0FA1, 0A0FA4, 0A0FAA, 0D0FA1, 0D0FA4, 0D0FAA, 0G0FA0, 0G1CP1G, 0G1CP1G-VERS.2004, 1A0FA1, 1A0FA2, 1A0FA4, 1A0FA5, 1A0FAA, 1A0FAB, 1A1FA1G, 1A1FA2G, 1A1FA4G, 1A1FA5G, 1A1FAAG, 1A1FABG, 1D0FA1, 1D0FA2, 1D0FA4, 1D0FA5, 1D0FAA, 1D0FAB, 1D1FA1G, 1D1FA2G, 1D1FA4G, 1D1FA5G, 1D1FAAG, 1D1FABG, 1G0FA0, 1G0GRG, 1G0TP0, 1G1CP1G, 1G1CP1G-VERS.2004, 1G1CP2G, 1G1CP2G-VERS.2004, 1G1FA0E, 1G1FA0EV, 1G1FA0G, 1G1FA0GV, 1G1FAPG, 1G1TP0G, 2A0FA1, 2A0FA4, 2A0FAA, 2A1FA1G...(Other models you can see in the webshop)		



<b>GEV No.</b>	110924	<b>Ref. No.</b>	6300486
<b>description</b>	knob gas thermostat t.max. 100°C 30-100°C ø 77mm shaft ø 8x6.5mm shaft flat upper red		
<b>For models:</b>	0A0BMG, 0D0BMG, 1A0BMG, 1D0BMG		



<b>GEV No.</b>	112191	<b>Ref. No.</b>	6300504
<b>description</b>	knob gas thermostat t.max. 280°C 100-280°C shaft ø 10x9mm shaft flat upper red		
<b>For models:</b>	0A0FT4G, 0A0FT5G, 0B0FT1G, 0B0FT2G, 0B0FT4G, 0B0FT5G, 0D0FT4G, 0D0FT5G, 0G0FT4G, 0G0FT5G, 1A0FT4G, 1A0FT6G, 1B0FT4G, 1B0FT6G, 1D0FT4G, 1D0FT6G, 1G0FT4G, 1G0FT6G		



<b>GEV No.</b>	112187	<b>Ref. No.</b>	6300488
<b>description</b>	knob gas thermostat t.max. 280°C 100-280°C shaft ø 8x6.5mm shaft flat upper red		
<b>For models:</b>	0A0FT1G, 0A0FT2G, 0A0FT4G, 0A0FT5G, 0D0FT1G, 0D0FT2G, 0D0FT4G, 0D0FT5G, 0G1BR3G, 1A0FT1G, 1A0FT2G, 1A0FT3G, 1A0FT4G, 1A0FT6G, 1D0FT1G, 1D0FT2G, 1D0FT3G, 1D0FT4G, 1D0FT6G, 1G1BR3G		



<b>GEV No.</b>	112186	<b>Ref. No.</b>	6300553
<b>description</b>	knob gas thermostat t.max. 280°C 160-280°C shaft ø 8x6.5mm shaft flat upper red		
<b>For models:</b>	1G1FA0G, 1G1FA0GV, 1G1FAPG, 1G1TP0G, 2G1FA0G, 2G1FA0GV, 2G1FADG, 2G1FADGV, 2G1FAPG, 2G1TP3G, G1FAGS, G1FAGST		



<b>GEV No.</b>	112710	<b>Ref. No.</b>	6300510
<b>description</b>	knob gas thermostat t.max. 300°C 100-300°C ø 79mm shaft ø 8x6.5mm shaft flat upper black/red		
<b>For models:</b>	1A1FA1G, 1A1FA2G, 1A1FA4G, 1A1FA5G, 1A1FAAG, 1A1FABG, 1A1TP0G-VERS.2002, 1B1FAS2G, 1B1FASG, 1D1FA1G, 1D1FA2G, 1D1FA4G, 1D1FA5G, 1D1FAAG, 1D1FABG, 1D1TP0G-VERS.2002, 2A1FA1G, 2A1FA4G, 2A1FAAG, 2A1TP3G, 2A1TP6G, 2A1TPCG, 2D1FA1G, 2D1FA4G, 2D1FAAG, 2D1TP3G, 2D1TP6G, 2D1TPCG, 3A1FA1G, 3A1FA4G, 3A1FAAG, 3D1FA1G, 3D1FA4G, 3D1FAAG		

Зип Общепит

vsezip.ru

+7(812)987-08-81



Зип Общепит

vsezip.ru

+7(812)987-08-81

1



<b>GEV No.</b>	112189	<b>Ref. No.</b>	6300563
<b>description</b>	knob gas thermostat t.max. 340°C 160-340°C shaft ø 10x9mm shaft flat upper red		
<b>For models:</b>	0A0FT1G, 0A0FT2G, 0D0FT1G, 0D0FT2G, 0G0FT1G, 0G0FT2G, 1A0FT1G, 1A0FT2G, 1A0FT3G, 1B0FT1G, 1B0FT2G, 1B0FT3G, 1D0FT1G, 1D0FT2G, 1D0FT3G, 1G0FT1G, 1G0FT2G, 1G0FT3G		

1



<b>GEV No.</b>	112188	<b>Ref. No.</b>	6300556
<b>description</b>	knob switch 7-position t.max. °C°C shaft ø 6x4.6mm shaft flat upper red		
<b>For models:</b>	0G0PE1, 0G0PE2, 0G1PE2, 1G0PE1, 1G0PE2, 1G1PE1E, 1G1PE1EV, 1G1PE2, 1G1PE2E, 1G1PE2EV, 2G0PE1, 2G0PE2, 2G1PE1E, 2G1PE1EV, 2G1PE2E, 2G1PE2EV		
<b>spare parts for</b>	112188		
	<b>GEV No.</b>	550965	<b>Ref. No.</b> 3170290
	knob spring ø 6x4.6mm Qty 1 pcs		

1



<b>GEV No.</b>	110927	<b>Ref. No.</b>	6300481
<b>description</b>	knob switch 0-1-0-1 t.max. °C°C ø 77mm shaft ø 6x4.6mm shaft flat upper red		
<b>For models:</b>	0A1FR1ED, 0A1FR1GD, 0A1FR1GD-VERS.2004, 0B1FR1GD, 0D1FR1ED, 0D1FR1GD, 0D1FR1GD-VERS.2004, 0G0FR3ED, 0G1FR3GD, 1A1FR2ED, 1A1FR2GD, 1A1FR2GD-VERS.2004, 1A1PI2G, 1A1PI2GA, 1D1FR2ED, 1D1FR2GD, 1D1FR2GD-VERS.2004, 1D1PI2G, 1D1PI2GA, 1G1FR4GD		

1



<b>GEV No.</b>	110926	<b>Ref. No.</b>	6300480
<b>description</b>	knob thermostat t.max. 190°C 110-190°C shaft ø 6x4.6mm shaft flat upper red temperature range 110-190°C		
<b>For models:</b>	0A1FR1E, 0A1FR1G, 0A1FR1G-VERS.2004, 0A1FR3E, 0A1FR3ED, 0A1FR3G, 0A1FR3GD, 0B1FR1G, 0D1FR1E, 0D1FR1G, 0D1FR1G-VERS.2004, 0D1FR3E, 0D1FR3ED, 0D1FR3G, 0D1FR3GD, 0G0FR3E, 0G1FR3G, 1A1FR2E, 1A1FR2G, 1A1FR2G-VERS.2004, 1A1FR4E, 1A1FR4ED, 1A1FR4G, 1A1FR4GD, 1D1FR2G, 1D1FR2G-VERS.2004, 1D1FR4E, 1D1FR4ED, 1D1FR4G, 1D1FR4GD, 1G0FR4E, 1G1FR4G		

1



<b>GEV No.</b>	110908	<b>Ref. No.</b>	6300485
<b>description</b>	knob switch 5-position t.max. °C°C ø 77mm shaft ø 6x4.6mm shaft flat upper red		
<b>For models:</b>	0A0PE4, 0A1CP1E, 0D0PE4, 0D1CP1E, 0G1CP1E, 0G1CP1E-VERS.2004, 1A0PE4, 1A1PE4E, 1A1PEFTE, 1A1PI2E, 1A1PI2EA, 1D0PE4, 1D1PE4E, 1D1PI2E, 1D1PI2EA, 1G1PI1E		

1



<b>GEV No.</b>	110923	<b>Ref. No.</b>	6300492
<b>description</b>	knob thermostat t.max. 270°C 100-270°C shaft ø 6x4.6mm shaft flat upper red rotation 270°		
<b>For models:</b>	0A0FT1E, 0A0FT2E, 0A0FT4E, 0A0FT5E, 0D0FT1E, 0D0FT2E, 0D0FT4E, 0D0FT5E, 0G0FT1E, 0G0FT2E, 0G0FT4E, 0G0FT5E, 0G1FT2E, 0G1FT4E, 1A0FT1E, 1A0FT2E, 1A0FT3E, 1A0FT4E, 1A0FT6E, 1D0FT1E, 1D0FT2E, 1D0FT3E, 1D0FT4E, 1D0FT6E, 1G0FT1E, 1G0FT2E, 1G0FT3E, 1G0FT4E, 1G1FT2E, 1G1FT4E, 1G1FT6E		

1



<b>GEV No.</b>	112275	<b>Ref. No.</b>	6300522
<b>description</b>	knob switch 7-position t.max. °C°C ø 84mm shaft ø 6x4.6mm shaft flat upper red		
<b>For models:</b>	60SME		

1



<b>GEV No.</b>	112190	<b>Ref. No.</b>	6300554
<b>description</b>	knob thermostat t.max. 300°C 80-300°C shaft ø 6x4.6mm shaft flat upper red		
<b>For models:</b>	1G1FA0E, 1G1FA0EV, 1G1PE1E, 1G1PE1EV, 1G1PE2E, 1G1PE2EV, 2G1PE1E, 2G1PE1EV, 2G1PE2E, 2G1PE2EV		

Зип Общепит

vsezip.ru

+7(812)987-08-81



1

<b>GEV No.</b>	110934	<b>Ref. No.</b>	6300493
<b>description</b>	knob energy regulators 1-8 t.max.°C°C shaft ø 6x4.6mm shaft flat upper red		
<b>For models:</b>	OG1BR3E, 1A1BR1E, 1A1BR2E, 1A1BR2EA, 1D1BR1E, 1D1BR2E, 1D1BR2EA, 1G1BR3E, 2A1BR1E, 2A1BR2E, 2A1BR2EA, 2A1PI3E, 2D1BR1E, 2D1BR2E, 2D1BR2EA		



1

<b>GEV No.</b>	110919	<b>Ref. no.</b>	6300483
<b>description</b>	knob thermostat t.max. 300°C 100-300°C ø 65mm shaft ø 6x4.6mm shaft flat upper red		
<b>For models:</b>	0M0FT1E, 0M0FT2E, 0M0FT4E, 0M0FT5E, 1A1PE4E, 1A1PEFTE, 1A1FBE, 1D1PE4E, 1D1FBE, 1M0FT1E, 1M0FT2E, 1M0FT3E, 1M0FT4E, 1M0FT5E, 1M0FT6E, 2M0FT1E, 2M0FT2E, 2M0FT3E, 2M0FT4E, 2M0FT5E, 2M0FT6E		



1

<b>GEV No.</b>	110909	<b>Ref. No.</b>	6300487
<b>description</b>	knob gas thermostat t.max. 300°C 100-300°C shaft ø 8x6.5mm shaft flat upper		
<b>For models:</b>	1A1FAS2G, 1A1FASG, 1A1TP0G, 1D1FAS2G, 1D1FASG, 1D1TP0G, 2A1FAS2G, 2A1FASG, 2A1TPSG, 2D1FAS2G, 2D1FASG, 2D1TPSG, 3A1FASG, 3D1FASG		



1

<b>GEV No.</b>	112193	<b>Ref. No.</b>	6300490
<b>description</b>	knob dial plate gas valves t.max.°C°C ø 65mm shaft ø 8x6.5mm shaft flat upper NOVASIT		
<b>For models:</b>	1A1BR1G, 1A1BR1GA, 1A1BR2G, 1A1BR2GA, 1D1BR1G, 1D1BR1GA, 1D1BR2G, 1D1BR2GA, 2A1BR1G, 2A1BR1GA, 2A1BR2G, 2A1BR2GA, 2D1BR1G, 2D1BR1GA, 2D1BR2G, 2D1BR2GA		



1

<b>GEV No.</b>	110922	<b>Ref. No.</b>	6300484
<b>description</b>	knob switch 4-position t.max.°C°C ø 65mm shaft ø 6x4.6mm shaft flat upper red		
<b>For models:</b>	1A1PE4E, 1A1PEFTE, 1A1FBE, 1D1PE4E, 1D1FBE		



1

<b>GEV No.</b>	112798	<b>Ref. No.</b>	3015731
<b>description</b>	knob gas tap with ignition flame t.max.°C°C ø 72mm shaft ø 10x8mm shaft flat upper red		
<b>For models:</b>	06WCP1GM, 08WCP1GM, 08WGRGV, 090FAVA, 090GRG, 091CP1G, 10CP1GA, 10WTPGE, 10WTPGV, 190FAB, 190GRG, 190TP0, 191CP1G, 191CP2G, 191FABG, 191PD1G, 191PD2G, 191PI1G, 191PI1GA, 191PI2G, 191PI2GA, 191TPG, 1G1PD1G, 1G1PI1G, 291PD3G, 291PI3G, 291TPCG		



1

<b>GEV No.</b>	110933	<b>Ref. No.</b>	6300491
<b>description</b>	knob thermostat t.max. 270°C 100-270°C shaft ø 6x4.6mm shaft flat upper red temperature range 100-270°C		
<b>For models:</b>	OG1BR3E, 1A1BR1E, 1A1BR1G, 1A1BR1GA, 1A1BR2E, 1A1BR2EA, 1A1BR2G, 1A1BR2GA, 1D1BR1E, 1D1BR1G, 1D1BR1GA, 1D1BR2E, 1D1BR2EA, 1D1BR2G, 1D1BR2GA, 1G1BR1E, 1G1BR3E, 2A1BR1E, 2A1BR1G, 2A1BR1GA, 2A1BR2E, 2A1BR2EA, 2A1BR2G, 2A1BR2GA, 2D1BR1E, 2D1BR1G, 2D1BR1GA, 2D1BR2E, 2D1BR2EA, 2D1BR2G, 2D1BR2GA		



1

<b>GEV No.</b>	112636	<b>Ref. No.</b>	3013170 3013171
<b>description</b>	knob gas tap with ignition flame t.max.°C°C ø 72mm shaft ø 8x6.5mm shaft flat upper red		
<b>For models:</b>	04WFAAV, 08WFA4E, 08WFA4G, 08WFAAE, 08WFAAG, 08WFAAV, 090FAA, 0G0FA0, 0G1CP1G-VERS.2004, 10WTPGE, 12WFA6E, 12WFA6G, 12WFAAA, 12WFAAE, 12WFAAG, 12WFAAN, 190FA, 190FAA, 190FAB, 190FAD, 191FAAE, 191FAAG, 191FABG, 191FADG, 191FAE, 191FAG, 1G0FA0, 1G0FA0B, 1G0GRG, 1G0TP0, 1G1CP1G-VERS.2004, 1G1CP2G-VERS.2004, 1G1FA0E, 1G1FA0EV, 1G1FA0G, 1G1FA0GV, 1G1FABG, 1G1FAPG, 1G1TP0G, 290FA, 291FAG, 291FAGF, 291TPCG, 2G0FA0, 2G0FA0A, 2G0FA0B, 2G1FA0E, 2G1FA0G, 2G1FA0GV, 2G1FABG...(Other models you can see in the webshop)		







Зип Общепит

vsezip.ru

+7(812)987-08-81

			
1			
<b>GEV No.</b>	112774	<b>Ref. No.</b>	3144110
<b>description</b>	knob gas thermostat t.max. 250°C 100-250°C ø 72mm shaft ø 8x6.5mm shaft flat upper red		
<b>For models:</b>	0G0FT1G-VERS.032008, 0G0FT2G-VERS.032008, 0G0FT4G-VERS.032008, 0G0FT5G-VERS.032008, 0G0FT7G, 1G0FT1G-VERS.032008, 1G0FT2G-VERS.032008, 1G0FT3G-VERS.032008, 1G0FT4G-VERS.032008, 1G0FT6E, 1G0FT6G-VERS.032008, 1G0FT7G		

			
1			
<b>GEV No.</b>	112638	<b>Ref. No.</b>	3020250 3020251
<b>description</b>	knob switch 4-position t.max.°C ø 72mm shaft ø 6x4.6mm shaft flat upper red		
<b>For models:</b>	08WFA4E, 08WFAAE, 10WTPGE, 12WFA6E, 12WFAAE, 191FAAE, 191FAE, 191PE4E		

			
1			
<b>GEV No.</b>	112641	<b>Ref. No.</b>	3010330 3010331
<b>description</b>	knob gas thermostat t.max. 270°C 140-270°C ø 72mm shaft ø 8x6.5mm shaft flat upper red		
<b>For models:</b>	08WFA4G, 08WFAAG, 08WFT1GV, 08WFT2GV, 08WFT3GV, 08WFT4GV, 08WFT6GV, 08WFT7GV, 090FT1G, 090FT2G, 090FT4G, 090FT5G, 090FT7G, 12WFA6G, 12WFAAG, 190FT15G, 190FT1G, 190FT2G, 190FT3G, 190FT42G, 190FT4G, 190FT6G, 190FT72G, 190FT7G, 191FAAG, 191FABG, 191FADG, 191FAG, 191TPG, 1G1BR1G, 291FAG, 291FAGF, 291TPCG, 391FAG		

			
1			
<b>GEV No.</b>	112634	<b>Ref. No.</b>	3015940 3015941
<b>description</b>	knob switch 5-position t.max.°C ø 72mm shaft ø 6x4.6mm shaft flat upper red		
<b>For models:</b>	04WPE4V, 08WPE4V, 090PE4, 0G1CP1E-VERS.2004, 190PE4, 191PE4E, 191PI2E, 191PI2EA, 1G1PI1E		

			
1			
<b>GEV No.</b>	112643	<b>Ref. No.</b>	3015990 3015991
<b>description</b>	knob switch 0-10 t.max.°C ø 72mm shaft ø 6x4.6mm shaft flat upper		
<b>For models:</b>	04WVT1V, 04WVT1IV-VERS.022010, 04WVT2IV, 04WVT2IV-VERS.022010, 08WVT1IV, 08WVT1IV-VERS.112009, 08WVT2IV, 08WVT2IV-VERS.112009, 090VT1I, 090VT1I-VERS.112010, 090VT1W, 090VT1W-VERS.102008, 091VT1I, 091VT1I-VERS.2009, 091VT1W, 091VT2I, 091VT2I-VERS.2009, 0G0VT1I, 0G0VT1I-VERS.112010, 0G0VT1IW, 190VT1I, 190VT1I-VERS.112010, 191VT1I, 191VT1I-VERS.2009, 191VT2I, 191VT2I-VERS.2009, 1G0VT1I, 1G0VT1I-VERS.122010		

			
1			
<b>GEV No.</b>	112635	<b>Ref. No.</b>	3015831
<b>description</b>	knob thermostat t.max. 190°C 110-190°C ø 72mm shaft ø 6x4.6mm shaft flat upper red		
<b>For models:</b>	091FR1E, 091FR1G, 091FR1I, 091FR1I-VERS.032012, 091FR3E, 091FR3G, 091FR7G, 091FR7G-VERS.052012, 0G0FR3E, 0G1FR3G, 191FR2E, 191FR2G, 191FR2I, 191FR2I-VERS.032012, 191FR4E, 191FR4G, 1G0FR4E, 1G1FR4G		

			
1			
<b>GEV No.</b>	112640	<b>Ref. No.</b>	3015850 3015851
<b>description</b>	knob switch 0-1-0-1 t.max.°C ø 72mm shaft ø 6x4.6mm shaft flat upper red		
<b>For models:</b>	04WFR3ED, 06WFR3GD, 08WFR4ED, 08WGREV, 091FR1ED, 091FR1GD, 091FR3ED, 091FR3GD, 0G0FR3ED, 0G1FR3GD, 10WFR4GD, 190GRE, 191FR2ED, 191FR2GD, 191FR4ED, 191FR4GD, 1G0GRE, 1G1FR4GD, 291PI3G, 2A1PI3G, 2D1PI3G		

			
1			
<b>GEV No.</b>	112797	<b>Ref. No.</b>	3015870 3015871
<b>description</b>	knob thermostat t.max. 270°C 110-270°C ø 72mm shaft ø 6x4.6mm shaft flat upper red		
<b>For models:</b>	06WBR3E, 06WFT1EV, 06WFT2EV, 06WFT3EV, 06WFT4EV, 06WFT6EV, 06WFT7EV, 08WFT1EV, 08WFT2EV, 08WFT3EV, 08WFT4EV, 08WFT6EV, 08WFT7EV, 090FT1E, 090FT2E, 090FT4E, 090FT5E, 090FT7E, 091FT1E, 091FT2E, 091FT4E, 091FT5E, 091FT7E, 0G0FT1E, 0G0FT2E, 0G0FT4E, 0G0FT5E, 0G0FT7E, 0G1BR3E, 0G1FT2E, 0G1FT4E, 0G1FT5E, 0G1FT7E, 190FT15E, 190FT1E, 190FT2E, 190FT3E, 190FT42E, 190FT4E, 190FT5E, 190FT6E, 190FT72E, 190FT7E, 191BR1E, 191BR1G, 191BR1GA, 191BR2E, 191BR2EA, 191BR2G, 191BR2GA...(Other models you can see in the webshop)		

Зип Общепит

vsezip.ru

+7(812)987-08-81



1

<b>GEV No.</b>	112639	<b>Ref. No.</b>	3015900 3015901
<b>description</b>	knob thermostat t.max. 300°C 100-300°C ø 72mm shaft ø 6x4.6mm shaft flat upper red		
<b>For models:</b>	08WFA4E, 08WFAAE, 10WTPGE, 12WFA6E, 12WFAAE, 191FAAE, 191FAE, 191PE4E		



1

<b>GEV No.</b>	110141	<b>Ref. No.</b>	36M3050
<b>description</b>	knob switch zero mark ø 67mm shaft ø 8x6.5mm shaft flat upper black		
<b>For models:</b>	030, 031, 032, 31, 31GE, 31TC, 32, 32TC, 32TP, 32TPV, 32V, 60SM		



1

<b>GEV No.</b>	112637	<b>Ref. No.</b>	3019901 3112000
<b>description</b>	knob water t.max.°C ø 72mm shaft ø 6x4.6mm shaft flat upper red		
<b>For models:</b>	04WCP1EM, 06WCP1GM, 08WCP1GM, 091CP1E, 091CP1G, 0G1CP1EC, 0G1CP1E-VERS.2004, 0G1CP1G-VERS.2004, 191CP1G, 191CP2G, 1G1CP1G-VERS.2004, 1G1CP2G-VERS.2004		



1

<b>GEV No.</b>	111745	<b>Ref. No.</b>	36M4970
<b>description</b>	knob switch zero mark ø 45mm shaft ø 6x4.6mm shaft flat upper blue/black		
<b>For models:</b>	FCV3EM, FCV4EM		



1

<b>GEV No.</b>	110140	<b>Ref. No.</b>	36M2390 36M5140
<b>description</b>	knob switch zero mark ø 67mm shaft ø 10x9mm shaft flat upper black		
<b>For models:</b>	030FT, 030FTR, 031FT, 031FTR, 031FTRL, 031TP, 070D, 070DGG, 070FT, 070FTR, 0712D, 0712VA, 071D, 071DGG, 071FT, 071FTR, 071FTRL, 071TP, 072D, 072DGG, 090, 090FT, 090FTR, 090GG, 091, 091FT, 091FTR, 091FTRL, 091GG, 091TP, 092, 092GG, 092VA, 092VAGG, 30CPS, 31, 31PD6, 31PI6, 31TC, 31TP, 32, 32TC, 32TP, 32TPV, 32V, 70CP, 712D, 712VA, 71CP, 71CP2...(Other models you can see in the webshop)		



1

<b>GEV No.</b>	110925	<b>Ref. No.</b>	36M4560
<b>description</b>	knob switch zero mark ø 45mm shaft ø 6x4.6mm shaft flat upper red		
<b>For models:</b>	030FE1B, 091FE28B, 30F1B, 30FES2B, 30FS2B, 70F1B, 70FE1B, 70FES2, 70FES2B, 71F2B, 71FE2B, 90F110B, 91AR, 91ARE, 91F210B, 91F223B, 91RA, FC101, FC101E, FC241, FC241E, FC241G, FC61, FC61E, FCV101, FCV101-CSA, FCV101E, FCV101E-UL, FCV141, FCV141-CSA, FCV141E, FCV241, FCV241E, FCV241E-UL, FCV241G, FCV241G-CSA, FCV61, FCV61-CSA, FCV61E, FCV61E-UL, FCV72E-UL		
<b>accessories for</b>	110925		
		<b>GEV No.</b>	550965
		<b>Ref. No.</b>	3170290
	knob spring ø 6x4.6mm Qty 1 pcs		



1

<b>GEV No.</b>	110142	<b>Ref. No.</b>	36M2400
<b>description</b>	knob switch zero mark ø 67mm shaft ø 6x4.6mm shaft flat upper black		
<b>For models:</b>	030BME, 030E, 030EBM, 030FE, 030FE1, 030FTE, 030FTE04, 030FTE06, 030FTE08, 031BME, 031E, 031EBM, 031FTE, 031FTE04, 031FTE06, 031FTE08, 031FTE08L, 070BME, 070E, 070FTE, 070FTE04, 070FTE05, 070FTE08, 071BME, 071E, 071FTE, 071FTE04, 071FTE06, 071FTE08, 071FTE08L, 30CPSE, 30F1, 30FES, 30FES2, 30FS2, 31GE, 31PIE6, 31TCE, 32TCE, 60SME, 70CPE, 70F1, 70FE, 70FE1, 70FES, 70FES2, 71E, 71F2, 71FE, 71FE2, 71PIE15, 71PIE15A		



1

<b>GEV No.</b>	112910	<b>Ref. No.</b>	36M5270
<b>description</b>	knob switch zero mark ø 45mm shaft ø 6x4.6mm shaft flat upper silver		



Зип Общепит

vsezip.ru

+7(812)987-08-81

 <p>1</p>			
<b>GEV No.</b>	110143	<b>Ref. No.</b>	36M0500
<b>description</b>	knob gas tap with ignition flame ø 65mm shaft ø 10x8mm shaft flat lower black		

 <p>1</p>			
<b>GEV No.</b>	112860	<b>Ref. No.</b>	3104143
<b>description</b>	knob ø 60mm shaft ø 6x9mm silver		

 <p>1</p>			
<b>GEV No.</b>	110292	<b>Ref. No.</b>	36M2800
<b>description</b>	cover cap switch zero mark t.max.°C ø 32mm shaft ø 6mm shaft flat red knob		
<b>For models:</b>	031FT04, 031FT06, 070BM, 070FT04, 070FT05, 071BM, 071FT04, 071FT06, 090BM, 090FT04, 090FT05, 091BM, 091FT04, 091FT06, 30F, 30FS, 31R, 31RE, 70F, 712D, 712VA, 71AR, 71ARE, 71D, 71DGG, 71E, 71F, 71GE, 71GEGG, 71RA, 71TP, 72D, 72DGG, 72TP, 72TPGG, 72VA, 72VAGG, 72VAS, 72VASGG, 73D, 73DGG, 73VA, 73VAD, 73VADGG, 73VAGG, A12A1E, A12B1E, A12B2E, A12M1E, A12Z1E...(Other models you can see in the webshop)		

 <p>1</p>			
<b>GEV No.</b>	112570	<b>Ref. No.</b>	36H0900 36H0901
<b>description</b>	knob potentiometer ø 62mm shaft ø 6x4.6mm shaft flat universal black		
<b>For models:</b>	FM1011E1, FM1011E1-VERS.2006, FM1011E2, FM1011E2-VERS.2006, FM1011E3, FM1011E3-VERS.2006, FM1011G1, FM1011G1-VERS.2006, FM1011G2, FM1011G2-VERS.2006, FM1011G3, FM1011G3-VERS.2006, FM1221E1, FM1221E1-VERS.2006, FM1221E2, FM1221E2-VERS.2006, FM1221E3, FM1221E3-VERS.2006, FM1221G1, FM1221G1-VERS.2006, FM1221G2, FM1221G2-VERS.2006, FM1221G3, FM1221G3-VERS.2006, FM2011E2-VERS.2006, FM2011E3-VERS.2006, FM2011G2-VERS.2006, FM2011G3-VERS.2006, FM2021E1, FM2021E2, FM2021E2-VERS.2006, FM2021E3, FM2021E3-VERS.2006, FM2021G1, FM2021G2, FM2021G2-VERS.2006, FM2021G3, FM2021G3-VERS.2006, FM423E1, FM423E2, FM611E1, FM611E1-VERS.2006, FM611E2, FM611E2-VERS.2006, FM611E3, FM611E3-VERS.2006, FM611G1, FM611G1-VERS.2006, FM611G2, FM611G2-VERS.2006...(Other models you can see in the webshop)		

 <p>1</p>			
<b>GEV No.</b>	110293	<b>Ref. No.</b>	36M2580
<b>description</b>	knob gas regulator t.max.°C ø 44mm shaft ø Minisitmm black		
<b>For models:</b>	031FT04, 031FT06, 070BM, 070FT04, 070FT05, 071BM, 071FT04, 071FT06, 090BM, 090FT04, 090FT05, 091BM, 091FT04, 091FT06, 1G1BR1G, 30F, 30FS, 31R, 70F, 712D, 712VA, 71D, 71DGG, 71F, 71TP, 72D, 72DGG, 72TP, 72TPGG, 72VA, 72VAGG, 72VAS, 72VASGG, 73D, 73DGG, 73VA, 73VAD, 73VADGG, 73VAGG, F530		

 <p>1</p>			
<b>GEV No.</b>	111213	<b>Ref. No.</b>	36M1590 alt
<b>description</b>	knob switch zero mark ø 38mm shaft ø 6x4.6mm shaft flat lower black		

 <p>1</p>			
<b>GEV No.</b>	110294	<b>Ref. No.</b>	36M2620
<b>description</b>	knob t.max.°C ø 44mm shaft ø 8x5.5mm shaft flat universal black		
<b>For models:</b>	31RE, 71AR, 71ARE, 71E, 71GE, 71GEGG, 71RA, A12A1E, A12B1E, A12B2E, A12M1E, A12Z1E, A12Z2E, A14A1E, A14B1E, A14B2E, A14M1E, A14Z1E, A14Z2E, A16A1E, A16B1E, A16B2E, A16M1E, A16Z1E, A16Z2E, A18A1E, A18B1E, A18B2E, A18M1E, A18Z1E, A18Z2E, A20A1E, A20B1E, A20B2E, A20M1E, A20Z1E, A20Z2E, ACBM, ACBM218, ACPN, ACPN218, AJ12AE, AJ12ME, AJ14AE, AJ14ME, AJ16AE, AJ16ME, AJ18AE, AJ18ME, AJ20AE...(Other models you can see in the webshop)		

 <p>1</p>			
<b>GEV No.</b>	111215	<b>Ref. No.</b>	36M1511
<b>description</b>	knob switch zero mark ø 38mm shaft ø 6x4.6mm shaft flat upper black		
<b>For models:</b>	F60P, F60PR, F60T, F80P, F80PR, L100, L40, L40S, L45, L60, L80, SM-1LAM, SM1LM		

Зип.Общепит

gaskets

vsezip.ru

+7(812)987-08-81



1

GEV No.	111212	Ref. No.	36M1800
description	knob switch zero mark ø 40mm shaft ø 6x4.6mm shaft flat upper black		



1

GEV No.	111218	Ref. No.	36M4620
description	knob switch zero mark ø 44mm shaft ø 6x4.6mm shaft flat upper black		
For models:	K16APGPZ, K16XPZAP, SA16AGB, SA16GB, SI14VB, SI21VB		



1

GEV No.	110918	Ref. No.	36M4710
description	knob switch zero mark ø 45mm shaft ø 6x6mm black		
accessories for	110918		
		GEV No.	510923
		Ref. No.	—
	clamping ring for shaft ø 10mm ID ø 9.4mm H 6mm		

accessories

button springs



1

GEV No.	550965	Ref. No.	3170290
description	knob spring ø 6x4.6mm Qty 1 pcs		
For models:	030BME, 030E, 030EBM, 030FE, 030FE1, 030FE1B, 030FTE, 030FTER, 031BME, 031E, 031EBM, 031FTE, 031FTE04, 031FTE06, 031FTER, 031FTERL, 070BME, 070E, 070FTE, 070FTE04, 070FTE05, 070FTER, 071BME, 071E, 071FTE, 071FTE04, 071FTE06, 071FTER, 071FTERL, 090BME, 090E, 090FTE, 090FTE04, 090FTE05, 090FTER, 090SPE, 091BME, 091E, 091FE28, 091FE28B, 091FR1ED, 091FR3ED, 091FTE, 091FTE04, 091FTE06, 091FTER, 091FTERL, 0A0BME, 0A0FT1E, 0A0FT2E...(Other models you can see in the webshop)		

1

GEV No.	550493	Ref. No.	3150790
description	gasket for knob		
For models:	030E, 030EBM, 030FE1, 030FE1B, 030FTE, 030FTER, 031E, 031EBM, 031FTE04, 031FTE06, 04WCP1EM, 06WFR3GD, 070E, 070FTE04, 070FTE05, 071E, 071FTE04, 071FTE06, 08WCP1GM, 08WFAAE, 090, 090BM, 090BME, 090E, 090FT, 090FTE04, 090FTE05, 090FTR, 090GG, 091, 091BM, 091BME, 091CP1E, 091CP1G, 091E, 091FE28, 091FE28B, 091FR1E, 091FR1ED, 091FR1GD, 091FR3G, 091FR3GD, 091FT, 091FTE04, 091FTE06, 091FTR, 091FTRL, 091GG, 091TP, 092...(Other models you can see in the webshop)		



1

GEV No.	101729	Ref. No.	3152250
description	gasket knob D1 ø 70mm D2 ø 7mm thickness 1mm equiv. no. 3152250 suitable for ANGELO PO		
For models:	04WFAAV, 06WCP1GM, 08WCP1GM, 08WFA4E, 08WFA4G, 08WFAAE, 08WFAAG, 08WFAAV, 08WFT1GV, 08WFT2GV, 08WFT3GV, 08WFT4GV, 08WFT6GV, 08WFT7GV, 08WGRGV, 090BM1G, 090FT1G, 090FT2G, 090FT4G, 090FT5G, 090FT7G, 090GRG, 091CP1G, 0A0BMG, 0A0FA1, 0A0FA4, 0A0FAA, 0A0FAS, 0A0FAVA, 0A0FT1G, 0A0FT2G, 0A0FT4G, 0A0FT5G, 0A0GRG, 0A1CP1G, 0B0FAS, 0B0FT1G, 0B0FT2G, 0B0FT4G, 0B0FT5G, 0B1CP1G, 0D0BMG, 0D0FA1, 0D0FA4, 0D0FAA, 0D0FAS, 0D0FAVA, 0D0FT1G, 0D0FT2G, 0D0FT4G...(Other models you can see in the webshop)		

handles and hand wheels

hand wheels

hand wheels



1

GEV No.	514026	Ref. No.	36M4910
description	hand wheel ø 160mm D1 ø 40mm bore ø 16mm thread M8 hole distance 9mm groove widthmm L1 22mm L2 50mm handle length 75mm with folding handle		
For models:	1G1BR1E, 1G1BR1G, 31R, 31RE		
accessories for	514026		
		GEV No.	560224
		Ref. No.	31W0020
	grub screw thread M8 L 10mm WS 4 Qty 1 pcs		



Зип Общежит  
cone handles

vsezip.ru

+7(812)987-08-81



1

<b>GEV No.</b>	694634	<b>Ref. No.</b>	3214440 3342840
<b>description</b>	hand wheel ø 200mm D1 ø 48mm bore ø 16mm depth of bore 34mm thread groove widthmm L1 29mm L2 55mm handle length 80mm with folding handle plastic		
<b>For models:</b>	191BR1E, 191BR1G, 191BR2E, 191BR2G, 1A1BR1E, 1A1BR1G, 1A1BR2E, 1A1BR2G, 1D1BR1E, 1D1BR1G, 1D1BR2E, 1D1BR2G, 291BR1E, 291BR1G, 291BR2E, 291BR2G, 2A1BR1E, 2A1BR1G, 2A1BR2E, 2A1BR2G, 2D1BR1E, 2D1BR1G, 2D1BR2E, 2D1BR2G		



1

<b>GEV No.</b>	690249	<b>Ref. No.</b>	36M5560 36M5561 36M5562
<b>description</b>	hand wheel ø 200mm D1 ø 48mm bore ø 20mm hole ø 7mm thread hole distance 11mm groove widthmm L1 30mm L2 60mm handle length 82mm with folding handle		
<b>For models:</b>	191BR1E, 191BR1G, 191BR2E, 191BR2G, 1A1BR1E, 1A1BR1G, 1A1BR2E, 1A1BR2G, 1D1BR1E, 1D1BR1G, 1D1BR2E, 1D1BR2G, 291BR1E, 291BR1G, 291BR2E, 291BR2G, 2A1BR1E, 2A1BR1G, 2A1BR2E, 2A1BR2G, 2D1BR1E, 2D1BR1G, 2D1BR2E, 2D1BR2G		
<b>spare parts for</b>	690249		
		<b>GEV No.</b>	514255 <b>Ref. No.</b> —
	folding handle ø 26mm total length 85mm seat ø 20mm shaft ømm thread M6 with pin L 85mm		

cylindrical handles

fixed



1

<b>GEV No.</b>	514065	<b>Ref. No.</b>	36M5750
<b>description</b>	cylindrical handle thread M12 ø 23mm L 65mm		
<b>For models:</b>	091FR1E, 091FR1EA, 091FR1ED, 0A1FR1E, 0A1FR1ED, 0D1FR1E, 0D1FR1ED, 191FR2E, 191FR2ED, 1A1FR2E, 1A1FR2ED, 1D1FR2ED		



1

<b>GEV No.</b>	G94633	<b>Ref. No.</b>	3000900
<b>description</b>	cone handle thread M8x1.25 ø 28mm plastic L 105mm black thread L 25mm		
<b>For models:</b>	08WGRGV, 090GRG, 0A0GRG, 0D0GRG, 190GRG, 191PD1G, 191PD2G, 191PI1G, 191PI1GA, 191PI2E, 191PI2EA, 191PI2G, 191PI2GA, 191PI2V, 191PI2VA, 1A0GRG, 1D0GRG, 1G0GRG		

handle bars

handle bars



1

<b>GEV No.</b>	691148	<b>Ref. No.</b>	36M4830
<b>description</b>	handle rod H 40mm L 450mm		



1

<b>GEV No.</b>	691149	<b>Ref. No.</b>	36M2441
<b>description</b>	handle rod H 40mm L 615mm		
<b>For models:</b>	712D, 712VA, 71D, 71DGG, 71E, 71GE, 71GEGG, 71TP, 72D, 72DGG, 72TP, 72TPGG, 72VA, 72VAGG, 72VAS, 72VASGG, 73D, 73DGG, 73VA, 73VAD, 73VADGG, 73VAGG, FS30, FS30E		

consoles



1

<b>GEV No.</b>	691135	<b>Ref. No.</b>	36M2910
<b>description</b>	console for door handle		
<b>For models:</b>	091T, 60SM, 60SME, 70CP, 70CPE, 70F, 70F1, 70F1B, 70FE, 70FE1, 70FE1B, 70FES, 70FES2, 70FES2B, 712D, 712VA, 71CP, 71CP2, 71D, 71DGG, 71E, 71F, 71F2, 71F2B, 71FE, 71FE2, 71FE2B, 71GE, 71GEGG, 71TP, 72D, 72DGG, 72TP, 72TPGG, 72VA, 72VAGG, 72VAS, 72VASGG, 73D, 73DGG, 73VA, 73VAD, 73VADGG, 73VAGG, 90CP, 90CPE, 91CP, 91F223B, FS30, FS30E		

Зип Общепит

vsezip.ru

+7(812)987-08-81

			
1			
<b>GEV No.</b>	690297	<b>Ref. No.</b>	36D0230
<b>description</b>	console Qty 1 pcs		

			
1			
<b>GEV No.</b>	690451	<b>Ref. No.</b>	36M4040
<b>description</b>	pull handle L 426mm H 40mm mounting distance 376mm black		
<b>For models:</b>	40EVP, 40PV, 40XPV, 55PV		

## handle rails

### ANGELO PO

			
1			
<b>GEV No.</b>	691153	<b>Ref. No.</b>	36M3590
<b>description</b>	handle rail hole distance 650mm		
<b>For models:</b>	31, 31GE, 31TC, 31TCE, 31TP, 32, 32TC, 32TCE, 32TP, 32TPV, 32V		

## covers

			
1			
<b>GEV No.</b>	691158	<b>Ref. No.</b>	3002970
<b>description</b>	cover for handle plastic		
<b>For models:</b>	PG22C, PG23CW		

## handle rails

			
1			
<b>GEV No.</b>	691153	<b>Ref. No.</b>	36M3590
<b>description</b>	handle rail hole distance 650mm		
<b>For models:</b>	31, 31GE, 31TC, 31TCE, 31TP, 32, 32TC, 32TCE, 32TP, 32TPV, 32V		

## fasteners

### locking screws

			
1			
<b>GEV No.</b>	514387	<b>Ref. No.</b>	36M0840
<b>description</b>	locking screw		
<b>accessories for</b>	514387		
	<b>GEV No.</b>	514386	<b>Ref. No.</b> 36M0830
	closing clamp for kettle		

## bracket handles

			
1			
<b>GEV No.</b>	692176	<b>Ref. No.</b>	3010570 3010571 3010572 3010573
<b>description</b>	pull handle L 295mm H 40mm mounting distance 255mm thread M5 chrome-plated		
<b>For models:</b>	04WBMEV, 04WCP1EM, 04WF AAV, 04WFR3ED, 04WPE4V, 04WPEBV, 04WVT1IV, 04WVT1IV-VERS.022010, 04WVT2IV, 04WVT2IV-VERS.022010, 04WVT3RV, 06WBR3E, 06WCP1GM, 06WFR3GD, 06WFT1EV, 06WFT2EV, 06WFT3EV, 06WFT4EV, 06WFT6EV, 06WFT7EV, 08WCP1GM, 08WF AAV, 08WFR4ED, 08WFT1EV, 08WFT1GV, 08WFT2EV, 08WFT2GV, 08WFT3EV, 08WFT3GV, 08WFT4EV, 08WFT4GV, 08WFT6EV, 08WFT6GV, 08WFT7EV, 08WFT7GV, 08WGRGV, 08WPE4V, 08WPEBV, 08WTPEV, 08WVT1IV, 08WVT1IV-VERS.112009, 08WVT2IV, 08WVT2IV-VERS.112009, 091CP1E, 091CP1G, 091FR1E, 091FR1EA, 091FR1ED, 091FR1EX, 091FR1G...(Other models you can see in the webshop)		

## miscellaneous

			
1			
<b>GEV No.</b>	110146	<b>Ref. No.</b>	36M1100
<b>description</b>	handle L 195mm W 65mm		



Зип Общепит  
vsezip.ru  
+7(812)987-08-81

			
1			
<b>GEV No.</b>	691193	<b>Ref. No.</b>	36M4640
<b>description</b>	handle thread M5		
<b>For models:</b>	BRPRV, BRVRV, SE14PRV, SE14VRV, S114PRV, S114VRV, SL14RPRV, SL14VRV, TPRV, TVRV		

			
1			
<b>GEV No.</b>	690662	<b>Ref. No.</b>	36M0140 36M5020
<b>description</b>	key cylinder with slide latch ø 23mm thread M19x1 cam width 11mm mounting measurements 16.5x19mm hub 20-28mm thread L 15mm		
<b>For models:</b>	135, 135-4, 135A, 135B, 135BA, 135BN, 135BNX, 135BX, 135BXE, 135BXR, 135CPX, 135NN, 135NNX, 135PVX, 135X, 135X-3, 135X-4, 135XE, 135XR, 40B, 40CP, 40CPX, 40EV, 40EVP, 65, 65A, 65B, 65BA, 65BX, 65BX-2, 65BXE, 65BXR, 65NB, 65NBX, 65NN, 65NNX, 65PVX, 65X, 65X-2, 65XE, 65XR, S125, S125-4, S125B, S125B-4, S125BE, S125BX, S125BX-4, S125E, S125X...(Other models you can see in the webshop)		

accessories







miscellaneous

			
1			
<b>GEV No.</b>	691134	<b>Ref. No.</b>	36M3720
<b>description</b>	spacer piece for door handle		
<b>For models:</b>	30CPS, 30CPSE, 30F1, 30F1B, 30FES2, 30FES2B, 30FS2, 30FS2B, 31, 31GE, 31TC, 31TCE, 31TP, 32, 32TC, 32TCE, 32TP, 32TPV, 32V		

turning lever locks

universal

RAHRBACH



			
1			
<b>GEV No.</b>	690500	<b>Ref. No.</b>	36M0880 36M3180 36M6380 6300421
<b>description</b>	handle latch right L 185mm H 66mm handle material plastic type 6300 series		
<b>For models:</b>	FC101, FC101E, FC241, FC241E, FC241G, FC61, FC61E, FCV101, FCV101-CSA, FCV101DM, FCV101DM-CSA, FCV101DS, FCV101DS-CSA, FCV101E, FCV101EDM, FCV101EDM-UL, FCV101EDS, FCV101EDS-UL, FCV101E-UL, FCV141, FCV141-CSA, FCV141DM, FCV141DM-CSA, FCV141DS, FCV141DS-CSA, FCV141E, FCV141EDM, FCV141EDS, FCV241, FCV241DM, FCV241DS, FCV241E, FCV241EDM, FCV241EDM-UL, FCV241EDS, FCV241EDS-UL, FCV241E-UL, FCV241G, FCV241G-CSA, FCV241GDM, FCV241GDM-CSA, FCV241GDS, FCV241GDS-CSA, FCV401DM, FCV401DM-CSA, FCV401EDM, FCV401EDM-UL, FCV61, FCV61-CSA, FCV61DM...(Other models you can see in the webshop)		
<b>spare parts for</b>	690500		
	<b>GEV No.</b>	699841	<b>Ref. No.</b> —
	cover cap for turning lever lock ø 32mm H 14mm		
<b>accessories for</b>	690500		
	<b>GEV No.</b>	514281	<b>Ref. No.</b> 36M1570
	base plate L 110mm W 35mm for door catch thickness 10mm		
	<b>GEV No.</b>	690136	<b>Ref. No.</b> 3FL0197
	sliding plate mounting pos. right L 28mm H 3mm W 21mm H2 12.5mm		
	<b>GEV No.</b>	691174	<b>Ref. No.</b> 35V9050
	counterpart L 90mm W 60mm for door latch		
	<b>GEV No.</b>	700091	<b>Ref. No.</b> —
	door catch mounting pos. right off-set 20mm L 110mm H 56mm W 33mm mounting distance 68/68mm zinc die cast series 6300		
	<b>GEV No.</b>	700098	<b>Ref. No.</b> 36M0820
	door catch mounting pos. right off-set 38mm L 110mm H 74mm W 33mm mounting distance 68/68mm series 1750		

locks

locking devices

producer-specific



ANGELO PO

			
1			
<b>GEV No.</b>	690462	<b>Ref. No.</b>	36M7070
<b>description</b>	key cylinder ø 23mm thread M19x1 mounting measurements 16.5x19mm hub 38-45mm shaft ø 11mm thread L 12mm		
<b>For models:</b>	AF1B, AF1B-OPR01, AF1N, AF1N-OPR01, AF2B, AF2B-OPR01, AF2N, AF2N-OPR01, AGL6B, CX120, CX120B, CX120NN, CX130, CX130B, CX130NN, CX140, CX140B, CX140BN, CX140BR, CX140CP, CX140NN, CX140R, CX150, CX150B, CX150BN, CX150BR, CX150CP, CX150NN, CX150R, CX55, CX55B, CX60, CX60B, CX65, CX652, CX65B, CX65BR, CX65NB, CX65NCP, CX65NN, CX65R, CX70, CX702, CX70B, CX70BR, CX70NB, CX70NN, CX70R, FG2B, FSD1B...(Other models you can see in the webshop)		
<b>spare parts for</b>	690462		
	<b>GEV No.</b>	691589	<b>Ref. No.</b> —
	spare keys for key cylinder 690462 key number 9233		

Зип-Общепит

vsezip.ru



+7(812)987-08-81

	<b>GEV No.</b> 700098	<b>Ref. No.</b> 36M0820
<b>description</b>	door catch mounting pos. right off-set 38mm L 110mm H 74mm W 33mm mounting distance 68/68mm series 1750	
<b>For models:</b>	FC101, FC101E, FC241, FC241E, FC241G, FC61, FC61E, FCV101, FCV101-CSA, FCV101DM, FCV101DM-CSA, FCV101DS, FCV101DS-CSA, FCV101E, FCV101EDM, FCV101EDM-UL, FCV101EDS, FCV101EDS-UL, FCV101E-UL, FCV141, FCV141-CSA, FCV141DM, FCV141DM-CSA, FCV141DS, FCV141DS-CSA, FCV141E, FCV141EDM, FCV141EDS, FCV241, FCV241DM, FCV241DS, FCV241E, FCV241EDM, FCV241EDM-UL, FCV241EDS, FCV241EDS-UL, FCV241E-UL, FCV241G, FCV241G-CSA, FCV241GDM, FCV241GDM-CSA, FCV241GDS, FCV241GDS-CSA, FCV401DM, FCV401DM-CSA, FCV401EDM, FCV401EDM-UL, FCV61, FCV61-CSA, FCV61DM...(Other models you can see in the webshop)	
<b>spare parts for</b>	700098	
	<b>GEV No.</b> 690136	<b>Ref. No.</b> 3FL0197
<b>accessories for</b>	700098	
	<b>GEV No.</b> 514281	<b>Ref. No.</b> 36M1570
	base plate L 110mm W 35mm for door catch thickness 10mm	

	<b>GEV No.</b> 690137	<b>Ref. No.</b> 36E2530 6300843
<b>description</b>	sliding plate mounting pos. left L 28mm H 3mm W 21mm H2 12.5mm	
<b>For models:</b>	FC101, FC1011E, FC1011G, FC101E, FC1221E, FC1221G, FC241, FC241E, FC241G, FC61, FC611E, FC611G, FC61E, FCV101, FCV101DM, FCV101DS, FCV101E, FCV101EDM, FCV101EDS, FCV141, FCV141DM, FCV141DS, FCV141E, FCV141EDM, FCV141EDS, FCV241, FCV241DM, FCV241DS, FCV241E, FCV241EDM, FCV241EDS, FCV241G, FCV241GDM, FCV241GDS, FCV401DM, FCV401EDM, FCV61, FCV61DM, FCV61DS, FCV61E, FCV61EDM, FCV61EDS, FM1011E1, FM1011E1-VERS.2006, FM1011E2, FM1011E2-VERS.2006, FM1011E3, FM1011E3-VERS.2006, FM1011G1, FM1011G1-VERS.2006...(Other models you can see in the webshop)	

	<b>GEV No.</b> 690136	<b>Ref. No.</b> 3FL0197
<b>description</b>	sliding plate mounting pos. right L 28mm H 3mm W 21mm H2 12.5mm	
<b>For models:</b>	FCV101-CSA, FCV101DM-CSA, FCV101DS-CSA, FCV101EDM-UL, FCV101EDS-UL, FCV101E-UL, FCV141-CSA, FCV141DM-CSA, FCV141DS-CSA, FCV241EDM-UL, FCV241EDS-UL, FCV241E-UL, FCV241G-CSA, FCV241GDM-CSA, FCV241GDS-CSA, FCV401DM-CSA, FCV401EDM-UL, FCV61-CSA, FCV61DM-CSA, FCV61DS-CSA, FCV61EDM-UL, FCV61EDS-UL, FCV61E-UL, FCV72EDM-UL, FCV72EDS-UL, FCV72E-UL	

	<b>GEV No.</b> 700098	<b>Ref. No.</b> 36M0820
<b>description</b>	door catch mounting pos. right off-set 38mm L 110mm H 74mm W 33mm mounting distance 68/68mm series 1750	
<b>For models:</b>	FC101, FC101E, FC241, FC241E, FC241G, FC61, FC61E, FCV101, FCV101-CSA, FCV101DM, FCV101DM-CSA, FCV101DS, FCV101DS-CSA, FCV101E, FCV101EDM, FCV101EDM-UL, FCV101EDS, FCV101EDS-UL, FCV101E-UL, FCV141, FCV141-CSA, FCV141DM, FCV141DM-CSA, FCV141DS, FCV141DS-CSA, FCV141E, FCV141EDM, FCV141EDS, FCV241, FCV241DM, FCV241DS, FCV241E, FCV241EDM, FCV241EDM-UL, FCV241EDS, FCV241EDS-UL, FCV241E-UL, FCV241G, FCV241G-CSA, FCV241GDM, FCV241GDM-CSA, FCV241GDS, FCV241GDS-CSA, FCV401DM, FCV401DM-CSA, FCV401EDM, FCV401EDM-UL, FCV61, FCV61-CSA, FCV61DM...(Other models you can see in the webshop)	
<b>accessories for</b>	700098	
	<b>GEV No.</b> 514281	<b>Ref. No.</b> 36M1570
	base plate L 110mm W 35mm for door catch thickness 10mm	

<b>producer-specific</b>			
<b>ANGELO PO</b>			
	<b>GEV No.</b> 694640	<b>Ref. No.</b> 36E2580 36E2581	
<b>description</b>	door catch H 42mm mounting pos. left L 98mm W 42mm for turning lever lock		
<b>For models:</b>	FC1011E, FC1011G, FC1221E, FC1221G, FC611E, FC611G, FM1011E1, FM1011E1-VERS.2006, FM1011E2, FM1011E2-VERS.2006, FM1011E3, FM1011E3-VERS.2006, FM1011G1, FM1011G1-VERS.2006, FM1011G2, FM1011G2-VERS.2006, FM1011G3, FM1011G3-VERS.2006, FM1221E1, FM1221E1-VERS.2006, FM1221E2, FM1221E2-VERS.2006, FM1221E3, FM1221E3-VERS.2006, FM1221G1, FM1221G1-VERS.2006, FM1221G2, FM1221G2-VERS.2006, FM1221G3, FM1221G3-VERS.2006, FM2011E2-VERS.2006, FM2011E3-VERS.2006, FM2011G2-VERS.2006, FM2011G3-VERS.2006, FM2021E1, FM2021E2, FM2021E2-VERS.2006, FM2021E3, FM2021E3-VERS.2006, FM2021G1, FM2021G2, FM2021G2-VERS.2006, FM2021G3, FM2021G3-VERS.2006, FM611E1, FM611E1-VERS.2006, FM611E2, FM611E2-VERS.2006, FM611E3, FM611E3-VERS.2006...(Other models you can see in the webshop)		
<b>accessories for</b>	694640		
	<b>GEV No.</b> 694227	<b>Ref. No.</b> 36E2570	
	handle latch convection oven		





Зип Общепит

vsezip.ru

+7(812)987-08-81

1			
<b>GEV No.</b>	694227	<b>Ref. No.</b>	36E2570
<b>description</b>	handle latch convection oven		
<b>For models:</b>	FC1011E, FC1011G, FC1221E, FC1221G, FC611E, FC611G, FM1011E1, FM1011E1-VERS.2006, FM1011E2, FM1011E2-VERS.2006, FM1011E3, FM1011E3-VERS.2006, FM1011G1, FM1011G1-VERS.2006, FM1011G2, FM1011G2-VERS.2006, FM1011G3, FM1011G3-VERS.2006, FM1221E1, FM1221E1-VERS.2006, FM1221E2, FM1221E2-VERS.2006, FM1221E3, FM1221E3-VERS.2006, FM1221G1, FM1221G1-VERS.2006, FM1221G2, FM1221G2-VERS.2006, FM1221G3, FM1221G3-VERS.2006, FM2011E2-VERS.2006, FM2011E3-VERS.2006, FM2011G2-VERS.2006, FM2011G3-VERS.2006, FM2021E1, FM2021E2, FM2021E2-VERS.2006, FM2021E3, FM2021E3-VERS.2006, FM2021G1, FM2021G2, FM2021G2-VERS.2006, FM2021G3, FM2021G3-VERS.2006, FM611E1, FM611E1-VERS.2006, FM611E2, FM611E2-VERS.2006, FM611E3, FM611E3-VERS.2006... (Other models you can see in the webshop)		
<b>accessories for</b>	694227		
	<b>GEV No.</b>	694640	<b>Ref. No.</b> 36E2580 36E2581
	door catch H 42mm mounting pos. left L 98mm W 42mm for turning lever lock		

1			
<b>GEV No.</b>	514281	<b>Ref. No.</b>	36M1570
<b>description</b>	base plate L 110mm W 35mm for door catch thickness 10mm		
<b>For models:</b>	FC101, FC101E, FC241, FC241E, FC241G, FC61, FC61E, FCV101, FCV101-CSA, FCV101DM, FCV101DM-CSA, FCV101DS, FCV101DS-CSA, FCV101E, FCV101EDM, FCV101EDM-UL, FCV101EDS, FCV101EDS-UL, FCV101E-UL, FCV141, FCV141-CSA, FCV141DM, FCV141DM-CSA, FCV141DS, FCV141DS-CSA, FCV141E, FCV141EDM, FCV141EDS, FCV241, FCV241DM, FCV241DS, FCV241E, FCV241EDM, FCV241EDM-UL, FCV241EDS, FCV241EDS-UL, FCV241E-UL, FCV241G, FCV241G-CSA, FCV241GDM, FCV241GDM-CSA, FCV241GDS, FCV241GDS-CSA, FCV61, FCV61-CSA, FCV61DM, FCV61DM-CSA, FCV61DS, FCV61DS-CSA, FCV61E... (Other models you can see in the webshop)		

1			
<b>GEV No.</b>	691174	<b>Ref. No.</b>	35V9050
<b>description</b>	counterpart L 90mm W 60mm for door latch		
<b>For models:</b>	FC101, FC101E, FC241E, FC241G, FC61, FC61E, FCV101, FCV101-CSA, FCV101DM, FCV101DM-CSA, FCV101DS, FCV101DS-CSA, FCV101E, FCV101EDM, FCV101EDM-UL, FCV101EDS, FCV101EDS-UL, FCV101E-UL, FCV141, FCV141-CSA, FCV141DM, FCV141DM-CSA, FCV141DS, FCV141DS-CSA, FCV141E, FCV141EDM, FCV141EDS, FCV241E, FCV241EDM, FCV241EDM-UL, FCV241EDS, FCV241EDS-UL, FCV241G, FCV241G-CSA, FCV241GDM, FCV241GDM-CSA, FCV241GDS, FCV241GDS-CSA, FCV61, FCV61-CSA, FCV61DM, FCV61DM-CSA, FCV61DS, FCV61DS-CSA, FCV61E, FCV61EDM, FCV61EDM-UL, FCV61EDS, FCV61EDS-UL, FCV61E-UL... (Other models you can see in the webshop)		







1			
<b>GEV No.</b>	700711	<b>Ref. No.</b>	6300420
<b>description</b>	door catch		
<b>For models:</b>	FC101, FC101E, FC241, FC241E, FC241G, FC61, FC61E, FCV101, FCV101-CSA, FCV101DM, FCV101DM-CSA, FCV101DS, FCV101DS-CSA, FCV101E, FCV101EDM, FCV101EDM-UL, FCV101EDS, FCV101EDS-UL, FCV101E-UL, FCV141, FCV141-CSA, FCV141DM, FCV141DM-CSA, FCV141DS, FCV141DS-CSA, FCV141E, FCV141EDM, FCV141EDS, FCV241, FCV241DM, FCV241DS, FCV241E, FCV241EDM, FCV241EDM-UL, FCV241EDS, FCV241EDS-UL, FCV241E-UL, FCV241G, FCV241G-CSA, FCV241GDM, FCV241GDM-CSA, FCV241GDS, FCV241GDS-CSA, FCV401DM, FCV401DM-CSA, FCV401EDM, FCV401EDM-UL, FCV61, FCV61-CSA, FCV61DM... (Other models you can see in the webshop)		
<b>accessories for</b>	700711		
	<b>GEV No.</b>	514281	<b>Ref. No.</b> 36M1570
	base plate L 110mm W 35mm for door catch thickness 10mm		
	<b>GEV No.</b>	700098	<b>Ref. No.</b> 36M0820
	door catch mounting pos. right off-set 38mm L 110mm H 74mm W 33mm mounting distance 68/68mm series 1750		

1			
<b>GEV No.</b>	700098	<b>Ref. No.</b>	36M0820
<b>description</b>	door catch mounting pos. right off-set 38mm L 110mm H 74mm W 33mm mounting distance 68/68mm series 1750		
<b>For models:</b>	FC101, FC101E, FC241, FC241E, FC241G, FC61, FC61E, FCV101, FCV101-CSA, FCV101DM, FCV101DM-CSA, FCV101DS, FCV101DS-CSA, FCV101E, FCV101EDM, FCV101EDM-UL, FCV101EDS, FCV101EDS-UL, FCV101E-UL, FCV141, FCV141-CSA, FCV141DM, FCV141DM-CSA, FCV141DS, FCV141DS-CSA, FCV141E, FCV141EDM, FCV141EDS, FCV241, FCV241DM, FCV241DS, FCV241E, FCV241EDM, FCV241EDM-UL, FCV241EDS, FCV241EDS-UL, FCV241E-UL, FCV241G, FCV241G-CSA, FCV241GDM, FCV241GDM-CSA, FCV241GDS, FCV241GDS-CSA, FCV401DM, FCV401DM-CSA, FCV401EDM, FCV401EDM-UL, FCV61, FCV61-CSA, FCV61DM... (Other models you can see in the webshop)		
<b>spare parts for</b>	700098		
	<b>GEV No.</b>	690136	<b>Ref. No.</b> 3FL0197
	sliding plate mounting pos. right L 28mm H 3mm W 21mm H2 12.5mm		
<b>accessories for</b>	700098		
	<b>GEV No.</b>	514281	<b>Ref. No.</b> 36M1570
	base plate L 110mm W 35mm for door catch thickness 10mm		

Зип Общепит

vsezip.ru

+7(812)987-09-81

			
1			
<b>GEV No.</b>	690500	<b>Ref. No.</b>	36M0880 36M3180 36M6380 6300421
<b>description</b>	handle latch right L 185mm H 66mm handle material plastic type 6300 series		
<b>For models:</b>	FC101, FC101E, FC241, FC241E, FC241G, FC61, FC61E, FCV101, FCV101-CSA, FCV101DM, FCV101DM-CSA, FCV101DS, FCV101DS-CSA, FCV101E, FCV101EDM, FCV101EDM-UL, FCV101EDS, FCV101EDS-UL, FCV101E-UL, FCV141, FCV141-CSA, FCV141DM, FCV141DM-CSA, FCV141DS, FCV141DS-CSA, FCV141E, FCV141EDM, FCV141EDS, FCV241, FCV241DM, FCV241DS, FCV241E, FCV241EDM, FCV241EDM-UL, FCV241EDS, FCV241EDS-UL, FCV241E-UL, FCV241G, FCV241G-CSA, FCV241GDM, FCV241GDM-CSA, FCV241GDS, FCV241GDS-CSA, FCV401DM, FCV401DM-CSA, FCV401EDM, FCV401EDM-UL, FCV61, FCV61-CSA, FCV61DM...(Other models you can see in the webshop)		
<b>spare parts for</b>	690500		
	<b>GEV No.</b>	699841	<b>Ref. No.</b> —
cover cap for turning lever lock ø 32mm H 14mm			
<b>accessories for</b>	690500		
	<b>GEV No.</b>	514281	<b>Ref. No.</b> 36M1570
base plate L 110mm W 35mm for door catch thickness 10mm			
	<b>GEV No.</b>	690136	<b>Ref. No.</b> 3FL0197
sliding plate mounting pos. right L 28mm H 3mm W 21mm H2 12.5mm			
	<b>GEV No.</b>	691174	<b>Ref. No.</b> 35V9050
counterpart L 90mm W 60mm for door latch			
	<b>GEV No.</b>	700091	<b>Ref. No.</b> —
door catch mounting pos. right off-set 20mm L 110mm H 56mm W 33mm mounting distance 68/68mm zinc die cast series 6300			
	<b>GEV No.</b>	700098	<b>Ref. No.</b> 36M0820
door catch mounting pos. right off-set 38mm L 110mm H 74mm W 33mm mounting distance 68/68mm series 1750			

			
1			
<b>GEV No.</b>	111786	<b>Ref. No.</b>	37M4040
<b>description</b>	knob dial plate		
<b>For models:</b>	FC101, FC101E, FC241, FC241E, FC241G, FC61, FC61E, FCV101, FCV101-CSA, FCV101DM, FCV101DS, FCV101E, FCV101EDM, FCV101EDS, FCV101EDS-UL, FCV101E-UL, FCV141, FCV141DM, FCV141DS, FCV141E, FCV141EDM, FCV141EDS, FCV241, FCV241DM, FCV241DS, FCV241E, FCV241EDM, FCV241EDM-UL, FCV241EDS, FCV241EDS-UL, FCV241G, FCV241G-CSA, FCV241GDM, FCV241GDS, FCV401DM, FCV401EDM, FCV4E, FCV4EDS, FCV61, FCV61DM, FCV61DS, FCV61E, FCV61EDM, FCV61EDS, FCV61E-UL, FCV72EDM-UL, FCV72EDS-UL		

<b>GEV No.</b>	690136	<b>Ref. No.</b>	3FL0197
<b>description</b>	sliding plate mounting pos. right L 28mm H 3mm W 21mm H2 12.5mm		
<b>For models:</b>	FCV101-CSA, FCV101DM-CSA, FCV101DS-CSA, FCV101EDM-UL, FCV101EDS-UL, FCV101E-UL, FCV141-CSA, FCV141DM-CSA, FCV141DS-CSA, FCV241EDM-UL, FCV241EDS-UL, FCV241E-UL, FCV241G-CSA, FCV241GDM-CSA, FCV241GDS-CSA, FCV401DM-CSA, FCV401EDM-UL, FCV61-CSA, FCV61DM-CSA, FCV61DS-CSA, FCV61EDM-UL, FCV61EDS-UL, FCV61E-UL, FCV72EDM-UL, FCV72EDS-UL, FCV72E-UL		

handle latches

universal

inside fixing

locks











			
1			
<b>GEV No.</b>	694054	<b>Ref. No.</b>	36M7000
<b>description</b>	door handle for headed units L 145mm W 40mm H 62mm spring length 33mm inner black		
<b>For models:</b>	BX101E, BX101E-VERS.122013, BX101G, BX101G-VERS.122013, BX122E, BX122E-VERS.122013, BX122G, BX122G-VERS.122013, BX61E, BX61E-VERS.122013, BX61G, BX61G-VERS.122013, BX82E, BX82E-VERS.122013, BX82G, BX82G-VERS.122013, FCV3EM, FCV4E, FCV4EDS, FCV4EM, FM423E1, FM423E2		
<b>spare parts for</b>	694054		
	<b>GEV No.</b>	514390	<b>Ref. No.</b> 3005920 3236250
spring for door handle ø 6mm L 54mm W 27.5mm			
	<b>GEV No.</b>	694675	<b>Ref. No.</b> —
door catch L 88mm W 40mm H 37mm spring length 33mm mounting distance 60mm			
	<b>GEV No.</b>	694734	<b>Ref. No.</b> —
door handle L 165mm W 40mm H 25mm black			
	<b>GEV No.</b>	694735	<b>Ref. No.</b> —
cap ø 32mm black			
<b>accessories for</b>	694054		
	<b>GEV No.</b>	691123	<b>Ref. No.</b> 36E2060
duct for door opener			
	<b>GEV No.</b>	694055	<b>Ref. No.</b> 3238740 3238750 36C4391
door catch L 25mm W 14mm total length 54mm thread M8 thread L 29mm			
	<b>GEV No.</b>	694066	<b>Ref. No.</b> —
door catch with spigot 2-stage L 28mm W 14mm H 15mm H1 16mm total length 51mm thread M8 thread L 23mm stainless steel			

Table continues overleaf



accessories for 694054	
	GEV No. 694067 Ref. No. 3108770
door catch with spigot 1-stage L 26mm total length 51mm thread M8	



producer-specific	
ANGELO PO	
	
1	
GEV No.	514289 Ref. No. 36D3670
description	bush for door mechanism
For models:	FCV3EM, FCV4E, FCV4EDS, FCV4EM



	
1	
GEV No.	514287 Ref. No. 36Q1360
description	bush H 8mm thickness 2mm D1 ø 14mm D2 ø 10mm
For models:	FCV3EM, FCV4E, FCV4EDS, FCV4EM

	
1	
GEV No.	514288 Ref. No. 30G1650 30G2192
description	door catch ø 10mm L 102mm door catch height 24mm T1: M8 T2: M20x1.5
For models:	FCV3EM, FCV4E, FCV4EDS, FCV4EM

accessories for 514288	
	GEV No. 514287 Ref. No. 36Q1360
bush H 8mm thickness 2mm D1 ø 14mm D2 ø 10mm	

	
1	
GEV No.	514290 Ref. No. 36M5340
description	door handle L 150mm W 42mm H 57mm black plastic shaft 8x8mm intake square
For models:	FCV3EM, FCV4E, FCV4EDS, FCV4EM

accessories for 514290	
	GEV No. 111746 Ref. No. 37M4700
knob dial plate W 1mm ø 36mm	
	GEV No. 111786 Ref. No. 37M4040
knob dial plate	
	GEV No. 514286 Ref. No. 36D8011
sleeve L 15mm M20x1.5	

accessories for 514290	
	GEV No. 514287 Ref. No. 36Q1360
bush H 8mm thickness 2mm D1 ø 14mm D2 ø 10mm	
	GEV No. 514288 Ref. No. 30G1650 30G2192
door catch ø 10mm L 102mm door catch height 24mm T1: M8 T2: M20x1.5	
	GEV No. 514289 Ref. No. 36D3670
bush for door mechanism	

	
1	
GEV No.	111786 Ref. No. 37M4040
description	knob dial plate
For models:	FC101, FC101E, FC241, FC241E, FC241G, FC61, FC61E, FCV101, FCV101-CSA, FCV101DM, FCV101DS, FCV101E, FCV101EDM, FCV101EDS, FCV101EDS-UL, FCV101E-UL, FCV141, FCV141DM, FCV141DS, FCV141E, FCV141EDM, FCV141EDS, FCV241, FCV241DM, FCV241DS, FCV241E, FCV241EDM, FCV241EDM-UL, FCV241EDS, FCV241EDS-UL, FCV241G, FCV241G-CSA, FCV241GDM, FCV241GDS, FCV401DM, FCV401EDM, FCV4E, FCV4EDS, FCV61, FCV61DM, FCV61DS, FCV61E, FCV61EDM, FCV61EDS, FCV61E-UL, FCV72EDM-UL, FCV72EDS-UL

	
1	
GEV No.	111746 Ref. No. 37M4700
description	knob dial plate W 1mm ø 36mm
For models:	FCV3EM, FCV4EM



	
1	
GEV No.	514286 Ref. No. 36D8011
description	sleeve L 15mm M20x1.5
For models:	FCV3EM, FCV4E, FCV4EDS, FCV4EM

Зип-Общепит

vsezip.ru

8 (812) 987-08-81



			
1			
<b>GEV No.</b>	694055	<b>Ref. No.</b>	3238740 3238750 36C4391
<b>description</b>	door catch L 25mm W 14mm total length 54mm thread M8 thread L 29mm		
<b>For models:</b>	BX101E, BX101E-VERS.122013, BX101G, BX101G-VERS.122013, BX122E, BX122E-VERS.122013, BX122G, BX122G-VERS.122013, BX61E, BX61E-VERS.122013, BX61G, BX61G-VERS.122013, BX82E, BX82E-VERS.122013, BX82G, BX82G-VERS.122013, FCV3EM, FCV4E, FCV4EDS, FCV4EM, FM423E1, FM423E2, FX101E1, FX101E1R, FX101E2, FX101E2C, FX101E2C-VERS.032014, FX101E2R, FX101E2R-VERS.032014, FX101E2-VERS.032014, FX101E3, FX101E3C, FX101E3C-VERS.022014, FX101E3R, FX101E3R-VERS.022014, FX101E3-VERS.022014, FX101G1, FX101G1R, FX101G2, FX101G2C, FX101G2C-VERS.032014, FX101G2R, FX101G2R-VERS.032014, FX101G2-VERS.032014, FX101G3, FX101G3C, FX101G3C-VERS.022014, FX101G3R, FX101G3R-VERS.022014, FX101G3-VERS.022014...(Other models you can see in the webshop)		
<b>accessories for</b>	694055		
	<b>GEV No.</b>	694772	<b>Ref. No.</b> 36E2490
protection cap for door catch ø 21mm			

			
1			
<b>GEV No.</b>	694055	<b>Ref. No.</b>	3238740 3238750 36C4391
<b>description</b>	door catch L 25mm W 14mm total length 54mm thread M8 thread L 29mm		
<b>For models:</b>	BX101E, BX101E-VERS.122013, BX101G, BX101G-VERS.122013, BX122E, BX122E-VERS.122013, BX122G, BX122G-VERS.122013, BX61E, BX61E-VERS.122013, BX61G, BX61G-VERS.122013, BX82E, BX82E-VERS.122013, BX82G, BX82G-VERS.122013, FCV3EM, FCV4E, FCV4EDS, FCV4EM, FM423E1, FM423E2, FX101E1, FX101E1R, FX101E2, FX101E2C, FX101E2C-VERS.032014, FX101E2R, FX101E2R-VERS.032014, FX101E2-VERS.032014, FX101E3, FX101E3C, FX101E3C-VERS.022014, FX101E3R, FX101E3R-VERS.022014, FX101E3-VERS.022014, FX101G1, FX101G1R, FX101G2, FX101G2C, FX101G2C-VERS.032014, FX101G2R, FX101G2R-VERS.032014, FX101G2-VERS.032014, FX101G3, FX101G3C, FX101G3C-VERS.022014, FX101G3R, FX101G3R-VERS.022014, FX101G3-VERS.022014...(Other models you can see in the webshop)		
<b>accessories for</b>	694055		
	<b>GEV No.</b>	694067	<b>Ref. No.</b> 3108770
door catch with spigot 1-stage L 26mm total length 51mm thread M8			

			
1			
<b>GEV No.</b>	691123	<b>Ref. No.</b>	36E2060
<b>description</b>	duct for door opener		
<b>For models:</b>	FCV3EM, FCV4E, FCV4EDS, FCV4EM, FM423E1, FM423E2		

			
1			
<b>GEV No.</b>	517174	<b>Ref. No.</b>	3110050 33Q6470
<b>description</b>	nut thread M8 H 6.5mm WS 13 SS DIN/ISO DIN 934 / ISO 4032/8673 Qty 1 pcs		

			
1			
<b>GEV No.</b>	694772	<b>Ref. No.</b>	36E2490
<b>description</b>	protection cap for door catch ø 21mm		
<b>For models:</b>	BX101E, BX101E-VERS.122013, BX101G, BX101G-VERS.122013, BX122E, BX122E-VERS.122013, BX122G, BX122G-VERS.122013, BX61E, BX61E-VERS.122013, BX61G, BX61G-VERS.122013, BX82E, BX82E-VERS.122013, BX82G, BX82G-VERS.122013, FCV3EM, FCV4E, FCV4EDS, FCV4EM, FM423E1, FM423E2, FX101E1, FX101E1R, FX101E2, FX101E2C, FX101E2C-VERS.032014, FX101E2R, FX101E2R-VERS.032014, FX101E2-VERS.032014, FX101E3, FX101E3C, FX101E3C-VERS.022014, FX101E3R, FX101E3R-VERS.022014, FX101E3-VERS.022014, FX101G1, FX101G1R, FX101G2, FX101G2C, FX101G2C-VERS.032014, FX101G2R, FX101G2R-VERS.032014, FX101G2-VERS.032014, FX101G3, FX101G3C, FX101G3C-VERS.022014, FX101G3R, FX101G3R-VERS.022014, FX101G3-VERS.022014...(Other models you can see in the webshop)		





			
1			
<b>GEV No.</b>	694054	<b>Ref. No.</b>	36M7000
<b>description</b>	door handle for headed units L 145mm W 40mm H 62mm spring length 33mm inner black		
<b>For models:</b>	BX101E, BX101E-VERS.122013, BX101G, BX101G-VERS.122013, BX122E, BX122E-VERS.122013, BX122G, BX122G-VERS.122013, BX61E, BX61E-VERS.122013, BX61G, BX61G-VERS.122013, BX82E, BX82E-VERS.122013, BX82G, BX82G-VERS.122013, FCV3EM, FCV4E, FCV4EDS, FCV4EM, FM423E1, FM423E2		
<b>spare parts for</b>	694054		
	<b>GEV No.</b>	514390	<b>Ref. No.</b> 3005920 3236250
spring for door handle ø 6mm L 54mm W 27.5mm			
	<b>GEV No.</b>	694675	<b>Ref. No.</b> —
door catch L 88mm W 40mm H 37mm spring length 33mm mounting distance 60mm			
	<b>GEV No.</b>	694734	<b>Ref. No.</b> —
door handle L 165mm W 40mm H 25mm black			
	<b>GEV No.</b>	694735	<b>Ref. No.</b> —
cap ø 32mm black			
<b>accessories for</b>	694054		
	<b>GEV No.</b>	691123	<b>Ref. No.</b> 36E2060
duct for door opener			

Зип Общепит edge mount latches

handle latches  
CAPTIVE MOD

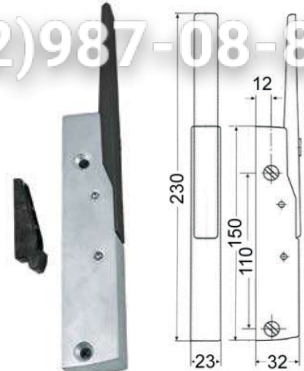
+7(812)987-08-81

			
<b>1</b>			
<b>GEV No.</b>	514390	<b>Ref. No.</b>	3005920 3236250
<b>description</b>	spring for door handle $\varnothing$ 6mm L 54mm W 27.5mm		
<b>For models:</b>	BX101E, BX101E-VERS.122013, BX101G, BX101G-VERS.122013, BX122E, BX122E-VERS.122013, BX122G, BX122G-VERS.122013, BX61E, BX61E-VERS.122013, BX61G, BX61G-VERS.122013, BX82E, BX82E-VERS.122013, BX82G, BX82G-VERS.122013, FCV3EM, FCV4E, FCV4EDS, FCV4EM, FM423E1, FM423E2, FX101E1R, FX101E2R, FX101E2R-VERS.032014, FX101E3R, FX101E3R-VERS.022014, FX101G1R, FX101G2R, FX101G2R-VERS.032014, FX101G3R, FX101G3R-VERS.022014, FX10E2CR, FX10E2CR-VERS.032014, FX10E3CR, FX10E3CR-VERS.022014, FX10G2CR, FX10G2CR-VERS.032014, FX10G3CR, FX10G3CR-VERS.022014, FX61E1R, FX61E2CR, FX61E2CR-VERS.032014, FX61E2R, FX61E2R-VERS.032014, FX61E3CR, FX61E3CR-VERS.022014, FX61E3R, FX61E3R-VERS.022014, FX61G1R...(Other models you can see in the webshop)		

			
<b>1</b>			
<b>GEV No.</b>	690454	<b>Ref. No.</b>	36M0470
<b>description</b>	handle latch L 150mm mounting distance 110mm matt chrome-plated/Rilsan non lockable heated units 560 black complete with door catch		
<b>spare parts for</b>	690454		
	<b>GEV No.</b>	690429	<b>Ref. No.</b> —
	door catch CT 25.5mm		
<b>accessories for</b>	690454		
	<b>GEV No.</b>	690428	<b>Ref. No.</b> 36M0480
	door catch H 51mm W 13.9mm mounting distance 30mm plastic CT 16.5mm		
	<b>GEV No.</b>	690445	<b>Ref. No.</b> —
	base plate H 2mm		
	<b>GEV No.</b>	690446	<b>Ref. No.</b> —
	base plate H 5mm L 56mm W 18mm		

<b>handles</b>			
			
<b>1</b>			
<b>GEV No.</b>	694631	<b>Ref. No.</b>	3104201 3104202 3104203
<b>description</b>	door handle for combi-steamer L 210mm W 170mm H 55mm silver plastic		
<b>For models:</b>	FX101E1, FX101E2, FX101E2C, FX101E2C-VERS.032014, FX101E2-VERS.032014, FX101E3, FX101E3C, FX101E3C-VERS.022014, FX101E3R, FX101E3-VERS.022014, FX101G1, FX101G2, FX101G2C, FX101G2C-VERS.032014, FX101G2-VERS.032014, FX101G3, FX101G3C, FX101G3C-VERS.022014, FX101G3-VERS.022014, FX10E2CR-VERS.032014, FX122E1, FX122E2, FX122E2C, FX122E2T, FX122E2T-VERS.032014, FX122E3, FX122E3C, FX122E3T, FX122E3T-VERS.022014, FX122G1, FX122G3, FX122G3C, FX122G3T, FX122G3T-VERS.022014, FX12E3CT, FX12E3CT-VERS.022014, FX12G3CT, FX12G3CT-VERS.022014, FX201E2, FX201E2P, FX201E2P-VERS.032014, FX201E2-VERS.032014, FX201E3, FX201E3P, FX201E3P-VERS.022014, FX201E3-VERS.022014, FX201G2, FX201G2P, FX201G2P-VERS.032014, FX201G2-VERS.032014...(Other models you can see in the webshop)		

Зип.Общедит

product reference

vsezip.ru

+7(812)987-08-81

RAHRBACH

6201 DUPLO series

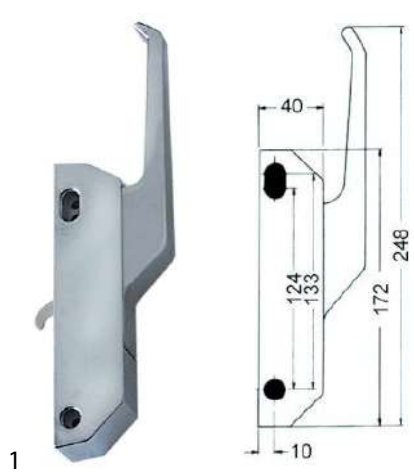

<b>GEV No.</b>	690024	<b>Ref. No.</b>	36M0600
<b>description</b>	handle latch L 172mm mounting distance 124/133mm chrome-plated non lockable refrigeration units 6201 H 65mm type DUPLO total length 248mm		
<b>accessories for</b>	690024		
	<b>GEV No.</b>	690123	<b>Ref. No.</b> —
	door catch with roller		

door catches



<b>GEV No.</b>	690428	<b>Ref. No.</b>	36M0480
<b>description</b>	door catch H 51mm W 13.9mm mounting distance 30mm plastic CT 16.5mm		

snap locks

universal



<b>GEV No.</b>	690596	<b>Ref. No.</b>	36M3600
<b>description</b>	snap lock L 60mm W 15mm H 36mm mounting distance 48/28mm spring thickness 1.5mm complete with door catch zamak		

espagnolette locks

universal



<b>GEV No.</b>	690041	<b>Ref. No.</b>	3088460
<b>description</b>	cam L 148mm mounting distance 32mm		

ANGELO PO



<b>GEV No.</b>	698478	<b>Ref. No.</b>	3142670
<b>description</b>	coupling for oven for door L 80mm W 26mm intake 7.8 x 7.8		
<b>For models:</b>	FX201E2, FX201E2P, FX201E2P-VERS.032014, FX201E2-VERS.032014, FX201E3, FX201E3P, FX201E3P-VERS.022014, FX201E3-VERS.022014, FX201G2, FX201G2P, FX201G2P-VERS.032014, FX201G2-VERS.032014, FX201G3P, FX201G3-VERS.022014, FX202E2, FX202E2-VERS.032014, FX202E3, FX202E3-230V-3-50Hz-60Hz, FX202E3-230V-3-50Hz-60Hz-VERS.022014, FX202E3-VERS.022014, FX202G2, FX202G2-VERS.032014, FX202G3, FX202G3-VERS.022014		



<b>GEV No.</b>	692718	<b>Ref. No.</b>	3104152 3104153
<b>description</b>	cover cap ø 38.5mm		
<b>For models:</b>	FX101E1, FX101E2, FX101E2C, FX101E2C-VERS.032014, FX101E2-VERS.032014, FX101E3, FX101E3C, FX101E3C-VERS.022014, FX101E3R, FX101E3-VERS.022014, FX101G1, FX101G2, FX101G2C, FX101G2C-VERS.032014, FX101G2-VERS.032014, FX101G3, FX101G3C, FX101G3C-VERS.022014, FX101G3-VERS.022014, FX10E2CR-VERS.032014, FX122E1, FX122E2, FX122E2C, FX122E2T, FX122E2T-VERS.032014, FX122E3, FX122E3C, FX122E3T, FX122E3T-VERS.022014, FX122G1, FX122G3, FX122G3C, FX122G3T, FX122G3T-VERS.022014, FX12E3CT, FX12E3CT-VERS.022014, FX12G3CT, FX12G3CT-VERS.022014, FX201E2, FX201E2P, FX201E2P-VERS.032014, FX201E2-VERS.032014, FX201E3, FX201E3P, FX201E3P-VERS.022014, FX201E3-VERS.022014, FX201G2, FX201G2P, FX201G2P-VERS.032014, FX201G2-VERS.032014...(Other models you can see in the webshop)		



<b>GEV No.</b>	694631	<b>Ref. No.</b>	3104201 3104202 3104203
<b>description</b>	door handle for combi-steamer L 210mm W 170mm H 55mm silver plastic		
<b>For models:</b>	FX101E1, FX101E2, FX101E2C, FX101E2C-VERS.032014, FX101E2-VERS.032014, FX101E3, FX101E3C, FX101E3C-VERS.022014, FX101E3R, FX101E3-VERS.022014, FX101G1, FX101G2, FX101G2C, FX101G2C-VERS.032014, FX101G2-VERS.032014, FX101G3, FX101G3C, FX101G3C-VERS.022014, FX101G3-VERS.022014, FX10E2CR-VERS.032014, FX122E1, FX122E2, FX122E2C, FX122E2T, FX122E2T-VERS.032014, FX122E3, FX122E3C, FX122E3T, FX122E3T-VERS.022014, FX122G1, FX122G3, FX122G3C, FX122G3T, FX122G3T-VERS.022014, FX12E3CT, FX12E3CT-VERS.022014, FX12G3CT, FX12G3CT-VERS.022014, FX201E2, FX201E2P, FX201E2P-VERS.032014, FX201E2-VERS.032014, FX201E3, FX201E3P, FX201E3P-VERS.022014, FX201E3-VERS.022014, FX201G2, FX201G2P, FX201G2P-VERS.032014, FX201G2-VERS.032014...(Other models you can see in the webshop)		

Зип-Общепит

hinges  
piano hinges  
universal

(2)987-08-81

			
<b>GEV No.</b>	698503	<b>Ref. No.</b>	6300965
<b>description</b>	espagnolette lock complete		
<b>For models:</b>	FX201E2, FX201E2P, FX201E2P-VERS.032014, FX201E2-VERS.032014, FX201E3, FX201E3P, FX201E3P-VERS.022014, FX201E3-VERS.022014, FX201G2, FX201G2P, FX201G2P-VERS.032014, FX201G2-VERS.032014, FX201G3P, FX201G3-VERS.022014, FX202E2, FX202E2-VERS.032014, FX202E3, FX202E3-230V-3-50Hz-60Hz, FX202E3-230V-3-50Hz-60Hz-VERS.022014, FX202E3-VERS.022014, FX202G2, FX202G2-VERS.032014, FX202G3, FX202G3-VERS.022014		
<b>accessories for</b>	698503		
	<b>GEV No.</b>	690041	<b>Ref. No.</b> 3088460
	cam L 148mm mounting distance 32mm		
	<b>GEV No.</b>	694409	<b>Ref. No.</b> —
	mounting set for espagnolette lock 694382		
	<b>GEV No.</b>	700604	<b>Ref. No.</b> —
	latch gear opening to the right shaft intake $\varnothing 8 \times 8 \text{mm}$ L 170mm W 40mm H 40mm		

			
<b>GEV No.</b>	692720	<b>Ref. No.</b>	3101630
<b>description</b>	gasket for door latch PTFE D1 $\varnothing 26 \text{mm}$ D2 $\varnothing 11.7 \text{mm}$ thickness 2mm		
<b>For models:</b>	FX201E2, FX201E2P, FX201E2P-VERS.032014, FX201E2-VERS.032014, FX201E3, FX201E3P, FX201E3P-VERS.022014, FX201E3-VERS.022014, FX201G2, FX201G2P, FX201G2P-VERS.032014, FX201G2-VERS.032014, FX201G3P, FX201G3-VERS.022014, FX202E2, FX202E2-VERS.032014, FX202E3, FX202E3-230V-3-50Hz-60Hz, FX202E3-230V-3-50Hz-60Hz-VERS.022014, FX202E3-VERS.022014, FX202G2, FX202G2-VERS.032014, FX202G3, FX202G3-VERS.022014		

miscellaneous

			
<b>GEV No.</b>	518585	<b>Ref. No.</b>	36M1240
<b>description</b>	door catch		

			
<b>GEV No.</b>	692866	<b>Ref. No.</b>	3085860
<b>description</b>	hinge L 25mm mounting distance 14mm hole $\varnothing 3 \text{mm}$ thickness 1mm		
<b>For models:</b>	BX101E, BX101E-VERS.122013, BX101G, BX101G-VERS.122013, BX122E, BX122E-VERS.122013, BX122G, BX122G-VERS.122013, BX61E, BX61E-VERS.122013, BX61G, BX61G-VERS.122013, BX82E, BX82E-VERS.122013, BX82G, BX82G-VERS.122013, FX101E1, FX101E1R, FX101E2, FX101E2C, FX101E2C-VERS.032014, FX101E2R, FX101E2R-VERS.032014, FX101E2-VERS.032014, FX101E3, FX101E3C, FX101E3C-VERS.022014, FX101E3R, FX101E3R-VERS.022014, FX101E3-VERS.022014, FX101G1, FX101G1R, FX101G2, FX101G2C, FX101G2C-VERS.032014, FX101G2R, FX101G2R-VERS.032014, FX101G2-VERS.032014, FX101G3, FX101G3C, FX101G3C-VERS.022014, FX101G3R, FX101G3R-VERS.022014, FX101G3-VERS.022014, FX10E2CR, FX10E2CR-VERS.032014, FX10E3CR, FX10E3CR-VERS.022014, FX10G2CR, FX10G2CR-VERS.032014...(Other models you can see in the webshop)		

spring assisted hinges

universal

CAFF/FERMOD

group 2

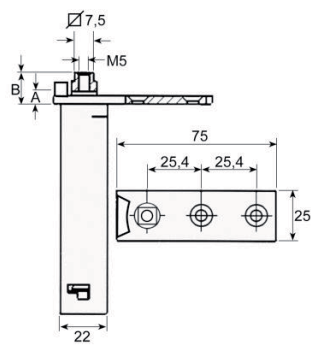
			
			
<b>GEV No.</b>	690574	<b>Ref. No.</b>	36M2460
<b>description</b>	spring assisted hinge series 176 mounting pos. left/right L 75mm W 25.6mm A 11mm B 15mm mounting measurements 22x22mm intake 7.5x7.5		

Зип Общепит

vsezip.ru

+7(812)98708301

INTERKLIMAT

hinges



1

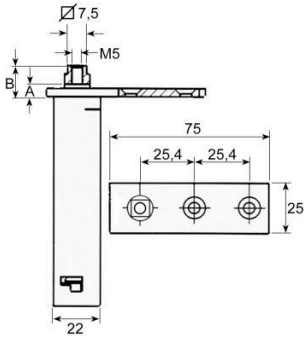

<b>GEV No.</b>	690622	<b>Ref. No.</b>	36G6520
<b>description</b>	spring assisted hinge series 28L mounting pos. left/right L 75mm W 25mm H 103mm A 13mm B 18mm mounting measurements 22x22mm intake 7.5x7.5 refrigeration units		

accessories



1

<b>GEV No.</b>	690747	<b>Ref. No.</b>	3178300
<b>description</b>	bush for hinge ID $\phi$ 7.5mm L 25.5mm W 25.5mm white mounting measurements 22x22mm H 4.5mm		
<b>For models:</b>	120, 120B, 120NN, 135, 135-4, 135A, 135B, 135BA, 135BN, 135BNX, 135BX, 135BXE, 135BXR, 135CPX, 135NN, 135NNX, 135X, 135X-3, 135X-4, 135XE, 135XR, 55, 55B, 65, 65A, 65B, 65BA, 65BX, 65BX-2, 65BXE, 65BXR, 65NB, 65NBX, 65NN, 65NNX, 65X, 65X-2, 65XE, 65XR, AF1B, AF1N, AF2B, AF2N, ART1L, ART1LA, ART1LD, ART1LDA, ART2LD, ART2SD, ART3SD...(Other models you can see in the webshop)		

producer-specific

ANGELO PO



1

<b>GEV No.</b>	691198	<b>Ref. No.</b>	36G2650
<b>description</b>	bar for spring hinge L 345mm $\phi$ 12mm		
<b>For models:</b>	191PD1G, 191PD2G, 191PI1G, 191PI1GA, 191PI2E, 191PI2EA, 191PI2G, 191PI2GA, 191PI2V, 191PI2VA, 1A1PD1G, 1A1PD2G, 1A1PI1G, 1A1PI1GA, 1A1PI2E, 1A1PI2EA, 1A1PI2G, 1A1PI2GA, 1A1PI2V, 1A1PI2VA, 1D1PD1G, 1D1PD2G, 1D1PI1G, 1D1PI1GA, 1D1PI2E, 1D1PI2EA, 1D1PI2G, 1D1PI2GA, 1D1PI2V, 1D1PI2VA, 1G1BR1E, 1G1BR1G, 1G1PD1G, 1G1PI1E, 1G1PI1G, 31PD6, 31PI6, 31PIE6, 31R, 31RE, 71AR, 71ARE, 71PD10, 71PD15, 71PI10, 71PI10A, 71PIE15, 71PIE15A, 71PV15, 71PV15A...(Other models you can see in the webshop)		

<b>GEV No.</b>	690747	<b>Ref. No.</b>	3178300
<b>description</b>	bush for hinge ID $\phi$ 7.5mm L 25.5mm W 25.5mm white mounting measurements 22x22mm H 4.5mm		
<b>For models:</b>	120, 120B, 120NN, 135, 135-4, 135A, 135B, 135BA, 135BN, 135BNX, 135BX, 135BXE, 135BXR, 135CPX, 135NN, 135NNX, 135X, 135X-3, 135X-4, 135XE, 135XR, 55, 55B, 65, 65A, 65B, 65BA, 65BX, 65BX-2, 65BXE, 65BXR, 65NB, 65NBX, 65NN, 65NNX, 65X, 65X-2, 65XE, 65XR, AF1B, AF1N, AF2B, AF2N, ART1L, ART1LA, ART1LD, ART1LDA, ART2LD, ART2SD, ART3SD...(Other models you can see in the webshop)		

<b>GEV No.</b>	691185	<b>Ref. No.</b>	36D2800
<b>description</b>	hinge camp mounting pos. left		
<b>For models:</b>	31PD6, 31PI6, 31PIE6, 31R, 31RE, 71AR, 71ARE, 71PD10, 71PD15, 71PI10, 71PI10A, 71PIE15, 71PIE15A, 71PV15, 71PV15A, 71RA, 91AR, 91ARE, 91PI10, 91PI10A, 91PIE15, 91PIE15A, 91RA		

<b>GEV No.</b>	691186	<b>Ref. No.</b>	36D2790
<b>description</b>	hinge camp mounting pos. right		
<b>For models:</b>	31PD6, 31PI6, 31PIE6, 31R, 31RE, 71AR, 71ARE, 71PD10, 71PD15, 71PI10, 71PI10A, 71PIE15, 71PIE15A, 71PV15, 71PV15A, 71RA, 91AR, 91ARE, 91PI10, 91PI10A, 91PIE15, 91PIE15A, 91RA		

<b>GEV No.</b>	690675	<b>Ref. No.</b>	6008500
<b>description</b>	spring assisted hinge left		
<b>For models:</b>	135PVX		

<b>GEV No.</b>	690573	<b>Ref. No.</b>	30M0350 36M0350
<b>description</b>	spring assisted hinge left refrigerator suitable for SAGI		





Зип Общепит

vsezip.ru

+7(812)987-08-81



1

<b>GEV No.</b>	690674	<b>Ref. No.</b>	6008490
<b>description</b>	spring assisted hinge right L 128mm spring thickness 2.5mm		
<b>For models:</b>	135PVX, 55PV		



1

<b>GEV No.</b>	690675	<b>Ref. No.</b>	6008500
<b>description</b>	spring assisted hinge left		
<b>For models:</b>	135PVX		



1

<b>GEV No.</b>	690572	<b>Ref. No.</b>	36M0340
<b>description</b>	spring assisted hinge right refrigerator suitable for SAGI		



1

<b>GEV No.</b>	690573	<b>Ref. No.</b>	30M0350 36M0350
<b>description</b>	spring assisted hinge left refrigerator suitable for SAGI		

**ELECTROLUX/ZANUSSI**



1

<b>GEV No.</b>	690747	<b>Ref. No.</b>	3178300
<b>description</b>	bush for hinge ID ø 7.5mm L 25.5mm W 25.5mm white mounting measurements 22x22mm H 4.5mm		
<b>For models:</b>	120, 120B, 120NN, 135, 135-4, 135A, 135B, 135BA, 135BN, 135BNX, 135BX, 135BXE, 135BXR, 135CPX, 135NN, 135NNX, 135X, 135X-3, 135X-4, 135XE, 135XR, 55, 55B, 65, 65A, 65B, 65BA, 65BX, 65BX-2, 65BXE, 65BXR, 65NB, 65NBX, 65NN, 65NNX, 65X, 65X-2, 65XE, 65XR, AF1B, AF1N, AF2B, AF2N, ART1L, ART1LA, ART1LD, ART1LDA, ART2LD, ART2SD, ART3SD...(Other models you can see in the webshop)		



1

<b>GEV No.</b>	690674	<b>Ref. No.</b>	6008490
<b>description</b>	spring assisted hinge right L 128mm spring thickness 2.5mm		
<b>For models:</b>	135PVX, 55PV		

**SAGI**



1

<b>GEV No.</b>	691198	<b>Ref. No.</b>	36G2650
<b>description</b>	bar for spring hinge L 345mm ø 12mm		
<b>For models:</b>	191PD1G, 191PD2G, 191PI1G, 191PI1GA, 191PI2E, 191PI2EA, 191PI2G, 191PI2GA, 191PI2V, 191PI2VA, 1A1PD1G, 1A1PD2G, 1A1PI1G, 1A1PI1GA, 1A1PI2E, 1A1PI2EA, 1A1PI2G, 1A1PI2GA, 1A1PI2V, 1A1PI2VA, 1D1PD1G, 1D1PD2G, 1D1PI1G, 1D1PI1GA, 1D1PI2E, 1D1PI2EA, 1D1PI2G, 1D1PI2GA, 1D1PI2V, 1D1PI2VA, 1G1BR1E, 1G1BR1G, 1G1PD1G, 1G1PI1E, 1G1PI1G, 31PD6, 31PI6, 31PIE6, 31R, 31RE, 71AR, 71ARE, 71PD10, 71PD15, 71PI10, 71PI10A, 71PIE15, 71PIE15A, 71PV15, 71PV15A...(Other models you can see in the webshop)		



1

<b>GEV No.</b>	690572	<b>Ref. No.</b>	36M0340
<b>description</b>	spring assisted hinge right refrigerator suitable for SAGI		



1

<b>GEV No.</b>	690747	<b>Ref. No.</b>	3178300
<b>description</b>	bush for hinge ID ø 7.5mm L 25.5mm W 25.5mm white mounting measurements 22x22mm H 4.5mm		
<b>For models:</b>	120, 120B, 120NN, 135, 135-4, 135A, 135B, 135BA, 135BN, 135BNX, 135BX, 135BXE, 135BXR, 135CPX, 135NN, 135NNX, 135X, 135X-3, 135X-4, 135XE, 135XR, 55, 55B, 65, 65A, 65B, 65BA, 65BX, 65BX-2, 65BXE, 65BXR, 65NB, 65NBX, 65NN, 65NNX, 65X, 65X-2, 65XE, 65XR, AF1B, AF1N, AF2B, AF2N, ART1L, ART1LA, ART1LD, ART1LDA, ART2LD, ART2SD, ART3SD...(Other models you can see in the webshop)		

oven hinges

Зип Общепит

vsezip.ru

+7(812)987-08-81



<b>GEV No.</b>	109720	<b>Ref. No.</b>	35U3170
<b>description</b>	cover mounting distance 94mm L 124mm W 20mm oven hinge		
<b>For models:</b>	08WFA4E, 08WFA4G, 08WFAAE, 08WFAAG, 10WTPGE, 12WFA6E, 12WFA6G, 12WFAAE, 12WFAAG, 191FAAE, 191FAAG, 191FABG, 191FADG, 191FAE, 191FAG, 191PE4E, 191TPG, 1A1FA1G, 1A1FA2G, 1A1FA4G, 1A1FA5G, 1A1FAAG, 1A1FABG, 1A1FAS2G, 1A1FASG, 1A1PE4E, 1A1PEFTE, 1A1TP0G, 1A1TP0G-VERS.2002, 1A1FBE, 1B1FAS2G, 1B1FASG, 1D1FA1G, 1D1FA2G, 1D1FA4G, 1D1FA5G, 1D1FAAG, 1D1FABG, 1D1FAS2G, 1D1FASG, 1D1PE4E, 1D1TP0G, 1D1TP0G-VERS.2002, 1D1FBE, 1G1FA0E, 1G1FA0EV, 1G1FA0G, 1G1FA0GV, 1G1FAPG, 1G1PE1E...(Other models you can see in the webshop)		

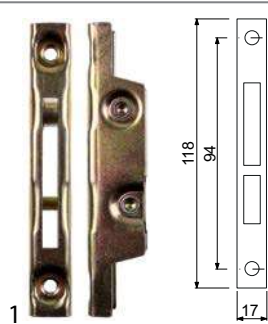

<b>GEV No.</b>	700001	<b>Ref. No.</b>	3094780 36M0120 36M0270
<b>description</b>	opposite support L 118mm W 17mm mounting distance 94mm		
<b>For models:</b>	08WFA4E, 08WFA4G, 08WFAAE, 08WFAAG, 10WTPGE, 12WFA6E, 12WFA6G, 12WFAAE, 12WFAAG, 191FAAE, 191FAAG, 191FABG, 191FADG, 191FAE, 191FAG, 191PE4E, 191TPG, 1A1FA1G, 1A1FA2G, 1A1FA4G, 1A1FA5G, 1A1FAAG, 1A1FABG, 1A1FAS2G, 1A1FASG, 1A1PE4E, 1A1PEFTE, 1A1TP0G, 1A1TP0G-VERS.2002, 1A1FBE, 1B1FAS2G, 1B1FASG, 1D1FA1G, 1D1FA2G, 1D1FA4G, 1D1FA5G, 1D1FAAG, 1D1FABG, 1D1FAS2G, 1D1FASG, 1D1PE4E, 1D1TP0G, 1D1TP0G-VERS.2002, 1D1FBE, 1G1FA0E, 1G1FA0EV, 1G1FA0G, 1G1FA0GV, 1G1FABG, 1G1FAPG...(Other models you can see in the webshop)		



<b>GEV No.</b>	700704 <sup>1</sup>	<b>Ref. No.</b>	36M0190
<b>description</b>	oven hinge mounting distance 120mm lug mounting 13mm lever length 115mm groove distance 7mm spring thickness 2.2mm mounting ear position left/right spring length 52mm W 27mm		

<sup>1</sup>with opposite support



<b>GEV No.</b>	700006	<b>Ref. No.</b>	36M0100 36M2420
<b>description</b>	oven hinge mounting distance 173mm mounting distance 2 105mm lug mounting 14mm lever length 120mm groove distance 11mm spring thickness 3.5mm mounting ear position left spring length 112mm W 25mm		
<b>For models:</b>	08WFA4E, 08WFA4G, 08WFAAE, 08WFAAG, 10WTPGE, 12WFA6E, 12WFA6G, 12WFAAE, 12WFAAG, 191FAAE, 191FAAG, 191FABG, 191FADG, 191FAE, 191FAG, 191PE4E, 191TPG, 1A1FA1G, 1A1FA2G, 1A1FA4G, 1A1FA5G, 1A1FAAG, 1A1FABG, 1A1FAS2G, 1A1FASG, 1A1PE4E, 1A1PEFTE, 1A1TP0G, 1A1TP0G-VERS.2002, 1A1FBE, 1B1FAS2G, 1B1FASG, 1D1FA1G, 1D1FA2G, 1D1FA4G, 1D1FA5G, 1D1FAAG, 1D1FABG, 1D1FAS2G, 1D1FASG, 1D1PE4E, 1D1TP0G, 1D1TP0G-VERS.2002, 1D1FBE, 1G1FA0E, 1G1FA0EV, 1G1FA0G, 1G1FA0GV, 1G1FABG, 1G1FAPG...(Other models you can see in the webshop)		

<b>accessories for</b>	700006			
	<b>GEV No.</b>	700001	<b>Ref. No.</b>	3094780 36M0120 36M0270
	opposite support L 118mm W 17mm mounting distance 94mm			
	<b>GEV No.</b>	700007	<b>Ref. No.</b>	36M0110 36M2430
	oven hinge mounting distance 173mm mounting distance 2 105mm lug mounting 14mm lever length 120mm groove distance 11mm spring thickness 3.5mm mounting ear position right spring length 112mm W 25mm			

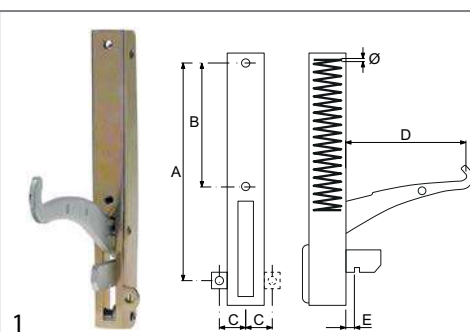

<b>GEV No.</b>	700007	<b>Ref. No.</b>	36M0110 36M2430
<b>description</b>	oven hinge mounting distance 173mm mounting distance 2 105mm lug mounting 14mm lever length 120mm groove distance 11mm spring thickness 3.5mm mounting ear position right spring length 112mm W 25mm		
<b>For models:</b>	08WFA4E, 08WFA4G, 08WFAAE, 08WFAAG, 10WTPGE, 12WFA6E, 12WFA6G, 12WFAAE, 12WFAAG, 191FAAE, 191FAAG, 191FABG, 191FADG, 191FAE, 191FAG, 191PE4E, 191TPG, 1A1FA1G, 1A1FA2G, 1A1FA4G, 1A1FA5G, 1A1FAAG, 1A1FABG, 1A1FAS2G, 1A1FASG, 1A1PE4E, 1A1PEFTE, 1A1TP0G, 1A1TP0G-VERS.2002, 1A1FBE, 1B1FAS2G, 1B1FASG, 1D1FA1G, 1D1FA2G, 1D1FA4G, 1D1FA5G, 1D1FAAG, 1D1FABG, 1D1FAS2G, 1D1FASG, 1D1PE4E, 1D1TP0G, 1D1TP0G-VERS.2002, 1D1FBE, 1G1FA0E, 1G1FA0EV, 1G1FA0G, 1G1FA0GV, 1G1FABG, 1G1FAPG...(Other models you can see in the webshop)		

<b>accessories for</b>	700007			
	<b>GEV No.</b>	700001	<b>Ref. No.</b>	3094780 36M0120 36M0270
	opposite support L 118mm W 17mm mounting distance 94mm			



door bearing

Зип Общепит

vsezip.ru

+7(812)987-08-81

			
1			
<b>GEV No.</b>	690686	<b>Ref. No.</b>	36G2810
<b>description</b>	bush for door hinge		
<b>For models:</b>	40, 40B, 40CP, 40CPX, 40PL, 40X, ART1L7, ART1L7A, ART1L7M, ART1LD7, ART1LD7A, ART1LD7M, BRPR, BRPR218, BRPR21C, BRPRV, BRVR, BRVR218, BRVR21C, BRVRV, K16APGPZ, K16XPZAP, SA16AGB, SA16GB, SA87, SM03LT7, SM03LT7A, SM03LT7M, SM1L7, SM1L7A, SM1L7FCV, SM1L7M, SM1LT7, SM1LT7A, SM1LT7M		

			
1			
<b>GEV No.</b>	690742	<b>Ref. No.</b>	36D4610
<b>description</b>	bush for door hinge		
<b>For models:</b>	6BEA11Z, 6BEA2Z, 6BEA3Z, 6BEABA, 6BEABB, 6BEABM, 6BEABZ, 6BEAZ, 6BEB11Z, 6BEB22Z, 6BEB2Z, 6BEB3Z, 6BEB4Z, 6BEBBA, 6BEBB, 6BEBBM, 6BEBBZ, 6BEBZ, 6BEC11Z, 6BEC22Z, 6BEC2Z, 6BEC33Z, 6BEC3Z, 6BEC4Z, 6BEC6Z, 6BECBA, 6BECBB, 6BECBM, 6BECBZ, 6BECZ, 6BMA11A, 6BMA11B, 6BMA11M, 6BMA11Z, 6BMA2A, 6BMA2B, 6BMA2M, 6BMA2Z, 6BMA3A, 6BMA3B, 6BMA3M, 6BMA3Z, 6BMAA, 6BMAB, 6BMABA, 6BMABB, 6BMABM, 6BMABZ, 6BMAM, 6BMAZ... (Other models you can see in the webshop)		

			
1			
<b>GEV No.</b>	690743	<b>Ref. No.</b>	36D4700
<b>description</b>	bush for door hinge		
<b>For models:</b>	6BEA11Z, 6BEA2Z, 6BEA3Z, 6BEABA, 6BEABB, 6BEABM, 6BEABZ, 6BEAZ, 6BEB11Z, 6BEB22Z, 6BEB2Z, 6BEB3Z, 6BEB4Z, 6BEBBA, 6BEBB, 6BEBBM, 6BEBBZ, 6BEBZ, 6BEC11Z, 6BEC22Z, 6BEC2Z, 6BEC33Z, 6BEC3Z, 6BEC4Z, 6BEC6Z, 6BECBA, 6BECBB, 6BECBM, 6BECBZ, 6BECZ, 6BMA11Z, 6BMA2Z, 6BMA3Z, 6BMABA, 6BMABB, 6BMABM, 6BMABZ, 6BMAZ, 6BMB11Z, 6BMB22Z, 6BMB2Z, 6BMB3Z, 6BMB4Z, 6BMBBZ, 6BMBZ, 6BMC11Z, 6BMC22Z, 6BMC2Z, 6BMC33Z, 6BMC3Z... (Other models you can see in the webshop)		

			
1			
<b>GEV No.</b>	695571	<b>Ref. No.</b>	36M0090
<b>description</b>	bush for door hinge		
<b>For models:</b>	135-4, 135CPX, 135X-3, 135X-4, 65BX-2, 65NB, 65NBX, 65NN, 65NNX, 65X-2, CX140CP, CX150CP, CX652, CX65NB, CX65NCP, CX65NN, CX702, CX70NB, CX70NN, FSD2B2-OPR01, FSD2N2, FSD2N2-OPR01, FSDR2B2-OPR01, FSE2B2, FSE2B2-OPR01, FSE2N2, FSE2N2-OPR01, FSER2B2-OPR01, FSER2N2-OPR01, ISFEB, ISFEB-OPR01, ISFEN, ISFEN-OPR01, MD1504, MD150B4, MD702, MD70B2, MD70NB, MD70NCP, MD70NN, PD150CP, PD702, PD70B2, S12004, S1200B4, S125-4, S125B-4, S125BX-4, S125X-4, S6002... (Other models you can see in the webshop)		

			
1			
<b>GEV No.</b>	690479	<b>Ref. No.</b>	3170250
<b>description</b>	bush H 20mm ø 7mm mounting measurements 22x22mm external size 26.5x26.5mm		
<b>For models:</b>	135-4, 135CPX, 135X-3, 135X-4, 65BX-2, 65NB, 65NBX, 65NN, 65NNX, 65X-2, SP135CP, SP65NB, SP65NN		

			
1			
<b>GEV No.</b>	690795	<b>Ref. No.</b>	36D9490
<b>description</b>	counterpart for spring hinge		
<b>For models:</b>	120, 120B, 120NN, 135, 135-4, 135A, 135B, 135BA, 135BN, 135BNX, 135BX, 135BXE, 135BXR, 135CPX, 135NN, 135NNX, 135X, 135X-3, 135X-4, 135XE, 135XR, 55, 55B, 65, 65A, 65B, 65BA, 65BX, 65BX-2, 65BXE, 65BXR, 65NB, 65NBX, 65NN, 65NNX, 65X, 65X-2, 65XE, 65XR, ART1L, ART1LA, ART1LD, ART1LDA, ART2LD, ART2SD, ART3SD, S125, S125-4, S125B, S125B-4... (Other models you can see in the webshop)		

			
1			
<b>GEV No.</b>	691157	<b>Ref. No.</b>	30T2000
<b>description</b>	door hinge mounting pos. bottom right		

			
1			
<b>GEV No.</b>	690563	<b>Ref. No.</b>	3AG0040
<b>description</b>	hinge		

			
1			
<b>GEV No.</b>	690489	<b>Ref. No.</b>	30T5910
<b>description</b>	hinge L 138mm mounting pos. upper/lower		
<b>For models:</b>	135-4, 135CPX, 135X-3, 135X-4, 65BX-2, 65NB, 65NBX, 65NN, 65NNX, 65X-2, S125-4, S125B-4, S125BX-4, S125X-4, S60-2, S60B-2, S60BX-2, S60X-2, SP135CP, SP65NB, SP65NN		

Зип Общепит

vsezip.ru

+7(812)987 08 81

			
1			
<b>GEV No.</b>	695570	<b>Ref. No.</b>	36M2490
<b>description</b>	hinge mounting pos. bottom left		
<b>For models:</b>	71CP, 71CP2, 71F, 71F2, 71F2B, 71FE, 71FE2, 71FE2B, 91CP, 91F210, 91F210B, 91F223B		

			
1			
<b>GEV No.</b>	690793	<b>Ref. No.</b>	30T4780
<b>description</b>	hinge mounting pos. bottom right		
<b>For models:</b>	120PV, 135PVX, 55PV, 65PVX		

			
1			
<b>GEV No.</b>	690788	<b>Ref. No.</b>	36M0320 36M2610
<b>description</b>	hinge mounting pos. centre with bolt		

			
1			
<b>GEV No.</b>	700740	<b>Ref. No.</b>	3043190 3088700
<b>description</b>	hinge mounting pos. lower		
<b>For models:</b>	3G65A, 3G65A2, 3G65A4, 4G65B, 4G65B2, 4G65B4, 4G65B6, 6BR15V, 6BR15VC, 6BR19V, 6BR19VC, 6EA, 6EA11, 6EA11A, 6EA11M, 6EA13, 6EA13A, 6EA13M, 6EA2, 6EA2A, 6EA2M, 6EAA, 6EAB, 6EABA, 6EABM, 6EAM, 6EB, 6EB11, 6EB11A, 6EB11M, 6EB13, 6EB13A, 6EB13M, 6EB2, 6EB22, 6EB22A, 6EB22M, 6EB2A, 6EB2M, 6EB4, 6EB4A, 6EB4M, 6EBA, 6EBB, 6EBBA, 6EBBM, 6EBM, 6EC, 6EC11, 6EC11A...(Other models you can see in the webshop)		

			
1			
<b>GEV No.</b>	700741	<b>Ref. No.</b>	3043180
<b>description</b>	hinge mounting pos. upper		
<b>For models:</b>	3G65A, 3G65A2, 3G65A4, 4G65B, 4G65B2, 4G65B4, 4G65B6, 6BR15V, 6BR15VC, 6BR19V, 6BR19VC, 6EA, 6EA11, 6EA11A, 6EA11M, 6EA13, 6EA13A, 6EA13M, 6EA2, 6EA2A, 6EA2M, 6EAA, 6EAB, 6EABA, 6EABM, 6EAM, 6EB, 6EB11, 6EB11A, 6EB11M, 6EB13, 6EB13A, 6EB13M, 6EB2, 6EB22, 6EB22A, 6EB22M, 6EB2A, 6EB2M, 6EB4, 6EB4A, 6EB4M, 6EBA, 6EBB, 6EBBA, 6EBBM, 6EBM, 6EC, 6EC11, 6EC11A...(Other models you can see in the webshop)		

			
1			
<b>GEV No.</b>	690787	<b>Ref. No.</b>	30T1980
<b>description</b>	hinge mounting pos. upper left		

			
1			
<b>GEV No.</b>	690794	<b>Ref. No.</b>	30T4800
<b>description</b>	hinge mounting pos. upper left		
<b>For models:</b>	120PV, 135PVX		

			
1			
<b>GEV No.</b>	690790	<b>Ref. No.</b>	30T1080
<b>description</b>	hinge mounting pos. upper right		

			
1			
<b>GEV No.</b>	700719	<b>Ref. No.</b>	36M2541
<b>description</b>	hinge mounting pos. upper right		
<b>For models:</b>	30CPS, 30CPSE, 30F1, 30F1B, 30FES2, 30FES2B, 30FS2, 30FS2B, 32TC, 32TCE, 32TPV, 32V, 70CP, 70CPE, 70F, 70F1, 70F1B, 70FE, 70FE1, 70FE1B, 70FES, 70FES2, 70FES2B, 71CP, 71CP2, 71F, 71F2, 71F2B, 71FE, 71FE2, 71FE2B, 72D, 72DGG, 72TP, 72TPGG, 72VA, 72VAGG, 72VAS, 72VASGG, 90CP, 90CPE, 90F110B, 91CP, 91F210, 91F210B, 91F223B		

			
1			
<b>GEV No.</b>	690746	<b>Ref. No.</b>	30T5900
<b>description</b>	hinge bearing mounting pos. centre with bolt		
<b>For models:</b>	135-4, 135CPX, 135X-3, 135X-4, 65BX-2, 65NB, 65NNB, 65NNX, 65X-2, S125-4, S125B-4, S125BX-4, S125X-4, S60-2, S60B-2, S60BX-2, S60X-2, SP135CP, SP65NB, SP65NN		



Зип Общепит

vsezip.ru

+7(812)98708181



1

<b>GEV No.</b>	690741	<b>Ref. No.</b>	30T6230
<b>description</b>	hinge bearing mounting pos. lower with bolt		
<b>For models:</b>	6BEA11Z, 6BEA2Z, 6BEA3Z, 6BEABA, 6BEABB, 6BEABM, 6BEABZ, 6BEAZ, 6BEB11Z, 6BEB22Z, 6BEB2Z, 6BEB3Z, 6BEB4Z, 6BEBBA, 6BEBBB, 6BEBBM, 6BEBBZ, 6BEBZ, 6BEC11Z, 6BEC22Z, 6BEC2Z, 6BEC33Z, 6BEC3Z, 6BEC4Z, 6BEC6Z, 6BECBA, 6BECBB, 6BECBM, 6BECBZ, 6BECZ, 6BMA11Z, 6BMA2Z, 6BMA3Z, 6BMABA, 6BMABB, 6BMABM, 6BMABZ, 6BMAZ, 6BMB11Z, 6BMB22Z, 6BMB2Z, 6BMB3Z, 6BMB4Z, 6BMBBA, 6BMBBB, 6BMBBM, 6BMBBZ, 6BMBZ, 6BMC11Z, 6BMC22Z...(Other models you can see in the webshop)		



1

<b>GEV No.</b>	690672	<b>Ref. No.</b>	30T5970
<b>description</b>	hinge bearing mounting pos. upper left with bolt		
<b>For models:</b>	120PV, 135PVX		



1

<b>GEV No.</b>	690755	<b>Ref. No.</b>	30T1950
<b>description</b>	hinge bearing mounting pos. lower with bolt		



1

<b>GEV No.</b>	690792	<b>Ref. No.</b>	30T4810
<b>description</b>	hinge bearing mounting pos. upper left with bolt		



1

<b>GEV No.</b>	690749	<b>Ref. No.</b>	36M2740
<b>description</b>	hinge bearing mounting pos. lower without bolt		
<b>For models:</b>	K16APGPZ, K16XPZAP, SA16AGB, SA16GB		



1

<b>GEV No.</b>	690671	<b>Ref. No.</b>	30T5800
<b>description</b>	hinge bearing mounting pos. upper right with bolt		
<b>For models:</b>	120PV, 135PVX, 55PV, 65PVX		



1

<b>GEV No.</b>	514282	<b>Ref. No.</b>	36M4122
<b>description</b>	hinge bearing mounting pos. right/left without bolt		
<b>For models:</b>	FC101, FC101E, FC241, FC241E, FC241G, FC61, FC61E, FCV101, FCV101-CSA, FCV101DM, FCV101DM-CSA, FCV101DS, FCV101DS-CSA, FCV101E, FCV101EDM, FCV101EDM-UL, FCV101EDS, FCV101EDS-UL, FCV101E-UL, FCV141, FCV141-CSA, FCV141DM, FCV141DM-CSA, FCV141DS, FCV141DS-CSA, FCV141E, FCV141EDM, FCV141EDS, FCV241, FCV241DM, FCV241DS, FCV241E, FCV241EDM, FCV241EDM-UL, FCV241EDS, FCV241EDS-UL, FCV241E-UL, FCV241G, FCV241G-CSA, FCV241GDM, FCV241GDM-CSA, FCV241GDS, FCV241GDS-CSA, FCV3EM, FCV401DM, FCV401DM-CSA, FCV401EDM, FCV401EDM-UL, FCV4E, FCV4EDS...(Other models you can see in the webshop)		



1

<b>GEV No.</b>	690748	<b>Ref. No.</b>	36M2730
<b>description</b>	hinge bearing mounting pos. upper right with bolt		
<b>For models:</b>	K16APGPZ, K16XPZAP, SA16AGB, SA16GB		



1

<b>GEV No.</b>	690740	<b>Ref. No.</b>	30T6220
<b>description</b>	hinge bearing mounting pos. upper with bolt		
<b>For models:</b>	6BEA11Z, 6BEA2Z, 6BEA3Z, 6BEABA, 6BEABB, 6BEABM, 6BEABZ, 6BEAZ, 6BEB11Z, 6BEB22Z, 6BEB2Z, 6BEB3Z, 6BEB4Z, 6BEBBA, 6BEBBB, 6BEBBM, 6BEBBZ, 6BEBZ, 6BEC11Z, 6BEC22Z, 6BEC2Z, 6BEC33Z, 6BEC3Z, 6BEC4Z, 6BEC6Z, 6BECBA, 6BECBB, 6BECBM, 6BECBZ, 6BECZ, 6BMA11Z, 6BMA2Z, 6BMA3Z, 6BMABA, 6BMABB, 6BMABM, 6BMABZ, 6BMAZ, 6BMB11Z, 6BMB22Z, 6BMB2Z, 6BMB3Z, 6BMB4Z, 6BMBBA, 6BMBBB, 6BMBBM, 6BMBBZ, 6BMBZ, 6BMC11Z, 6BMC22Z...(Other models you can see in the webshop)		

Зип Общепит  
vsezip.ru  
+7(812)987-08-81



<b>GEV No.</b>	690684	<b>Ref. No.</b>	35V7760
<b>description</b>	hinge bearing mounting pos. upper without bolt		
<b>For models:</b>	40, 40B, 40CP, 40CPX, 40PL, 40X		



<b>GEV No.</b>	692861	<b>Ref. No.</b>	36E2680
<b>description</b>	hinge bearing without bolt mounting pos. upper right		
<b>For models:</b>	FC1011E, FC1011G, FC1221E, FC1221G, FC611E, FC611G, FM1011E1, FM1011E1-VERS.2006, FM1011E2, FM1011E2-VERS.2006, FM1011E3, FM1011E3-VERS.2006, FM1011G1, FM1011G1-VERS.2006, FM1011G2, FM1011G2-VERS.2006, FM1011G3, FM1011G3-VERS.2006, FM1221E1, FM1221E1-VERS.2006, FM1221E2, FM1221E2-VERS.2006, FM1221E3, FM1221E3-VERS.2006, FM1221G1, FM1221G1-VERS.2006, FM1221G2, FM1221G2-VERS.2006, FM1221G3, FM1221G3-VERS.2006, FM2011E2-VERS.2006, FM2011E3-VERS.2006, FM2011G2-VERS.2006, FM2011G3-VERS.2006, FM2021E1, FM2021E2, FM2021E2-VERS.2006, FM2021E3, FM2021E3-VERS.2006, FM2021G1, FM2021G2, FM2021G2-VERS.2006, FM2021G3, FM2021G3-VERS.2006, FM611E1, FM611E1-VERS.2006, FM611E2, FM611E2-VERS.2006, FM611E3, FM611E3-VERS.2006... (Other models you can see in the webshop)		



<b>GEV No.</b>	690688	<b>Ref. No.</b>	35V8800
<b>description</b>	hinge bearing mounting pos. upper without bolt		
<b>For models:</b>	40EV, 40EVP, 40PV, 40XPV		



<b>GEV No.</b>	690571	<b>Ref. No.</b>	30T5810
<b>description</b>	hinge bearing with bolt suitable for SAGI		
<b>For models:</b>	120, 120B, 120NN, 135, 135A, 135B, 135BA, 135BN, 135BNX, 135BX, 135BXE, 135BXR, 135CPX, 135NN, 135NNX, 135X, 135X-3, 135XE, 135XR, 55, 55B, 65, 65A, 65B, 65BA, 65BX, 65BXE, 65BXR, 65X, 65XE, 65XR, S125, S125B, S125BE, S125BX, S125E, S125X, S60, S60B, S60BE, S60BX, S60E, S60X, SP120, SP120B, SP120BN, SP120NN, SP135, SP135B, SP135BN...(Other models you can see in the webshop)		



<b>GEV No.</b>	505513	<b>Ref. No.</b>	30T1350
<b>description</b>	spring assisted hinge left		
<b>For models:</b>	F60P, F60PR, F60T, F80P, F80PR		



<b>GEV No.</b>	690751	<b>Ref. No.</b>	30T2051
<b>description</b>	hinge bearing with bolt suitable for SAGI		
<b>For models:</b>	K16APGPZ, K16XPZAP, SA16AGB, SA16GB		



<b>GEV No.</b>	505512	<b>Ref. No.</b>	30T1340
<b>description</b>	spring assisted hinge right		
<b>For models:</b>	F60P, F60PR, F60T, F80P, F80PR		



<b>GEV No.</b>	692862	<b>Ref. No.</b>	3108730
<b>description</b>	hinge bearing without bolt mounting pos. bottom right		
<b>For models:</b>	BX101E, BX101E-VERS.122013, BX101G, BX101G-VERS.122013, BX122E, BX122E-VERS.122013, BX122G, BX122G-VERS.122013, BX61E, BX61E-VERS.122013, BX61G, BX61G-VERS.122013, BX82E, BX82E-VERS.122013, BX82G, BX82G-VERS.122013, FX101E1, FX101E1R, FX101E2, FX101E2C, FX101E2C-VERS.032014, FX101E2R, FX101E2R-VERS.032014, FX101E2-VERS.032014, FX101E3, FX101E3C, FX101E3C-VERS.022014, FX101E3R, FX101E3R-VERS.022014, FX101E3-VERS.022014, FX101G1, FX101G1R, FX101G2, FX101G2C, FX101G2C-VERS.032014, FX101G2R, FX101G2R-VERS.032014, FX101G2-VERS.032014, FX101G3, FX101G3C, FX101G3C-VERS.022014, FX101G3R, FX101G3R-VERS.022014, FX101G3-VERS.022014, FX10E2CR, FX10E2CR-VERS.032014, FX10E3CR, FX10E3CR-VERS.022014, FX10G2CR, FX10G2CR-VERS.032014...(Other models you can see in the webshop)		

**miscellaneous**



Image not available

<b>GEV No.</b>	700715	<b>Ref. No.</b>	30T3150
<b>description</b>	hinge mounting pos. left/right		
<b>For models:</b>	L45		



Зип Общепит

vsezip.ru

+7(812)987-08-81

			
1			
<b>GEV No.</b>	698474	<b>Ref. No.</b>	36E2820
<b>description</b>	hinge block total length 50mm overall height 14mm suitable for ANGELO PO		
<b>For models:</b>	FC1011E, FC1011G, FC1221E, FC1221G, FC611E, FC611G, FM1011E1, FM1011E1-VERS.2006, FM1011E2, FM1011E2-VERS.2006, FM1011E3, FM1011E3-VERS.2006, FM1011G1, FM1011G1-VERS.2006, FM1011G2, FM1011G2-VERS.2006, FM1011G3, FM1011G3-VERS.2006, FM1221E1, FM1221E1-VERS.2006, FM1221E2, FM1221E2-VERS.2006, FM1221E3, FM1221E3-VERS.2006, FM1221G1, FM1221G1-VERS.2006, FM1221G2, FM1221G2-VERS.2006, FM1221G3, FM1221G3-VERS.2006, FM2011E2-VERS.2006, FM2011E3-VERS.2006, FM2011G2-VERS.2006, FM2011G3-VERS.2006, FM2021E1, FM2021E2, FM2021E2-VERS.2006, FM2021E3, FM2021E3-VERS.2006, FM2021G1, FM2021G2, FM2021G2-VERS.2006, FM2021G3, FM2021G3-VERS.2006, FM611E1, FM611E1-VERS.2006, FM611E2, FM611E2-VERS.2006, FM611E3, FM611E3-VERS.2006... (Other models you can see in the webshop)		

			
1			
<b>GEV No.</b>	690689	<b>Ref. No.</b>	35X3460
<b>description</b>	spacer ring		
<b>For models:</b>	40EV, 40EVP, 40PV, 40XPV		

accessories

miscellaneous

			
1			
<b>GEV No.</b>	692864	<b>Ref. No.</b>	3108741
<b>description</b>	hinge bearing latching with bolt mounting pos. bottom right		

			
1			
<b>GEV No.</b>	692863	<b>Ref. No.</b>	36E2660
<b>description</b>	hinge bearing latching without bolt mounting pos. bottom right		
<b>For models:</b>	FC1011E, FC1011G, FC1221E, FC1221G, FC611E, FC611G, FM1011E1, FM1011E1-VERS.2006, FM1011E2, FM1011E2-VERS.2006, FM1011E3, FM1011E3-VERS.2006, FM1011G1, FM1011G1-VERS.2006, FM1011G2, FM1011G2-VERS.2006, FM1011G3, FM1011G3-VERS.2006, FM1221E1, FM1221E1-VERS.2006, FM1221E2, FM1221E2-VERS.2006, FM1221E3, FM1221E3-VERS.2006, FM1221G1, FM1221G1-VERS.2006, FM1221G2, FM1221G2-VERS.2006, FM1221G3, FM1221G3-VERS.2006, FM2011E2-VERS.2006, FM2011E3-VERS.2006, FM2011G2-VERS.2006, FM2011G3-VERS.2006, FM2021E1, FM2021E2, FM2021E2-VERS.2006, FM2021E3, FM2021E3-VERS.2006, FM2021G1, FM2021G2, FM2021G2-VERS.2006, FM2021G3, FM2021G3-VERS.2006, FM611E1, FM611E1-VERS.2006, FM611E2, FM611E2-VERS.2006, FM611E3, FM611E3-VERS.2006... (Other models you can see in the webshop)		

			
1			
<b>GEV No.</b>	690687	<b>Ref. No.</b>	36D2880
<b>description</b>	plain washer		
<b>For models:</b>	40, 40B, 40CP, 40CPX, 40PL, 40X, SA87		



			
1			
<b>GEV No.</b>	690691	<b>Ref. No.</b>	36C2440
<b>description</b>	spacer ring		
<b>For models:</b>	40EV, 40EVP, 40PV, 40XPV		

pullouts

drawer slides

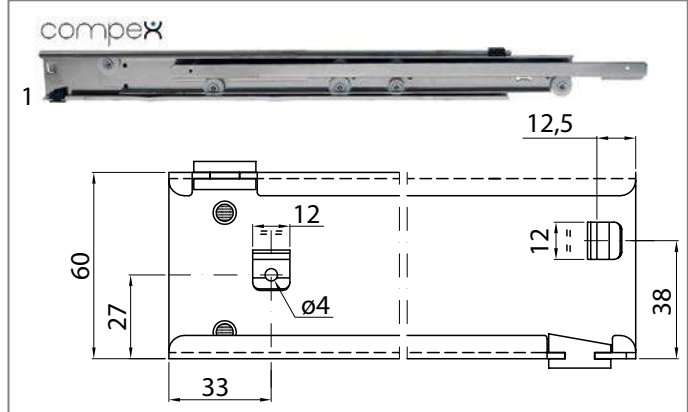
universal



				
1				
<b>GEV No.</b>	696714 <sup>1</sup>	<b>Ref. No.</b>	36M8080 36M8090	
<b>description</b>	drawer slide L 550mm pull-out length 610mm total length 1160mm Qty 1 pair capacity 50kg W 16mm H 60mm SS telescopic			
<b>For models:</b>	3G6SA, 3G6SA2, 3G6SA4, 4G6SB, 4G6SB2, 4G6SB4, 4G6SB6, 6BR15V, 6BR15VC, 6BR19V, 6BR19VC, 6EA11, 6EA11A, 6EA11M, 6EA13, 6EA13A, 6EA13M, 6EA2, 6EA2A, 6EA2M, 6EB11, 6EB11A, 6EB11M, 6EB13, 6EB13A, 6EB13M, 6EB2, 6EB22, 6EB22A, 6EB22M, 6EB2A, 6EB2M, 6EB4, 6EB4A, 6EB4M, 6EC11, 6EC11A, 6EC11M, 6EC13, 6EC13A, 6EC13M, 6EC2, 6EC22, 6EC22A, 6EC22M, 6EC2A, 6EC2M, 6EC4, 6EC4A, 6EC4M... (Other models you can see in the webshop)			
<b>spare parts for</b>	696714			
	<b>GEV No.</b>	690750	<b>Ref. No.</b>	—
	stop for telescopic rail L 20mm plastic H 12mm D 9mm			
	<b>GEV No.</b>	696333	<b>Ref. No.</b>	—
	stop for telescopic rail L 20mm plastic H 15mm D 8mm			

<sup>1</sup>multiple slide (60mm more than nominal length)

Зип.ОбщениТ

product specification

vsezip.ru

+7 (812) 987-08-81

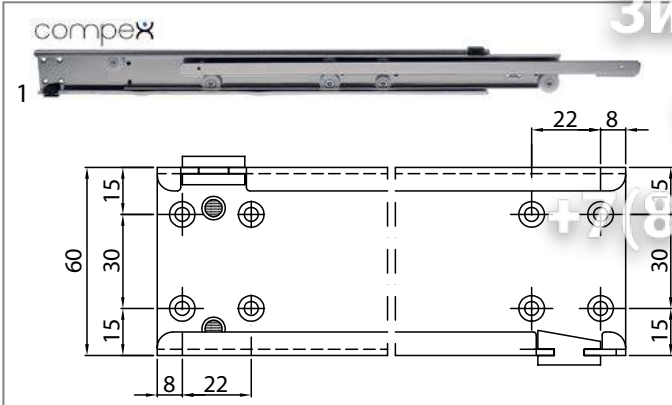

<b>GEV No.</b>	690752 <sup>1</sup>	<b>Ref. No.</b>	36M2700 36M2710 36M4920 36M4940
<b>description</b>	drawer slide L 600mm pull-out length 660mm total length 1260mm Qty 1 pair capacity 45kg H 60mm SS telescopic		
<b>spare parts for</b>	690752		
	<b>GEV No.</b>	690750	<b>Ref. No.</b> —
	stop for telescopic rail L 20mm plastic H 12mm D 9mm		
	<b>GEV No.</b>	696333	<b>Ref. No.</b> —
	stop for telescopic rail L 20mm plastic H 15mm D 8mm		

<sup>1</sup>multiple slide (60mm more than nominal length)

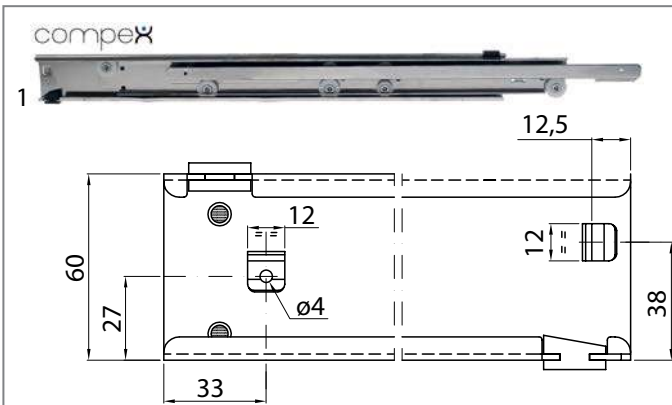

<b>GEV No.</b>	690744 <sup>1</sup>	<b>Ref. No.</b>	36M5380 36M5390
<b>description</b>	drawer slide L 600mm pull-out length 660mm total length 1260mm Qty 1 pair capacity 45kg W 17mm H 60mm mounting pos. right/left SS telescopic		
<b>For models:</b>	6BEA11A, 6BEA11B, 6BEA11M, 6BEA11Z, 6BEA2A, 6BEA2B, 6BEA2M, 6BEA2Z, 6BEA3A, 6BEA3B, 6BEA3M, 6BEA3Z, 6BEB11A, 6BEB11B, 6BEB11M, 6BEB11Z, 6BEB22A, 6BEB22B, 6BEB22M, 6BEB22Z, 6BEB2A, 6BEB2B, 6BEB2M, 6BEB2Z, 6BEB3A, 6BEB3B, 6BEB3M, 6BEB3Z, 6BEB4A, 6BEB4B, 6BEB4M, 6BEB4Z, 6BEC11A, 6BEC11B, 6BEC11M, 6BEC11Z, 6BEC22A, 6BEC22B, 6BEC22M, 6BEC22Z, 6BEC2A, 6BEC2B, 6BEC2M, 6BEC2Z, 6BEC33A, 6BEC33B, 6BEC33M, 6BEC33Z, 6BEC3A, 6BEC3B...(Other models you can see in the webshop)		
<b>spare parts for</b>	690744		
	<b>GEV No.</b>	690750	<b>Ref. No.</b> —
	stop for telescopic rail L 20mm plastic H 12mm D 9mm		
	<b>GEV No.</b>	696333	<b>Ref. No.</b> —
	stop for telescopic rail L 20mm plastic H 15mm D 8mm		

<sup>1</sup>multiple slide (60mm more than nominal length)



<b>GEV No.</b>	690770	<b>Ref. No.</b>	30A2660 36M2660
<b>description</b>	drawer slide L 500mm pull-out length 400mm Qty 1 piece W 23mm mounting pos. left		

rollers

rollers

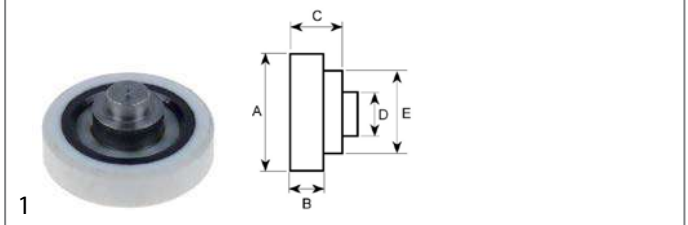

<b>GEV No.</b>	690680	<b>Ref. No.</b>	36G2810
<b>description</b>	roller rollerø 24mm B1 6mm overall width 9mm A 24mm B 6mm C 9mm D 6mm E 10mm ceramic bearing ball bearing		

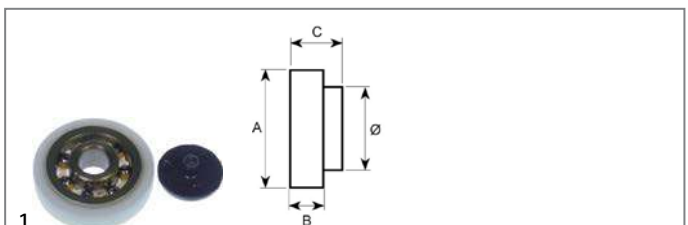

<b>GEV No.</b>	691127	<b>Ref. No.</b>	36F0440
<b>description</b>	roller rollerø 24mm B1 6mm overall width 7.5mm A 24mm B 6mm C 7.5mm ø 10mm plastic tread plastic bore ø 6mm		







1

<b>GEV No.</b>	691197	<b>Ref. No.</b>	36G3940
<b>description</b>	roller rollerø 30mm overall width 10mm A 90mm B 10mm plastic		
<b>For models:</b>	A12A1E, A12B1E, A12B2E, A12M1E, A12Z1E, A12Z2E, A14A1E, A14B1E, A14B2E, A14M1E, A14Z1E, A14Z2E, A16A1E, A16B1E, A16B2E, A16M1E, A16Z1E, A16Z2E, A18A1E, A18B1E, A18B2E, A18M1E, A18Z1E, A18Z2E, A20A1E, A20B1E, A20B2E, A20M1E, A20Z1E, A20Z2E, ACBM, ACBM218, ACPN, ACPN218, AJ12AE, AJ12ME, AJ14AE, AJ14ME, AJ16AE, AJ16ME, AJ18AE, AJ18ME, AJ20AE, AJ20ME, ANBM, ANBM218, ART1LD, ART1LDA, ART2LD, ART2SD... (Other models you can see in the webshop)		
<b>accessories for</b>	691197		
	<b>GEV No.</b>	691126	<b>Ref. No.</b>
			36D4440
	bushing H 11mm for roller		

accessories



1

<b>GEV No.</b>	691126	<b>Ref. No.</b>	36D4440
<b>description</b>	bushing H 11mm for roller		
<b>For models:</b>	A12A1E, A12B1E, A12B2E, A12M1E, A12Z1E, A12Z2E, A14A1E, A14B1E, A14B2E, A14M1E, A14Z1E, A14Z2E, A16A1E, A16B1E, A16B2E, A16M1E, A16Z1E, A16Z2E, A18A1E, A18B1E, A18B2E, A18M1E, A18Z1E, A18Z2E, A20A1E, A20B1E, A20B2E, A20M1E, A20Z1E, A20Z2E, ACBM, ACBM218, ACPN, ACPN218, AJ12AE, AJ12ME, AJ14AE, AJ14ME, AJ16AE, AJ16ME, AJ18AE, AJ18ME, AJ20AE, AJ20ME, ANBM, ANBM218, ART1LD, ART1LDA, ART2LD, ART2SD... (Other models you can see in the webshop)		

fittings for catering equipment

outlet taps

universal



1

<b>GEV No.</b>	540685	<b>Ref. No.</b>	33D0853
<b>description</b>	outlet tap stainless steel angled W 46mm H 40mm thread 3/4" IT		
<b>For models:</b>	030FE1, 030FE1B		

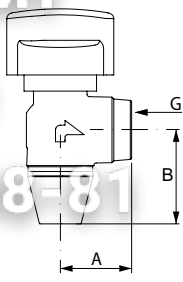



1

<b>GEV No.</b>	540699	<b>Ref. No.</b>	3072720
<b>description</b>	outlet tap W 35mm H 35mm thread 3/4" IT		
<b>For models:</b>	6BM, 6CP, 6FR		

producer-specific

ANGELO PO



1

<b>GEV No.</b>	540683	<b>Ref. No.</b>	36D4080
<b>description</b>	adapter thread		
<b>For models:</b>	030BME, 030EBM, 030FE, 031BME, 031EBM		



1

<b>GEV No.</b>	540730	<b>Ref. No.</b>	33D0170
<b>description</b>	ball valve connection 3/4" IT - 3/4" IT DN20 total length 70mm with lever handle length 95mm		
<b>For models:</b>	030BME, 030EBM, 030FE, 031BME, 031EBM, 070BM, 070BME, 071BM, 071BME, 090BM, 090BME, 091BM, 091BME, 30F, 30FES, 30FS, 70FES		



1

<b>GEV No.</b>	540681	<b>Ref. No.</b>	36D4070
<b>description</b>	drain pipe L 97mm thread 3/4" ET		
<b>For models:</b>	030BME, 030FE, 031BME		



1

<b>GEV No.</b>	514153	<b>Ref. No.</b>	3AZ0100
<b>description</b>	drain pipe thread		
<b>For models:</b>	091FR1E, 091FR1EA, 091FR1ED, 091FR1G, 091FR1GD, 091FR1I, 091FR1IA, 091FR1ID, 091FR1I-VERS.032012, 091FR7G, 091FR7G-VERS.052012, 0A1FR1E, 0A1FR1ED, 0A1FR1G, 0A1FR1GD, 0A1FR1GD-VERS.2004, 0A1FR1G-VERS.2004, 0B1FR1G, 0B1FR1GD, 0D1FR1E, 0D1FR1ED, 0D1FR1G, 0D1FR1GD, 0D1FR1GD-VERS.2004, 0D1FR1G-VERS.2004, 191FR2E, 191FR2ED, 191FR2G, 191FR2GD, 191FR2I, 191FR2ID, 191FR2I-VERS.032012, 1A1FR2E, 1A1FR2ED, 1A1FR2G, 1A1FR2GD, 1A1FR2GD-VERS.2004, 1A1FR2G-VERS.2004, 1D1FR2ED, 1D1FR2G, 1D1FR2GD, 1D1FR2GD-VERS.2004, 1D1FR2G-VERS.2004, 70F1, 70F1B, 70FE1, 70FE1B, 71F2, 71F2B, 71FE2... (Other models you can see in the webshop)		

Зип Общепит





vsezip.ru





(812)987-08-81

			
<b>1</b>			
<b>GEV No.</b>	541530	<b>Ref. No.</b>	3268961 3AZ0090
<b>description</b>	drain pipe thread		
<b>For models:</b>	04WFR3ED, 06WFR3GD, 08WFR4ED, 091FE28, 091FE28B, 091FR3E, 091FR3ED, 091FR3G, 091FR3GD, 0A1FR3E, 0A1FR3ED, 0A1FR3G, 0A1FR3GD, 0D1FR3E, 0D1FR3ED, 0D1FR3G, 0D1FR3GD, 0G1FR3G, 0G1FR3GD, 0G1FR7G, 10WFR4GD, 191FR4E, 191FR4ED, 191FR4G, 191FR4GD, 1A1FR4E, 1A1FR4ED, 1A1FR4G, 1A1FR4GD, 1D1FR4E, 1D1FR4ED, 1D1FR4G, 1D1FR4GD, 1G1FR4G, 1G1FR4GD, 1G1FR8G, 30F1, 30F1B, 30FES2, 30FES2B, 30FS2, 30FS2B, 90F110B, 91F210, 91F210B		

			
<b>1</b>			
<b>GEV No.</b>	540684	<b>Ref. No.</b>	33Q5020
<b>description</b>	drain pipe thread total length 54mm shaft intake ø 22mm		
<b>For models:</b>	030BME, 030EBM, 030FE, 031BME, 031EBM		

			
<b>1</b>			
<b>GEV No.</b>	540952	<b>Ref. No.</b>	33D2840
<b>description</b>	outlet tap L 84mm fryer lever handle grommet ø 30mm grommet length 29mm thread 3/4" IT handle length 81mm		
<b>For models:</b>	0M0BME, 0M0FR1E, 0M0FR1G, 1M0BME, 1M0CP1E, 1M0FR2E, 1M0FR2G		

			
<b>1</b>			
<b>GEV No.</b>	540759	<b>Ref. No.</b>	3111510 33D1760
<b>description</b>	outlet tap without handle thread 1" IT		
<b>For models:</b>	091FR1E, 091FR1EA, 091FR1ED, 091FR1G, 091FR1GD, 091FR1I, 091FR1IA, 091FR1ID, 091FR1ID-VERS.052012, 091FR1I-VERS.032012, 091FR7G, 091FR7G-VERS.052012, 0A1FR1E, 0A1FR1ED, 0A1FR1G, 0A1FR1GD, 0A1FR1GD-VERS.2004, 0A1FR1G-VERS.2004, 0B1FR1G, 0B1FR1GD, 0D1FR1E, 0D1FR1ED, 0D1FR1G, 0D1FR1GD, 0D1FR1GD-VERS.2004, 0D1FR1G-VERS.2004, 191FR2E, 191FR2ED, 191FR2G, 191FR2GD, 191FR2I, 191FR2ID, 191FR2ID-VERS.092012, 191FR2I-VERS.032012, 1A1FR2E, 1A1FR2ED, 1A1FR2G, 1A1FR2GD, 1A1FR2GD-VERS.2004, 1A1FR2G-VERS.2004, 1D1FR2ED, 1D1FR2G, 1D1FR2GD, 1D1FR2GD-VERS.2004, 1D1FR2G-VERS.2004, 70F1, 70F1B, 70FE1, 70FE1B, 71F2...(Other models you can see in the webshop)		
<b>spare parts for</b>	540759		
	<b>GEV No.</b>	504561	<b>Ref. No.</b> 3151080
	O-ring EPDM thickness 2.62mm ID ø 29.82mm Qty 1 pcs		
<b>accessories for</b>	540759		
	<b>GEV No.</b>	504561	<b>Ref. No.</b> 3151080
	O-ring EPDM thickness 2.62mm ID ø 29.82mm Qty 1 pcs		
	<b>GEV No.</b>	540530	<b>Ref. No.</b> —
	handle plastic white L 109mm		
	<b>GEV No.</b>	541529	<b>Ref. No.</b> —
	drain pipe L 110mm thread		

			
<b>1</b>			
<b>GEV No.</b>	540689	<b>Ref. No.</b>	33D1770
<b>description</b>	outlet tap without handle thread 3/4" IT		
<b>For models:</b>	04WFR3ED, 06WFR3GD, 08WFR4ED, 091FE28, 091FE28B, 091FR3E, 091FR3ED, 091FR3G, 091FR3GD, 0A1FR3E, 0A1FR3ED, 0A1FR3G, 0A1FR3GD, 0D1FR3E, 0D1FR3ED, 0D1FR3G, 0D1FR3GD, 0G1FR3G, 0G1FR3GD, 0G1FR7G, 10WFR4GD, 191FR4E, 191FR4ED, 191FR4G, 191FR4GD, 1A1FR4E, 1A1FR4ED, 1A1FR4G, 1A1FR4GD, 1D1FR4E, 1D1FR4ED, 1D1FR4G, 1D1FR4GD, 1G1FR4G, 1G1FR4GD, 1G1FR8G, 30F1, 30F1B, 30FES2, 30FES2B, 30FS2, 30FS2B, 6043840, 6043970, 70FES2, 70FES2B, 90F110B, 91F210, 91F210B		
<b>accessories for</b>	540689		
	<b>GEV No.</b>	514217	<b>Ref. No.</b> —
	handle for outlet tap		
	<b>GEV No.</b>	532487	<b>Ref. No.</b> 3150690
	O-ring Viton thickness 2.62mm ID ø 25.07mm Qty 1 pcs		
	<b>GEV No.</b>	541530	<b>Ref. No.</b> 3268961 3AZ0090
	drain pipe thread		

aerators and air bleeders

			
<b>1</b>			
<b>GEV No.</b>	540827	<b>Ref. No.</b>	33G0170
<b>description</b>	aerator and air bleeder thread 3/4" ET chrome-plated L 45mm ø 36mm		
<b>For models:</b>	31PI6, 31PIE6, 71PI10, 71PI10A, 71PIE15, 71PIE15A, 71PV15, 71PV15A, 91PI10, 91PI10A, 91PIE15, 91PIE15A, BPV2, MCF40V, PV200, PV200A, PV300, PV300A		

			
<b>1</b>			
<b>GEV No.</b>	540825	<b>Ref. No.</b>	33G0650
<b>description</b>	aerator and air bleeder thread 3/8" ET WS 24 chrome-plated L 37mm		
<b>For models:</b>	191PI1G, 191PI1GA, 191PI2E, 191PI2EA, 191PI2G, 191PI2GA, 191PI2V, 191PI2VA, 1A1PI1G, 1A1PI1GA, 1A1PI2E, 1A1PI2EA, 1A1PI2G, 1A1PI2GA, 1A1PI2V, 1A1PI2VA, 1D1PI1G, 1D1PI1GA, 1D1PI2E, 1D1PI2EA, 1D1PI2G, 1D1PI2GA, 1D1PI2V, 1D1PI2VA, 2A1PI3G, 2D1PI3G, PV200, PV200A, PV300, PV300A		



steam valves

Зип Общепит

vsezip.ru

+7(812)987-08-81

 <p>1</p>			
<b>GEV No.</b>	520000	<b>Ref. No.</b>	33G0030 33G0031
<b>description</b>	steam valve angled connection 1 1/4" IT total length 52mm H 190mm brass		
<b>For models:</b>	191PI2V, 191PI2VA, 1A1PI2V, 1A1PI2VA, 1D1PI2V, 1D1PI2VA, 71PV15, 71PV15A, PV200, PV200A, PV300, PV300A		
<b>spare parts for</b>	520000		
	<b>GEV No.</b>	541566	<b>Ref. No.</b> —
	 <p>tap head for steam tap 1 1/4" shaft 9x9mm</p>		
	<b>GEV No.</b>	541567	<b>Ref. No.</b> —
	 <p>star handle shaft 9x9mm ø 74mm L 24mm black plastic</p>		

 <p>1</p>			
<b>GEV No.</b>	692705	<b>Ref. No.</b>	36C2590
<b>description</b>	bracket mounting pos. right mounting distance 45mm for lid		
<b>For models:</b>	10CP1EA, 10CP1GA, 12CP1EA, 12CP1GA, 18CP2EA, 18CP2GA, 191BR1E, 191BR1G, 191BR1GA, 191BR2E, 191BR2EA, 191BR2G, 191BR2GA, 191PD1G, 191PD2G, 191PI1G, 191PI1GA, 191PI2E, 191PI2EA, 191PI2G, 191PI2GA, 191PI2V, 191PI2VA, 1A1BR1E, 1A1BR1G, 1A1BR1GA, 1A1BR2E, 1A1BR2EA, 1A1BR2G, 1A1BR2GA, 1A1PD1G, 1A1PD2G, 1A1PI1G, 1A1PI1GA, 1A1PI2E, 1A1PI2EA, 1A1PI2G, 1A1PI2GA, 1A1PI2V, 1A1PI2VA, 1D1BR1E, 1D1BR1G, 1D1BR1GA, 1D1BR2E, 1D1BR2EA, 1D1BR2G, 1D1BR2GA, 1D1PD1G, 1D1PD2G, 1D1PI1G... (Other models you can see in the webshop)		

lid hinges

ANGELO PO

 <p>1</p>			
<b>GEV No.</b>	692704	<b>Ref. No.</b>	36C2600
<b>description</b>	bracket mounting pos. left mounting distance 45mm for lid		
<b>For models:</b>	10CP1EA, 10CP1GA, 12CP1EA, 12CP1GA, 18CP2EA, 18CP2GA, 191BR1E, 191BR1G, 191BR1GA, 191BR2E, 191BR2EA, 191BR2G, 191BR2GA, 191PD1G, 191PD2G, 191PI1G, 191PI1GA, 191PI2E, 191PI2EA, 191PI2G, 191PI2GA, 191PI2V, 191PI2VA, 1A1BR1E, 1A1BR1G, 1A1BR1GA, 1A1BR2E, 1A1BR2EA, 1A1BR2G, 1A1BR2GA, 1A1PD1G, 1A1PD2G, 1A1PI1G, 1A1PI1GA, 1A1PI2E, 1A1PI2EA, 1A1PI2G, 1A1PI2GA, 1A1PI2V, 1A1PI2VA, 1D1BR1E, 1D1BR1G, 1D1BR1GA, 1D1BR2E, 1D1BR2EA, 1D1BR2G, 1D1BR2GA, 1D1PD1G, 1D1PD2G, 1D1PI1G... (Other models you can see in the webshop)		

 <p>1</p>			
<b>GEV No.</b>	692706	<b>Ref. No.</b>	36H0260
<b>description</b>	spindle L 445mm ø 12mm for lid		
<b>For models:</b>	10CP1EA, 10CP1GA, 10CP1IA, 12CP1EA, 12CP1GA, 12CP1IA, 18CP2EA, 18CP2GA, 18CP2IA, 191BR1E, 191BR1G, 191BR1GA, 191BR2E, 191BR2EA, 191BR2G, 191BR2GA, 1A1BR1E, 1A1BR1G, 1A1BR1GA, 1A1BR2E, 1A1BR2EA, 1A1BR2G, 1A1BR2GA, 1D1BR1E, 1D1BR1G, 1D1BR1GA, 1D1BR2E, 1D1BR2EA, 1D1BR2G, 1D1BR2GA, 291BR1E, 291BR1G, 291BR1GA, 291BR2E, 291BR2EA, 291BR2G, 291BR2GA, 2A1BR1E, 2A1BR1G, 2A1BR1GA, 2A1BR2E, 2A1BR2EA, 2A1BR2G, 2A1BR2GA, 2D1BR1E, 2D1BR1G, 2D1BR1GA, 2D1BR2E, 2D1BR2EA, 2D1BR2G... (Other models you can see in the webshop)		

miscellaneous

spare parts



 <p>1</p>			
<b>GEV No.</b>	700683	<b>Ref. No.</b>	36G2680
<b>description</b>	bolt for torsion spring		
<b>For models:</b>	12CP1GA, 12CP1IA, 191BR1E, 191BR1G, 191BR1GA, 191BR2E, 191BR2EA, 191BR2G, 191BR2GA, 191PD1G, 191PD2G, 191PI1G, 191PI1GA, 191PI2E, 191PI2EA, 191PI2G, 191PI2GA, 191PI2V, 191PI2VA, 1A1BR1E, 1A1BR1G, 1A1BR1GA, 1A1BR2E, 1A1BR2EA, 1A1BR2G, 1A1BR2GA, 1A1PD1G, 1A1PD2G, 1A1PI1G, 1A1PI1GA, 1A1PI2E, 1A1PI2EA, 1A1PI2G, 1A1PI2GA, 1A1PI2V, 1A1PI2VA, 1D1BR1E, 1D1BR1G, 1D1BR1GA, 1D1BR2E, 1D1BR2EA, 1D1BR2G, 1D1BR2GA, 1D1PD1G, 1D1PD2G, 1D1PI1G, 1D1PI1GA, 1D1PI2E, 1D1PI2EA, 1D1PI2G... (Other models you can see in the webshop)		

drain taps





brass

drain taps



<b>GEV No.</b>	540131	<b>Ref. No.</b>	33D0080
<b>description</b>	drain tap 1 1/4" IT chrome-plated brass		
<b>spare parts for</b>	540131		
	<b>GEV No.</b>	540213	<b>Ref. No.</b> —
	handle ID ø 5mm L 117mm		
	<b>GEV No.</b>	540461	<b>Ref. No.</b> —
	shim for drain tap		
	<b>GEV No.</b>	540464	<b>Ref. No.</b> —
	nut for drain tap thread 1 1/2"		



<b>GEV No.</b>	540134	<b>Ref. No.</b>	33D2291
<b>description</b>	drain tap 2" IT fixed A 115mm B1 90mm B2 165mm chrome-plated brass		
<b>For models:</b>	191CP1GA, 191PD1G, 191PD2G, 191PI1G, 191PI1GA, 191PI2E, 191PI2EA, 191PI2G, 191PI2GA, 191PI2V, 191PI2VA, 1A1CP1GA, 1A1PD1G, 1A1PD2G, 1A1PI1G, 1A1PI1GA, 1A1PI2E, 1A1PI2EA, 1A1PI2G, 1A1PI2GA, 1A1PI2V, 1A1PI2VA, 1D1CP1GA, 1D1PD1G, 1D1PD2G, 1D1PI1G, 1D1PI1GA, 1D1PI2E, 1D1PI2EA, 1D1PI2G, 1D1PI2GA, 1D1PI2V, 1D1PI2VA, 1G1PD1G, 1G1PI1E, 1G1PI1G, 291PD3G, 291PI3E, 291PI3G, 2A1PD3G, 2A1PI3E, 2A1PI3G, 2D1PI3G, 31PD6, 31PI6, 31PIE6, 71PD10, 71PD15, 71PI10, 71PI10A...(Other models you can see in the webshop)		
<b>spare parts for</b>	540134		
	<b>GEV No.</b>	540214	<b>Ref. No.</b> —
	handle ID ø 6mm L 145mm		
	<b>GEV No.</b>	540462	<b>Ref. No.</b> —
	ring for drain tap		
	<b>GEV No.</b>	540465	<b>Ref. No.</b> —
	nut for drain tap thread 2 3/4"		
<b>accessories for</b>	540134		
	<b>GEV No.</b>	529484	<b>Ref. No.</b> —
	flat gasket fibre ED ø 58mm ID ø 50mm thickness 2mm Qty 1 pcs		

Зип Общепит



vsezip.ru

+7(812)987-08481



<b>GEV No.</b>	540275	<b>Ref. No.</b>	33D0600
<b>description</b>	drain tap 2" IT with union nut A 90mm B 151mm B1 80mm chrome-plated brass		
<b>For models:</b>	31PD6, 31PI6, 31PIE6, 71PD10, 71PD15, 71PI10, 71PI10A, 71PIE15, 71PIE15A, 71PV15, 71PV15A, 91PI10, 91PI10A, 91PIE15, 91PIE15A		
<b>spare parts for</b>	540275		
	<b>GEV No.</b>	540214	<b>Ref. No.</b> —
	handle ID ø 6mm L 145mm		
<b>accessories for</b>	540275		
	<b>GEV No.</b>	529484	<b>Ref. No.</b> —
	flat gasket fibre ED ø 58mm ID ø 50mm thickness 2mm Qty 1 pcs		
	<b>GEV No.</b>	542448	<b>Ref. No.</b> —
	gasket silicone 60x49x2 for drain tap 2"		



<b>GEV No.</b>	540267	<b>Ref. No.</b>	33D2290
<b>description</b>	drain tap connection with union nut thread 2"		
<b>For models:</b>	191CP1GA, 191PD1G, 191PD2G, 191PI1G, 191PI1GA, 191PI2E, 191PI2EA, 191PI2G, 191PI2GA, 191PI2V, 191PI2VA, 1A1CP1GA, 1A1PD1G, 1A1PD2G, 1A1PI1G, 1A1PI1GA, 1A1PI2E, 1A1PI2EA, 1A1PI2G, 1A1PI2GA, 1A1PI2V, 1A1PI2VA, 1D1CP1GA, 1D1PD1G, 1D1PD2G, 1D1PI1G, 1D1PI1GA, 1D1PI2E, 1D1PI2EA, 1D1PI2G, 1D1PI2GA, 1D1PI2V, 1D1PI2VA, 1G1PD1G, 1G1PI1E, 1G1PI1G, 291PD3G, 291PI3E, 291PI3G, 2A1PD3G, 2A1PI3E, 2A1PI3G, 2D1PI3G, 31PD6, 31PI6, 31PIE6, 71PD10, 71PD15, 71PI10, 71PI10A...(Other models you can see in the webshop)		
<b>spare parts for</b>	540267		
	<b>GEV No.</b>	505517	<b>Ref. No.</b> —
	O-ring EPDM thickness 5.34mm ID ø 53.34mm Qty 1 pcs		
	<b>GEV No.</b>	540214	<b>Ref. No.</b> —
	handle ID ø 6mm L 145mm		



Зип Общежит

vsezip.ru

7(812)987-08-81

accessories

1



<b>GEV No.</b>	541485	<b>Ref. No.</b>	3525100
<b>description</b>	screw-in socket for drain tap thread 2" L 167mm		
<b>For models:</b>	71PD10, 71PD15, 71PI10, 71PI10A, 71PIE15, 71PIE15A, 71PV15, 71PV15A, 91PI10, 91PI10A, 91PIE15, 91PIE15A		

test taps

test taps

1

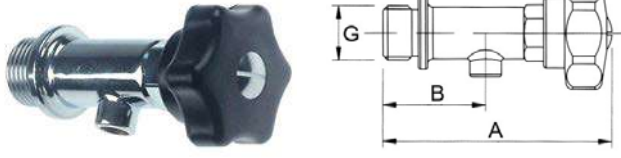

<b>GEV No.</b>	540818	<b>Ref. No.</b>	3028010
<b>description</b>	test tap thread 1/2" ET W 88mm W1 38mm		
<b>For models:</b>	191PI1G, 191PI1GA, 191PI2E, 191PI2EA, 191PI2G, 191PI2GA, 1A1PI1G, 1A1PI1GA, 1A1PI2E, 1A1PI2EA, 1D1PI1G, 1D1PI1GA, 1D1PI2E, 1D1PI2EA, 1G1PI1E, 1G1PI1G, 31PI6, 31PIE6, 71PI10, 71PI10A, 71PIE15, 71PIE15A, 91PI10, 91PI10A, 91PIE15, 91PIE15A		

accessories

1



<b>GEV No.</b>	515105	<b>Ref. No.</b>	37M0590
<b>description</b>	rosette		
<b>For models:</b>	1A1PI1G, 1A1PI1GA, 1A1PI2E, 1A1PI2EA, 1D1PI1G, 1D1PI1GA, 1D1PI2E, 1D1PI2EA, 1G1PI1E, 1G1PI1G, 31PI6, 31PIE6, 71PI10, 71PI10A, 71PIE15, 71PIE15A, 91PI10, 91PI10A, 91PIE15, 91PIE15A		

safety fittings

1



<b>GEV No.</b>	514275	<b>Ref. No.</b>	3006310	
<b>description</b>	safety fitting thread 3/4" 0.45bar with manometer and aerator/air bleeder 3.3kg H 200mm W 150mm			
<b>For models:</b>	191PI1G, 191PI1GA, 191PI2E, 191PI2EA, 191PI2G, 191PI2GA, 191PI2V, 191PI2VA, 1A1PI1G, 1A1PI1GA, 1A1PI2E, 1A1PI2EA, 1A1PI2G, 1A1PI2GA, 1A1PI2V, 1A1PI2VA, 1D1PI1G, 1D1PI1GA, 1D1PI2E, 1D1PI2EA, 1D1PI2G, 1D1PI2GA, 1D1PI2V, 1D1PI2VA, 1G1PI1E, 1G1PI1G, 291PI3E, 291PI3G, 2A1PI3G, 2D1PI3G, PV200, PV200A, PV300, PV300A			
<b>spare parts for</b>	514275			
	<b>GEV No.</b>	514094	<b>Ref. No.</b>	—
	angle piece thread 3/8"			
	<b>GEV No.</b>	514276	<b>Ref. No.</b>	—
	safety fitting thread 3/4" 0.45bar H 165mm ø 65mm			
	<b>GEV No.</b>	540825	<b>Ref. No.</b>	33G0650
	aerator and air bleeder thread 3/8" ET WS 24 chrome-plated L 37mm			
	<b>GEV No.</b>	540828	<b>Ref. No.</b>	—
	manometer siphon thread 3/8"			
	<b>GEV No.</b>	541579	<b>Ref. No.</b>	—
	manometer ø 52mm pressure range 0 up to 1bar connection marking 0.5 thread 1/4"			

accessories

1



<b>GEV No.</b>	540633	<b>Ref. No.</b>	33G0560
<b>description</b>	fitting support thread 1/2" IT		
<b>For models:</b>	1A1PI1G, 1A1PI1GA, 1A1PI2E, 1A1PI2EA, 1A1PI2V, 1A1PI2VA, 1D1PI1G, 1D1PI1GA, 1D1PI2E, 1D1PI2EA, 1D1PI2V, 1D1PI2VA		

1



<b>GEV No.</b>	540821	<b>Ref. No.</b>	33G0130
<b>description</b>	fitting support thread 1/4"		
<b>For models:</b>	31PI6, 31PIE6, 71PI10, 71PI10A, 71PIE15, 71PIE15A, 71PV15, 71PV15A, 91PI10, 91PI10A, 91PIE15, 91PIE15A		

Зип-Общепит

vsezip.ru

+7(812)987-08-81



1

<b>GEV No.</b>	540830	<b>Ref. No.</b>	33G0160
<b>description</b>	pressure gauge tap IT 1/4" ET 1/4"		



1

<b>GEV No.</b>	541501	<b>Ref. No.</b>	33Q4650
<b>description</b>	reducer for safety fitting IT 1 1/4" ET 3/4"		

safety valves



1

<b>GEV No.</b>	540721	<b>Ref. No.</b>	33G0200
<b>description</b>	safety valve triggering pressure 0.5bar M88 thread 1 1/4"		
<b>For models:</b>	31PI6, 31PIE6, 71PI10, 71PI10A, 71PIE15, 71PIE15A, 71PV15, 71PV15A, 91PI10, 91PI10A, 91PIE15, 91PIE15A, PV200, PV200A, PV300, PV300A		
<b>accessories for</b>	540721		
	<b>GEV No.</b>	541501	<b>Ref. No.</b> 33Q4650
	reducer for safety fitting IT 1 1/4" ET 3/4"		



1

<b>GEV No.</b>	540722	<b>Ref. No.</b>	33G0150
<b>description</b>	safety valve with outlet for lid		
<b>For models:</b>	191PI1GA, 191PI2EA, 191PI2GA, 191PI2VA, 1A1PI1GA, 1A1PI2EA, 1A1PI2GA, 1A1PI2VA, 1D1PI1GA, 1D1PI2E, 1D1PI2EA, 1D1PI2GA, 1D1PI2VA, 71PI10A, 71PIE15A, 71PV15A, 91PI10A, 91PIE15A, PV200A, PV300A		

air filters



1

<b>GEV No.</b>	750164	<b>Ref. No.</b>	36D5560
<b>description</b>	air filter L 240mm W 190mm H 5mm		
<b>For models:</b>	AL1433, AL1433V, AL1437, AL1437V, AL1633, AL1633V, AL2033, AL2033V, AL2533, AL2533V, PE1633, PE1633V, PE2033, PE2033V, PM1633, PM1633V, PM2033, PM2033V, PZ1633A, PZ1633B, PZ2033A, PZ2033B, PZ2533A, PZ2533B, SP120, SP120BN, SP120NN, SP135, SP135BN, SP135CP, SP135NN, SP55, SP65, SP65NN		

equipment feet and end caps

equipment feet

with screw mounting



1

<b>GEV No.</b>	701638	<b>Ref. No.</b>	3313390
<b>description</b>	equipment foot tube ø 63.5mm thread M10 IT H 145-230mm SS Qty 1 pcs		

components



1

<b>GEV No.</b>	701091	<b>Ref. No.</b>	6000150
<b>description</b>	equipment foot H 125mm WS 55 1 1/2" IT		



Зип Общепит

vsezip.ru

+7(812)987-08-81

with fixing plate

 <p>1</p>			
<b>GEV No.</b>	701379	<b>Ref. No.</b>	3137690 36C5600
<b>description</b>	equipment foot tube ø 64mm plate size 80-100mm hole distance 60-80mm H 105-155mm SS size 2 1/2" Qty 1 pcs		
<b>For models:</b>	3G6SA, 3G6SA2, 3G6SA4, 4G6SB, 4G6SB2, 4G6SB4, 4G6SB6, 6SA, 6SA2, 6SA2M, 6SAM, 6SB, 6SB2, 6SB2M, 6SBM, AF1B, AF1B-OPR01, AF1N, AF1N-OPR01, AF2B, AF2B-OPR01, AF2N, AF2N-OPR01, AGL6B, B1101S, BF101L, BF101S, C12Q1M, C12Q2M, CX120, CX120B, CX120NN, CX130, CX130B, CX130NN, CX140, CX140B, CX140BN, CX140BR, CX140CP, CX140NN, CX140PV, CX140R, CX150, CX150B, CX150BN, CX150BR, CX150CP, CX150NN, CX150PV...(Other models you can see in the webshop)		

 <p>1</p>			
<b>GEV No.</b>	700708	<b>Ref. No.</b>	36C4540 36C4540 old
<b>description</b>	equipment foot tube ø 64mm plate size 90x90mm hole distance 70x70mm H 140-195mm SS size 2 1/2" Qty 1 pcs		

 <p>2</p>			
<b>GEV No.</b>	700709	<b>Ref. No.</b>	36C5550
<b>description</b>	equipment foot tube ø 64mm plate size 80x100mm hole distance 60x80mm H 115-170mm SS size 2 2/3" Qty 1 pcs		
<b>For models:</b>	3G6SA, 3G6SA2, 3G6SA4, 4G6SB, 4G6SB2, 4G6SB4, 4G6SB6, 6MRA, 6MRA2, 6MRA2A, 6MRA2M, 6MRA2Z, 6MRA4, 6MRA4A, 6MRA4M, 6MRA4Z, 6MRAA, 6MRAM, 6MRAZ, 6MRB, 6MRB11, 6MRB11A, 6MRB11M, 6MRB11Z, 6MRB2, 6MRB2A, 6MRB2M, 6MRB2Z, 6MRB4, 6MRB4A, 6MRB4M, 6MRB4Z, 6MRB6, 6MRB6A, 6MRB6M, 6MRB6Z, 6MRBA, 6MRBM, 6MRBZ, 6MRC, 6MRC11, 6MRC11A, 6MRC11M, 6MRC11Z, 6MRC2, 6MRC2A, 6MRC2M, 6MRC2Z, 6MRC4, 6MRC4A...(Other models you can see in the webshop)		

<p>components</p>  <p>1</p>			
<b>GEV No.</b>	701091	<b>Ref. No.</b>	6000150
<b>description</b>	equipment foot H 125mm WS 55 1 1/2" IT		

 <p>1</p>			
<b>GEV No.</b>	701378	<b>Ref. No.</b>	3145280 36C4540
<b>description</b>	equipment foot tube ø 64mm plate size 80x100mm hole distance 60x80mm H 150-200mm SS size 2 1/2" Qty 1 pcs		
<b>For models:</b>	6BR15V, 6BR15VC, 6BR19V, 6BR19VC, 6EA, 6EA11, 6EA11A, 6EA11M, 6EA13, 6EA13A, 6EA13M, 6EA2, 6EA2A, 6EA2M, 6EAA, 6EAB, 6EABA, 6EABM, 6EAM, 6EB, 6EB11, 6EB11A, 6EB11M, 6EB13, 6EB13A, 6EB13M, 6EB2, 6EB22, 6EB22A, 6EB22M, 6EB2A, 6EB2M, 6EB4, 6EB4A, 6EB4M, 6EBA, 6EBB, 6EBBA, 6EBBM, 6EBM, 6EC, 6EC11, 6EC11A, 6EC11M, 6EC13, 6EC13A, 6EC13M, 6EC2, 6EC22, 6EC22A...(Other models you can see in the webshop)		

 <p>1</p>			
<b>GEV No.</b>	701090	<b>Ref. No.</b>	36D4000
<b>description</b>	equipment foot tube ø 51mm plate size 80mm hole distance 145mm plastic size 2" ET Qty 1 pcs		
<b>For models:</b>	30CPS, 30CPSE, 30F, 30F1, 30F1B, 30FES, 30FES2, 30FES2B, 30FS, 30FS2, 30FS2B, 31, 31GE, 31PD6, 31PI6, 31PIE6, 31R, 31RE, 31TC, 31TCE, 31TP, 32, 32TC, 32TCE, 32TP, 32TPV, 32V, 40, 40B, 40CP, 40CPX, 40EV, 40EVP, 40PV, 40X, 40XPV		

<p>miscellaneous</p>  <p>1</p>			
<b>GEV No.</b>	691162	<b>Ref. No.</b>	36D0160
<b>description</b>	equipment foot H 25mm WS 46 plastic		

Зип, Общепит

Baskets

fryer baskets

vsezip.ru

ANGELO-PO

+7(812)987-08-81



1

<b>GEV No.</b>	691161	<b>Ref. No.</b>	36D0150
<b>description</b>	equipment foot H 41mm WS 56 bottom part plastic		
<b>spare parts for</b>	691161		
	GEV No.	694485	Ref. No. —
	sign for walk-in cold room catch Exit ø 78mm		

## screw-in feet



1

<b>GEV No.</b>	695601	<b>Ref. No.</b>	3095690
<b>description</b>	equipment foot thread M17 thread L 23mm ø 24mm H 11mm plastic WS 24 Qty 1 pcs		



1

<b>GEV No.</b>	697815	<b>Ref. No.</b>	36D4430
<b>description</b>	equipment foot thread M8 thread L 10mm ø 48mm H 47mm rubber Qty 1 pcs		



1

<b>GEV No.</b>	697770	<b>Ref. No.</b>	36D5690
<b>description</b>	equipment foot thread M8 thread L 12mm ø 47mm H 35mm Qty 1 pcs		
<b>For models:</b>	FCV3EM, FCV4E, FCV4EDS, FCV4EM, FM423E1, FM423E2, FMS, FMSX		



1

<b>GEV No.</b>	691122	<b>Ref. No.</b>	36E0010
<b>description</b>	equipment foot thread M8 thread L 24mm ø 38mm H 13mm Qty 1 pcs		
<b>For models:</b>	6CP, 6FA, 6FA1, 6FR, 6FTL, 6FTR, 6PC, 6VTIM, 6VTIMM, 6VTIW, 6VTIWM, 6VTR, 6VTR2, F60P, F60PR, F60T, L45		



1

<b>GEV No.</b>	970547	<b>Ref. No.</b>	3007210 3007220
<b>description</b>	fryer basket L1 280mm W1 225mm H1 115mm		
<b>For models:</b>	04WFR3ED, 06WFR3GD, 08WFR4ED, 091FR3E, 091FR3ED, 091FR3G, 091FR3GD, 0A1FR3E, 0A1FR3ED, 0A1FR3G, 0A1FR3GD, 0D1FR3E, 0D1FR3ED, 0D1FR3G, 0D1FR3GD, 0G0FR3E, 0G0FR3ED, 0G1FR3G, 0G1FR3GD, 0G1FR7G, 10WFR4GD, 191FR4E, 191FR4ED, 191FR4G, 191FR4GD, 1A1FR4E, 1A1FR4ED, 1A1FR4G, 1A1FR4GD, 1D1FR4E, 1D1FR4ED, 1D1FR4G, 1D1FR4GD, 1G0FR4E, 1G1FR4G, 1G1FR4GD, 1G1FR8G, 6043840, 6043970		



1

<b>GEV No.</b>	970175	<b>Ref. No.</b>	36A2640
<b>description</b>	fryer basket L1 288mm W1 190mm H1 115mm L2 570mm H2 135mm H3 185mm chrome-plated steel		
<b>For models:</b>	030FE, 30F, 30FES, 30FS, 70FES		



1

<b>GEV No.</b>	970338	<b>Ref. No.</b>	36A3481
<b>description</b>	fryer basket L1 290mm W1 190mm H1 115mm L2 520mm H2 210mm H3 260mm chrome-plated steel plastic/rubber with holder		
<b>For models:</b>	030FE1, 030FE1B, 091FE28, 091FE28B, 30F1, 30F1B, 30FES2, 30FES2B, 30FS2, 30FS2B, 70FES2, 70FES2B, 90F110B, 91F210, 91F210B		



1

<b>GEV No.</b>	970551	<b>Ref. No.</b>	36A5350
<b>description</b>	fryer basket L1 305mm W1 225mm H1 115mm		





Зип Общепит

vsezip.ru

47(812)987-08-81

			
1			
<b>GEV No.</b>	970172	<b>Ref. No.</b>	36A1300
<b>description</b>	fryer basket L1 315mm W1 210mm H1 120mm L2 495mm H2 170mm chrome-plated steel		

			
1			
<b>GEV No.</b>	970775	<b>Ref. No.</b>	55AL942 C3830AD
<b>description</b>	fryer basket W1 300mm L1 365mm H1 120mm		

			
1			
<b>GEV No.</b>	970174	<b>Ref. No.</b>	36A2020
<b>description</b>	fryer basket L1 368mm W1 150mm H1 120mm L2 700mm H2 140mm H3 200mm chrome-plated steel		
<b>For models:</b>	70F, 70FE, 71F, 71FE		

pasta baskets

ANGELO PO

ANGELO PO

			
1			
<b>GEV No.</b>	970339	<b>Ref. No.</b>	36A3491
<b>description</b>	fryer basket L1 368mm W1 150mm H1 120mm L2 700mm H2 210mm H3 250mm chrome-plated steel		
<b>For models:</b>	70F1, 70F1B, 70FE1, 70FE1B, 71F2, 71F2B, 71FE2, 71FE2B, 91F223B		

			
1			
<b>GEV No.</b>	970952	<b>Ref. No.</b>	55AG018 C3023
<b>description</b>	pasta basket H1 200mm W1 230mm L1 306mm L2 480mm H2 250mm H3 310mm SS holder length 165mm		

			
1			
<b>GEV No.</b>	970340	<b>Ref. No.</b>	36A2340
<b>description</b>	fryer basket L1 370mm W1 150mm H1 120mm chrome-plated steel		
<b>For models:</b>	091FR1E, 091FR1ED, 091FR1G, 091FR1GD, 091FR1I, 091FR1ID, 091FR1ID-VERS.052012, 091FR1I-VERS.032012, 0A1FR1E, 0A1FR1ED, 0A1FR1G, 0A1FR1GD, 0A1FR1GD-VERS.2004, 0A1FR1G-VERS.2004, 0B1FR1G, 0B1FR1GD, 0D1FR1E, 0D1FR1ED, 0D1FR1G, 0D1FR1GD, 0D1FR1GD-VERS.2004, 0D1FR1G-VERS.2004, 191FR2E, 191FR2ED, 191FR2G, 191FR2GD, 191FR2I, 191FR2ID, 191FR2ID-VERS.092012, 191FR2I-VERS.032012, 1A1FR2E, 1A1FR2ED, 1A1FR2G, 1A1FR2GD, 1A1FR2GD-VERS.2004, 1A1FR2G-VERS.2004, 1D1FR2ED, 1D1FR2G, 1D1FR2GD, 1D1FR2GD-VERS.2004, 1D1FR2G-VERS.2004		

			
1			
<b>GEV No.</b>	970678	<b>Ref. No.</b>	C4627
<b>description</b>	pasta basket H1 200mm W1 270mm L1 460mm		

			
1			
<b>GEV No.</b>	970173	<b>Ref. No.</b>	36A0901
<b>description</b>	fryer basket L1 400mm W1 230mm H1 130mm L2 185mm H2 165mm H3 180mm		

			
1			
<b>GEV No.</b>	970563	<b>Ref. No.</b>	3012120 C1011
<b>description</b>	pasta basket L1 110mm W1 100mm H1 150mm size GN 1/8 stainless steel		

Зип Общепит

vsezip.ru

+7(812)987-08-81



1

<b>GEV No.</b>	970565	<b>Ref. No.</b>	3012140
<b>description</b>	pasta basket L1 280mm W1 300mm H1 150mm size GN 3/4 stainless steel		



1

<b>GEV No.</b>	970777	<b>Ref. No.</b>	55AG028 KCP40G
<b>description</b>	pasta basket set 4 pieces L1 265mm H1 200mm W1 115mm		



1

<b>GEV No.</b>	970337	<b>Ref. No.</b>	36A2582
<b>description</b>	pasta basket L1 295mm W1 100mm H1 150mm size GN 2/8 L2 470mm H2 230mm H3 310mm stainless steel		
<b>For models:</b>	30CPS, 30CPSE, 70CP, 70CPE, 71CP, 71CP2, 90CP, 90CPE, 91CP		

accessories



1

<b>GEV No.</b>	692119	<b>Ref. No.</b>	36A4631
<b>description</b>	chargrill grid L 500mm W 296mm H 83mm for pasta cooker		
<b>For models:</b>	06WCP1GM, 08WCP1GM, 091CP1G, 0A1CP1G, 0B1CP1G, 0D1CP1G, 191CP2G, 1A1CP2G, 1D1CP2G, 1G1CP1G, 1G1CP1G-VERS.2004		



1

<b>GEV No.</b>	970564	<b>Ref. No.</b>	3012130 51AL961 C2028
<b>description</b>	pasta basket L1 295mm W1 180mm H1 150mm size GN 1/2 stainless steel		

crumb screens



1

<b>GEV No.</b>	970553	<b>Ref. No.</b>	36A2591
<b>description</b>	crumb screen L 340mm W 330mm H handle 185mm stainless steel suitable for pasta cooker		
<b>For models:</b>	70CP, 71CP2, 90CP		



1

<b>GEV No.</b>	970548	<b>Ref. No.</b>	3240680 C0930
<b>description</b>	pasta basket L1 305mm W1 95mm H1 205mm size GN 2/8 H3 320mm stainless steel		



1

<b>GEV No.</b>	970554	<b>Ref. No.</b>	36A2270
<b>description</b>	crumb screen L 500mm W 295mm H 135mm		
<b>For models:</b>	0A1CP1E, 0A1CP1G, 0D1CP1E, 0D1CP1G, 1A1CP2G, 1D1CP2G		



Зип Общепит  
vsezip.ru  
+7(812)987-08-81

1

  
Image not available

<b>GEV No.</b>	970573	<b>Ref. No.</b>	36A2301
<b>description</b>	crumb screen L 650mm W 340mm H handle 175mm stainless steel suitable for pasta cooker		
<b>For models:</b>	71CP, 91CP		

1



<b>GEV No.</b>	970951	<b>Ref. No.</b>	36A5260
<b>description</b>	grate L 340mm W 240mm H 100mm for pasta cooker		
<b>For models:</b>	0G1CP1E, 0G1CP1EC, 0G1CP1E-VERS.2004, 0G1CP1G, 0G1CP1G-VERS.2004, 1G1CP2G, 1G1CP2G-VERS.2004		

1



<b>GEV No.</b>	970560	<b>Ref. No.</b>	3006800
<b>description</b>	crumb screen L 335mm W 235mm suitable for fryer		
<b>For models:</b>	091FR3E, 091FR3ED, 0A1FR3E, 0A1FR3ED, 0D1FR3E, 0D1FR3ED, 0G0FR3E, 0G0FR3ED, 0G0FR5G, 191FR4E, 191FR4ED, 1A1FR4E, 1A1FR4ED, 1D1FR4E, 1D1FR4ED, 1G0FR4E, 1G0FR6G, 6043840, 6043970, 6FR		

1



<b>GEV No.</b>	970849	<b>Ref. No.</b>	3007230
<b>description</b>	crumb screen L 335mm W 235mm H 148mm fryer		
<b>For models:</b>	091FR3G, 091FR3GD, 0A1FR3G, 0A1FR3GD, 0D1FR3G, 0D1FR3GD, 0G1FR3G, 0G1FR3GD, 0G1FR7G, 191FR4G, 191FR4GD, 1A1FR4G, 1A1FR4GD, 1D1FR4G, 1D1FR4GD, 1G1FR4G, 1G1FR4GD, 1G1FR8G		

1



<b>GEV No.</b>	970552	<b>Ref. No.</b>	36A2320
<b>description</b>	crumb screen L 430mm W 310mm H 190mm suitable for fryer		
<b>For models:</b>	091FR1E, 091FR1ED, 091FR1G, 091FR1GD, 091FR1I, 091FR1ID, 091FR1ID-VERS.052012, 091FR1I-VERS.032012, 0A1FR1E, 0A1FR1ED, 0A1FR1G, 0A1FR1GD, 0A1FR1GD-VERS.2004, 0A1FR1G-VERS.2004, 0B1FR1G, 0B1FR1GD, 0D1FR1E, 0D1FR1ED, 0D1FR1G, 0D1FR1GD, 0D1FR1GD-VERS.2004, 0D1FR1G-VERS.2004, 191FR2E, 191FR2ED, 191FR2G, 191FR2GD, 191FR2I, 191FR2ID, 191FR2ID-VERS.092012, 191FR2I-VERS.032012, 1A1FR2E, 1A1FR2ED, 1A1FR2G, 1A1FR2GD, 1A1FR2GD-VERS.2004, 1A1FR2G-VERS.2004, 1D1FR2ED, 1D1FR2G, 1D1FR2GD, 1D1FR2GD-VERS.2004, 1D1FR2G-VERS.2004		

warewashing baskets

steel wire baskets round

mix baskets

1



<b>GEV No.</b>	970323	<b>Ref. No.</b>	3053810
<b>description</b>	mix basket ED ø 370mm H 145mm seat ø 325mm		

plastic baskets round

1



<b>GEV No.</b>	970699	<b>Ref. No.</b>	3053810
<b>description</b>	mix basket ED ø 380mm H 170mm seat ø 325mm plastic		

1



<b>GEV No.</b>	970949	<b>Ref. No.</b>	36A4641 36A4642
<b>description</b>	crumb screen L 500mm W 295mm H 105mm stainless steel for pasta cooker		
<b>For models:</b>	04WCP1EM, 091CP1E, 6040090, 6040310, 6043850, 6043980		

## shelves and shelf rails

## chargrill grids



1

<b>GEV No.</b>	210042	<b>Ref. No.</b>	3000930 3000931
<b>description</b>	chargrill grid L 470mm W 300mm H 55mm cast iron suitable for ANGELO PO chargrill		
<b>For models:</b>	1G0GRG		

## grates

## universal

## without upstand



1

<b>GEV No.</b>	970120	<b>Ref. No.</b>	36M3540 G610
<b>description</b>	grate W 325mm D 530mm GN 1/1 chrome-plated steel wire gauge frame 7mm lengthwise wires gauge 4mm crossing wires 1		
<b>For models:</b>	31GE, 31TC, 31TCE, 32TC, 32TCE		
<b>accessories for</b>	970120		
	<b>GEV No.</b>	<b>690330</b>	<b>Ref. No.</b> —
	rack L 1000mm W 22mm H 4mm aperture 3x8mm hole distance 12.5mm stainless steel		
	<b>GEV No.</b>	<b>694700</b>	<b>Ref. No.</b> —
	shelf support L 31/28mm W 22mm H 18mm SS Qty 12 pcs		
	<b>GEV No.</b>	<b>694701</b>	<b>Ref. No.</b> —
	shelf support L 31/28mm W 22mm H 17mm SS with hook Qty 12 pcs		

Зип Общепит

vsezip.ru

+7(812)987-08-81



1

<b>GEV No.</b>	970122	<b>Ref. No.</b>	G610X
<b>description</b>	grate W 325mm D 530mm GN 1/1 H 8mm stainless steel wire gauge frame 7mm lengthwise wires gauge 4mm crossing wires 1		
<b>accessories for</b>	970122		
	<b>GEV No.</b>	<b>690330</b>	<b>Ref. No.</b> —
	rack L 1000mm W 22mm H 4mm aperture 3x8mm hole distance 12.5mm stainless steel		
	<b>GEV No.</b>	<b>694700</b>	<b>Ref. No.</b> —
	shelf support L 31/28mm W 22mm H 18mm SS Qty 12 pcs		
	<b>GEV No.</b>	<b>694701</b>	<b>Ref. No.</b> —
	shelf support L 31/28mm W 22mm H 17mm SS with hook Qty 12 pcs		



1

<b>GEV No.</b>	970125	<b>Ref. No.</b>	32A2430 36A2430
<b>description</b>	grate W 325mm D 530mm GN 1/1 plastic-coated steel crossing wires 1 white suitable for refrigerator		
<b>For models:</b>	BRPR218, BRPR21C, BRVR218, BRVR21C, K16APGPZ, K16XPZAP, SA16AGB, SA16GB, SL21RPR, SL21RVR		
<b>accessories for</b>	970125		
	<b>GEV No.</b>	<b>690330</b>	<b>Ref. No.</b> —
	rack L 1000mm W 22mm H 4mm aperture 3x8mm hole distance 12.5mm stainless steel		
	<b>GEV No.</b>	<b>694700</b>	<b>Ref. No.</b> —
	shelf support L 31/28mm W 22mm H 18mm SS Qty 12 pcs		
	<b>GEV No.</b>	<b>694701</b>	<b>Ref. No.</b> —
	shelf support L 31/28mm W 22mm H 17mm SS with hook Qty 12 pcs		



Зип Общежит

vsezip.ru

+7(812)987-08-81



<b>GEV No.</b>	970132	<b>Ref. No.</b>	36A0131
<b>description</b>	grate W 400mm D 600mm plastic-coated steel crossing wires 1 white suitable for refrigerator		
<b>For models:</b>	40, 40-OPR01, 40CP, 40CP-OPR01, 40CPX, 40CPX-OPR01, 40PV, 40PV-OPR01, 40X, 40X-OPR01, 40XPV		
<b>accessories for</b>	970132		
	<b>GEV No.</b>	<b>Ref. No.</b>	—
	rack L 1000mm W 22mm H 4mm aperture 3x8mm hole distance 12.5mm stainless steel		
	<b>GEV No.</b>	<b>Ref. No.</b>	—
	shelf support L 31/28mm W 22mm H 18mm SS Qty 12 pcs		
	<b>GEV No.</b>	<b>Ref. No.</b>	—
	shelf support L 31/28mm W 22mm H 17mm SS with hook Qty 12 pcs		



<b>GEV No.</b>	970123	<b>Ref. No.</b>	G241X
<b>description</b>	grate W 650mm D 530mm GN 2/1 stainless steel wire gauge frame 7.8mm lengthwise wires gauge 3.8mm crossing wires 2 suitable for refrigerator		
<b>accessories for</b>	970123		
	<b>GEV No.</b>	<b>Ref. No.</b>	—
	rack L 1000mm W 22mm H 4mm aperture 3x8mm hole distance 12.5mm stainless steel		
	<b>GEV No.</b>	<b>Ref. No.</b>	—
	shelf support L 31/28mm W 22mm H 18mm SS Qty 12 pcs		
	<b>GEV No.</b>	<b>Ref. No.</b>	—
	shelf support L 31/28mm W 22mm H 17mm SS with hook Qty 12 pcs		

<b>GEV No.</b>	970558	<b>Ref. No.</b>	3012000
<b>description</b>	grate W 325mm D 530mm GN 1/1 chrome-plated iron		
<b>For models:</b>	1G1FA0EV, 1G1FA0GV, 1G1PE1EV, 1G1PE2EV, 2G1FA0GV, 2G1PE1EV, 2G1PE2EV, 31GE, 31TC, 31TCE, 32TC, 32TCE		

<b>GEV No.</b>	970527	<b>Ref. No.</b>	36A0990 G241
<b>description</b>	grate W 530mm D 650mm GN 2/1 chrome-plated steel with hinge camp crossing wires 2 suitable for refrigerator		
<b>accessories for</b>	970527		
	<b>GEV No.</b>	<b>Ref. No.</b>	—
	rack L 1000mm W 22mm H 4mm aperture 3x8mm hole distance 12.5mm stainless steel		
	<b>GEV No.</b>	<b>Ref. No.</b>	—
	shelf support L 31/28mm W 22mm H 18mm SS Qty 12 pcs		
	<b>GEV No.</b>	<b>Ref. No.</b>	—
	shelf support L 31/28mm W 22mm H 17mm SS with hook Qty 12 pcs		

<b>GEV No.</b>	970555	<b>Ref. No.</b>	36A0990
<b>description</b>	grate W 530mm D 650mm GN 2/1 chrome-plated steel with hinge camp for fridge		
<b>For models:</b>	191FAAE, 191FAAG, 191FABG, 191FADG, 191FAE, 191FAG, 191PE4E, 191TPG, 1A1FA1G, 1A1FA2G, 1A1FA4G, 1A1FA5G, 1A1FAAG, 1A1FABG, 1A1FAS2G, 1A1FASG, 1A1PE4E, 1A1PEFTE, 1A1TP0G, 1A1TP0G-VERS.2002, 1A1FBE, 1D1FA1G, 1D1FA2G, 1D1FA4G, 1D1FA5G, 1D1FAAG, 1D1FABG, 1D1FAS2G, 1D1FASG, 1D1PE4E, 1D1TP0G, 1D1TP0G-VERS.2002, 1D1FBE, 1G1FA0E, 1G1FA0G, 1G1FABG, 1G1FAPG, 1G1PE1E, 1G1PE2E, 1G1TP0G, 291FAG, 291TPCG, 2A1FA1G, 2A1FA4G, 2A1FAAG, 2A1FAS2G, 2A1FASG, 2A1TP3G, 2A1TP6G, 2A1TPCG... (Other models you can see in the webshop)		

Зип Общепит

vsezip.ru

+7(812)987-08-81

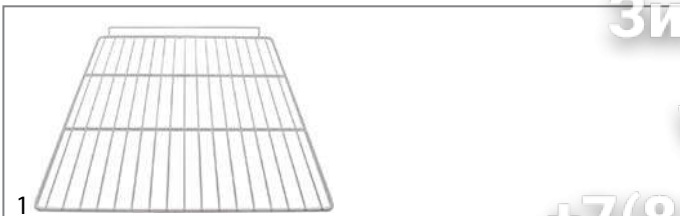

<b>GEV No.</b>	970556	<b>Ref. No.</b>	36A0710 36A1040 36A3630 RGP/2-1
<b>description</b>	grate W 530mm D 650mm GN 2/1 plastic-coated steel with hinge camp wire gauge frame 9mm lengthwise wires gauge 5mm crossing wires 2 white suitable for refrigerator		
<b>For models:</b>	135, 135-4, 135A, 135B, 135BA, 135BN, 135BNX, 135BX, 135BXE, 135BXR, 135CPX, 135NN, 135NNX, 135PVX, 135X, 135X-3, 135X-4, 135XE, 135XR, 65, 65A, 65B, 65BA, 65BX, 65BX-2, 65BXE, 65BXR, 65NB, 65NBX, 65NN, 65NNX, 65PVX, 65X, 65X-2, 65XE, 65XR, CX140, CX140B, CX140BN, CX140BR, CX140CP, CX140NN, CX140PV, CX140R, CX150, CX150B, CX150BN, CX150BR, CX150CP, CX150NN...(Other models you can see in the webshop)		
<b>accessories for</b>	970556		
	<b>GEV No.</b>	<b>Ref. No.</b>	—
	690330		
	rack L 1000mm W 22mm H 4mm aperture 3x8mm hole distance 12.5mm stainless steel		
	<b>GEV No.</b>	<b>Ref. No.</b>	—
	690332		
	shelf support L 31/28mm W 22mm H 17mm SS with hook Qty 1 pcs		
	<b>GEV No.</b>	<b>Ref. No.</b>	—
	694700		
	shelf support L 31/28mm W 22mm H 18mm SS Qty 12 pcs		
	<b>GEV No.</b>	<b>Ref. No.</b>	—
	694701		
	shelf support L 31/28mm W 22mm H 17mm SS with hook Qty 12 pcs		



<b>GEV No.</b>	970643	<b>Ref. No.</b>	36A3010
<b>description</b>	grate W 555mm D 510mm H 60mm plastic-coated steel with hinge camp crossing wires 1		
<b>For models:</b>	120, 120B, 120NN, 120PV, 55, 55B, 55PV, SP120, SP120B, SP120BN, SP120NN, SP55, SP55B		
<b>accessories for</b>	970643		
	<b>GEV No.</b>	<b>Ref. No.</b>	—
	690330		
	rack L 1000mm W 22mm H 4mm aperture 3x8mm hole distance 12.5mm stainless steel		
	<b>GEV No.</b>	<b>Ref. No.</b>	—
	694700		
	shelf support L 31/28mm W 22mm H 18mm SS Qty 12 pcs		
	<b>GEV No.</b>	<b>Ref. No.</b>	—
	694701		
	shelf support L 31/28mm W 22mm H 17mm SS with hook Qty 12 pcs		



<b>GEV No.</b>	970557	<b>Ref. No.</b>	36A3020
<b>description</b>	grate W 555mm D 670mm plastic-coated steel with hinge camp crossing wires 2 suitable for refrigerator		
<b>accessories for</b>	970557		
	<b>GEV No.</b>	<b>Ref. No.</b>	—
	690330		
	rack L 1000mm W 22mm H 4mm aperture 3x8mm hole distance 12.5mm stainless steel		
	<b>GEV No.</b>	<b>Ref. No.</b>	—
	694700		
	shelf support L 31/28mm W 22mm H 18mm SS Qty 12 pcs		
	<b>GEV No.</b>	<b>Ref. No.</b>	—
	694701		
	shelf support L 31/28mm W 22mm H 17mm SS with hook Qty 12 pcs		

grates



<b>GEV No.</b>	210248	<b>Ref. No.</b>	36C4230
<b>description</b>	chimney grate		
<b>For models:</b>	08WFA4E, 08WFA4G, 12WFA6E, 12WFA6G, 12WFAAN, 1B0FAS, 1B0FAS2, 1B1FAS2G, 1B1FASG, 6043590		

grid attachments



<b>GEV No.</b>	695572	<b>Ref. No.</b>	36M7340
<b>description</b>	rack support		
<b>For models:</b>	6MRA, 6MRA2, 6MRA2A, 6MRA2M, 6MRA2Z, 6MRA4, 6MRA4A, 6MRA4M, 6MRA4Z, 6MRAA, 6MRAAM, 6MRAZ, 6MRB, 6MRB11, 6MRB11A, 6MRB11M, 6MRB11Z, 6MRB2, 6MRB2A, 6MRB2M, 6MRB2Z, 6MRB4, 6MRB4A, 6MRB4M, 6MRB4Z, 6MRB6, 6MRB6A, 6MRB6M, 6MRB6Z, 6MRBA, 6MRBM, 6MRBZ, 6MRC, 6MRC11, 6MRC11A, 6MRC11M, 6MRC11Z, 6MRC2, 6MRC2A, 6MRC2M, 6MRC2Z, 6MRC4, 6MRC4A, 6MRC4M, 6MRC4Z, 6MRC6, 6MRC6A, 6MRC6M, 6MRC6Z, 6MRCA...(Other models you can see in the webshop)		



Зип Общепит

vsezip.ru

+7(812)98708781



1

<b>GEV No.</b>	695577	<b>Ref. No.</b>	36G8640
<b>description</b>	rack support L 20mm H 15.5mm W 11mm plastic		
<b>For models:</b>	6JA, 6JA2, 6JA2A, 6JA2M, 6JAA, 6JAM, 6JB, 6JB2, 6JB2A, 6JB2M, 6JB4A, 6JB4M, 6JBA, 6JBM, 6MRA, 6MRA2, 6MRA2A, 6MRA2M, 6MRA2Z, 6MRA4, 6MRA4A, 6MRA4M, 6MRA4Z, 6MRAA, 6MRAM, 6MRAZ, 6MRB, 6MRB11, 6MRB11A, 6MRB11M, 6MRB11Z, 6MRB2, 6MRB2A, 6MRB2M, 6MRB2Z, 6MRB4, 6MRB4A, 6MRB4M, 6MRB4Z, 6MRB6, 6MRB6A, 6MRB6M, 6MRB6Z, 6MRBA, 6MRBM, 6MRBZ, 6MRC, 6MRC11, 6MRC11A, 6MRC11M...(Other models you can see in the webshop)		



1

<b>GEV No.</b>	691925	<b>Ref. No.</b>	35V6610
<b>description</b>	guide U-shape L 430mm W 13mm mounting pos. right inner height 21mm		
<b>For models:</b>	40CP, 40CPX		

shelf rails and supports

producer-specific



1

<b>GEV No.</b>	701465	<b>Ref. No.</b>	3069950
<b>description</b>	guide L-shape L 600mm W 20mm H 30mm mounting pos. left		
<b>For models:</b>	BP53G, BP53V, BP53X, BP64G, BP64V, BP64X, BP83A, BP83G, BP83M, BP83V, BP83X, BP94G, BP94V, BP94X, BPZ16, BPZ163A, BPZ163B, BPZ163S, BPZ167A, BPZ167B, BPZ167S, BPZ20, BPZ203A, BPZ203B, BPZ203S, BPZ207A, BPZ207B, BPZ207S, BPZ25, BPZ253A, BPZ253B, BPZ257A, BPZ257B, BS11, BS11A, BS11M, BS16, BS16A, BS16M, BS21, BS21A, BS21M, BSR11, BSR11A, BSR11M, BSR16, BSR16A, BSR16M, BSR21, BSR21A...(Other models you can see in the webshop)		



1

<b>GEV No.</b>	970888	<b>Ref. No.</b>	35R9140
<b>description</b>	guide U-shape L 638mm W 13mm H 20mm mounting pos. right/left		
<b>For models:</b>	CX140, CX140B, CX140BN, CX140BR, CX140CP, CX140NN, CX140PV, CX140R, CX150, CX150B, CX150BN, CX150BR, CX150CP, CX150NN, CX150PV, CX150R, CX65, CX65B, CX65BR, CX65NB, CX65NCP, CX65NN, CX65PV, CX65R, CX70, CX702, CX70B, CX70BR, CX70NB, CX70NN, CX70PV, CX70R, FX150, FX150B, FX150NN, FX70, FX70B, ISFEB, ISFEN, MD150, MD150A, MD150B, MD150B4, MD150BB, MD150BN, MD150BPV, MD150BR, MD150NCP, MD150NN...(Other models you can see in the webshop)		



1

<b>GEV No.</b>	701466	<b>Ref. No.</b>	3069940
<b>description</b>	guide L-shape L 600mm W 20mm H 30mm mounting pos. right		
<b>For models:</b>	BP53G, BP53V, BP53X, BP64G, BP64V, BP64X, BP83A, BP83G, BP83M, BP83V, BP83X, BP94G, BP94V, BP94X, BPZ16, BPZ163A, BPZ163B, BPZ163S, BPZ167A, BPZ167B, BPZ167S, BPZ20, BPZ203A, BPZ203B, BPZ203S, BPZ207A, BPZ207B, BPZ207S, BPZ25, BPZ253A, BPZ253B, BPZ257A, BPZ257B, BS11, BS11A, BS11M, BS16, BS16A, BS16M, BS21, BS21A, BS21M, BSR11, BSR11A, BSR11M, BSR16, BSR16A, BSR16M, BSR21, BSR21A...(Other models you can see in the webshop)		



1

<b>GEV No.</b>	690657	<b>Ref. No.</b>	36D9470
<b>description</b>	rack L 650mm W 34mm H 57mm mounting pos. vertical		
<b>For models:</b>	120PV, 135, 135-4, 135A, 135B, 135BA, 135BN, 135BNX, 135BX, 135BXE, 135BXR, 135CPX, 135NN, 135NNX, 135X, 135X-3, 135X-4, 135XE, 135XR, 55PV, 65, 65A, 65B, 65BA, 65BX, 65BX-2, 65BXE, 65BXR, 65PVX, 65X, 65X-2, 65XE, 65XR		



1

<b>GEV No.</b>	691841	<b>Ref. No.</b>	35V6620
<b>description</b>	guide U-shape L 430mm W 13mm mounting pos. left inner height 21mm		
<b>For models:</b>	40CP, 40CPX		

## gaskets

## refrigeration gaskets

## plug-in gaskets

## profile 9048

We offer custom-made gaskets for this profile

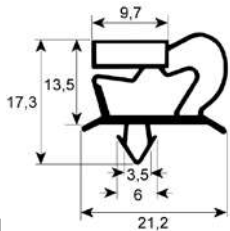

GEV No.	900863	Ref. No.	37Q4730
description	refrigeration gasket profile 9048 W 138mm L 373mm plug size		
For models:	6BMA11A, 6BMA11M, 6BMA11Z, 6BMA3A, 6BMA3M, 6BMA3Z, 6MB11A, 6MB11M, 6MB11Z, 6BMB22A, 6BMB22M, 6BMB22Z, 6BMB3A, 6BMB3M, 6BMB3Z, 6BMC11A, 6BMC11M, 6BMC11Z, 6BMC22A, 6BMC22M, 6BMC22Z, 6BMC33A, 6BMC33M, 6BMC33Z, 6BMC3A, 6BMC3M, 6BMC3Z, 6EA11, 6EA11A, 6EA11M, 6EA13, 6EA13A, 6EA13M, 6EB11, 6EB11A, 6EB11M, 6EB13, 6EB13A, 6EB13M, 6EB22, 6EB22A, 6EB22M, 6EC11, 6EC11A, 6EC11M, 6EC13, 6EC13A, 6EC13M, 6EC22, 6EC22A... (Other models you can see in the webshop)		

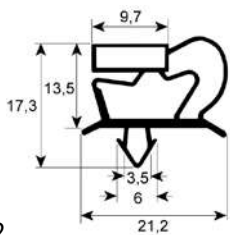

GEV No.	900862	Ref. No.	37Q4720
description	refrigeration gasket profile 9048 W 246mm L 373mm plug size		
For models:	6BMA2A, 6BMA2M, 6BMA2Z, 6BMB2A, 6BMB2M, 6BMB2Z, 6BMB4A, 6BMB4M, 6BMB4Z, 6BMC2A, 6BMC2M, 6BMC2Z, 6BMC4A, 6BMC4M, 6BMC4Z, 6BMC6A, 6BMC6M, 6BMC6Z, 6EA2, 6EA2A, 6EA2M, 6EB2, 6EB2A, 6EB2M, 6EB4, 6EB4A, 6EB4M, 6EC2, 6EC2A, 6EC2M, 6EC4, 6EC4A, 6EC4M, 6ERA2, 6ERA2A, 6ERA2M, 6ERB2, 6ERB2A, 6ERB2M, 6ERB4, 6ERB4A, 6ERB4M, 6ERC2, 6ERC2A, 6ERC2M, 6MA2, 6MA2A, 6MA2M, 6MB2, 6MB2A... (Other models you can see in the webshop)		

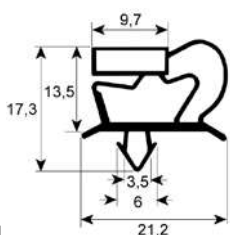

GEV No.	900860	Ref. No.	37Q3950
description	refrigeration gasket profile 9048 W 253mm L 373mm plug size		
For models:	6JA2, 6JA2A, 6JA2M, 6JB2, 6JB2A, 6JB2M, 6JB4A, 6JB4M, 6SMA2, 6SMA2A, 6SMA2B, 6SMA2M, 6SMA2Z, 6SMA4Z, 6SMB2, 6SMB2A, 6SMB2B, 6SMB2M, 6SMB2Z, 6SMB4, 6SMB4A, 6SMB4B, 6SMB4M, 6SMB4Z, 6SMB6Z, 6SMC2, 6SMC2A, 6SMC2B, 6SMC2M, 6SMC2Z, 6SMC4, 6SMC4A, 6SMC4B, 6SMC4M, 6SMC4Z, 6SMC6, 6SMC6A, 6SMC6B, 6SMC6M, 6SMC6Z, 6SMC8Z		

## Зип Общежит

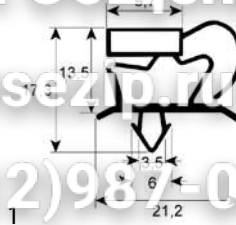

GEV No.	900864	Ref. No.	37Q4740
description	refrigeration gasket profile 9048 W 354mm L 373mm plug size		
For models:	6BMA11A, 6BMA11M, 6BMA11Z, 6BMB11A, 6BMB11M, 6BMB11Z, 6BMB22A, 6BMB22M, 6BMB22Z, 6BMC11A, 6BMC11M, 6BMC11Z, 6BMC22A, 6BMC22M, 6BMC22Z, 6BMC33A, 6BMC33M, 6BMC33Z, 6EA11, 6EA11A, 6EA11M, 6EB11, 6EB11A, 6EB11M, 6EB22, 6EB22A, 6EB22M, 6EC11, 6EC11A, 6EC11M, 6EC22, 6EC22A, 6EC22M, 6MB11, 6MB11A, 6MB11M, 6MC11, 6MC11A, 6MC11M, 6MRB11, 6MRB11A, 6MRB11M, 6MRB11Z, 6MRC11, 6MRC11A, 6MRC11M, 6MRC11Z, 6RB11, 6RB11A, 6RB11M... (Other models you can see in the webshop)		

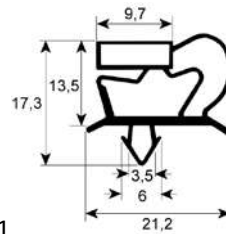

GEV No.	900861	Ref. No.	37Q4710
description	refrigeration gasket profile 9048 W 373mm L 570mm plug size		
For models:	6BMA11A, 6BMA11B, 6BMA11M, 6BMA11Z, 6BMA2A, 6BMA2B, 6BMA2M, 6BMA2Z, 6BMA3A, 6BMA3B, 6BMA3M, 6BMA3Z, 6BMAA, 6BMAAB, 6BMAAM, 6BMAZ, 6BMB11A, 6BMB11B, 6BMB11M, 6BMB11Z, 6BMB22A, 6BMB22B, 6BMB22M, 6BMB22Z, 6BMB2A, 6BMB2B, 6BMB2M, 6BMB2Z, 6BMB3A, 6BMB3B, 6BMB3M, 6BMB3Z, 6BMB4A, 6BMB4B, 6BMB4M, 6BMB4Z, 6BMBBA, 6BMBBB, 6BMBBM, 6BMBBZ, 6BMC11A, 6BMC11B, 6BMC11M, 6BMC11Z, 6BMC22A, 6BMC22B, 6BMC22M, 6BMC22Z, 6BMC2A, 6BMC2B... (Other models you can see in the webshop)		

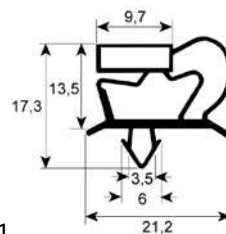

GEV No.	900709	Ref. No.	37Q3870
description	refrigeration gasket profile 9048 W 373mm L 580mm plug size		
For models:	6JA, 6JA2, 6JA2A, 6JA2M, 6JAA, 6JAM, 6JB, 6JB2, 6JB2A, 6JB2M, 6JB4A, 6JB4M, 6JBA, 6JBM, 6SMA, 6SMA2, 6SMA2A, 6SMA2B, 6SMA2M, 6SMA2Z, 6SMAA, 6SMAB, 6SMAM, 6SMAZ, 6SMB, 6SMB2, 6SMB2A, 6SMB2B, 6SMB2M, 6SMB2Z, 6SMB4, 6SMB4A, 6SMB4B, 6SMB4M, 6SMB4Z, 6SMBBA, 6SMBBB, 6SMBBM, 6SMBBZ, 6SMC, 6SMC2, 6SMC2A, 6SMC2B, 6SMC2M, 6SMC2Z, 6SMC4, 6SMC4A, 6SMC4B, 6SMC4M, 6SMC4Z... (Other models you can see in the webshop)		







Зип Общепит

vsezip.ru

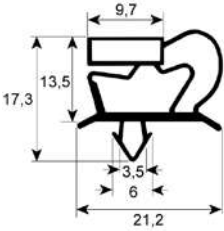
+7(812)987-08-81



<b>GEV No.</b>	900812	<b>Ref. No.</b>	37Q4490
<b>description</b>	refrigeration gasket profile 9048 W 400mm L 650mm plug size for blast chiller		
<b>For models:</b>	ART1L7, ART1L7A, ART1L7M, ART1LD7, ART1LD7A, ART1LD7M, B151M, BF51M, DA51, DA51A, DA51M, DS31, DS31A, DS31C, DS31M, DS51, DS51A, DS51C, DS51M, IA51, IA51A, IA51C, IA51M, IS51, IS51A, IS51AR, IS51C, IS51CR, IS51M, IS51MR, IS51R, IS51W, IS51WA, IS51WC, IS51WM, SM03LT7, SM03LT7A, SM03LT7M, SM1L7, SM1L7A, SM1L7FCV, SM1L7M, SM1LT7, SM1LT7A, SM1LT7M, VA51, VA51M, VS31, VS31M, VS51...(Other models you can see in the webshop)		



<b>GEV No.</b>	900710	<b>Ref. No.</b>	37Q5450
<b>description</b>	refrigeration gasket profile 9048 W 655mm L 1500mm plug size		
<b>For models:</b>	AGL6B, CX120, CX120B, CX120NN, CX140, CX140B, CX140BN, CX140BR, CX140CP, CX140NN, CX140R, CX55, CX55B, CX65, CX65B, CX65BR, CX65R, GD150, GD150B, GD70, GD70B, MD130, MD130B, MD130BN, MD130NN, MD150, MD150B, MD150BB, MD150BN, MD150BR, MD150NCP, MD150NN, MD150R, MD60, MD60B, MD70, MD70B, MD70BR, MD70CP, MD70R, MDE150, MDE150B, MDE70, MDE70B, MX120, MX120B, MX120NN, MX140, MX140B, MX140NN...(Other models you can see in the webshop)		

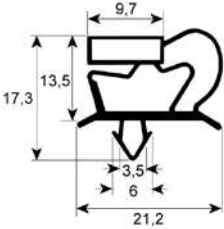

<b>GEV No.</b>	901207	<b>Ref. No.</b>	37Q3810
<b>description</b>	refrigeration gasket profile 9048 W 429mm L 675mm plug size for blast chiller		
<b>For models:</b>	ART1L, ART1LA, ART1LD, ART1LDA, BF51H, DS351H, IS51H, IS51HW, SM1L, SM1LA, SM1LAM, SM1LAR, SM1LAT, SM1LAW, SM1LM, SM1LR, SM1LT, SM1LW		

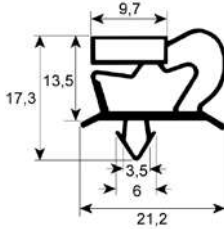

<b>GEV No.</b>	901329	<b>Ref. No.</b>	37Q5460
<b>description</b>	refrigeration gasket profile 9048 W 655mm L 704mm plug size		
<b>For models:</b>	CX140CP, CX652, CX65NB, CX65NCP, CX65NN, MD1504, MD150B4, MD702, MD70B2, MD70NB, MD70NCP, MD70NN, PD150CP, PD702, PD70B2		



<b>GEV No.</b>	902533	<b>Ref. No.</b>	37Q4140
<b>description</b>	refrigeration gasket profile 9048 W 450mm L 600mm plug size		

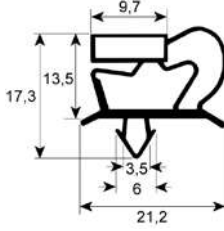

<b>GEV No.</b>	900706	<b>Ref. No.</b>	37Q4370
<b>description</b>	refrigeration gasket profile 9048 W 660mm L 1610mm plug size		
<b>For models:</b>	CX130, CX130B, CX130NN, CX150, CX150B, CX150BN, CX150BR, CX150CP, CX150NN, CX150R, CX60, CX60B, CX70, CX70B, CX70BR, CX70R, FX150, FX150B, FX150NN, FX70, FX70B, MX130, MX130B, MX130NN, MX150, MX150B, MX150NN, MX60, MX60B, MX70, MX70B		

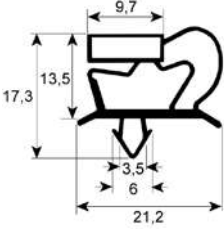

<b>GEV No.</b>	900712	<b>Ref. No.</b>	37Q1020 37Q4850
<b>description</b>	refrigeration gasket profile 9048 W 595mm L 1590mm plug size		
<b>For models:</b>	S1200, S1200B, S1200BE, S1200E, S125, S125B, S125BE, S125BX, S125E, S125X, S60, S600, S600B, S600BE, S600E, S60B, S60BE, S60BX, S60E, S60X		

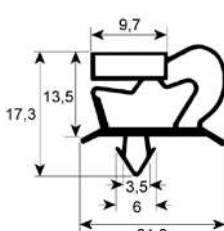

<b>GEV No.</b>	900350	<b>Ref. No.</b>	37Q2600
<b>description</b>	refrigeration gasket profile 9048 W 670mm L 760mm plug size 1/2 door		
<b>For models:</b>	135-4, 135CPX, 135X-3, 135X-4, 65BX-2, 65NB, 65NBX, 65NN, 65NNX, 65X-2, SP135CP, SP65NB, SP65NN		

Зип Общепит

vsezip.ru

+7(812)987-08-81

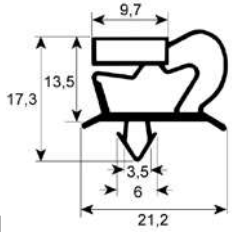

1

<b>GEV No.</b>	900351	<b>Ref. No.</b>	37Q2590
<b>description</b>	refrigeration gasket profile 9048 W 672mm L 1587mm plug size door		
<b>For models:</b>	120, 120B, 120NN, 135, 135A, 135B, 135BA, 135BN, 135BNX, 135BX, 135BXE, 135BXR, 135CPX, 135NN, 135NNX, 135X, 135X-3, 135XE, 135XR, 55, 55B, 55PV, 65, 65A, 65B, 65BA, 65BX, 65BXE, 65BXR, 65X, 65XE, 65XR, SP120, SP120B, SP120BN, SP120NN, SP135, SP135B, SP135BN, SP135CP, SP135NN, SP55, SP55B, SP65, SP65B		

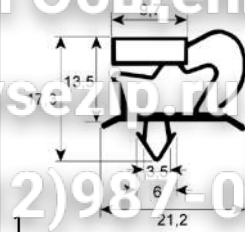

1

<b>GEV No.</b>	901205	<b>Ref. No.</b>	37Q5340
<b>description</b>	refrigeration gasket profile 9048 W 690mm L 835mm plug size for blast chiller		
<b>For models:</b>	B1101S, BF101L, BF101S, IA101L, IA101S, IS101L, IS101LR, IS101LW, IS101S, IS101SR, IS101SW, VS101L, XA101L, XA101S, XS101L, XS101S		

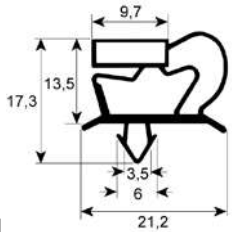

1

<b>GEV No.</b>	900328	<b>Ref. No.</b>	37Q1370
<b>description</b>	refrigeration gasket profile 9048 W 675mm L 1525mm plug size glass door		
<b>For models:</b>	40EV, 40EVP, 40PV, 40XPV		

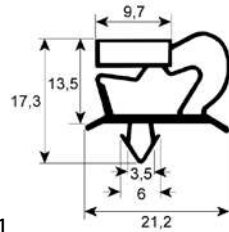

1

<b>GEV No.</b>	901204	<b>Ref. No.</b>	37Q5380
<b>description</b>	refrigeration gasket profile 9048 W 941mm L 1002mm plug size for blast chiller		
<b>For models:</b>	IA72S, IS102S, IS102SR, IS102SR-0NR01, IS102SW, IS72S, IS72SR, IS72SW		

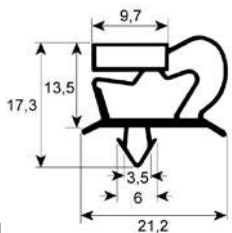

1

<b>GEV No.</b>	901206	<b>Ref. No.</b>	37Q3800
<b>description</b>	refrigeration gasket profile 9048 W 675mm L 820mm plug size for blast chiller		
<b>For models:</b>	ART2LD, ART2SD, SM2L, SM2LR, SM2LW, SM2S, SM2SR, SM2SW		

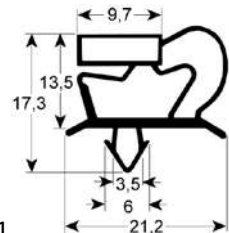

1

<b>GEV No.</b>	902258	<b>Ref. No.</b>	N/A
<b>description</b>	refrigeration gasket profile 9048 Wmm L 2500mm		

profile 9046

We offer custom-made gaskets for this profile

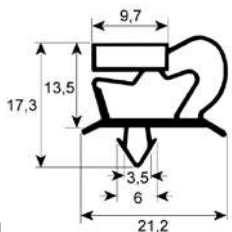

1

<b>GEV No.</b>	900326	<b>Ref. No.</b>	37Q1380
<b>description</b>	refrigeration gasket profile 9048 W 685mm L 1600mm plug size glass door		
<b>For models:</b>	120PV, 135PVX, 65PVX		

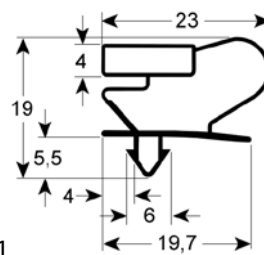

1

<b>GEV No.</b>	902515	<b>Ref. No.</b>	3125970
<b>description</b>	refrigeration gasket profile 9046 W 377mm L 395mm plug size		
<b>For models:</b>	3G6SA, 3G6SA2, 3G6SA4, 4G6SB, 4G6SB2, 4G6SB4, 4G6SB6, 6BR15V, 6BR15VC, 6BR19V, 6BR19VC, 6SA, 6SA2, 6SA2M, 6SAM, 6SB, 6SB2, 6SB2M, 6SBM		



Зип Общепит

vsezip.ru

+7(812)987-08-81

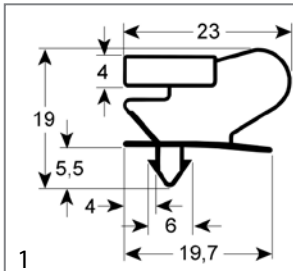

<b>GEV No.</b>	902314	<b>Ref. No.</b>	37Q5510
<b>description</b>	refrigeration gasket profile 9046 W 520mm L 1495mm plug size		
<b>For models:</b>	AF1B, AF1B-OPR01, AF1N, AF1N-OPR01, FSD1B, FSD1B-OPR01, FSD1N, FSD1N-OPR01, FSDR1B-OPR01, FSDR1N-OPR01		

profile 9753

We offer custom-made gaskets for this profile

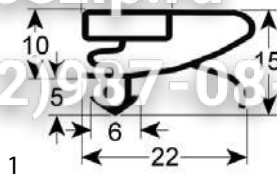

<b>GEV No.</b>	900875	<b>Ref. No.</b>	N/A
<b>description</b>	refrigeration gasket profile 9753 Wmm L 2500mm		

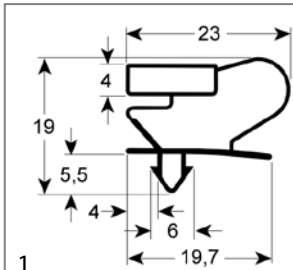

<b>GEV No.</b>	901801	<b>Ref. No.</b>	37Q4470
<b>description</b>	refrigeration gasket profile 9046 W 650mm L 750mm plug size		
<b>For models:</b>	CX150CP, CX702, CX70NB, CX70NN		

profile 9333

We offer custom-made gaskets for this profile

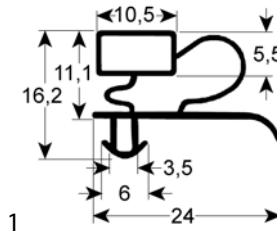

<b>GEV No.</b>	900016	<b>Ref. No.</b>	37Q1890
<b>description</b>	refrigeration gasket profile 9333 W 650mm L 1550mm plug size 1/2 door		

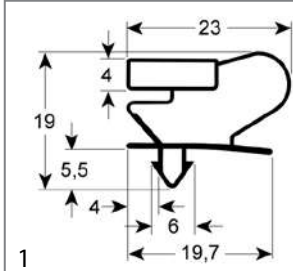

<b>GEV No.</b>	902257	<b>Ref. No.</b>	N/A
<b>description</b>	refrigeration gasket profile 9046 Wmm L 2500mm		

profile 9012

We offer custom-made gaskets for this profile

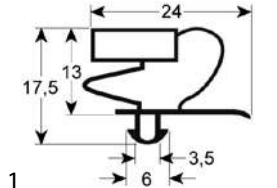

<b>GEV No.</b>	900354	<b>Ref. No.</b>	37Q7730
<b>description</b>	refrigeration gasket profile 9012 W 130mm L 367mm plug size drawer size 1/3		
<b>For models:</b>	6BEA11A, 6BEA11B, 6BEA11M, 6BEA11Z, 6BEA3A, 6BEA3B, 6BEA3M, 6BEA3Z, 6BEB11A, 6BEB11M, 6BEB11Z, 6BEB22A, 6BEB22M, 6BEB22Z, 6BEB3A, 6BEB3B, 6BEB3M, 6BEB3Z, 6BEC11A, 6BEC11B, 6BEC11M, 6BEC11Z, 6BEC22A, 6BEC22B, 6BEC22M, 6BEC22Z, 6BEC33A, 6BEC33B, 6BEC33M, 6BEC33Z, 6BEC3A, 6BEC3B, 6BEC3M, 6BEC3Z, 6BMA11A, 6BMA11B, 6BMA11M, 6BMA11Z, 6BMA3A, 6BMA3M, 6BMA3Z, 6BMB11A, 6BMB11B, 6BMB11M, 6BMB11Z, 6BMB22A, 6BMB22B, 6BMB22M, 6BMB22Z, 6BMB3A...(Other models you can see in the webshop)		

profile 9704

We offer custom-made gaskets for this profile

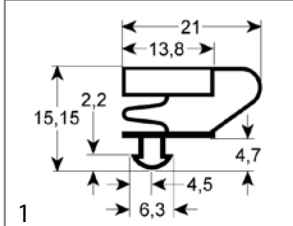

<b>GEV No.</b>	902315	<b>Ref. No.</b>	37Q5490
<b>description</b>	refrigeration gasket profile 9704 W 655mm L 1500mm plug size		
<b>For models:</b>	CX140PV, CX65PV, MD150BPV, MD150PV, MD70BPV, MD70PV, PD70B-PV, PD70PV, TE140PV, TE65PV		

Зип Общепит

vsezip.ru

+7(812)987-08-81

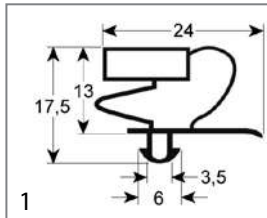

<b>GEV No.</b>	900353	<b>Ref. No.</b>	37Q7690
<b>description</b>	refrigeration gasket profile 9012 W 242mm L 367mm plug size drawer size 1/2		
<b>For models:</b>	6BEA2A, 6BEA2B, 6BEA2M, 6BEA2Z, 6BEB2A, 6BEB2B, 6BEB2M, 6BEB2Z, 6BEB4A, 6BEB4B, 6BEB4M, 6BEB4Z, 6BEC2A, 6BEC2B, 6BEC2M, 6BEC2Z, 6BEC4A, 6BEC4B, 6BEC4M, 6BEC4Z, 6BEC6A, 6BEC6B, 6BEC6M, 6BEC6Z, 6BMA2M, 6BMA2Z, 6BMB2B, 6BMB2M, 6BMB2Z, 6BMB4A, 6BMB4B, 6BMB4M, 6BMB4Z, 6BMC2A, 6BMC2B, 6BMC2M, 6BMC2Z, 6BMC4A, 6BMC4B, 6BMC4M, 6BMC4Z, 6BMC6A, 6BMC6B, 6BMC6M, 6BMC6Z, 6FMA2A, 6FMA2B, 6FMA2M, 6FMA2Z, 6FMA4A...(Other models you can see in the webshop)		

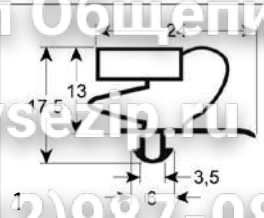

<b>GEV No.</b>	900327	<b>Ref. No.</b>	37Q0210
<b>description</b>	refrigeration gasket profile 9012 W 657mm L 1512mm plug size door refrigeration		
<b>For models:</b>	40, 40B, 40CP, 40CPX, 40PL, 40X		

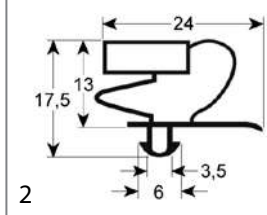

<b>GEV No.</b>	900325	<b>Ref. No.</b>	37Q7720
<b>description</b>	refrigeration gasket profile 9012 W 345mm L 362mm plug size drawer size 2/3		
<b>For models:</b>	6BEA11A, 6BEA11B, 6BEA11M, 6BEA11Z, 6BEB11A, 6BEB11M, 6BEB11Z, 6BEB22A, 6BEB22M, 6BEB22Z, 6BEC11A, 6BEC11B, 6BEC11M, 6BEC11Z, 6BEC22A, 6BEC22B, 6BEC22M, 6BEC22Z, 6BEC33A, 6BEC33B, 6BEC33M, 6BEC33Z, 6BMA11A, 6BMA11B, 6BMA11M, 6BMA11Z, 6BMB11A, 6BMB11B, 6BMB11M, 6BMB11Z, 6BMB22A, 6BMB22B, 6BMB22M, 6BMB22Z, 6BMC11A, 6BMC11B, 6BMC11M, 6BMC11Z, 6BMC22A, 6BMC22B, 6BMC22M, 6BMC22Z, 6BMC33A, 6BMC33B, 6BMC33M, 6BMC33Z, 6FMA11A, 6FMA11B, 6FMA11M, 6FMA11Z...(Other models you can see in the webshop)		

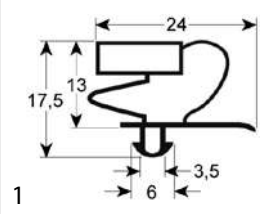

<b>GEV No.</b>	900017	<b>Ref. No.</b>	37Q2010
<b>description</b>	refrigeration gasket profile 9012 W 657mm L 747mm plug size door/glass door		

profile 9251

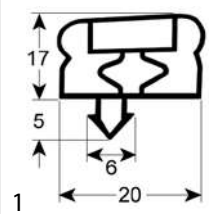

<b>GEV No.</b>	901504	<b>Ref. No.</b>	37Q4290
<b>description</b>	refrigeration gasket profile 9251 W 750mm L 2000mm plug size 3-sided short side open		
<b>For models:</b>	10003C, 10003CP, 10003CPB, 10043C, 10043CP, 10043CPB, 11703C, 11703CP, 11703CPB, 12003C, 12003CP, 12003CPB, 12043C, 12043CP, 12043CPB, 14003C, 14003CP, 14003CPB, 14043C, 14043CP, 14043CPB, 14343C, 14343CP, 14343CPB, 16743C, 16743CP, 16743CPB, 3103C, 3103CP, 3103CPB, 3743C, 3743CP, 3743CPB, 4103C, 4103CP, 4103CPB, 4943C, 4943CP, 4943CPB, 5103C, 5103CP, 5103CPB, 5403C, 5403CP, 5403CPB, 6103C, 6103CP, 6103CPB, 6143C, 6143CP...(Other models you can see in the webshop)		

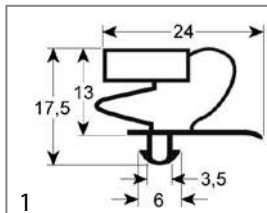

<b>GEV No.</b>	900352	<b>Ref. No.</b>	37Q7590
<b>description</b>	refrigeration gasket profile 9012 W 367mm L 567mm plug size door size 1/1		
<b>For models:</b>	6BEA11A, 6BEA11B, 6BEA11M, 6BEA11Z, 6BEA2A, 6BEA2B, 6BEA2M, 6BEA2Z, 6BEA3A, 6BEA3B, 6BEA3M, 6BEA3Z, 6BEA4A, 6BEA4B, 6BEA4M, 6BEA4Z, 6BEA5A, 6BEA5B, 6BEA5M, 6BEA5Z, 6BEA6A, 6BEA6B, 6BEA6M, 6BEA6Z, 6BEB11A, 6BEB11B, 6BEB11M, 6BEB11Z, 6BEB22A, 6BEB22B, 6BEB22M, 6BEB22Z, 6BEB3A, 6BEB3B, 6BEB3M, 6BEB3Z, 6BEB4A, 6BEB4B, 6BEB4M, 6BEB4Z, 6BEB5A, 6BEB5B, 6BEB5M, 6BEB5Z, 6BEB6A, 6BEB6B, 6BEB6M, 6BEB6Z, 6BEB7A, 6BEB7B, 6BEB7M, 6BEB7Z, 6BEB8A, 6BEB8B, 6BEB8M, 6BEB8Z, 6BEB9A, 6BEB9B, 6BEB9M, 6BEB9Z, 6BEB0A, 6BEB0B, 6BEB0M, 6BEB0Z, 6BEB1A, 6BEB1B, 6BEB1M, 6BEB1Z...(Other models you can see in the webshop)		

screw-in gaskets

profile 9031

We offer custom-made gaskets for this profile

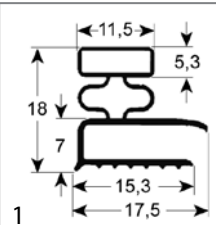

<b>GEV No.</b>	901006	<b>Ref. No.</b>	37Q0470
<b>description</b>	refrigeration gasket profile 9031 W 614mm L 590mm external size		



Зип Общепит

vsezip.ru

+7(812)987-08-81

<b>GEV No.</b>	901005	<b>Ref. No.</b>	37Q0450
<b>description</b>	refrigeration gasket profile 9031 W 660mm L 1360mm external size		

<b>GEV No.</b>	900717	<b>Ref. No.</b>	37Q2380
<b>description</b>	refrigeration gasket profile 9140 W 575mm L 610mm external size		

profile 9140

We offer custom-made gaskets for this profile

<b>GEV No.</b>	900705	<b>Ref. No.</b>	37Q2050
<b>description</b>	refrigeration gasket profile 9140 W 295mm L 380mm external size		
<b>For models:</b>	K16APGPZ, K16XPZAP, SA16AGB, SA16GB		

<b>GEV No.</b>	901606	<b>Ref. No.</b>	37Q3320
<b>description</b>	refrigeration gasket profile 9140 W 600mm L 645mm external size		
<b>For models:</b>	BRPR, BRPR218, BRPR21C, BRPRV, BRVR, BRVR218, BRVR21C, BRVRV		

<b>GEV No.</b>	900009	<b>Ref. No.</b>	37Q2040
<b>description</b>	refrigeration gasket profile 9140 W 380mm L 610mm external size		
<b>For models:</b>	K16APGPZ, K16XPZAP, SA16AGB, SA16GB		

<b>GEV No.</b>	901657	<b>Ref. No.</b>	37Q0760
<b>description</b>	refrigeration gasket profile 9140 W 655mm L 1555mm external size		

<b>GEV No.</b>	900858	<b>Ref. No.</b>	37Q3210
<b>description</b>	refrigeration gasket profile 9140 W 383mm L 531mm external size		
<b>For models:</b>	SA87		

<b>GEV No.</b>	902264	<b>Ref. No.</b>	N/A
<b>description</b>	refrigeration gasket profile 9140 Wmm L 2500mm		

<b>GEV No.</b>	900859	<b>Ref. No.</b>	37Q3250
<b>description</b>	refrigeration gasket profile 9140 W 459mm L 613mm external size		

profile 9106

We offer custom-made gaskets for this profile

<b>GEV No.</b>	902262	<b>Ref. No.</b>	N/A
<b>description</b>	refrigeration gasket profile 9106 Wmm L 2500mm		

Зип Общепит

vsezip.ru

+7(812)987 08 81

profile 9207

We offer custom-made gaskets for this profile

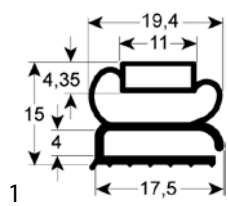

<b>GEV No.</b>	901004	<b>Ref. No.</b>	37Q0770
<b>description</b>	refrigeration gasket profile 9207 W 660mm L 755mm external size		

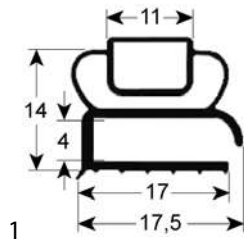

<b>GEV No.</b>	902277	<b>Ref. No.</b>	N/A
<b>description</b>	refrigeration gasket profile 9207 Wmm L 2500mm		

<b>GEV No.</b>	900443	<b>Ref. No.</b>	37Q2991 37Q2992
<b>description</b>	window gasket profile 1630 L 1800mm Qty 1		
<b>For models:</b>	FC101, FC101E, FCV101, FCV101-CSA, FCV101DM, FCV101DM-CSA, FCV101DS, FCV101DS-CSA, FCV101E, FCV101EDM, FCV101EDM-UL, FCV101EDS, FCV101EDS-UL, FCV101E-UL		

<b>GEV No.</b>	900449	<b>Ref. No.</b>	37Q7530 37Q7531
<b>description</b>	window gasket profile 1630 L 2050mm Qty 1		
<b>For models:</b>	FCV141, FCV141-CSA, FCV141DM, FCV141DM-CSA, FCV141DS, FCV141DS-CSA, FCV141E, FCV141EDM, FCV141EDS, FCV72EDM-UL, FCV72EDS-UL, FCV72E-UL		

gaskets for heated units

window seals

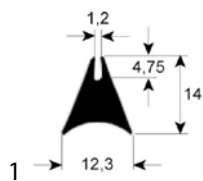

<b>GEV No.</b>	900058	<b>Ref. No.</b>	37Q2470
<b>description</b>	window gasket profile 1620 Qty supplied by meter		

<b>GEV No.</b>	900450	<b>Ref. No.</b>	37Q3000 37Q3001
<b>description</b>	window gasket profile 1630 L 2700mm Qty 1		
<b>For models:</b>	FC241, FC241E, FC241G, FCV241, FCV241DM, FCV241DS, FCV241E, FCV241EDM, FCV241EDM-UL, FCV241EDS, FCV241EDS-UL, FCV241E-UL, FCV241G, FCV241G-CSA, FCV241GDM, FCV241GDM-CSA, FCV241GDS, FCV241GDS-CSA		

<b>GEV No.</b>	900442	<b>Ref. No.</b>	37Q7400 37Q7401
<b>description</b>	window gasket profile 1630 L 1075mm Qty 1		
<b>For models:</b>	FCV3EM, FCV4E, FCV4EDS, FCV4EM, FM423E1, FM423E2		

<b>GEV No.</b>	900730	<b>Ref. No.</b>	N/A
<b>description</b>	window gasket profile 1630 Qty supplied by meter		

<b>GEV No.</b>	900447	<b>Ref. No.</b>	37Q2981 37Q2982
<b>description</b>	window gasket profile 1630 L 1350mm Qty 1		
<b>For models:</b>	71AR, 71ARE, 71RA, 91AR, 91ARE, 91RA, FC61, FC61E, FCV61, FCV61-CSA, FCV61DM, FCV61DM-CSA, FCV61DS, FCV61DS-CSA, FCV61E, FCV61EDM, FCV61EDM-UL, FCV61EDS, FCV61EDS-UL, FCV61E-UL		

door seals

Зип Общепит

vsezip.ru

+7(812)981-08-81

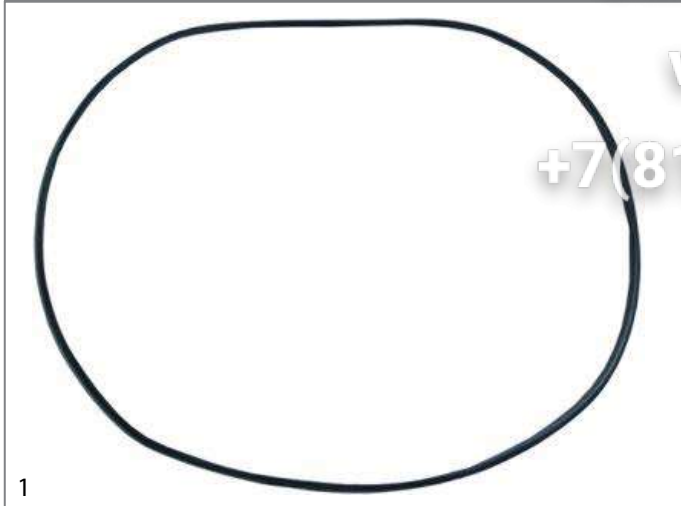

<b>GEV No.</b>	900725	<b>Ref. No.</b>	37Q7621
<b>description</b>	door seal		
<b>For models:</b>	FCV401DM, FCV401DM-CSA, FCV401EDM, FCV401EDM-UL		



<b>GEV No.</b>	900720	<b>Ref. No.</b>	3031880
<b>description</b>	door seal profile 1855 Qty supplied by meter		
<b>For models:</b>	1G1FA0E, 1G1FA0G, 1G1FABG, 1G1FAPG, 1G1PE1E, 1G1PE2E, 1G1TP0G, 2G1FAGF, 2G1FA0E, 2G1FA0G, 2G1FABG, 2G1FACG, 2G1FADG, 2G1FADGV, 2G1FAPG, 2G1PE1E, 2G1PE2E, 2G1TP3G		

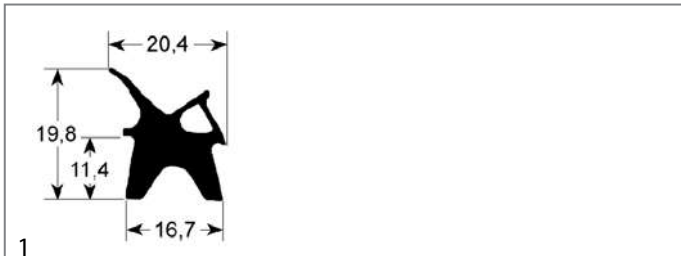

<b>GEV No.</b>	900059	<b>Ref. No.</b>	37Q2480
<b>description</b>	door seal profile 2410 Qty supplied by meter		

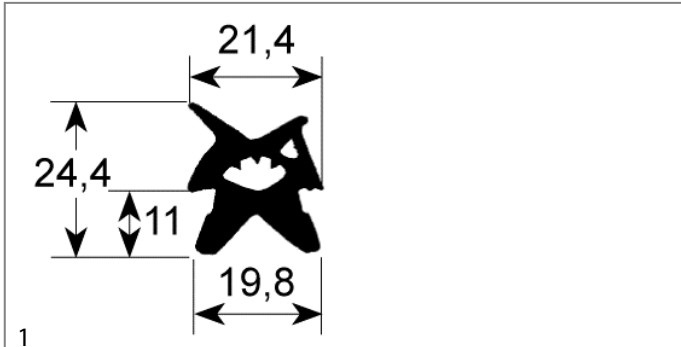

<b>GEV No.</b>	900441	<b>Ref. No.</b>	37Q1001 37Q1002
<b>description</b>	door seal profile 2420 W 330mm L 410mm external size Qty 1		
<b>For models:</b>	FCV3EM, FCV4E, FCV4EDS, FCV4EM		

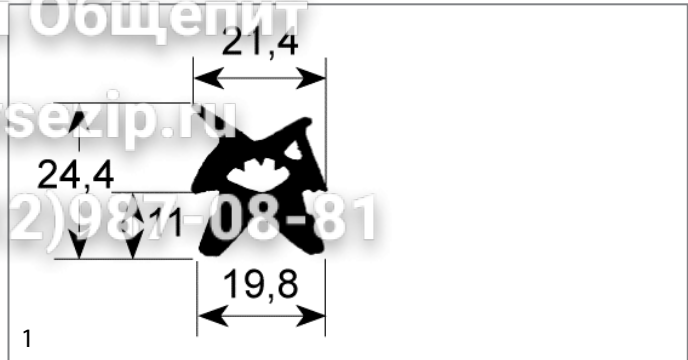

<b>GEV No.</b>	900443	<b>Ref. No.</b>	37Q0951 37Q0952
<b>description</b>	door seal profile 2420 W 450mm L 460mm outer plug size Qty 1 suitable for CONVOTHERM		
<b>For models:</b>	FC61, FC61E, FCV61, FCV61-CSA, FCV61DM, FCV61DM-CSA, FCV61DS, FCV61DS-CSA, FCV61E, FCV61EDM, FCV61EDM-UL, FCV61EDS, FCV61EDS-UL, FCV61E-UL		

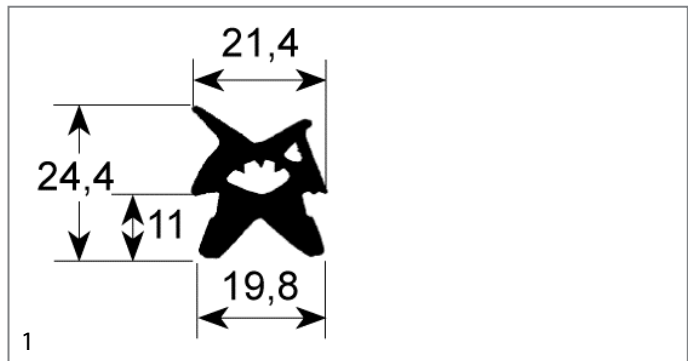

<b>GEV No.</b>	900713	<b>Ref. No.</b>	37Q2952
<b>description</b>	door seal profile 2420 W 450mm L 700mm external size Qty 1		

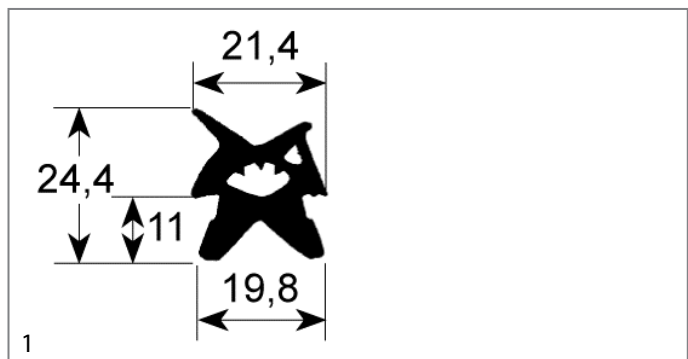

<b>GEV No.</b>	900444	<b>Ref. No.</b>	37Q0970 37Q0971 37Q0972
<b>description</b>	door seal profile 2420 W 450mm L 700mm outer plug size Qty 1 suitable for CONVOTHERM		
<b>For models:</b>	FC101, FC101E, FCV101, FCV101-CSA, FCV101DM, FCV101DM-CSA, FCV101DS, FCV101DS-CSA, FCV101E, FCV101EDM, FCV101EDM-UL, FCV101EDS, FCV101EDS-UL, FCV101E-UL		

Зип Общепит

vsezip.ru

+7(812)987-08-81

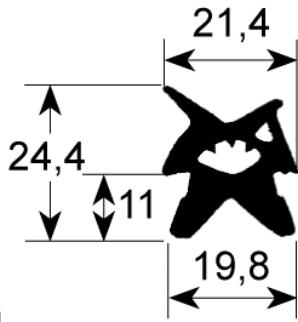

<b>GEV No.</b>	900445	<b>Ref. No.</b>	37Q0981 37Q0982
<b>description</b>	door seal profile 2420 W 565mm L 680mm external size Qty 1		
<b>For models:</b>	FCV141, FCV141-CSA, FCV141DM, FCV141DM-CSA, FCV141DS, FCV141DS-CSA, FCV141E, FCV141EDM, FCV141EDS, FCV141EDS-UL, FCV72EDS-UL, FCV72E-UL		



<b>GEV No.</b>	901394	<b>Ref. No.</b>	37Q4980
<b>description</b>	door seal profile 2438 W 330mm L 410mm external size		
<b>For models:</b>	FCV3EM, FCV4E, FCV4EDS, FCV4EM, FM423E1, FM423E2		

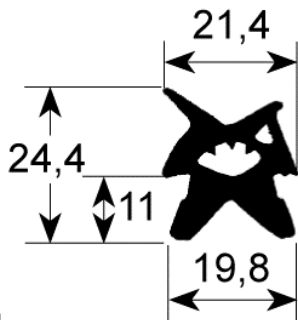

<b>GEV No.</b>	900446	<b>Ref. No.</b>	37Q0990 37Q0991 37Q0992
<b>description</b>	door seal profile 2420 W 670mm L 860mm external size Qty 1		
<b>For models:</b>	FC241, FC241E, FC241G, FCV241, FCV241DM, FCV241DS, FCV241E, FCV241EDM, FCV241EDM-UL, FCV241EDS, FCV241EDS-UL, FCV241E-UL, FCV241G, FCV241G-CSA, FCV241GDM, FCV241GDM-CSA, FCV241GDS, FCV241GDS-CSA		

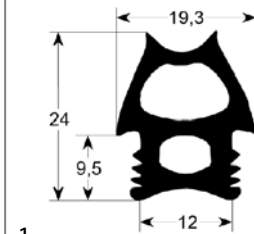

<b>GEV No.</b>	900748	<b>Ref. No.</b>	3050160
<b>description</b>	door seal profile 2780 W 475mm L 1360mm external size Qty 1		
<b>For models:</b>	FM2011E2-VERS.2006, FM2011E3-VERS.2006, FM2011G2-VERS.2006, FM2011G3-VERS.2006		



<b>GEV No.</b>	900721	<b>Ref. No.</b>	37Q7633
<b>description</b>	door seal profile 2420 W 680mm L 1380mm external size Qty 1		
<b>For models:</b>	FCV401DM, FCV401DM-CSA, FCV401EDM, FCV401EDM-UL		

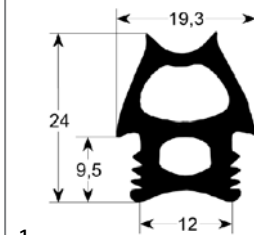

<b>GEV No.</b>	900716	<b>Ref. No.</b>	36E3030 36E3031
<b>description</b>	door seal profile 2780 W 485mm L 485mm external size Qty 1		
<b>For models:</b>	FC611E, FC611G, FM611E1, FM611E1-VERS.2006, FM611E2, FM611E2-VERS.2006, FM611E3, FM611E3-VERS.2006, FM611G1, FM611G1-VERS.2006, FM611G2, FM611G2-VERS.2006, FM611G3, FM611G3-VERS.2006		

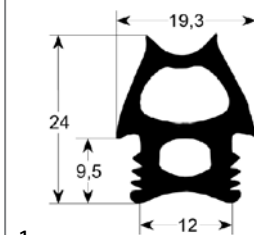

<b>GEV No.</b>	900715	<b>Ref. No.</b>	36E3020 36E3021
<b>description</b>	door seal profile 2780 W 490mm L 700mm external size Qty 1		
<b>For models:</b>	FC1011E, FC1011G, FM1011E1, FM1011E1-VERS.2006, FM1011E2, FM1011E2-VERS.2006, FM1011E3, FM1011E3-VERS.2006, FM1011G1, FM1011G1-VERS.2006, FM1011G2, FM1011G2-VERS.2006, FM1011G3, FM1011G3-VERS.2006		





Зип Общепит

vsezip.ru

+7(812)987-08-81

<b>GEV No.</b>	900749	<b>Ref. No.</b>	36E4061
<b>description</b>	door seal profile 2780 W 630mm L 690mm external size Qty 1		
<b>For models:</b>	FM721E1, FM721E1-VERS.2006, FM721E2, FM721E2-VERS.2006, FM721E3, FM721E3-VERS.2006, FM721G1, FM721G1-VERS.2006, FM721G2, FM721G2-VERS.2006, FM721G3, FM721G3-VERS.2006		

<b>GEV No.</b>	901622	<b>Ref. No.</b>	3077260 3077261 3077262
<b>description</b>	door seal profile 2781 W 475mm L 475mm external size suitable for ANGELO PO		
<b>For models:</b>	BX61E, BX61E-VERS.122013, BX61G, BX61G-VERS.122013, FX61E1, FX61E1R, FX61E2, FX61E2C, FX61E2CR, FX61E2CR-VERS.032014, FX61E2C-VERS.032014, FX61E2R, FX61E2R-VERS.032014, FX61E2-VERS.032014, FX61E3, FX61E3C, FX61E3CR, FX61E3CR-VERS.022014, FX61E3C-VERS.022014, FX61E3R, FX61E3R-VERS.022014, FX61E3-VERS.022014, FX61G1, FX61G1R, FX61G2, FX61G2C, FX61G2CR, FX61G2CR-VERS.032014, FX61G2C-VERS.032014, FX61G2R, FX61G2R-VERS.032014, FX61G2-VERS.032014, FX61G3, FX61G3C, FX61G3CR, FX61G3CR-VERS.022014, FX61G3C-VERS.022014, FX61G3R, FX61G3R-VERS.022014, FX61G3-VERS.022014		

<b>GEV No.</b>	900746	<b>Ref. No.</b>	36E3921
<b>description</b>	door seal profile 2780 W 690mm L 1360mm external size Qty 1		
<b>For models:</b>	FM2021E1, FM2021E2, FM2021E2-VERS.2006, FM2021E3, FM2021E3-VERS.2006, FM2021G1, FM2021G2, FM2021G2-VERS.2006, FM2021G3, FM2021G3-VERS.2006		

<b>GEV No.</b>	901623	<b>Ref. No.</b>	3077270 3077271 3077272
<b>description</b>	door seal profile 2781 W 475mm L 725mm external size suitable for ANGELO PO		
<b>For models:</b>	BX101E, BX101E-VERS.122013, BX101G, BX101G-VERS.122013, FX101E1, FX101E1R, FX101E2, FX101E2C, FX101E2C-VERS.032014, FX101E2R, FX101E2R-VERS.032014, FX101E2-VERS.032014, FX101E3, FX101E3C, FX101E3C-VERS.022014, FX101E3R, FX101E3R-VERS.022014, FX101E3-VERS.022014, FX101G1, FX101G1R, FX101G2, FX101G2C, FX101G2C-VERS.032014, FX101G2R, FX101G2R-VERS.032014, FX101G2-VERS.032014, FX101G3, FX101G3C, FX101G3C-VERS.022014, FX101G3R, FX101G3R-VERS.022014, FX101G3-VERS.022014, FX10E2CR, FX10E2CR-VERS.032014, FX10E3CR, FX10E3CR-VERS.022014, FX10G2CR, FX10G2CR-VERS.032014, FX10G3CR, FX10G3CR-VERS.022014		

<b>GEV No.</b>	900747	<b>Ref. No.</b>	36E3520 36E3521
<b>description</b>	door seal profile 2780 W 690mm L 860mm external size Qty 1		
<b>For models:</b>	FC1221E, FC1221G, FM1221E1, FM1221E1-VERS.2006, FM1221E2, FM1221E2-VERS.2006, FM1221E3, FM1221E3-VERS.2006, FM1221G1, FM1221G1-VERS.2006, FM1221G2, FM1221G2-VERS.2006, FM1221G3, FM1221G3-VERS.2006		

<b>GEV No.</b>	901624	<b>Ref. No.</b>	3077280 3077281 3077282
<b>description</b>	door seal profile 2781 W 475mm L 1410mm external size suitable for ANGELO PO		
<b>For models:</b>	FX201E2, FX201E2P, FX201E2P-VERS.032014, FX201E2-VERS.032014, FX201E3, FX201E3P, FX201E3P-VERS.022014, FX201E3-VERS.022014, FX201G2, FX201G2P, FX201G2P-VERS.032014, FX201G2-VERS.032014, FX201G3P, FX201G3-VERS.022014		

Зип Общепит  
gaskets for tray rack trolleys  
vsezip.ru  
+7(812)987-08-81

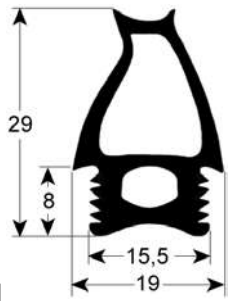

1

<b>GEV No.</b>	901625	<b>Ref. No.</b>	3077290 3077291 3077292
<b>description</b>	door seal profile 2781 W 628mm L 686mm external size suitable for ANGELO PO		
<b>For models:</b>	BX82E, BX82E-VERS.122013, BX82G, BX82G-VERS.122013, FX82E1, FX82E2, FX82E2C, FX82E2T, FX82E2T-VERS.032014, FX82E3, FX82E3C, FX82E3CT, FX82E3CT-VERS.022014, FX82E3T, FX82E3T-VERS.022014, FX82G1, FX82G2, FX82G2C, FX82G2T, FX82G2T-VERS.032014, FX82G3, FX82G3C, FX82G3CT, FX82G3CT-VERS.022014, FX82G3T, FX82G3T-VERS.022014		

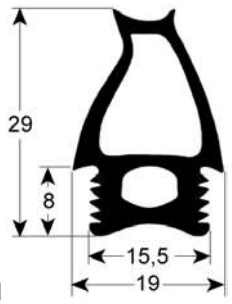

1

<b>GEV No.</b>	901627	<b>Ref. No.</b>	3077310 3077311 3077312
<b>description</b>	door seal profile 2781 W 688mm L 1410mm external size suitable for ANGELO PO		
<b>For models:</b>	FX202E2, FX202E2-VERS.032014, FX202E3, FX202E3-230V-3-50Hz-60Hz, FX202E3-230V-3-50Hz-60Hz-VERS.022014, FX202E3-VERS.022014, FX202G2, FX202G2-VERS.032014, FX202G3, FX202G3-VERS.022014		

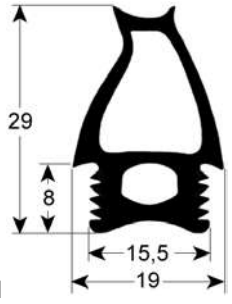

1

<b>GEV No.</b>	901626	<b>Ref. No.</b>	3077300 3077301 3077302
<b>description</b>	door seal profile 2781 W 688mm L 886mm external size suitable for ANGELO PO		
<b>For models:</b>	BX122E, BX122E-VERS.122013, BX122G, BX122G-VERS.122013, FX122E1, FX122E2, FX122E2C, FX122E2T, FX122E2T-VERS.032014, FX122E3, FX122E3C, FX122E3T, FX122E3T-VERS.022014, FX122G1, FX122G3, FX122G3C, FX122G3T, FX122G3T-VERS.022014, FX12E3CT, FX12E3CT-VERS.022014, FX12G3CT, FX12G3CT-VERS.022014		

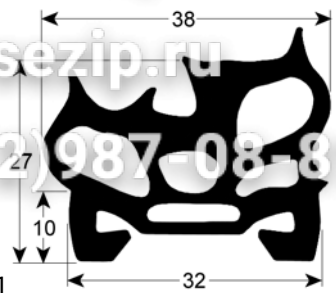

1

<b>GEV No.</b>	902513	<b>Ref. No.</b>	3040480
<b>description</b>	tray rack trolley gasket profile 4110 L 510mm Qty 1		
<b>For models:</b>	FM2011E2-VERS.2006, FM2011E3-VERS.2006, FM2011G2-VERS.2006, FM2011G3-VERS.2006		

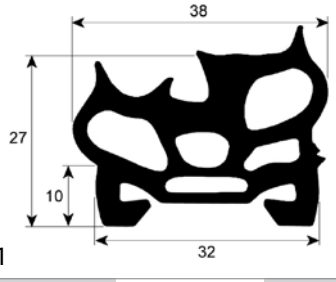

1

<b>GEV No.</b>	901396	<b>Ref. No.</b>	3039710
<b>description</b>	tray rack trolley gasket profile 4110 L 712mm Qty 1		
<b>For models:</b>	FM2021E2-VERS.2006, FM2021E3-VERS.2006, FM2021G2-VERS.2006, FM2021G3-VERS.2006		

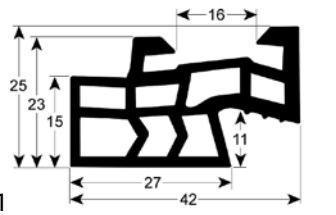

1

<b>GEV No.</b>	902520	<b>Ref. No.</b>	3091160 3199570
<b>description</b>	tray rack trolley gasket profile 4140 L 515mm Qty 1		
<b>For models:</b>	FX201E2, FX201E2P, FX201E2P-VERS.032014, FX201E2-VERS.032014, FX201E3, FX201E3P, FX201E3P-VERS.022014, FX201E3-VERS.022014, FX201G2, FX201G2P, FX201G2P-VERS.032014, FX201G2-VERS.032014, FX201G3P, FX201G3-VERS.022014		



O-rings

EPDM

<b>GEV No.</b>	540682	<b>Ref. No.</b>	3150840 37Q1210
<b>description</b>	O-ring EPDM thickness 1.78mm ID ø 18.77mm Qty 1 pcs		
<b>For models:</b>	030BME, 030EBM, 030FE, 031BME, 031EBM, 04WBMEV, 08WGREV, 090BM1E, 090BM1G, 091CP1E, 091CP1G, 091FR1EX, 091FR7GS, 091FR7GX, 0A1CP1E, 0A1CP1G, 0B1CP1G, 0D1CP1E, 0D1CP1G, 0G1CP1E, 0G1CP1E-VERS.2004, 0G1CP1G, 0G1CP1G-VERS.2004, 190BM2E, 190BM2G, 190GRE, 191CP1G, 191CP2G, 1A1CP1G, 1A1CP2G, 1D1CP1G, 1D1CP2G, 1G0GRE, 1G1CP1G, 1G1CP1G-VERS.2004, 1G1CP2G, 1G1CP2G-VERS.2004, 30CP5, 30CPSE, 6040090, 6040110, 6040310, 6042680, 6043850, 6043980, 70CP, 71CP2, 90CP		

<b>GEV No.</b>	510303	<b>Ref. No.</b>	3152180
<b>description</b>	O-ring EPDM thickness 1.78mm ID ø 6.75mm Qty 1 pcs		
<b>For models:</b>	LC100, LC100-VERS.2001, LC130, LC130-VERS.2001, LC80, LF50, LF50E, LF50EM, LF50EMPS, LP124, LP124S-VERS.052006, LP124V, LP124-VERS.052006, LP124VS-VERS.052006, LP124V-VERS.052006, LP84, LP84S-VERS.052006, LP84V, LP84-VERS.052006, LP84VS-VERS.052006, LP84V-VERS.052006		

<b>GEV No.</b>	510177	<b>Ref. No.</b>	3035830 3152210
<b>description</b>	O-ring EPDM thickness 1.78mm ID ø 7.66mm Qty 1 pcs		

<b>GEV No.</b>	519181	<b>Ref. No.</b>	3152400
<b>description</b>	O-ring EPDM thickness 1mm ID ø 5mm Qty 1 pcs		

<b>GEV No.</b>	102997	<b>Ref. No.</b>	3152550
<b>description</b>	O-ring EPDM thickness 1mm ID ø 6mm Qty 1 pcs		
<b>For models:</b>	04WFAAV, 08WFA4E, 08WFA4G, 08WFAAE, 08WFAAG, 08WFAAV, 090FAA, 0A0FA1, 0A0FA4, 0A0FAA, 0D0FA1, 0D0FA4, 0D0FAA, 0G0FA0, 12WFA6E, 12WFA6G, 12WFAAA, 12WFAAE, 12WFAAG, 12WFAAN, 190FA, 190FAA, 190FAB, 190FAD, 191FAAE, 191FAAG, 191FABG, 191FADG, 191FAE, 191FAG, 1A0FA1, 1A0FA2, 1A0FA4, 1A0FA5, 1A0FAA, 1A0FAB, 1A1FA1G, 1A1FA2G, 1A1FA4G, 1A1FA5G, 1A1FAAG, 1A1FABG, 1D0FA1, 1D0FA2, 1D0FA4, 1D0FA5, 1D0FAA, 1D0FAB, 1D1FA1G, 1D1FA2G...(Other models you can see in the webshop)		

<b>GEV No.</b>	528223	<b>Ref. No.</b>	3152100
<b>description</b>	O-ring EPDM thickness 2.62mm ID ø 11.91mm Qty 1 pcs		

<b>GEV No.</b>	518227	<b>Ref. No.</b>	N/A
<b>description</b>	O-ring EPDM thickness 2.62mm ID ø 12.37mm Qty 1 pcs		

<b>GEV No.</b>	528333	<b>Ref. No.</b>	3152410
<b>description</b>	O-ring EPDM thickness 2.62mm ID ø 13.1mm Qty 1 pcs		
<b>For models:</b>	LC80		

<b>GEV No.</b>	516026	<b>Ref. No.</b>	3186287
<b>description</b>	O-ring EPDM thickness 2.62mm ID ø 17.86mm Qty 1 pcs		

Зип Общепит  
vsezip.ru  
7(812)987-08-81

<b>GEV No.</b>	504590	<b>Ref. No.</b>	3152170
<b>description</b>	O-ring EPDM thickness 2.62mm ID ø 18.72mm Qty 1 pcs		
<b>For models:</b>	C165D, C165S, C165VD, C165VS, C207D, C207D-VERS.2006, C207S, C207S-VERS.2006, C207VD, C207VD-VERS.2006, C207VS, C207VS-VERS.2006, C304AD, C304AD-VERS.2006, C304AS, C304AS-VERS.2006, C304AVD, C304AVD-VERS.2006, C304AVS, C304AVS-VERS.2006, C304D, C304D-VERS.2006, C304S, C304S-VERS.2006, C304VD, C304VD-VERS.2006, C304VS, C304VS-VERS.2006, C92D-VERS.2006, C92S-VERS.2006, C92VD-VERS.2006, C92VS-VERS.2006, CS243D, CS243D-VERS.2006, CS243S, CS243S-VERS.2006, CS243VD, CS243VD-VERS.2006, CS243VS, CS243VS-VERS.2006, CS370AD, CS370AD-VERS.2006, CS370AS, CS370AS-VERS.2006, CS370AVD, CS370AVD-VERS.2006, CS370AVS, CS370AVS-VERS.2006, CS370D, CS370D-VERS.2006...(Other models you can see in the webshop)		

<b>GEV No.</b>	511518	<b>Ref. No.</b>	3150520
<b>description</b>	O-ring EPDM thickness 3.53mm ID ø 23.4mm Qty 10 pcs		
<b>For models:</b>	F60P, F60PR, F80PR, L45		

<b>GEV No.</b>	511512	<b>Ref. No.</b>	3150410
<b>description</b>	O-ring EPDM thickness 2.62mm ID ø 18.72mm Qty 10 pcs		
<b>For models:</b>	090BME, 091BME, L100, L40, L40S, L60, L80, PGA20, PGA30, PGA40, PGA60, PGA80, PGW20, PGW30, PGW40, PGW60, PGW80		

<b>GEV No.</b>	511524	<b>Ref. No.</b>	3150260
<b>description</b>	O-ring EPDM thickness 3.53mm ID ø 32.93mm Qty 10 pcs		
<b>For models:</b>	L100, L40, L40S, L60, L80		

<b>GEV No.</b>	504561	<b>Ref. No.</b>	3151080
<b>description</b>	O-ring EPDM thickness 2.62mm ID ø 29.82mm Qty 1 pcs		
<b>For models:</b>	091FR1E, 091FR1EA, 091FR1ED, 091FR1G, 091FR1GD, 091FR1I, 091FR1IA, 091FR1ID, 091FR1ID-VERS.052012, 091FR1I-VERS.032012, 091FR7G, 091FR7G-VERS.052012, 0A1FR1E, 0A1FR1ED, 0A1FR1G, 0A1FR1GD, 0A1FR1GD-VERS.2004, 0A1FR1G-VERS.2004, 0B1FR1G, 0B1FR1GD, 0D1FR1E, 0D1FR1ED, 0D1FR1G, 0D1FR1GD, 0D1FR1GD-VERS.2004, 0D1FR1G-VERS.2004, 191FR2E, 191FR2ED, 191FR2G, 191FR2GD, 191FR2I, 191FR2ID, 191FR2ID-VERS.092012, 191FR2I-VERS.032012, 1A1FR2E, 1A1FR2ED, 1A1FR2G, 1A1FR2GD, 1A1FR2GD-VERS.2004, 1A1FR2G-VERS.2004, 1D1FR2ED, 1D1FR2G, 1D1FR2GD, 1D1FR2GD-VERS.2004, 1D1FR2G-VERS.2004, 70F1, 70F1B, 70FE1, 70FE1B, 71F2...(Other models you can see in the webshop)		

<b>GEV No.</b>	511526	<b>Ref. No.</b>	3150010
<b>description</b>	O-ring EPDM thickness 3.53mm ID ø 36.1mm Qty 10 pcs		
<b>For models:</b>	F60P, F60PR, F60T, F80P, F80PR, L40, L40S, L45, L60		

<b>GEV No.</b>	532064	<b>Ref. No.</b>	3150140
<b>description</b>	O-ring EPDM thickness 2.62mm ID ø 32.99mm Qty 10 pcs		
<b>For models:</b>	L100, L40, L40S, L60, L80		

<b>GEV No.</b>	519179	<b>Ref. No.</b>	3151930
<b>description</b>	O-ring EPDM thickness 3.53mm ID ø 41.28mm Qty 1 pcs		
<b>For models:</b>	C165D, C165S, C165VD, C165VS, C207D, C207D-VERS.2006, C207S, C207S-VERS.2006, C207VD, C207VD-VERS.2006, C207VS, C207VS-VERS.2006, C304AD, C304AD-VERS.2006, C304AS, C304AS-VERS.2006, C304AVD, C304AVD-VERS.2006, C304AVS, C304AVS-VERS.2006, C304D, C304D-VERS.2006, C304S, C304S-VERS.2006, C304VD, C304VD-VERS.2006, C304VS, C304VS-VERS.2006, C92D-VERS.2006, C92S-VERS.2006, C92VD-VERS.2006, C92VS-VERS.2006, CS243D, CS243D-VERS.2006, CS243S, CS243S-VERS.2006, CS243VD, CS243VD-VERS.2006, CS243VS, CS243VS-VERS.2006, CS370AD, CS370AD-VERS.2006, CS370AS, CS370AS-VERS.2006, CS370AVD, CS370AVD-VERS.2006, CS370AVS, CS370AVS-VERS.2006, CS370D, CS370D-VERS.2006...(Other models you can see in the webshop)		

<b>GEV No.</b>	532109	<b>Ref. No.</b>	3150360
<b>description</b>	O-ring EPDM thickness 3.53mm ID ø 42.86mm Qty 10 pcs		



Зип Общежит

vsezip.ru

7(812)987-08-81

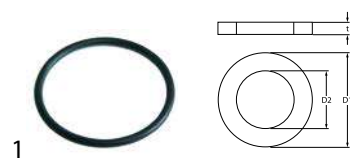

<b>GEV No.</b>	532114	<b>Ref. No.</b>	3150240
<b>description</b>	O-ring EPDM thickness 3.53mm ID ø 50.8mm Qty 10 pcs		
<b>For models:</b>	L100, L40, L40S, L60, L80		



<b>GEV No.</b>	510551	<b>Ref. No.</b>	3FL1123
<b>description</b>	pump cover gasket ID ø 158.3mm pump type 1214/1293/1225/2243/1226/1204/3473/1241 thickness 3.53mm EPDM Qty 1 pcs		



<b>GEV No.</b>	511331	<b>Ref. No.</b>	3152390
<b>description</b>	O-ring EPDM thickness 3.53mm ID ø 53.57mm Qty 1 pcs		

silicone



<b>GEV No.</b>	532521	<b>Ref. No.</b>	3152370
<b>description</b>	O-ring silicone thickness 1.78mm ID ø 34.65mm Qty 1 pcs		
<b>For models:</b>	04WFAAV, 08WFA4E, 08WFA4G, 08WFAAE, 08WFAAG, 08WFAAV, 090FAA, 0A0FA1, 0A0FA4, 0A0FAA, 0D0FA1, 0D0FA4, 0D0FAA, 0G0FA0, 12WFA6E, 12WFA6G, 12WFAAA, 12WFAAE, 12WFAAG, 12WFAAN, 190FA, 190FAA, 190FAB, 190FAD, 191FAAE, 191FAAG, 191FABG, 191FADG, 191FAE, 191FAG, 1A0FA1, 1A0FA2, 1A0FA4, 1A0FA5, 1A0FAA, 1A0FAB, 1A1FA1G, 1A1FA2G, 1A1FA4G, 1A1FA5G, 1A1FAAG, 1A1FABG, 1D0FA1, 1D0FA2, 1D0FA4, 1D0FA5, 1D0FAA, 1D0FAB, 1D1FA1G, 1D1FA2G...(Other models you can see in the webshop)		

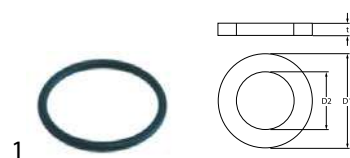

<b>GEV No.</b>	521120	<b>Ref. No.</b>	3035850 3152160
<b>description</b>	O-ring EPDM thickness 5.34mm ID ø 37.47mm Qty 1 pcs		
<b>For models:</b>	C165D, C165S, C165VD, C165VS, C207D, C207D-VERS.2006, C207S, C207S-VERS.2006, C207VD, C207VS, C304AD, C304AD-VERS.2006, C304AS, C304AS-VERS.2006, C304AVD, C304AVS, C304D, C304D-VERS.2006, C304S, C304S-VERS.2006, C304VD, C304VS, C92D-VERS.2006, C92S-VERS.2006, CS243D, CS243D-VERS.2006, CS243S, CS243S-VERS.2006, CS243VD, CS243VS, CS370AD, CS370AD-VERS.2006, CS370AS, CS370AS-VERS.2006, CS370AVD, CS370AVS, CS370D, CS370D-VERS.2006, CS370S, CS370S-VERS.2006, CS370VD, CS370VS, CS466AD, CS466AD-VERS.2006, CS466AS, CS466AS-VERS.2006, CS466AVD, CS466AVS, CS466D, CS466D-VERS.2006...(Other models you can see in the webshop)		

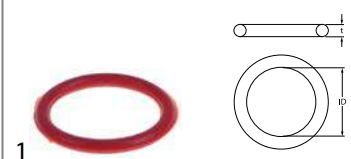

<b>GEV No.</b>	532541	<b>Ref. No.</b>	3152040
<b>description</b>	O-ring silicone thickness 1.78mm ID ø 47.35mm Qty 1 pcs		
<b>For models:</b>	04WFAAV, 08WFA4E, 08WFA4G, 08WFAAE, 08WFAAG, 08WFAAV, 090FAA, 0A0FA1, 0A0FA4, 0A0FAA, 0D0FA1, 0D0FA4, 0D0FAA, 0G0FA0, 12WFA6E, 12WFA6G, 12WFAAA, 12WFAAE, 12WFAAG, 12WFAAN, 190FA, 190FAA, 190FAB, 190FAD, 191FAAE, 191FAAG, 191FABG, 191FADG, 191FAE, 191FAG, 1A0FA1, 1A0FA2, 1A0FA4, 1A0FA5, 1A0FAA, 1A0FAB, 1A1FA1G, 1A1FA2G, 1A1FA4G, 1A1FA5G, 1A1FAAG, 1A1FABG, 1D0FA1, 1D0FA2, 1D0FA4, 1D0FA5, 1D0FAA, 1D0FAB, 1D1FA1G, 1D1FA2G...(Other models you can see in the webshop)		



<b>GEV No.</b>	510408	<b>Ref. No.</b>	3152650
<b>description</b>	O-ring EPDM thickness 5.34mm ID ø 47mm Qty 1 pcs		

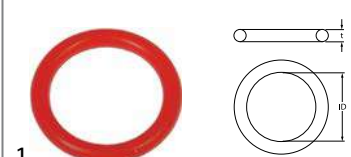

<b>GEV No.</b>	532520	<b>Ref. No.</b>	3150390
<b>description</b>	O-ring silicone thickness 2.62mm ID ø 15.08mm Qty 1 pcs		
<b>For models:</b>	030BME, 030FE, 031BME, 070BM, 070BME, 071BM, 071BME, 090BM, 090BME, 091BM, 091BME, 1A1PI1G, 1A1PI1GA, 1D1PI1G, 1D1PI1GA, 1G1PI1G, 30F, 30FES, 30FS, 31PI6, 70F, 70FE, 70FES, 71F, 71FE, 71PI10, 71PI10A, 91PI10, 91PI10A		

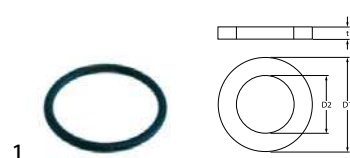

<b>GEV No.</b>	510409	<b>Ref. No.</b>	3150430 3151960 37Q5260
<b>description</b>	O-ring EPDM thickness 5.34mm ID ø 56.52mm Qty 1 pcs		
<b>For models:</b>	091CP1E, 0A1CP1E, 0G1CP1E, 0G1CP1EC, 0G1CP1E-VERS.2004, 191PI2E, 191PI2EA, 1A1PI2E, 1A1PI2EA, 1D1PI2E, 1D1PI2EA, 1G1PI1E, 30CPSE, 31PIE6, 6040090, 6040310, 6043850, 6043980, 70CPE, 71PIE15, 71PIE15A, 90CPE, 91PIE15, 91PIE15A, F60P, F60PR, F60T, F80P, F80PR, KD100, KD100A, KD100PSD, KD130, KD130A, KD130E, KD130EAT, KD60, KD60E, KD60EAT, KD60M, KD60MA, KD60ME, KD60MPS, KD60MPSA, KD60PS, KD60PSD, KD6EATSD, KD85, KD85A, KD85E...(Other models you can see in the webshop)		

Зип-Общепит

HNBR

vsezip.ru

+7(812)987-08-81

			
<b>GEV No.</b>	532519	<b>Ref. No.</b>	3152331
<b>description</b>	O-ring silicone thickness 5.34mm ID $\varnothing$ 53.34mm Qty 1 pcs		
<b>For models:</b>	191CP1GA, 191PD1G, 191PD2G, 191PI1G, 191PI1GA, 191PI2E, 191PI2EA, 191PI2G, 191PI2GA, 191PI2V, 191PI2VA, 1A1CP1GA, 1A1PD1G, 1A1PD2G, 1A1PI1G, 1A1PI1GA, 1A1PI2E, 1A1PI2EA, 1A1PI2G, 1A1PI2GA, 1A1PI2V, 1A1PI2VA, 1D1CP1GA, 1D1PD1G, 1D1PD2G, 1D1PI1G, 1D1PI1GA, 1D1PI2E, 1D1PI2EA, 1D1PI2G, 1D1PI2GA, 1D1PI2V, 1D1PI2VA, 1G1PD1G, 1G1PI1E, 1G1PI1G, 291PD3G, 291PI3E, 291PI3G, 2A1PD3G, 2A1PI3E, 2A1PI3G, 2D1PI3G, PV200, PV200A, PV300, PV300A		

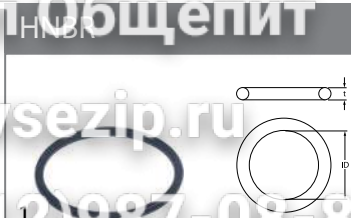
			
<b>GEV No.</b>	526272	<b>Ref. No.</b>	3152151
<b>description</b>	O-ring HNBR thickness 3.53mm ID $\varnothing$ 47.22mm Qty 1 pcs		

## sealing washers

## fibre gaskets

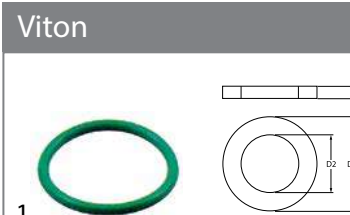
			
<b>GEV No.</b>	532487	<b>Ref. No.</b>	3150690
<b>description</b>	O-ring Viton thickness 2.62mm ID $\varnothing$ 25.07mm Qty 1 pcs		
<b>For models:</b>	04WFR3ED, 06WFR3GD, 08WFR4ED, 091FE28, 091FE28B, 091FR3E, 091FR3ED, 091FR3G, 091FR3GD, 0A1FR3E, 0A1FR3ED, 0A1FR3G, 0A1FR3GD, 0D1FR3E, 0D1FR3ED, 0D1FR3G, 0D1FR3GD, 0G1FR3G, 0G1FR3GD, 0G1FR7G, 10WFR4GD, 191FR4E, 191FR4ED, 191FR4G, 191FR4GD, 1A1FR4E, 1A1FR4ED, 1A1FR4G, 1A1FR4GD, 1D1FR4E, 1D1FR4ED, 1D1FR4G, 1D1FR4GD, 1G1FR4G, 1G1FR4GD, 1G1FR8G, 30F1, 30F1B, 30FES2, 30FES2B, 30FS2, 30FS2B, 70FES2, 70FES2B, 90F110B, 91F210, 91F210B, FC1011G, FC1221G, FC611G...(Other models you can see in the webshop)		

			
<b>GEV No.</b>	517173	<b>Ref. No.</b>	37Q5130
<b>description</b>	flat gasket FIBER ED $\varnothing$ 14mm ID $\varnothing$ 8mm thickness 1.5mm Qty 1 pcs		

			
<b>GEV No.</b>	506071	<b>Ref. No.</b>	37Q2340
<b>description</b>	flat gasket FIBER ED $\varnothing$ 25mm ID $\varnothing$ 18mm thickness 2mm Qty 1 pcs		

			
<b>GEV No.</b>	510123	<b>Ref. No.</b>	37Q4070
<b>description</b>	flat gasket FIBER ED $\varnothing$ 60mm ID $\varnothing$ 46mm thickness 2mm Qty 1 pcs		
<b>For models:</b>	191PD1G, 191PD2G, 191PI1G, 191PI1GA, 191PI2E, 191PI2EA, 191PI2G, 191PI2GA, 191PI2V, 191PI2VA, 1A1PI2G, 1A1PI2GA, 1D1PI2G, 1D1PI2GA, MCF20, MCF40, PV200, PV200A, PV300, PV300A		

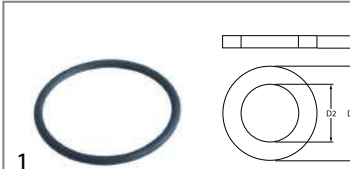
			
<b>GEV No.</b>	550494	<b>Ref. No.</b>	3152150 3152151
<b>description</b>	O-ring Viton thickness 3.53mm ID $\varnothing$ 47.22mm Qty 1 pcs		
<b>For models:</b>	0A1FR1E, 0A1FR1ED, 0D1FR1E, 0D1FR1ED, 1A1FR2E, 1A1FR2ED, 1D1FR2ED		

			
<b>GEV No.</b>	510405	<b>Ref. No.</b>	N/A
<b>description</b>	flat gasket fibre ED $\varnothing$ 56mm ID $\varnothing$ 42mm thickness 2mm for thread 1/4" Qty 1 pcs		

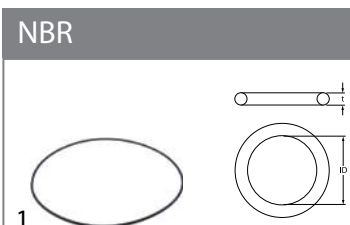
			
<b>GEV No.</b>	532609	<b>Ref. No.</b>	3151750
<b>description</b>	O-ring NBR thickness 7mm ID $\varnothing$ 387mm Qty 1 pcs		
<b>For models:</b>	LCV, P10, P102, P10M, P20, P202, P5		



Зип Общепит  
vsezip.ru  
+7(812)9812981

rubber gaskets			
			
1			
<b>GEV No.</b>	505405	<b>Ref. No.</b>	3045960
<b>description</b>	flat gasket NBR ED ø 58mm ID ø 40mm thickness 3mm drain		
<b>For models:</b>	BX101E, BX101E-VERS.122013, BX101G, BX101G-VERS.122013, BX122E, BX122E-VERS.122013, BX122G, BX122G-VERS.122013, BX61E, BX61E-VERS.122013, BX61G, BX61G-VERS.122013, BX82E, BX82E-VERS.122013, BX82G, BX82G-VERS.122013, FC1011E, FC1011G, FC1221E, FC1221G, FC611E, FC611G, FM1011E1, FM1011E1-VERS.2006, FM1011E2, FM1011E2-VERS.2006, FM1011E3, FM1011E3-VERS.2006, FM1011G1, FM1011G1-VERS.2006, FM1011G2, FM1011G2-VERS.2006, FM1011G3, FM1011G3-VERS.2006, FM1221E1, FM1221E1-VERS.2006, FM1221E2, FM1221E2-VERS.2006, FM1221E3, FM1221E3-VERS.2006, FM1221G1, FM1221G1-VERS.2006, FM1221G2, FM1221G2-VERS.2006, FM1221G3, FM1221G3-VERS.2006, FM2011E2-VERS.2006, FM2011E3-VERS.2006, FM2011G2-VERS.2006, FM2011G3-VERS.2006...(Other models you can see in the webshop)		

			
1			
<b>GEV No.</b>	519141	<b>Ref. No.</b>	3151980
<b>description</b>	flat gasket rubber ED ø 40mm ID ø 5.5mm thickness 2mm Qty 1 pcs		
<b>For models:</b>	C165D, C165S, C165VD, C165VS, C207D, C207D-VERS.2006, C207S, C207S-VERS.2006, C207VD, C207VD-VERS.2006, C207VS, C207VS-VERS.2006, C304AD, C304AD-VERS.2006, C304AS, C304AS-VERS.2006, C304AVD, C304AVD-VERS.2006, C304AVS, C304AVS-VERS.2006, C304D, C304D-VERS.2006, C304S, C304S-VERS.2006, C304VD, C304VD-VERS.2006, C304VS, C304VS-VERS.2006, C92D-VERS.2006, C92S-VERS.2006, C92VD-VERS.2006, C92VS-VERS.2006, CS243D, CS243D-VERS.2006, CS243S, CS243S-VERS.2006, CS243VD, CS243VD-VERS.2006, CS243VS, CS243VS-VERS.2006, CS370AD, CS370AD-VERS.2006, CS370AS, CS370AS-VERS.2006, CS370AVD, CS370AVD-VERS.2006, CS370AVS, CS370AVS-VERS.2006, CS370D, CS370D-VERS.2006...(Other models you can see in the webshop)		

			
2			
<b>GEV No.</b>	520054 <sup>1</sup>	<b>Ref. No.</b>	3152480
<b>description</b>	flat gasket rubber ED ø 23.5mm ID ø 14mm thickness 2.3mm Qty 10 pcs		

			
1			
<b>GEV No.</b>	517181	<b>Ref. No.</b>	3030160
<b>description</b>	flat gasket rubber ED ø 44mm ID ø 32mm thickness 3mm Qty 1 pcs		
<b>For models:</b>	KD37, KD40, LP202, LP202HC, LP302, LP302HC, LP402, LP402HC, LP402V, N100D, N100S, N100VD, N100VS, N38D, N38S, N38VD, N38VS, N42D, N42S, N42VD, N42VS, N50D, N50S, N50VD, N50VS, N66D, N66S, N66VD, N66VS, N70D, N70S, N70VD, N70VS, N85D, N85S, N85VD, N85VS		

<sup>1</sup>Qty 10 pieces

			
1			
<b>GEV No.</b>	519114	<b>Ref. No.</b>	3151890
<b>description</b>	flat gasket rubber ED ø 25mm ID ø 16.5mm thickness 2mm Qty 1 pcs		
<b>For models:</b>	C165D, C165S, C165VD, C165VS, C207D, C207D-VERS.2006, C207S, C207S-VERS.2006, C207VD, C207VD-VERS.2006, C207VS, C207VS-VERS.2006, C304AD, C304AD-VERS.2006, C304AS, C304AS-VERS.2006, C304AVD, C304AVD-VERS.2006, C304AVS, C304AVS-VERS.2006, C304D, C304D-VERS.2006, C304S, C304S-VERS.2006, C304VD, C304VD-VERS.2006, C304VS, C304VS-VERS.2006, C92D-VERS.2006, C92S-VERS.2006, C92VD-VERS.2006, C92VS-VERS.2006, CS243D, CS243D-VERS.2006, CS243S, CS243S-VERS.2006, CS243VD, CS243VD-VERS.2006, CS243VS, CS243VS-VERS.2006, CS370AD, CS370AD-VERS.2006, CS370AS, CS370AS-VERS.2006, CS370AVD, CS370AVD-VERS.2006, CS370AVS, CS370AVS-VERS.2006, CS370D, CS370D-VERS.2006...(Other models you can see in the webshop)		

			
1			
<b>GEV No.</b>	511435	<b>Ref. No.</b>	37Q3420
<b>description</b>	flat gasket rubber ED ø 47mm ID ø 39mm thickness 2mm Qty 1 pcs		

			
1			
<b>GEV No.</b>	519117	<b>Ref. No.</b>	37Q4220
<b>description</b>	flat gasket rubber ED ø 60mm ID ø 47mm thickness 3mm Qty 1 pcs		

			
1			
<b>GEV No.</b>	507360	<b>Ref. No.</b>	3150060
<b>description</b>	flat gasket rubber ED ø 30mm ID ø 21mm thickness 2mm Qty 1 pcs		
<b>For models:</b>	L100, L80		

			
1			
<b>GEV No.</b>	519118	<b>Ref. No.</b>	37Q4190
<b>description</b>	flat gasket rubber ED ø 70mm ID ø 52mm thickness 3mm Qty 1 pcs		
<b>For models:</b>	LF50, LF50E, LF50EM, LF50EMPS, LF50EMPS-VERS.122012, LF50EM-VERS.122012, LF50E-VERS.122012, LF50E-VERS.2007, LP70		

			
1			
<b>GEV No.</b>	511318	<b>Ref. No.</b>	37Q1580
<b>description</b>	flat gasket rubber ED ø 75mm ID ø 59mm thickness 2mm Qty 1 pcs		
<b>For models:</b>	KSV25P, KSV325P		



<b>GEV No.</b>	510680	<b>Ref. No.</b>	37Q4210
<b>description</b>	flat gasket rubber ED ø 82mm ID ø 62mm thickness 2mm Qty 1 pcs		
<b>For models:</b>	LC100, LC100-VERS.2001, LC130, LC130-VERS.2001		



<b>GEV No.</b>	519383	<b>Ref. No.</b>	3150290
<b>description</b>	gasket rubber ED ø 110mm ID ø 83mm thickness 3mm Qty 1 pcs		
<b>For models:</b>	F60P, F60PR, F60T, F80P, F80PR, L45		

### plastic gaskets



<b>GEV No.</b>	504435	<b>Ref. No.</b>	3152010
<b>description</b>	flat gasket plastic ED ø 18mm ID ø 9.5mm thickness 2.5mm for door hinge Qty 1 pcs		

### copper gaskets

#### DIN-7603-A



<b>GEV No.</b>	506411	<b>Ref. No.</b>	3151730
<b>description</b>	flat gasket copper ED ø 32.9mm ID ø 27mm thickness 1.5mm		
<b>For models:</b>	FC101, FC101E, FC241E, FC241G, FC61, FC61E, FCV101, FCV101-CSA, FCV101DM, FCV101DM-CSA, FCV101DS, FCV101DS-CSA, FCV101E, FCV101EDM, FCV101EDM-UL, FCV101EDS, FCV101EDS-UL, FCV101E-UL, FCV141, FCV141-CSA, FCV141DM, FCV141DM-CSA, FCV141DS, FCV141DS-CSA, FCV141E, FCV141EDM, FCV141EDS, FCV241E, FCV241EDM, FCV241EDM-UL, FCV241EDS, FCV241EDS-UL, FCV241E-UL, FCV241G, FCV241G-CSA, FCV241GDM, FCV241GDM-CSA, FCV241GDS, FCV241GDS-CSA, FCV3EM, FCV401DM, FCV401DM-CSA, FCV401EDM, FCV401EDM-UL, FCV4E, FCV4EDS, FCV4EM, FCV61, FCV61-CSA, FCV61DM...(Other models you can see in the webshop)		

### silicone gaskets



<b>GEV No.</b>	694916	<b>Ref. No.</b>	36E3320
<b>description</b>	gasket silicone ED ø 45mm ID ø 34mm thickness 5mm		
<b>For models:</b>	BX101E, BX101E-VERS.122013, BX101G, BX101G-VERS.122013, BX122E, BX122E-VERS.122013, BX122G, BX122G-VERS.122013, BX61E, BX61E-VERS.122013, BX61G, BX61G-VERS.122013, BX82E, BX82E-VERS.122013, BX82G, BX82G-VERS.122013, FC1011E, FC1011G, FC1221E, FC1221G, FC611E, FC611G, FM1011E1, FM1011E1-VERS.2006, FM1011E2, FM1011E2-VERS.2006, FM1011E3, FM1011E3-VERS.2006, FM1011G1, FM1011G1-VERS.2006, FM1011G2, FM1011G2-VERS.2006, FM1011G3, FM1011G3-VERS.2006, FM1221E1, FM1221E1-VERS.2006, FM1221E2, FM1221E2-VERS.2006, FM1221E3, FM1221E3-VERS.2006, FM1221G1, FM1221G1-VERS.2006, FM1221G2, FM1221G2-VERS.2006, FM1221G3, FM1221G3-VERS.2006, FM2011E2-VERS.2006, FM2011E3-VERS.2006, FM2011G2-VERS.2006, FM2011G3-VERS.2006...(Other models you can see in the webshop)		

## Зип-Общепит

foam rubber gaskets



<b>GEV No.</b>	901678	<b>Ref. No.</b>	3022960
<b>description</b>	foam rubber gasket Qty 1200mm incl. adhesive for lid		
<b>For models:</b>	DP10		

### shaft gaskets

#### shaft gaskets



<b>GEV No.</b>	520473	<b>Ref. No.</b>	3004400
<b>description</b>	gasket		
<b>For models:</b>	FC1011E, FC1011G, FC1221E, FC1221G, FC611E, FC611G, FM1011E1, FM1011E1-VERS.2006, FM1011E2, FM1011E2-VERS.2006, FM1011E3, FM1011E3-VERS.2006, FM1011G1, FM1011G1-VERS.2006, FM1011G2, FM1011G2-VERS.2006, FM1011G3, FM1011G3-VERS.2006, FM1221E1, FM1221E1-VERS.2006, FM1221E2, FM1221E2-VERS.2006, FM1221E3, FM1221E3-VERS.2006, FM1221G1, FM1221G1-VERS.2006, FM1221G2, FM1221G2-VERS.2006, FM1221G3, FM1221G3-VERS.2006, FM2011E2-VERS.2006, FM2011E3-VERS.2006, FM2011G2-VERS.2006, FM2011G3-VERS.2006, FM2021E1, FM2021E2, FM2021E2-VERS.2006, FM2021E3, FM2021E3-VERS.2006, FM2021G1, FM2021G2, FM2021G2-VERS.2006, FM2021G3, FM2021G3-VERS.2006, FM611E1, FM611E1-VERS.2006, FM611E2, FM611E2-VERS.2006, FM611E3, FM611E3-VERS.2006...(Other models you can see in the webshop)		



<b>GEV No.</b>	550685	<b>Ref. No.</b>	3151670
<b>description</b>	shaft seal ID ø 12mm ED ø 32mm thickness 7mm		
<b>For models:</b>	FCV3EM, FCV4E, FCV4EDS, FCV4EM		



<b>GEV No.</b>	698207	<b>Ref. No.</b>	3FL1137
<b>description</b>	shaft seal ID ø 30mm ED ø 40mm thickness 7mm		





special gaskets

for combi-steamers



<b>GEV No.</b>	505405	<b>Ref. No.</b>	3045960
<b>description</b>	flat gasket NBR ED $\varnothing$ 58mm ID $\varnothing$ 40mm thickness 3mm drain		
<b>For models:</b>	BX101E, BX101E-VERS.122013, BX101G, BX101G-VERS.122013, BX122E, BX122E-VERS.122013, BX122G, BX122G-VERS.122013, BX61E, BX61E-VERS.122013, BX61G, BX61G-VERS.122013, BX82E, BX82E-VERS.122013, BX82G, BX82G-VERS.122013, FC1011E, FC1011G, FC1221E, FC1221G, FC611E, FC611G, FM1011E1, FM1011E1-VERS.2006, FM1011E2, FM1011E2-VERS.2006, FM1011E3, FM1011E3-VERS.2006, FM1011G1, FM1011G1-VERS.2006, FM1011G2, FM1011G2-VERS.2006, FM1011G3, FM1011G3-VERS.2006, FM1221E1, FM1221E1-VERS.2006, FM1221E2, FM1221E2-VERS.2006, FM1221E3, FM1221E3-VERS.2006, FM1221G1, FM1221G1-VERS.2006, FM1221G2, FM1221G2-VERS.2006, FM1221G3, FM1221G3-VERS.2006, FM2011E2-VERS.2006, FM2011E3-VERS.2006, FM2011G2-VERS.2006, FM2011G3-VERS.2006...(Other models you can see in the webshop)		



<b>GEV No.</b>	699497	<b>Ref. No.</b>	3332580
<b>description</b>	gasket ED $\varnothing$ 92.5mm ID $\varnothing$ 51mm graphite thickness 2mm		



<b>GEV No.</b>	696776	<b>Ref. No.</b>	36E3780
<b>description</b>	gasket for heat exchanger L 50mm W 50mm flange ID $\varnothing$ 34mm thickness 1mm hole distance 40mm		
<b>For models:</b>	FM1011G1, FM1011G2, FM1011G3, FM1221G1, FM1221G2, FM1221G3, FM2021G1, FM2021G2, FM2021G3, FM611G1, FM611G2, FM611G3, FM721G1, FM721G2, FM721G3		



<b>GEV No.</b>	696779	<b>Ref. No.</b>	36E3400
<b>description</b>	gasket for heat exchanger L 60mm W 60mm flange ID $\varnothing$ 34mm thickness 3mm hole distance 40mm		
<b>For models:</b>	FC1011G, FC1221G, FC611G, FM1011G1, FM1011G1-VERS.2006, FM1011G2, FM1011G2-VERS.2006, FM1011G3, FM1011G3-VERS.2006, FM1221G1, FM1221G1-VERS.2006, FM1221G2, FM1221G2-VERS.2006, FM1221G3, FM1221G3-VERS.2006, FM2011G2-VERS.2006, FM2011G3-VERS.2006, FM2021G1, FM2021G2, FM2021G2-VERS.2006, FM2021G3, FM2021G3-VERS.2006, FM611G1, FM611G1-VERS.2006, FM611G2, FM611G2-VERS.2006, FM611G3, FM611G3-VERS.2006, FM721G1, FM721G1-VERS.2006, FM721G2, FM721G2-VERS.2006, FM721G3, FM721G3-VERS.2006		

door seals for dish washers



<b>GEV No.</b>	518254	<b>Ref. No.</b>	37Q3910
<b>description</b>	door seal L 450mm W 28mm H 6mm Qty 1 with 5 holes		
<b>For models:</b>	LT10R, LT20F, LT25F		

miscellaneous



<b>GEV No.</b>	901678	<b>Ref. No.</b>	3022960
<b>description</b>	foam rubber gasket Qty 1200mm incl. adhesive for lid		
<b>For models:</b>	DP10		



<b>GEV No.</b>	519385	<b>Ref. No.</b>	3150220
<b>description</b>	gasket for core temperature probe ED $\varnothing$ 8mm ID $\varnothing$ 4mm thickness 5mm		
<b>For models:</b>	FCV101DM, FCV101DM-CSA, FCV101DS, FCV101DS-CSA, FCV101EDM, FCV101EDM-UL, FCV101EDS, FCV101EDS-UL, FCV141DM, FCV141DM-CSA, FCV141DS, FCV141DS-CSA, FCV141EDM, FCV141EDS, FCV241DM, FCV241DS, FCV241EDM, FCV241EDM-UL, FCV241EDS, FCV241EDS-UL, FCV241GDM, FCV241GDM-CSA, FCV241GDS, FCV241GDS-CSA, FCV401DM, FCV401DM-CSA, FCV401EDM, FCV401EDM-UL, FCV4EDS, FCV61DM, FCV61DM-CSA, FCV61DS, FCV61DS-CSA, FCV61EDM, FCV61EDM-UL, FCV61EDS, FCV61EDS-UL, FCV72EDM-UL, FCV72EDS-UL, FM1011E2, FM1011E3, FM1011G2, FM1011G3, FM1221E2, FM1221E3, FM1221G2, FM1221G3, FM2021E2, FM2021E3, FM2021G2...(Other models you can see in the webshop)		



<b>GEV No.</b>	510847	<b>Ref. No.</b>	N/A
<b>description</b>	gasket polishing agent dosing ID $\varnothing$ 22mm ED $\varnothing$ 32mm external height 5mm		

Зип Общепит  
vsezip.ru  
+7(812)987-08-81

			
1			
<b>GEV No.</b>	541499	<b>Ref. No.</b>	3151450
<b>description</b>	gasket suitable for ANGELO PO size 1¼"		
<b>For models:</b>	FC101, FC1011E, FC1011G, FC101E, FC1221E, FC1221G, FC241, FC241E, FC241G, FC61, FC611E, FC611G, FC61E, FCV101, FCV101-CSA, FCV101DM, FCV101DM-CSA, FCV101DS, FCV101DS-CSA, FCV101E, FCV101EDM, FCV101EDM-UL, FCV101EDS, FCV101EDS-UL, FCV101E-UL, FCV141, FCV141-CSA, FCV141DM, FCV141DM-CSA, FCV141DS, FCV141DS-CSA, FCV141E, FCV141EDM, FCV141EDS, FCV241, FCV241DM, FCV241DS, FCV241E, FCV241EDM, FCV241EDM-UL, FCV241EDS, FCV241EDS-UL, FCV241E-UL, FCV241G, FCV241G-CSA, FCV241GDM, FCV241GDM-CSA, FCV241GDS, FCV241GDS-CSA, FCV401DM...(Other models you can see in the webshop)		

			
2			
<b>GEV No.</b>	519384	<b>Ref. No.</b>	3150880
<b>description</b>	gasket thickness 3mm hole ø 40mm dimensions 100x100mm		

			
1			
<b>GEV No.</b>	900854	<b>Ref. No.</b>	37Q4440
<b>description</b>	oven gasket L 332mm W 128mm mineral wool		
<b>For models:</b>	FPZ14E, FPZ16E, FPZ24E, FPZ2635E, FPZ26E, FPZ4G, FPZ6G		

thermostat gaskets

			
1			
<b>GEV No.</b>	550492	<b>Ref. No.</b>	3152240
<b>description</b>	gasket for thermostat		
<b>For models:</b>	04WBMEV, 04WCP1EM, 04WVT1IV, 04WVT1IV-VERS.022010, 04WVT2IV, 04WVT2IV-VERS.022010, 04WVT3RV, 06WBR3E, 06WCP1GM, 06WFT1EV, 06WFT2EV, 06WFT3EV, 06WFT4EV, 06WFT6EV, 06WFT7EV, 08WCP1GM, 08WFA4E, 08WFAAE, 08WFT1EV, 08WFT2EV, 08WFT3EV, 08WFT4EV, 08WFT6EV, 08WFT7EV, 08WVT1IV, 08WVT1IV-VERS.112009, 08WVT2IV, 08WVT2IV-VERS.112009, 090FT1E, 090FT2E, 090FT4E, 090FT5E, 090FT7E, 090PE4, 090VT1I, 090VT1I-VERS.112010, 090VT1W, 090VT1W-VERS.102008, 090VTR, 091CP1E, 091FR1E, 091FR1ED, 091FR1G, 091FR1GD, 091FR1I, 091FR1I-VERS.032012, 091FR3ED, 091FR3G, 091FR3GD, 091FR7G...(Other models you can see in the webshop)		

			
1			
<b>GEV No.</b>	510167	<b>Ref. No.</b>	3150270 315Q270
<b>description</b>	gasket for thermostat ED ø 41mm ID ø 18mm Qty ANGELO PO/ ZANUSSI pcs equiv. no. 3150270/66717		
<b>For models:</b>	030BME, 031BME		

gaskets for wash arm support

			
1			
<b>GEV No.</b>	519445	<b>Ref. No.</b>	3150230
<b>description</b>	gasket D1 ø 80mm D2 ø 50mm thickness 3mm with 4 screw holes		
<b>For models:</b>	F60P, F60PR, F60T, F80P, F80PR, FCV61EDS, FCV61EDS-UL, L45, LF50E, LF50EM, LF50EMPS, LF50EMPS-VERS.122012, LF50EM-VERS.122012, LF50E-VERS.122012, LF50E-VERS.2007, LP70		

refrigeration cycle components

valves

expansion valves

DANFOSS

valves

type TS2/TE2

			
1			
<b>GEV No.</b>	750520	<b>Ref. No.</b>	33A0500
<b>description</b>	expansion valve DANFOSS type TES2 coolant R404a/R507 angled 90° inlet 3/8" SAE outlet 12mm soldering connection 6mm soldering connection p max 34bar capillary pipe 1500mm		
<b>For models:</b>	IS102S, IS102SR, IS102SR-ONR01, IS102SW, SM2L, SM2LR, SM2LW, SM2S, SM2SR, SM2SW, SM3S, SM3SR, SM4SR		

			
1			
<b>GEV No.</b>	750304	<b>Ref. No.</b>	33A0870
<b>description</b>	expansion valve DANFOSS type TES2 coolant R404a/R507 angled 90° thermostatically controlled inlet 3/8" SAE outlet 12mm soldering connection 6mm soldering connection p max 34bar -40 up to +10°C capillary pipe 1500mm		
<b>For models:</b>	ART2LD, ART2SD, ART3SD, GR4A-ONR01, IA101L, IA101S, IA72S, XA101L, XA101S, XA72S		



filter driers

miscellaneous



<b>GEV No.</b>	750177	<b>Ref. No.</b>	33A0180
----------------	--------	-----------------	---------

**description** dryer ø 24mm L 155mm connection 6,3/6,3mm

**For models:** 120, 120NN, 120PV, 135, 135-4, 135A, 135BN, 135BNX, 135CPX, 135NN, 135NNX, 135PVX, 135X, 135X-3, 135X-4, 135XE, 3G6SA, 3G6SA2, 3G6SA4, 40, 40-OPR01, 40B, 40B-OPR01, 40BX-OPR01, 40CP, 40CP-OPR01, 40CPX, 40CPX-OPR01, 40EV, 40EV-OPR01, 40EVP, 40PL, 40PV, 40PV-OPR01, 40X, 40X-OPR01, 40XPV, 4G6SB, 4G6SB2, 4G6SB4, 4G6SB6, 55, 55B, 55PV, 65, 65A, 65B, 65BA, 65BX, 65BX-2...(Other models you can see in the webshop)



<b>GEV No.</b>	750058	<b>Ref. No.</b>	33A1150
----------------	--------	-----------------	---------

**description** dryer ø 24mm L 158mm connection 3.1/6.3mm

**For models:** 120PV, 55, 55PV, TVRV

evaporators

for fridges

producer-specific



<b>GEV No.</b>	750248	<b>Ref. No.</b>	34E0640
----------------	--------	-----------------	---------

**description** evaporator complete with fan

**For models:** MX120, MX130, MX140, MX150

Зип Общепит

vsezip.ru

+7(812)987-08-81

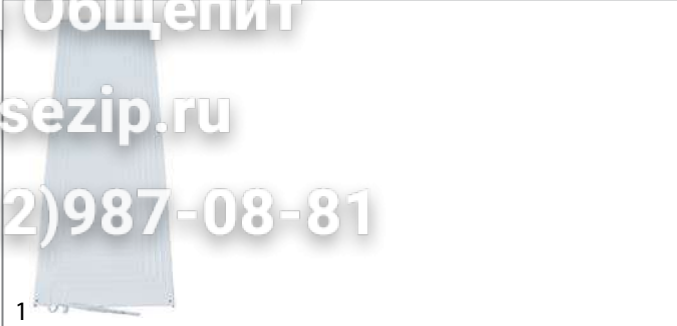

<b>GEV No.</b>	750049	<b>Ref. No.</b>	34D0360
----------------	--------	-----------------	---------

**description** evaporator L 1340mm W 430mm H 5mm type

**For models:** 120, 120NN, 120PV, 55, 55PV



<b>GEV No.</b>	750247	<b>Ref. No.</b>	32Z3420
----------------	--------	-----------------	---------

**description** evaporator L 255mm H 255mm W 50mm

**For models:** 6BEA11A, 6BEA11B, 6BEA11M, 6BEA11Z, 6BEA2A, 6BEA2B, 6BEA2M, 6BEA2Z, 6BEA3A, 6BEA3B, 6BEA3M, 6BEA3Z, 6BEAA, 6BEAB, 6BEAM, 6BEAZ, 6BEB11A, 6BEB11B, 6BEB11M, 6BEB11Z, 6BEB22A, 6BEB22B, 6BEB22M, 6BEB22Z, 6BEB2A, 6BEB2B, 6BEB2M, 6BEB2Z, 6BEB3A, 6BEB3B, 6BEB3M, 6BEB3Z, 6BEB4A, 6BEB4B, 6BEB4M, 6BEB4Z, 6BEBA, 6BEBB, 6BEBM, 6BEBZ, 6BMA11A, 6BMA11B, 6BMA11M, 6BMA11Z, 6BMA2A, 6BMA2B, 6BMA2M, 6BMA2Z, 6BMA3A, 6BMA3B...(Other models you can see in the webshop)

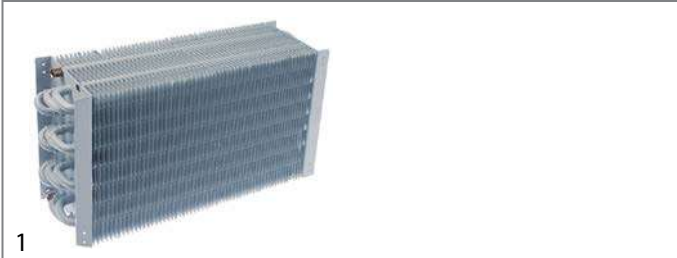

<b>GEV No.</b>	750230	<b>Ref. No.</b>	34D3390
----------------	--------	-----------------	---------

**description** evaporator L 360mm W 110mm H 200mm

**For models:** 6BEA11A, 6BEA11B, 6BEA11M, 6BEA2A, 6BEA2B, 6BEA2M, 6BEA3A, 6BEA3B, 6BEA3M, 6BEAA, 6BEAB, 6BEAM, 6BMA11A, 6BMA11B, 6BMA11M, 6BMA2A, 6BMA2B, 6BMA2M, 6BMA3A, 6BMA3B, 6BMA3M, 6BMAA, 6BMAB, 6BMAM, 6RMA2A, 6RMA2B, 6RMA2M, 6RMA2Z, 6RMAA, 6RMAB, 6RMAM, 6RMAZ, 6RMB2A, 6RMB2B, 6RMB2M, 6RMB2Z, 6RMB4A, 6RMB4B, 6RMB4M, 6RMB4Z, 6RMBA, 6RMBB, 6RMBM, 6RMBZ, BE1A, BE1A-11, BE1A-2, BE1A-3, BM1A, BM1A-11...(Other models you can see in the webshop)

Зип.Общепит

CONDENSORS

condensers

vsezip.ru

+7(812)987-08-81



1

<b>GEV No.</b>	750118	<b>Ref. No.</b>	34D4260
<b>description</b>	evaporator L 410mm W 90mm H 130mm		
<b>For models:</b>	CX120NN, CX130NN, CX140BN, CX140CP, CX140NN, CX150BN, CX150CP, CX150NN, CX55, CX60, CX65, CX652, CX65NB, CX65NCP, CX65NN, CX65PV, CX70, CX702, CX70NB, CX70NN, CX70PV, CX70R, ISFEN, S60, S60-2, S60E, S60X, S60X-2		



1

<b>GEV No.</b>	750658	<b>Ref. No.</b>	34E2930
<b>description</b>	evaporator L 415mm W 105mm H 330mm		
<b>For models:</b>	6EB, 6EB11, 6EB11A, 6EB11M, 6EB13, 6EB13A, 6EB13M, 6EB2, 6EB22, 6EB22A, 6EB22M, 6EB2A, 6EB2M, 6EB4, 6EB4A, 6EB4M, 6EBA, 6EBM, 6EC, 6EC11, 6EC11A, 6EC11M, 6EC13, 6EC13A, 6EC13M, 6EC2, 6EC22, 6EC22A, 6EC22M, 6EC2A, 6EC2M, 6EC4, 6EC4A, 6EC4M, 6ECA, 6ECM, 6ERB, 6ERB2, 6ERB2A, 6ERB2M, 6ERB4, 6ERB4A, 6ERB4M, 6ERBA, 6ERBM, 6ERC, 6ERC2, 6ERC2A, 6ERC2M, 6ERC4...(Other models you can see in the webshop)		



1

<b>GEV No.</b>	750069	<b>Ref. No.</b>	34D7670
<b>description</b>	evaporator L 420mm W 47mm H 300mm		
<b>For models:</b>	6JA, 6JA2, 6JA2A, 6JA2M, 6JAA, 6JAM, 6JB, 6JB2, 6JB2A, 6JB2M, 6JB4A, 6JB4M, 6JBA, 6JBM		



1

<b>GEV No.</b>	750000	<b>Ref. No.</b>	34D4300
<b>description</b>	evaporator L 730mm W 90mm H 130mm		
<b>For models:</b>	CX120, CX130, CX140, CX140PV, CX150, CX150PV, CX150R, S125, S125-4, S125E, S125X, S125X-4		



1

<b>GEV No.</b>	605131	<b>Ref. No.</b>	34D4831
<b>description</b>	condenser W 260mm D 110mm H 260mm		
<b>For models:</b>	135XE, 55B, 65BA, 65BXE, CX60B, DS31, DS31A, DS31C, DS31M, FX70B, MX60B, MX70B, S125, S125X, S600B, S600B2, S600BE, S60BE, SM03LT7, SM03LT7A, SM03LT7M, SP120BN, SP55B, VS31, VS31M		



1

<b>GEV No.</b>	750543	<b>Ref. No.</b>	34d6180
<b>description</b>	condenser W 275mm D 100mm H 260mm		
<b>For models:</b>	135BN, 135BNX, 135CPX, 55, 55PV, 65, 65A, 65PVX, 65X, 65X-2, 65XE, 6FMB11A, 6FMB11B, 6FMB11M, 6FMB11Z, 6FMB2A, 6FMB2B, 6FMB2M, 6FMB2Z, 6FMB4A, 6FMB4B, 6FMB4M, 6FMB4Z, 6FMB4A, 6FMB4B, 6FMB4M, 6FMB4Z, 6FMB4A, 6FMB4B, 6FMB4M, 6FMB4Z, 6FMC11A, 6FMC11B, 6FMC11M, 6FMC11Z, 6FMC2A, 6FMC2B, 6FMC2M, 6FMC2Z, 6FMC4A, 6FMC4B, 6FMC4M, 6FMC4Z, 6FMC4A, 6FMC4B, 6FMC4M, 6FMC4Z, 6JB, 6JB2, 6JB2A, 6JB2M, 6JB4A, 6JB4M, 6JBA...(Other models you can see in the webshop)		



## evaporation and condensing trays

### evaporation trays

 <p>1</p>			
<b>GEV No.</b>	750716	<b>Ref. No.</b>	36Z0300
<b>description</b>	evaporation tray L 610mm W 295mm H 50mm		
<b>For models:</b>	120, 120B, 120NN, 120PV, 135, 135-4, 135A, 135B, 135BA, 135BN, 135BNX, 135BX, 135BXE, 135BXR, 135CPX, 135NN, 135NNX, 135PVX, 135X, 135X-3, 135X-4, 135XE, 135XR, 55, 55B, 55PV, 65, 65A, 65B, 65BA, 65BX, 65BX-2, 65BXE, 65BXR, 65NB, 65NBX, 65NN, 65NNX, 65PVX, 65X, 65X-2, 65XE, 65XR, 6FMA11A, 6FMA11B, 6FMA11M, 6FMA11Z, 6FMA2A, 6FMA2B, 6FMA2M...(Other models you can see in the webshop)		

### miscellaneous

 <p>1</p>			
<b>GEV No.</b>	750059	<b>Ref. No.</b>	36Z6471
<b>description</b>	evaporation tray for condenser L 440mm W 357mm		
<b>For models:</b>	135BN, 135BNX, 65B, 65BA, 65BX, 65BX-2, 65BXE, 65BXR, SP135BN, SP65B		

## transmission technology and ball bearings

### drive belts

#### poly-v belts

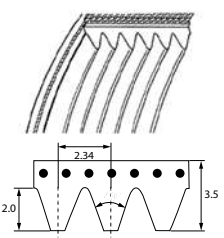
  <p>1</p>			
<b>GEV No.</b>	692144	<b>Ref. No.</b>	36G6610
<b>description</b>	poly-v belt grooves 12 W 28mm L 559mm profile J		
<b>For models:</b>	LCV, P10, P102, P10M, P20, P202, P5, TV1, TV1M, TV2L		

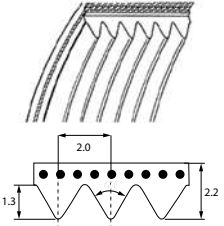
  <p>1</p>			
<b>GEV No.</b>	698156	<b>Ref. No.</b>	36G6630
<b>description</b>	poly-v belt grooves 14 W 28mm L 430mm profile TB2		

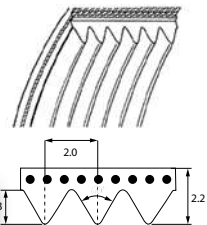
  <p>1</p>			
<b>GEV No.</b>	698223	<b>Ref. No.</b>	3042690
<b>description</b>	poly-v belt grooves 6 W 12mm L 660mm profile TB2		
<b>For models:</b>	SC4, SC6		

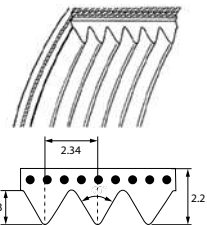
  <p>1</p>			
<b>GEV No.</b>	698206	<b>Ref. No.</b>	36G4900
<b>description</b>	poly-v belt grooves 12 W 28mm L 457mm profile TB2.34		

## springs

### torsion springs

 <p>1</p>			
<b>GEV No.</b>	516090	<b>Ref. No.</b>	36G8360
<b>description</b>	torsion spring mounting pos. right for door		

 <p>1</p>			
<b>GEV No.</b>	700221	<b>Ref. No.</b>	36E0220
<b>description</b>	torsion spring $\phi$ 17mm wire gauge $\phi$ 1.5mm L1 48mm		
<b>For models:</b>	C1424		

 <p>1</p>			
<b>GEV No.</b>	700185	<b>Ref. No.</b>	36G1300
<b>description</b>	torsion spring $\phi$ 30.5mm wire gauge $\phi$ 4.7mm L1 30mm L2 295mm L3 30mm		
<b>For models:</b>	1G1BR1E, 1G1BR1G, 1G1PD1G, 1G1PI1E, 1G1PI1G, 31PD6, 31PI6, 31PIE6, 31R, 31RE		

Зип-Общепит

roller springs

roller springs  
vsezip.ru

812)987-08-81

			
<b>GEV No.</b>	700186	<b>Ref. No.</b>	36G2640
<b>description</b>	torsion spring $\varnothing$ 31.7mm wire gauge $\varnothing$ 5.5mm L1 30mm L2 300mm L3 30mm		
<b>For models:</b>	191PD1G, 191PD2G, 191PI1G, 191PI1GA, 191PI2E, 191PI2EA, 191PI2G, 191PI2GA, 191PI2V, 191PI2VA, 1A1PD1G, 1A1PD2G, 1A1PI1G, 1A1PI1GA, 1A1PI2E, 1A1PI2EA, 1A1PI2G, 1A1PI2GA, 1A1PI2V, 1A1PI2VA, 1D1PD1G, 1D1PD2G, 1D1PI1G, 1D1PI1GA, 1D1PI2E, 1D1PI2EA, 1D1PI2G, 1D1PI2GA, 1D1PI2V, 1D1PI2VA, 71AR, 71ARE, 71PD10, 71PD15, 71PI10, 71PI10A, 71PIE15, 71PIE15A, 71PV15, 71PV15A, 71RA, 91AR, 91ARE, 91PI10, 91PI10A, 91PIE15, 91PIE15A, 91RA		

			
<b>GEV No.</b>	517338	<b>Ref. No.</b>	36G7650
<b>description</b>	roller spring		
<b>For models:</b>	N303D, N303S, N303VD, N303VS, N354D, N354S, N354VD, N354VS, N506D, N506S, N506VD, N506VS, N607D, N607S, N607VD, N607VS, N760D, N760S, N760VD, N760VS, N886D, N886S, N886VD, N886VS		

			
<b>GEV No.</b>	691182	<b>Ref. No.</b>	36G9970
<b>description</b>	torsion spring $\varnothing$ 52mm wire gauge $\varnothing$ 6mm L1 110mm L2 30mm L3 30mm Qty 2 pcs		
<b>For models:</b>	PV200A, PV300		

compression springs

			
<b>GEV No.</b>	516247	<b>Ref. No.</b>	36G1730
<b>description</b>	compression spring $\varnothing$ 18mm L 30mm		
<b>For models:</b>	LT10R, LT20F, LT25F		

			
<b>GEV No.</b>	519340	<b>Ref. No.</b>	36G8430
<b>description</b>	roller spring		
<b>For models:</b>	LP124, LP124S-VERS.052006, LP124V, LP124-VERS.052006, LP124VS-VERS.052006, LP124V-VERS.052006		

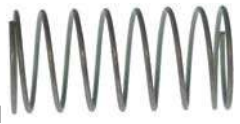
			
<b>GEV No.</b>	514284	<b>Ref. No.</b>	36G5320
<b>description</b>	compression spring $\varnothing$ 9mm L 18mm wire gauge $\varnothing$ 0.5mm		
<b>For models:</b>	04WCP1EM, 08WCP1GM, BX101E, BX101E-VERS.122013, BX101G, BX101G-VERS.122013, BX122E, BX122E-VERS.122013, BX122G, BX122G-VERS.122013, BX61E, BX61E-VERS.122013, BX61G, BX61G-VERS.122013, BX82E, BX82E-VERS.122013, BX82G, BX82G-VERS.122013, FC101, FC1011E, FC1011G, FC101E, FC1221E, FC1221G, FC241, FC241E, FC241G, FC61, FC611E, FC611G, FC61E, FCV101, FCV101-CSA, FCV101DM, FCV101DM-CSA, FCV101DS, FCV101DS-CSA, FCV101E, FCV101EDM, FCV101EDM-UL, FCV101EDS, FCV101EDS-UL, FCV101E-UL, FCV141, FCV141-CSA, FCV141DM, FCV141DM-CSA, FCV141DS, FCV141DS-CSA, FCV141E...(Other models you can see in the webshop)		

			
<b>GEV No.</b>	519616	<b>Ref. No.</b>	36G8740
<b>description</b>	roller spring W 40mm ID $\varnothing$ 36mm lug length 50mm		
<b>For models:</b>	C165D, C165S, C165VD, C165VS, C207D, C207D-VERS.2006, C207S, C207S-VERS.2006, C207VD, C207VD-VERS.2006, C207VS, C207VS-VERS.2006, C304AD, C304AD-VERS.2006, C304AS, C304AS-VERS.2006, C304AVD, C304AVD-VERS.2006, C304AVS, C304AVS-VERS.2006, C304D, C304D-VERS.2006, C304S, C304S-VERS.2006, C304VD, C304VD-VERS.2006, C304VS, C304VS-VERS.2006, C92D-VERS.2006, C92S-VERS.2006, C92VD-VERS.2006, C92VS-VERS.2006, CS243D, CS243D-VERS.2006, CS243S, CS243S-VERS.2006, CS243VD, CS243VD-VERS.2006, CS243VS, CS243VS-VERS.2006, CS370AD, CS370AD-VERS.2006, CS370AS, CS370AS-VERS.2006, CS370AVD, CS370AVD-VERS.2006, CS370AVS, CS370AVS-VERS.2006, CS370D, CS370D-VERS.2006...(Other models you can see in the webshop)		



Зип Общепит  
vsezip.ru  
+7(812)987-08-81  
kitchen accessories



1	<b>GEV No.</b>	519619	<b>Ref. No.</b>	36G8750
<b>description</b> roller spring with holder W 40mm ID ø 36.5mm lug length 60mm mounting distance 18mm bore ø 5mm				
<b>For models:</b> C207D-VERS.2006, C207S-VERS.2006, C207VD-VERS.2006, C207VS-VERS.2006, C304AD, C304AD-VERS.2006, C304AS, C304AS-VERS.2006, C304AVD, C304AVD-VERS.2006, C304AVS, C304AVS-VERS.2006, C304D, C304D-VERS.2006, C304S, C304S-VERS.2006, C304VD, C304VD-VERS.2006, C304VS, C304VS-VERS.2006, C92D-VERS.2006, C92S-VERS.2006, C92VD-VERS.2006, C92VS-VERS.2006, CS243D, CS243D-VERS.2006, CS243S, CS243VD, CS243VD-VERS.2006, CS243VS, CS243VS-VERS.2006, CS370AD, CS370AD-VERS.2006, CS370AS, CS370AS-VERS.2006, CS370AVD, CS370AVD-VERS.2006, CS370AVS, CS370AVS-VERS.2006, CS370D, CS370D-VERS.2006, CS370S, CS370S-VERS.2006, CS370VD, CS370VD-VERS.2006, CS370VS, CS370VS-VERS.2006, CS466AD, CS466AD-VERS.2006, CS466AS...(Other models you can see in the webshop)				

1	<b>GEV No.</b>	519163	<b>Ref. No.</b>	36G8870
<b>description</b> tension spring ø 38.5mm total length 394mm wire gauge ø 6.5mm for hood				
<b>For models:</b> LC100, LC100-VERS.2001, LC130, LC130-VERS.2001, LC80				

shock absorbers



1	<b>GEV No.</b>	691188	<b>Ref. No.</b>	36G1370
<b>description</b> shock absorber				

gastronorm

bridges



1	<b>GEV No.</b>	691173	<b>Ref. No.</b>	35S6320
<b>description</b> bridge for Gastronorm container L1 175mm L2 155mm SS W 25mm H 15mm Qty 1 pcs				
<b>For models:</b> SA87				

tension springs



1	<b>GEV No.</b>	505501	<b>Ref. No.</b>	36G1340
<b>description</b> tension spring ø 11mm wire gauge ø 1.5mm L 220mm				
<b>For models:</b> F60P, F60PR, F60T, F80P, F80PR, L45				

manometers



1	<b>GEV No.</b>	541508	<b>Ref. No.</b>	33D1680
<b>description</b> manometer ø 40mm pressure range 0-4bar connection thread 1/8"				
<b>For models:</b> BX101E, BX101E-VERS.122013, BX101G, BX101G-VERS.122013, BX122E, BX122E-VERS.122013, BX122G, BX122G-VERS.122013, BX61E, BX61E-VERS.122013, BX61G, BX61G-VERS.122013, BX82E, BX82E-VERS.122013, BX82G, BX82G-VERS.122013, FCV101, FCV101-CSA, FCV101DM, FCV101DM-CSA, FCV101DS, FCV101DS-CSA, FCV101E, FCV101EDM, FCV101EDM-UL, FCV101EDS, FCV101EDS-UL, FCV101E-UL, FCV141, FCV141-CSA, FCV141DM, FCV141DM-CSA, FCV141DS, FCV141DS-CSA, FCV141E, FCV141EDM, FCV141EDS, FCV241, FCV241DM, FCV241DS, FCV241E, FCV241EDM, FCV241EDM-UL, FCV241EDS, FCV241EDS-UL, FCV241E-UL, FCV241G, FCV241G-CSA, FCV241GDM, FCV241GDM-CSA...(Other models you can see in the webshop)				



1	<b>GEV No.</b>	501296	<b>Ref. No.</b>	36H1430
<b>description</b> tension spring ø 12mm total length 275mm wire gauge ø 1.6mm				



1	<b>GEV No.</b>	700718	<b>Ref. No.</b>	36G5240
<b>description</b> tension spring ø 16.4mm total length 79.2mm wire gauge ø 2.9mm				
<b>For models:</b> 0A1CP1E, 0A1CP1G, 0A1FR1E, 0A1FR1ED, 0A1FR1G, 0A1FR1GD, 0A1FR1GD-VERS.2004, 0A1FR1G-VERS.2004, 0A1FR3G, 0A1FR3GD, 0B1CP1G, 0B1FR1G, 0B1FR1GD, 0D1CP1E, 0D1CP1G, 0D1FR1E, 0D1FR1ED, 0D1FR1G, 0D1FR1GD, 0D1FR1GD-VERS.2004, 0D1FR1G-VERS.2004, 0D1FR3G, 0D1FR3GD, 1A1CP1G, 1A1CP2G, 1A1FR2E, 1A1FR2ED, 1A1FR2G, 1A1FR2GD, 1A1FR2GD-VERS.2004, 1A1FR2G-VERS.2004, 1A1FR4G, 1A1FR4GD, 1D1CP1G, 1D1CP2G, 1D1FR2ED, 1D1FR2G, 1D1FR2GD, 1D1FR2GD-VERS.2004, 1D1FR2G-VERS.2004, 1D1FR4G, 1D1FR4GD, 30CPS, 30CPSE, 30F1, 30F1B, 30FES2, 30FES2B, 30FS2, 30FS2B...(Other models you can see in the webshop)				



1	<b>GEV No.</b>	541880	<b>Ref. No.</b>	33D1680-old
<b>description</b> manometer ø 41mm pressure range 0-6bar thread 1/8" 0-90PSI				





1	<b>GEV No.</b>	517286	<b>Ref. No.</b>	36H1460
<b>description</b> tension spring ø 35mm total length 865mm wire gauge ø 5mm				
<b>For models:</b> KD100, KD100A, KD100PSD, KD130, KD130A, KD130E, KD130EAT				

Зип Общепит

vsezip.ru

+7(812)987-08-81

			
1			
<b>GEV No.</b>	541334	<b>Ref. No.</b>	32V0940
<b>description</b>	manometer ø 60mm pressure range 0 up to 1bar thread 1/8" marking 0.5 kettle connection on the backside		
<b>For models:</b>	1A1PI1G, 1A1PI1GA, 1A1PI2E, 1A1PI2EA, 1A1PI2G, 1A1PI2GA, 1A1PI2V, 1A1PI2VA, 1D1PI1G, 1D1PI1GA, 1D1PI2E, 1D1PI2EA, 1D1PI2G, 1D1PI2GA, 1D1PI2V, 1D1PI2VA, 2A1PI3G, 2D1PI3G		

			
1			
<b>GEV No.</b>	541062	<b>Ref. No.</b>	32Z0060
<b>description</b>	manometer ø 63mm pressure range 0 up to 1bar connection marking adjustable kettle thread 1/4"		
<b>For models:</b>	191PI1G, 191PI1GA, 191PI2E, 191PI2EA, 191PI2G, 191PI2GA, 191PI2V, 191PI2VA, 1A1PI1G, 1A1PI1GA, 1A1PI2E, 1A1PI2EA, 1A1PI2V, 1A1PI2VA, 1D1PI1G, 1D1PI1GA, 1D1PI2E, 1D1PI2EA, 1D1PI2V, 1D1PI2VA, 1G1PI1E, 1G1PI1G, 291PI3E, 291PI3G, 2A1PI3E, 31PI6, 31PIE6, 71PI10, 71PI10A, 71PIE15, 71PIE15A, 71PV15, 71PV15A, 91PI10, 91PI10A, 91PIE15, 91PIE15A, BPV2, PV200, PV200A, PV300, PV300A		
<b>spare parts for</b>	541062		
	<b>GEV No.</b>	541130	<b>Ref. No.</b> —
glass panel ø 58mm thickness 2mm			

hose reels and spray guns

spray guns

			
1			
<b>GEV No.</b>	691048	<b>Ref. No.</b>	33D1700
<b>description</b>	spray gun for appliances 1/2" ET L 225mm type STAR		
<b>spare parts for</b>	691048		
	<b>GEV No.</b>	507309	<b>Ref. No.</b> —
O-ring EPDM thickness 2.62mm ID ø 17.13mm Qty 1 pcs			
	<b>GEV No.</b>	510322	<b>Ref. No.</b> —
O-ring EPDM thickness 1.78mm ID ø 17.17mm Qty 1 pcs			
	<b>GEV No.</b>	524055	<b>Ref. No.</b> —
flat gasket rubber ED ø 18mm ID ø 12mm thickness 2mm Qty 1 pcs			
	<b>GEV No.</b>	528485	<b>Ref. No.</b> —
O-ring EPDM thickness 1.78mm ID ø 6.07mm Qty 1 pcs			
	<b>GEV No.</b>	528494	<b>Ref. No.</b> —
gasket rubber ED ø 13mm ID ø 4mm thickness 4mm Qty 1 pcs			







			
1			
<b>GEV No.</b>	542068	<b>Ref. No.</b>	33D1700
<b>description</b>	spray gun for appliances 1/2" IT L 219mm with D-ring type KLARCO		

			
1			
<b>GEV No.</b>	540675	<b>Ref. No.</b>	3212740 3FL0182
<b>description</b>	shower head		

dosing pumps

peristaltic dosing pumps

- BORES
- built-in version
- with flow control

			
1			
<b>GEV No.</b>	361028	<b>Ref. No.</b>	33D0750
<b>description</b>	dosing pump BORES flow control 0.39l/h 230VAC rinse aid hose ø 4x6mm hose silicone type Perios built-in version with integrated non-return valve CODE P1B		
<b>For models:</b>	F60PR, F60T, F80P, F80PR		
<b>spare parts for</b>	361028		
	<b>GEV No.</b>	361127	<b>Ref. No.</b> —
pump hose Perios rinse aid hose ø 3x6mm hose type silicone L 120mm			
	<b>GEV No.</b>	361464	<b>Ref. No.</b> —
roller assembly rinse aid/detergent hose type Santoprene/silicone pump type Perios			
<b>accessories for</b>	361028		
	<b>GEV No.</b>	361142	<b>Ref. No.</b> —
mounting set detergent hose type 4x6mm hose length 2m PVC 2x hose/container filter/tank intake transparent			
	<b>GEV No.</b>	520090	<b>Ref. No.</b> —
PVC hose ID ø 4mm ED ø 6mm L 2m thickness 1mm t.max. 60°C transparent			
	<b>GEV No.</b>	520091	<b>Ref. No.</b> —
nylon hose ID ø 4mm ED ø 6mm L 2m thickness 1mm operating p. 10bar burst p. 50bar t.max. 100°C transparent			









Зип-Общепит

vsezip.ru

+7(812)987-08-81

SEKO			
spare parts			
			
1			
GEV No.	362021	Ref. No.	3183560
description	pump hose SEKO hose ø 6x10mm hose Santoprene		
For models:	FX101E3, FX101E3C, FX101E3C-VERS.022014, FX101E3R, FX101E3R-VERS.022014, FX101E3-VERS.022014, FX101G3, FX101G3C, FX101G3C-VERS.022014, FX101G3R, FX101G3R-VERS.022014, FX101G3-VERS.022014, FX10E3CR, FX10E3CR-VERS.022014, FX10G3CR, FX10G3CR-VERS.022014, FX122E3, FX122E3C, FX122E3T, FX122E3T-VERS.022014, FX122G3, FX122G3C, FX122G3T, FX122G3T-VERS.022014, FX12E3CT, FX12E3CT-VERS.022014, FX12G3CT, FX12G3CT-VERS.022014, FX201E3, FX201E3P, FX201E3P-VERS.022014, FX201E3-VERS.022014, FX201G3P, FX201G3-VERS.022014, FX202E3, FX202E3-230V-3-50Hz-60Hz, FX202E3-230V-3-50Hz-60Hz-VERS.022014, FX202E3-VERS.022014, FX202G3, FX202G3-VERS.022014, FX61E3, FX61E3C, FX61E3CR, FX61E3CR-VERS.022014, FX61E3C-VERS.022014, FX61E3R, FX61E3R-VERS.022014, FX61E3-VERS.022014, FX61G3, FX61G3C...(Other models you can see in the webshop)		

spare parts for 361003				
	GEV No.	361123	Ref. No.	—
membrane type DELTA				
	GEV No.	361169	Ref. No.	—
nose connector type DELTA				
	GEV No.	361188	Ref. No.	—
disc type DELTA				
	GEV No.	361319	Ref. No.	—
flat gasket rubber ID ø 9mm ED ø 14.5mm thickness 1mm type DELTA				

piston pumps



spare parts			
			
1			
GEV No.	361113	Ref. No.	—
description	solenoid coil 230VAC for type DB2		

spare parts			
			
1			
GEV No.	361169	Ref. No.	—
description	hose connector type DELTA		

			
1			
GEV No.	510298	Ref. No.	N/A
description	lip valve dosing pump suitable for DB2/DS5		

			
1			
GEV No.	361123	Ref. No.	—
description	membrane type DELTA		

membrane dosing pumps

electric dosing pumps				
Delta				
				
1				
GEV No.	361003	Ref. No.	32Z1610	
description	dosing pump 220V rinse aid duty cycle 25% type EL-1 valve lip valve			
spare parts for	361003			
	GEV No.	361122	Ref. No.	—
lip valve type DELTA				





self-priming				
LANG				
				
1				
GEV No.	361575	Ref. No.	33D2300	
description	dosing pump type N6 rinse aid pressure connection ø straight, 4x6mm suction connection ø angled, 6mm LANG			
spare parts for	361575			
	GEV No.	361079	Ref. No.	—
spring for type N5/N6 for ball				
	GEV No.	361080	Ref. No.	—
O-ring EPDM thickness 2mm ID ø 16mm Qty 1 pcs				
	GEV No.	361085	Ref. No.	—
O-ring EPDM thickness 2mm ID ø 8mm Qty 1 pcs				
	GEV No.	361309	Ref. No.	—
ball for type N5/N6				
	GEV No.	361310	Ref. No.	—
bracket for type N6 ball guide				

Table continues overleaf

Зип-Общепит

vsezip.ru

+7(812)987-08-81



spare parts for		361575	
GEV No.	361311	Ref. No.	—
	O-ring EPDM thickness 2mm ID ø 6mm Qty 1 pcs for type N6		
	361314	Ref. No.	—
valve ring for type N6 holder for O-ring			
	361317	Ref. No.	—
sealing disc for type N6			
	361886	Ref. No.	—
non-return valve inletmm outletmm outlet ø 12.4mm L 12.7mm			

accessories



1



GEV No.	101286	Ref. No.	36Q0020
<b>description</b>	olive ID ø 6mm Qty 1 pcs		
<b>For models:</b>	04WFAAV, 08WFA4E, 08WFA4G, 08WFAAE, 08WFAAG, 08WFAAV, 090FAA, 0A0FA1, 0A0FA4, 0A0FAA, 0D0FA1, 0D0FA4, 0D0FAA, 0G0FA0, 12WFA6E, 12WFA6G, 12WFAAA, 12WFAAE, 12WFAAG, 12WFAAN, 190FA, 190FAA, 190FAB, 190FAD, 191FAAE, 191FAAG, 191FABG, 191FADG, 191FAE, 191FAG, 1A0FA1, 1A0FA2, 1A0FA4, 1A0FA5, 1A0FAA, 1A0FAB, 1A1FA1G, 1A1FA2G, 1A1FA4G, 1A1FA5G, 1A1FAAG, 1A1FABG, 1D0FA1, 1D0FA2, 1D0FA4, 1D0FA5, 1D0FAA, 1D0FAB, 1D1FA1G, 1D1FA2G...(Other models you can see in the webshop)		





accessories for		101286	
GEV No.	100909	Ref. No.	36Q0060
	union screw thread M10x1 for pipe ø 6mm Qty 1 pcs		
	101464	Ref. No.	—
union nut thread M12x1 for pipe ø 6mm			

various



1

GEV No.	361002	Ref. No.	33D0060 33D0061
<b>description</b>	dosing pump rinse aid inlet 6x8mm outlet 4x6mm pressure connection ø 4x6mm suction connection ø 6x8mm		
<b>For models:</b>	F60P, L100, L40, L40S, L45, L60, L80		
spare parts for		361002	
	510297	Ref. No.	N/A
membrane for dosing pump ED ø 83mm thickness 1mm dosing pump equiv. no. 630614 suitable for COMENDA			
	510298	Ref. No.	N/A
lip valve dosing pump suitable for DB2/DS5			

spare parts for		361002	
GEV No.	510299	Ref. No.	N/A
	hose connector for dosing pump		
	510338	Ref. No.	N/A
union nut dosing pump thread 1/2" ø 32mm H 15mm for dosing pump			
	510847	Ref. No.	N/A
gasket polishing agent dosing ID ø 22mm ED ø 32mm external height 5mm			
	510870	Ref. No.	N/A
filter support for dosing pump			
	510916	Ref. No.	N/A
filter for dosing pump			

spare parts



1

GEV No.	510916	Ref. No.	N/A
<b>description</b>	filter for dosing pump		



1

GEV No.	510870	Ref. No.	N/A
<b>description</b>	filter support for dosing pump		



1

GEV No.	510847	Ref. No.	N/A
<b>description</b>	gasket polishing agent dosing ID ø 22mm ED ø 32mm external height 5mm		



1

GEV No.	510298	Ref. No.	N/A
<b>description</b>	lip valve dosing pump suitable for DB2/DS5		





Зип Общепит

GERMANY

vsezip.ru

77(812)987-08-81

			
1			
<b>GEV No.</b>	510297	<b>Ref. No.</b>	N/A
<b>description</b>	membrane for dosing pump ED ø 83mm thickness 1mm dosing pump equiv. no. 630614 suitable for COMENDA		

			
1			
<b>GEV No.</b>	510338	<b>Ref. No.</b>	N/A
<b>description</b>	union nut dosing pump thread 1/2" ø 32mm H 15mm for dosing pump		

self-priming with supporting pressure

DIHR

			
1			
<b>GEV No.</b>	361744	<b>Ref. No.</b>	33D3240
<b>description</b>	dosing pump type DW with auxiliary pressure connection rinse aid inlet 4mm outlet 8mm suction connection ø 4mm auxiliary pressure connection 10mm		
<b>For models:</b>	KD100, KD100A, KD100PSD, KD130E, KD130EAT, KD37, KD40, KD40E-PSD, KD40LEPS, KD40LSPS, KD40LUX, KD40LUXE, KD40-VERS.112009, KD60, KD60M, KD60MA, KD60MPS, KD60MPSA, KD60PS, KD60PSD, KD85, KD85A, KD85E, KD85EA, KD85EAT, KD85EATS, KD85EPS, KD85E-PSA, KD85PS, KD85PSA, KN1100, KN1100SD, KN11PSDD, KN35, KN37, KN37PS, KN40, KN40PS, KN40PSD, KN50, KN50M, KN50MPS, KN50PS, KN50PSD, KN50PSDD, KN80, KN800, KN800PSD, KN80PS, LP70		
<b>spare parts for</b>	361744		
	<b>GEV No.</b>	520026	<b>Ref. No.</b> —
	PVC hose ID ø 4mm ED ø 6mm L 10m thickness 1mm t.max. 60°C transparent		
	<b>GEV No.</b>	520090	<b>Ref. No.</b> —
	PVC hose ID ø 4mm ED ø 6mm L 2m thickness 1mm t.max. 60°C transparent		

ELETTROBAR

			
1			
<b>GEV No.</b>	510298	<b>Ref. No.</b>	N/A
<b>description</b>	lip valve dosing pump suitable for DB2/DS5		

spare parts			
1			
<b>GEV No.</b>	510298	<b>Ref. No.</b>	N/A
<b>description</b>	lip valve dosing pump suitable for DB2/DS5		

accessories

			
1			
<b>GEV No.</b>	361829	<b>Ref. No.</b>	—
<b>description</b>	container filter complete plastic hose ø 5mm		

hose couplings

metal

			
1			
<b>GEV No.</b>	361507	<b>Ref. No.</b>	3016150
<b>description</b>	screw pipe fitting angled nickel-plated brass thread 1/4" hose ø 6/8mm Qty 1 pcs		

			
1			
<b>GEV No.</b>	361506	<b>Ref. No.</b>	3014470
<b>description</b>	screw pipe fitting angled nickel-plated brass thread 1/8" hose ø 6/8mm Qty 1 pcs		
<b>For models:</b>	FM1011E2-VERS.2006, FM1011E3, FM1011E3-VERS.2006, FM1011G2-VERS.2006, FM1011G3, FM1011G3-VERS.2006, FM1221E2-VERS.2006, FM1221E3, FM1221E3-VERS.2006, FM1221G2-VERS.2006, FM1221G3, FM1221G3-VERS.2006, FM2011E2-VERS.2006, FM2011E3-VERS.2006, FM2011G2-VERS.2006, FM2011G3-VERS.2006, FM2021E2-VERS.2006, FM2021E3-VERS.2006, FM2021G2-VERS.2006, FM2021G3-VERS.2006, FM423E2, FM611E2-VERS.2006, FM611E3, FM611E3-VERS.2006, FM611G2-VERS.2006, FM611G3, FM611G3-VERS.2006, FM721E2-VERS.2006, FM721E3, FM721E3-VERS.2006, FM721G2-VERS.2006, FM721G3, FM721G3-VERS.2006, FX101E2, FX101E2C, FX101E2C-VERS.032014, FX101E2R, FX101E2R-VERS.032014, FX101E3, FX101E3C, FX101E3C-VERS.022014, FX101E3R, FX101E3R-VERS.022014, FX101E3-VERS.022014, FX101G2, FX101G2C, FX101G2C-VERS.032014, FX101G2R, FX101G2R-VERS.032014...(Other models you can see in the webshop)		

			
1			
<b>GEV No.</b>	361182	<b>Ref. No.</b>	3117580
<b>description</b>	nut thread 1/4" H 5mm nickel-plated brass WS 17 Qty 1 pcs		
<b>For models:</b>	L100, L40, L40S, L60, L80, P5		

T-pieces

without non-return valve



<b>GEV No.</b>	516082	<b>Ref. No.</b>	35Z1090
<b>description</b>	T-piece plastic hose ø 12-7-12mm 3-way hose ø 12-7-12mmmm		





<b>GEV No.</b>	519217	<b>Ref. No.</b>	33Q3070
<b>description</b>	T-piece plastic hose ø 12-9-12mm 3-way hose ø 12-9-12mmmm		
<b>For models:</b>	F60P, L45, LC100, LC100-VERS.2001, LC130, LC130-VERS.2001, LC80, LF50		

hoses

supply hoses

PVC supply hoses



<b>GEV No.</b>	520010	<b>Ref. No.</b>	33M0350
<b>description</b>	supply hose PVC straight-curved DN13 connections 3/4" L 1500mm operating p. 10bar burst p. 32bar t.max. 90°C blue approval VDE flat seal		
<b>accessories for</b>	520010		
	<b>GEV No.</b>	520053	<b>Ref. No.</b> —
	screen connection 3/4" D1 ø 26mm D2 ø 15mm Qty 10 pcs rubber thickness 8mm		
	<b>GEV No.</b>	520054	<b>Ref. No.</b> 3152480
	flat gasket rubber ED ø 23.5mm ID ø 14mm thickness 2.3mm Qty 10 pcs		

drain hoses



<b>GEV No.</b>	530608	<b>Ref. No.</b>	33M1660
<b>description</b>	drain hose DN24 L 1500mm A int. ø 24mm A ext. ø 28mm B int. ø 28mm B ext. ø 35mm outer hose ø 29mm temp.-resist. 90°C		
<b>For models:</b>	KD100, KD100A, KD100PSD, KD40, KD40EPSD, KD40LEPS, KD40LSPS, KD40PS, KD60, KD60E, KD60EAT, KD60M, KD60MA, KD60ME, KD60MPS, KD60MPSA, KD60PS, KD60PSD, KD60EATSD, KN1100, KN1100SD, KN11PSDD, KN35, KN37PS, KN40PS, KN50MPS, KN50PS, KN50PSD, KN50PSDD, KN800, KN800PSD, KN80PS, N100D, N100S, N100VD, N100VS, N38D, N38S, N38VD, N38VS, N42D, N42S, N42VD, N42VS, N50D, N50S, N50VD, N50VS, N66D, N66S...(Other models you can see in the webshop)		

Зип Общепит

vsezip.ru

+7(812)987-08-81



<b>GEV No.</b>	530574	<b>Ref. No.</b>	3033760
<b>description</b>	drain hose DN24 L 2000mm A int. ø 31mm A ext. ø 35mm B int. ø 40mm B ext. ø 46mm outer hose ø 38mm		
<b>For models:</b>	KD85EATS, KD85EPS, KD85EPSA		



<b>GEV No.</b>	519272	<b>Ref. No.</b>	3029590 36U0730
<b>description</b>	drain hose DN24 L 1500mm straight ø inside 32mm straight ext. ø 35mm elbow ø inside 40mm elbow ext. ø 46mm outer hose ø 38mm		
<b>For models:</b>	LC100, LC100-VERS.2001, LC130, LC130-VERS.2001, LC80, LF50, LF50E, LF50EM, LF50EMPS-VERS.122012, LF50EM-VERS.122012, LF50E-VERS.122012, LP70		

industrial hoses

Niplaflex hoses



<b>GEV No.</b>	530561	<b>Ref. No.</b>	111AA05 131AA12 131AA14 131AA16
<b>description</b>	pressure hose ID ø 10mm ED ø 17mm L 5m thickness 3.5mm operating p. 10bar burst p. 30bar t.max. 110°C		
<b>For models:</b>	04WBMEV, 04WCP1EM, 06WCP1GM, 06WFR3GD, 08WCP1GM, 08WGREV, 090BM1E, 090BM1G, 091CP1E, 091CP1G, 0G1CP1EC, 0G1CP1E-VERS.2004, 0G1CP1G-VERS.2004, 10CP1EA, 10CP1GA, 10CP1IA, 10WFR4GD, 12CP1EA, 12CP1GA, 12CP1IA, 18CP2EA, 18CP2GA, 18CP2IA, 190BM2E, 190BM2G, 190GRE, 191BR1E, 191BR1G, 191BR1GA, 191BR2E, 191BR2EA, 191BR2G, 191BR2GA, 191CP1G, 191CP2G, 1G0GRE, 1G1CP1G-VERS.2004, 1G1CP2G-VERS.2004, 291BR1E, 291BR1G, 291BR1GA, 291BR2E, 291BR2EA, 291BR2G, 291BR2GA, 6040090, 6040110, 6040310, 6042610, 6042630...(Other models you can see in the webshop)		

pressure control hoses



<b>GEV No.</b>	530560	<b>Ref. No.</b>	111AA04
<b>description</b>	pressure control hose ID ø 5mm ED ø 9mm L 5m operating p. 30bar burst p. 90bar temp.-resist. 60°C		



Зип-Общепит

vsezip.ru

+7(812)987-08-81

PU hoses

<b>GEV No.</b>	512475	<b>Ref. No.</b>	3003920
<b>description</b>	dosing hose ED ø 8mm ID ø 6mm polyurethane blue Qty supplied by meter		
<b>For models:</b>	FM1011E3, FM1011E3-VERS.2006, FM1011G3, FM1011G3-VERS.2006, FM1221E3, FM1221E3-VERS.2006, FM1221G3-VERS.2006, FM2011E3-VERS.2006, FM2011G3-VERS.2006, FM2021E3, FM2021E3-VERS.2006, FM2021G3, FM2021G3-VERS.2006, FM611E3, FM611E3-VERS.2006, FM611G3, FM611G3-VERS.2006, FM721E3, FM721E3-VERS.2006, FM721G3, FM721G3-VERS.2006, FX101E3, FX101E3C, FX101E3C-VERS.022014, FX101E3R, FX101E3R-VERS.022014, FX101E3-VERS.022014, FX101G3, FX101G3C, FX101G3C-VERS.022014, FX101G3R, FX101G3R-VERS.022014, FX101G3-VERS.022014, FX10E3CR, FX10E3CR-VERS.022014, FX10G3CR, FX10G3CR-VERS.022014, FX122E3, FX122E3C, FX122E3T, FX122E3T-VERS.022014, FX122G3, FX122G3C, FX122G3T, FX122G3T-VERS.022014, FX12E3CT, FX12E3CT-VERS.022014, FX12G3CT, FX12G3CT-VERS.022014, FX201E3...(Other models you can see in the webshop)		

<b>GEV No.</b>	510677	<b>Ref. No.</b>	3000290
<b>description</b>	dosing hose ED ø 8mm ID ø 6mm polyurethane red Qty supplied by meter		
<b>For models:</b>	FM1011E3, FM1011E3-VERS.2006, FM1011G3, FM1011G3-VERS.2006, FM1221E3, FM1221E3-VERS.2006, FM1221G3-VERS.2006, FM2011E3-VERS.2006, FM2011G3-VERS.2006, FM2021E3, FM2021E3-VERS.2006, FM2021G3, FM2021G3-VERS.2006, FM611E3, FM611E3-VERS.2006, FM611G3, FM611G3-VERS.2006, FM721E3, FM721E3-VERS.2006, FM721G3, FM721G3-VERS.2006, FX101E3, FX101E3C, FX101E3R, FX101G3, FX101G3C, FX101G3R, FX10E3CR, FX10G3CR, FX122E3, FX122E3C, FX122G3, FX122G3C, FX201E3, FX202E3, FX61E3, FX61E3C, FX61E3CR, FX61E3R, FX61G3, FX61G3C, FX61G3CR, FX61G3R, FX82E3, FX82E3C, FX82G3, FX82G3C		

<b>GEV No.</b>	519160	<b>Ref. No.</b>	33M1260
<b>description</b>	formed hose L 150mm warewashing L-shape equiv. no. 903876 W 110mm hose int. ø 40mm		
<b>For models:</b>	LF50, LF50E, LF50EM, LP70		

<b>GEV No.</b>	517228	<b>Ref. No.</b>	3115800
<b>description</b>	formed hose warewashing L-shape equiv. no. 15032/A		
<b>For models:</b>	KD130, KD130A, KD130E, KD130EAT		

<b>GEV No.</b>	519382	<b>Ref. No.</b>	3300230
<b>description</b>	formed hose warewashing L-shape hose int. ø 44mm		
<b>For models:</b>	F60P, F60PR, F60T, L45		

formed hoses

straight

<b>GEV No.</b>	506412	<b>Ref. No.</b>	111AA08
<b>description</b>	formed hose dishwasher straight hose ext. ø 60mm hose int. ø 50mm		
<b>For models:</b>	FM1221E1, FM1221E2, FM1221E3, FM1221G1, FM1221G2, FM1221G3, FM2021E1, FM2021E2, FM2021E3, FM2021G1, FM2021G2, FM2021G3, FM721E1, FM721E2, FM721E3, FM721G1, FM721G2, FM721G3, FX101E1, FX101E1R, FX101E2, FX101E2C, FX101E2R, FX101E3, FX101E3C, FX101E3R, FX101G1, FX101G1R, FX101G2, FX101G2C, FX101G2R, FX101G3, FX101G3C, FX101G3R, FX10E2CR, FX10E3CR, FX10G2CR, FX10G3CR, FX61E1, FX61E1R, FX61E2, FX61E2C, FX61E2CR, FX61E2R, FX61E3, FX61E3C, FX61E3CR, FX61E3R, FX61G1, FX61G1R...(Other models you can see in the webshop)		

<b>GEV No.</b>	512384	<b>Ref. No.</b>	32Z2810
<b>description</b>	formed hose warewashing L-shape L2 100mm hose ext. ø 65mm hose int. ø 45mm		



with branch



1

<b>GEV No.</b>	517364	<b>Ref. No.</b>	3031860
<b>description</b>	formed hose ext. ø 58 D1 ø 50mm D2 ø 35mm L 455mm black Qty 1		
<b>For models:</b>	KD130, KD130A, KD130E, KD130EAT		



1

<b>GEV No.</b>	517361	<b>Ref. No.</b>	3031860
<b>description</b>	formed hose L 450mm rubber Qty 1		

form S



1

<b>GEV No.</b>	510678	<b>Ref. No.</b>	3300240
<b>description</b>	formed hose hose ext. ø 48mm hose int. ø 39mm L 235mm Qty 1 S-shape		
<b>For models:</b>	F60P, F60PR, F60T, L45		

Зип-Общепит

for dishwashers

miscellaneous

vsezip.ru



1

<b>GEV No.</b>	530590	<b>Ref. no.</b>	33M1310
<b>description</b>	hose ED ø 15mm ID ø 8mm equiv. no. 200117 Qty supplied by meter		

fittings, hose and pipe connectors

hose connectors

without screw connection



1

<b>GEV No.</b>	519216	<b>Ref. No.</b>	36G9050
<b>description</b>	T-piece plastic hose ø 12-12-12mm 3-way		
<b>For models:</b>	LC100, LC100-VERS.2001, LC130, LC130-VERS.2001, LC80, LF50, LF50E, LF50EM, LP70		



1

<b>GEV No.</b>	516082	<b>Ref. No.</b>	35Z1090
<b>description</b>	T-piece plastic hose ø 12-7-12mm 3-way hose ø 12-7-12mmmm		



1

<b>GEV No.</b>	519217	<b>Ref. No.</b>	33Q3070
<b>description</b>	T-piece plastic hose ø 12-9-12mm 3-way hose ø 12-9-12mmmm		
<b>For models:</b>	F60P, L45, LC100, LC100-VERS.2001, LC130, LC130-VERS.2001, LC80, LF50		



Зип-Общепит

vsezip.ru

+7(812)987-08-81



1

<b>GEV No.</b>	519630	<b>Ref. No.</b>	3008090
<b>description</b>	T-piece plastic hose $\varnothing$ 6x6x6mm 3-way		
<b>For models:</b>	191CP1G, 1G1CP1G-VERS.2004, FM1011E3, FM1011E3-VERS.2006, FM1011G3, FM1011G3-VERS.2006, FM1221E3-VERS.2006, FM1221G3-VERS.2006, FM2011E3-VERS.2006, FM2011G3-VERS.2006, FM2021E3-VERS.2006, FM2021G3-VERS.2006, FM611E3, FM611E3-VERS.2006, FM611G3, FM611G3-VERS.2006, FM721E3-VERS.2006, FM721G3-VERS.2006		



1

<b>GEV No.</b>	520700	<b>Ref. No.</b>	33Q5650
<b>description</b>	reducer thread 3/4" IT - 1/2" ET brass		
<b>For models:</b>	FCV101, FCV101-CSA, FCV101DM, FCV101DM-CSA, FCV101DS, FCV101DS-CSA, FCV101E, FCV101EDM, FCV101EDM-UL, FCV101EDS, FCV101EDS-UL, FCV101E-UL, FCV141, FCV141-CSA, FCV141DM, FCV141DM-CSA, FCV141DS, FCV141DS-CSA, FCV141E, FCV141EDM, FCV141EDS, FCV241, FCV241DM, FCV241DS, FCV241E, FCV241EDM, FCV241EDM-UL, FCV241EDS, FCV241EDS-UL, FCV241E-UL, FCV241G, FCV241G-CSA, FCV241GDM, FCV241GDM-CSA, FCV241GDS, FCV241GDS-CSA, FCV3EM, FCV401DM, FCV401DM-CSA, FCV401EDM, FCV401EDM-UL, FCV4E, FCV4EDS, FCV4EM, FCV61, FCV61-CSA, FCV61DM, FCV61DM-CSA, FCV61DS, FCV61DS-CSA...(Other models you can see in the webshop)		

fittings

double nipples



1

<b>GEV No.</b>	520160	<b>Ref. No.</b>	3005480
<b>description</b>	double nipple nickel-plated brass thread 1/8" - 1/8" Qty 1 pcs		



1

<b>GEV No.</b>	520177	<b>Ref. No.</b>	3040920
<b>description</b>	reducer thread 1/4" ET - 1/8" IT nickel-plated brass total length 13mm WS 17		



1

<b>GEV No.</b>	541504	<b>Ref. No.</b>	33Q5880
<b>description</b>	double nipple thread 1/2" - 1/2"		
<b>For models:</b>	FC101, FC241G, FC61, FCV101, FCV101-CSA, FCV101DM, FCV101DM-CSA, FCV101DS, FCV101DS-CSA, FCV141-CSA, FCV141DM-CSA, FCV141DS-CSA, FCV241G, FCV241G-CSA, FCV241GDM, FCV241GDM-CSA, FCV241GDS, FCV241GDS-CSA, FCV401DM, FCV401DM-CSA, FCV61, FCV61-CSA, FCV61DM, FCV61DM-CSA, FCV61DS, FCV61DS-CSA		

angle pieces



1

<b>GEV No.</b>	541924	<b>Ref. No.</b>	33Q4790
<b>description</b>	angle piece thread 1/2" IT - 1/2" IT brass		
<b>For models:</b>	C165D, C165S, C165VD, C165VS, C207D, C207S, C207VD, C207VD-VERS.2006, C207VS, C207VS-VERS.2006, C304AD, C304AS, C304AVD, C304AVD-VERS.2006, C304AVS, C304AVS-VERS.2006, C304D, C304S, C304VD, C304VD-VERS.2006, C304VS, C304VS-VERS.2006, C92VD-VERS.2006, C92VS-VERS.2006, CS243D, CS243S, CS243VD, CS243VD-VERS.2006, CS243VS, CS243VS-VERS.2006, CS370AD, CS370AS, CS370AVD, CS370AVD-VERS.2006, CS370AVS, CS370AVS-VERS.2006, CS370D, CS370S, CS370VD, CS370VD-VERS.2006, CS370VS, CS370VS-VERS.2006, CS466AD, CS466AS, CS466AVD, CS466AVD-VERS.2006, CS466AVS, CS466AVS-VERS.2006, CS466D, CS466S...(Other models you can see in the webshop)		



1

<b>GEV No.</b>	520883	<b>Ref. No.</b>	3020420
<b>description</b>	reducer SS thread 1" - 1/4" Qty 1 pcs L1 15mm L2 7mm WS 50		
<b>For models:</b>	KD100, KD100A, KD100PSD, N100D, N100S, N100VD, N100VS, N38D, N38S, N38VD, N38VS, N42D, N42S, N42VD, N42VS, N50D, N50S, N50VD, N50VS, N66D, N66S, N66VD, N66VS, N70D, N70S, N70VD, N70VS, N85D, N85S, N85VD, N85VS		



Зип Общепит  
vsezip.ru  
+7(812)987-08-81

water and beverage technology

			
1			
<b>GEV No.</b>	541493	<b>Ref. No.</b>	33Q3900
<b>description</b>	angle piece thread 1/2" IT - 1/2" ET chrome-plated brass		
<b>For models:</b>	1A1PI1G, 1A1PI1GA, 1A1PI2E, 1A1PI2EA, 1A1PI2V, 1A1PI2VA, 1D1PI1G, 1D1PI1GA, 1D1PI2E, 1D1PI2EA, 1D1PI2V, 1D1PI2VA, 2A1PI3G, 2D1PI3G		

			
1			
<b>GEV No.</b>	541492	<b>Ref. No.</b>	33Q0570
<b>description</b>	angle piece T 1/2" ET 1, 2"		
<b>For models:</b>	FCV3EM, FCV4E, FCV4EDS, FCV4EM, FM1011E3, FM1011G3, FM1221E3, FM1221G3, FM423E1, FM423E2, FM611E3, FM611G3, FM721E3, FM721G3, L100, L40S, L80, PIER06HD, PIER15HD		

			
1			
<b>GEV No.</b>	520821	<b>Ref. No.</b>	33Q4360
<b>description</b>	angle piece thread 1/4" IT - 1/4" IT nickel-plated brass		
<b>For models:</b>	LC100, LC100-VERS.2001, LC130, LC130-VERS.2001, LC80, LP124S-VERS.052006, LP124-VERS.052006, LP124VS-VERS.052006, LP124V-VERS.052006, LP84S-VERS.052006, LP84-VERS.052006, LP84VS-VERS.052006, LP84V-VERS.052006		

<b>T-pieces</b>			
nickel-plated brass			
			
1			
<b>GEV No.</b>	520385	<b>Ref. No.</b>	3003770
<b>description</b>	T-piece thread 1/8" IT - 1/8" IT - 1/8" IT nickel-plated brass L 35mm		
<b>For models:</b>	FM1011E3, FM1011G3, FM1221E3, FM611E3, FM611G3, FM721E3, FM721G3		

			
1			
<b>GEV No.</b>	520824	<b>Ref. No.</b>	3003750
<b>description</b>	angle piece thread 1/8" ET - 1/8" IT nickel-plated brass		
<b>For models:</b>	FM1011E3, FM1011G3, FM1221E3, FM1221G3, FM2021E3, FM2021G3, FM611E3, FM611G3		

<b>Y-pieces</b>			
			
1			
<b>GEV No.</b>	521197	<b>Ref. No.</b>	36E4290
<b>description</b>	Y-piece thread 1/8" IT - 1/8" IT - 1/8" IT stainless steel WS 13		
<b>For models:</b>	FM1011E3, FM1011G3, FM1221E3, FM1221G3, FM611E3, FM611G3, FM721E3, FM721G3		

			
1			
<b>GEV No.</b>	541496	<b>Ref. No.</b>	33Q5280
<b>description</b>	angle piece thread 1/2" ET - 3/4" IT zinc-coated cast iron		

<b>hose connectors</b>			
plastic			
			
1			
<b>GEV No.</b>	361735	<b>Ref. No.</b>	33Q5040
<b>description</b>	hose connector plastic angled thread 1/4" hose ø 7mm Qty 1 pcs		

			
1			
<b>GEV No.</b>	541494	<b>Ref. No.</b>	33Q0600
<b>description</b>	angle piece thread 3/4" ET - 3/4" IT zinc-coated cast iron		
<b>For models:</b>	ACBM, ACBM218, ANBM, ANBM218, ANBM75, L100, L80, SE14VB, SE21VB, S114VB, S121VB, SL14CVB, SL14NVB, SL21CVB, SL21NVB, SL7NVB, TBM, TBM218		





Зип Общежит

product specification

vsezip.ru

+7(812)987-08-81

nickel-plated brass

			
1			
<b>GEV No.</b>	520159	<b>Ref. No.</b>	3007950
<b>description</b>	hose connector nickel-plated brass straight thread 1/8" hose ø 6mm Qty 1 pcs WS 12 total length 32mm thread L 7.5mm grommet ø 6mm grommet length 19.5mm		
<b>For models:</b>	FM1011E3, FM1011G3, FM1221E3, FM1221G3, FM2021E3, FM2021G3, FM423E2, FM611E3, FM611G3, FM721E3, FM721G3		

			
1			
<b>GEV No.</b>	517108	<b>Ref. No.</b>	3110340
<b>description</b>	hose connector nickel-plated brass angled thread 3/8" ET - M10x1 IT hose ø 12mm Qty 1 pcs		

			
1			
<b>GEV No.</b>	519239	<b>Ref. No.</b>	33Q4270
<b>description</b>	hose connector nickel-plated brass thread 1/4" hose ø 11mm Qty 1 pcs		

			
1			
<b>GEV No.</b>	361507	<b>Ref. No.</b>	3016150
<b>description</b>	screw pipe fitting angled nickel-plated brass thread 1/4" hose ø 6/8mm Qty 1 pcs		

			
1			
<b>GEV No.</b>	361506	<b>Ref. No.</b>	3014470
<b>description</b>	screw pipe fitting angled nickel-plated brass thread 1/8" hose ø 6/8mm Qty 1 pcs		
<b>For models:</b>	FM1011E2-VERS.2006, FM1011E3, FM1011E3-VERS.2006, FM1011G2-VERS.2006, FM1011G3, FM1011G3-VERS.2006, FM1221E2-VERS.2006, FM1221E3, FM1221E3-VERS.2006, FM1221G2-VERS.2006, FM1221G3, FM1221G3-VERS.2006, FM2011E2-VERS.2006, FM2011E3-VERS.2006, FM2011G2-VERS.2006, FM2011G3-VERS.2006, FM2021E2-VERS.2006, FM2021E3-VERS.2006, FM2021G2-VERS.2006, FM2021G3-VERS.2006, FM423E2, FM611E2-VERS.2006, FM611E3, FM611E3-VERS.2006, FM611G2-VERS.2006, FM611G3, FM611G3-VERS.2006, FM721E2-VERS.2006, FM721E3, FM721E3-VERS.2006, FM721G2-VERS.2006, FM721G3, FM721G3-VERS.2006, FX101E2, FX101E2C, FX101E2C-VERS.032014, FX101E2R, FX101E2R-VERS.032014, FX101E2-VERS.032014, FX101E3, FX101E3C, FX101E3C-VERS.022014, FX101E3R, FX101E3R-VERS.022014, FX101E3-VERS.022014, FX101G2, FX101G2C, FX101G2C-VERS.032014, FX101G2R, FX101G2R-VERS.032014...(Other models you can see in the webshop)		

			
1			
<b>GEV No.</b>	519291	<b>Ref. No.</b>	3012220
<b>description</b>	hose connector		

			
1			
<b>GEV No.</b>	541490	<b>Ref. No.</b>	33Q0590
<b>description</b>	hose connector thread 1/2" grommet ø 15mm		
<b>For models:</b>	ACBM, ACBM218, ANBM75, SL14CVB, SL21CVB, SL7NVB		

			
1			
<b>GEV No.</b>	541489	<b>Ref. No.</b>	33Q0150
<b>description</b>	hose connector thread 1/2" IT grommet ø 15mm		
<b>For models:</b>	L40, L60		

			
1			
<b>GEV No.</b>	520337	<b>Ref. No.</b>	3007980
<b>description</b>	hose connector thread 1/4" grommet ø 7mm ID ø 4.5mm grommet length 19mm WS 14 total length 35mm thread L 10mm		
<b>For models:</b>	04WCP1EM, 06WCP1GM, 08WCP1GM, 091CP1E, 091CP1G, 0G1CP1EC, 0G1CP1E-VERS.2004, 0G1CP1G-VERS.2004, 191CP1G, 191CP2G, 1G1CP1G-VERS.2004, 1G1CP2G-VERS.2004, 6040090, 6040310, 6043850, 6043980, FM1011E3, FM1011G3, FM1221E3, FM1221G3, FM611E3, FM611G3, FM721E3, FM721G3		

			
1			
<b>GEV No.</b>	541491	<b>Ref. No.</b>	33Q1060
<b>description</b>	hose connector thread 3/4" grommet ø 19mm		

Зип-Общепит

vsezip.ru

+7(812)987-08-81



1

<b>GEV No.</b>	541497	<b>Ref. No.</b>	33Q5450
<b>description</b>	hose connector thread 3/4" grommet ø 28mm		
<b>For models:</b>	FC101, FC101E, FC241, FC241E, FC241G, FC61, FC61E, FCV101, FCV101-CSA, FCV101DM, FCV101DM-CSA, FCV101DS, FCV101DS-CSA, FCV101E, FCV101EDM, FCV101EDM-UL, FCV101EDS, FCV101EDS-UL, FCV101E-UL, FCV141, FCV141-CSA, FCV141DM, FCV141DM-CSA, FCV141DS, FCV141DS-CSA, FCV141E, FCV141EDM, FCV141EDS, FCV241, FCV241DM, FCV241DS, FCV241E, FCV241EDM, FCV241EDM-UL, FCV241EDS, FCV241EDS-UL, FCV241E-UL, FCV241G, FCV241G-CSA, FCV241GDM, FCV241GDM-CSA, FCV241GDS, FCV241GDS-CSA, FCV3EM, FCV401DM, FCV401DM-CSA, FCV4E, FCV4EDS, FCV4EM, FCV61...(Other models you can see in the webshop)		

ball valve with lever handle



1

<b>GEV No.</b>	540730	<b>Ref. No.</b>	33D0170
<b>description</b>	ball valve connection 3/4" IT - 3/4" IT DN20 total length 70mm with lever handle handle length 95mm		
<b>For models:</b>	030BME, 030EBM, 030FE, 031BME, 031EBM, 070BM, 070BME, 071BM, 071BME, 090BM, 090BME, 091BM, 091BME, 30F, 30FES, 30FS, 70FES		

producer-specific

ANGELO PO



2

<b>GEV No.</b>	541488	<b>Ref. No.</b>	33Q5591 33Q5592
<b>description</b>	hose connector thread M14x1 ET - 1/8" IT angled		
<b>For models:</b>	FC101, FC101E, FC241, FC241E, FC241G, FC61, FC61E, FCV101, FCV101-CSA, FCV101DM, FCV101DM-CSA, FCV101DS, FCV101DS-CSA, FCV101E, FCV101EDM, FCV101EDM-UL, FCV101EDS, FCV101EDS-UL, FCV101E-UL, FCV141, FCV141-CSA, FCV141DM, FCV141DM-CSA, FCV141DS, FCV141DS-CSA, FCV141E, FCV141EDM, FCV141EDS, FCV241, FCV241DM, FCV241DS, FCV241E, FCV241EDM, FCV241EDM-UL, FCV241EDS, FCV241EDS-UL, FCV241E-UL, FCV241G, FCV241G-CSA, FCV241GDM, FCV241GDM-CSA, FCV241GDS, FCV241GDS-CSA, FCV3EM, FCV401DM, FCV401DM-CSA, FCV401EDM, FCV401EDM-UL, FCV4E, FCV4EDS...(Other models you can see in the webshop)		



1

<b>GEV No.</b>	514080	<b>Ref. No.</b>	33D1530
<b>description</b>	ball valve handle length 70mm L 83mm inlet 3/4" IT lever handle outlet ø30mm		

<b>accessories for</b>	541488			
	<b>GEV No.</b>	541507	<b>Ref. No.</b>	33T4110
	nozzle cooling thread 1/8"			
	<b>GEV No.</b>	541509	<b>Ref. No.</b>	33T3720
	nozzle cooling thread 1/8"			



1

<b>GEV No.</b>	540687	<b>Ref. No.</b>	33D0890
<b>description</b>	ball valve inlet 1" ET outlet 1" IT L 92mm without handle shaft ø 13x10mm		
<b>For models:</b>	70F, 71F, 71FE		

valves and tank inlets

ball valves

universal

ball valves with butterfly handle



1

<b>GEV No.</b>	542182	<b>Ref. No.</b>	33A0850
<b>description</b>	ball valve connection 1/2" IT - 1/2" IT DN15 total length 50mm		







1

<b>GEV No.</b>	514392	<b>Ref. No.</b>	33D0250
<b>description</b>	ball valve inlet 1" IT outlet 1" IT L 69mm without handle shaft ø 9x12mm shaft L 54mm		





shut-off valves

universal

 <p>1</p>			
<b>GEV No.</b>	540694	<b>Ref. No.</b>	33D2040
<b>description</b>	shut-off valve connection 1/2" 1/2" without handle total length 124.5mm mounting pos. any shaft L 15mm rosette thread G2 1" shaft ø 7.8mm		
<b>For models:</b>	0A1CP1E, 0A1CP1G, 0B1CP1G, 0D1CP1E, 0D1CP1G, 191CP1GA, 1A1BR1E, 1A1BR1G, 1A1BR1GA, 1A1BR2E, 1A1BR2EA, 1A1BR2G, 1A1BR2GA, 1A1CP1G, 1A1CP1GA, 1A1CP2G, 1A1PD1G, 1A1PD2G, 1A1PI1G, 1A1PI1GA, 1A1PI2E, 1A1PI2EA, 1A1PI2G, 1A1PI2GA, 1A1PI2V, 1A1PI2VA, 1D1BR1E, 1D1BR1G, 1D1BR1GA, 1D1BR2E, 1D1BR2EA, 1D1BR2G, 1D1BR2GA, 1D1CP1G, 1D1CP1GA, 1D1CP2G, 1D1PD1G, 1D1PD2G, 1D1PI1G, 1D1PI1GA, 1D1PI2E, 1D1PI2EA, 1D1PI2G, 1D1PI2GA, 1D1PI2V, 1D1PI2VA, 2A1BR1E, 2A1BR1G, 2A1BR1GA, 2A1BR2E...(Other models you can see in the webshop)		
<b>accessories for</b>	540694		
	<b>GEV No.</b>	514090	<b>Ref. No.</b> —
star handle cold/warm			
	<b>GEV No.</b>	520666	<b>Ref. No.</b> 36Q0590
union nut thread 1/2" H 12mm			
	<b>GEV No.</b>	541818	<b>Ref. No.</b> —
rosette chrome-plated thread 28x19G ø 58mm H 25mm WS			

producer-specific

ANGELO PO

 <p>1</p>			
<b>GEV No.</b>	514385	<b>Ref. No.</b>	3005990 33D2930
<b>description</b>	shut-off valve connection 3/8" 3/8" without handle mounting pos. any		
<b>For models:</b>	0A0BME, 0A0BMG, 0A1CP1E, 0A1CP1G, 0B1CP1G, 0D0BME, 0D0BMG, 0D1CP1E, 0D1CP1G, 0G1CP1E, 0G1CP1G, 191PD1G, 191PD2G, 191PI1G, 191PI1GA, 191PI2E, 191PI2EA, 191PI2G, 191PI2GA, 191PI2V, 191PI2VA, 1A0BME, 1A0BMG, 1A1BR1E, 1A1BR1G, 1A1BR1GA, 1A1BR2E, 1A1BR2EA, 1A1BR2G, 1A1BR2GA, 1A1CP1G, 1A1CP2G, 1A1PD1G, 1A1PD2G, 1A1PI1G, 1A1PI1GA, 1A1PI2E, 1A1PI2EA, 1A1PI2G, 1A1PI2GA, 1A1PI2V, 1A1PI2VA, 1D0BME, 1D0BMG, 1D1BR1E, 1D1BR1G, 1D1BR1GA, 1D1BR2E, 1D1BR2EA, 1D1BR2G...(Other models you can see in the webshop)		
<b>spare parts for</b>	514385		
	<b>GEV No.</b>	541533	<b>Ref. No.</b> —
handle cold water H 39.5mm blue ID ø 32.5mm ED ø 50mm			
	<b>GEV No.</b>	541813	<b>Ref. No.</b> 36M2631 36M2632
star handle cold total length 36mm shaft intake ø 8mm plastic for valve			

3ип Общежит

vsezip.ru

+7(812)987-08-81

<b>GEV No.</b>	541587	<b>Ref. No.</b>	6300728
<b>description</b>	shut-off valve connection 3/8" conversion kit		
<b>For models:</b>	1A1BR1E, 1A1BR1G, 1A1BR1GA, 1A1BR2E, 1A1BR2EA, 1A1BR2G, 1A1BR2GA, 1D1BR1E, 1D1BR1G, 1D1BR1GA, 1D1BR2E, 1D1BR2EA, 1D1BR2G, 1D1BR2GA, 2A1BR1E, 2A1BR1G, 2A1BR1GA, 2A1BR2E, 2A1BR2EA, 2A1BR2G, 2A1BR2GA, 2D1BR1E, 2D1BR1G, 2D1BR1GA, 2D1BR2E, 2D1BR2EA, 2D1BR2G, 2D1BR2GA		



<b>GEV No.</b>	541588	<b>Ref. No.</b>	6300729
<b>description</b>	shut-off valve connection 3/8" conversion kit		
<b>For models:</b>	0A1CP1E, 0A1CP1G, 0D1CP1E, 0D1CP1G, 191CP1GA, 1A1CP1G, 1A1CP2G, 1D1CP1G, 1D1CP2G		



<b>GEV No.</b>	541589	<b>Ref. No.</b>	6300727
<b>description</b>	shut-off valve connection 3/8" conversion kit		
<b>For models:</b>	0A0BME, 0A0BMG, 0D0BME, 0D0BMG, 1A0BME, 1A0BMG, 1D0BME, 1D0BMG		



<b>GEV No.</b>	541584	<b>Ref. No.</b>	6300730
<b>description</b>	shut-off valve connection 3/8" conversion kit Qty 2 pcs		
<b>For models:</b>	1A1PD1G, 1A1PD2G, 1A1PI1G, 1A1PI1GA, 1D1PD1G, 1D1PD2G, 1D1PI1G, 1D1PI1GA		

Зип Общепит

vsezip.ru

+7(812)987-08-81



1

<b>GEV No.</b>	541590	<b>Ref. No.</b>	6300731
<b>description</b>	shut-off valve connection 3/8" ET conversion kit total length 97mm		



1

<b>GEV No.</b>	540690	<b>Ref. No.</b>	33D0590
<b>description</b>	shut-off valve connection 3/8" total length 27mm mounting pos. angled shaft intake ø M4mm rosette thread G2 1" shaft star-shaped		
<b>For models:</b>	070BM, 070BME, 071BM, 071BME, 090BM, 090BME, 091BM, 091BME, 30CPS, 30CPE, 31PD6, 31PI6, 31PIE6, 70CP, 70CPE, 71AR, 71ARE, 71CP, 71CP2, 71PD10, 71PD15, 71PI10, 71PI10A, 71PIE15, 71PIE15A, 71PV15, 71PV15A, 71RA, 90CP, 90CPE, 91AR, 91ARE, 91CP, 91PI10, 91PI10A, 91PIE15, 91PIE15A, 91RA, ACBM, ACBM218, ANBM, ANBM218, ANBM75, SE14VB, SE21VB, SI14VB, SI21VB, SL14CVB, SL14NVB, SL21CVB...(Other models you can see in the webshop)		
<b>spare parts for</b>	540690		



<b>GEV No.</b>	514357	<b>Ref. No.</b>	36M2642 36M4010
<b>description</b>	tap handle hot water for valve plastic total length 36mm shaft diameter ø8mmmm		



<b>GEV No.</b>	541813	<b>Ref. No.</b>	36M2631 36M2632
<b>description</b>	star handle cold total length 36mm shaft intake ø 8mm plastic for valve		



1

<b>GEV No.</b>	541813	<b>Ref. No.</b>	36M2631 36M2632
<b>description</b>	star handle cold total length 36mm shaft intake ø 8mm plastic for valve		
<b>For models:</b>	191PD1G, 191PD2G, 191PI1G, 191PI1GA, 191PI2E, 191PI2EA, 191PI2G, 191PI2GA, 191PI2V, 191PI2VA, 1A1PD1G, 1A1PD2G, 1A1PI1G, 1A1PI1GA, 1A1PI2E, 1A1PI2EA, 1A1PI2V, 1A1PI2VA, 1D1PD1G, 1D1PD2G, 1D1PI1G, 1D1PI1GA, 1D1PI2E, 1D1PI2EA, 1D1PI2V, 1D1PI2VA, 1G1PD1G, 1G1PI1E, 1G1PI1G, 291PI3E, 291PI3G, 31PD6, 31PI6, 31PIE6, 71AR, 71ARE, 71PD10, 71PD15, 71PI10, 71PI10A, 71PIE15, 71PIE15A, 71PV15, 71PV15A, 71RA, 91AR, 91ARE, 91PI10, 91PI10A, 91PIE15...(Other models you can see in the webshop)		



1

<b>GEV No.</b>	514383	<b>Ref. No.</b>	36M2641
<b>description</b>	star handle hot total length 36mm shaft intake ø 8mm plastic for valve		
<b>For models:</b>	070BM, 070BME, 071BM, 071BME, 090BM, 090BME, 091BM, 091BME, 0A0BME, 0A0BMG, 0A1CP1E, 0A1CP1G, 0B1CP1G, 0D0BME, 0D0BMG, 0D1CP1E, 0D1CP1G, 0G1CP1E, 0G1CP1G, 191PD1G, 191PD2G, 191PI1G, 191PI1GA, 191PI2E, 191PI2EA, 191PI2G, 191PI2GA, 191PI2V, 191PI2VA, 1A0BME, 1A0BMG, 1A1BR1E, 1A1BR1G, 1A1BR1GA, 1A1BR2E, 1A1BR2EA, 1A1BR2G, 1A1BR2GA, 1A1CP1G, 1A1CP2G, 1A1PD1G, 1A1PD2G, 1A1PI1G, 1A1PI1GA, 1A1PI2E, 1A1PI2EA, 1A1PI2V, 1A1PI2VA, 1D0BME, 1D0BMG, 1D1BR1E, 1D1BR1G, 1D1BR1GA, 1D1BR2E, 1D1BR2EA, 1D1BR2G, 1D1BR2GA, 1D1CP1G, 1D1CP2G...(Other models you can see in the webshop)		



<b>GEV No.</b>	514357	<b>Ref. No.</b>	36M2642 36M4010
<b>description</b>	tap handle hot water for valve plastic total length 36mm shaft diameter ø8mmmm		
<b>For models:</b>	070BM, 070BME, 071BM, 071BME, 090BM, 090BME, 091BM, 091BME, 0A1CP1E, 0A1CP1G, 0B1CP1G, 0D1CP1E, 0D1CP1G, 1A1BR1E, 1A1BR1G, 1A1BR1GA, 1A1BR2E, 1A1BR2EA, 1A1BR2G, 1A1BR2GA, 1A1CP1G, 1A1CP2G, 1A1PD1G, 1A1PD2G, 1A1PI1G, 1A1PI1GA, 1A1PI2E, 1A1PI2EA, 1A1PI2G, 1A1PI2GA, 1A1PI2V, 1A1PI2VA, 1D1BR1E, 1D1BR1G, 1D1BR1GA, 1D1BR2E, 1D1BR2EA, 1D1BR2G, 1D1BR2GA, 1D1CP1G, 1D1CP2G, 1D1PD1G, 1D1PD2G, 1D1PI1G, 1D1PI1GA, 1D1PI2E, 1D1PI2EA, 1D1PI2G, 1D1PI2GA, 1D1PI2V...(Other models you can see in the webshop)		

accessories



1

<b>GEV No.</b>	540696	<b>Ref. No.</b>	36M4030
<b>description</b>	hood handle for valve blue		
<b>For models:</b>	04WBMEV, 191CP1GA, 1A1CP1GA, 1A1PD1G, 1A1PD2G, 1A1PI1G, 1A1PI1GA, 1A1PI2E, 1A1PI2EA, 1A1PI2G, 1A1PI2GA, 1A1PI2V, 1A1PI2VA, 1D1CP1GA, 1D1PD1G, 1D1PD2G, 1D1PI1G, 1D1PI1GA, 1D1PI2E, 1D1PI2EA, 1D1PI2G, 1D1PI2GA, 1D1PI2V, 1D1PI2VA, 291PD3G, 2A1PD3G, 2A1PI3E, 2A1PI3G, 2D1PI3G		



1

<b>GEV No.</b>	514438	<b>Ref. No.</b>	3162200
<b>description</b>	star handle plastic thread 7.5 ø 50mm H 50mm WS chrome-plated shaft star-shaped		
<b>For models:</b>	0A0BME, 0A0BMG, 0A1CP1E, 0A1CP1G, 0D0BME, 0D0BMG, 0D1CP1E, 0D1CP1G, 0G1CP1E, 0G1CP1G, 191PD1G, 191PD2G, 191PI1G, 191PI1GA, 191PI2E, 191PI2EA, 191PI2G, 191PI2GA, 191PI2V, 191PI2VA, 1A0BME, 1A0BMG, 1A1BR1E, 1A1BR1G, 1A1BR1GA, 1A1BR2E, 1A1BR2EA, 1A1BR2G, 1A1BR2GA, 1A1CP1G, 1A1CP2G, 1A1PD1G, 1A1PD2G, 1A1PI1G, 1A1PI1GA, 1A1PI2E, 1A1PI2EA, 1A1PI2V, 1A1PI2VA, 1D0BME, 1D0BMG, 1D1BR1E, 1D1BR1G, 1D1BR1GA, 1D1BR2E, 1D1BR2EA, 1D1BR2G, 1D1BR2GA, 1D1CP1G, 1D1CP2G...(Other models you can see in the webshop)		



Зип Общепит

vsezip.ru

+7(812)987-08-81

steam valves

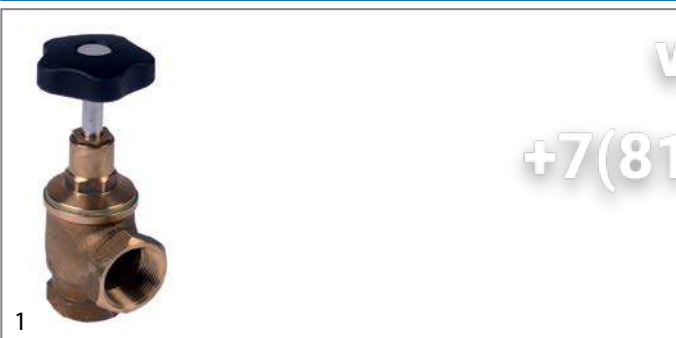

<b>GEV No.</b>	520000	<b>Ref. No.</b>	33G0030 33G0031
<b>description</b>	steam valve angled connection 1 1/4" IT total length 52mm H 190mm brass		
<b>For models:</b>	191PI2V, 191PI2VA, 1A1PI2V, 1A1PI2VA, 1D1PI2V, 1D1PI2VA, 71PV15, 71PV15A, PV200, PV200A, PV300, PV300A		
<b>spare parts for</b>	520000		
	<b>GEV No.</b>	541566	<b>Ref. No.</b> —
	tap head for steam tap 1/4" shaft 9x9mm		

<b>GEV No.</b>	514081	<b>Ref. No.</b>	3003440 3003441 33Q3500
<b>description</b>	inlet spout connection 3/8" ET tube ø 10mm projection 50mm overall height 56mm spout height 25mm rotation°		
<b>For models:</b>	04WCP1EM, 06WCP1GM, 08WCP1GM, 091CP1E, 091CP1G, 0A1CP1E, 0A1CP1G, 0B1CP1G, 0D1CP1E, 0D1CP1G, 0G1CP1E, 0G1CP1EC, 0G1CP1E-VERS.2004, 0G1CP1G, 0G1CP1G-VERS.2004, 191CP1G, 191CP2G, 1A1CP1G, 1A1CP2G, 1D1CP1G, 1D1CP2G, 1G1CP1G, 1G1CP1G-VERS.2004, 1G1CP2G, 1G1CP2G-VERS.2004, 6040090, 6040310, 6043850, 6043980		
<b>accessories for</b>	514081		
	<b>GEV No.</b>	503042	<b>Ref. No.</b> 33Q2190 36Q1110
	nut thread 3/8" H 6mm brass WS 22 Qty 1 pcs		
	<b>GEV No.</b>	540682	<b>Ref. No.</b> 3150840 37Q1210
	O-ring EPDM thickness 1.78mm ID ø 18.77mm Qty 1 pcs		

inlet taps



<b>GEV No.</b>	514078	<b>Ref. No.</b>	33Q2730
<b>description</b>	inlet spout connection 3/8" ET tube ø 10mm projection 48mm overall height 46mm spout height 25mm		
<b>For models:</b>	070BM, 070BME, 071BM, 071BME, 090BM, 090BME, 091BM, 091BME, 30CPS, 30CPE, 70CP, 70CPE, 71CP, 71CP2, 90CP, 90CPE, 91CP		
<b>accessories for</b>	514078		
	<b>GEV No.</b>	101278	<b>Ref. No.</b> 36Q0080
	olive for pipe ø 10mm Qty 1 pcs		
	<b>GEV No.</b>	101478	<b>Ref. No.</b> —
	union nut thread 3/8" for pipe ø 10mm		
	<b>GEV No.</b>	506024	<b>Ref. No.</b> —
	nut thread 3/8" H 6mm SS WS 22 Qty 1 pcs		
	<b>GEV No.</b>	514079	<b>Ref. No.</b> 3120740
	washer ED ø 30mm ID ø 17mm thickness 3mm		
	<b>GEV No.</b>	540682	<b>Ref. No.</b> 3150840 37Q1210
	O-ring EPDM thickness 1.78mm ID ø 18.77mm Qty 1 pcs		



<b>GEV No.</b>	541816	<b>Ref. No.</b>	33Q4690
<b>description</b>	inlet spout connection 3/8" IT for bain marie		
<b>For models:</b>	0A0BME, 0A0BMG, 0D0BME, 0D0BMG, 1A0BME, 1A0BMG, 1D0BME, 1D0BMG		

<b>GEV No.</b>	540693	<b>Ref. No.</b>	33Q2582
<b>description</b>	inlet spout for kettle type series 700/900		
<b>For models:</b>	31PD6, 31PI6, 31PIE6, 71PD10, 71PD15, 71PI10, 71PI10A, 71PIE15, 71PIE15A, 71PV15, 71PV15A, 91PI10, 91PI10A, 91PIE15, 91PIE15A		



Зип Общепит

vsezip.ru

+7(812)987-08-81



<b>GEV No.</b>	540697	<b>Ref. No.</b>	3003430 33Q3570
<b>description</b>	inlet spout tube ø 18mm thread 1/2" IT for kettle		
<b>For models:</b>	191PD1G, 191PD2G, 191PI1G, 191PI1GA, 191PI2E, 191PI2EA, 191PI2G, 191PI2GA, 191PI2V, 191PI2VA, 1A1PD1G, 1A1PD2G, 1A1PI1G, 1A1PI1GA, 1A1PI2E, 1A1PI2EA, 1A1PI2G, 1A1PI2GA, 1A1PI2V, 1A1PI2VA, 1D1PD1G, 1D1PD2G, 1D1PI1G, 1D1PI1GA, 1D1PI2E, 1D1PI2EA, 1D1PI2G, 1D1PI2GA, 1D1PI2V, 1D1PI2VA, 1G1PD1G, 1G1PI1E, 1G1PI1G		



<b>GEV No.</b>	540691	<b>Ref. No.</b>	36M2640
<b>description</b>	hood handle for valve red		
<b>For models:</b>	070BM, 070BME, 071BM, 071BME, 090BM, 090BME, 091BM, 091BME, 0A0BME, 0A0BMG, 0A1CP1E, 0A1CP1G, 0B1CP1G, 0D0BME, 0D0BMG, 0D1CP1E, 0D1CP1G, 0G1CP1E, 0G1CP1G, 1A0BME, 1A0BMG, 1A1BR1E, 1A1BR1G, 1A1BR1GA, 1A1BR2E, 1A1BR2EA, 1A1BR2G, 1A1BR2GA, 1A1CP1G, 1A1CP2G, 1A1PD1G, 1A1PD2G, 1A1PI1G, 1A1PI1GA, 1A1PI2E, 1A1PI2EA, 1A1PI2V, 1A1PI2VA, 1D0BME, 1D0BMG, 1D1BR1E, 1D1BR1G, 1D1BR1GA, 1D1BR2E, 1D1BR2EA, 1D1BR2G, 1D1BR2GA, 1D1CP1G, 1D1CP2G, 1D1PD1G...(Other models you can see in the webshop)		

accessories

turning handles



<b>GEV No.</b>	540692	<b>Ref. No.</b>	36M2630
<b>description</b>	hood handle for valve blue		
<b>For models:</b>	1A1PD1G, 1A1PD2G, 1A1PI1G, 1A1PI1GA, 1A1PI2E, 1A1PI2EA, 1A1PI2V, 1A1PI2VA, 1D1PD1G, 1D1PD2G, 1D1PI1G, 1D1PI1GA, 1D1PI2E, 1D1PI2EA, 1D1PI2V, 1D1PI2VA, 1G1PD1G, 1G1PI1E, 1G1PI1G, 31PD6, 31PI6, 31PIE6, 71AR, 71ARE, 71PD10, 71PD15, 71PI10, 71PI10A, 71PIE15, 71PIE15A, 71PV15, 71PV15A, 71RA, 91AR, 91ARE, 91PI10, 91PI10A, 91PIE15, 91PIE15A, 91RA		



<b>GEV No.</b>	540696	<b>Ref. No.</b>	36M4030
<b>description</b>	hood handle for valve blue		
<b>For models:</b>	04WBMEV, 191CP1GA, 1A1CP1GA, 1A1PD1G, 1A1PD2G, 1A1PI1G, 1A1PI1GA, 1A1PI2E, 1A1PI2EA, 1A1PI2G, 1A1PI2GA, 1A1PI2V, 1A1PI2VA, 1D1CP1GA, 1D1PD1G, 1D1PD2G, 1D1PI1G, 1D1PI1GA, 1D1PI2E, 1D1PI2EA, 1D1PI2G, 1D1PI2GA, 1D1PI2V, 1D1PI2VA, 291PD3G, 2A1PD3G, 2A1PI3E, 2A1PI3G, 2D1PI3G		

beverage technology

valves

non-return valves



<b>GEV No.</b>	440729	<b>Ref. No.</b>	3114800
<b>description</b>	non-return valve John Guest pipe connection 5/16" - 5/16" operating pressure at 20°C 10bar opening pressure 0.02bar POM		
<b>For models:</b>	FM1011E3-VERS.2006, FM1011G3-VERS.2006, FM1221E3-VERS.2006, FM1221G3-VERS.2006, FM2011E3-VERS.2006, FM2011G3-VERS.2006, FM2021E3-VERS.2006, FM2021G3-VERS.2006, FM611E3-VERS.2006, FM611G3-VERS.2006, FM721E3-VERS.2006, FM721G3-VERS.2006, FX101E3, FX101E3C, FX101E3C-VERS.022014, FX101E3R, FX101E3R-VERS.022014, FX101E3-VERS.022014, FX101G3, FX101G3C, FX101G3C-VERS.022014, FX101G3R, FX101G3R-VERS.022014, FX101G3-VERS.022014, FX10E3CR, FX10E3CR-VERS.022014, FX10G3CR, FX10G3CR-VERS.022014, FX122E3, FX122E3C, FX122E3T, FX122E3T-VERS.022014, FX122G3, FX122G3C, FX122G3T, FX122G3T-VERS.022014, FX12E3CT, FX12E3CT-VERS.022014, FX12G3CT, FX12G3CT-VERS.022014, FX201E3, FX201E3P, FX201E3P-VERS.022014, FX201E3-VERS.022014, FX201G3P, FX201G3-VERS.022014, FX202E3, FX202E3-230V-3-50Hz-60Hz, FX202E3-230V-3-50Hz-60Hz-VERS.022014, FX202E3-VERS.022014...(Other models you can see in the webshop)		



water cycle components

Зип Общепит ancillary products

pressure reduction valves

pressure reduction valves

universal



1

<b>GEV No.</b>	520271	<b>Ref. No.</b>	33D1650
<b>description</b>	pressure reduction valve connection 1/2" default setting 3bar setting range 1 up to 7bar p max 20bar t.max. 80°C		
<b>For models:</b>	BX101E, BX101E-VERS.122013, BX101G, BX101G-VERS.122013, BX122E, BX122E-VERS.122013, BX122G, BX122G-VERS.122013, BX61E, BX61E-VERS.122013, BX61G, BX61G-VERS.122013, BX82E, BX82E-VERS.122013, BX82G, BX82G-VERS.122013, FCV101, FCV101-CSA, FCV101DM, FCV101DM-CSA, FCV101DS, FCV101DS-CSA, FCV101E, FCV101EDM, FCV101EDM-UL, FCV101EDS, FCV101EDS-UL, FCV101E-UL, FCV141, FCV141-CSA, FCV141DM, FCV141DM-CSA, FCV141DS, FCV141DS-CSA, FCV141E, FCV141EDM, FCV141EDS, FCV241, FCV241DM, FCV241DS, FCV241E, FCV241EDM, FCV241EDM-UL, FCV241EDS, FCV241EDS-UL, FCV241E-UL, FCV241G, FCV241G-CSA, FCV241GDM, FCV241GDM-CSA...(Other models you can see in the webshop)		

supply filters



1

<b>GEV No.</b>	520261	<b>Ref. No.</b>	35Q2780
<b>description</b>	supply filter thread 1/2" IT - 1/2" IT total length 58mm red brass mesh opening 0.4mm		



1

<b>GEV No.</b>	520262	<b>Ref. No.</b>	33Q6090 33Q6091 35Q2790
<b>description</b>	supply filter thread 3/4" IT - 3/4" IT total length 70mm red brass DN20 mesh opening 0.4mm		

clamps

hose clamps

DIN 3017 -W2



1

<b>GEV No.</b>	520111	<b>Ref. No.</b>	36E4320
<b>description</b>	hose clamp ø 10-16mm width 9mm Qty 10 pcs DIN 3017		
<b>For models:</b>	FM1011E2-VERS.2006, FM1011E3, FM1011E3-VERS.2006, FM1011G2-VERS.2006, FM1011G3, FM1011G3-VERS.2006, FM1221E2-VERS.2006, FM1221E3, FM1221E3-VERS.2006, FM1221G2-VERS.2006, FM1221G3, FM1221G3-VERS.2006, FM2011E2-VERS.2006, FM2011E3-VERS.2006, FM2011G2-VERS.2006, FM2011G3-VERS.2006, FM2021E2-VERS.2006, FM2021E3, FM2021E3-VERS.2006, FM2021G2-VERS.2006, FM2021G3, FM2021G3-VERS.2006, FM423E2, FM611E2-VERS.2006, FM611E3, FM611E3-VERS.2006, FM611G2-VERS.2006, FM611G3, FM611G3-VERS.2006, FM721E2-VERS.2006, FM721E3, FM721E3-VERS.2006, FM721G2-VERS.2006, FM721G3, FM721G3-VERS.2006		



1

<b>GEV No.</b>	520115	<b>Ref. No.</b>	3140220
<b>description</b>	hose clamp ø 25-40mm width 9mm Qty 10 pcs DIN 3017		



1

<b>GEV No.</b>	520119	<b>Ref. No.</b>	3140200
<b>description</b>	hose clamp ø 60-80mm width 9mm Qty 5 pcs DIN 3017		
<b>For models:</b>	L100, L80, LP202, LP202HC, LP302, LP302HC, LP402, LP402HC, LP402V		

1 water and beverage technology

Зип.Общепит

Ø52mm

vsezip.ru

+7(812)987-08-81

tools, fastening materials, consumables

tools

hand tools

pullers



<b>GEV No.</b>	801197	<b>Ref. No.</b>	3018670 6003060
<b>description</b>	puller for fan wheel seat Ø 27-33mm thread M16x1.5 WS 17		
<b>For models:</b>	FM1011E1, FM1011E2, FM1011E3, FM1011G1, FM1011G2, FM1011G3, FM1221E1, FM1221E2, FM1221E3, FM1221G1, FM1221G2, FM1221G3, FM611E1, FM611E2, FM611E3, FM611G1, FM611G2, FM611G3		
<b>spare parts for</b>	801197		
	<b>GEV No.</b>	801198	<b>Ref. No.</b> 3019160
	screw for puller thread M16x1.5 L 63mm WS 17		

	<b>GEV No.</b>	801198	<b>Ref. No.</b> 3019160
	<b>description</b> screw for puller thread M16x1.5 L 63mm WS 17		



<b>GEV No.</b>	541065	<b>Ref. No.</b>	32z2930
<b>description</b>	thermometer mounting Ø 52mm t.max. 120°C 0 up to +120°C probe Ø 6.5mm probe L 28mm capillary pipe 1500mm		



<b>GEV No.</b>	541347	<b>Ref. No.</b>	32Z0151
<b>description</b>	thermometer mounting Ø 52mm t.max. 350°C +50 up to +350°C probe Ø 4mm probe L 60mm capillary pipe 1000mm		
<b>For models:</b>	FC101, FC1011E, FC1011G, FC101E, FC1221E, FC1221G, FC241, FC241E, FC241G, FC61, FC611E, FC611G, FC61E		

measuring equipment

thermometers

built-in thermometers



<b>GEV No.</b>	541086	<b>Ref. No.</b>	32V1900 32z0020
<b>description</b>	thermometer mounting measurements 58x25.5mm 0 up to +120°C capillary pipe 2000mm probe Ø 6mm probe L 23mm		
<b>For models:</b>	LC100, LC100-VERS.2001, LC130, LC130-VERS.2001		



<b>GEV No.</b>	541305	<b>Ref. No.</b>	32V7230
<b>description</b>	thermometer mounting measurements 62x11mm +20 up to +120°C capillary pipe 1500mm probe Ø 6.5mm probe L 16mm		



<b>GEV No.</b>	541582	<b>Ref. No.</b>	32Z0040
<b>description</b>	thermometer mounting Ø 52mm t.max. 350°C +50 up to +350°C probe Ø 6mm probe L 17mm capillary pipe 1700mm		

Ø60mm



<b>GEV No.</b>	541082	<b>Ref. No.</b>	32Z3190
<b>description</b>	thermometer mounting Ø 60mm t.max. 40°C -40 up to +40°C probe Ø 6mm probe L 135mm capillary pipe 2000mm		





Зип Общепит

vsezip.ru

+7(812)987-08-81

external power supply



<b>GEV No.</b>	541193	<b>Ref. No.</b>	32Z 367J 32Z3680
<b>description</b>	thermometer mounting measurements 58x25.5mm -40 up to +40°C cable length 2500mm probe ø 6mm probe L 40mm		
<b>For models:</b>	SA87		

grub screws			
DIN 914/ISO 4027			
<b>GEV No.</b>	560224	<b>Ref. No.</b>	31W0020
<b>description</b>	grub screw thread M8 L 10mm WS 4 Qty 1 pcs		
<b>For models:</b>	1A1BR1E, 1A1BR1G, 1A1BR2E, 1A1BR2G, 1D1BR1E, 1D1BR1G, 1D1BR2E, 1D1BR2G, 1G1BR1E, 1G1BR1G, 2A1BR1E, 2A1BR1G, 2A1BR2E, 2A1BR2G, 2D1BR1E, 2D1BR1G, 2D1BR2E, 2D1BR2G, 31R, 31RE		

## fastening material

### screws

#### countersunk screws



<b>GEV No.</b>	698481	<b>Ref. No.</b>	31C0070
<b>description</b>	screw thread M4 L 8mm SS DIN 965/ISO 7046 Qty 1 pcs intake Phillips head ø 7mm		
<b>For models:</b>	LC100, LC100-VERS.2001, LC130, LC130-VERS.2001, LC80, LF50, LF50E, LF50EM, LF50EMPS		

#### hexagonal screws



<b>GEV No.</b>	506445	<b>Ref. No.</b>	3016470
<b>description</b>	hexagonal screw thread M10 thread L 35mm SS WS 17 Qty 1 pcs DIN 933 / ISO 4017		
<b>For models:</b>	BX101E, BX101E-VERS.122013, BX101G, BX101G-VERS.122013, BX122E, BX122E-VERS.122013, BX122G, BX122G-VERS.122013, BX61E, BX61E-VERS.122013, BX61G, BX61G-VERS.122013, BX82E, BX82E-VERS.122013, BX82G, BX82G-VERS.122013, FC1011E, FC1011G, FC1221E, FC1221G, FC611E, FC611G, FM1011E1, FM1011E1-VERS.2006, FM1011E2, FM1011E2-VERS.2006, FM1011E3, FM1011E3-VERS.2006, FM1011G1, FM1011G1-VERS.2006, FM1011G2, FM1011G2-VERS.2006, FM1011G3, FM1011G3-VERS.2006, FM1221E1, FM1221E1-VERS.2006, FM1221E2, FM1221E2-VERS.2006, FM1221E3, FM1221E3-VERS.2006, FM1221G1, FM1221G1-VERS.2006, FM1221G2, FM1221G2-VERS.2006, FM1221G3, FM1221G3-VERS.2006, FM2011E2-VERS.2006, FM2011E3-VERS.2006, FM2011G2-VERS.2006, FM2011G3-VERS.2006...(Other models you can see in the webshop)		



<b>GEV No.</b>	560086	<b>Ref. No.</b>	31A0560
<b>description</b>	hexagonal screw thread M6 thread L 10mm SS WS 10 Qty 20 pcs DIN 933 / ISO 4017		
<b>For models:</b>	BX101E, BX101E-VERS.122013, BX101G, BX101G-VERS.122013, BX122E, BX122E-VERS.122013, BX122G, BX122G-VERS.122013, BX61E, BX61E-VERS.122013, BX61G, BX61G-VERS.122013, BX82E, BX82E-VERS.122013, BX82G, BX82G-VERS.122013, FX101E1, FX101E1R, FX101E2, FX101E2C, FX101E2C-VERS.032014, FX101E2R, FX101E2R-VERS.032014, FX101E2-VERS.032014, FX101E3, FX101E3C, FX101E3C-VERS.022014, FX101E3R, FX101E3R-VERS.022014, FX101E3-VERS.022014, FX101G1, FX101G1R, FX101G2, FX101G2C, FX101G2C-VERS.032014, FX101G2R, FX101G2R-VERS.032014, FX101G2-VERS.032014, FX101G3, FX101G3C, FX101G3C-VERS.022014, FX101G3R, FX101G3R-VERS.022014, FX101G3-VERS.022014, FX10E2CR, FX10E2CR-VERS.032014, FX10E3CR, FX10E3CR-VERS.022014, FX10G2CR, FX10G2CR-VERS.032014...(Other models you can see in the webshop)		

### knurled screws



<b>GEV No.</b>	524804	<b>Ref. No.</b>	3036730
<b>description</b>	Thumb screw thread M5 thread L 7mm ø 30mm H 5mm SS Qty 1 pcs		
<b>For models:</b>	KD100, KD100A, KD100PSD, KD130, KD130A, KD130E, KD130EAT, KD40EPSD, KD40LEPS, KD40LUXE, KD60, KD60E, KD60EAT, KD60M, KD60MA, KD60ME, KD60MPS, KD60MPSA, KD60PS, KD60PSD, KD6E-ATSD, KD85, KD85A, KD85E, KD85EA, KD85EAT, KD85EATS, KD85EPS, KD85EPSA, KD85PS, KD85PSA, KN1100, KN1100SD, KN11PSDD, KN80, KN80PS, LP151, LP202, LP202HC, LP302, LP302HC, LP402, LP402HC, LP402V, LP70		
<b>accessories for</b>	524804		
	<b>GEV No.</b>	505277	<b>Ref. No.</b>
			3036720 33q6400
	rinse arm shaft warewashing ø 14mm H 38mm thread 1/4"		

### miscellaneous



<b>GEV No.</b>	514285	<b>Ref. No.</b>	3190040
<b>description</b>	screw		
<b>For models:</b>	090GRG, 190GRG, FC101, FC1011E, FC1011G, FC101E, FC1221E, FC1221G, FC241, FC241E, FC241G, FC61, FC611E, FC611G, FC61E, FCV101, FCV101-CSA, FCV101DM, FCV101DM-CSA, FCV101DS, FCV101DS-CSA, FCV101E, FCV101EDM, FCV101EDM-UL, FCV101EDS, FCV101EDS-UL, FCV101E-UL, FCV141, FCV141-CSA, FCV141DM, FCV141DM-CSA, FCV141DS, FCV141DS-CSA, FCV141E, FCV141EDM, FCV141EDS, FCV241, FCV241DM, FCV241DS, FCV241E, FCV241EDM, FCV241EDM-UL, FCV241EDS, FCV241EDS-UL, FCV241E-UL, FCV241G, FCV241G-CSA, FCV241GDM, FCV241GDM-CSA, FCV241GDS...(Other models you can see in the webshop)		

Зип Общежит  
hexagonal nuts metric (without norm)

vsezip.ru

+7(812)987-08-81



1

**GEV No.** 691459 **Ref. No.** 3190020**description** screw thread M6 L 10mm WS 14**For models:** FC101, FC1011E, FC1011G, FC101E, FC1221E, FC1221G, FC241, FC241E, FC241G, FC61, FC611E, FC611G, FC61E, FCV101, FCV101-CSA, FCV101DM, FCV101DM-CSA, FCV101DS, FCV101DS-CSA, FCV101E, FCV101EDM, FCV101EDM-UL, FCV101EDS, FCV101EDS-UL, FCV101E-UL, FCV141, FCV141-CSA, FCV141DM, FCV141DM-CSA, FCV141DS, FCV141DS-CSA, FCV141E, FCV141EDM, FCV141EDS, FCV241, FCV241DM, FCV241DS, FCV241E, FCV241EDM, FCV241EDM-UL, FCV241EDS, FCV241EDS-UL, FCV241E-UL, FCV241G, FCV241G-CSA, FCV241GDM, FCV241GDM-CSA, FCV241GDS, FCV241GDS-CSA, FCV3EM...(Other models you can see in the webshop)

## nuts

## wing nuts



1

**GEV No.** 560147 **Ref. No.** 33Q3200**description** wing nuts thread M6 SS DIN/ISO DIN 315 Qty 20 pcs**For models:** LT10R, LT20F, LT25F

## knurled nuts



1

**GEV No.** 519386 **Ref. No.** 3190800**description** knurled nut for glass plate thread M4**For models:** BRPRV, BRVRV, SE14PRV, SE14PRW, SE14VRV, SE14VRW, SI14PRV, SI14PRW, SI14VRV, SI14VRW, SL14RPRV, SL14RPRW, SL14RVRV, SL14RVRW, TPRV, TVRV

## hexagonal nuts

## DIN 934 / ISO 4032/8673



1

**GEV No.** 517174 **Ref. No.** 3110050  
33Q6470**description** nut thread M8 H 6.5mm WS 13 SS DIN/ISO DIN 934 / ISO 4032/8673 Qty 1 pcs

hexagonal nuts inch thread



1

**GEV No.** 517180 **Ref. No.** 3030170**description** nut thread 1" H 5mm WS 36 SS Qty 1 pcs**For models:** KD37, KD37PS, KD37-VERS.112009, KD40, LP202, LP202HC, LP302, LP302HC, LP402, LP402HC, LP402V, LPG300, N100D, N100S, N100VD, N100VS, N38D, N38S, N38VD, N38VS, N42D, N42S, N42VD, N42VS, N50D, N50S, N50VD, N50VS, N66D, N66S, N66VD, N66VS, N70D, N70S, N70VD, N70VS, N85D, N85S, N85VD, N85VS

1

**GEV No.** 503155 **Ref. No.** 33Q4410**description** nut thread 1/2" H 7mm WS 25 brass Qty 1 pcs**For models:** LT10R, LT20F, LT25F

1

**GEV No.** 361182 **Ref. No.** 3117580**description** nut thread 1/4" H 5mm nickel-plated brass WS 17 Qty 1 pcs**For models:** L100, L40, L40S, L60, L80, P5

1

**GEV No.** 503042 **Ref. No.** 33Q2190  
36Q1110**description** nut thread 3/8" H 6mm brass WS 22 Qty 1 pcs**For models:** 030FT, 030FTR, 031FT, 031FT04, 031FT06, 031FTR, 031FTRL, 04WB-MEV, 06WFR3GD, 070BM, 070BME, 070FT, 070FT04, 070FT05, 070FTR, 0712VA, 071BM, 071BME, 071FT, 071FT04, 071FT06, 071FTR, 071FTRL, 08WGREV, 090BM, 090BM1E, 090BM1G, 090BME, 090FAVA, 090FT, 090FT04, 090FT05, 090FT1G, 090FT2G, 090FT4G, 090FT5G, 090FT7G, 090FTR, 091BM, 091BME, 091CP1E, 091CP1G, 091FR1EA, 091FR1EX, 091FR1I, 091FR1IA, 091FR1ID, 091FR1ID-VERS.052012, 091FR1I-VERS.032012, 091FR7G...(Other models you can see in the webshop)



Зип Общежит

vsezip.ru

+7(812)987-08-81

1			
<b>GEV No.</b>	511182	<b>Ref. No.</b>	33Q2190
<b>description</b>	nut thread 3/8" H 8mm brass WS 24 Qty 1 pcs		
<b>For models:</b>	C165D, C165S, C165VD, C165VS, C207D, C207D-VERS.2006, C207S, C207S-VERS.2006, C207VD, C207VD-VERS.2006, C207VS, C207VS-VERS.2006, C304AD, C304AD-VERS.2006, C304AS, C304AS-VERS.2006, C304AVD, C304AVD-VERS.2006, C304AVS, C304AVS-VERS.2006, C304D, C304D-VERS.2006, C304S, C304S-VERS.2006, C304VD, C304VD-VERS.2006, C304VS, C304VS-VERS.2006, C92D-VERS.2006, C92S-VERS.2006, C92VD-VERS.2006, C92VS-VERS.2006, CS243D, CS243D-VERS.2006, CS243S, CS243S-VERS.2006, CS243VD, CS243VD-VERS.2006, CS243VS, CS243VS-VERS.2006, CS370AD, CS370AD-VERS.2006, CS370AS, CS370AS-VERS.2006, CS370AVD, CS370AVD-VERS.2006, CS370AVS, CS370AVS-VERS.2006, CS370D, CS370D-VERS.2006...(Other models you can see in the webshop)		

<b>WASHERS</b>			
<b>DIN 125A</b>			
1			
<b>GEV No.</b>	560312	<b>Ref. No.</b>	3120080
<b>description</b>	plain washer ID ø 10.5mm ED ø 20mm thickness 2mm SS Qty 1 pcs DIN 125A for thread M10		
<b>For models:</b>	10CP1EA, 10CP1GA, 10CP1IA, 12CP1EA, 12CP1GA, 12CP1IA, 18CP2EA, 18CP2GA, 18CP2IA, BRE21HD, BRE31HD, FCV101-CSA, FCV101DM-CSA, FCV101DS-CSA, FCV101EDM-UL, FCV101EDS-UL, FCV101E-UL, FCV141-CSA, FCV141DM-CSA, FCV141DS-CSA, FCV241EDM-UL, FCV241EDS-UL, FCV241E-UL, FCV401DM-CSA, FCV401EDM-UL, FCV61-CSA, FCV61DM-CSA, FCV61DS-CSA, FCV61EDM-UL, FCV61EDS-UL, FCV61E-UL, FCV72EDS-UL, FCV72E-UL, PIER06HD, PIER10HD, PIER15HD		

1			
<b>GEV No.</b>	511309	<b>Ref. No.</b>	33Q0240
<b>description</b>	nut thread 1 1/2" ø 66mm H 9mm WS 51 brass Qty 1 pcs		
<b>For models:</b>	L100, L40, L40S, L60, L80		

1			
<b>GEV No.</b>	560113	<b>Ref. No.</b>	3121480
<b>description</b>	plain washer ID ø 6.4mm ED ø 12mm thickness 1.6mm SS Qty 20 pcs DIN 125A for thread M6		
<b>For models:</b>	030FE1, 30F1, 30FES2, 30FS2, 70F1, 70FE1, 70FES2, 70FES2B, 71F2, 71FE2, 91F210		

<b>union nuts</b>			
1			
<b>GEV No.</b>	520667	<b>Ref. No.</b>	36Q0100
<b>description</b>	union nut thread 1/4" H 11mm steel WS 17 Qty 1 pcs		

<b>DIN 9021</b>			
1			
<b>GEV No.</b>	560210	<b>Ref. No.</b>	3014810
<b>description</b>	plain washer ID ø 11mm ED ø 30mm thickness 2mm SS Qty 1 pcs DIN 9021 for thread M10		
<b>For models:</b>	FC1011E, FC1011G, FC1221E, FC1221G, FC611E, FC611G, FM1011E1, FM1011E1-VERS.2006, FM1011E2, FM1011E2-VERS.2006, FM1011E3, FM1011E3-VERS.2006, FM1011G1, FM1011G1-VERS.2006, FM1011G2, FM1011G2-VERS.2006, FM1011G3, FM1011G3-VERS.2006, FM1221E1, FM1221E1-VERS.2006, FM1221E2, FM1221E2-VERS.2006, FM1221E3, FM1221E3-VERS.2006, FM1221G1, FM1221G1-VERS.2006, FM1221G2, FM1221G2-VERS.2006, FM1221G3, FM1221G3-VERS.2006, FM2011E2-VERS.2006, FM2011E3-VERS.2006, FM2011G2-VERS.2006, FM2011G3-VERS.2006, FM2021E1, FM2021E2, FM2021E2-VERS.2006, FM2021E3, FM2021E3-VERS.2006, FM2021G1, FM2021G2, FM2021G2-VERS.2006, FM2021G3, FM2021G3-VERS.2006, FM611E1, FM611E1-VERS.2006, FM611E2, FM611E2-VERS.2006, FM611E3, FM611E3-VERS.2006...(Other models you can see in the webshop)		

<b>washers</b>			
<b>spring rings</b>			
1			
<b>GEV No.</b>	560209	<b>Ref. No.</b>	3000860
<b>description</b>	lock washer ID ø 10.3mm ED ø 17.2mm SS Qty 1 pcs for thread M10		
<b>For models:</b>	08WGRGV, 090GRG, 0A0GRG, 0D0GRG, 190GRG, 1A0GRG, 1D0GRG		

<b>miscellaneous</b>			
1			
<b>GEV No.</b>	690687	<b>Ref. No.</b>	36D2880
<b>description</b>	plain washer		
<b>For models:</b>	40, 40B, 40CP, 40CPX, 40PL, 40X, SA87		

Зип Общепит

vsezip.ru

+7(812)987 08 01



1

GEV No.	691180	Ref. No.	3120100
description	plain washer		
For models:	10CP1EA, 10CP1GA, 10CP1IA, 12CP1EA, 12CP1GA, 12CP1IA, 18CP2EA, 18CP2GA, 18CP2IA, C304AD, C304AS, C304AVD, C304AVS, CS370AD, CS370AS, CS370AVD, CS370AVS, CS466AD, CS466AS, CS466AVD, CS466AVS, FCV101DM, FCV101DM-CSA, FCV101DS, FCV101DS-CSA, FCV101EDM, FCV101EDM-UL, FCV101EDS, FCV101EDS-UL, FCV141DM, FCV141DM-CSA, FCV141DS, FCV141DS-CSA, FCV141EDM, FCV141EDS, FCV241DM, FCV241DS, FCV241EDM, FCV241EDM-UL, FCV241EDS, FCV241EDS-UL, FCV241GDM, FCV241GDM-CSA, FCV241GDS, FCV241GDS-CSA, FCV401DM, FCV401DM-CSA, FCV401EDM, FCV401EDM-UL, FCV4EDS...(Other models you can see in the webshop)		

1

GEV No.	520115	Ref. No.	3140220
description	hose clamp ø 25-40mm width 9mm Qty 10 pcs DIN 3017		

1

GEV No.	520119	Ref. No.	3140200
description	hose clamp ø 60-80mm width 9mm Qty 5 pcs DIN 3017		
For models:	L100, L80, LP202, LP202HC, LP302, LP302HC, LP402, LP402HC, LP402V		



2

GEV No.	506160	Ref. No.	3120050
description	plain washer ID ø 8.6mm ED ø 16mm thickness 1.5mm SS Qty 1 pcs		
For models:	091FR1EX, 091FR7GS, 091FR7GX, BRE21HD, BRE31HD, FM1011E2-VERS.2006, FM1011E3-VERS.2006, FM1011G2-VERS.2006, FM1011G3-VERS.2006, FM1221E2-VERS.2006, FM1221E3-VERS.2006, FM1221G2-VERS.2006, FM1221G3-VERS.2006, FM611E2-VERS.2006, FM611E3-VERS.2006, FM611G2-VERS.2006, FM611G3-VERS.2006, FM721E3-VERS.2006, FM721G3-VERS.2006, FX101E2C, FX101E3C, FX101G2C, FX101G3C, FX10E2CR, FX10E3CR, FX10G2CR, FX10G3CR, FX122E2C, FX122E3, FX122E3C, FX122E3T, FX122E3T-VERS.022014, FX122G2C, FX122G3, FX122G3C, FX122G3T, FX122G3T-VERS.022014, FX12E3CT, FX12E3CT-VERS.022014, FX12G3CT, FX12G3CT-VERS.022014, FX61E2C, FX61E2CR, FX61E3CR, FX61G2C, FX61G2CR, FX61G3C, FX61G3CR, FX82E2C, FX82E3C...(Other models you can see in the webshop)		

## retaining rings

DIN 6799



1

GEV No.	518557	Ref. No.	3120460
description	retaining ring E D1 ø 5mm D2 ø 11mm SS DIN 6799 thickness 0.7mm		
For models:	04WFAAV, 04WVT1IV, 04WVT2IV, 08WFA4E, 08WFA4G, 08WFAAE, 08WFAAG, 08WFAAV, 08WVT1IV, 08WVT2IV, 090FAA, 091VT1I, 091VT2I, 0A0FA1, 0A0FA4, 0A0FAA, 0A1VT1I, 0A1VT2I, 0D0FA1, 0D0FA4, 0D0FAA, 0D1VT1I, 0D1VT2I, 0G0FA0, 12WFA6E, 12WFA6G, 12WFAAA, 12WFAAE, 12WFAAG, 12WFAAN, 190FA, 190FAA, 190FAB, 190FAD, 191FAAE, 191FAAG, 191FABG, 191FADG, 191FAE, 191FAG, 191VT1I, 191VT2I, 1A0FA1, 1A0FA2, 1A0FA4, 1A0FA5, 1A0FAA, 1A0FAB, 1A1FA1G, 1A1FA2G...(Other models you can see in the webshop)		

## fasteners

## clamps

## hose clamps

DIN 3017 - W2



1

GEV No.	520111	Ref. No.	36E4320
description	hose clamp ø 10-16mm width 9mm Qty 10 pcs DIN 3017		
For models:	FM1011E2-VERS.2006, FM1011E3, FM1011E3-VERS.2006, FM1011G2-VERS.2006, FM1011G3, FM1011G3-VERS.2006, FM1221E2-VERS.2006, FM1221E3, FM1221E3-VERS.2006, FM1221G2-VERS.2006, FM1221G3, FM1221G3-VERS.2006, FM2011E2-VERS.2006, FM2011E3-VERS.2006, FM2011G2-VERS.2006, FM2011G3-VERS.2006, FM2021E2-VERS.2006, FM2021E3, FM2021E3-VERS.2006, FM2021G2-VERS.2006, FM2021G3, FM2021G3-VERS.2006, FM423E2, FM611E2-VERS.2006, FM611E3, FM611E3-VERS.2006, FM611G2-VERS.2006, FM611G3, FM611G3-VERS.2006, FM721E2-VERS.2006, FM721E3, FM721E3-VERS.2006, FM721G2-VERS.2006, FM721G3, FM721G3-VERS.2006		

## roll pins



1

GEV No.	691398	Ref. No.	31Z8930
description	roll pin ø 3mm L 16mm		
For models:	0A0BMG, 0A0FT1G, 0A0FT2G, 0A0FT4G, 0A0FT5G, 0D0BMG, 0D0FT1G, 0D0FT2G, 0D0FT4G, 0D0FT5G, 1A0BMG, 1A0FT1G, 1A0FT2G, 1A0FT3G, 1A0FT4G, 1A0FT6G, 1A1BR1G, 1A1BR1GA, 1A1BR2G, 1A1BR2GA, 1A1FA1G, 1A1FA2G, 1A1FA4G, 1A1FA5G, 1A1FAS2G, 1A1FASG, 1A1TP0G, 1A1TP0G-VERS.2002, 1B1FAS2G, 1B1FASG, 1D0B-MG, 1D0FT1G, 1D0FT2G, 1D0FT3G, 1D0FT4G, 1D0FT6G, 1D1BR1G, 1D1BR1GA, 1D1BR2G, 1D1BR2GA, 1D1FA1G, 1D1FA2G, 1D1FA4G, 1D1FA5G, 1D1FAS2G, 1D1FASG, 1D1TP0G, 1D1TP0G-VERS.2002, 2A1BR1G, 2A1BR1GA...(Other models you can see in the webshop)		



screw caps

Зип Общепит

vsezip.ru

+7(812)987-08-81

			
1			
<b>GEV No.</b>	512516	<b>Ref. No.</b>	3005450
<b>description</b>	screw cap thread 1/2" thread L 8mm SS Qty 1 WS 17 head thickness 4.5mm		
<b>For models:</b>	FM1011E3, FM1011G3, FM1221E3, FM611E3, FM611G3, FM721E3, FM721G3		

<b>GEV No.</b>	358671	<b>Ref. No.</b>	3200020
<b>description</b>	fine fuse size ø5x20mm 1A fast-acting rated 250V Qty 10 pcs		
<b>For models:</b>	06WBR3E, 0G1BR3E, 191BR1E, 191BR1GA, 191BR2E, 191BR2EA, 191BR2GA, 1A1BR1E, 1A1BR1GA, 1A1BR2E, 1A1BR2EA, 1A1BR2GA, 1D1BR1E, 1D1BR1GA, 1D1BR2E, 1D1BR2EA, 1D1BR2GA, 1G1BR3E, 291BR1E, 291BR1GA, 291BR2E, 291BR2EA, 291BR2GA, 2A1BR1E, 2A1BR1GA, 2A1BR2E, 2A1BR2EA, 2A1BR2GA, 2D1BR1E, 2D1BR1GA, 2D1BR2E, 2D1BR2EA, 2D1BR2GA, 71ARE, 91ARE, FCV401DM, FCV401EDM		

consumables

lava rocks / ceramic briquetts

			
1			
<b>GEV No.</b>	211049	<b>Ref. No.</b>	37T1320
<b>description</b>	ceramic briquetts size 50x50x26mm Qty 40 pieces (2.4kg)		
<b>For models:</b>	08WGRGV, 090GRG, 0A0GRG, 0D0GRG, 190GRG, 1A0GRG, 1D0GRG, 1G0GRG, 6042120-08WGRGV		

			
1			
<b>GEV No.</b>	358031	<b>Ref. No.</b>	32V6210
<b>description</b>	fine fuse size ø10x38mm 10A rated 500V type Gg fast-acting Qty 1 pcs		
<b>For models:</b>	BX101E, BX101E-VERS.122013, BX122E, BX122E-VERS.122013, BX61E, BX61E-VERS.122013, BX82E, BX82E-VERS.122013, FC1011E, FC1221E, FC611E, FM1011E1, FM1011E1-VERS.2006, FM1011E2, FM1011E2-VERS.2006, FM1011E3, FM1011E3-VERS.2006, FM1221E1, FM1221E1-VERS.2006, FM1221E2, FM1221E2-VERS.2006, FM1221E3-VERS.2006, FM2011E2-VERS.2006, FM2011E3-VERS.2006, FM2021E1, FM2021E2, FM2021E2-VERS.2006, FM2021E3, FM2021E3-VERS.2006, FM611E1, FM611E1-VERS.2006, FM611E2, FM611E2-VERS.2006, FM611E3, FM611E3-VERS.2006, FM721E1, FM721E1-VERS.2006, FM721E2, FM721E2-VERS.2006, FM721E3, FM721E3-VERS.2006, FX101E1, FX101E1R, FX101E2, FX101E2C, FX101E2C-VERS.032014, FX101E2R, FX101E2R-VERS.032014, FX101E2-VERS.032014, FX101E3...(Other models you can see in the webshop)		

fuses

fine fuses

			
1			
<b>GEV No.</b>	358668	<b>Ref. No.</b>	3201540
<b>description</b>	fine fuse size ø5x20mm 0.5A fast-acting rated 250V Qty 10 pcs		
<b>For models:</b>	04WFR3ED, 08WFR4ED, 08WGREV, 091FR3ED, 0A1FR1ED, 0A1FR3ED, 0D1FR1ED, 0D1FR3ED, 0G0FR3ED, 10CP1EA, 10CP1GA, 10CP1IA, 12CP1EA, 12CP1GA, 12CP1IA, 18CP2EA, 18CP2GA, 18CP2IA, 191FR4ED, 1A1FR2ED, 1A1FR4ED, 1D1FR2ED, 1D1FR4ED, 71RA, 91RA, FC101, FC101E, FC101G, FC101E, FC1221E, FC1221G, FC241, FC241E, FC241G, FC61, FC61E, FC61G, FC61E, FCV101, FCV101DM, FCV101DS, FCV101E, FCV101EDM, FCV101EDS, FCV141, FCV141DM, FCV141DS, FCV141E, FCV141EDM, FCV141EDS...(Other models you can see in the webshop)		

**Зип Общепит**

**vsezip.ru**

**+7(812)987-08-81**

Зип Общепит

vsezip.ru

+7(812)987-08-81

<b>A</b>		fastening material	297
alarm devices	59	filter driers	275
axial fans	90	float switches	41
<b>B</b>		fine fuses	301
ball valves	290	fittings	287
bar burners	158	foam rubber gaskets	272
beverage technology	294	forced air burners	162
bi-metal thermostats	19, 19	formed hoses	285
booster pumps I	106	fridge lamps	51
<b>C</b>		fuses	109, 301
cables	109	<b>G</b>	
cam switches	41	gas burners	148
clamps	34, 295, 300	gas control valves	127
coil heating elements	9	gas lines	177
cold air circulating fans (complete)	94	gas nozzles	162
compressors	88	gas solenoid valves	132
condensators & interference suppression filters	107	gas taps	112
condensing trays heated	90	gas thermostats	118
connection cables	110	gaskets for heated units	262
consumables	301	gaskets for tray rack trolleys	266
contactors	60	gaskets for wash arm support	274
container filters	283	gastronorm	279
control equipment	45	grates	252
control thermostats	20, 30	grub screws	297
countersunk screws	297	<b>H</b>	
cross flow fans	94	halogen lamp	51
<b>D</b>		hand tools	296
defrost timers	59	handle latches	229
door catches	230	heater battery	9
door seals	263	heating cables	8
door seals for dishwashers	273	heating cartridges	9
dosing pumps	280	heating elements	3
double nipples	287	heating elements for bain maries	4
drain hoses	284	heating elements for charrills	8
drain pumps	106	heating elements for convection	16
<b>E</b>		heating elements for defrosting	7
earthing cables	109	heating elements for fryers	5
edgemount latches	229	heating elements for griddles	6
electric accessories	109	heating elements for heating bridges	8
electronic controllers	64	heating elements for ovens	3
energy regulators	19	heating elements for pasta cookers	7
espagnolette locks	230	heating elements for refrigeration	7
evaporators	275	heating elements for salamanders/toasters	8
expansion valves	274	heating elements for tilting bratt pan	7
<b>F</b>		hexagonal nuts	298
fans	90	hexagonal screws	297
fasteners	300	hob burners	148
		hose clamps	295, 300
		hose connectors	286, 288

hose couplings	283	pressure switches	85
hoses	284	probe clips	34
hot air fans	99	probes	68
hot air motors	95	programme timers	55
hot plates	110	PVC hoses	285
		pulleys	296
<b>I</b>		pumps	100
ignition boxes	131	pumps for ice machines	107
ignition cables	143	push/momentary push switches	35
ignition units	145	PVC supply hoses	284
immersion heating elements	10		
indicator lights	48	<b>R</b>	
indicator lights (complete)	48	radial fans	99
industrial hoses	284	radiation heaters	17
inlet spouts	293	reducers	287
inlet taps	293	refrigeration cycle components	274
		refrigeration fans	91
<b>K</b>		refrigeration gaskets	256
knurled nuts	298	refrigeration motors universal	91
knurled screws	297	refrigeration thermostats	32
		relays	62
<b>L</b>		retaining rings	300
lamp accessories	55	ribbon cables	110
lamps	48	rocker/momentary rocker switches	35
lava rocks / ceramic briquetts	178, 301	roll pins	300
light bulbs	50	rotary switches	43
<b>M</b>		<b>S</b>	
magnetic switches	44	safety bi-metal thermostats	19
measuring equipment	296	safety thermostats	23, 31
mechanical timers	58	safety valves	132
microswitches	37	screw caps	301
		screw-in gaskets	260
<b>N</b>		screws	297
Niplaflex hoses	284	sealing washers	270
non-return valves	294	shaft gaskets	272
nuts	298	shelves and shelf rails	252
		shut-off valves	291
<b>O</b>		snap locks	230
operating capacitors	108	solenoid valves	76
O-rings	267	solid top burners	161
oven hinges	234	spray guns	280
oven lamps	51	spray guns with external thread	280
		spring assisted hinges	231
<b>P</b>		spring rings	299
piano hinges	231	starting capacitors	107
piezoelectric igniters	144	steam valves	293
pilot burners	132	supply filters	295, 295
plug connectors	110, 110	supply hoses	284
plug-in gaskets	256	switches and momentary switches	35
position switches	40	system switches (ROLD)	40
pressure control hoses	284		
pressure reduction valves	295, 295		



Зип Общепит

vsezip.ru

+7(812)987-08-81

**T**

temperature probes	68
terminals	110
terminals and connectors	110
thermocouples	146
thermostat gaskets	274
thermostats	19
timers	55
tools	296
transformers	63
tube burners	161
turning lever locks	223

**U**

union nuts	299
universal probes	68

**V**

valves	294
valves and tank inlets	290
vibration pumps	107

**W**

wash and rinse pumps	100
washers	299
water cycle components	295
window seals	262
wing nuts	298