

Зип Общепит

vsezip.ru

+7(812)987-08-81

# COOKING APPLIANCES

COOKING LINES

TYPE: CT

Accessories

WITHOUT ACCESSORY

---

## Spare Parts Manual

---

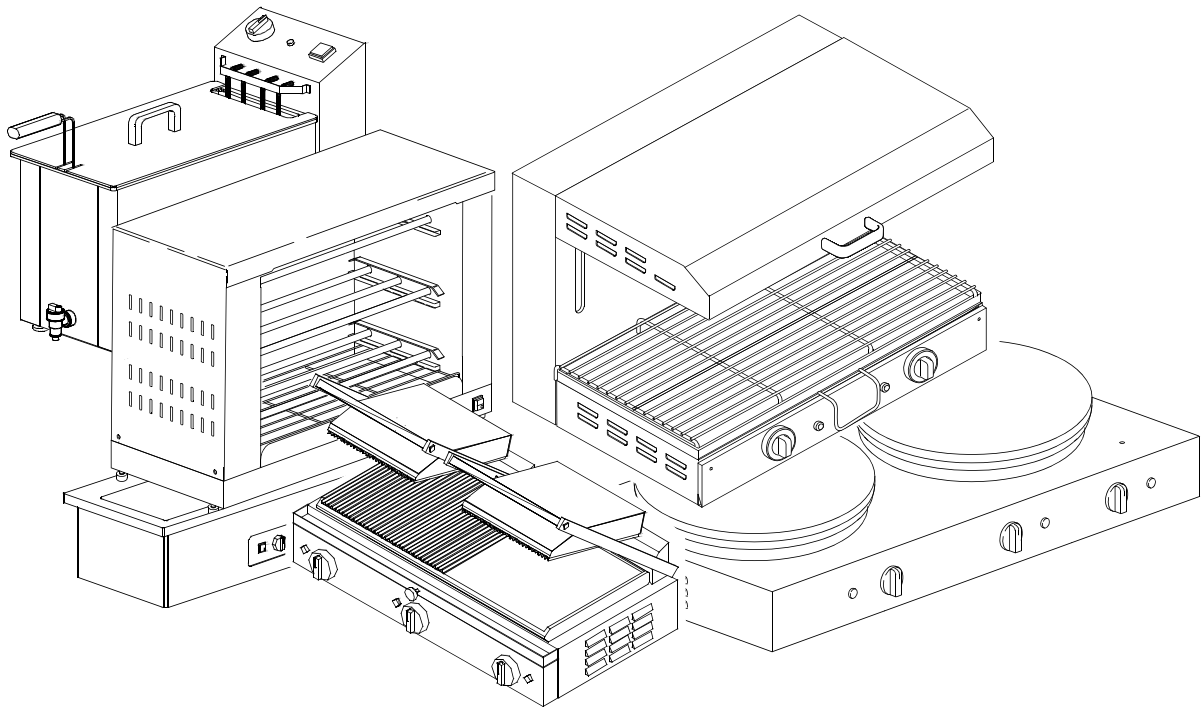

---

S/N:

Valid from:07/2006

Rev.: 7.0

---

**INFORMAZIONI GENERALI**

Questo catalogo serve per richiedere con esattezza le parti di ricambio

Nelle ordinazioni indicare:

1) il numero dei codici dei particolari seguito dalla descrizione e la quantità desiderata;

2) Il codice alfa-numerico presente nella seconda colonna della tabella ;

**I disegni delle parti di ricambio sono solo indicativi e non rappresentano il pezzo in oggetto.**

**I dati contenuti in questo catalogo sono indicativi e possono essere soggetti a modifiche senza impegno di preavviso.**

**ALLGEMEINE INFORMATIONEN**

Dieser Ersatzteilkatalog dient zur genauen Angabe der Teile bei Ersatzteilbestellungen.

Bei Ersatzbestellung ist folgendes anzugeben:

1) Die Bestellnummer der Ersatzteile mit der entsprechenden Beschreibung genaue Menge;

2) Der alpha-numerischer Code auf der zweiten Reihe in dein Sculd;

**Die Zeichnungen der Ersatzteile sind nur als Hinweise gedacht und stellen nicht das betroffene Teil dar.**

**Bei den im Katalog angeführten Daten handelt es sich um Anhaltsdaten, die jederzeit, ohne Vorankündigung, geändert werden können.**

**GENERAL INFORMATION**

The present spare parts order exactly the right spare parts

When ordering specify:

1) the part's code number followed by its description and quantity needed;

2) The alpha-numeric code is in the second column in the chart;

**Spare parts drawings are general and do not represent the part.**

**The contents of this catalogue are general and can undergo changes without prior notice.**

**INFORMACIONES GENERALES**

El presente catálogo sirve para pedir con exactitud las partes de repuesto

En los pedidos se debe indicar:

1) el número de código de la parte y a continuación la descripción cantidad deseada;

2) El código alfanumerico presente en la segnada columna de la tabla;

**Los diseños de las partes de recambio son solo indicativos y no representan la pieza en cuestión.**

**Los datos contenidos en el presente catálogo son indicativos y pueden modificarse sin aviso previo.**

**INFORMATIONS GENERALES**

Ce catalogue permet de commander correctement les pièces détachées

Les commandes doivent être passées en indiquant:

1) le numero de code des pièces détachées suivi de leur description quantité désirée;

2) le code alphanumérique dans la deuxième colonne du tableau;

**Les plans des pièces détachées sont fournis seulement à titre indicatif et ne représentent pas la pièce concernée.**

**Les données de ce catalogue sont citées seulement à titre indicatif et peuvent être l'objet de modifications sans avis préalable.**

**ESEMPIO  
EXAMPLE  
EXEMPLE  
BEISPIEL**

Rif.	Codici
MODULE:Particolari	
10505	540903
10510	540908
10515	15065/A
10520	540086
10525	540028



**Note**

Tutte le informazioni riportate si intendono aggiornate alla data di stampa. Il Produttore si riserva il diritto di apportare qualsiasi modifica richiesta dallo sviluppo evolutivo dei suddetti prodotti.

Per la sicurezza, la garanzia, l'affidabilità ed il valore della lavastoviglie usa solo ricambi originali. **Per alcuni codici, sono richieste quantità minime d'ordine.**



**Attenzione**

Questo libretto è parte integrante della lavastoviglie e, in caso di passaggio di proprietà, deve essere consegnato al nuovo acquirente.



**Remarque**

Toutes les informations contenues dans ce manuel s'entendent mises à jour à la date d'impression. En raison du développement constant de ses produits, usine se réserve le droit d'apporter à tout instant les modifications qu'elle jugera utiles.

Pour la sécurité, la garantie, la fiabilité et la valeur de votre lavevaisselles n'utilisez que des pièces de rechange d'origine. **Pour quelque référence on demande un minimum de pièces par commande**



**Attention**

Ce manuel doit être considéré comme partie intégrante de la lavevaisselles, en cas de transfert de propriété, doit toujours être remis au nouveau propriétaire.



**Note**

The information contained herein is valid at the time of going to print. The Company reserves the right to make any changes required by the future development of the above-mentioned products.

For your safety, as well as to preserve the warranty reliability and worth of your dishwashers, use original spare parts only. **For some codes a minimum quantity for order is required.**



**Warning**

This manual forms an integral part of the dishwashers and - if a transfer of title occurs - must always be handed over to the new owner.



**Hinweis**



Die Der Hersteller behält sich das Recht vor, jegliche, durch eine Weiterentwicklung der genannten Produkte bedingte Änderungen vornehmen zu können.

Verwenden Sie für Ihre Sicherheit, die Garantie, die Zuverlässigkeit und den Wert Ihrer machine originale Ersatzteile. **Für bestimmte Code nummer werden mindesten bestellungen verlangt.**



**Achtung**

Diese Betriebsanleitung ist Bestandteil des machine und muss bei seinem Weiterverkauf dem neuen Besitzer ausgehändigt werden.

+7(812)987-08-81

**Code DW 999XYYYY**  
**Model DESCRIPTION**  
**S/N DW A 1015770 Type .....**

**CL/Part** 

400V 3N 3500W	50HZ		8A 500W
<b>IPX3</b>		16A	

**TECHICAL SPECIFICATION**



Pressione Dinamica alimentazione idrica **200-500 kPa**  
 Pression dynamique arrivée d'eau  
 Dynamic pressure water supply  
 Dynamischer Druck asserreinlauf

**MADE IN ITALY** 

Pressione dinamica vapore saturo  
 Pression dynamique vapeur satueèè  
 Dyanischer Druck gesattigter Dampf  
 Pression Dinamica Vapor Saturado

Temperatura massima acqua in ingresso **60°C**  
 Temperature max eau a l'entre  
 Maximale Temperatur Wasseranschlù  
 Maximum Water temperature in-feeding

---

Model  S/N 

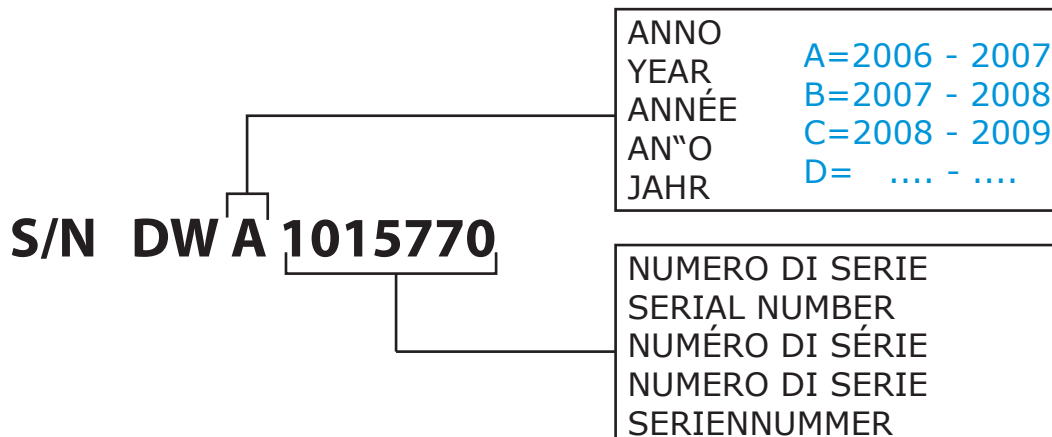
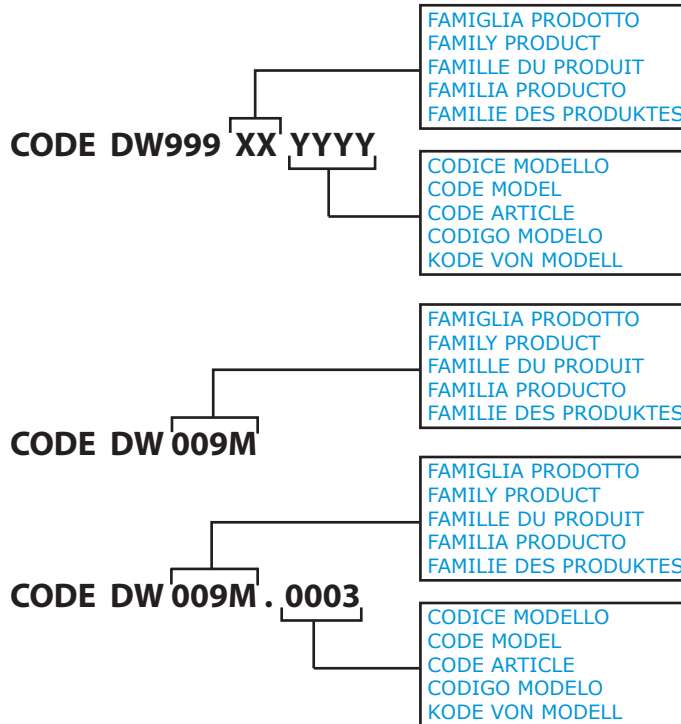

Spare parts

---

**Зип Общепит**

**vsezip.ru**

**+7(812)987-08-81**

vsezip.ru

+7(812)987-08-81

## 1. Spare parts

Toaster F6 .....	5
Toaster F60 ( TK-60P) .....	7
Toaster F60 ( TK-60P) .....	9
Toaster F12 .....	11
Toaster F120 ( TK-120 P) .....	13
Toaster F120 ( TK-120 P) .....	15
Crepe-X1 ( TK-20 ) .....	17
Crepe-X2 ( TK-21 ) .....	19
Single grill ( K1-L + K1-R ) .....	21
Double grill ( K2-L + K2-R + K2-M ).	25
Salamander S1 .....	29
Salamander S2 .....	31
Bain Marie BM100-200-300 .....	33
5M-6M/T-8T deep-fryer .....	37
5+5M-6+6M/T-8+8T deep-fryer .....	39

vsezip.ru

+7(812)987-08-81

## 1.1 Voltage codes

Volt	Voltage code
A	3/N/PE~380-400V 50-60Hz
D	3/PE~200-210V 50-60Hz
F	2/PE~220-240V 50-60Hz
G	3/N/PE~415V 50-60Hz
H	3/PE~220-230V 50-60Hz
K	3/PE~380-400V 50-60Hz
L	3/PE~415V 50-60Hz
M	3/PE~440V 60Hz
P	1/N/PE~220-230V 50-60Hz
R	2/PE~220-240V 50-60Hz
U	1/N/PE~240V 50-60Hz
V	3/PE~240V 50-60Hz
W	1/N/PE~100-110V 50-60Hz

## 1.2 Product codes

Product code	Full name
Model codes	
ct	COOKING LINES
Type codes	
CT	CT
Accessory codes	
wa	WITHOUT ACCESSORY

vsezip.ru

+7(812)987-08-81

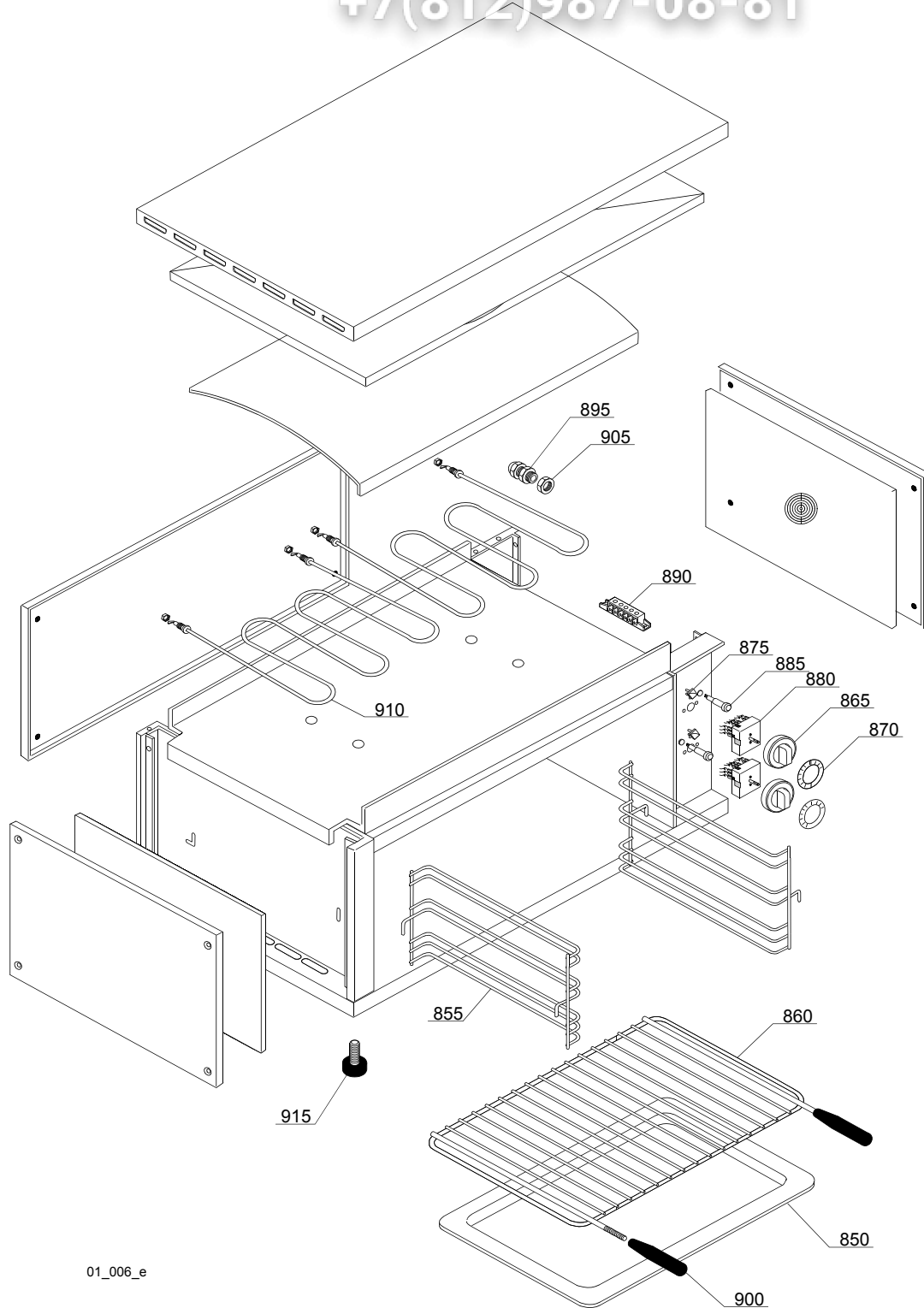

01\_006\_e



vsezip.ru

ID	P-code	SN from	SN to	Mod	Acces.	Volt	Description
<b>Module:Salamander S1</b>							
850	9101		-				T-1/1 H20 tray
855	9102		-				Grid holder
860	9103		-				Grid
865	9104		-				Black knob
870	9105		-				Silk-screen processed disk
875	9106		-				Knob index
880	9107		-				Energy regulator
885	9108		-				White light
890	9109		-				3 phase terminal board
895	9110		-				Cable holder
900	9111		-				Handle
905	9112		-				Hexagon lock nut
910	9113		-				Heating element
915	9114		-				Small foot

ct=COOKING LINES

CT=CT

wa= WITHOUT ACCESSORY

A=3/N/PE~380-400V 50-60Hz, D=3/PE~200-210V 50-60Hz, F=2/PE~220-240V 50-60Hz, G=3/N/PE~415V 50-60Hz, H=3/PE~220-230V 50-60Hz, K=3/PE~380-400V 50-60Hz, L=3/PE~415V 50-60Hz, M=3/PE~440V 60Hz, P=1/N/PE~220-230V 50-60Hz, R=2/PE~220-240V 50-60Hz, U=1/N/PE~240V 50-60Hz, V=3/PE~240V 50-60Hz, W=1/N/PE~100-110V 50-60Hz