

**TAVOLA** **REV**  
**IT3210** **03**

**TEKNO 4**

Зип-Сервисит  
vsezip.ru  
+7(812)987-08-81

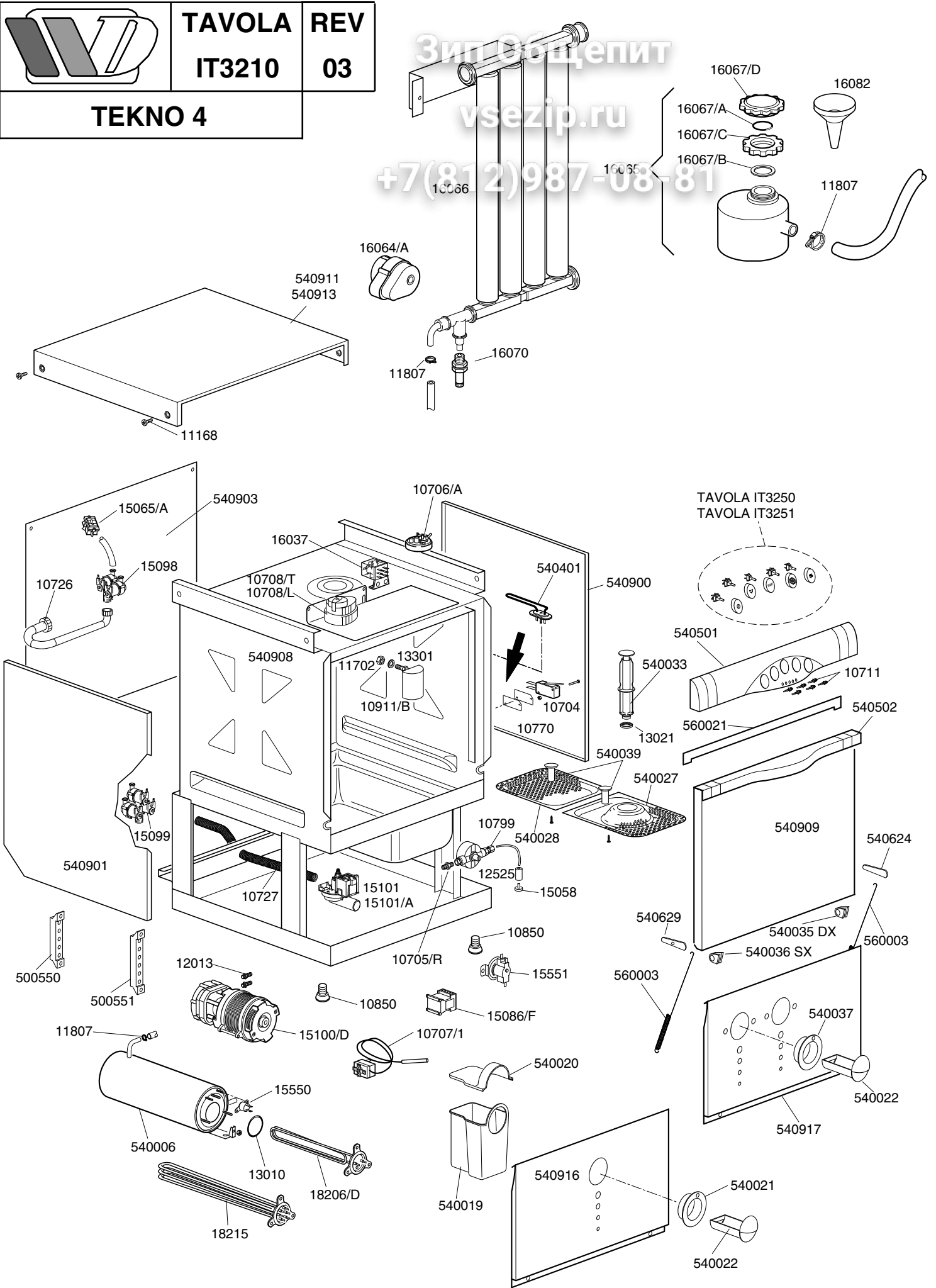

## LAVASTOVIGLIE TEKNO 4

Зип Общепит

TAVOLA  
IT3210

CODICE	DESCRIZIONE	CODICE	DESCRIZIONE
10704	Micro 16A sicurezza porta	560021	Guarnizione battuta sportello
10711	Spia verde segnalazione piccola	10705/R	Raccordo per tubo d. 8
10726	Canna carico acqua	10706/A	Pressostato 55 30
10727	Canna scarico	10707/1	Termostato 0-90°C TR2 senza albero
10770	Isolante per microswitch	10708/L	Timer 120" aggancio rapido
10799	Dosatore brillantante 3 vie	10708/T	Timer 150" 230V 50HZ Termostop
10850	Piedino regolabile in plastica	10911/B	Assieme gabbia d'aria azzurra L=75
11168	Vite M6X12 TC testa larga	15065/A	Fissacavo con viti
11702	Dado M8 inox	15086/F	Teleruttore 230V 50/60Hz 4C faston
11807	Fascette inox 12-22	15100/D	Pompa aumento pressione 230/240V 50Hz
12013	Portagomma 3/8M	15101/A	Pompa scarico chiocciola orientabile
12525	Contrapeso per filtrino dos. Brillantante	16064/A	Timer rigenerazione 3 camme
13010	Guarnizione OR resistenza	16067/A	Guarnizione OR tappo boccia sale
13021	Guarnizione per troppopieno	16067/B	Guarnizione boccia sale
13301	Guarnizione amianto d. 14X8X1,5	16067/C	Ghiera boccia sale
15058	Filtrino aspirazione brillantante	16067/D	Tappo boccia sale
15098	Elettrovalvola doppia	18206/D	Resistenza 2800W 230V
15099	Elettrovalvola tripla		
15101	Pompa di scarico		
15550	Termostato di sicurezza a contatto		
15551	Termostato vasca fisso in deviazione		
16037	Relè bipolare 16A 230V		
16065	Contentitore sale		
16066	Decalcificatore 4 elementi 1 litro		
16070	Valvola non ritorno		
16082	Imbuto		
18215	Resistenza 4000W 230V		
500550	Morsettiera 3 poli FV110		
500551	Morsettiera 6 poli FV112		
540006	Boiler		
540019	Serbatoio per dosatore brillantante		
540020	Coperchio per serbatoio dos. brillantante		
540021	Portacassetto per dos. brillan. Simbolo "R"		
540022	Cassetto per dosatore brillantante		
540027	Semifiltro superficie senza foro		
540028	Semifiltro superficie con foro		
540033	Troppopieno		
540035	Boccola asse cerniera destra		
540036	Boccola asse cerniera sinistra		
540037	Portacassetto per dos. brillan. Simbolo "D"		
540039	Maniglia filtro superficie		
540401	Resistenza 1100W 230V		
540501	Cruscotto abs grigio scuro		
540502	Maniglia abs grigio scuro		
540624	Bracetto di manovra destro porta		
540629	Bracetto di manovra sinistro porta		
540900	Fianco destro		
540901	Fianco sinistro		
540903	Schienale		
540908	Carrozzeria completa		
540909	Porta completa maniglia plastica		
540911	Coperchio frontale in plastica		
540913	Coperchio frontale inox		
540916	Sottoporta serbatoio brillantante singolo		
540917	Sottoporta serbatoio brillantante doppio		
560003	Molla sportello		



**TAVOLA REV**  
**IT3240 01**

**TEKNO 4 LS**

Зип Общепит

vsezip.ru

+7(812)987-08-81

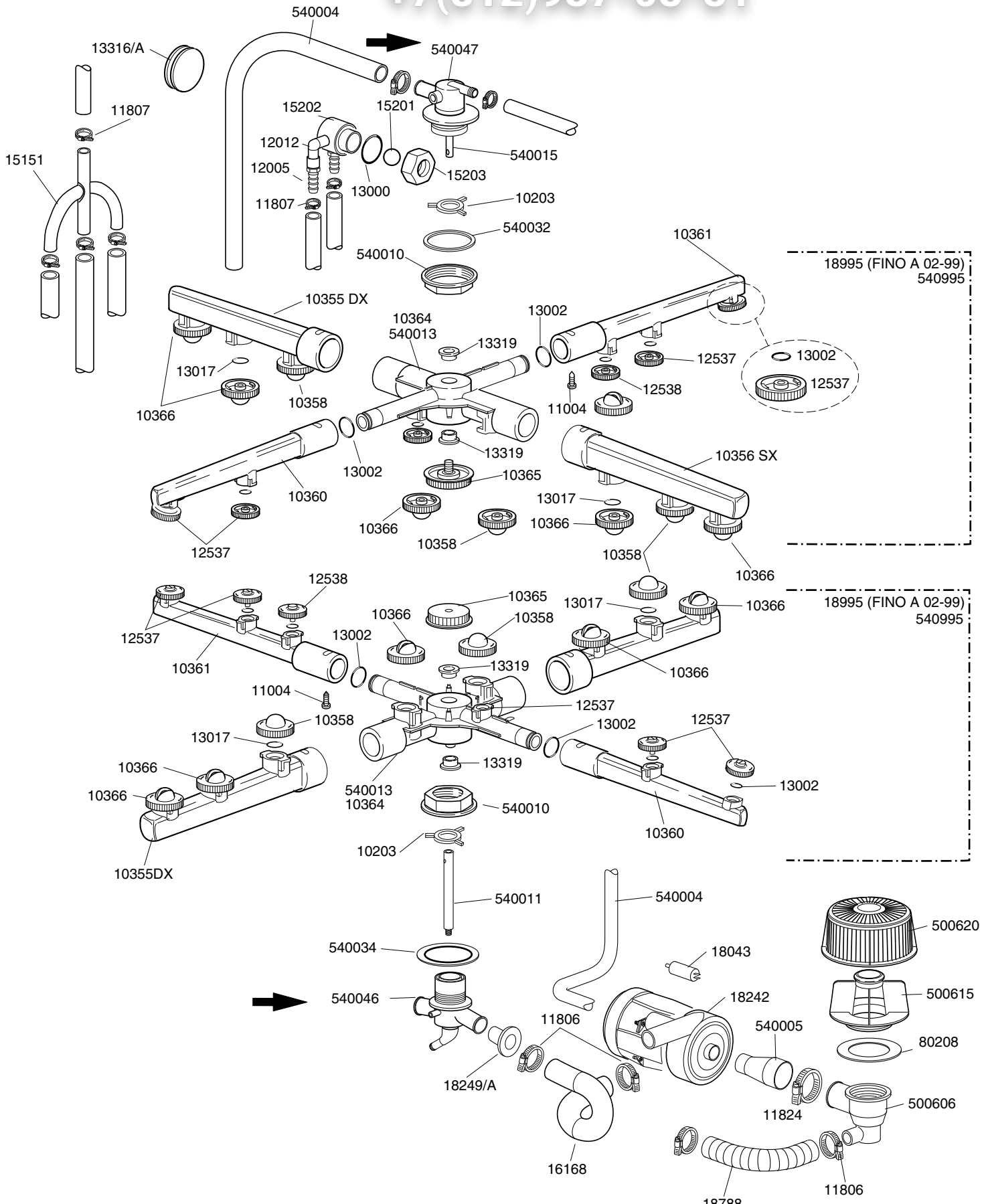



	<b>TAVOLA</b>	<b>REV</b>
	<b>IT3250</b>	<b>01</b>
<b>TASTI SERIE TEKNO 4</b>		

Зип Общепит

vsezip.ru

## SERIE TEKNO 4 DI SERIE +7(812)987-08-81

Tasti

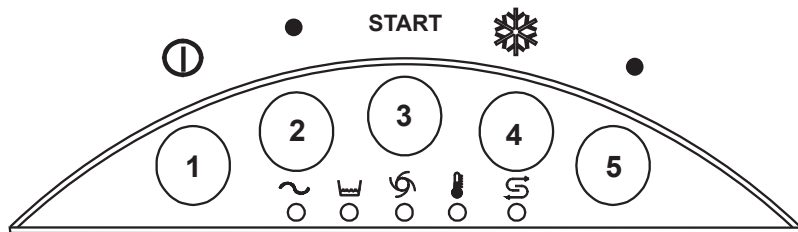

- 1 Cod. 560527/A
- 2 Cod. 560523/A
- 3 Cod. 560529/A
- 4 Cod. 560534/A
- 5 Cod. 560526/A

Comandi



## SERIE TEKNO 4 DEPURAZIONE

Tasti

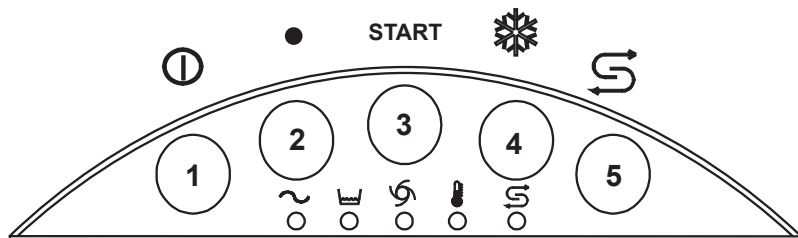

- 1 Cod. 560527/A
- 2 Cod. 560523/A
- 3 Cod. 560529/A
- 4 Cod. 560534/A
- 5 Cod. 560531/A

Comandi



## SERIE TEKNO 4 POMPA DI SCARICO

Tasti

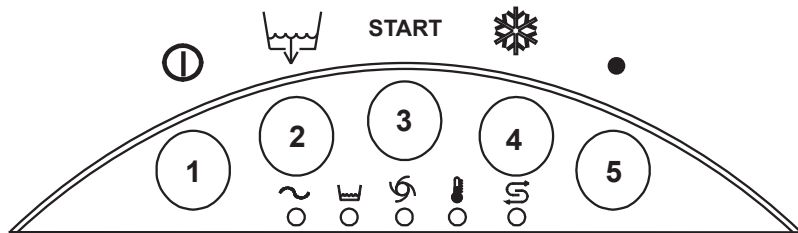

- 1 Cod. 560527/A
- 2 Cod. 560528/A
- 3 Cod. 560529/A
- 4 Cod. 560534/A
- 5 Cod. 560526/A

Comandi

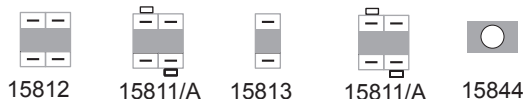

## SERIE TEKNO 4 DEPURAZIONE-POMPA DI SCARICO

Tasti

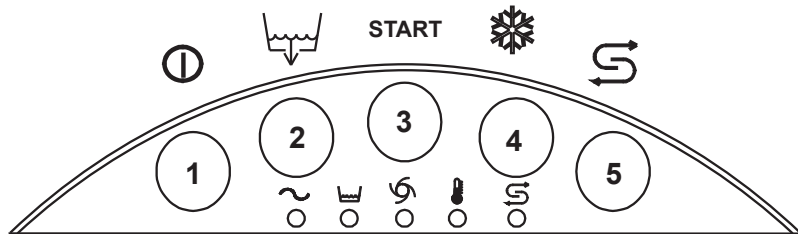

- 1 Cod. 560527/A
- 2 Cod. 560528/A
- 3 Cod. 560529/A
- 4 Cod. 560534/A
- 5 Cod. 560531/A

Comandi







TAVOLA  
IT3251

REV  
01

Зип Общепит

vsezip.ru

TASTI SERIE TEKNO 4

SERIE TEKNO 4 RISCIAQCUC CALDO FREDDO 7(812)987 08-81

Tasti

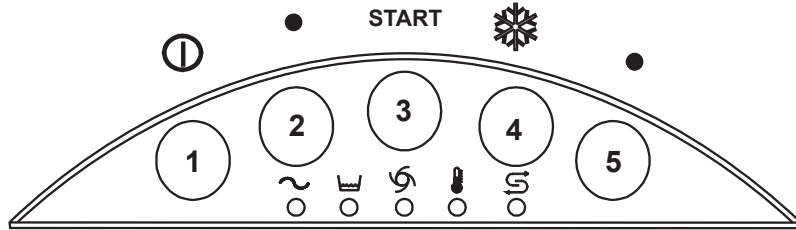

- 1 Cod. 560527/A
- 2 Cod. 560523/A
- 3 Cod. 560529/A
- 4 Cod. 560534/A
- 5 Cod. 560526/A

Comandi



15812



15844



15813



15811



15844

