	TAVOLA	REV
	IT1010	01
GS 40		

ЗипОбщепит
 zip.ru
 +7(812)987-08-81

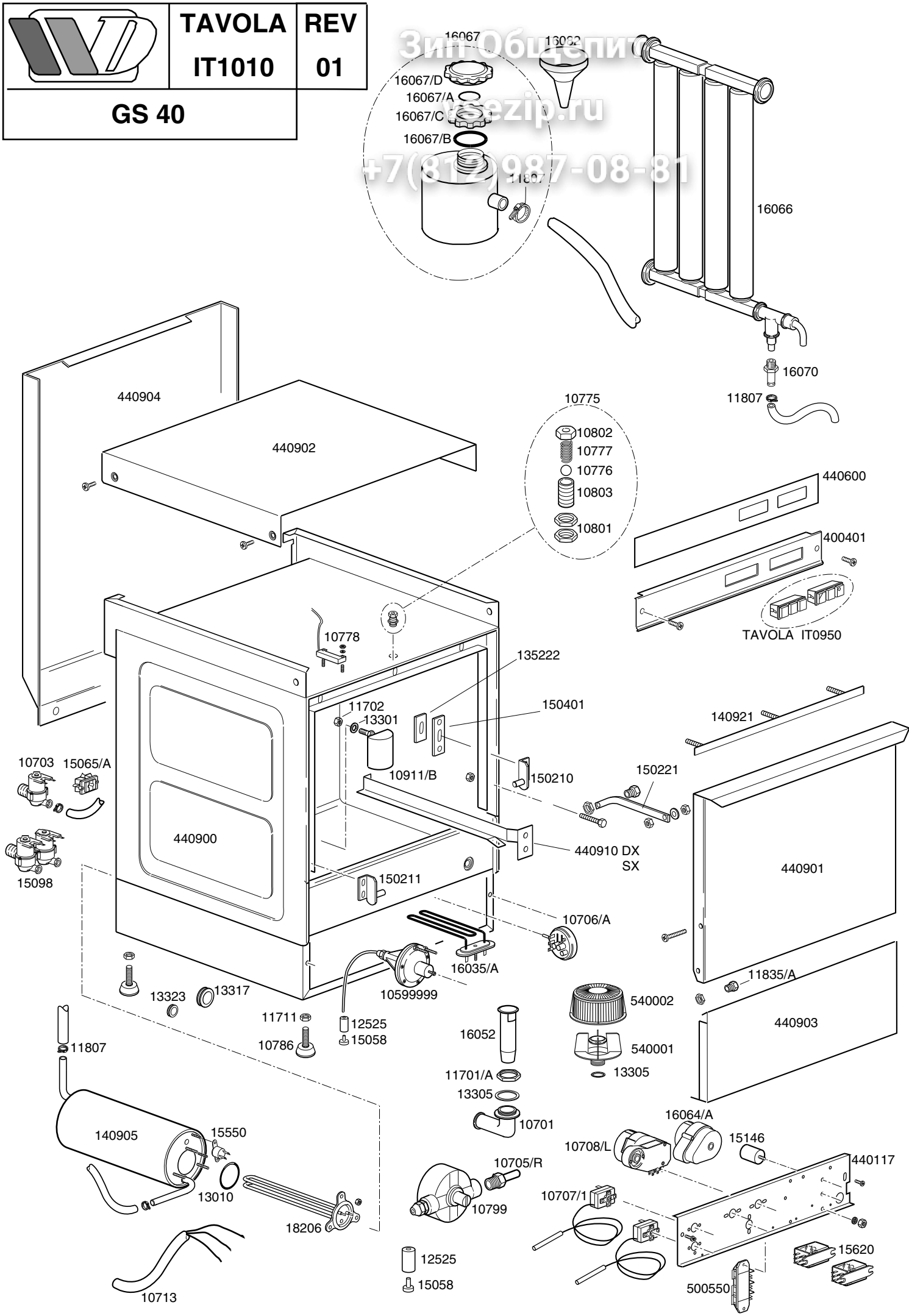

CODICE	DESCRIZIONE	CODICE	DESCRIZIONE
10701	Gomito scarico	10911/B	Assieme gabbia d'aria
10703	Elettrovalvola singola	11701/A	Dado esago sale 36x5
10713	Cavo alimentazione 3x2,5x2500	11835/A	Boccola in ottone filetto completo
10775	Cricco porta	15065/A	Fissacavo con viti
10776	Sfera cricco porta	16035/A	Resistenza vasca 1850W
10777	Molla cricco porta	16064/A	Timer rigenerazione CDC
10778	Microcontatto magnetico reed	16067/A	Guarnizione OR per tappo boccia sale
10786	Piedino M10x25 d.40 nero	16067/B	Guarnizione boccia sale
10799	Dosatore brillantante 3 vie	16067/C	Ghiera per boccia sale
10801	Dado cricco porta	16067/D	Tappo boccia sale
10802	Controdado cricco porta		
10803	Corpo cricco porta		
11702	Dado M8 inox		
11711	Dado M10 zincato		
11807	Fascette inox 12-22		
12525	Contropeso filtrino aspirazione brillantante		
13010	Guarnizione OR resistenza		
13301	Guarnizione amianto d.14x8x1,5		
13305	Guarnizione gomito scarico		
13317	Passacavo in gomma d.40		
13323	Passacavo in gomma d.13		
15058	Filtrino aspirazione brillantante		
15098	Elettrovalvola doppia		
15146	Filtro antidisturbo F1		
15550	Termostato di sicurezza a contatto		
15620	Relè bipolare 16A in deviazione		
16052	Troppopieno		
16066	Decalcificatore 4 elementi		
16067	Contentitore sale		
16070	Valvola non ritorno completa		
16082	Imbuto		
18206	Resistenza boiler 2400W		
135222	Battuta Cerniera porta		
140905	Boiler completo		
140921	Angolare per guarnizione porta		
150210	Cerniera porta dx		
150211	Cerniera porta sx		
150221	Asta porta		
150401	Guida asta curva		
400401	Supporto comandi		
440117	Portacomponenti		
440600	Mostrina serigrafata		
440900	Carrozzeria interna completa		
440901	Porta completa		
440902	Coperchio		
440903	Pannello sottoporta		
440904	Schienale		
440910	Correntino interno DX-SX		
500550	Morsettiera 3 poli FV110		
540001	Corpo filtro filettato		
540002	Filtro per corpo		
10599999	Dosatore brillantante		
10705/R	Raccordo per tubo d.8		
10706/A	Pressostato 55-30		
10707/1	Termostato 0-90°C TR2 senza albero		
10708/L	Timer 120" aggancio rapido		

	TAVOLA IT0950	REV 00
	TASTI GS50-GS45-GS40	

Зип Общепит

vsezip.ru

+7(812)987-08-81

SERIE GS50-GS45-GS40 DI SERIE

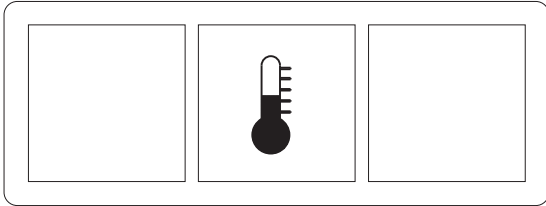

15889

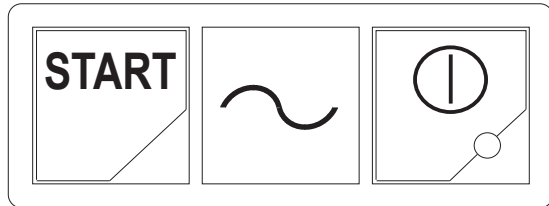

15888

SERIE GS50-GS45-GS40 POMPA DI SCARICO

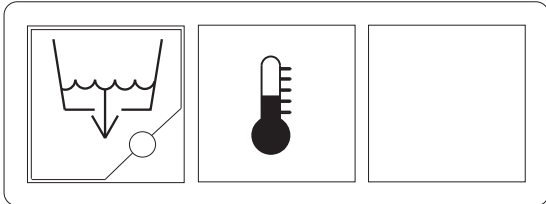

15893

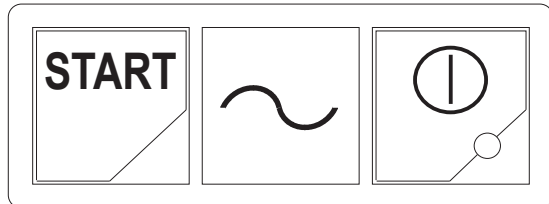

15888

SERIE GS50-GS45-GS40 DEPURAZIONE

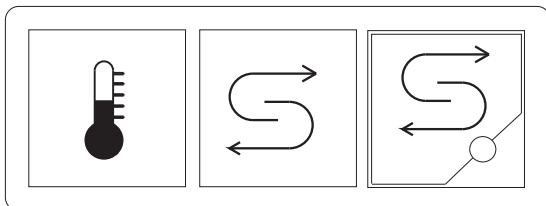

15894

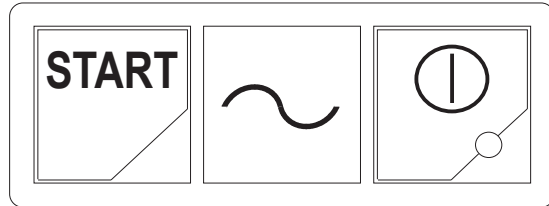

15891

SERIE GS50-GS45-GS40 DEPURAZIONE-POMPA DI SCARICO

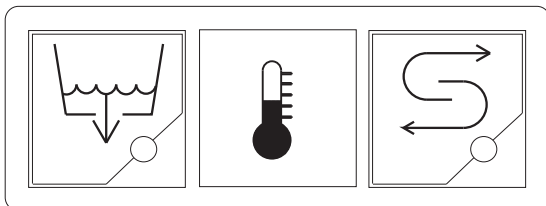

15892

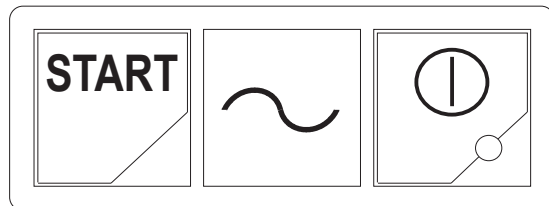

15891

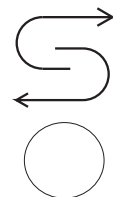

10711/B

	TAVOLA IT0951	REV 01
---	--------------------------	-------------------

TASTI GS45-GS40-GS50

Dalla matricola 99027816

Зип Общепит

vsezip.ru

+7(812)987-08-81

SERIE GS40-GS45 CALDO FREDDO COMBINATO

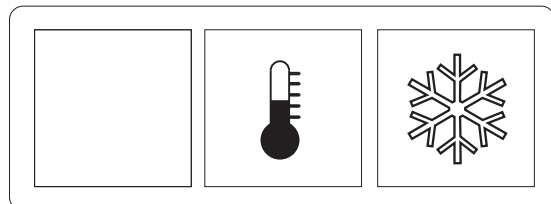

15796

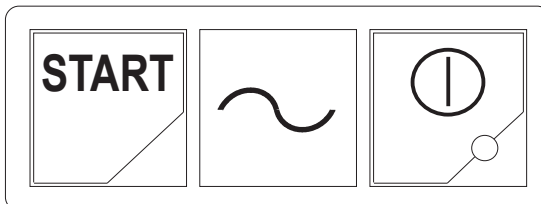

15888

SERIE GS50 RISCIAQUO FREDDO- POMPA DI SCARICO

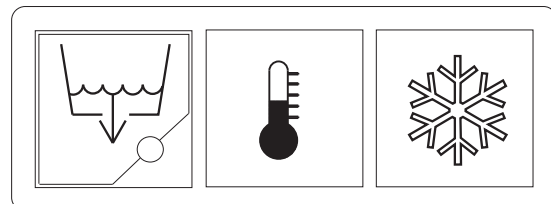

15893/A

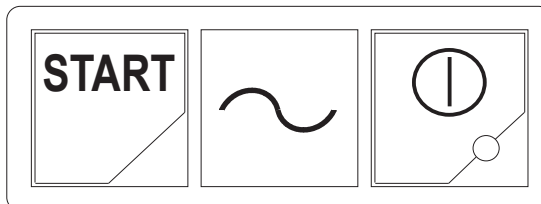

15888

CODICE

DESCRIZIONE

SERIE GS40-GS45 CALDO-FREDDO COMBINATO

	Triplo supporto grigio
15888	Pulsante unipolare Start - Spia Ciclo - Interruttore bipolare 0-1
15796	Pulsante deviatore Freddo - Spia Temperatura -vuoto

SERIE GS50 RISCIAQUO CALDO-FREDDO /POMPA DI SCARICO

→ 15893/A	Pulsante bipolare Scarico - spia Temperatura - Pulsante deviatore Freddo
15888	Pulsante unipolare Start - Spia Ciclo -Interruttore bipolare 0-1