

Зип Общепит

vsezip.ru

+7(812)987-08-81



1G1PE2EV

Edition 20120630-

Зип Общепит

vsezip.ru

+7(812)987-08-81

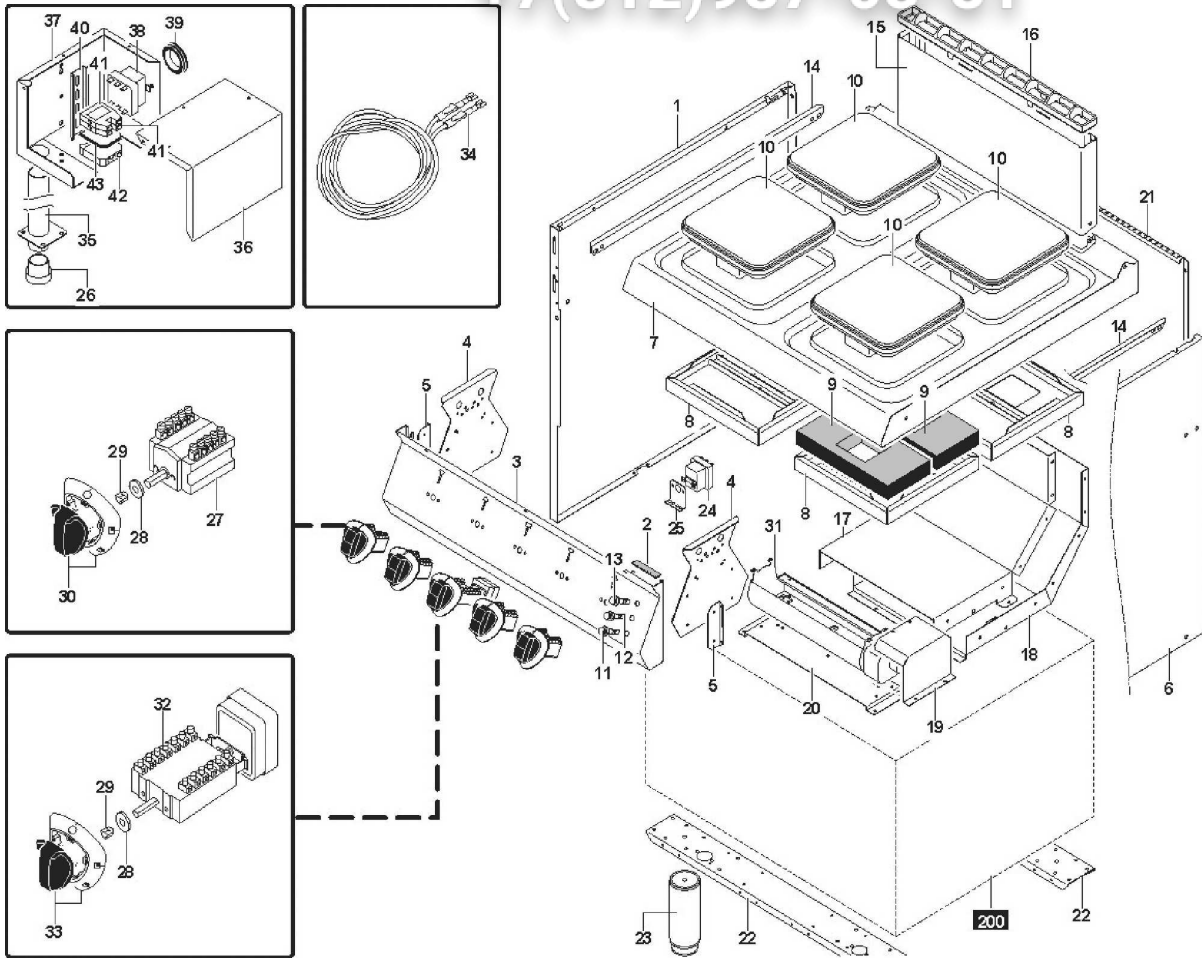

10M-592-03983

Зип Общепит

vsezip.ru

+7(812)987-08-81

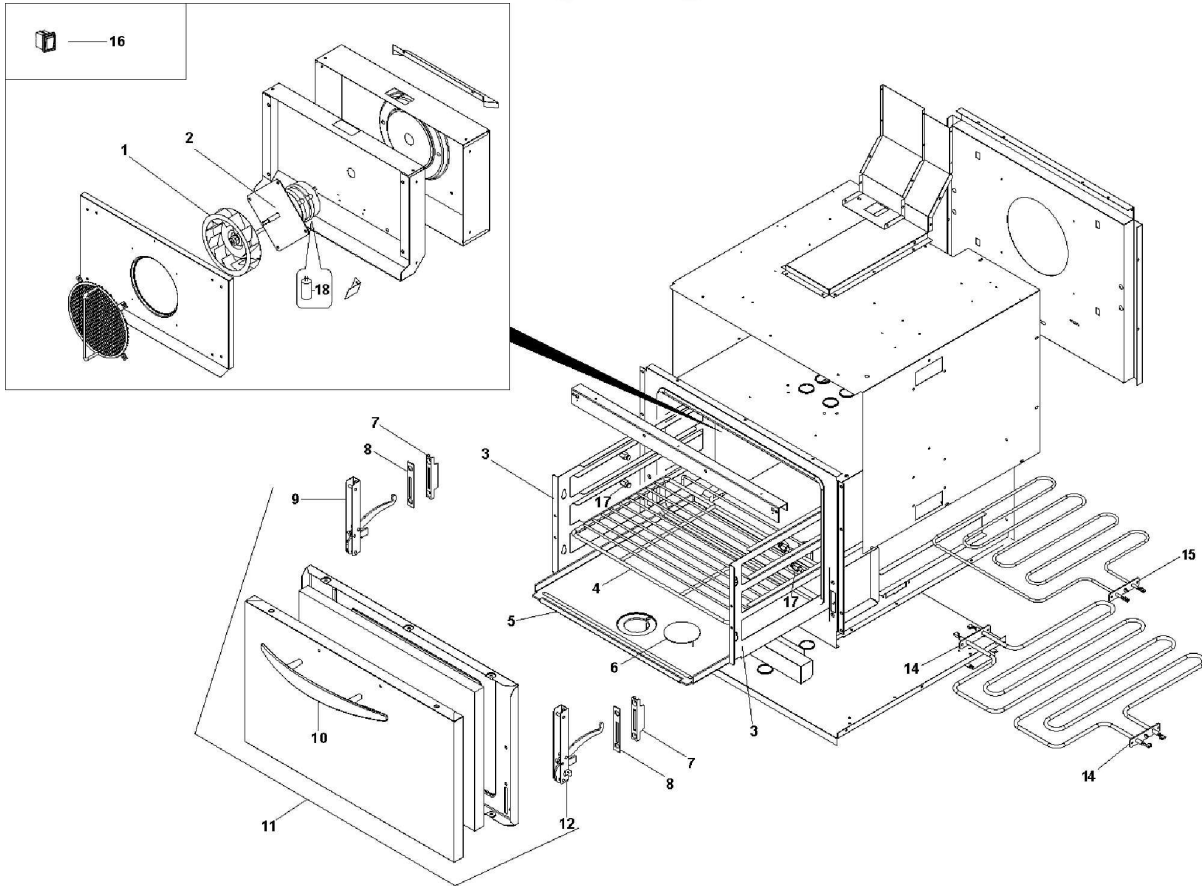

Page	Pos	Code	Description	DATE
002	001	35H2290	LH PANEL	01/06/2002-
002	002	137AA04	GASKET	01/06/2002-
002	003	30A5671	UPPER CONTROL BOARD	01/06/2002-
002	004	35E5791	PARA-SPRINKLES BOARD	10/03/2006-
002	005	35P4600	"SUPPORT ""L""	01/06/2002-
002	006	35H2280	RH PANEL	01/06/2002-
002	007	30M9861	TOP EL. ASS. Y	01/06/2002-
002	008	30Q1530	EL. PLATE PROTECTION	01/06/2002-
002	009	37Q4940	INSULANTING PANEL	01/06/2002-
002	010	32G2860	ELECTRIC PLATE	01/06/2002-
002	011	3106710	GREEN LIGHT 230V	23/05/2007-
002	012	6300651	ORANGE LIGHT 400V ASS.Y	23/05/2007-
002	013	3106720	RED LIGHT 230V	23/05/2007-
002	014	35Y4510	L BRACKET	01/06/2002-
002	015	30Q1780	EXT FLUE ASS. Y	01/06/2002-
002	016	36C4810	FLUE GUARD	01/06/2002-
002	017	3000430	AIR CONVEYOR	01/06/2002-
002	018	3000440	AIR CONVEYOR	01/06/2002-
002	019	3001560	MOTOR PROTEC. PLATE	01/06/2002-
002	020	3000450	FAN SUPPORT	01/06/2002-
002	021	35E1900	REAR PANEL 700	01/06/2002-
002	022	35U8050	SECTION 692X75X30	01/06/2002-
002	023	36C5360	4 FOOTS ASS.Y	01/06/2002-
002	024	3001550	ELECTRIC THERMOSTAT	01/06/2002-
002	025	35S6361	L" SHAPED BAR	01/06/2002-
002	026	3036530	BUSHING	08/06/2006-
002	027	32W0760	SWITCH	01/06/2002-
002	028	3152240	THERMOSTAT PROTECT.	01/06/2002-
002	029	3170290	KNOB SPRING	01/06/2002-
002	030	3135860	ELECT. CONTROL KNOB	01/03/2008-
002	031	3001330	TANGENTIAL FAN	01/06/2002-
002	032	32Z3551	THERMOSTAT 50-300°	01/06/2002-
002	033	3135470	KNOB Ø6	01/03/2008-
002	034	32Q6330	CABLE GROUP	01/06/2002-
002	035	30Z3561	EL. CABLES PIPE	04/05/2005-
002	036	35Z7490	EL. BOX PROTECTION	01/06/2002-
002	037	35Z7620	TERM. BLOCK SUPPORT	01/06/2002-
002	038	32Z9202	SAFETY THERMOSTAT	10/11/2004-
002	039	32X0130	GROMMET Ø29-Ø37	01/06/2002-
002	040	35S5420	""OMEGA"" BRACKET"	01/06/2002-
002	041	32D0950	LIVE TERMINAL	01/06/2002-
002	042	32D0970	GROUND TERMINAL	01/06/2002-
002	043	32D1280	SCREEN COLOR	01/06/2002-
002	200	M010990	M. AIRY ELECTRIC OVEN	01/06/2002-
003	001	32M0370	FAN	01/06/2002-
003	002	32M4301	MOTOR	01/06/2002-
003	003	35Y2820	TRAY RACK ASS. Y	01/06/2002-
003	004	3012000	OVEN GRID 530X325X35	01/06/2002-
003	005	35D4340	OVEN BOTTOM PLATE	01/06/2002-
003	006	30D1260	OVEN PLATE HOLE COVER	01/06/2002-
003	007	36M0270	HINGE CATCH	01/06/2002-

Page	Pos	Code	Description	Info
003	008	35U3170	FLAT BRACKET	01/06/2002-
003	009	36M2430	LEFT HAND HINGE	01/06/2002-
003	012	36M2420	RIGHT-HAND HINGE	01/06/2002-
003	014	32G1591	HEATING EL.	01/06/2002-
003	014	32G1621	HEATING ELEMENT 2600W/400V	01/06/2002-
003	015	3003790	HEATING EL. 2700W, 230V	01/06/2002-
003	015	32G3250	HEATING EL.	01/06/2002-
003	016	32W0631	SWITCH	01/06/2002-
003	017	36C3011	PIN CH14	01/06/2002-
003	018	32Z6660	CAPACITOR 2MF 450V	01/06/2002-