



Вип Общелит

**FAEMA**

vsezip.ru

PARTI DI RICAMBIO

+7(812)987-08-81

PIECES DETACHEES

SPARE PARTS

ERSATZTEILE

LISTA DE RECAMBIOS

2 Gruppi

**E91 A/S**

Groupes

**Ambassador**

3 Cups

4 Gruppen

**E91 A/S**

Grupos

**Ambassador SE**



zip Общепит  
vsezip.ru

+7(812)987-08-81

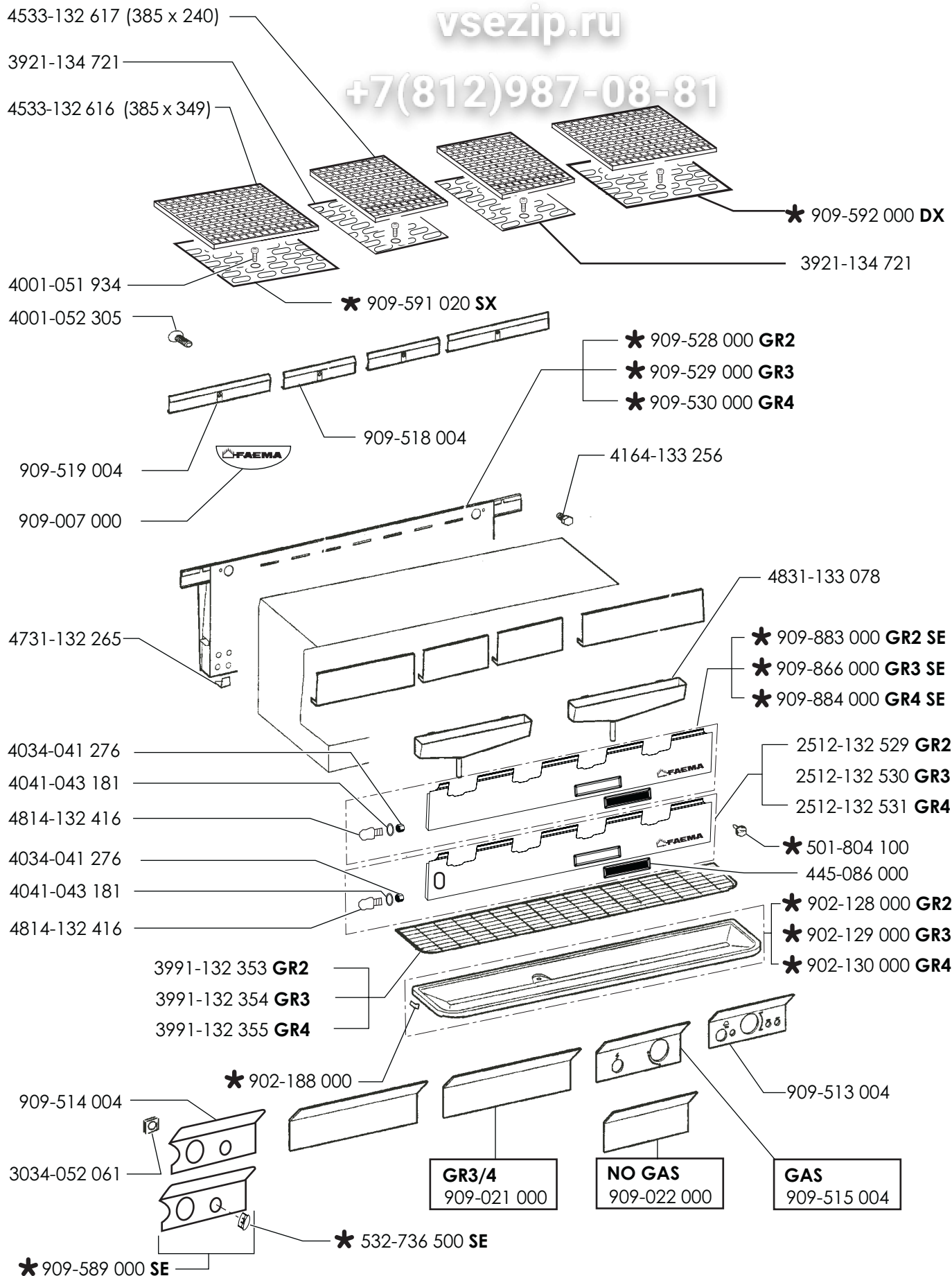

Valido dalla matricola n.°

Valable à partir du matricule n.°

Valid from No. - Gültig ab der Abkenn.-Nr. - Valido a partir de la matricula n.°

\* Particolare nuovo o modificato - Piéce nouvelle ou modifiée - New or modified part  
Neues oder geänderes teil - Particular nuevo o modificado

03 - 07

Edizione del  
Edition du  
Edition of  
Ausgabe vom  
Edición del

91212

TAB.

vsezip.ru

+7(812)987-08-81

- \* 909-585 000 **GR2 SE**
- \* 909-586 000 **GR3 SE**
- \* 909-587 000 **GR4 SE**

- 909-510 004 **GR2**
- 909-511 004 **GR3**
- 909-512 004 **GR4**

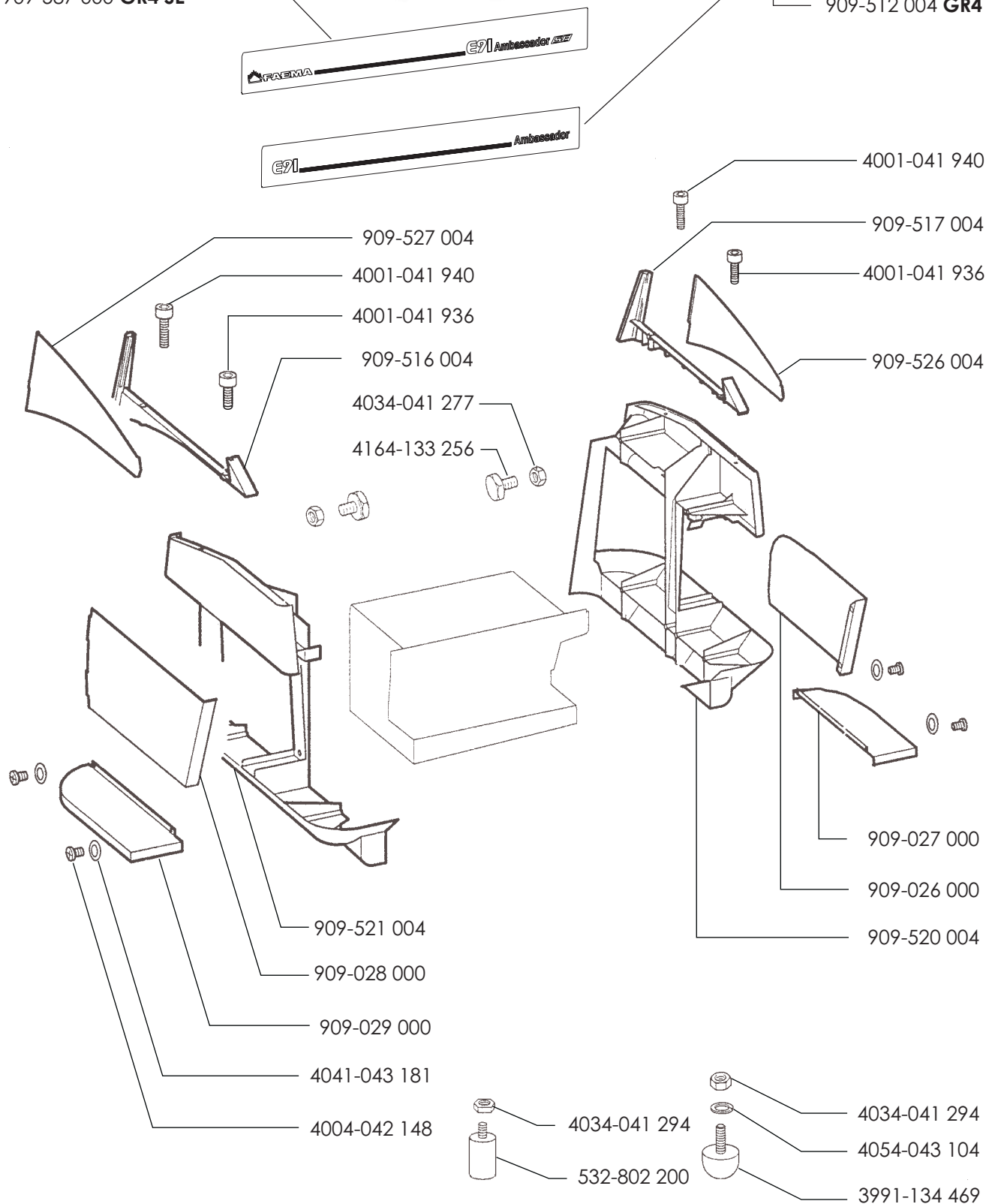

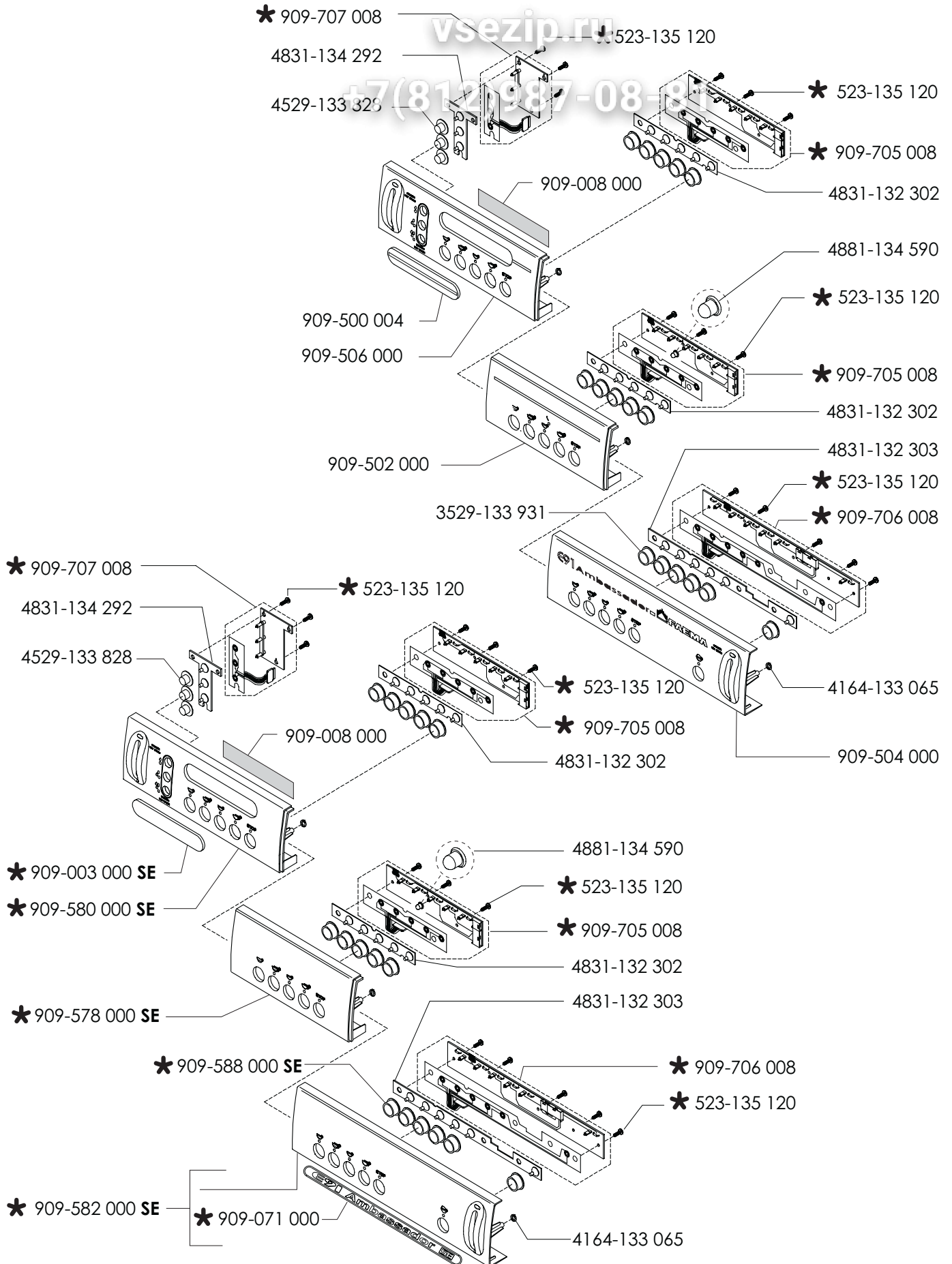

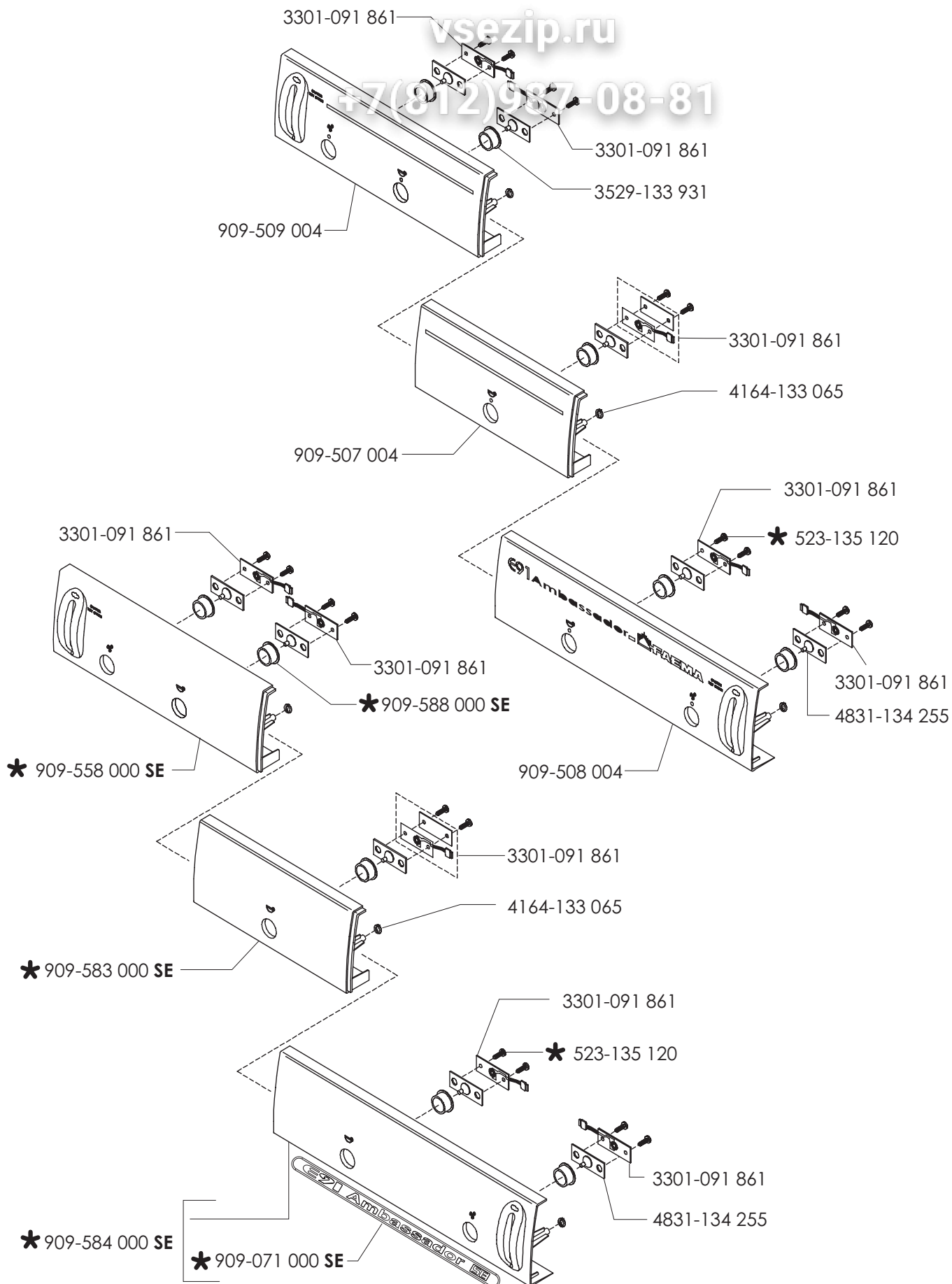

SCATOLA ELETTRICA - BOITE ELECTRIQUE - SWITCH BOX  
SCHALKASTEN - CAJA ELECTRICA

**E91 Ambassador A/S**  
**E91 Ambassador A/S SE**

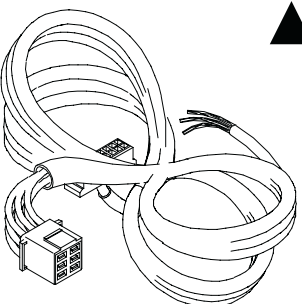

909-700 000 **GR2 A**  
909-718 000 **GR3 A**  
909-719 000 **GR4 A**  
3301-135 123 **GR2 S**  
3301-135 124 **GR3 S**  
3301-135 125 **GR4 S**

Cablaggio elettrico  
Complete electrical wire

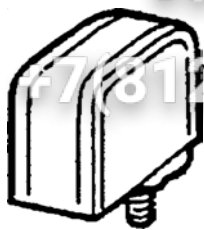

\* 3501-117 399 **T 0,1A**

\* 2231-131 900 (•)

\* 531-193 100

\* 531-191 800 (•)

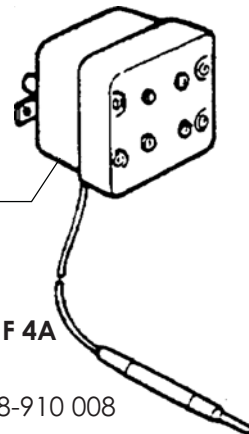

\* 918-910 008

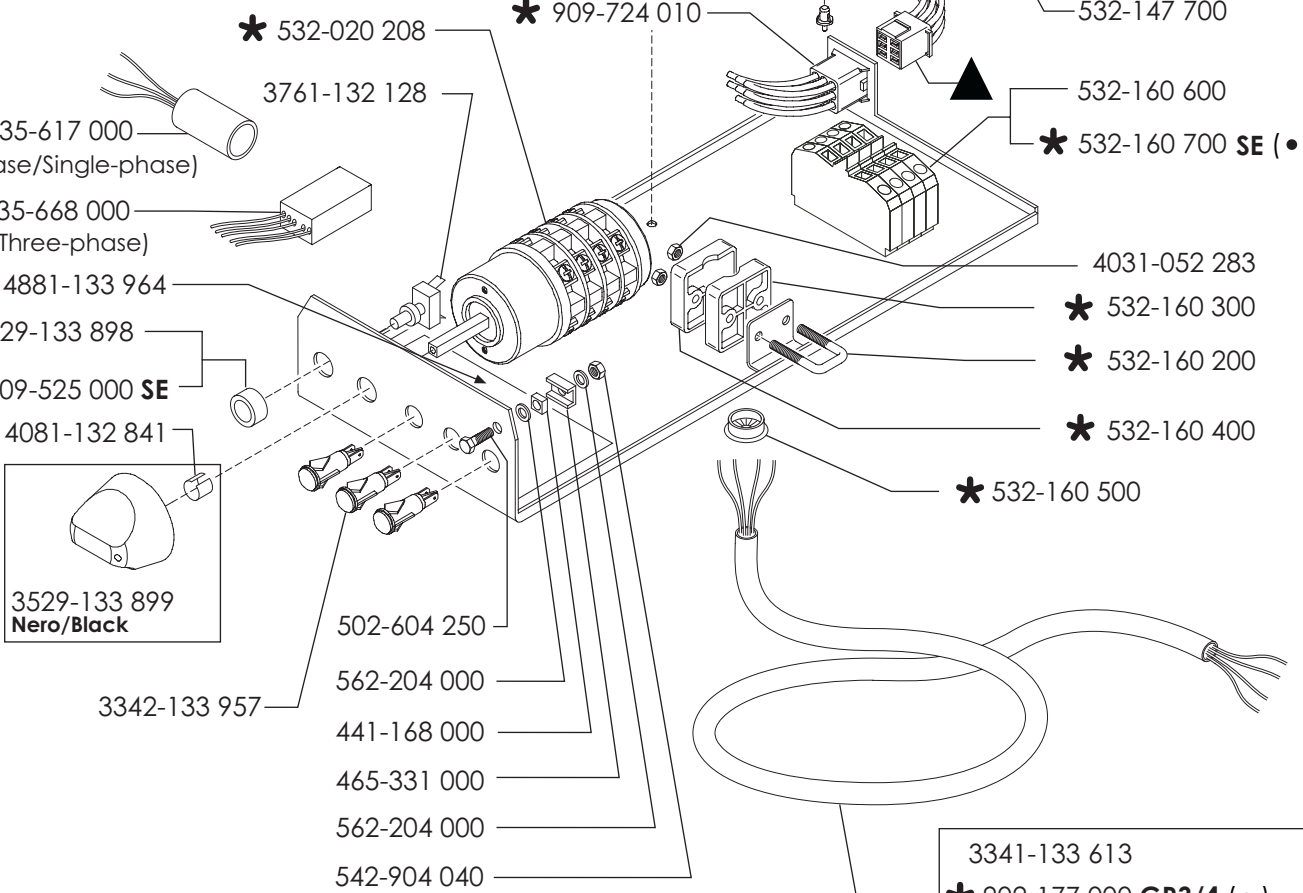

\* 532-020 208

\* 535-617 000  
(Monofase/Single-phase)

\* 535-668 000  
(Trifase/Three-phase)

4881-133 964

3529-133 898

\* 909-525 000 **SE**

4081-132 841

3529-133 899  
**Nero/Black**

3761-132 128

\* 909-724 010

532-147 700

532-160 600

\* 532-160 700 **SE (•)**

4031-052 283

\* 532-160 300

\* 532-160 200

\* 532-160 400

\* 532-160 500

502-604 250

562-204 000

441-168 000

465-331 000

562-204 000

542-904 040

3342-133 957

\* 530-112 200 **15 A (•)**

\* 530-111 000 (•)

3341-133 613

\* 902-177 000 **GR3/4 (•)**

3751-134 591 **GR2 (•)**

2341-091 853  
Kit allacciamento monofase

(•) Only for North America Market



Valido dalla matricola n.°  
Valable à partir du matricule n.°  
Valid from No. - Gültig ab der Abkenn.-Nr. - Valido a partir de la matricula n.°

\* Particolare nuovo o modificato - Piéce nouvelle ou modifiée - New or modified part  
Neues oder geänderes teil - Particular nuevo o modificado

**03 - 07**

Edizione del  
Edition du  
Edition of  
Ausgabe vom  
Edición del

**91216**

TAB.

vsezip.ru  
+7(812)987-08-81

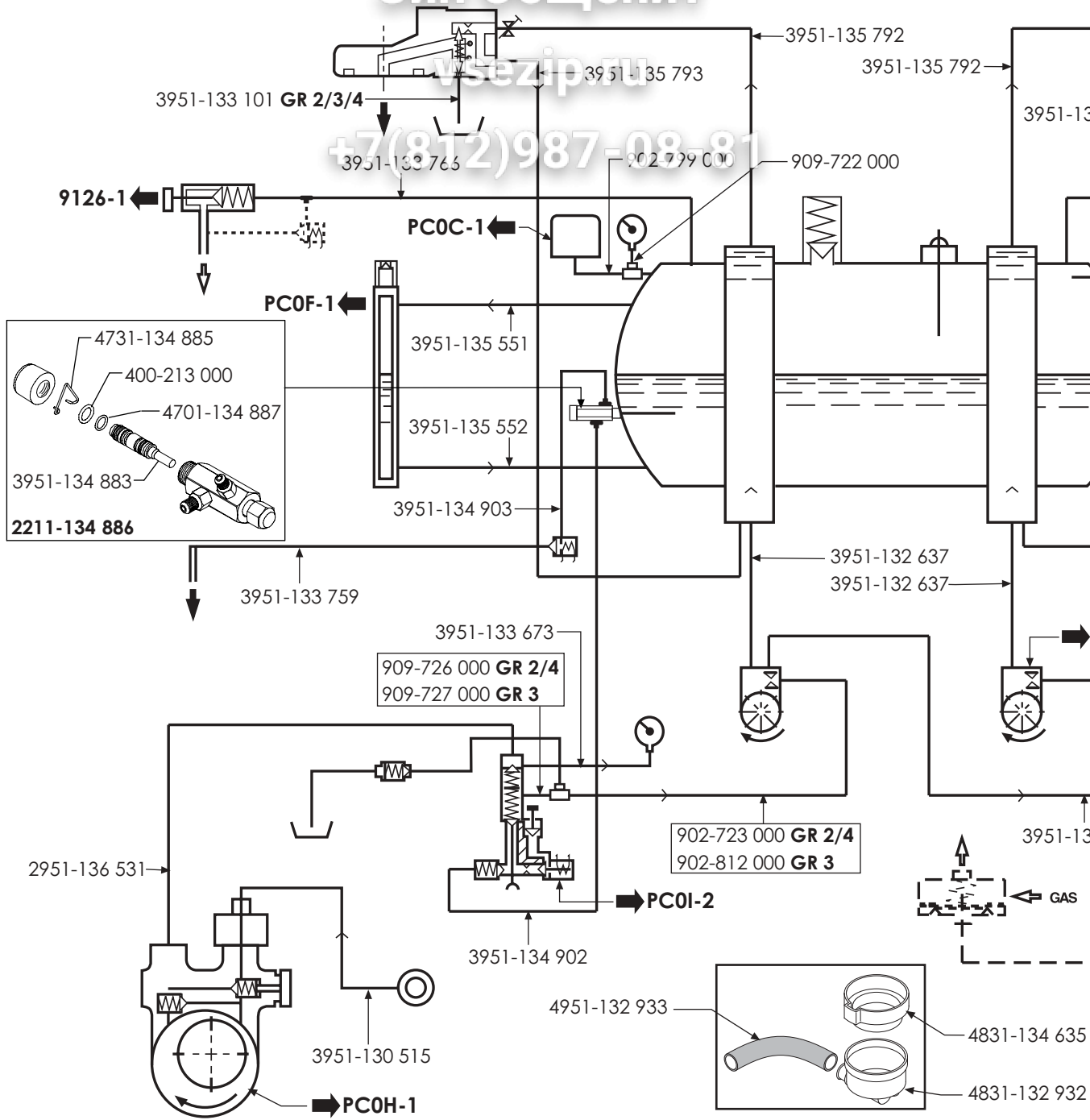

Valido dalla matricola n.°  
Validable à partir du matricule n.°  
Valid from No. - matricola n.°  
Valido a partir de la matricula n.°  
Edition of Ausgabe vom Edition del

01-03

91217  
TAB.



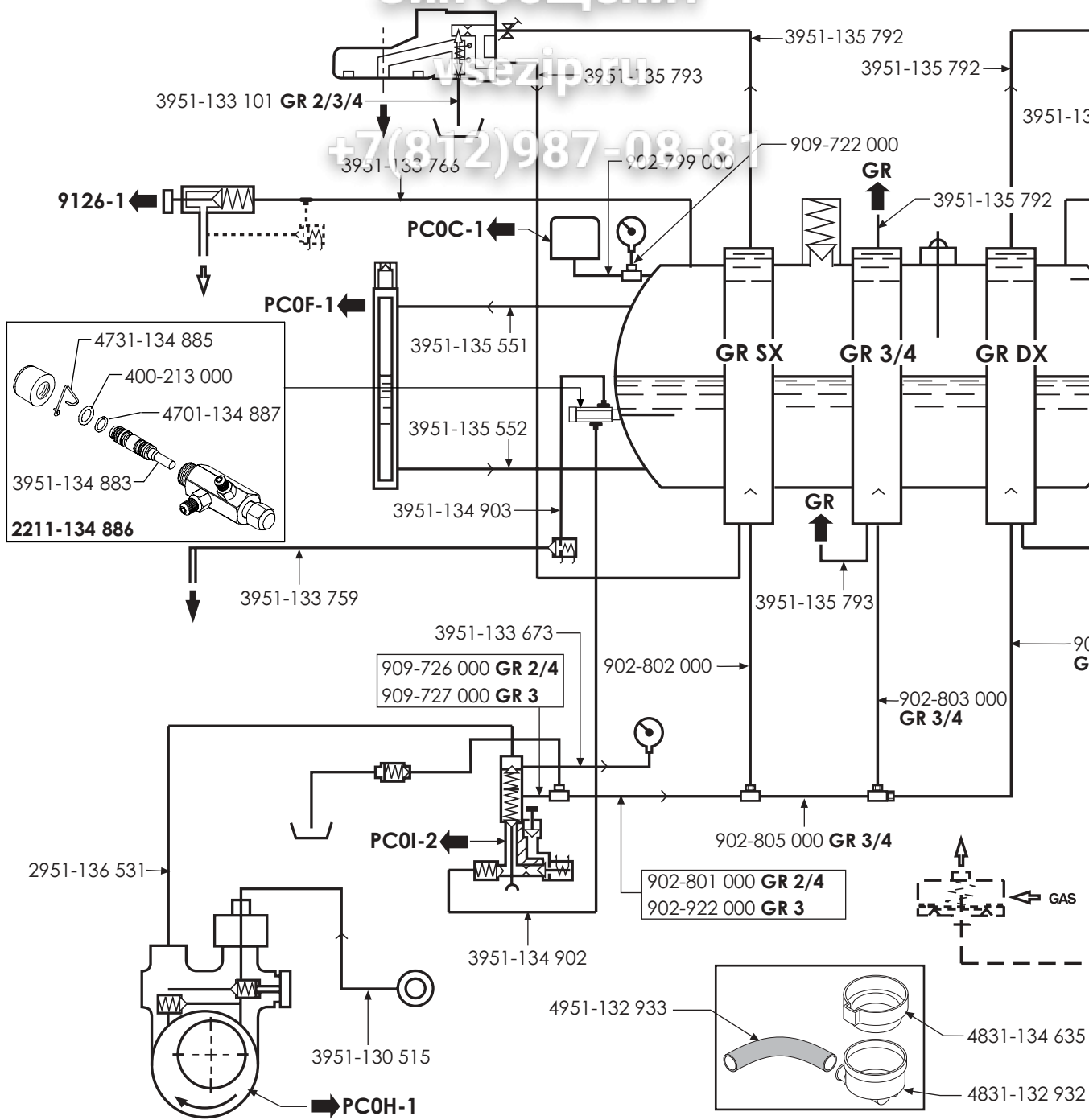

Valido dalla matricola n.°  
 Valable à partir du matricule n.°  
 Valid from No. - Gültig ab der Abkenn.-Nr. - Valido a partir de la matricula n.°  
 Particolare nuovo o modificato - Piéce nouvelle ou modifiée - New or modified part  
 Neues oder geändertes Teil - Particular nuevo o modificado

01 - 03

Edizione del  
 Edition of  
 Ausgabe vom  
 Edición del

91218

TAB.

TUBAZIONI - TUBES  
PIPING - ROHRE - TUBOS

Зип Общепит Е91 Ambassador A SE

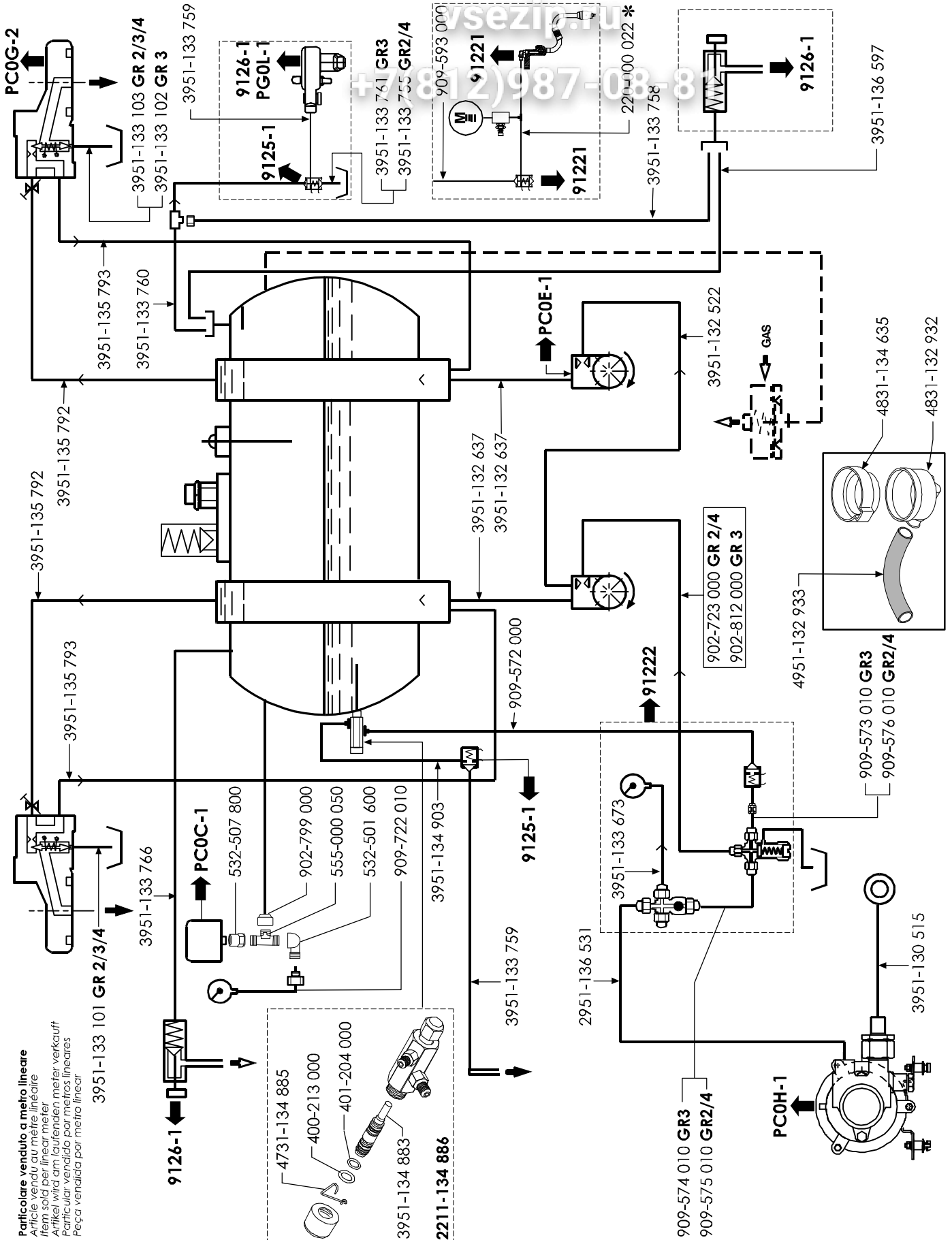

\* Particolare venduto a metro lineare  
Article vendu au metre lineaire  
Item sold per linear meter  
Artikel wird arm. laengenden meter verkauft  
Particular vendido por metros lineares  
Pecca vendida por metro lineare



Valido dalla matricola n.° \_\_\_\_\_  
Valable à partir du matricule n.° \_\_\_\_\_  
Valid from No. - Gültig ab der Abkenn.-Nr. - Valido a partir de la matricula n.° \_\_\_\_\_

\* Particolare nuovo o modificato - Piéce nouvé lle ou modifiée - New or modified part  
Neues oder geändertes teil - Particular nuevo o modificado

03 - 07

Edizione del  
Edition du  
Edition of  
Ausgabe vom  
Edicion del

91219

TAB.

TUBAZIONI - TUBES  
PIPING - ROHRE - TUBOS

E91 Ambassador S SE

Зип Общепит

vsezip.ru

731-987-08-8

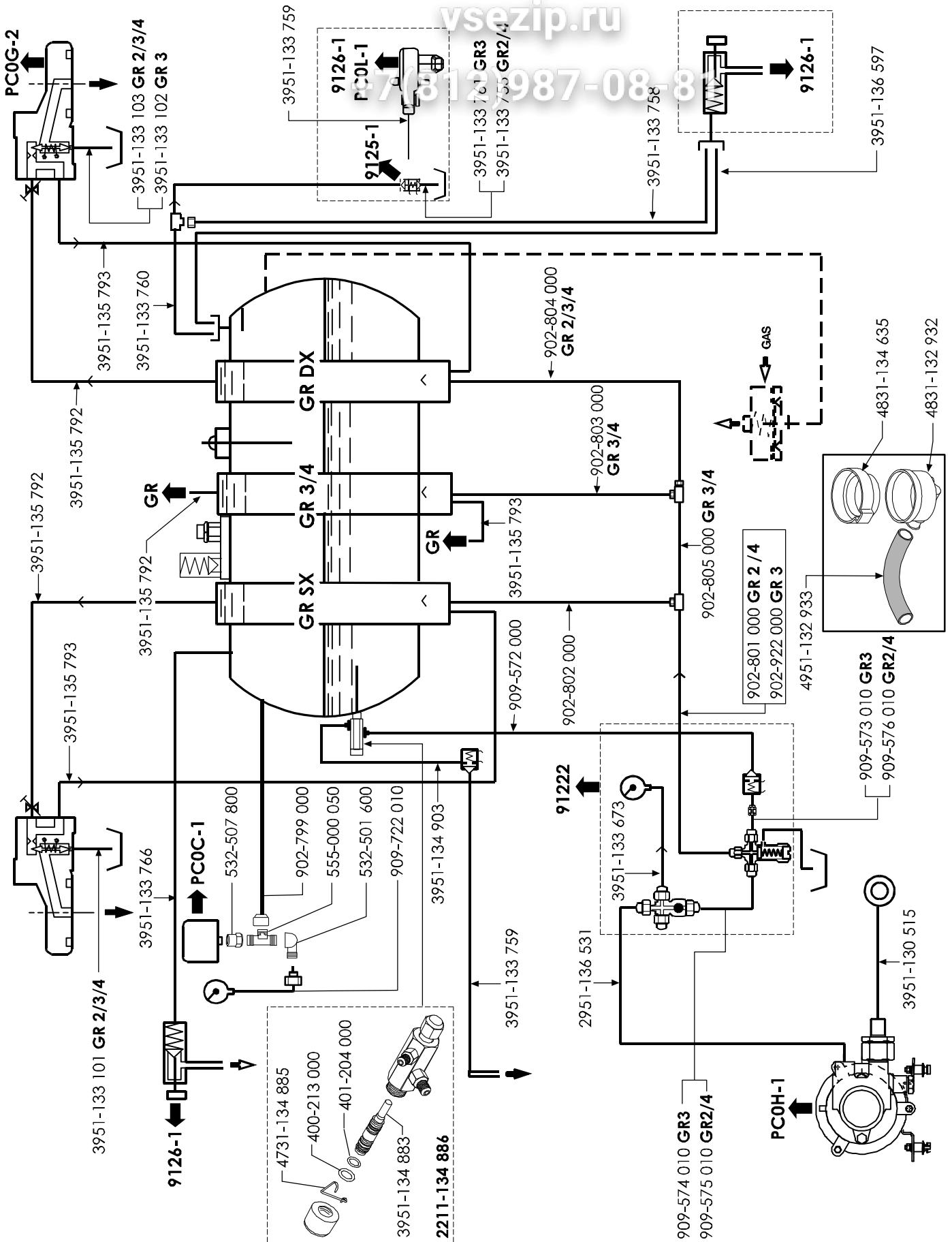

Valido dalla matricola n.°   
 Valable à partir du matricule n.°   
 Valid from No.- Gültig ab der Abkenn.-N r. - Valido a partir de la matricula n.°

\* Particolare nuovo o modificato - Piéce nouvelle ou modifiée - New or modified part  
 Neues oder geändertes teil - Particular nuevo o modificado

03 - 07

Ediz ione del  
 Edition du  
 Edizion of  
 Ausgabe vom  
 Edizion del

91220

TAB.

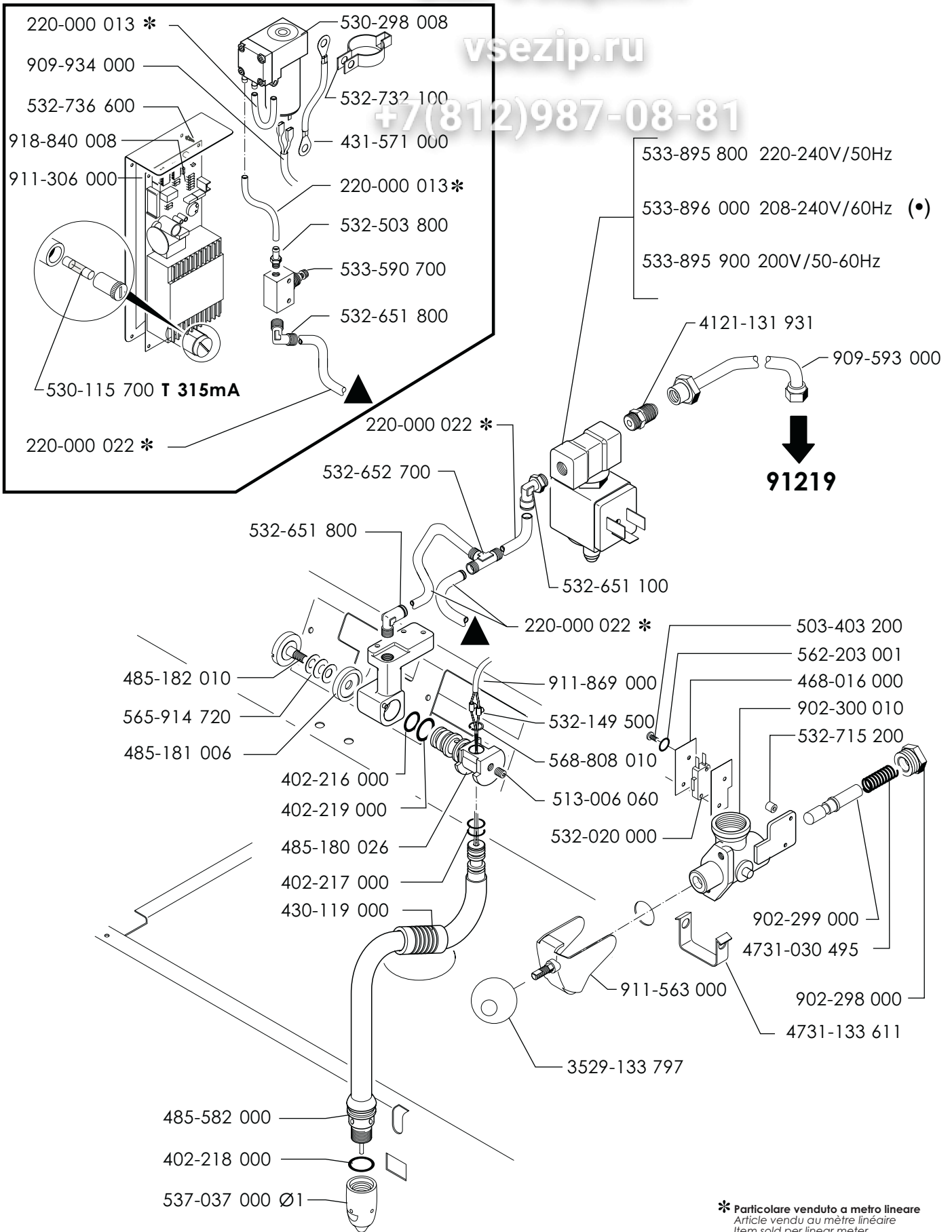

(•) ONLY FOR NORTH AMERICA MARKET

\* Particolare venduto a metro lineare  
 Article vendu au mètre linéaire  
 Item sold per linear meter  
 Artikel wird am laufenden meter verkauft  
 Particular vendido por metros lineares  
 Peça vendida por metro linear



Valido dalla matricola n.°  
 Valable à partir du matricule n.°

Valid from No. - Gültig ab der Abkenn-Nr. - Valido a partir de la matrícula n.°

\* Particolare nuovo o modificato - Piéce nouvelle ou modifiée - New or modified part  
 Neues oder geändertes teil - Particular nuevo o modificado

03 - 07

Edizione del  
 Edition du  
 Edition of  
 Ausgabe vom  
 Edición del

91221

TAB.

VALVOLE CON AUTOLIVELLO - VANNES AVEC ENTREE D'EAU AUTOM.  
 VALVE WITH SELF LEVEL - VENTIL MIT AUTOM. WASSERSTAND  
 VALVULAS CON AUTONIVEL

# 91 Ambassador SE

vsezip.ru

+7(812)987-08-81

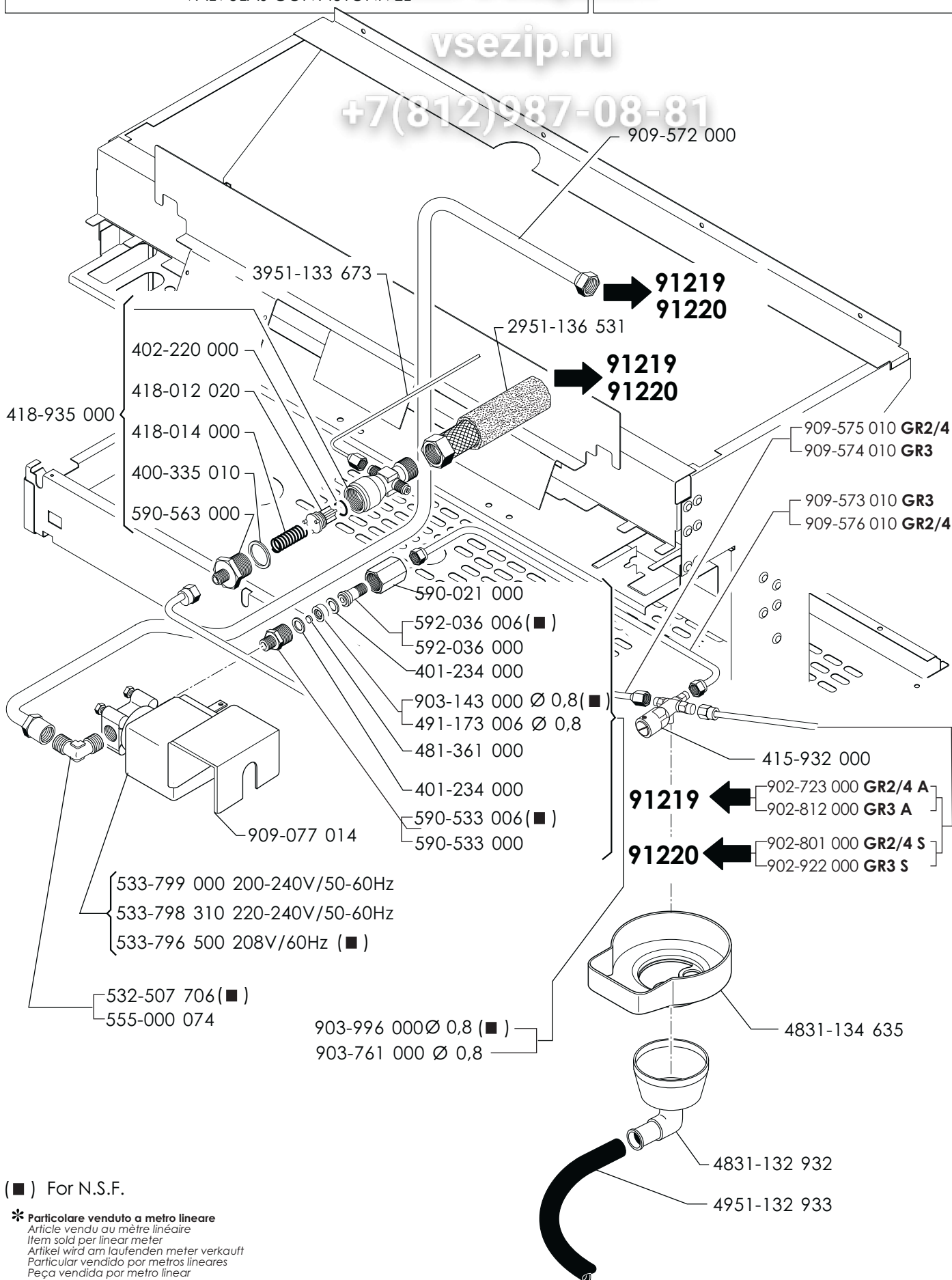

(■) For N.S.F.

\* **Particolare venduto a metro lineare**  
 Article vendu au mètre linéaire  
 Item sold per linear meter  
 Artikel wird am laufenden meter verkauft  
 Particular vendido por metros lineares  
 Peça vendida por metro linear

Valido dalla matricola n.°   
 Valable à partir du matricule n.°   
 Valid from No. - Gültig ab der Abkenn.-Nr. - Valido a partir de la matricula n.°

\* **Particolare nuovo o modificato - Pièce nouvelle ou modifiée - New or modified part**  
 Neues oder geändertes teil - Particular nuevo o modificado

03-07

Edizione del  
 Edition du  
 Edition of  
 Ausgabe vom  
 Edición del

91222

TAB.