

С О М Б И Т Н Е Р М®
G A S

Зип Общепит

vsezip.ru

+7(812)987-08-81

TECHNICAL SERVICE MANUAL



ALTO-SHAAM®

How to Use this Technical Service Manual

This manual has been compiled as a complete resource for a technician working on Combitherm Gas models. It includes necessary product information and drawings, along with helpful troubleshooting procedures.

Introduction gives a quick overview of the Combitherm Gas line to aid in model identification.

Sections 1 through 5 contain information applying to Combitherm Gas models:

- **CONTROL PANEL IDENTIFICATION** includes information on using the controllers and operating instructions. It is the same material supplied to the customer.
- **PREVENTIVE MAINTENANCE** includes procedures for cleaning. This information is also supplied to the customer.
- **SERVICE MODE AND ERROR CODES** explains the special programming available to you as a technician to view status, make adjustments and test functions on models equipped with Standard and Deluxe Controllers. Information is also included on the use of displayed error codes to resolve problems and on the functions that can be operated under fault conditions.
- **TROUBLESHOOTING TREES** are provided for the most common conditions you will be required to address.
- **COMBITHERM PARTS** has drawings and lists of available parts that apply to the electric models.

Section 6 contains Wiring Diagrams that are specific to each model.

Printing

From this CD, you may print the Current Page or any range of pages. If you would like to print out a complete manual for a specific model, print pages 1 – 102 (Sections 1 – 5) along with the pages in that model's section (7.14 ESG, for example). Here's a tip: Because printers vary in their capacity to handle large drawings, make a test print of one of the Wiring Diagrams before printing the model's section.

How to Use this Technical Service Manual.....	2
Introduction	4
1 — Control Panel Identification.....	5
2 — Preventive Maintenance.....	49
3 — Service Mode and Error Codes.....	63
4 — Troubleshooting Trees.....	68
5 — Combitherm Parts.....	78
6 — Wiring Diagrams.....	115

INTRODUCTION

MODEL NUMBERS

This manual covers the following gas models:

Boiler-Free Models
6.10ESG
10.10ESG
7.14ESG
12.18ESG
10.20ESG
20.20ESG

vsezip.ru

+7(812)987-08-81

CONTROLLERS

- Standard is a touch key controller.
- Deluxe is a touch key controller with programmable Rapid-Touch™ keys.
- S-Control is rotary dial controller.

FEATURES AND OPTIONS

- Recessed Door is available on all models.
- Smoker Mode is available on boiler-free gas models.
- Core Temp Probe (single point) is optional on S-control models.

MODES

The Combitherm combination oven/steamer is a multipurpose oven used for:



STEAM MODE



COMBINATION MODE



CONVECTION MODE



RETHERM MODE



CORE TEMPERATURE MODE

CONTROL PANEL IDENTIFICATION







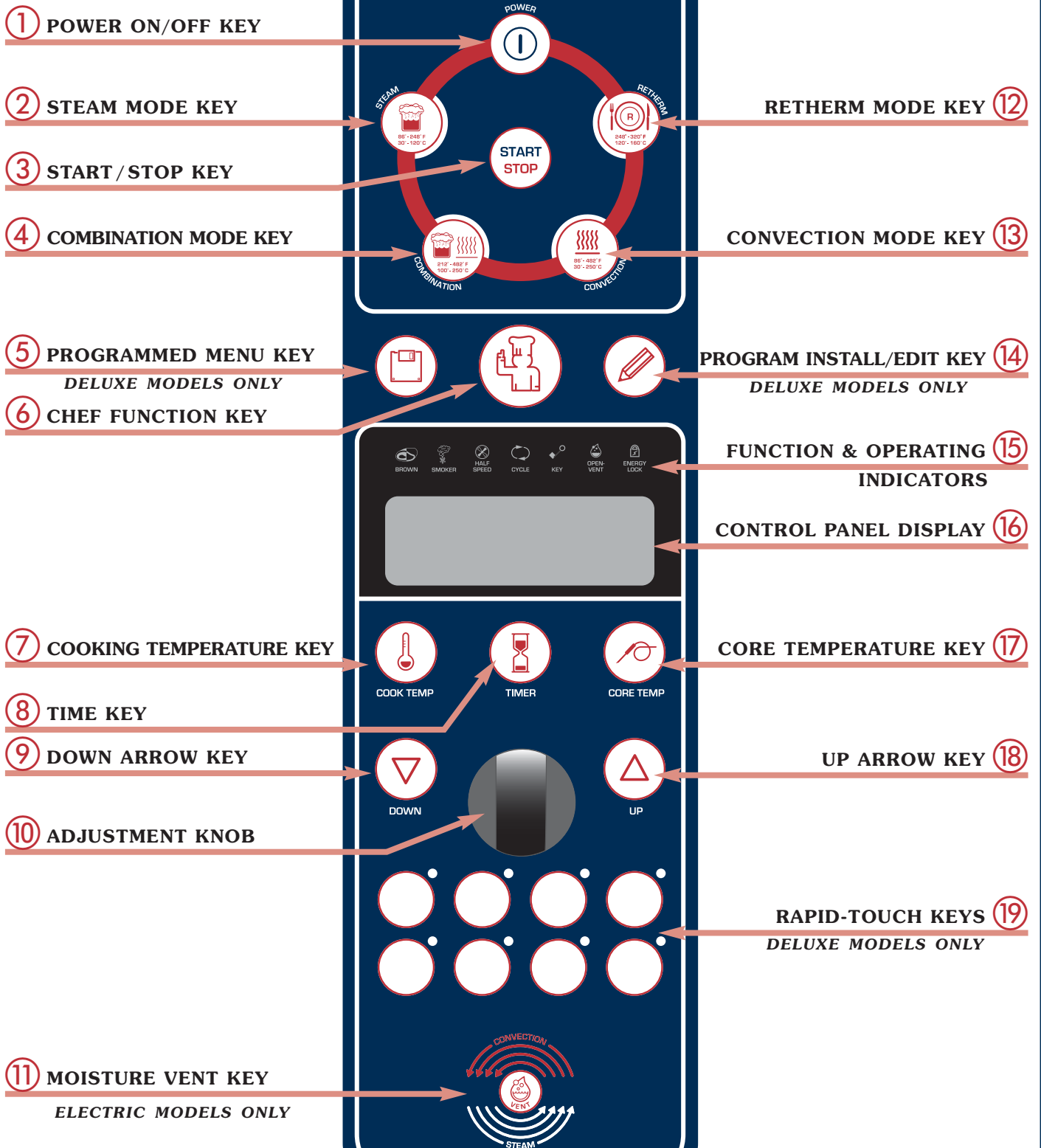







Standard and Deluxe Control.....	6
S-Control	45
Return to Main Table of Contents	3

CONTROL PANEL IDENTIFICATION STANDARD AND PROGRAMMABLE DELUXE MODELS

vsezip.ru
ALTO-SHAAM
 COMBITHERM®
 +7(812)987-08-81



STANDARD & DELUXE CONTROL PANEL BASIC FUNCTION

- 1 POWER ON/OFF KEY**
 Activates power to the oven.
- 2 STEAM MODE KEY**
 The oven will operate in the steam mode at a temperature range of 86°F to 248°F (30°C to 120°C).
 - Automatic steaming at 212°F (100°C) **FACTORY-SET DEFAULT.**
 - Quick steaming between 213°F and 248°F (101°C and 120°C).
 - Low Temperature Steaming between 86°F and 211°F (30°C and 99°C).
- 3 START/STOP KEY**
 Initiates all cooking mode functions and programmed procedures stored in memory. Stops an activated cooking mode or programmed procedure currently in progress, and exits the Chef function key **6**.
- 4 COMBINATION MODE KEY**
 Selection key for cooking with a combination of steam and convection heat that can be set within a temperature range of 212°F to 482°F (100°C to 250°C).
- 5 PROGRAMMED MENU KEY**
 Used to access and exit a menu list of all stored cooking programs that can be reviewed in display **16**. **DELUXE MODELS ONLY**
- 6 CHEF FUNCTION KEY**
 Used to select programmed menu functions, various auxiliary functions, and several chef help instructions.
- 7 COOKING TEMPERATURE KEY**
 Used to set the required cooking temperature, to recall the set cooking temperature, or to check the actual oven temperature in conjunction with the down arrow key **9**, the up arrow key **18** or the adjustment knob **10**.
- 8 TIME KEY**
 Used to set the required cooking time or recall the set cooking time in conjunction with the down arrow key **9**, the up arrow key **18**, or the adjustment knob **10**.
- 9 DOWN ARROW KEY**
 Used to decrease displayed cook temperature **7**, time **8**, or core temperature **17** and as a scrolling key for programming functions.
- 10 ADJUSTMENT KNOB**
 Displays oven functions. Serves the same function as the up and down arrow keys to increase or decrease the displayed cook temperature **7**, time **8**, or core temperature **17**.
- 11 MOISTURE VENT KEY**
 Immediately vents steam and condensate from the oven compartment while cooking in the Convection mode **13** or in the Combination mode **4**.
- 12 RETHERM MODE KEY**
 Food rethermalization or reheating mode will operate with automatic steam injection at a temperature range of 248°F to 320°F (120°C to 160°C).
- 13 CONVECTION MODE KEY**
 Selection key for convection cooking without steam at a temperature range of 86°F to 482°F (30°C to 250°C).
- 14 PROGRAM INSTALL AND EDIT KEY**
 Used to create, change, duplicate, and delete programmed menus. **DELUXE MODELS ONLY.**
- 16CONTROL PANEL DISPLAY**
- 17 CORE TEMPERATURE KEY**
 Used to set the required internal product temperature, to recall the internal product temperature set by the operator, or to display the current internal temperature of the product in conjunction with the down arrow key **9**, the up arrow key **18**, or the adjustment knob **10**.
- 18 UP ARROW KEY**
 Used to increase displayed cook temperature **7**, time **8**, or core temperature **17** and as a scrolling key for programming functions.
- 19RAPID-TOUCH KEYS DELUXE MODELS ONLY.**
One-touch cooking for immediate access to frequently used operator set programs including cooking modes, cleaning, and other oven functions.

CONTINUED

STANDARD & DELUXE CONTROL PANEL BASIC FUNCTIONS

Зип Общепит

15 FUNCTION & OPERATING INDICATORS

vsezip.ru

+7(812)987-08-81



A. GOLD-N-BROWN FEATURE

This indicator will illuminate when the browning function is set by the operator in a timed or programmed cooking cycle in either convection mode or combination mode.



B. COMBI SMOKER (ON EQUIPPED MODELS)

This indicator will illuminate when the smoking function is set by the operator in a timer, probe or programmed cooking cycle in either convection mode or combination mode.



C. REDUCED FAN SPEED

This indicator will illuminate whenever the operator sets a reduced fan speed to protect products affected by high-velocity air movement.

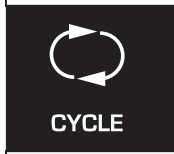

D. CONFIRMATION OF OVEN OPERATION

This indicator illuminates whenever the oven is operating in any mode.



E. KEY LOCK

This indicator will illuminate when operator has locked any mode key or function to prevent unauthorized or accidental changes.



F. MOISTURE VENT

This indicator will illuminate whenever the Moisture Vent Key  is pressed by the operator to eliminate excessive moisture.



G. ENERGY LOCK

FOR USE WITH OVENS INSTALLED UNDER AN ALTO-SHAAM VENTLESS HOOD.

This indicator is a safety feature that will illuminate and prevent the oven from being operated unless the ventless oven hood is operating.

SET-UP PROCEDURES

Зип Общепит

SET UP MENU

Following installation, the control should be set with the date and time. In addition to the date and time, the set-up function provides the operator with the ability to adjust a number of other Combitherm operating conditions to conform with the needs of the individual installation.

+7(812)987-08-81

① PRESS THE ON/OFF POWER KEY TO THE ON POSITION.

② PRESS THE CHEF FUNCTION KEY.

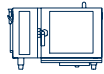

Rotate the adjustment knob until the set up symbol is highlighted within the display.

③ PRESS THE CHEF FUNCTION KEY.

Press the up Δ and down ∇ arrow keys or rotate the adjustment knob to select "YES" for the set up function.

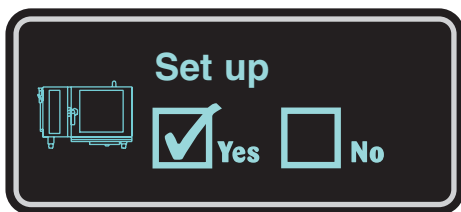

④ PRESS THE CHEF FUNCTION KEY TO CONFIRM THE SET UP FUNCTION.

Press the up Δ and down ∇ arrow keys or rotate the adjustment knob to highlight one of the following adjustment functions:

SET UP ADJUSTMENT CHOICES



SIGNAL TONE



VOLUME



TIME



DATE



PROGRAM INDEX



DEFAULT/MEMO SETTINGS



TEMPERATURE DISPLAY



NETWORK ADDRESS



LANGUAGE

SIGNAL TONE



Rotate the adjustment knob until the signal tone symbol  is highlighted within the display.

⑤ PRESS THE CHEF FUNCTION KEY TO CONFIRM THE SIGNAL TONE SELECTION.





Press the up Δ and down ∇ arrow keys or rotate the adjustment knob to select each tone offered. Stop rotation at each individual setting to hear an audio playback. Select the tone desired.

⑥ PRESS THE CHEF FUNCTION KEY TO CONFIRM THE SELECTED SIGNAL TONE SETTING.



SET-UP PROCEDURES

ALWAYS BEGIN SET UP ADJUSTMENTS FROM THE SET UP MENU .

VOLUME



 Rotate the adjustment knob until the volume symbol  is highlighted within the display.

 PRESS THE CHEF FUNCTION KEY TO CONFIRM THE VOLUME SELECTION.



 Press the up  and down  arrow keys or rotate the adjustment knob to select each volume level offered. Stop rotation at each individual setting to hear an audio playback. Select the volume desired with consideration of the noise level within the kitchen during peak production periods.

 PRESS THE CHEF FUNCTION KEY TO CONFIRM THE VOLUME SETTING.

TIME



 Rotate the adjustment knob until the time symbol  is highlighted within the display.

 PRESS THE CHEF FUNCTION KEY TO CONFIRM THE TIME SELECTION.

 Press the up  and down  arrow keys to alternate between hours and minutes and rotate the adjustment knob in each to adjust the numbers to the correct time.



 PRESS THE CHEF FUNCTION KEY TO CONFIRM THE SET TIME.

DATE

 Rotate the adjustment knob until the date symbol  is highlighted within the display.



 PRESS THE CHEF FUNCTION KEY TO CONFIRM THE DATE SELECTION.

Rotate the adjustment knob to select the preferred date format.



 Press the up  and down  arrow keys to alternate between day, month and year, and rotate the adjustment knob in each to adjust the numbers to the correct settings.

 PRESS THE CHEF FUNCTION KEY TO CONFIRM THE SET DATE.

PROGRAM INDEX

 Rotate the adjustment knob until the program index symbol  is highlighted within the display.

 PRESS THE CHEF FUNCTION KEY TO CONFIRM THE PROGRAM INDEX SELECTION.

Press the up  and down  arrow keys or rotate the adjustment knob to select the preferred index format:

 **“YES”** for a listing of programs entered alphabetically with the program install/edit key.

“NO” for a listing of programs entered numerically with the program install/edit key.

 PRESS THE CHEF FUNCTION KEY TO CONFIRM THE PROGRAM INDEX SETTING.

SET-UP PROCEDURES

ALWAYS BEGIN SET UP ADJUSTMENTS FROM THE SET UP MENU .

DEFAULT/MEMO SETTING

The default/memo setting allows the operator to choose between a display showing the factory set defaults for time and temperature or the last operator set values for time and temperature in each cooking mode. This adjustment function also allows the operator to change the defaults from those set at the factory to settings that better meet the needs of the individual operation.

Cooking product with operator set defaults for time and temperature can help reduce operator error. Cooking with the oven in the memo setting is particularly useful when several batches are cooked in succession. The memo setting eliminates the necessity to set time and temperature for each batch.

 Rotate the adjustment knob until the default/memo symbol  is highlighted within the display.

 PRESS THE CHEF FUNCTION KEY TO CONFIRM THE DEFAULT/MEMO SELECTION.

 Rotate the adjustment knob to “NO” for memo. This setting will display the last operator set values for time and temperature in each cooking mode.









 PRESS THE CHEF FUNCTION KEY TO CONFIRM THE MEMO SETTING.

TO CHANGE THE DEFAULT SETTINGS

 Rotate the adjustment knob to select “YES”.

A numbered list of default descriptions will appear in the display. Rotate the adjustment knob until the setting to be changed is highlighted. Press the up Δ arrow key to highlight the time or temperature to be changed. Rotate the adjustment knob to change the default to the setting desired. Press the down ∇ arrow key to save the new default setting.

 PRESS THE CHEF FUNCTION KEY TO CONFIRM THE NEW DEFAULT SETTINGS.

COMBITHERM FACTORY SET DEFAULT SETTINGS			
COOKING MODE	OVEN TEMPERATURE 	CORE TEMPERATURE 	COOKING TIME 
 STEAM MODE	212°F (100°C)	158°F (70°C)	25 MINUTES
 COMBINATION STEAM MODE	302°F (150°C)	158°F (70°C)	70 MINUTES
 CONVECTION MODE	338°F (170°C)	158°F (70°C)	30 MINUTES
 RETHERM MODE	275°F (135°C)	158°F (70°C)	5 MINUTES
 DELTA-T MODE	122°F (50°C)	172°F (77°C)	FREE
 PREHEAT MODE	374°F (140°C)	FREE	—

SET-UP PROCEDURES

ALWAYS BEGIN SET UP ADJUSTMENTS FROM THE SET UP MENU 

TEMPERATURE DISPLAY



 Rotate the adjustment knob until the temperature display symbol  is highlighted within the display.

 PRESS THE CHEF FUNCTION KEY TO CONFIRM THE TEMPERATURE DISPLAY SELECTION.

 Press the up Δ and down ∇ arrow keys or rotate the adjustment knob to select either Fahrenheit or Celsius.

 PRESS THE CHEF FUNCTION KEY TO CONFIRM THE TEMPERATURE DISPLAY SETTING.

NETWORK ADDRESS

 Press the up Δ and down ∇ arrow keys or rotate the adjustment knob until the network address symbol  is highlighted within the display.



 PRESS THE CHEF FUNCTION KEY TO CONFIRM THE NETWORK ADDRESS SELECTION.

The current network address will appear in the display.

 Rotate the adjustment knob to select 1 through 99 and assign a different network number for each PC to be connected.

 PRESS THE CHEF FUNCTION KEY TO CONFIRM EACH NETWORK ADDRESS.

LANGUAGE

 Press the up Δ and down ∇ arrow keys or rotate the adjustment knob until the language symbol  is highlighted within the display.

 PRESS THE CHEF FUNCTION KEY TO CONFIRM THE LANGUAGE PROGRAM SELECTION.

 Rotate the adjustment knob to select the required language.

CHINESE
DUTCH
ENGLISH*
FRENCH
GERMAN

ITALIAN
JAPANESE
KOREAN
POLISH
PORTUGUESE

RUSSIAN
SPANISH
SWEDISH

*U.S. FACTORY SETTING

NOTE: SOME OF THE LANGUAGE SELECTIONS SHOWN ABOVE MAY NOT BE AVAILABLE ON ALL MODELS.

 PRESS THE CHEF FUNCTION KEY TO CONFIRM THE LANGUAGE SETTING.

IMPORTANT SAFETY PRECAUTIONS

NOTE: Automatic steam venting is a standard safety feature built into all Combitherm oven models. This feature vents all steam from the oven compartment

IMMEDIATELY BEFORE COOKING TIME EXPIRES.

This function is provided in all programmed and timed production when operating in any Steam, Combination, Convection, and Retherm cooking mode. Automatic steam venting does not function if the oven door is opened before time expires or when the oven has been set to continuous operation.

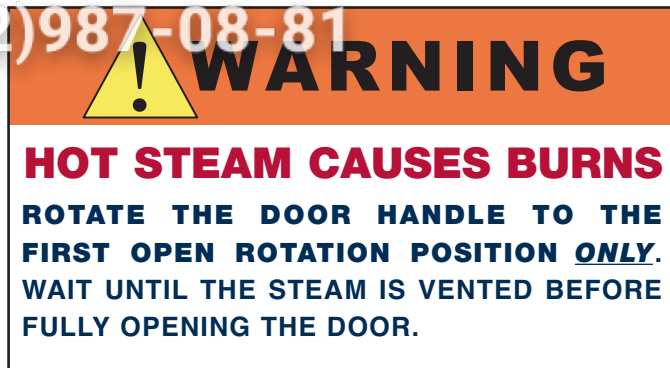

WARNING

HOT STEAM CAUSES BURNS

ROTATE THE DOOR HANDLE TO THE FIRST OPEN ROTATION POSITION **ONLY**. WAIT UNTIL THE STEAM IS VENTED BEFORE FULLY OPENING THE DOOR.



DANGER

AT NO TIME SHOULD THE INTERIOR OR EXTERIOR BE STEAM CLEANED, HOSED DOWN, OR FLOODED WITH WATER OR LIQUID SOLUTION OF ANY KIND. DO NOT USE WATER JET TO CLEAN.

SEVERE DAMAGE OR ELECTRICAL HAZARD COULD RESULT.

WARRANTY BECOMES VOID IF APPLIANCE IS FLOODED.

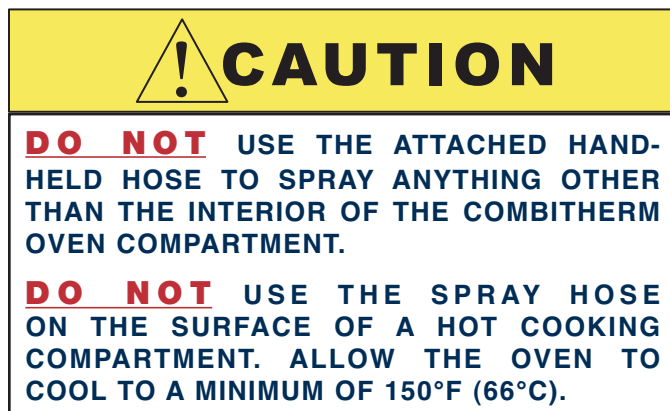

CAUTION

DO NOT USE THE ATTACHED HAND-HELD HOSE TO SPRAY ANYTHING OTHER THAN THE INTERIOR OF THE COMBITHERM OVEN COMPARTMENT.

DO NOT USE THE SPRAY HOSE ON THE SURFACE OF A HOT COOKING COMPARTMENT. ALLOW THE OVEN TO COOL TO A MINIMUM OF 150°F (66°C).



WARNING

DO NOT HANDLE PANS CONTAINING LIQUID OR SEMILIQUID PRODUCTS POSITIONED ABOVE THE EYE LEVEL OF THE OPERATOR. SUCH PRODUCTS CAN SCALD AND CAUSE SERIOUS INJURY.

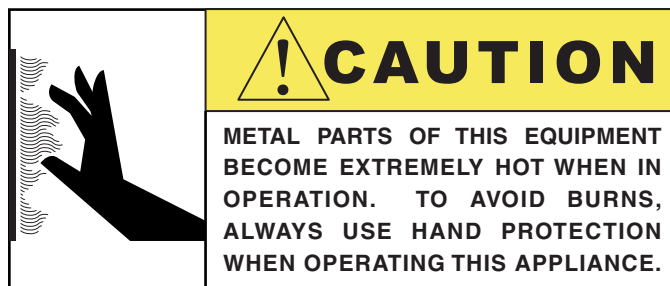

CAUTION

METAL PARTS OF THIS EQUIPMENT BECOME EXTREMELY HOT WHEN IN OPERATION. TO AVOID BURNS, ALWAYS USE HAND PROTECTION WHEN OPERATING THIS APPLIANCE.

NOTE: USE AUTHORIZED COMBITHERM OVEN CLEANER ONLY. UNAUTHORIZED CLEANING AGENTS MAY DISCOLOR OR HARM INTERIOR SURFACES OF THE OVEN. READ AND UNDERSTAND LABEL AND MATERIAL SAFETY DATA SHEET BEFORE USING THE OVEN CLEANER.

FOR OPERATOR SAFETY

NOTE AND OBSERVE ALL SAFETY PRECAUTIONS LOCATED THROUGHOUT THIS GUIDE.

STEAM MODE

STEAM ● LOW TEMPERATURE STEAM ● QUICK STEAM

The Steam mode provides the operator with the ability to steam, poach, or blanch. This mode will automatically steam at the boiling point of water, quick-steam above the boiling point for faster cooking results; or low temperature steam, below the boiling point, for more delicate products such as pâté, mousse, seafood, or custard.



 PRESS THE ON/OFF POWER KEY TO THE ON POSITION.

 PRESS THE STEAM MODE KEY.

Automatic Steam temperature of 212°F (100°C) will appear in the display.

The last set time or oven control default setting for time will appear in the display.

 **PRESS THE START KEY TO STEAM AT THE SETTINGS SHOWN.**

TO CHANGE THE SETTINGS SHOWN:

 PRESS THE TEMPERATURE KEY.

The cooking temperature will appear highlighted within the oven display.

 Press the up Δ and down ∇ arrow keys or rotate the adjustment knob to select the desired cooking temperature.

- Automatic Steaming 212°F (100°C)
- Quick-steaming 213°F to 248°F (101°C to 120°C)
- Low Temperature Steaming 86°F to 211°F (30°C to 99°C)

TO COOK BY TIME:

 PRESS THE TIME KEY.

The cooking time will appear highlighted within the oven display.

 Press the up Δ and down ∇ arrow keys or rotate the adjustment knob to select the time desired...

or

Set control for continuous operation by rotating the adjustment knob to the right until  appears in the display.





TO COOK BY INTERNAL PRODUCT TEMPERATURE:

 PRESS THE CORE TEMP KEY.

The previously set core temperature or oven control default setting will appear highlighted within the oven display.

 Press the up Δ and down ∇ arrow keys or rotate the adjustment knob to select the internal temperature desired and insert the product probe.

 **PRESS THE START KEY TO BEGIN COOKING IN THE STEAM MODE.**

- The set cooking temperature will appear in the display. To adjust the set temperature, press the  key once and make corrections as required. To display the actual oven temperature, press the  key twice.
- The remaining cooking time will appear in the display. To display the set time or to change the set values for time during operation, press the time key  once and make corrections as required.
- The actual internal product temperature will appear in the display. To display the set internal product temperature or to change the set values for core temperature during operation, press the  key once and make corrections as required.

When the cooking time has expired or the operator set internal temperature has been reached, a buzzer will sound indicating the end of the operating mode.

- To stop the buzzer, press the start/stop key  or open the oven door.

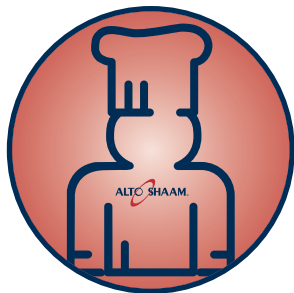

STEAM MODE

CHEF OPERATING TIPS

This mode will steam a full or partial load of a single product, or multiple products without transfer of flavors. When steaming multiple products, however, individual product cooking times must be taken into consideration. The non-pressurized atmosphere of the Combitherm also provides the ability to open the door during the steam mode in order to monitor products more closely throughout the steaming process.

STEAM

Perforated, 2-1/2" deep pans (65mm) are particularly suitable for use in this program mode. These pans will provide a shorter cooking time and will prevent product over-cooking at the bottom of the pan.

Separate ice-encased vegetables before steaming to assure more even cooking.

A variety of products can be steamed at the same time but attention must be paid to the different cooking times required for each food product.

Butter and season vegetables after steaming.

Steam long-grain rice using approximately 1-part rice to approximately 1-1/2-parts water or seasoned liquid.

Steam durum wheat noodles in unperforated pans using 1-part noodles to 5-parts cold water.

QUICK STEAMING

Quick steaming is suitable for hearty, root-type vegetables such as potatoes, legumes, and cabbage.

Quick steaming provides a cooking time which is approximately 10-percent shorter than the regular steam mode temperature of 212°F (100°C).

Set the steam cooking temperature between 221°F (105°C) and 230°F (110°C) for small loads and between 230°F (110°C) and 248°F (120°C) for full loads.

LOW TEMP STEAM

The low temperature steam mode will function whenever the oven compartment temperature is below 212°F (100°C).

Proof yeast dough at a temperature setting of 90°F to 110°F (32°C to 43°C).

It will take longer to steam products using the low temperature steam mode.

Steaming sausages in low temperature steam prevents cracked or peeling skins.

Use low temperature steam for delicate foods such as shrimp, fish, seafood, and crème caramel.

For best results, low temperature steam all delicate food items at a temperature of 210°F (99°C) or below.

COMBINATION MODE

The Combination mode will prove to be the most versatile and widely used mode the Combitherm oven has to offer. It will produce the best possible results on the widest variety of products — all within the shortest period of time. The unique control function of this mode enables the operator to roast or bake with a combination of steam and convection heat. In addition to shorter cooking times, this combination of steam and heat offers less product shrinkage and more moisture retention than obtained in a standard convection oven.





 PRESS THE ON/OFF POWER KEY TO THE ON POSITION.

 PRESS THE COMBINATION MODE KEY.
The last set values or oven control default setting for temperature will appear in the display.
The last set time or oven control default setting for time will appear in the display.

 **PRESS THE START KEY TO COOK AT THE SETTINGS SHOWN.**



TO CHANGE THE SETTINGS SHOWN:

 PRESS THE TEMPERATURE KEY.
The cooking temperature will appear highlighted within the oven display.

 Press the up Δ and down ∇ arrow keys or rotate the adjustment knob to select the desired cooking temperature.
• 212°F to 482°F (100°C to 250°C)

TO COOK BY TIME:

 PRESS THE TIME KEY.
The cooking time will appear highlighted within the oven display.





 Press the up Δ and down ∇ arrow keys or rotate the adjustment knob to select the time desired...
or
Set control for continuous operation by rotating the adjustment knob to the right until  appears in the display.

TO COOK BY INTERNAL PRODUCT TEMPERATURE:

 PRESS THE CORE TEMP KEY.
The core temperature will appear highlighted within the oven display.

 Press the up Δ and down ∇ arrow keys or rotate the adjustment knob to select the internal temperature desired and insert the product probe.

 **PRESS THE START KEY TO BEGIN COOKING IN THE COMBINATION MODE.**

- The set cooking temperature will appear in the display. To adjust the set temperature, press the  key once and make corrections as required. To display the actual oven temperature, press the  key twice.
- The remaining cooking time will appear in the display. To display the set time or to change the set values for time during operation, press the time key  once and make corrections as required.
- The actual internal product temperature will appear in the display. To display the set internal product temperature or to change the set values for core temperature during operation, press the  key once and make corrections as required.

When the cooking time has expired or the operator set internal temperature has been reached, a buzzer will sound indicating the end of the operating mode.

- To stop the buzzer, press the start/stop key  or open the oven door.

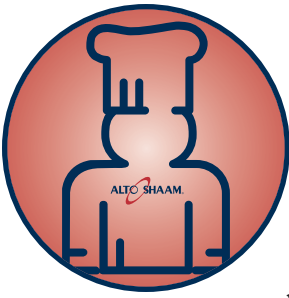

COMBINATION MODE CHEF OPERATING TIPS

The Combination mode injects the optimum amount of steam automatically. There is no need to select moisture levels. Foods do not dry out. Flavors are retained with no transfer of flavors when mixing product loads.

Due to the automatic steam adjustment, the door can be opened at any time during a cooking operation. Be certain to observe the safety warning when opening the oven door.

The Combination mode is particularly efficient when used for baking, broiling, grilling, stewing, braising, and roasting.

When using the Combination mode, cooking temperatures can be reduced 10- to 20-percent below the temperatures used for conventional cooking methods.

Cooking time will be reduced approximately 40-percent when cooking at the same temperature used for convection oven cooking and up to 50- to 60-percent less time when cooking at the same temperature used for a conventional oven.

Food browning in the Combitherm begins at a cooking temperature of approximately 248°F (120°C).

A higher cooking temperature results in heavier browning but also results in greater product weight loss. To achieve additional browning use the Moisture Vent Key or set Gold-n-Brown into the product procedure. Gold-n-Brown is particularly useful for adding color to high moisture products such as chicken and other poultry items or for additional browning of full loads and other moist products.

The Combination mode provides even browning without the necessity to turn the pans.

For more even cooking, do not cook in pans deeper than 4-inches (100mm).

CONVECTION MODE

The Convection mode operates with hot circulated air within a temperature range of 86° to 482°F (30° to 250°C). For many applications, better results may be achieved with the Combination mode; therefore, the operator may want to consider using the Convection mode on a more limited basis.

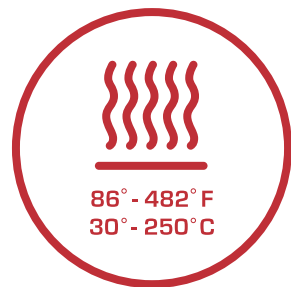



 PRESS THE ON/OFF POWER KEY TO THE ON POSITION.

 PRESS THE CONVECTION MODE KEY.
The last set values or oven control default setting for temperature will appear in the display.
The last set time or oven control default setting for time will appear in the display.

 **PRESS THE START KEY TO COOK AT THE SETTINGS SHOWN.**

TO CHANGE THE SETTINGS SHOWN:

 PRESS THE TEMPERATURE KEY.
The cooking temperature will appear highlighted within the oven display.

 Press the up Δ and down ∇ arrow keys or rotate the adjustment knob to select the desired cooking temperature.
• 86° to 482°F (30° to 250°C)

TO COOK BY TIME:

 PRESS THE TIME KEY.
The cooking time will appear highlighted within the oven display.

 Press the up Δ and down ∇ arrow keys or rotate the adjustment knob to select the time desired...

or





Set control for continuous operation by rotating the adjustment knob to the right until  appears in the display.

TO COOK BY INTERNAL PRODUCT TEMPERATURE:

 PRESS THE CORE TEMP KEY.
The core temperature will appear highlighted within the oven display.

 Press the up Δ and down ∇ arrow keys or rotate the adjustment knob to select the internal temperature desired and insert the product probe.

 **PRESS THE START KEY TO BEGIN THE COOKING MODE.**

- The set cooking temperature will appear in the display. To adjust the set temperature, press the  key once and make corrections as required. To display the actual oven temperature, press the  key twice.
- The remaining cooking time will appear in the display. To display the set time or to change the set values for time during operation, press the time key  once and make corrections as required.
- The actual internal product temperature will appear in the display. To display the set internal product temperature or to change the set values for core temperature during operation, press the  key once and make corrections as required.

When the cooking time has expired or the operator set internal temperature has been reached, a buzzer will sound indicating the end of the operating mode.

- To stop the buzzer, press the start/stop key  or open the oven door.

To check the length of time the product has been operating in the core temperature mode, press and hold the time key  along with the core temperature key . The time period will appear at the top of the display.

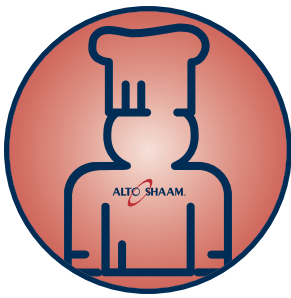

CONVECTION MODE CHEF OPERATING TIPS

The Convection Mode can be used to roast or bake products needing very short cooking times or for high moisture products such as muffins, cakes, and cookies, or for browning the surface of the product.

The Convection mode works best with foods containing little moisture or for very moist food which require a dryer finished product.

For baking, preheat the Combitherm at a temperature of 36°F to 54°F (20°C to 30°C) above the baking temperature required. Once preheated, reset the temperature as required.

A higher cooking temperature results in heavier browning but also results in greater product weight loss. To achieve additional browning use the Moisture Vent Key or set the Browning Feature into the product procedure.

To prevent the surface of food from excessive drying, the fan will not engage if the internal oven temperature is above 212°F (100°C) and the set oven temperature is below 212°F (100°C).

RE THERM MODE

The Retherm mode can be used to rethermize (regenerate) portioned food on plates, trays, or platters within a short period of time. Steam is automatically injected into the oven compartment as required. Items are brought up to proper serving temperatures without dry edges or condensate forming on the plates.

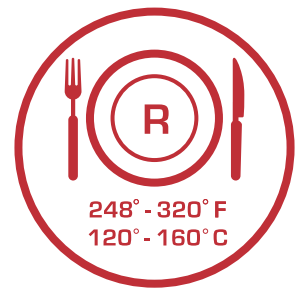



 PRESS THE ON/OFF POWER KEY TO THE ON POSITION.

 PRESS THE RETHERM MODE KEY.
The last set values or the default settings will appear in the display.

 **PRESS THE START KEY TO COOK AT THE SETTINGS SHOWN.**



TO CHANGE THE SETTINGS SHOWN:

 PRESS THE TEMPERATURE KEY.
The cooking temperature will appear highlighted within the oven display.

 Press the up Δ and down ∇ arrow keys or rotate the adjustment knob to select the desired cooking temperature.
• 248° to 320°F (120° to 180°C)

TO COOK BY TIME:

 PRESS THE TIME KEY.
The cooking time will appear highlighted within the oven display.





 Press the up Δ and down ∇ arrow keys or rotate the adjustment knob to select the time desired...
or
Set control for continuous operation by rotating the adjustment knob to the right until  appears in the display.

TO COOK BY INTERNAL PRODUCT TEMPERATURE:

 PRESS THE CORE TEMP KEY.
The core temperature will appear highlighted within the oven display.

 Press the up Δ and down ∇ arrow keys or rotate the adjustment knob to select the internal temperature desired and insert the product probe.

 **PRESS THE START KEY TO BEGIN THE RETHERM MODE.**

- The set cooking temperature will appear in the display. To adjust the set temperature, press the  key once and make corrections as required. To display the actual oven temperature, press the  key twice.
- The remaining cooking time will appear in the display. To display the set time or to change the set values for time during operation, press the time key  once and make corrections as required.
- The actual internal product temperature will appear in the display. To display the set internal product temperature or to change the set values for core temperature during operation, press the  key once and make corrections as required.

When the cooking time has expired or the operator set internal temperature has been reached, a buzzer will sound indicating the end of the operating mode.

- To stop the buzzer, press the start/stop key  or open the oven door.

To check the length of time the product has been operating in the core temperature mode, press and hold the time key  along with the core temperature key . The time period will appear at the top of the display.



RE THERM MODE CHEF OPERATING TIPS

Since plated meals consist of dissimilar products, there are several important factors to consider in order to produce the finest results. Product density (compactness), thickness, quantity of product on each plate, and quantity of plates all relate to the length of time necessary to reheat. Again, experience is the best method to determine reheating time. Once the time has been determined and recorded for a specific meal, the results will be consistent for future reheating times.

HELPFUL HINTS FOR REHEATING ON THE PLATE

- ALL FOOD COMPONENTS ON THE PLATE SHOULD BE OF SIMILAR DENSITIES.
- ALL FOOD COMPONENTS ON THE PLATE SHOULD BE SIMILAR IN THICKNESS.
- ARRANGE ALL FOOD COMPONENTS EVENLY ON THE PLATE.
- AVOID EXCESSIVE OVERLAPPING OF PRODUCT.
- SAUCES MUST BE HEATED AND ADDED TO PRODUCT AFTER REHEATING.
- A MIXED VARIETY OF MEALS CAN BE REHEATED AT THE SAME TIME.

• À LA CARTE RETHERMALIZATION

À la carte rethermalization is designed to take a single plate from a refrigerated temperature to serving temperature for immediate service. Plates are prepared in advance, covered, and refrigerated. Preheat the Combitherm oven. Remove plate from refrigeration and place in the oven at 275°F (135°C) for an uncovered plate or 300°F (150°C) for a covered plate. Plates with meat components will take more time than plates containing all vegetable components. Follow internal temperature requirements for reheating and allow for override time. After reheating, remove the plate from the oven, add any sauces, garnish, and serve. This process can be repeated as required.

For the most efficient continuous service, it is suggested that the Combitherm oven be dedicated to the rethermalization process during serving hours.

• BANQUET RETHERMALIZATION

Banquet rethermalization is designed for high volume, full or partial load (multiple plate) reheating. For maximum efficiency, it is essential that volume rethermalization be used in conjunction with the utilization of holding cabinets to keep rethermalized food at proper temperatures.

Plates are assembled in advance, covered, and refrigerated or loaded on the roll-in cart and refrigerated. Preheat the Combitherm oven at 275°F (135°C) for uncovered plates or 300°F (150°C) for covered plates. Remove plates or the roll-in cart from refrigeration, load in the oven and set timer as

required. Follow internal temperature requirements for reheating and allow for override time. Remove the plates or roll-in cart from the Combitherm and roll into the companion holding cabinet. Relocate the holding cabinet to the banquet service area.

• RETHERMALIZING PREFABRICATED AND VACUUM-PACKED FROZEN FOODS

For bulk product rethermalization, completely defrost product bags in walk-in cooler. DO NOT REMOVE PRODUCT FROM THE BAG. Load thawed bags in preheated oven and rethermalize in the Low Temperature Steam mode until the required internal temperature is reached. Place rethermalized bags in a preheated holding cabinet set at 140° to 165°F (60° to 74°C) until ready for service.

For large volume on-the-plate regeneration, defrost bags in walk-in cooler. Open bags and plate per menu requirements in a (MAXIMUM) 55°F (13°C) refrigerated room. Cover plates, place on Alto-Shaam roll-in cart (trolley), and roll into Combitherm oven preheated at 275°F (135°C).

Regenerate in the Convection mode for 3 to 5 minutes. Switch to the Retherm mode for an additional 3 minutes or more if required. Transfer full trolley to a preheated holding cabinet set at 160°F (71°C) until ready for service. In the case of meat cooked to rare, set the cabinet at 140°F (60°C).

PLATE COVERS MUST BE USED FOR ON-THE-PLATE REGENERATION.

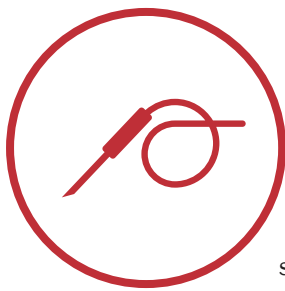

CORE TEMPERATURE PROBE MODE

Зип Общепит

vsezip.ru

+7(812)987-08-81

As an alternative to timer operation, the Core Temperature Probe mode can be used in conjunction with any program mode to cook by sensing internal product temperature. For a more accurate internal temperature, a specialized Combitherm product probe senses temperature from four strategic points and displays a temperature average.

 PRESS THE ON/OFF POWER KEY TO THE ON POSITION.

 INSERT THE PRODUCT PROBE.

The probe must be inserted so that the tip is positioned in the center of the food mass. For liquid or semiliquid foods, suspend the probe in the center of the product and secure the probe wire to the container edge.

 SELECT AND PRESS THE REQUIRED COOKING PROGRAM.

 PRESS THE TEMPERATURE KEY.

The cooking temperature will appear highlighted within the oven display.

 Press the up Δ and down ∇ arrow keys or rotate the adjustment knob to select the desired cooking temperature within the temperature range of the cooking mode selected.

 PRESS THE CORE TEMP KEY.

The core temperature will appear highlighted within the oven display.



 Press the up Δ and down ∇ arrow keys or rotate the adjustment knob to select the internal product cutoff temperature.

 PRESS THE START KEY TO BEGIN THE COOKING MODE.

- The actual internal product temperature will appear in the display. To display the set internal product temperature or to change the set values for core temperature during operation, press the  key once and make corrections as required.

When the operator set internal temperature has been reached, a buzzer will sound indicating the end of the operating mode.

- To stop the buzzer, press the start/stop key  or open the oven door.

To check the length of time the product has been operating in the core temperature mode, press and hold the time key  along with the core temperature key . The time period will appear at the top of the display.

CHEF OPERATING TIPS

To prevent over-cooking, remove product from the oven as soon as the required internal temperature is reached in either the Core Temperature mode or the Core Temperature Delta-T mode. The Core Temperature mode should not be used for cooking thin product items.

DO NOT USE THE PROBE WHEN COOKING THIN PRODUCTS.

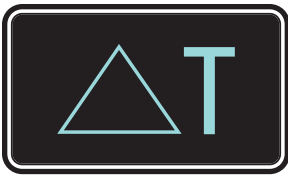

DELTA-T CORE TEMPERATURE COOKING

This special program function cooks by internal product temperature with the use of the probe. Unlike the standard core temperature mode, however, the Delta-T oven temperature automatically increases in direct proportion to the internal temperature of the product. The Delta-T mode cooks with convection heat but provides a more gentle method of cooking. Browning occurs toward the end of the cooking cycle.

① PRESS THE ON/OFF POWER KEY TO THE ON POSITION.

② PRESS THE CHEF FUNCTION KEY.

Press the up Δ and down ∇ arrow keys or rotate the adjustment knob until the Delta-T ΔT symbol is highlighted in the display.

③ PRESS THE CHEF FUNCTION KEY.

Press the up Δ and down ∇ arrow keys or rotate the adjustment knob to select "YES" for the Delta-T function.

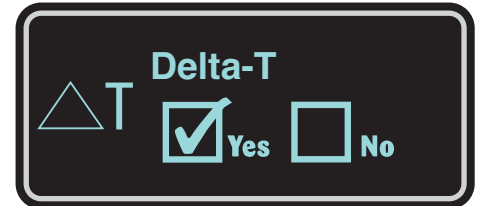

④ PRESS THE CHEF FUNCTION KEY TO CONFIRM THE SETTING.

⑤ PRESS THE TEMPERATURE KEY.

Press the up Δ and down ∇ arrow keys or rotate the adjustment knob to select the desired Delta-T cooking temperature within the cooking temperature ranges shown below.

⑥ PRESS THE CORE TEMP KEY.

Press the up Δ and down ∇ arrow keys or rotate the adjustment knob to select the internal product cutoff temperature within the temperature ranges shown below.

PRODUCT	ΔT DELTA-T TEMPERATURE ΔT	CORE TEMPERATURE SETTING
BEEF ROAST	122°F to 131°F (50°C to 55°C)	118°F to 136°F (48°C to 58°C)
TENDERLOIN	122°F to 140°F (50°C to 60°C)	122°F to 140°F (50°C to 60°C)
VEAL & LAMB	122°F to 158°F (50°C to 70°C)	172°F (78°C)
PORK ROAST	122°F to 158°F (50°C to 70°C)	172°F (78°C)
HAM	122°F to 140°F (50°C to 60°C)	172°F (78°C)

THE OVEN WILL BEGIN THE DELTA-T CONVECTION COOKING MODE.

The set Delta-T temperature will appear in the display.
The actual internal product temperature will appear in the display.

When the operator set internal temperature has been reached, a buzzer will sound indicating the end of the operating mode.

- To stop the buzzer, press the start/stop key  or open the oven door.

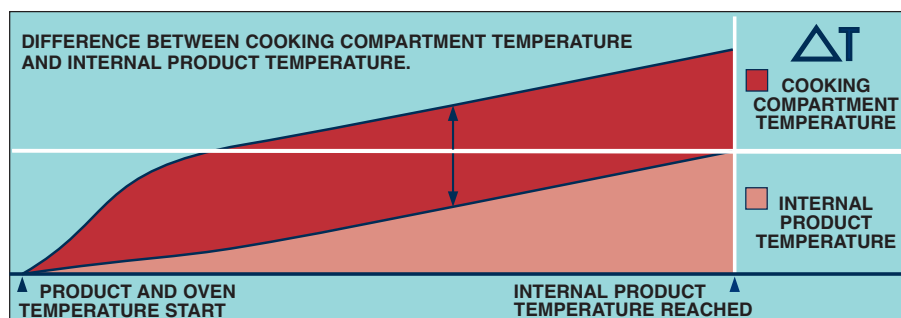

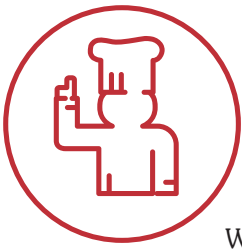

AUXILIARY FUNCTIONS

CHEF FUNCTION KEY



There are several auxiliary functions available through the use of the Chef Function Key.



With the exception of the ability to add additional moisture to the oven compartment, that can only be used during the convection mode, all additional functions can be engaged at any time during any cooking mode. Chef Functions can also be programmed into a cooking procedure in oven models that include the deluxe programmable feature. At the end of a cooking mode or program, the oven automatically disengages all operator-set chef functions. These functions, however, do remain programmed and will reengage the next time the programmed procedure is used.

PREHEATING

THE PREHEATING FUNCTION IS ENGAGED IN THE CONVECTION  MODE AT A FIXED TEMPERATURE AND TIME. BOTH THE TEMPERATURE AND TIME CAN BE ADJUSTED BY THE OPERATOR TO COMPLY WITH THE REQUIREMENTS OF THE INDIVIDUAL OPERATION.

SEE START UP PROCEDURES UNDER DEFAULT/MEMO SETTING 

 PRESS THE CHEF FUNCTION KEY.
Rotate the adjustment knob until the preheat symbol  is highlighted in the display.

 PRESS THE CHEF FUNCTION KEY.
Press the up  and down  arrow keys or rotate the adjustment knob to select "YES" for the Preheat function.

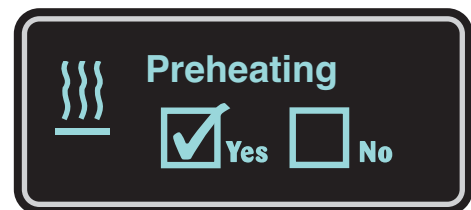

 PRESS THE CHEF FUNCTION KEY TO CONFIRM THE SETTING.

 **THE OVEN WILL BEGIN THE PREHEAT FUNCTION.**

- The set preheat temperature will appear in the display.
- The set preheat time will appear in the display.
- The preheat symbol  will appear in the display.

When the set time and temperature has been reached, a buzzer will sound indicating the end of the preheat function.

- To stop the buzzer, press the start/stop key  or open the oven door.

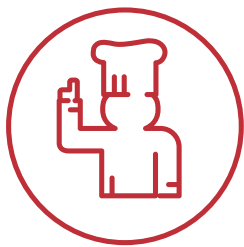

AUXILIARY FUNCTIONS

Зип Общепит

CHEF FUNCTION KEY

vsezip.ru

GOLD-N-BROWN

The browning feature is an automatic function designed to regulate humidity for additional color to products as needed. This feature is particularly useful for adding color to high moisture products such as chicken and other poultry items or for additional browning of full loads and other moist products. In addition, this feature may be used to add texture to fried items such as French fries or breaded chicken. Gold-n-Brown can be used in both the combination mode and the convection mode and can be programmed into a cooking procedure.

Browning can be used for any product with a set cooking time more than 5-minutes. Depending on the type of product and product load, the browning feature may also slightly increase the set cooking time in order to fully complete the browning function. This is a standard operating condition of this feature.



SELECT AND PRESS THE REQUIRED COOKING MODE AND SET MODE FUNCTIONS.





PRESS THE CHEF FUNCTION KEY.

Rotate the adjustment knob until the browning symbol  is highlighted within the display.



PRESS THE CHEF FUNCTION KEY.

Press the up  and down  arrow keys or rotate the adjustment knob to select "YES" for the browning function.



is highlighted within

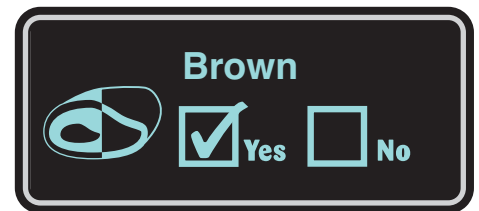

PRESS THE CHEF FUNCTION KEY TO CONFIRM THE SETTING.

The browning indicator light  will illuminate directly above the display.



PRESS THE START KEY.

The oven will engage the browning feature in the Combination or Convection mode set by the operator.



AUXILIARY FUNCTIONS

CHEF FUNCTION KEY

COOL-DOWN FEATURE

The cool-down feature provides the operator with the ability to lower the temperature of the oven compartment at an accelerated pace. This function is useful when it is necessary to immediately change from a high temperature cooking function to a lower temperature function or to the steam program. This function is also useful to help cool the oven compartment in preparation for cleaning.



CHEF OPERATING TIP

When using the cool-down feature in preparation for cleaning, it is important to remember the temperature in the display indicates the air temperature inside the oven compartment and not the interior walls of the oven. Always make certain to allow the oven walls to cool to a minimum of 140°F (60°C) before spraying the compartment with oven cleaner.





PRESS THE CHEF FUNCTION KEY.

Rotate the adjustment knob until the cool-down symbol  is highlighted in the display.



PRESS THE CHEF FUNCTION KEY.

Press the up  and down  arrow keys or rotate the adjustment knob to select “YES” for the cool-down function.

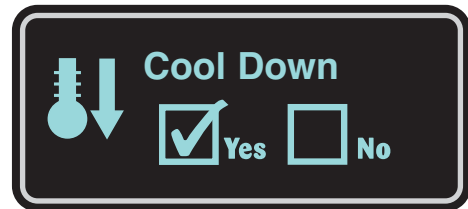

PRESS THE CHEF FUNCTION KEY TO CONFIRM THE SETTING.



OPEN THE OVEN DOOR.

The display will indicate the current temperature of the oven.



ROTATE THE ADJUSTMENT KNOB TO SELECT A COOL-DOWN TEMPERATURE WITHIN A RANGE OF 212°F TO 68°F (100°C TO 20°C). THE FACTORY SET DEFAULT IS 122°F (50°C).

The displayed temperature will continue to decline until it reaches the operator set temperature or factory default temperature if not selected by the operator.

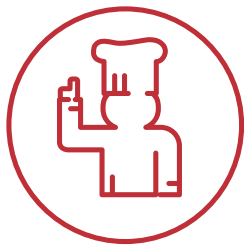

AUXILIARY FUNCTIONS

CHEF FUNCTION KEY

REDUCED FAN SPEED

The reduced fan speed function is useful for flow-sensitive products such as soufflés and meringues, or any products affected by a high velocity of air movement.



SELECT AND PRESS THE REQUIRED COOKING MODE AND SET MODE FUNCTIONS.



PRESS THE CHEF FUNCTION KEY.

Rotate the adjustment knob until the fan symbol  is highlighted in the display.



PRESS THE CHEF FUNCTION KEY.

Press the up Δ and down ∇ arrow keys or rotate the adjustment knob to select “YES” for the reduced fan speed function.



PRESS THE CHEF FUNCTION KEY TO CONFIRM THE SETTING.

The reduced fan speed indicator light  will illuminate directly above the display.

HALF SPEED



PRESS THE START KEY.

The oven will start at a reduced fan speed in whatever cooking mode set by the operator.

REDUCED POWER *ELECTRIC MODELS ONLY*

The reduced power function can be used to reduce kitchen power peaks and energy consumption.



SELECT AND PRESS THE REQUIRED COOKING MODE AND SET MODE FUNCTIONS.



PRESS THE CHEF FUNCTION KEY.

Rotate the adjustment knob until the reduced power symbol  is highlighted in the display.



PRESS THE CHEF FUNCTION KEY.

Press the up Δ and down ∇ arrow keys or rotate the adjustment knob to select “YES” for the reduced power function.

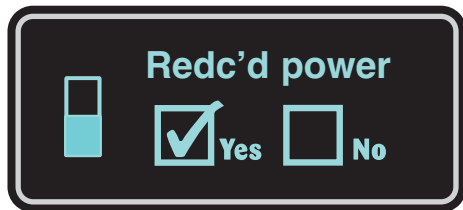

PRESS THE CHEF FUNCTION KEY TO CONFIRM THE SETTING.



PRESS THE START KEY.

The oven will operate with reduced power in whatever cooking mode set by the operator.

REDUCED POWER WILL RESULT IN LONGER COOKING TIMES.

AUXILIARY FUNCTIONS

CHEF FUNCTION KEY



KEY LOCK

Except as noted, all of the mode keys and functions available on the Combitherm can be locked to prevent unauthorized or accidental changes to the settings.

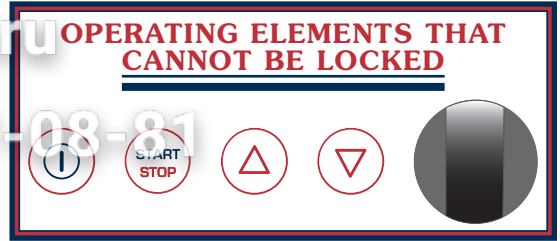



PRESS THE CHEF FUNCTION KEY.

Rotate the adjustment knob until the key symbol  is highlighted within the display.



PRESS THE CHEF FUNCTION KEY.

Press the up  and down  arrow keys or rotate the adjustment knob to select “YES” for the key lock function.

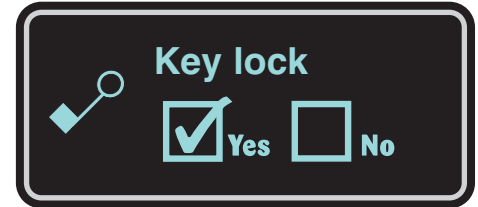

PRESS THE CHEF FUNCTION KEY TO CONFIRM THE SETTING.



The display will indicate PIN 000.



ROTATE THE ADJUSTMENT KNOB TO **PIN 000**.

⇒ PIN 000 is the factory set default to prevent an accidental lock or unlock of the control functions.



PRESS THE CHEF FUNCTION KEY.



THE DISPLAY WILL INDICATE “ALL KEYS UNLOCKED.”

SELECT AND PRESS THE FIRST CONTROL FUNCTION TO BE LOCKED.



The display will indicate “LOCK.”

If the wrong key has been selected and locked in error, press the same control key again and “UNLOCK” will appear in the display.

Continue in this manner until all desired control functions are locked.



PRESS THE START KEY TO CONFIRM THE LOCKING FUNCTION.



Whenever any control function has been locked, the key lock symbol will be illuminated within the display.

KEY

Whenever any locked control function is pressed, the key lock symbol will flash and an audible signal will sound.

KEY UNLOCK

FOLLOW THE SAME PROCEDURE AS ABOVE UNTIL THE DISPLAY INDICATES “**ALL KEYS UNLOCKED.**”

To unlock the Chef Function  key.



PRESS THE POWER KEY TO TURN THE OVEN OFF.



PRESS THE CHEF FUNCTION KEY



ROTATE THE ADJUSTMENT KNOB TO **PIN 000** TO DISENGAGE ALL LOCK FUNCTIONS.



PRESS THE CHEF FUNCTION KEY. **THE DISPLAY WILL INDICATE “ALL KEYS UNLOCKED.”**

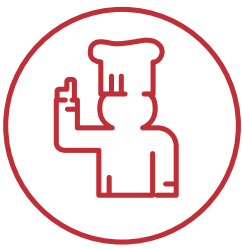

AUXILIARY FUNCTIONS

Вип Общепит

CHEF FUNCTION KEY

STEAM INJECTION

vsezip.ru

47(812)987-08-81

Additional steam can be added to the cooking compartment at any time when cooking in the convection mode.





PRESS THE CHEF FUNCTION KEY.

Rotate the adjustment knob until the steam injection symbol  is highlighted within the display.



PRESS THE CHEF FUNCTION KEY.

Press the up  and down  arrow keys or rotate the adjustment knob to select “YES” for the steam injection function.



PRESS THE CHEF FUNCTION KEY TO ACTIVATE THE STEAM INJECTION FUNCTION.

Additional steam is injected into the oven compartment for a time period of approximately 15 seconds.

NOTE: Steam injection cannot be programmed through the control keypad, but can be programmed through optional Kitchen Management software.



AUXILIARY FUNCTIONS

GENERAL SMOKER OPERATION

SMOKING FUNCTION

ON EQUIPPED MODELS

LOAD WOOD CHIPS.

- Measure one container full of dry wood chips.
- Soak dry chips in water for 5 minutes.
- Shake excess water off wood chips.
- Place moistened chips back into the container and position the container securely on the two prongs located on the interior back panel of the oven.



A full container of wood chips will produce smoke for an approximate period of one to two hours depending on the cooking temperature being used for the selected product. The tested procedures in this manual for many of the products that are appropriate for smoking provide complete product smoke penetration and full smoke flavor.

AVAILABLE FROM ALTO-SHAAM

WOOD CHIPS	20 POUND BULK PACKS	
THE TOTAL WEIGHT OF WOOD CHIP BULK PACKS MAY VARY DUE TO HIGH MOISTURE CONTENT WHEN PACKAGED.	APPLE	WC-22543
	HICKORY	WC-2829
	CHERRY	WC-22541
	SUGAR MAPLE	WC-22545



CHEF OPERATING TIP

Products such as ribs that require heavier smoke penetration to reach full smoke flavor should remain in the oven after cooking has been completed. Do not open the oven door. Set the oven in the Low Temperature Steam Mode at 140° to 160°F (60° to 71°C) and allow the product to remain in the oven for a period of one hour.

If you would like assistance, you are invited to contact an Alto-Shaam corporate chef for recommendations.

NOTE: Always keep the OVEN DOOR CLOSED whenever operating the smoking function.

The Combitherm Smoker can be operated without using the smoking function. After using the oven as a smoker, however, it is necessary to clean the oven in order to prevent a transfer of smoke flavor to non-smoked products. Cleaning instructions are provided in this manual.



CAUTION

DO NOT OPEN THE OVEN DOOR DURING THE SMOKING FUNCTION. The introduction of outside air in the oven compartment may cause the wood chips to flame.



WARNING

THE USE OF IMPROPER MATERIALS FOR THE SMOKING FUNCTION COULD RESULT IN DAMAGE, HAZARD, EQUIPMENT FAILURE, OR COULD REDUCE THE OVERALL LIFE OF THE OVEN.

DO NOT USE SAWDUST FOR SMOKING.
DO NOT USE WOOD CHIPS SMALLER THAN THUMBNAIL SIZE.



AUXILIARY FUNCTIONS

Зип Общепит

CHEF FUNCTION KEY

SMOKER FEATURE

vsezip.ru

ON EQUIPPED MODELS U.S. PAT. 7,157,668

The ability to smoke product, hot or cold, is offered on all boiler-free electric models and on all gas models with the exception of the 10•20ESGAS, the 12•18ESGAS, and the 20•20ESGAS. The smoking function can be engaged in either the Combination mode or the Convection mode of operation. The smoking function cannot be operated when the oven is operating in the steam mode or the retherm mode.



SELECT AND PRESS THE REQUIRED COOKING MODE (CONVECTION OR COMBINATION).

TO SET COOK TEMPERATURE:



PRESS THE TEMPERATURE KEY.

The cooking temperature will appear highlighted within the oven display.

Press the up Δ and down ∇ arrow keys or rotate the adjustment knob to select the desired cooking temperature.

TO SET COOK TIME:



PRESS THE TIME KEY.

The cooking time will appear highlighted within the oven display.

Press the up Δ and down ∇ arrow keys or rotate the adjustment knob to select the time desired.

or

Set control for continuous operation by rotating the adjustment knob to the right until desired time appears in the display.

TO ACTIVATE SMOKER:



PRESS THE CHEF FUNCTION KEY.



Rotate the adjustment knob until the smoker symbol  is highlighted within the display.



PRESS THE CHEF FUNCTION KEY.

Press the up Δ and down ∇ arrow keys or rotate the adjustment knob to select "YES" for the Smoker function.



PRESS THE CHEF FUNCTION KEY TO CONFIRM THE SETTING.



PRESS THE START KEY TO ACTIVATE THE SMOKER FUNCTION.

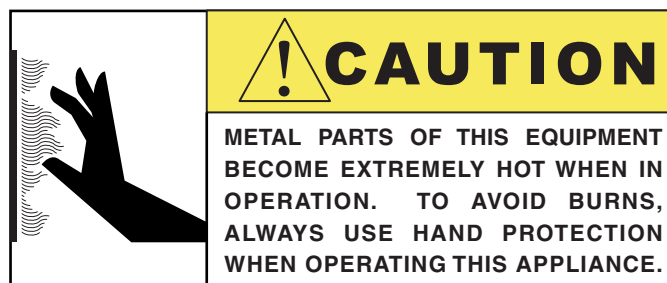

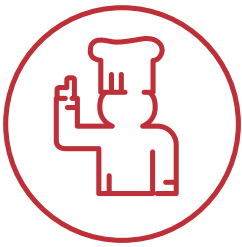

AUXILIARY FUNCTIONS

Зип Общепит

CHEF FUNCTION KEY

vsezip.ru

ENERGY LOCK

FOR USE WITH OVENS INSTALLED UNDER A VENTLESS HOOD.

Energy lock is a safety feature to prevent the oven control from being operated unless the ventless oven hood is in operation. The energy lock indicator light will illuminate in the control display if this situation occurs and the oven control will be inoperable until the oven hood is reset and operating.



PRESS THE CHEF FUNCTION KEY.

Rotate the adjustment knob until the energy lock symbol  is highlighted within the display.



PRESS THE CHEF FUNCTION KEY.

Press the up Δ and down ∇ arrow keys or rotate the adjustment knob to select “YES” for the energy lock function.

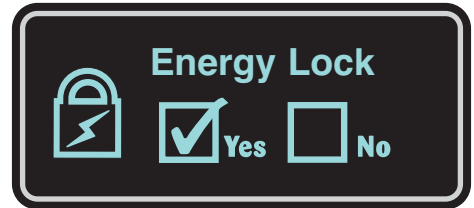

PRESS THE CHEF FUNCTION KEY TO ACTIVATE THE ENERGY LOCK FUNCTION.

The oven control will not operate when power is engaged until the ventless hood is reset and operating.



Press the “Combi Reset” button on the ventless hood to energize the hood and return the oven control to normal operation.

ENERGY PROTECTION FURNISHED UPON REQUEST AS A FACTORY INSTALLED OPTION

In locations where the electric service is regulated with a device installed on site, this function will protect full power to the Combitherm for the duration of the next operator set program or cooking mode. This function cannot be set during an active cooking mode or program. Power interruption may affect all other electric service within the regulated location.

FOR USE ONLY IN THOSE COUNTRIES WHERE THE LOCAL ELECTRIC UTILITY PROVIDES AN ENERGY OPTIMIZATION SYSTEM INSTALLED ON SITE.



PRESS THE CHEF FUNCTION KEY.

Rotate the adjustment knob until the program protection symbol  is highlighted within the display.



PRESS THE CHEF FUNCTION KEY.

Press the up Δ and down ∇ arrow keys or rotate the adjustment knob to select “YES” for the energy protection function.

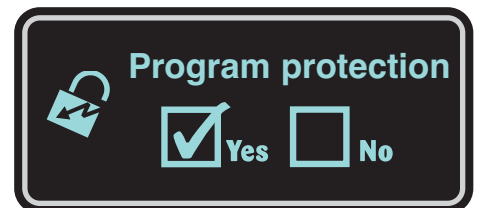

PRESS THE CHEF FUNCTION KEY TO ACTIVATE THE PROGRAM PROTECTION FUNCTION.

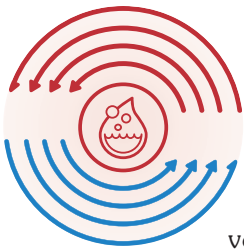

ADVANCE FEATURES

MOISTURE VENT KEY

This function provides the operator with the ability to eliminate excessive moisture from the oven compartment and the exterior surface of the foods being cooked. The moisture vent key is designed to operate in both the Combination mode and in the Convection cooking mode. On deluxe models, this function can also be made part of a cooking program.



PRESS THE MOISTURE VENT KEY TO REDUCE STEAM AND MOISTURE LEVELS IN THE OVEN.

The illuminated, blue portion of the Moisture Vent Key will go out. Open vent  symbol will illuminate within the display.



PRESS THE MOISTURE VENT KEY TO DISENGAGE THE MOISTURE VENT KEY FUNCTION.

The blue portion of the Moisture Vent Key will illuminate. Open vent  symbol within the display will extinguish.

AT THE END OF A COOKING MODE, THE MOISTURE VENT KEY WILL AUTOMATICALLY DISENGAGE.

ADVANCE FEATURES

QUICK PROGRAMMING

This quick programming function provides the operator with the ability to temporarily program a cooking procedure using multiple cooking modes, along with any auxiliary functions desired. Quick programming is particularly useful when cooking several batches of the same product back-to-back and will remain programmed until any new cooking mode key is pressed.



PRESS AND HOLD THE FIRST REQUIRED COOKING MODE FOR A PERIOD OF 3-SECONDS.

01/01 will appear at the top of the display indicating STEP ONE.
The temperature and time will appear directly below 01/01.



PRESS THE TEMPERATURE KEY.

The temperature will become highlighted within the display.



ROTATE THE ADJUSTMENT KNOB TO SELECT THE REQUIRED TEMPERATURE.



PRESS THE TIME KEY OR THE CORE TEMP KEY .

The time or core temperature will become highlighted within the display.



ROTATE THE ADJUSTMENT KNOB TO SELECT THE REQUIRED SETTING.



PRESS AND HOLD THE SECOND REQUIRED COOKING MODE FOR A PERIOD OF 3-SECONDS.

Follow the above directions until all steps have been entered.



PRESS THE START KEY.

The oven will begin cooking as programmed, automatically switching to each cooking mode entered. Each step entered will be indicated in the display as the oven cycles from mode to mode. **EXAMPLE: 01/05 = STEP ONE OF FIVE**

02/05 = STEP TWO OF FIVE



PRESS THE STOP KEY OR OPEN THE OVEN DOOR WHEN THE BUZZER SOUNDS AT THE END OF THE PROGRAM.

THIS PROGRAM WILL REMAIN IN TEMPORARY MEMORY UNTIL ANY NEW COOKING MODE KEY IS PRESSED. QUICK PROGRAMMING CAN BE SAVED AND STORED IN MEMORY ON DELUXE MODELS ONLY.

ADVANCE FEATURES

Auxiliary Functions are made part of the control as an additional convenience to the operator, however, these functions are not necessary for the general operation of the Combitherm oven.

START TIME PRESELECT

Start time preselect provides the operator with the ability to program a fixed start time for oven operation. This function can be operated when cooking in any mode and is offered as a convenience to set an advanced start-up of the preheating function prior to the beginning of the production day. It can also be used for advance start-up for non-refrigerated items such as baked potatoes.

! CAUTION

To prevent food spoilage, this feature is not recommended for use with any raw product that requires temperature maintenance at or under 40°F (4°C).

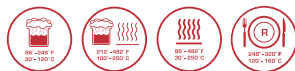

SELECT AND PRESS THE REQUIRED COOKING MODE.

Set all mode functions such as temperature, time, core temperature, etc.



The time entered in the initial operational mode setup will automatically be reflected on the start time preselect display.



PRESS AND HOLD THE TIME KEY WHILE TURNING THE ADJUSTMENT KNOB.

The display will indicate the current programmed settings in 24-hour (military) time.



1-HOUR TOTAL COOKING TIME

OVEN START
IN 48 MINUTES

STARTING TIME
10:23 A.M.

ENDING TIME
11:23 A.M.

A.M.		P.M.	
1:00	1:00	1:00	13:00
2:00	2:00	2:00	14:00
3:00	3:00	3:00	15:00
4:00	4:00	4:00	16:00
5:00	5:00	5:00	17:00
6:00	6:00	6:00	18:00
7:00	7:00	7:00	19:00
8:00	8:00	8:00	20:00
9:00	9:00	9:00	21:00
10:00	10:00	10:00	22:00
11:00	11:00	11:00	23:00
12:00	12:00	12:00	24:00

The cooking time shown (UPPER RIGHT) indicates automatic oven operation for a period of one hour and appears only when cooking by time as entered in the initial operational mode setup.



TO CHANGE THE STARTING TIME, PRESS AND HOLD THE TIME KEY AND TURN THE ADJUSTMENT KNOB.



Rotate the adjustment knob to select the starting time desired. As the starting time is changed, the countdown for oven start (LEFT) and the ending time will automatically adjust accordingly.

RELEASE THE TIME KEY AFTER THE REQUIRED STARTING TIME HAS BEEN SELECTED.

The oven preselect start time display will immediately begin a countdown and will automatically start the oven when zero is reached.

THIS FUNCTION CAN BE CANCELLED AT ANY TIME BY PRESSING THE START/STOP KEY

COMBITHERM PROGRAMMING SYMBOLS



RECORD



COPY PROCEDURE



INSERT STEP



SAVE



DELETE PROCEDURE



APPEND STEP



NEW PROCEDURE



EDIT PROCEDURE



DELETE STEP



RECORDING A COOKING PROCEDURE

Recording a cooking procedure provides the operator with the ability to test and verify all set operating parameters for the selected cooking modes and to make any necessary adjustments before saving and storing the procedure into memory.



PRESS THE PROGRAM INSTALL AND EDIT KEY.



Press the up Δ and down ∇ arrow keys or rotate the adjustment knob until the record symbol  is highlighted in the display.



PRESS THE PROGRAM INSTALL KEY TO CONFIRM THE SELECTION.

The display will indicate **“Recorder ON”** and the record symbol  will appear in the display.



SELECT AND PRESS THE **FIRST** REQUIRED COOKING MODE.

Set all cooking mode parameters for temperature, time, or internal product temperature plus auxiliary functions, and advanced features for the first step to be recorded.



PRESS THE START KEY TO BEGIN THE FIRST RECORDED STEP.

When the cooking time has expired or the operator set internal temperature has been reached, a buzzer will sound indicating the end of the operating mode.

- To stop the buzzer, press the start/stop key  or open the oven door.



SELECT AND PRESS THE **SECOND** REQUIRED COOKING MODE.

Set all cooking mode parameters for temperature, time, or internal product temperature plus auxiliary functions, and advanced features for the second step to be recorded.



PRESS THE START KEY TO BEGIN THE SECOND RECORDED STEP.

Continue to record cooking modes as indicated for up to 20 steps.

All cooking mode steps entered with **“Recorder ON”** will remain in memory, in the order entered, until the recorder is turned off. Recorded procedures will not be lost or affected by pressing the stop/start key .

Deluxe PROGRAM FUNCTION

Зип Общепит



TO CANCEL THE RECORDING FUNCTION



WITH THE “Recorder ON” FUNCTION ACTIVATED, PRESS THE PROGRAM INSTALL AND EDIT KEY.



Press the up Δ and down ∇ arrow keys or rotate the adjustment knob until the record symbol  is highlighted in the display.

PRESS THE PROGRAM INSTALL KEY TO CONFIRM THE SELECTION.

“Recorder OFF” will appear in the display and the oven can be operated normally.



SAVING A RECORDED COOKING PROCEDURE

When the previous cooking mode steps recorded produce satisfactory results, the recorded cooking procedure can be saved in memory for future use.



PRESS THE PROGRAM INSTALL/EDIT KEY.



Press the up Δ and down ∇ arrow keys or rotate the

adjustment knob until the save symbol  is highlighted in the display.



PRESS THE PROGRAM INSTALL/EDIT KEY TO CONFIRM THE SELECTION.



Name the procedure. Rotate the adjustment knob to select the first letter of the procedure name. Press the up Δ and down ∇ arrow key to select second letter position and rotate the adjustment knob to select the second letter. Continue this procedure for each subsequent alpha character, number, or symbol required.

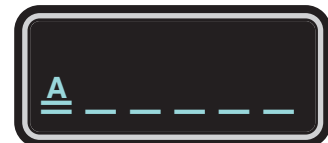



PRESS THE PROGRAM INSTALL AND EDIT KEY TO CONFIRM THE PROCEDURE NAME.

The display will indicate the first unoccupied memory location within the programmed menu. If an alternate location is desired, rotate the adjustment knob to highlight another unoccupied, numbered memory location within the programmed menu. If an *occupied* location is selected, the existing procedure will be replaced by the new procedure.



PRESS THE PROGRAM INSTALL/EDIT KEY TO CONFIRM THE PROCEDURE LOCATION.

The display will indicate “please wait” and will return to the main menu display. The procedure has now been saved in the selected location and can be verified by rotating the adjustment knob to the saved procedure.

To review the set operating parameters of any programmed procedure, press the programmed menu  key and rotate the adjustment knob until the procedure to be reviewed is highlighted in the display. Press the chef function  key. The cooking mode key for the first step will illuminate and the program mode, temperature, time, or core temperature will appear in the display. Rotate the adjustment knob to review each step.

Deluxe PROGRAM FUNCTION

Зип Общепит



CREATING A NEW COOKING PROCEDURE

Cooking procedures for items prepared on a regular basis can be stored in memory.

PRESS THE PROGRAM INSTALL/EDIT KEY.

Press the up Δ and down ∇ arrow keys or rotate the adjustment knob until the new procedure symbol is highlighted in the display.

PRESS THE PROGRAM INSTALL/EDIT KEY TO CONFIRM THE SELECTION.

All cooking mode keys will begin to flash and 01/01 will appear at the top of the display indicating the first cooking step.

SELECT AND PRESS THE FIRST REQUIRED COOKING MODE.

Set cooking mode functions for temperature and time, or internal core temperature. Add any auxiliary functions along with the moisture venting feature. Follow the basic operating instructions located in this booklet. Auxiliary functions can be added by pressing the chef function key after entering the operating mode parameters for each individual step and pressing the up Δ and down ∇ arrow keys or rotating the adjustment knob to select the auxiliary function required. Press the chef function key to confirm the auxiliary function setting(s) for each step.

PRESS THE PROGRAM INSTALL/EDIT KEY TO CONFIRM THE FIRST STEP.

SELECT AND PRESS THE SECOND REQUIRED COOKING MODE.

The display will indicate 02/02 indicating the second cooking mode step. Set all cooking mode functions as indicated above.

PRESS THE PROGRAM INSTALL/EDIT KEY TO CONFIRM THE SECOND STEP.

**CONTINUE WITH THE ABOVE INSTRUCTIONS UNTIL ALL MODE STEPS AND FUNCTIONS ARE ENTERED.
UP TO 20 COOKING MODE STEPS CAN BE SAVED IN A SINGLE PROCEDURE.**

**AFTER ALL FUNCTIONS ARE ENTERED,
PRESS THE PROGRAM INSTALL/EDIT KEY TO CONFIRM THE NEW PROCEDURE.**

Name the procedure. Rotate the adjustment knob to select the first letter of the procedure name. Press the up Δ and down ∇ arrow key to select second letter position and rotate the adjustment knob to select the second letter. Continue for each subsequent alpha character, number, or symbol required.

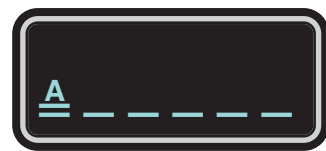

PRESS THE PROGRAM INSTALL AND EDIT KEY TO CONFIRM THE PROCEDURE NAME.

Rotate the adjustment knob to highlight an unoccupied, numbered memory location within the programmed menu. If an occupied location is selected, the existing procedure will be replaced by the new procedure.

PRESS THE PROGRAM INSTALL AND EDIT KEY TO CONFIRM THE PROGRAM INSTALLATION.
The display will indicate “please wait” and will return to the main menu display.

Deluxe PROGRAM FUNCTION

Зип Общежит



START A PROGRAMMED PROCEDURE



PRESS THE PROGRAMMED MENU KEY.



All stored procedures are listed alphabetically or numerically as selected by the operator in the initial oven start up procedures under the program index category.



Rotate the adjustment knob until the required procedure is highlighted in the display.



PRESS THE START KEY.

To review the set parameters of any programmed procedure, press the programmed menu  key and rotate the adjustment knob until the procedure to be reviewed is highlighted in the display. Press the chef function  key. The cooking mode, temperature, time, or core temperature will appear in the display.



COPY A PROGRAMMED PROCEDURE



PRESS THE PROGRAMMED MENU KEY.



Rotate the adjustment knob until the procedure to be copied is highlighted in the display.



PRESS THE PROGRAM INSTALL AND EDIT KEY.



Press the up  and down  arrow keys or rotate the adjustment knob until the procedure symbol is highlighted in the display.  copy»



PRESS THE PROGRAM INSTALL AND EDIT KEY.

The display will select an empty, numbered location to insert the duplicate copy.



PRESS THE PROGRAM INSTALL AND EDIT KEY TO CONFIRM THE DUPLICATION.

The display will indicate “please wait” and will return to the main menu display.

An exact duplicate of the selected procedure has been inserted in the new location under the same name as the original procedure. The duplicate can be renamed and edited as required. *See additional editing instructions.*



DELETE A PROGRAMMED PROCEDURE





PRESS THE PROGRAMMED MENU KEY.

Rotate the adjustment knob to highlight the procedure to be deleted.



PRESS THE PROGRAM INSTALL/EDIT KEY.

Press the up  and down  arrow keys or rotate the adjustment knob until the delete  symbol is highlighted in the display.



PRESS THE PROGRAM INSTALL AND EDIT KEY TO CONFIRM THE SELECTION.

The programmed procedure has been deleted from the menu.

Deluxe PROGRAM FUNCTION

PROGRAM EDITING



EDIT A PROGRAMMED PROCEDURE



PRESS THE PROGRAMMED MENU KEY.

Rotate the adjustment knob until the procedure to be edited is highlighted in the display.



PRESS THE PROGRAM INSTALL AND EDIT KEY.

Press the up Δ and down ∇ arrow keys or rotate the adjustment knob until the edit symbol is highlighted in the display.



PRESS THE PROGRAM INSTALL AND EDIT KEY TO CONFIRM THE SELECTION.

The display will indicate the procedure name, cooking step number (EXAMPLE: "01/05" = STEP ONE OF FIVE), and operating parameters for temperature, time, or internal product temperature.

To change the operating parameters for the first step:

Press the cooking temperature  key and rotate the adjustment knob.

Press the time  key and rotate the adjustment knob to change the cooking time.

Press the core temperature  key and rotate the adjustment knob to change the core temp.

Auxiliary functions can be added by pressing the chef function  key after entering the operating mode parameters for each individual step and pressing the up Δ and down ∇ arrow keys or rotate the adjustment knob to select the auxiliary function required. Press the chef function key to confirm the auxiliary function setting.

Press the down arrow key for each subsequent step of the procedure and make changes to each step as required.



PRESS THE PROGRAM INSTALL AND EDIT KEY TO CONFIRM THE SETTING.

The display will indicate the same name as the original procedure, minus the last letter. Install the last letter by rotating the adjustment knob to the correct letter.

Rename the procedure by pressing the down arrow key to clear the display.



Press the up Δ and down ∇ arrow key to select each individual alpha character, number, or symbol. Rotate the adjustment knob to select each subsequent letter.



PRESS THE PROGRAM INSTALL AND EDIT KEY TO CONFIRM THE NAME.











PRESS THE PROGRAM INSTALL AND EDIT KEY TO INSTALL THE PROGRAM.





To review the set operating parameters of any programmed procedure, press the programmed menu  key and rotate the adjustment knob until the procedure to be reviewed is highlighted in the display. Press the chef function  key. The cooking mode key for the first step will illuminate and the program mode, temperature, time, or core temperature will appear in the display. Rotate the adjustment knob to review each step.

Deluxe PROGRAM FUNCTION

PROGRAM EDITING

INSERT A PROGRAMMED PROCEDURE STEP

-  PRESS THE PROGRAMMED MENU KEY.
Rotate the adjustment knob until the procedure to add a new step is highlighted in the display.
-  PRESS THE PROGRAM INSTALL KEY.
Press the up Δ and down ∇ arrow keys or rotate the adjustment knob until the edit procedure  symbol is highlighted in the display.
-  PRESS THE PROGRAM INSTALL AND EDIT KEY TO CONFIRM THE SELECTION.
The display will indicate the procedure name, cooking step number and operating parameters for temperature, time, or internal product temperature.
Press the up Δ or down ∇ arrow keys to select the step *immediately following* the position wanted for the new step.
-  PRESS THE CHEF FUNCTION KEY.
A choice of editing symbols and auxiliary functions will appear in the display. Press the up Δ and down ∇ arrow keys or rotate the adjustment knob to select the insert step  symbol.
-  PRESS THE CHEF FUNCTION KEY TO CONFIRM THE SELECTION.
Press the up Δ and down ∇ arrow keys or rotate the adjustment knob to select “YES” for step insertion.
-  PRESS THE CHEF FUNCTION KEY TO CONFIRM THE SELECTION.
- 





Insert step ?
 Yes No
- All cooking modes will begin to flash. Select and press the cooking mode to be inserted. Press and set cooking temperature, time, or internal core temperature. Auxiliary functions can be added by pressing the chef function  key after entering the operating mode parameters for each individual step and pressing the up Δ and down ∇ arrow keys or rotating the adjustment knob to select the auxiliary function required. Press the chef function key to confirm the auxiliary function setting. Add the moisture vent key function if required.
-  PRESS THE INSTALL/EDIT KEY TO CONFIRM THE SELECTED MODE AND FUNCTIONS.
The display will indicate the procedure name minus the last letter. Reinsert the last letter with the adjustment knob or use the up Δ and down ∇ arrow keys in conjunction with the adjustment knob to rename the procedure.
-  PRESS THE INSTALL/EDIT KEY TO CONFIRM THE NAME.
-  PRESS THE INSTALL/EDIT KEY TO INSERT THE NEW STEP INTO THE PROCEDURE.
The display will indicate “please wait” and will return to the main menu display.



TO VERIFY THE INSERTED STEP, PRESS THE CHEF FUNCTION KEY WHILE THE ALTERED PROCEDURE IS HIGHLIGHTED. ROTATE THE ADJUSTMENT KNOB TO REVIEW ALL SET PARAMETERS.

Deluxe PROGRAM FUNCTION

PROGRAM EDITING

APPEND A PROGRAMMED PROCEDURE STEP

-  PRESS THE PROGRAMMED MENU KEY.
Rotate the adjustment knob until the procedure to include a final step is highlighted in the display.
-  PRESS THE PROGRAM INSTALL KEY.
Press the up \triangle and down ∇ arrow keys or rotate the adjustment knob until the edit procedure  symbol is highlighted in the display.
-  PRESS THE PROGRAM INSTALL AND EDIT KEY TO CONFIRM THE SELECTION.
The display will indicate the procedure name, cooking step number and operating parameters for temperature, time, or internal product temperature.
Press the up \triangle or down ∇ arrow keys to select the last step of the procedure.

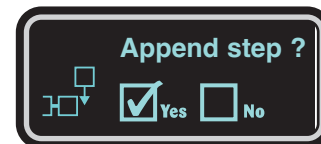

-  PRESS THE CHEF FUNCTION KEY.
A choice of editing symbols and auxiliary functions will appear in the display. Press the up \triangle and down ∇ arrow keys or rotate the adjustment knob to select the append step  symbol.

-  PRESS THE CHEF FUNCTION KEY TO CONFIRM THE SELECTION.
Press the up \triangle and down ∇ arrow keys or rotate the adjustment knob to select “YES” for append step.



-  PRESS THE CHEF FUNCTION KEY TO CONFIRM THE SELECTION.

All cooking modes will begin to flash. Select and press the cooking mode to be appended. Press and set cooking temperature, time, or internal core temperature. Auxiliary functions can be added by pressing the chef function  key after entering the operating mode parameters for each individual step and pressing the up \triangle and down ∇ arrow keys or rotating the adjustment knob to select the auxiliary function required. Press the chef function key to confirm the auxiliary function setting. Add the moisture vent key function if required.

-  PRESS THE INSTALL/EDIT KEY TO CONFIRM THE SELECTED MODE AND FUNCTIONS.
The display will indicate the procedure name minus the last letter. Reinsert the last letter with the adjustment knob or use the up \triangle and down ∇ arrow keys in conjunction with the adjustment knob to rename the procedure.
-  PRESS THE INSTALL/EDIT KEY TO CONFIRM THE NAME.
-  PRESS THE INSTALL/EDIT KEY TO INSERT THE NEW STEP INTO THE PROCEDURE.
The display will indicate “please wait” and will return to the main menu display.

TO VERIFY THE INSERTED STEP, PRESS THE CHEF FUNCTION KEY WHILE THE ALTERED PROCEDURE IS HIGHLIGHTED. ROTATE THE ADJUSTMENT KNOB TO REVIEW ALL SET PARAMETERS.

Deluxe PROGRAM FUNCTION

PROGRAM EDITING







Зип Общепит





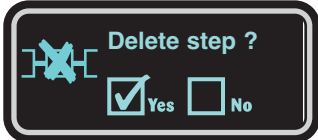

DELETE A PROGRAMMED STEP

vsezip.ru

+7(812)987-08-81

-  PRESS THE PROGRAMMED MENU KEY.
Rotate the adjustment knob to highlight the procedure in which a step is to be deleted.
 -  PRESS THE PROGRAM INSTALL KEY.
Press the up Δ and down ∇ arrow keys or rotate the adjustment knob until the edit procedure  symbol is highlighted in the display.
 -  PRESS THE PROGRAM INSTALL AND EDIT KEY TO CONFIRM THE SELECTION.
The display will indicate the procedure name, cooking step number and operating parameters for temperature, time, or internal product temperature.
Press the up Δ or down ∇ arrow keys to select the step to be deleted.
 -  PRESS THE CHEF FUNCTION KEY.
A choice of editing symbols and auxiliary functions will appear in the display. Press the up Δ and down ∇ arrow keys or rotate the adjustment knob to select the delete step  symbol.
 -  PRESS THE CHEF FUNCTION KEY TO CONFIRM THE SELECTION.
Press the up Δ and down ∇ arrow keys or rotate the adjustment knob to select "YES" for step deletion.
- 

Delete step ?
 Yes No
-  PRESS THE CHEF FUNCTION KEY TO CONFIRM THE SELECTION.
 -  PRESS THE INSTALL/EDIT KEY TO CONFIRM THE DELETION.
The display will indicate the name of the procedure as originally programmed.
 -  PRESS THE INSTALL/EDIT KEY TO CONFIRM THE NAME.
 -  PRESS THE INSTALL/EDIT KEY TO REMOVE THE DELETED STEP FROM THE PROGRAM.
The display will indicate "please wait" and will return to the main menu display.

TO VERIFY THE STEP HAS BEEN DELETED, PRESS THE CHEF FUNCTION KEY WHILE THE DELETE STEP PROCEDURE IS HIGHLIGHTED. ROTATE THE ADJUSTMENT KNOB TO REVIEW ALL SET PARAMETERS.

RAPID-TOUCH™ KEYS

Rapid-Touch programmed quick-keys provide the operator with the ability to assign procedures used on a regular basis to individual keys that can be identified with a picture graphic resembling the product. Various picture graphics are included with the Combitherm oven.

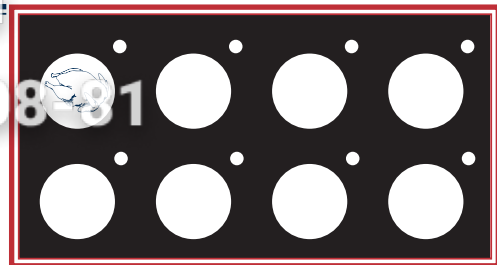

TO ASSIGN A PROCEDURE TO A PROGRAM RAPID-TOUCH KEY

 PRESS THE PROGRAMMED MENU KEY.

 Rotate the adjustment knob to highlight the procedure to be assigned to Rapid-Touch operation.

 PRESS AND HOLD THE SELECTED RAPID TOUCH KEY FOR A PERIOD OF THREE SECONDS.

When the buzzer sounds, the programmed procedure has been assigned to the Rapid-Touch key selected.

Identify the Rapid-Touch key with a corresponding picture graphic.

TO OPERATE A PROCEDURE ON RAPID-TOUCH KEY

 PRESS AN ASSIGNED RAPID TOUCH KEY.

The indicator light to the upper right of the selected Rapid-Touch key will illuminate. The oven will begin operating as programmed with the display indicating the name of the procedure, the step number, the total number of steps, and the temperature, time, or internal product temperature.



When the cooking time for all programmed modes has expired or the operator set internal temperature has been reached, a buzzer will sound indicating the completion of the program.

- To stop the buzzer, press the start/stop key  or open the oven door.

Once a Rapid-Touch key is programmed with a procedure, care should be taken not to press and hold the programmed key with another procedure highlighted in the display by means of the programmed menu key. The highlighted procedure will override the Rapid-Touch key program and the picture graphic will no longer match the procedure.

S-CONTROL PANEL IDENTIFICATION

сайт общенит

vsezip.ru

+7(812)987-08-81

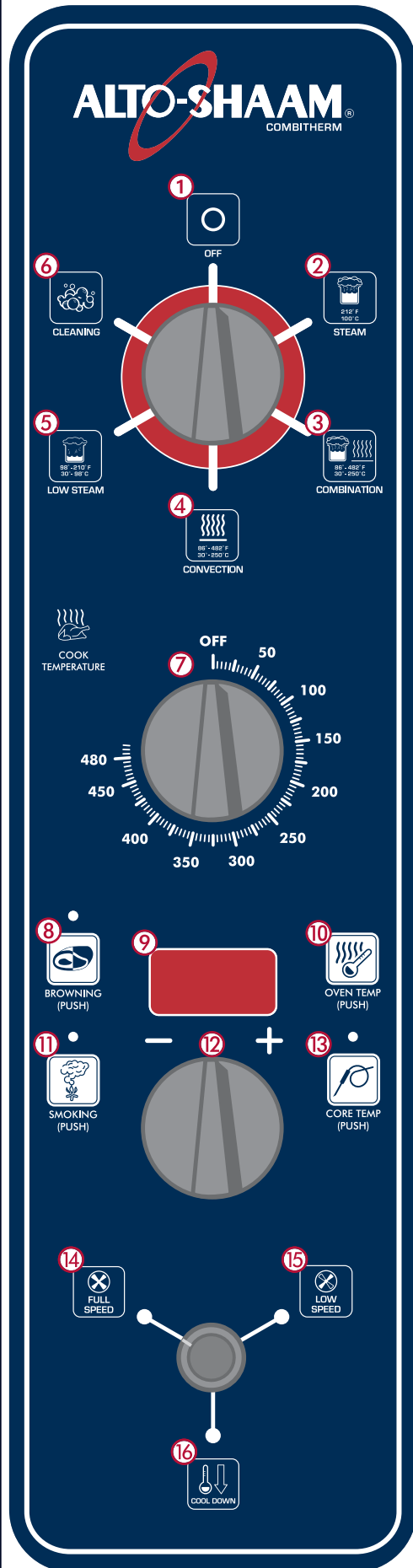

① OFF POSITION

Maintains oven in a stand-by mode.

② STEAM

The oven will operate at a fixed steam temperature of 212° F (100°C).

③ COMBINATION

A combination of steam and convection heat to cook at a temperature between 86°F and 482°F (30°C to 250°C) to be set by the operator.

④ CONVECTION

Convection heat to cook without steam at a temperature between 86°F and 482°F (30°C and 250°C) to be set by the operator.

⑤ LOW STEAM

Low temperature steaming within an operator set temperature range of 98°F to 210°F (30°C and 98°C).

⑥ CLEANING FUNCTION

An automatic cleaning cycle to heat the oven to the correct temperature, followed by a manual application of Combitherm Oven Cleaner and cleaning cycle.

⑦ COOKING TEMPERATURE DIAL

To be manually set by the operator to the cooking temperature required.

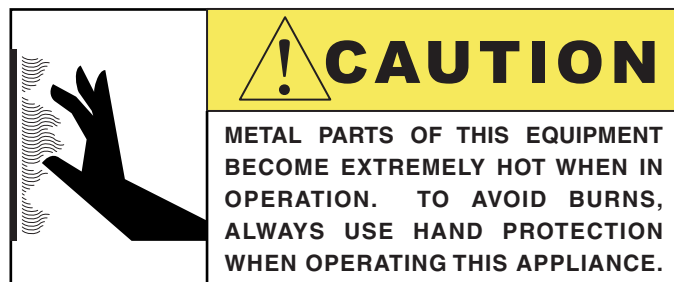

S-CONTROL PANEL IDENTIFICATION

сайт общенит

vsezip.ru

+7(812)987-08-81

⑧ GOLD-N-BROWN™

The browning feature is an automatic function designed to regulate humidity for additional color to products as needed. This feature is particularly useful for adding color to high moisture products such as chicken and other poultry items or for additional browning of full loads and other moist products. In addition, this feature may be used to add texture to fried items such as French fries or breaded chicken. Gold-n-Brown can be used in both the combination mode and the convection mode and can be programmed into a cooking procedure.

⑨ OVEN DISPLAY

Indicates time remaining, interior oven temperature, or internal product temperature.

⑩ OVEN TEMPERATURE

To be pressed to display interior oven temperature.

⑪ SMOKING FEATURE (OPTION)

Provides the ability to smoke product, hot or cold, on all boiler-free electric models and on all gas models with the exception of the 10•20ESGAS, the 12•18ESGAS, and the 20•20ESGAS. The smoking function can be engaged in either the Combination mode or the Convection mode of operation. The smoking function cannot be operated when the oven is operating in either steam mode or low temperature steam mode.

⑫ COOKING TIMER

- ⊖ Turned to the left for continuous cooking time or to decrease time in increments of one minute.
- ⊕ Turn to the right to set and increase time in increments of one minute.

⑬ CORE TEMPERATURE PROBE (OPTION)

Used to set the required internal product temperature.

⑭ FULL SPEED FAN POSITION

⑮ HALF SPEED FAN POSITION

⑯ OVEN COOL-DOWN POSITION

Assists in cooling the oven at an accelerated pace when changing from high to lower temperature cooking. **The oven door should be open when using this feature.**

S-CONTROL OPERATION



The simplified, S-Control Combitherm oven includes all of the basic operating functions of the standard, ES-Series, Combitherm oven models. Oven operation is initiated with the use of rotary dials. Additional functions are initiated by pressing the represented function symbol.

All of the cooking procedures shown in this guide can be adapted for use with S-Control models by manually setting the suggested cooking mode, time, and temperature indicated.

PREHEATING

1. Rotate the **Cooking Mode** dial to the convection mode. 
2. Rotate the **Cooking Temperature** dial to the preheating temperature required.
3. Rotate the **Cooking Timer** dial to the preheating time desired.
 - ⊖ Turn to the left for continuous time or to decrease time in increments of one minute.
 - ⊕ Turn to the right to set and increase time in increments of one minute.
4. When preheated, the oven can be operated in any cooking mode required.

CORE TEMPERATURE (OPTION)

1. Rotate the **Cooking Mode** dial to the required cooking mode. 
2. Rotate the **Cooking Temperature** dial to the cooking temperature required.
3. Press the **Core Temperature** symbol.  The letters "Cor" will appear in the display.

Cor

4. When "Cor" appears in the display, the timer dial will convert to internal product temperature.
Rotate the **Cooking Timer** dial to the internal product temperature desired.
 - ⊖ Turn to the left to decrease temperature in increments of one degree.
 - ⊕ Turn to the right to increase temperature in increments of one degree.
5. In 3-seconds, oven will begin the cook and the display will indicate the internal product temperature reading of the probe.
6. One minute after the product reaches the set internal product temperature, a buzzer will sound indicating the end of the operating mode.

TO STOP THE BUZZER, OPEN THE OVEN DOOR OR TURN THE COOKING MODE DIAL TO THE OFF POSITION.



CHEF OPERATING TIPS

The Core Temperature should not be used for cooking thin products.



WARNING

DO NOT HANDLE PANS CONTAINING LIQUID OR SEMILIQUID PRODUCTS POSITIONED ABOVE THE EYE LEVEL OF THE OPERATOR. SUCH PRODUCTS CAN SCALD AND CAUSE SERIOUS INJURY.

S-CONTROL OPERATION

Зип Общепит

vsezip.ru

+7(812)987-08-81

GOLD-N-BROWN™



Press the GOLD-N-BROWN browning symbol at the start of any cooking cycle in the combination mode or convection mode to automatically add additional product color.

SMOKING (OPTION)

LOAD WOOD CHIPS.

- Measure one container full of dry wood chips.
- Soak dry chips in water for 5 minutes.
- Shake excess water off wood chips.
- Place moistened chips back into the container and position the container securely on the two prongs located on the interior back panel of the oven.

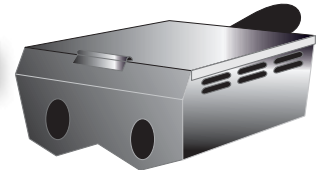

AVAILABLE FROM ALTO-SHAAM	
WOOD CHIPS	20 POUND BULK PACKS
	APPLE WC-22543
	HICKORY WC-2829
	CHERRY WC-22541
	SUGAR MAPLE WC-22545

THE TOTAL WEIGHT OF WOOD CHIP BULK PACKS MAY VARY DUE TO HIGH MOISTURE CONTENT WHEN PACKAGED.

SMOKING feature may be started at the beginning of any cooking cycle in the Combination mode or Convection mode.

Push the Smoker icon key.



A full container of wood chips will produce smoke for an approximate period of one to two hours depending on the cooking temperature being used for the selected product. The tested procedures in this manual for many of the products that are appropriate for smoking provide complete product smoke penetration and full smoke flavor.

When the cooking cycle is completed, a buzzer will sound indicating the end of the preheat function.

TO STOP THE BUZZER, OPEN THE OVEN DOOR OR TURN THE COOKING MODE DIAL TO THE OFF POSITION.



CHEF OPERATING TIP

Products such as ribs that require heavier smoke penetration to reach full smoke flavor should remain in the oven after cooking has been completed. Do not open the oven door. Set the oven in the Low Temperature Steam Mode at 140° to 160°F (60° to 71°C) and allow the product to remain in the oven for a period of one hour.

NOTE: Always keep the OVEN DOOR CLOSED whenever operating the smoking function.

The Combitherm Smoker can be operated without using the smoking function. After using the oven as a smoker, however, it is necessary to clean the oven in order to prevent a transfer of smoke flavor to non-smoked products. Cleaning instructions are provided in this manual.

WARNING

HOT STEAM CAUSES BURNS

ROTATE THE DOOR HANDLE TO THE FIRST OPEN ROTATION POSITION ONLY.

STAND BACK AND WAIT UNTIL THE STEAM IS VENTED BEFORE FULLY OPENING THE DOOR.

PREVENTIVE MAINTENANCE

Preventive Maintenance.....	50
Food Trolley Cleaning	50
Cleaning Agents and Materials	51
Daily and Monthly Cleaning	52
Auto-Clean - Standard or Deluxe Control (prior to 3/09)	54
Auto-Clean - S-Control (prior to 3/09)	56
SmartClean™ - Standard or Deluxe Control (after 3/09)	57
SmartClean™ - S-Control (after 3/09)	59
Return to Main Table of Contents	3

Preventive Maintenance

In addition to the routine cleaning and maintenance procedures, there are several additional steps to be taken for both sanitation purposes and to keep the oven running at top operating efficiency. These additional safeguards will help prevent inconvenient down time and costly repairs.

- **DO NOT DISPOSE OF GREASE, FAT, OR SOLID WASTE DOWN THE OVEN DRAIN.** Fats and solids will eventually coagulate in the drain system, causing blockage. Consequently, water will back-up into the condenser and interior oven compartment, resulting in an oven that is inoperable.
- **MAKE CERTAIN THE DRAIN SCREEN IS ALWAYS IN PLACE. REMOVE ANY SOLID WASTE MATERIAL FROM THE DRAIN SCREEN BEFORE IT ENTERS THE DRAIN SYSTEM.** The routine removal of solids from the drain screen will help prevent blockage.
- **USE THE AUTHORIZED COMBITHERM OVEN CLEANER ONLY.** The use of unauthorized cleaning agents may discolor or harm the interior surfaces of the oven.
- **TO PROLONG THE LIFE OF THE DOOR GASKET, CLEAN THIS ITEM DAILY.** The acids and related compounds found in fat, particularly chicken fat, will weaken the composition of the gasket unless cleaned on a daily basis. Wipe with a hot, soapy cloth.
- **TO ADDITIONALLY PROTECT GASKET LIFE, ALLOW OVEN DOOR TO REMAIN SLIGHTLY OPEN AT THE END OF THE PRODUCTION DAY.** An open door will relieve the pressure on the door gasket.
- **ROUTINELY CLEAN DOOR HINGES.** Open oven door to relieve tension. Clean all parts of the hinge.

ROLL-IN CART/FOOD TROLLEY CLEANING (ON EQUIPPED MODELS)

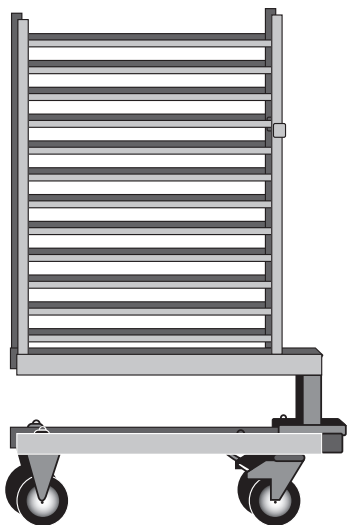

1. Remove food trolley to a cart wash area. Trolleys may be cleaned using any mild cleaning detergent and warm water.
2. Hand wipe all framing, slides, drip pan, and base. Thoroughly clean debris from the casters. A spray hose can be used for easier cart cleaning.
3. Remove detergent solution with warm water.
4. Wipe or spray with a sanitizing solution designed for use on metal and vinyl food contact surfaces.
5. Allow trolley to air dry.

As an alternative, trolleys can be sprayed with Combitherm liquid oven cleaner while inside the oven. Allow the trolley to remain in the oven through the normal cleaning cycle, followed by steps 2 through 5 above.

PROTECTING STAINLESS STEEL SURFACES



It is important to guard against corrosion in the care of stainless steel surfaces. Harsh, corrosive, or inappropriate chemicals can completely destroy the protective surface layer of stainless steel. Abrasive pads, steel wool, or metal implements will abrade surfaces causing damage to this protective coating and will eventually result in areas of corrosion. Even water, particularly hard water that contains high to moderate concentrations of chloride, will cause oxidation and pitting that result in rust and corrosion. In addition, many acidic foods spilled and left to remain on metal surfaces are contributing factors that will corrode surfaces. Proper cleaning agents, materials, and methods are vital to maintaining the appearance and life of this appliance. Spilled foods should be removed and the area wiped as soon as possible but at the very least, a minimum of once a day. Always thoroughly rinse surfaces after using a cleaning agent and wipe standing water as quickly as possible after rinsing.

CLEANING AGENTS

USE AUTHORIZED COMBITHERM LIQUID OVEN CLEANER ONLY

Cleaning agents must be chloride-free compounds and must not contain quaternary salts. Never use hydrochloric acid (muriatic acid) on stainless steel surfaces. Unauthorized cleaning agents may discolor or harm interior surfaces of the oven. Read and understand label and material safety data sheet before using the oven cleaner.

CLEANING MATERIALS

The cleaning function can usually be accomplished with the proper cleaning agent and a soft, clean cloth. When more aggressive methods must be employed, use a non-abrasive scouring pad on difficult areas and make certain to scrub with the visible grain of surface metal to avoid surface scratches. Never use wire brushes, metal scouring pads, or scrapers to remove food residue.



	<p>CAUTION</p> <p>TO PROTECT STAINLESS STEEL SURFACES, COMPLETELY AVOID THE USE OF ABRASIVE CLEANING COMPOUNDS, CHLORIDE BASED CLEANERS, OR CLEANERS CONTAINING QUATERNARY SALTS. NEVER USE HYDROCHLORIC ACID (MURIATIC ACID) ON STAINLESS STEEL. NEVER USE WIRE BRUSHES, METAL SCOURING PADS OR SCRAPERS.</p>
--	---

PREVENTIVE MAINTENANCE

Establishing a routine cleaning and maintenance schedule will help keep the Combitherm oven running at top operating efficiency and is an absolutely essential part of a comprehensive sanitation program. Good equipment maintained and kept clean works better and lasts longer. **PROTECT YOUR INVESTMENT.**

DAILY GASKET CLEANING

It is important to prolong the life of the oven gasket by cleaning this item on a daily basis. Routine cleaning will help protect the composition of the gasket from deterioration caused by acidic foods.

1. After allowing the oven to cool, wipe the gasket and crevices with warm detergent solution and a clean cloth.
2. Remove detergent by wiping the gasket and crevices with clean rinse water and a cloth.

Do not remove or place gasket in the dishwasher.

PROBE USAGE AND CLEANING

After each use of the CORE TEMP mode, wipe the probe tip with a clean paper towel to remove food debris. Follow by wiping the probe with a disposable alcohol pad. Return the probe to the proper door bracket position.

PROBE CLEANING PROCEDURES

1. Remove all food soil from probe between loads and at the end of each production shift. Wipe the entire probe, probe cable assembly, and probe holding bracket with warm detergent solution and a clean cloth.
2. Remove detergent by wiping the probe, cable, and bracket with clean rinse water and a cloth.
3. Wipe probe and probe bracket with disposable alcohol pad or sanitizing solution recommended for food contact surfaces.
4. Allow probe and cable to air dry in the probe holding bracket.
5. Wipe the probe with a disposable alcohol pad prior to inserting in a new food product.

DAILY OVEN CLEANING

To be performed at the end of the production day or between production shifts.

MONTHLY CLEANING

- Water Intake Filter
- Drain Pipe
- Spray Head



CAUTION

ALLOW THE OVEN TO COOL BELOW 280°F (140°C) BEFORE STARTING THE AUTO-CLEAN FUNCTION.

NOTE: The temperature in the display indicates the air temperature inside the oven compartment and not the interior walls of the oven. Always make certain to allow the oven walls to cool to a minimum of 280°F (140°C) before cleaning.

NOTE

USE AUTHORIZED COMBITHERM LIQUID OVEN CLEANER ONLY.



DANGER

RUBBER GLOVES AND PROTECTIVE EYE WEAR MUST BE WORN WHEN USING THE OVEN CLEANER.



WARNING

WATER SUPPLY MUST BE OPEN WHEN CLEANING PROGRAM IS ACTIVATED.
VERIFY WATER SUPPLY BEFORE STARTING CLEANING PROGRAM.

Unauthorized cleaning agents may discolor or harm interior surfaces of the oven. Read and understand label and material safety data sheet before using the oven cleaner.



Combitherm Cleaning Liquid:

Causes severe burns. Always wear rubber glove when handling.

Do not get in eyes, on skin, or on clothing.

Do not wear contacts.

Harmful or fatal if swallowed.

Do not breathe mist.

Use in well ventilated area.

Keep out of reach of children.

Do not use on aluminum. Do not mix with anything but water.

THOROUGHLY RINSE EMPTY CONTAINER WITH WATER AND SAFELY DISCARD.

Combitherm SmartClean™ Cleaning Tabs:

Protective packaging will begin to dissolve onto skin if handled with damp or wet hands.

Cleaning agent causes severe burns. Always wear rubber gloves when handling.

Do not get in eyes, on skin, or on clothing.

Do not wear contacts.

Harmful or fatal if swallowed.

Keep out of reach of children.

Do not use on aluminum.

Do not mix with anything but water.

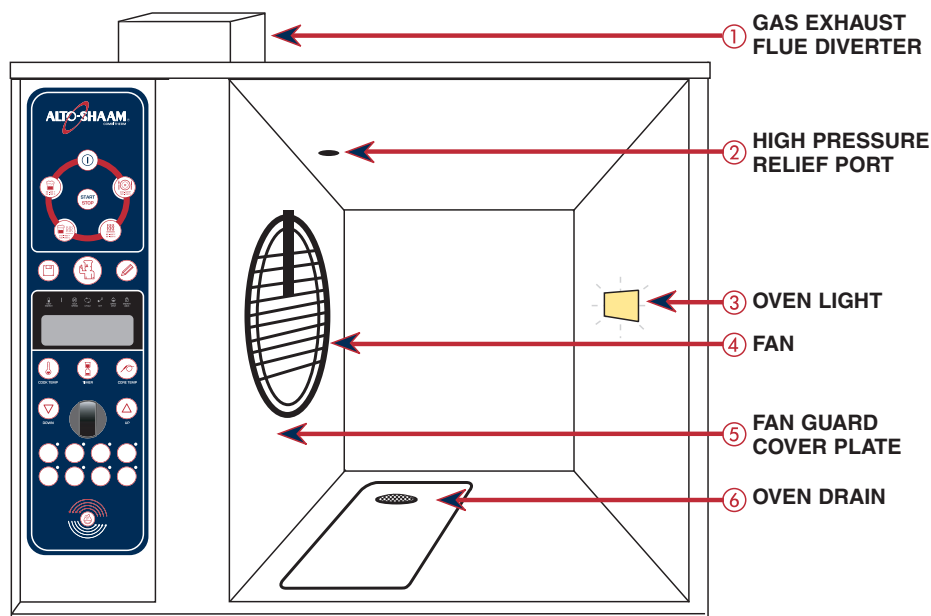



PREVENTIVE MAINTENANCE

AUTOCLEAN™ AUTOMATIC CLEANING PROGRAM (units prior to 3/09)

Remove all food scraps and residue from the oven drain. Remove shelves, side racks and pans and wash separately.

With the oven power  on



 PRESS THE CHEF FUNCTION KEY.

  Rotate the adjustment knob until the AutoClean symbol is highlighted in the display.

 PRESS THE CHEF FUNCTION KEY.

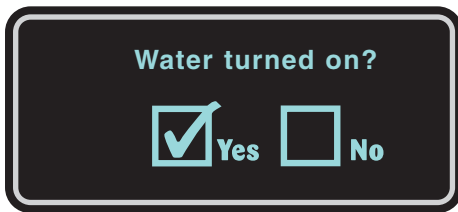

 THE CONTROL WILL ASK FOR VERIFICATION OF THE FOLLOWING ITEMS BEFORE THE FUNCTION CAN BE STARTED:

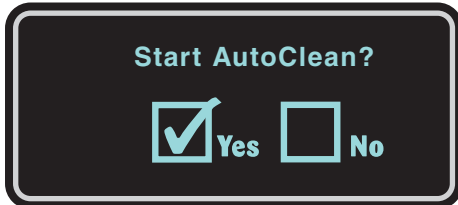

 Verify water is supplied to the oven and press the up  and down  arrow keys or rotate the adjustment knob to select "YES".

 PRESS THE CHEF FUNCTION KEY.



 Press the up  and down  arrow keys or rotate the adjustment knob to select "YES" for the automatic cleaning function.

 PRESS THE CHEF FUNCTION KEY TO CONFIRM THE SETTING AND START THE CLEANING PROGRAM.

THE OVEN WILL BEGIN A 50 MINUTE CLEANING AND RINSE CYCLE.

DISPLAY WILL COUNT DOWN INDICATING TIME REMAINING IN THE CLEANING CYCLE.

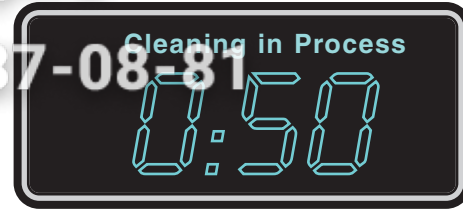

After 10 minutes, a buzzer will sound and Display will show "Open Door/Spray Cleaner".



Wearing safety glasses and rubber gloves, open door, remove the drain screen and spray Combitherm liquid oven cleaner directly into the drain pipe.

Generously spray the interior oven surfaces with an even coat of Combitherm Liquid Oven Cleaner. Spray all built-in components.

Insert the Combitherm Liquid Oven Cleaner spray nozzle directly into the High Pressure Relief Port and spray several times.

ON A WEEKLY BASIS - Loosen the thumb screw(s) and swing Fan Guard Cover Plate toward the back of the oven. Spray the back of the Fan Guard Cover Plate, the oven fan, and the left-hand side of the oven.

When oven door is closed again cleaning cycle will resume for the remaining 40 minutes.



At the end of the cleaning cycle, the oven will beep and the display will indicate the end of the cycle.

Press the start / stop key to stop the buzzer and return the oven to normal operation.

LEAVE DOOR SLIGHTLY OPEN AFTER CLEANING

FORCED RINSING MODE:

If the cleaning cycle is stopped during cleaning, the unit will immediately go into a Forced Rinsing mode for 5 minutes.

If power is lost or the unit is turned off during cleaning, the unit will go into a Forced Rinsing mode when power is restored, or unit is turned back on.



Once the Forced Rinsing is complete "Cleaning Interrupted" will appear on the display.



Press the start/stop key to return the oven to normal operation.

NOTE:

IF THE DOOR IS OPENED DURING THE CLEANING PROCESS, "CLOSE THE DOOR!" WILL APPEAR IN THE DISPLAY.

LEAVE DOOR SLIGHTLY OPEN AFTER CLEANING

PREVENTIVE MAINTENANCE

AUTO CLEAN™ AUTOMATIC CLEANING PROGRAM

(units prior to 3/09)

S-CONTROL OPTION

Remove all food scraps and residue from the oven drain. Remove shelves, side racks and pans and wash separately.

With the oven power ON.



Rotate the **Cooking Mode** dial to the **Cleaning** mode.

CLEANING

“CLN” will appear in the display.



After 1 minute “50” will appear in the display indicating a 50 minute cleaning cycle.



THE OVEN WILL BEGIN A 50 MINUTE CLEANING AND RINSE CYCLE.

DISPLAY WILL COUNT DOWN INDICATING TIME REMAINING IN THE CLEANING CYCLE.

After 10 minutes, a buzzer will sound and display will show “DOR”.



Wearing safety glasses and rubber gloves, open door, remove the drain screen and spray Combitherm liquid oven cleaner directly into the drain pipe.

Generously spray the interior oven surfaces with an even coat of Combitherm Liquid Oven Cleaner. Spray all built-in components.

Insert the Combitherm Liquid Oven Cleaner spray nozzle directly into the High Pressure Relief Port and spray several times.

ON A WEEKLY BASIS - Loosen the thumb screw(s) and swing Fan Guard Cover Plate toward the back of the oven. Spray the back of the Fan Guard Cover Plate, the oven fan, and the left-hand side of the oven.

When oven door is closed again cleaning cycle will resume for the remaining 40 minutes.



At the end of the cleaning cycle “FIN” will appear in the display. Turn the **Cooking Mode** dial to the **OFF** position.

FORCED RINSING MODE:

If the cleaning cycle is stopped after 10 minutes in the cleaning cycle, the unit will immediately go into a Forced Rinsing mode and display “RIN” for 5 minutes.

If power is lost or the unit is turned off during cleaning, the unit will go into a Forced Rinsing mode when power is restored, or unit is turned back on.



After a period of 5 minutes “FIN” will appear in the display.



LEAVE DOOR SLIGHTLY OPEN AFTER CLEANING

SMART CLEAN™ AUTOMATIC CLEANING PROGRAM

(units after to 3/09)



Remove all food scraps and residue from the oven drain.
Remove shelves, side racks and pans and wash separately.



Easy to use Combitherm tablets, Combitherm spray cleaner or a combination of both may be used in this cleaning program.

With the oven power  on



 **PRESS THE CHEF FUNCTION KEY.**

  Rotate the adjustment knob until the Clean symbol is highlighted in the display.

 **PRESS THE CHEF FUNCTION KEY.**

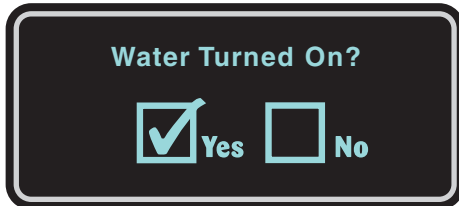

THE CONTROL WILL ASK FOR VERIFICATION FOR A SERIES OF ITEMS BEFORE THE CLEANING FUNCTION CAN BE STARTED:



 Verify water is supplied to the oven and press the up  and down  arrow keys or rotate the adjustment knob to select "YES".

 **PRESS THE CHEF FUNCTION KEY.**







 Press the up  and down  arrow keys or rotate the adjustment knob to make the appropriate selection.

 **PRESS THE CHEF FUNCTION KEY.**

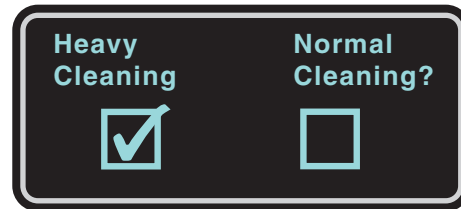
If "Yes" is selected, the oven will begin a 20 minute rinse cycle. Display will count down indicating time remaining in the rinse cycle.

If "No" is selected, the display will indicate a choice of Cleaning levels.



 Press the up  and down  arrow keys or rotate the adjustment knob to make the appropriate selection.

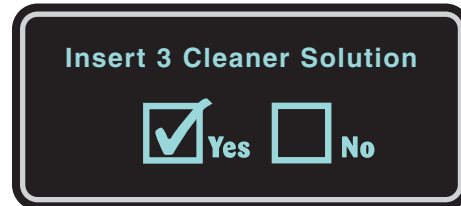

 **PRESS THE CHEF FUNCTION KEY.**

If "Heavy Cleaning" is selected:

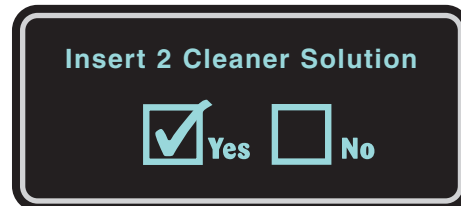

If "Normal Cleaning" is selected:



 Wearing rubber gloves, remove drain screen at bottom of oven and place the appropriate number of cleaning packets in drain opening. Replace drain screen. Press the up  and down  arrow keys or rotate the adjustment knob to select "YES".

 **PRESS THE CHEF FUNCTION KEY.**

PREVENTIVE MAINTENANCE

SMART CLEAN™ AUTOMATIC CLEANING PROGRAM (CONTINUED)

If "Yes" is selected, the display will indicate:

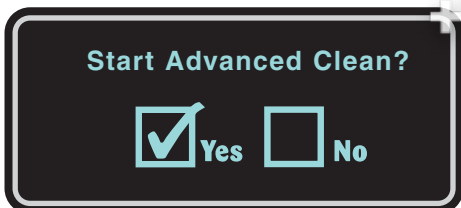

Press the up \triangle and down ∇ arrow keys or rotate the adjustment knob to select "YES".



PRESS THE CHEF FUNCTION KEY TO CONFIRM AND START THE CLEANING PROGRAM.

HEAVY CLEANING WILL BEGIN A 135 MINUTE CLEANING AND RINSE CYCLE.

NORMAL CLEANING WILL BEGIN A 90 MINUTE CLEANING AND RINSE CYCLE.

DISPLAY WILL COUNT DOWN INDICATING TIME REMAINING.

At the end of the SmartClean function, the oven will beep and the display will indicate:



After 3 minutes, beeping will stop. Display will continue to indicate cleaning finished.

Press the start / stop key to stop the buzzer and return the oven to normal operation.

NOTE:

If "No" is selected, the cleaning program will be exited and revert to the last cooking program used.

FORCED RINSING MODE:

If the cleaning cycle is stopped during cleaning, the unit will immediately go into a Forced Rinsing mode for 6 minutes.

If power is lost or the unit is turned off during cleaning, the unit will go into a Forced Rinsing mode when power is restored, or unit is turned back on.



Once the Forced Rinsing is complete "Cleaning Interrupted" will appear on the Display.



Press the start/stop key to return the oven to normal operation.

NOTE:

IF THE DOOR IS OPENED DURING THE CLEANING PROCESS, "CLOSE THE DOOR!" WILL APPEAR IN THE DISPLAY.

ATTENTION:

In a forced rinse situation, circulating water will **not** reach all areas of the oven. The cleaning program will need to be initiated again.

LEAVE DOOR SLIGHTLY OPEN AFTER CLEANING

S-CONTROL OPTION

SMARTCLEAN™ AUTOMATIC CLEANING PROGRAM

Remove all food scraps and residue from the oven drain. Remove shelves, side racks and pans and wash separately.

Wearing rubber gloves, remove drain screen at bottom of oven and place 3-4 cleaning packets in drain opening. Replace drain screen.

With the oven power ON,



rotate the **Cooking Mode** dial to the **Cleaning** mode position.

“CLN” will appear in the display.



After 1 minute “135” will appear in the display indicating a 135 minute cleaning cycle.



THE OVEN WILL BEGIN A 135 MINUTE CLEANING AND RINSE CYCLE.

DISPLAY WILL COUNT DOWN INDICATING TIME REMAINING IN THE CLEANING CYCLE.

At the end of the SmartClean function, the oven will beep and the display will indicate “FIN.”



After 3 minutes, beeping will stop. Display will continue to indicate cleaning finished. Turn the **Cooking Mode** dial to the **OFF** position.

FORCED RINSING MODE:

If the cleaning cycle is stopped after 10 minutes in the cleaning cycle, the unit will immediately go into a Forced Rinsing mode and display “RIN” for 5 minutes.

If power is lost or the unit is turned off during cleaning, the unit will go into a Forced Rinsing mode when power is restored, or unit is turned back on.



After a period of 5 minutes “FIN” will appear in the display.



LEAVE DOOR SLIGHTLY OPEN AFTER CLEANING

SERVICE MODE, GAS RESET AND ERROR CODES

Service Mode Instructions	61
Gas Reset.....	63
Error Codes.....	64
Emergency Operation	67
Return to Main Table of Contents	3

SERVICE MODE, GAS RESET AND ERROR CODES

SERVICE MODE INSTRUCTIONS

The service mode is accessible on units with Standard or Deluxe controls only.

TO ACCESS THE SERVICE MODE

 PRESS THE ON/OFF POWER KEY TO THE ON POSITION.

   PRESS THE COOK TEMP, TIME AND CORE TEMP KEYS SIMULTANEOUSLY.

The service mode will appear in the display.

or

If the unit does not have a core temperature key, an additional black button is located on the back of the display board. Remove the left-hand side of the unit or the front control panel to access it.

TO NAVIGATE IN THE SERVICE MODE

R-Number Menu

The service mode has three menus and will open in the R-Number Menu. This menu is read-only and displays the current temperature (in Celsius), the status of all other sensors and switches, and the most recent errors and their time of occurrence. Rotate the adjustment knob to view the status values.

To view the last 10 errors that have occurred:

- Rotate the adjustment knob until the parameter R38 shows in the display.
- Press the up Δ arrow to display the last 10 errors.
- Press the Chef Function  key to toggle between the error description and the date and time it occurred.
- Press the down ∇ arrow to return to the parameter R38.
- Rotate the adjustment knob to scroll to another parameter.

C-Number Menu

The second menu, the C-Number Menu, is where all sensor values are set. These values are changeable, but should only be changed under the direction of an Alto-Shaam factory representative. **Unauthorized changes can cause damage.** Rotate the adjustment knob to view these values.

D-Number Menu

The third menu, the D-Number Menu, is the diagnostic menu. Here all components can be activated for 10 seconds at a time to aid in troubleshooting the oven. To test a component:

- Rotate the adjustment knob until the desired parameter (D07 Fan [0], D12 Oven Lamp [0], etc.) shows in the display.
- Press the up Δ arrow to highlight the value [0].
- Rotate the adjustment knob to change [0] to [1]. The component will activate for 10 seconds and then the display will return to [0].
- Press the down ∇ arrow to return to the parameter *without* the value highlighted.
- Rotate the adjustment knob to scroll to another parameter.

SERVICE MODE, GAS RESET AND ERROR CODES

vsezip.ru

TO EXIT THE SERVICE MODE

 PRESS THE START KEY TO EXIT FROM THE SERVICE MODE TO THE NORMAL TIME DISPLAY.

MOST COMMONLY USED PARAMETERS

R-Numbers	C-Numbers	D-Numbers
R01 CTC-1 Multi-Point Product Probe	C01 Nom Standby Temp	D01 Delete Errors
R02 CTC-2 Multi-Point Product Probe	C02 Nom Cond Temp	D02 Key Lock
R03 CTC-3 Multi-Point Product Probe	C03 Fan on Cycle	D03 Delete All Programs
R04 CTC-4 Multi-Point Product Probe	C04 Fan off Cycle	D04 Self Test BM (Display Board)
R05 Oven Temp Sensor (N-6)	C05 Cont Steam	D06 Red Fan Speed
R06 Bypass Probe (B-5)	C06 Init	D07 Fan
R07 Condensate Probe (B-3)	C07 Humidity S	D08 Steam Gen 1
R08 Steam Generator (B-4)	C08 Humidity SS	D09 Convection 1
R09 STB Probe (N-8 Immersion Safety Probe)	C09 Humidity Quick	D10 Steam Gen 2
R10 PT-100 Single-Point Product Probe	C10 Humidity Reg	D11 Convection 2
R13 Electronic Temp (Control Temperature)	C11 Humidity Reg g	D12 Oven Lamp
R20 Lower Level-Water Level Probe *	C12 Bitfield 1	D13 Cond Cooling
R21 Upper Level-Water Level Probe *	C13 Bitfield 2	D14 Steam Gen Fill
R23 Door Switch *	C19 PIN	D28 Venting Motor
R29 Software BM (Display Board)	C23 Time Browning	D30 Smoking Element
R30 Software SM (Relay Board)	C24 Door Venting	D31 Solenoid Valve
R31 Software KM (HACCP Board)		
R38 Errors (see R-Number instructions)		

* For these parameters, [0] = Not Satisfied, [1] = Satisfied.

TO REBOOT THE CONTROL

Rebooting the control can sometimes fix an error code or a control that is frozen or confused:

 PRESS AND HOLD THE ON/OFF POWER KEY FOR FIVE SECONDS.

The display will flash and show ST5000 for 20 seconds, followed by “Please Wait”, and then will return to the time and date.

 PRESS THE ON/OFF POWER KEY MOMENTARILY.

The unit will turn on and can be operated normally.

SERVICE MODE, GAS RESET AND ERROR CODES

GAS RESET

There is a gas ignition failure light located on the left hand side of the oven. The oven will not heat when the reset light is on. If the reset light is lit, follow the instructions below:



STOP THE COOKING PROGRAM AND PRESS THE RESET BUTTON LOCATED UNDER THE LIGHT.

CHECK TO MAKE SURE THE GAS LINE IS CONNECTED TO THE UNIT AND THAT ITS VALVE IS TURNED TO THE OPEN/ON POSITION.



PRESS START TO BEGIN THE COOKING PROGRAM.

IF THE LIGHT CONTINUES TO COME ON, REFER TO THE TROUBLESHOOTING TRENDS SECTION OF THIS MANUAL AND FOLLOW "NO IGNITION ON A CALL FOR HEAT".

SERVICE MODE, GAS RESET AND ERROR CODES

ERROR CODES

When the oven malfunctions, an error code will appear in the display.



PRESS THE START KEY TO ACKNOWLEDGE THE ERROR.

The keys that begin to flash represent operational modes that are still usable. Refer to Emergency Operation.

When the oven fault is corrected, the Combitherm will return to normal Operation.

ERROR CODES AND REASONS

Error Code	Display Shows	When does the error occur?	Possible reason
E01	Low Water	ES units only: <ul style="list-style-type: none"> Activated if running in any mode and the water level drops below the low level sensor. Activated if in Standby mode and the water level drops below the low level sensor for 3 minutes. 	<ul style="list-style-type: none"> Water supply is shut off. Low water pressure. Steam generator drain cap is off or loose. Drain pump is not sealing. Faulty or scaled water level probe. Faulty or plugged solenoid valve assembly. Wiring or connection issue.
E02	Control Temp High	Activated if the temperature of the electrical control is higher than 176°F (80°C) for 20 seconds.	<ul style="list-style-type: none"> Cooling fan not operating. Unit is next to a heat producing source (there is less than 20" clearance for the control side). Exhaust hood is not operating (if applicable).
E03	Fan Malfunction	Activated if the motor protection switch is tripped.	<ul style="list-style-type: none"> Motor rotation is backwards. Incorrect power to the unit. Connection problem at X-7 plug on the relay board pins 3-4.
E04	Aux Fan Fault	Auxiliary fan malfunction.	<ul style="list-style-type: none"> Control setup programming error. Contact factory.
E11	Excess Oven Temp	Activated if the oven cavity temperature is higher than 572°F (300°C) for 25 seconds.	<ul style="list-style-type: none"> Connection issue with oven temperature sensor. Convection element contactor is stuck. Faulty oven temperature sensor.
E13	Excess Steam Gen Temp	ES units only: Activated if the temperature of the steam generator probe (B-4) is higher than 248°F (120°C) for 26 seconds.	<ul style="list-style-type: none"> Problem with water level probe. Scale build-up inside steam generator. Steam element contactor is stuck. Connection issue with B-4 probe. Faulty B-4 probe.
		ESi/ESG units only: <ul style="list-style-type: none"> Activated if the position of personality jumper on X-3 is incorrect. Activated if the position of B-4 jumper is incorrect. 	<ul style="list-style-type: none"> Jumper on X-3 is improperly positioned. Should be between 2-8 or, if it is a smoker, between 2-9. Jumper on X-6a is improperly positioned. Should be between 13-14.

SERVICE MODE, GAS RESET AND ERROR CODES

ERROR CODES AND REASONS (continued)

vsezip.ru

+7(812)987-08-81

Error Code	Display Shows	When does the error occur?	Possible reason
E15	Excess Condensate Temp	Activated if the temperature of the condensate probe (B-3) is higher than 212°F (100°C) for 26 seconds.	<ul style="list-style-type: none"> Water supply is shut off. Faulty or plugged solenoid valve (Y-2). Connection issue at B-3 probe. Faulty B-3 probe.
E21	Oven Probe Fault	Activated if oven temperature probe (N-6) is interrupted.	<ul style="list-style-type: none"> Connection issue at N-6 probe. Faulty N-6 probe.
E22	Core Temp Probe Fault	Activated if cooking in Core Temp mode and the CTC sensor measures an excessive temperature.	<ul style="list-style-type: none"> CTC sensor is damaged. 4-point CTC sensor is activated, but 1-point CTC sensor is installed. Cable connection of CTC sensor is damaged. Hardware problem on control unit (SM).
E23	Steam Gen Probe Fault	<p>ES units only: Activated if the steam generator probe (B-4) is interrupted.</p> <p>ESi/ESG units only:</p> <ul style="list-style-type: none"> Activated if the position of personality jumper on X-3 is incorrect. Activated if the position of B-4 jumper is incorrect. 	<ul style="list-style-type: none"> Connection issue at B-4 probe. Faulty B-4 probe. Jumper on X-3 is improperly positioned. Should be between 2-8 or, if it is a smoker, between 2-9. Jumper on X-6a is improperly positioned. Should be between 13-14.
E24	Bypass Probe Fault	Activated if the bypass probe (B-5) is interrupted.	<ul style="list-style-type: none"> Connection issue at B-5 probe. Faulty B-5 probe.
E25	Condensate Probe Fault	Activated if the condensate probe (B-3) is interrupted.	<ul style="list-style-type: none"> Connection issue at B-3 probe. Faulty B-3 probe.
E26	Steam Gen Safety Probe Fault	Activated if the steam generator safety probe (N-8) is interrupted.	<ul style="list-style-type: none"> Connection issue at N-8 probe. Faulty N-8 probe.
E27	Excess Steam Gen Safety Temp	<p>ES units only: Activated if the steam generator safety probe (N-8) measures a temperature in excess of 266°F (130°C).</p> <p>ESi/ESG units only:</p> <ul style="list-style-type: none"> Activated if the position of N-8 jumper is incorrect. 	<ul style="list-style-type: none"> Problem with water level probe. Scale build-up inside steam generator. Steam element contactor is stuck. Connection issue with N-8 probe. Faulty N-8 probe. Jumper on X-6b is improperly positioned. Should be between 1-2.
E29	Probe Short to Frame	Activated if one or more of the temperature sensors were connected to GND for 5 seconds.	<ul style="list-style-type: none"> Connection issue at any of the temperature sensors. Temperature sensor shorted to ground/faulty.

SERVICE MODE, GAS RESET AND ERROR CODES

ERROR CODES AND REASONS (continued)

vsezip.ru

+7(812)987-08-81

Error Code	Display Shows	When does the error occur?	Possible reason
E34	DE (Drain) Pump Failure	Activated if water level did not drop below the low level sensor in the generator during a steam generator flush.	<ul style="list-style-type: none"> • Problem with water level probe. • Scale build-up inside steam generator. • Scale plugging drain pump. • Faulty drain pump.
E35	Venting Error	Activated when vent switch reads open (vent closed) when it should be closed (vent open), or when it reads closed (vent open) when it should be open (vent closed).	<ul style="list-style-type: none"> • Alignment issue between motor cam and micro switch. • Connection issue at micro switch. • Connection issue at control. • Faulty vent switch. • Faulty vent motor.
E36	Steam Temp High	Activated when oven temperature probe (N-6) measures a temperature in excess of 395°F (202°C) when running in Steam mode.	<ul style="list-style-type: none"> • Water supply is shut off while unit is running in Steam or Combi mode. • Plugged or faulty Y-1 solenoid. • Obstruction between Y-01 solenoid and water inlet.
E80	ID Error	Control is unable to detect whether unit is gas or electric.	<ul style="list-style-type: none"> • Connection issue at X-3 personality jumper. • Faulty control.
E81	Program Memory Error	Temperature value or time value of a program step is not allowed.	<ul style="list-style-type: none"> • Program was generated in °C and control has been switched to °F. • Program was generated in °F and control has been switched to °C.
E82	WP Error	Temperature value or time value of current cooking algorithm is out of allowed array.	<ul style="list-style-type: none"> • Delete program and reinstall.
E83	Algo Error	Cooking algorithm sent by operating module (BM) is unknown to control unit (SM).	<ul style="list-style-type: none"> • Software versions of control unit and operating module are incompatible. • Software error in operating module.
E96	Connection Error	No or bad communication between control unit (SM) and operating module (BM).	<ul style="list-style-type: none"> • Connection issue at ribbon cable on display or relay board. • Faulty ribbon cable. • Software versions of control unit and operating module are incompatible.

SERVICE MODE, GAS RESET AND ERROR CODES

EMERGENCY OPERATION

In the event of an error code, the Combitherm may be operated on a limited basis. Error conditions under which continued operation can be conducted are indicated by “Yes” in the chart shown below.

When the oven malfunctions, an error code will appear in the display.



PRESS THE START KEY TO ACKNOWLEDGE THE ERROR.

The keys that begin to flash represent operational modes that are still usable.



SELECT AND PRESS ONE OF THE COOKING MODES INDICATED.

The oven control will only respond to the mode keys that are flashing.

SET THE OVEN CONTROLS AS IF OPERATING UNDER NORMAL CIRCUMSTANCES.

Depending on the error code involved, oven function, such as temperature range, may be limited.



PRESS THE START KEY TO BEGIN THE COOKING PROCESS.



PRESS THE START KEY WHEN THE TIMER EXPIRES.

When the oven fault is corrected, the Combitherm will return to normal Operation.

CONTINUED OPERATION UNDER ERROR CONDITIONS

Error Code	Display Shows	ES	ESi/ESG	Steam Mode	Combination Mode	Convection Mode	Retherm Mode
E01	Low Water	Yes	N/A	No	No	To 365°F	No
E02	Control Temp High	Yes	Yes	Yes	To 284°F	To 284°F	To 284°F
E03	Fan Malfunction	N/A	N/A	—	—	—	—
E04	Aux Fan Fault	Yes	Yes	Yes	To 284°F	To 284°F	To 284°F
E11	Excess Oven Temp	Yes	Yes	No	No	No	No
E13	Excess Steam Gen Temp	Yes	N/A	No	No	No	No
E15	Excess Condensate Temp	Yes	Yes	No	No	To 356°F	No
E21	Oven Probe Fault	Yes	Yes	212°F only	No	No	No
E22	Core Temp Probe Fault	Yes	Yes	Yes	Yes	Yes	Yes
E23	Steam Gen Probe Fault	Yes	N/A	Yes	Yes	Yes	Yes
E24	Bypass Probe Fault	Yes	Yes	To 210°F	No	Yes	No
E25	Condensate Probe Fault	Yes	Yes	Yes	To 356°F	To 356°F	To 320°F
E26	Steam Gen Safety Probe Fault	Yes	N/A	Yes	Yes	Yes	Yes
E27	Excess Steam Gen Safety Temp	Yes	N/A	No	No	No	No
E29	Probe Short to Frame	Yes	Yes	No	No	No	No
E34	DE (Drain) Pump Failure	Yes	N/A	Yes	Yes	Yes	Yes
E35	Venting Error	Yes	Yes	Yes	Yes	Yes	Yes
E36	Steam Temp High	N/A	Yes	No	No	Yes	No
E80	ID Error	Yes	Yes	Yes	Yes	Yes	Yes
E81	Program Memory Error	Yes	Yes	Yes	Yes	Yes	Yes
E82	WP Error	Yes	Yes	Yes	Yes	Yes	Yes
E83	Algo Error	Yes	Yes	Yes	Yes	Yes	Yes
E96	Connection Error	Yes	Yes	No	No	No	No

TROUBLESHOOTING TREES

ESG Units	
Unit Dead — No Display and No Operation	69
Unit Does Not Run When Start Is Pressed	70
No Motor Operation	71
No Ignition on a Call for Heat (K-2 Contactor Pulled In)	72
No Steam Production in Steam Mode	73
No Heat in Convection Mode	74
No Steam in Combination Mode	75
No Convection Heat in Combination Mode	76
No Smoke Production	77
 Return to Main Table of Contents	 3

NOTE: Troubleshooting Guides reflect all counter top models. When working on a 20.20 there are additional elements, motors, and contactors. The following components are wired to operate together on a 20.20:

- K-41 and K-43 Convection Element Contactors
- K-42 and K-44 Convection Element Contactors
- K-51 and K-71 High Speed Motor Contactors
- K-52 and K-72 Low Speed Motor Contactors

TROUBLESHOOTING TREE

ESG — Unit Dead — No Display and No Operation

vsezip.ru

+7(812)987-08-81

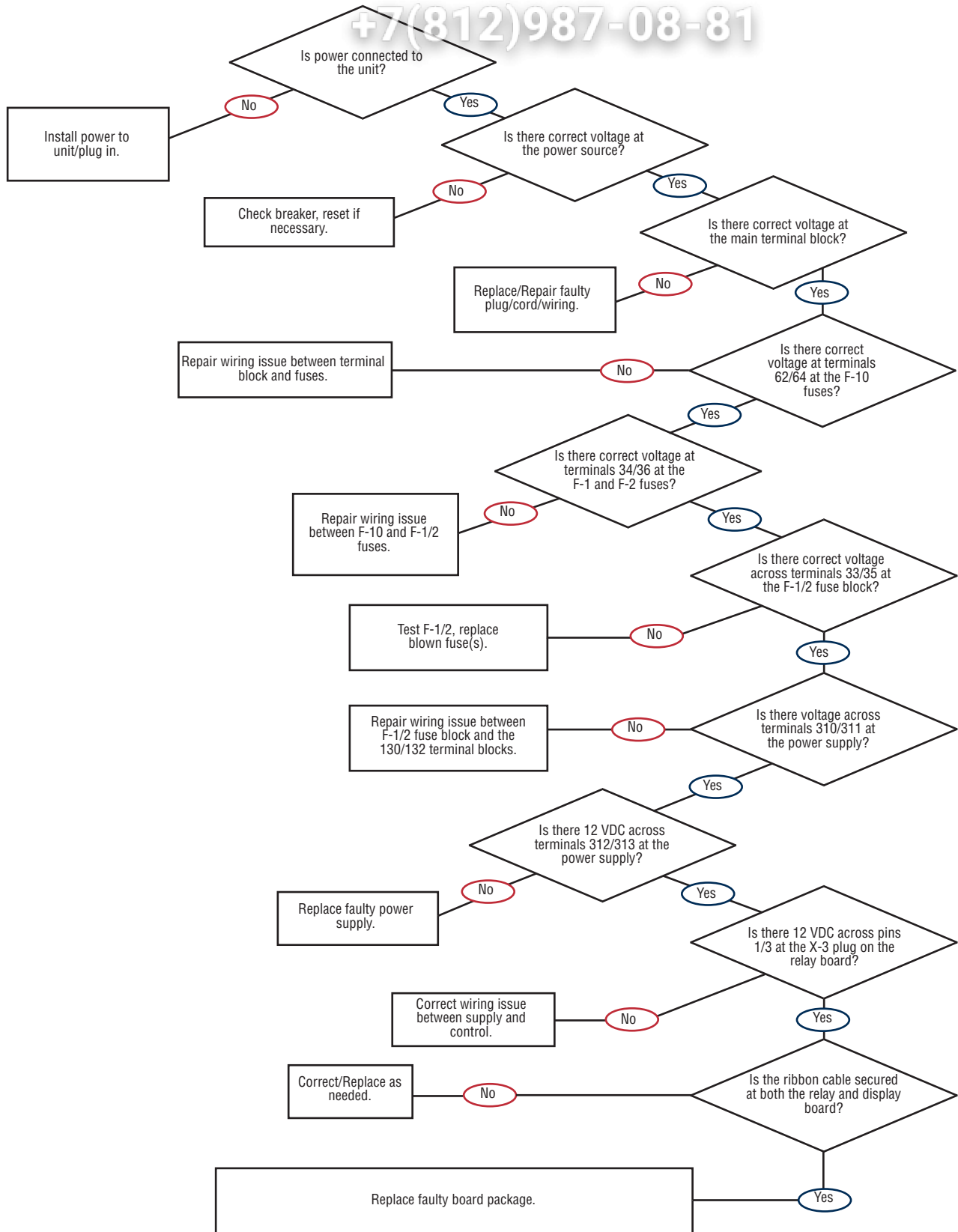

TRUBLESHOOTING TREES

ESG — Unit Does Not Run When Start Is Pressed

vsezip.ru

+7(812)987-08-81

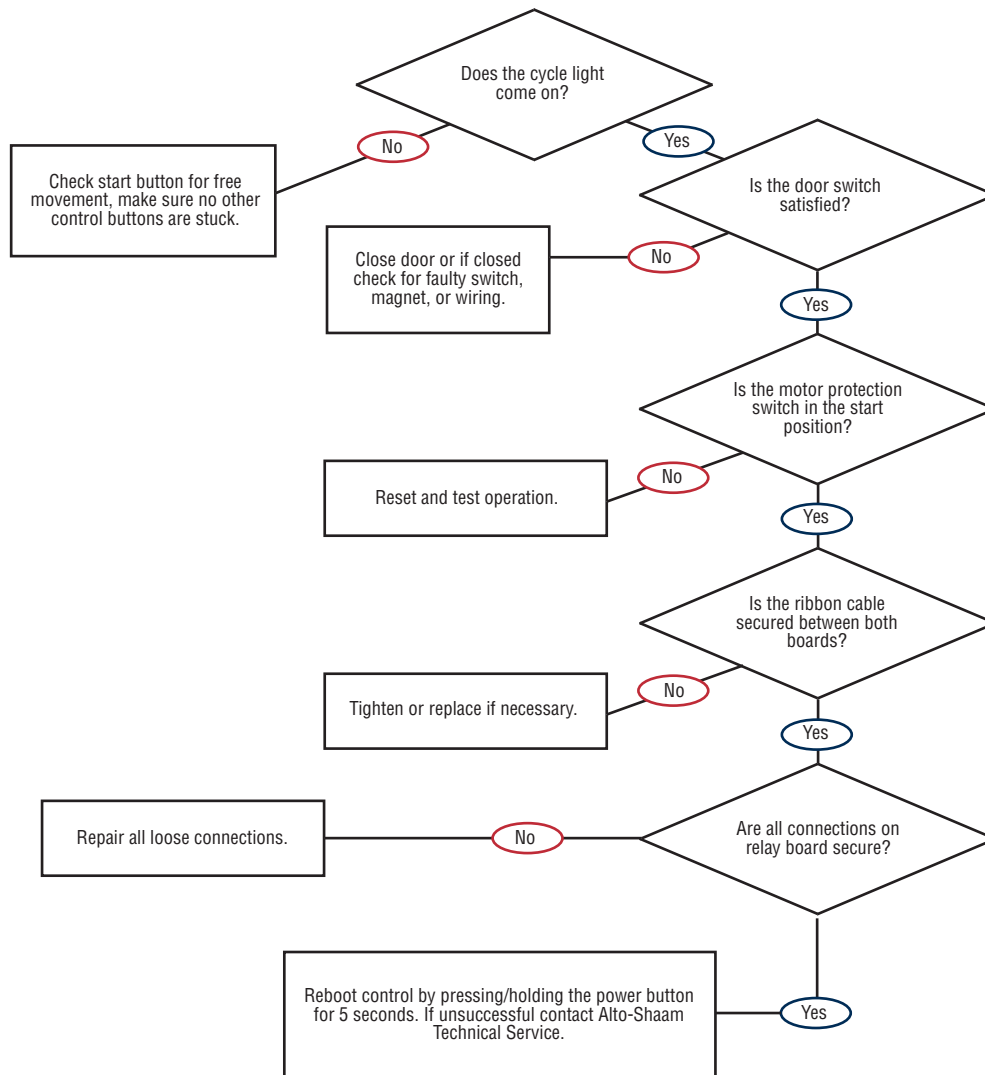

TROUBLESHOOTING TREE

ESG — No Motor Operation

vsezip.ru

7(812)987-08-81

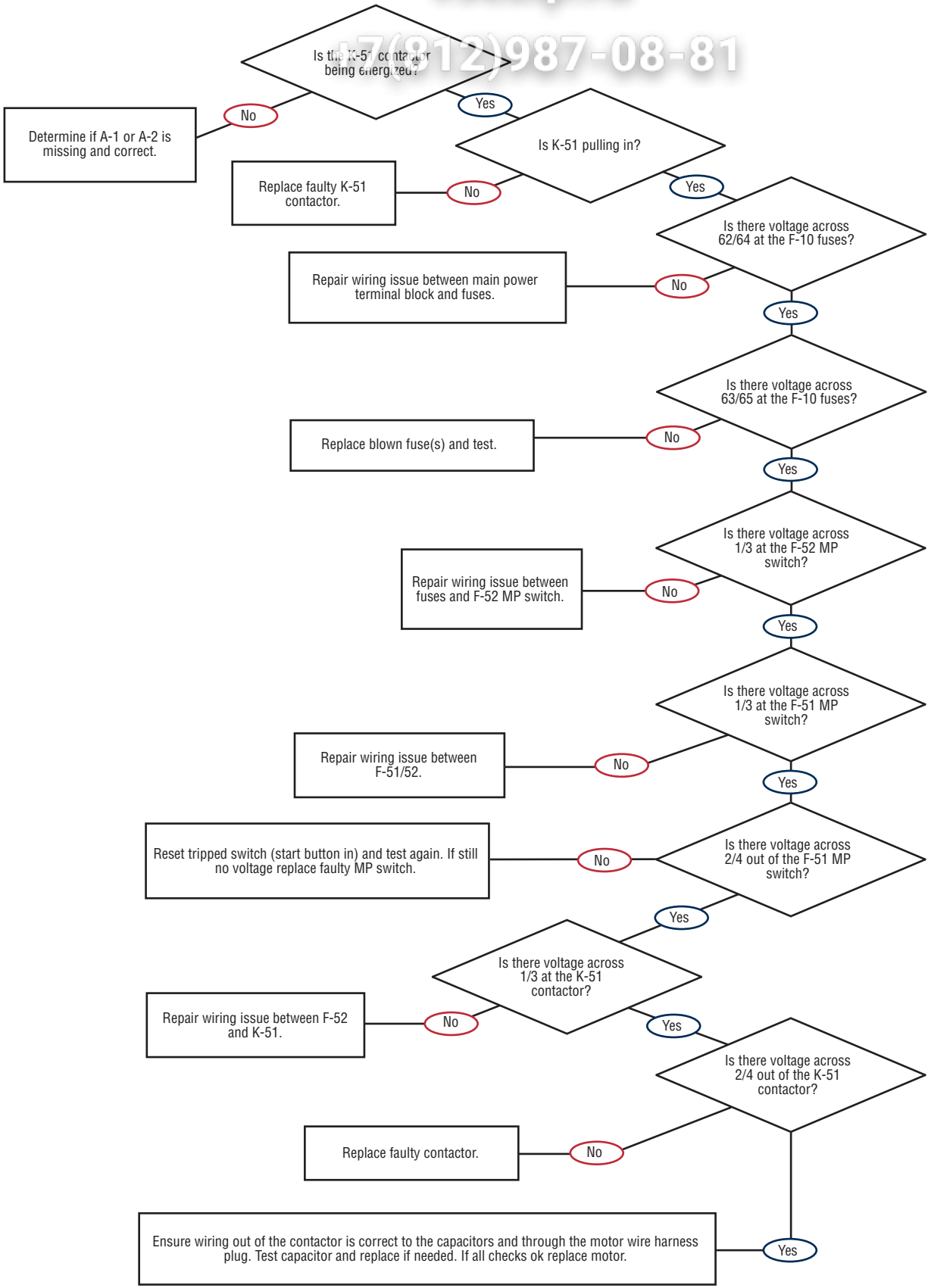

TR TROUBLESHOOTING TREES

ESG — No Ignition on a Call for Heat (K-2 Contactor Pulled In)

vsezip.ru

+7(812)987-08-81

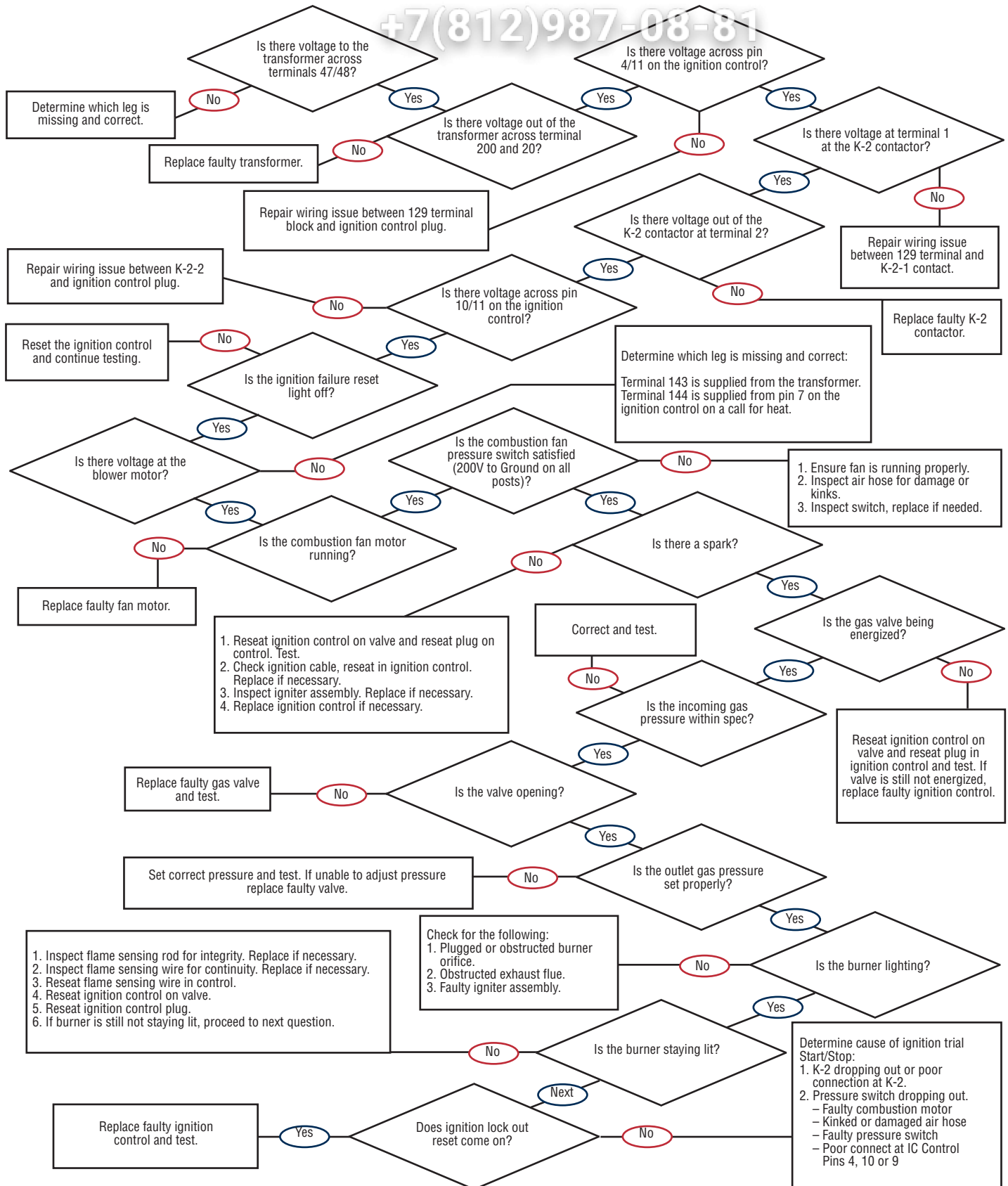

TROUBLESHOOTING

ESG — No Steam Production in Steam Mode

vsezip.ru

+7(812)987-08-81

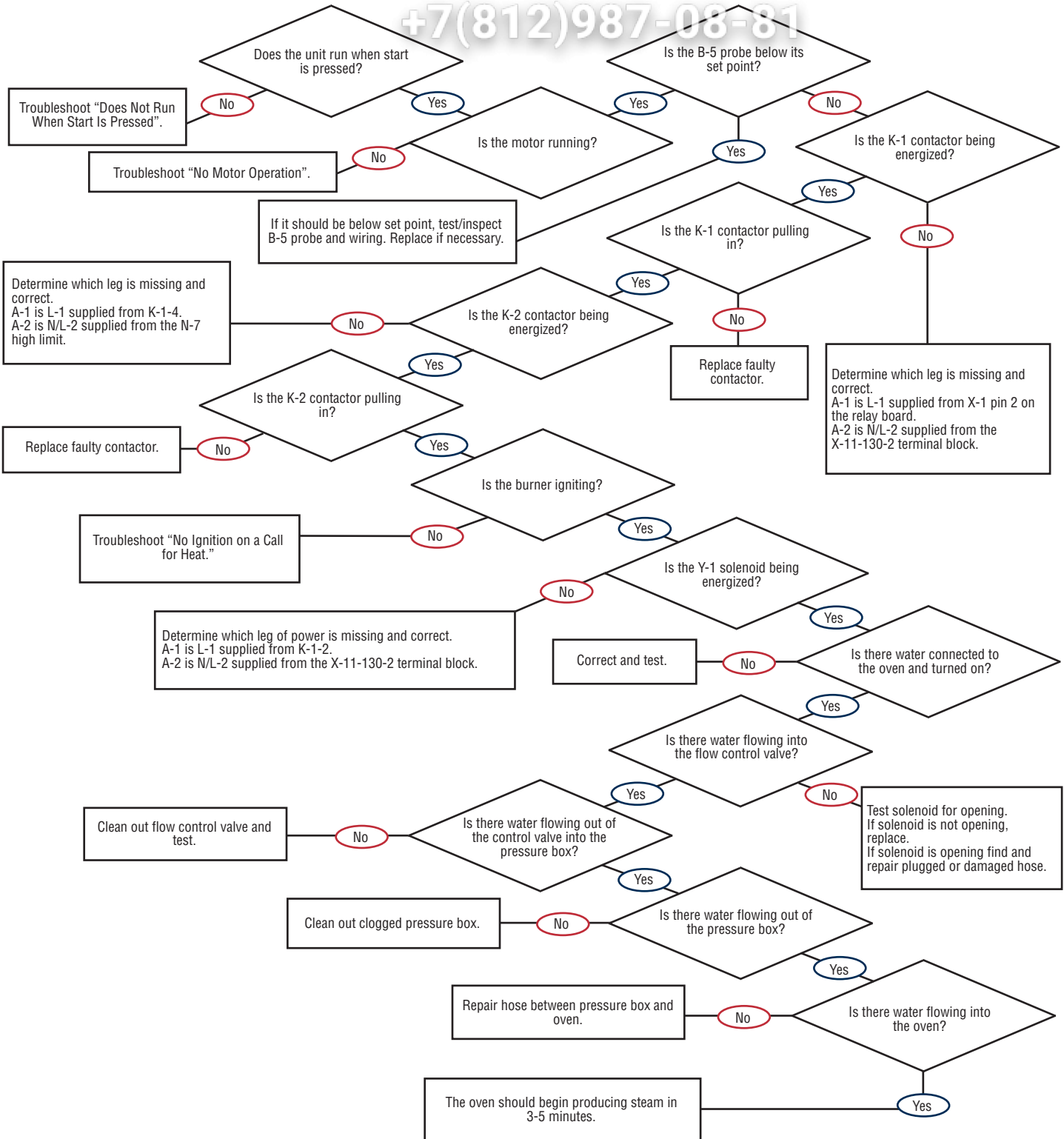

TRUBLESHOOTING TREES

ESG — No Heat in Convection Mode

vsezip.ru

+7(812)987-08-81

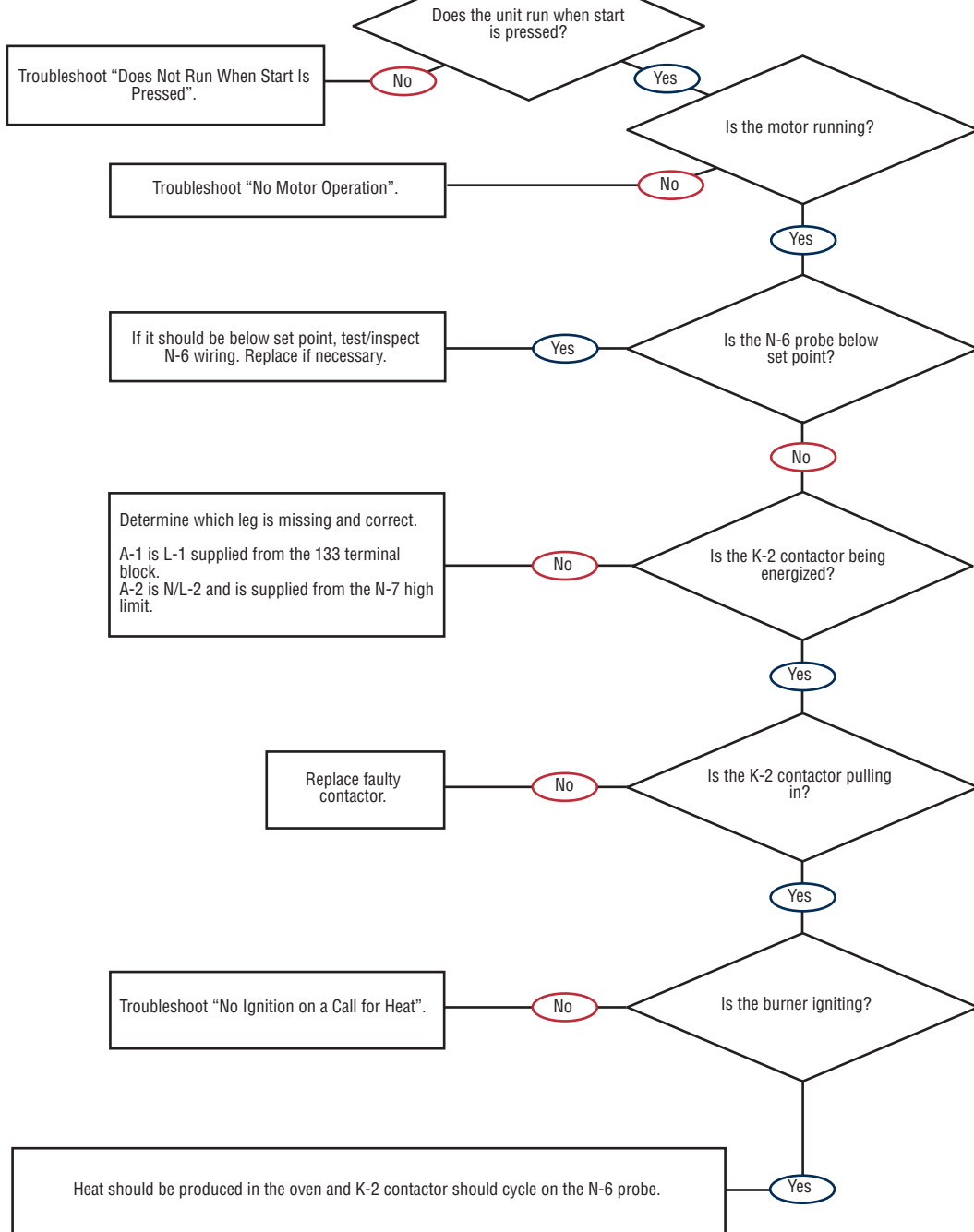

TROUBLESHOOTING TRENDS

ESG — No Steam in Combination Mode

vsezip.ru

+7(812)987-08-81

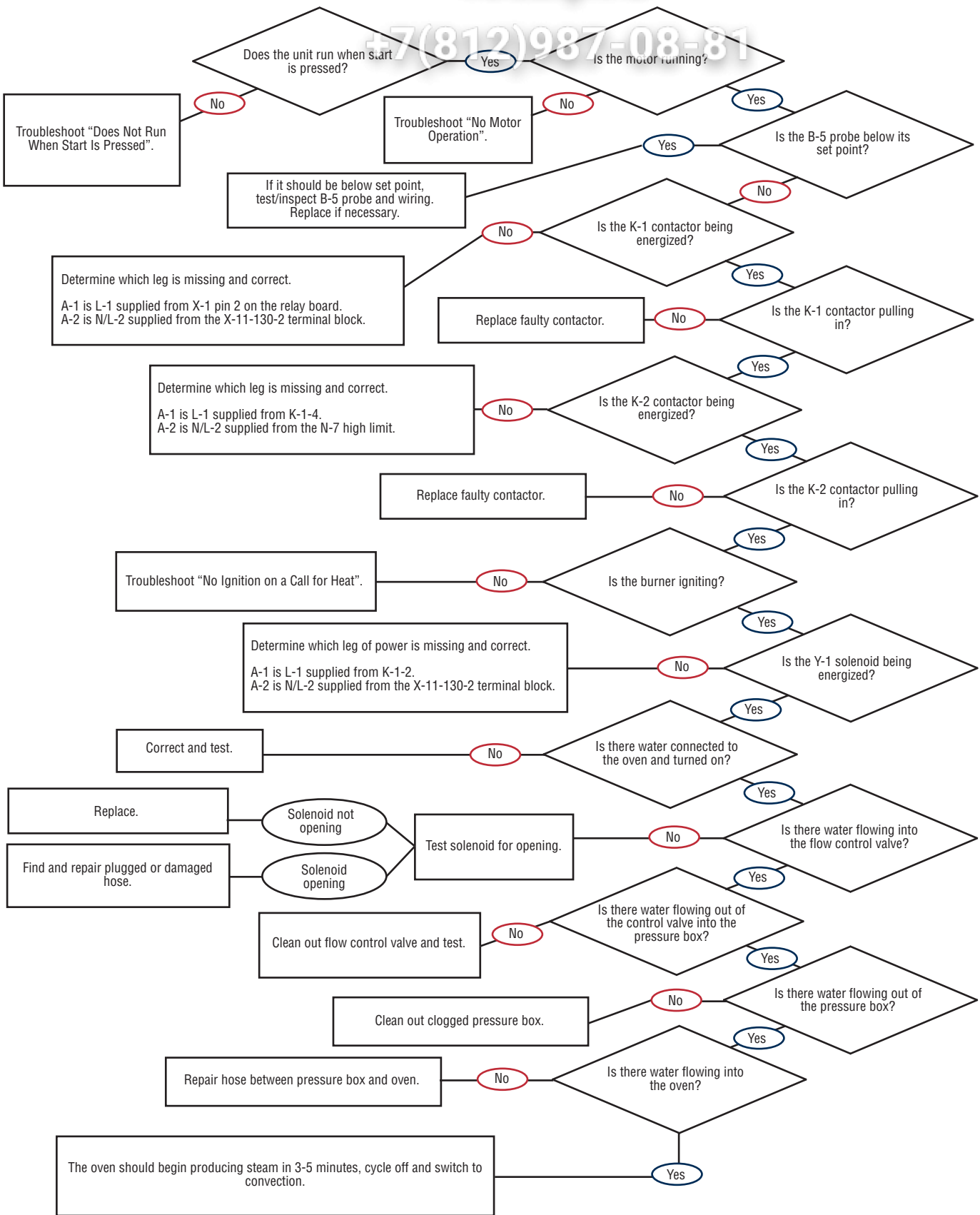

TR TROUBLESHOOTING TREES

ESG — No Convection Heat in Combination Mode

vsezip.ru

+7(812)987-08-81

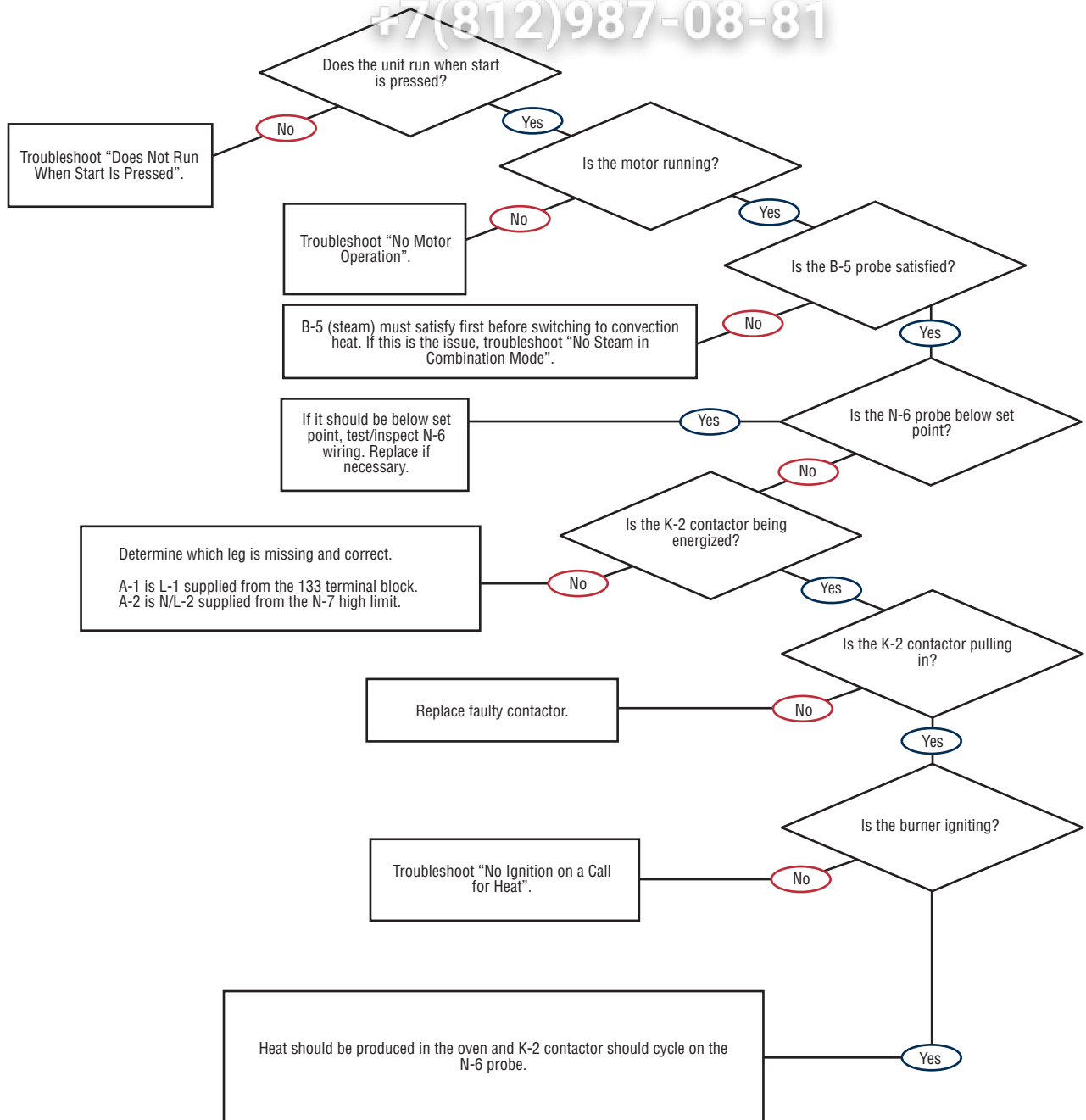

NOTE: If at any time the B-5 bypass probe falls below set point, the unit will drop out of the convection mode and begin steam production running in the steam mode. Steam (B-5 probe) always takes priority over convection (N-6 probe).

TROUBLESHOOTING TREE

ESG — No Smoke Production

vsezip.ru

+7(812)987-08-81

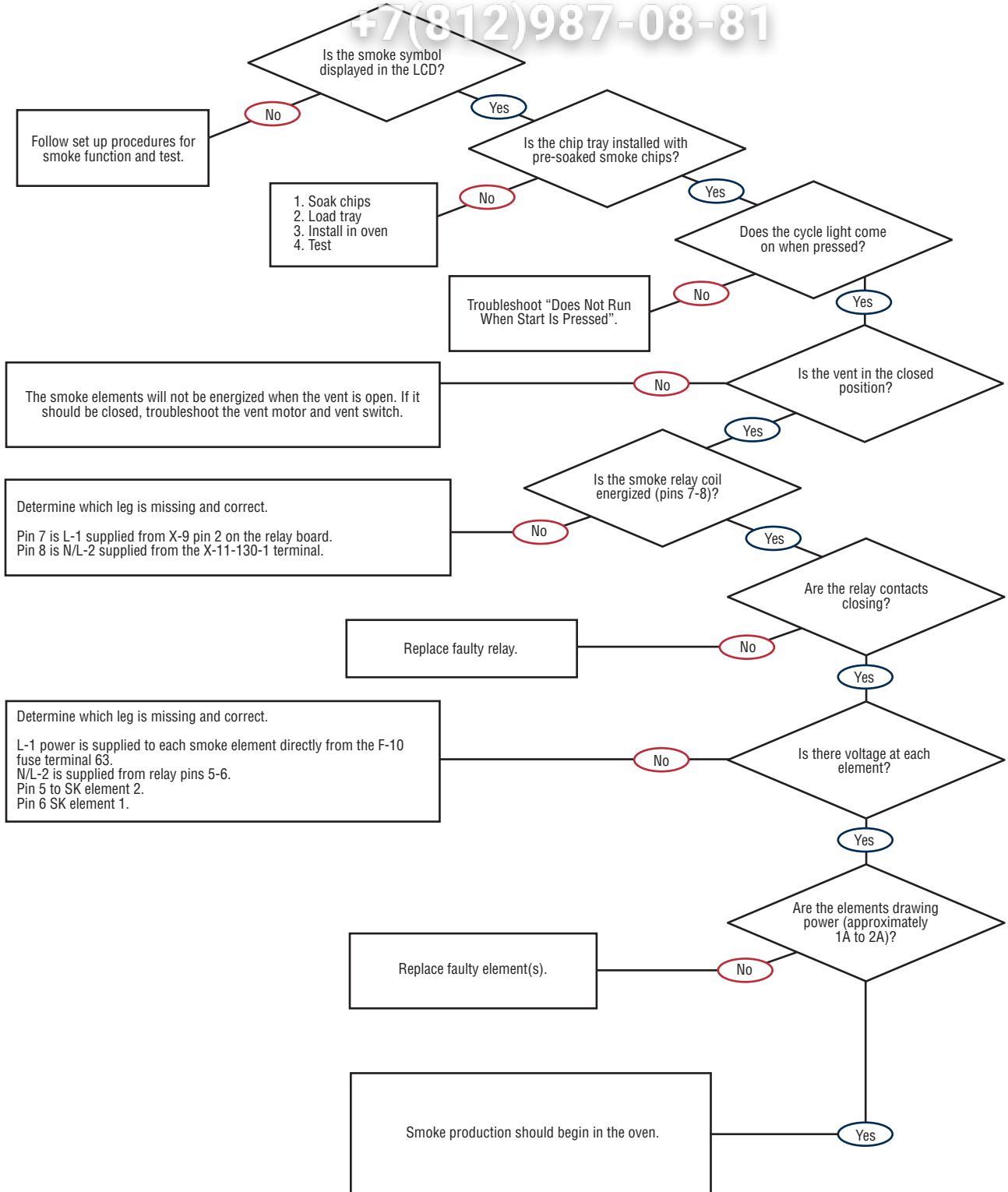

COMBITHERM PARTS

Rear Service Parts — Auto Clean, SmartClean.....	79
Left-Hand Side Service Parts — Auto Clean, SmartClean.....	80
Rear and Left-Hand Side Service Parts — CombiClean.....	81
CombiClean Plumbing Hoses.....	83
Wash Nozzles.....	88
Condensation Tank.....	89
Sprayer Holder Assembly.....	90
Oven Light Assembly.....	90
Smoker Box Assembly.....	90
Hinge Assemblies.....	91
Standard Control.....	92
Deluxe Control.....	93
Simple Control.....	94
Routing of Ribbon Cable — Tabletop.....	95
Routing of Ribbon Cable — Floor-Standing.....	96
Combitherm Motor.....	97
SmartClean Motor Pump Assembly.....	97
Pressure Box Assembly.....	98
Countertop Mechanical Parts.....	99
Floor-Standing Mechanical Parts.....	102
Countertop Right-Hand Door Assembly (Single Latch).....	104
Floor-Standing Right-Hand Door Assembly (Single Latch).....	105
Countertop Right-Hand Door Assembly (Dual Latch).....	106
Floor-Standing Right-Hand Door Assembly (Dual Latch).....	107
Countertop Left-Hand Door Assembly (Single Latch).....	108
Countertop Recessed Door Assembly (Single Latch).....	109
Countertop Recessed Door Track Assembly.....	110
Floor-Standing Recessed Door Assembly.....	111
Floor-Standing Recessed Door Track Assembly.....	112
Countertop Electrical Assembly.....	113
Floor-Standing Electrical Assembly.....	114
Return to Main Table of Contents.....	3

PARTS INFORMATION **Всё в одном**

REAR SERVICE PARTS — AUTO CLEAN, SMART CLEAN

vsezip.ru

+7(812)987-08-81

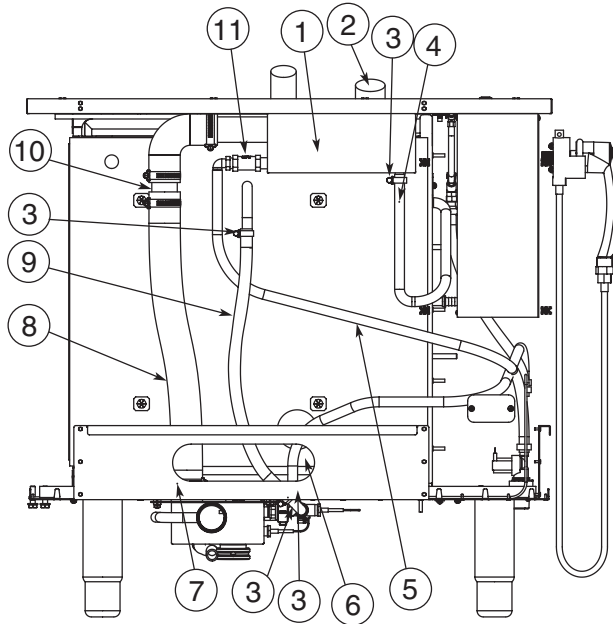

Item	Part	Description	Qty.
1	5005009	Pressure Box Assembly, 6.10ESG, 10.10ESG, 7.14ESG, 10.20ESG, 12.18ESG	1
	5008633	Pressure Box Assembly, 20.20ESG	1
2	VA-27978	Low Pressure Relief Valve	1
	SA-29171	Seal, Low Pressure Relief Valve	1
3	FT-28124	Worm Gear, 1/2"	13
4	HO-27893	Hose, Injector	1
5	HO-22255	Hose, Pressure Box	1
6	HO-22255	Hose, Condenser Cooling	1
7	CL-22234	Clamp, Worm Gear, 40-60, Hose	8
8	HO-27891	Hose, Condenser	1
9	HO-2957	Hose, Bypass	1
10	FT-27406	Vent, Condensate Tank	2
11	VA-25549	Flow Control, .13 GPM	1

LEFT-HAND SIDE SERVICE PARTS — AUTO CLEAN, SMART CLEAN

vsezip.ru

+7(812)987 08 81

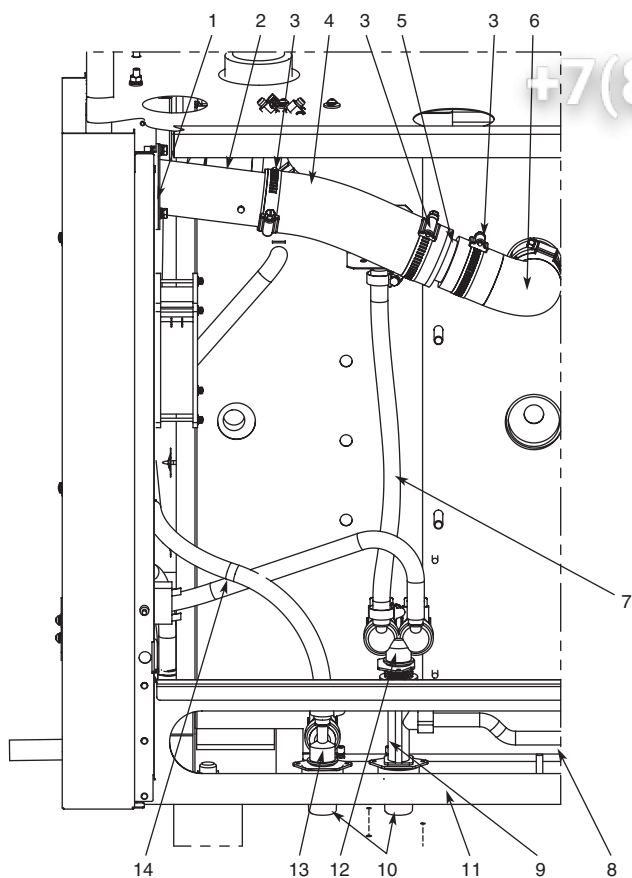

Item	Part	Left-Hand Side Service Parts Description	Qty.
1	SA-28190	Seal, Vent Motor	1
2	VA-26838	Vent, Motor with Switch	1
3	CL-22234	Clamp, Worm Gear, 40-60, Hose	8
4	HO-27891	Hose, Air Intake	1
5	FT-27406	Vent, Condensate Tank	2
6	EB-27207	Washer Drain Support Elbow	2
7	HO-22255	Cleaning Hose	1
8	HO-27300	Hose, Hand Shower Connection, 6.10ESG, 10.10ESG, 10.20ESG, 12.18ESG	1
	HO-27203	Hose, Hand Shower Connection, 7.14ESG	1
9	TE-27204	Connector	1
10	NP-27538	Valve Holder Assembly	2
	SA-28149	Seal for Valve Holder Assembly	2
11	NU-22286	M4-0.7 Hex Nut 18-8	4
12	VA-34461	Valve, Double Port, 120V	1
	VA-34045	Valve, Double Port, 208-240V	1
13	VA-34344	Valve, Single Port, 120V	1
	VA-34300	Valve, Single Port, 208-240V	1
14	HO-22255	Hose, Pressure Box	1

PARTS INFORMATION

Общепит

REAR AND LEFT-HAND SIDE SERVICE PARTS — COMBICLEAN

vsezip.ru

+7(812)987-08-81

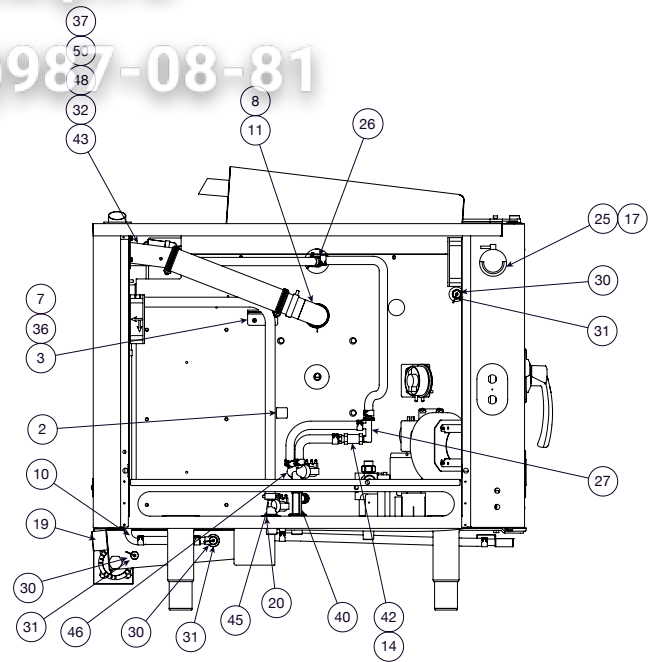
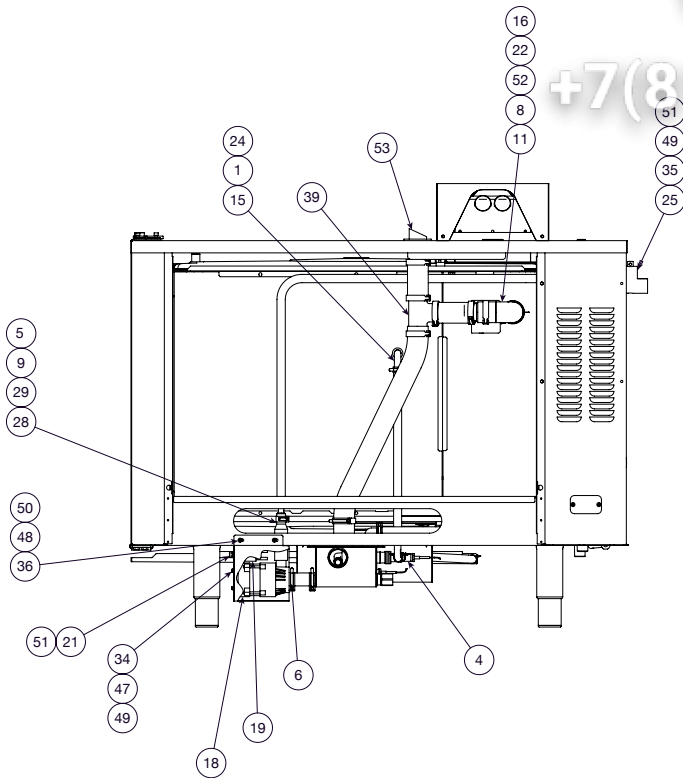

Item	Part	Service Parts Description	Qty.
1	1008395	Conical Washer	1
2	1008846	Bracket, Hose Guide	1
3	1010730	Bracket, Hose Guide	1
4	PB-28095	Condensor Tank	1
5	HO-27892	Hose, 7/8"	1
6	BG-29085	Bearing, Flanged Sleeve	2
7	BU-28391	Bushing, Socket Membrane	1
8	CM-29039	Clamp, Hose, 55mm	4
9	CM-29301	Clamp, Hose, 23mm	1
10	EB-22221	Elbow	1
11	EB-27207	Washer, Drain Support	2
12	FR-22496	Rubber "C" Gasket (not shown)	1.5'
13	FT-27406	Coupling, without Stop, 1.5"	1
14	FT-29124	Fitting, 1/2" Barb to 3/8" NPT Adaptor	1
15	FT-29263	Fitting	1
16	FT-29273	Fitting, Low Pressure	1
17	HO-27203	Hose, Hand Shower, 46" long	1
18	MO-34635	Pump, Circulation, 110V	1
	MO-34636	Pump, Circulation, 208-240V	1
19		Capacitor – supplied with Motor MO-34635	1
20	NP-27538	Valve Holder Assembly	2
21	NU-22292	Hex Nut	1
22	NU-22759	Hex Nut	1
23*	NU-27107	Hex Nut Cap	1
24	NU-28710	Hex Jam Nut	1
25	PB-26960	Sprayer Holder	1
26	PB-27838	Plumbing, Nylon, 1/2" Y	1
27	PB-29162	Manifold, Injection Tube	1

Item	Part	Service Parts Description	Qty.
28	PB-29289	Reducer	1
29	PB-29489	Coupler, 1/2" to 1/2"	1
30	PR-33724	Thermocouple	1
31	SA-25061	Thermocouple Probe	1
32	SA-26890	Seal, Vent Motor	1
33	SA-28149	O-Ring	2
34	SC-22273	PH Pan Head Screw	2
35	SC-22766	Phillips Pan Head Screw	4
36	SC-22779	PH Pan Head Screw	5
37	SC-22926	HHCS	3
38*	SL-3836	Sleeve, Grommet Edging	1.1'
39	TE-24257	1-3/4" OD Copper Tee	1
40	TE-27204	Connector	1
41	TU-22256	Tubing, Black PVC	5'
42	VA-25549	Valve, Flow Control	1
43	VA-26838	Vent Motor with Switch	1
44*	VA-29262	Low Pressure Valve	1
45	VA-34344	Valve, Single Port, 120V	1
	VA-34300	Valve, Single Port, 208-240V	1
46	VA-34461	Valve, Double Port, 120V	1
	VA-34045	Valve, Double Port, 208-240V	1
47	WS-22294	Washer, Flat	2
48	WS-22295	Washer, Flat	12
49	WS-22300	Washer, Split Lock	2
50	WS-22301	Washer, Split Lock	12
51	WS-24396	Washer, Serrated Bevel	1
52	WS-25092	Washer, Conical	1
53	5004589	Vent Holder Assembly	1

REAR & LEFT-HAND SIDE SERVICE PARTS — 20.20ESG COMBICLEAN

vsezip.ru

+7(812)987-18-81

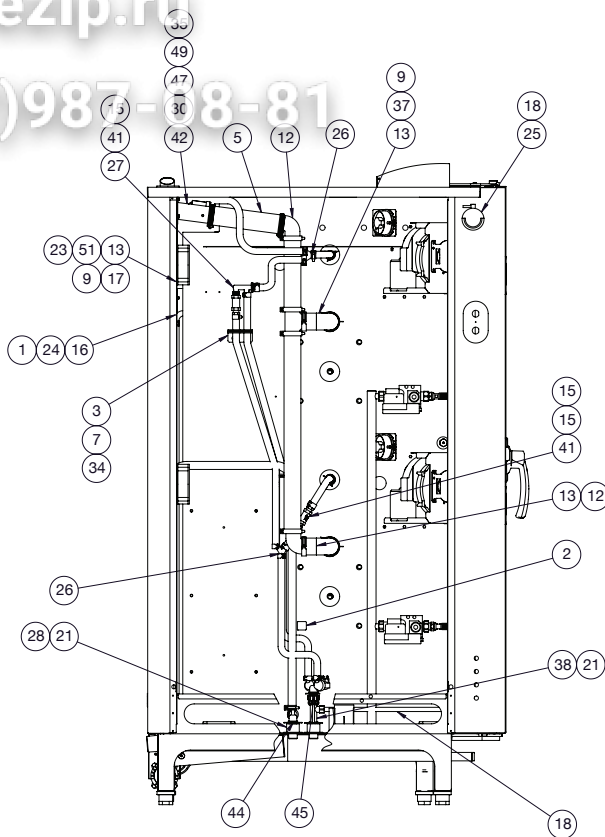
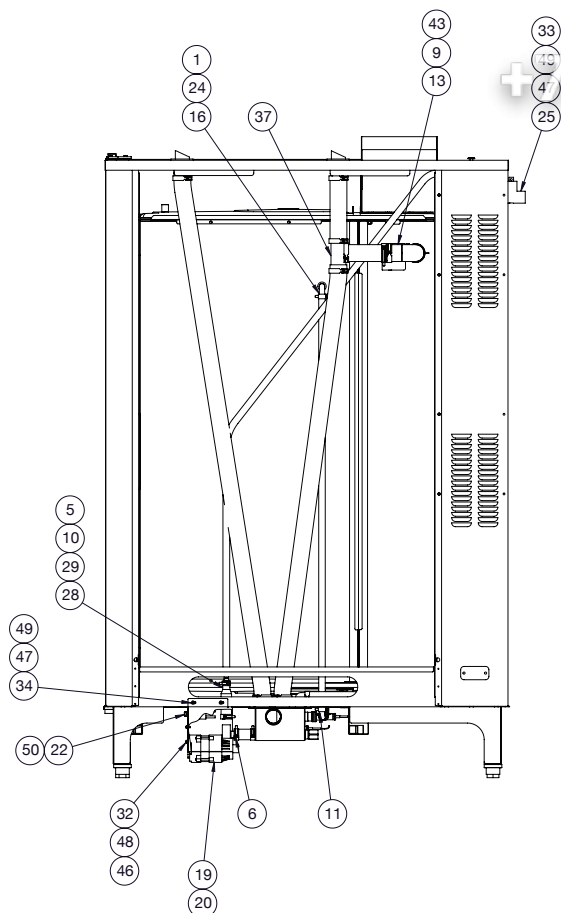

Item	Part	Service Parts Description	Qty.
1	1008395	Conical Washer	1
2	1008846	Bracket, Hose Guide	1
3	1010730	Bracket, Hose Guide	2
4	PB-28968	Condensor Tank – 20.20ESG	1
5	HO-27892	Hose, 7/8"	1
6	BG-29085	Bearing, Flanged Sleeve	2
7	BU-28391	Bushing, Socket Membrane	2
8	CM-29037	Clamp, Hose, 32mm	1
9	CM-29039	Clamp, Hose, 55mm	6
10	CM-29301	Clamp, Hose, 23mm	1
11	EB-22221	Elbow	1
12	EB-23949	Elbow, 1-1/2, 90 Degree, Copper	2
13	EB-27207	Washer, Drain Support	3
14	FR-22496	Rubber "C" Gasket (not shown)	1
15	FT-29124	Fitting, 1/2" Barb to 3/8" NPT Adaptor	1
16	FT-29263	Fitting	1
17	FT-29273	Fitting, Low Pressure	1
18	HO-27301	Hose, Hand Shower	1
19	MO-34635	Pump, Circulation, 110V	1
	MO-34636	Pump, Circulation, 208-240V	1
20		Capacitor – supplied with Motor MO-34635	1
21	NP-27538	Valve Holder Assembly	2
22	NU-22292	Hex Nut	1
23	NU-22759	Hex Nut	1
24	NU-28710	Hex Jam Nut	1
25	PB-26960	Sprayer Holder	1

Item	Part	Service Parts Description	Qty.
26	PB-27838	Plumbing, Nylon, 1/2" Y	2
27	PB-29162	Manifold, Injection Tube	1
28	PB-29289	Reducer	1
29	PB-29489	Coupler, 1/2" to 1/2"	1
30	SA-26890	Seal, Vent Motor	1
31	SA-28149	O-Ring	2
32	SC-22273	PH Pan Head Screw	2
33	SC-22766	Phillips Pan Head Screw	4
34	SC-22779	PH Pan Head Screw	7
35	SC-22926	HHCS	3
36	SL-3836	Sleeve, Grommet Edging (not shown)	1.1'
37	TE-24257	1-3/4" OD Copper Tee	2
38	TE-27204	Connector	1
39	TU-22256	Tubing, Black PVC	15'
40	TU-28163	Tubing, Vacuum (not shown)	13'
41	VA-27837	Valve, Flow Control, .35 gpm	2
42	VA-26838	Vent Motor with Switch	1
43	VA-29262	Low Pressure Valve	1
44	VA-34344	Valve, Single Port, 120V	1
	VA-34300	Valve, Single Port, 208-240V	1
45	VA-34461	Valve, Double Port, 120V	1
	VA-34045	Valve, Double Port, 208-240V	1
46	WS-22294	Washer, Flat	2
47	WS-22295	Washer, Flat	14
48	WS-22300	Washer, Split Lock	2
49	WS-22301	Washer, Split Lock	14
50	WS-24396	Washer, Serrated Bevel	1
51	WS-25092	Washer, Conical	1

PARTS INFORMATION **Всёzip.ru**

PLUMBING HOSES — 6.10ESG

vsezip.ru
+7(812)987-08-81

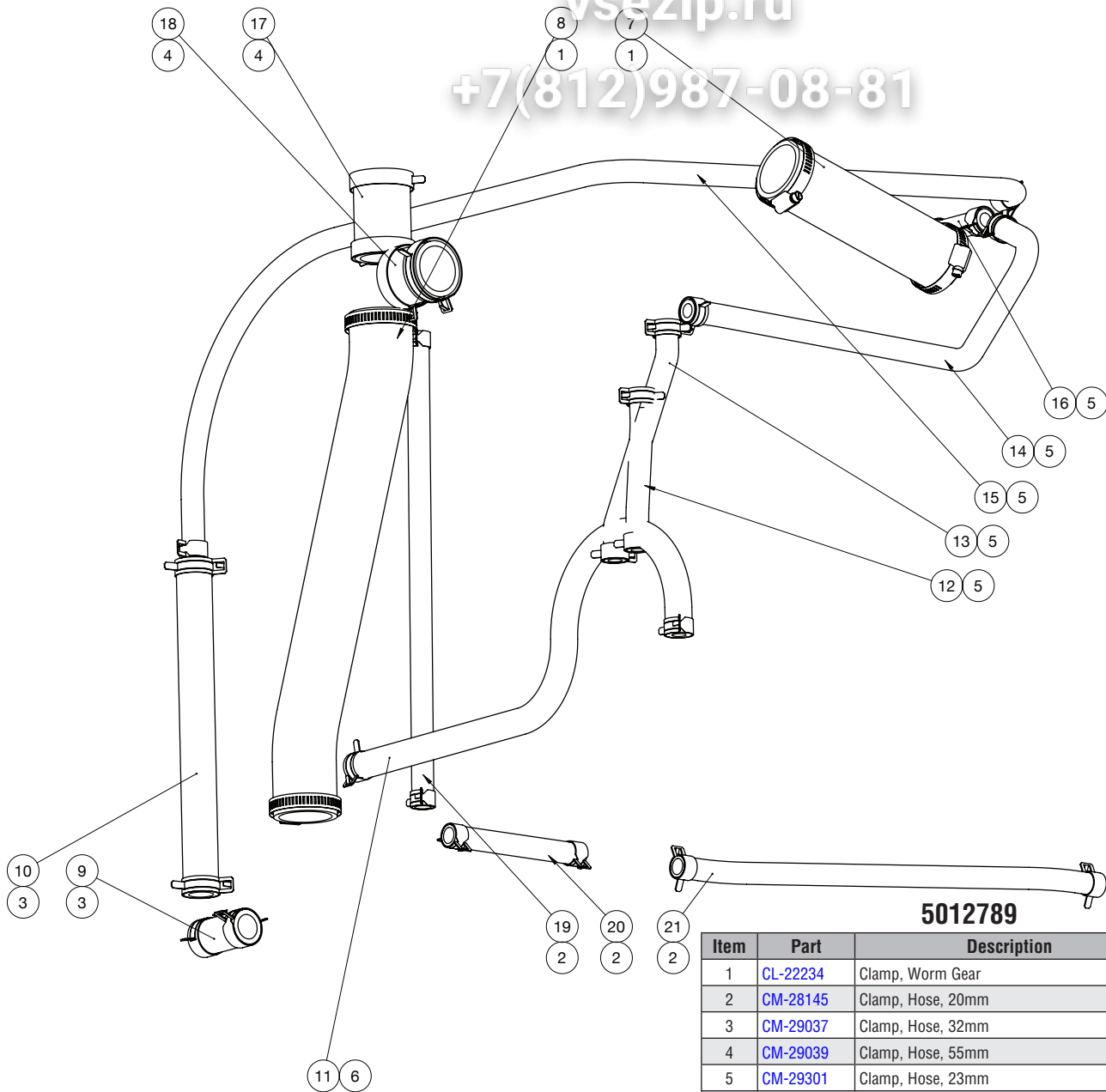

5012789

Item	Part	Description	Qty.
1	CL-22234	Clamp, Worm Gear	4
2	CM-28145	Clamp, Hose, 20mm	6
3	CM-29037	Clamp, Hose, 32mm	4
4	CM-29039	Clamp, Hose, 55mm	4
5	CM-29301	Clamp, Hose, 23mm	10
6	FT-28124	Clamp, Hose, 24mm	2
7	HO-27891	Hose, 1-7/8", 8.5" long	1
8	HO-27891	Hose, 1-7/8", 18" long	1
9	HO-27892	Hose, 7/8", 2.5" long	1
10	HO-27892	Hose, 7/8", 12" long	1
11	HO-27893	Hose, 1/2", 30" long	1
12	HO-27890	Hose, 1/2" Hi-Temp Silicon, 11" long	1
13	HO-27890	Hose, 1/2" Hi-Temp Silicon, 13" long	1
14	HO-27890	Hose, 1/2" Hi-Temp Silicon, 17" long	1
15	HO-27890	Hose, 1/2" Hi-Temp Silicon, 40" long	1
16	HO-27890	Hose, 1/2" Hi-Temp Silicon, 3" long	1
17	HO-29435	Hose, 1-5/8", 4.5" long	1
18	HO-29435	Hose, 1-5/8", 2.25" long	1
19	HO-2957	Hose, Translucent Silicon, 17" long	1
20	HO-2957	Hose, Translucent Silicon, 6" long	1
21	HO-2957	Hose, Translucent Silicon, 14" long	1

PLUMBING HOSES — 10.10ESG

vsezip.ru

+7(812)987-08-81

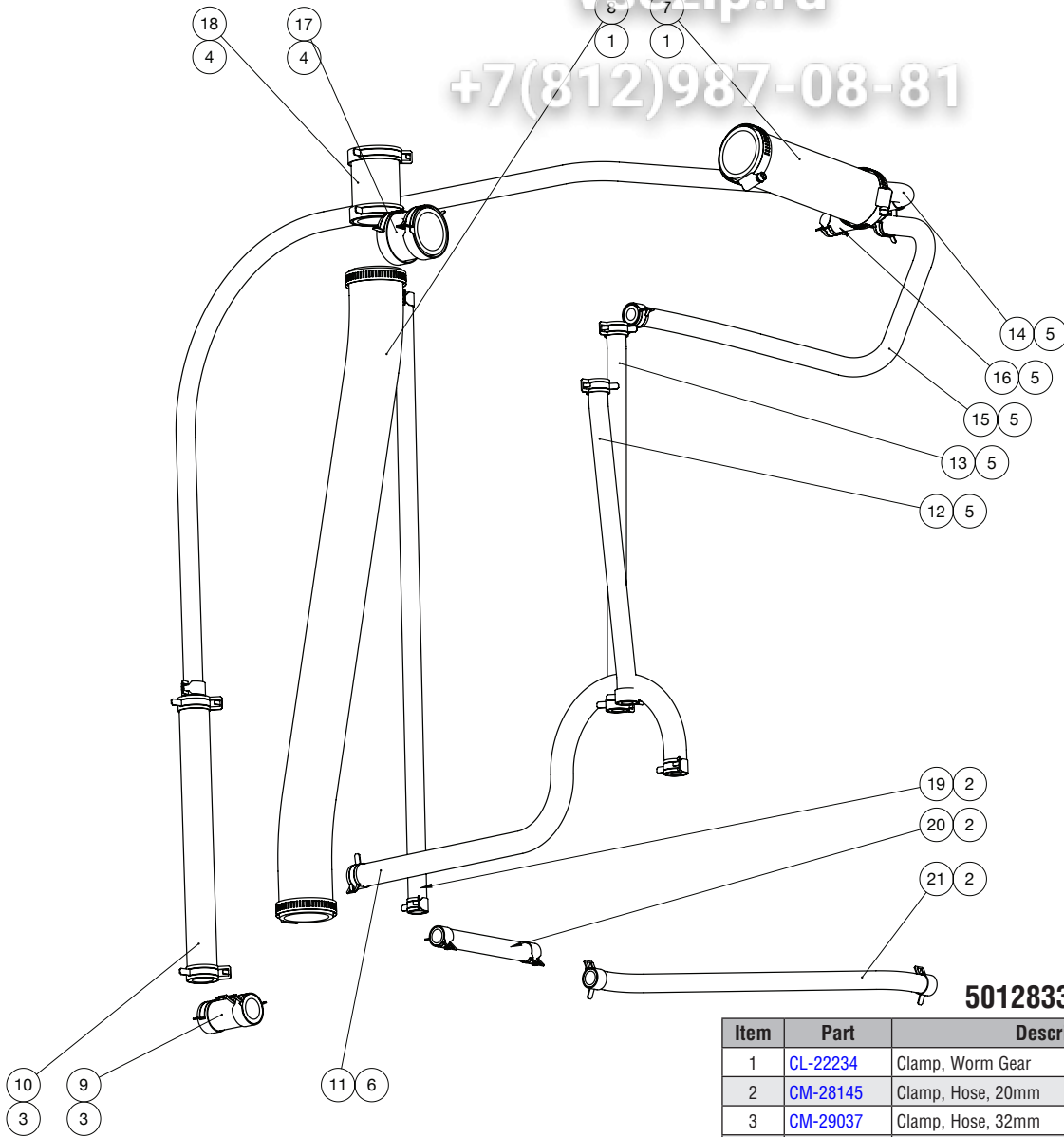

5012833

Item	Part	Description	Qty.
1	CL-22234	Clamp, Worm Gear	4
2	CM-28145	Clamp, Hose, 20mm	6
3	CM-29037	Clamp, Hose, 32mm	4
4	CM-29039	Clamp, Hose, 55mm	4
5	CM-29301	Clamp, Hose, 23mm	10
6	FT-28124	Clamp, Hose, 24mm	2
7	HO-27891	Hose, 1-7/8", 8.5" long	1
8	HO-27891	Hose, 1-7/8", 28" long	1
9	HO-27892	Hose, 7/8", 2.5" long	1
10	HO-27892	Hose, 7/8", 12" long	1
11	HO-27893	Hose, 1/2", 30" long	1
12	HO-27890	Hose, 1/2" Hi-Temp Silicon, 21" long	1
13	HO-27890	Hose, 1/2" Hi-Temp Silicon, 23" long	1
14	HO-27890	Hose, 1/2" Hi-Temp Silicon, 44" long	1
15	HO-27890	Hose, 1/2" Hi-Temp Silicon, 15" long	1
16	HO-27890	Hose, 1/2" Hi-Temp Silicon, 3" long	1
17	HO-29435	Hose, 1-5/8", 2.25" long	1
18	HO-29435	Hose, 1-5/8", 4.5" long	1
19	HO-2957	Hose, Translucent Silicon, 25" long	1
20	HO-2957	Hose, Translucent Silicon, 6" long	1
21	HO-2957	Hose, Translucent Silicon, 14" long	1

PARTS INFORMATION **Всё в одном**

PLUMBING HOSES — 7.14ESG

vsezip.ru

+7(812)987-08-81

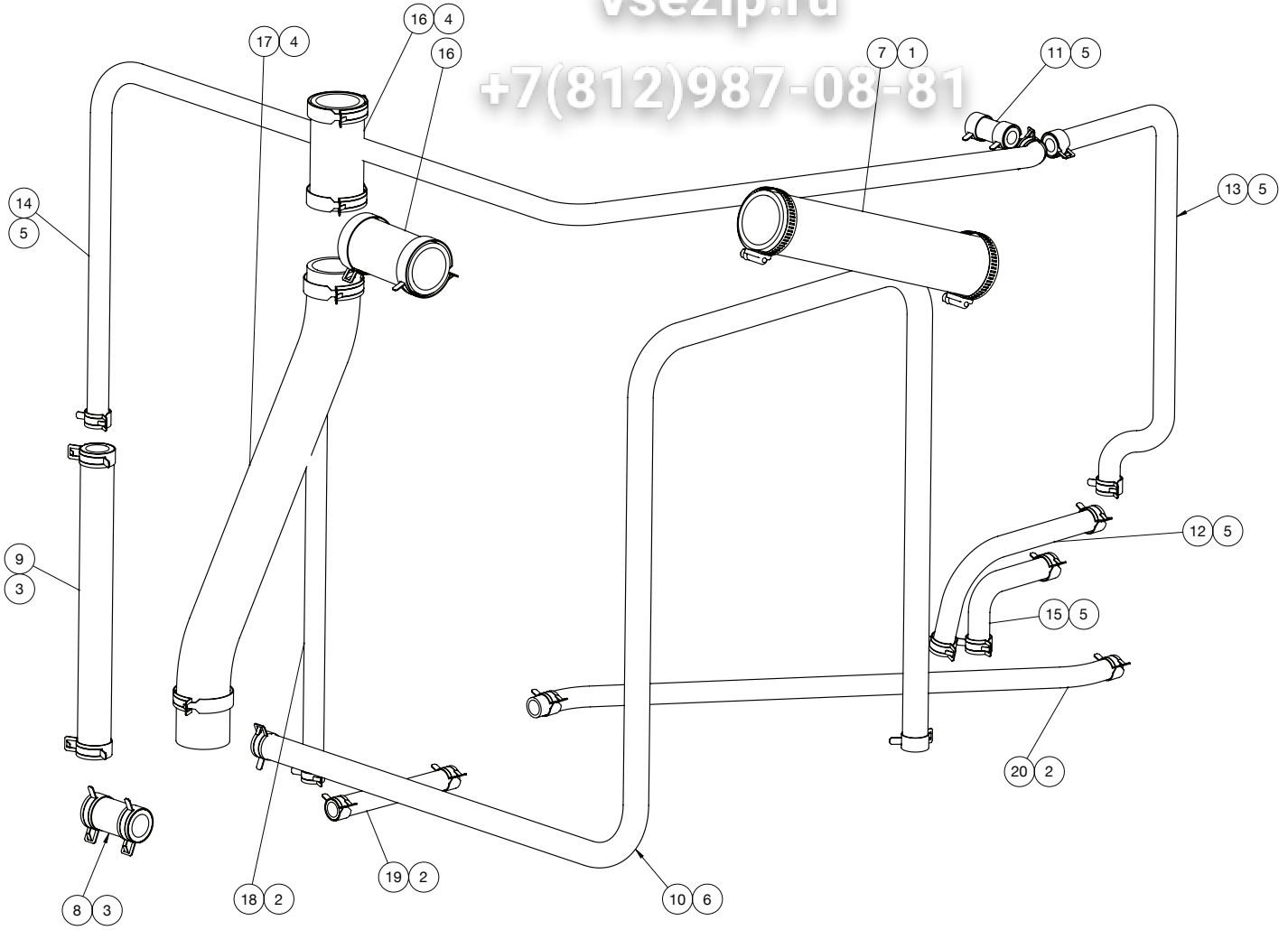

5012291

Item	Part	Description	Qty.
1	CL-22234	Clamp, Worm Gear	2
2	CM-28145	Clamp, Hose, 20mm	6
3	CM-29037	Clamp, Hose, 32mm	4
4	CM-29039	Clamp, Hose, 55mm	6
5	CM-29301	Clamp, Hose, 23mm	10
6	FT-28124	Clamp, Hose, 24mm	2
7	HO-27891	Hose, 1-7/8", 12.5" long	1
8	HO-27892	Hose, 7/8", 2.5" long	1
9	HO-27892	Hose, 7/8", 12" long	1
10	HO-27893	Hose, 1/2", 60" long	1
11	HO-27890	Hose, 1/2" Hi-Temp Silicon, 2" long	1
12	HO-27890	Hose, 1/2" Hi-Temp Silicon, 9" long	1
13	HO-27890	Hose, 1/2" Hi-Temp Silicon, 15.5" long	1
14	HO-27890	Hose, 1/2" Hi-Temp Silicon, 52" long	1
15	HO-27890	Hose, 1/2" Hi-Temp Silicon, 5.5" long	1
16	HO-29435	Hose, 1-5/8", 5" long	2
17	HO-29435	Hose, 1-5/8", 23" long	1
18	HO-2957	Hose, Translucent Silicon, 17" long	1
19	HO-2957	Hose, Translucent Silicon, 6" long	1
20	HO-2957	Hose, Translucent Silicon, 22" long	1

PLUMBING HOSES — 12.18ESG, 10.20ESG

vsezip.ru

+7(812)987-08-81

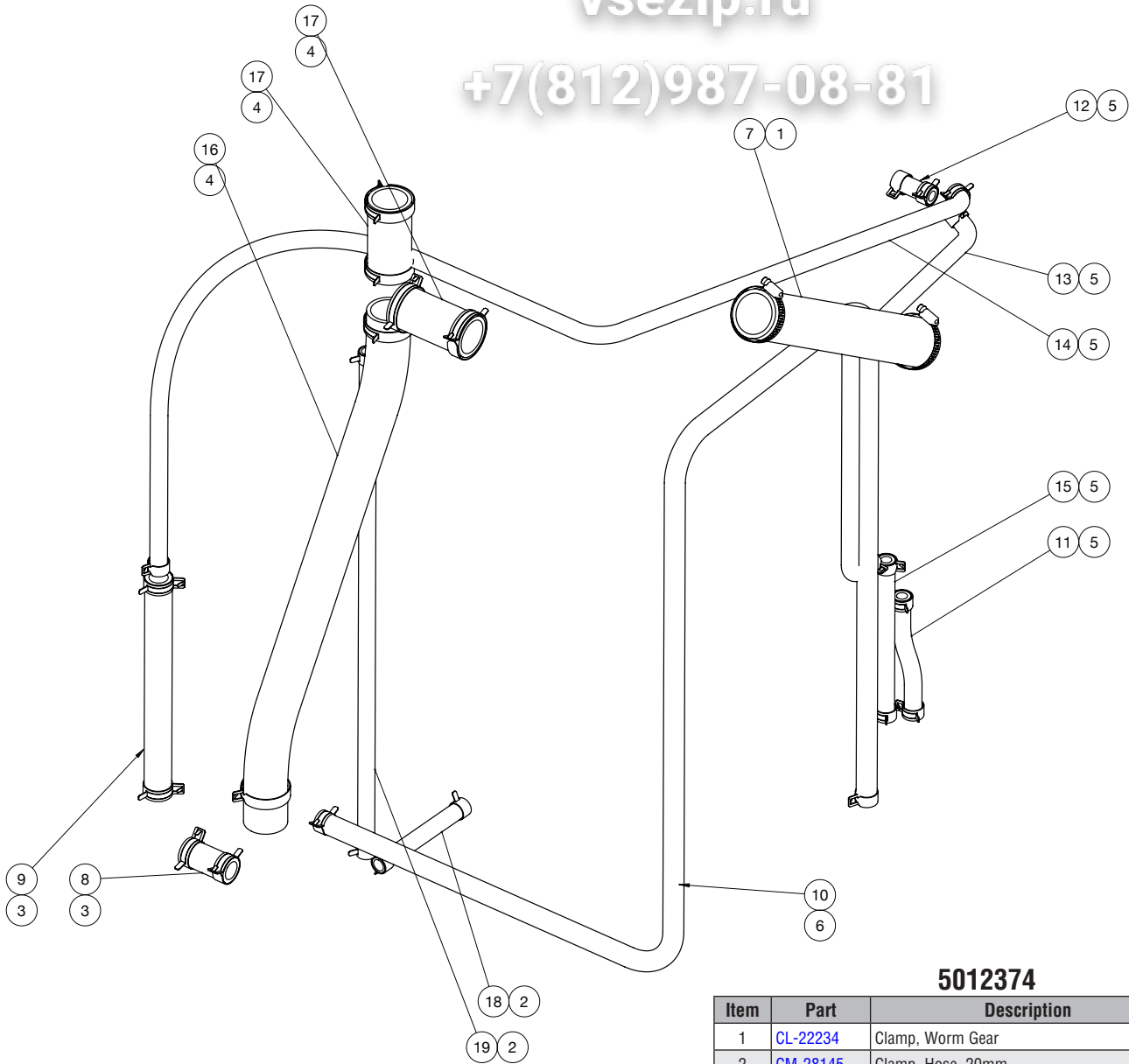

5012374

Item	Part	Description	Qty.
1	CL-22234	Clamp, Worm Gear	2
2	CM-28145	Clamp, Hose, 20mm	4
3	CM-29037	Clamp, Hose, 32mm	4
4	CM-29039	Clamp, Hose, 55mm	6
5	CM-29301	Clamp, Hose, 23mm	10
6	FT-28124	Clamp, Hose, 24mm	2
7	HO-27891	Hose, 1-7/8", 15" long	1
8	HO-27892	Hose, 7/8", 2.5" long	1
9	HO-27892	Hose, 7/8", 12" long	1
10	HO-27893	Hose, 1/2", 80" long	1
11	HO-27890	Hose, 1/2" Hi-Temp Silicon, 5.5" long	1
12	HO-27890	Hose, 1/2" Hi-Temp Silicon, 2" long	1
13	HO-27890	Hose, 1/2" Hi-Temp Silicon, 25" long	1
14	HO-27890	Hose, 1/2" Hi-Temp Silicon, 58" long	1
15	HO-27890	Hose, 1/2" Hi-Temp Silicon, 9" long	1
16	HO-29435	Hose, 1-5/8", 33" long	1
17	HO-29435	Hose, 1-5/8", 5" long	2
18	HO-2957	Hose, Translucent Silicon, 6" long	1
19	HO-2957	Hose, Translucent Silicon, 27" long	1

PARTS INFORMATION **Всёzip** ОБЩЕПИТ

PLUMBING HOSES — 20.20ESG

vsezip.ru

7(812)987-08-81

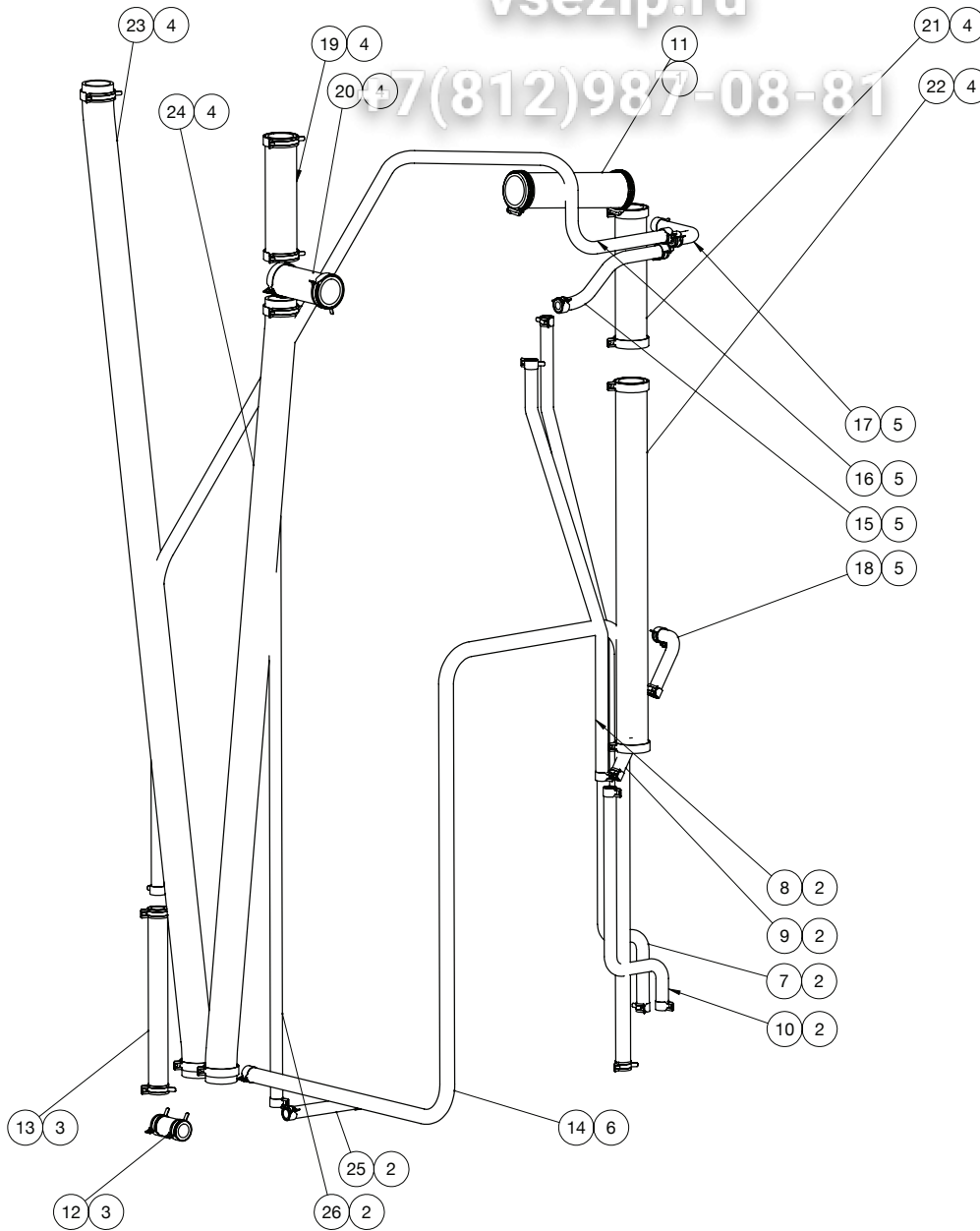

5012312

Item	Part	Description	Qty.
1	CL-22234	Clamp, Worm Gear	2
2	CM-28145	Clamp, Hose, 20mm	12
3	CM-29037	Clamp, Hose, 32mm	4
4	CM-29039	Clamp, Hose, 55mm	12
5	CM-29301	Clamp, Hose, 23mm	8
6	FT-28124	Clamp, Hose, 24mm	2
7	HO-22255	Hose, 1/2" Flexible Clear, 47" long	1
8	HO-22255	Hose, 1/2" Flexible Clear, 25" long	1
9	HO-22255	Hose, 1/2" Flexible Clear, 4" long	1
10	HO-22255	Hose, 1/2" Flexible Clear, 18" long	1
11	HO-27891	Hose, 1-7/8", 9.5" long	1
12	HO-27892	Hose, 7/8", 2.5" long	1
13	HO-27892	Hose, 7/8", 12" long	1

Item	Part	Description	Qty.
14	HO-27893	Hose, 1/2", 80" long	1
15	HO-27890	Hose, 1/2", Hi-Temp Silicon, 7" long	1
16	HO-27890	Hose, 1/2" Hi-Temp Silicon, 76" long	1
17	HO-27890	Hose, 1/2" Hi-Temp Silicon, 5" long	1
18	HO-27890	Hose, 1/2" Hi-Temp Silicon, 6" long	1
19	HO-29435	Hose, 1-5/8", 9" long	1
20	HO-29435	Hose, 1-5/8", 5" long	1
21	HO-29435	Hose, 1-5/8", 9.5" long	1
22	HO-29435	Hose, 1-5/8", 25" long	1
23	HO-29435	Hose, 1-5/8", 65" long	1
24	HO-29435	Hose, 1-5/8", 53" long	1
25	HO-2957	Hose, Translucent Silicon, 6" long	1
26	HO-2957	Hose, Translucent Silicon, 50" long	1

vsezip.ru

+7(812)987-08-81

AUTO CLEAN™ WASH NOZZLE

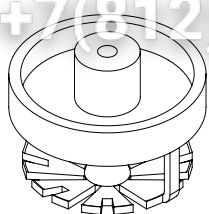
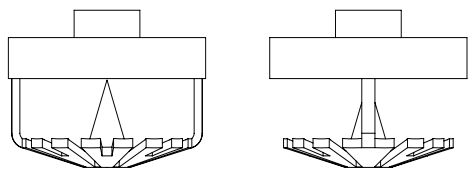

Part	Auto Clean Inner Tube & Wash Nozzle Description	Qty.
NZ-27952	Nozzle, Spray, Cleaning Kit	4

SMART CLEAN™ INNER TUBE & WASH NOZZLE

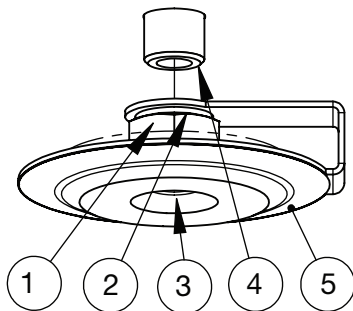

Item	Part	SmartClean Inner Tube & Wash Nozzle Description	Qty.
1	NU-28710	Nut, Hex Jam	1
2	1008395	Washer, Conical	1
3	NZ-28523	Nozzle	1
4	—	SmartClean Pipe Assembly	1
5	5009022	Inner Casing	1

COMBICLEAN™ INNER TUBE & WASH NOZZLE

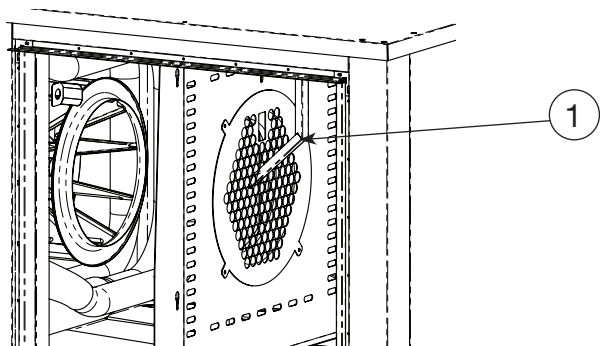

Item	Part	CombiClean Wash Nozzle Description	Qty.
1	PB-28782	Water Injection Tube, 6.10ESG, 10.10ESG	1
	PB-27729	Water Injection Tube, 7.14ESG	1
	PB-27730	Water Injection Tube, 12.18ESG, 10.20ESG	1
	PB-27730	Water Injection Tube, 20.20ESG	2
2	1001204	Disintegration Box (not shown)	1
3	SC-23737	Screw, M5 Hex Head for Disintegration Box (not shown)	1

CONDENSATION TANK

vsezip.ru

+7(812)987-08-81

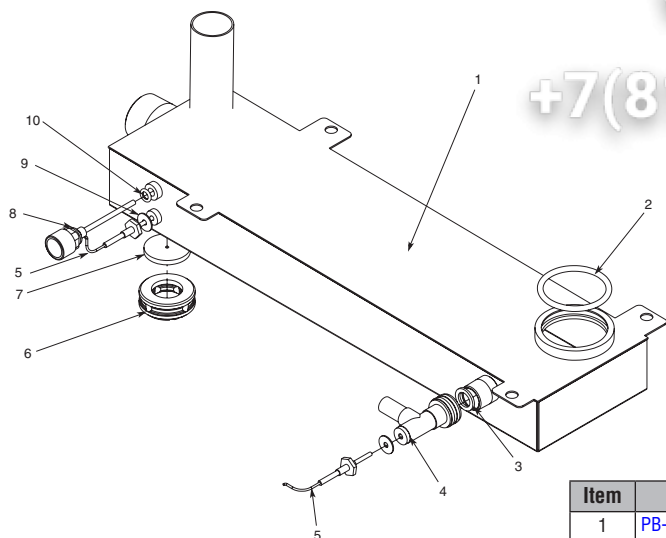

Auto Clean units (prior to 3/09)

Item	Part	Description	Qty.
1	PB-28969	Condensor Tank – 6.10ESG,10.10ESG, 7.14ESG, 10.20ESG, 12.18ESG	1
1	PB-28895	Condensor Tank – 20.20ESG	1
2	SA-22212	O-Ring, Red, Silicone 70 Durometer, 225 C, 59.6 x 5.33mm	1
3	WS-22207	Seal, 3/4 x 2, Flat Vulcan Fiber	1
4	PB-26512	Measure Probe	1
5	PR-33724	Combitherm, Thermocouple, 1650mm Wire Length: 6.10ESG, 10.10ESG, 7.14ESG	2
	PR-33751	Combitherm, Thermocouple, 3050mm Wire Length: 10.20ESG, 12.18ESG, 20.20ESG	2
6	CP-22758	Outlet, Steam Generator, 303-304 Stainless Steel	1
7	WS-22751	Silicone, Seal, 45 mm FDA, 500°F Temp.	1
8	5000284	Injection Nozzle	1
9	SA-25061	T-Couple Probe	2
10	SA-22209	O-Ring, 8 x 3mm V75 Vitan 75 Durometer	1

SmartClean and CombiClean units (after 3/09)

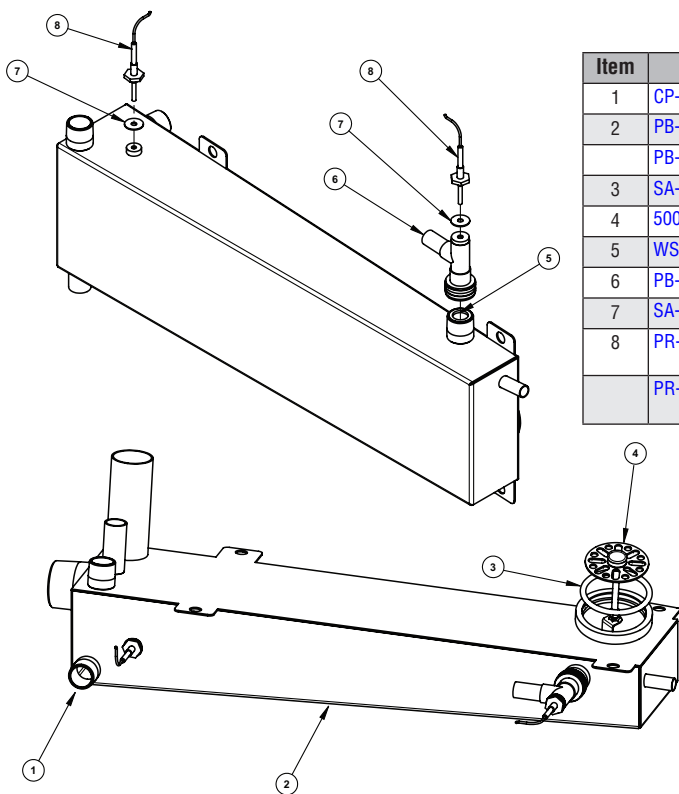

Item	Part	Description	Qty.
1	CP-28016	Drain Cap	1
2	PB-28095	Condensor Tank – 6.10ESG, 10.10ESG, 7.14ESG, 10.20ESG, 12.18ESG	1
	PB-28968	Condensor Tank – 20.20ESG	1
3	SA-22212	O-Ring, Red, Silicone 70 Durometer, 225 C, 59.6 x 5.33mm	1
4	5008964	Drain Screen	1
5	WS-22207	Seal, 3/4 x 2, Flat Vulcan Fiber	1
6	PB-26512	Measure Probe	1
7	SA-25061	T-Couple Probe, Combitherm	2
8	PR-33724	Combitherm, Thermocouple, 1650mm Wire Length: 6.10ESG, 10.10ESG, 7.14ESG	2
	PR-33751	Combitherm, Thermocouple, 3050mm Wire Length: 10.20ESG, 12.18ESG, 20.20ESG	2

PARTS INFORMATION

Всички Общепит

SPRAYER HOLDER ASSEMBLY

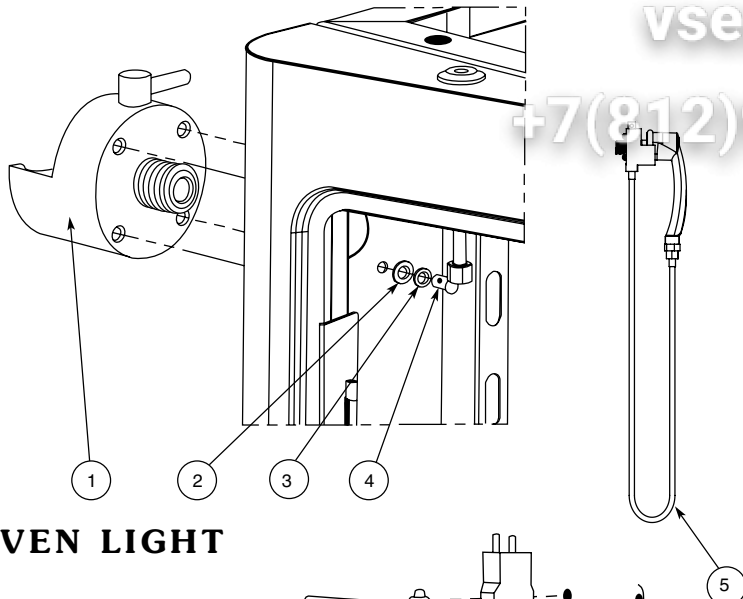

Item	Part	Description	Qty.
1	PB-26960	Hand Shower Holder	1
2	WS-22295	Flat Washer	4
3	W-3-2301	Packing Washer	4
4	SC-22/66	Philips Screw	4
5	HO-26964	Hand Shower Hose (6.10/7.14/10.20/12.18)	1
	HO-26965	Hand Shower Hose (20.20)	1
6	WS-29074	Hand Shower Hose Washer	1
7	5011315	Hand Shower Sprayer Kit	1

OVEN LIGHT

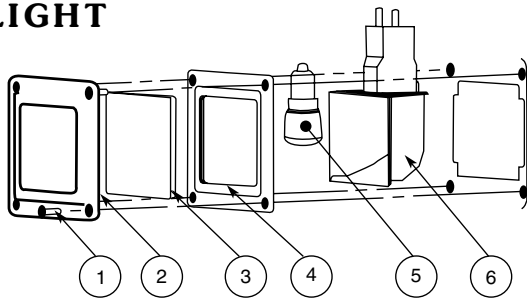

Item	Part	Description	Qty.
1	SC-23141	Screw	4
2	CV-26607	Oven Light Cover	1
3	GL-26608	Oven Light Glass	1
4	GS-26609	Oven Light Gasket	1
5	LP-34206	Light, 25W Bulb	1
	LP-34205	Light, 25W Bulb, 120V	1
6	LP-34161	Light, Snap-In	1

SMOKER CHIP TRAY ASSEMBLY

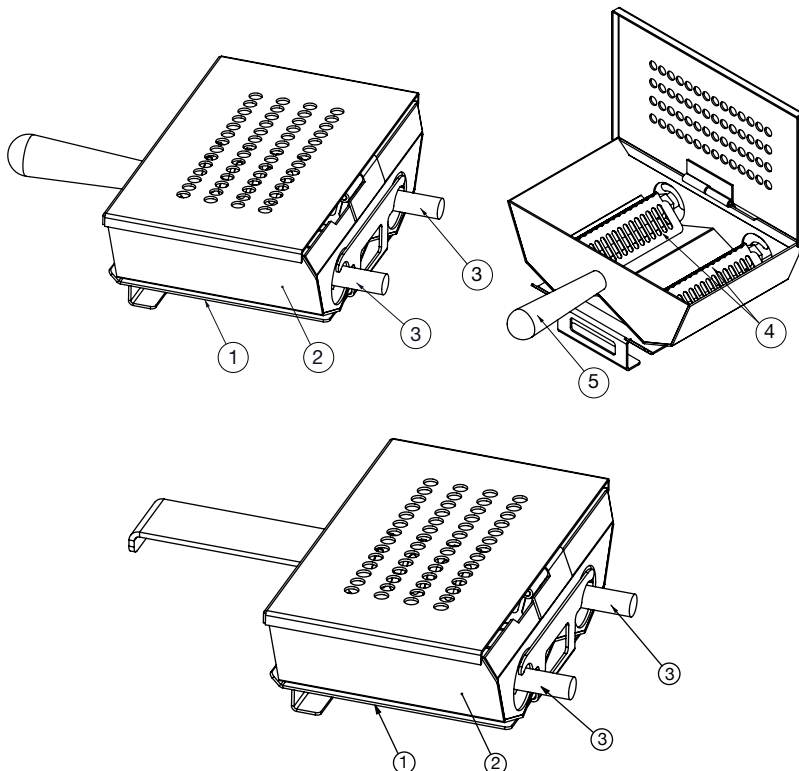

EFFECTIVE PRIOR TO 10/2009

Item	Part	Description	Qty.
1	1010343	Smoker Box Holder	4
2	5006630	Chip Tray with Handle	1
3	EL-34554	Element, Smoker Heater, 208V/260W	2
	EL-34553	Element, Smoker Heater, 110V/260W	2
4	1007141	Smoke Tray Insert	2
5	HD-2724	Smoker Box Handle	1
6*	SC-2332	Smoker Box Handle Screw	1

EFFECTIVE 10/2009

Item	Part	Description	Qty.
1	1010343	Smoker Box Holder	1
2	5005669	Chip Tray with Handle	1
3	EL-34554	Element, Smoker Heater, 208V/260W	2
	EL-34553	Element, Smoker Heater, 110V/260W	2
4	1007141	Smoke Tray Insert	2
5*	CE-26277	Cleaner Kit, Smoker	1

*NOT SHOWN

TOP HINGE ASSEMBLY

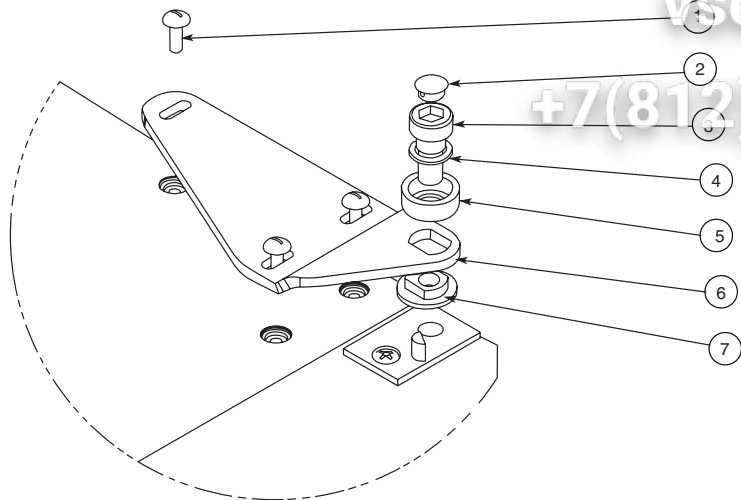

EFFECTIVE PRIOR TO 2009

Item	Part	Description	Qty.
1	SC-28256	Screw, Hex Head	3
2	PG-25132	Plug	1
3	SC-25102	Screw	1
4	WS-25478	Washer, Serrated	1
5	WS-25127	Covering Washer	1
6	HG-25099	Upper Hinge Plate	1
7	WS-25124	Block Washer	1

EFFECTIVE 2009

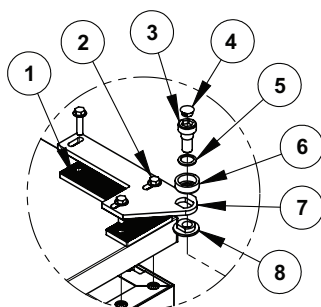

Item	Part	Description	Qty.
1	HG-28094	Hinge Ratchet, Part 2	1
2	SC-28891	Screw, Truss Head	3
3	SC-25102	Screw	1
4	PG-25132	Plug	1
5	WS-25478	Washer, Serrated	1
6	WS-25127	Covering Washer	1
7	HG-28296	Hinge Ratchet, Part 1	1
8	WS-25124	Block Washer	1

BOTTOM HINGE ASSEMBLY

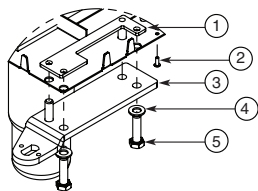

Right-Hand
6.10, 10.10, 7.14

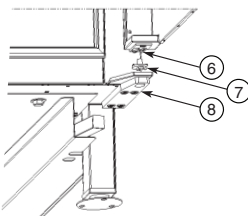

Right-Hand
10.20, 12.18, 20.20

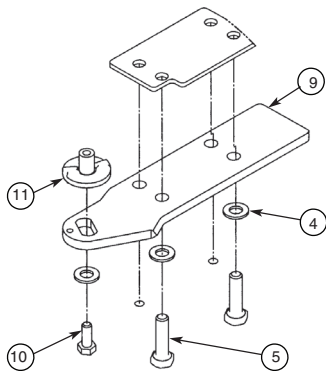

Left-Hand
6.10

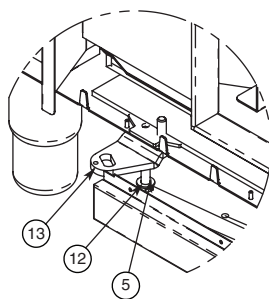

Left-Hand
10.10, 7.14

Item	Part	Description	Qty.
1	HG-27684	Door Mounting Plate	1
2	RI-27108	Sealed Rivet	1
3	HG-28525	Lower Plate	1
4	WS-22298	Washer, M8, 18-8	4
5	SC-22279	Hex Head Screw, M8 x 30	4
6	HG-25079	Lower Plate	1
7	HG-25101	Lower Hinge Ratchet	1
8	HG-28524	Lower Hinge, R-H	1
9	HG-28155	Lower Hinge, L-H	1
10	SC-22284	Hex Head Screw, M6 x 16	1
11	HG-25101	Lower Hinge Ratchet	1
12	WS-22323	Washer	1
13	HG-26299	Lower Hinge	1

PARTS INFORMATION **Вопрос-Ответ**

STANDARD CONTROL

vsezip.ru

+7(812)987-08-81

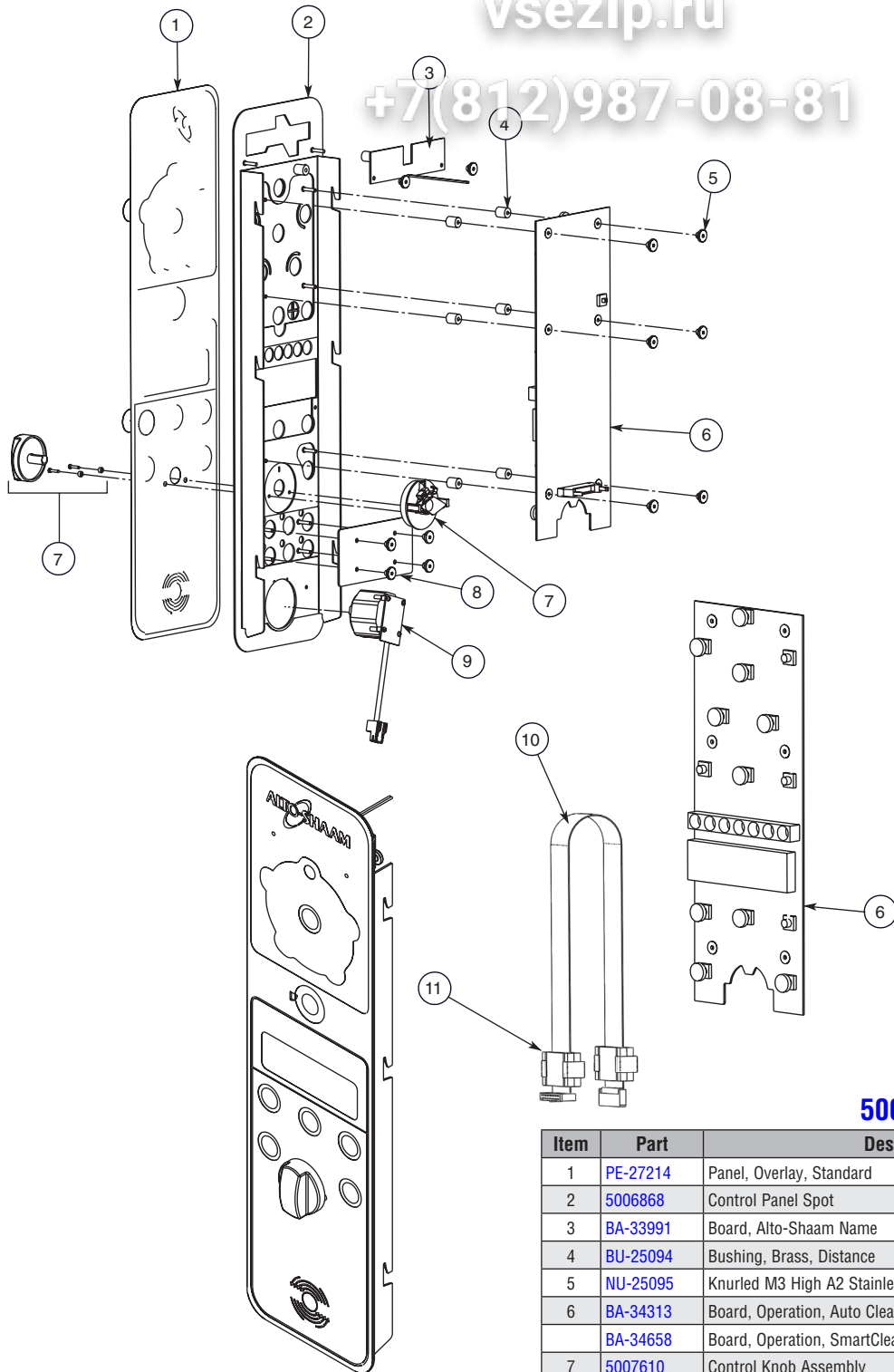

5005991

Item	Part	Description	Qty.
1	PE-27214	Panel, Overlay, Standard	1
2	5006868	Control Panel Spot	1
3	BA-33991	Board, Alto-Shaam Name	1
4	BU-25094	Bushing, Brass, Distance	8
5	NU-25095	Knurled M3 High A2 Stainless Steel	12
6	BA-34313	Board, Operation, Auto Clean	1
	BA-34658	Board, Operation, SmartClean, CombiClean	1
7	5007610	Control Knob Assembly	1
8	1001128	Control Cover - Optional	1
9	BA-33733	Board, LED, Closed System	1
	5011189	Vent Button Retainer Kit	1
10	CB-34400	Cable, Communication - Display to Relay	1
11	CB-35024	Ferrite for Communication Cable	2
12	BA-34626	Relay Control Board, SmartClean, CombiClean (not shown)	1
	BA-34301	Relay Control Board, Auto Clean (not shown)	1

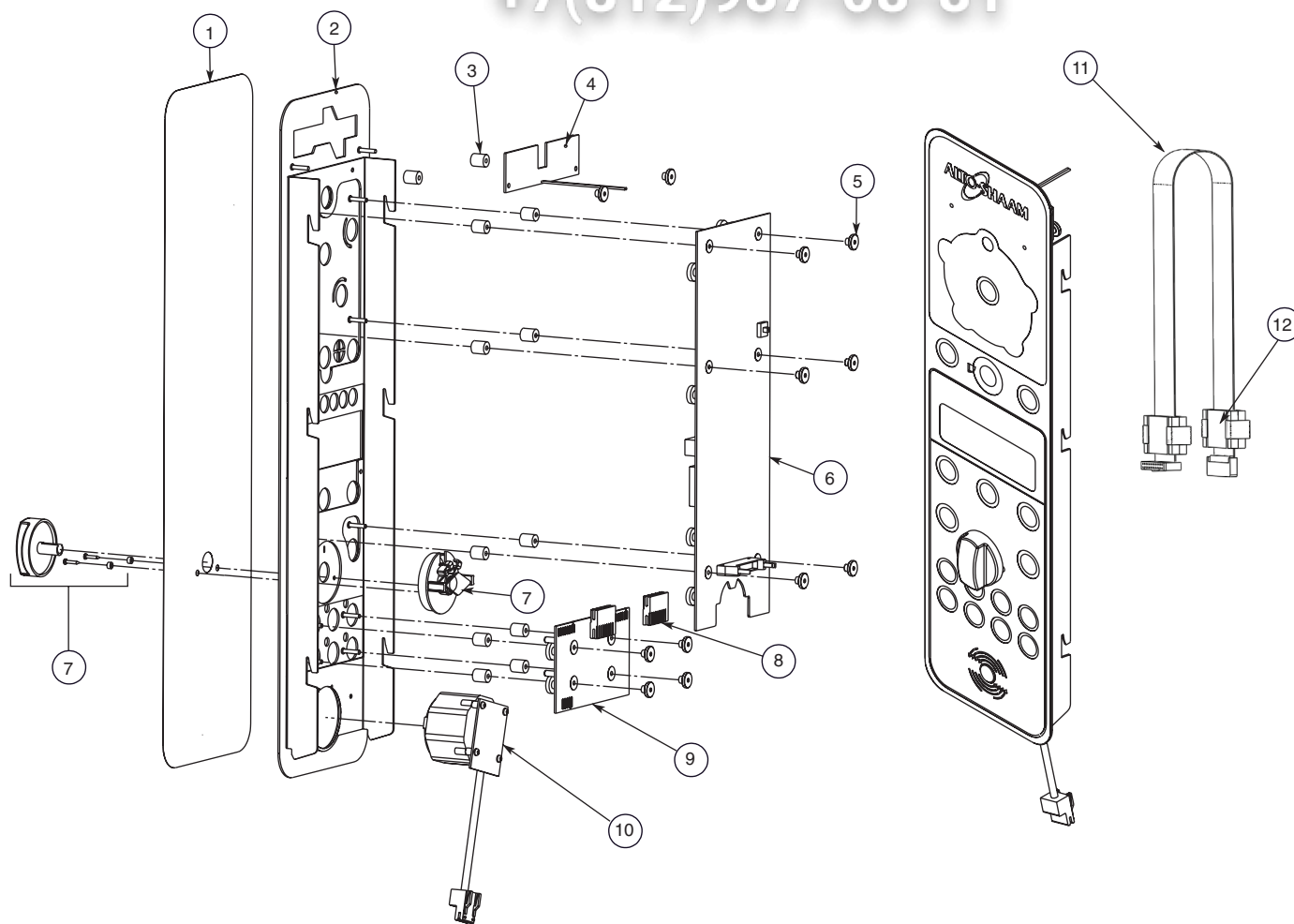

5005726

Item	Part	Description	Qty.
1	PE-27215	Panel, Overlay, Deluxe	1
2	5006868	Control Panel Spot	1
3	BU-25094	Bushing, Brass, Distance	12
4	BA-33991	Board, Alto-Shaam Name	1
5	NU-25095	Knurled M3 High A2 Stainless Steel	12
6	BA-34313	Board, Operation, Auto Clean	1
	BA-34658	Board, Operation, SmartClean, CombiClean	1
7	5007610	Control Knob Assembly	1
8	CR-33743	Connector	2
9	BA-33742	Board, Program	1
10	BA-33733	Board, LED, Closed System	1
	5011189	Vent Button Retainer Kit	1
11	CB-34400	Cable, Communication - Display to Relay	1
12	CB-35024	Ferrite for Communication Cable	2
13	BA-34626	Relay Control Board, SmartClean, CombiClean (not shown)	1
	BA-34301	Relay Control Board, Auto Clean (not shown)	1

PARTS INFORMATION

Общепит

SIMPLE CONTROL

vsezip.ru

+7(812)987-08-81

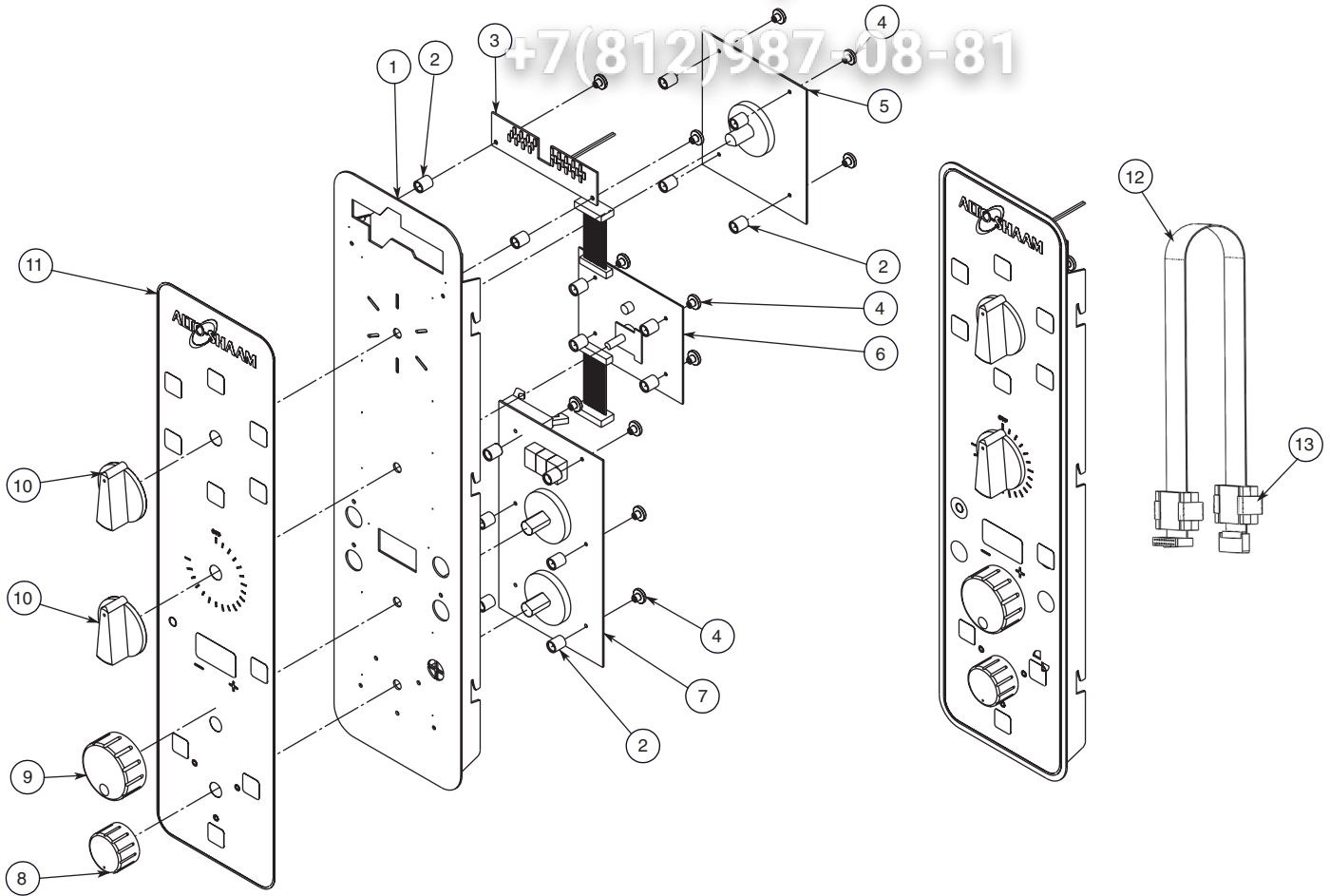

5005727

Item	Part	Description	Qty.
1	5005847	Simple Control Panel	1
2	BU-25094	Bushing, Brass, Distance	16
3	BA-33991	Board, Alto-Shaam Name	1
4	NU-25095	Knurled M3 High A2 Stainless Steel	16
5	BA-34030	Board, Program, "S" BM-P	1
6	BA-34029	Board Temperature "S" BM-T	1
7	BA-34342	Board, Speed/Timer, "S", BMS 2006, Auto Clean	1
	BA-34763	Board, Speed/Timer, "S", BMS 2006, SmartClean, CombiClean	1
8	KN-34035	Knob, Fan Speed	1
9	KN-34036	Knob, Timer, Combitherm	1
10	KN-34037	Knob, Program/Temperature, Combitherm	2
11	PE-27213	Overlay, Simple Control	1
	PE-27570	Overlay, Simple Control, Smoker Option	1
	LA-25546	Label, Option	1
	CP-25405	White Button Cap	1
12	CB-34400	Cable, Communication - Display to Relay	1
13	CB-35024	Ferrite for Communication Cable	2
14	BA-34341	Relay Board, Simple Control, Auto Clean (not shown)	1
	BA-34764	Relay Board, Simple Control, SmartClean (not shown)	1

PARTS INFORMATION **Всezip** ОБЩЕПИТ

RIBBON CABLE ROUTING

vsezip.ru

+7(812)987-08-81

6•10ESG
10•10ESG
7•14ESG

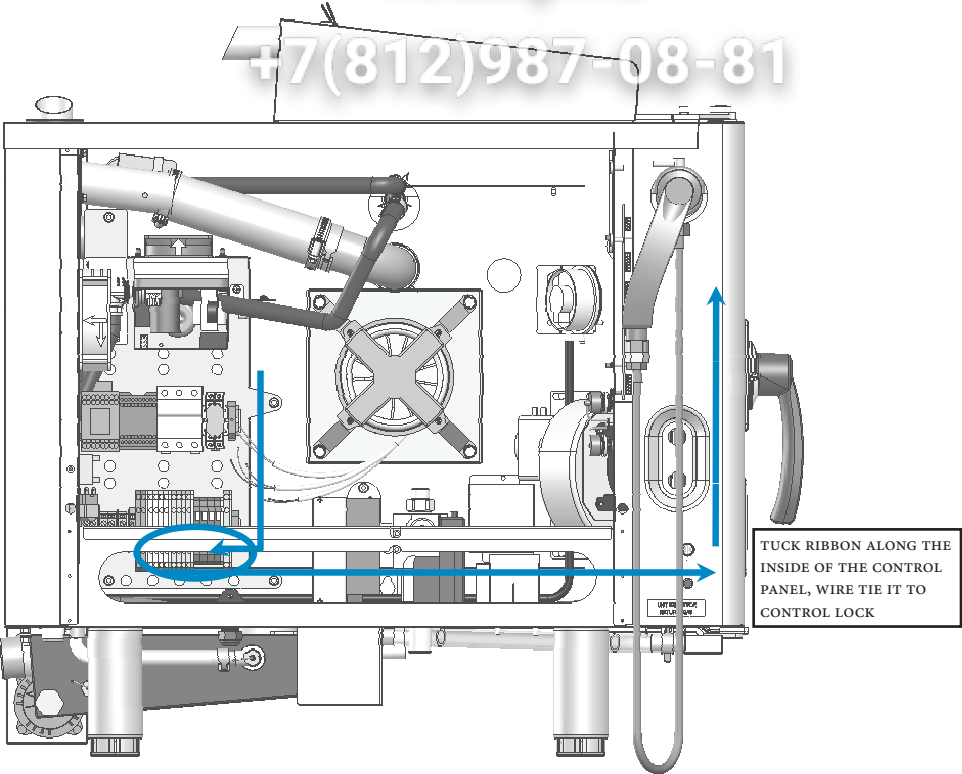

12•18ESG
10•20ESG

USE SUPPORT TABS ON THE INNER TOP TO HOLD RIBBON CABLE IN PLACE

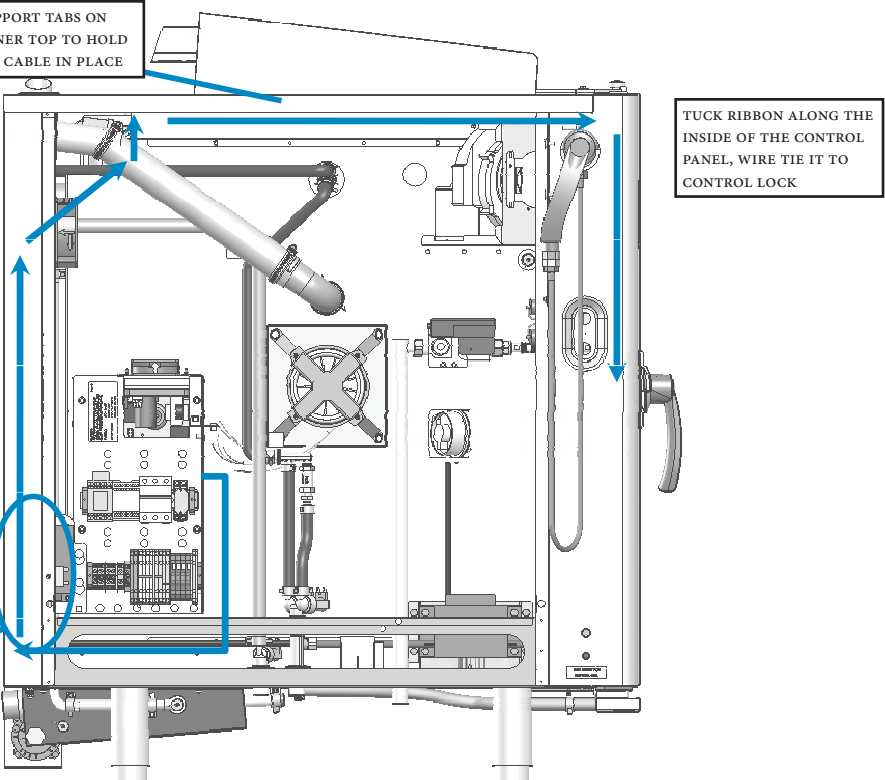

RIBBON CABLE ROUTING

vsezip.ru

20•20ESG

+7(812)987-08-81

USE SUPPORT TABS ON THE INNER TOP TO HOLD RIBBON CABLE IN PLACE

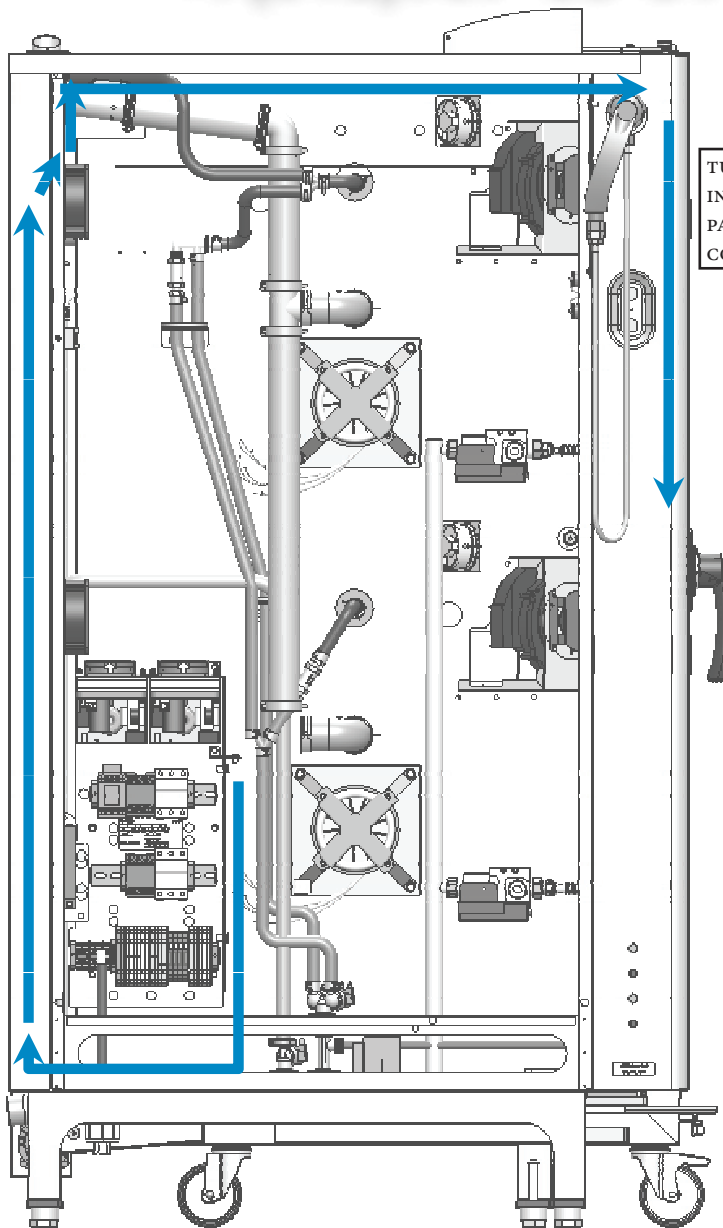

TUCK RIBBON ALONG THE INSIDE OF THE CONTROL PANEL, WIRE TIE IT TO CONTROL LOCK

COMBITHERM MOTOR

vsezip.ru

+7(812)987-08-81

Apply anti-seize on the motor shaft (fully) before and after installing part #5 (SL-22214).

Please Verify Correct Voltage Motor

Motor Assembly ESG

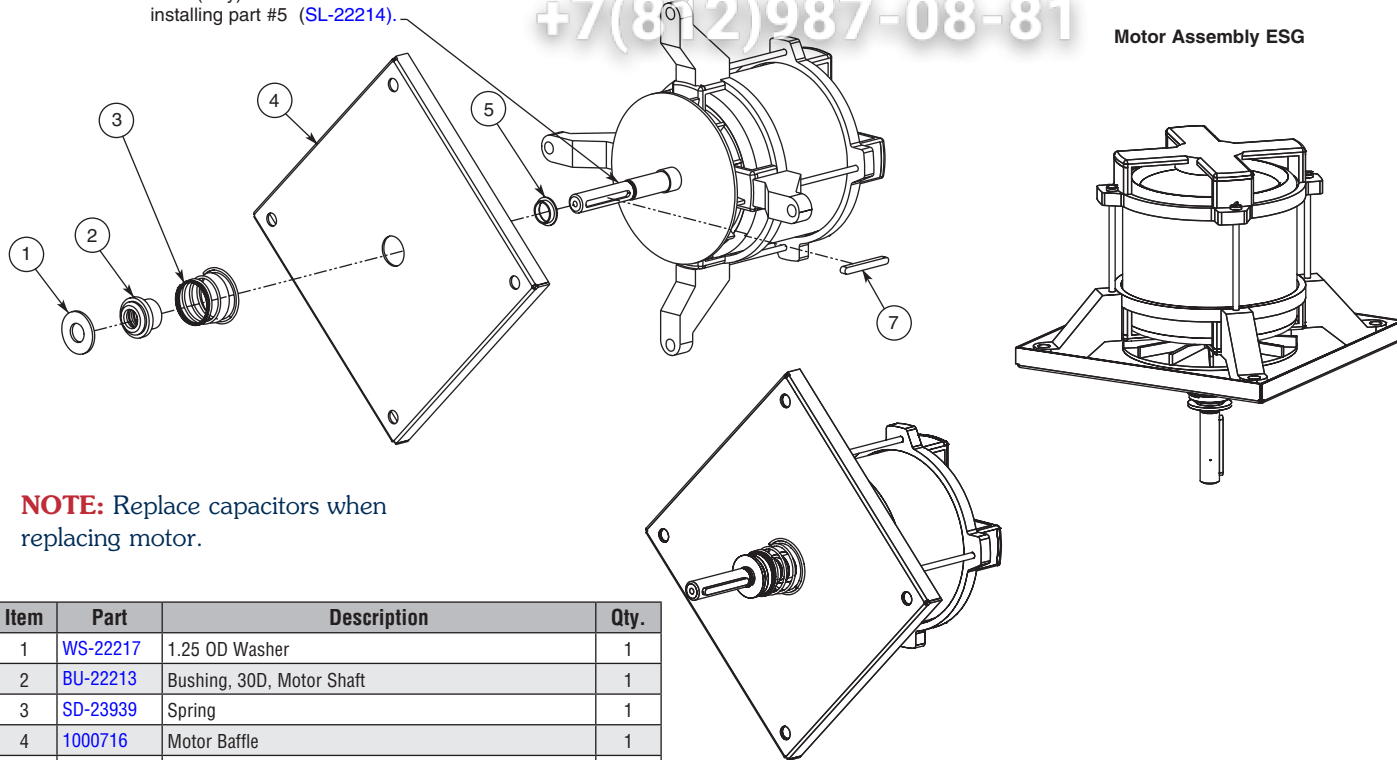

NOTE: Replace capacitors when replacing motor.

Item	Part	Description	Qty.
1	WS-22217	1.25 OD Washer	1
2	BU-22213	Bushing, 30D, Motor Shaft	1
3	SD-23939	Spring	1
4	1000716	Motor Baffle	1
5	SL-22214	Motor, Defle, Phosphor Bronze	1
6	5008295	Motor Assembly, 115V: 6.10ESG, 10.10ESG, 7.14ESG	1
	5008294	Motor Assembly, 115V: 10.20ESG, 12.18ESG, 20.20ESG	1
	5009824	Motor Assembly, 208V, 1ph: 7.14ESG, 12.18ESG, 10.20ESG, 20.20ESG	1
	5000276	Motor Assembly, 208V, 3ph	1
7	MO-22191	Keyway, Motor	1

SMARTCLEAN™ MOTOR PUMP ASSEMBLY

Item	Part	Description	Qty.
1	SC-22779	Screw	2
2	NU-2292	Nut	1
	WS-24396	Washer for Nut	1
3	SC-22273	Screw	2
	WS-22300	Washer (not shown)	2
	WS-22294	Washer (not shown)	2
4	WS-22301	Washer	2
5	WS-22295	Washer	2
6	1010151	Pump Housing	1
7	MO-34635	Motor, 120V	1
	MO-34636	Motor, 230V	1

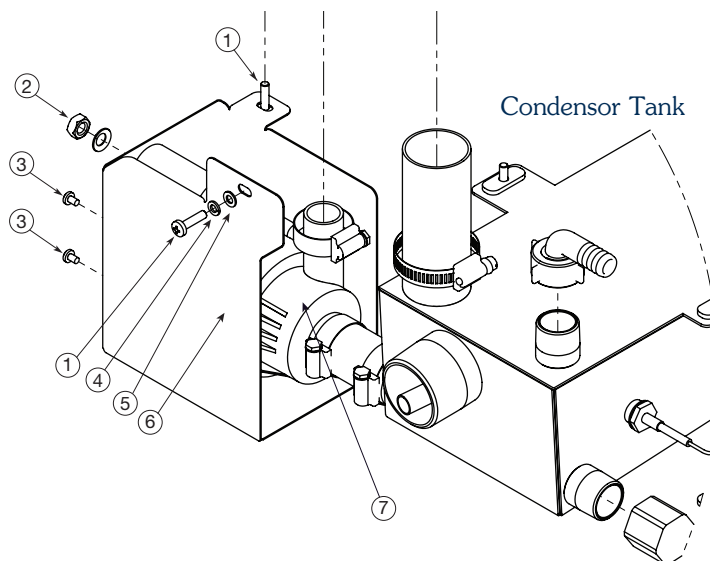

PRESSURE BOX ASSEMBLY

vsezip.ru

+7(812)987-08-81

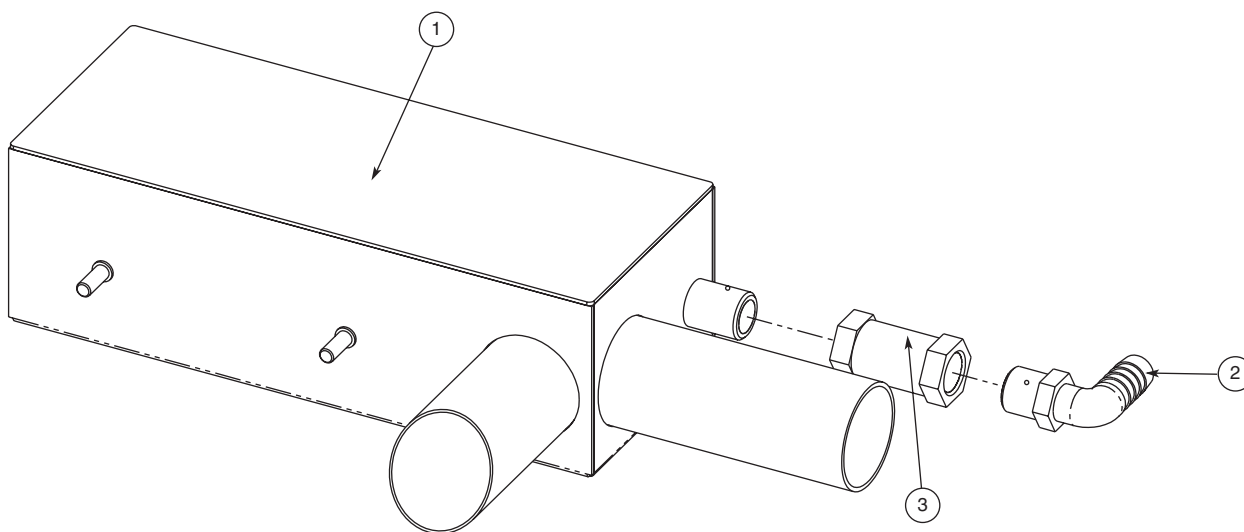
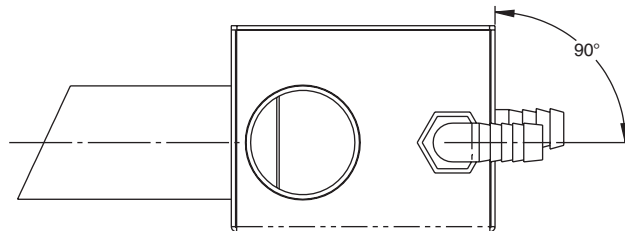

Item	Part	Description	Qty.
1	5005009	Pressure Box	1
2	EB-25551	Elbow, Nylon, 1/2" x 3/8"	1
3	VA-25549	Valve, 3/8", Flow Control, 0.13 GPM, 6.10ESG, 10.10ESG, 7.14ESG, 12.18ESG, 10.20ESG	1
	VA-27837	Valve, 3/8" Flow Control, 0.35 GPM, 20.20ESG	1

PARTS INFORMATION

Службени делови

SERVICE PARTS — 6•10ESG, 10•10ESG, 7•14ESG

vsezip.ru

+7(812)987-08-81

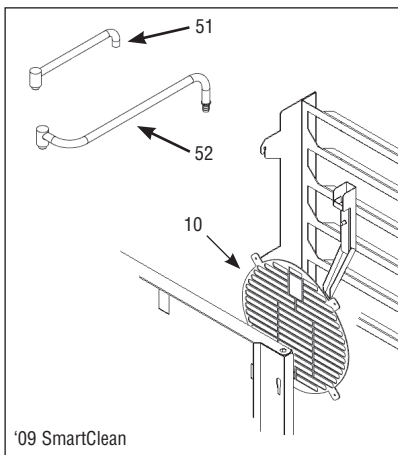

'09 SmartClean

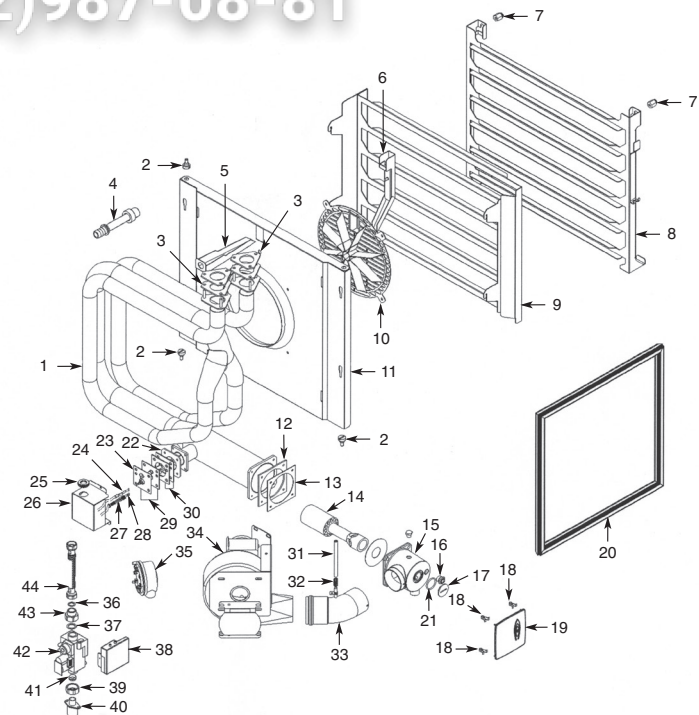
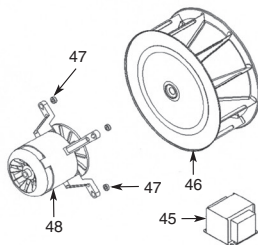
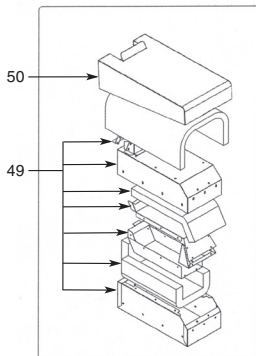

Item	Part	Description	Qty.
1	BN-27702	Heat Exchanger Complete, 6.10esG	1
	BN-27703	Heat Exchanger Complete, 10.10esG	1
	BN-27704	Heat Exchanger Complete, 7.14esG	1
2	SC-28774	Screw TE M6 x 20 CH14	4
3	5010494	Heat Exchanger Service Kit, 7.14ESG	1
	5010495	Heat Exchanger Service Kit, 6.10ESG, 10.10ESG	1
4	PB-27733	Water Injection Pipe	1
5	PB-27731	Water Injection Trove, 6.10ESG, 10.10ESG	1
	PB-27732	Water Injection Trove, 7.14ESG	1
6	PB-28782	Water Injection Tube for Direction Panel, 6.10ESG, 10.10ESG	1
	PB-27729	Water Injection Tube for Direction Panel, 7.14ESG	1
7	SP-28623	M6 Side Rack Stud, Bullet Style	2
	SC-22753	M6 Side Rack Stud Screw	2
8	SR-27746	Side Rack Right, 6.10ESG (Auto Clean)	1
	SR-27748	Side Rack Right, 10.10ESG (Auto Clean)	1
	SR-27750	Side Rack Right, 7.14ESG (Auto Clean)	1
	SR-28992	Side Rack Right, 6.10ESG (SmartClean, CombiClean)	1
	SR-28996	Side Rack Right, 10.10ESG (SmartClean, CombiClean)	1
	SR-28994	Side Rack Right, 7.14ESG (SmartClean, CombiClean)	1
9	SR-27745	Side Rack Left, 6.10ESG (Auto Clean)	1
	SR-27747	Side Rack Left, 10.10ESG (Auto Clean)	1
	SR-27749	Side Rack Left, 7.14ESG (Auto Clean)	1
	SR-28991	Side Rack Left, 6.10ESG (SmartClean, CombiClean)	1
	SR-28995	Side Rack Left, 10.10ESG (SmartClean, CombiClean)	1
	SR-28993	Side Rack Left, 7.14ESG (SmartClean, CombiClean)	1

Item	Part	Description	Qty.
10	CG-28762	Screen Grille, 6.10ESG	1
	GD-28780	Screen Grille, 10.10ESG	1
	CG-28799	Screen Grille, 7.14ESG	1
11	PE-27734	Direction Panel Complete, 6.10ESG	1
	PE-28771	Direction Panel Complete, 10.10ESG	1
	PE-27736	Direction Panel Complete, 7.14ESG	1
12	GS-28630	Interior Combustion Chamber Gasket	1
13	GS-28629	Exterior Combustion Chamber Gasket	1
14	BN-28775	Burner	1
15	BN-27710	Air-Gas Distributor	1
16	GL-27724	Burner Control Glass Complete	1
17	SC-29099	Injector Plug	1
18	CL-27105	Clip for Burner Cover	4
19	CV-27106	Cover for Burner Flame	1
20	GS-27129	Door Gasket, 6.10ESG	1
	GS-27128	Door Gasket, 10.10ESG	1
	GS-27130	Door Gasket, 7.14ESG	1
21	SA-28768	O-Ring Ø25.07	1
22	GS-28567	Ignition Plug Flange Gasket	1
23	FL-34702	Flange Ignitor	1
24	WI-34696	Sensing Wire, Flame	1
25	SA-29100	Grommet Ø48 Ø60	1
26	PE-29101	Shield	1
27	SL-34824	Insulating Sleeve	1

[continued on next page]

[continued from previous page]

**Item Not Shown

Item	Part	Description	Qty.
28	CB-34699	Cable "HF" 400mm	1
29	IG-34694	Igniter	1
30	SP-34703	Ignition Plug Spacer	2
31	PP-28798	Air Pipe Ø8 x Ø5	1
32	FT-29104	Pressure Test Point Pipe	1
33	PP-28761	Air Pipe	1
34	FA-34396	Burner Blower Fan 80 Watt Assembly	1
35	SW-34399	Air Pressure Switch	1
36	WS-28765	Washer 1/2"	2
37	WS-28764	Washer 3/4"	1
38	BA-34397	Gas Valve Control Ignition Module	1
39	NU-28797	Ogival Retainer Union 3/4 Ø16, 6.10ESG, 10.10ESG	1
	NP-28800	Ogival Retainer Union 3/4 Ø16, 7.14ESG	1
40	FT-29105	Intake Union, Gas R3/4 NPT, 6.10ESG, 10.10ESG	1
	NP-28801	Intake Union, Gas R3/4 NPT, 7.14ESG	
41	WS-28796	Ogival Gasket Ø16 Ø18.5 x 8	1
42	VA-34398	Valve Honeywell	1
43	NP-28800	Sleeve F3/4 M1/2	1
44	PP-28804	Burner Pipe	1
45	TN-34640	Step Up Transformer	1
46	WH-27752	Fan Wheel Diameter 285mm, 6.10ESG, 10.10ESG	1
	WH-27751	Fan Wheel Diameter 340mm, 7.14ESG	1
47	SP-27895	Motor Spacer	4
48	5008295	Motor 0.37 kW 110 V 60 HZ	1

Item	Part	Description	Qty.
49	BN-27707	Burner Flue Complete, 6.10ESG, 10.10ESG	1
	BN-27708	Burner Flue Complete, 7.14ESG	1
50	CV-28767	Flue Cover, 6.10ESG, 10.10ESG	1
	PE-27740	Flue Cover, 7.14ESG	1
51	TU-29114	SmartClean Overhead Tubing	1
52	TU-29111	SmartClean Water Supply Piping	1
**	DA-27532	Drain, Black Elbow with Fitting	1
**	SA-29116	Siphon Gasket	1
**	NZ-28184	Nozzle, Natural Gas, 6.10ESG, Size 365	1
**	NZ-28181	Nozzle, Propane Gas, 6.10ESG, Size 240	1
**	NZ-28185	Nozzle, Natural Gas, 10.10ESG, Size 450	1
**	NZ-28182	Nozzle, Propane Gas, 10.10ESG, Size 290	1
**	NZ-27725	Nozzle, Natural Gas, 7.14ESG, Size 510	1
**	NZ-27726	Nozzle, Propane Gas, 7.14ESG, Size 325	1
**	LG-26867	Legs	4
**	FT-29080	Legs, Seismic (option)	4
**	PR-33746	Probe, Multiple Point	1
**	PR-34299	Probe Receptacle, Removable	1
**	PR-34298	Probe, Single Point, Removable	1
**	PR-34747	Probe, Sous Vide	1
**	SH-2903	Shelves, 6.10ESG, 10.10ESG	1
**	SH-22584	Shelves, 7.14ESG, 12.18ESG, 10.20ESG, 20.20ESG	1

PARTS INFORMATION

Всё в одном

SERVICE PARTS— 12•18ESG, 10•20ESG

vsezip.ru

+7(812)987-08-81

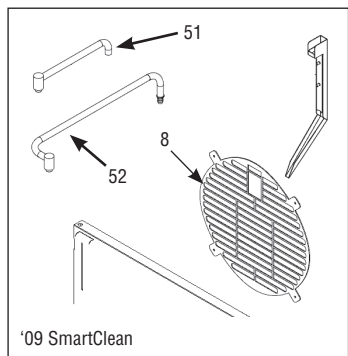

'09 SmartClean

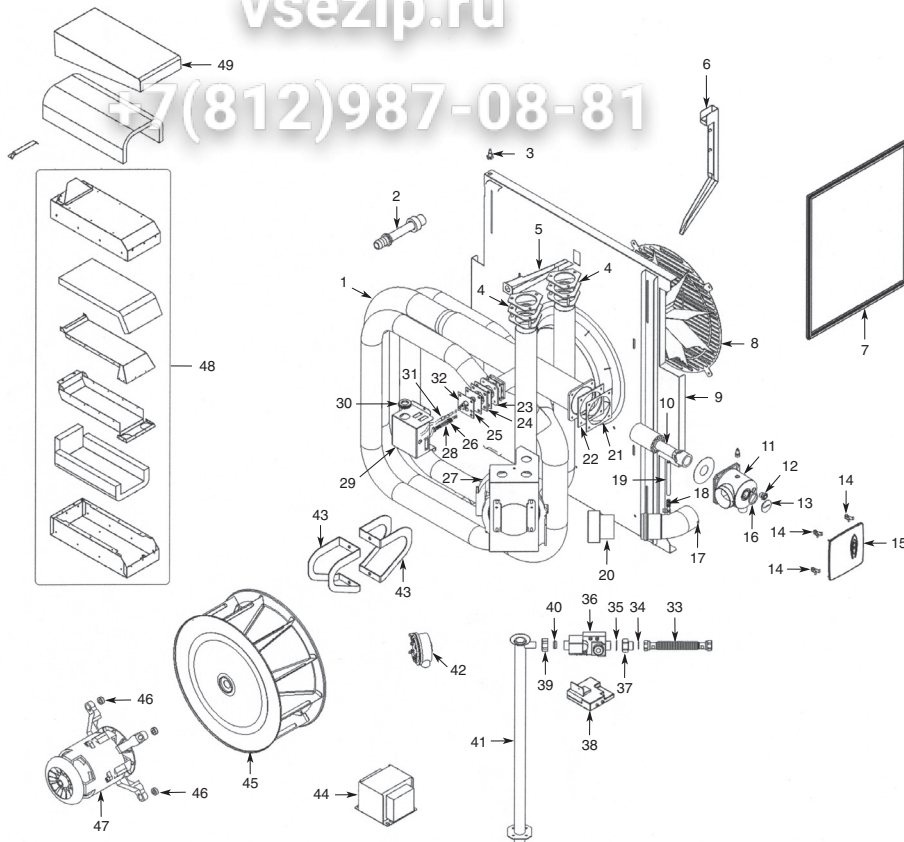

**Item Not Shown

Item	Part	Description	Qty.
1	BN-22705	Heat Exchanger Complete	1
2	PB-27733	Water Injection Pipe	1
3	SC-28774	Screw TE M6 x 20 CH14	4
4	SA-29093	Outlet Flange Gasket	4
5	PB-27732	Water Injection Trove	1
6	PB-27730	Water Injection Tube for Direction Panel	1
7	GS-27127	Door Gasket, 12.18ESG, 10.20ESG	1
8	CG-28791	Screen Grille	1
9	PE-27739	Direction Panel Complete 12.18ESG, 10.20ESG	1
10	BN-29098	Burner	1
11	BN-28776	Air-Gas Distributor	1
12	GL-27724	Burner Control Glass Complete	1
13	SC-29099	Injector Plug	1
14	CL-27105	Clip for Burner Cover	4
15	CV-27106	Cover for Burner Flame	1
16	SA-28788	O-Ring Ø25.07	1
17	PP-28761	Air Pipe	1
18	FT-29104	Pressure Test Point Pipe	1
19	PP-28798	Air Pipe Ø8 x Ø5	1
20	RR-28787	Fan Manifold	1
21	GS-28630	Combustion Chamber Gasket, Interior	1
22	GS-28629	Combustion Chamber Gasket, Exterior	1
23	GS-28567	Ignition Plug Flange Gasket	1
24	SP-34703	Ignition Plug Spacer	2
25	IG-34695	Igniter	1
26	CB-34699	Spark Cable "HF" 400mm	1
27	FA-34395	Burner Blower Watt Assembly, 54 Watt	1
28	SL-34824	Insulating Sleeve	1
29	PE-29102	Shield	1
30	SA-29100	Grommet Ø48 Ø60	1
31	WI-34696	Sensing Wire	1
32	FL-34702	Flange	1

Item	Part	Description	Qty.
33	PP-28804	Burner Pipe	1
34	WS-28765	Washer 1/2"	2
35	WS-28764	Washer 3/4"	1
36	VA-34398	Valve Honeywell	1
37	NP-28800	Sleeve F3/4 M1/2	1
38	BA-34397	Gas Valve Control Ignitional Module	1
39	NP-28800	Ogival Retainer Union 3/4 Ø16	1
40	WS-28796	Ogival Gasket Ø16 Ø18.5 x 8	1
41	NP-28803	Gas Manifold Assembly Y 3/4 NPT	1
42	SW-34399	Air Pressure Switch	1
43	BT-28794	Exchanger Bracket	2
44	TN-34640	Step Up Transformer	1
45	WH-27751	Fan Wheel Diameter 365mm	1
46	SP-27895	Motor Spacer	4
47	5008294	Motor 0.37 kW 110V 60 HZ	1
48	BN-27708	Burner Flue Complete	1
49	PE-27740	Flue Cover	1
50	BN-27714	Flue Exhaust Pipe	1
51	TU-29114	SmartClean Overhead Tubing	1
52	TU-29113	SmartClean Water Supply Piping	1
**	DA-27532	Drain Fitting ES/ESG	1
**	SA-29116	Siphon Gasket, Auto Clean	1
**	NZ-28187	Nozzle, Natural Gas, Size 565	1
**	NZ-28184	Nozzle, Propane Gas, Size 365	1
**	WS-29112	Diaphragm	1
**	SR-27984	Side Rack Assembly, 12.18ESG	1
**	LG-26867	Legs, 12.18ESG	4
**	FT-29080	Legs, Seismic, 12.18ESG (option)	4
**	PR-33746	Probe, Multiple Point	1
**	PR-34299	Probe Receptacle, Removable	1
**	PR-34298	Probe, Single Point, Removable	1
**	PR-34747	Probe, Sous Vide	1
**	SH-22584	Shelves, 12.18ESG, 10.20ESG	1

SERVICE PARTS— 20-20ESG (SERIES VALVE)

vsezip.ru

+7(812)987-08-81

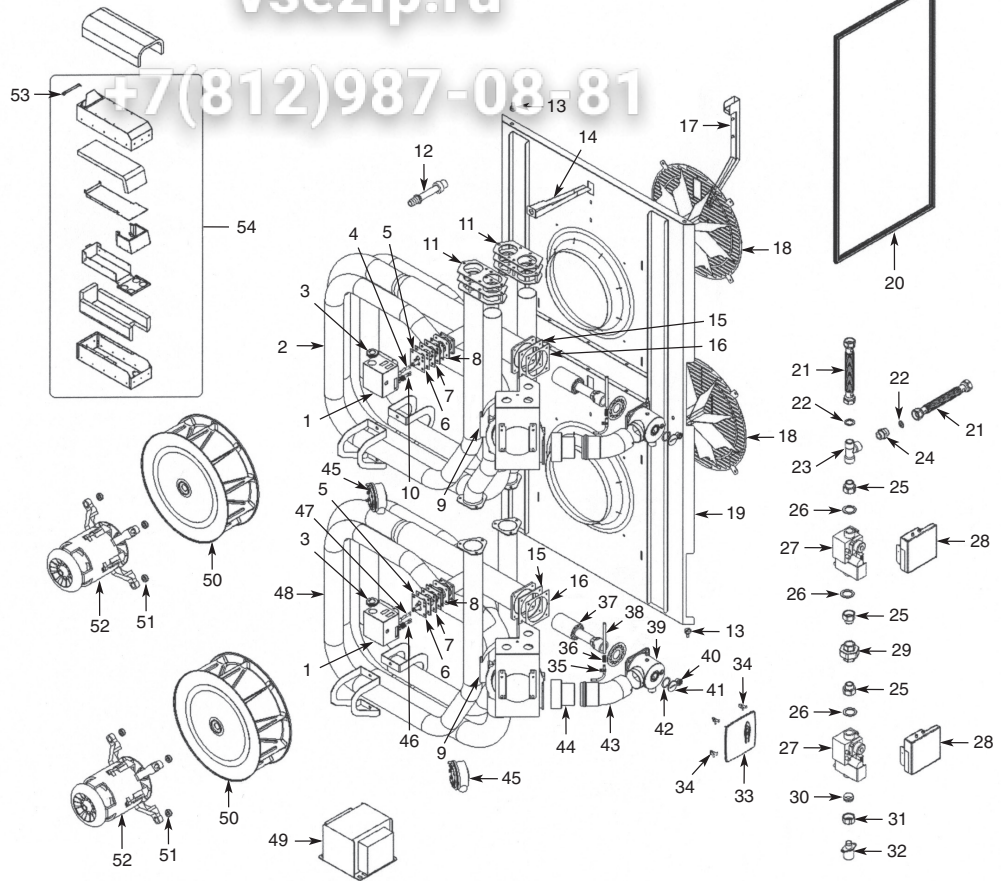
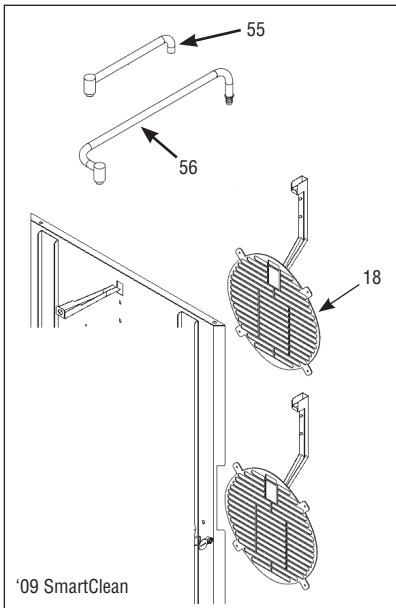

**Item Not Shown

Item	Part	Description	Qty.
1	PE-29102	Shield	2
2	BN-28815	Heat Exchanger Complete	1
3	SA-29100	Grommet Ø48 Ø60	2
4	WI-34697	Flame Sense Ionization Cable 1400mm	1
5	FL-34702	Flange	2
6	IG-34695	Igniter	2
7	SP-34703	Ignition Plug Spacer	4
8	GS-28567	Ignition Plug Flange Gasket	2
9	FA-34395	Burner Blower Fan 80 Watt Assembly	2
10	WI-34700	Spark Cable "HF" 1300mm	1
11	SA-29094	Outlet Flange Gasket	4
12	PB-27733	Water Injection Pipe	2
13	SC-28774	Screw TE M6 x 20 CH14	4
14	PB-27730	Water Injection Trove	2
15	SA-28770	Combustion Chamber Gasket	2
16	SA-28769	Combustion Chamber Gasket	2
17	PB-27730	Water Injection Tube For Direction Panel	2
18	CG-28791	Screen Grille	2
19	PE-28816	Direction Panel Complete 20.20ESG	1
20	GS-27126	Door Gasket 20.20ESG	1
21	PB-28804	Burner Pipe, Parallel Gas Valve	2
	PB-29095	Burner Pipe, Serial Gas Valve	2
22	WS-28765	Washer 1/2"	2
23	FT-28818	T Joint 1/2" F-F-M.	1
24	NP-28817	Nipple M 1/2"	1
25	NP-28800	Sleeve F3/4 M1/2	3
26	WS-28764	Washer 3/4"	3
27	VA-34398	Valve Honeywell	2
28	BA-34397	Gas Valve Control	1
29	FT-28819	Union FF 1/2"	1
30	WS-28796	Ogival Gasket Ø16 Ø18.5 x 8	1

Item	Part	Description	Qty.
31	NP-28800	Ogival Retainer Union 3/4 Ø16	1
32	FT-29105	Intake Union, Gas R3/4 NPT	1
33	CV-27106	Cover for Burner Flame	2
34	CL-27105	Clip for Burner Cover	8
35	FT-29104	Pressure Test Point Pipe	2
36	FT-29104	Pressure Test Point Pipe	2
37	BN-28775	Burner	2
38	PP-28798	Air Pipe Ø8 x Ø5	2
39	BN-28776	Air-Gas Distributor	2
40	GL-27724	Burner Control Glass Complete	2
41	SC-29099	Injector Plug	2
42	SA-28768	O-Ring Ø25.07	2
43	PP-28761	Air Pipe	2
44	RR-28787	Fan Manifold	2
45	SW-34399	Air Pressure Switch	2
46	WI-34701	Spark	1
47	WI-34698	Flame Sensor	1
48	BN-28795	Heat Exchanger Complete	1
49	TN-34640	Step Up Transformer	2
50	WH-27751	Fan Wheel Diameter 340mm	2
51	SP-27895	Motor Spacer	8
52	5008294	Motor 0.50 kW 115V-120V 60 HZ	2
53	BN-29108	Flue Exhaust Pipe Complete	1
54	BN-29107	Burner Flue Complete, Serial Gas Valve	1
	BN-29106	Burner Flue Complete, Parallel Gas Valve	1
55	TU-29115	SmartClean Overhead Tubing	1
56	TU-29113	SmartClean Water Supply Piping	1
**	DA-27532	Drain Fitting	1
**	SA-29116	Siphon Gasket	1
**	NZ-28186	Nozzle, Natural Gas, Size 550	2
**	NZ-28183	Nozzle, Propane Gas, Size 335	2

PARTS INFORMATION

Службныя часты

SERVICE PARTS— 20-20ESG (PARALLEL VALVE)

vsezip.ru

+7(812)987-08-81

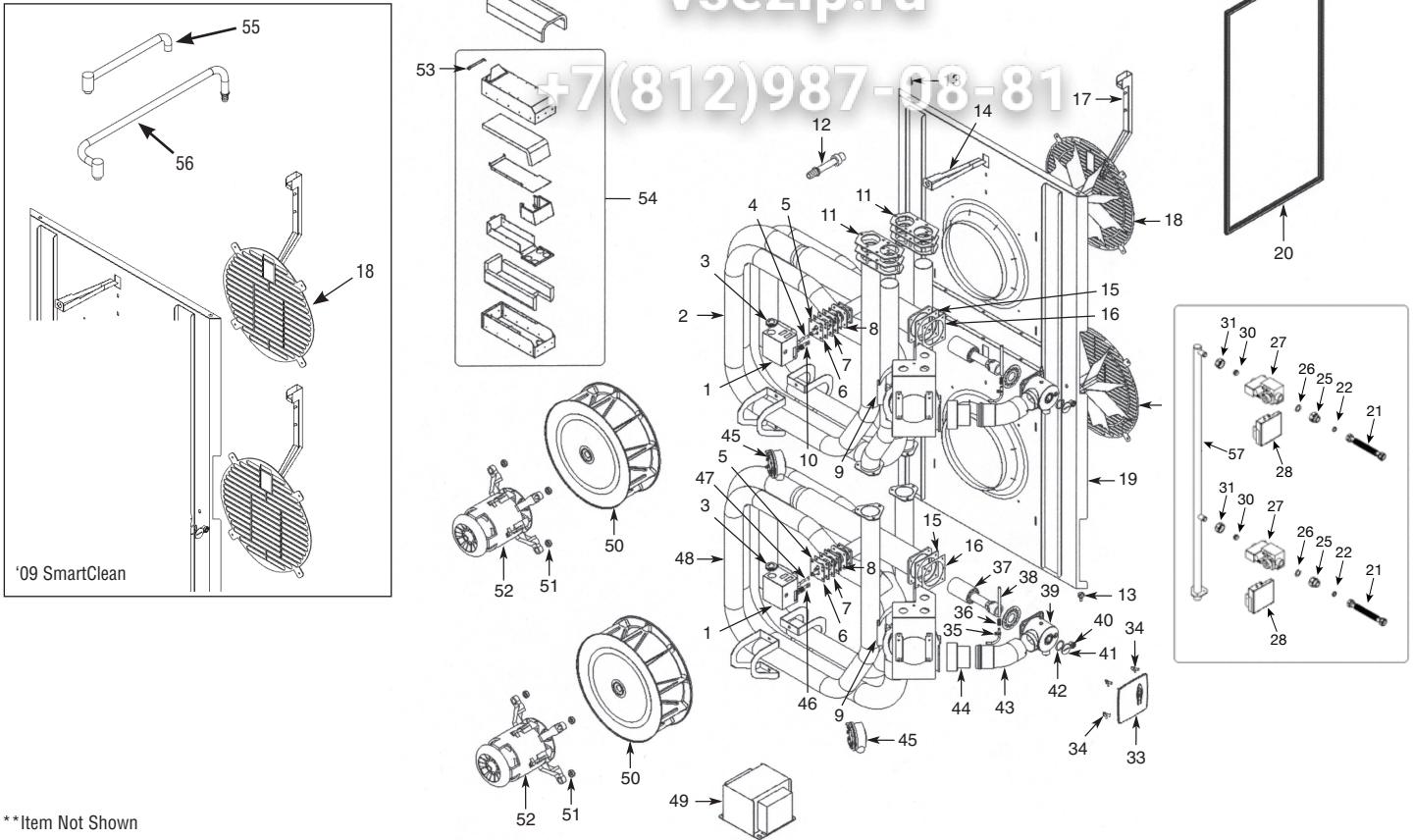

**Item Not Shown

Item	Part	Description	Qty.
1	PE-29102	Shield	2
2	BN-28815	Heat Exchanger Complete	1
3	SA-29100	Grommet Ø48 Ø60	2
4	WI-34697	Flame Sense Ionization Cable 1400mm	1
5	FL-34702	Flange	2
6	IG-34695	Igniter	2
7	SP-34703	Ignition Plug Spacer	4
8	GS-28567	Ignition Plug Flange Gasket	2
9	FA-34395	Burner Blower Fan 80 Watt Assembly	2
10	WI-34700	Spark Cable "HF" 1300mm	1
11	SA-29094	Outlet Flange Gasket	4
12	PB-27733	Water Injection Pipe	2
13	SC-28774	Screw TE M6 x 20 CH14	4
14	PB-27730	Water Injection Trove	2
15	SA-28770	Combustion Chamber Gasket	2
16	SA-28769	Combustion Chamber Gasket	2
17	PB-27730	Water Injection Tube For Direction Panel	2
18	CG-28791	Screen Grille	2
19	PE-28816	Direction Panel Complete 20.20ESG	1
20	GS-27126	Door Gasket 20.20ESG	1
21	PB-28804	Burner Pipe, Parallel Gas Valve	2
	PB-29095	Burner Pipe, Serial Gas Valve	2
22	WS-28765	Washer 1/2"	2
23	FT-28818	T Joint 1/2" F-F-M.	1
24	NP-28817	Nipple M 1/2"	1
25	NP-28800	Sleeve F3/4 M1/2	3
26	WS-28764	Washer 3/4"	3
27	VA-34398	Valve Honeywell	2
28	BA-34397	Gas Valve Control	1
29	FT-28819	Union FF 1/2"	1
30	WS-28796	Ogival Gasket Ø16 Ø18.5 x 8	1
31	NP-28800	Ogival Retainer Union 3/4 Ø16	1

Item	Part	Description	Qty.
32	FT-29105	Intake Union, Gas R3/4 NPT	1
33	CV-27106	Cover for Burner Flame	2
34	CL-27105	Clip for Burner Cover	8
35	FT-29104	Pressure Test Point Pipe	2
36	FT-29104	Pressure Test Point Pipe	2
37	BN-28775	Burner	2
38	PP-28798	Air Pipe Ø8 x Ø5	2
39	BN-28776	Air-Gas Distributor	2
40	GL-27724	Burner Control Glass Complete	2
41	SC-29099	Injector Plug	2
42	SA-28768	O-Ring Ø25.07	2
43	PP-28761	Air Pipe	2
44	RR-28787	Fan Manifold	2
45	SW-34399	Air Pressure Switch	2
46	WI-34701	Spark	1
47	WI-34698	Flame Sensor	1
48	BN-28795	Heat Exchanger Complete	1
49	TN-34640	Step Up Transformer	2
50	WH-27751	Fan Wheel Diameter 340mm	2
51	SP-27895	Motor Spacer	8
52	5008294	Motor 0.50 kW 115V-120V 60 HZ	2
53	BN-29108	Flue Exhaust Pipe Complete	1
54	BN-29107	Burner Flue Complete, Serial Gas Valve	1
	BN-29106	Burner Flue Complete, Parallel Gas Valve	1
55	TU-29115	SmartClean Overhead Tubing	1
56	TU-29113	SmartClean Water Supply Piping	1
57	TU-29566	Gas Manifold, 3/4" Parallel	1
**	DA-27532	Drain Fitting	1
**	SA-29116	Siphon Gasket	1
**	NZ-28186	Nozzle, Natural Gas, Size 550	2
**	NZ-28183	Nozzle, Propane Gas, Size 335	2

RIGHT-HAND DOOR ASSEMBLY (SINGLE LATCH PRIOR TO 3/09) — 6.10ESG, 10.10ESG, 7.14ESG, 12.18ESG

vsezip.ru

+7(812)987-08481

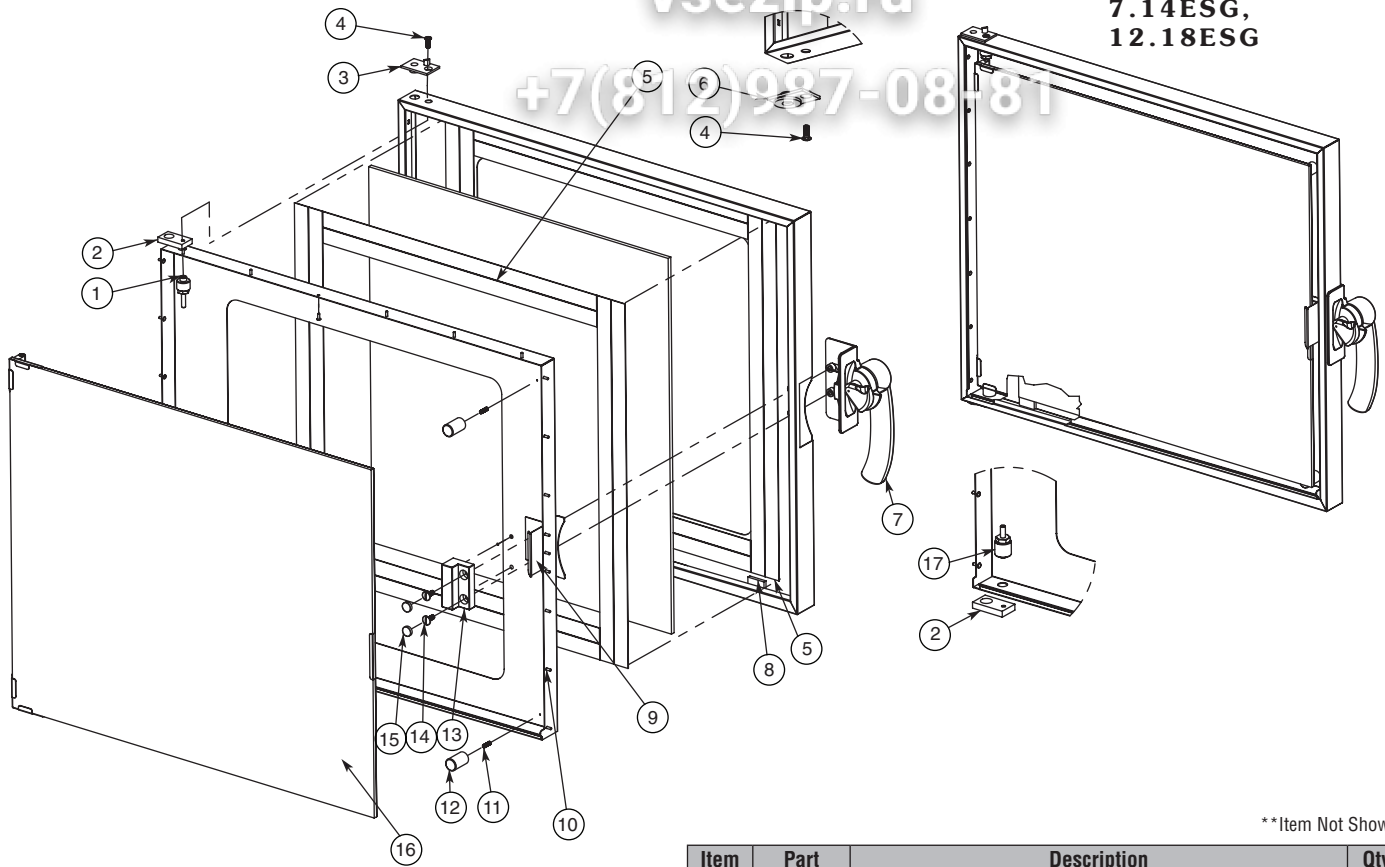

**Item Not Shown

Item	Part	Description	Qty.
-	DR-27715	Complete Right-hand Door Assembly, 6.10ESG	1
	DR-27716	Complete Right-hand Door Assembly, 10.10ESG	1
	DR-27717	Complete Right-hand Door Assembly, 7.14ESG	1
	5007182	Complete Right-hand Door Assembly, 12.18ESG	1
1	PI-26973	Pin, Upper	1
2	HG-25078	Hinge, Anchor, Combis	2
3	HG-25077	Upper Lock Spacer	1
4	SC-22282	Screw, 1.0X 16mm, Phillips Head Oval, Heavy-Duty N/S 18-8, DIN # 966A	2
5	TA-25125	Tape, Double Sided	2
6	HG-25079	Lower Lock Spacer	1
7	HD-26966	Handle, Door, Right	1
8	BM-27116	Bumper	2
9	CL-27854	Inner Door Latch	1
10	RI-27108	Rivet, Sealed	22
11	SC-25091	Screw, M5X16, DIN 551, A2 Stainless Steel, Set Screw Flat Point	2
12	BM-27146	Bumper Stop/Inner Door	2
13	SP-27212	Spacer, Window Latch	1
14	SC-27125	Screw, Truss Head, Stainless Steel	2
15	PG-24789	Plug, 15mm	2
16	5007001	Inner Door, Glass Assembly, 6.10ESG	1
	5009164	Inner Door, Glass Assembly, 10.10ESG	1
	5005225	Inner Door, Glass Assembly, 7.14ESG	1
	5007181	Inner Door, Glass Assembly, 12.18ESG	1
17	PI-26974	Pin, Lower	1
**	GS-27129	Door Gasket, 6.10ESG	1
**	GS-27128	Door Gasket, 10.10ESG	1
**	GS-27130	Door Gasket, 7.14ESG	1
**	GS-27127	Door Gasket, 12.18ESG	1

PARTS INFORMATION **Всezip.ru**

RIGHT-HAND DOOR ASSEMBLY (SINGLE LATCH PRIOR TO 3/09) — 10.20ESG, 20.20ESG

vsezip.ru

+7(812)987-08-81

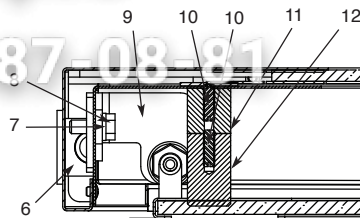
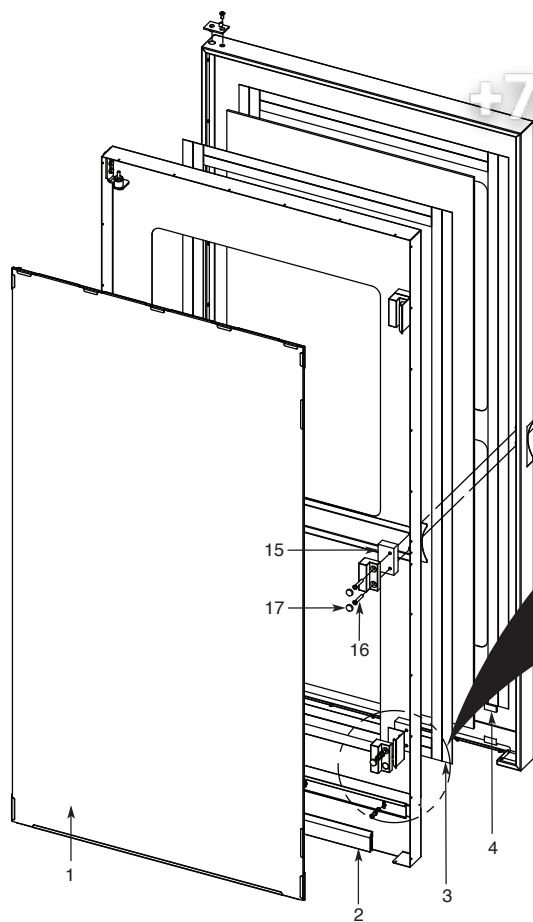

Bottom Hinge from above

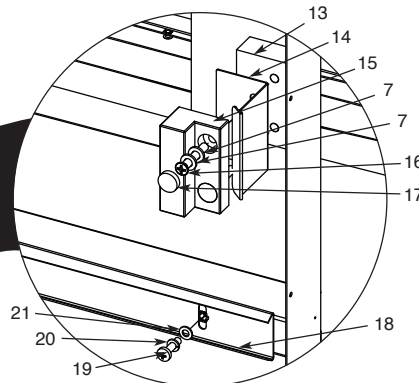

**Item Not Shown

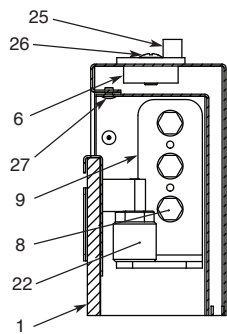

Top Hinge Area

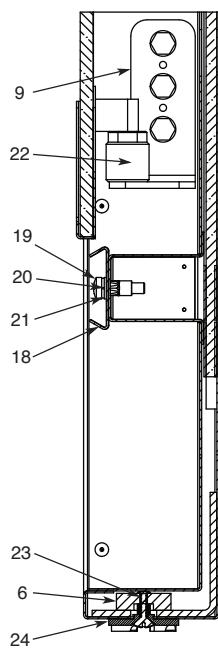

Bottom Hinge Area

Item	Part	Description	Qty.
-	5007179	Complete Door Assembly, 10.20ESG	1
-	5007973	Complete Door Assembly, 20.20ESG	1
1	5007178	Inner Door, Glass Assembly, 10.20ESG	1
	5007862	Inner Door, Glass Assembly, 20.20ESG	1
2	GS-25619	Door Gasket	1
3	TA-25125	Tape, Double Sided	2
4	BM-27116	Bumper	4
5	HD-26966	Handle, Door, Right	1
6	HG-25078	Hinge, Anchor	2
7	WS-22297	Washer, Flat, M6, DIN 125, 20.20ESG	14
8	SC-22284	Screw, M6 x 16 Hex Stainless Steel Heavy-Duty, 20.20ESG	6
9	1007893	Hinge, Lower Glass Holder	2
10	SC-25091	Screw, M5 x 16, DIN 551, A2 Stainless Steel, Slotted Set Screw Flat Point	6
11	SP-27657	Spacer, Glass, 20mm	3
12	BM-27146	Bumper Stop/Inner Door	3
13	SP-27682	Spacer, Inner Glass Latch	3
14	CL-27854	Clip, Door Glass	2
15	SP-27212	Spacer, Window Latch	3
16	SC-22283	Screw, M6 x 35mm LG, Phillips Head Oval Heavy-Duty N/S 18-8, DIN 966A	6
17	PG-24789	Plug, 15mm	6
18	1008902	Door Seal Support Bracket	1
19	SC-22779	M5-0.8 x 20mm, Phillips Head Pan Heavy-Duty	4
20	WS-22301	Washer, M5 Split Lock Stainless Steel 18-8 DIN 127B	4
21	WS-22295	Washer, Flat M5 Stainless Steel	4
22	PI-26974	Pin, Lower	2
23	SC-22282	Screw, 1.0 x 16mm, Phillips Head Oval Heavy-Duty N/S 18-8, DIN 966A	1
24	HG-25079	Hinge, Upper Ratchet	1
25	HG-25077	Hinge, Top Stop	1
26	SC-25085	M6 x 12, Oval Heavy-Duty	1
27	RI-27108	Rivet, Sealed	37
	RI-2097	#42 Stainless Rivet	90
**	GS-27127	Door Gasket, 10.20ESG	1
**	GS-27126	Door Gasket, 20.20ESG	1
**	1010739	Preheat Sealing Strip (to preheat units without roll-in trolley)	1

RIGHT-HAND DOOR ASSEMBLY (DUAL LATCH AFTER 3/09) — 6.10ESG, 10.10ESG, 7.14ESG, 12.18ESG

vsezip.ru

+7(812)987-08-81

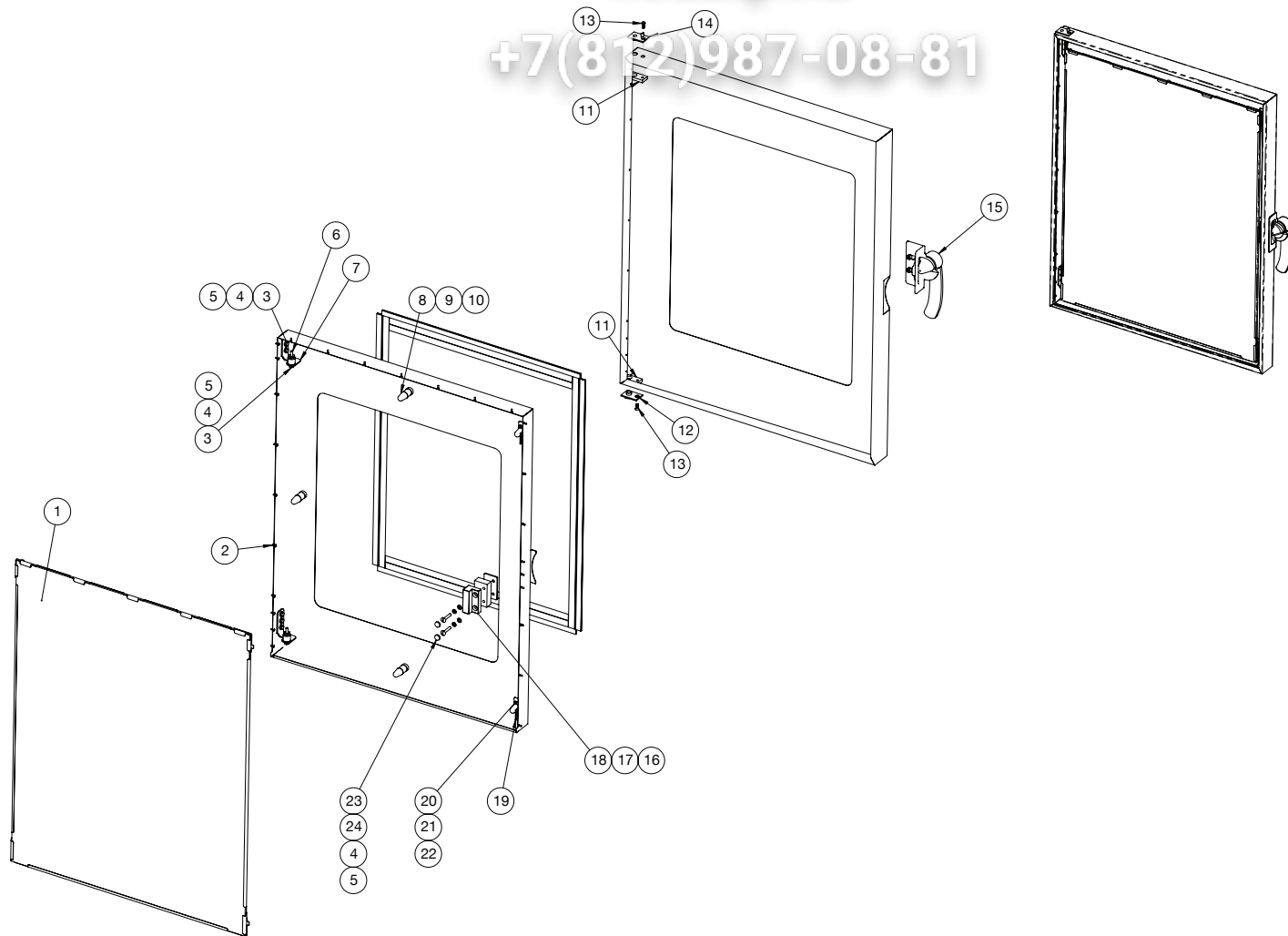

**Item Not Shown

Item	Part	Description	Qty.
-	DR-27715	Complete Right-hand Door Assembly, 6.10ESG	1
-	DR-27716	Complete Right-hand Door Assembly, 10.10ESG	1
-	DR-27717	Complete Right-hand Door Assembly, 7.14ESG	1
-	5007182	Complete Right-hand Door Assembly, 12.18ESG	1
1	5012405	Inner Door, Glass Assembly, 12.18ESG	1
	5013324	Inner Door, Glass Assembly, 6.10ESG	1
	5012651	Inner Door, Glass Assembly, 10.10ESG	1
	5012653	Inner Door, Glass Assembly, 7.14ESG	1
2	RI-27108	Rivet, Sealed	44
3	SC-22284	Screw, M6 x 16 Hex Stainless Steel Heavy-Duty	8
4	WS-22302	Washer, Split Lock	10
5	WS-22297	Washer, Flat, M6, DIN 125	10
6	PI-26974	Pin, Lower	2
7	1007893	Hinge, Lower Glass Holder	2
8	BM-25072	Bumper Stop/Inner Door	5
9	SP-27657	Spacer, Glass, 20mm	5
10	SC-25091	Screw, Slotted Set Screw Flat Point	5
11	HG-25078	Hinge, Anchor	2

Item	Part	Description	Qty.
12	HG-25079	Hinge, Upper Ratchet	1
13	SC-22282	Screw, Phillips Head Oval Heavy-Duty	2
14	HG-25077	Hinge, Top Stop	1
15	HD-26966	Handle, Door, Right	1
16	1009380	Spacer	1
17	SP-27682	Spacer, Inner Glass Latch	1
18	SP-27212	Spacer, Window Latch	1
19	LT-34777	Latch, Inner Door	2
20	SC-22271	Screws, Phillips	2
21	WS-22300	Washer, Split Lock	2
22	WS-22294	Washer, Flat M4 Stainless Steel	2
23	PG-24789	Plug, 15mm	2
24	SC-29089	Screw, Truss Head	2
**	GS-27129	Door Gasket, 6.10ESG	1
**	GS-27128	Door Gasket, 10.10ESG	1
**	GS-27130	Door Gasket, 7.14ESG	1
**	GS-27127	Door Gasket, 12.18ESG	1

PARTS INFORMATION **Всezip.ru**

RIGHT-HAND DOOR ASSEMBLY (DUAL LATCH AFTER 3/09) — 10.20ESG, 20.20ESG

vsezip.ru

7(812)987-08-81

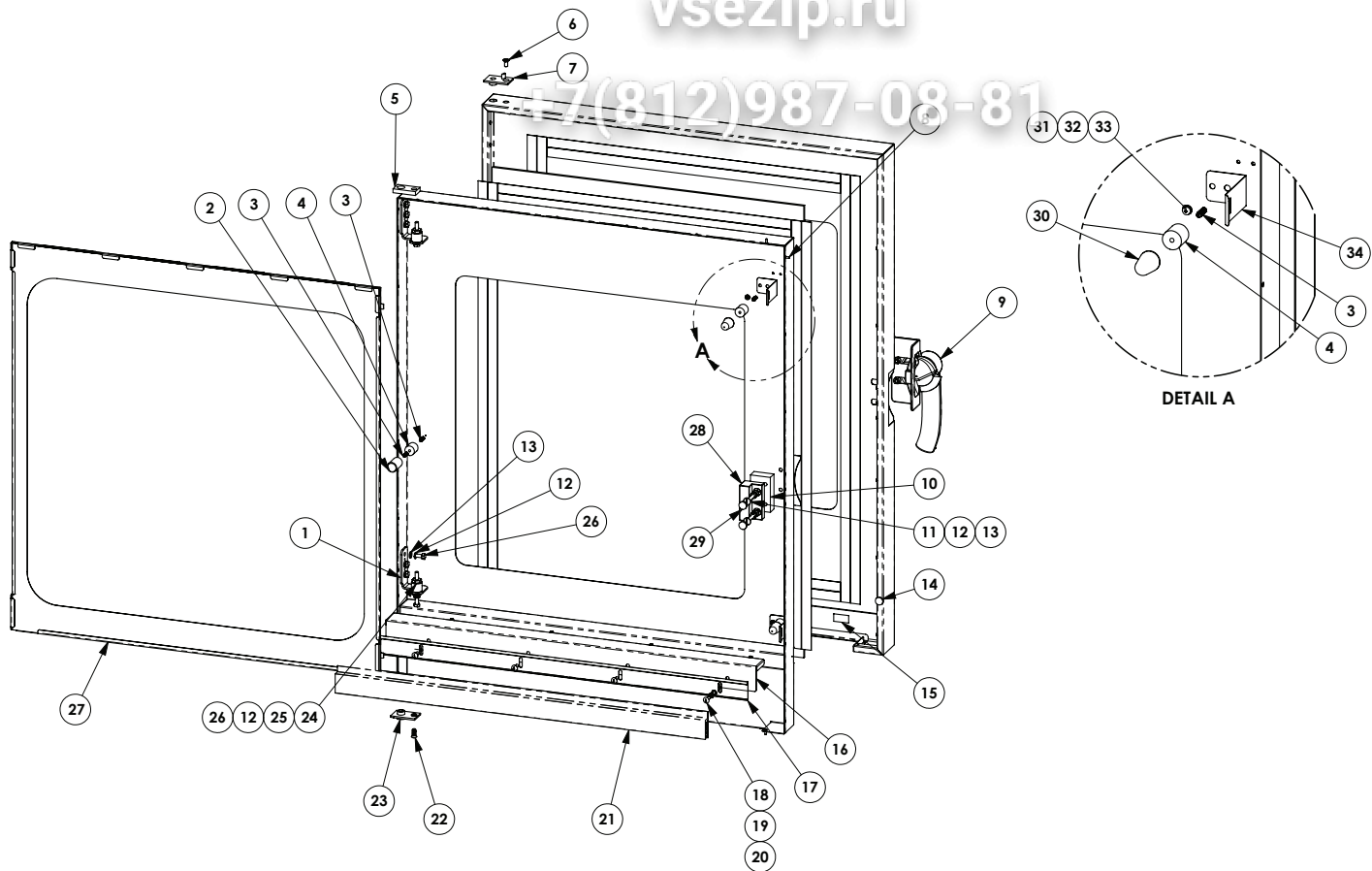

**Item Not Shown

Item	Part	Description	Qty.
-	5007179	Complete Door Assembly, 10.20ESG	1
-	5007973	Complete Door Assembly, 20.20ESG	1
1	1007893	Hinge, Lower Glass Holder	2
2	BM-27146	Bumper Stop/Inner Door	1
3	SC-25091	Screw, Slotted Set Screw Flat Point	4
4	SP-27657	Spacer, Glass, 20mm	3
5	HG-25078	Hinge, Anchor	2
6	SC-25085	Screw, M6 x 12, Oval Heavy-Duty	1
7	HG-25077	Hinge, Top Stop	1
8	RI-27108	Rivet, Sealed	34
9	HD-26966	Handle, Door, Right	1
10	SP-27682	Spacer, Inner Glass Latch	1
11	SC-29089	Screw, Truss Head	2
12	WS-22302	Washer, Split Lock	10
13	WS-22297	Washer, Flat, M6, DIN 125	8
14	SC-22753	Screws, Round, Hanging Rack	2
15	BM-27116	Bumper	4
16	1010070	Backer Support Sweep Gasket	1
17	1010294	Sweep Gasket Holder	1
18	SC-27109	Screw, Truss Head	4
19	WS-22301	Washer, M5 Split Lock Stainless Steel 18-8 DIN 127B	4
20	WS-22295	Washer, Flat M5 Stainless Steel	4

Item	Part	Description	Qty.
21	GS-28593	Door Gasket	1
22	SC-22282	Screw, Phillips Head Oval Heavy-Duty	1
23	HG-25079	Hinge, Upper Ratchet	1
24	PI-26974	Pin, Lower	2
25	WS-22094	Washer, Flat	2
26	SC-22284	Screw, M6 x 16 Hex Stainless Steel Heavy-Duty	8
27	5012128	Inner Door, Glass Assembly, 10.20ESG	1
	5012172	Inner Door, Glass Assembly, 20.20ESG	1
28	SP-27212	Spacer, Window Latch	1
29	PG-24789	Plug, 15mm	2
30	BM-25072	Bumper, Rubber	2
31	WS-22300	Washer, Split Lock	2
32	WS-22294	Washer, Flat	2
33	SC-22271	Screws, Phillips	2
34	LT-34777	Latch, Inner Door	2
**	GS-27127	Door Gasket, 10.20ESG	1
**	GS-27126	Door Gasket, 20.20ESG	1
**	1010739	Preheat Sealing Strip (to preheat units without roll-in trolley)	1

LEFT-HAND DOOR ASSEMBLY (SINGLE LATCH) — 6.10ESG, 10.10ESG, 7.14ESG

vsezip.ru

+7(812)987-08-81

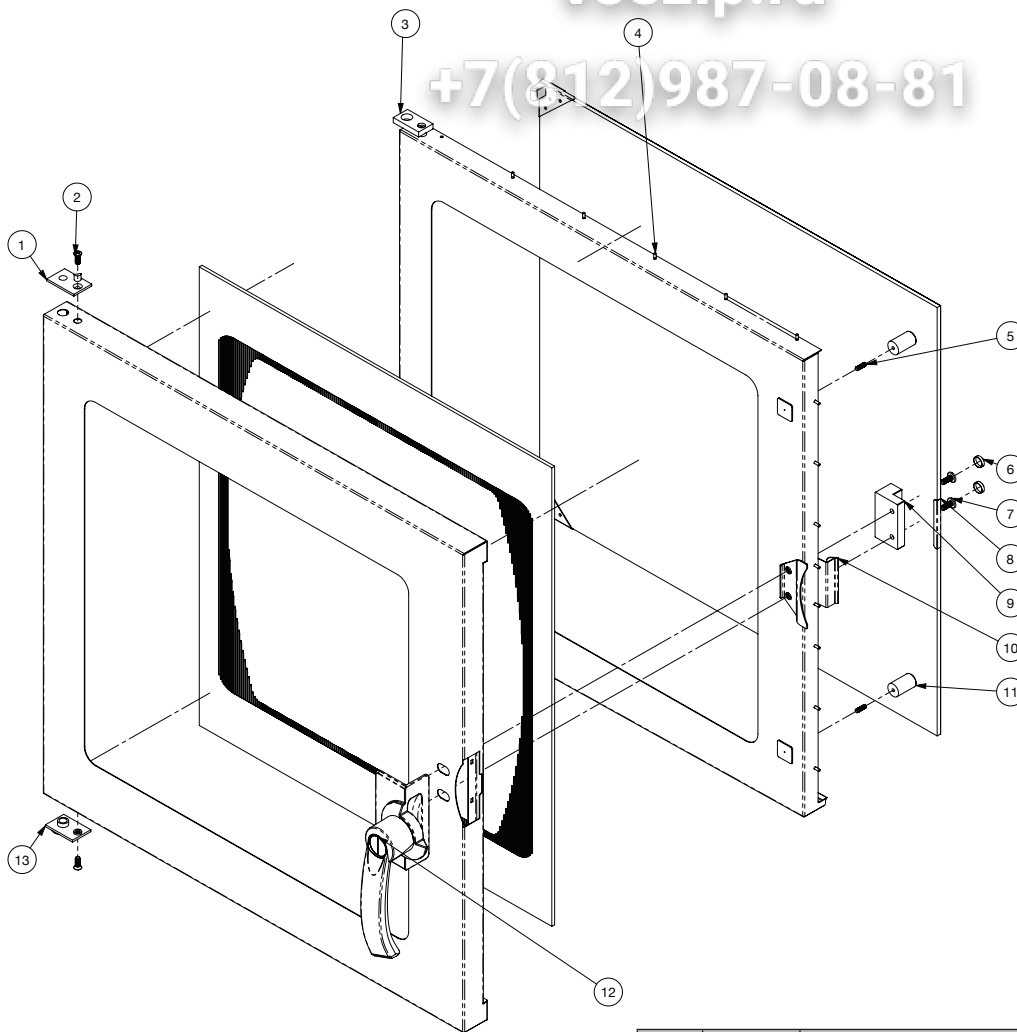

**Item Not Shown

Item	Part	Description	Qty.
–	5008169	Complete Left-Hand Door Assembly, 6.10ESG	1
–	5008234	Complete Left-Hand Door Assembly, 10.10ESG	1
–	5007424	Complete Left-Hand Door Assembly, 7.14ESG	1
1	HG-25077	Hinge, Top Stop	1
2	PI-26973	Pin, Upper	1
3	HG-25078	Hinge, Anchor	2
4	RI-27108	Rivet, Sealed	21
5	SC-25091	Screw, Slotted Set Screw Flat Point	2
6	PG-24789	Plug, 15mm	2
7	SC-27125	Screw, Truss Head	2
8	5018173	Inner Door, Glass Assembly, 6.10ESG	1
	5018237	Inner Door, Glass Assembly, 10.10ESG	1
	5007428	Inner Door, Glass Assembly, 7.14ESG	1
9	SP-27212	Spacer, Window Latch	1
10	1008564	Latch, Inner Door	1
11	BM-27146	Bumper	2
12	HD-26967	Handle, Door, Left	1
13	HG-25079	Hinge, Upper Ratchet	1
14	PI-26974	Pin, Lower (not shown)	1
15	BM-27116	Bumper (not shown)	2
**	GS-27129	Door Gasket, 6.10ESG	1
**	GS-27128	Door Gasket, 10.10ESG	1
**	GS-27130	Door Gasket, 7.14ESG	1

PARTS INFORMATION

Всezip.ru

RECESSED DOOR ASSEMBLY — (DUAL LATCH AFTER 3/09) 6.10ESG, 10.20ESG, 7.14ESG, 12.18ESG

+7(812)987-08-81

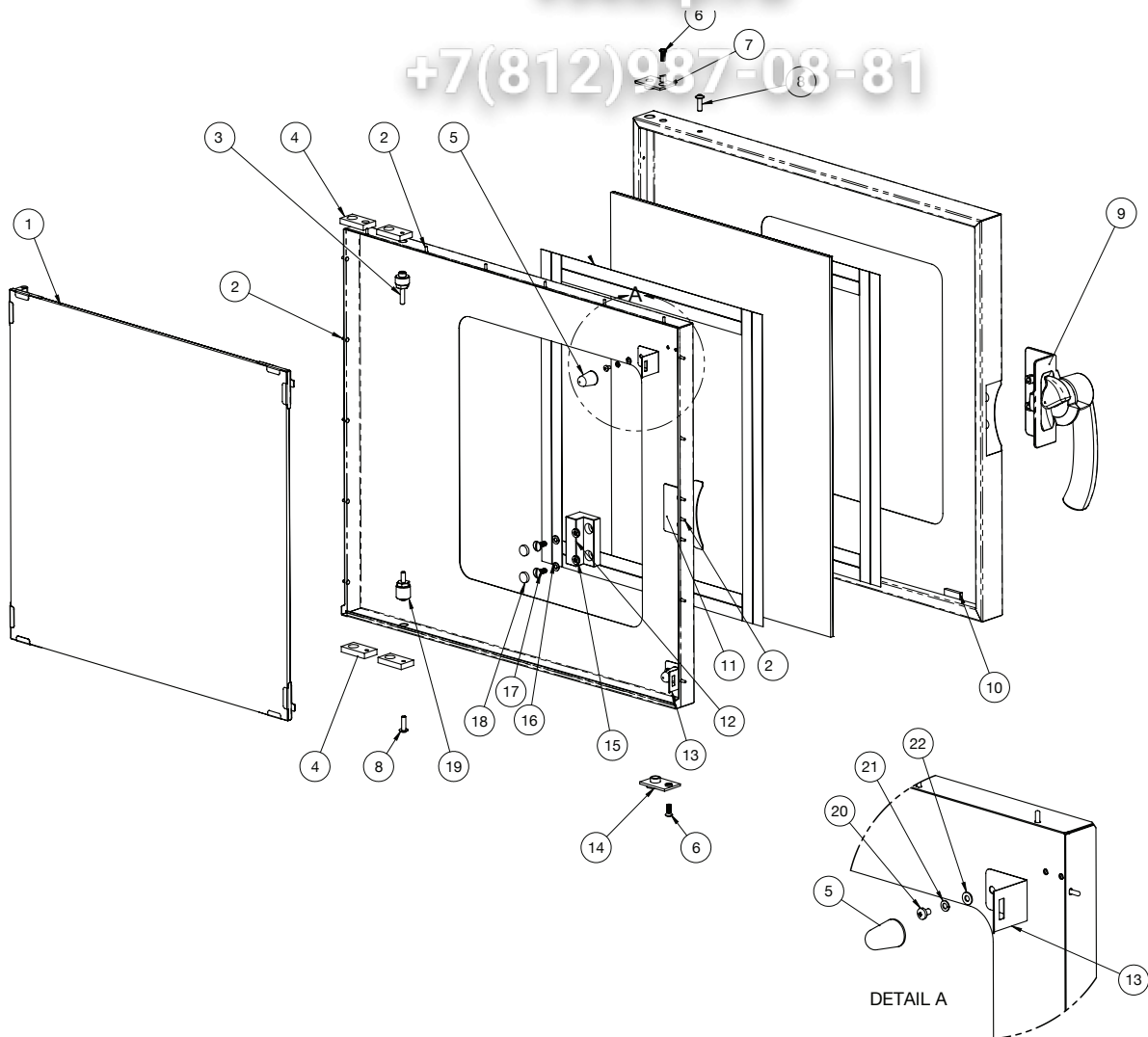

**Item Not Shown

Item	Part	Description	Qty.
-	5009777	Complete Right-hand Door Assembly, 6.10ESG	1
-	5009163	Complete Right-hand Door Assembly, 10.10ESG	1
-	5009775	Complete Right-hand Door Assembly, 7.14ESG	1
-	5011957	Complete Right-hand Door Assembly, 12.18ESG	1
1	5012652	Inner Door, Glass Assembly, 6.10ESG	1
	5012651	Inner Door, Glass Assembly, 10.10ESG	1
	5012653	Inner Door, Glass Assembly, 7.14ESG	1
	5012405	Inner Door, Glass Assembly, 12.18ESG	1
2	RI-27108	Rivet, Sealed	various
3	PI-26973	Pin, Upper	2
4	HG-25078	Hinge, Anchor	2
5	BM-25072	Bumper Stop/Inner Door	2
6	SC-22282	Screw, Phillips Head Oval Heavy-Duty	2
7	HG-25077	Hinge, Top Stop	1
8	SC-25128	Screw, Truss Head	2
9	HD-26966	Handle, Door, Right	1
10	BM-27116	Bumper	2

Item	Part	Description	Qty.
11	1009381	Spacer, 14 gauge, 6.10ESG, 10.10ESG	1
	1009380	Spacer, 11 gauge, 7.14ESG	1
12	SP-27212	Spacer, Window Latch	1
13	LT-29086	Latch, Inner Door Glass	2
14	HG-25079	Hinge, Upper Ratchet	1
15	WS-22297	Washer, Flat, M6, DIN 125	4
16	WS-22302	Washer, Split Lock	2
17	SC-27125	Screws, Truss Head	2
18	PG-24789	Plug, 15mm	2
19	PI-26974	Pin, Lower	1
20	SC-22271	Screws, Phillips Head	2
21	WS-22300	Washer, Split Lock	2
22	WS-22294	Washer, Flat M4 Stainless Steel	2
**	GS-27129	Door Gasket, 6.10ESG	1
**	GS-27128	Door Gasket, 10.10ESG	1
**	GS-27130	Door Gasket, 7.14ESG	1
**	GS-27127	Door Gasket, 12.18ESG	1

RECESSED DOOR TRACK — 6.10ESG, 10.10ESG, 7.14ESG, 12.18ESG

vsezip.ru

7(812)987-08-81

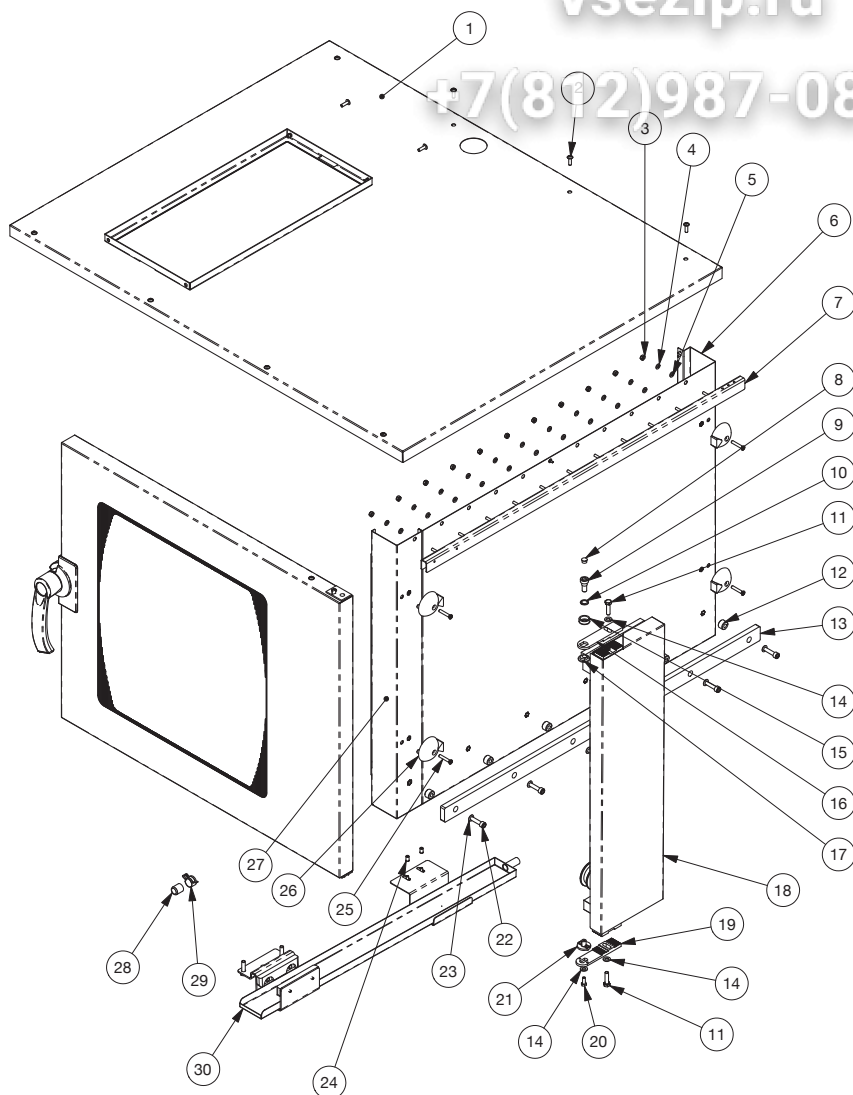

5012762

Item	Part	Description	Qty.
1	5010649	Outer Top Cover Assembly, 6.10ESG, SmartClean	1
	5006992	Outer Top Cover Assembly, 10.10ESG, SmartClean	1
	5012656	Outer Top Cover Assembly, 6.10ESG, 10.10ESG, CombiClean	1
	5012761	Outer Top Cover Assembly, 7.14ESG, CombiClean	1
	5009832	Outer Top Cover Assembly, 7.14ESG, SmartClean	1
2	SC-25128	Screw, Truss Head, M6	10
3	NU-22291	Nut, Hex Head, M6	9
4	WS-22302	Washer, Split Lock, M6	11
5	WS-22297	Washer, Flat, M6	11
6	5009831	Right Side Assembly, 6.10ESG	1
	5009167	Right Side Assembly, 10.10ESG	1
	5009830	Right Side Assembly, 7.14ESG	1
7	5009168	Guide Rail Assembly, 6.10ESG, 10.10ESG	1
	5009746	Guide Rail Assembly, 7.14ESG	1
8	PG-25460	Plug	1
9	SC-25102	Upper Hinge Axis Screw	1
10	WS-25478	Washer, Serrated	1
11	SC-22279	Screw, Hex Head, M8	2
12	SP-28440	Rail Spacer	6
13	RA-28206	Rail, Bottom, 6.10ESG, 10.10ESG	1
	RA-28292	Rail, Bottom, 7.14ESG	1

Item	Part	Description	Qty.
14	WS-22298	Washer, M8	3
15	WS-25127	Washer, Covering for Hinge	1
16	HG-28041	Hinge, Recessed Door	1
17	WS-25124	Washer, Eccentric	1
18	5009771	Trolley Assembly, 6.10esG	1
	5009140	Trolley Assembly, 10.10esG	1
	5009772	Trolley Assembly, 7.14esG	1
19	HG-28040	Hinge, Recessed Door	1
20	SC-22284	Screw, Hex Head, M6	1
21	HG-25101	Hinge, Lower, Ratchet	1
22	SC-24388	Screw, SHC M8	6
23	WS-24396	Washer, Serrated Bevel, M8	6
24	NU-22385	Insert Nut, Threaded, M5	2
25	SC-22283	Screw, Oval Head, M6	4
26	BK-27412	Block, Recessed Door	4
27	5009829	Corner Assembly, 6.10ESG	1
	5009166	Corner Assembly, 10.10ESG	1
	5009828	Corner Assembly, 7.14ESG	1
28	CP-29358	Cap, Push-on	1
29	CM-28145	Clamp, Hose, 20mm	1
30	5009736	Lower Drip Tray Assembly	1

PARTS INFORMATION **Всezip** ОБЩЕПИТ

RECESSED DOOR ASSEMBLY — 10.20ESG, 20.20ESG

vsezip.ru

+7(812)987-08-81

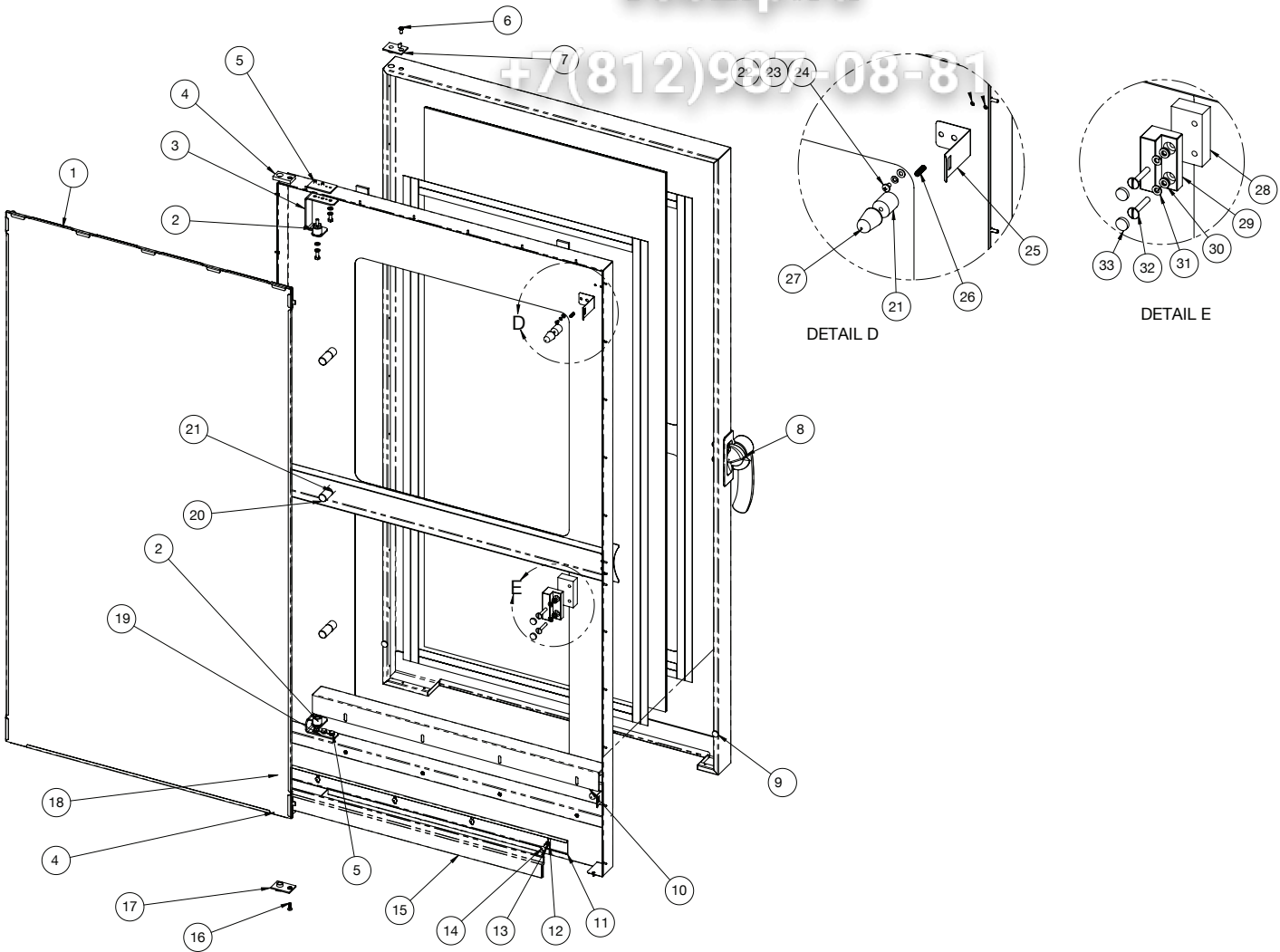

**Item Not Shown

Item	Part	Description	Qty.
-	5009740	Complete Right-hand Door Assembly, 10.20ESG	1
-	5009779	Complete Right-hand Door Assembly, 20.20ESG	1
1	5012128	Inner Door, Glass Assembly, 10.20ESG	1
	5012172	Inner Door, Glass Assembly, 20.20ESG	1
2	PI-26974	Pin, Lower	1
3	1010306	Hinge, Upper Glass Holder, 10.20ESG	1
	1009424	Hinge, Upper Glass Holder, 20.20ESG	1
4	HG-25078	Hinge, Anchor	2
5	SC-22284	Screw, Hex Head	8
6	SC-25085	Screw, Oval Head	1
7	HG-25077	Hinge, Top Stop	1
8	HD-26966	Handle, Door, Right	1
9	SC-22753	Screws, Round, Hanging Rack	2
10	1010070	Backer, Sweep Support Gasket	1
11	1010294	Sweep Gasket Holder	1
12	WS-22295	Washer, Flat M5 Stainless Steel	4
13	WS-22301	Washer, Split Lock, M5	4
14	SC-27109	Screw, Truss Head, M5	4
15	GS-28593	Door Gasket	1
16	SC-22282	Screw, Phillips Head Oval Heavy-Duty	1

Item	Part	Description	Qty.
17	HG-25079	Hinge, Upper Ratchet	1
18	RI-27108	Rivet, Sealed	various
19	1009295	Hinge, Lower Glass Holder	1
20	BM-27146	Bumper Stop/Inner Door	3
21	SP-27657	Spacer, Glass, 20mm	5
22	WS-22294	Washer, Flat M4 Stainless Steel	2
23	WS-22300	Washer, Split Lock	2
24	SC-22271	Screws, Phillips Head	2
25	LT-34777	Latch, Inner Door, 20.20ESG	2
26	SC-25091	Screw, Solid Set Flat	8
27	BM-25072	Bumper, Ribber	2
28	SP-27682	Spacer, Inner Glass Latch	1
29	SP-27212	Spacer, Window Latch	1
30	WS-22297	Washer, Flat, M6, DIN 125	12
31	WS-22302	Washer, Split Lock	10
32	SC-29089	Screw, Truss Head, M6	2
33	PG-24789	Plug, 15mm	2
**	GS-27127	Door Gasket, 10.20ESG	1
**	GS-27126	Door Gasket, 20.20ESG	1
**	1010752	Preheat Sealing Strip (to preheat units w/o roll-in trolley)	1

RECESSED DOOR TRACK — 12.18ESG, 10.20ESG, 20.20ESG

vsezip.ru

+7(812)987-08-81

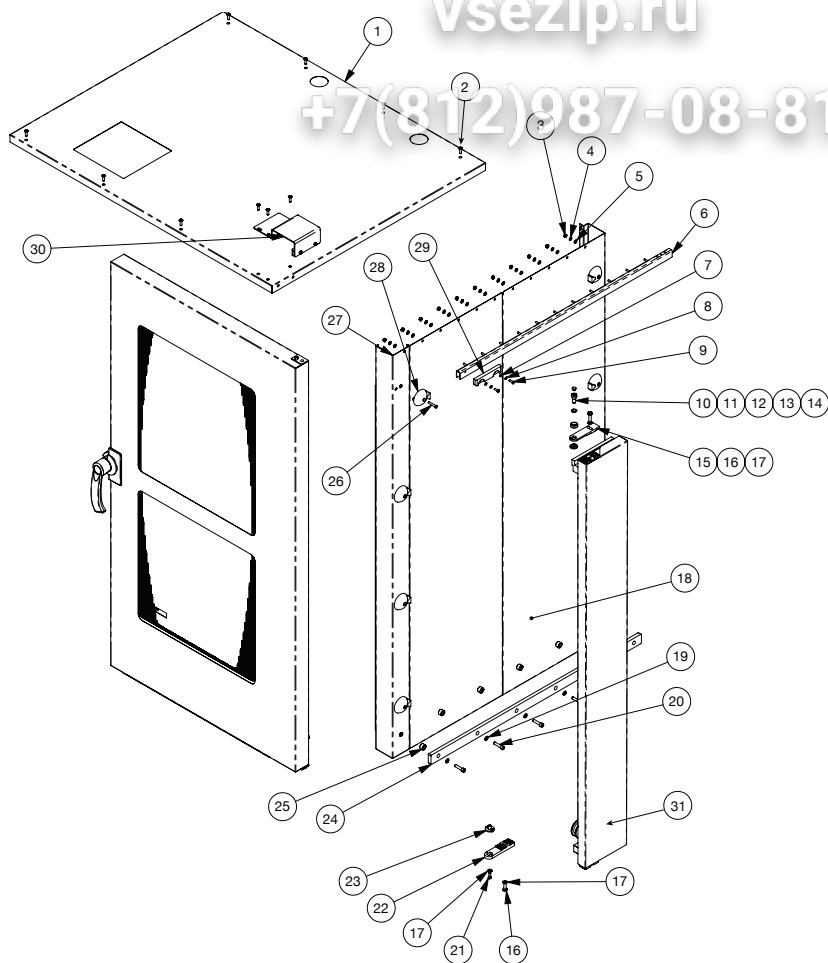

**Item Not Shown

Item	Part	Description	Qty.
1	5009745	Cover, Top, 12.18ESG, 10.20ESG, SmartClean	1
	5012765	Cover, Top, 12.18ESG, 10.20ESG, CombiClean	1
	1010467	Cover, Top, 20.20ESG, SmartClean	1
	1011729	Cover, Top, 20.20ESG, CombiClean	1
2	SC-25128	Screw, Truss Head, M6	10
3	NU-22291	Nut, Hex, M6	11
4	WS-22302	Washer, Split Lock, M6	11
5	WS-22297	Washer, Flat, M5	11
6	5009746	Guide Rail Assembly	1
7	WS-22295	Washer, Flat, M5	2
8	WS-22301	Washer, Split Lock, M5	2
9	SC-22926	HHCS, M5	2
10	SC-25102	Screw, Upper Hinge Axis	1
11	WS-25478	Washer, Serrated	1
12	WS-25127	Covering Washer for Hinge	1
13	WS-25124	Eccentric Washer	1
14	PG-25460	Plug	1
15	HG-28041	Hinge, Recessed Door	1
16	SC-22279	Screw, Hex Head, M8	2

Item	Part	Description	Qty.
17	WS-22298	Washer, M8	3
18	5009730	Right Hand Side Panel, 12.18ESG, 10.20ESG	1
	5010609	Right Hand Side Panel, 20.20ESG	1
19	WS-24396	Washer, Serrated Bevel, M8	6
20	SC-24388	Screw, SHC M8	6
21	SC-22284	Screw, Hex Head, M6	1
22	HG-28411	Hinge, Recessed Door	1
23	HG-25101	Hinge, Lower Ratchet	1
24	RA-28292	Rail, Bottom	1
25	SP-28440	Rail Spacer	6
26	SC-22283	Screw, Pan Head Oval, M6	8
27	5009729	Right-Front Corner Assembly, 12.18ESG, 10.20ESG	1
	5009848	Right-Front Corner Assembly, 20.20ESG	1
28	BK-27412	Block, Recessed Door	8
29	BK-28571	Cart Guide Block, White Teflon	1
30	5009954	Upper Door Guide	1
31	5009732	Recessed Door Trolley Assembly, 12.18ESG, 10.20ESG	1
	5009773	Recessed Door Trolley Assembly, 20.20ESG	1
**	5011866	Wear Pad Assembly, 12.18ESG	1

PARTS INFORMATION Всички Общепит

ELECTRICAL ASSEMBLY — 6.10ESG, 10.10ESG, 7.14ESG, 12.18ESG, 10.20ESG

vsezip.ru

+7(812)987-08-81

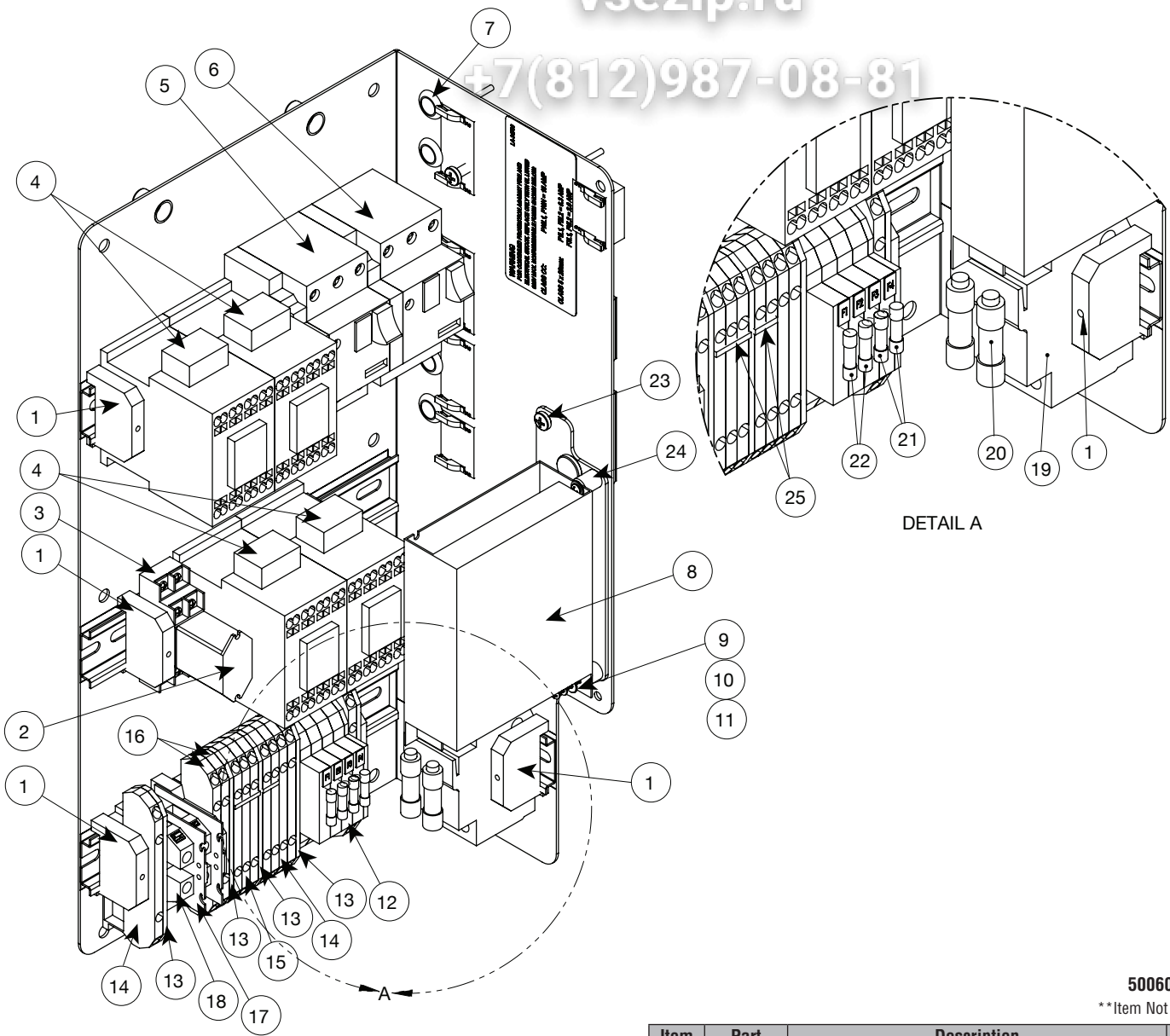

5006056
**Item Not Shown

Item	Part	Description	Qty.
1	TM-34305	Terminal, Screwless End	8
2	RL-34279	Relay, Smoke	1
3	RL-34634	Socket, Relay Smoke	1
4	CN-34343	Contactor, 25 Amp, 120V	4
	CN-34304	Contactor, 25 Amp, 208/240V	4
5	SW-34017	Switch Motor Protect, 9 to 14 Amp, High Speed, 120V 6.10ESG, 10.10ESG, 7.14ESG, 12.18ESG, 10.20ESG	1
	SW-33378	Switch Motor Protect, 1.5 to 2.5 Amp, 208V - 3ph Low and High Speed, 6.10ESG, 10.10ESG, 7.14ESG, 12.18ESG, 10.20ESG	1
	SW-33855	Switch Motor Protect, 6.0 to 10.0 Amp, 208V - 1 ph Low and High Speed, 7.14ESG	1
6	SW-33500	Switch Motor Protect, 2.5 to 4.0 Amp, Low Speed, 120V 6.10ESG, 10.10ESG, 7.14ESG	1
	SW-33856	Switch Motor Protect, 6.3 Amp, Low Speed, 120V 10.20ESG, 12.18ESG	1
7	SL-3830	Sleeve, Wire Protector	6
8	BA-34508	Power Supply, 40 Watt, 12V.DC	1
9	SC-22270	Screw, Phillips Head, M3	2
10	WS-22293	Washer, M3	2

Item	Part	Description	Qty.
11	WS-22299	Washer, Split Lock, M3	2
12	TM-34311	Terminal Fuse Holder, 8mm	4
13	TM-34309	Terminal, End Section, Spring	5
14	TM-34307	Terminal, Orange, Spring, 6mm	5
15	TM-34308	Terminal, Blue, Spring, 6mm	4
16	TM-34306	Terminal, Ground, Spring, 6mm	2
17	TM-3785	Partition	2
18	TM-3779	Terminal Block	2
19	FU-34771	Fuse Holder, 2 Bank (120V - 1ph)	1
	FU-34770	Fuse Holder, 3 Bank (208V - 3ph)	1
20	FU-34772	Fuse, 15 Amp, 120V	2
21	FU-33184	Slow Blow, 2 Amp, 250V	4
22	FU-33452	Neozed, 6.3AMP	4
23	SC-22766	Screw, Pan Head Phillips	2
24	BU-25094	Bushing, Brass	2
25	TM-34310	Jumper Bar	1
**	TM-34315	Terminal, End Plate	1
**	TM-3932	Terminal, Ground	1

vsezip.ru
+7(812)98708181

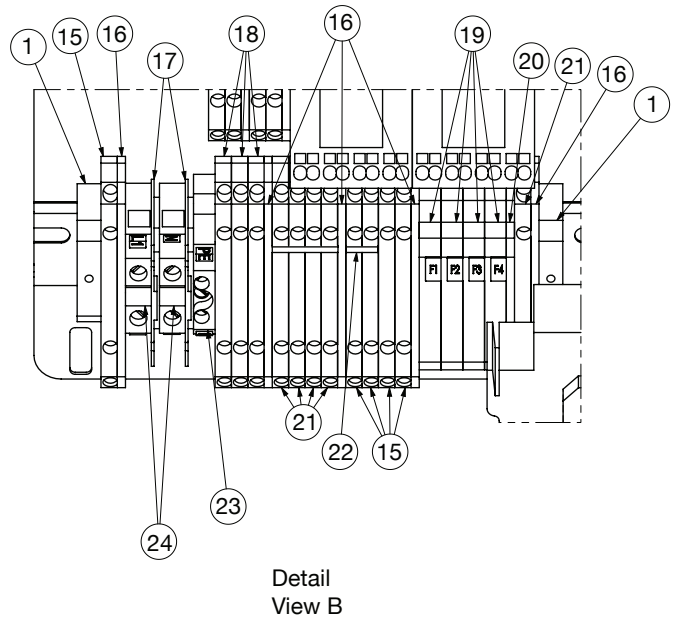
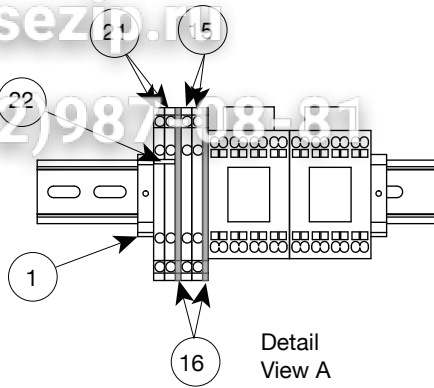
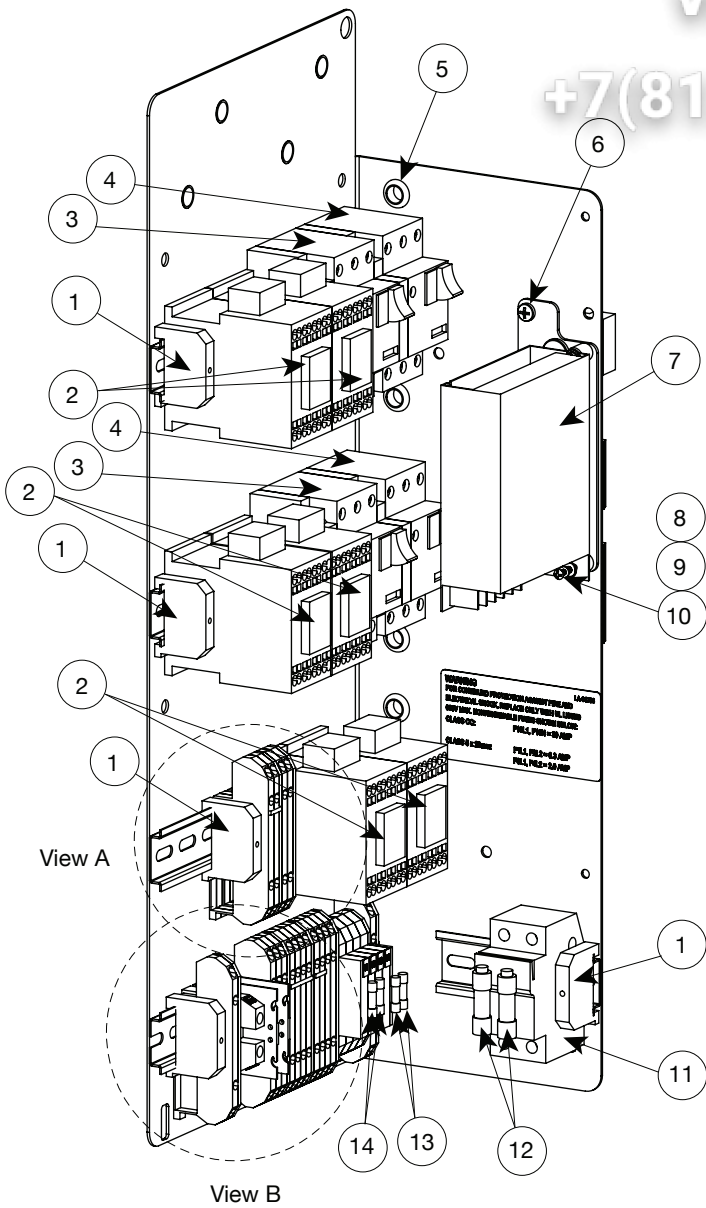

5006056

**Item Not Shown

Item	Part	Description	Qty.
1	TM-34305	Terminal, Screwless End	10
2	CN-34343	Contactors, 25 Amp, 120V	6
	CN-34304	Contactors, 25 Amp, 208/240V	6
3	SW-34017	Switch Motor Protect, 9 to 14 Amp, High Speed, 120V	1
	SW-33856	Switch Motor Protect, 6.3 Amp, 208-240V 3ph, Low and High Speed	1
	SW-33855	Switch Motor Protect, 6.0 to 10.0 Amp, 208V - 1ph Low and High Speed	1
4	SW-33856	Switch Motor Protect, 6.3 Amp, Low Speed, 120V	1
5	SL-3830	Sleeve, Wire Protector	6
6	SC-22766	Screw, Pan Head Phillips	2
7	BA-34508	Power Supply, 40 Watt, 12V.DC	1
8	WS-22293	Washer, M3	2
9	WS-22299	Washer, Split Lock, M3	2
10	SC-22270	Screw, Phillips Head, M3	2
11	FU-34771	Fuse Holder, 2 Bank	1
	FU-34770	Fuse Holder, 3 Bank, 208V	1

Item	Part	Description	Qty.
12	FU-34773	Fuse, 30 Amp, 120V	2
	FU-34772	Fuse, 15 Amp, 208V	3
13	FU-33184	Slow Blow, 2 Amp, 250V	4
14	FU-33452	Neozed, 6.3 AMP	4
15	TM-34307	Terminal, Orange, Spring, 6mm	5
16	TM-34309	Terminal, End Section, Spring	5
17	TM-3785	Partition	2
18	TM-34306	Terminal, Ground, Spring, 6mm	2
19	TM-34311	Terminal Fuse Holder, 8mm	4
20	TM-34315	Terminal, End Plate	1
21	TM-34308	Terminal, Blue, Spring, 6mm	4
22	TM-34310	Jumper Bar	1
23	TM-3932	Terminal, Ground	1
24	TM-3779	Terminal Block	2
**	BU-25094	Bushing, Brass	2

6.10ESG, 10.10ESG, 7.14ESG	vsezip.ru	
120V, 1ph: Diagram #77054.....	77(812)987-08-81	116
6.10ESG, 10.10ESG, 7.14ESG		
208-240V, 1ph: Diagram #77122.....		117
6.10ESG, 10.10ESG, 7.14ESG		
208-240V, 3ph: Diagram #77237.....		118
10.20ESG, 12.18ESG		
120V, 1ph: Diagram #77083.....		119
10.20ESG, 12.18ESG		
208-240V, 1ph: Diagram #77176.....		120
20.20ESG		
120V, 1ph: Diagram #77285.....		121
20.20ESG		
208-240V, 3ph: Diagram #77299.....		122

NOTE: Lafert Motor
125(WHT),126(BLK),127(RD) to #4
135(WHT),136(BLK),137(RD) to #6

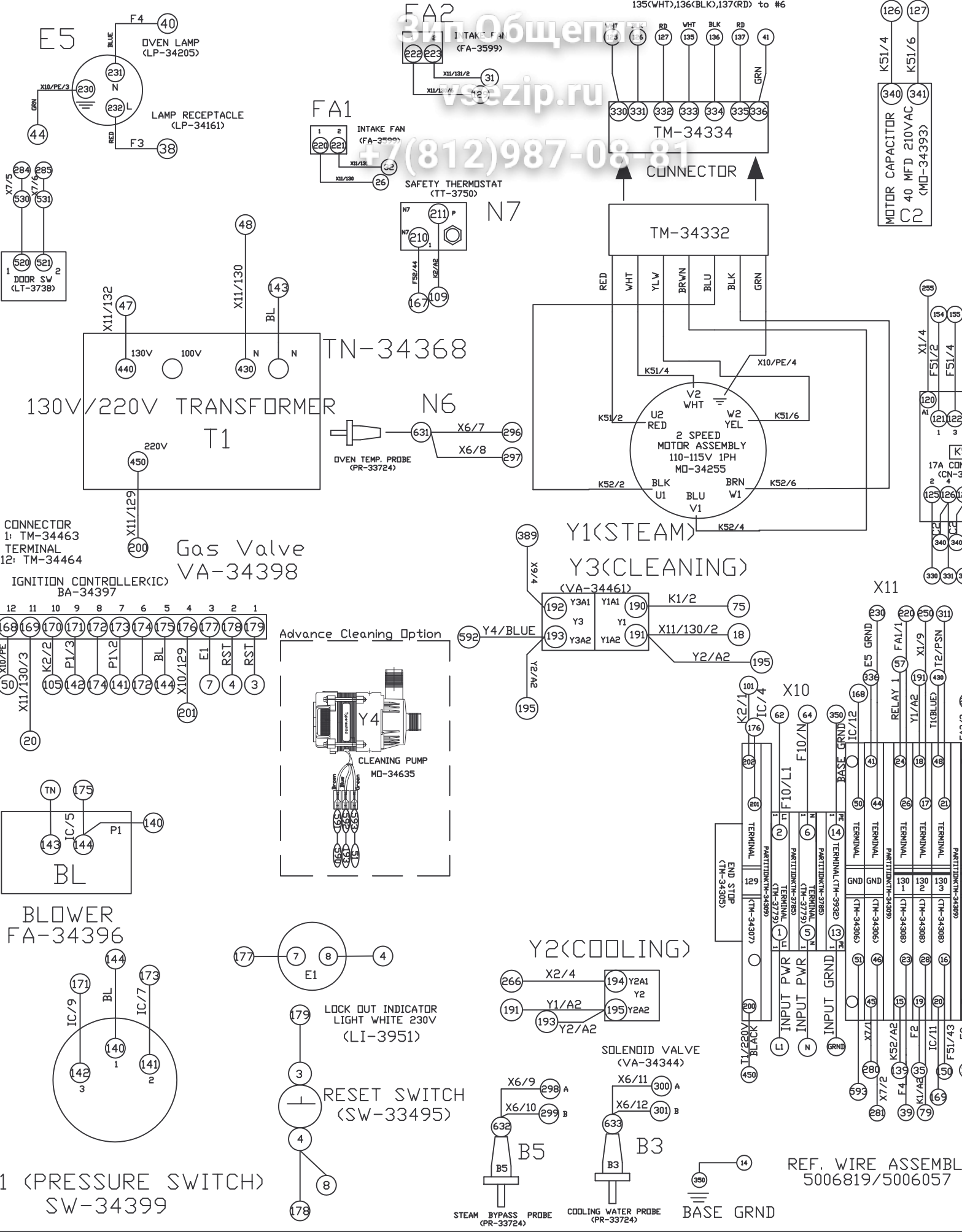

zip-Общепит
vsezip.ru
+7(812)987-08-81

REF. WIRE ASSEMBLY
5006819/5006057

Знак Общепит

vs.zip.ru

+7(812)991-08-81

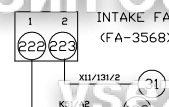
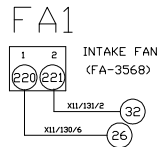
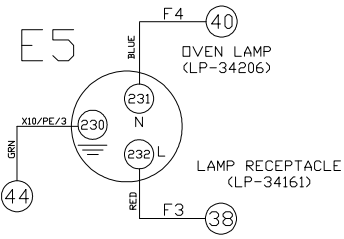

SAFETY THERMOSTAT (TT-3750)

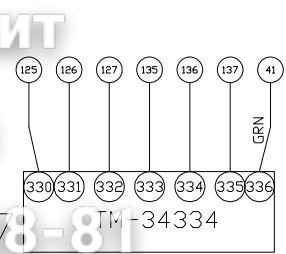
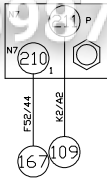

NOTE: 6.10
12 MFD
(FA-33499)



NOTE: 6.10
MD-33725
(5000276)

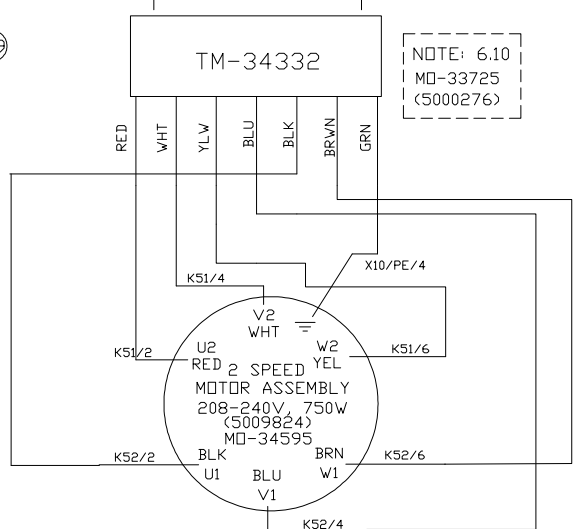
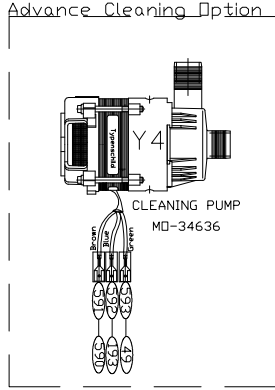

N6

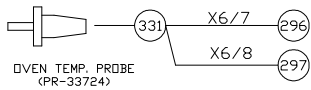

Gas Valve BA-34397
VA-34398 TM-34463

IGNITION CONTROLLER (IC)

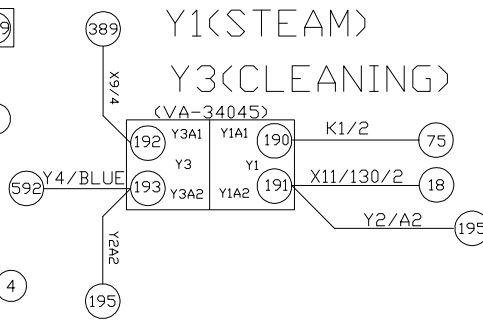
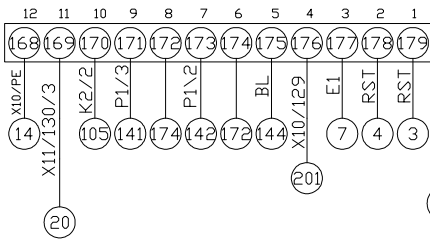

Y1 (STEAM)
Y3 (CLEANING)

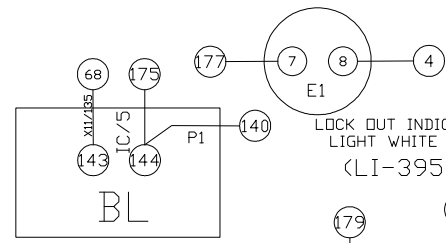

LOCK OUT INDICATOR LIGHT WHITE 230V (LI-3951)

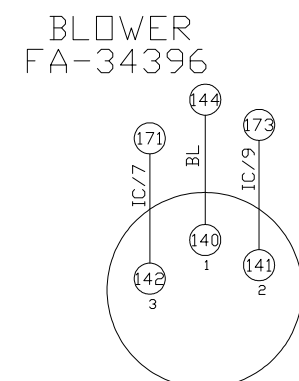

BLOWER FA-34396

RESET SWITCH (SW-33495)

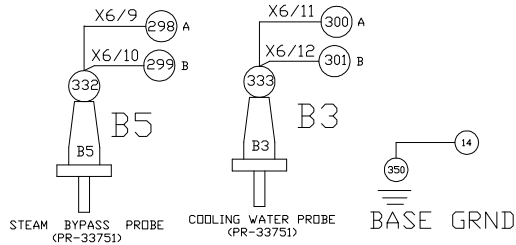

STEAM BYPASS PROBE (PR-33751) COOLING WATER PROBE (PR-33751) BASE GRND

P1 (PRESSURE SWITCH) SW-34399

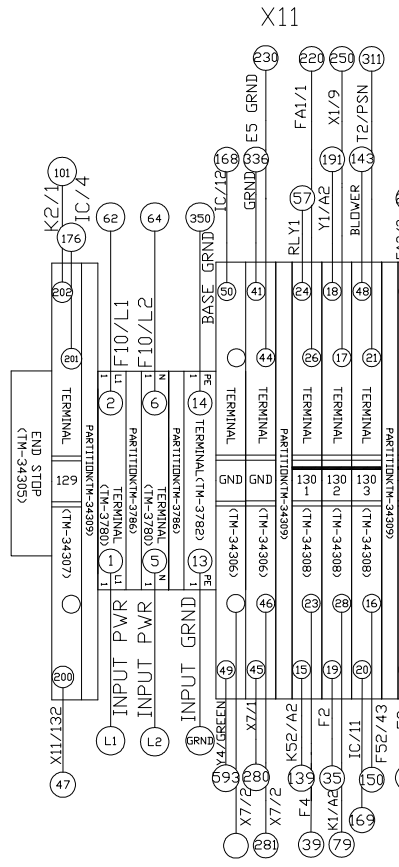

Зип-Общепит

vseip.ru

+7(812)987-08-81

Receptical PR-342598

B11x6/1

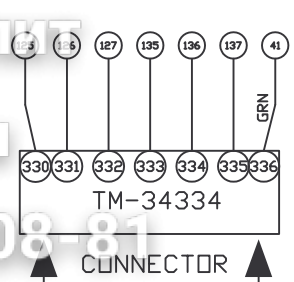
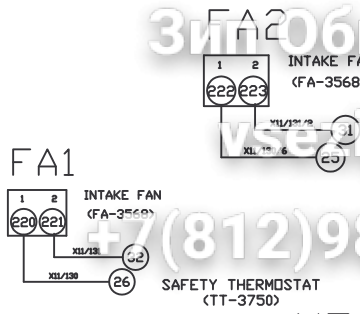
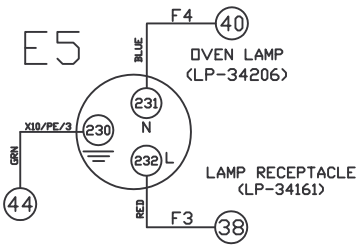

Advance Cleaning Option

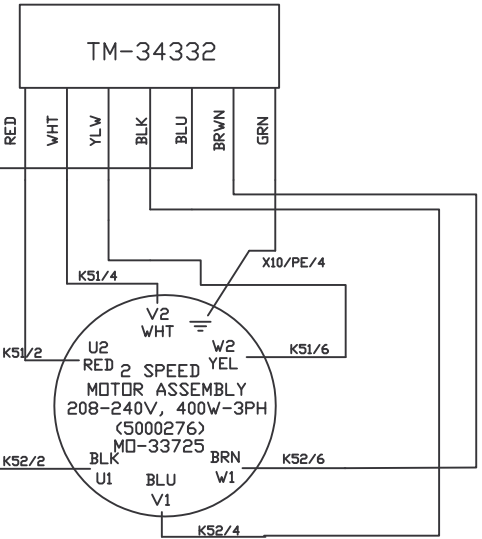
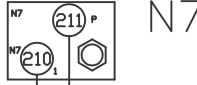
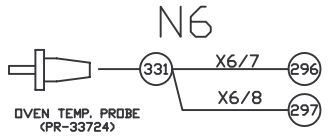
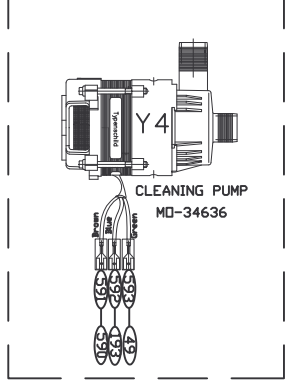

Gas Valve VA-34397

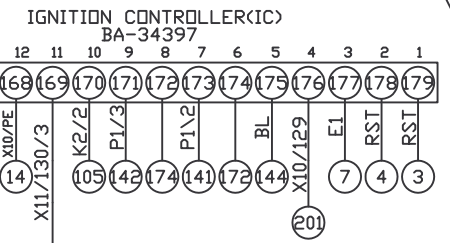

CONNECTOR 1: TM-34463 TERMINAL 12: TM-34464

Y1(STEAM) Y3(CLEANING) Y2(COOLING)

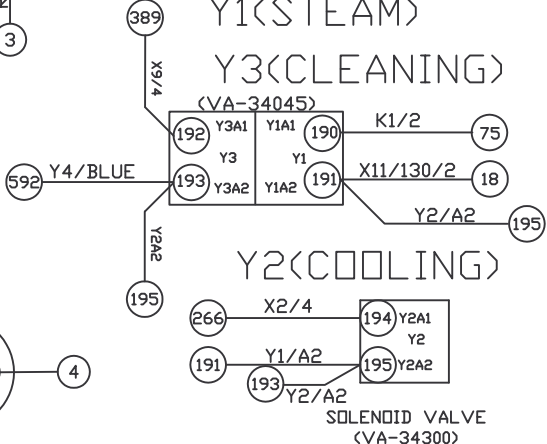
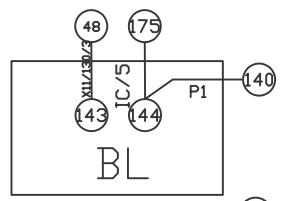

BLOWER FA-34396

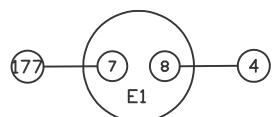
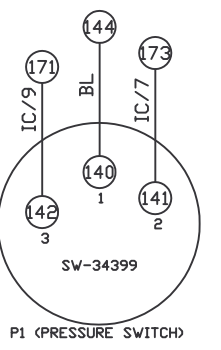

LOCK OUT INDICATOR LIGHT WHITE 230V (LI-3951)

RESET SWITCH (SW-33495)

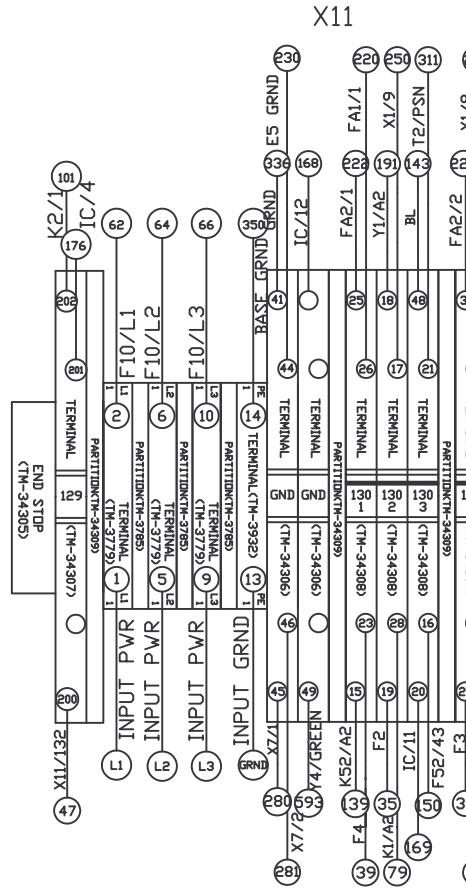
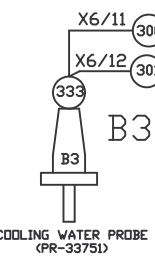
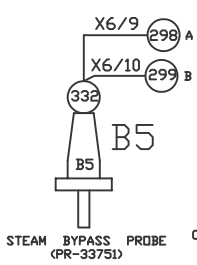
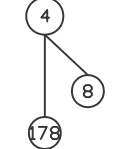

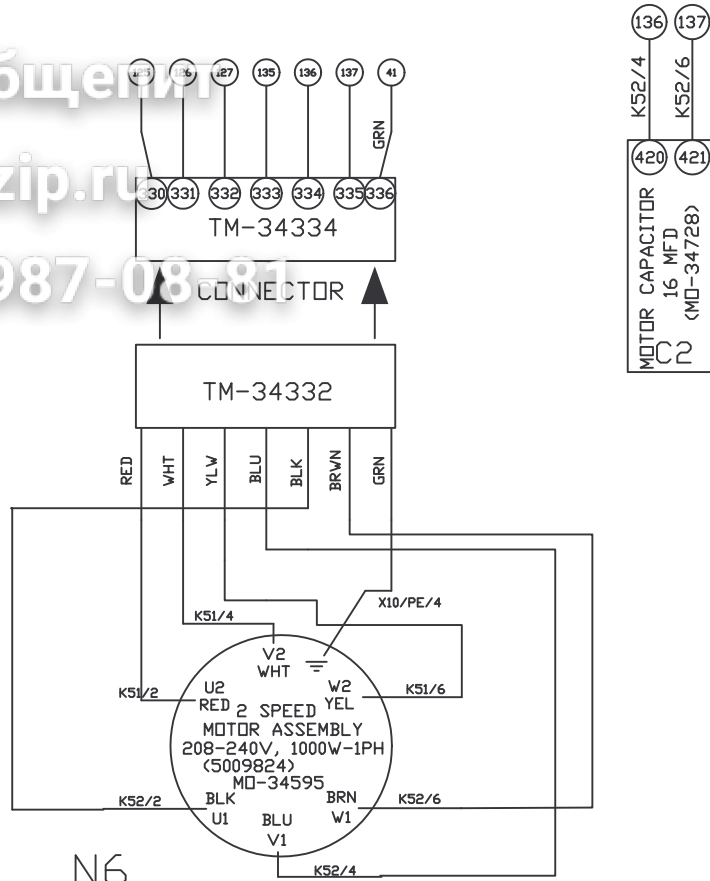
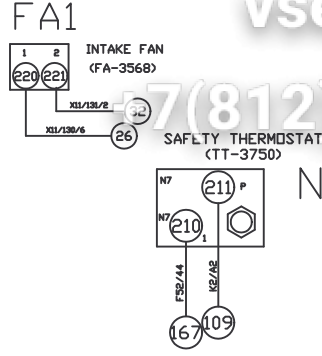
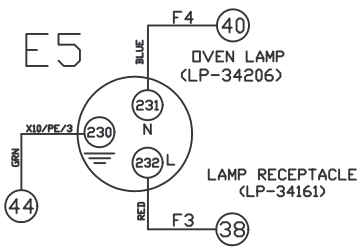

Advance Cleaning Option

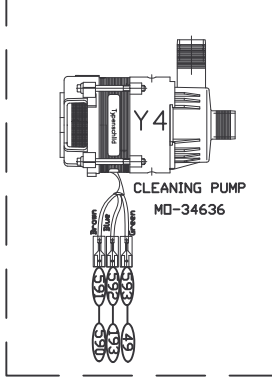

Gas Valve VA-34398

IGNITION CONTROLLER(IC) BA-34397

CONNECTOR
1: TM-34463
TERMINAL
12: TM-34464

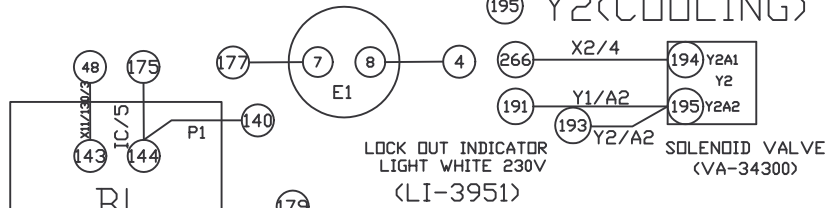
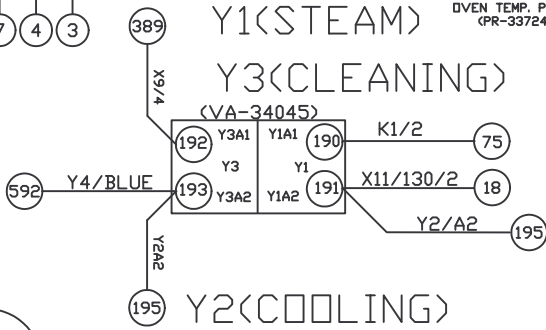
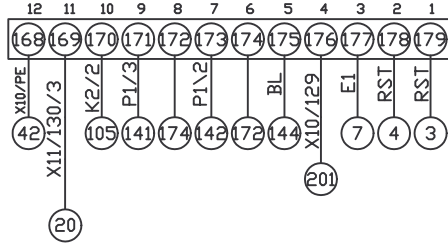
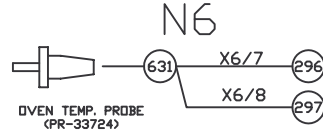

BLOWER FA-34396

RESET SWITCH (SW-33495)

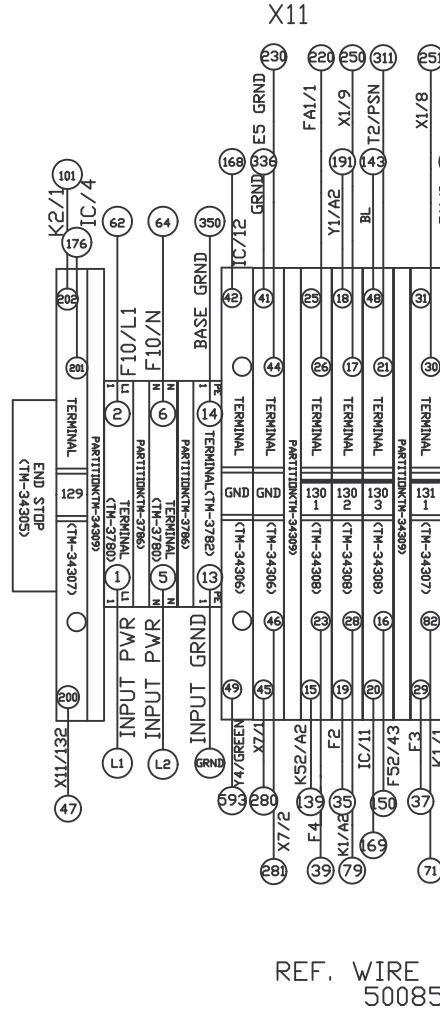
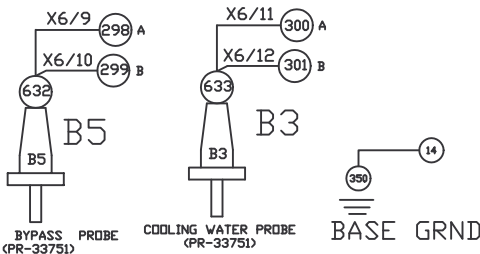
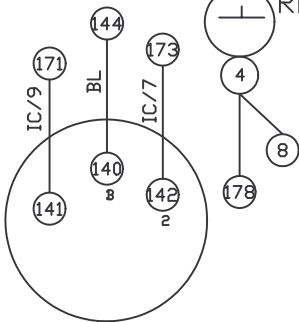

P1 (PRESSURE SWITCH) SW-34399

Зип Общелит
vsc.zip.ru

+7(812)987-08-81

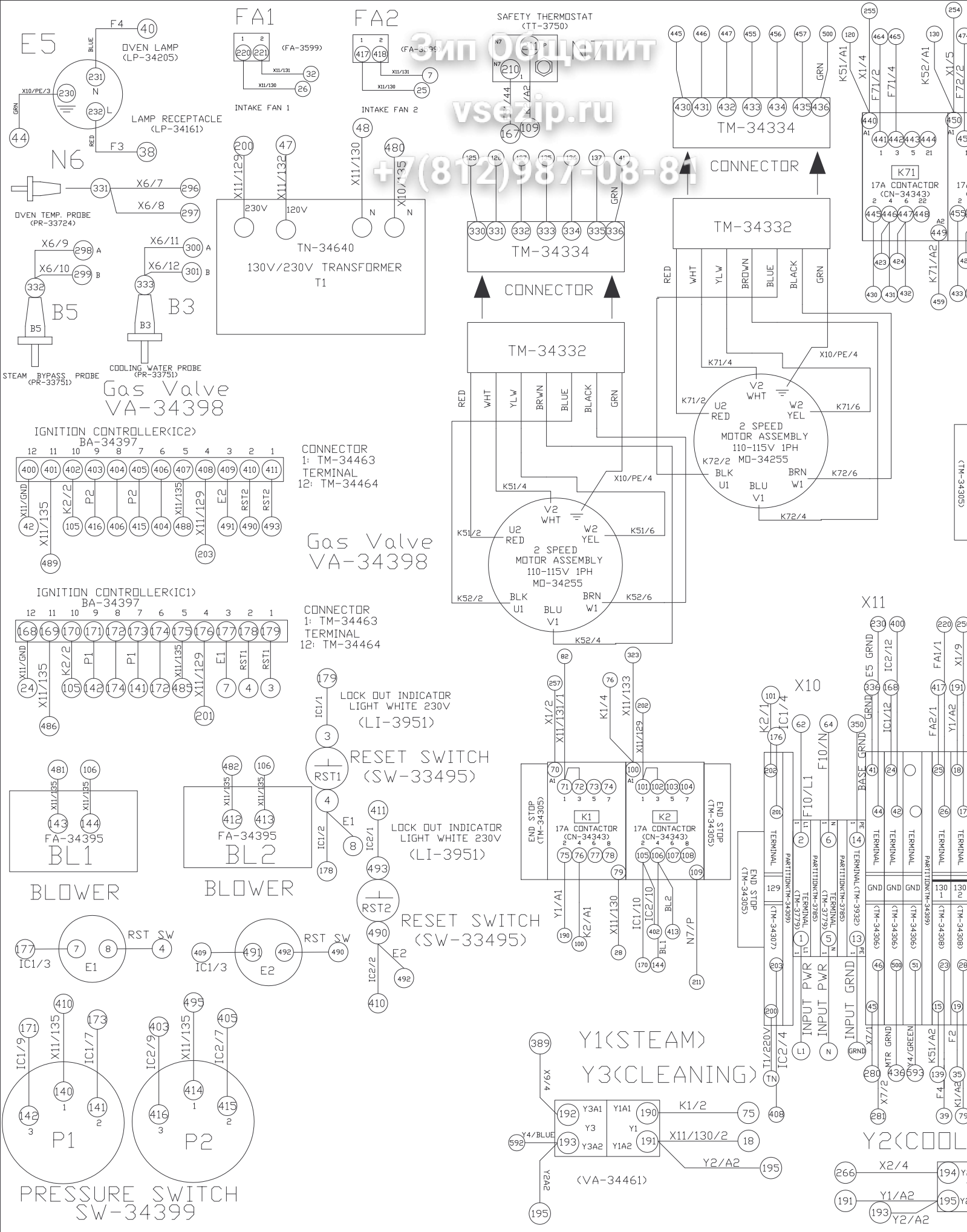

3ит Общедоступно
Veezip.ru
+7(812)98708-81

