







3ip Общепит

XEFT-04HS-ELD7/0.D03 FORNO ARIANNA LED 4 460X330

vsezip.ru

+7(812)987-08-81





Codice assieme	Descrizione assieme	Immagine assieme
ASM3420A/0.D00	Porta	
ASM3408A/0.D02	Copertura esterna	
ASM3402A/0.D01	Camera di cottura	
ASM3438A/0.D01	Impianto elettrico	

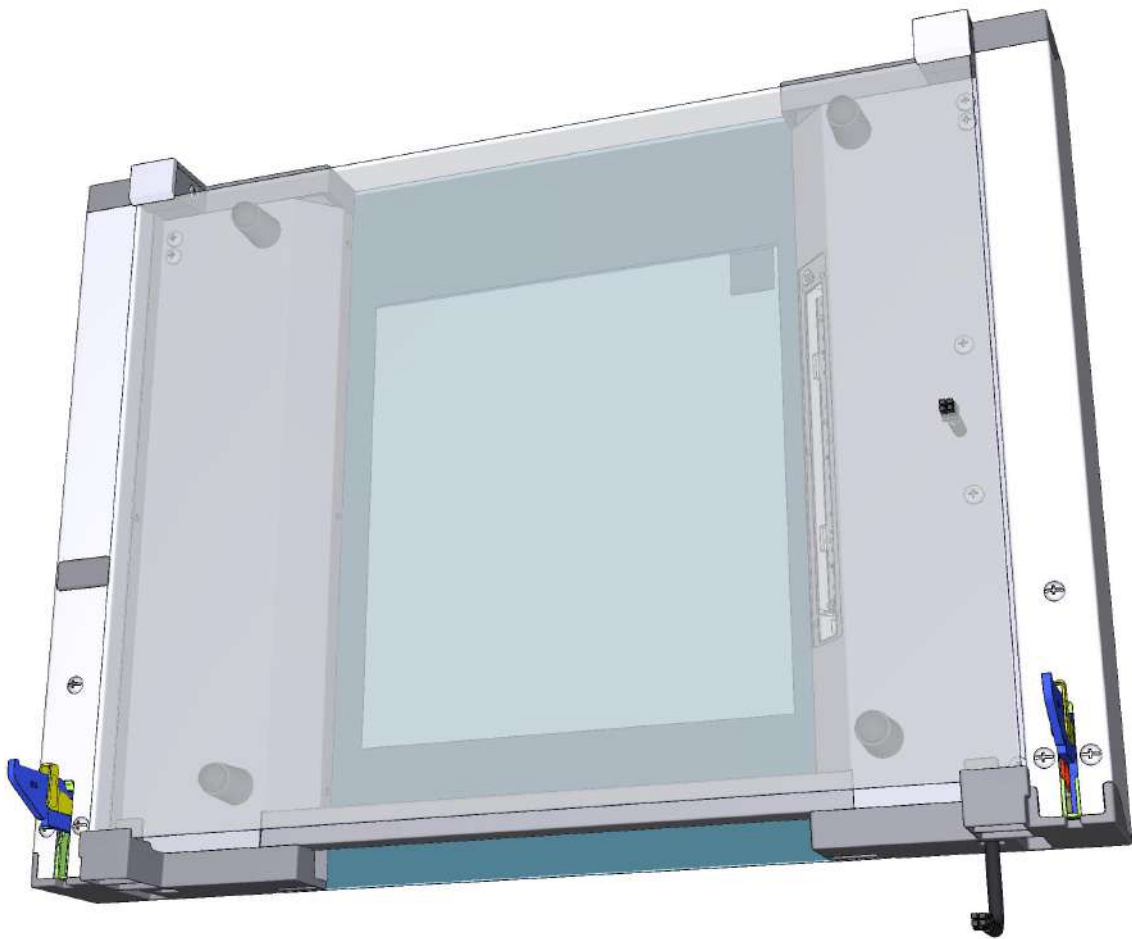

FRONTE

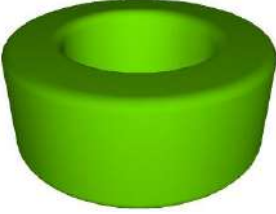



RETRO

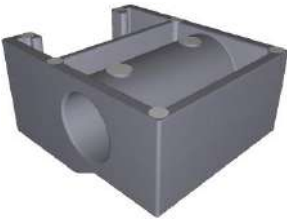





COMPONENTE			RICAMBIO																										
Codice	Descrizione	Immagine	Codice	Descrizione	Lista componenti																								
CE1285A	FERRITE EMI ROUND MOD. 2643801502		CE1285A0	FERRITE EMI ROUND MOD. 2643801502																									
0B1290A	COLONNINA INT SX RIBALTA ARI-ROS S		0B1290A0	COLONNINA INT SX RIBALTA ARI-ROS S																									
0B1292A	COLONNINA INT DX RIBALTA ARI-ROS S		0B1292A0	COLONNINA INT DX RIBALTA ARI-ROS S																									
LP1050A	BARRA ILLUMINAZIONE LED L180 SP COMPLETA		KLP1050A	KIT BARRA ILLUMINAZIONE LED L180 BL SP	<table border="1"> <thead> <tr> <th>Codice</th> <th>Descrizione</th> <th>Qta</th> <th>UM</th> </tr> </thead> <tbody> <tr> <td>IP1385A1</td> <td>IMB POL ANGOLARE 110X80X2000 D30</td> <td>0.300</td> <td>M</td> </tr> <tr> <td>LP1050A0</td> <td>BARRA ILLUMINAZION E LED L180 SP COMPLETA</td> <td>1</td> <td>PZ</td> </tr> <tr> <td>VI1014A0</td> <td>RONDELLA PIANA 4.5X9X0.8 INO</td> <td>1</td> <td>PZ</td> </tr> <tr> <td>VI1220A1</td> <td>VITE AUTOFILETTA NTE 4.2X11 TCS+ MARUTE</td> <td>1</td> <td>PZ</td> </tr> <tr> <td>VM1059A1</td> <td>FILM TERMORETRA IBILE H800</td> <td>0.300</td> <td>M</td> </tr> </tbody> </table>	Codice	Descrizione	Qta	UM	IP1385A1	IMB POL ANGOLARE 110X80X2000 D30	0.300	M	LP1050A0	BARRA ILLUMINAZION E LED L180 SP COMPLETA	1	PZ	VI1014A0	RONDELLA PIANA 4.5X9X0.8 INO	1	PZ	VI1220A1	VITE AUTOFILETTA NTE 4.2X11 TCS+ MARUTE	1	PZ	VM1059A1	FILM TERMORETRA IBILE H800	0.300	M
Codice	Descrizione	Qta	UM																										
IP1385A1	IMB POL ANGOLARE 110X80X2000 D30	0.300	M																										
LP1050A0	BARRA ILLUMINAZION E LED L180 SP COMPLETA	1	PZ																										
VI1014A0	RONDELLA PIANA 4.5X9X0.8 INO	1	PZ																										
VI1220A1	VITE AUTOFILETTA NTE 4.2X11 TCS+ MARUTE	1	PZ																										
VM1059A1	FILM TERMORETRA IBILE H800	0.300	M																										

COMPONENTE			RICAMBIO																														
Codice	Descrizione	Immagine	Codice	Descrizione	Lista componenti																												
VM2471A	SEDE INF CORSOIO BLOCCA VETRO INTERNO SP		KVM2471A	KIT SUPPORTO BLOCCA VETRO INTERNO BL SP	<table border="1"> <thead> <tr> <th>Codice</th> <th>Descrizione</th> <th>Qtà</th> <th>UM</th> </tr> </thead> <tbody> <tr> <td>V11930A0</td> <td>VITE 5X25 TRUCIOLARE INOX</td> <td>2</td> <td>PZ</td> </tr> <tr> <td>VM1224A0</td> <td>TUBOLARE TERMORETR 65MY 220MM 2 COLORI</td> <td>0.150</td> <td>M</td> </tr> <tr> <td>VM2471A0</td> <td>SEDE INF CORSOIO BLOCCA VETRO INTERNO SP</td> <td>1</td> <td>PZ</td> </tr> <tr> <td>VM2471A0</td> <td>SEDE INF CORSOIO BLOCCA VETRO INTERNO SP</td> <td>1</td> <td>PZ</td> </tr> <tr> <td>VM2472A0</td> <td>SEDE SUP CORSOIO BLOCCA VETRO INTERNO SP</td> <td>1</td> <td>PZ</td> </tr> <tr> <td>VM2472A0</td> <td>SEDE SUP CORSOIO BLOCCA VETRO INTERNO SP</td> <td>1</td> <td>PZ</td> </tr> </tbody> </table>	Codice	Descrizione	Qtà	UM	V11930A0	VITE 5X25 TRUCIOLARE INOX	2	PZ	VM1224A0	TUBOLARE TERMORETR 65MY 220MM 2 COLORI	0.150	M	VM2471A0	SEDE INF CORSOIO BLOCCA VETRO INTERNO SP	1	PZ	VM2471A0	SEDE INF CORSOIO BLOCCA VETRO INTERNO SP	1	PZ	VM2472A0	SEDE SUP CORSOIO BLOCCA VETRO INTERNO SP	1	PZ	VM2472A0	SEDE SUP CORSOIO BLOCCA VETRO INTERNO SP	1	PZ
Codice	Descrizione	Qtà	UM																														
V11930A0	VITE 5X25 TRUCIOLARE INOX	2	PZ																														
VM1224A0	TUBOLARE TERMORETR 65MY 220MM 2 COLORI	0.150	M																														
VM2471A0	SEDE INF CORSOIO BLOCCA VETRO INTERNO SP	1	PZ																														
VM2471A0	SEDE INF CORSOIO BLOCCA VETRO INTERNO SP	1	PZ																														
VM2472A0	SEDE SUP CORSOIO BLOCCA VETRO INTERNO SP	1	PZ																														
VM2472A0	SEDE SUP CORSOIO BLOCCA VETRO INTERNO SP	1	PZ																														
VM2503A	CORSOIO BLOCCA VETRO INTERNO FISSO SP		KVM2503A	KIT 2PZ BLOCCA VETRO INT FISSO BL SP	<table border="1"> <thead> <tr> <th>Codice</th> <th>Descrizione</th> <th>Qtà</th> <th>UM</th> </tr> </thead> <tbody> <tr> <td>VM1224A0</td> <td>TUBOLARE TERMORETR 65MY 220MM 2 COLORI</td> <td>0.150</td> <td>M</td> </tr> <tr> <td>VM2503A0</td> <td>CORSOIO BLOCCA VETRO INTERNO FISSO SP</td> <td>2</td> <td>PZ</td> </tr> <tr> <td>VM2503A0</td> <td>CORSOIO BLOCCA VETRO INTERNO FISSO SP</td> <td>2</td> <td>PZ</td> </tr> </tbody> </table>	Codice	Descrizione	Qtà	UM	VM1224A0	TUBOLARE TERMORETR 65MY 220MM 2 COLORI	0.150	M	VM2503A0	CORSOIO BLOCCA VETRO INTERNO FISSO SP	2	PZ	VM2503A0	CORSOIO BLOCCA VETRO INTERNO FISSO SP	2	PZ												
Codice	Descrizione	Qtà	UM																														
VM1224A0	TUBOLARE TERMORETR 65MY 220MM 2 COLORI	0.150	M																														
VM2503A0	CORSOIO BLOCCA VETRO INTERNO FISSO SP	2	PZ																														
VM2503A0	CORSOIO BLOCCA VETRO INTERNO FISSO SP	2	PZ																														
VM2464A	TAPPO SUPERIORE SX PORTA RIBALTA SP		KVM2464A	KIT TAPPO SUP SX PORTA RIBALTA BL SP	<table border="1"> <thead> <tr> <th>Codice</th> <th>Descrizione</th> <th>Qtà</th> <th>UM</th> </tr> </thead> <tbody> <tr> <td>VM1224A0</td> <td>TUBOLARE TERMORETR 65MY 220MM 2 COLORI</td> <td>0.300</td> <td>M</td> </tr> <tr> <td>VM2464A0</td> <td>TAPPO SUPERIORE SX PORTA RIBALTA SP</td> <td>1</td> <td>PZ</td> </tr> <tr> <td>VM2464A0</td> <td>TAPPO SUPERIORE SX PORTA RIBALTA SP</td> <td>1</td> <td>PZ</td> </tr> </tbody> </table>	Codice	Descrizione	Qtà	UM	VM1224A0	TUBOLARE TERMORETR 65MY 220MM 2 COLORI	0.300	M	VM2464A0	TAPPO SUPERIORE SX PORTA RIBALTA SP	1	PZ	VM2464A0	TAPPO SUPERIORE SX PORTA RIBALTA SP	1	PZ												
Codice	Descrizione	Qtà	UM																														
VM1224A0	TUBOLARE TERMORETR 65MY 220MM 2 COLORI	0.300	M																														
VM2464A0	TAPPO SUPERIORE SX PORTA RIBALTA SP	1	PZ																														
VM2464A0	TAPPO SUPERIORE SX PORTA RIBALTA SP	1	PZ																														

COMPONENTE			RICAMBIO																														
Codice	Descrizione	Immagine	Codice	Descrizione	Lista componenti																												
VM2472A	SEDE SUP CORSOIO BLOCCA VETRO INTERNO SP		KVM2471A	KIT SUPPORTO BLOCCA VETRO INTERNO BL SP	<table border="1"> <thead> <tr> <th>Codice</th> <th>Descrizione</th> <th>Qtà</th> <th>UM</th> </tr> </thead> <tbody> <tr> <td>VI1930A0</td> <td>VITE 5X25 TRUCIOLARE INOX</td> <td>2</td> <td>PZ</td> </tr> <tr> <td>VM1224A0</td> <td>TUBOLARE TERMORETR 65MY 220MM 2 COLORI</td> <td>0.150</td> <td>M</td> </tr> <tr> <td>VM2471A0</td> <td>SEDE INF CORSOIO BLOCCA VETRO INTERNO SP</td> <td>1</td> <td>PZ</td> </tr> <tr> <td>VM2471A0</td> <td>SEDE INF CORSOIO BLOCCA VETRO INTERNO SP</td> <td>1</td> <td>PZ</td> </tr> <tr> <td>VM2472A0</td> <td>SEDE SUP CORSOIO BLOCCA VETRO INTERNO SP</td> <td>1</td> <td>PZ</td> </tr> <tr> <td>VM2472A0</td> <td>SEDE SUP CORSOIO BLOCCA VETRO INTERNO SP</td> <td>1</td> <td>PZ</td> </tr> </tbody> </table>	Codice	Descrizione	Qtà	UM	VI1930A0	VITE 5X25 TRUCIOLARE INOX	2	PZ	VM1224A0	TUBOLARE TERMORETR 65MY 220MM 2 COLORI	0.150	M	VM2471A0	SEDE INF CORSOIO BLOCCA VETRO INTERNO SP	1	PZ	VM2471A0	SEDE INF CORSOIO BLOCCA VETRO INTERNO SP	1	PZ	VM2472A0	SEDE SUP CORSOIO BLOCCA VETRO INTERNO SP	1	PZ	VM2472A0	SEDE SUP CORSOIO BLOCCA VETRO INTERNO SP	1	PZ
Codice	Descrizione	Qtà	UM																														
VI1930A0	VITE 5X25 TRUCIOLARE INOX	2	PZ																														
VM1224A0	TUBOLARE TERMORETR 65MY 220MM 2 COLORI	0.150	M																														
VM2471A0	SEDE INF CORSOIO BLOCCA VETRO INTERNO SP	1	PZ																														
VM2471A0	SEDE INF CORSOIO BLOCCA VETRO INTERNO SP	1	PZ																														
VM2472A0	SEDE SUP CORSOIO BLOCCA VETRO INTERNO SP	1	PZ																														
VM2472A0	SEDE SUP CORSOIO BLOCCA VETRO INTERNO SP	1	PZ																														
VM2503A	CORSOIO BLOCCA VETRO INTERNO FISSO SP		KVM2503A	KIT 2PZ BLOCCA VETRO INT FISSO BL SP	<table border="1"> <thead> <tr> <th>Codice</th> <th>Descrizione</th> <th>Qtà</th> <th>UM</th> </tr> </thead> <tbody> <tr> <td>VM1224A0</td> <td>TUBOLARE TERMORETR 65MY 220MM 2 COLORI</td> <td>0.150</td> <td>M</td> </tr> <tr> <td>VM2503A0</td> <td>CORSOIO BLOCCA VETRO INTERNO FISSO SP</td> <td>2</td> <td>PZ</td> </tr> <tr> <td>VM2503A0</td> <td>CORSOIO BLOCCA VETRO INTERNO FISSO SP</td> <td>2</td> <td>PZ</td> </tr> </tbody> </table>	Codice	Descrizione	Qtà	UM	VM1224A0	TUBOLARE TERMORETR 65MY 220MM 2 COLORI	0.150	M	VM2503A0	CORSOIO BLOCCA VETRO INTERNO FISSO SP	2	PZ	VM2503A0	CORSOIO BLOCCA VETRO INTERNO FISSO SP	2	PZ												
Codice	Descrizione	Qtà	UM																														
VM1224A0	TUBOLARE TERMORETR 65MY 220MM 2 COLORI	0.150	M																														
VM2503A0	CORSOIO BLOCCA VETRO INTERNO FISSO SP	2	PZ																														
VM2503A0	CORSOIO BLOCCA VETRO INTERNO FISSO SP	2	PZ																														
VM2463A	TAPPO SUPERIORE DX PORTA RIBALTA SP		KVM2463A	KIT TAPPO SUP DX PORTA RIBALTA BL SP	<table border="1"> <thead> <tr> <th>Codice</th> <th>Descrizione</th> <th>Qtà</th> <th>UM</th> </tr> </thead> <tbody> <tr> <td>VM1224A0</td> <td>TUBOLARE TERMORETR 65MY 220MM 2 COLORI</td> <td>0.300</td> <td>M</td> </tr> <tr> <td>VM2463A0</td> <td>TAPPO SUPERIORE DX PORTA RIBALTA SP</td> <td>1</td> <td>PZ</td> </tr> <tr> <td>VM2463A0</td> <td>TAPPO SUPERIORE DX PORTA RIBALTA SP</td> <td>1</td> <td>PZ</td> </tr> </tbody> </table>	Codice	Descrizione	Qtà	UM	VM1224A0	TUBOLARE TERMORETR 65MY 220MM 2 COLORI	0.300	M	VM2463A0	TAPPO SUPERIORE DX PORTA RIBALTA SP	1	PZ	VM2463A0	TAPPO SUPERIORE DX PORTA RIBALTA SP	1	PZ												
Codice	Descrizione	Qtà	UM																														
VM1224A0	TUBOLARE TERMORETR 65MY 220MM 2 COLORI	0.300	M																														
VM2463A0	TAPPO SUPERIORE DX PORTA RIBALTA SP	1	PZ																														
VM2463A0	TAPPO SUPERIORE DX PORTA RIBALTA SP	1	PZ																														

COMPONENTE			RICAMBIO																										
Codice	Descrizione	Immagine	Codice	Descrizione	Lista componenti																								
VM2461A	TAPPO INFERIORE DX PORTA RIBALTA SP		KVM2461A	KIT TAPPO INF DX PORTA RIBALTA BL SP	<table border="1"> <thead> <tr> <th>Codice</th> <th>Descrizione</th> <th>Qtà</th> <th>UM</th> </tr> </thead> <tbody> <tr> <td>VM1224A0</td> <td>TUBOLARE TERMORETR 65MY 220MM 2 COLORI</td> <td>0.300</td> <td>M</td> </tr> <tr> <td>VM2461A0</td> <td>TAPPO INFERIORE DX PORTA RIBALTA SP</td> <td>1</td> <td>PZ</td> </tr> <tr> <td>VM2461A0</td> <td>TAPPO INFERIORE DX PORTA RIBALTA SP</td> <td>1</td> <td>PZ</td> </tr> </tbody> </table>	Codice	Descrizione	Qtà	UM	VM1224A0	TUBOLARE TERMORETR 65MY 220MM 2 COLORI	0.300	M	VM2461A0	TAPPO INFERIORE DX PORTA RIBALTA SP	1	PZ	VM2461A0	TAPPO INFERIORE DX PORTA RIBALTA SP	1	PZ								
Codice	Descrizione	Qtà	UM																										
VM1224A0	TUBOLARE TERMORETR 65MY 220MM 2 COLORI	0.300	M																										
VM2461A0	TAPPO INFERIORE DX PORTA RIBALTA SP	1	PZ																										
VM2461A0	TAPPO INFERIORE DX PORTA RIBALTA SP	1	PZ																										
VM2462A	TAPPO INFERIORE SX PORTA RIBALTA SP		KVM2462A	KIT TAPPO INF SX PORTA RIBALTA BL SP	<table border="1"> <thead> <tr> <th>Codice</th> <th>Descrizione</th> <th>Qtà</th> <th>UM</th> </tr> </thead> <tbody> <tr> <td>VM1224A0</td> <td>TUBOLARE TERMORETR 65MY 220MM 2 COLORI</td> <td>0.300</td> <td>M</td> </tr> <tr> <td>VM2462A0</td> <td>TAPPO INFERIORE SX PORTA RIBALTA SP</td> <td>1</td> <td>PZ</td> </tr> <tr> <td>VM2462A0</td> <td>TAPPO INFERIORE SX PORTA RIBALTA SP</td> <td>1</td> <td>PZ</td> </tr> </tbody> </table>	Codice	Descrizione	Qtà	UM	VM1224A0	TUBOLARE TERMORETR 65MY 220MM 2 COLORI	0.300	M	VM2462A0	TAPPO INFERIORE SX PORTA RIBALTA SP	1	PZ	VM2462A0	TAPPO INFERIORE SX PORTA RIBALTA SP	1	PZ								
Codice	Descrizione	Qtà	UM																										
VM1224A0	TUBOLARE TERMORETR 65MY 220MM 2 COLORI	0.300	M																										
VM2462A0	TAPPO INFERIORE SX PORTA RIBALTA SP	1	PZ																										
VM2462A0	TAPPO INFERIORE SX PORTA RIBALTA SP	1	PZ																										
VM2478A	SPINGIVETRO VETRO H4 BL SP		KVM2478A	KIT 4 PZ SPINGIVETRO VETRO H4 BL SP	<table border="1"> <thead> <tr> <th>Codice</th> <th>Descrizione</th> <th>Qtà</th> <th>UM</th> </tr> </thead> <tbody> <tr> <td>VM1224A0</td> <td>TUBOLARE TERMORETR 65MY 220MM 2 COLORI</td> <td>0.200</td> <td>M</td> </tr> <tr> <td>VM1630A0</td> <td>TAPPO PREMI VETRO INTERNO</td> <td>4</td> <td>PZ</td> </tr> <tr> <td>VM1630A1</td> <td>TAPPO PREMI VETRO INTERNO</td> <td>4</td> <td>PZ</td> </tr> <tr> <td>VM2478A0</td> <td>SPINGIVETRO VETRO H4 BL SP</td> <td>4</td> <td>PZ</td> </tr> <tr> <td>VM2478A0</td> <td>SPINGIVETRO VETRO H4 BL SP</td> <td>4</td> <td>PZ</td> </tr> </tbody> </table>	Codice	Descrizione	Qtà	UM	VM1224A0	TUBOLARE TERMORETR 65MY 220MM 2 COLORI	0.200	M	VM1630A0	TAPPO PREMI VETRO INTERNO	4	PZ	VM1630A1	TAPPO PREMI VETRO INTERNO	4	PZ	VM2478A0	SPINGIVETRO VETRO H4 BL SP	4	PZ	VM2478A0	SPINGIVETRO VETRO H4 BL SP	4	PZ
Codice	Descrizione	Qtà	UM																										
VM1224A0	TUBOLARE TERMORETR 65MY 220MM 2 COLORI	0.200	M																										
VM1630A0	TAPPO PREMI VETRO INTERNO	4	PZ																										
VM1630A1	TAPPO PREMI VETRO INTERNO	4	PZ																										
VM2478A0	SPINGIVETRO VETRO H4 BL SP	4	PZ																										
VM2478A0	SPINGIVETRO VETRO H4 BL SP	4	PZ																										
VM1630A	TAPPO PREMI VETRO INTERNO		KVM1630A	KIT 10 PZ TAPPO PREMI VETRO INTERNO	<table border="1"> <thead> <tr> <th>Codice</th> <th>Descrizione</th> <th>Qtà</th> <th>UM</th> </tr> </thead> <tbody> <tr> <td>VM1224A0</td> <td>TUBOLARE TERMORETR 65MY 220MM 2 COLORI</td> <td>0.200</td> <td>M</td> </tr> <tr> <td>VM1630A0</td> <td>TAPPO PREMI VETRO INTERNO</td> <td>10</td> <td>PZ</td> </tr> <tr> <td>VM1630A1</td> <td>TAPPO PREMI VETRO INTERNO</td> <td>10</td> <td>PZ</td> </tr> </tbody> </table>	Codice	Descrizione	Qtà	UM	VM1224A0	TUBOLARE TERMORETR 65MY 220MM 2 COLORI	0.200	M	VM1630A0	TAPPO PREMI VETRO INTERNO	10	PZ	VM1630A1	TAPPO PREMI VETRO INTERNO	10	PZ								
Codice	Descrizione	Qtà	UM																										
VM1224A0	TUBOLARE TERMORETR 65MY 220MM 2 COLORI	0.200	M																										
VM1630A0	TAPPO PREMI VETRO INTERNO	10	PZ																										
VM1630A1	TAPPO PREMI VETRO INTERNO	10	PZ																										

+7(812)987-08-81

COMPONENTE			RICAMBIO																														
Codice	Descrizione	Immagine	Codice	Descrizione	Lista componenti																												
CE1095A	CAVO BUS MICROFIT 4POLI 2M		KCE1095A	KIT CAVO BUS 4 POLI 2M POTENZA-CONTRO LLO	<table border="1"> <thead> <tr> <th>Codice</th> <th>Descrizione</th> <th>Qtà</th> <th>UM</th> </tr> </thead> <tbody> <tr> <td>CE1095A0</td> <td>CAVO BUS MICROFIT 4POLI 2M</td> <td>1</td> <td>PZ</td> </tr> <tr> <td>VM1224A0</td> <td>TUBOLARE TERMORETR 65MY 220MM 2 COLORI</td> <td>0.250</td> <td>M</td> </tr> </tbody> </table>	Codice	Descrizione	Qtà	UM	CE1095A0	CAVO BUS MICROFIT 4POLI 2M	1	PZ	VM1224A0	TUBOLARE TERMORETR 65MY 220MM 2 COLORI	0.250	M																
Codice	Descrizione	Qtà	UM																														
CE1095A0	CAVO BUS MICROFIT 4POLI 2M	1	PZ																														
VM1224A0	TUBOLARE TERMORETR 65MY 220MM 2 COLORI	0.250	M																														
CR1112A	CERNIERA PORTA RIBALTA SP ARIANNA-ELENA		KCR1112A	KIT CERNIERA PORTA RIBALTA SP ARI-ELE	<table border="1"> <thead> <tr> <th>Codice</th> <th>Descrizione</th> <th>Qtà</th> <th>UM</th> </tr> </thead> <tbody> <tr> <td>CR1112A0</td> <td>CERNIERA PORTA RIBALTA SP ARIANNA-ELE NA</td> <td>1</td> <td>PZ</td> </tr> <tr> <td>VI1875A0</td> <td>VITE M5X10 TC1/2T INOX</td> <td>3</td> <td>PZ</td> </tr> </tbody> </table>	Codice	Descrizione	Qtà	UM	CR1112A0	CERNIERA PORTA RIBALTA SP ARIANNA-ELE NA	1	PZ	VI1875A0	VITE M5X10 TC1/2T INOX	3	PZ																
Codice	Descrizione	Qtà	UM																														
CR1112A0	CERNIERA PORTA RIBALTA SP ARIANNA-ELE NA	1	PZ																														
VI1875A0	VITE M5X10 TC1/2T INOX	3	PZ																														
VM2512A	BATTUTA SOFT MICRO PORTA BAKERLUX SP		KVM2512A	KIT BATTUTA SOFT MICRO PORTA SHOP.PRO	<table border="1"> <thead> <tr> <th>Codice</th> <th>Descrizione</th> <th>Qtà</th> <th>UM</th> </tr> </thead> <tbody> <tr> <td>VM1224A0</td> <td>TUBOLARE TERMORETR 65MY 220MM 2 COLORI</td> <td>0.250</td> <td>M</td> </tr> <tr> <td>VM2512A0</td> <td>BATTUTA SOFT MICRO PORTA BAKERLUX SP</td> <td>1</td> <td>PZ</td> </tr> <tr> <td>VM2512A0</td> <td>BATTUTA SOFT MICRO PORTA BAKERLUX SP</td> <td>1</td> <td>PZ</td> </tr> </tbody> </table>	Codice	Descrizione	Qtà	UM	VM1224A0	TUBOLARE TERMORETR 65MY 220MM 2 COLORI	0.250	M	VM2512A0	BATTUTA SOFT MICRO PORTA BAKERLUX SP	1	PZ	VM2512A0	BATTUTA SOFT MICRO PORTA BAKERLUX SP	1	PZ												
Codice	Descrizione	Qtà	UM																														
VM1224A0	TUBOLARE TERMORETR 65MY 220MM 2 COLORI	0.250	M																														
VM2512A0	BATTUTA SOFT MICRO PORTA BAKERLUX SP	1	PZ																														
VM2512A0	BATTUTA SOFT MICRO PORTA BAKERLUX SP	1	PZ																														
VT1324A	VETRO EST SER ARIANNA SP 357X439X4		KVT1324A	KIT VETRO ESTERNO ARIANNA BL SHOP.PRO	<table border="1"> <thead> <tr> <th>Codice</th> <th>Descrizione</th> <th>Qtà</th> <th>UM</th> </tr> </thead> <tbody> <tr> <td>OB0387A0</td> <td>PROFILO SUPPORTO VETRO EST ARI-ROS SP</td> <td>2</td> <td>PZ</td> </tr> <tr> <td>ED1240A0</td> <td>ETICHETTA DATI TECNICI</td> <td>1</td> <td>PZ</td> </tr> <tr> <td>IP1385A1</td> <td>IMB POL ANGOLARE 110X80X2000 D30</td> <td>1</td> <td>M</td> </tr> <tr> <td>IP1508A1</td> <td>POLISTIROLO PROFILO AD U 2000X60X60</td> <td>1</td> <td>M</td> </tr> <tr> <td>SL1155A1</td> <td>SILICONE BICOMPONEN TE LOCTITE</td> <td>18</td> <td>ML</td> </tr> <tr> <td>VI1220A1</td> <td>VITE AUTOFILETTA NTE 4.2X11 TCS+ MARUTE</td> <td>6</td> <td>PZ</td> </tr> </tbody> </table>	Codice	Descrizione	Qtà	UM	OB0387A0	PROFILO SUPPORTO VETRO EST ARI-ROS SP	2	PZ	ED1240A0	ETICHETTA DATI TECNICI	1	PZ	IP1385A1	IMB POL ANGOLARE 110X80X2000 D30	1	M	IP1508A1	POLISTIROLO PROFILO AD U 2000X60X60	1	M	SL1155A1	SILICONE BICOMPONEN TE LOCTITE	18	ML	VI1220A1	VITE AUTOFILETTA NTE 4.2X11 TCS+ MARUTE	6	PZ
Codice	Descrizione	Qtà	UM																														
OB0387A0	PROFILO SUPPORTO VETRO EST ARI-ROS SP	2	PZ																														
ED1240A0	ETICHETTA DATI TECNICI	1	PZ																														
IP1385A1	IMB POL ANGOLARE 110X80X2000 D30	1	M																														
IP1508A1	POLISTIROLO PROFILO AD U 2000X60X60	1	M																														
SL1155A1	SILICONE BICOMPONEN TE LOCTITE	18	ML																														
VI1220A1	VITE AUTOFILETTA NTE 4.2X11 TCS+ MARUTE	6	PZ																														

COMPONENTE

RICAMBIO

<i>Codice</i>	<i>Descrizione</i>	<i>Immagine</i>	<i>Codice</i>	<i>Descrizione</i>	<i>Lista componenti</i>																																																								
VT1324A	VETRO EST SER ARIANNA SP 357X439X4		KVT1324A	KIT VETRO ESTERNO ARIANNA BL SHOP.PRO	<table border="1"> <thead> <tr> <th>Codice</th> <th>Descrizione</th> <th>Qtà</th> <th>UM</th> </tr> </thead> <tbody> <tr> <td>VM1059A1</td> <td>FILM TERMORETRA IBILE H800</td> <td>1.400</td> <td>M</td> </tr> <tr> <td>VT1324A0</td> <td>VETRO EST SER ARIANNA SP 357X439X4</td> <td>1</td> <td>PZ</td> </tr> <tr> <td>VT1324A0</td> <td>VETRO EST SER ARIANNA SP 357X439X4</td> <td>1</td> <td>PZ</td> </tr> </tbody> </table>	Codice	Descrizione	Qtà	UM	VM1059A1	FILM TERMORETRA IBILE H800	1.400	M	VT1324A0	VETRO EST SER ARIANNA SP 357X439X4	1	PZ	VT1324A0	VETRO EST SER ARIANNA SP 357X439X4	1	PZ																																								
Codice	Descrizione	Qtà	UM																																																										
VM1059A1	FILM TERMORETRA IBILE H800	1.400	M																																																										
VT1324A0	VETRO EST SER ARIANNA SP 357X439X4	1	PZ																																																										
VT1324A0	VETRO EST SER ARIANNA SP 357X439X4	1	PZ																																																										
			KDR1287A	PORTA EST ARIANNA BLSP TOUCH-MASTER LEFT	<table border="1"> <thead> <tr> <th>Codice</th> <th>Descrizione</th> <th>Qtà</th> <th>UM</th> </tr> </thead> <tbody> <tr> <td>0B1297A0</td> <td>COLONNINA EST SX RIGHT ARI-ROS SP</td> <td>1</td> <td>PZ</td> </tr> <tr> <td>0B1298A0</td> <td>COLONNINA INT SX RIGHT ARI-ROS SP</td> <td>1</td> <td>PZ</td> </tr> <tr> <td>0B1299B0</td> <td>COLONNINA EST DX RIGHT ARI-ROS SP</td> <td>1</td> <td>PZ</td> </tr> <tr> <td>0B1300A0</td> <td>COLONNINA INT DX RIGHT ARI-ROS SP</td> <td>1</td> <td>PZ</td> </tr> <tr> <td>CR1040A0</td> <td>PERNO CHIUSURA ELETTRMEC C. L.M. MATIC</td> <td>1</td> <td>PZ</td> </tr> <tr> <td>ED1240A0</td> <td>ETICHETTA DATI TECNICI</td> <td>1</td> <td>PZ</td> </tr> <tr> <td>IP1325B0</td> <td>IMB POL ANGOLARE 200X140X1880 D20</td> <td>0.800</td> <td>PZ</td> </tr> <tr> <td>IP1385A1</td> <td>IMB POL ANGOLARE 110X80X2000 D30</td> <td>0.500</td> <td>M</td> </tr> <tr> <td>IP1508A1</td> <td>POLISTIROLO PROFILO AD U 2000X60X60</td> <td>0.800</td> <td>M</td> </tr> <tr> <td>ML1005A0</td> <td>MOLLA A COMPRESSIO NE DE5 DF0.6 H18</td> <td>2</td> <td>PZ</td> </tr> <tr> <td>SL1155A1</td> <td>SILICONE BICOMPONEN TE LOCTITE</td> <td>18</td> <td>ML</td> </tr> <tr> <td>TB1562A0</td> <td>TUBO TRAVERSO PORTA SP600</td> <td>2</td> <td>PZ</td> </tr> <tr> <td>TB3304A0</td> <td>TUBO MANIGLIA BANDIERA ARI-ROS SP</td> <td>1</td> <td>PZ</td> </tr> </tbody> </table>	Codice	Descrizione	Qtà	UM	0B1297A0	COLONNINA EST SX RIGHT ARI-ROS SP	1	PZ	0B1298A0	COLONNINA INT SX RIGHT ARI-ROS SP	1	PZ	0B1299B0	COLONNINA EST DX RIGHT ARI-ROS SP	1	PZ	0B1300A0	COLONNINA INT DX RIGHT ARI-ROS SP	1	PZ	CR1040A0	PERNO CHIUSURA ELETTRMEC C. L.M. MATIC	1	PZ	ED1240A0	ETICHETTA DATI TECNICI	1	PZ	IP1325B0	IMB POL ANGOLARE 200X140X1880 D20	0.800	PZ	IP1385A1	IMB POL ANGOLARE 110X80X2000 D30	0.500	M	IP1508A1	POLISTIROLO PROFILO AD U 2000X60X60	0.800	M	ML1005A0	MOLLA A COMPRESSIO NE DE5 DF0.6 H18	2	PZ	SL1155A1	SILICONE BICOMPONEN TE LOCTITE	18	ML	TB1562A0	TUBO TRAVERSO PORTA SP600	2	PZ	TB3304A0	TUBO MANIGLIA BANDIERA ARI-ROS SP	1	PZ
Codice	Descrizione	Qtà	UM																																																										
0B1297A0	COLONNINA EST SX RIGHT ARI-ROS SP	1	PZ																																																										
0B1298A0	COLONNINA INT SX RIGHT ARI-ROS SP	1	PZ																																																										
0B1299B0	COLONNINA EST DX RIGHT ARI-ROS SP	1	PZ																																																										
0B1300A0	COLONNINA INT DX RIGHT ARI-ROS SP	1	PZ																																																										
CR1040A0	PERNO CHIUSURA ELETTRMEC C. L.M. MATIC	1	PZ																																																										
ED1240A0	ETICHETTA DATI TECNICI	1	PZ																																																										
IP1325B0	IMB POL ANGOLARE 200X140X1880 D20	0.800	PZ																																																										
IP1385A1	IMB POL ANGOLARE 110X80X2000 D30	0.500	M																																																										
IP1508A1	POLISTIROLO PROFILO AD U 2000X60X60	0.800	M																																																										
ML1005A0	MOLLA A COMPRESSIO NE DE5 DF0.6 H18	2	PZ																																																										
SL1155A1	SILICONE BICOMPONEN TE LOCTITE	18	ML																																																										
TB1562A0	TUBO TRAVERSO PORTA SP600	2	PZ																																																										
TB3304A0	TUBO MANIGLIA BANDIERA ARI-ROS SP	1	PZ																																																										



Зип Общепит
vsezip.ru

LISTA PARTI DI RICAMBIO

ASM3420A/0.D00 Porta

+7(812)987-08-81

COMPONENTE			RICAMBIO																																																																						
Codice	Descrizione	Immagine	Codice	Descrizione	Lista componenti																																																																				
VT1324A	VETRO EST SER ARIANNA SP 357X439X4		KDR1287A	PORTA EST ARIANNA BLSP TOUCH-MASTER LEFT	<table border="1"> <thead> <tr> <th>Codice</th> <th>Descrizione</th> <th>Qtà</th> <th>UM</th> </tr> </thead> <tbody> <tr> <td>VI1036A0</td> <td>INSERTO FILETTATO M10 FTT/C INOX RIGATO</td> <td>1</td> <td>PZ</td> </tr> <tr> <td>VI1220A1</td> <td>VITE AUTOFISETTA NTE 4.2X11 TCS+ MARUTE</td> <td>14</td> <td>PZ</td> </tr> <tr> <td>VI1930A0</td> <td>VITE 5X25 TRUCIOLARE INOX</td> <td>22</td> <td>PZ</td> </tr> <tr> <td>VM1059A1</td> <td>FILM TERMORETRA IBILE H800</td> <td>1.400</td> <td>M</td> </tr> <tr> <td>VM1209A0</td> <td>BOCCOLA PERNO ELETTROSER RATURA SP</td> <td>1</td> <td>PZ</td> </tr> <tr> <td>VM1630A0</td> <td>TAPPO PREMI VETRO INTERNO</td> <td>4</td> <td>PZ</td> </tr> <tr> <td>VM1630A1</td> <td>TAPPO PREMI VETRO INTERNO</td> <td>4</td> <td>PZ</td> </tr> <tr> <td>VM2274A0</td> <td>BOCCOLA SCANALATA CORTA</td> <td>1</td> <td>PZ</td> </tr> <tr> <td>VM2275A0</td> <td>BOCCOLA LISCIA CORTA</td> <td>1</td> <td>PZ</td> </tr> <tr> <td>VM2456A0</td> <td>TERMINALE MANIGLIA BL SP</td> <td>2</td> <td>PZ</td> </tr> <tr> <td>VM2456A0</td> <td>TERMINALE MANIGLIA BL SP</td> <td>2</td> <td>PZ</td> </tr> <tr> <td>VM2465A0</td> <td>TAPPO INFERIORE DX PORTA BANDIERA SP</td> <td>1</td> <td>PZ</td> </tr> <tr> <td>VM2465A0</td> <td>TAPPO INFERIORE DX PORTA BANDIERA SP</td> <td>1</td> <td>PZ</td> </tr> <tr> <td>VM2466A0</td> <td>TAPPO INFERIORE SX PORTA BANDIERA SP</td> <td>1</td> <td>PZ</td> </tr> <tr> <td>VM2466A0</td> <td>TAPPO INFERIORE SX PORTA BANDIERA SP</td> <td>1</td> <td>PZ</td> </tr> <tr> <td>VM2467A0</td> <td>TAPPO SUPERIORE DX PORTA BANDIERA SP</td> <td>1</td> <td>PZ</td> </tr> </tbody> </table>	Codice	Descrizione	Qtà	UM	VI1036A0	INSERTO FILETTATO M10 FTT/C INOX RIGATO	1	PZ	VI1220A1	VITE AUTOFISETTA NTE 4.2X11 TCS+ MARUTE	14	PZ	VI1930A0	VITE 5X25 TRUCIOLARE INOX	22	PZ	VM1059A1	FILM TERMORETRA IBILE H800	1.400	M	VM1209A0	BOCCOLA PERNO ELETTROSER RATURA SP	1	PZ	VM1630A0	TAPPO PREMI VETRO INTERNO	4	PZ	VM1630A1	TAPPO PREMI VETRO INTERNO	4	PZ	VM2274A0	BOCCOLA SCANALATA CORTA	1	PZ	VM2275A0	BOCCOLA LISCIA CORTA	1	PZ	VM2456A0	TERMINALE MANIGLIA BL SP	2	PZ	VM2456A0	TERMINALE MANIGLIA BL SP	2	PZ	VM2465A0	TAPPO INFERIORE DX PORTA BANDIERA SP	1	PZ	VM2465A0	TAPPO INFERIORE DX PORTA BANDIERA SP	1	PZ	VM2466A0	TAPPO INFERIORE SX PORTA BANDIERA SP	1	PZ	VM2466A0	TAPPO INFERIORE SX PORTA BANDIERA SP	1	PZ	VM2467A0	TAPPO SUPERIORE DX PORTA BANDIERA SP	1	PZ
Codice	Descrizione	Qtà	UM																																																																						
VI1036A0	INSERTO FILETTATO M10 FTT/C INOX RIGATO	1	PZ																																																																						
VI1220A1	VITE AUTOFISETTA NTE 4.2X11 TCS+ MARUTE	14	PZ																																																																						
VI1930A0	VITE 5X25 TRUCIOLARE INOX	22	PZ																																																																						
VM1059A1	FILM TERMORETRA IBILE H800	1.400	M																																																																						
VM1209A0	BOCCOLA PERNO ELETTROSER RATURA SP	1	PZ																																																																						
VM1630A0	TAPPO PREMI VETRO INTERNO	4	PZ																																																																						
VM1630A1	TAPPO PREMI VETRO INTERNO	4	PZ																																																																						
VM2274A0	BOCCOLA SCANALATA CORTA	1	PZ																																																																						
VM2275A0	BOCCOLA LISCIA CORTA	1	PZ																																																																						
VM2456A0	TERMINALE MANIGLIA BL SP	2	PZ																																																																						
VM2456A0	TERMINALE MANIGLIA BL SP	2	PZ																																																																						
VM2465A0	TAPPO INFERIORE DX PORTA BANDIERA SP	1	PZ																																																																						
VM2465A0	TAPPO INFERIORE DX PORTA BANDIERA SP	1	PZ																																																																						
VM2466A0	TAPPO INFERIORE SX PORTA BANDIERA SP	1	PZ																																																																						
VM2466A0	TAPPO INFERIORE SX PORTA BANDIERA SP	1	PZ																																																																						
VM2467A0	TAPPO SUPERIORE DX PORTA BANDIERA SP	1	PZ																																																																						



COMPONENTE

RICAMBIO

<i>Codice</i>	<i>Descrizione</i>	<i>Immagine</i>	<i>Codice</i>	<i>Descrizione</i>	<i>Lista componenti</i>																																																				
VT1324A	VETRO EST SER ARIANNA SP 357X439X4		KDR1287A	PORTA EST ARIANNA BLSP TOUCH-MASTER LEFT	<table border="1"> <thead> <tr> <th><i>Codice</i></th> <th><i>Descrizione</i></th> <th><i>Qtà</i></th> <th><i>UM</i></th> </tr> </thead> <tbody> <tr> <td>VM2467A0</td> <td>TAPPO SUPERIORE DX PORTA BANDIERA SP</td> <td>1</td> <td>PZ</td> </tr> <tr> <td>VM2468A0</td> <td>TAPPO SUPERIORE SX PORTA BANDIERA SP</td> <td>1</td> <td>PZ</td> </tr> <tr> <td>VM2468A0</td> <td>TAPPO SUPERIORE SX PORTA BANDIERA SP</td> <td>1</td> <td>PZ</td> </tr> <tr> <td>VM2470A0</td> <td>CORSOIO BLOCCA VETRO INTERNO SHOP.PRO</td> <td>2</td> <td>PZ</td> </tr> <tr> <td>VM2470A0</td> <td>CORSOIO BLOCCA VETRO INTERNO SHOP.PRO</td> <td>2</td> <td>PZ</td> </tr> <tr> <td>VM2471A0</td> <td>SEDE INF CORSOIO BLOCCA VETRO INTERNO SP</td> <td>1</td> <td>PZ</td> </tr> <tr> <td>VM2471A0</td> <td>SEDE INF CORSOIO BLOCCA VETRO INTERNO SP</td> <td>1</td> <td>PZ</td> </tr> <tr> <td>VM2472A0</td> <td>SEDE SUP CORSOIO BLOCCA VETRO INTERNO SP</td> <td>1</td> <td>PZ</td> </tr> <tr> <td>VM2472A0</td> <td>SEDE SUP CORSOIO BLOCCA VETRO INTERNO SP</td> <td>1</td> <td>PZ</td> </tr> <tr> <td>VM2473A0</td> <td>BLOCCA PERNO INF CERNIERA VETRO INT SP</td> <td>1</td> <td>PZ</td> </tr> <tr> <td>VM2473A0</td> <td>BLOCCA PERNO INF CERNIERA VETRO INT SP</td> <td>1</td> <td>PZ</td> </tr> <tr> <td>VM2474A0</td> <td>BLOCCA PERNO SUP CERNIERA VETRO INT SP</td> <td>1</td> <td>PZ</td> </tr> </tbody> </table>	<i>Codice</i>	<i>Descrizione</i>	<i>Qtà</i>	<i>UM</i>	VM2467A0	TAPPO SUPERIORE DX PORTA BANDIERA SP	1	PZ	VM2468A0	TAPPO SUPERIORE SX PORTA BANDIERA SP	1	PZ	VM2468A0	TAPPO SUPERIORE SX PORTA BANDIERA SP	1	PZ	VM2470A0	CORSOIO BLOCCA VETRO INTERNO SHOP.PRO	2	PZ	VM2470A0	CORSOIO BLOCCA VETRO INTERNO SHOP.PRO	2	PZ	VM2471A0	SEDE INF CORSOIO BLOCCA VETRO INTERNO SP	1	PZ	VM2471A0	SEDE INF CORSOIO BLOCCA VETRO INTERNO SP	1	PZ	VM2472A0	SEDE SUP CORSOIO BLOCCA VETRO INTERNO SP	1	PZ	VM2472A0	SEDE SUP CORSOIO BLOCCA VETRO INTERNO SP	1	PZ	VM2473A0	BLOCCA PERNO INF CERNIERA VETRO INT SP	1	PZ	VM2473A0	BLOCCA PERNO INF CERNIERA VETRO INT SP	1	PZ	VM2474A0	BLOCCA PERNO SUP CERNIERA VETRO INT SP	1	PZ
<i>Codice</i>	<i>Descrizione</i>	<i>Qtà</i>	<i>UM</i>																																																						
VM2467A0	TAPPO SUPERIORE DX PORTA BANDIERA SP	1	PZ																																																						
VM2468A0	TAPPO SUPERIORE SX PORTA BANDIERA SP	1	PZ																																																						
VM2468A0	TAPPO SUPERIORE SX PORTA BANDIERA SP	1	PZ																																																						
VM2470A0	CORSOIO BLOCCA VETRO INTERNO SHOP.PRO	2	PZ																																																						
VM2470A0	CORSOIO BLOCCA VETRO INTERNO SHOP.PRO	2	PZ																																																						
VM2471A0	SEDE INF CORSOIO BLOCCA VETRO INTERNO SP	1	PZ																																																						
VM2471A0	SEDE INF CORSOIO BLOCCA VETRO INTERNO SP	1	PZ																																																						
VM2472A0	SEDE SUP CORSOIO BLOCCA VETRO INTERNO SP	1	PZ																																																						
VM2472A0	SEDE SUP CORSOIO BLOCCA VETRO INTERNO SP	1	PZ																																																						
VM2473A0	BLOCCA PERNO INF CERNIERA VETRO INT SP	1	PZ																																																						
VM2473A0	BLOCCA PERNO INF CERNIERA VETRO INT SP	1	PZ																																																						
VM2474A0	BLOCCA PERNO SUP CERNIERA VETRO INT SP	1	PZ																																																						



COMPONENTE			RICAMBIO																																										
Codice	Descrizione	Immagine	Codice	Descrizione	Lista componenti																																								
VT1324A	VETRO EST SER ARIANNA SP 357X439X4		KDR1287A	PORTA EST ARIANNA BLSP TOUCH-MASTER LEFT	<table border="1"> <thead> <tr> <th>Codice</th> <th>Descrizione</th> <th>Qtà</th> <th>UM</th> </tr> </thead> <tbody> <tr> <td>VM2474A0</td> <td>BLOCCA PERNO SUP CERNIERA VETRO INT SP</td> <td>1</td> <td>PZ</td> </tr> <tr> <td>VM2478A0</td> <td>SPINGIVETRO VETRO H4 BL SP</td> <td>4</td> <td>PZ</td> </tr> <tr> <td>VM2478A0</td> <td>SPINGIVETRO VETRO H4 BL SP</td> <td>4</td> <td>PZ</td> </tr> <tr> <td>VM2489A0</td> <td>TERMINALE MANIGLIA CON SEDE PENNINO SP</td> <td>1</td> <td>PZ</td> </tr> <tr> <td>VM2504A0</td> <td>PIOLINO GUIDA MOLLA CORSOIO SHOP.PRO</td> <td>2</td> <td>PZ</td> </tr> <tr> <td>VM2504A0</td> <td>PIOLINO GUIDA MOLLA CORSOIO SHOP.PRO</td> <td>2</td> <td>PZ</td> </tr> <tr> <td>VM2527A0</td> <td>PENNINO CONTROLLO SP</td> <td>1</td> <td>PZ</td> </tr> <tr> <td>VT1324A0</td> <td>VETRO EST SER ARIANNA SP 357X439X4</td> <td>1</td> <td>PZ</td> </tr> <tr> <td>VT1324A0</td> <td>VETRO EST SER ARIANNA SP 357X439X4</td> <td>1</td> <td>PZ</td> </tr> </tbody> </table>	Codice	Descrizione	Qtà	UM	VM2474A0	BLOCCA PERNO SUP CERNIERA VETRO INT SP	1	PZ	VM2478A0	SPINGIVETRO VETRO H4 BL SP	4	PZ	VM2478A0	SPINGIVETRO VETRO H4 BL SP	4	PZ	VM2489A0	TERMINALE MANIGLIA CON SEDE PENNINO SP	1	PZ	VM2504A0	PIOLINO GUIDA MOLLA CORSOIO SHOP.PRO	2	PZ	VM2504A0	PIOLINO GUIDA MOLLA CORSOIO SHOP.PRO	2	PZ	VM2527A0	PENNINO CONTROLLO SP	1	PZ	VT1324A0	VETRO EST SER ARIANNA SP 357X439X4	1	PZ	VT1324A0	VETRO EST SER ARIANNA SP 357X439X4	1	PZ
			Codice	Descrizione	Qtà	UM																																							
VM2474A0	BLOCCA PERNO SUP CERNIERA VETRO INT SP	1	PZ																																										
VM2478A0	SPINGIVETRO VETRO H4 BL SP	4	PZ																																										
VM2478A0	SPINGIVETRO VETRO H4 BL SP	4	PZ																																										
VM2489A0	TERMINALE MANIGLIA CON SEDE PENNINO SP	1	PZ																																										
VM2504A0	PIOLINO GUIDA MOLLA CORSOIO SHOP.PRO	2	PZ																																										
VM2504A0	PIOLINO GUIDA MOLLA CORSOIO SHOP.PRO	2	PZ																																										
VM2527A0	PENNINO CONTROLLO SP	1	PZ																																										
VT1324A0	VETRO EST SER ARIANNA SP 357X439X4	1	PZ																																										
VT1324A0	VETRO EST SER ARIANNA SP 357X439X4	1	PZ																																										
KDR1286A	PORTA EST ARIANNA BLSP TOUCH-MASTER	<table border="1"> <thead> <tr> <th>Codice</th> <th>Descrizione</th> <th>Qtà</th> <th>UM</th> </tr> </thead> <tbody> <tr> <td>0B1297A0</td> <td>COLONNINA EST SX RIGHT ARI-ROS SP</td> <td>1</td> <td>PZ</td> </tr> <tr> <td>0B1298A0</td> <td>COLONNINA INT SX RIGHT ARI-ROS SP</td> <td>1</td> <td>PZ</td> </tr> <tr> <td>0B1299B0</td> <td>COLONNINA EST DX RIGHT ARI-ROS SP</td> <td>1</td> <td>PZ</td> </tr> <tr> <td>0B1300A0</td> <td>COLONNINA INT DX RIGHT ARI-ROS SP</td> <td>1</td> <td>PZ</td> </tr> <tr> <td>CR1040A0</td> <td>PERNO CHIUSURA ELETTROMECC C. L.M. MATIC</td> <td>1</td> <td>PZ</td> </tr> <tr> <td>ED1240A0</td> <td>ETICHETTA DATI TECNICI</td> <td>1</td> <td>PZ</td> </tr> <tr> <td>IP1325B0</td> <td>IMB POL ANGOLARE 200X140X1880 D20</td> <td>0.800</td> <td>PZ</td> </tr> </tbody> </table>	Codice	Descrizione	Qtà	UM	0B1297A0	COLONNINA EST SX RIGHT ARI-ROS SP	1	PZ	0B1298A0	COLONNINA INT SX RIGHT ARI-ROS SP	1	PZ	0B1299B0	COLONNINA EST DX RIGHT ARI-ROS SP	1	PZ	0B1300A0	COLONNINA INT DX RIGHT ARI-ROS SP	1	PZ	CR1040A0	PERNO CHIUSURA ELETTROMECC C. L.M. MATIC	1	PZ	ED1240A0	ETICHETTA DATI TECNICI	1	PZ	IP1325B0	IMB POL ANGOLARE 200X140X1880 D20	0.800	PZ											
Codice	Descrizione	Qtà	UM																																										
0B1297A0	COLONNINA EST SX RIGHT ARI-ROS SP	1	PZ																																										
0B1298A0	COLONNINA INT SX RIGHT ARI-ROS SP	1	PZ																																										
0B1299B0	COLONNINA EST DX RIGHT ARI-ROS SP	1	PZ																																										
0B1300A0	COLONNINA INT DX RIGHT ARI-ROS SP	1	PZ																																										
CR1040A0	PERNO CHIUSURA ELETTROMECC C. L.M. MATIC	1	PZ																																										
ED1240A0	ETICHETTA DATI TECNICI	1	PZ																																										
IP1325B0	IMB POL ANGOLARE 200X140X1880 D20	0.800	PZ																																										

+7(812)987-08-81

COMPONENTE			RICAMBIO																																																																						
Codice	Descrizione	Immagine	Codice	Descrizione	Lista componenti																																																																				
VT1324A	VETRO EST SER ARIANNA SP 357X439X4		KDR1286A	PORTA EST ARIANNA BLSP TOUCH-MASTER	<table border="1"> <thead> <tr> <th>Codice</th> <th>Descrizione</th> <th>Qtà</th> <th>UM</th> </tr> </thead> <tbody> <tr> <td>IP1385A1</td> <td>IMB POL ANGOLARE 110X80X2000 D30</td> <td>0.500</td> <td>M</td> </tr> <tr> <td>IP1508A1</td> <td>POLISTIROLO PROFILO AD U 2000X60X60</td> <td>0.800</td> <td>M</td> </tr> <tr> <td>ML1005A0</td> <td>MOLLA A COMPRESSIO NE DE5 DF0.6 H18</td> <td>2</td> <td>PZ</td> </tr> <tr> <td>SL1155A1</td> <td>SILICONE BICOMPONEN TE LOCTITE</td> <td>18</td> <td>ML</td> </tr> <tr> <td>TB1562A0</td> <td>TUBO TRAVERSO PORTA SP600</td> <td>2</td> <td>PZ</td> </tr> <tr> <td>TB3304A0</td> <td>TUBO MANIGLIA BANDIERA ARI-ROS SP</td> <td>1</td> <td>PZ</td> </tr> <tr> <td>VI1036A0</td> <td>INSERTO FILETTATO M10 FTT/C INOX RIGATO</td> <td>1</td> <td>PZ</td> </tr> <tr> <td>VI1220A1</td> <td>VITE AUTOFILETTA NTE 4.2X11 TCS+ MARUTE</td> <td>14</td> <td>PZ</td> </tr> <tr> <td>VI1930A0</td> <td>VITE 5X25 TRUCIOLARE INOX</td> <td>22</td> <td>PZ</td> </tr> <tr> <td>VM1059A1</td> <td>FILM TERMORETRA IBILE H800</td> <td>1.400</td> <td>M</td> </tr> <tr> <td>VM1209A0</td> <td>BOCCOLA PERNO ELETTROSER RATURA SP</td> <td>1</td> <td>PZ</td> </tr> <tr> <td>VM1630A0</td> <td>TAPPO PREMI VETRO INTERNO</td> <td>4</td> <td>PZ</td> </tr> <tr> <td>VM1630A1</td> <td>TAPPO PREMI VETRO INTERNO</td> <td>4</td> <td>PZ</td> </tr> <tr> <td>VM2274A0</td> <td>BOCCOLA SCANALATA CORTA</td> <td>1</td> <td>PZ</td> </tr> <tr> <td>VM2275A0</td> <td>BOCCOLA LISCIA CORTA</td> <td>1</td> <td>PZ</td> </tr> <tr> <td>VM2456A0</td> <td>TERMINALE MANIGLIA BL SP</td> <td>2</td> <td>PZ</td> </tr> </tbody> </table>	Codice	Descrizione	Qtà	UM	IP1385A1	IMB POL ANGOLARE 110X80X2000 D30	0.500	M	IP1508A1	POLISTIROLO PROFILO AD U 2000X60X60	0.800	M	ML1005A0	MOLLA A COMPRESSIO NE DE5 DF0.6 H18	2	PZ	SL1155A1	SILICONE BICOMPONEN TE LOCTITE	18	ML	TB1562A0	TUBO TRAVERSO PORTA SP600	2	PZ	TB3304A0	TUBO MANIGLIA BANDIERA ARI-ROS SP	1	PZ	VI1036A0	INSERTO FILETTATO M10 FTT/C INOX RIGATO	1	PZ	VI1220A1	VITE AUTOFILETTA NTE 4.2X11 TCS+ MARUTE	14	PZ	VI1930A0	VITE 5X25 TRUCIOLARE INOX	22	PZ	VM1059A1	FILM TERMORETRA IBILE H800	1.400	M	VM1209A0	BOCCOLA PERNO ELETTROSER RATURA SP	1	PZ	VM1630A0	TAPPO PREMI VETRO INTERNO	4	PZ	VM1630A1	TAPPO PREMI VETRO INTERNO	4	PZ	VM2274A0	BOCCOLA SCANALATA CORTA	1	PZ	VM2275A0	BOCCOLA LISCIA CORTA	1	PZ	VM2456A0	TERMINALE MANIGLIA BL SP	2	PZ
Codice	Descrizione	Qtà	UM																																																																						
IP1385A1	IMB POL ANGOLARE 110X80X2000 D30	0.500	M																																																																						
IP1508A1	POLISTIROLO PROFILO AD U 2000X60X60	0.800	M																																																																						
ML1005A0	MOLLA A COMPRESSIO NE DE5 DF0.6 H18	2	PZ																																																																						
SL1155A1	SILICONE BICOMPONEN TE LOCTITE	18	ML																																																																						
TB1562A0	TUBO TRAVERSO PORTA SP600	2	PZ																																																																						
TB3304A0	TUBO MANIGLIA BANDIERA ARI-ROS SP	1	PZ																																																																						
VI1036A0	INSERTO FILETTATO M10 FTT/C INOX RIGATO	1	PZ																																																																						
VI1220A1	VITE AUTOFILETTA NTE 4.2X11 TCS+ MARUTE	14	PZ																																																																						
VI1930A0	VITE 5X25 TRUCIOLARE INOX	22	PZ																																																																						
VM1059A1	FILM TERMORETRA IBILE H800	1.400	M																																																																						
VM1209A0	BOCCOLA PERNO ELETTROSER RATURA SP	1	PZ																																																																						
VM1630A0	TAPPO PREMI VETRO INTERNO	4	PZ																																																																						
VM1630A1	TAPPO PREMI VETRO INTERNO	4	PZ																																																																						
VM2274A0	BOCCOLA SCANALATA CORTA	1	PZ																																																																						
VM2275A0	BOCCOLA LISCIA CORTA	1	PZ																																																																						
VM2456A0	TERMINALE MANIGLIA BL SP	2	PZ																																																																						



COMPONENTE			RICAMBIO																																																										
Codice	Descrizione	Immagine	Codice	Descrizione	Lista componenti																																																								
VT1324A	VETRO EST SER ARIANNA SP 357X439X4		KDR1286A	PORTA EST ARIANNA BLSP TOUCH-MASTER	<table border="1"> <thead> <tr> <th>Codice</th> <th>Descrizione</th> <th>Qtà</th> <th>UM</th> </tr> </thead> <tbody> <tr> <td>VM2456A0</td> <td>TERMINALE MANIGLIA BL SP</td> <td>2</td> <td>PZ</td> </tr> <tr> <td>VM2465A0</td> <td>TAPPO INFERIORE DX PORTA BANDIERA SP</td> <td>1</td> <td>PZ</td> </tr> <tr> <td>VM2465A0</td> <td>TAPPO INFERIORE DX PORTA BANDIERA SP</td> <td>1</td> <td>PZ</td> </tr> <tr> <td>VM2466A0</td> <td>TAPPO INFERIORE SX PORTA BANDIERA SP</td> <td>1</td> <td>PZ</td> </tr> <tr> <td>VM2466A0</td> <td>TAPPO INFERIORE SX PORTA BANDIERA SP</td> <td>1</td> <td>PZ</td> </tr> <tr> <td>VM2467A0</td> <td>TAPPO SUPERIORE DX PORTA BANDIERA SP</td> <td>1</td> <td>PZ</td> </tr> <tr> <td>VM2467A0</td> <td>TAPPO SUPERIORE DX PORTA BANDIERA SP</td> <td>1</td> <td>PZ</td> </tr> <tr> <td>VM2468A0</td> <td>TAPPO SUPERIORE SX PORTA BANDIERA SP</td> <td>1</td> <td>PZ</td> </tr> <tr> <td>VM2468A0</td> <td>TAPPO SUPERIORE SX PORTA BANDIERA SP</td> <td>1</td> <td>PZ</td> </tr> <tr> <td>VM2470A0</td> <td>CORSOIO BLOCCA VETRO INTERNO SHOP.PRO</td> <td>2</td> <td>PZ</td> </tr> <tr> <td>VM2470A0</td> <td>CORSOIO BLOCCA VETRO INTERNO SHOP.PRO</td> <td>2</td> <td>PZ</td> </tr> <tr> <td>VM2471A0</td> <td>SEDE INF CORSOIO BLOCCA VETRO INTERNO SP</td> <td>1</td> <td>PZ</td> </tr> <tr> <td>VM2471A0</td> <td>SEDE INF CORSOIO BLOCCA VETRO INTERNO SP</td> <td>1</td> <td>PZ</td> </tr> </tbody> </table>	Codice	Descrizione	Qtà	UM	VM2456A0	TERMINALE MANIGLIA BL SP	2	PZ	VM2465A0	TAPPO INFERIORE DX PORTA BANDIERA SP	1	PZ	VM2465A0	TAPPO INFERIORE DX PORTA BANDIERA SP	1	PZ	VM2466A0	TAPPO INFERIORE SX PORTA BANDIERA SP	1	PZ	VM2466A0	TAPPO INFERIORE SX PORTA BANDIERA SP	1	PZ	VM2467A0	TAPPO SUPERIORE DX PORTA BANDIERA SP	1	PZ	VM2467A0	TAPPO SUPERIORE DX PORTA BANDIERA SP	1	PZ	VM2468A0	TAPPO SUPERIORE SX PORTA BANDIERA SP	1	PZ	VM2468A0	TAPPO SUPERIORE SX PORTA BANDIERA SP	1	PZ	VM2470A0	CORSOIO BLOCCA VETRO INTERNO SHOP.PRO	2	PZ	VM2470A0	CORSOIO BLOCCA VETRO INTERNO SHOP.PRO	2	PZ	VM2471A0	SEDE INF CORSOIO BLOCCA VETRO INTERNO SP	1	PZ	VM2471A0	SEDE INF CORSOIO BLOCCA VETRO INTERNO SP	1	PZ
Codice	Descrizione	Qtà	UM																																																										
VM2456A0	TERMINALE MANIGLIA BL SP	2	PZ																																																										
VM2465A0	TAPPO INFERIORE DX PORTA BANDIERA SP	1	PZ																																																										
VM2465A0	TAPPO INFERIORE DX PORTA BANDIERA SP	1	PZ																																																										
VM2466A0	TAPPO INFERIORE SX PORTA BANDIERA SP	1	PZ																																																										
VM2466A0	TAPPO INFERIORE SX PORTA BANDIERA SP	1	PZ																																																										
VM2467A0	TAPPO SUPERIORE DX PORTA BANDIERA SP	1	PZ																																																										
VM2467A0	TAPPO SUPERIORE DX PORTA BANDIERA SP	1	PZ																																																										
VM2468A0	TAPPO SUPERIORE SX PORTA BANDIERA SP	1	PZ																																																										
VM2468A0	TAPPO SUPERIORE SX PORTA BANDIERA SP	1	PZ																																																										
VM2470A0	CORSOIO BLOCCA VETRO INTERNO SHOP.PRO	2	PZ																																																										
VM2470A0	CORSOIO BLOCCA VETRO INTERNO SHOP.PRO	2	PZ																																																										
VM2471A0	SEDE INF CORSOIO BLOCCA VETRO INTERNO SP	1	PZ																																																										
VM2471A0	SEDE INF CORSOIO BLOCCA VETRO INTERNO SP	1	PZ																																																										



COMPONENTE

RICAMBIO

<i>Codice</i>	<i>Descrizione</i>	<i>Immagine</i>	<i>Codice</i>	<i>Descrizione</i>	<i>Lista componenti</i>																																																												
VT1324A	VETRO EST SER ARIANNA SP 357X439X4		KDR1286A	PORTA EST ARIANNA BLSP TOUCH-MASTER	<table border="1"> <thead> <tr> <th><i>Codice</i></th> <th><i>Descrizione</i></th> <th><i>Qtà</i></th> <th><i>UM</i></th> </tr> </thead> <tbody> <tr> <td>VM2472A0</td> <td>SEDE SUP CORSOIO BLOCCA VETRO INTERNO SP</td> <td>1</td> <td>PZ</td> </tr> <tr> <td>VM2472A0</td> <td>SEDE SUP CORSOIO BLOCCA VETRO INTERNO SP</td> <td>1</td> <td>PZ</td> </tr> <tr> <td>VM2473A0</td> <td>BLOCCA PERNO INF CERNIERA VETRO INT SP</td> <td>1</td> <td>PZ</td> </tr> <tr> <td>VM2473A0</td> <td>BLOCCA PERNO INF CERNIERA VETRO INT SP</td> <td>1</td> <td>PZ</td> </tr> <tr> <td>VM2474A0</td> <td>BLOCCA PERNO SUP CERNIERA VETRO INT SP</td> <td>1</td> <td>PZ</td> </tr> <tr> <td>VM2474A0</td> <td>BLOCCA PERNO SUP CERNIERA VETRO INT SP</td> <td>1</td> <td>PZ</td> </tr> <tr> <td>VM2478A0</td> <td>SPINGIVETRO VETRO H4 BL SP</td> <td>4</td> <td>PZ</td> </tr> <tr> <td>VM2478A0</td> <td>SPINGIVETRO VETRO H4 BL SP</td> <td>4</td> <td>PZ</td> </tr> <tr> <td>VM2489A0</td> <td>TERMINALE MANIGLIA CON SEDE PENNINO SP</td> <td>1</td> <td>PZ</td> </tr> <tr> <td>VM2504A0</td> <td>PIOLINO GUIDA MOLLA CORSOIO SHOP.PRO</td> <td>2</td> <td>PZ</td> </tr> <tr> <td>VM2504A0</td> <td>PIOLINO GUIDA MOLLA CORSOIO SHOP.PRO</td> <td>2</td> <td>PZ</td> </tr> <tr> <td>VM2527A0</td> <td>PENNINO CONTROLLO SP</td> <td>1</td> <td>PZ</td> </tr> <tr> <td>VT1324A0</td> <td>VETRO EST SER ARIANNA SP 357X439X4</td> <td>1</td> <td>PZ</td> </tr> <tr> <td>VT1324A0</td> <td>VETRO EST SER ARIANNA SP 357X439X4</td> <td>1</td> <td>PZ</td> </tr> </tbody> </table>	<i>Codice</i>	<i>Descrizione</i>	<i>Qtà</i>	<i>UM</i>	VM2472A0	SEDE SUP CORSOIO BLOCCA VETRO INTERNO SP	1	PZ	VM2472A0	SEDE SUP CORSOIO BLOCCA VETRO INTERNO SP	1	PZ	VM2473A0	BLOCCA PERNO INF CERNIERA VETRO INT SP	1	PZ	VM2473A0	BLOCCA PERNO INF CERNIERA VETRO INT SP	1	PZ	VM2474A0	BLOCCA PERNO SUP CERNIERA VETRO INT SP	1	PZ	VM2474A0	BLOCCA PERNO SUP CERNIERA VETRO INT SP	1	PZ	VM2478A0	SPINGIVETRO VETRO H4 BL SP	4	PZ	VM2478A0	SPINGIVETRO VETRO H4 BL SP	4	PZ	VM2489A0	TERMINALE MANIGLIA CON SEDE PENNINO SP	1	PZ	VM2504A0	PIOLINO GUIDA MOLLA CORSOIO SHOP.PRO	2	PZ	VM2504A0	PIOLINO GUIDA MOLLA CORSOIO SHOP.PRO	2	PZ	VM2527A0	PENNINO CONTROLLO SP	1	PZ	VT1324A0	VETRO EST SER ARIANNA SP 357X439X4	1	PZ	VT1324A0	VETRO EST SER ARIANNA SP 357X439X4	1	PZ
<i>Codice</i>	<i>Descrizione</i>	<i>Qtà</i>	<i>UM</i>																																																														
VM2472A0	SEDE SUP CORSOIO BLOCCA VETRO INTERNO SP	1	PZ																																																														
VM2472A0	SEDE SUP CORSOIO BLOCCA VETRO INTERNO SP	1	PZ																																																														
VM2473A0	BLOCCA PERNO INF CERNIERA VETRO INT SP	1	PZ																																																														
VM2473A0	BLOCCA PERNO INF CERNIERA VETRO INT SP	1	PZ																																																														
VM2474A0	BLOCCA PERNO SUP CERNIERA VETRO INT SP	1	PZ																																																														
VM2474A0	BLOCCA PERNO SUP CERNIERA VETRO INT SP	1	PZ																																																														
VM2478A0	SPINGIVETRO VETRO H4 BL SP	4	PZ																																																														
VM2478A0	SPINGIVETRO VETRO H4 BL SP	4	PZ																																																														
VM2489A0	TERMINALE MANIGLIA CON SEDE PENNINO SP	1	PZ																																																														
VM2504A0	PIOLINO GUIDA MOLLA CORSOIO SHOP.PRO	2	PZ																																																														
VM2504A0	PIOLINO GUIDA MOLLA CORSOIO SHOP.PRO	2	PZ																																																														
VM2527A0	PENNINO CONTROLLO SP	1	PZ																																																														
VT1324A0	VETRO EST SER ARIANNA SP 357X439X4	1	PZ																																																														
VT1324A0	VETRO EST SER ARIANNA SP 357X439X4	1	PZ																																																														

COMPONENTE
RICAMBIO

<i>Codice</i>	<i>Descrizione</i>	<i>Immagine</i>	<i>Codice</i>	<i>Descrizione</i>	<i>Lista componenti</i>																																																																				
VT1324A	VETRO EST SER ARIANNA SP 357X439X4		KDR1281A	PORTA COMPLETA RIBALTA ARIANNA BL SP	<table border="1"> <thead> <tr> <th><i>Codice</i></th> <th><i>Descrizione</i></th> <th><i>Qtà</i></th> <th><i>UM</i></th> </tr> </thead> <tbody> <tr> <td>0B1289A0</td> <td>COLONNINA EST SX RIBALTA ARI-ROS SP</td> <td>1</td> <td>PZ</td> </tr> <tr> <td>0B1290A0</td> <td>COLONNINA INT SX RIBALTA ARI-ROS SP</td> <td>1</td> <td>PZ</td> </tr> <tr> <td>0B1291A0</td> <td>COLONNINA EST DX RIBALTA ARI-ROS SP</td> <td>1</td> <td>PZ</td> </tr> <tr> <td>0B1292A0</td> <td>COLONNINA INT DX RIBALTA ARI-ROS SP</td> <td>1</td> <td>PZ</td> </tr> <tr> <td>CR1112A0</td> <td>CERNIERA PORTA RIBALTA SP ARIANNA-ELE NA</td> <td>2</td> <td>PZ</td> </tr> <tr> <td>IP1508A1</td> <td>POLISTIROLO PROFILO AD U 2000X60X60</td> <td>1.500</td> <td>M</td> </tr> <tr> <td>LP1050A0</td> <td>BARRA ILLUMINAZION E LED L180 SP COMPLETA</td> <td>1</td> <td>PZ</td> </tr> <tr> <td>SL1155A1</td> <td>SILICONE BICOMPONEN TE LOCTITE</td> <td>18</td> <td>ML</td> </tr> <tr> <td>TB1562A0</td> <td>TUBO TRAVERSO PORTA SP600</td> <td>1</td> <td>PZ</td> </tr> <tr> <td>TB3301A0</td> <td>TUBO MANIGLIA RIBALTA SP60</td> <td>1</td> <td>PZ</td> </tr> <tr> <td>VH1014A0</td> <td>RONDELLA PIANA 4.5X9X0.8 INO</td> <td>1</td> <td>PZ</td> </tr> <tr> <td>VH1220A1</td> <td>VITE AUTOFILETTA NTE 4.2X11 TCS+ MARUTE</td> <td>10</td> <td>PZ</td> </tr> <tr> <td>VI1875A0</td> <td>VITE M5X10 TC1/2T INOX</td> <td>6</td> <td>PZ</td> </tr> <tr> <td>VI1930A0</td> <td>VITE 5X25 TRUCIOLARE INOX</td> <td>12</td> <td>PZ</td> </tr> <tr> <td>VM1059A1</td> <td>FILM TERMORETRA IBILE H800</td> <td>0.500</td> <td>M</td> </tr> <tr> <td>VM1630A0</td> <td>TAPPO PREMI VETRO INTERNO</td> <td>1</td> <td>PZ</td> </tr> </tbody> </table>	<i>Codice</i>	<i>Descrizione</i>	<i>Qtà</i>	<i>UM</i>	0B1289A0	COLONNINA EST SX RIBALTA ARI-ROS SP	1	PZ	0B1290A0	COLONNINA INT SX RIBALTA ARI-ROS SP	1	PZ	0B1291A0	COLONNINA EST DX RIBALTA ARI-ROS SP	1	PZ	0B1292A0	COLONNINA INT DX RIBALTA ARI-ROS SP	1	PZ	CR1112A0	CERNIERA PORTA RIBALTA SP ARIANNA-ELE NA	2	PZ	IP1508A1	POLISTIROLO PROFILO AD U 2000X60X60	1.500	M	LP1050A0	BARRA ILLUMINAZION E LED L180 SP COMPLETA	1	PZ	SL1155A1	SILICONE BICOMPONEN TE LOCTITE	18	ML	TB1562A0	TUBO TRAVERSO PORTA SP600	1	PZ	TB3301A0	TUBO MANIGLIA RIBALTA SP60	1	PZ	VH1014A0	RONDELLA PIANA 4.5X9X0.8 INO	1	PZ	VH1220A1	VITE AUTOFILETTA NTE 4.2X11 TCS+ MARUTE	10	PZ	VI1875A0	VITE M5X10 TC1/2T INOX	6	PZ	VI1930A0	VITE 5X25 TRUCIOLARE INOX	12	PZ	VM1059A1	FILM TERMORETRA IBILE H800	0.500	M	VM1630A0	TAPPO PREMI VETRO INTERNO	1	PZ
<i>Codice</i>	<i>Descrizione</i>	<i>Qtà</i>	<i>UM</i>																																																																						
0B1289A0	COLONNINA EST SX RIBALTA ARI-ROS SP	1	PZ																																																																						
0B1290A0	COLONNINA INT SX RIBALTA ARI-ROS SP	1	PZ																																																																						
0B1291A0	COLONNINA EST DX RIBALTA ARI-ROS SP	1	PZ																																																																						
0B1292A0	COLONNINA INT DX RIBALTA ARI-ROS SP	1	PZ																																																																						
CR1112A0	CERNIERA PORTA RIBALTA SP ARIANNA-ELE NA	2	PZ																																																																						
IP1508A1	POLISTIROLO PROFILO AD U 2000X60X60	1.500	M																																																																						
LP1050A0	BARRA ILLUMINAZION E LED L180 SP COMPLETA	1	PZ																																																																						
SL1155A1	SILICONE BICOMPONEN TE LOCTITE	18	ML																																																																						
TB1562A0	TUBO TRAVERSO PORTA SP600	1	PZ																																																																						
TB3301A0	TUBO MANIGLIA RIBALTA SP60	1	PZ																																																																						
VH1014A0	RONDELLA PIANA 4.5X9X0.8 INO	1	PZ																																																																						
VH1220A1	VITE AUTOFILETTA NTE 4.2X11 TCS+ MARUTE	10	PZ																																																																						
VI1875A0	VITE M5X10 TC1/2T INOX	6	PZ																																																																						
VI1930A0	VITE 5X25 TRUCIOLARE INOX	12	PZ																																																																						
VM1059A1	FILM TERMORETRA IBILE H800	0.500	M																																																																						
VM1630A0	TAPPO PREMI VETRO INTERNO	1	PZ																																																																						



COMPONENTE

RICAMBIO



Codice	Descrizione	Immagine	Codice	Descrizione	Lista componenti																																																								
VT1324A	VETRO EST SER ARIANNA SP 357X439X4		KDR1281A	PORTA COMPLETA RIBALTA ARIANNA BL SP	<table border="1"> <thead> <tr> <th>Codice</th> <th>Descrizione</th> <th>Qtà</th> <th>UM</th> </tr> </thead> <tbody> <tr> <td>VM1630A1</td> <td>TAPPO PREMI VETRO INTERNO</td> <td>1</td> <td>PZ</td> </tr> <tr> <td>VM2456A0</td> <td>TERMINALE MANIGLIA BL SP</td> <td>2</td> <td>PZ</td> </tr> <tr> <td>VM2456A0</td> <td>TERMINALE MANIGLIA BL SP</td> <td>2</td> <td>PZ</td> </tr> <tr> <td>VM2461A0</td> <td>TAPPO INFERIORE DX PORTA RIBALTA SP</td> <td>1</td> <td>PZ</td> </tr> <tr> <td>VM2461A0</td> <td>TAPPO INFERIORE DX PORTA RIBALTA SP</td> <td>1</td> <td>PZ</td> </tr> <tr> <td>VM2462A0</td> <td>TAPPO INFERIORE SX PORTA RIBALTA SP</td> <td>1</td> <td>PZ</td> </tr> <tr> <td>VM2462A0</td> <td>TAPPO INFERIORE SX PORTA RIBALTA SP</td> <td>1</td> <td>PZ</td> </tr> <tr> <td>VM2463A0</td> <td>TAPPO SUPERIORE DX PORTA RIBALTA SP</td> <td>1</td> <td>PZ</td> </tr> <tr> <td>VM2463A0</td> <td>TAPPO SUPERIORE DX PORTA RIBALTA SP</td> <td>1</td> <td>PZ</td> </tr> <tr> <td>VM2464A0</td> <td>TAPPO SUPERIORE SX PORTA RIBALTA SP</td> <td>1</td> <td>PZ</td> </tr> <tr> <td>VM2464A0</td> <td>TAPPO SUPERIORE SX PORTA RIBALTA SP</td> <td>1</td> <td>PZ</td> </tr> <tr> <td>VM2471A0</td> <td>SEDE INF CORSOIO BLOCCA VETRO INTERNO SP</td> <td>1</td> <td>PZ</td> </tr> <tr> <td>VM2471A0</td> <td>SEDE INF CORSOIO BLOCCA VETRO INTERNO SP</td> <td>1</td> <td>PZ</td> </tr> </tbody> </table>	Codice	Descrizione	Qtà	UM	VM1630A1	TAPPO PREMI VETRO INTERNO	1	PZ	VM2456A0	TERMINALE MANIGLIA BL SP	2	PZ	VM2456A0	TERMINALE MANIGLIA BL SP	2	PZ	VM2461A0	TAPPO INFERIORE DX PORTA RIBALTA SP	1	PZ	VM2461A0	TAPPO INFERIORE DX PORTA RIBALTA SP	1	PZ	VM2462A0	TAPPO INFERIORE SX PORTA RIBALTA SP	1	PZ	VM2462A0	TAPPO INFERIORE SX PORTA RIBALTA SP	1	PZ	VM2463A0	TAPPO SUPERIORE DX PORTA RIBALTA SP	1	PZ	VM2463A0	TAPPO SUPERIORE DX PORTA RIBALTA SP	1	PZ	VM2464A0	TAPPO SUPERIORE SX PORTA RIBALTA SP	1	PZ	VM2464A0	TAPPO SUPERIORE SX PORTA RIBALTA SP	1	PZ	VM2471A0	SEDE INF CORSOIO BLOCCA VETRO INTERNO SP	1	PZ	VM2471A0	SEDE INF CORSOIO BLOCCA VETRO INTERNO SP	1	PZ
Codice	Descrizione	Qtà	UM																																																										
VM1630A1	TAPPO PREMI VETRO INTERNO	1	PZ																																																										
VM2456A0	TERMINALE MANIGLIA BL SP	2	PZ																																																										
VM2456A0	TERMINALE MANIGLIA BL SP	2	PZ																																																										
VM2461A0	TAPPO INFERIORE DX PORTA RIBALTA SP	1	PZ																																																										
VM2461A0	TAPPO INFERIORE DX PORTA RIBALTA SP	1	PZ																																																										
VM2462A0	TAPPO INFERIORE SX PORTA RIBALTA SP	1	PZ																																																										
VM2462A0	TAPPO INFERIORE SX PORTA RIBALTA SP	1	PZ																																																										
VM2463A0	TAPPO SUPERIORE DX PORTA RIBALTA SP	1	PZ																																																										
VM2463A0	TAPPO SUPERIORE DX PORTA RIBALTA SP	1	PZ																																																										
VM2464A0	TAPPO SUPERIORE SX PORTA RIBALTA SP	1	PZ																																																										
VM2464A0	TAPPO SUPERIORE SX PORTA RIBALTA SP	1	PZ																																																										
VM2471A0	SEDE INF CORSOIO BLOCCA VETRO INTERNO SP	1	PZ																																																										
VM2471A0	SEDE INF CORSOIO BLOCCA VETRO INTERNO SP	1	PZ																																																										



+7(812)987-08-81

COMPONENTE			RICAMBIO																																																														
Codice	Descrizione	Immagine	Codice	Descrizione	Lista componenti																																																												
VT1324A	VETRO EST SER ARIANNA SP 357X439X4		KDR1281A	PORTA COMPLETA RIBALTA ARIANNA BL SP	<table border="1"> <thead> <tr> <th>Codice</th> <th>Descrizione</th> <th>Qtà</th> <th>UM</th> </tr> </thead> <tbody> <tr> <td>VM2472A0</td> <td>SEDE SUP CORSOIO BLOCCA VETRO INTERNO SP</td> <td>1</td> <td>PZ</td> </tr> <tr> <td>VM2472A0</td> <td>SEDE SUP CORSOIO BLOCCA VETRO INTERNO SP</td> <td>1</td> <td>PZ</td> </tr> <tr> <td>VM2478A0</td> <td>SPINGIVETRO VETRO H4 BL SP</td> <td>1</td> <td>PZ</td> </tr> <tr> <td>VM2478A0</td> <td>SPINGIVETRO VETRO H4 BL SP</td> <td>1</td> <td>PZ</td> </tr> <tr> <td>VM2489A0</td> <td>TERMINALE MANIGLIA CON SEDE PENNINO SP</td> <td>1</td> <td>PZ</td> </tr> <tr> <td>VM2503A0</td> <td>CORSOIO BLOCCA VETRO INTERNO FISSO SP</td> <td>2</td> <td>PZ</td> </tr> <tr> <td>VM2503A0</td> <td>CORSOIO BLOCCA VETRO INTERNO FISSO SP</td> <td>2</td> <td>PZ</td> </tr> <tr> <td>VM2512A0</td> <td>BATTUTA SOFT MICRO PORTA BAKERLUX SP</td> <td>1</td> <td>PZ</td> </tr> <tr> <td>VM2512A0</td> <td>BATTUTA SOFT MICRO PORTA BAKERLUX SP</td> <td>1</td> <td>PZ</td> </tr> <tr> <td>VM2527A0</td> <td>PENNINO CONTROLLO SP</td> <td>1</td> <td>PZ</td> </tr> <tr> <td>VT1324A0</td> <td>VETRO EST SER ARIANNA SP 357X439X4</td> <td>1</td> <td>PZ</td> </tr> <tr> <td>VT1324A0</td> <td>VETRO EST SER ARIANNA SP 357X439X4</td> <td>1</td> <td>PZ</td> </tr> <tr> <td>VT1330A0</td> <td>VETRO INT ARIANNA SP 515X393.5X4</td> <td>1</td> <td>PZ</td> </tr> <tr> <td>VT1330A0</td> <td>VETRO INT ARIANNA SP 515X393.5X4</td> <td>1</td> <td>PZ</td> </tr> </tbody> </table>	Codice	Descrizione	Qtà	UM	VM2472A0	SEDE SUP CORSOIO BLOCCA VETRO INTERNO SP	1	PZ	VM2472A0	SEDE SUP CORSOIO BLOCCA VETRO INTERNO SP	1	PZ	VM2478A0	SPINGIVETRO VETRO H4 BL SP	1	PZ	VM2478A0	SPINGIVETRO VETRO H4 BL SP	1	PZ	VM2489A0	TERMINALE MANIGLIA CON SEDE PENNINO SP	1	PZ	VM2503A0	CORSOIO BLOCCA VETRO INTERNO FISSO SP	2	PZ	VM2503A0	CORSOIO BLOCCA VETRO INTERNO FISSO SP	2	PZ	VM2512A0	BATTUTA SOFT MICRO PORTA BAKERLUX SP	1	PZ	VM2512A0	BATTUTA SOFT MICRO PORTA BAKERLUX SP	1	PZ	VM2527A0	PENNINO CONTROLLO SP	1	PZ	VT1324A0	VETRO EST SER ARIANNA SP 357X439X4	1	PZ	VT1324A0	VETRO EST SER ARIANNA SP 357X439X4	1	PZ	VT1330A0	VETRO INT ARIANNA SP 515X393.5X4	1	PZ	VT1330A0	VETRO INT ARIANNA SP 515X393.5X4	1	PZ
Codice	Descrizione	Qtà	UM																																																														
VM2472A0	SEDE SUP CORSOIO BLOCCA VETRO INTERNO SP	1	PZ																																																														
VM2472A0	SEDE SUP CORSOIO BLOCCA VETRO INTERNO SP	1	PZ																																																														
VM2478A0	SPINGIVETRO VETRO H4 BL SP	1	PZ																																																														
VM2478A0	SPINGIVETRO VETRO H4 BL SP	1	PZ																																																														
VM2489A0	TERMINALE MANIGLIA CON SEDE PENNINO SP	1	PZ																																																														
VM2503A0	CORSOIO BLOCCA VETRO INTERNO FISSO SP	2	PZ																																																														
VM2503A0	CORSOIO BLOCCA VETRO INTERNO FISSO SP	2	PZ																																																														
VM2512A0	BATTUTA SOFT MICRO PORTA BAKERLUX SP	1	PZ																																																														
VM2512A0	BATTUTA SOFT MICRO PORTA BAKERLUX SP	1	PZ																																																														
VM2527A0	PENNINO CONTROLLO SP	1	PZ																																																														
VT1324A0	VETRO EST SER ARIANNA SP 357X439X4	1	PZ																																																														
VT1324A0	VETRO EST SER ARIANNA SP 357X439X4	1	PZ																																																														
VT1330A0	VETRO INT ARIANNA SP 515X393.5X4	1	PZ																																																														
VT1330A0	VETRO INT ARIANNA SP 515X393.5X4	1	PZ																																																														

+7(812)987-08-81

COMPONENTE			RICAMBIO																														
Codice	Descrizione	Immagine	Codice	Descrizione	Lista componenti																												
VT1330A	VETRO INT ARIANNA SP 515X393.5X4		KVT1330A	KIT VETRO INT ARIANNA SP 515X393.5X4	<table border="1"> <thead> <tr> <th>Codice</th> <th>Descrizione</th> <th>Qtà</th> <th>UM</th> </tr> </thead> <tbody> <tr> <td>IP1508A1</td> <td>POLISTIROLO PROFILO AD U 2000X60X60</td> <td>0.800</td> <td>M</td> </tr> <tr> <td>VM1059A1</td> <td>FILM TERMORETRA IBILE H800</td> <td>1.200</td> <td>M</td> </tr> <tr> <td>VT1330A0</td> <td>VETRO INT ARIANNA SP 515X393.5X4</td> <td>1</td> <td>PZ</td> </tr> <tr> <td>VT1330A0</td> <td>VETRO INT ARIANNA SP 515X393.5X4</td> <td>1</td> <td>PZ</td> </tr> </tbody> </table>	Codice	Descrizione	Qtà	UM	IP1508A1	POLISTIROLO PROFILO AD U 2000X60X60	0.800	M	VM1059A1	FILM TERMORETRA IBILE H800	1.200	M	VT1330A0	VETRO INT ARIANNA SP 515X393.5X4	1	PZ	VT1330A0	VETRO INT ARIANNA SP 515X393.5X4	1	PZ								
Codice	Descrizione	Qtà	UM																														
IP1508A1	POLISTIROLO PROFILO AD U 2000X60X60	0.800	M																														
VM1059A1	FILM TERMORETRA IBILE H800	1.200	M																														
VT1330A0	VETRO INT ARIANNA SP 515X393.5X4	1	PZ																														
VT1330A0	VETRO INT ARIANNA SP 515X393.5X4	1	PZ																														
TB3301A	TUBO MANIGLIA RIBALTA SP600		KTB3301A	KIT TUBO MANIGLIA RIBALTA BL SP 460X330	<table border="1"> <thead> <tr> <th>Codice</th> <th>Descrizione</th> <th>Qtà</th> <th>UM</th> </tr> </thead> <tbody> <tr> <td>TB3301A0</td> <td>TUBO MANIGLIA RIBALTA SP600</td> <td>1</td> <td>PZ</td> </tr> <tr> <td>VI1930A0</td> <td>VITE 5X25 TRUCIOLARE INOX</td> <td>4</td> <td>PZ</td> </tr> <tr> <td>VM2456A0</td> <td>TERMINALE MANIGLIA BL SP</td> <td>2</td> <td>PZ</td> </tr> <tr> <td>VM2456A0</td> <td>TERMINALE MANIGLIA BL SP</td> <td>2</td> <td>PZ</td> </tr> <tr> <td>VM2489A0</td> <td>TERMINALE MANIGLIA CON SEDE PENNINO SP</td> <td>1</td> <td>PZ</td> </tr> <tr> <td>VM2527A0</td> <td>PENNINO CONTROLLO SP</td> <td>1</td> <td>PZ</td> </tr> </tbody> </table>	Codice	Descrizione	Qtà	UM	TB3301A0	TUBO MANIGLIA RIBALTA SP600	1	PZ	VI1930A0	VITE 5X25 TRUCIOLARE INOX	4	PZ	VM2456A0	TERMINALE MANIGLIA BL SP	2	PZ	VM2456A0	TERMINALE MANIGLIA BL SP	2	PZ	VM2489A0	TERMINALE MANIGLIA CON SEDE PENNINO SP	1	PZ	VM2527A0	PENNINO CONTROLLO SP	1	PZ
Codice	Descrizione	Qtà	UM																														
TB3301A0	TUBO MANIGLIA RIBALTA SP600	1	PZ																														
VI1930A0	VITE 5X25 TRUCIOLARE INOX	4	PZ																														
VM2456A0	TERMINALE MANIGLIA BL SP	2	PZ																														
VM2456A0	TERMINALE MANIGLIA BL SP	2	PZ																														
VM2489A0	TERMINALE MANIGLIA CON SEDE PENNINO SP	1	PZ																														
VM2527A0	PENNINO CONTROLLO SP	1	PZ																														
VM2456A	TERMINALE MANIGLIA BL SP		KVM2456A	KIT 2 PZ TERMINALE MANIGLIA BAKERLUX SP	<table border="1"> <thead> <tr> <th>Codice</th> <th>Descrizione</th> <th>Qtà</th> <th>UM</th> </tr> </thead> <tbody> <tr> <td>VI1930A0</td> <td>VITE 5X25 TRUCIOLARE INOX</td> <td>4</td> <td>PZ</td> </tr> <tr> <td>VM1224A0</td> <td>TUBOLARE TERMORETR 65MY 220MM 2 COLORI</td> <td>0.300</td> <td>M</td> </tr> <tr> <td>VM2456A0</td> <td>TERMINALE MANIGLIA BL SP</td> <td>2</td> <td>PZ</td> </tr> <tr> <td>VM2456A0</td> <td>TERMINALE MANIGLIA BL SP</td> <td>2</td> <td>PZ</td> </tr> <tr> <td>VM2489A0</td> <td>TERMINALE MANIGLIA CON SEDE PENNINO SP</td> <td>1</td> <td>PZ</td> </tr> <tr> <td>VM2527A0</td> <td>PENNINO CONTROLLO SP</td> <td>1</td> <td>PZ</td> </tr> </tbody> </table>	Codice	Descrizione	Qtà	UM	VI1930A0	VITE 5X25 TRUCIOLARE INOX	4	PZ	VM1224A0	TUBOLARE TERMORETR 65MY 220MM 2 COLORI	0.300	M	VM2456A0	TERMINALE MANIGLIA BL SP	2	PZ	VM2456A0	TERMINALE MANIGLIA BL SP	2	PZ	VM2489A0	TERMINALE MANIGLIA CON SEDE PENNINO SP	1	PZ	VM2527A0	PENNINO CONTROLLO SP	1	PZ
Codice	Descrizione	Qtà	UM																														
VI1930A0	VITE 5X25 TRUCIOLARE INOX	4	PZ																														
VM1224A0	TUBOLARE TERMORETR 65MY 220MM 2 COLORI	0.300	M																														
VM2456A0	TERMINALE MANIGLIA BL SP	2	PZ																														
VM2456A0	TERMINALE MANIGLIA BL SP	2	PZ																														
VM2489A0	TERMINALE MANIGLIA CON SEDE PENNINO SP	1	PZ																														
VM2527A0	PENNINO CONTROLLO SP	1	PZ																														



+7(812)987-08-81

COMPONENTE			RICAMBIO																										
Codice	Descrizione	Immagine	Codice	Descrizione	Lista componenti																								
PE2107A	CONTROLLO COMPLETO SP LED		KPE2107A	KIT CONTROLLO COMPLETO BL LED	<table border="1"><thead><tr><th>Codice</th><th>Descrizione</th><th>Qtà</th><th>UM</th></tr></thead><tbody><tr><td>PE2107A0</td><td>CONTROLLO COMPLETO BL LED</td><td>1</td><td>PZ</td></tr><tr><td>PE2107A1</td><td>CONTROLLO COMPLETO SP LED</td><td>1</td><td>PZ</td></tr><tr><td>PE2107A2</td><td>CONTROLLO COMPLETO SP LED</td><td>1</td><td>PZ</td></tr><tr><td>VI1930A0</td><td>VITE 5X25 TRUCIOLARE INOX</td><td>2</td><td>PZ</td></tr><tr><td>VM2147A0</td><td>SPUGNA ESD ROSA LISCIA 410X343X15 M</td><td>1</td><td>PZ</td></tr></tbody></table>	Codice	Descrizione	Qtà	UM	PE2107A0	CONTROLLO COMPLETO BL LED	1	PZ	PE2107A1	CONTROLLO COMPLETO SP LED	1	PZ	PE2107A2	CONTROLLO COMPLETO SP LED	1	PZ	VI1930A0	VITE 5X25 TRUCIOLARE INOX	2	PZ	VM2147A0	SPUGNA ESD ROSA LISCIA 410X343X15 M	1	PZ
Codice	Descrizione	Qtà	UM																										
PE2107A0	CONTROLLO COMPLETO BL LED	1	PZ																										
PE2107A1	CONTROLLO COMPLETO SP LED	1	PZ																										
PE2107A2	CONTROLLO COMPLETO SP LED	1	PZ																										
VI1930A0	VITE 5X25 TRUCIOLARE INOX	2	PZ																										
VM2147A0	SPUGNA ESD ROSA LISCIA 410X343X15 M	1	PZ																										



Зип Общежит

ASM3408A/0.D02 Copertura esterna

vsezip.ru

+7(812)987-08-81





ASM3408A/0.D02 - Copertura esterna

FRONTE



RETRO







COMPONENTE			RICAMBIO																		
Codice	Descrizione	Immagine	Codice	Descrizione	Lista componenti																
VM1750A	MORSETTO A PETTINE		KVM1750A	KIT MORSETTIERA A PETTINE	<table border="1"> <thead> <tr> <th>Codice</th> <th>Descrizione</th> <th>Qtà</th> <th>UM</th> </tr> </thead> <tbody> <tr> <td>VM1224A0</td> <td>TUBOLARE TERMORETR 65MY 220MM 2 COLORI</td> <td>0.150</td> <td>M</td> </tr> <tr> <td>VM1750A0</td> <td>MORSETTO A PETTINE</td> <td>1</td> <td>PZ</td> </tr> </tbody> </table>	Codice	Descrizione	Qtà	UM	VM1224A0	TUBOLARE TERMORETR 65MY 220MM 2 COLORI	0.150	M	VM1750A0	MORSETTO A PETTINE	1	PZ				
Codice	Descrizione	Qtà	UM																		
VM1224A0	TUBOLARE TERMORETR 65MY 220MM 2 COLORI	0.150	M																		
VM1750A0	MORSETTO A PETTINE	1	PZ																		
CR1000A	ATTACCO CERNIERA PORTA FORNO RIBALTA		KCR1000A	KIT ATTACCO CERNIERA RIBALTA LM	<table border="1"> <thead> <tr> <th>Codice</th> <th>Descrizione</th> <th>Qtà</th> <th>UM</th> </tr> </thead> <tbody> <tr> <td>CR1000A0</td> <td>ATTACCO CERNIERA PORTA FORNO RIBALTA</td> <td>1</td> <td>PZ</td> </tr> <tr> <td>VI1875A0</td> <td>VITE M5X10 TC1/2T INOX</td> <td>2</td> <td>PZ</td> </tr> <tr> <td>VM1224A0</td> <td>TUBOLARE TERMORETR 65MY 220MM 2 COLORI</td> <td>0.200</td> <td>M</td> </tr> </tbody> </table>	Codice	Descrizione	Qtà	UM	CR1000A0	ATTACCO CERNIERA PORTA FORNO RIBALTA	1	PZ	VI1875A0	VITE M5X10 TC1/2T INOX	2	PZ	VM1224A0	TUBOLARE TERMORETR 65MY 220MM 2 COLORI	0.200	M
Codice	Descrizione	Qtà	UM																		
CR1000A0	ATTACCO CERNIERA PORTA FORNO RIBALTA	1	PZ																		
VI1875A0	VITE M5X10 TC1/2T INOX	2	PZ																		
VM1224A0	TUBOLARE TERMORETR 65MY 220MM 2 COLORI	0.200	M																		
VM2249A	ANGOLO FACCIATA MUFFOLA PPS		KVM2249A	KIT ANGOLO FACCIATA MUFFOL	<table border="1"> <thead> <tr> <th>Codice</th> <th>Descrizione</th> <th>Qtà</th> <th>UM</th> </tr> </thead> <tbody> <tr> <td>VM1224A0</td> <td>TUBOLARE TERMORETR 65MY 220MM 2 COLORI</td> <td>0.150</td> <td>M</td> </tr> <tr> <td>VM2249A0</td> <td>ANGOLO FACCIATA MUFFOLA PPS</td> <td>1</td> <td>PZ</td> </tr> </tbody> </table>	Codice	Descrizione	Qtà	UM	VM1224A0	TUBOLARE TERMORETR 65MY 220MM 2 COLORI	0.150	M	VM2249A0	ANGOLO FACCIATA MUFFOLA PPS	1	PZ				
Codice	Descrizione	Qtà	UM																		
VM1224A0	TUBOLARE TERMORETR 65MY 220MM 2 COLORI	0.150	M																		
VM2249A0	ANGOLO FACCIATA MUFFOLA PPS	1	PZ																		
0D2409A	PROFILO INF FACCIATA RIBALTA SP600		0D2409A0	PROFILO INF FACCIATA RIBALTA SP600																	
0E1381A	FONDO ESTERNO SP600		0E1381A0	FONDO ESTERNO SP600																	



COMPONENTE			RICAMBIO																		
Codice	Descrizione	Immagine	Codice	Descrizione	Lista componenti																
VM2502A	ANELLO CAMINO SP		KVM2502A	KIT ANELLO CAMINO BAKERLUX SHOP.PRO	<table border="1"> <thead> <tr> <th>Codice</th> <th>Descrizione</th> <th>Qtà</th> <th>UM</th> </tr> </thead> <tbody> <tr> <td>VM1224A0</td> <td>TUBOLARE TERMORETR 65MY 220MM 2 COLORI</td> <td>0.300</td> <td>M</td> </tr> <tr> <td>VM2502A0</td> <td>ANELLO CAMINO SP</td> <td>1</td> <td>PZ</td> </tr> <tr> <td>VM2502A0</td> <td>ANELLO CAMINO SP</td> <td>1</td> <td>PZ</td> </tr> </tbody> </table>	Codice	Descrizione	Qtà	UM	VM1224A0	TUBOLARE TERMORETR 65MY 220MM 2 COLORI	0.300	M	VM2502A0	ANELLO CAMINO SP	1	PZ	VM2502A0	ANELLO CAMINO SP	1	PZ
Codice	Descrizione	Qtà	UM																		
VM1224A0	TUBOLARE TERMORETR 65MY 220MM 2 COLORI	0.300	M																		
VM2502A0	ANELLO CAMINO SP	1	PZ																		
VM2502A0	ANELLO CAMINO SP	1	PZ																		
VE1295A	MICROINTERRUTTORE PORTA MK 16A 230V UL		KVE1295A	KIT MICROINTERRUTTORE PORTA 16A 230V	<table border="1"> <thead> <tr> <th>Codice</th> <th>Descrizione</th> <th>Qtà</th> <th>UM</th> </tr> </thead> <tbody> <tr> <td>VE1295A0</td> <td>MICROINTERRUTTORE PORTA MK 16A 230V UL</td> <td>1</td> <td>PZ</td> </tr> <tr> <td>VM1224A0</td> <td>TUBOLARE TERMORETR 65MY 220MM 2 COLORI</td> <td>0.300</td> <td>M</td> </tr> </tbody> </table>	Codice	Descrizione	Qtà	UM	VE1295A0	MICROINTERRUTTORE PORTA MK 16A 230V UL	1	PZ	VM1224A0	TUBOLARE TERMORETR 65MY 220MM 2 COLORI	0.300	M				
Codice	Descrizione	Qtà	UM																		
VE1295A0	MICROINTERRUTTORE PORTA MK 16A 230V UL	1	PZ																		
VM1224A0	TUBOLARE TERMORETR 65MY 220MM 2 COLORI	0.300	M																		
VM2508A	COVER MICRO PORTA BAKERLUX SHOP.PRO		KVM2508A	KIT COVER MICRO PORTA BAKERLUX SHOP.PRO	<table border="1"> <thead> <tr> <th>Codice</th> <th>Descrizione</th> <th>Qtà</th> <th>UM</th> </tr> </thead> <tbody> <tr> <td>VM1224A0</td> <td>TUBOLARE TERMORETR 65MY 220MM 2 COLORI</td> <td>0.300</td> <td>M</td> </tr> <tr> <td>VM2508A0</td> <td>COVER MICRO PORTA BAKERLUX SHOP.PRO</td> <td>1</td> <td>PZ</td> </tr> <tr> <td>VM2508A0</td> <td>COVER MICRO PORTA BAKERLUX SHOP.PRO</td> <td>1</td> <td>PZ</td> </tr> </tbody> </table>	Codice	Descrizione	Qtà	UM	VM1224A0	TUBOLARE TERMORETR 65MY 220MM 2 COLORI	0.300	M	VM2508A0	COVER MICRO PORTA BAKERLUX SHOP.PRO	1	PZ	VM2508A0	COVER MICRO PORTA BAKERLUX SHOP.PRO	1	PZ
Codice	Descrizione	Qtà	UM																		
VM1224A0	TUBOLARE TERMORETR 65MY 220MM 2 COLORI	0.300	M																		
VM2508A0	COVER MICRO PORTA BAKERLUX SHOP.PRO	1	PZ																		
VM2508A0	COVER MICRO PORTA BAKERLUX SHOP.PRO	1	PZ																		
VM2481A	TAPPO FACCIATA COPERTURA ESTERNA SX SP		KVM2481A	KIT TAPPO FACCIATA COPERTURA EST SX SP	<table border="1"> <thead> <tr> <th>Codice</th> <th>Descrizione</th> <th>Qtà</th> <th>UM</th> </tr> </thead> <tbody> <tr> <td>VM1224A0</td> <td>TUBOLARE TERMORETR 65MY 220MM 2 COLORI</td> <td>0.150</td> <td>M</td> </tr> <tr> <td>VM2481A0</td> <td>TAPPO FACCIATA COPERTURA ESTERNA SX SP</td> <td>1</td> <td>PZ</td> </tr> <tr> <td>VM2481A0</td> <td>TAPPO FACCIATA COPERTURA ESTERNA SX SP</td> <td>1</td> <td>PZ</td> </tr> </tbody> </table>	Codice	Descrizione	Qtà	UM	VM1224A0	TUBOLARE TERMORETR 65MY 220MM 2 COLORI	0.150	M	VM2481A0	TAPPO FACCIATA COPERTURA ESTERNA SX SP	1	PZ	VM2481A0	TAPPO FACCIATA COPERTURA ESTERNA SX SP	1	PZ
Codice	Descrizione	Qtà	UM																		
VM1224A0	TUBOLARE TERMORETR 65MY 220MM 2 COLORI	0.150	M																		
VM2481A0	TAPPO FACCIATA COPERTURA ESTERNA SX SP	1	PZ																		
VM2481A0	TAPPO FACCIATA COPERTURA ESTERNA SX SP	1	PZ																		



COMPONENTE			RICAMBIO																						
Codice	Descrizione	Immagine	Codice	Descrizione	Lista componenti																				
VM2480A	TAPPO FACCIATA COPERTURA ESTERNA DX SP		KVM2480A	KIT TAPPO FACCIATA COPERTURA EST DX SP	<table border="1"> <thead> <tr> <th>Codice</th> <th>Descrizione</th> <th>Qtà</th> <th>UM</th> </tr> </thead> <tbody> <tr> <td>VM1224A0</td> <td>TUBOLARE TERMORETR 65MY 220MM 2 COLORI</td> <td>0.150</td> <td>M</td> </tr> <tr> <td>VM2480A0</td> <td>TAPPO FACCIATA COPERTURA ESTERNA DX SP</td> <td>1</td> <td>PZ</td> </tr> <tr> <td>VM2480A0</td> <td>TAPPO FACCIATA COPERTURA ESTERNA DX SP</td> <td>1</td> <td>PZ</td> </tr> </tbody> </table>	Codice	Descrizione	Qtà	UM	VM1224A0	TUBOLARE TERMORETR 65MY 220MM 2 COLORI	0.150	M	VM2480A0	TAPPO FACCIATA COPERTURA ESTERNA DX SP	1	PZ	VM2480A0	TAPPO FACCIATA COPERTURA ESTERNA DX SP	1	PZ				
Codice	Descrizione	Qtà	UM																						
VM1224A0	TUBOLARE TERMORETR 65MY 220MM 2 COLORI	0.150	M																						
VM2480A0	TAPPO FACCIATA COPERTURA ESTERNA DX SP	1	PZ																						
VM2480A0	TAPPO FACCIATA COPERTURA ESTERNA DX SP	1	PZ																						
VM1631A	TAPPO PREMI VETRO INTERNO PLUS		KVM1631A	KIT 10 PZ TAPPO PREMI VETRO INTERNO PLUS	<table border="1"> <thead> <tr> <th>Codice</th> <th>Descrizione</th> <th>Qtà</th> <th>UM</th> </tr> </thead> <tbody> <tr> <td>VM1224A0</td> <td>TUBOLARE TERMORETR 65MY 220MM 2 COLORI</td> <td>0.200</td> <td>M</td> </tr> <tr> <td>VM1631A0</td> <td>TAPPO PREMI VETRO INTERNO PLU</td> <td>10</td> <td>PZ</td> </tr> </tbody> </table>	Codice	Descrizione	Qtà	UM	VM1224A0	TUBOLARE TERMORETR 65MY 220MM 2 COLORI	0.200	M	VM1631A0	TAPPO PREMI VETRO INTERNO PLU	10	PZ								
Codice	Descrizione	Qtà	UM																						
VM1224A0	TUBOLARE TERMORETR 65MY 220MM 2 COLORI	0.200	M																						
VM1631A0	TAPPO PREMI VETRO INTERNO PLU	10	PZ																						
VM2490A	GUARNIZIONE FONDO EST. FRONTALE L600 SP		KVM2490A	KIT 2PZ GUARNIZ FONDO FRONT BLSP 460X330	<table border="1"> <thead> <tr> <th>Codice</th> <th>Descrizione</th> <th>Qtà</th> <th>UM</th> </tr> </thead> <tbody> <tr> <td>VM1794A0</td> <td>FASCETTA 430X4.8 PA66 NERA</td> <td>1</td> <td>PZ</td> </tr> <tr> <td>VM2103A0</td> <td>PIASTRINA FERMAFASCE TTA</td> <td>1</td> <td>PZ</td> </tr> <tr> <td>VM2490A0</td> <td>GUARNIZIONE FONDO EST. FRONTALE L600 SP</td> <td>2</td> <td>PZ</td> </tr> <tr> <td>VM2490A0</td> <td>GUARNIZIONE FONDO EST. FRONTALE L600 SP</td> <td>2</td> <td>PZ</td> </tr> </tbody> </table>	Codice	Descrizione	Qtà	UM	VM1794A0	FASCETTA 430X4.8 PA66 NERA	1	PZ	VM2103A0	PIASTRINA FERMAFASCE TTA	1	PZ	VM2490A0	GUARNIZIONE FONDO EST. FRONTALE L600 SP	2	PZ	VM2490A0	GUARNIZIONE FONDO EST. FRONTALE L600 SP	2	PZ
Codice	Descrizione	Qtà	UM																						
VM1794A0	FASCETTA 430X4.8 PA66 NERA	1	PZ																						
VM2103A0	PIASTRINA FERMAFASCE TTA	1	PZ																						
VM2490A0	GUARNIZIONE FONDO EST. FRONTALE L600 SP	2	PZ																						
VM2490A0	GUARNIZIONE FONDO EST. FRONTALE L600 SP	2	PZ																						
VM2491A	GUARNIZIONE FONDO EST LAT 460X330 BL SP		KVM2491A	KIT 2PZ GUARNIZ FONDO LATO BLSP 460X330	<table border="1"> <thead> <tr> <th>Codice</th> <th>Descrizione</th> <th>Qtà</th> <th>UM</th> </tr> </thead> <tbody> <tr> <td>VM1631A0</td> <td>TAPPO PREMI VETRO INTERNO PLU</td> <td>4</td> <td>PZ</td> </tr> <tr> <td>VM1794A0</td> <td>FASCETTA 430X4.8 PA66 NERA</td> <td>1</td> <td>PZ</td> </tr> <tr> <td>VM2103A0</td> <td>PIASTRINA FERMAFASCE TTA</td> <td>1</td> <td>PZ</td> </tr> <tr> <td>VM2491A0</td> <td>GUARNIZIONE FONDO EST LAT 460X330 BL SP</td> <td>2</td> <td>PZ</td> </tr> </tbody> </table>	Codice	Descrizione	Qtà	UM	VM1631A0	TAPPO PREMI VETRO INTERNO PLU	4	PZ	VM1794A0	FASCETTA 430X4.8 PA66 NERA	1	PZ	VM2103A0	PIASTRINA FERMAFASCE TTA	1	PZ	VM2491A0	GUARNIZIONE FONDO EST LAT 460X330 BL SP	2	PZ
Codice	Descrizione	Qtà	UM																						
VM1631A0	TAPPO PREMI VETRO INTERNO PLU	4	PZ																						
VM1794A0	FASCETTA 430X4.8 PA66 NERA	1	PZ																						
VM2103A0	PIASTRINA FERMAFASCE TTA	1	PZ																						
VM2491A0	GUARNIZIONE FONDO EST LAT 460X330 BL SP	2	PZ																						

COMPONENTE			RICAMBIO																		
Codice	Descrizione	Immagine	Codice	Descrizione	Lista componenti																
VM2491A	GUARNIZIONE FONDO EST LAT 460X330 BL SP		KVM2491A	KIT 2PZ GUARNIZ FONDO LATO BLSP 460X330	<table border="1"> <thead> <tr> <th>Codice</th> <th>Descrizione</th> <th>Qtà</th> <th>UM</th> </tr> </thead> <tbody> <tr> <td>VM2491A0</td> <td>GUARNIZIONE FONDO EST LAT 460X330 BL SP</td> <td>2</td> <td>PZ</td> </tr> <tr> <td>VM2491A1</td> <td>GUARNIZIONE FONDO EST. LATERALE SP600</td> <td>2</td> <td>PZ</td> </tr> </tbody> </table>	Codice	Descrizione	Qtà	UM	VM2491A0	GUARNIZIONE FONDO EST LAT 460X330 BL SP	2	PZ	VM2491A1	GUARNIZIONE FONDO EST. LATERALE SP600	2	PZ				
Codice	Descrizione	Qtà	UM																		
VM2491A0	GUARNIZIONE FONDO EST LAT 460X330 BL SP	2	PZ																		
VM2491A1	GUARNIZIONE FONDO EST. LATERALE SP600	2	PZ																		
VM1222A	FERMACAVI ALLACCIAMENTI-AC CESSORI SP		VM1222A0	FERMACAVI ALLACCIAMENTI-AC CESSORI SP																	
VM2455A	CLIP PASSAGGIO CAVO CONTROLLO COMANDI SP		KVM2455A	KIT CLIP PASSAGGIO CAVO CONTROLLO BL SP	<table border="1"> <thead> <tr> <th>Codice</th> <th>Descrizione</th> <th>Qtà</th> <th>UM</th> </tr> </thead> <tbody> <tr> <td>VM1224A0</td> <td>TUBOLARE TERMORETR 65MY 220MM 2 COLORI</td> <td>0.150</td> <td>M</td> </tr> <tr> <td>VM2455A0</td> <td>CLIP PASSAGGIO CAVO CONTROLLO COMANDI SP</td> <td>1</td> <td>PZ</td> </tr> <tr> <td>VM2455A0</td> <td>CLIP PASSAGGIO CAVO CONTROLLO COMANDI SP</td> <td>1</td> <td>PZ</td> </tr> </tbody> </table>	Codice	Descrizione	Qtà	UM	VM1224A0	TUBOLARE TERMORETR 65MY 220MM 2 COLORI	0.150	M	VM2455A0	CLIP PASSAGGIO CAVO CONTROLLO COMANDI SP	1	PZ	VM2455A0	CLIP PASSAGGIO CAVO CONTROLLO COMANDI SP	1	PZ
Codice	Descrizione	Qtà	UM																		
VM1224A0	TUBOLARE TERMORETR 65MY 220MM 2 COLORI	0.150	M																		
VM2455A0	CLIP PASSAGGIO CAVO CONTROLLO COMANDI SP	1	PZ																		
VM2455A0	CLIP PASSAGGIO CAVO CONTROLLO COMANDI SP	1	PZ																		
VN1175A	VENTOLA RAFFR. 120X120 230V 50/60HZ 80°C		KVN1175A	KIT VENTOLA RAFFREDDAMENTO 120X120 230V	<table border="1"> <thead> <tr> <th>Codice</th> <th>Descrizione</th> <th>Qtà</th> <th>UM</th> </tr> </thead> <tbody> <tr> <td>VN1175A0</td> <td>VENTOLA RAFFR. 120X120 230V 50/60HZ 80°C</td> <td>1</td> <td>PZ</td> </tr> <tr> <td>VN1175A0</td> <td>VENTOLA RAFFR. 120X120 230V 50/60HZ 80°C</td> <td>1</td> <td>PZ</td> </tr> </tbody> </table>	Codice	Descrizione	Qtà	UM	VN1175A0	VENTOLA RAFFR. 120X120 230V 50/60HZ 80°C	1	PZ	VN1175A0	VENTOLA RAFFR. 120X120 230V 50/60HZ 80°C	1	PZ				
Codice	Descrizione	Qtà	UM																		
VN1175A0	VENTOLA RAFFR. 120X120 230V 50/60HZ 80°C	1	PZ																		
VN1175A0	VENTOLA RAFFR. 120X120 230V 50/60HZ 80°C	1	PZ																		



Зип Общепит

ASM3408A/0.D02 Copertura esterna

vsezip.ru

+7(812)987-08-81

COMPONENTE			RICAMBIO														
Codice	Descrizione	Immagine	Codice	Descrizione	Lista componenti												
VM2495A	SUPPORTO VENTOLA RAFFREDDAMENTO SP		KVM2495A	KIT SUPPORTO VENTOLA RAFFREDDAMENTO	<table border="1"><thead><tr><th>Codice</th><th>Descrizione</th><th>Qtà</th><th>UM</th></tr></thead><tbody><tr><td>VI1220A1</td><td>VITE AUTOFILETTA NTE 4.2X11 TCS+ MARUTE</td><td>2</td><td>PZ</td></tr><tr><td>VM2495A0</td><td>SUPPORTO VENTOLA RAFFREDDAM ENTO SP</td><td>1</td><td>PZ</td></tr></tbody></table>	Codice	Descrizione	Qtà	UM	VI1220A1	VITE AUTOFILETTA NTE 4.2X11 TCS+ MARUTE	2	PZ	VM2495A0	SUPPORTO VENTOLA RAFFREDDAM ENTO SP	1	PZ
Codice	Descrizione	Qtà	UM														
VI1220A1	VITE AUTOFILETTA NTE 4.2X11 TCS+ MARUTE	2	PZ														
VM2495A0	SUPPORTO VENTOLA RAFFREDDAM ENTO SP	1	PZ														
0D2402B	MANTELLO FORNO RIBALTA ARIANNA S		0D2402B1	MANTELLO FORNO RIBALTA ARIANNA S													
0F1542B	SCHIENA ARIANNA SP		0F1542B0	SCHIENA ARIANNA SP													



Зип Общепит

ASM3402A/0.D01 Camera di cottura

vsezip.ru

+7(812)987-08-81

ASM3402A/0.D01 - Camera di cottura

FRONTE



RETRO

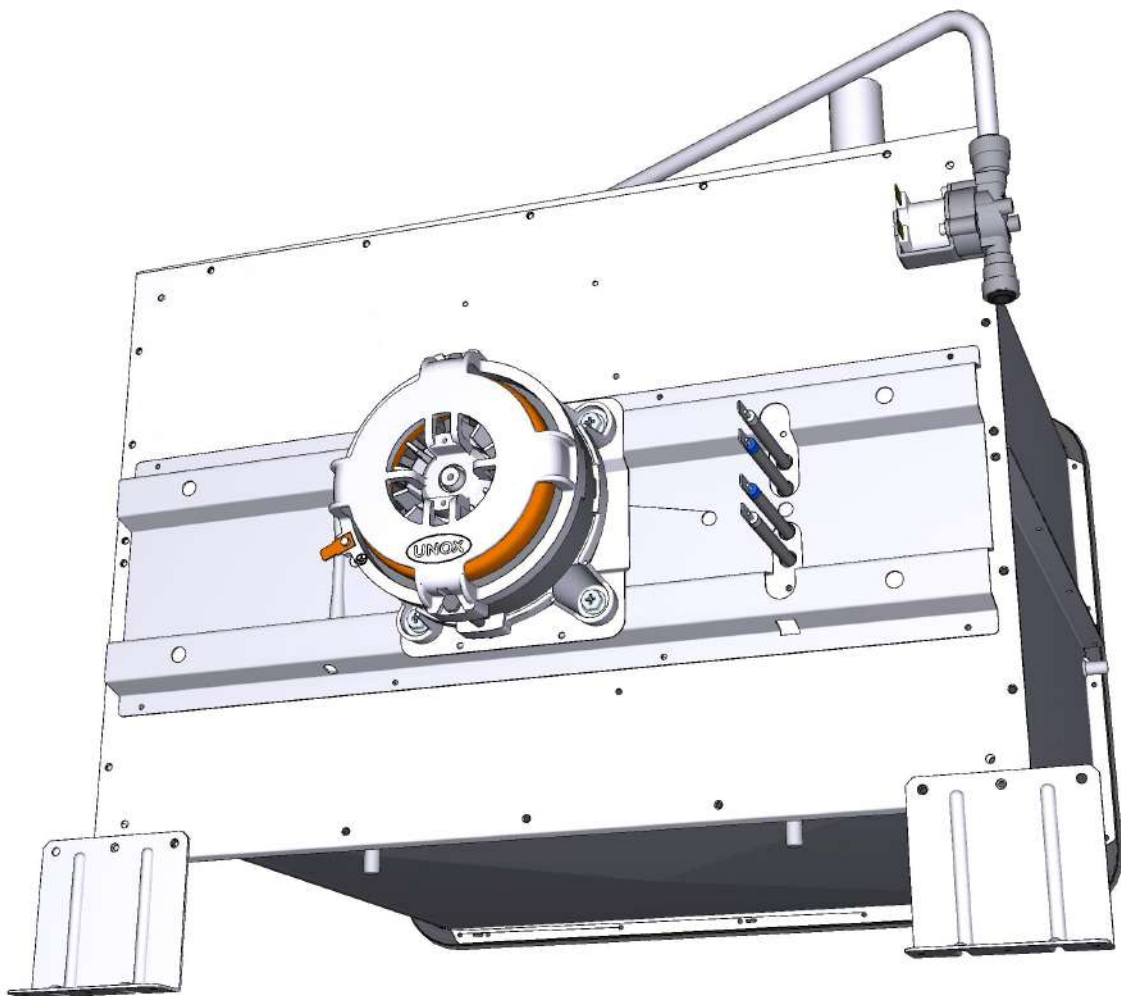



COMPONENTE

RICAMBIO

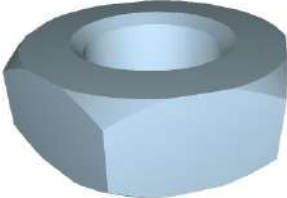
Codice	Descrizione	Immagine	Codice	Descrizione	Lista componenti																																												
TR1105A	SONDA TEMPERATURA PT100 L1000		KTR1105A	KIT SONDA TEMPERATURA PT100 L1000	<table border="1"> <thead> <tr> <th>Codice</th> <th>Descrizione</th> <th>Qtà</th> <th>UM</th> </tr> </thead> <tbody> <tr> <td>GN1120A0</td> <td>GUARNIZIONE SONDA DI TEMPERATUR A NTC</td> <td>1</td> <td>PZ</td> </tr> <tr> <td>GN1120A1</td> <td>GUARNIZIONE SONDA TEMPERATUR A NTC LM</td> <td>1</td> <td>PZ</td> </tr> <tr> <td>GN1285A0</td> <td>GUARNIZIONE SONDA DI TEMPERATUR A NTC</td> <td>1</td> <td>PZ</td> </tr> <tr> <td>MOV0010A0</td> <td>FILMATO RICAMBIO SONDA TEMP MM TR1105A</td> <td>0.100</td> <td>PZ</td> </tr> <tr> <td>SL1045A0</td> <td>SILICONE ANTRACITE S57 80 ML</td> <td>1</td> <td>PZ</td> </tr> <tr> <td>TR1105A4</td> <td>SONDA TEMPERATUR A PT100 L1000</td> <td>1</td> <td>PZ</td> </tr> <tr> <td>VI1220A1</td> <td>VITE AUTOFILETTA NTE 4.2X11 TCS+ MARUTE</td> <td>2</td> <td>PZ</td> </tr> <tr> <td>VM1464A1</td> <td>COPERCHIO SONDA TEMPERATUR A CT BT CON PA</td> <td>1</td> <td>PZ</td> </tr> <tr> <td>VM1465A1</td> <td>COPERCHIO SONDA TEMPERATUR A CT BT</td> <td>1</td> <td>PZ</td> </tr> <tr> <td>VM2052A0</td> <td>COPERCHIO SONDA TEMPERATUR A LM</td> <td>1</td> <td>PZ</td> </tr> </tbody> </table>	Codice	Descrizione	Qtà	UM	GN1120A0	GUARNIZIONE SONDA DI TEMPERATUR A NTC	1	PZ	GN1120A1	GUARNIZIONE SONDA TEMPERATUR A NTC LM	1	PZ	GN1285A0	GUARNIZIONE SONDA DI TEMPERATUR A NTC	1	PZ	MOV0010A0	FILMATO RICAMBIO SONDA TEMP MM TR1105A	0.100	PZ	SL1045A0	SILICONE ANTRACITE S57 80 ML	1	PZ	TR1105A4	SONDA TEMPERATUR A PT100 L1000	1	PZ	VI1220A1	VITE AUTOFILETTA NTE 4.2X11 TCS+ MARUTE	2	PZ	VM1464A1	COPERCHIO SONDA TEMPERATUR A CT BT CON PA	1	PZ	VM1465A1	COPERCHIO SONDA TEMPERATUR A CT BT	1	PZ	VM2052A0	COPERCHIO SONDA TEMPERATUR A LM	1	PZ
Codice	Descrizione	Qtà	UM																																														
GN1120A0	GUARNIZIONE SONDA DI TEMPERATUR A NTC	1	PZ																																														
GN1120A1	GUARNIZIONE SONDA TEMPERATUR A NTC LM	1	PZ																																														
GN1285A0	GUARNIZIONE SONDA DI TEMPERATUR A NTC	1	PZ																																														
MOV0010A0	FILMATO RICAMBIO SONDA TEMP MM TR1105A	0.100	PZ																																														
SL1045A0	SILICONE ANTRACITE S57 80 ML	1	PZ																																														
TR1105A4	SONDA TEMPERATUR A PT100 L1000	1	PZ																																														
VI1220A1	VITE AUTOFILETTA NTE 4.2X11 TCS+ MARUTE	2	PZ																																														
VM1464A1	COPERCHIO SONDA TEMPERATUR A CT BT CON PA	1	PZ																																														
VM1465A1	COPERCHIO SONDA TEMPERATUR A CT BT	1	PZ																																														
VM2052A0	COPERCHIO SONDA TEMPERATUR A LM	1	PZ																																														
RC1170A	DADO M14 H=8 CH=22 INOX		KRC1170A	KIT 10 DADI M14 H8 CH22 INOX	<table border="1"> <thead> <tr> <th>Codice</th> <th>Descrizione</th> <th>Qtà</th> <th>UM</th> </tr> </thead> <tbody> <tr> <td>RC1170A1</td> <td>DADO M14 H=8 CH=22 INOX</td> <td>10</td> <td>PZ</td> </tr> <tr> <td>VM1224A0</td> <td>TUBOLARE TERMORETR 65MY 220MM 2 COLORI</td> <td>0.200</td> <td>M</td> </tr> </tbody> </table>	Codice	Descrizione	Qtà	UM	RC1170A1	DADO M14 H=8 CH=22 INOX	10	PZ	VM1224A0	TUBOLARE TERMORETR 65MY 220MM 2 COLORI	0.200	M																																
Codice	Descrizione	Qtà	UM																																														
RC1170A1	DADO M14 H=8 CH=22 INOX	10	PZ																																														
VM1224A0	TUBOLARE TERMORETR 65MY 220MM 2 COLORI	0.200	M																																														



Зип Общепит



ASM3402A/0.D01 Camera di cottura



vsezip.ru

+7(812)987-08-81

COMPONENTE			RICAMBIO																						
Codice	Descrizione	Immagine	Codice	Descrizione	Lista componenti																				
GN1352A	GN1110A-GUARNIZI ONE PORTA LM ARIANNA		KG1352A	KIT GUARNIZIONE PORTA ARIANNA/ARMADI B	<table border="1"> <thead> <tr> <th>Codice</th> <th>Descrizione</th> <th>Qtà</th> <th>UM</th> </tr> </thead> <tbody> <tr> <td>GN1110A2</td> <td>GUARNIZIONE PORTA PROFILO 248</td> <td>1.600</td> <td>M</td> </tr> <tr> <td>VM1224A0</td> <td>TUBOLARE TERMORETR 65MY 220MM 2 COLORI</td> <td>0.350</td> <td>M</td> </tr> </tbody> </table>	Codice	Descrizione	Qtà	UM	GN1110A2	GUARNIZIONE PORTA PROFILO 248	1.600	M	VM1224A0	TUBOLARE TERMORETR 65MY 220MM 2 COLORI	0.350	M								
Codice	Descrizione	Qtà	UM																						
GN1110A2	GUARNIZIONE PORTA PROFILO 248	1.600	M																						
VM1224A0	TUBOLARE TERMORETR 65MY 220MM 2 COLORI	0.350	M																						
0H7875A	STAFFA SOSTEGNO MUFFOLA SP		0H7875A0	STAFFA SOSTEGNO MUFFOLA SP																					
EL1251A	ELETTROVALVOLA H2O 1 VIA RID. MARRONE		KEL1251A	KIT ELETTROVALVOLA 1 VIA MAR. JG D8-D1	<table border="1"> <thead> <tr> <th>Codice</th> <th>Descrizione</th> <th>Qtà</th> <th>UM</th> </tr> </thead> <tbody> <tr> <td>EL1251A0</td> <td>ELETTROVALV OLA H2O 1 VIA RID. MARRON</td> <td>1</td> <td>PZ</td> </tr> <tr> <td>VM1224A0</td> <td>TUBOLARE TERMORETR 65MY 220MM 2 COLORI</td> <td>0.250</td> <td>M</td> </tr> </tbody> </table>	Codice	Descrizione	Qtà	UM	EL1251A0	ELETTROVALV OLA H2O 1 VIA RID. MARRON	1	PZ	VM1224A0	TUBOLARE TERMORETR 65MY 220MM 2 COLORI	0.250	M								
Codice	Descrizione	Qtà	UM																						
EL1251A0	ELETTROVALV OLA H2O 1 VIA RID. MARRON	1	PZ																						
VM1224A0	TUBOLARE TERMORETR 65MY 220MM 2 COLORI	0.250	M																						
0H3020A	DISCO TENUTA ALBERO MOTORE		0H3020A1	DISCO TENUTA ALBERO MOTORE																					
MT1012A	MOTORE SIMMETRICO 330W 230V ALBERO D12		KMT1012A	KIT MOTORE 330W 230V ALBERO D12	<table border="1"> <thead> <tr> <th>Codice</th> <th>Descrizione</th> <th>Qtà</th> <th>UM</th> </tr> </thead> <tbody> <tr> <td>0H4305A1</td> <td>DISCO TENUTA ALBERO MOTORE INOX STP</td> <td>1</td> <td>PZ</td> </tr> <tr> <td>GN1140A2</td> <td>GUARNIZIONE PORTAMOTO RE STAMPAT</td> <td>1</td> <td>PZ</td> </tr> <tr> <td>GN1140A3</td> <td>GUARNIZIONE PORTAMOTO RE STAMPAT</td> <td>1</td> <td>PZ</td> </tr> <tr> <td>MOV0007A0</td> <td>FILMATO RICAMBIO MOTORE MM MT1012A</td> <td>0.100</td> <td>PZ</td> </tr> </tbody> </table>	Codice	Descrizione	Qtà	UM	0H4305A1	DISCO TENUTA ALBERO MOTORE INOX STP	1	PZ	GN1140A2	GUARNIZIONE PORTAMOTO RE STAMPAT	1	PZ	GN1140A3	GUARNIZIONE PORTAMOTO RE STAMPAT	1	PZ	MOV0007A0	FILMATO RICAMBIO MOTORE MM MT1012A	0.100	PZ
Codice	Descrizione	Qtà	UM																						
0H4305A1	DISCO TENUTA ALBERO MOTORE INOX STP	1	PZ																						
GN1140A2	GUARNIZIONE PORTAMOTO RE STAMPAT	1	PZ																						
GN1140A3	GUARNIZIONE PORTAMOTO RE STAMPAT	1	PZ																						
MOV0007A0	FILMATO RICAMBIO MOTORE MM MT1012A	0.100	PZ																						

COMPONENTE
RICAMBIO

<i>Codice</i>	<i>Descrizione</i>	<i>Immagine</i>	<i>Codice</i>	<i>Descrizione</i>	<i>Lista componenti</i>																																				
MT1012A	MOTORE SIMMETRICO 330W 230V ALBERO D12		KMT1012A	KIT MOTORE 330W 230V ALBERO D12	<table border="1"> <thead> <tr> <th><i>Codice</i></th> <th><i>Descrizione</i></th> <th><i>Qtà</i></th> <th><i>UM</i></th> </tr> </thead> <tbody> <tr> <td>MT1012A0</td> <td>MOTORE SIMMETRICO 330W 230V ALBERO D12</td> <td>1</td> <td>PZ</td> </tr> <tr> <td>VE1550A0</td> <td>MAGNETE NEODIMIO 5X3 MM</td> <td>1</td> <td>PZ</td> </tr> <tr> <td>VI1077A1</td> <td>VITE M6X12 TE INOX</td> <td>1</td> <td>PZ</td> </tr> <tr> <td>VI1521A0</td> <td>RONDELLA PIANA 6X12X1 INOX</td> <td>1</td> <td>PZ</td> </tr> <tr> <td>VI1966A0</td> <td>VITE M4X14 TSP+ ZN</td> <td>1</td> <td>PZ</td> </tr> <tr> <td>VM1635A0</td> <td>DISCO SUPPORTO MAGNETE</td> <td>1</td> <td>PZ</td> </tr> <tr> <td>VM1794A0</td> <td>FASCETTA 430X4.8 PA66 NERA</td> <td>4</td> <td>PZ</td> </tr> <tr> <td>VM2103A0</td> <td>PIASTRINA FERMAFASCE TTA</td> <td>4</td> <td>PZ</td> </tr> </tbody> </table>	<i>Codice</i>	<i>Descrizione</i>	<i>Qtà</i>	<i>UM</i>	MT1012A0	MOTORE SIMMETRICO 330W 230V ALBERO D12	1	PZ	VE1550A0	MAGNETE NEODIMIO 5X3 MM	1	PZ	VI1077A1	VITE M6X12 TE INOX	1	PZ	VI1521A0	RONDELLA PIANA 6X12X1 INOX	1	PZ	VI1966A0	VITE M4X14 TSP+ ZN	1	PZ	VM1635A0	DISCO SUPPORTO MAGNETE	1	PZ	VM1794A0	FASCETTA 430X4.8 PA66 NERA	4	PZ	VM2103A0	PIASTRINA FERMAFASCE TTA	4	PZ
					<i>Codice</i>	<i>Descrizione</i>	<i>Qtà</i>	<i>UM</i>																																	
					MT1012A0	MOTORE SIMMETRICO 330W 230V ALBERO D12	1	PZ																																	
					VE1550A0	MAGNETE NEODIMIO 5X3 MM	1	PZ																																	
					VI1077A1	VITE M6X12 TE INOX	1	PZ																																	
					VI1521A0	RONDELLA PIANA 6X12X1 INOX	1	PZ																																	
					VI1966A0	VITE M4X14 TSP+ ZN	1	PZ																																	
					VM1635A0	DISCO SUPPORTO MAGNETE	1	PZ																																	
					VM1794A0	FASCETTA 430X4.8 PA66 NERA	4	PZ																																	
					VM2103A0	PIASTRINA FERMAFASCE TTA	4	PZ																																	
VN1172A	VENTOLA D195 H40 8 PALE DADO M8		KVN1172A	KIT VENTOLA D195 H40 8 PALE DADO M	<table border="1"> <thead> <tr> <th><i>Codice</i></th> <th><i>Descrizione</i></th> <th><i>Qtà</i></th> <th><i>UM</i></th> </tr> </thead> <tbody> <tr> <td>VI1077A1</td> <td>VITE M6X12 TE INOX</td> <td>1</td> <td>PZ</td> </tr> <tr> <td>VI1521A0</td> <td>RONDELLA PIANA 6X12X1 INOX</td> <td>1</td> <td>PZ</td> </tr> <tr> <td>VN1172A0</td> <td>VENTOLA D195 H40 8 PALE DADO M</td> <td>1</td> <td>PZ</td> </tr> <tr> <td>VN1172A0</td> <td>VENTOLA D195 H40 8 PALE DADO M</td> <td>1</td> <td>PZ</td> </tr> </tbody> </table>	<i>Codice</i>	<i>Descrizione</i>	<i>Qtà</i>	<i>UM</i>	VI1077A1	VITE M6X12 TE INOX	1	PZ	VI1521A0	RONDELLA PIANA 6X12X1 INOX	1	PZ	VN1172A0	VENTOLA D195 H40 8 PALE DADO M	1	PZ	VN1172A0	VENTOLA D195 H40 8 PALE DADO M	1	PZ																
					<i>Codice</i>	<i>Descrizione</i>	<i>Qtà</i>	<i>UM</i>																																	
					VI1077A1	VITE M6X12 TE INOX	1	PZ																																	
					VI1521A0	RONDELLA PIANA 6X12X1 INOX	1	PZ																																	
VN1172A0	VENTOLA D195 H40 8 PALE DADO M	1	PZ																																						
VN1172A0	VENTOLA D195 H40 8 PALE DADO M	1	PZ																																						
GN1547A	GUARNIZIONE ALBERO MOTORE D11.8		KGN1547A	KIT 3 PZ GUARNIZIONE ALBERO MOTORE D11.6	<table border="1"> <thead> <tr> <th><i>Codice</i></th> <th><i>Descrizione</i></th> <th><i>Qtà</i></th> <th><i>UM</i></th> </tr> </thead> <tbody> <tr> <td>GN1547A1</td> <td>GUARNIZIONE ALBERO MOTORE D11.</td> <td>3</td> <td>PZ</td> </tr> <tr> <td>VM1224A0</td> <td>TUBOLARE TERMORETR 65MY 220MM 2 COLORI</td> <td>0.200</td> <td>M</td> </tr> </tbody> </table>	<i>Codice</i>	<i>Descrizione</i>	<i>Qtà</i>	<i>UM</i>	GN1547A1	GUARNIZIONE ALBERO MOTORE D11.	3	PZ	VM1224A0	TUBOLARE TERMORETR 65MY 220MM 2 COLORI	0.200	M																								
					<i>Codice</i>	<i>Descrizione</i>	<i>Qtà</i>	<i>UM</i>																																	
GN1547A1	GUARNIZIONE ALBERO MOTORE D11.	3	PZ																																						
VM1224A0	TUBOLARE TERMORETR 65MY 220MM 2 COLORI	0.200	M																																						

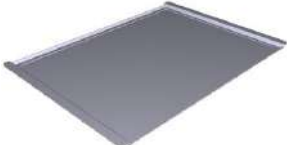
COMPONENTE			RICAMBIO																														
Codice	Descrizione	Immagine	Codice	Descrizione	Lista componenti																												
0H7170A	PREMI LANA DI VETRO MOTORE M		0H7170A0	PREMI LANA DI VETRO MOTORE M																													
RS1283A	RES. CIRC. 3200W 230V+210W 160V 4SP H60		KRS1283A	KIT RES CIRC 3200W 230V+210W 160V 4SP	<table border="1"> <thead> <tr> <th>Codice</th> <th>Descrizione</th> <th>Qtà</th> <th>UM</th> </tr> </thead> <tbody> <tr> <td>GN1327A0</td> <td>GUARNIZIONE RESISTENZA 100X22</td> <td>1</td> <td>PZ</td> </tr> <tr> <td>RS1283A0</td> <td>RES. CIRC. 3200W 230V+210W 160V 4SP H60</td> <td>1</td> <td>PZ</td> </tr> <tr> <td>SL1045A0</td> <td>SILICONE ANTRACITE S57 80 ML</td> <td>1</td> <td>PZ</td> </tr> <tr> <td>VH1220A1</td> <td>VITE AUTOFILETTA NTE 4.2X11 TCS+ MARUTE</td> <td>1</td> <td>PZ</td> </tr> <tr> <td>VM1794A0</td> <td>FASCETTA 430X4.8 PA66 NERA</td> <td>2</td> <td>PZ</td> </tr> <tr> <td>VM2103A0</td> <td>PIASTRINA FERMAFASCE TTA</td> <td>2</td> <td>PZ</td> </tr> </tbody> </table>	Codice	Descrizione	Qtà	UM	GN1327A0	GUARNIZIONE RESISTENZA 100X22	1	PZ	RS1283A0	RES. CIRC. 3200W 230V+210W 160V 4SP H60	1	PZ	SL1045A0	SILICONE ANTRACITE S57 80 ML	1	PZ	VH1220A1	VITE AUTOFILETTA NTE 4.2X11 TCS+ MARUTE	1	PZ	VM1794A0	FASCETTA 430X4.8 PA66 NERA	2	PZ	VM2103A0	PIASTRINA FERMAFASCE TTA	2	PZ
Codice	Descrizione	Qtà	UM																														
GN1327A0	GUARNIZIONE RESISTENZA 100X22	1	PZ																														
RS1283A0	RES. CIRC. 3200W 230V+210W 160V 4SP H60	1	PZ																														
SL1045A0	SILICONE ANTRACITE S57 80 ML	1	PZ																														
VH1220A1	VITE AUTOFILETTA NTE 4.2X11 TCS+ MARUTE	1	PZ																														
VM1794A0	FASCETTA 430X4.8 PA66 NERA	2	PZ																														
VM2103A0	PIASTRINA FERMAFASCE TTA	2	PZ																														
VM1815A	NOTTOLINO M6 CROMATO FISS. GRIGLIE		KVM1815A	KIT 10 NOTTOLINI MISS/MICRO/S.4/S.3 SVAS	<table border="1"> <thead> <tr> <th>Codice</th> <th>Descrizione</th> <th>Qtà</th> <th>UM</th> </tr> </thead> <tbody> <tr> <td>VM1224A0</td> <td>TUBOLARE TERMORETR 65MY 220MM 2 COLORI</td> <td>0.200</td> <td>M</td> </tr> <tr> <td>VM1815A0</td> <td>NOTTOLINO M6 CROMATO FISS. GRIGLIE</td> <td>10</td> <td>PZ</td> </tr> </tbody> </table>	Codice	Descrizione	Qtà	UM	VM1224A0	TUBOLARE TERMORETR 65MY 220MM 2 COLORI	0.200	M	VM1815A0	NOTTOLINO M6 CROMATO FISS. GRIGLIE	10	PZ																
Codice	Descrizione	Qtà	UM																														
VM1224A0	TUBOLARE TERMORETR 65MY 220MM 2 COLORI	0.200	M																														
VM1815A0	NOTTOLINO M6 CROMATO FISS. GRIGLIE	10	PZ																														
ATG305	TEGLIA 460X330 PIANA ALLUMINIO		ATG3050	TEGLIA 460X330 PIANA ALLUMINIO																													







Зип Общепит

ASM3402A/0.D01 Camera di cottura

vsezip.ru

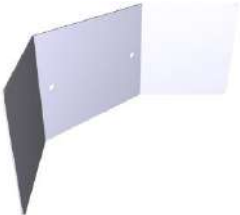
+7(812)987-08-81

COMPONENTE			RICAMBIO																		
Codice	Descrizione	Immagine	Codice	Descrizione	Lista componenti																
GRL1010A	GRIGLIA LATERALE DX/SX CROMATA		KGRL1010A	KIT GRIGLIA LATERALE DX/SX CROMATA	<table border="1"> <thead> <tr> <th>Codice</th> <th>Descrizione</th> <th>Qtà</th> <th>UM</th> </tr> </thead> <tbody> <tr> <td>GRL1010A2</td> <td>GRIGLIA LATERALE DX/SX CROMATA</td> <td>2</td> <td>PZ</td> </tr> <tr> <td>IP1508A1</td> <td>POLISTIROLO PROFILO AD U 2000X60X60</td> <td>2</td> <td>M</td> </tr> <tr> <td>VM1059A1</td> <td>FILM TERMORETRA IBILE H800</td> <td>1.500</td> <td>M</td> </tr> </tbody> </table>	Codice	Descrizione	Qtà	UM	GRL1010A2	GRIGLIA LATERALE DX/SX CROMATA	2	PZ	IP1508A1	POLISTIROLO PROFILO AD U 2000X60X60	2	M	VM1059A1	FILM TERMORETRA IBILE H800	1.500	M
Codice	Descrizione	Qtà	UM																		
GRL1010A2	GRIGLIA LATERALE DX/SX CROMATA	2	PZ																		
IP1508A1	POLISTIROLO PROFILO AD U 2000X60X60	2	M																		
VM1059A1	FILM TERMORETRA IBILE H800	1.500	M																		
TB1574A	CAMINO FUMI D30 S		TB1574A0	CAMINO FUMI D30 S																	
TB1568A	TUBO EST UMIDITA SALDATO SP ARI-STE-ROS		TB1568A0	TUBO EST UMIDITA SALDATO SP ARI-STE-ROS																	
0C1759A	DEFLETTORE CARTER ARIA ARIANNA SP		0C1759A0	DEFLETTORE CARTER ARIA ARIANNA SP																	
0G1652B	CARTER ARIA ARIANNA SP		0G1652B0	CARTER ARIA ARIANNA SP																	



Зип Общепит

ASM3402A/0.D01 Camera di cottura

vsezip.ru

+7(812)987-08-81

COMPONENTE			RICAMBIO		
<i>Codice</i>	<i>Descrizione</i>	<i>Immagine</i>	<i>Codice</i>	<i>Descrizione</i>	<i>Lista componenti</i>
TB1578B	TUBO INTERNO UMIDITA ARIANNA S		TB1578B0	TUBO INTERNO UMIDITA ARIANNA S	



Зип Общепит

ASM3438A/0.D01 Impianto elettrico

vsezip.ru

+7(812)987-08-81

ASM3438A/0.D01 - Impianto elettrico

FRONTE

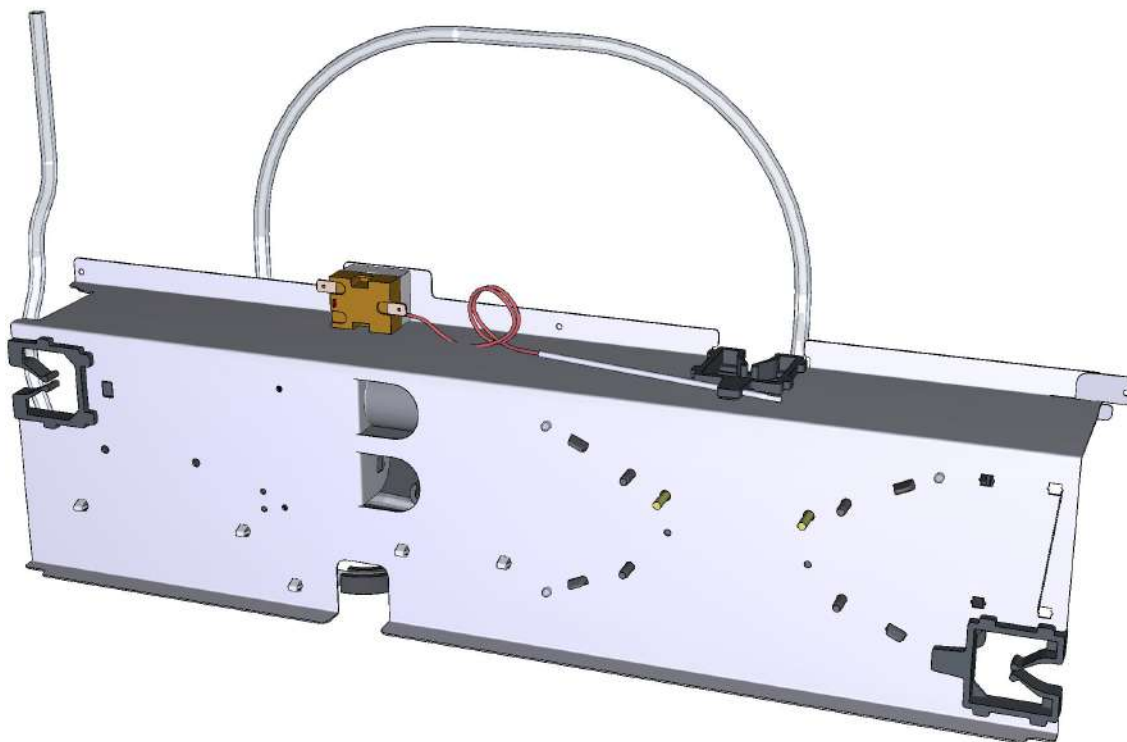



Зип Общепит

ASM3438A/0.D01 Impianto elettrico



vsezip.ru



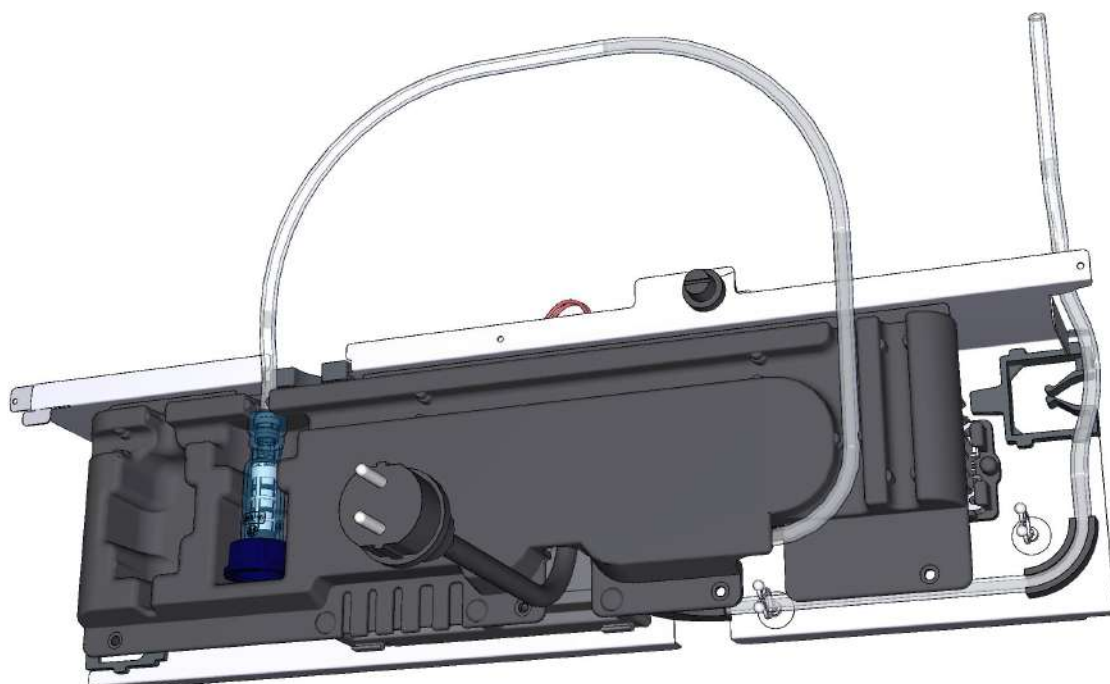

+7(812)987-08-81



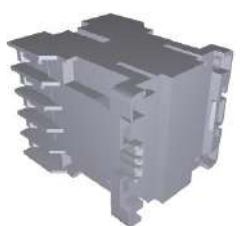

ASM3438A/0.D01 - Impianto elettrico

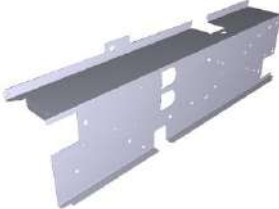

RETRO

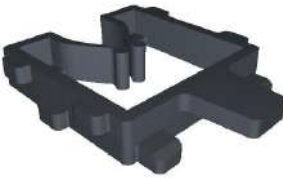

COMPONENTE			RICAMBIO																														
Codice	Descrizione	Immagine	Codice	Descrizione	Lista componenti																												
TR1136A	TERMOSTATO SIC. UNIP. 330°C		KTR1136A	KIT TERMOSTATO SICUREZZA 330°C	<table border="1"> <thead> <tr> <th>Codice</th> <th>Descrizione</th> <th>Qtà</th> <th>UM</th> </tr> </thead> <tbody> <tr> <td>0H7030A0</td> <td>COPERCHIO INGRESSO BULBO</td> <td>1</td> <td>PZ</td> </tr> <tr> <td>GN1531A0</td> <td>GUARNIZIONE TENUTA INGRESSO BULBO</td> <td>1</td> <td>PZ</td> </tr> <tr> <td>MOV0011A0</td> <td>FILMATO RICAMBIO TERMOSTATO MM TR1136A</td> <td>0.100</td> <td>PZ</td> </tr> <tr> <td>SL1045A0</td> <td>SILICONE ANTRACITE S57 80 ML</td> <td>1</td> <td>PZ</td> </tr> <tr> <td>TR1136A0</td> <td>TERMOSTATO SIC. UNIP. 330°C</td> <td>1</td> <td>PZ</td> </tr> <tr> <td>VI1220A1</td> <td>VITE AUTOFILETTA NTE 4.2X11 TCS+ MARUTE</td> <td>3</td> <td>PZ</td> </tr> </tbody> </table>	Codice	Descrizione	Qtà	UM	0H7030A0	COPERCHIO INGRESSO BULBO	1	PZ	GN1531A0	GUARNIZIONE TENUTA INGRESSO BULBO	1	PZ	MOV0011A0	FILMATO RICAMBIO TERMOSTATO MM TR1136A	0.100	PZ	SL1045A0	SILICONE ANTRACITE S57 80 ML	1	PZ	TR1136A0	TERMOSTATO SIC. UNIP. 330°C	1	PZ	VI1220A1	VITE AUTOFILETTA NTE 4.2X11 TCS+ MARUTE	3	PZ
Codice	Descrizione	Qtà	UM																														
0H7030A0	COPERCHIO INGRESSO BULBO	1	PZ																														
GN1531A0	GUARNIZIONE TENUTA INGRESSO BULBO	1	PZ																														
MOV0011A0	FILMATO RICAMBIO TERMOSTATO MM TR1136A	0.100	PZ																														
SL1045A0	SILICONE ANTRACITE S57 80 ML	1	PZ																														
TR1136A0	TERMOSTATO SIC. UNIP. 330°C	1	PZ																														
VI1220A1	VITE AUTOFILETTA NTE 4.2X11 TCS+ MARUTE	3	PZ																														
CN1003A	CONDENSATORE CORAZZATO 6,3 UF		KCN1003A	KIT CONDENSATORE MOTORE 6,3 UF	<table border="1"> <thead> <tr> <th>Codice</th> <th>Descrizione</th> <th>Qtà</th> <th>UM</th> </tr> </thead> <tbody> <tr> <td>CN1003A0</td> <td>CONDENSATO RE CORAZZATO 6,3 UF</td> <td>1</td> <td>PZ</td> </tr> <tr> <td>VI1931A0</td> <td>DADO M8X1.65 H4 CH13 ZINCATO</td> <td>1</td> <td>PZ</td> </tr> <tr> <td>VI1932A0</td> <td>RONDELLA DENTELLATA D8 ZINCATA</td> <td>1</td> <td>PZ</td> </tr> <tr> <td>VM1224A0</td> <td>TUBOLARE TERMORETR 65MY 220MM 2 COLORI</td> <td>0.200</td> <td>M</td> </tr> </tbody> </table>	Codice	Descrizione	Qtà	UM	CN1003A0	CONDENSATO RE CORAZZATO 6,3 UF	1	PZ	VI1931A0	DADO M8X1.65 H4 CH13 ZINCATO	1	PZ	VI1932A0	RONDELLA DENTELLATA D8 ZINCATA	1	PZ	VM1224A0	TUBOLARE TERMORETR 65MY 220MM 2 COLORI	0.200	M								
Codice	Descrizione	Qtà	UM																														
CN1003A0	CONDENSATO RE CORAZZATO 6,3 UF	1	PZ																														
VI1931A0	DADO M8X1.65 H4 CH13 ZINCATO	1	PZ																														
VI1932A0	RONDELLA DENTELLATA D8 ZINCATA	1	PZ																														
VM1224A0	TUBOLARE TERMORETR 65MY 220MM 2 COLORI	0.200	M																														
VE1115A	MINICONTATTORE QUADRIPOLARE 20 A 230V		KVE1115A	KIT MINICONTATTORE QUADRIPOLARE 20A 230V	<table border="1"> <thead> <tr> <th>Codice</th> <th>Descrizione</th> <th>Qtà</th> <th>UM</th> </tr> </thead> <tbody> <tr> <td>VE1115A0</td> <td>MINICONTATT ORE QUADRIPOLA RE 20 A 230V</td> <td>1</td> <td>PZ</td> </tr> <tr> <td>VM1075A1</td> <td>CLIP DI FISSAGGIO PER TELERUTTORI</td> <td>4</td> <td>PZ</td> </tr> <tr> <td>VM1224A0</td> <td>TUBOLARE TERMORETR 65MY 220MM 2 COLORI</td> <td>0.250</td> <td>M</td> </tr> </tbody> </table>	Codice	Descrizione	Qtà	UM	VE1115A0	MINICONTATT ORE QUADRIPOLA RE 20 A 230V	1	PZ	VM1075A1	CLIP DI FISSAGGIO PER TELERUTTORI	4	PZ	VM1224A0	TUBOLARE TERMORETR 65MY 220MM 2 COLORI	0.250	M												
Codice	Descrizione	Qtà	UM																														
VE1115A0	MINICONTATT ORE QUADRIPOLA RE 20 A 230V	1	PZ																														
VM1075A1	CLIP DI FISSAGGIO PER TELERUTTORI	4	PZ																														
VM1224A0	TUBOLARE TERMORETR 65MY 220MM 2 COLORI	0.250	M																														

COMPONENTE			RICAMBIO																						
Codice	Descrizione	Immagine	Codice	Descrizione	Lista componenti																				
VM1056A	STAFFA TELERUTTORE PICCOLO VE1115A		VM1056A0	STAFFA TELERUTTORE PICCOLO VE1115A																					
RC1006A	CURVA GUIDA TUBO PET D8		KRC1006A	KIT 20 PZ.CURVA GUIDA TUBO 8	<table border="1"> <thead> <tr> <th>Codice</th> <th>Descrizione</th> <th>Qtà</th> <th>UM</th> </tr> </thead> <tbody> <tr> <td>RC1006A0</td> <td>CURVA GUIDA TUBO PET D8</td> <td>20</td> <td>PZ</td> </tr> <tr> <td>VM1224A0</td> <td>TUBOLARE TERMORETR 65MY 220MM 2 COLORI</td> <td>0.200</td> <td>M</td> </tr> </tbody> </table>	Codice	Descrizione	Qtà	UM	RC1006A0	CURVA GUIDA TUBO PET D8	20	PZ	VM1224A0	TUBOLARE TERMORETR 65MY 220MM 2 COLORI	0.200	M								
Codice	Descrizione	Qtà	UM																						
RC1006A0	CURVA GUIDA TUBO PET D8	20	PZ																						
VM1224A0	TUBOLARE TERMORETR 65MY 220MM 2 COLORI	0.200	M																						
0P1021A	PORTACOMPONEN TI STE-ARI SP		0P1021A0	PORTACOMPONEN TI STE-ARI SP																					
VM1187A	TELAIO SCHEDA POTENZA SHOP.PR		VM1187A0	TELAIO SCHEDA POTENZA SHOP.PR																					
PE2102A	SCHEDA POTENZA BL LED/TOUCH/PLUS 230V		KPE2102A	KIT SCHEDA POT BL LED/TOUCH/MASTE R 230V	<table border="1"> <thead> <tr> <th>Codice</th> <th>Descrizione</th> <th>Qtà</th> <th>UM</th> </tr> </thead> <tbody> <tr> <td>PE2102A0</td> <td>SCHEDA POTENZA BL LED/TOUCH/M ASTER 230V</td> <td>1</td> <td>PZ</td> </tr> <tr> <td>PE2102A1</td> <td>SCHEDA POTENZA BL LED/TOUCH/P LUS 230V</td> <td>1</td> <td>PZ</td> </tr> <tr> <td>PE2102A2</td> <td>SCHEDA POTENZA BL LED/TOUCH/M ASTER 230V</td> <td>1</td> <td>PZ</td> </tr> <tr> <td>VI1988A0</td> <td>VITE AUTOFIL. 4.2X19 TCB+ INOX</td> <td>3</td> <td>PZ</td> </tr> </tbody> </table>	Codice	Descrizione	Qtà	UM	PE2102A0	SCHEDA POTENZA BL LED/TOUCH/M ASTER 230V	1	PZ	PE2102A1	SCHEDA POTENZA BL LED/TOUCH/P LUS 230V	1	PZ	PE2102A2	SCHEDA POTENZA BL LED/TOUCH/M ASTER 230V	1	PZ	VI1988A0	VITE AUTOFIL. 4.2X19 TCB+ INOX	3	PZ
Codice	Descrizione	Qtà	UM																						
PE2102A0	SCHEDA POTENZA BL LED/TOUCH/M ASTER 230V	1	PZ																						
PE2102A1	SCHEDA POTENZA BL LED/TOUCH/P LUS 230V	1	PZ																						
PE2102A2	SCHEDA POTENZA BL LED/TOUCH/M ASTER 230V	1	PZ																						
VI1988A0	VITE AUTOFIL. 4.2X19 TCB+ INOX	3	PZ																						

COMPONENTE			RICAMBIO														
Codice	Descrizione	Immagine	Codice	Descrizione	Lista componenti												
PE2102A	SCHEDA POTENZA BL LED/TOUCH/PLUS 230V		KPE2102A	KIT SCHEDA POT BL LED/TOUCH/MASTE R 230V	<table border="1"> <thead> <tr> <th>Codice</th> <th>Descrizione</th> <th>Qtà</th> <th>UM</th> </tr> </thead> <tbody> <tr> <td>VM1187A0</td> <td>TELAIO SCHEDA POTENZA SHOP.PRO</td> <td>1</td> <td>PZ</td> </tr> <tr> <td>VM2147A0</td> <td>SPUGNA ESD ROSA LISCIA 410X343X15 M</td> <td>1</td> <td>PZ</td> </tr> </tbody> </table>	Codice	Descrizione	Qtà	UM	VM1187A0	TELAIO SCHEDA POTENZA SHOP.PRO	1	PZ	VM2147A0	SPUGNA ESD ROSA LISCIA 410X343X15 M	1	PZ
Codice	Descrizione	Qtà	UM														
VM1187A0	TELAIO SCHEDA POTENZA SHOP.PRO	1	PZ														
VM2147A0	SPUGNA ESD ROSA LISCIA 410X343X15 M	1	PZ														
CE1581A	CAVO H07RNF 3G1.5 L1.5MT+SPINA SCHUKO		KCE1581A	KIT CAVO H07RNF 3G1.5 L1.5 MT + SHUKO	<table border="1"> <thead> <tr> <th>Codice</th> <th>Descrizione</th> <th>Qtà</th> <th>UM</th> </tr> </thead> <tbody> <tr> <td>CE1581A0</td> <td>CAVO H07RNF 3G1.5 L1.5MT+SPINA SCHUKO</td> <td>1</td> <td>PZ</td> </tr> </tbody> </table>	Codice	Descrizione	Qtà	UM	CE1581A0	CAVO H07RNF 3G1.5 L1.5MT+SPINA SCHUKO	1	PZ				
Codice	Descrizione	Qtà	UM														
CE1581A0	CAVO H07RNF 3G1.5 L1.5MT+SPINA SCHUKO	1	PZ														
MR1025A	MORSETTIERA 3 POLI 450V 41A + TERRA		KMR1025A	KIT MORSETTIERA 3 POLI MR1025A1	<table border="1"> <thead> <tr> <th>Codice</th> <th>Descrizione</th> <th>Qtà</th> <th>UM</th> </tr> </thead> <tbody> <tr> <td>MR1025A1</td> <td>MORSETTIER A 3 POLI 450V 41A + TERRA</td> <td>1</td> <td>PZ</td> </tr> <tr> <td>VM1224A0</td> <td>TUBOLARE TERMORETR 65MY 220MM 2 COLORI</td> <td>0.150</td> <td>M</td> </tr> </tbody> </table>	Codice	Descrizione	Qtà	UM	MR1025A1	MORSETTIER A 3 POLI 450V 41A + TERRA	1	PZ	VM1224A0	TUBOLARE TERMORETR 65MY 220MM 2 COLORI	0.150	M
Codice	Descrizione	Qtà	UM														
MR1025A1	MORSETTIER A 3 POLI 450V 41A + TERRA	1	PZ														
VM1224A0	TUBOLARE TERMORETR 65MY 220MM 2 COLORI	0.150	M														
VI1328A	VITE AUTOFIL. 4.8X45 TCB+ INOX		VI1328A0	VITE AUTOFIL. 4.8X45 TCB+ INOX													
VM1188A	PASSACAVI SCHEDA POTENZA SP		KVM1188A	KIT 10PZ PASSACAVI SCHEDA POTENZA BL SP	<table border="1"> <thead> <tr> <th>Codice</th> <th>Descrizione</th> <th>Qtà</th> <th>UM</th> </tr> </thead> <tbody> <tr> <td>VM1188A0</td> <td>PASSACAVI SCHEDA POTENZA SP</td> <td>10</td> <td>PZ</td> </tr> <tr> <td>VM1224A0</td> <td>TUBOLARE TERMORETR 65MY 220MM 2 COLORI</td> <td>0.200</td> <td>M</td> </tr> </tbody> </table>	Codice	Descrizione	Qtà	UM	VM1188A0	PASSACAVI SCHEDA POTENZA SP	10	PZ	VM1224A0	TUBOLARE TERMORETR 65MY 220MM 2 COLORI	0.200	M
Codice	Descrizione	Qtà	UM														
VM1188A0	PASSACAVI SCHEDA POTENZA SP	10	PZ														
VM1224A0	TUBOLARE TERMORETR 65MY 220MM 2 COLORI	0.200	M														

COMPONENTE			RICAMBIO																							
Codice	Descrizione	Immagine	Codice	Descrizione	Lista componenti																					
VM2484A	FERMACAVO ALLACCIAMENTO ELETTRICO		KVM2484A	KIT FERMACAVO ALLACCIAMENTO ELETTRICO	<table border="1"> <thead> <tr> <th>Codice</th> <th>Descrizione</th> <th>Qtà</th> <th>UM</th> </tr> </thead> <tbody> <tr> <td>VM1224A0</td> <td>TUBOLARE TERMORETR 65MY 220MM 2 COLORI</td> <td>0.300</td> <td>M</td> </tr> <tr> <td>VM2484A0</td> <td>FERMACAVO ALLACCIAMEN TO ELETTRIC</td> <td>1</td> <td>PZ</td> </tr> <tr> <td>VM2484A0</td> <td>FERMACAVO ALLACCIAMEN TO ELETTRIC</td> <td>1</td> <td>PZ</td> </tr> </tbody> </table>	Codice	Descrizione	Qtà	UM	VM1224A0	TUBOLARE TERMORETR 65MY 220MM 2 COLORI	0.300	M	VM2484A0	FERMACAVO ALLACCIAMEN TO ELETTRIC	1	PZ	VM2484A0	FERMACAVO ALLACCIAMEN TO ELETTRIC	1	PZ					
			Codice	Descrizione	Qtà	UM																				
VM1224A0	TUBOLARE TERMORETR 65MY 220MM 2 COLORI	0.300	M																							
VM2484A0	FERMACAVO ALLACCIAMEN TO ELETTRIC	1	PZ																							
VM2484A0	FERMACAVO ALLACCIAMEN TO ELETTRIC	1	PZ																							
KVM2482A	KIT PORTA COMPONENTI E FERMACAVO BL SP	<table border="1"> <thead> <tr> <th>Codice</th> <th>Descrizione</th> <th>Qtà</th> <th>UM</th> </tr> </thead> <tbody> <tr> <td>VM1224A0</td> <td>TUBOLARE TERMORETR 65MY 220MM 2 COLORI</td> <td>0.300</td> <td>M</td> </tr> <tr> <td>VM2482A0</td> <td>TELAIO PORTA COMPONENTI ELETTRICI SP</td> <td>1</td> <td>PZ</td> </tr> <tr> <td>VM2482A0</td> <td>TELAIO PORTA COMPONENTI ELETTRICI SP</td> <td>1</td> <td>PZ</td> </tr> <tr> <td>VM2484A0</td> <td>FERMACAVO ALLACCIAMEN TO ELETTRIC</td> <td>1</td> <td>PZ</td> </tr> <tr> <td>VM2484A0</td> <td>FERMACAVO ALLACCIAMEN TO ELETTRIC</td> <td>1</td> <td>PZ</td> </tr> </tbody> </table>	Codice	Descrizione	Qtà	UM	VM1224A0	TUBOLARE TERMORETR 65MY 220MM 2 COLORI	0.300	M	VM2482A0	TELAIO PORTA COMPONENTI ELETTRICI SP	1	PZ	VM2482A0	TELAIO PORTA COMPONENTI ELETTRICI SP	1	PZ	VM2484A0	FERMACAVO ALLACCIAMEN TO ELETTRIC	1	PZ	VM2484A0	FERMACAVO ALLACCIAMEN TO ELETTRIC	1	PZ
Codice	Descrizione	Qtà	UM																							
VM1224A0	TUBOLARE TERMORETR 65MY 220MM 2 COLORI	0.300	M																							
VM2482A0	TELAIO PORTA COMPONENTI ELETTRICI SP	1	PZ																							
VM2482A0	TELAIO PORTA COMPONENTI ELETTRICI SP	1	PZ																							
VM2484A0	FERMACAVO ALLACCIAMEN TO ELETTRIC	1	PZ																							
VM2484A0	FERMACAVO ALLACCIAMEN TO ELETTRIC	1	PZ																							
TB3280A	TB1815A-TUBO JGB L1800 SP600		KTB2529A	KIT 2M TUBO PE TRASPARENTE Ø8 TB1815	<table border="1"> <thead> <tr> <th>Codice</th> <th>Descrizione</th> <th>Qtà</th> <th>UM</th> </tr> </thead> <tbody> <tr> <td>TB1815A0</td> <td>TUBO PE 7,93X4,75 TRASPARENT</td> <td>2</td> <td>M</td> </tr> </tbody> </table>	Codice	Descrizione	Qtà	UM	TB1815A0	TUBO PE 7,93X4,75 TRASPARENT	2	M													
Codice	Descrizione	Qtà	UM																							
TB1815A0	TUBO PE 7,93X4,75 TRASPARENT	2	M																							
VM2482A	TELAIO PORTA COMPONENTI ELETTRICI SP		KVM2482A	KIT PORTA COMPONENTI E FERMACAVO BL SP	<table border="1"> <thead> <tr> <th>Codice</th> <th>Descrizione</th> <th>Qtà</th> <th>UM</th> </tr> </thead> <tbody> <tr> <td>VM1224A0</td> <td>TUBOLARE TERMORETR 65MY 220MM 2 COLORI</td> <td>0.300</td> <td>M</td> </tr> <tr> <td>VM2482A0</td> <td>TELAIO PORTA COMPONENTI ELETTRICI SP</td> <td>1</td> <td>PZ</td> </tr> <tr> <td>VM2482A0</td> <td>TELAIO PORTA COMPONENTI ELETTRICI SP</td> <td>1</td> <td>PZ</td> </tr> </tbody> </table>	Codice	Descrizione	Qtà	UM	VM1224A0	TUBOLARE TERMORETR 65MY 220MM 2 COLORI	0.300	M	VM2482A0	TELAIO PORTA COMPONENTI ELETTRICI SP	1	PZ	VM2482A0	TELAIO PORTA COMPONENTI ELETTRICI SP	1	PZ					
			Codice	Descrizione	Qtà	UM																				
			VM1224A0	TUBOLARE TERMORETR 65MY 220MM 2 COLORI	0.300	M																				
VM2482A0	TELAIO PORTA COMPONENTI ELETTRICI SP	1	PZ																							
VM2482A0	TELAIO PORTA COMPONENTI ELETTRICI SP	1	PZ																							



Зип Общепит

ASM3438A/0.D01 Impianto elettrico

vsezip.ru

+7(812)987-08-81

COMPONENTE			RICAMBIO																						
Codice	Descrizione	Immagine	Codice	Descrizione	Lista componenti																				
VM2482A	TELAIO PORTA COMPONENTI ELETTRICI SP		KVM2482A	KIT PORTA COMPONENTI E FERMACAVO BL SP	<table border="1"> <thead> <tr> <th>Codice</th> <th>Descrizione</th> <th>Qtà</th> <th>UM</th> </tr> </thead> <tbody> <tr> <td>VM2484A0</td> <td>FERMACAVO ALLACCIAMENTI ELETTRICI</td> <td>1</td> <td>PZ</td> </tr> <tr> <td>VM2484A0</td> <td>FERMACAVO ALLACCIAMENTI ELETTRICI</td> <td>1</td> <td>PZ</td> </tr> </tbody> </table>	Codice	Descrizione	Qtà	UM	VM2484A0	FERMACAVO ALLACCIAMENTI ELETTRICI	1	PZ	VM2484A0	FERMACAVO ALLACCIAMENTI ELETTRICI	1	PZ								
Codice	Descrizione	Qtà	UM																						
VM2484A0	FERMACAVO ALLACCIAMENTI ELETTRICI	1	PZ																						
VM2484A0	FERMACAVO ALLACCIAMENTI ELETTRICI	1	PZ																						
VM2483A	COPERCHIO PORTA COMPONENTI SP		KVM2483A	KIT COPERCHIO PORTA COMPONENTI SHOP.PRO	<table border="1"> <thead> <tr> <th>Codice</th> <th>Descrizione</th> <th>Qtà</th> <th>UM</th> </tr> </thead> <tbody> <tr> <td>VM1224A0</td> <td>TUBOLARE TERMORETR 65MY 220MM 2 COLORI</td> <td>0.300</td> <td>M</td> </tr> <tr> <td>VM2483A0</td> <td>COPERCHIO PORTA COMPONENTI SHOP.PRO</td> <td>1</td> <td>PZ</td> </tr> <tr> <td>VM2483A0</td> <td>COPERCHIO PORTA COMPONENTI SHOP.PRO</td> <td>1</td> <td>PZ</td> </tr> <tr> <td>VM2483A1</td> <td>COPERCHIO PORTA COMPONENTI SP</td> <td>1</td> <td>PZ</td> </tr> </tbody> </table>	Codice	Descrizione	Qtà	UM	VM1224A0	TUBOLARE TERMORETR 65MY 220MM 2 COLORI	0.300	M	VM2483A0	COPERCHIO PORTA COMPONENTI SHOP.PRO	1	PZ	VM2483A0	COPERCHIO PORTA COMPONENTI SHOP.PRO	1	PZ	VM2483A1	COPERCHIO PORTA COMPONENTI SP	1	PZ
Codice	Descrizione	Qtà	UM																						
VM1224A0	TUBOLARE TERMORETR 65MY 220MM 2 COLORI	0.300	M																						
VM2483A0	COPERCHIO PORTA COMPONENTI SHOP.PRO	1	PZ																						
VM2483A0	COPERCHIO PORTA COMPONENTI SHOP.PRO	1	PZ																						
VM2483A1	COPERCHIO PORTA COMPONENTI SP	1	PZ																						
VL1145A	RACCORDO 3/4-JG8 CON FILTRO E VNR		KVL1145A	KIT RACCORDO 3/4-JG8 CON FILTRO VNR	<table border="1"> <thead> <tr> <th>Codice</th> <th>Descrizione</th> <th>Qtà</th> <th>UM</th> </tr> </thead> <tbody> <tr> <td>VL1145A0</td> <td>RACCORDO 3/4-JG8 CON FILTRO E VNR</td> <td>1</td> <td>PZ</td> </tr> <tr> <td>VM1224A0</td> <td>TUBOLARE TERMORETR 65MY 220MM 2 COLORI</td> <td>0.150</td> <td>M</td> </tr> </tbody> </table>	Codice	Descrizione	Qtà	UM	VL1145A0	RACCORDO 3/4-JG8 CON FILTRO E VNR	1	PZ	VM1224A0	TUBOLARE TERMORETR 65MY 220MM 2 COLORI	0.150	M								
Codice	Descrizione	Qtà	UM																						
VL1145A0	RACCORDO 3/4-JG8 CON FILTRO E VNR	1	PZ																						
VM1224A0	TUBOLARE TERMORETR 65MY 220MM 2 COLORI	0.150	M																						