

Service Manual

LENGHTWISE OVENS

TOUCH - Functional Level

K - Functional Level

CONTENTS: This document contains the information about parameters that can be read and/or modified by means of user interface, service utilities...

PROJECT REF: Oven range ONE lenghtwise Touch level

AUTHORS: F.Ornella
M.Gerolami

CONTRIBUTION BY:

DOCUMENT HISTORY:

Rel.	Date:	File:	Author:	Note:
6	15/06/2016	-	F.ornella	Cleaning behind suction wall, ECAD to EAD1...EAD5, gas adjustments reference table
2	20/06/2012		F.Ornella	General update
3	22/01/2013		F.Ornella	Dip switch position update / hardware revision 4 (LED screen)
4	23/05/2013		F.Ornella	10 levels of umidity, timing
5	08/05/2014		F.Ornella	SW 5.20 Service maintenance update

1 IDENTIFICATION OF THE APPLIANCE (MODEL / SERIAL NUMBER)	4
1.1 PRODUCT NUMBER CODE- PNC	4
1.2 SERIAL NUMBER	4
2 FUNCTIONAL SCHEME / POWER BOARD WIRING CONNECTIONS / DIGITAL INPUT / RELÈ DESCRIPTION	5
3 FUNCTIONAL DIAGRAM / USER BOARD CONNECTIONS	9
4 TOUCH SCREEN: MAIN WINDOW/ENVIRONMENT	11
4.1 MAIN MENU	12
4.2 DRAWER UTILITIES & INFORMATION BAR	13
4.3 DRAWER COOKING UTILITIES	14
4.4 MESSAGE DIALOGS	15
4.5 INFORMATION AREA (WARNINGS, ALARMS AND UTILITY)	16
5 “SERVICE MAINTENANCE AREA” ENVIRONMENT	17
6 CYCLES, UTILITY AND MAIN PARAMETERS	31
7 “SERVICE UTILITIES” ENVIRONMENT	33
7.1 UPGRADE SOFTWARE TOUCH USER	34
8 “DATA MONITOR” ENVIRONMENT	36
9 CALIBRATION	39
9.1 CAVITY OFFSET CALIBRATION	39
10 SOFTWARE USER INTERFACE TOUCH AND MAIN POWER BOARD SPARE PART	40
10.1 SOFTWARE USER UPGRADE	40
10.2 USER TOUCH COMPONENT REPLACEMENT	42
11 GAS SYSTEM	43
11.1 MAIN COMPONENTS	43
11.2 SETTINGS AND PARAMETER GAS BURNER ADJUSTEMENTS	43
11.3 OFFSET CALIBRATION OF THE GAS VALVE	45
11.4 USE OF PASCALIMETER (FOR OFFSET PRESSURE MEASURE)	46
11.5 GAS ADJUSTMENTS REFERENCE TABLE	47
11.6 GAS FUNCTIONAL DIAGRAM	48
12 ELECTRIC OVEN: FUNCTIONAL CONTACTORS DIAGRAM	49
13 BOILER FUNCTIONALITY / SUPPLY WATER CHARACTERISTICS	51
13.1 HUMIDITY LEVELS (ONLY LEVEL K)	52
13.2 WATER CHARACTERISTIC AND TREATMENT	53
14 “CLEANING” ENVIRONMENT	54

Зип Общепит
vsezip.ru
+7(812)987-08-81

14.2 GREEN UTILITIES	55
15 LAMBDA PROBE FUNCTIONALITY AND HUMIDITY MEASURE	56
15.1 BASE INFORMATIONS	56
15.2 LAMBDA PROBE	56
15.3 LAMBDA PROBE CONNECTORS	57
16 CLEANING BEHIND SUCTION WALL	58
17 ALARM AND WARNING CODES	60
17.1 ALARM TABLE (THE ALARM STOPS THE OVEN)	60
17.2 WARNING TABLE (THE WARNING DOESN'T STOP THE OVEN)	61

1 Identification of the appliance (model / serial number)

Each appliance is identified by a Product Number Code (PNC) and a serial number (see data label in the left side of the oven).

Mod. ELX-Made in EU

PNC No.

EL: ~ Hz kW

GB-ES PT-IE	DE	NL	AT-CH	FR	BE	HU	LU	IS-CY-MT
Cat. 112H3P	112ELL3B/P	112L3B/P	112H3B/P	112E3B/P	112E(R)B3P	112HS3B/P	112E3P	13B/P
noor 20;37	20;50	25;30	20;50	20/25;30	20/25;37	25;30	20;50	30

PL	IT-DK-FI-NO	BG-EE-HR-LT
GR-SE-CZ-SK	RO-SI-LV-TR	
Cat. 112E3PB/P	112H3B/P	112H3B/P
noor 20;37	20;30	20;30

ΣQn kW G 30 kg/h G 31 kg/h G 20 m³/h G 25,1 m³/h

Type-Bauart-Tipo

IP25 CE 0051 EN 203-1

**BOTTOM PART
OF THE LEFT
SIDE OF THE
OVEN**



1.1 Product Number Code- PNC

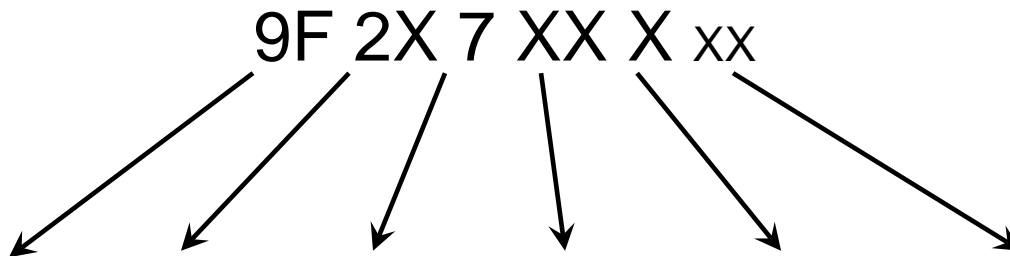

FACTORY CODE	BRAND	LEVEL	VERSION	MODEL	STATUS LEVEL
9F=Ovens Platf.	26=Electrolux 23=Zanussi	7 = TOUCH 8 = LEVEL B 9 = LEVEL C	20=ELECTRIC 70=GAS	0= 6 GRIDS 1/1 1= 6 GRIDS 2/1 2= 10 GRIDS 1/1 3= 10 GRIDS 2/1 4= 20 GRIDS 1/1 5= 20 GRIDS 2/1	Bill of Material product update

1.2 Serial Number

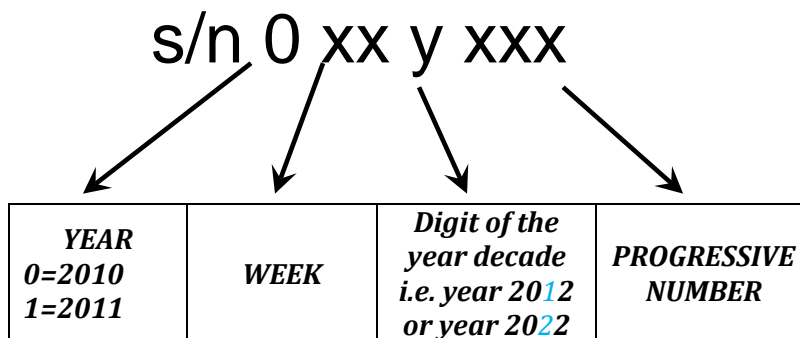

2 Functional scheme / Power board wiring connections / Digital Input / Relè description

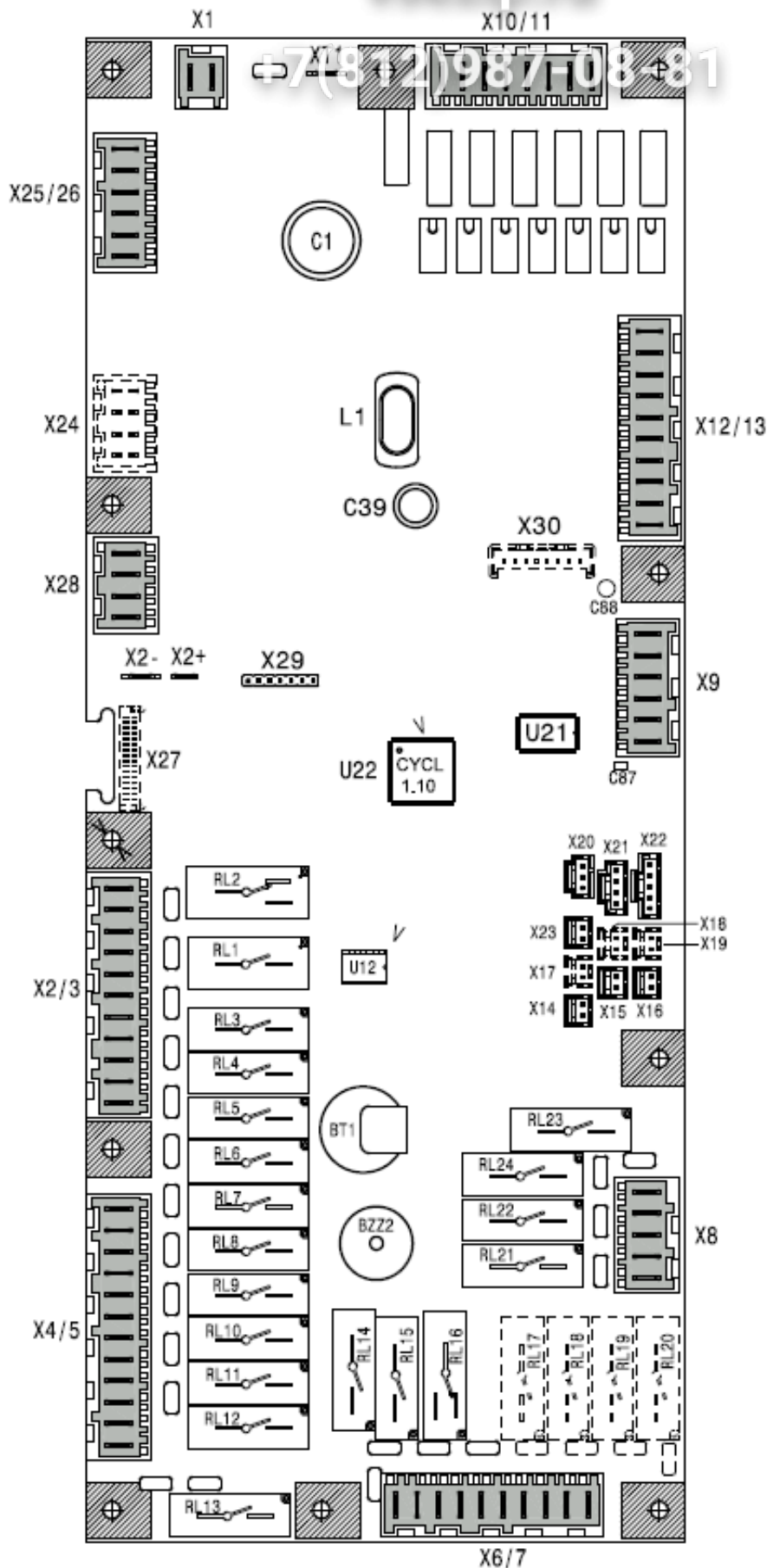

Зип Общепит

vsezip.ru
+7(812)987-08-81

CONNECTORS	DESCRIPTION
X1	supply voltage main power (24 Vac)
X2+ X2-	supply voltage user Touch
X2/3	power supply cavity motors, cooling fans, cavity flap motor, switching feeder lambda probe
X4/5	Power supply to coils of cavity/boiler heating element contactors or cavity/boiler burner gas valves, steam condensing valve, humidifier valve, cavity lamps
X6/7	Power supply to boiler water filling valves, boiler drain valve
X8	Power supply to cleaning system
X9	Output of PWM signal and 12 Vdc for burner fans
X10/11	High voltage digital input, i.e. thermal protection of the cavity fan motors and command signal of the burner fans from the ignition devices
X12/13	Low voltage digital input, i.e. cleaning system water pressure switch, cavity limiter, boiler limiter, door micro switch and micro switch of the cavity flap
X14	Connection of bypass probe
X15	Connection of cavity probe
X16	Connection of boiler probe
X17	Connection of single point meat probe
X18	Connection of second cavity probe
X19	Connection of second boiler probe
X20, X21, X22	Connections of multi point probe
X23	Connection of lambda probe
X25/26	Connections of water level probes
X28	RS485 connection



For the probe connections not used (X17, X18, X19) use a jumper.

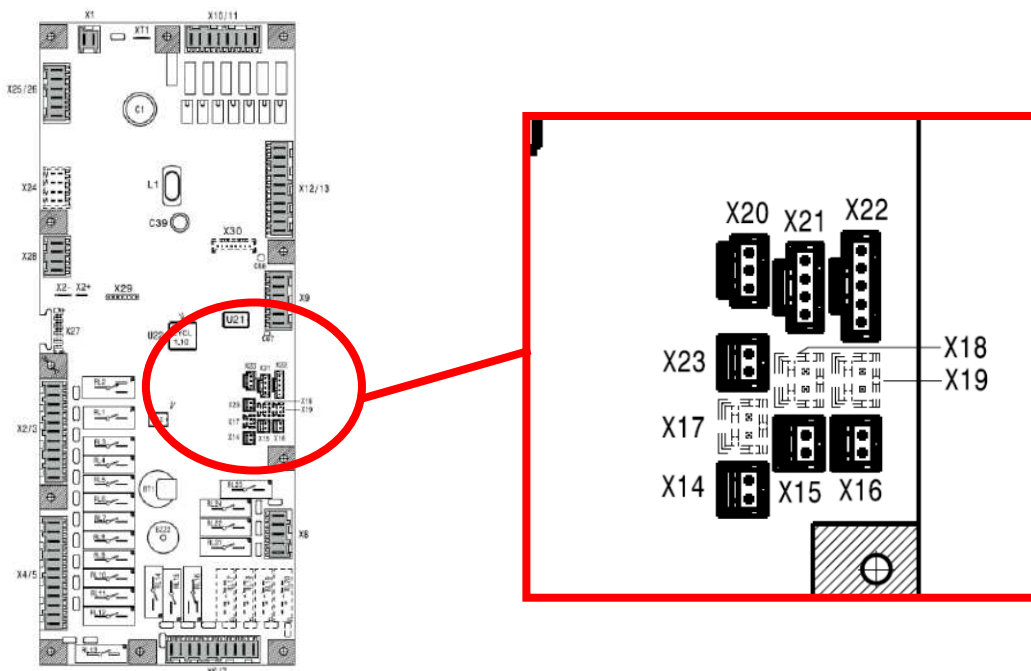

Зип Общепит

DESCRIPTION

RELE'

Touch Electric oven

RL 1/do1	FAN MOTOR POWER SUPPLY
RL 2/do2	HALF/FULL SPEED FAN MOTOR
RL 3/do3	COOLING FAN/S
RL 4/do4	SAFETY CONTACTOR (KS OR KS1&KS2) /LAMBDA FEEDER
RL 5/do5	N/A
RL 6/do6	CAVITY VENT VALVE
RL 7/do7	K2/K6 CONTACTOR/S (FOR CAVITY)
RL 8/do8	K4/K8 CONTACTOR/S (FOR BOILER)
RL 9/do9	K1/K5 CONTACTOR/S (FOR CAVITY)
RL 10/do10	K3/K7 CONTACTOR/S (FOR BOILER)
RL 11/do11	CAVITY UMIDIFIER SOLENOID VALVE
RL 12/do12	STEAM CONDENSER SOLENOID VALVE
RL 13/do13	CAVITY LAMPS
RL 14/do14	BOILER SLOW WATER FILLING
RL 15/do15	BOILER FAST WATER FILLING
RL 16/do16	BOILER AUTOMATIC DRAIN VALVE
RL 17/do17	N/A
RL 18/do18	N/A
RL 19/do19	N/A
RL 20 /do20	N/A
RL 21/do21	DETERGENT PUMP
RL 22/do22	RINSE PUMP
RL 23/do23	WATER SOLENOID VALVE (CLEANING SYSTEM)
RL 24/do24	N/A

Touch Gas oven

RL 1/do1	FAN MOTOR POWER SUPPLY
RL 2/do2	HALF/FULL SPEED FAN MOTOR
RL 3/do3	COOLING FAN/S
RL 4/do4	LAMBDA SWITCHING FEEDER
RL 5/do5	N/A
RL 6/do6	CAVITY VENT VALVE
RL 7/do7	CAVITY IGNITION DEVICE RESET
RL 8/do8	BOILER IGNITION DEVICE RESET
RL 9/do9	CAVITY IGNITION DEVICE POWER SUPPLY
RL 10/do10	BOILER IGNITION DEVICE POWER SUPPLY
RL 11/do11	CAVITY UMIDIFIER SOLENOID VALVE
RL 12/do12	STEAM CONDENSER SOLENOID VALVE
RL 13/do13	CAVITY LAMPS
RL 14/do14	BOILER SLOW WATER FILLING
RL 15/do15	BOILER FAST WATER FILLING
RL 16/do16	BOILER AUTOMATIC DRAIN VALVE
RL 17/do17	N/A
RL 18/do18	N/A
RL 19/do19	N/A
RL 20/do20	N/A
RL 21/do21	DETERGENT PUMP
RL 22/do22	RINSE PUMP
RL 23/do23	WATER SOLENOID VALVE (CLEANING SYSTEM)
RL 24/do24	N/A

DIGITAL INPUTS CORRESPONDANCE									
	1	2	3	4	5	6	7	8	
High voltage inputs	1 ► <input type="checkbox"/> <input type="checkbox"/> <input type="checkbox"/> <input type="checkbox"/> <input type="checkbox"/> <input type="checkbox"/> <input type="checkbox"/> <input type="checkbox"/> <input type="checkbox"/> ◀ 8								
	IN1	IN2	IN3	IN4	IN5	IN6	IN7	IN8	
	X10/11-1	X10/11-2	X10/11-3	X10/11-4	X10/11-5	X10/11-6	X10/11-7	X10/11-8	
	neutral (com)	upper motor	lower motor	N/A	boiler up (Flame)	boiler down (Flame)	cavity up (Flame)	cavity down (Flame)	Meaning of signals
230V~	<input type="checkbox"/>	<input type="checkbox"/>	<input type="checkbox"/>	<input type="checkbox"/>	<input type="checkbox"/>	<input type="checkbox"/>	<input type="checkbox"/>	<input type="checkbox"/>	Appliance status MODE
	0V~	<input type="checkbox"/>	<input checked="" type="checkbox"/>	<input checked="" type="checkbox"/>	<input type="checkbox"/>	<input checked="" type="checkbox"/>	<input checked="" type="checkbox"/>	<input checked="" type="checkbox"/>	
230V~	<input type="checkbox"/>	<input checked="" type="checkbox"/>	<input checked="" type="checkbox"/>	<input type="checkbox"/>	<input checked="" type="checkbox"/>	<input checked="" type="checkbox"/>	<input checked="" type="checkbox"/>	<input checked="" type="checkbox"/>	TEST MODE (TEST DIGITAL I/O)
	0V~	<input checked="" type="checkbox"/>	<input type="checkbox"/>	<input type="checkbox"/>	<input type="checkbox"/>	<input type="checkbox"/>	<input type="checkbox"/>	<input type="checkbox"/>	
	9	10	11	12	13	14	15	16	
Low voltage inputs	9 ► <input type="checkbox"/> <input type="checkbox"/> <input type="checkbox"/> <input type="checkbox"/> <input type="checkbox"/> <input type="checkbox"/> <input type="checkbox"/> <input type="checkbox"/> <input type="checkbox"/> ◀ 16								
	IN9	IN10	IN11	IN12	IN13	IN14	IN15	IN16	
	X12/13-7	X12/13-8	X12/13-9	X12/13-10	X12/13-2	X12/13-3	X12/13-4	X12/13-5	
	cavity safety thermostat	boiler safety thermostat	door microswitch	cavity vent valve	N/A	N/A	N/A	water pressure switch	meaning of signals
Closed	<input checked="" type="checkbox"/>	<input checked="" type="checkbox"/>	<input checked="" type="checkbox"/>	<input type="checkbox"/>	<input type="checkbox"/>	<input type="checkbox"/>	<input type="checkbox"/>	<input checked="" type="checkbox"/>	Appliance Status MODE
	Open	<input type="checkbox"/>	<input type="checkbox"/>	<input type="checkbox"/>	<input checked="" type="checkbox"/>	<input type="checkbox"/>	<input type="checkbox"/>	<input type="checkbox"/>	
Closed	<input checked="" type="checkbox"/>	<input checked="" type="checkbox"/>	<input checked="" type="checkbox"/>	<input type="checkbox"/>	<input type="checkbox"/>	<input type="checkbox"/>	<input type="checkbox"/>	<input checked="" type="checkbox"/>	TEST MODE (TEST DIGITAL I/O)
	Open	<input type="checkbox"/>	<input type="checkbox"/>	<input type="checkbox"/>	<input checked="" type="checkbox"/>	<input type="checkbox"/>	<input type="checkbox"/>	<input type="checkbox"/>	

In the pages "Appliance status" (included the page with the detail of the alarms) refer to the rows "Appliance status MODE"

Note 1: the inputs not used (as IN3) are showed as a "empty box"

Note 2: the logic for the high voltage input is the opposite of the one for low voltage input "voltage presence = empty box"

On the page "Test digital I/O" inputs are shown in the same way of the page "appliance status"

As soon as we enter in TEST mode (by pressing one of the test buttons) also the visualization of the inputs move to "TEST MODE"

In this case no masks are applied and the logic "voltage presence= black box" is followed.

3 Functional diagram / user board connections

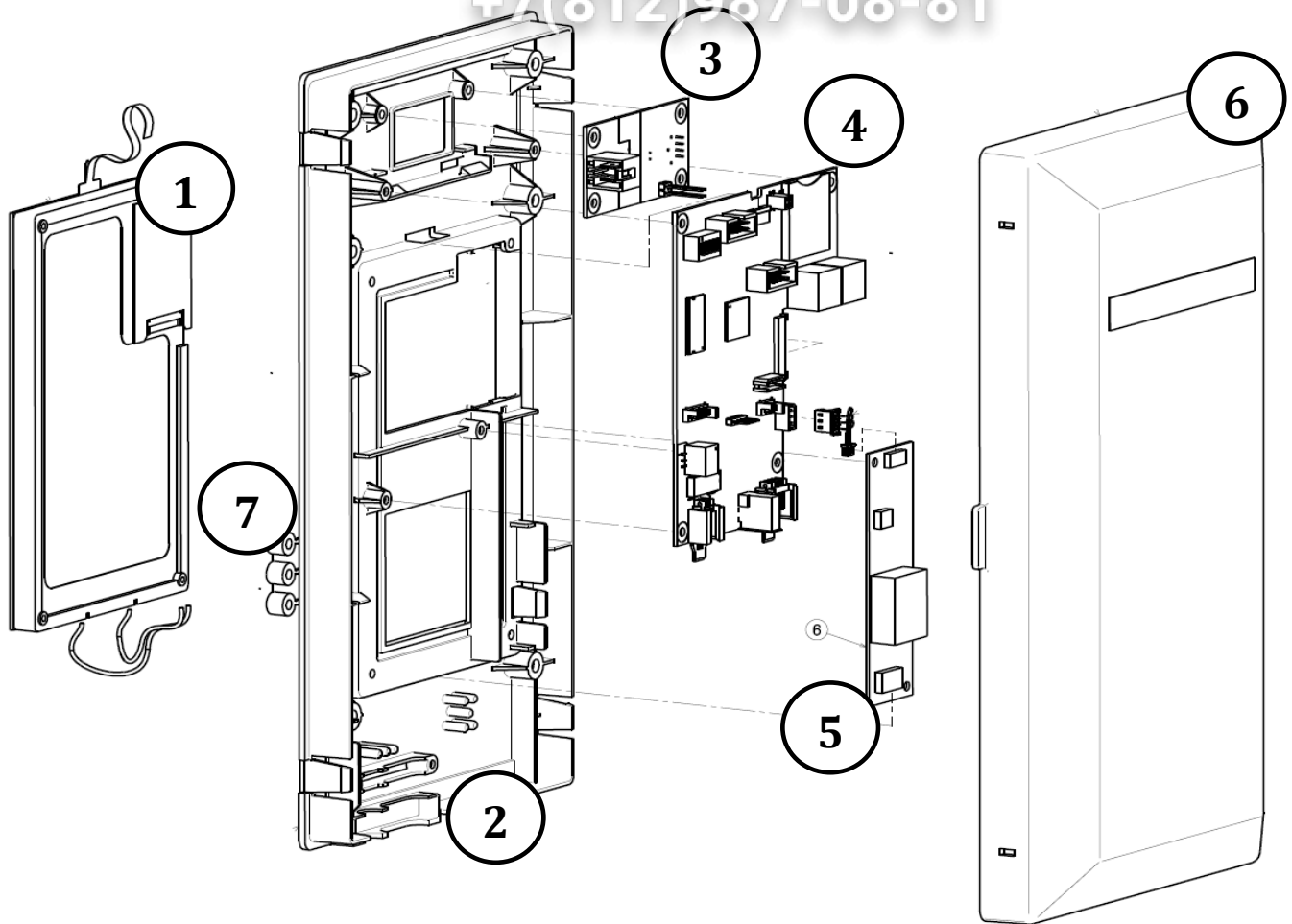

1. Display LCD/LED;
2. Thermoplastic protective box;
3. ON / OFF switch;
4. Electronic board;
5. Inverter for lamp(Not present in hardware rev.4 with LCD screen);
6. Termoplastic protective cover;
7. Spacer / bumper to fix user on the control panel.

Зип Общепит

DESCRIPTION

CONNECTORS	DESCRIPTION
MAIN SWITCH	Main power supply (230Vac)
POWER SUPPLY	RS485 connections with main board
USB PORT	USB connections.

vsezip.ru

+7(812)987-08-81

LED	DESCRIPTION & status
LD1	SIGNAL LED, blinking.
LD2	Communication Led with main board, blinking
LD3	Communication Led with main board, blinking
LD7	Led, ON when the oven start



The blinking frequency of the LD2 e LD3 shows the status of the communication between the electronic user and power.

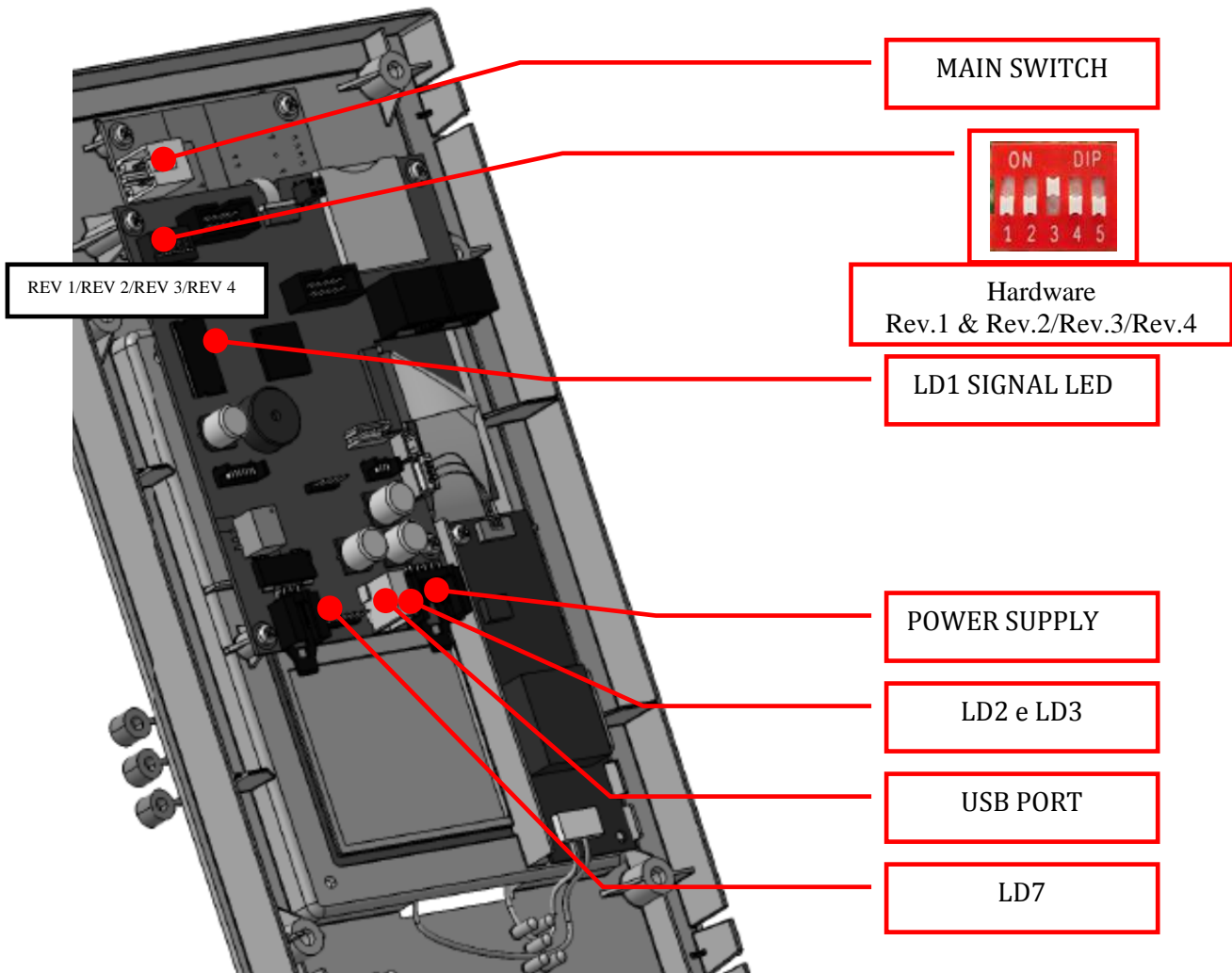

RED SWITCH DS1 IN THE TOUCH USER INTERFACE. THE SWITCH N.3 MUST BE IN UPPER POSITION!!!

Зип Общепит
vsezip.ru

4 Touch Screen: main window/environment



Зип Ощепит

vsezip.ru

8 (812) 987-08-81

4.1 Main menu

The main menu is almost visible and active at the top of the screen (not during a cooking or cleaning cycle). The active screen is highlighted with the mark /

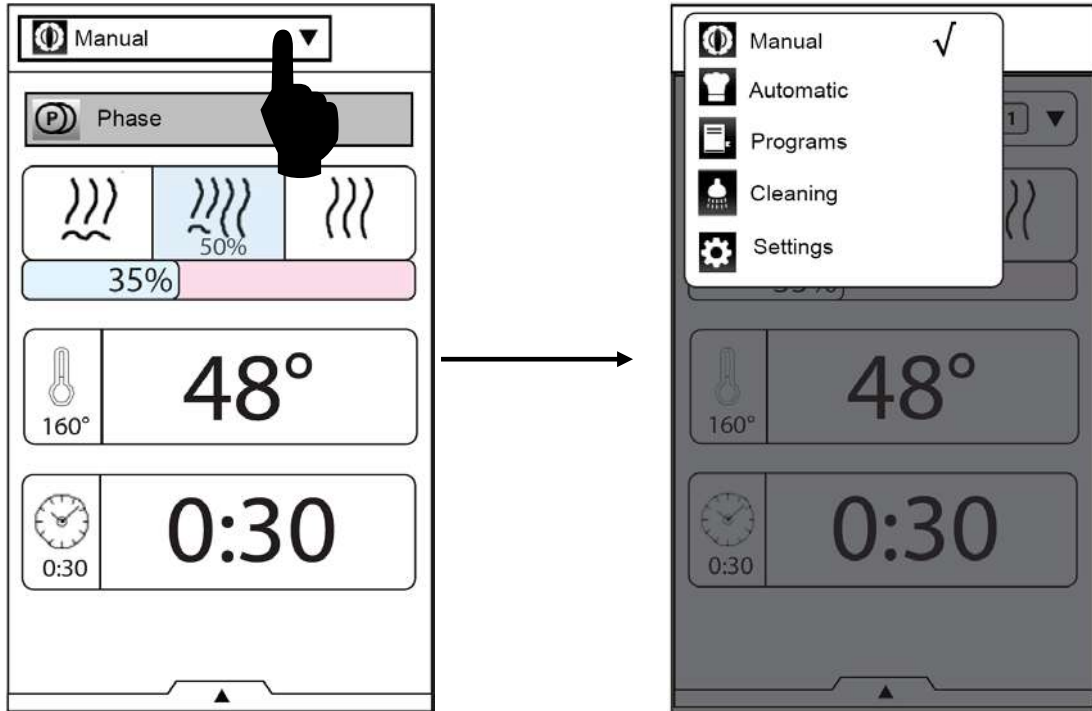

Press the corresponding icon to switch to a new work environment.

MAIN MENU: SELECTION LIST

ICON	NAME	DESCRIPTION
	Manual	Manual cooking screen
	Automatic	Automatic cooking screen
	Data Monitor	Environment with data about status of the oven (service function) Visible when the parameter DATM nr97 is set at 1
	Programs	Programs cooking screen (recipes saved by customer)
	Cleaning	Cleaning cycle and green function screen
	Setting	Setting parameters and "service" utilities



For the manual, automatic and programs cooking screen, see the handbook for the description of each utilities and functions.

4.2 Drawer utilities & information bar

The main information about the status of the oven is visible in the drawer utilities in the bottom of the screen (in “manual” and “programs” environment).

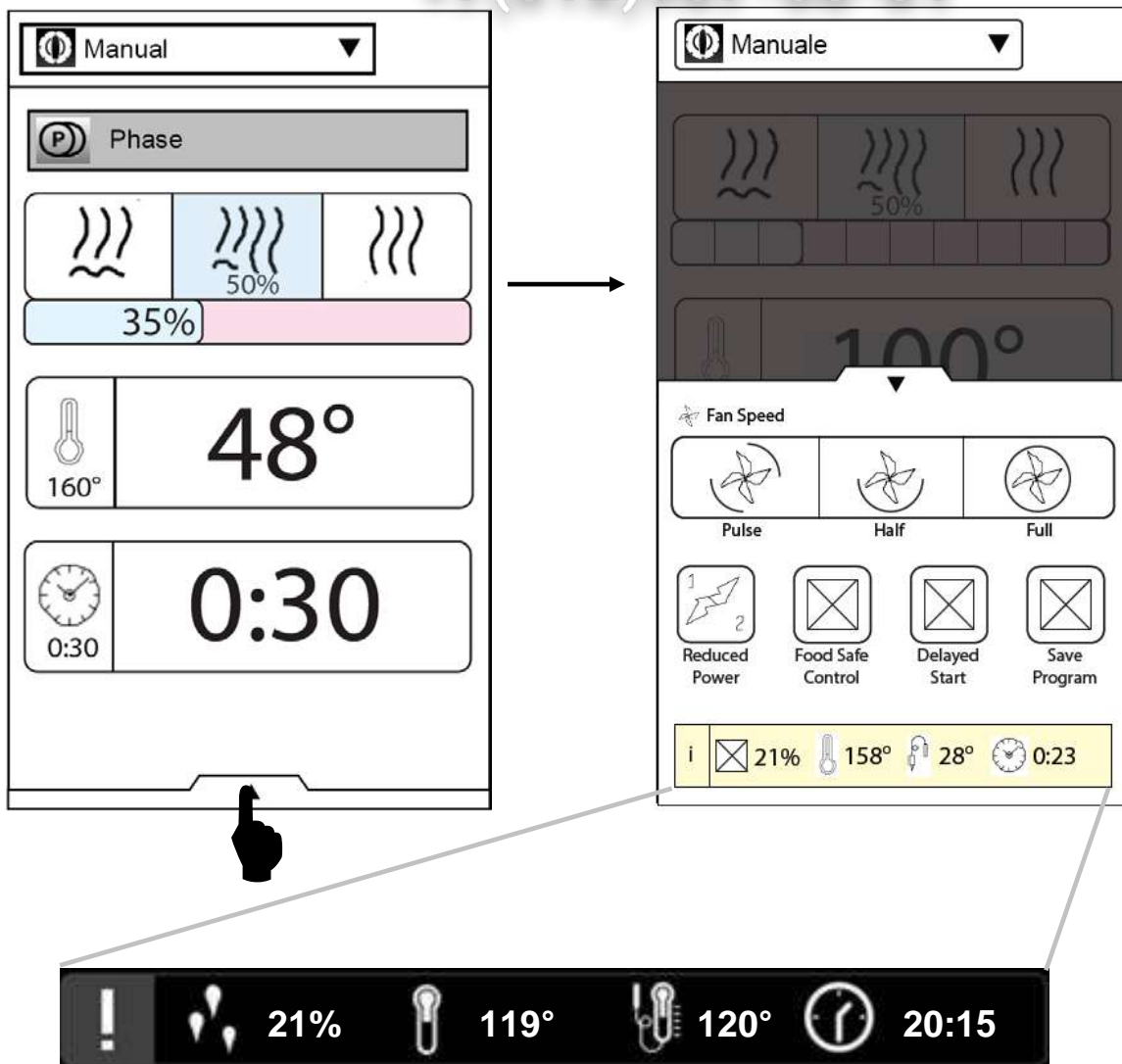

“information bar”

ICON	DESCRIPTION
	Cavity humidity (%)
	Cavity temperature
	Meat probe temperature (the minimum of the 6 measured points)
	Clock

4.3 Drawer cooking utilities

Press the drawer icon in the bottom of the screen to see the special cooking utilities (in the “manual” and “programs” environment.)

Press the relevant icon to activate the utility.

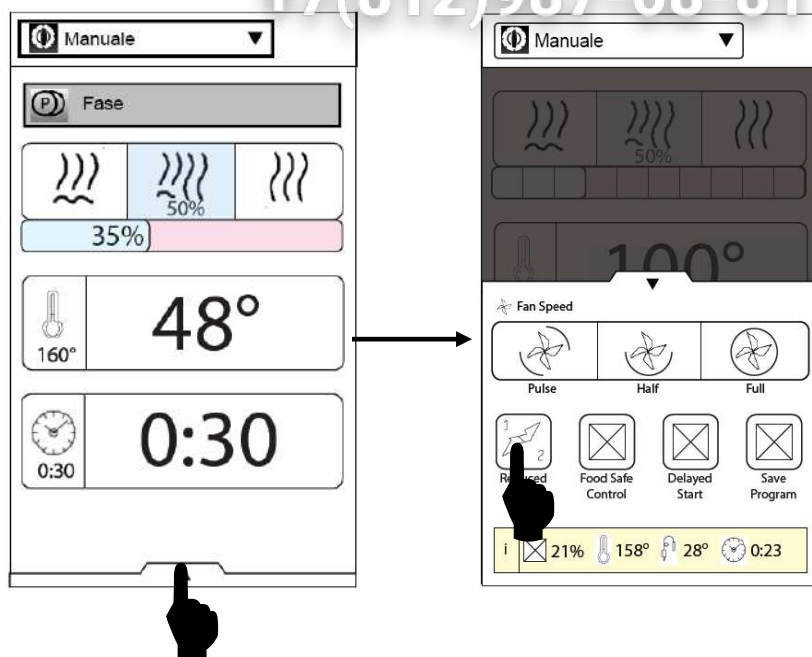

ICON	NAME	DESCRIPTION
	Manual cavity water injection: time	Only for convection cooking cycle. Range: 10...120sec.
	Full fan speed	Cooking cycle with full fan speed (default selection)
	Half fan speed	Cooking cycle with half fan speed
	Pulsed fan speed	Cooking cycle with pulse fan speed: fan is 5 sec ON and 55 sec OFF
	Food Save Control (FSC) standard risk	Food save control for not manipulated food
	Food Save Control (FSC) high risk	Food save control for manipulated food or for food with high risk (es. pork or fish)
	Reduced power	cavity/ boiler heating element with reduced power
	Multitimer cooking	To set a sequence of cooking with different timing, all related to the same cooking mode(steam or combi or convection)



Зип Общепит

vsezip.ru

+7(812)987-08-81

4.4 Message dialogs

During the use of the oven the screen can show different messages:

ICON	POP UP	DESCRIPTION
	Information dialog	To display information that the user has requested or should know.
	Alarm / warning dialog	For warning issue or alarm that the user must know. In some cases the warning can contain a OK button
	Question dialog	Used for questions like YES/NO

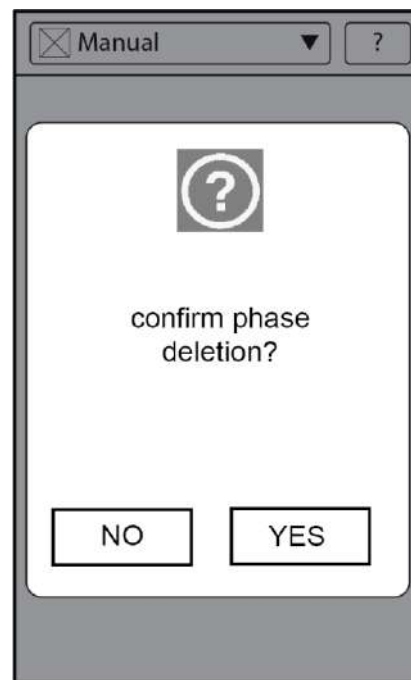

4.5 Information area (warnings, alarms and utility)

In the cleaning and cooking environment (manual, programs and automatic) it's active in the bottom part of the screen an area where some information are visible:

- ✓ **COOKING UTILITY ON** (icon);
- ✓ **WARNING** (blinking icon);
- ✓ **ALARM** (blinking icon).

Press the icon:

- ✓ To disable the relevant cooking utility;
- ✓ To visualize a message dialog about alarm/warning icon.

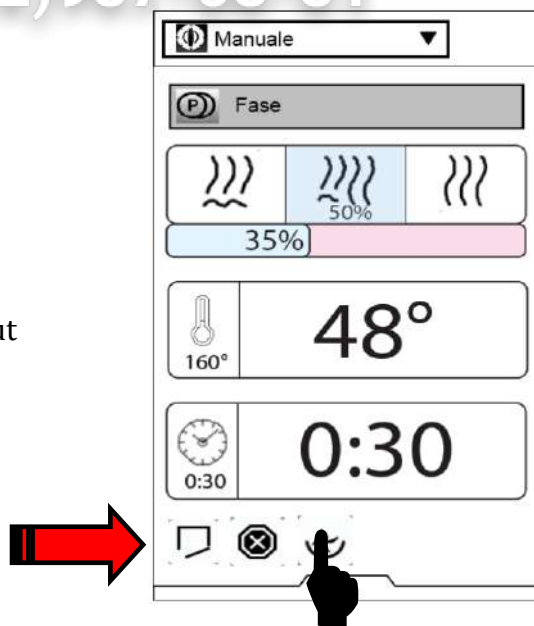

INFORMATION AREA: TABLE OF THE ICONS

ICON	TYPE	DESCRIPTION
	Warning	Door oven open
	Warning	“Descaling” warning of the boiler
	Alarm	Burner’s alarm. Press the icon to visualize the message dialog with description.
	Alarm	Press the icon to visualize the type of alarm.
	Warning	Preheating of the boiler ON
	Warning	Water in the boiler is below safety level (filling activate)
	Utility ON	Half speed of the fan during cooking cycle

Зип Общепит

vsezip.ru

+7(812)987-08-81

	Utility ON	Pulse fan speed during cooking cycle
	Utility ON	FSC standard risk utility ON
	Utility ON	FSC high risk utility ON
	Utility ON	Manual water spray utility ON
	Utility ON	Half power utility ON

5 “Service Maintenance Area” environment

To enter in the “Service Maintenance Area” select “Settings” from the Main Menu and then press the “Service Maintenance” icon



for the description and values range for each parameter see the relevant “parameter list” attached

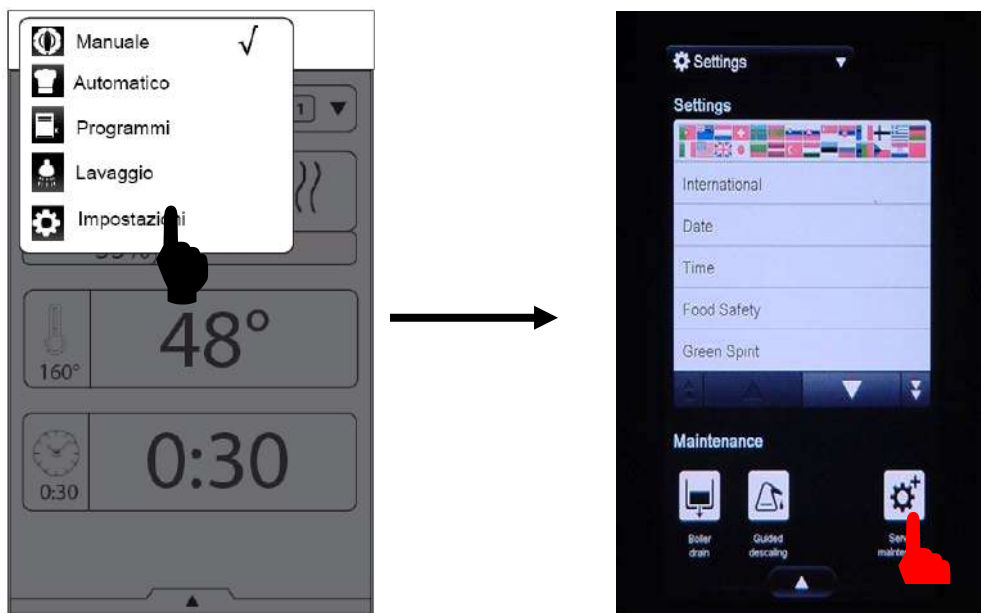

Зип Общепит

vsezip.ru

+7(812)987-08-81

A PASSWORD IS NOW REQUIRED TO ENTER IN THE SERVICE AREA

The service PASSWORD is not modifiable and it is the same for all the markets/areas.

It is a numeric password from the Fibonacci numbers. The Fibonacci series is a numeric sequence on where each subsequent number is the sum of the previous two.

The PASSWORD is :

1 1 2 3 5 8 1 3

By definition 0 and 1 are the first two numbers of the sequence.

We omitted the 0 (zero) in our password :

- First character = 1
- 1+0=1
- 1+1=2
- 2+1=3
- 3+2=5
- 5+3=8
- 8+5=13

Enter in Settings and press “Service maintenance” button. The password is then requested. Select the numeric option. Insert the password **1 1 2 3 5 8 1 3** and confirm with “OK”

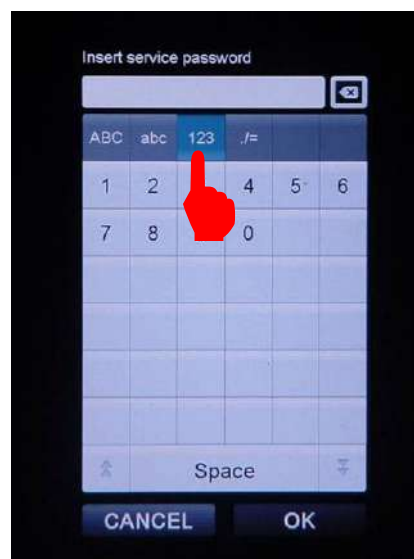
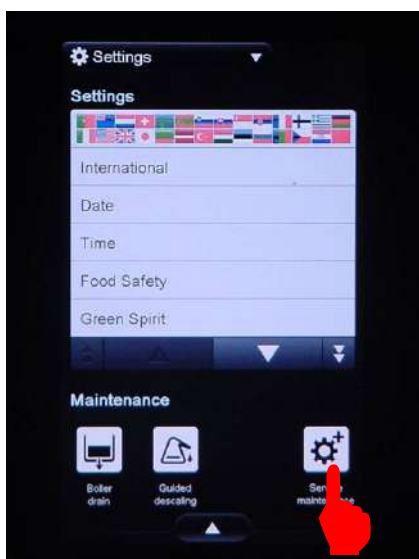

Зип Общепит

vsezip.ru

SERVICE

+7(812)987-08-81

A new service environment has been developed, to have all the utilities available in two pages:

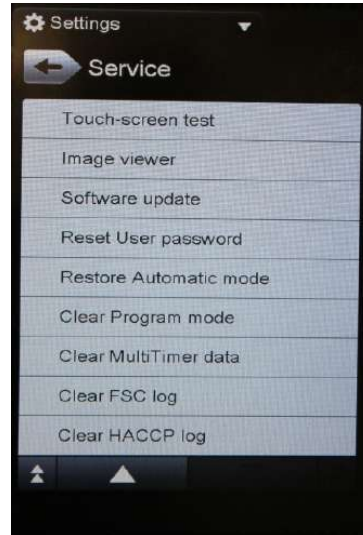
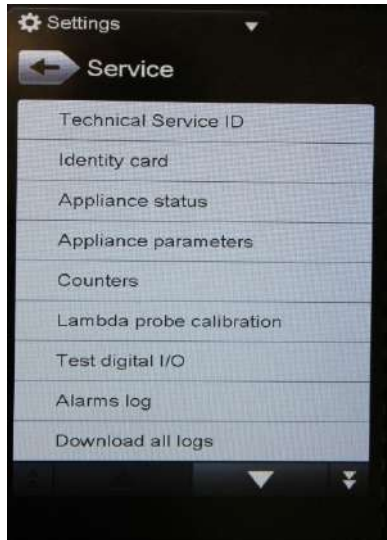

TECHNICAL SERVICE ID

It is possible to insert the name, telephone number and notes of technical service agency. In case of an error, the oven will display the name and telephone number.

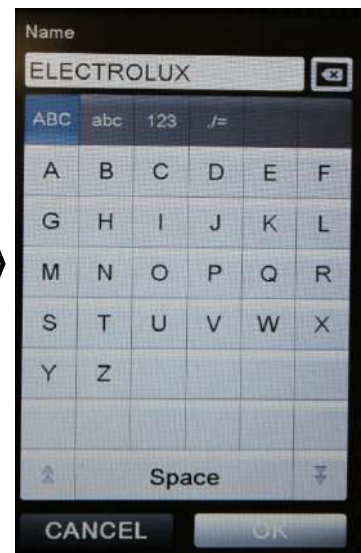
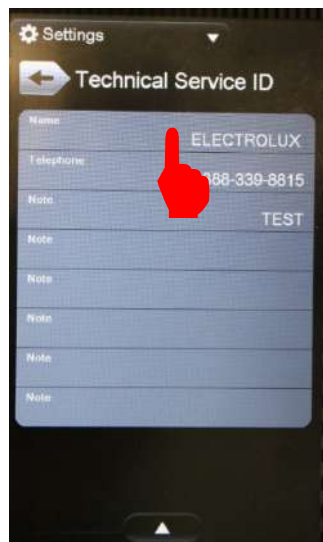
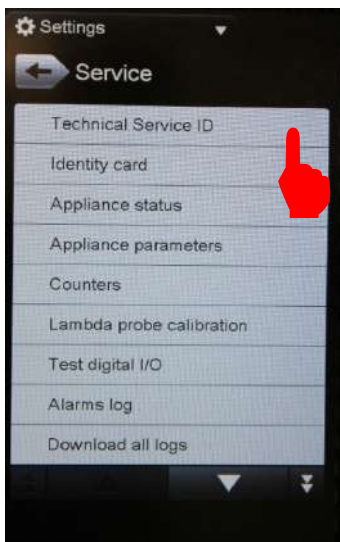

Зип Общепит
IDENTITY CARD
vsezip.ru

+7(812)987-08-81

The *identity card* provide information about firmware version, PNC, model name, serial number and other data.

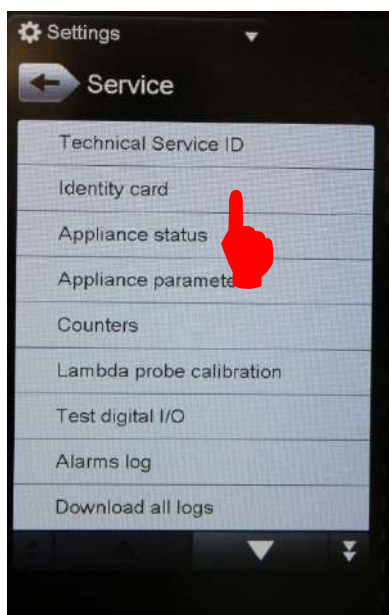

APPLIANCE STATUS

All temperatures are displayed as well as the humidity level and lambda signal, the active relays, input signals to the power board and water level sensors status.

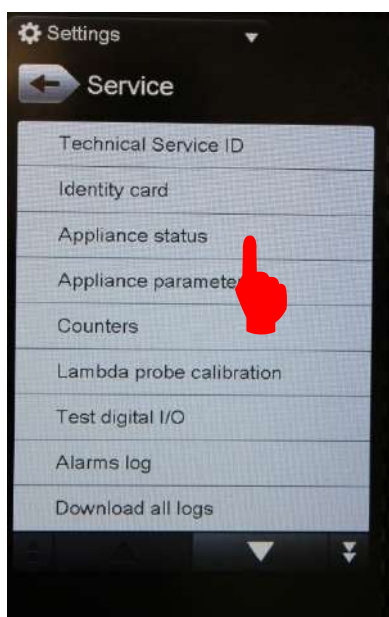

АПЛИАНС ПАРАМЕТРИ

By pressing *appliance parameters* you access to the list of the parameters. The number, the name and the value of the parameter is displayed in a list.

Press the “single down arrow” to continue the list or the “double down arrow” to reach directly the end.

By selecting the needed parameter you enter in parameter programming to set the correct value (see relevant parameter list) or the default value. Confirm with OK

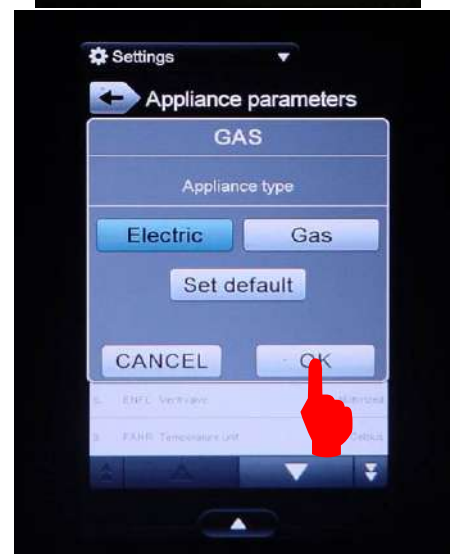
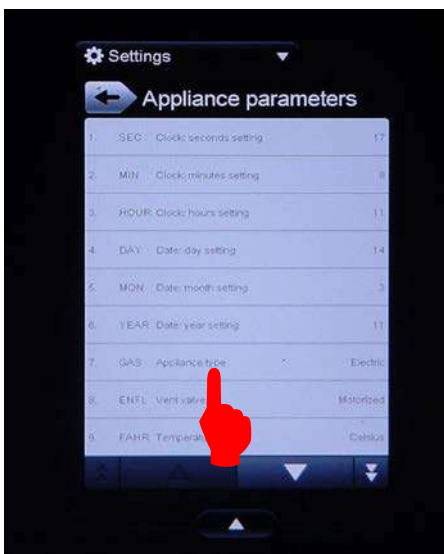
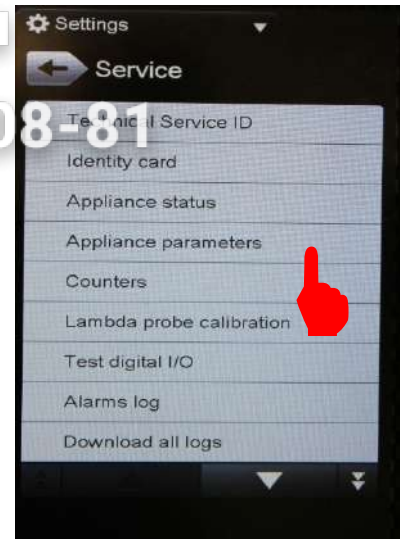

Confirm the value with “OK” button to save the single parameter configuration. Selecting the bottom drawer there is the option to download the parameter configuration of the appliance or directly upload the configuration that has been previously saved. It is possible to set the parameters at the default values.

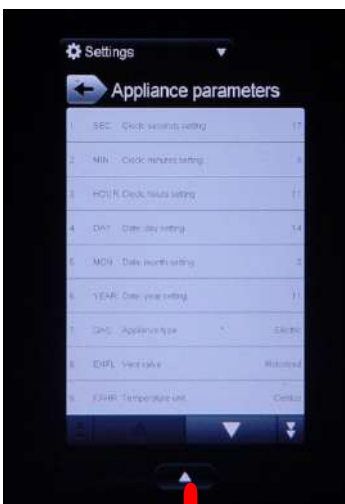

The default file name saved is *UI40.PAR (Parameters)* and it is saved into a subfolder *Touch oven/conf/UI40.PAR*. If need, rename the file. Don't change the extension *.par*

Зип Общепит

COUNTERS

vsezip.ru

+7(812)987-08-81

All hour counters are displayed in a glance in cooking and cleaning modality.

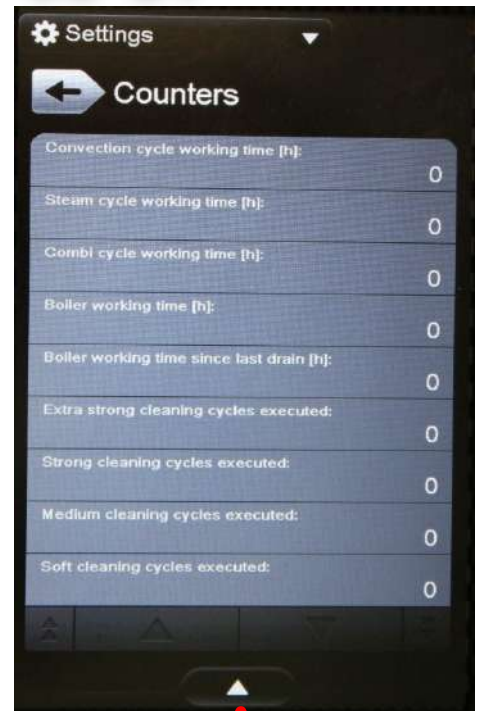
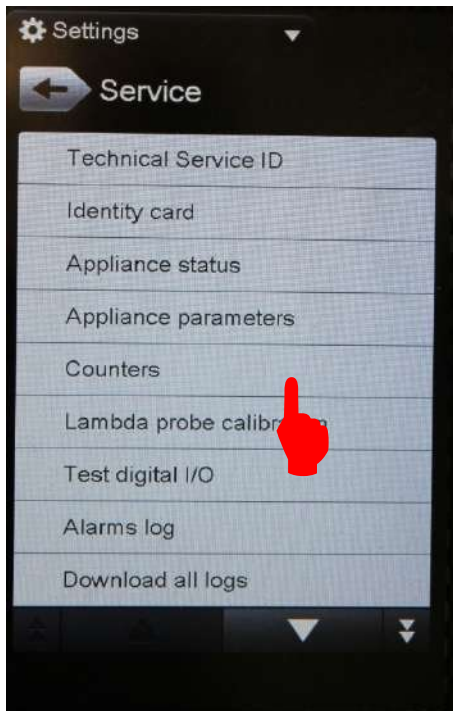

It is possible to save them into the USB stick.

LAMBDA PROBE CALIBRATION (only for level Touch, not level K)

With this the *lambda probe calibration* is performed. The procedure is completely automatic.

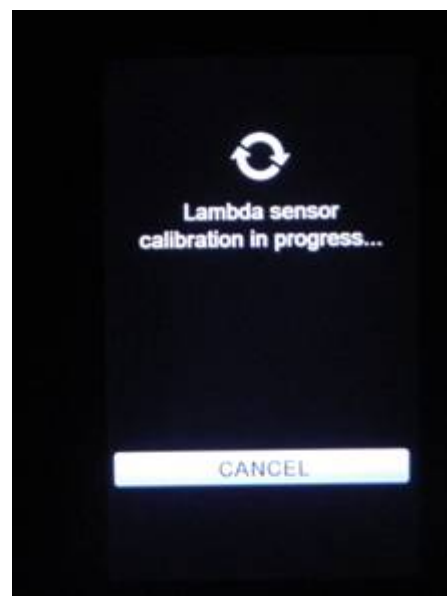
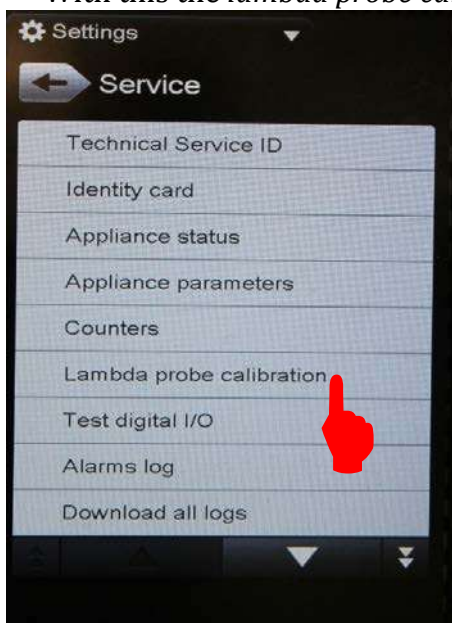

Зип Общепит
TEST DIGITAL I/O

vsezip.ru

+7(812)987-08-81

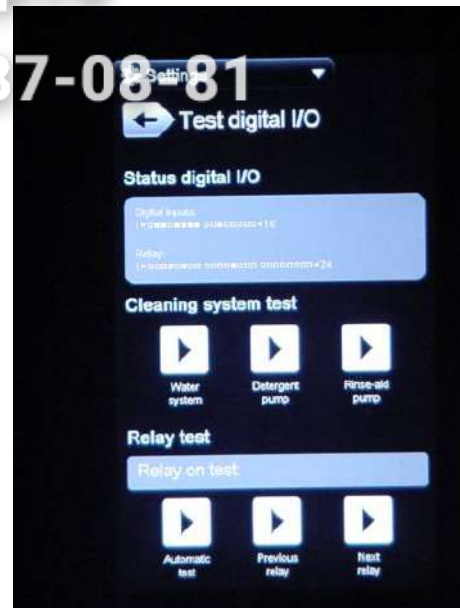
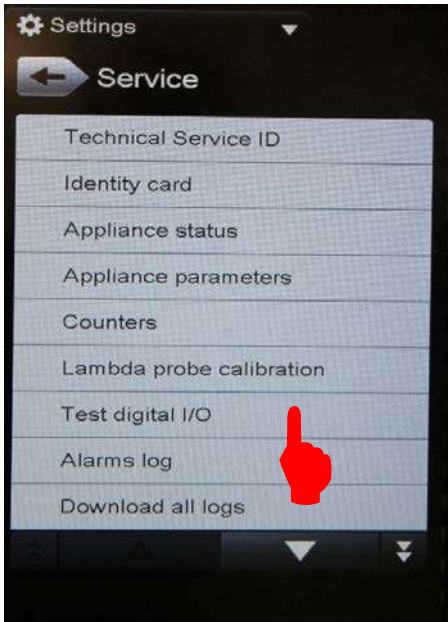

It is possible to test the *detergent pump*, *rinse pump* and the *water valve* of the cleaning system.

It is possible to activate sequentially the output relays of the power board with the *automatic test*, or activate the *previous* or *next relay*.

Reference tables regarding active relay and related auxiliary circuit feed at chapter 2 page 7.

ALARMS LOG

A log of alarms history is available and downloadable in text format (.txt) in the USB memory stick.

Press "Alarm Log"

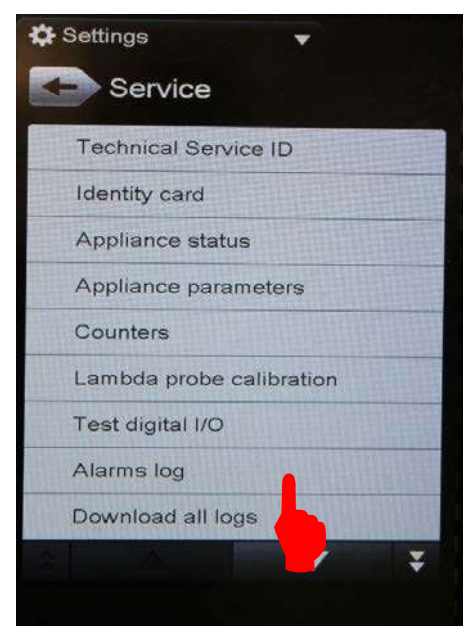

Зип Общепит

DOWNLOAD ALL LOGS

vsezip.ru

+7(812)987-08-81

It is possible to save all Logs in the USB stick in one touch

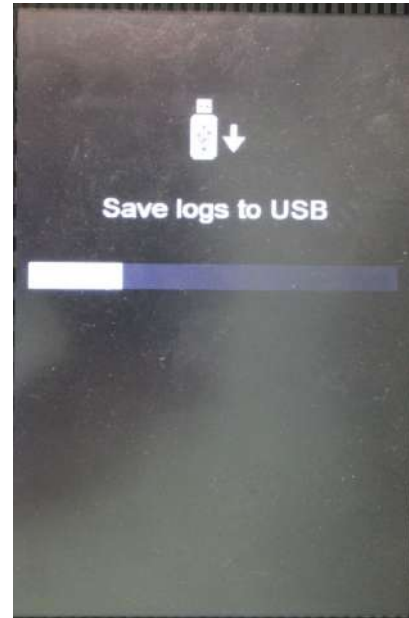
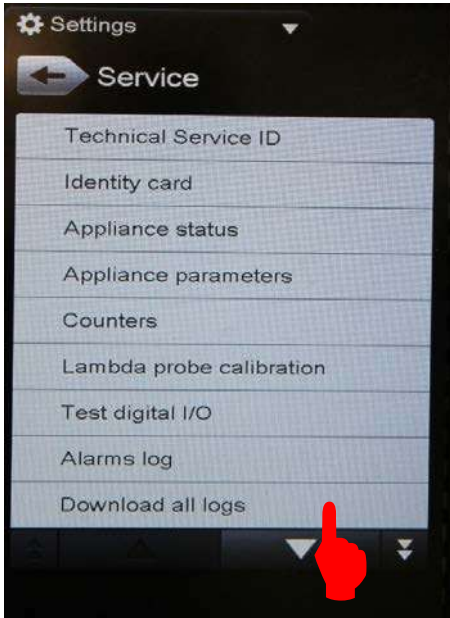

TOUCH SCREEN TEST

It is possible to verify the touch screen response by pressing it. The cross must be nearby the pressing point.

In case of non correspondence, screw or unscrew the 7 fixing screws of the user interface to have more or less contact to the control panel membrane.

It is also suggested to remove the complete user interface from the control panel and verify the correspondence by directly pressing on the screen. If the problem persist is necessary to replace the user board.

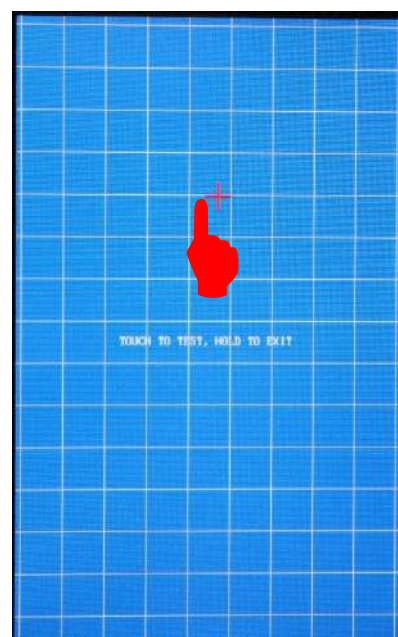
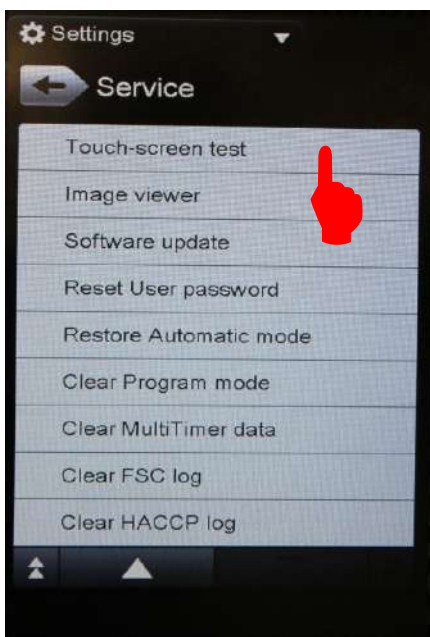

ЗИП Общепит
IMAGE VIEWER

This utility permit to visualize bitmap (.bmp) images with 480x800-24 bits resolution. This is to verify the screen response in terms of luminosity, contrast, dark areas and image loading speed without stops.
In case of malfunctioning it can be necessary to replace the user interface.

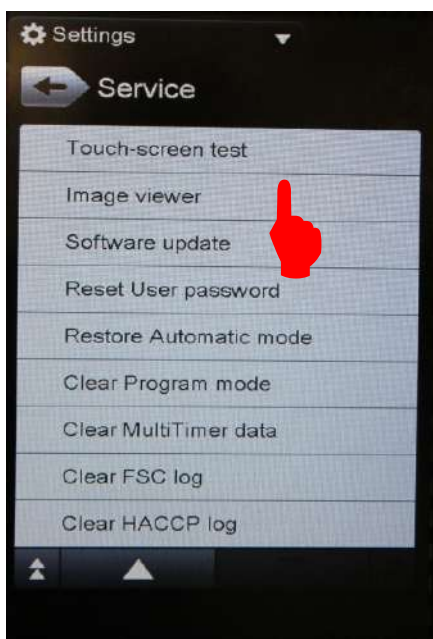

SOFTWARE UPDATE

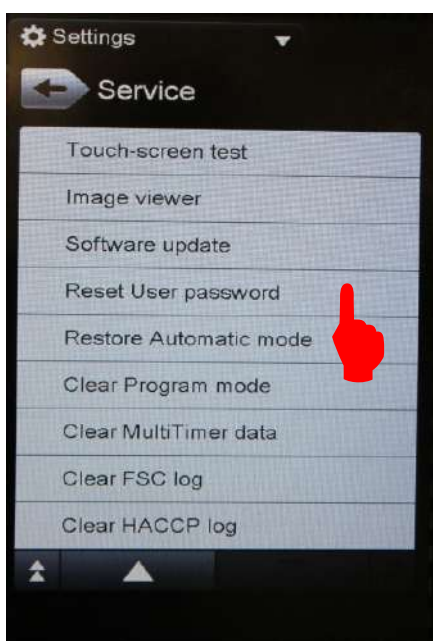

By this command is now possible to perform the software update from the Service Area. Stick the USB with the software and press “Software update”

Зип Общепит

RESET USER PASSWORD

vsezip.ru

+7(812)987-08-81

This is to reset the chef's password to a default factory value,

1 2 3 4 5 6 7 8 .

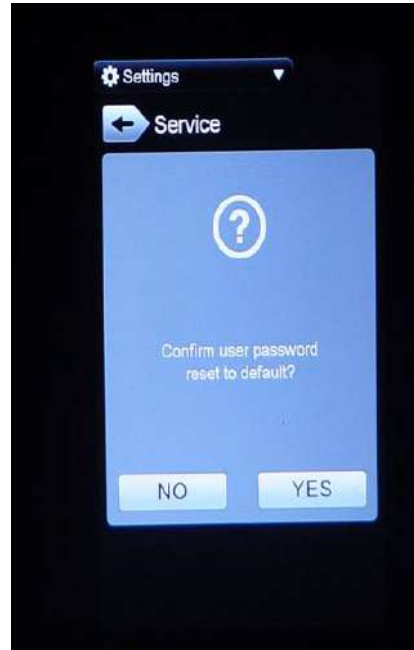
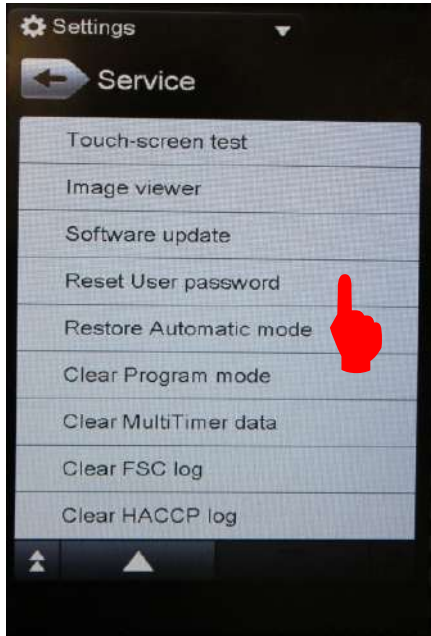

RESTORE AUTOMATIC MODE

The automatic cooking mode is restored to the original factory configuration. All the user presets are lost and the factory presets are restored.

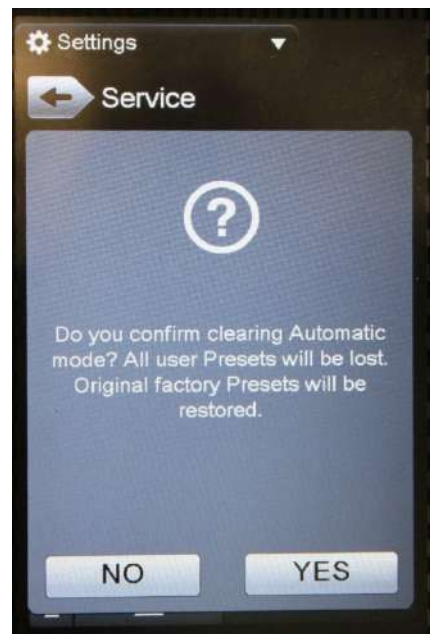
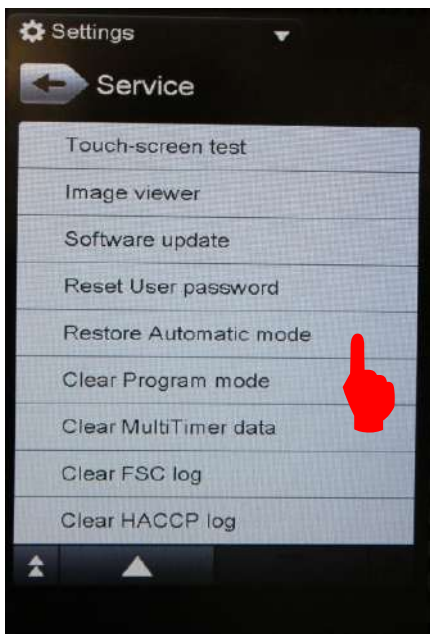

CLEAR PROGRAM MODE

Зип Общепит

vsezip.ru

+7(812)987-08-81

By selecting this option all the user cooking programs will be deleted as well as the categories on where they are organized.

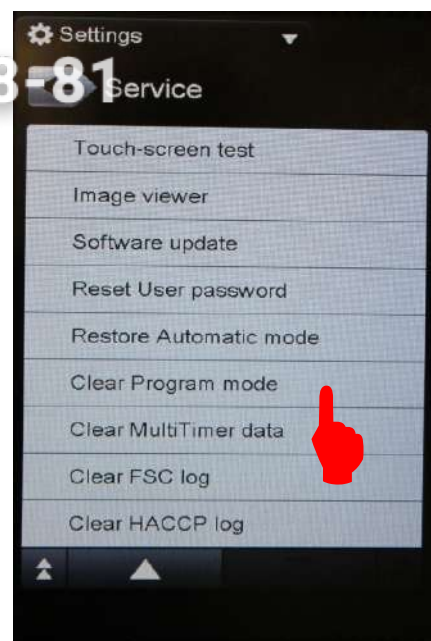

CLEAR MULTITIMER DATA

This function is to erase all Multitimer cooking programs and the related Multitimer presets.

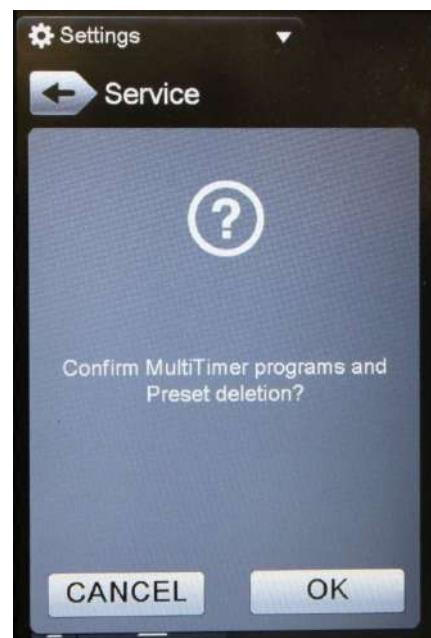
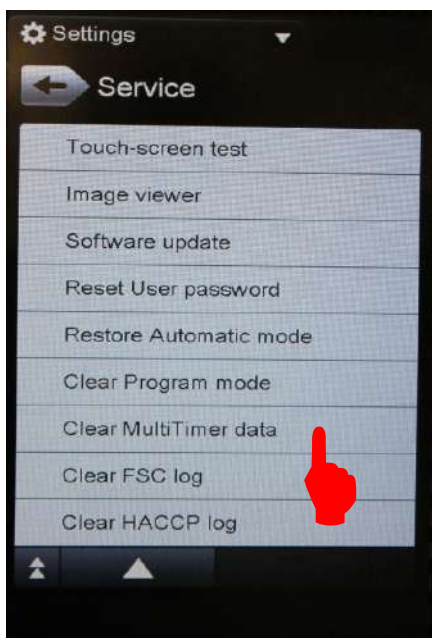

CLEAR FSC LOG & HACCP LOG

Those two buttons are to clear the history log of *FSC (Food Safe Control)* only in the Touch Level or *HACCP* in both Touch and K level

GUIDED DESCALING OF THE BOILER

The automatic descaling of the boiler is intended to be performed with vinegar and is made of 5 steps:

- 1) empty the cavity
- 2) automatic boiler drain (the oven opens the drain valve and wait for 2 and a half minutes before closing it, if the safety sensor level after this phase is still sensing water the oven stops the automatic descaling giving out a warning that is impossible to drain the boiler)
- 3) the oven ask to fill with vinegar until a sound (beep) is emitted
- 4) descaling phase (20 min water to 97 °C, one hour pause, 10 min water 97 °C, one hour pause)
- 5) boiler drain, boiler and cavity rinsing

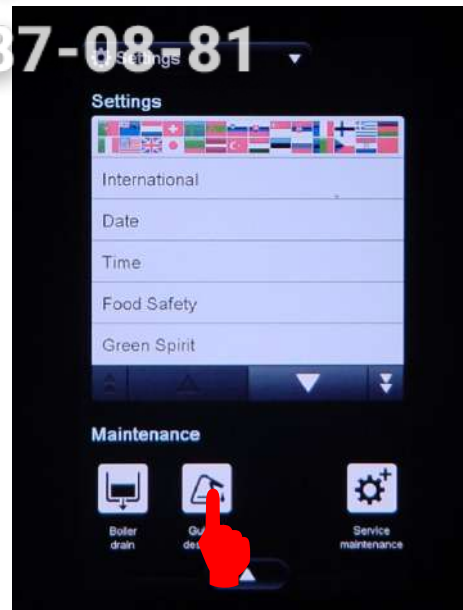

Зип Общепит
MAKE IT MINE

vsezip.ru

Р(812)907 08 81

Once the chef has configured the oven according to his needs such as the language, date, time, the food safety tools, green functions, sound, manual cooking mode, cooking programs management, Multitimer, automatic cleaning cycles, password and auto start of the oven, he has the possibility to download the configuration and upload in a different oven, or reset it back to the factory settings (Default configuration)

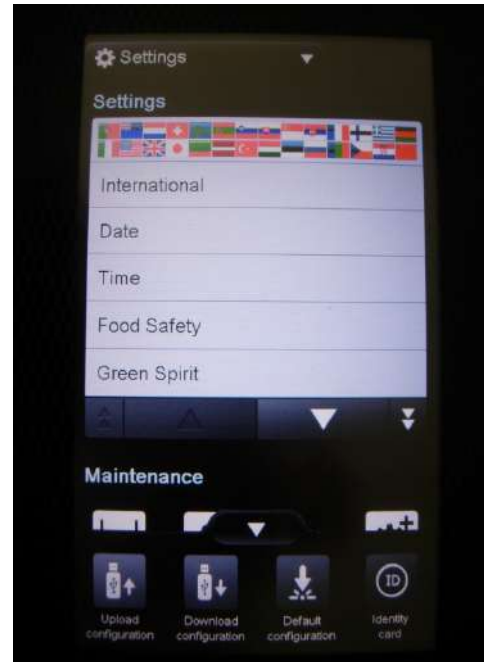
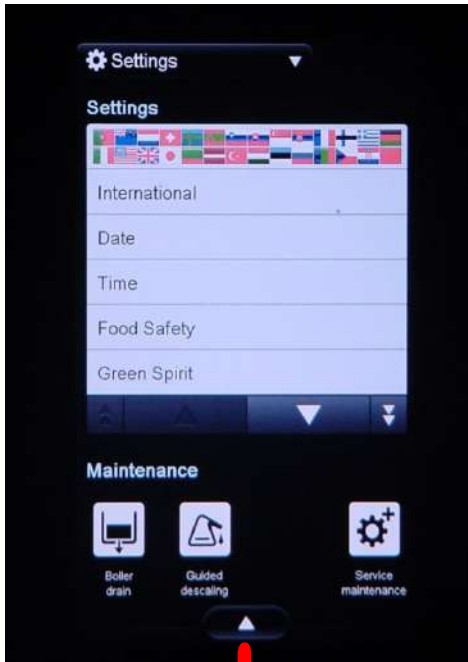

The default file name saved is *UI40.MIM (Make It Mine)* and it is saved into a subfolder

TouchOven/conf/UI40.MIM

If need, rename the file. Don't change the extension .MIM



In alternative, is possible to restore the user configuration *Make it Mine* to the factory settings

Зип Общепит

vsezip.ru

+7(812)987-08-81

Furthermore is possible to visualize the identity card of the oven:

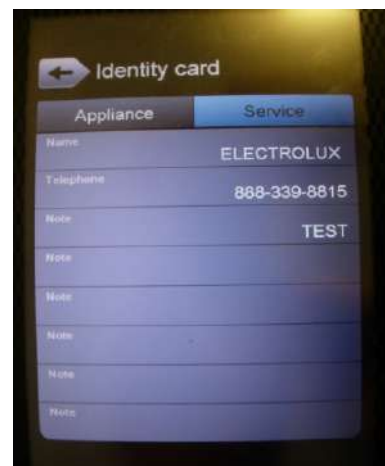

6 Cycles, utility and main parameters

ICON PARAMETER	NAME	DESCRIPTION
	Convection cooking cycle	ON only the heating/burner of the cavity (max temperature 300°C); If set temp.>250°C, DUTM (nr.27) define the max working time. If set a humidity level, the lambda probe control the cavity flap.
	Steam cooking cycle	Max setting temperature: 130°C. If set temperature<100°C: only the boiler works according cavity probe; Is set temperature>100°C: the boiler works according the lambda probe and the heating / burner of cavity works according cavity probe.
	Combi cooking cycle	ON heating / burners of the cavity and of the boiler (max. setting temperature: 250°C); The cavity probe controls the heating/burner of the cavity; The lambda probe controls the heating/burner of the boiler. If the set temperature < 100°C to obtain the steam the oven use the humidifier and not the boiler.
	Rigeneration cooking cycle	Boiler and cavity heating element/burner work alternatively during the first rising till to reach the set temperature. After that, the boiler and the cavità work together to maintain the set (temperature and humidity)
	Delta Cooking cycle	Cooking cycle with meat probe. Set the delta Δ temperature, the cavity heating element/burner works to have a cavity temperature that is Δ°C over the meat probe temperature.

	COOL, cavity temperature cooling phase	<p>The cool cycle works with the cavity fan and the water spray injection (from 180°C, parameter TRMA, till 40 °C, parameter TRMN).</p> <p>Passing from a cooking cycle to a steam cycle, an automatic cool phase start if the cavity temperature is upper the setting temperature.</p>
	Automatic Boiler drain	<p>The automatic drain of the boiler is done when the boiler is used for over 15 minutes (DBON parameter) and if the water temperature is lower than 50°C (TCDB parameter).</p> <p>After a drain operation, the boiler is automatically filled.</p>
SBC	Power board cooling fan set	<p>Temperature of the main board over that the cooling fan is activated.</p>
	Boiler preheating phase	<p>DSPS parameter (value 1): preheating of the boiler also with oven not used.</p> <p>SPHB parameter: minimum temperature of the water when the boiler is not used.</p>
Nr.56 PPM	Peak power System	<p>Set to 1, the Energy Optimiser function is enabled (with Sicotronic system) in the electric ovens. The 2 high voltage digital inputs, IND4 (X10-11/5) and IND5 (X10-11/6), and the 2 output relays RL5 and RL24 are used. RL5 is closed each time the oven has to use the heating elements at half or full power while RL24 is closed when the heating elements have to be used at full power (independently from Sicotronic system). IND4 and IND5 are the high voltage inputs of the commands from Sicotronic system: if on IND4 and IND5 are present 230V the oven is working normally; if only one is at 230V the oven is forced from Sicotronic system to work at half power (with no visualization on the display); if both IND4 and IND5 are at 0V, the oven is forced to cut all the heating elements.</p>
Nr.57 DEMO	Oven DEMO mode	<p>Demo use of the oven. The screen is fully working but the oven doesn't any function Funzionamento del forno in modalità demo, la scheda user interface funziona ma il forno non esegue alcuna funzione reale (non attiva alcun carico).</p>
Nr.55 OLDB	Lambda sensor calibration	<p>Range: -200...100; Default value: -40</p>
Nr.106 STBY	Stand-by time	<p>Default value: 0 (stand-by not enable); Parameter to set in minutes the stand-by of the oven.</p>
Nr.22 SEAL	Altitude above sea level	<p>The altitude above sea level can influence the functionality of the oven (example the water boiling point of the boiler)</p>



For the description of each parameter see the parameters list attached.

7 “Service utilities” environment

Зип Общепит

vsezip.ru

+7(812)987-08-81

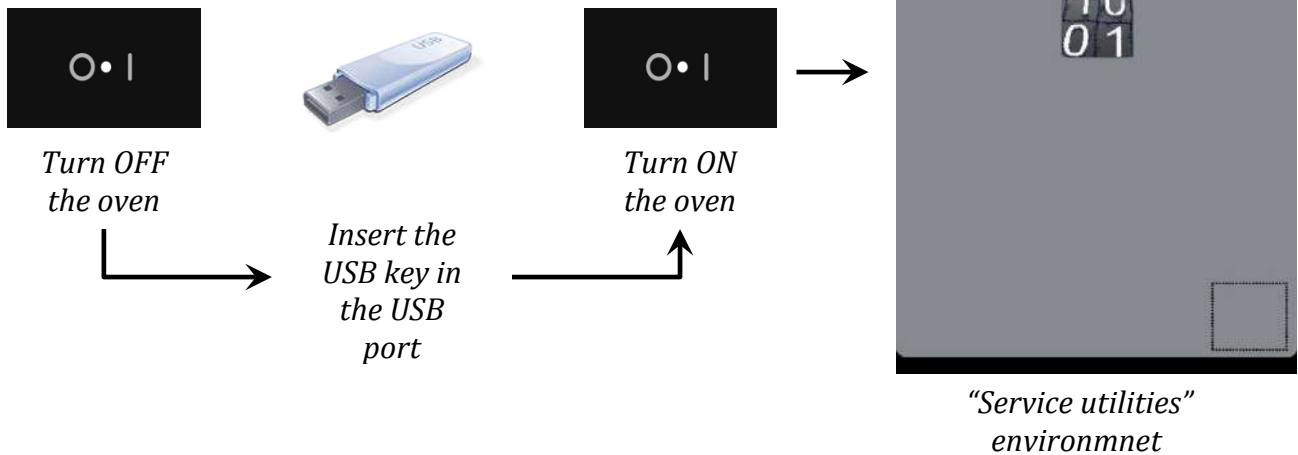

ICON	DESCRIPTION
	Automatic upload from USB key of the Touch screen software

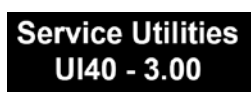

The Touch screen software release is visualized in the top of the screen.



It's not possible to see the firmware release of the main Power board. It is possible to see in the “Service Maintenance” → “Identity Card”

Зип Общепит

vsezip.ru

+7(812)987-08-81

7.1 Upgrade software Touch user



For the complete upgrade procedure see the specifics chapter and instruction attached.

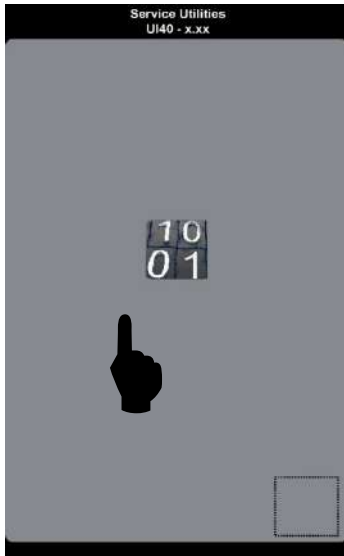

Keep pressed the icon



The upload start automatically.



The message "script end" indicates that the procedure is finished. Press the screen to come back to main screen



SOFTWARE RELEASE INSTALLED IN THE OVEN



BAR STATUS and PHASE of the UPLOAD procedure



MESSAGE AREA (see table)



STATUS of THE UPLOAD procedure

MESSAGE TABLE

MESSAGE	DESCRIPTION
WAIT	Start procedure with communication test between oven and USB key
EXECUTING SCRIPT <i>File name</i>	Software upgrade (see the file name upgraded in the message text). The bar shows the status of the procedure for each phase/file, the number “x/4” shows the phase/file loaded (x of 4)
INSERT USB KEY	USB key not present or not correctly insert in the port.
SCRIPT END	Upgrade finished.
FILE NOT FOUND	File not found in the USB key.
BAD SCRIPT	Error in the upgrade procedure. Restart the procedure.

SOFTWARE FILES List

SEQUENCE	FILE	DESCRIPTION
1/4	<i>filename.bld</i>	Bootloader file
2/4	<i>filename.bc2</i>	Service file
3/4	<i>filename.bc1</i>	Main file
4/4	<i>filename.rcs</i>	Resources file

All the file of the software release must be present in the USB key also if not present in the list above.



The software must be saved in the main directory of the USB key and not in a subdirectory, otherwise the system doesn't recognize the files.



Stop the upload procedure before it is finished may damage the user interface.

8 “Data Monitor” environment



To have the “Data Monitor” option in the Main menu it is necessary to enable the parameter nr.97 DATM “data monitor” to 1

The “Data Monitor” environment shows to the Service all the information about the status of the oven:

- ✓ Warning and alarm status;
- ✓ Temperature and humidity of the cavity;
- ✓ Other information about utilities and oven status.



Keep pressed the icon “data monitor” in the main menù

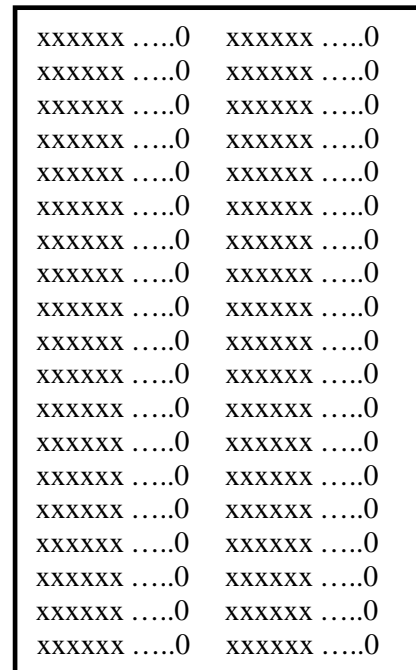

The screen visualizes all the information about ovens status (see list below)
Press the screen to exit

OVEN STATUS LIST

NOME	DESCRIZIONE	VALUE
STAND BY ON	- FACTORY VALUE -	ND
SYSTEM IN START	- FACTORY VALUE -	ND
PRB COOKING ACTIVE	- FACTORY VALUE -	ND
WAIT BOILER PREH	- FACTORY VALUE -	ND
HACCP ON	- FACTORY VALUE -	ND
COOL AND TEMP.REC	- FACTORY VALUE -	ND
PREHEAT	- FACTORY VALUE -	ND
PREHEAT COOLING DOWN	- FACTORY VALUE -	ND
LOAD AFTER PREHEAT	- FACTORY VALUE -	ND
START AFTER LOAD	- FACTORY VALUE -	ND
TEMP.RECOVERY	- FACTORY VALUE -	ND
COOL DOWN INI	- FACTORY VALUE -	ND

<i>HUMIDIFICATION</i>	- FACTORY VALUE -	ND
<i>SENSING</i>	- FACTORY VALUE -	ND
<i>END COOKING SOUND REQ</i>	- FACTORY VALUE -	ND
<i>WARNING DOOR OPEN</i>	Warning door open	0: OFF, 1: ON
<i>WARNING BOILER PREH</i>	Warning boiler preheat	0: OFF, 1: ON
<i>WARNING WATER FILL</i>	Warning boiler water fill	0: OFF, 1: ON
<i>WARNING BURNER LOCK</i>	Warning burner lock	0: OFF, 1: ON
<i>ALR. CAVITY OVERTEMP</i>	Error ETUC: cavity over temperature	0: OFF, 1: ON
<i>ALR. BOILER OVERTEMP</i>	Error ETUB: boiler over temperature	0: OFF, 1: ON
<i>ALR. CAVITY TEMP</i>	Error ECEL: cavity probe interrupted	0: OFF, 1: ON
<i>ALR. BOILER TEMP</i>	Error EBOL: boiler probe interrupted	0: OFF, 1: ON
<i>ALR. DRAIN TEMP</i>	Error EBYP: bypass probe interrupted	0: OFF, 1: ON
<i>ALR. PROBE TEMP</i>	Error EPRB: meat probe probe interrupted	0: OFF, 1: ON
<i>ALR. BOARD TEMP</i>	- FACTORY VALUE -	ND
<i>ALR. NTC</i>	Error ENTC: main power over temperature	0: OFF, 1: ON
<i>ALR. A2D</i>	Error ECAD: analog to digital converter	0: OFF, 1: ON
<i>ALR. VENTING VALVE</i>	Error EFLP: cavity flap	0: OFF, 1: ON
<i>ALR. BURN BOIL. UP</i>	Upper boiler: burner lock	0: OFF, 1: ON
<i>ALR. BURN BOIL. DOWN</i>	Lower boiler: burner lock	0: OFF, 1: ON
<i>ALR. BURN CELL UP</i>	Upper cavity: burner lock	0: OFF, 1: ON
<i>ALR. BURN CELL DOWN</i>	Lower cavity: burner lock	0: OFF, 1: ON
<i>ALR. RTC</i>	Error ERTC: internal clock	0: OFF, 1: ON
<i>ALR. RAM</i>	Error ERAM: RAM comunication	0: OFF, 1: ON
<i>ALR. PWM</i>	Error EPWM: PWM comunication (gas version)	0: OFF, 1: ON
<i>ALR. FAN UP</i>	Error EFUN upper motor	0: OFF, 1: ON
<i>ALR. FAN DOWN</i>	Error EFUN lower motor	0: OFF, 1: ON
<i>ALR. DRY HEATERS</i>	- FACTORY VALUE -	ND
<i>ACTIVE PHASE</i>	- FACTORY VALUE -	ND
<i>ACTIVE DURATION [hms]</i>	- FACTORY VALUE -	ND
<i>COOKING CODE</i>	- FACTORY VALUE -	ND
<i>ACTIVE HUMIDITY [%]</i>	- FACTORY VALUE -	ND
<i>CAVITY SET</i>	- FACTORY VALUE -	ND
<i>PROBE SET</i>	- FACTORY VALUE -	ND
<i>DURATION SET [hh:mm]</i>	- FACTORY VALUE -	ND
<i>CAVITY TEMP</i>	Cavity temperature	measured value
<i>BOILER TEMP</i>	Boiler temperature	measured value
<i>PROBE TEMP</i>	Meat probe (min) temperature	measured value
<i>PROBE 1 TEMP</i>	6 points meat probe: temperature point 1	measured value
<i>PROBE 2 TEMP</i>	6 points meat probe: temperature point 2	measured value
<i>PROBE 3 TEMP</i>	6 points meat probe: temperature point 3	measured value
<i>PROBE 4 TEMP</i>	6 points meat probe: temperature point 4	measured value
<i>PROBE 5 TEMP</i>	6 points meat probe: temperature point 5	measured value
<i>PROBE 6 TEMP</i>	6 points meat probe: temperature point 6	measured value
<i>DRAIN TEMP</i>	Quenching system temprarature	measured value
<i>BOARD TEMP</i>	Main power temperature	measured value

HUMIDITY [%]	Cavity humidity	measured value
CLEAN TYPE	- FACTORY VALUE -	ND
CNTUP PR.NOREC T [hms]	- FACTORY VALUE -	ND
CNTUP PR.C/REC T [hms]	- FACTORY VALUE -	ND
CNTUP FA.NOREC T [hms]	- FACTORY VALUE -	ND
CNTUP FA.C/REC T [hms]	- FACTORY VALUE -	ND
AUTO PROG.PHASE OPT	- FACTORY VALUE -	ND
AUTO LIV.1	- FACTORY VALUE -	ND
AUTO LIV.2	- FACTORY VALUE -	ND
AUTO LIV.3	- FACTORY VALUE -	ND
AUTO LIV.4A	- FACTORY VALUE -	ND
AUTO LIV.4B	- FACTORY VALUE -	ND
NO START REASON	- FACTORY VALUE -	ND
F (FSC)	- FACTORY VALUE -	ND
LOW TEMP CODE	- FACTORY VALUE -	ND
ECAP MASTER RETRY	- FACTORY VALUE -	ND
ECAP MASTER ERROR	- FACTORY VALUE -	ND



In GREY and with indication **-FACTORY VALUE-**, the oven parameters that has not information that can be used by SERVICE (only for factory).

9 Calibration

9.1 Cavity offset calibration

- ✓ Enter in the settings environment (level 3) and set the parameters **CORT** e **OCA1** to 0;
- ✓ Run a steam cooking cycle and check the cavity temperature when stabilized at the water boiling point.
- ✓ If the cavity temperature is less or greater than the water boiling point (see table below), set the corrective value in the OCA1 parameter.
- ✓ At the end of the calibration procedure, set the parameter CORT to 1 and set the correct altitude above sea level in the parameter **SEAL**.

Level (m)	Water boiling point (°C)
0	100.00
300	98.90
500	98.30
800	97.50
1000	96.80
1500	95.00
2000	93.50

10 Software user interface Touch and main power board spare part

In the oven there are 2 different software:

1. the firmware of the main power board (can be upgrade only changing the power board);
2. Touch user software (can be upgrade by USB port).



ATTENTION: To avoid any type of issue and communication problems between power and user, the two software's release must be compatible (see table attached).

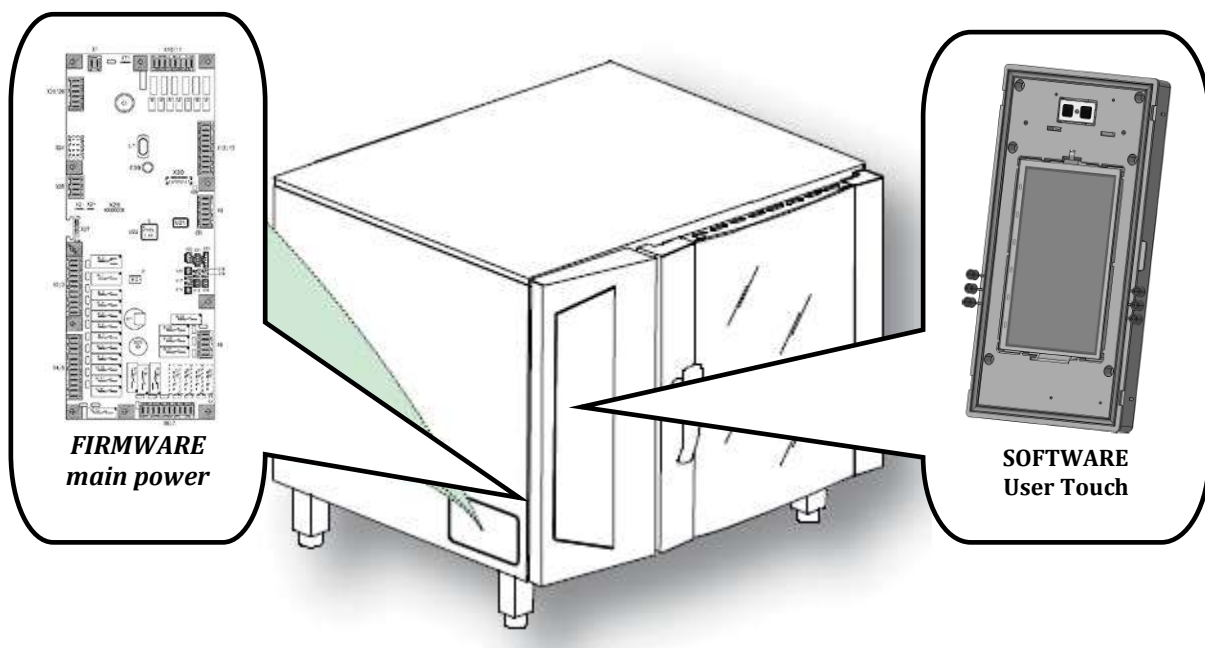

The firmware release is visible in the label of the power board; the software release can be seeing in the “service utilities” or in “Service Maintenance” “Identity Card” environment.

10.1 Software user upgrade



For the text messages and step by step procedure see the specific chapter n°7 for the upgrade of the User Touch software in “service utilities” environment and the instruction attached.

10.2 Main power component replacement

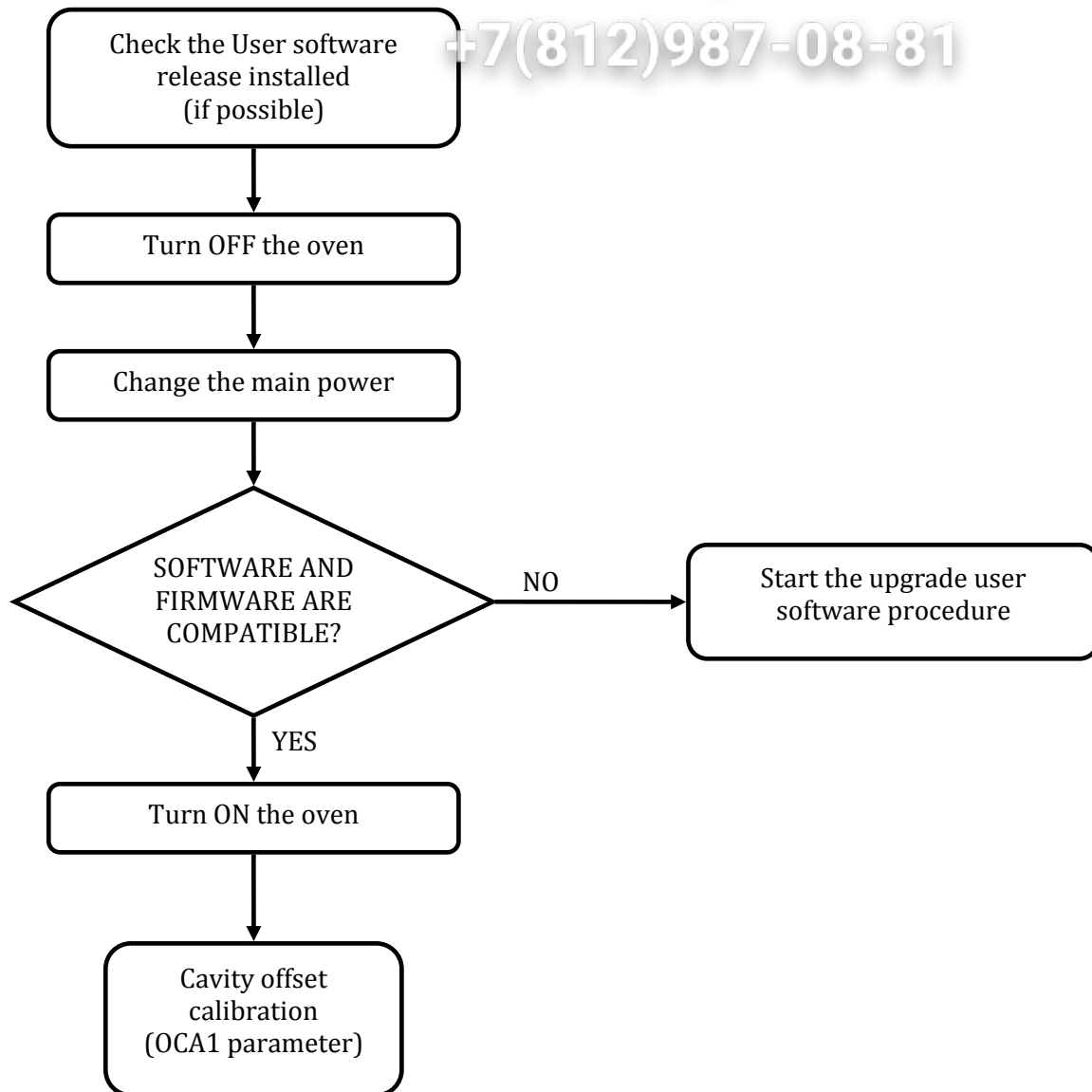

Зип Общепит

vsezip.ru

+7(812)987-08-81

10.2 User touch component replacement



For the text messages and step by step procedure see the specific charter for the upgrade of the User Touch software ("service utilities" environment) and the instruction attached.



The spare part user has already installed a start up software (4.01 release) only necessary for the first installation of the Touch software.



It's necessary have the software in the USB key in case of a replacement of the electronic user Touch screen.



ATTENTION: the power firmware and user Touch software must be compatible otherwise don't proceed with the operation.

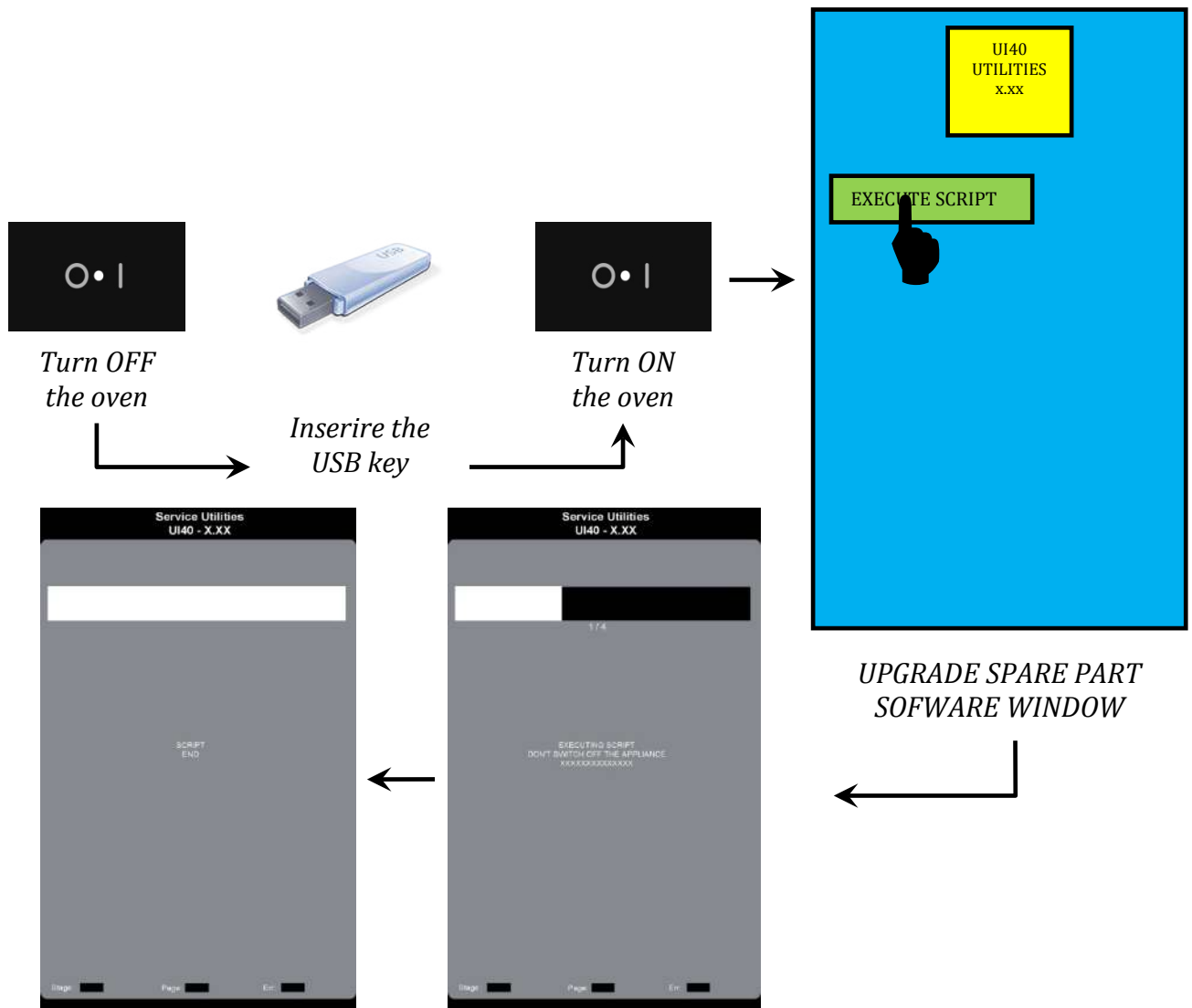

The message "script end" indicates that the procedure is finished. Press the screen to come back to main screen

The upload start automatically.

Зип Общепит

vsezip.ru

+7(812)987-08-81

11 Gas system

11.1 Main components

NAME	DESCRIPTION
GAS VALVE	
BURNER BLOWER (alternate current AC)	To create the air – gas mixture through a calibrated mixer (according the power and gas type). After that, the blower conveys the mixture to the burner
HEAT EXCHANGER (boiler and cavity)	made with a corrugated tube for increasing the efficiency
IGNITION AND DETECTION ROD	
IGNITER	
FLAME CONTROL DEVICE	

11.2 Settings and parameter gas burner adjustments

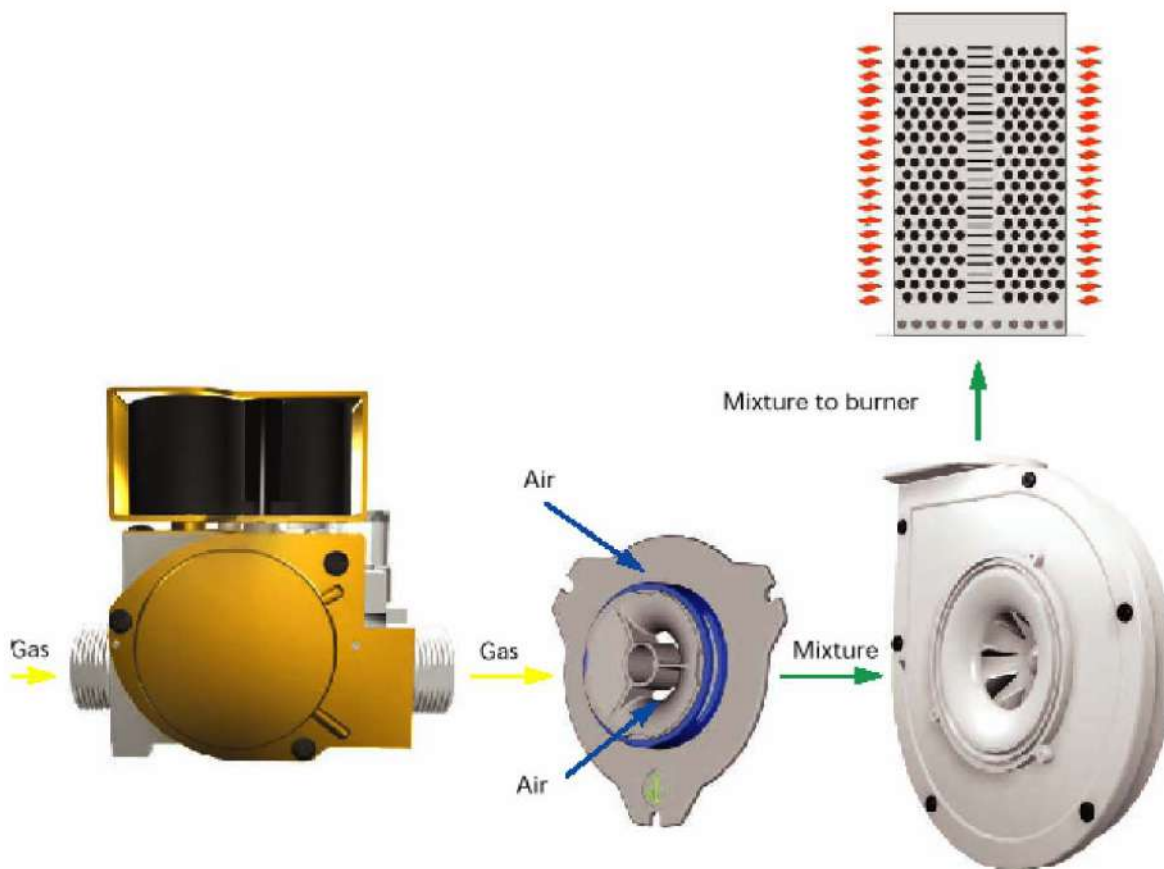

COMPONENTS /
SETTINGS

DESCRIPTION

<i>Offset gas valve</i>	To set the sucked gas pressure (negative)
<i>Nozze</i>	To set the max quantity of the gas to the burner
<i>Calibrated aereator</i>	To set the max quantity of air that the fan can use.
<i>PWM parameter: STCA e STBO</i>	To set the starting speed of the cavity/boiler burners (vs nominal speed of the fan).
<i>PWM parameter: FUCA e FUBO</i>	To set the full power the cavity/boiler burners (vs nominal speed of the fan).
<i>PWM parameter: HACA e HABO</i>	To set the half power of the cavity/boiler burners (vs nominal speed of the fan).
<i>Burner flange</i>	Assembled after the burner blower, set the max power of the burner.

To change the gas type (according the gas table adjustment):

- ✓ change the nozzle;
- ✓ set the PWM signal (using the parameters);
- ✓ set the offset of the gas valve;
- ✓ change the burner flange (only for some models).

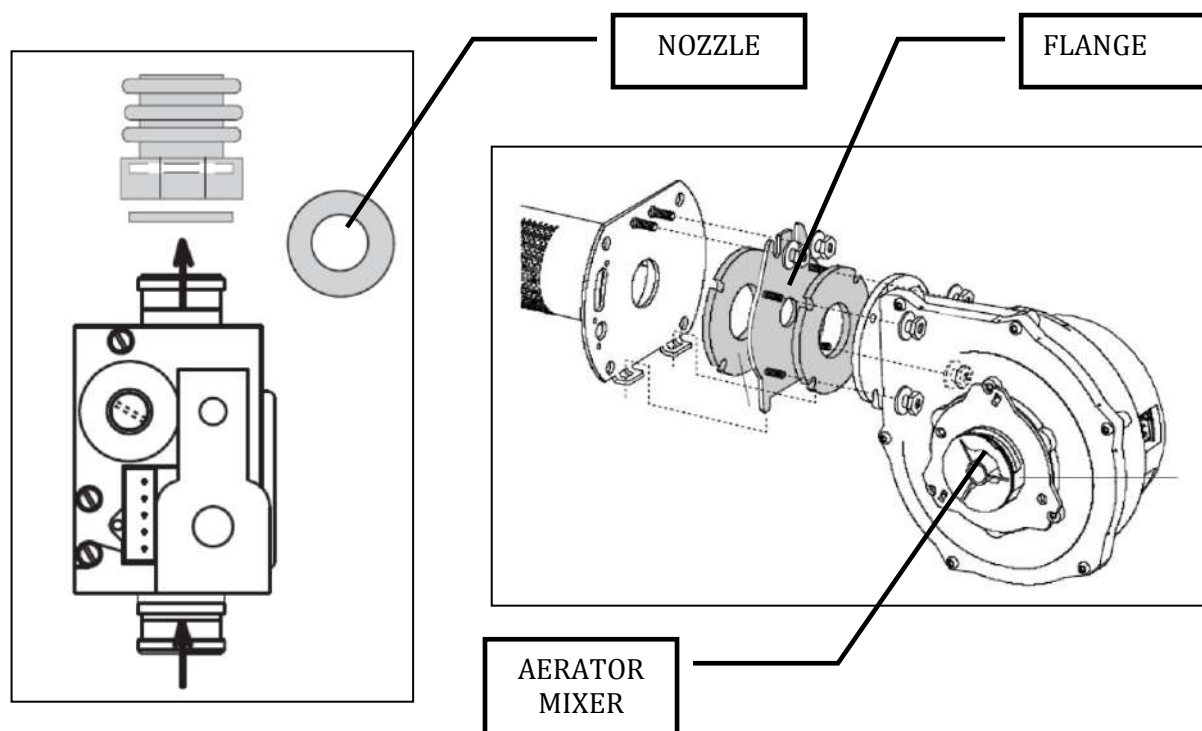

Зип Общепит

11.3 Offset calibration of the gas valve

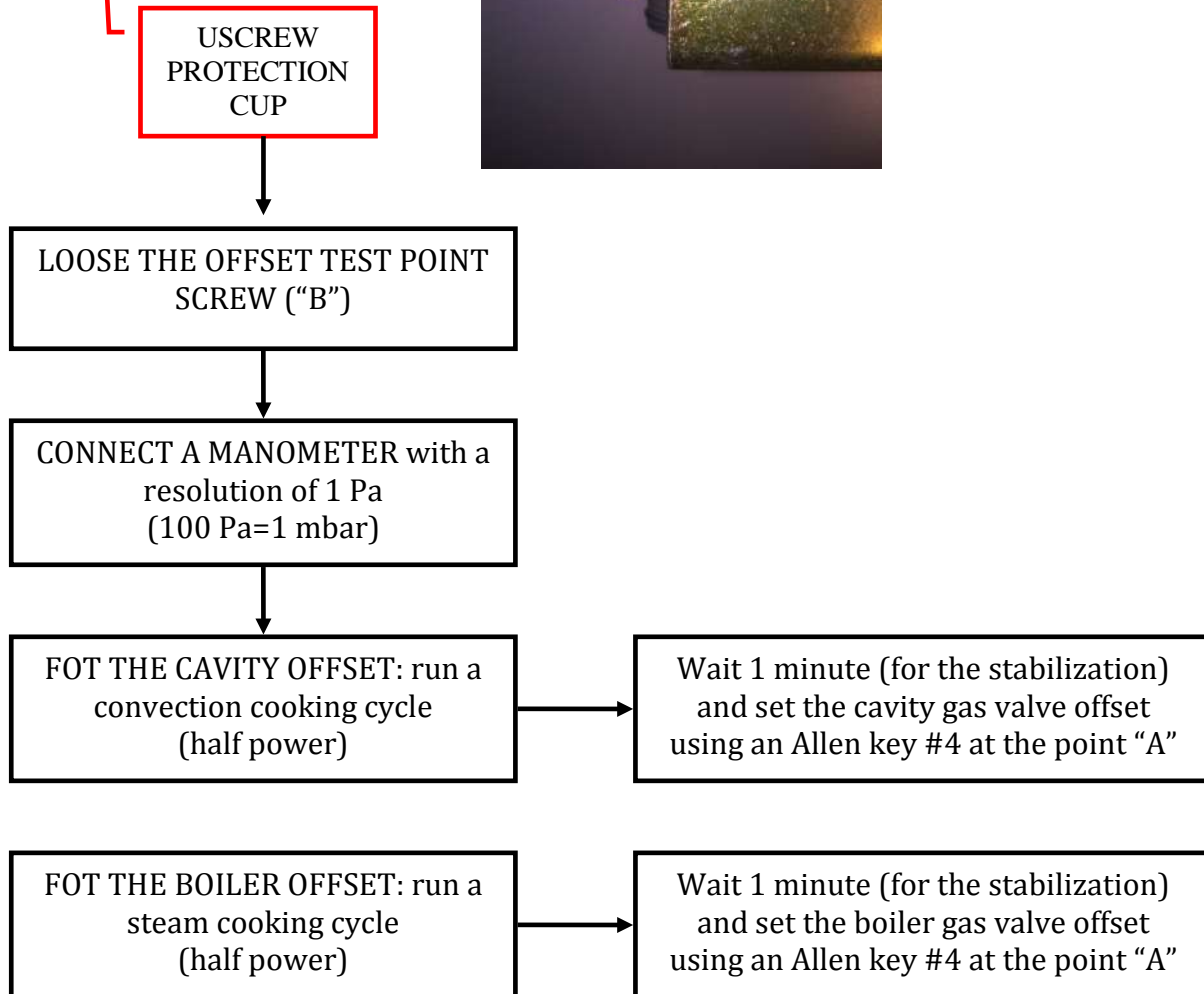
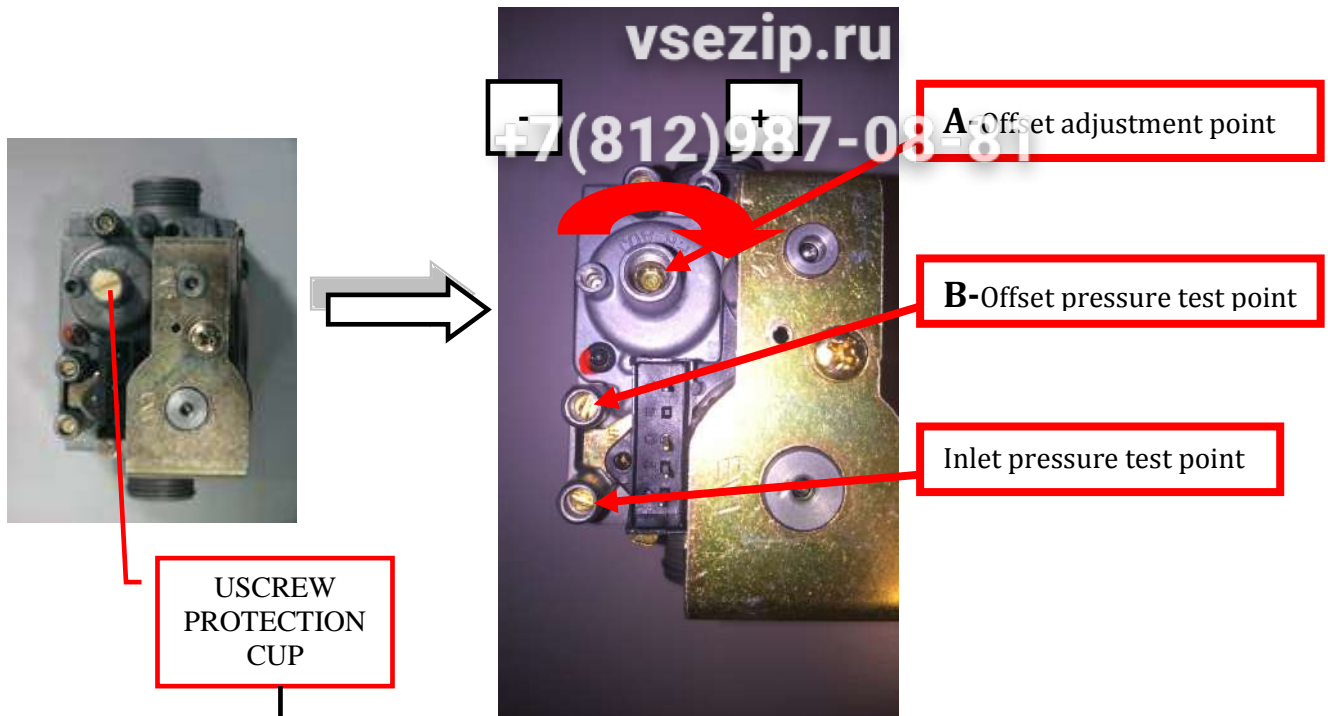

For the use of the pascalimeter, see instruction attached.

11.4 Use of pascalimeter (for offset pressure measure)



Зип Общепит

vsezip.ru

+7(812)987-08-81

PASCALIMETER
SPARE PART CODE
0S0388



 <p>PRESSURE INLET “+”</p>	<p>Using the pressure inlet signed with “+” and with negative reading on the display, this means we are measuring - 0.16 hPa = - 16 Pa</p>	
	<p>Using the pressure inlet signed with “+” and with positive reading on the display, this means we are measuring + 0.16 hPa = + 16 Pa</p>	
 <p>PRESSURE INLET “-“</p>	<p>Using the pressure inlet signed with “-” and with negative reading on the display, this means we are measuring + 0.16 hPa = + 16 Pa</p>	
	<p>Using the pressure inlet signed with “-” and with positive reading on the display, this means we are measuring - 0.16 hPa = - 16 Pa</p>	

Зип Общепит

11.5 Gas adjustments reference table

vsezip.ru

+7(812)987-08-81

CAVITY																					
AOS ONE 061G							AOS ONE 101G							AOS ONE 201G							
Gas	ø flange	aerator	pwm st-ha-fu	ø nozzle	offset(hPa)	kW max	kW ½	ø flange	aerator	pwm st-ha-fu	ø nozzle	offset(hPa)	kW max	kW ½	ø flange	aerator	pwm st-ha-fu	ø nozzle	offset(hPa)	kW max	kW ½
G20	12	pink	40_50_100	6,00	0,00	10	7	18	red	40_45_90	7,00	0,00	20	15	18	red	40_45_90	7,00	up 0.00 down 0.00	40	30
G25	12	pink	40_40_80	6,75	-0,10	10	7	18	red	40_40_70	8,00	0,00	20	15	18	red	40_40_70	8,00	up 0.00 down 0.00	40	30
G30	12	pink	35_35_45	5,25	-0,10	10	7	18	red	40_30_50	5,50	0,00	20	15	18	red	40_30_50	5,50	up 0.00 down 0.00	40	30
G31	12	pink	40_35_55	5,50	-0,10	10	7	18	red	40_35_60	5,70	from 0.00 to -0.05	20	15	18	red	40_35_60	5,70	up 0.00 / -0.05 do 0.00 / -0.05	40	30

BOILER																					
AOS ONE 061G							AOS ONE 101G							AOS ONE 201G							
Gas	ø flange	aerator	pwm st-ha-fu	ø nozzle	offset(hPa)	kW max	kW ½	ø flange	aerator	pwm st-ha-fu	ø nozzle	offset(hPa)	kW max	kW ½	ø flange	aerator	pwm st-ha-fu	ø nozzle	offset(hPa)	kW max	kW ½
G20	12	pink	40_50_90	6,00	0,00	10	7	21	green	45_45_65	7,50	0,00	20	15	21	green	45_55_85	7,50	0,00	25	18
G25	12	pink	40_40_80	6,75	-0,10	10	7	21	green	45_30_60	8,50	0,00	20	15	21	green	45_35_60	9,00	-0,10	25	18
G30	12	pink	35_35_60	4,75	0,00	10	7	18	green	40_35_55	5,80	-0,10	20	15	18	green	40_47_90	5,80	-0,10	25	18
G31	12	pink	40_35_70	5,00	0,00	10	7	18	green	40_40_65	6,15	from 0.00 to -0.10	20	15	18	green	40_55_100	6,15	from 0.00 to -0.10	25	18

CAVITY																					
AOS ONE 062G							AOS ONE 102G							AOS ONE 202G							
Gas	ø flange	aerator	pwm st-ha-fu	ø nozzle	offset(hPa)	kW max	kW ½	ø flange	aerator	pwm st-ha-fu	ø nozzle	offset(hPa)	kW max	kW ½	ø flange	aerator	pwm st-ha-fu	ø nozzle	offset(hPa)	kW max	kW ½
G20	18	red	30_55_100	7,80	-0,10	20	15	21	green	30_50_85	7,80	-0,20	27	20	21	green	30_50_85	7,80	up -0.20 down -0.10	55	40
G25								21	green	35_50_85	9,25	0,00	27	20	21	green	35_50_85	9,25	up 0.00 down 0.00	55	40
G30								18	green	35_50_95	5,80	0,00	27	20	18	green	35_50_95	5,80	up 0.00 down 0.00	55	40
G31	18	red	40_45_80	5,80	from 0.00 to -0.05	20	15	18	green	35_50_95	6,25	from 0.00 to -0.08	27	20	18	green	35_55_100	6,25	up 0.00 / -0.08 do 0.00 / -0.08	55	40

BOILER																					
AOS ONE 062G							AOS ONE 102G							AOS ONE 202G							
Gas	ø flange	aerator	pwm st-ha-fu	ø nozzle	offset(hPa)	kW max	kW ½	ø flange	aerator	pwm st-ha-fu	ø nozzle	offset(hPa)	kW max	kW ½	ø flange	aerator	pwm st-ha-fu	ø nozzle	offset(hPa)	kW max	kW ½
G20	18	red	40_37_65	6,75	0,00	15	11	21	green	45_55_85	7,50	0,00	25	18	21	green	35_47_88	7,50	up 0.00 down 0.00	55	40
G25								21	green	45_35_60	9,00	-0,10	25	18	21	green	35_47_88	9,00	up 0.00 down 0.00	55	40
G30								18	green	40_47_90	5,80	-0,10	25	18	21	green	35_35_60	6,00	up 0.00 down 0.00	55	40
G31	18	red	45_30_50	5,50	from 0.00 to -0.05	15	11	18	green	40_55_100	6,15	from 0.00 to -0.10	25	18	21	green	35_45_75	6,25	up 0.00 / -0.10 do -0.10 / -0.15	55	40

Зип Общепит

vsezip.ru

+7(812)987-08-81

11.6 Gas Functional diagram

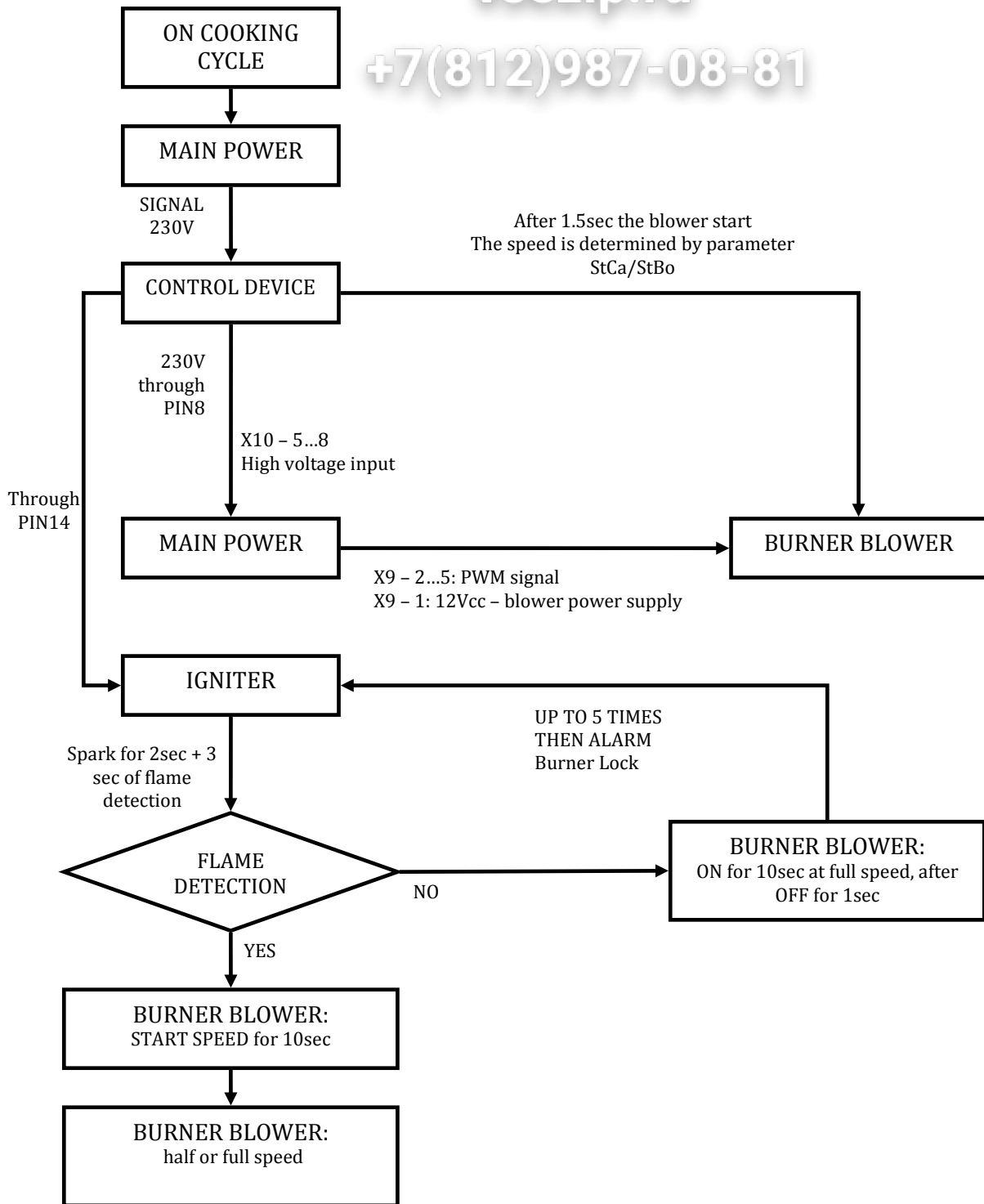

In case of loosening of the flame signal during working, only one re-ignition attempts takes place.

So if the burner fan is off for at least 0.5 s (the fan is controlled from the flame control device through the 230Vac signal form pin 8), the POWER board deduces that the flame control device is going to try again an ignition sequence and then goes back to the beginning of the ignition sequence. If on the contrary the burner fan is off for at least 5 s, the POWER board deduces that the flame control device is in lockout.

12 Electric oven: functional contactors diagram

Зип Общепит

vsezip.ru

+7(812)987-08331

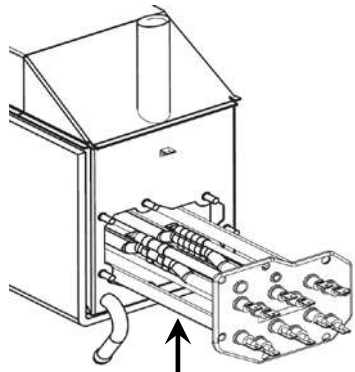

Boiler heating element

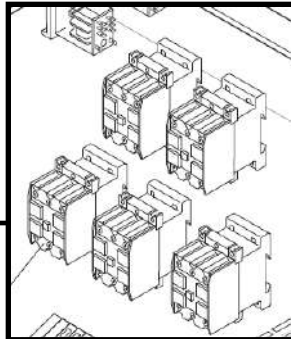

Safety (KS), cavity and boiler contactors

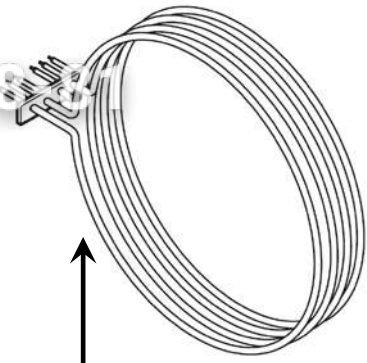

Cavity heating element

LEGEND:

100% : FULL POWER

½ : HALF POWER

- OPEN CONTACTOR (heating element OFF)
- CLOSED CONTACTOR (heating element ON)

		CONVECTION CYCLE		COMBI CYCLE		STEAM CYCLE	
		100%	½	100%	½	100%	½
		6 GN1/1, 6 GN2/1, 10 GN1/1, GN10 2/1					
KS	Safety						
K1	Cavity heating element						
K2	Cavity heating element						
K3	Boiler heating element						
K4	Boiler heating element						

		CONVECTION CYCLE		COMBI CYCLE		STEAM CYCLE	
		100%	½	100%	½	100%	½
		20 1/1 standard					
KS	Safety						
K1	Cavity heating element						
K2	Cavity heating element						
K3	Boiler heating element						
K4	Boiler heating element						
K5	Cavity heating element						
K6	Cavity heating element						

CONVECTION	COMBI CYCLE	STEAM CYCLE
------------	-------------	-------------

Зип Общепит

vsezip.ru

+7(812)987-08-81

20 1/1
(200V, 208V, 230V, 240v)

		CYCLE					
		100%	½	100%	½	100%	½
KS1	Safety 1						
KS2	Safety 2						
K1	Cavity heating el. UP						
K2	Cavity heating el. UP						
K3	Boiler heating element						
K4	Boiler heating element						
K5	Cavity heating el. DOWN						
K6	Cavity heating el. DOWN						

20 2/1

		CONVECTION CYCLE		COMBI CYCLE		STEAM CYCLE	
		100%	½	100%	½	100%	½
KS1	Safety 1						
KS2	Safety 2						
K1	Cavity heating el. UP						
K2	Cavity heating el. UP						
K3	Boiler heating el. UP						
K4	Boiler heating el. UP						
K5	Cavity heating el. DOWN						
K6	Cavity heating el. DOWN						
K7	Boiler heating el. DOWN						
K8	Boiler heating el. DOWN						

13 Boiler functionality / supply water characteristics

Зип Общепит
vsezip.ru

+7(812)987-08-81

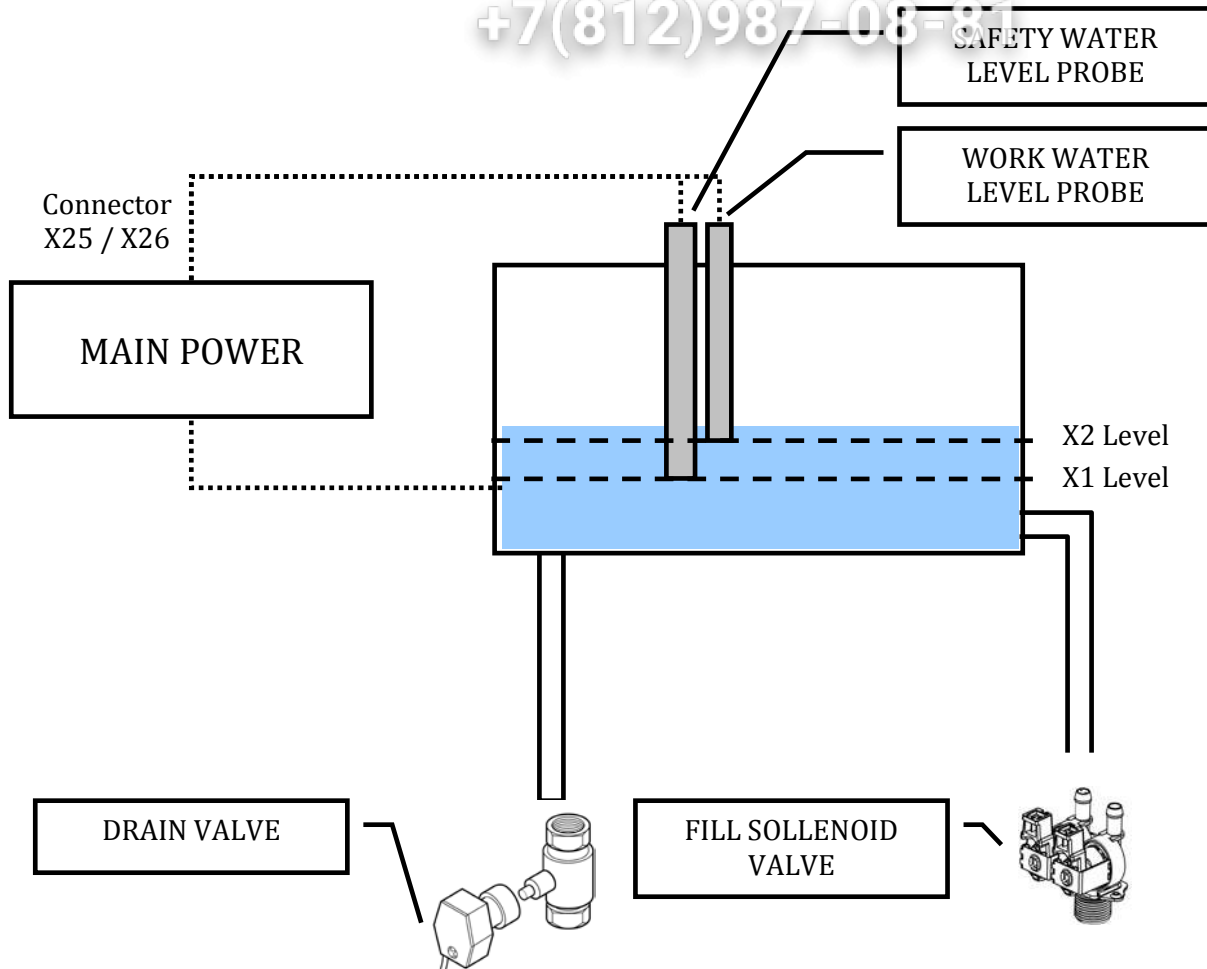

Each level probe works using the ground of the boiler to close the signal circuit.

WATER LEVEL SENSOR WORKING TABLE

WATER LEVEL	WATER SOLENOID VALVE	BOILER HEATING ELEMENT
Water level < X1 (safety level)	ON	OFF
X1 (safety) <= water level > X2 (work)	ON	ON
Water level > X2 (work)	OFF	ON

13.1 Humidity levels (only level K)

The functional level “K” manages 10 levels of humidity which is obtained by injecting water directly on the cavity fan. Water then changes status becoming steam once it encounters the cavity heaters (gas or electric). The obtained steam is then mixed with air and put in circulation through the fan.

A dedicated water valve with nominal flow rate of **0,25 l/min** is used for the above purpose.

The 10 humidity levels are the result of a different timing of the water solenoid valve, as per following table:

Humidity level	Time on (sec)	Time off (sec)
0	0	0
1	1	43
2	1	39
3	1	34
4	1	29
5	1	25
6	1	20
7	1	15
8	1	10
9	2	10
10	7	3

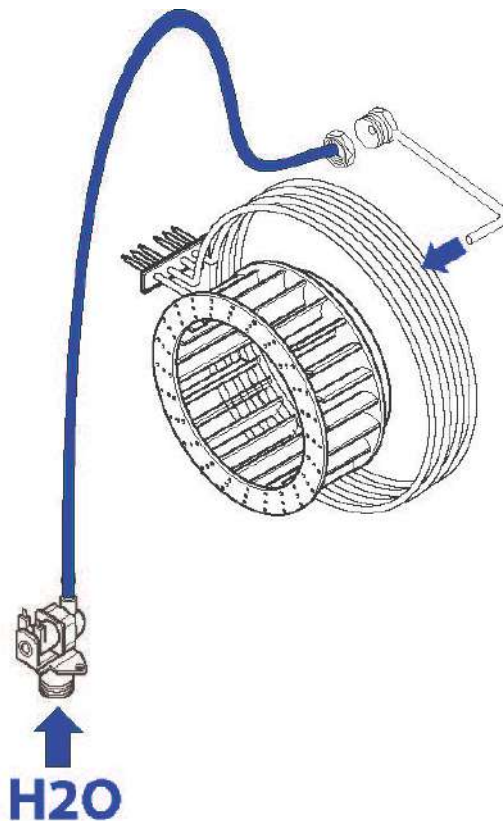

Example of electric heated oven

13.2 Water characteristic and treatment

Read the instructions in the handbook about the suggested water treatment according the water net characteristics:

- ✓ Hardness: $\leq 5^\circ\text{F}$;
- ✓ Chloride (ppm): see graph below;
- ✓ PH: see graph below; vedi grafico sotto;
- ✓ Conductivity: see graph below;

LEVEL TOUCH (WITH STEAM GENERATOR)

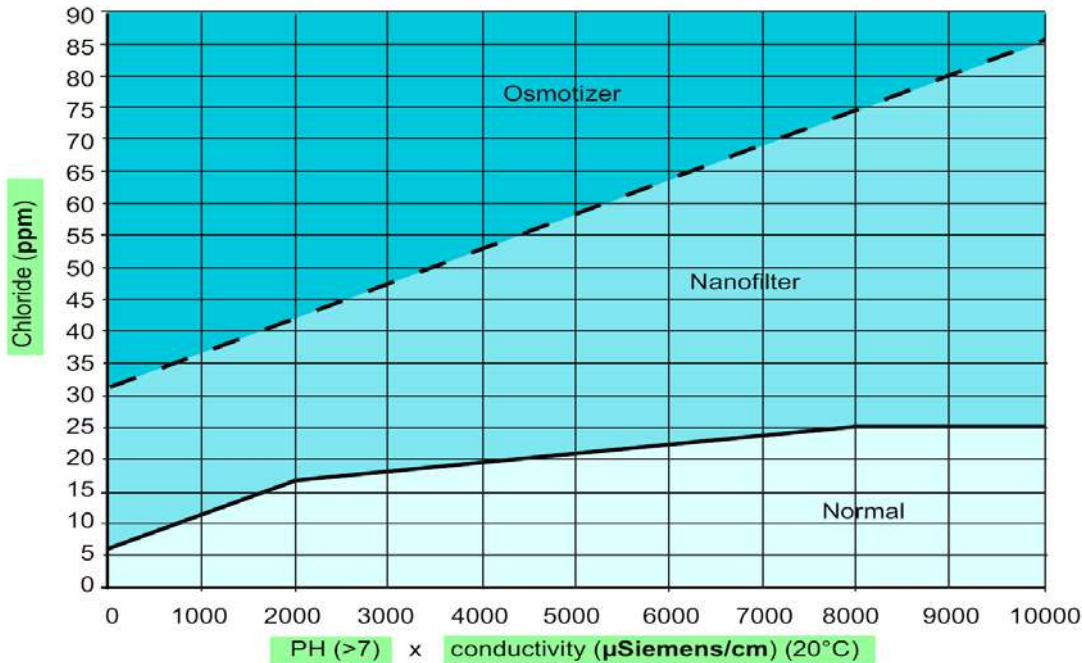

LEVEL K (ISG - WITH INSTANT STEAM GENERATOR)

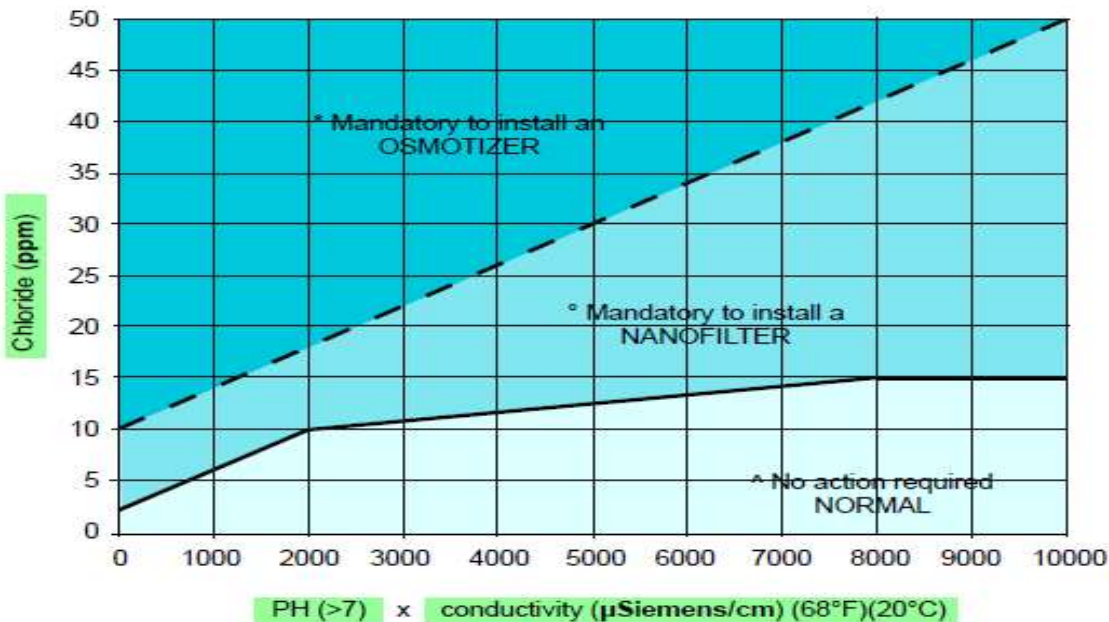

If the water net is not treated according the indication of the handbook, the corrosion risk and the possibility of problems of the boiler is increased.



For a better explanation about the water characteristics and treatment see relevant technical bulletin attached.

14 “Cleaning” environment



Press the icon “Cleaning” to enter in the cleaning cycles environment

You can select 4 different automatic cleaning cycles or/and to activate the green function utility

14.1 Automatic cleanings cycles: phases

Each cleaning cycle can be divided in 2 phases:

- ✓ **Phase A:** cleaning phase controlled by the parameters **CLT1** (detergent injection time) and **CLT2** (water + detergent injection time);
- ✓ **Phase B:** rinse and dry phase controlled by the parameters **CLT3** (rinse injection time) and **CLT4** (water injection time).

Here below each cycle with the phase’s sequence:

Cycle	Sequence of the phases
SOFT	A+B
MEDIUM	2A+B
STRONG	4A +B
EXTRA - STRONG	6A+B

To have the max efficiency of the cleaning system, verify that:

- ✓ Dynamic water pressure (measured with the cleaning ON): 1,5 – 4,5bar
- ✓ Water flow speed, measured through the cleaning arm speed: 100 – 120 rpm;
- ✓ Detergent and rinse type used (see handbook for the suggested type).

Зип Общепит

vsezip.ru

+7(812)987-08-81

14.2 Green utilities



Press the "Green function" bar

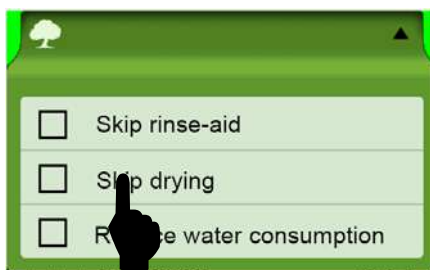
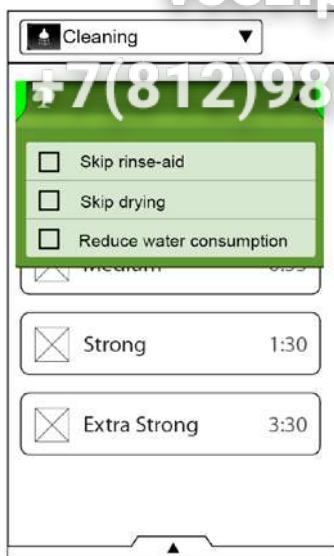

Press one or more utilities

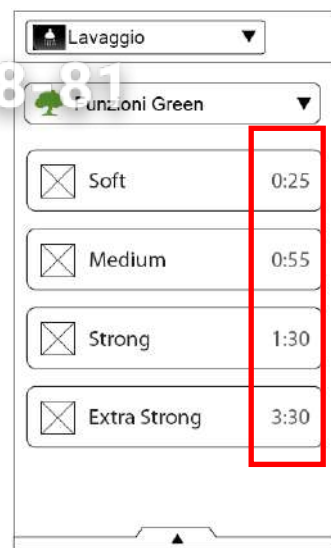

The cycle's time will be reduced according the green utilities activated

ICON	UTILITY	DESCRIPTION	NOTES
	SKIP RINSE-AID	To disable the rinse phase	It's possible that traces of scale might remain in the chamber after cleaning.
	SKIP DRYING	To disable the drying phase at the end of the cleaning cycle	It's suggested to open the door after cleaning to allow the oven to ventilate.
	REDUCE WATER CONSUMPTION	To disable the air-break quenching system (cold water injection in the air-break).	It's suggested to have a properly ventilation system activated due to the steam produced during the cycle from the air-break

Зип Общепит
vsezip.ru

15 Lambda probe functionality and humidity measure

15.1 Base informations

Since the Oxygen/Nitrogen ratio in the air is constant, a measurement of the concentration of oxygen enables the percentage of a third gas (in this case water vapor) to be determined. In fact the addition of a third gas to a sample of air has the effect of reducing in a proportional manner the presence of oxygen and nitrogen so that, as said, determining the relative concentration of oxygen allows the amount of the third introduced gas of the mixture to be determined (see the diagram).

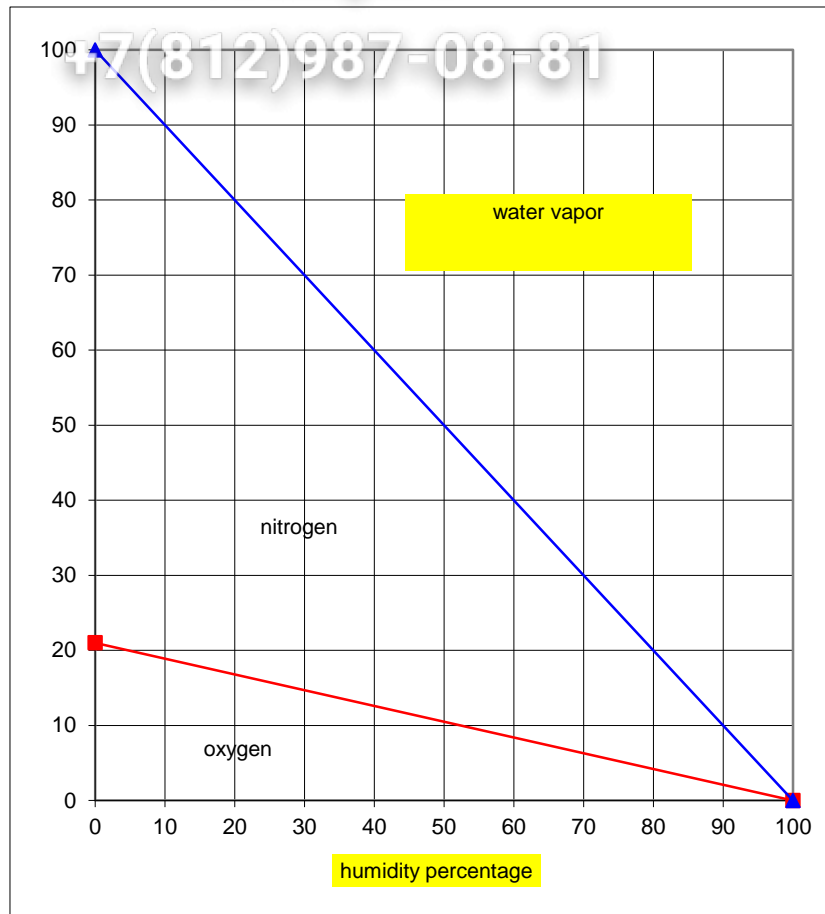

15.2 Lambda probe

The lambda probe permits measurement of oxygen concentration through a solid electrolyte (ceramic element). The ceramic part of the probe is in the form of a tube closed at one end. The inside and outside surfaces of the ceramic sensor have a micro porous platinum layer (electrode). The platinum layer, which is in contact with the analyzed gas, is covered with a highly porous protective ceramic layer.

The ceramic sensor (ZrOB2 – solid electrolyte) is heated from inside by means of a ceramic heater so that the temperature of the ceramic sensor remains above 350 °C. Starting from 300°C, the ZrOB2B sensor becomes conductive for the oxygen ions so that if there is a different concentration of oxygen at the two sides of the sensors (one side is in contact with the analyzed gas, the other side is in contact with the external), a voltage is generated.

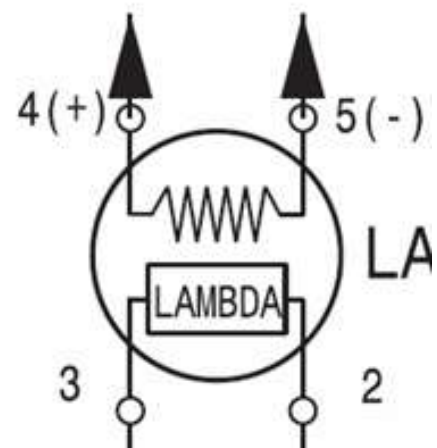

15.3 Lambda probe connectors

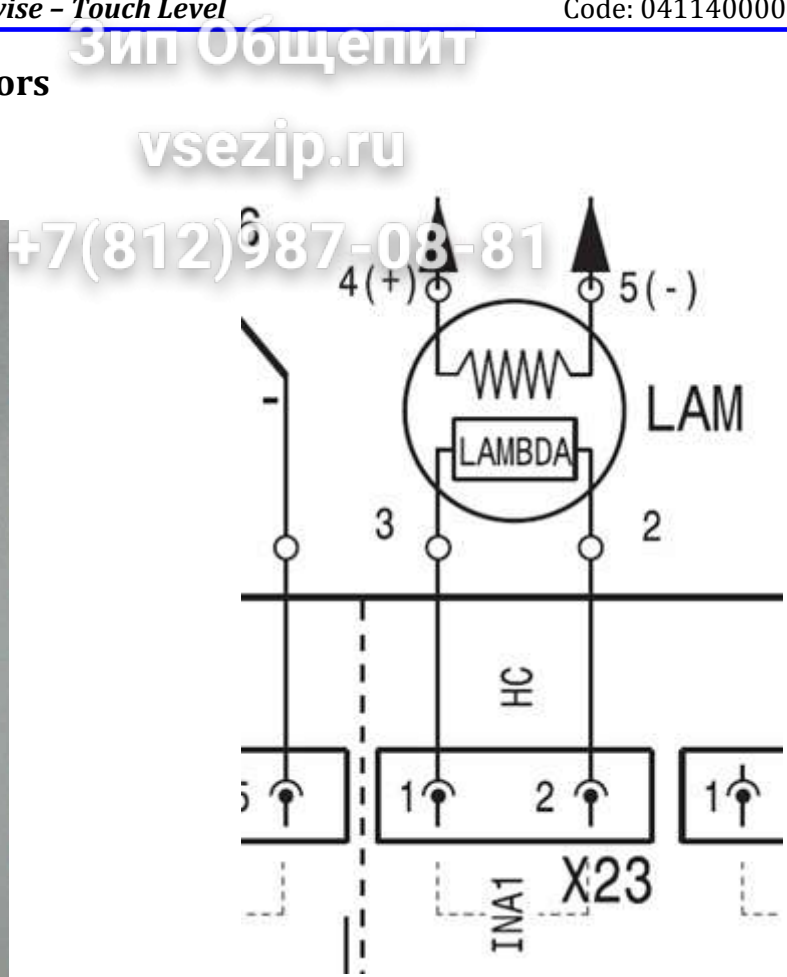

PIN	CONNECTION	DESCRIPTION
1	NOT USED	-
2 e 3	Connection with main power (connector X23)	Standard output range: -10...600mV With a value out of the range (-50...1200mV) the oven display the ELMB error
4 e 5	Connection with the switching feeder in direct current	Pin 4 positive and Pin 5 negative. (connected to the oven ground) Supply voltage: about 9.5volt



ATTENTION: the lambda component works with a temperature of about 350°C. With the probe cold (for example after a cleaning cycle or in the morning) the signal can be out of the range and the oven display the warning ELMB.

As soon as the probe is hot, the output signal will be within the range and the warning disappears.

16 Cleaning behind suction wall

THIS CHAPTER REFERS ONLY TO THE UNITS PROVIDED WITH THIS EXTRA FEATURE

This units are provided by an additional detergent injection system on the back of the suction wall (Cavity Fan area), such as also this area is cleaned during the automatic cleaning cycle.

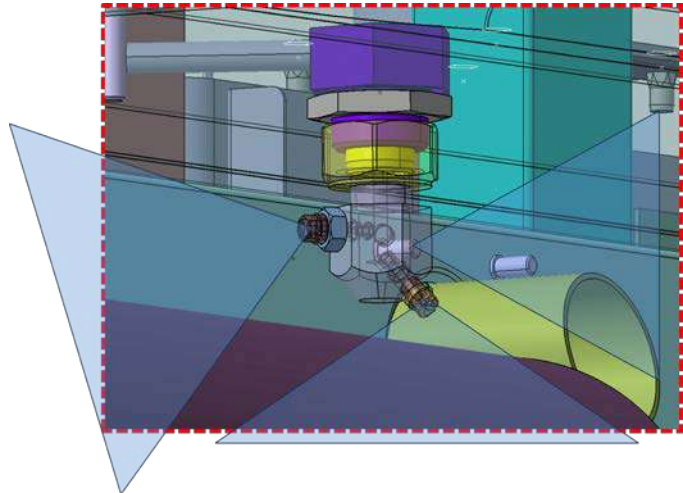
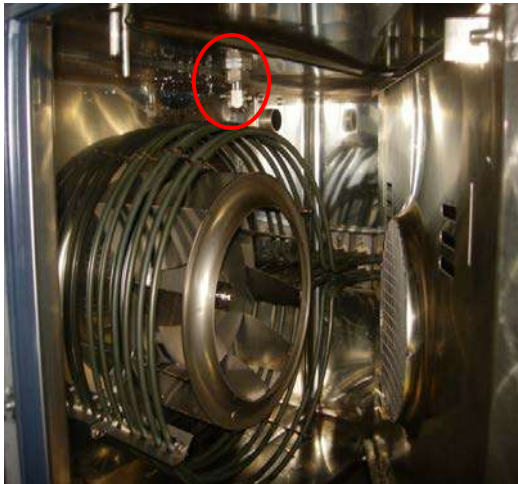

HYDRAULIC CIRCUIT:

New oven models in production with additional injection system on the back of the suction wall (ONLY DETERGENT). Starting from standard oven models, it has been designed an additional injection system and obtained a dedicated oven models (specific PNC's).

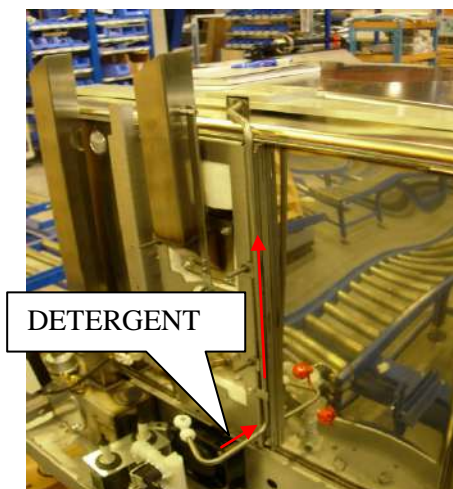
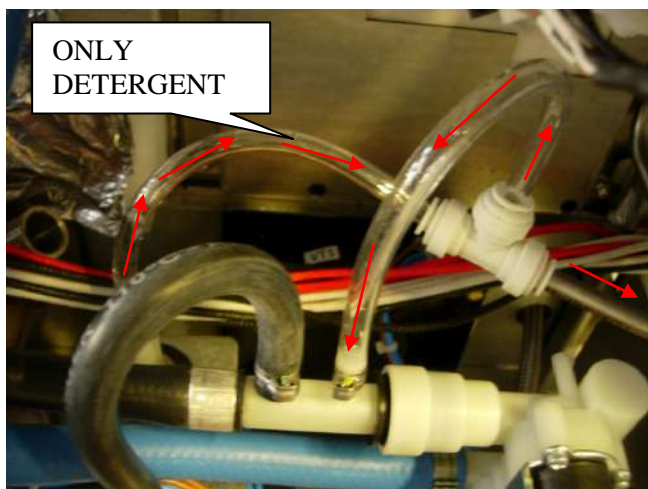



New cleaning parameters values on Clt1, Clt2 (related to detergent pump), according to parameter list (available in Pride- software version 6.20).

Note: in case the cleaning result is not satisfactory with the values of detergent injection given in the parameter list, it is possible to increase the time activation of the detergent pump.

Do not increase more than 1,5 sec from the original value given for ovens without cleaning behind the suction wall. Risk to waste detergent without any significant improvement on cleaning results.

17 Alarm and warning codes

17.1 Alarm table (the alarm stops the oven)

NAME	DESCRIPTION
EE2P	Comunication error with EEPROM
ETUC	Alarm cavity over temperature (see reference parameter nr.28 COT).
ETUB	Allarme boiler over temperature (see reference parameter nr.29 BOT).
EFUP	Thermic protection of the upper cavity motor. There is an automatic reset of the protection but the user/service must to reset to 0 the parameter nr.19 ALFN .
EFDW	Thermic protection of the lower cavity motor. There is an automatic reset of the protection but the user/service must to reset to 0 the parameter nr.19 ALFN .
ETC	Cavity safety thermostat
ETB	Boiler Cavity safety thermostat
ESCH	Main power board over temperature. Check the cooling fan and the air circulation (example the bottom part of the control panel).
ECEL	Cavity probe interrupted (it's possible to use the oven only with steam cycle - 100°C)
EBOL	Boiler probe interrupted (it's possible to use the oven only with convection cycle)
EPRB	Meat probe interrupted (it's possible to use only with cooking cycle with time set)
EBYP	Bypass probe interrupted (it's possible to use the oven only with convection, regenerating and lower steam cooking cycles)
ENTC	NTC probe interrupted. Power board temperature sensor (on board). Replace the power board
ECAD EAD1 EAD2 EAD3 EAD4 EAD5	Analogic / Digital converter locked. Check input signal of all temperature probes, food probe, lambda sensor. Verify the oven is correctly set as level Touch or level K by the related parameter APPL. Replace power board if the problem persist.
ERTC	No communication with the internal clock.
EPWM	Communication error with the PWM system. Burner fan speed control. Replace power board.
ESL	Water level probe error (probes in short circuit). If the boiler heating elements or burners are ON for a time over the value defined in parameter TBON without a water charging phase, this error message is activated. To reset it, parameter ALFN has to be reset to 0.
ECUP (gas ovens)	UPPER cavity burner lock (6, 10 grids and upper burner in the 20 grids)
ECDW (gas ovens)	LOWER cavity burner lock (lower burner in the 20 grids oven)
EBUP (gas ovens)	UPPER boiler burner lock (6, 10 grids and upper burner in the 20 grids)
EBDW	LOWER boiler burner lock (lower burner in the 20 grids oven)

<i>(gas ovens)</i>	
PVAL	Error due to a wrong value in the parameter list (out of the range)
PDEF	Default parameters procedure automatically done (example after a replacement of the user touch). After the default procedure, turn OFF and ON the oven and the error disappears.
EPWR	Communication error with the main power. Verify that the green and orange led are blinking together with the oven on. If the green led is blinking and the orange is off, the power board must be changed since it is not responding. If the orange led is blinking and the green one is off, the user interface must be changed.

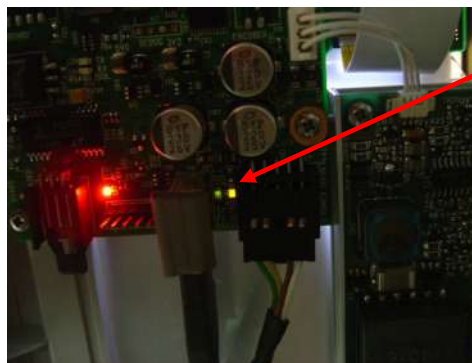

LED2-3

17.2 Warning table (the warning doesn't stop the oven)

NAME	DESCRIPTION
EH20	Low dynamic water pressure. Check: <ul style="list-style-type: none"> ✓ water pressure (min 1.5bar with a cleaning cycle ON); ✓ the pressostat switch; ✓ if there are obstructions in the supply water inlet pipe of the cleaning system.
EFLP	Cavity ventilation flap error. If the motoreducer does not close the flap within 20 seconds, the error appears. Check the motoreducer or the micro switch that detects the close position of the flap.
ELMB	Error lambda probe: output value out of the range [-50mV ; 1200mV] for over 24secs. The error doesn't stop the cooking cycle and it disappears when the value go inside the range.
EPRG	Multiphase cooking: error in the phase reading
EIND	Error in the programs index
EDES	Error in the program description
ERAM	Communication error with RAM