

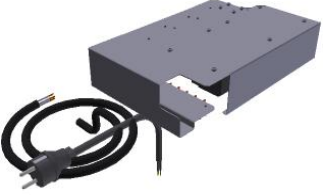

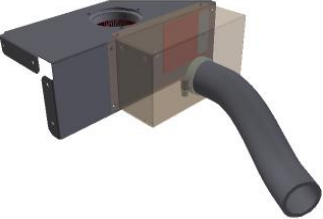
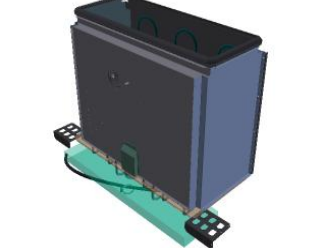

3ип.Общепит
XEBDC-01EU-D/0.D02 INTEGRATED CONTROL DECKTOP OVEN 1 60X40

vsezip.ru

+7(812)987-08-81

Assembly code	Assembly revision	Assembly image
ASM4039A/0.D00	Door	
ASM4070A/0.D00	General overview	
ASM1668A/0.D00	General overview	
ASM1603A/0.D03	Cooking chamber	
ASM4038A/0.D01	External cover	



Зип Общепит
vsezip.ru

SPARE PARTS LIST

ASM4039A/0.D00 Door

+7(812)987-08-81
ASM4039A/0.D00 - Door

FRONT

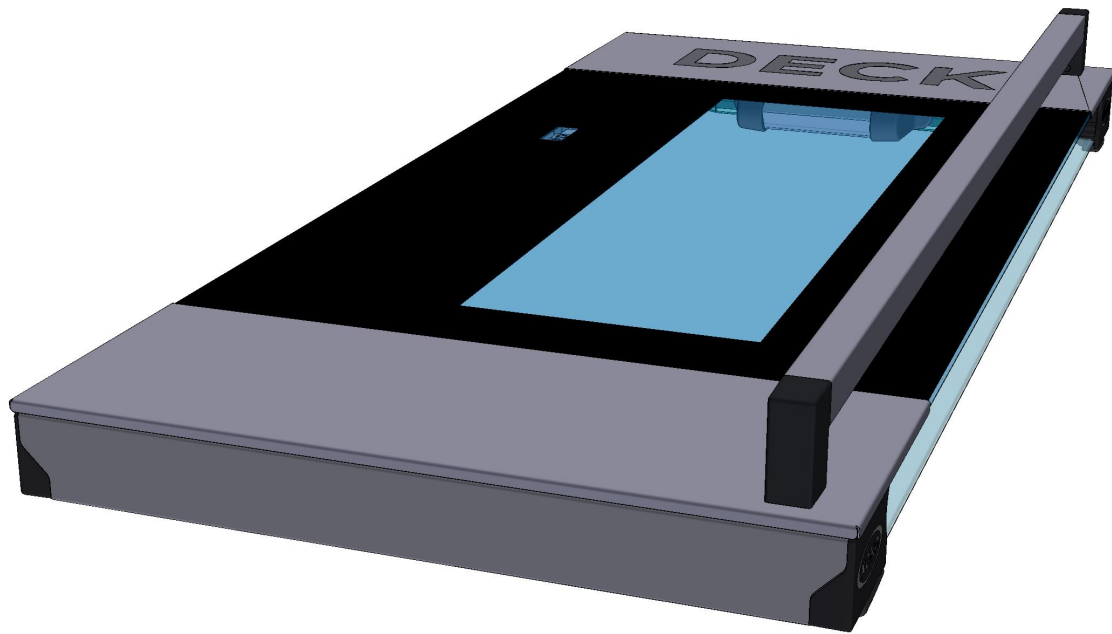



Зип Общепит
vsezip.ru

SPARE PARTS LIST



ASM4039A/0.D00 Door

+7(812)987-08-81
ASM4039A/0.D00 - Door

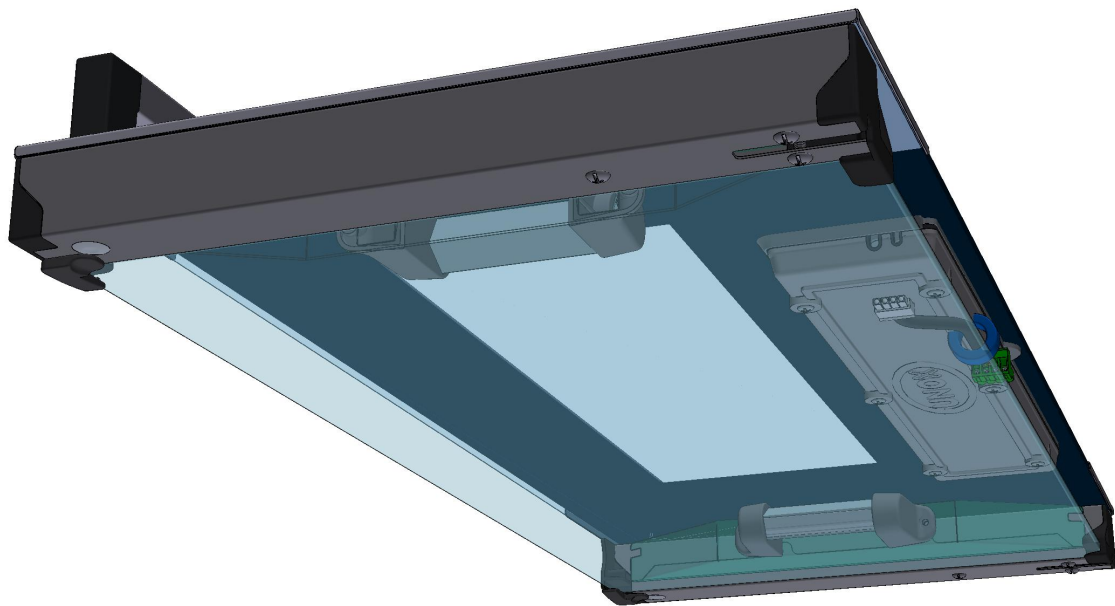
REAR

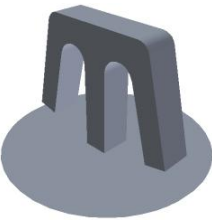

+7(812)987-08-81

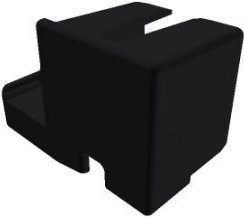
COMPONENT			SPARE PART																																																						
Code	Description	Image	Code	Description	Components list																																																				
VM1025A	Ø16 GREY NYLON LI		KVM1025A	GREY NYLON CAPS 20 PCS KIT	<table border="1"> <thead> <tr> <th>Code</th> <th>Description</th> <th>Qty</th> <th>UOM</th> </tr> </thead> <tbody> <tr> <td>VM1025A0</td> <td>Ø16 GREY NYLON LID</td> <td>20</td> <td>PZ</td> </tr> </tbody> </table>	Code	Description	Qty	UOM	VM1025A0	Ø16 GREY NYLON LID	20	PZ																																												
Code	Description	Qty	UOM																																																						
VM1025A0	Ø16 GREY NYLON LID	20	PZ																																																						
VI1855A	5X25 SELF-TAPPING SCREW		KVI1855A	5X25 SELF-TAPPING SCREW 20 PCS.	<table border="1"> <thead> <tr> <th>Code</th> <th>Description</th> <th>Qty</th> <th>UOM</th> </tr> </thead> <tbody> <tr> <td>VI1855A0</td> <td>5X25 SELF-TAPPING SCREW</td> <td>20</td> <td>PZ</td> </tr> </tbody> </table>	Code	Description	Qty	UOM	VI1855A0	5X25 SELF-TAPPING SCREW	20	PZ																																												
Code	Description	Qty	UOM																																																						
VI1855A0	5X25 SELF-TAPPING SCREW	20	PZ																																																						
VM1918A	RIGHT LOWER COLUMN CAP		KVT1253A	XF195-EG- VT1253A EXTERNAL GLASS KIT	<table border="1"> <thead> <tr> <th>Code</th> <th>Description</th> <th>Qty</th> <th>UOM</th> </tr> </thead> <tbody> <tr> <td>IP1235B0</td> <td>POLYSTYREN E FLAT PACKING</td> <td>1</td> <td>PZ</td> </tr> <tr> <td>RC1200A0</td> <td>ED=4 WIRE D.=0.5 COMPRESSIO N SPRING</td> <td>2</td> <td>PZ</td> </tr> <tr> <td>SL1050A1</td> <td>3M TRANSFER ADHESIVE TAPE</td> <td>0.820</td> <td>M</td> </tr> <tr> <td>TB2301A0</td> <td>RIGHT COLUMN XVC105E 40X40X1</td> <td>2</td> <td>PZ</td> </tr> <tr> <td>TB3081A0</td> <td>LMISS ARIANNA/ROS SELLA DOOR LEFT COLUMN</td> <td>1</td> <td>PZ</td> </tr> <tr> <td>VM1025A0</td> <td>Ø16 GREY NYLON LID</td> <td>2</td> <td>PZ</td> </tr> <tr> <td>VM1695A0</td> <td>HANDLE POSITION PIN</td> <td>2</td> <td>PZ</td> </tr> <tr> <td>VM1916A0</td> <td>RIGHT UPPER COLUMN CAP</td> <td>1</td> <td>PZ</td> </tr> <tr> <td>VM1917A0</td> <td>LEFT UPPER COLUMN CAP</td> <td>1</td> <td>PZ</td> </tr> <tr> <td>VM1918A0</td> <td>RIGHT LOWER COLUMN CAP</td> <td>1</td> <td>PZ</td> </tr> <tr> <td>VM1919A0</td> <td>LEFT LOWER COLUMN CAP</td> <td>1</td> <td>PZ</td> </tr> <tr> <td>VM1920A0</td> <td>INTERNAL GLASS CLOSING RIGHT PLATE</td> <td>1</td> <td>PZ</td> </tr> </tbody> </table>	Code	Description	Qty	UOM	IP1235B0	POLYSTYREN E FLAT PACKING	1	PZ	RC1200A0	ED=4 WIRE D.=0.5 COMPRESSIO N SPRING	2	PZ	SL1050A1	3M TRANSFER ADHESIVE TAPE	0.820	M	TB2301A0	RIGHT COLUMN XVC105E 40X40X1	2	PZ	TB3081A0	LMISS ARIANNA/ROS SELLA DOOR LEFT COLUMN	1	PZ	VM1025A0	Ø16 GREY NYLON LID	2	PZ	VM1695A0	HANDLE POSITION PIN	2	PZ	VM1916A0	RIGHT UPPER COLUMN CAP	1	PZ	VM1917A0	LEFT UPPER COLUMN CAP	1	PZ	VM1918A0	RIGHT LOWER COLUMN CAP	1	PZ	VM1919A0	LEFT LOWER COLUMN CAP	1	PZ	VM1920A0	INTERNAL GLASS CLOSING RIGHT PLATE	1	PZ
Code	Description	Qty	UOM																																																						
IP1235B0	POLYSTYREN E FLAT PACKING	1	PZ																																																						
RC1200A0	ED=4 WIRE D.=0.5 COMPRESSIO N SPRING	2	PZ																																																						
SL1050A1	3M TRANSFER ADHESIVE TAPE	0.820	M																																																						
TB2301A0	RIGHT COLUMN XVC105E 40X40X1	2	PZ																																																						
TB3081A0	LMISS ARIANNA/ROS SELLA DOOR LEFT COLUMN	1	PZ																																																						
VM1025A0	Ø16 GREY NYLON LID	2	PZ																																																						
VM1695A0	HANDLE POSITION PIN	2	PZ																																																						
VM1916A0	RIGHT UPPER COLUMN CAP	1	PZ																																																						
VM1917A0	LEFT UPPER COLUMN CAP	1	PZ																																																						
VM1918A0	RIGHT LOWER COLUMN CAP	1	PZ																																																						
VM1919A0	LEFT LOWER COLUMN CAP	1	PZ																																																						
VM1920A0	INTERNAL GLASS CLOSING RIGHT PLATE	1	PZ																																																						



Зип Общепит
vsezip.ru

SPARE PARTS LIST

ASM4039A/0.D00 Door

+7(812)987-08-81

COMPONENT

SPARE PART

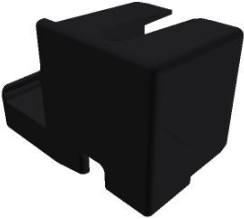
Code	Description	Image	Code	Description	Components list																																																																					
VM1918A	RIGHT LOWER COLUMN CAP		KVT1253A	XF195-EG- VT1253A EXTERNAL GLASS KIT	<table border="1"> <thead> <tr> <th>Code</th> <th>Description</th> <th>Qty</th> <th>UOM</th> </tr> </thead> <tbody> <tr> <td>VM1921A0</td> <td>INTERNAL GLASS CLOSING LEFT PLATE</td> <td>1</td> <td>PZ</td> </tr> <tr> <td>VT1253A0</td> <td>XFT195 DOOR EXT. BLACK GLASS - ENGEFOOD</td> <td>1</td> <td>PZ</td> </tr> </tbody> </table>	Code	Description	Qty	UOM	VM1921A0	INTERNAL GLASS CLOSING LEFT PLATE	1	PZ	VT1253A0	XFT195 DOOR EXT. BLACK GLASS - ENGEFOOD	1	PZ																																																									
			Code	Description	Qty	UOM																																																																				
VM1921A0	INTERNAL GLASS CLOSING LEFT PLATE	1	PZ																																																																							
VT1253A0	XFT195 DOOR EXT. BLACK GLASS - ENGEFOOD	1	PZ																																																																							
KVT1072A	L.M. ROSSELLA BLACK EXTERNAL GLASS KIT	<table border="1"> <thead> <tr> <th>Code</th> <th>Description</th> <th>Qty</th> <th>UOM</th> </tr> </thead> <tbody> <tr> <td>IP1385A1</td> <td>CORNER POLYSTYREN E PACKING 110X80X2000</td> <td>0.960</td> <td>M</td> </tr> <tr> <td>IP1508A0</td> <td></td> <td>1.280</td> <td>PZ</td> </tr> <tr> <td>IP1508A1</td> <td>POLYSTYREN E U SHAPED PROFILE 2000X60X60</td> <td>1.270</td> <td>M</td> </tr> <tr> <td>RC1200A0</td> <td>ED=4 WIRE D.=0.5 COMPRESSION SPRING</td> <td>2</td> <td>PZ</td> </tr> <tr> <td>SL1050A1</td> <td>3M TRANSFER ADHESIVE TAPE</td> <td>0.820</td> <td>M</td> </tr> <tr> <td>TB2301A0</td> <td>RIGHT COLUMN XVC105E 40X40X1</td> <td>2</td> <td>PZ</td> </tr> <tr> <td>TB3081A0</td> <td>LMISS ARIANNA/ROS SELLA DOOR LEFT COLUMN</td> <td>1</td> <td>PZ</td> </tr> <tr> <td>VM1025A0</td> <td>Ø16 GREY NYLON LID</td> <td>2</td> <td>PZ</td> </tr> <tr> <td>VM1059A1</td> <td>HEAT SHRINK FILM H800</td> <td>1.300</td> <td>M</td> </tr> <tr> <td>VM1695A0</td> <td>HANDLE POSITION PIN</td> <td>2</td> <td>PZ</td> </tr> <tr> <td>VM1916A0</td> <td>RIGHT UPPER COLUMN CAP</td> <td>1</td> <td>PZ</td> </tr> <tr> <td>VM1917A0</td> <td>LEFT UPPER COLUMN CAP</td> <td>1</td> <td>PZ</td> </tr> <tr> <td>VM1918A0</td> <td>RIGHT LOWER COLUMN CAP</td> <td>1</td> <td>PZ</td> </tr> <tr> <td>VM1919A0</td> <td>LEFT LOWER COLUMN CAP</td> <td>1</td> <td>PZ</td> </tr> <tr> <td>VM1920A0</td> <td>INTERNAL GLASS CLOSING RIGHT PLATE</td> <td>1</td> <td>PZ</td> </tr> <tr> <td>VM1921A0</td> <td>INTERNAL GLASS CLOSING LEFT PLATE</td> <td>1</td> <td>PZ</td> </tr> <tr> <td>VT1072A0</td> <td>LINEMISS ROSSELLA BLACK EXTERNAL GLASS</td> <td>1</td> <td>PZ</td> </tr> </tbody> </table>	Code	Description	Qty	UOM	IP1385A1	CORNER POLYSTYREN E PACKING 110X80X2000	0.960	M	IP1508A0		1.280	PZ	IP1508A1	POLYSTYREN E U SHAPED PROFILE 2000X60X60	1.270	M	RC1200A0	ED=4 WIRE D.=0.5 COMPRESSION SPRING	2	PZ	SL1050A1	3M TRANSFER ADHESIVE TAPE	0.820	M	TB2301A0	RIGHT COLUMN XVC105E 40X40X1	2	PZ	TB3081A0	LMISS ARIANNA/ROS SELLA DOOR LEFT COLUMN	1	PZ	VM1025A0	Ø16 GREY NYLON LID	2	PZ	VM1059A1	HEAT SHRINK FILM H800	1.300	M	VM1695A0	HANDLE POSITION PIN	2	PZ	VM1916A0	RIGHT UPPER COLUMN CAP	1	PZ	VM1917A0	LEFT UPPER COLUMN CAP	1	PZ	VM1918A0	RIGHT LOWER COLUMN CAP	1	PZ	VM1919A0	LEFT LOWER COLUMN CAP	1	PZ	VM1920A0	INTERNAL GLASS CLOSING RIGHT PLATE	1	PZ	VM1921A0	INTERNAL GLASS CLOSING LEFT PLATE	1	PZ	VT1072A0	LINEMISS ROSSELLA BLACK EXTERNAL GLASS	1	PZ
Code	Description	Qty	UOM																																																																							
IP1385A1	CORNER POLYSTYREN E PACKING 110X80X2000	0.960	M																																																																							
IP1508A0		1.280	PZ																																																																							
IP1508A1	POLYSTYREN E U SHAPED PROFILE 2000X60X60	1.270	M																																																																							
RC1200A0	ED=4 WIRE D.=0.5 COMPRESSION SPRING	2	PZ																																																																							
SL1050A1	3M TRANSFER ADHESIVE TAPE	0.820	M																																																																							
TB2301A0	RIGHT COLUMN XVC105E 40X40X1	2	PZ																																																																							
TB3081A0	LMISS ARIANNA/ROS SELLA DOOR LEFT COLUMN	1	PZ																																																																							
VM1025A0	Ø16 GREY NYLON LID	2	PZ																																																																							
VM1059A1	HEAT SHRINK FILM H800	1.300	M																																																																							
VM1695A0	HANDLE POSITION PIN	2	PZ																																																																							
VM1916A0	RIGHT UPPER COLUMN CAP	1	PZ																																																																							
VM1917A0	LEFT UPPER COLUMN CAP	1	PZ																																																																							
VM1918A0	RIGHT LOWER COLUMN CAP	1	PZ																																																																							
VM1919A0	LEFT LOWER COLUMN CAP	1	PZ																																																																							
VM1920A0	INTERNAL GLASS CLOSING RIGHT PLATE	1	PZ																																																																							
VM1921A0	INTERNAL GLASS CLOSING LEFT PLATE	1	PZ																																																																							
VT1072A0	LINEMISS ROSSELLA BLACK EXTERNAL GLASS	1	PZ																																																																							

+7(812)987-08-81

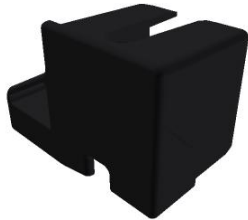
COMPONENT			SPARE PART																																																																																					
Code	Description	Image	Code	Description	Components list																																																																																			
VM1918A	RIGHT LOWER COLUMN CAP		KVT1071A	L.M. ROSSELLA EXTERNAL GLASS KIT	<table border="1"> <thead> <tr> <th>Code</th> <th>Description</th> <th>Qty</th> <th>UOM</th> </tr> </thead> <tbody> <tr> <td>IP1385A1</td> <td>CORNER POLYSTYREN E PACKING 110X80X2000</td> <td>0.960</td> <td>M</td> </tr> <tr> <td>IP1508A0</td> <td></td> <td>1.300</td> <td>PZ</td> </tr> <tr> <td>IP1508A1</td> <td>POLYSTYREN E U SHAPED PROFILE 2000X60X60</td> <td>2</td> <td>M</td> </tr> <tr> <td>RC1200A0</td> <td>ED=4 WIRE D.=0.5 COMPRESSIO N SPRING</td> <td>2</td> <td>PZ</td> </tr> <tr> <td>SL1050A1</td> <td>3M TRANSFER ADHESIVE TAPE</td> <td>0.820</td> <td>M</td> </tr> <tr> <td>TB2301A0</td> <td>RIGHT COLUMN XVC105E 40X40X1</td> <td>2</td> <td>PZ</td> </tr> <tr> <td>VM1025A0</td> <td>Ø16 GREY NYLON LID</td> <td>2</td> <td>PZ</td> </tr> <tr> <td>VM1059A1</td> <td>HEAT SHRINK FILM H800</td> <td>1.350</td> <td>M</td> </tr> <tr> <td>VM1695A0</td> <td>HANDLE POSITION PIN</td> <td>2</td> <td>PZ</td> </tr> <tr> <td>VM1916A0</td> <td>RIGHT UPPER COLUMN CAP</td> <td>1</td> <td>PZ</td> </tr> <tr> <td>VM1917A0</td> <td>LEFT UPPER COLUMN CAP</td> <td>1</td> <td>PZ</td> </tr> <tr> <td>VM1918A0</td> <td>RIGHT LOWER COLUMN CAP</td> <td>1</td> <td>PZ</td> </tr> <tr> <td>VM1919A0</td> <td>LEFT LOWER COLUMN CAP</td> <td>1</td> <td>PZ</td> </tr> <tr> <td>VM1920A0</td> <td>INTERNAL GLASS CLOSING RIGHT PLATE</td> <td>1</td> <td>PZ</td> </tr> <tr> <td>VM1921A0</td> <td>INTERNAL GLASS CLOSING LEFT PLATE</td> <td>1</td> <td>PZ</td> </tr> <tr> <td>VT1071A2</td> <td>YELLOW SER GLASS 798X424X5</td> <td>1</td> <td>PZ</td> </tr> </tbody> </table>	Code	Description	Qty	UOM	IP1385A1	CORNER POLYSTYREN E PACKING 110X80X2000	0.960	M	IP1508A0		1.300	PZ	IP1508A1	POLYSTYREN E U SHAPED PROFILE 2000X60X60	2	M	RC1200A0	ED=4 WIRE D.=0.5 COMPRESSIO N SPRING	2	PZ	SL1050A1	3M TRANSFER ADHESIVE TAPE	0.820	M	TB2301A0	RIGHT COLUMN XVC105E 40X40X1	2	PZ	VM1025A0	Ø16 GREY NYLON LID	2	PZ	VM1059A1	HEAT SHRINK FILM H800	1.350	M	VM1695A0	HANDLE POSITION PIN	2	PZ	VM1916A0	RIGHT UPPER COLUMN CAP	1	PZ	VM1917A0	LEFT UPPER COLUMN CAP	1	PZ	VM1918A0	RIGHT LOWER COLUMN CAP	1	PZ	VM1919A0	LEFT LOWER COLUMN CAP	1	PZ	VM1920A0	INTERNAL GLASS CLOSING RIGHT PLATE	1	PZ	VM1921A0	INTERNAL GLASS CLOSING LEFT PLATE	1	PZ	VT1071A2	YELLOW SER GLASS 798X424X5	1	PZ	KVT1067A	L.M. ELENA BLACK EXTERNAL GLASS KIT	<table border="1"> <thead> <tr> <th>Code</th> <th>Description</th> <th>Qty</th> <th>UOM</th> </tr> </thead> <tbody> <tr> <td>IP1385A1</td> <td>CORNER POLYSTYREN E PACKING 110X80X2000</td> <td>0.800</td> <td>M</td> </tr> <tr> <td>IP1508A0</td> <td></td> <td>1.710</td> <td>PZ</td> </tr> </tbody> </table>	Code	Description	Qty	UOM	IP1385A1	CORNER POLYSTYREN E PACKING 110X80X2000	0.800	M	IP1508A0		1.710	PZ
			Code	Description	Qty	UOM																																																																																		
IP1385A1	CORNER POLYSTYREN E PACKING 110X80X2000	0.960	M																																																																																					
IP1508A0		1.300	PZ																																																																																					
IP1508A1	POLYSTYREN E U SHAPED PROFILE 2000X60X60	2	M																																																																																					
RC1200A0	ED=4 WIRE D.=0.5 COMPRESSIO N SPRING	2	PZ																																																																																					
SL1050A1	3M TRANSFER ADHESIVE TAPE	0.820	M																																																																																					
TB2301A0	RIGHT COLUMN XVC105E 40X40X1	2	PZ																																																																																					
VM1025A0	Ø16 GREY NYLON LID	2	PZ																																																																																					
VM1059A1	HEAT SHRINK FILM H800	1.350	M																																																																																					
VM1695A0	HANDLE POSITION PIN	2	PZ																																																																																					
VM1916A0	RIGHT UPPER COLUMN CAP	1	PZ																																																																																					
VM1917A0	LEFT UPPER COLUMN CAP	1	PZ																																																																																					
VM1918A0	RIGHT LOWER COLUMN CAP	1	PZ																																																																																					
VM1919A0	LEFT LOWER COLUMN CAP	1	PZ																																																																																					
VM1920A0	INTERNAL GLASS CLOSING RIGHT PLATE	1	PZ																																																																																					
VM1921A0	INTERNAL GLASS CLOSING LEFT PLATE	1	PZ																																																																																					
VT1071A2	YELLOW SER GLASS 798X424X5	1	PZ																																																																																					
Code	Description	Qty	UOM																																																																																					
IP1385A1	CORNER POLYSTYREN E PACKING 110X80X2000	0.800	M																																																																																					
IP1508A0		1.710	PZ																																																																																					

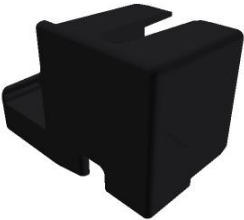

+7(812)987-08-81

COMPONENT			SPARE PART																																																																																	
Code	Description	Image	Code	Description	Components list																																																																															
VM1918A	RIGHT LOWER COLUMN CAP		KVT1067A	L.M. ELENA BLACK EXTERNAL GLASS KIT	<table border="1"> <thead> <tr> <th>Code</th> <th>Description</th> <th>Qty</th> <th>UOM</th> </tr> </thead> <tbody> <tr> <td>IP1508A1</td> <td>POLYSTYREN E U SHAPED PROFILE 2000X60X60</td> <td>2</td> <td>M</td> </tr> <tr> <td>RC1200A0</td> <td>ED=4 WIRE D.=0.5 COMPRESSIO N SPRING</td> <td>2</td> <td>PZ</td> </tr> <tr> <td>SL1050A1</td> <td>3M TRANSFER ADHESIVE TAPE</td> <td>0.660</td> <td>M</td> </tr> <tr> <td>TB2306A0</td> <td>LMISS STEFANIA/ELE NA DOOR RIGHT COLUM</td> <td>2</td> <td>PZ</td> </tr> <tr> <td>TB3080A0</td> <td>LMISS STEFANIA/ELE NA DOOR LEFT COLUMN</td> <td>1</td> <td>PZ</td> </tr> <tr> <td>VM1025A0</td> <td>Ø16 GREY NYLON LID</td> <td>2</td> <td>PZ</td> </tr> <tr> <td>VM1059A1</td> <td>HEAT SHRINK FILM H800</td> <td>1.350</td> <td>M</td> </tr> <tr> <td>VM1695A0</td> <td>HANDLE POSITION PIN</td> <td>2</td> <td>PZ</td> </tr> <tr> <td>VM1916A0</td> <td>RIGHT UPPER COLUMN CAP</td> <td>1</td> <td>PZ</td> </tr> <tr> <td>VM1917A0</td> <td>LEFT UPPER COLUMN CAP</td> <td>1</td> <td>PZ</td> </tr> <tr> <td>VM1918A0</td> <td>RIGHT LOWER COLUMN CAP</td> <td>1</td> <td>PZ</td> </tr> <tr> <td>VM1919A0</td> <td>LEFT LOWER COLUMN CAP</td> <td>1</td> <td>PZ</td> </tr> <tr> <td>VM1920A0</td> <td>INTERNAL GLASS CLOSING RIGHT PLATE</td> <td>1</td> <td>PZ</td> </tr> <tr> <td>VM1921A0</td> <td>INTERNAL GLASS CLOSING LEFT PLATE</td> <td>1</td> <td>PZ</td> </tr> <tr> <td>VT1067A0</td> <td>LINEMISS ELENA BLACK EXTERNAL DOOR GLASS</td> <td>1</td> <td>PZ</td> </tr> </tbody> </table>	Code	Description	Qty	UOM	IP1508A1	POLYSTYREN E U SHAPED PROFILE 2000X60X60	2	M	RC1200A0	ED=4 WIRE D.=0.5 COMPRESSIO N SPRING	2	PZ	SL1050A1	3M TRANSFER ADHESIVE TAPE	0.660	M	TB2306A0	LMISS STEFANIA/ELE NA DOOR RIGHT COLUM	2	PZ	TB3080A0	LMISS STEFANIA/ELE NA DOOR LEFT COLUMN	1	PZ	VM1025A0	Ø16 GREY NYLON LID	2	PZ	VM1059A1	HEAT SHRINK FILM H800	1.350	M	VM1695A0	HANDLE POSITION PIN	2	PZ	VM1916A0	RIGHT UPPER COLUMN CAP	1	PZ	VM1917A0	LEFT UPPER COLUMN CAP	1	PZ	VM1918A0	RIGHT LOWER COLUMN CAP	1	PZ	VM1919A0	LEFT LOWER COLUMN CAP	1	PZ	VM1920A0	INTERNAL GLASS CLOSING RIGHT PLATE	1	PZ	VM1921A0	INTERNAL GLASS CLOSING LEFT PLATE	1	PZ	VT1067A0	LINEMISS ELENA BLACK EXTERNAL DOOR GLASS	1	PZ	KVT1066A	L.M. ELENA EXTERNAL GLASS KIT	<table border="1"> <thead> <tr> <th>Code</th> <th>Description</th> <th>Qty</th> <th>UOM</th> </tr> </thead> <tbody> <tr> <td>IP1385A1</td> <td>CORNER POLYSTYREN E PACKING 110X80X2000</td> <td>0.800</td> <td>M</td> </tr> <tr> <td>IP1508A0</td> <td></td> <td>1.710</td> <td>PZ</td> </tr> </tbody> </table>	Code	Description	Qty	UOM	IP1385A1	CORNER POLYSTYREN E PACKING 110X80X2000	0.800	M	IP1508A0		1.710	PZ
			Code	Description	Qty	UOM																																																																														
IP1508A1	POLYSTYREN E U SHAPED PROFILE 2000X60X60	2	M																																																																																	
RC1200A0	ED=4 WIRE D.=0.5 COMPRESSIO N SPRING	2	PZ																																																																																	
SL1050A1	3M TRANSFER ADHESIVE TAPE	0.660	M																																																																																	
TB2306A0	LMISS STEFANIA/ELE NA DOOR RIGHT COLUM	2	PZ																																																																																	
TB3080A0	LMISS STEFANIA/ELE NA DOOR LEFT COLUMN	1	PZ																																																																																	
VM1025A0	Ø16 GREY NYLON LID	2	PZ																																																																																	
VM1059A1	HEAT SHRINK FILM H800	1.350	M																																																																																	
VM1695A0	HANDLE POSITION PIN	2	PZ																																																																																	
VM1916A0	RIGHT UPPER COLUMN CAP	1	PZ																																																																																	
VM1917A0	LEFT UPPER COLUMN CAP	1	PZ																																																																																	
VM1918A0	RIGHT LOWER COLUMN CAP	1	PZ																																																																																	
VM1919A0	LEFT LOWER COLUMN CAP	1	PZ																																																																																	
VM1920A0	INTERNAL GLASS CLOSING RIGHT PLATE	1	PZ																																																																																	
VM1921A0	INTERNAL GLASS CLOSING LEFT PLATE	1	PZ																																																																																	
VT1067A0	LINEMISS ELENA BLACK EXTERNAL DOOR GLASS	1	PZ																																																																																	
Code	Description	Qty	UOM																																																																																	
IP1385A1	CORNER POLYSTYREN E PACKING 110X80X2000	0.800	M																																																																																	
IP1508A0		1.710	PZ																																																																																	



Зип Общепит
vsezip.ru

SPARE PARTS LIST

ASM4039A/0.D00 Door

+7(812)987-08-81

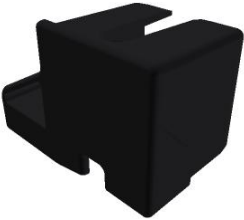
COMPONENT			SPARE PART																																																																									
Code	Description	Image	Code	Description	Components list																																																																							
VM1918A	RIGHT LOWER COLUMN CAP		KVT1066A	L.M. ELENA EXTERNAL GLASS KIT	<table border="1"> <thead> <tr> <th>Code</th> <th>Description</th> <th>Qty</th> <th>UOM</th> </tr> </thead> <tbody> <tr> <td>IP1508A1</td> <td>POLYSTYREN E U SHAPED PROFILE 2000X60X60</td> <td>2</td> <td>M</td> </tr> <tr> <td>RC1200A0</td> <td>ED=4 WIRE D.=0.5 COMPRESSIO N SPRING</td> <td>2</td> <td>PZ</td> </tr> <tr> <td>SL1050A1</td> <td>3M TRANSFER ADHESIVE TAPE</td> <td>0.660</td> <td>M</td> </tr> <tr> <td>TB2306A0</td> <td>LMISS STEFANIA/ELE NA DOOR RIGHT COLUM</td> <td>2</td> <td>PZ</td> </tr> <tr> <td>VM1025A0</td> <td>Ø16 GREY NYLON LID</td> <td>2</td> <td>PZ</td> </tr> <tr> <td>VM1059A1</td> <td>HEAT SHRINK FILM H800</td> <td>1.350</td> <td>M</td> </tr> <tr> <td>VM1695A0</td> <td>HANDLE POSITION PIN</td> <td>2</td> <td>PZ</td> </tr> <tr> <td>VM1916A0</td> <td>RIGHT UPPER COLUMN CAP</td> <td>1</td> <td>PZ</td> </tr> <tr> <td>VM1917A0</td> <td>LEFT UPPER COLUMN CAP</td> <td>1</td> <td>PZ</td> </tr> <tr> <td>VM1918A0</td> <td>RIGHT LOWER COLUMN CAP</td> <td>1</td> <td>PZ</td> </tr> <tr> <td>VM1919A0</td> <td>LEFT LOWER COLUMN CAP</td> <td>1</td> <td>PZ</td> </tr> <tr> <td>VM1920A0</td> <td>INTERNAL GLASS CLOSING RIGHT PLATE</td> <td>1</td> <td>PZ</td> </tr> <tr> <td>VM1921A0</td> <td>INTERNAL GLASS CLOSING LEFT PLATE</td> <td>1</td> <td>PZ</td> </tr> <tr> <td>VT1066A2</td> <td>YELLOW SER GLASS 798X344X5</td> <td>1</td> <td>PZ</td> </tr> </tbody> </table>	Code	Description	Qty	UOM	IP1508A1	POLYSTYREN E U SHAPED PROFILE 2000X60X60	2	M	RC1200A0	ED=4 WIRE D.=0.5 COMPRESSIO N SPRING	2	PZ	SL1050A1	3M TRANSFER ADHESIVE TAPE	0.660	M	TB2306A0	LMISS STEFANIA/ELE NA DOOR RIGHT COLUM	2	PZ	VM1025A0	Ø16 GREY NYLON LID	2	PZ	VM1059A1	HEAT SHRINK FILM H800	1.350	M	VM1695A0	HANDLE POSITION PIN	2	PZ	VM1916A0	RIGHT UPPER COLUMN CAP	1	PZ	VM1917A0	LEFT UPPER COLUMN CAP	1	PZ	VM1918A0	RIGHT LOWER COLUMN CAP	1	PZ	VM1919A0	LEFT LOWER COLUMN CAP	1	PZ	VM1920A0	INTERNAL GLASS CLOSING RIGHT PLATE	1	PZ	VM1921A0	INTERNAL GLASS CLOSING LEFT PLATE	1	PZ	VT1066A2	YELLOW SER GLASS 798X344X5	1	PZ	KVM1918A	LMISS 60X40 RIGHT LOWER DOOR COLUMN CAP	<table border="1"> <thead> <tr> <th>Code</th> <th>Description</th> <th>Qty</th> <th>UOM</th> </tr> </thead> <tbody> <tr> <td>VM1918A0</td> <td>RIGHT LOWER COLUMN CAP</td> <td>1</td> <td>PZ</td> </tr> </tbody> </table>	Code	Description	Qty	UOM	VM1918A0	RIGHT LOWER COLUMN CAP	1	PZ
			Code	Description	Qty	UOM																																																																						
IP1508A1	POLYSTYREN E U SHAPED PROFILE 2000X60X60	2	M																																																																									
RC1200A0	ED=4 WIRE D.=0.5 COMPRESSIO N SPRING	2	PZ																																																																									
SL1050A1	3M TRANSFER ADHESIVE TAPE	0.660	M																																																																									
TB2306A0	LMISS STEFANIA/ELE NA DOOR RIGHT COLUM	2	PZ																																																																									
VM1025A0	Ø16 GREY NYLON LID	2	PZ																																																																									
VM1059A1	HEAT SHRINK FILM H800	1.350	M																																																																									
VM1695A0	HANDLE POSITION PIN	2	PZ																																																																									
VM1916A0	RIGHT UPPER COLUMN CAP	1	PZ																																																																									
VM1917A0	LEFT UPPER COLUMN CAP	1	PZ																																																																									
VM1918A0	RIGHT LOWER COLUMN CAP	1	PZ																																																																									
VM1919A0	LEFT LOWER COLUMN CAP	1	PZ																																																																									
VM1920A0	INTERNAL GLASS CLOSING RIGHT PLATE	1	PZ																																																																									
VM1921A0	INTERNAL GLASS CLOSING LEFT PLATE	1	PZ																																																																									
VT1066A2	YELLOW SER GLASS 798X344X5	1	PZ																																																																									
Code	Description	Qty	UOM																																																																									
VM1918A0	RIGHT LOWER COLUMN CAP	1	PZ																																																																									



Зип Общепит
vsezip.ru

SPARE PARTS LIST

ASM4039A/0.D00 Door

+7(812)987-08-81

COMPONENT			SPARE PART																																																																																	
Code	Description	Image	Code	Description	Components list																																																																															
VM1919A	LEFT LOWER COLUMN CAP		KVT1253A	XF195-EG- VT1253A EXTERNAL GLASS KIT	<table border="1"> <thead> <tr> <th>Code</th> <th>Description</th> <th>Qty</th> <th>UOM</th> </tr> </thead> <tbody> <tr> <td>IP1235B0</td> <td>POLYSTYREN E FLAT PACKING</td> <td>1</td> <td>PZ</td> </tr> <tr> <td>RC1200A0</td> <td>ED=4 WIRE D.=0.5 COMPRESSIO N SPRING</td> <td>2</td> <td>PZ</td> </tr> <tr> <td>SL1050A1</td> <td>3M TRANSFER ADHESIVE TAPE</td> <td>0.820</td> <td>M</td> </tr> <tr> <td>TB2301A0</td> <td>RIGHT COLUMN XVC105E 40X40X1</td> <td>2</td> <td>PZ</td> </tr> <tr> <td>TB3081A0</td> <td>LMISS ARIANNA/ROS SELLA DOOR LEFT COLUMN</td> <td>1</td> <td>PZ</td> </tr> <tr> <td>VM1025A0</td> <td>Ø16 GREY NYLON LID</td> <td>2</td> <td>PZ</td> </tr> <tr> <td>VM1695A0</td> <td>HANDLE POSITION PIN</td> <td>2</td> <td>PZ</td> </tr> <tr> <td>VM1916A0</td> <td>RIGHT UPPER COLUMN CAP</td> <td>1</td> <td>PZ</td> </tr> <tr> <td>VM1917A0</td> <td>LEFT UPPER COLUMN CAP</td> <td>1</td> <td>PZ</td> </tr> <tr> <td>VM1918A0</td> <td>RIGHT LOWER COLUMN CAP</td> <td>1</td> <td>PZ</td> </tr> <tr> <td>VM1919A0</td> <td>LEFT LOWER COLUMN CAP</td> <td>1</td> <td>PZ</td> </tr> <tr> <td>VM1920A0</td> <td>INTERNAL GLASS CLOSING RIGHT PLATE</td> <td>1</td> <td>PZ</td> </tr> <tr> <td>VM1921A0</td> <td>INTERNAL GLASS CLOSING LEFT PLATE</td> <td>1</td> <td>PZ</td> </tr> <tr> <td>VT1253A0</td> <td>XFT195 DOOR EXT. BLACK GLASS - ENGEFOOD</td> <td>1</td> <td>PZ</td> </tr> </tbody> </table>	Code	Description	Qty	UOM	IP1235B0	POLYSTYREN E FLAT PACKING	1	PZ	RC1200A0	ED=4 WIRE D.=0.5 COMPRESSIO N SPRING	2	PZ	SL1050A1	3M TRANSFER ADHESIVE TAPE	0.820	M	TB2301A0	RIGHT COLUMN XVC105E 40X40X1	2	PZ	TB3081A0	LMISS ARIANNA/ROS SELLA DOOR LEFT COLUMN	1	PZ	VM1025A0	Ø16 GREY NYLON LID	2	PZ	VM1695A0	HANDLE POSITION PIN	2	PZ	VM1916A0	RIGHT UPPER COLUMN CAP	1	PZ	VM1917A0	LEFT UPPER COLUMN CAP	1	PZ	VM1918A0	RIGHT LOWER COLUMN CAP	1	PZ	VM1919A0	LEFT LOWER COLUMN CAP	1	PZ	VM1920A0	INTERNAL GLASS CLOSING RIGHT PLATE	1	PZ	VM1921A0	INTERNAL GLASS CLOSING LEFT PLATE	1	PZ	VT1253A0	XFT195 DOOR EXT. BLACK GLASS - ENGEFOOD	1	PZ	KVT1072A	L.M. ROSSELLA BLACK EXTERNAL GLASS KIT	<table border="1"> <thead> <tr> <th>Code</th> <th>Description</th> <th>Qty</th> <th>UOM</th> </tr> </thead> <tbody> <tr> <td>IP1385A1</td> <td>CORNER POLYSTYREN E PACKING 110X80X2000</td> <td>0.960</td> <td>M</td> </tr> <tr> <td>IP1508A0</td> <td></td> <td>1.280</td> <td>PZ</td> </tr> <tr> <td>IP1508A1</td> <td>POLYSTYREN E U SHAPED PROFILE 2000X60X60</td> <td>1.270</td> <td>M</td> </tr> </tbody> </table>	Code	Description	Qty	UOM	IP1385A1	CORNER POLYSTYREN E PACKING 110X80X2000	0.960	M	IP1508A0		1.280	PZ	IP1508A1	POLYSTYREN E U SHAPED PROFILE 2000X60X60	1.270	M
			Code	Description	Qty	UOM																																																																														
IP1235B0	POLYSTYREN E FLAT PACKING	1	PZ																																																																																	
RC1200A0	ED=4 WIRE D.=0.5 COMPRESSIO N SPRING	2	PZ																																																																																	
SL1050A1	3M TRANSFER ADHESIVE TAPE	0.820	M																																																																																	
TB2301A0	RIGHT COLUMN XVC105E 40X40X1	2	PZ																																																																																	
TB3081A0	LMISS ARIANNA/ROS SELLA DOOR LEFT COLUMN	1	PZ																																																																																	
VM1025A0	Ø16 GREY NYLON LID	2	PZ																																																																																	
VM1695A0	HANDLE POSITION PIN	2	PZ																																																																																	
VM1916A0	RIGHT UPPER COLUMN CAP	1	PZ																																																																																	
VM1917A0	LEFT UPPER COLUMN CAP	1	PZ																																																																																	
VM1918A0	RIGHT LOWER COLUMN CAP	1	PZ																																																																																	
VM1919A0	LEFT LOWER COLUMN CAP	1	PZ																																																																																	
VM1920A0	INTERNAL GLASS CLOSING RIGHT PLATE	1	PZ																																																																																	
VM1921A0	INTERNAL GLASS CLOSING LEFT PLATE	1	PZ																																																																																	
VT1253A0	XFT195 DOOR EXT. BLACK GLASS - ENGEFOOD	1	PZ																																																																																	
Code	Description	Qty	UOM																																																																																	
IP1385A1	CORNER POLYSTYREN E PACKING 110X80X2000	0.960	M																																																																																	
IP1508A0		1.280	PZ																																																																																	
IP1508A1	POLYSTYREN E U SHAPED PROFILE 2000X60X60	1.270	M																																																																																	



Зип Общепит
vsezip.ru

SPARE PARTS LIST

ASM4039A/0.D00 Door

+7(812)987-08-81

COMPONENT			SPARE PART																																																														
Code	Description	Image	Code	Description	Components list																																																												
VM1919A	LEFT LOWER COLUMN CAP		KVT1072A	L.M. ROSSELLA BLACK EXTERNAL GLASS KIT	<table border="1"> <thead> <tr> <th>Code</th> <th>Description</th> <th>Qty</th> <th>UOM</th> </tr> </thead> <tbody> <tr> <td>RC1200A0</td> <td>ED=4 WIRE D.=0.5 COMPRESSIO N SPRING</td> <td>2</td> <td>PZ</td> </tr> <tr> <td>SL1050A1</td> <td>3M TRANSFER ADHESIVE TAPE</td> <td>0.820</td> <td>M</td> </tr> <tr> <td>TB2301A0</td> <td>RIGHT COLUMN XVC105E 40X40X1</td> <td>2</td> <td>PZ</td> </tr> <tr> <td>TB3081A0</td> <td>LMISS ARIANNA/ROS SELLA DOOR LEFT COLUMN</td> <td>1</td> <td>PZ</td> </tr> <tr> <td>VM1025A0</td> <td>Ø16 GREY NYLON LID</td> <td>2</td> <td>PZ</td> </tr> <tr> <td>VM1059A1</td> <td>HEAT SHRINK FILM H800</td> <td>1.300</td> <td>M</td> </tr> <tr> <td>VM1695A0</td> <td>HANDLE POSITION PIN</td> <td>2</td> <td>PZ</td> </tr> <tr> <td>VM1916A0</td> <td>RIGHT UPPER COLUMN CAP</td> <td>1</td> <td>PZ</td> </tr> <tr> <td>VM1917A0</td> <td>LEFT UPPER COLUMN CAP</td> <td>1</td> <td>PZ</td> </tr> <tr> <td>VM1918A0</td> <td>RIGHT LOWER COLUMN CAP</td> <td>1</td> <td>PZ</td> </tr> <tr> <td>VM1919A0</td> <td>LEFT LOWER COLUMN CAP</td> <td>1</td> <td>PZ</td> </tr> <tr> <td>VM1920A0</td> <td>INTERNAL GLASS CLOSING RIGHT PLATE</td> <td>1</td> <td>PZ</td> </tr> <tr> <td>VM1921A0</td> <td>INTERNAL GLASS CLOSING LEFT PLATE</td> <td>1</td> <td>PZ</td> </tr> <tr> <td>VT1072A0</td> <td>LINEMISS ROSSELLA BLACK EXTERNAL GLASS</td> <td>1</td> <td>PZ</td> </tr> </tbody> </table>	Code	Description	Qty	UOM	RC1200A0	ED=4 WIRE D.=0.5 COMPRESSIO N SPRING	2	PZ	SL1050A1	3M TRANSFER ADHESIVE TAPE	0.820	M	TB2301A0	RIGHT COLUMN XVC105E 40X40X1	2	PZ	TB3081A0	LMISS ARIANNA/ROS SELLA DOOR LEFT COLUMN	1	PZ	VM1025A0	Ø16 GREY NYLON LID	2	PZ	VM1059A1	HEAT SHRINK FILM H800	1.300	M	VM1695A0	HANDLE POSITION PIN	2	PZ	VM1916A0	RIGHT UPPER COLUMN CAP	1	PZ	VM1917A0	LEFT UPPER COLUMN CAP	1	PZ	VM1918A0	RIGHT LOWER COLUMN CAP	1	PZ	VM1919A0	LEFT LOWER COLUMN CAP	1	PZ	VM1920A0	INTERNAL GLASS CLOSING RIGHT PLATE	1	PZ	VM1921A0	INTERNAL GLASS CLOSING LEFT PLATE	1	PZ	VT1072A0	LINEMISS ROSSELLA BLACK EXTERNAL GLASS	1	PZ
Code	Description	Qty	UOM																																																														
RC1200A0	ED=4 WIRE D.=0.5 COMPRESSIO N SPRING	2	PZ																																																														
SL1050A1	3M TRANSFER ADHESIVE TAPE	0.820	M																																																														
TB2301A0	RIGHT COLUMN XVC105E 40X40X1	2	PZ																																																														
TB3081A0	LMISS ARIANNA/ROS SELLA DOOR LEFT COLUMN	1	PZ																																																														
VM1025A0	Ø16 GREY NYLON LID	2	PZ																																																														
VM1059A1	HEAT SHRINK FILM H800	1.300	M																																																														
VM1695A0	HANDLE POSITION PIN	2	PZ																																																														
VM1916A0	RIGHT UPPER COLUMN CAP	1	PZ																																																														
VM1917A0	LEFT UPPER COLUMN CAP	1	PZ																																																														
VM1918A0	RIGHT LOWER COLUMN CAP	1	PZ																																																														
VM1919A0	LEFT LOWER COLUMN CAP	1	PZ																																																														
VM1920A0	INTERNAL GLASS CLOSING RIGHT PLATE	1	PZ																																																														
VM1921A0	INTERNAL GLASS CLOSING LEFT PLATE	1	PZ																																																														
VT1072A0	LINEMISS ROSSELLA BLACK EXTERNAL GLASS	1	PZ																																																														
			KVT1071A	L.M. ROSSELLA EXTERNAL GLASS KIT	<table border="1"> <thead> <tr> <th>Code</th> <th>Description</th> <th>Qty</th> <th>UOM</th> </tr> </thead> <tbody> <tr> <td>IP1385A1</td> <td>CORNER POLYSTYREN E PACKING 110X80X2000</td> <td>0.960</td> <td>M</td> </tr> <tr> <td>IP1508A0</td> <td></td> <td>1.300</td> <td>PZ</td> </tr> <tr> <td>IP1508A1</td> <td>POLYSTYREN E U SHAPED PROFILE 2000X60X60</td> <td>2</td> <td>M</td> </tr> </tbody> </table>	Code	Description	Qty	UOM	IP1385A1	CORNER POLYSTYREN E PACKING 110X80X2000	0.960	M	IP1508A0		1.300	PZ	IP1508A1	POLYSTYREN E U SHAPED PROFILE 2000X60X60	2	M																																												
Code	Description	Qty	UOM																																																														
IP1385A1	CORNER POLYSTYREN E PACKING 110X80X2000	0.960	M																																																														
IP1508A0		1.300	PZ																																																														
IP1508A1	POLYSTYREN E U SHAPED PROFILE 2000X60X60	2	M																																																														



+7(812)987-08-81



COMPONENT			SPARE PART																																																																																					
Code	Description	Image	Code	Description	Components list																																																																																			
VM1919A	LEFT LOWER COLUMN CAP		KVT1071A	L.M. ROSSELLA EXTERNAL GLASS KIT	<table border="1"> <thead> <tr> <th>Code</th> <th>Description</th> <th>Qty</th> <th>UOM</th> </tr> </thead> <tbody> <tr> <td>RC1200A0</td> <td>ED=4 WIRE D.=0.5 COMPRESSIO N SPRING</td> <td>2</td> <td>PZ</td> </tr> <tr> <td>SL1050A1</td> <td>3M TRANSFER ADHESIVE TAPE</td> <td>0.820</td> <td>M</td> </tr> <tr> <td>TB2301A0</td> <td>RIGHT COLUMN XVC105E 40X40X1</td> <td>2</td> <td>PZ</td> </tr> <tr> <td>VM1025A0</td> <td>Ø16 GREY NYLON LID</td> <td>2</td> <td>PZ</td> </tr> <tr> <td>VM1059A1</td> <td>HEAT SHRINK FILM H800</td> <td>1.350</td> <td>M</td> </tr> <tr> <td>VM1695A0</td> <td>HANDLE POSITION PIN</td> <td>2</td> <td>PZ</td> </tr> <tr> <td>VM1916A0</td> <td>RIGHT UPPER COLUMN CAP</td> <td>1</td> <td>PZ</td> </tr> <tr> <td>VM1917A0</td> <td>LEFT UPPER COLUMN CAP</td> <td>1</td> <td>PZ</td> </tr> <tr> <td>VM1918A0</td> <td>RIGHT LOWER COLUMN CAP</td> <td>1</td> <td>PZ</td> </tr> <tr> <td>VM1919A0</td> <td>LEFT LOWER COLUMN CAP</td> <td>1</td> <td>PZ</td> </tr> <tr> <td>VM1920A0</td> <td>INTERNAL GLASS CLOSING RIGHT PLATE</td> <td>1</td> <td>PZ</td> </tr> <tr> <td>VM1921A0</td> <td>INTERNAL GLASS CLOSING LEFT PLATE</td> <td>1</td> <td>PZ</td> </tr> <tr> <td>VT1071A2</td> <td>YELLOW SER GLASS 798X424X5</td> <td>1</td> <td>PZ</td> </tr> </tbody> </table>	Code	Description	Qty	UOM	RC1200A0	ED=4 WIRE D.=0.5 COMPRESSIO N SPRING	2	PZ	SL1050A1	3M TRANSFER ADHESIVE TAPE	0.820	M	TB2301A0	RIGHT COLUMN XVC105E 40X40X1	2	PZ	VM1025A0	Ø16 GREY NYLON LID	2	PZ	VM1059A1	HEAT SHRINK FILM H800	1.350	M	VM1695A0	HANDLE POSITION PIN	2	PZ	VM1916A0	RIGHT UPPER COLUMN CAP	1	PZ	VM1917A0	LEFT UPPER COLUMN CAP	1	PZ	VM1918A0	RIGHT LOWER COLUMN CAP	1	PZ	VM1919A0	LEFT LOWER COLUMN CAP	1	PZ	VM1920A0	INTERNAL GLASS CLOSING RIGHT PLATE	1	PZ	VM1921A0	INTERNAL GLASS CLOSING LEFT PLATE	1	PZ	VT1071A2	YELLOW SER GLASS 798X424X5	1	PZ	KVT1067A	L.M. ELENA BLACK EXTERNAL GLASS KIT	<table border="1"> <thead> <tr> <th>Code</th> <th>Description</th> <th>Qty</th> <th>UOM</th> </tr> </thead> <tbody> <tr> <td>IP1385A1</td> <td>CORNER POLYSTYREN E PACKING 110X80X2000</td> <td>0.800</td> <td>M</td> </tr> <tr> <td>IP1508A0</td> <td></td> <td>1.710</td> <td>PZ</td> </tr> <tr> <td>IP1508A1</td> <td>POLYSTYREN E U SHAPED PROFILE 2000X60X60</td> <td>2</td> <td>M</td> </tr> <tr> <td>RC1200A0</td> <td>ED=4 WIRE D.=0.5 COMPRESSIO N SPRING</td> <td>2</td> <td>PZ</td> </tr> <tr> <td>SL1050A1</td> <td>3M TRANSFER ADHESIVE TAPE</td> <td>0.660</td> <td>M</td> </tr> </tbody> </table>	Code	Description	Qty	UOM	IP1385A1	CORNER POLYSTYREN E PACKING 110X80X2000	0.800	M	IP1508A0		1.710	PZ	IP1508A1	POLYSTYREN E U SHAPED PROFILE 2000X60X60	2	M	RC1200A0	ED=4 WIRE D.=0.5 COMPRESSIO N SPRING	2	PZ	SL1050A1	3M TRANSFER ADHESIVE TAPE	0.660	M
			Code	Description	Qty	UOM																																																																																		
RC1200A0	ED=4 WIRE D.=0.5 COMPRESSIO N SPRING	2	PZ																																																																																					
SL1050A1	3M TRANSFER ADHESIVE TAPE	0.820	M																																																																																					
TB2301A0	RIGHT COLUMN XVC105E 40X40X1	2	PZ																																																																																					
VM1025A0	Ø16 GREY NYLON LID	2	PZ																																																																																					
VM1059A1	HEAT SHRINK FILM H800	1.350	M																																																																																					
VM1695A0	HANDLE POSITION PIN	2	PZ																																																																																					
VM1916A0	RIGHT UPPER COLUMN CAP	1	PZ																																																																																					
VM1917A0	LEFT UPPER COLUMN CAP	1	PZ																																																																																					
VM1918A0	RIGHT LOWER COLUMN CAP	1	PZ																																																																																					
VM1919A0	LEFT LOWER COLUMN CAP	1	PZ																																																																																					
VM1920A0	INTERNAL GLASS CLOSING RIGHT PLATE	1	PZ																																																																																					
VM1921A0	INTERNAL GLASS CLOSING LEFT PLATE	1	PZ																																																																																					
VT1071A2	YELLOW SER GLASS 798X424X5	1	PZ																																																																																					
Code	Description	Qty	UOM																																																																																					
IP1385A1	CORNER POLYSTYREN E PACKING 110X80X2000	0.800	M																																																																																					
IP1508A0		1.710	PZ																																																																																					
IP1508A1	POLYSTYREN E U SHAPED PROFILE 2000X60X60	2	M																																																																																					
RC1200A0	ED=4 WIRE D.=0.5 COMPRESSIO N SPRING	2	PZ																																																																																					
SL1050A1	3M TRANSFER ADHESIVE TAPE	0.660	M																																																																																					



+7(812)987-08-81

COMPONENT			SPARE PART																																																						
Code	Description	Image	Code	Description	Components list																																																				
VM1919A	LEFT LOWER COLUMN CAP		KVT1067A	L.M. ELENA BLACK EXTERNAL GLASS KIT	<table border="1"> <thead> <tr> <th>Code</th> <th>Description</th> <th>Qty</th> <th>UOM</th> </tr> </thead> <tbody> <tr> <td>TB2306A0</td> <td>LMISS STEFANIA/ELENA DOOR RIGHT COLUMN</td> <td>2</td> <td>PZ</td> </tr> <tr> <td>TB3080A0</td> <td>LMISS STEFANIA/ELENA DOOR LEFT COLUMN</td> <td>1</td> <td>PZ</td> </tr> <tr> <td>VM1025A0</td> <td>Ø16 GREY NYLON LID</td> <td>2</td> <td>PZ</td> </tr> <tr> <td>VM1059A1</td> <td>HEAT SHRINK FILM H800</td> <td>1.350</td> <td>M</td> </tr> <tr> <td>VM1695A0</td> <td>HANDLE POSITION PIN</td> <td>2</td> <td>PZ</td> </tr> <tr> <td>VM1916A0</td> <td>RIGHT UPPER COLUMN CAP</td> <td>1</td> <td>PZ</td> </tr> <tr> <td>VM1917A0</td> <td>LEFT UPPER COLUMN CAP</td> <td>1</td> <td>PZ</td> </tr> <tr> <td>VM1918A0</td> <td>RIGHT LOWER COLUMN CAP</td> <td>1</td> <td>PZ</td> </tr> <tr> <td>VM1919A0</td> <td>LEFT LOWER COLUMN CAP</td> <td>1</td> <td>PZ</td> </tr> <tr> <td>VM1920A0</td> <td>INTERNAL GLASS CLOSING RIGHT PLATE</td> <td>1</td> <td>PZ</td> </tr> <tr> <td>VM1921A0</td> <td>INTERNAL GLASS CLOSING LEFT PLATE</td> <td>1</td> <td>PZ</td> </tr> <tr> <td>VT1067A0</td> <td>LINEMISS ELENA BLACK EXTERNAL DOOR GLASS</td> <td>1</td> <td>PZ</td> </tr> </tbody> </table>	Code	Description	Qty	UOM	TB2306A0	LMISS STEFANIA/ELENA DOOR RIGHT COLUMN	2	PZ	TB3080A0	LMISS STEFANIA/ELENA DOOR LEFT COLUMN	1	PZ	VM1025A0	Ø16 GREY NYLON LID	2	PZ	VM1059A1	HEAT SHRINK FILM H800	1.350	M	VM1695A0	HANDLE POSITION PIN	2	PZ	VM1916A0	RIGHT UPPER COLUMN CAP	1	PZ	VM1917A0	LEFT UPPER COLUMN CAP	1	PZ	VM1918A0	RIGHT LOWER COLUMN CAP	1	PZ	VM1919A0	LEFT LOWER COLUMN CAP	1	PZ	VM1920A0	INTERNAL GLASS CLOSING RIGHT PLATE	1	PZ	VM1921A0	INTERNAL GLASS CLOSING LEFT PLATE	1	PZ	VT1067A0	LINEMISS ELENA BLACK EXTERNAL DOOR GLASS	1	PZ
			Code	Description	Qty	UOM																																																			
TB2306A0	LMISS STEFANIA/ELENA DOOR RIGHT COLUMN	2	PZ																																																						
TB3080A0	LMISS STEFANIA/ELENA DOOR LEFT COLUMN	1	PZ																																																						
VM1025A0	Ø16 GREY NYLON LID	2	PZ																																																						
VM1059A1	HEAT SHRINK FILM H800	1.350	M																																																						
VM1695A0	HANDLE POSITION PIN	2	PZ																																																						
VM1916A0	RIGHT UPPER COLUMN CAP	1	PZ																																																						
VM1917A0	LEFT UPPER COLUMN CAP	1	PZ																																																						
VM1918A0	RIGHT LOWER COLUMN CAP	1	PZ																																																						
VM1919A0	LEFT LOWER COLUMN CAP	1	PZ																																																						
VM1920A0	INTERNAL GLASS CLOSING RIGHT PLATE	1	PZ																																																						
VM1921A0	INTERNAL GLASS CLOSING LEFT PLATE	1	PZ																																																						
VT1067A0	LINEMISS ELENA BLACK EXTERNAL DOOR GLASS	1	PZ																																																						
KVT1066A	L.M. ELENA EXTERNAL GLASS KIT	<table border="1"> <thead> <tr> <th>Code</th> <th>Description</th> <th>Qty</th> <th>UOM</th> </tr> </thead> <tbody> <tr> <td>IP1385A1</td> <td>CORNER POLYSTYREN E PACKING 110X80X2000</td> <td>0.800</td> <td>M</td> </tr> <tr> <td>IP1508A0</td> <td></td> <td>1.710</td> <td>PZ</td> </tr> <tr> <td>IP1508A1</td> <td>POLYSTYREN E U SHAPED PROFILE 2000X60X60</td> <td>2</td> <td>M</td> </tr> <tr> <td>RC1200A0</td> <td>ED=4 WIRE D.=0.5 COMPRESSIO N SPRING</td> <td>2</td> <td>PZ</td> </tr> <tr> <td>SL1050A1</td> <td>3M TRANSFER ADHESIVE TAPE</td> <td>0.660</td> <td>M</td> </tr> </tbody> </table>	Code	Description	Qty	UOM	IP1385A1	CORNER POLYSTYREN E PACKING 110X80X2000	0.800	M	IP1508A0		1.710	PZ	IP1508A1	POLYSTYREN E U SHAPED PROFILE 2000X60X60	2	M	RC1200A0	ED=4 WIRE D.=0.5 COMPRESSIO N SPRING	2	PZ	SL1050A1	3M TRANSFER ADHESIVE TAPE	0.660	M																															
Code	Description	Qty	UOM																																																						
IP1385A1	CORNER POLYSTYREN E PACKING 110X80X2000	0.800	M																																																						
IP1508A0		1.710	PZ																																																						
IP1508A1	POLYSTYREN E U SHAPED PROFILE 2000X60X60	2	M																																																						
RC1200A0	ED=4 WIRE D.=0.5 COMPRESSIO N SPRING	2	PZ																																																						
SL1050A1	3M TRANSFER ADHESIVE TAPE	0.660	M																																																						

+7(812)987-08-81

COMPONENT			SPARE PART																																																		
Code	Description	Image	Code	Description	Components list																																																
VM1919A	LEFT LOWER COLUMN CAP		KVT1066A	L.M. ELENA EXTERNAL GLASS KIT	<table border="1"> <thead> <tr> <th>Code</th> <th>Description</th> <th>Qty</th> <th>UOM</th> </tr> </thead> <tbody> <tr> <td>TB2306A0</td> <td>LMISS STEFANIA/ELE NA DOOR RIGHT COLUM</td> <td>2</td> <td>PZ</td> </tr> <tr> <td>VM1025A0</td> <td>Ø16 GREY NYLON LID</td> <td>2</td> <td>PZ</td> </tr> <tr> <td>VM1059A1</td> <td>HEAT SHRINK FILM H800</td> <td>1.350</td> <td>M</td> </tr> <tr> <td>VM1695A0</td> <td>HANDLE POSITION PIN</td> <td>2</td> <td>PZ</td> </tr> <tr> <td>VM1916A0</td> <td>RIGHT UPPER COLUMN CAP</td> <td>1</td> <td>PZ</td> </tr> <tr> <td>VM1917A0</td> <td>LEFT UPPER COLUMN CAP</td> <td>1</td> <td>PZ</td> </tr> <tr> <td>VM1918A0</td> <td>RIGHT LOWER COLUMN CAP</td> <td>1</td> <td>PZ</td> </tr> <tr> <td>VM1919A0</td> <td>LEFT LOWER COLUMN CAP</td> <td>1</td> <td>PZ</td> </tr> <tr> <td>VM1920A0</td> <td>INTERNAL GLASS CLOSING RIGHT PLATE</td> <td>1</td> <td>PZ</td> </tr> <tr> <td>VM1921A0</td> <td>INTERNAL GLASS CLOSING LEFT PLATE</td> <td>1</td> <td>PZ</td> </tr> <tr> <td>VT1066A2</td> <td>YELLOW SER GLASS 798X344X5</td> <td>1</td> <td>PZ</td> </tr> </tbody> </table>	Code	Description	Qty	UOM	TB2306A0	LMISS STEFANIA/ELE NA DOOR RIGHT COLUM	2	PZ	VM1025A0	Ø16 GREY NYLON LID	2	PZ	VM1059A1	HEAT SHRINK FILM H800	1.350	M	VM1695A0	HANDLE POSITION PIN	2	PZ	VM1916A0	RIGHT UPPER COLUMN CAP	1	PZ	VM1917A0	LEFT UPPER COLUMN CAP	1	PZ	VM1918A0	RIGHT LOWER COLUMN CAP	1	PZ	VM1919A0	LEFT LOWER COLUMN CAP	1	PZ	VM1920A0	INTERNAL GLASS CLOSING RIGHT PLATE	1	PZ	VM1921A0	INTERNAL GLASS CLOSING LEFT PLATE	1	PZ	VT1066A2	YELLOW SER GLASS 798X344X5	1	PZ
			Code	Description	Qty	UOM																																															
TB2306A0	LMISS STEFANIA/ELE NA DOOR RIGHT COLUM	2	PZ																																																		
VM1025A0	Ø16 GREY NYLON LID	2	PZ																																																		
VM1059A1	HEAT SHRINK FILM H800	1.350	M																																																		
VM1695A0	HANDLE POSITION PIN	2	PZ																																																		
VM1916A0	RIGHT UPPER COLUMN CAP	1	PZ																																																		
VM1917A0	LEFT UPPER COLUMN CAP	1	PZ																																																		
VM1918A0	RIGHT LOWER COLUMN CAP	1	PZ																																																		
VM1919A0	LEFT LOWER COLUMN CAP	1	PZ																																																		
VM1920A0	INTERNAL GLASS CLOSING RIGHT PLATE	1	PZ																																																		
VM1921A0	INTERNAL GLASS CLOSING LEFT PLATE	1	PZ																																																		
VT1066A2	YELLOW SER GLASS 798X344X5	1	PZ																																																		
KVM1919A	LMISS 60X40 LEFT LOWER DOOR	<table border="1"> <thead> <tr> <th>Code</th> <th>Description</th> <th>Qty</th> <th>UOM</th> </tr> </thead> <tbody> <tr> <td>VM1919A0</td> <td>LEFT LOWER COLUMN CAP</td> <td>1</td> <td>PZ</td> </tr> </tbody> </table>	Code	Description	Qty	UOM	VM1919A0	LEFT LOWER COLUMN CAP	1	PZ																																											
Code	Description	Qty	UOM																																																		
VM1919A0	LEFT LOWER COLUMN CAP	1	PZ																																																		
VM1916A	RIGHT UPPER COLUMN CAP		KVT1253A	COLUMN CAP XF195-EG- VT1253A EXTERNAL GLASS KIT	<table border="1"> <thead> <tr> <th>Code</th> <th>Description</th> <th>Qty</th> <th>UOM</th> </tr> </thead> <tbody> <tr> <td>IP1235B0</td> <td>POLYSTYREN E FLAT PACKING</td> <td>1</td> <td>PZ</td> </tr> <tr> <td>RC1200A0</td> <td>ED=4 WIRE D.=0.5 COMPRESSIO N SPRING</td> <td>2</td> <td>PZ</td> </tr> <tr> <td>SL1050A1</td> <td>3M TRANSFER ADHESIVE TAPE</td> <td>0.820</td> <td>M</td> </tr> <tr> <td>TB2301A0</td> <td>RIGHT COLUMN XVC105E 40X40X1</td> <td>2</td> <td>PZ</td> </tr> <tr> <td>TB3081A0</td> <td>LMISS ARIANNA/ROS SELLA DOOR LEFT COLUMN</td> <td>1</td> <td>PZ</td> </tr> <tr> <td>VM1025A0</td> <td>Ø16 GREY NYLON LID</td> <td>2</td> <td>PZ</td> </tr> </tbody> </table>	Code	Description	Qty	UOM	IP1235B0	POLYSTYREN E FLAT PACKING	1	PZ	RC1200A0	ED=4 WIRE D.=0.5 COMPRESSIO N SPRING	2	PZ	SL1050A1	3M TRANSFER ADHESIVE TAPE	0.820	M	TB2301A0	RIGHT COLUMN XVC105E 40X40X1	2	PZ	TB3081A0	LMISS ARIANNA/ROS SELLA DOOR LEFT COLUMN	1	PZ	VM1025A0	Ø16 GREY NYLON LID	2	PZ																				
			Code	Description	Qty	UOM																																															
			IP1235B0	POLYSTYREN E FLAT PACKING	1	PZ																																															
			RC1200A0	ED=4 WIRE D.=0.5 COMPRESSIO N SPRING	2	PZ																																															
			SL1050A1	3M TRANSFER ADHESIVE TAPE	0.820	M																																															
			TB2301A0	RIGHT COLUMN XVC105E 40X40X1	2	PZ																																															
			TB3081A0	LMISS ARIANNA/ROS SELLA DOOR LEFT COLUMN	1	PZ																																															
VM1025A0	Ø16 GREY NYLON LID	2	PZ																																																		



Зип Общепит
vsezip.ru

+7(812)987-08-81

COMPONENT			SPARE PART																																															
Code	Description	Image	Code	Description	Components list																																													
VM1916A	RIGHT UPPER COLUMN CAP		KVT1253A	XF195-EG- VT1253A EXTERNAL GLASS KIT	<table border="1"> <thead> <tr> <th>Code</th> <th>Description</th> <th>Qty</th> <th>UOM</th> </tr> </thead> <tbody> <tr> <td>VM1695A0</td> <td>HANDLE POSITION PIN</td> <td>2</td> <td>PZ</td> </tr> <tr> <td>VM1916A0</td> <td>RIGHT UPPER COLUMN CAP</td> <td>1</td> <td>PZ</td> </tr> <tr> <td>VM1917A0</td> <td>LEFT UPPER COLUMN CAP</td> <td>1</td> <td>PZ</td> </tr> <tr> <td>VM1918A0</td> <td>RIGHT LOWER COLUMN CAP</td> <td>1</td> <td>PZ</td> </tr> <tr> <td>VM1919A0</td> <td>LEFT LOWER COLUMN CAP</td> <td>1</td> <td>PZ</td> </tr> <tr> <td>VM1920A0</td> <td>INTERNAL GLASS CLOSING RIGHT PLATE</td> <td>1</td> <td>PZ</td> </tr> <tr> <td>VM1921A0</td> <td>INTERNAL GLASS CLOSING LEFT PLATE</td> <td>1</td> <td>PZ</td> </tr> <tr> <td>VT1253A0</td> <td>XFT195 DOOR EXT. BLACK GLASS - ENGEFOOD</td> <td>1</td> <td>PZ</td> </tr> </tbody> </table>	Code	Description	Qty	UOM	VM1695A0	HANDLE POSITION PIN	2	PZ	VM1916A0	RIGHT UPPER COLUMN CAP	1	PZ	VM1917A0	LEFT UPPER COLUMN CAP	1	PZ	VM1918A0	RIGHT LOWER COLUMN CAP	1	PZ	VM1919A0	LEFT LOWER COLUMN CAP	1	PZ	VM1920A0	INTERNAL GLASS CLOSING RIGHT PLATE	1	PZ	VM1921A0	INTERNAL GLASS CLOSING LEFT PLATE	1	PZ	VT1253A0	XFT195 DOOR EXT. BLACK GLASS - ENGEFOOD	1	PZ									
			Code	Description	Qty	UOM																																												
VM1695A0	HANDLE POSITION PIN	2	PZ																																															
VM1916A0	RIGHT UPPER COLUMN CAP	1	PZ																																															
VM1917A0	LEFT UPPER COLUMN CAP	1	PZ																																															
VM1918A0	RIGHT LOWER COLUMN CAP	1	PZ																																															
VM1919A0	LEFT LOWER COLUMN CAP	1	PZ																																															
VM1920A0	INTERNAL GLASS CLOSING RIGHT PLATE	1	PZ																																															
VM1921A0	INTERNAL GLASS CLOSING LEFT PLATE	1	PZ																																															
VT1253A0	XFT195 DOOR EXT. BLACK GLASS - ENGEFOOD	1	PZ																																															
KVT1072A	L.M. ROSSELLA BLACK EXTERNAL GLASS KIT	<table border="1"> <thead> <tr> <th>Code</th> <th>Description</th> <th>Qty</th> <th>UOM</th> </tr> </thead> <tbody> <tr> <td>IP1385A1</td> <td>CORNER POLYSTYREN E PACKING 110X80X2000</td> <td>0.960</td> <td>M</td> </tr> <tr> <td>IP1508A0</td> <td></td> <td>1.280</td> <td>PZ</td> </tr> <tr> <td>IP1508A1</td> <td>POLYSTYREN E U SHAPED PROFILE 2000X60X60</td> <td>1.270</td> <td>M</td> </tr> <tr> <td>RC1200A0</td> <td>ED=4 WIRE D.=0.5 COMPRESSIO N SPRING</td> <td>2</td> <td>PZ</td> </tr> <tr> <td>SL1050A1</td> <td>3M TRANSFER ADHESIVE TAPE</td> <td>0.820</td> <td>M</td> </tr> <tr> <td>TB2301A0</td> <td>RIGHT COLUMN XVC105E 40X40X1</td> <td>2</td> <td>PZ</td> </tr> <tr> <td>TB3081A0</td> <td>LMISS ARIANNA/ROS SELLA DOOR LEFT COLUMN</td> <td>1</td> <td>PZ</td> </tr> <tr> <td>VM1025A0</td> <td>Ø16 GREY NYLON LID</td> <td>2</td> <td>PZ</td> </tr> <tr> <td>VM1059A1</td> <td>HEAT SHRINK FILM H800</td> <td>1.300</td> <td>M</td> </tr> <tr> <td>VM1695A0</td> <td>HANDLE POSITION PIN</td> <td>2</td> <td>PZ</td> </tr> <tr> <td>VM1916A0</td> <td>RIGHT UPPER COLUMN CAP</td> <td>1</td> <td>PZ</td> </tr> </tbody> </table>	Code	Description	Qty	UOM	IP1385A1	CORNER POLYSTYREN E PACKING 110X80X2000	0.960	M	IP1508A0		1.280	PZ	IP1508A1	POLYSTYREN E U SHAPED PROFILE 2000X60X60	1.270	M	RC1200A0	ED=4 WIRE D.=0.5 COMPRESSIO N SPRING	2	PZ	SL1050A1	3M TRANSFER ADHESIVE TAPE	0.820	M	TB2301A0	RIGHT COLUMN XVC105E 40X40X1	2	PZ	TB3081A0	LMISS ARIANNA/ROS SELLA DOOR LEFT COLUMN	1	PZ	VM1025A0	Ø16 GREY NYLON LID	2	PZ	VM1059A1	HEAT SHRINK FILM H800	1.300	M	VM1695A0	HANDLE POSITION PIN	2	PZ	VM1916A0	RIGHT UPPER COLUMN CAP	1	PZ
Code	Description	Qty	UOM																																															
IP1385A1	CORNER POLYSTYREN E PACKING 110X80X2000	0.960	M																																															
IP1508A0		1.280	PZ																																															
IP1508A1	POLYSTYREN E U SHAPED PROFILE 2000X60X60	1.270	M																																															
RC1200A0	ED=4 WIRE D.=0.5 COMPRESSIO N SPRING	2	PZ																																															
SL1050A1	3M TRANSFER ADHESIVE TAPE	0.820	M																																															
TB2301A0	RIGHT COLUMN XVC105E 40X40X1	2	PZ																																															
TB3081A0	LMISS ARIANNA/ROS SELLA DOOR LEFT COLUMN	1	PZ																																															
VM1025A0	Ø16 GREY NYLON LID	2	PZ																																															
VM1059A1	HEAT SHRINK FILM H800	1.300	M																																															
VM1695A0	HANDLE POSITION PIN	2	PZ																																															
VM1916A0	RIGHT UPPER COLUMN CAP	1	PZ																																															



+7(812)987-08-81

COMPONENT			SPARE PART																																																							
Code	Description	Image	Code	Description	Components list																																																					
VM1916A	RIGHT UPPER COLUMN CAP		KVT1072A	L.M. ROSSELLA BLACK EXTERNAL GLASS KIT	<table border="1"> <thead> <tr> <th>Code</th> <th>Description</th> <th>Qty</th> <th>UOM</th> </tr> </thead> <tbody> <tr> <td>VM1917A0</td> <td>LEFT UPPER COLUMN CAP</td> <td>1</td> <td>PZ</td> </tr> <tr> <td>VM1918A0</td> <td>RIGHT LOWER COLUMN CAP</td> <td>1</td> <td>PZ</td> </tr> <tr> <td>VM1919A0</td> <td>LEFT LOWER COLUMN CAP</td> <td>1</td> <td>PZ</td> </tr> <tr> <td>VM1920A0</td> <td>INTERNAL GLASS CLOSING RIGHT PLATE</td> <td>1</td> <td>PZ</td> </tr> <tr> <td>VM1921A0</td> <td>INTERNAL GLASS CLOSING LEFT PLATE</td> <td>1</td> <td>PZ</td> </tr> <tr> <td>VT1072A0</td> <td>LINEMISS ROSSELLA BLACK EXTERNAL GLASS</td> <td>1</td> <td>PZ</td> </tr> </tbody> </table>	Code	Description	Qty	UOM	VM1917A0	LEFT UPPER COLUMN CAP	1	PZ	VM1918A0	RIGHT LOWER COLUMN CAP	1	PZ	VM1919A0	LEFT LOWER COLUMN CAP	1	PZ	VM1920A0	INTERNAL GLASS CLOSING RIGHT PLATE	1	PZ	VM1921A0	INTERNAL GLASS CLOSING LEFT PLATE	1	PZ	VT1072A0	LINEMISS ROSSELLA BLACK EXTERNAL GLASS	1	PZ																									
			Code	Description	Qty	UOM																																																				
VM1917A0	LEFT UPPER COLUMN CAP	1	PZ																																																							
VM1918A0	RIGHT LOWER COLUMN CAP	1	PZ																																																							
VM1919A0	LEFT LOWER COLUMN CAP	1	PZ																																																							
VM1920A0	INTERNAL GLASS CLOSING RIGHT PLATE	1	PZ																																																							
VM1921A0	INTERNAL GLASS CLOSING LEFT PLATE	1	PZ																																																							
VT1072A0	LINEMISS ROSSELLA BLACK EXTERNAL GLASS	1	PZ																																																							
KVT1071A	L.M. ROSSELLA EXTERNAL GLASS KIT	<table border="1"> <thead> <tr> <th>Code</th> <th>Description</th> <th>Qty</th> <th>UOM</th> </tr> </thead> <tbody> <tr> <td>IP1385A1</td> <td>CORNER POLYSTYREN E PACKING 110X80X2000</td> <td>0.960</td> <td>M</td> </tr> <tr> <td>IP1508A0</td> <td></td> <td>1.300</td> <td>PZ</td> </tr> <tr> <td>IP1508A1</td> <td>POLYSTYREN E U SHAPED PROFILE 2000X60X60</td> <td>2</td> <td>M</td> </tr> <tr> <td>RC1200A0</td> <td>ED=4 WIRE D.=0.5 COMPRESSIO N SPRING</td> <td>2</td> <td>PZ</td> </tr> <tr> <td>SL1050A1</td> <td>3M TRANSFER ADHESIVE TAPE</td> <td>0.820</td> <td>M</td> </tr> <tr> <td>TB2301A0</td> <td>RIGHT COLUMN XVC105E 40X40X1</td> <td>2</td> <td>PZ</td> </tr> <tr> <td>VM1025A0</td> <td>Ø16 GREY NYLON LID</td> <td>2</td> <td>PZ</td> </tr> <tr> <td>VM1059A1</td> <td>HEAT SHRINK FILM H800</td> <td>1.350</td> <td>M</td> </tr> <tr> <td>VM1695A0</td> <td>HANDLE POSITION PIN</td> <td>2</td> <td>PZ</td> </tr> <tr> <td>VM1916A0</td> <td>RIGHT UPPER COLUMN CAP</td> <td>1</td> <td>PZ</td> </tr> <tr> <td>VM1917A0</td> <td>LEFT UPPER COLUMN CAP</td> <td>1</td> <td>PZ</td> </tr> <tr> <td>VM1918A0</td> <td>RIGHT LOWER COLUMN CAP</td> <td>1</td> <td>PZ</td> </tr> <tr> <td>VM1919A0</td> <td>LEFT LOWER COLUMN CAP</td> <td>1</td> <td>PZ</td> </tr> </tbody> </table>	Code	Description	Qty	UOM	IP1385A1	CORNER POLYSTYREN E PACKING 110X80X2000	0.960	M	IP1508A0		1.300	PZ	IP1508A1	POLYSTYREN E U SHAPED PROFILE 2000X60X60	2	M	RC1200A0	ED=4 WIRE D.=0.5 COMPRESSIO N SPRING	2	PZ	SL1050A1	3M TRANSFER ADHESIVE TAPE	0.820	M	TB2301A0	RIGHT COLUMN XVC105E 40X40X1	2	PZ	VM1025A0	Ø16 GREY NYLON LID	2	PZ	VM1059A1	HEAT SHRINK FILM H800	1.350	M	VM1695A0	HANDLE POSITION PIN	2	PZ	VM1916A0	RIGHT UPPER COLUMN CAP	1	PZ	VM1917A0	LEFT UPPER COLUMN CAP	1	PZ	VM1918A0	RIGHT LOWER COLUMN CAP	1	PZ	VM1919A0	LEFT LOWER COLUMN CAP	1	PZ
Code	Description	Qty	UOM																																																							
IP1385A1	CORNER POLYSTYREN E PACKING 110X80X2000	0.960	M																																																							
IP1508A0		1.300	PZ																																																							
IP1508A1	POLYSTYREN E U SHAPED PROFILE 2000X60X60	2	M																																																							
RC1200A0	ED=4 WIRE D.=0.5 COMPRESSIO N SPRING	2	PZ																																																							
SL1050A1	3M TRANSFER ADHESIVE TAPE	0.820	M																																																							
TB2301A0	RIGHT COLUMN XVC105E 40X40X1	2	PZ																																																							
VM1025A0	Ø16 GREY NYLON LID	2	PZ																																																							
VM1059A1	HEAT SHRINK FILM H800	1.350	M																																																							
VM1695A0	HANDLE POSITION PIN	2	PZ																																																							
VM1916A0	RIGHT UPPER COLUMN CAP	1	PZ																																																							
VM1917A0	LEFT UPPER COLUMN CAP	1	PZ																																																							
VM1918A0	RIGHT LOWER COLUMN CAP	1	PZ																																																							
VM1919A0	LEFT LOWER COLUMN CAP	1	PZ																																																							

+7(812)987-08-81

COMPONENT			SPARE PART																																																															
Code	Description	Image	Code	Description	Components list																																																													
VM1916A	RIGHT UPPER COLUMN CAP		KVT1071A	L.M. ROSSELLA EXTERNAL GLASS KIT	<table border="1"> <thead> <tr> <th>Code</th> <th>Description</th> <th>Qty</th> <th>UOM</th> </tr> </thead> <tbody> <tr> <td>VM1920A0</td> <td>INTERNAL GLASS CLOSING RIGHT PLATE</td> <td>1</td> <td>PZ</td> </tr> <tr> <td>VM1921A0</td> <td>INTERNAL GLASS CLOSING LEFT PLATE</td> <td>1</td> <td>PZ</td> </tr> <tr> <td>VT1071A2</td> <td>YELLOW SER GLASS 798X424X5</td> <td>1</td> <td>PZ</td> </tr> </tbody> </table>	Code	Description	Qty	UOM	VM1920A0	INTERNAL GLASS CLOSING RIGHT PLATE	1	PZ	VM1921A0	INTERNAL GLASS CLOSING LEFT PLATE	1	PZ	VT1071A2	YELLOW SER GLASS 798X424X5	1	PZ																																													
			Code	Description	Qty	UOM																																																												
VM1920A0	INTERNAL GLASS CLOSING RIGHT PLATE	1	PZ																																																															
VM1921A0	INTERNAL GLASS CLOSING LEFT PLATE	1	PZ																																																															
VT1071A2	YELLOW SER GLASS 798X424X5	1	PZ																																																															
KVT1067A	L.M. ELENA BLACK EXTERNAL GLASS KIT	<table border="1"> <thead> <tr> <th>Code</th> <th>Description</th> <th>Qty</th> <th>UOM</th> </tr> </thead> <tbody> <tr> <td>IP1385A1</td> <td>CORNER POLYSTYREN E PACKING 110X80X2000</td> <td>0.800</td> <td>M</td> </tr> <tr> <td>IP1508A0</td> <td></td> <td>1.710</td> <td>PZ</td> </tr> <tr> <td>IP1508A1</td> <td>POLYSTYREN E U SHAPED PROFILE 2000X60X60</td> <td>2</td> <td>M</td> </tr> <tr> <td>RC1200A0</td> <td>ED=4 WIRE D.=0.5 COMPRESSIO N SPRING</td> <td>2</td> <td>PZ</td> </tr> <tr> <td>SL1050A1</td> <td>3M TRANSFER ADHESIVE TAPE</td> <td>0.660</td> <td>M</td> </tr> <tr> <td>TB2306A0</td> <td>LMISS STEFANIA/ELE NA DOOR RIGHT COLUM</td> <td>2</td> <td>PZ</td> </tr> <tr> <td>TB3080A0</td> <td>LMISS STEFANIA/ELE NA DOOR LEFT COLUMN</td> <td>1</td> <td>PZ</td> </tr> <tr> <td>VM1025A0</td> <td>Ø16 GREY NYLON LID</td> <td>2</td> <td>PZ</td> </tr> <tr> <td>VM1059A1</td> <td>HEAT SHRINK FILM H800</td> <td>1.350</td> <td>M</td> </tr> <tr> <td>VM1695A0</td> <td>HANDLE POSITION PIN</td> <td>2</td> <td>PZ</td> </tr> <tr> <td>VM1916A0</td> <td>RIGHT UPPER COLUMN CAP</td> <td>1</td> <td>PZ</td> </tr> <tr> <td>VM1917A0</td> <td>LEFT UPPER COLUMN CAP</td> <td>1</td> <td>PZ</td> </tr> <tr> <td>VM1918A0</td> <td>RIGHT LOWER COLUMN CAP</td> <td>1</td> <td>PZ</td> </tr> <tr> <td>VM1919A0</td> <td>LEFT LOWER COLUMN CAP</td> <td>1</td> <td>PZ</td> </tr> <tr> <td>VM1920A0</td> <td>INTERNAL GLASS CLOSING RIGHT PLATE</td> <td>1</td> <td>PZ</td> </tr> </tbody> </table>	Code	Description	Qty	UOM	IP1385A1	CORNER POLYSTYREN E PACKING 110X80X2000	0.800	M	IP1508A0		1.710	PZ	IP1508A1	POLYSTYREN E U SHAPED PROFILE 2000X60X60	2	M	RC1200A0	ED=4 WIRE D.=0.5 COMPRESSIO N SPRING	2	PZ	SL1050A1	3M TRANSFER ADHESIVE TAPE	0.660	M	TB2306A0	LMISS STEFANIA/ELE NA DOOR RIGHT COLUM	2	PZ	TB3080A0	LMISS STEFANIA/ELE NA DOOR LEFT COLUMN	1	PZ	VM1025A0	Ø16 GREY NYLON LID	2	PZ	VM1059A1	HEAT SHRINK FILM H800	1.350	M	VM1695A0	HANDLE POSITION PIN	2	PZ	VM1916A0	RIGHT UPPER COLUMN CAP	1	PZ	VM1917A0	LEFT UPPER COLUMN CAP	1	PZ	VM1918A0	RIGHT LOWER COLUMN CAP	1	PZ	VM1919A0	LEFT LOWER COLUMN CAP	1	PZ	VM1920A0	INTERNAL GLASS CLOSING RIGHT PLATE	1	PZ
Code	Description	Qty	UOM																																																															
IP1385A1	CORNER POLYSTYREN E PACKING 110X80X2000	0.800	M																																																															
IP1508A0		1.710	PZ																																																															
IP1508A1	POLYSTYREN E U SHAPED PROFILE 2000X60X60	2	M																																																															
RC1200A0	ED=4 WIRE D.=0.5 COMPRESSIO N SPRING	2	PZ																																																															
SL1050A1	3M TRANSFER ADHESIVE TAPE	0.660	M																																																															
TB2306A0	LMISS STEFANIA/ELE NA DOOR RIGHT COLUM	2	PZ																																																															
TB3080A0	LMISS STEFANIA/ELE NA DOOR LEFT COLUMN	1	PZ																																																															
VM1025A0	Ø16 GREY NYLON LID	2	PZ																																																															
VM1059A1	HEAT SHRINK FILM H800	1.350	M																																																															
VM1695A0	HANDLE POSITION PIN	2	PZ																																																															
VM1916A0	RIGHT UPPER COLUMN CAP	1	PZ																																																															
VM1917A0	LEFT UPPER COLUMN CAP	1	PZ																																																															
VM1918A0	RIGHT LOWER COLUMN CAP	1	PZ																																																															
VM1919A0	LEFT LOWER COLUMN CAP	1	PZ																																																															
VM1920A0	INTERNAL GLASS CLOSING RIGHT PLATE	1	PZ																																																															



+7(812)987-08-81

COMPONENT			SPARE PART																																																																			
Code	Description	Image	Code	Description	Components list																																																																	
VM1916A	RIGHT UPPER COLUMN CAP		KVT1067A	L.M. ELENA BLACK EXTERNAL GLASS KIT	<table border="1"> <thead> <tr> <th>Code</th> <th>Description</th> <th>Qty</th> <th>UOM</th> </tr> </thead> <tbody> <tr> <td>VM1921A0</td> <td>INTERNAL GLASS CLOSING LEFT PLATE</td> <td>1</td> <td>PZ</td> </tr> <tr> <td>VT1067A0</td> <td>LINEMISS ELENA BLACK EXTERNAL DOOR GLASS</td> <td>1</td> <td>PZ</td> </tr> </tbody> </table>	Code	Description	Qty	UOM	VM1921A0	INTERNAL GLASS CLOSING LEFT PLATE	1	PZ	VT1067A0	LINEMISS ELENA BLACK EXTERNAL DOOR GLASS	1	PZ																																																					
			Code	Description	Qty	UOM																																																																
VM1921A0	INTERNAL GLASS CLOSING LEFT PLATE	1	PZ																																																																			
VT1067A0	LINEMISS ELENA BLACK EXTERNAL DOOR GLASS	1	PZ																																																																			
KVT1066A	L.M. ELENA EXTERNAL GLASS KIT	<table border="1"> <thead> <tr> <th>Code</th> <th>Description</th> <th>Qty</th> <th>UOM</th> </tr> </thead> <tbody> <tr> <td>IP1385A1</td> <td>CORNER POLYSTYREN E PACKING 110X80X2000</td> <td>0.800</td> <td>M</td> </tr> <tr> <td>IP1508A0</td> <td></td> <td>1.710</td> <td>PZ</td> </tr> <tr> <td>IP1508A1</td> <td>POLYSTYREN E U SHAPED PROFILE 2000X60X60</td> <td>2</td> <td>M</td> </tr> <tr> <td>RC1200A0</td> <td>ED=4 WIRE D.=0.5 COMPRESSION SPRING</td> <td>2</td> <td>PZ</td> </tr> <tr> <td>SL1050A1</td> <td>3M TRANSFER ADHESIVE TAPE</td> <td>0.660</td> <td>M</td> </tr> <tr> <td>TB2306A0</td> <td>LMISS STEFANIA/ELENA DOOR RIGHT COLUMN</td> <td>2</td> <td>PZ</td> </tr> <tr> <td>VM1025A0</td> <td>Ø16 GREY NYLON LID</td> <td>2</td> <td>PZ</td> </tr> <tr> <td>VM1059A1</td> <td>HEAT SHRINK FILM H800</td> <td>1.350</td> <td>M</td> </tr> <tr> <td>VM1695A0</td> <td>HANDLE POSITION PIN</td> <td>2</td> <td>PZ</td> </tr> <tr> <td>VM1916A0</td> <td>RIGHT UPPER COLUMN CAP</td> <td>1</td> <td>PZ</td> </tr> <tr> <td>VM1917A0</td> <td>LEFT UPPER COLUMN CAP</td> <td>1</td> <td>PZ</td> </tr> <tr> <td>VM1918A0</td> <td>RIGHT LOWER COLUMN CAP</td> <td>1</td> <td>PZ</td> </tr> <tr> <td>VM1919A0</td> <td>LEFT LOWER COLUMN CAP</td> <td>1</td> <td>PZ</td> </tr> <tr> <td>VM1920A0</td> <td>INTERNAL GLASS CLOSING RIGHT PLATE</td> <td>1</td> <td>PZ</td> </tr> <tr> <td>VM1921A0</td> <td>INTERNAL GLASS CLOSING LEFT PLATE</td> <td>1</td> <td>PZ</td> </tr> <tr> <td>VT1066A2</td> <td>YELLOW SER 798X344X5</td> <td>1</td> <td>PZ</td> </tr> </tbody> </table>	Code	Description	Qty	UOM	IP1385A1	CORNER POLYSTYREN E PACKING 110X80X2000	0.800	M	IP1508A0		1.710	PZ	IP1508A1	POLYSTYREN E U SHAPED PROFILE 2000X60X60	2	M	RC1200A0	ED=4 WIRE D.=0.5 COMPRESSION SPRING	2	PZ	SL1050A1	3M TRANSFER ADHESIVE TAPE	0.660	M	TB2306A0	LMISS STEFANIA/ELENA DOOR RIGHT COLUMN	2	PZ	VM1025A0	Ø16 GREY NYLON LID	2	PZ	VM1059A1	HEAT SHRINK FILM H800	1.350	M	VM1695A0	HANDLE POSITION PIN	2	PZ	VM1916A0	RIGHT UPPER COLUMN CAP	1	PZ	VM1917A0	LEFT UPPER COLUMN CAP	1	PZ	VM1918A0	RIGHT LOWER COLUMN CAP	1	PZ	VM1919A0	LEFT LOWER COLUMN CAP	1	PZ	VM1920A0	INTERNAL GLASS CLOSING RIGHT PLATE	1	PZ	VM1921A0	INTERNAL GLASS CLOSING LEFT PLATE	1	PZ	VT1066A2	YELLOW SER 798X344X5	1	PZ
Code	Description	Qty	UOM																																																																			
IP1385A1	CORNER POLYSTYREN E PACKING 110X80X2000	0.800	M																																																																			
IP1508A0		1.710	PZ																																																																			
IP1508A1	POLYSTYREN E U SHAPED PROFILE 2000X60X60	2	M																																																																			
RC1200A0	ED=4 WIRE D.=0.5 COMPRESSION SPRING	2	PZ																																																																			
SL1050A1	3M TRANSFER ADHESIVE TAPE	0.660	M																																																																			
TB2306A0	LMISS STEFANIA/ELENA DOOR RIGHT COLUMN	2	PZ																																																																			
VM1025A0	Ø16 GREY NYLON LID	2	PZ																																																																			
VM1059A1	HEAT SHRINK FILM H800	1.350	M																																																																			
VM1695A0	HANDLE POSITION PIN	2	PZ																																																																			
VM1916A0	RIGHT UPPER COLUMN CAP	1	PZ																																																																			
VM1917A0	LEFT UPPER COLUMN CAP	1	PZ																																																																			
VM1918A0	RIGHT LOWER COLUMN CAP	1	PZ																																																																			
VM1919A0	LEFT LOWER COLUMN CAP	1	PZ																																																																			
VM1920A0	INTERNAL GLASS CLOSING RIGHT PLATE	1	PZ																																																																			
VM1921A0	INTERNAL GLASS CLOSING LEFT PLATE	1	PZ																																																																			
VT1066A2	YELLOW SER 798X344X5	1	PZ																																																																			





Зип Общепит
vsezip.ru

SPARE PARTS LIST

ASM4039A/0.D00 Door

+7(812)987-08-81

COMPONENT			SPARE PART																																																														
Code	Description	Image	Code	Description	Components list																																																												
VM1916A	RIGHT UPPER COLUMN CAP		KVM1916A	LMISS 60X40 RIGHT UPPER DOOR COLUMN CAP	<table border="1"> <thead> <tr> <th>Code</th> <th>Description</th> <th>Qty</th> <th>UOM</th> </tr> </thead> <tbody> <tr> <td>VM1916A0</td> <td>RIGHT UPPER COLUMN CAP</td> <td>1</td> <td>PZ</td> </tr> </tbody> </table>	Code	Description	Qty	UOM	VM1916A0	RIGHT UPPER COLUMN CAP	1	PZ																																																				
Code	Description	Qty	UOM																																																														
VM1916A0	RIGHT UPPER COLUMN CAP	1	PZ																																																														
VM1920A	INTERNAL GLASS CLOSING RIGHT PLATE		KVT1253A	XF195-EG- VT1253A EXTERNAL GLASS KIT	<table border="1"> <thead> <tr> <th>Code</th> <th>Description</th> <th>Qty</th> <th>UOM</th> </tr> </thead> <tbody> <tr> <td>IP1235B0</td> <td>POLYSTYREN E FLAT PACKING</td> <td>1</td> <td>PZ</td> </tr> <tr> <td>RC1200A0</td> <td>ED=4 WIRE D.=0.5 COMPRESSIO N SPRING</td> <td>2</td> <td>PZ</td> </tr> <tr> <td>SL1050A1</td> <td>3M TRANSFER ADHESIVE TAPE</td> <td>0.820</td> <td>M</td> </tr> <tr> <td>TB2301A0</td> <td>RIGHT COLUMN XVC105E 40X40X1</td> <td>2</td> <td>PZ</td> </tr> <tr> <td>TB3081A0</td> <td>LMISS ARIANNA/ROS SELLA DOOR LEFT COLUMN</td> <td>1</td> <td>PZ</td> </tr> <tr> <td>VM1025A0</td> <td>Ø16 GREY NYLON LID</td> <td>2</td> <td>PZ</td> </tr> <tr> <td>VM1695A0</td> <td>HANDLE POSITION PIN</td> <td>2</td> <td>PZ</td> </tr> <tr> <td>VM1916A0</td> <td>RIGHT UPPER COLUMN CAP</td> <td>1</td> <td>PZ</td> </tr> <tr> <td>VM1917A0</td> <td>LEFT UPPER COLUMN CAP</td> <td>1</td> <td>PZ</td> </tr> <tr> <td>VM1918A0</td> <td>RIGHT LOWER COLUMN CAP</td> <td>1</td> <td>PZ</td> </tr> <tr> <td>VM1919A0</td> <td>LEFT LOWER COLUMN CAP</td> <td>1</td> <td>PZ</td> </tr> <tr> <td>VM1920A0</td> <td>INTERNAL GLASS CLOSING RIGHT PLATE</td> <td>1</td> <td>PZ</td> </tr> <tr> <td>VM1921A0</td> <td>INTERNAL GLASS CLOSING LEFT PLATE</td> <td>1</td> <td>PZ</td> </tr> <tr> <td>VT1253A0</td> <td>XFT195 DOOR EXT. BLACK GLASS - ENGEFOOD</td> <td>1</td> <td>PZ</td> </tr> </tbody> </table>	Code	Description	Qty	UOM	IP1235B0	POLYSTYREN E FLAT PACKING	1	PZ	RC1200A0	ED=4 WIRE D.=0.5 COMPRESSIO N SPRING	2	PZ	SL1050A1	3M TRANSFER ADHESIVE TAPE	0.820	M	TB2301A0	RIGHT COLUMN XVC105E 40X40X1	2	PZ	TB3081A0	LMISS ARIANNA/ROS SELLA DOOR LEFT COLUMN	1	PZ	VM1025A0	Ø16 GREY NYLON LID	2	PZ	VM1695A0	HANDLE POSITION PIN	2	PZ	VM1916A0	RIGHT UPPER COLUMN CAP	1	PZ	VM1917A0	LEFT UPPER COLUMN CAP	1	PZ	VM1918A0	RIGHT LOWER COLUMN CAP	1	PZ	VM1919A0	LEFT LOWER COLUMN CAP	1	PZ	VM1920A0	INTERNAL GLASS CLOSING RIGHT PLATE	1	PZ	VM1921A0	INTERNAL GLASS CLOSING LEFT PLATE	1	PZ	VT1253A0	XFT195 DOOR EXT. BLACK GLASS - ENGEFOOD	1	PZ
Code	Description	Qty	UOM																																																														
IP1235B0	POLYSTYREN E FLAT PACKING	1	PZ																																																														
RC1200A0	ED=4 WIRE D.=0.5 COMPRESSIO N SPRING	2	PZ																																																														
SL1050A1	3M TRANSFER ADHESIVE TAPE	0.820	M																																																														
TB2301A0	RIGHT COLUMN XVC105E 40X40X1	2	PZ																																																														
TB3081A0	LMISS ARIANNA/ROS SELLA DOOR LEFT COLUMN	1	PZ																																																														
VM1025A0	Ø16 GREY NYLON LID	2	PZ																																																														
VM1695A0	HANDLE POSITION PIN	2	PZ																																																														
VM1916A0	RIGHT UPPER COLUMN CAP	1	PZ																																																														
VM1917A0	LEFT UPPER COLUMN CAP	1	PZ																																																														
VM1918A0	RIGHT LOWER COLUMN CAP	1	PZ																																																														
VM1919A0	LEFT LOWER COLUMN CAP	1	PZ																																																														
VM1920A0	INTERNAL GLASS CLOSING RIGHT PLATE	1	PZ																																																														
VM1921A0	INTERNAL GLASS CLOSING LEFT PLATE	1	PZ																																																														
VT1253A0	XFT195 DOOR EXT. BLACK GLASS - ENGEFOOD	1	PZ																																																														



Зип Общепит
vsezip.ru

+7(812)987-08-81

COMPONENT			SPARE PART																																																																									
Code	Description	Image	Code	Description	Components list																																																																							
VM1920A	INTERNAL GLASS CLOSING RIGHT PLATE		KVT1252A	XF135-EG- VT1252A EXTERNAL GLASS KIT	<table border="1"> <thead> <tr> <th>Code</th> <th>Description</th> <th>Qty</th> <th>UOM</th> </tr> </thead> <tbody> <tr> <td>RC1200A0</td> <td>ED=4 WIRE D.=0.5 COMPRESSIO N SPRING</td> <td>2</td> <td>PZ</td> </tr> <tr> <td>SL1050A1</td> <td>3M TRANSFER ADHESIVE TAPE</td> <td>0.820</td> <td>M</td> </tr> <tr> <td>TB2301A0</td> <td>RIGHT COLUMN XVC105E 40X40X1</td> <td>2</td> <td>PZ</td> </tr> <tr> <td>TB3081A0</td> <td>LMISS ARIANNA/ROS SELLA DOOR LEFT COLUMN</td> <td>1</td> <td>PZ</td> </tr> <tr> <td>VM1025A0</td> <td>Ø16 GREY NYLON LID</td> <td>2</td> <td>PZ</td> </tr> <tr> <td>VM1695A0</td> <td>HANDLE POSITION PIN</td> <td>2</td> <td>PZ</td> </tr> <tr> <td>VM1920A0</td> <td>INTERNAL GLASS CLOSING RIGHT PLATE</td> <td>1</td> <td>PZ</td> </tr> <tr> <td>VM1921A0</td> <td>INTERNAL GLASS CLOSING LEFT PLATE</td> <td>1</td> <td>PZ</td> </tr> <tr> <td>VM2062A0</td> <td>L.MISS 46X33 RIGHT UPPER DOOR COLUMN CAP</td> <td>1</td> <td>PZ</td> </tr> <tr> <td>VM2063A0</td> <td>L.MISS 46X33 LEFT UPPER DOOR COLUMN CAP</td> <td>1</td> <td>PZ</td> </tr> <tr> <td>VM2064A0</td> <td>L.MISS 46X33 RIGHT LOWER DOOR COLUMN CAP</td> <td>1</td> <td>PZ</td> </tr> <tr> <td>VM2065A0</td> <td>L.MISS 46X33 LEFT LOWER DOOR COLUMN CAP</td> <td>1</td> <td>PZ</td> </tr> <tr> <td>VT1252A0</td> <td>XFT135 DOOR EXT. BLACK GLASS - ENGEFOOD</td> <td>1</td> <td>PZ</td> </tr> </tbody> </table>	Code	Description	Qty	UOM	RC1200A0	ED=4 WIRE D.=0.5 COMPRESSIO N SPRING	2	PZ	SL1050A1	3M TRANSFER ADHESIVE TAPE	0.820	M	TB2301A0	RIGHT COLUMN XVC105E 40X40X1	2	PZ	TB3081A0	LMISS ARIANNA/ROS SELLA DOOR LEFT COLUMN	1	PZ	VM1025A0	Ø16 GREY NYLON LID	2	PZ	VM1695A0	HANDLE POSITION PIN	2	PZ	VM1920A0	INTERNAL GLASS CLOSING RIGHT PLATE	1	PZ	VM1921A0	INTERNAL GLASS CLOSING LEFT PLATE	1	PZ	VM2062A0	L.MISS 46X33 RIGHT UPPER DOOR COLUMN CAP	1	PZ	VM2063A0	L.MISS 46X33 LEFT UPPER DOOR COLUMN CAP	1	PZ	VM2064A0	L.MISS 46X33 RIGHT LOWER DOOR COLUMN CAP	1	PZ	VM2065A0	L.MISS 46X33 LEFT LOWER DOOR COLUMN CAP	1	PZ	VT1252A0	XFT135 DOOR EXT. BLACK GLASS - ENGEFOOD	1	PZ	KVT1072A	L.M. ROSSELLA BLACK EXTERNAL GLASS KIT	<table border="1"> <thead> <tr> <th>Code</th> <th>Description</th> <th>Qty</th> <th>UOM</th> </tr> </thead> <tbody> <tr> <td>IP1385A1</td> <td>CORNER POLYSTYREN E PACKING 110X80X2000</td> <td>0.960</td> <td>M</td> </tr> <tr> <td>IP1508A0</td> <td></td> <td>1.280</td> <td>PZ</td> </tr> </tbody> </table>	Code	Description	Qty	UOM	IP1385A1	CORNER POLYSTYREN E PACKING 110X80X2000	0.960	M	IP1508A0		1.280	PZ
			Code	Description	Qty	UOM																																																																						
RC1200A0	ED=4 WIRE D.=0.5 COMPRESSIO N SPRING	2	PZ																																																																									
SL1050A1	3M TRANSFER ADHESIVE TAPE	0.820	M																																																																									
TB2301A0	RIGHT COLUMN XVC105E 40X40X1	2	PZ																																																																									
TB3081A0	LMISS ARIANNA/ROS SELLA DOOR LEFT COLUMN	1	PZ																																																																									
VM1025A0	Ø16 GREY NYLON LID	2	PZ																																																																									
VM1695A0	HANDLE POSITION PIN	2	PZ																																																																									
VM1920A0	INTERNAL GLASS CLOSING RIGHT PLATE	1	PZ																																																																									
VM1921A0	INTERNAL GLASS CLOSING LEFT PLATE	1	PZ																																																																									
VM2062A0	L.MISS 46X33 RIGHT UPPER DOOR COLUMN CAP	1	PZ																																																																									
VM2063A0	L.MISS 46X33 LEFT UPPER DOOR COLUMN CAP	1	PZ																																																																									
VM2064A0	L.MISS 46X33 RIGHT LOWER DOOR COLUMN CAP	1	PZ																																																																									
VM2065A0	L.MISS 46X33 LEFT LOWER DOOR COLUMN CAP	1	PZ																																																																									
VT1252A0	XFT135 DOOR EXT. BLACK GLASS - ENGEFOOD	1	PZ																																																																									
Code	Description	Qty	UOM																																																																									
IP1385A1	CORNER POLYSTYREN E PACKING 110X80X2000	0.960	M																																																																									
IP1508A0		1.280	PZ																																																																									



Зип Общепит
vsezip.ru

SPARE PARTS LIST

ASM4039A/0.D00 Door

+7(812)987-08-81

COMPONENT			SPARE PART																																																																		
Code	Description	Image	Code	Description	Components list																																																																
VM1920A	INTERNAL GLASS CLOSING RIGHT PLATE		KVT1072A	L.M. ROSSELLA BLACK EXTERNAL GLASS KIT	<table border="1"> <thead> <tr> <th>Code</th> <th>Description</th> <th>Qty</th> <th>UOM</th> </tr> </thead> <tbody> <tr> <td>IP1508A1</td> <td>POLYSTYREN E U SHAPED PROFILE 2000X60X60</td> <td>1.270</td> <td>M</td> </tr> <tr> <td>RC1200A0</td> <td>ED=4 WIRE D.=0.5 COMPRESSIO N SPRING</td> <td>2</td> <td>PZ</td> </tr> <tr> <td>SL1050A1</td> <td>3M TRANSFER ADHESIVE TAPE</td> <td>0.820</td> <td>M</td> </tr> <tr> <td>TB2301A0</td> <td>RIGHT COLUMN XVC105E 40X40X1</td> <td>2</td> <td>PZ</td> </tr> <tr> <td>TB3081A0</td> <td>LMISS ARIANNA/ROS SELLA DOOR LEFT COLUMN</td> <td>1</td> <td>PZ</td> </tr> <tr> <td>VM1025A0</td> <td>Ø16 GREY NYLON LID</td> <td>2</td> <td>PZ</td> </tr> <tr> <td>VM1059A1</td> <td>HEAT SHRINK FILM H800</td> <td>1.300</td> <td>M</td> </tr> <tr> <td>VM1695A0</td> <td>HANDLE POSITION PIN</td> <td>2</td> <td>PZ</td> </tr> <tr> <td>VM1916A0</td> <td>RIGHT UPPER COLUMN CAP</td> <td>1</td> <td>PZ</td> </tr> <tr> <td>VM1917A0</td> <td>LEFT UPPER COLUMN CAP</td> <td>1</td> <td>PZ</td> </tr> <tr> <td>VM1918A0</td> <td>RIGHT LOWER COLUMN CAP</td> <td>1</td> <td>PZ</td> </tr> <tr> <td>VM1919A0</td> <td>LEFT LOWER COLUMN CAP</td> <td>1</td> <td>PZ</td> </tr> <tr> <td>VM1920A0</td> <td>INTERNAL GLASS CLOSING RIGHT PLATE</td> <td>1</td> <td>PZ</td> </tr> <tr> <td>VM1921A0</td> <td>INTERNAL GLASS CLOSING LEFT PLATE</td> <td>1</td> <td>PZ</td> </tr> <tr> <td>VT1072A0</td> <td>LINEMISS ROSSELLA BLACK EXTERNAL GLASS</td> <td>1</td> <td>PZ</td> </tr> </tbody> </table>	Code	Description	Qty	UOM	IP1508A1	POLYSTYREN E U SHAPED PROFILE 2000X60X60	1.270	M	RC1200A0	ED=4 WIRE D.=0.5 COMPRESSIO N SPRING	2	PZ	SL1050A1	3M TRANSFER ADHESIVE TAPE	0.820	M	TB2301A0	RIGHT COLUMN XVC105E 40X40X1	2	PZ	TB3081A0	LMISS ARIANNA/ROS SELLA DOOR LEFT COLUMN	1	PZ	VM1025A0	Ø16 GREY NYLON LID	2	PZ	VM1059A1	HEAT SHRINK FILM H800	1.300	M	VM1695A0	HANDLE POSITION PIN	2	PZ	VM1916A0	RIGHT UPPER COLUMN CAP	1	PZ	VM1917A0	LEFT UPPER COLUMN CAP	1	PZ	VM1918A0	RIGHT LOWER COLUMN CAP	1	PZ	VM1919A0	LEFT LOWER COLUMN CAP	1	PZ	VM1920A0	INTERNAL GLASS CLOSING RIGHT PLATE	1	PZ	VM1921A0	INTERNAL GLASS CLOSING LEFT PLATE	1	PZ	VT1072A0	LINEMISS ROSSELLA BLACK EXTERNAL GLASS	1	PZ
Code	Description	Qty	UOM																																																																		
IP1508A1	POLYSTYREN E U SHAPED PROFILE 2000X60X60	1.270	M																																																																		
RC1200A0	ED=4 WIRE D.=0.5 COMPRESSIO N SPRING	2	PZ																																																																		
SL1050A1	3M TRANSFER ADHESIVE TAPE	0.820	M																																																																		
TB2301A0	RIGHT COLUMN XVC105E 40X40X1	2	PZ																																																																		
TB3081A0	LMISS ARIANNA/ROS SELLA DOOR LEFT COLUMN	1	PZ																																																																		
VM1025A0	Ø16 GREY NYLON LID	2	PZ																																																																		
VM1059A1	HEAT SHRINK FILM H800	1.300	M																																																																		
VM1695A0	HANDLE POSITION PIN	2	PZ																																																																		
VM1916A0	RIGHT UPPER COLUMN CAP	1	PZ																																																																		
VM1917A0	LEFT UPPER COLUMN CAP	1	PZ																																																																		
VM1918A0	RIGHT LOWER COLUMN CAP	1	PZ																																																																		
VM1919A0	LEFT LOWER COLUMN CAP	1	PZ																																																																		
VM1920A0	INTERNAL GLASS CLOSING RIGHT PLATE	1	PZ																																																																		
VM1921A0	INTERNAL GLASS CLOSING LEFT PLATE	1	PZ																																																																		
VT1072A0	LINEMISS ROSSELLA BLACK EXTERNAL GLASS	1	PZ																																																																		
			KVT1071A	L.M. ROSSELLA EXTERNAL GLASS KIT	<table border="1"> <thead> <tr> <th>Code</th> <th>Description</th> <th>Qty</th> <th>UOM</th> </tr> </thead> <tbody> <tr> <td>IP1385A1</td> <td>CORNER POLYSTYREN E PACKING 110X80X2000</td> <td>0.960</td> <td>M</td> </tr> <tr> <td>IP1508A0</td> <td></td> <td>1.300</td> <td>PZ</td> </tr> </tbody> </table>	Code	Description	Qty	UOM	IP1385A1	CORNER POLYSTYREN E PACKING 110X80X2000	0.960	M	IP1508A0		1.300	PZ																																																				
Code	Description	Qty	UOM																																																																		
IP1385A1	CORNER POLYSTYREN E PACKING 110X80X2000	0.960	M																																																																		
IP1508A0		1.300	PZ																																																																		



Зип Общепит
vsezip.ru

+7(812)987-08-81

COMPONENT			SPARE PART																																																																																					
Code	Description	Image	Code	Description	Components list																																																																																			
VM1920A	INTERNAL GLASS CLOSING RIGHT PLATE		KVT1071A	L.M. ROSSELLA EXTERNAL GLASS KIT	<table border="1"> <thead> <tr> <th>Code</th> <th>Description</th> <th>Qty</th> <th>UOM</th> </tr> </thead> <tbody> <tr> <td>IP1508A1</td> <td>POLYSTYREN E U SHAPED PROFILE 2000X60X60</td> <td>2</td> <td>M</td> </tr> <tr> <td>RC1200A0</td> <td>ED=4 WIRE D.=0.5 COMPRESSIO N SPRING</td> <td>2</td> <td>PZ</td> </tr> <tr> <td>SL1050A1</td> <td>3M TRANSFER ADHESIVE TAPE</td> <td>0.820</td> <td>M</td> </tr> <tr> <td>TB2301A0</td> <td>RIGHT COLUMN XVC105E 40X40X1</td> <td>2</td> <td>PZ</td> </tr> <tr> <td>VM1025A0</td> <td>Ø16 GREY NYLON LID</td> <td>2</td> <td>PZ</td> </tr> <tr> <td>VM1059A1</td> <td>HEAT SHRINK FILM H800</td> <td>1.350</td> <td>M</td> </tr> <tr> <td>VM1695A0</td> <td>HANDLE POSITION PIN</td> <td>2</td> <td>PZ</td> </tr> <tr> <td>VM1916A0</td> <td>RIGHT UPPER COLUMN CAP</td> <td>1</td> <td>PZ</td> </tr> <tr> <td>VM1917A0</td> <td>LEFT UPPER COLUMN CAP</td> <td>1</td> <td>PZ</td> </tr> <tr> <td>VM1918A0</td> <td>RIGHT LOWER COLUMN CAP</td> <td>1</td> <td>PZ</td> </tr> <tr> <td>VM1919A0</td> <td>LEFT LOWER COLUMN CAP</td> <td>1</td> <td>PZ</td> </tr> <tr> <td>VM1920A0</td> <td>INTERNAL GLASS CLOSING RIGHT PLATE</td> <td>1</td> <td>PZ</td> </tr> <tr> <td>VM1921A0</td> <td>INTERNAL GLASS CLOSING LEFT PLATE</td> <td>1</td> <td>PZ</td> </tr> <tr> <td>VT1071A2</td> <td>YELLOW SER GLASS 798X424X5</td> <td>1</td> <td>PZ</td> </tr> </tbody> </table>	Code	Description	Qty	UOM	IP1508A1	POLYSTYREN E U SHAPED PROFILE 2000X60X60	2	M	RC1200A0	ED=4 WIRE D.=0.5 COMPRESSIO N SPRING	2	PZ	SL1050A1	3M TRANSFER ADHESIVE TAPE	0.820	M	TB2301A0	RIGHT COLUMN XVC105E 40X40X1	2	PZ	VM1025A0	Ø16 GREY NYLON LID	2	PZ	VM1059A1	HEAT SHRINK FILM H800	1.350	M	VM1695A0	HANDLE POSITION PIN	2	PZ	VM1916A0	RIGHT UPPER COLUMN CAP	1	PZ	VM1917A0	LEFT UPPER COLUMN CAP	1	PZ	VM1918A0	RIGHT LOWER COLUMN CAP	1	PZ	VM1919A0	LEFT LOWER COLUMN CAP	1	PZ	VM1920A0	INTERNAL GLASS CLOSING RIGHT PLATE	1	PZ	VM1921A0	INTERNAL GLASS CLOSING LEFT PLATE	1	PZ	VT1071A2	YELLOW SER GLASS 798X424X5	1	PZ	KVT1067A	L.M. ELENA BLACK EXTERNAL GLASS KIT	<table border="1"> <thead> <tr> <th>Code</th> <th>Description</th> <th>Qty</th> <th>UOM</th> </tr> </thead> <tbody> <tr> <td>IP1385A1</td> <td>CORNER POLYSTYREN E PACKING 110X80X2000</td> <td>0.800</td> <td>M</td> </tr> <tr> <td>IP1508A0</td> <td></td> <td>1.710</td> <td>PZ</td> </tr> <tr> <td>IP1508A1</td> <td>POLYSTYREN E U SHAPED PROFILE 2000X60X60</td> <td>2</td> <td>M</td> </tr> <tr> <td>RC1200A0</td> <td>ED=4 WIRE D.=0.5 COMPRESSIO N SPRING</td> <td>2</td> <td>PZ</td> </tr> </tbody> </table>	Code	Description	Qty	UOM	IP1385A1	CORNER POLYSTYREN E PACKING 110X80X2000	0.800	M	IP1508A0		1.710	PZ	IP1508A1	POLYSTYREN E U SHAPED PROFILE 2000X60X60	2	M	RC1200A0	ED=4 WIRE D.=0.5 COMPRESSIO N SPRING	2	PZ
			Code	Description	Qty	UOM																																																																																		
IP1508A1	POLYSTYREN E U SHAPED PROFILE 2000X60X60	2	M																																																																																					
RC1200A0	ED=4 WIRE D.=0.5 COMPRESSIO N SPRING	2	PZ																																																																																					
SL1050A1	3M TRANSFER ADHESIVE TAPE	0.820	M																																																																																					
TB2301A0	RIGHT COLUMN XVC105E 40X40X1	2	PZ																																																																																					
VM1025A0	Ø16 GREY NYLON LID	2	PZ																																																																																					
VM1059A1	HEAT SHRINK FILM H800	1.350	M																																																																																					
VM1695A0	HANDLE POSITION PIN	2	PZ																																																																																					
VM1916A0	RIGHT UPPER COLUMN CAP	1	PZ																																																																																					
VM1917A0	LEFT UPPER COLUMN CAP	1	PZ																																																																																					
VM1918A0	RIGHT LOWER COLUMN CAP	1	PZ																																																																																					
VM1919A0	LEFT LOWER COLUMN CAP	1	PZ																																																																																					
VM1920A0	INTERNAL GLASS CLOSING RIGHT PLATE	1	PZ																																																																																					
VM1921A0	INTERNAL GLASS CLOSING LEFT PLATE	1	PZ																																																																																					
VT1071A2	YELLOW SER GLASS 798X424X5	1	PZ																																																																																					
Code	Description	Qty	UOM																																																																																					
IP1385A1	CORNER POLYSTYREN E PACKING 110X80X2000	0.800	M																																																																																					
IP1508A0		1.710	PZ																																																																																					
IP1508A1	POLYSTYREN E U SHAPED PROFILE 2000X60X60	2	M																																																																																					
RC1200A0	ED=4 WIRE D.=0.5 COMPRESSIO N SPRING	2	PZ																																																																																					

+7(812)987-08-81

COMPONENT			SPARE PART																																																																																					
Code	Description	Image	Code	Description	Components list																																																																																			
VM1920A	INTERNAL GLASS CLOSING RIGHT PLATE		KVT1067A	L.M. ELENA BLACK EXTERNAL GLASS KIT	<table border="1"> <thead> <tr> <th>Code</th> <th>Description</th> <th>Qty</th> <th>UOM</th> </tr> </thead> <tbody> <tr> <td>SL1050A1</td> <td>3M TRANSFER ADHESIVE TAPE</td> <td>0.660</td> <td>M</td> </tr> <tr> <td>TB2306A0</td> <td>LMISS STEFANIA/ELE NA DOOR RIGHT COLUM</td> <td>2</td> <td>PZ</td> </tr> <tr> <td>TB3080A0</td> <td>LMISS STEFANIA/ELE NA DOOR LEFT COLUMN</td> <td>1</td> <td>PZ</td> </tr> <tr> <td>VM1025A0</td> <td>Ø16 GREY NYLON LID</td> <td>2</td> <td>PZ</td> </tr> <tr> <td>VM1059A1</td> <td>HEAT SHRINK FILM H800</td> <td>1.350</td> <td>M</td> </tr> <tr> <td>VM1695A0</td> <td>HANDLE POSITION PIN</td> <td>2</td> <td>PZ</td> </tr> <tr> <td>VM1916A0</td> <td>RIGHT UPPER COLUMN CAP</td> <td>1</td> <td>PZ</td> </tr> <tr> <td>VM1917A0</td> <td>LEFT UPPER COLUMN CAP</td> <td>1</td> <td>PZ</td> </tr> <tr> <td>VM1918A0</td> <td>RIGHT LOWER COLUMN CAP</td> <td>1</td> <td>PZ</td> </tr> <tr> <td>VM1919A0</td> <td>LEFT LOWER COLUMN CAP</td> <td>1</td> <td>PZ</td> </tr> <tr> <td>VM1920A0</td> <td>INTERNAL GLASS CLOSING RIGHT PLATE</td> <td>1</td> <td>PZ</td> </tr> <tr> <td>VM1921A0</td> <td>INTERNAL GLASS CLOSING LEFT PLATE</td> <td>1</td> <td>PZ</td> </tr> <tr> <td>VT1067A0</td> <td>LINEMISS ELENA BLACK EXTERNAL DOOR GLASS</td> <td>1</td> <td>PZ</td> </tr> </tbody> </table>	Code	Description	Qty	UOM	SL1050A1	3M TRANSFER ADHESIVE TAPE	0.660	M	TB2306A0	LMISS STEFANIA/ELE NA DOOR RIGHT COLUM	2	PZ	TB3080A0	LMISS STEFANIA/ELE NA DOOR LEFT COLUMN	1	PZ	VM1025A0	Ø16 GREY NYLON LID	2	PZ	VM1059A1	HEAT SHRINK FILM H800	1.350	M	VM1695A0	HANDLE POSITION PIN	2	PZ	VM1916A0	RIGHT UPPER COLUMN CAP	1	PZ	VM1917A0	LEFT UPPER COLUMN CAP	1	PZ	VM1918A0	RIGHT LOWER COLUMN CAP	1	PZ	VM1919A0	LEFT LOWER COLUMN CAP	1	PZ	VM1920A0	INTERNAL GLASS CLOSING RIGHT PLATE	1	PZ	VM1921A0	INTERNAL GLASS CLOSING LEFT PLATE	1	PZ	VT1067A0	LINEMISS ELENA BLACK EXTERNAL DOOR GLASS	1	PZ	KVT1066A	L.M. ELENA EXTERNAL GLASS KIT	<table border="1"> <thead> <tr> <th>Code</th> <th>Description</th> <th>Qty</th> <th>UOM</th> </tr> </thead> <tbody> <tr> <td>IP1385A1</td> <td>CORNER POLYSTYREN E PACKING 110X80X2000</td> <td>0.800</td> <td>M</td> </tr> <tr> <td>IP1508A0</td> <td></td> <td>1.710</td> <td>PZ</td> </tr> <tr> <td>IP1508A1</td> <td>POLYSTYREN E U SHAPED PROFILE 2000X60X60</td> <td>2</td> <td>M</td> </tr> <tr> <td>RC1200A0</td> <td>ED=4 WIRE D.=0.5 COMPRESSIO N SPRING</td> <td>2</td> <td>PZ</td> </tr> <tr> <td>SL1050A1</td> <td>3M TRANSFER ADHESIVE TAPE</td> <td>0.660</td> <td>M</td> </tr> </tbody> </table>	Code	Description	Qty	UOM	IP1385A1	CORNER POLYSTYREN E PACKING 110X80X2000	0.800	M	IP1508A0		1.710	PZ	IP1508A1	POLYSTYREN E U SHAPED PROFILE 2000X60X60	2	M	RC1200A0	ED=4 WIRE D.=0.5 COMPRESSIO N SPRING	2	PZ	SL1050A1	3M TRANSFER ADHESIVE TAPE	0.660	M
			Code	Description	Qty	UOM																																																																																		
SL1050A1	3M TRANSFER ADHESIVE TAPE	0.660	M																																																																																					
TB2306A0	LMISS STEFANIA/ELE NA DOOR RIGHT COLUM	2	PZ																																																																																					
TB3080A0	LMISS STEFANIA/ELE NA DOOR LEFT COLUMN	1	PZ																																																																																					
VM1025A0	Ø16 GREY NYLON LID	2	PZ																																																																																					
VM1059A1	HEAT SHRINK FILM H800	1.350	M																																																																																					
VM1695A0	HANDLE POSITION PIN	2	PZ																																																																																					
VM1916A0	RIGHT UPPER COLUMN CAP	1	PZ																																																																																					
VM1917A0	LEFT UPPER COLUMN CAP	1	PZ																																																																																					
VM1918A0	RIGHT LOWER COLUMN CAP	1	PZ																																																																																					
VM1919A0	LEFT LOWER COLUMN CAP	1	PZ																																																																																					
VM1920A0	INTERNAL GLASS CLOSING RIGHT PLATE	1	PZ																																																																																					
VM1921A0	INTERNAL GLASS CLOSING LEFT PLATE	1	PZ																																																																																					
VT1067A0	LINEMISS ELENA BLACK EXTERNAL DOOR GLASS	1	PZ																																																																																					
Code	Description	Qty	UOM																																																																																					
IP1385A1	CORNER POLYSTYREN E PACKING 110X80X2000	0.800	M																																																																																					
IP1508A0		1.710	PZ																																																																																					
IP1508A1	POLYSTYREN E U SHAPED PROFILE 2000X60X60	2	M																																																																																					
RC1200A0	ED=4 WIRE D.=0.5 COMPRESSIO N SPRING	2	PZ																																																																																					
SL1050A1	3M TRANSFER ADHESIVE TAPE	0.660	M																																																																																					

+7(812)987-08-81

COMPONENT			SPARE PART																																																		
Code	Description	Image	Code	Description	Components list																																																
VM1920A	INTERNAL GLASS CLOSING RIGHT PLATE		KVT1066A	L.M. ELENA EXTERNAL GLASS KIT	<table border="1"> <thead> <tr> <th>Code</th> <th>Description</th> <th>Qty</th> <th>UOM</th> </tr> </thead> <tbody> <tr> <td>TB2306A0</td> <td>LMISS STEFANIA/ELE NA DOOR RIGHT COLUM</td> <td>2</td> <td>PZ</td> </tr> <tr> <td>VM1025A0</td> <td>Ø16 GREY NYLON LID</td> <td>2</td> <td>PZ</td> </tr> <tr> <td>VM1059A1</td> <td>HEAT SHRINK FILM H800</td> <td>1.350</td> <td>M</td> </tr> <tr> <td>VM1695A0</td> <td>HANDLE POSITION PIN</td> <td>2</td> <td>PZ</td> </tr> <tr> <td>VM1916A0</td> <td>RIGHT UPPER COLUMN CAP</td> <td>1</td> <td>PZ</td> </tr> <tr> <td>VM1917A0</td> <td>LEFT UPPER COLUMN CAP</td> <td>1</td> <td>PZ</td> </tr> <tr> <td>VM1918A0</td> <td>RIGHT LOWER COLUMN CAP</td> <td>1</td> <td>PZ</td> </tr> <tr> <td>VM1919A0</td> <td>LEFT LOWER COLUMN CAP</td> <td>1</td> <td>PZ</td> </tr> <tr> <td>VM1920A0</td> <td>INTERNAL GLASS CLOSING RIGHT PLATE</td> <td>1</td> <td>PZ</td> </tr> <tr> <td>VM1921A0</td> <td>INTERNAL GLASS CLOSING LEFT PLATE</td> <td>1</td> <td>PZ</td> </tr> <tr> <td>VT1066A2</td> <td>YELLOW SER GLASS 798X344X5</td> <td>1</td> <td>PZ</td> </tr> </tbody> </table>	Code	Description	Qty	UOM	TB2306A0	LMISS STEFANIA/ELE NA DOOR RIGHT COLUM	2	PZ	VM1025A0	Ø16 GREY NYLON LID	2	PZ	VM1059A1	HEAT SHRINK FILM H800	1.350	M	VM1695A0	HANDLE POSITION PIN	2	PZ	VM1916A0	RIGHT UPPER COLUMN CAP	1	PZ	VM1917A0	LEFT UPPER COLUMN CAP	1	PZ	VM1918A0	RIGHT LOWER COLUMN CAP	1	PZ	VM1919A0	LEFT LOWER COLUMN CAP	1	PZ	VM1920A0	INTERNAL GLASS CLOSING RIGHT PLATE	1	PZ	VM1921A0	INTERNAL GLASS CLOSING LEFT PLATE	1	PZ	VT1066A2	YELLOW SER GLASS 798X344X5	1	PZ
			Code	Description	Qty	UOM																																															
TB2306A0	LMISS STEFANIA/ELE NA DOOR RIGHT COLUM	2	PZ																																																		
VM1025A0	Ø16 GREY NYLON LID	2	PZ																																																		
VM1059A1	HEAT SHRINK FILM H800	1.350	M																																																		
VM1695A0	HANDLE POSITION PIN	2	PZ																																																		
VM1916A0	RIGHT UPPER COLUMN CAP	1	PZ																																																		
VM1917A0	LEFT UPPER COLUMN CAP	1	PZ																																																		
VM1918A0	RIGHT LOWER COLUMN CAP	1	PZ																																																		
VM1919A0	LEFT LOWER COLUMN CAP	1	PZ																																																		
VM1920A0	INTERNAL GLASS CLOSING RIGHT PLATE	1	PZ																																																		
VM1921A0	INTERNAL GLASS CLOSING LEFT PLATE	1	PZ																																																		
VT1066A2	YELLOW SER GLASS 798X344X5	1	PZ																																																		
KVT1063A	L.MISS ARIANNA FORNETTI EXT. GLASS KIT	<table border="1"> <thead> <tr> <th>Code</th> <th>Description</th> <th>Qty</th> <th>UOM</th> </tr> </thead> <tbody> <tr> <td>IP1385A1</td> <td>CORNER POLYSTYREN E PACKING 110X80X2000</td> <td>0.980</td> <td>M</td> </tr> <tr> <td>IP1508A0</td> <td></td> <td>0.960</td> <td>PZ</td> </tr> <tr> <td>IP1508A1</td> <td>POLYSTYREN E U SHAPED PROFILE 2000X60X60</td> <td>0.960</td> <td>M</td> </tr> <tr> <td>MS1009A0</td> <td>FORNETTI LOGO LABEL</td> <td>1</td> <td>PZ</td> </tr> <tr> <td>RC1200A0</td> <td>ED=4 WIRE D.=0.5 COMPRESSIO N SPRING</td> <td>2</td> <td>PZ</td> </tr> <tr> <td>SL1050A1</td> <td>3M TRANSFER ADHESIVE TAPE</td> <td>0.820</td> <td>M</td> </tr> <tr> <td>TB2301A0</td> <td>RIGHT COLUMN XVC105E 40X40X1</td> <td>2</td> <td>PZ</td> </tr> </tbody> </table>	Code	Description	Qty	UOM	IP1385A1	CORNER POLYSTYREN E PACKING 110X80X2000	0.980	M	IP1508A0		0.960	PZ	IP1508A1	POLYSTYREN E U SHAPED PROFILE 2000X60X60	0.960	M	MS1009A0	FORNETTI LOGO LABEL	1	PZ	RC1200A0	ED=4 WIRE D.=0.5 COMPRESSIO N SPRING	2	PZ	SL1050A1	3M TRANSFER ADHESIVE TAPE	0.820	M	TB2301A0	RIGHT COLUMN XVC105E 40X40X1	2	PZ																			
Code	Description	Qty	UOM																																																		
IP1385A1	CORNER POLYSTYREN E PACKING 110X80X2000	0.980	M																																																		
IP1508A0		0.960	PZ																																																		
IP1508A1	POLYSTYREN E U SHAPED PROFILE 2000X60X60	0.960	M																																																		
MS1009A0	FORNETTI LOGO LABEL	1	PZ																																																		
RC1200A0	ED=4 WIRE D.=0.5 COMPRESSIO N SPRING	2	PZ																																																		
SL1050A1	3M TRANSFER ADHESIVE TAPE	0.820	M																																																		
TB2301A0	RIGHT COLUMN XVC105E 40X40X1	2	PZ																																																		



+7(812)987-08-81

COMPONENT			SPARE PART																																																																									
Code	Description	Image	Code	Description	Components list																																																																							
VM1920A	INTERNAL GLASS CLOSING RIGHT PLATE		KVT1063A	L.MISS ARIANNA FORNETTI EXT. GLASS KIT	<table border="1"> <thead> <tr> <th>Code</th> <th>Description</th> <th>Qty</th> <th>UOM</th> </tr> </thead> <tbody> <tr> <td>TB3081A0</td> <td>LMISS ARIANNA/ROS SELLA DOOR LEFT COLUMN</td> <td>1</td> <td>PZ</td> </tr> <tr> <td>VM1025A0</td> <td>Ø16 GREY NYLON LID</td> <td>2</td> <td>PZ</td> </tr> <tr> <td>VM1059A1</td> <td>HEAT SHRINK FILM H800</td> <td>1.300</td> <td>M</td> </tr> <tr> <td>VM1695A0</td> <td>HANDLE POSITION PIN</td> <td>2</td> <td>PZ</td> </tr> <tr> <td>VM1920A0</td> <td>INTERNAL GLASS CLOSING RIGHT PLATE</td> <td>1</td> <td>PZ</td> </tr> <tr> <td>VM1921A0</td> <td>INTERNAL GLASS CLOSING LEFT PLATE</td> <td>1</td> <td>PZ</td> </tr> <tr> <td>VM2062A0</td> <td>L.MISS 46X33 RIGHT UPPER DOOR COLUMN CAP</td> <td>1</td> <td>PZ</td> </tr> <tr> <td>VM2063A0</td> <td>L.MISS 46X33 LEFT UPPER DOOR COLUMN CAP</td> <td>1</td> <td>PZ</td> </tr> <tr> <td>VM2064A0</td> <td>L.MISS 46X33 RIGHT LOWER DOOR COLUMN CAP</td> <td>1</td> <td>PZ</td> </tr> <tr> <td>VM2065A0</td> <td>L.MISS 46X33 LEFT LOWER DOOR COLUMN CAP</td> <td>1</td> <td>PZ</td> </tr> <tr> <td>VT1063A0</td> <td>XF135F EXTERNAL GLASS 598X42</td> <td>1</td> <td>PZ</td> </tr> </tbody> </table>	Code	Description	Qty	UOM	TB3081A0	LMISS ARIANNA/ROS SELLA DOOR LEFT COLUMN	1	PZ	VM1025A0	Ø16 GREY NYLON LID	2	PZ	VM1059A1	HEAT SHRINK FILM H800	1.300	M	VM1695A0	HANDLE POSITION PIN	2	PZ	VM1920A0	INTERNAL GLASS CLOSING RIGHT PLATE	1	PZ	VM1921A0	INTERNAL GLASS CLOSING LEFT PLATE	1	PZ	VM2062A0	L.MISS 46X33 RIGHT UPPER DOOR COLUMN CAP	1	PZ	VM2063A0	L.MISS 46X33 LEFT UPPER DOOR COLUMN CAP	1	PZ	VM2064A0	L.MISS 46X33 RIGHT LOWER DOOR COLUMN CAP	1	PZ	VM2065A0	L.MISS 46X33 LEFT LOWER DOOR COLUMN CAP	1	PZ	VT1063A0	XF135F EXTERNAL GLASS 598X42	1	PZ	KVT1062A	L.M. ARIANNA BLACK EXTERNAL GLASS KIT	<table border="1"> <thead> <tr> <th>Code</th> <th>Description</th> <th>Qty</th> <th>UOM</th> </tr> </thead> <tbody> <tr> <td>IP1385A1</td> <td>CORNER POLYSTYREN E PACKING 110X80X2000</td> <td>1.280</td> <td>M</td> </tr> <tr> <td>RC1200A0</td> <td>ED=4 WIRE D.=0.5 COMPRESSIO N SPRING</td> <td>2</td> <td>PZ</td> </tr> <tr> <td>SL1050A1</td> <td>3M TRANSFER ADHESIVE TAPE</td> <td>0.820</td> <td>M</td> </tr> <tr> <td>TB2301A0</td> <td>RIGHT COLUMN XVC105E 40X40X1</td> <td>2</td> <td>PZ</td> </tr> </tbody> </table>	Code	Description	Qty	UOM	IP1385A1	CORNER POLYSTYREN E PACKING 110X80X2000	1.280	M	RC1200A0	ED=4 WIRE D.=0.5 COMPRESSIO N SPRING	2	PZ	SL1050A1	3M TRANSFER ADHESIVE TAPE	0.820	M	TB2301A0	RIGHT COLUMN XVC105E 40X40X1	2	PZ
			Code	Description	Qty	UOM																																																																						
TB3081A0	LMISS ARIANNA/ROS SELLA DOOR LEFT COLUMN	1	PZ																																																																									
VM1025A0	Ø16 GREY NYLON LID	2	PZ																																																																									
VM1059A1	HEAT SHRINK FILM H800	1.300	M																																																																									
VM1695A0	HANDLE POSITION PIN	2	PZ																																																																									
VM1920A0	INTERNAL GLASS CLOSING RIGHT PLATE	1	PZ																																																																									
VM1921A0	INTERNAL GLASS CLOSING LEFT PLATE	1	PZ																																																																									
VM2062A0	L.MISS 46X33 RIGHT UPPER DOOR COLUMN CAP	1	PZ																																																																									
VM2063A0	L.MISS 46X33 LEFT UPPER DOOR COLUMN CAP	1	PZ																																																																									
VM2064A0	L.MISS 46X33 RIGHT LOWER DOOR COLUMN CAP	1	PZ																																																																									
VM2065A0	L.MISS 46X33 LEFT LOWER DOOR COLUMN CAP	1	PZ																																																																									
VT1063A0	XF135F EXTERNAL GLASS 598X42	1	PZ																																																																									
Code	Description	Qty	UOM																																																																									
IP1385A1	CORNER POLYSTYREN E PACKING 110X80X2000	1.280	M																																																																									
RC1200A0	ED=4 WIRE D.=0.5 COMPRESSIO N SPRING	2	PZ																																																																									
SL1050A1	3M TRANSFER ADHESIVE TAPE	0.820	M																																																																									
TB2301A0	RIGHT COLUMN XVC105E 40X40X1	2	PZ																																																																									



+7(812)987-08-81

COMPONENT			SPARE PART																																																		
Code	Description	Image	Code	Description	Components list																																																
VM1920A	INTERNAL GLASS CLOSING RIGHT PLATE		KVT1062A	L.M. ARIANNA BLACK EXTERNAL GLASS KIT	<table border="1"> <thead> <tr> <th>Code</th> <th>Description</th> <th>Qty</th> <th>UOM</th> </tr> </thead> <tbody> <tr> <td>TB3081A0</td> <td>LMISS ARIANNA/ROS SELLA DOOR LEFT COLUMN</td> <td>1</td> <td>PZ</td> </tr> <tr> <td>VM1025A0</td> <td>Ø16 GREY NYLON LID</td> <td>2</td> <td>PZ</td> </tr> <tr> <td>VM1059A1</td> <td>HEAT SHRINK FILM H800</td> <td>1</td> <td>M</td> </tr> <tr> <td>VM1695A0</td> <td>HANDLE POSITION PIN</td> <td>2</td> <td>PZ</td> </tr> <tr> <td>VM1920A0</td> <td>INTERNAL GLASS CLOSING RIGHT PLATE</td> <td>1</td> <td>PZ</td> </tr> <tr> <td>VM1921A0</td> <td>INTERNAL GLASS CLOSING LEFT PLATE</td> <td>1</td> <td>PZ</td> </tr> <tr> <td>VM2062A0</td> <td>L.MISS 46X33 RIGHT UPPER DOOR COLUMN CAP</td> <td>1</td> <td>PZ</td> </tr> <tr> <td>VM2063A0</td> <td>L.MISS 46X33 LEFT UPPER DOOR COLUMN CAP</td> <td>1</td> <td>PZ</td> </tr> <tr> <td>VM2064A0</td> <td>L.MISS 46X33 RIGHT LOWER DOOR COLUMN CAP</td> <td>1</td> <td>PZ</td> </tr> <tr> <td>VM2065A0</td> <td>L.MISS 46X33 LEFT LOWER DOOR COLUMN CAP</td> <td>1</td> <td>PZ</td> </tr> <tr> <td>VT1062A0</td> <td>LINEMISS ARIANNA GREY EXTERNAL GLASS</td> <td>1</td> <td>PZ</td> </tr> </tbody> </table>	Code	Description	Qty	UOM	TB3081A0	LMISS ARIANNA/ROS SELLA DOOR LEFT COLUMN	1	PZ	VM1025A0	Ø16 GREY NYLON LID	2	PZ	VM1059A1	HEAT SHRINK FILM H800	1	M	VM1695A0	HANDLE POSITION PIN	2	PZ	VM1920A0	INTERNAL GLASS CLOSING RIGHT PLATE	1	PZ	VM1921A0	INTERNAL GLASS CLOSING LEFT PLATE	1	PZ	VM2062A0	L.MISS 46X33 RIGHT UPPER DOOR COLUMN CAP	1	PZ	VM2063A0	L.MISS 46X33 LEFT UPPER DOOR COLUMN CAP	1	PZ	VM2064A0	L.MISS 46X33 RIGHT LOWER DOOR COLUMN CAP	1	PZ	VM2065A0	L.MISS 46X33 LEFT LOWER DOOR COLUMN CAP	1	PZ	VT1062A0	LINEMISS ARIANNA GREY EXTERNAL GLASS	1	PZ
Code	Description	Qty	UOM																																																		
TB3081A0	LMISS ARIANNA/ROS SELLA DOOR LEFT COLUMN	1	PZ																																																		
VM1025A0	Ø16 GREY NYLON LID	2	PZ																																																		
VM1059A1	HEAT SHRINK FILM H800	1	M																																																		
VM1695A0	HANDLE POSITION PIN	2	PZ																																																		
VM1920A0	INTERNAL GLASS CLOSING RIGHT PLATE	1	PZ																																																		
VM1921A0	INTERNAL GLASS CLOSING LEFT PLATE	1	PZ																																																		
VM2062A0	L.MISS 46X33 RIGHT UPPER DOOR COLUMN CAP	1	PZ																																																		
VM2063A0	L.MISS 46X33 LEFT UPPER DOOR COLUMN CAP	1	PZ																																																		
VM2064A0	L.MISS 46X33 RIGHT LOWER DOOR COLUMN CAP	1	PZ																																																		
VM2065A0	L.MISS 46X33 LEFT LOWER DOOR COLUMN CAP	1	PZ																																																		
VT1062A0	LINEMISS ARIANNA GREY EXTERNAL GLASS	1	PZ																																																		
			KVT1061A	L.M. ARIANNA EXTERNAL YELLOW GLASS KIT	<table border="1"> <thead> <tr> <th>Code</th> <th>Description</th> <th>Qty</th> <th>UOM</th> </tr> </thead> <tbody> <tr> <td>IP1385A1</td> <td>CORNER POLYSTYREN E PACKING 110X80X2000</td> <td>1.280</td> <td>M</td> </tr> <tr> <td>RC1200A0</td> <td>ED=4 WIRE D.=0.5 COMPRESSIO N SPRING</td> <td>2</td> <td>PZ</td> </tr> <tr> <td>SL1050A1</td> <td>3M TRANSFER ADHESIVE TAPE</td> <td>0.820</td> <td>M</td> </tr> </tbody> </table>	Code	Description	Qty	UOM	IP1385A1	CORNER POLYSTYREN E PACKING 110X80X2000	1.280	M	RC1200A0	ED=4 WIRE D.=0.5 COMPRESSIO N SPRING	2	PZ	SL1050A1	3M TRANSFER ADHESIVE TAPE	0.820	M																																
Code	Description	Qty	UOM																																																		
IP1385A1	CORNER POLYSTYREN E PACKING 110X80X2000	1.280	M																																																		
RC1200A0	ED=4 WIRE D.=0.5 COMPRESSIO N SPRING	2	PZ																																																		
SL1050A1	3M TRANSFER ADHESIVE TAPE	0.820	M																																																		

+7(812)987-08-81

COMPONENT			SPARE PART																																																		
Code	Description	Image	Code	Description	Components list																																																
VM1920A	INTERNAL GLASS CLOSING RIGHT PLATE		KVT1061A	L.M. ARIANNA EXTERNAL YELLOW GLASS KIT	<table border="1"> <thead> <tr> <th>Code</th> <th>Description</th> <th>Qty</th> <th>UOM</th> </tr> </thead> <tbody> <tr> <td>TB2301A0</td> <td>RIGHT COLUMN XVC105E 40X40X1</td> <td>2</td> <td>PZ</td> </tr> <tr> <td>VM1025A0</td> <td>Ø16 GREY NYLON LID</td> <td>2</td> <td>PZ</td> </tr> <tr> <td>VM1059A1</td> <td>HEAT SHRINK FILM H800</td> <td>1.300</td> <td>M</td> </tr> <tr> <td>VM1695A0</td> <td>HANDLE POSITION PIN</td> <td>2</td> <td>PZ</td> </tr> <tr> <td>VM1920A0</td> <td>INTERNAL GLASS CLOSING RIGHT PLATE</td> <td>1</td> <td>PZ</td> </tr> <tr> <td>VM1921A0</td> <td>INTERNAL GLASS CLOSING LEFT PLATE</td> <td>1</td> <td>PZ</td> </tr> <tr> <td>VM2062A0</td> <td>L.MISS 46X33 RIGHT UPPER DOOR COLUMN CAP</td> <td>1</td> <td>PZ</td> </tr> <tr> <td>VM2063A0</td> <td>L.MISS 46X33 LEFT UPPER DOOR COLUMN CAP</td> <td>1</td> <td>PZ</td> </tr> <tr> <td>VM2064A0</td> <td>L.MISS 46X33 RIGHT LOWER DOOR COLUMN CAP</td> <td>1</td> <td>PZ</td> </tr> <tr> <td>VM2065A0</td> <td>L.MISS 46X33 LEFT LOWER DOOR COLUMN CAP</td> <td>1</td> <td>PZ</td> </tr> <tr> <td>VT1061A2</td> <td>EXTERNAL YELLOW SER.GLASS 598X424X5</td> <td>1</td> <td>PZ</td> </tr> </tbody> </table>	Code	Description	Qty	UOM	TB2301A0	RIGHT COLUMN XVC105E 40X40X1	2	PZ	VM1025A0	Ø16 GREY NYLON LID	2	PZ	VM1059A1	HEAT SHRINK FILM H800	1.300	M	VM1695A0	HANDLE POSITION PIN	2	PZ	VM1920A0	INTERNAL GLASS CLOSING RIGHT PLATE	1	PZ	VM1921A0	INTERNAL GLASS CLOSING LEFT PLATE	1	PZ	VM2062A0	L.MISS 46X33 RIGHT UPPER DOOR COLUMN CAP	1	PZ	VM2063A0	L.MISS 46X33 LEFT UPPER DOOR COLUMN CAP	1	PZ	VM2064A0	L.MISS 46X33 RIGHT LOWER DOOR COLUMN CAP	1	PZ	VM2065A0	L.MISS 46X33 LEFT LOWER DOOR COLUMN CAP	1	PZ	VT1061A2	EXTERNAL YELLOW SER.GLASS 598X424X5	1	PZ
			Code	Description	Qty	UOM																																															
TB2301A0	RIGHT COLUMN XVC105E 40X40X1	2	PZ																																																		
VM1025A0	Ø16 GREY NYLON LID	2	PZ																																																		
VM1059A1	HEAT SHRINK FILM H800	1.300	M																																																		
VM1695A0	HANDLE POSITION PIN	2	PZ																																																		
VM1920A0	INTERNAL GLASS CLOSING RIGHT PLATE	1	PZ																																																		
VM1921A0	INTERNAL GLASS CLOSING LEFT PLATE	1	PZ																																																		
VM2062A0	L.MISS 46X33 RIGHT UPPER DOOR COLUMN CAP	1	PZ																																																		
VM2063A0	L.MISS 46X33 LEFT UPPER DOOR COLUMN CAP	1	PZ																																																		
VM2064A0	L.MISS 46X33 RIGHT LOWER DOOR COLUMN CAP	1	PZ																																																		
VM2065A0	L.MISS 46X33 LEFT LOWER DOOR COLUMN CAP	1	PZ																																																		
VT1061A2	EXTERNAL YELLOW SER.GLASS 598X424X5	1	PZ																																																		
KVT1057A	LM STEFANIA BLACK EXTERNAL GLASS KIT	<table border="1"> <thead> <tr> <th>Code</th> <th>Description</th> <th>Qty</th> <th>UOM</th> </tr> </thead> <tbody> <tr> <td>IP1385A1</td> <td>CORNER POLYSTYREN E PACKING 110X80X2000</td> <td>0.810</td> <td>M</td> </tr> <tr> <td>IP1508A0</td> <td></td> <td>0.950</td> <td>PZ</td> </tr> <tr> <td>IP1508A1</td> <td>POLYSTYREN E U SHAPED PROFILE 2000X60X60</td> <td>0.960</td> <td>M</td> </tr> <tr> <td>RC1200A0</td> <td>ED=4 WIRE D.=0.5 COMPRESSIO N SPRING</td> <td>2</td> <td>PZ</td> </tr> </tbody> </table>	Code	Description	Qty	UOM	IP1385A1	CORNER POLYSTYREN E PACKING 110X80X2000	0.810	M	IP1508A0		0.950	PZ	IP1508A1	POLYSTYREN E U SHAPED PROFILE 2000X60X60	0.960	M	RC1200A0	ED=4 WIRE D.=0.5 COMPRESSIO N SPRING	2	PZ																															
Code	Description	Qty	UOM																																																		
IP1385A1	CORNER POLYSTYREN E PACKING 110X80X2000	0.810	M																																																		
IP1508A0		0.950	PZ																																																		
IP1508A1	POLYSTYREN E U SHAPED PROFILE 2000X60X60	0.960	M																																																		
RC1200A0	ED=4 WIRE D.=0.5 COMPRESSIO N SPRING	2	PZ																																																		



Зип Общепит
vsezip.ru

SPARE PARTS LIST

ASM4039A/0.D00 Door

+7(812)987-08-81

COMPONENT			SPARE PART																																																										
Code	Description	Image	Code	Description	Components list																																																								
VM1920A	INTERNAL GLASS CLOSING RIGHT PLATE		KVT1057A	LM STEFANIA BLACK EXTERNAL GLASS KIT	<table border="1"> <thead> <tr> <th>Code</th> <th>Description</th> <th>Qty</th> <th>UOM</th> </tr> </thead> <tbody> <tr> <td>SL1050A1</td> <td>3M TRANSFER ADHESIVE TAPE</td> <td>0.660</td> <td>M</td> </tr> <tr> <td>TB2306A0</td> <td>LMISS STEFANIA/ELE NA DOOR RIGHT COLUM</td> <td>2</td> <td>PZ</td> </tr> <tr> <td>TB3080A0</td> <td>LMISS STEFANIA/ELE NA DOOR LEFT COLUMN</td> <td>1</td> <td>PZ</td> </tr> <tr> <td>VM1025A0</td> <td>Ø16 GREY NYLON LID</td> <td>2</td> <td>PZ</td> </tr> <tr> <td>VM1059A1</td> <td>HEAT SHRINK FILM H800</td> <td>1</td> <td>M</td> </tr> <tr> <td>VM1695A0</td> <td>HANDLE POSITION PIN</td> <td>2</td> <td>PZ</td> </tr> <tr> <td>VM1920A0</td> <td>INTERNAL GLASS CLOSING RIGHT PLATE</td> <td>1</td> <td>PZ</td> </tr> <tr> <td>VM1921A0</td> <td>INTERNAL GLASS CLOSING LEFT PLATE</td> <td>1</td> <td>PZ</td> </tr> <tr> <td>VM2062A0</td> <td>L.MISS 46X33 RIGHT UPPER DOOR COLUMN CAP</td> <td>1</td> <td>PZ</td> </tr> <tr> <td>VM2063A0</td> <td>L.MISS 46X33 LEFT UPPER DOOR COLUMN CAP</td> <td>1</td> <td>PZ</td> </tr> <tr> <td>VM2064A0</td> <td>L.MISS 46X33 RIGHT LOWER DOOR COLUMN CAP</td> <td>1</td> <td>PZ</td> </tr> <tr> <td>VM2065A0</td> <td>L.MISS 46X33 LEFT LOWER DOOR COLUMN CAP</td> <td>1</td> <td>PZ</td> </tr> <tr> <td>VT1057A0</td> <td>L.MISS STEFANIA EXTERNAL GLASS 598X344X5</td> <td>1</td> <td>PZ</td> </tr> </tbody> </table>	Code	Description	Qty	UOM	SL1050A1	3M TRANSFER ADHESIVE TAPE	0.660	M	TB2306A0	LMISS STEFANIA/ELE NA DOOR RIGHT COLUM	2	PZ	TB3080A0	LMISS STEFANIA/ELE NA DOOR LEFT COLUMN	1	PZ	VM1025A0	Ø16 GREY NYLON LID	2	PZ	VM1059A1	HEAT SHRINK FILM H800	1	M	VM1695A0	HANDLE POSITION PIN	2	PZ	VM1920A0	INTERNAL GLASS CLOSING RIGHT PLATE	1	PZ	VM1921A0	INTERNAL GLASS CLOSING LEFT PLATE	1	PZ	VM2062A0	L.MISS 46X33 RIGHT UPPER DOOR COLUMN CAP	1	PZ	VM2063A0	L.MISS 46X33 LEFT UPPER DOOR COLUMN CAP	1	PZ	VM2064A0	L.MISS 46X33 RIGHT LOWER DOOR COLUMN CAP	1	PZ	VM2065A0	L.MISS 46X33 LEFT LOWER DOOR COLUMN CAP	1	PZ	VT1057A0	L.MISS STEFANIA EXTERNAL GLASS 598X344X5	1	PZ
Code	Description	Qty	UOM																																																										
SL1050A1	3M TRANSFER ADHESIVE TAPE	0.660	M																																																										
TB2306A0	LMISS STEFANIA/ELE NA DOOR RIGHT COLUM	2	PZ																																																										
TB3080A0	LMISS STEFANIA/ELE NA DOOR LEFT COLUMN	1	PZ																																																										
VM1025A0	Ø16 GREY NYLON LID	2	PZ																																																										
VM1059A1	HEAT SHRINK FILM H800	1	M																																																										
VM1695A0	HANDLE POSITION PIN	2	PZ																																																										
VM1920A0	INTERNAL GLASS CLOSING RIGHT PLATE	1	PZ																																																										
VM1921A0	INTERNAL GLASS CLOSING LEFT PLATE	1	PZ																																																										
VM2062A0	L.MISS 46X33 RIGHT UPPER DOOR COLUMN CAP	1	PZ																																																										
VM2063A0	L.MISS 46X33 LEFT UPPER DOOR COLUMN CAP	1	PZ																																																										
VM2064A0	L.MISS 46X33 RIGHT LOWER DOOR COLUMN CAP	1	PZ																																																										
VM2065A0	L.MISS 46X33 LEFT LOWER DOOR COLUMN CAP	1	PZ																																																										
VT1057A0	L.MISS STEFANIA EXTERNAL GLASS 598X344X5	1	PZ																																																										
			KVT1056A	LM STEFANIA YELLOW EXTERNAL GLASS KIT	<table border="1"> <thead> <tr> <th>Code</th> <th>Description</th> <th>Qty</th> <th>UOM</th> </tr> </thead> <tbody> <tr> <td>IP1385A1</td> <td>CORNER POLYSTYREN E PACKING 110X80X2000</td> <td>0.980</td> <td>M</td> </tr> <tr> <td>IP1508A0</td> <td></td> <td>0.960</td> <td>PZ</td> </tr> </tbody> </table>	Code	Description	Qty	UOM	IP1385A1	CORNER POLYSTYREN E PACKING 110X80X2000	0.980	M	IP1508A0		0.960	PZ																																												
Code	Description	Qty	UOM																																																										
IP1385A1	CORNER POLYSTYREN E PACKING 110X80X2000	0.980	M																																																										
IP1508A0		0.960	PZ																																																										



+7(812)987-08-81

COMPONENT			SPARE PART																																																																									
Code	Description	Image	Code	Description	Components list																																																																							
VM1920A	INTERNAL GLASS CLOSING RIGHT PLATE		KVT1056A	LM STEFANIA YELLOW EXTERNAL GLASS KIT	<table border="1"> <thead> <tr> <th>Code</th> <th>Description</th> <th>Qty</th> <th>UOM</th> </tr> </thead> <tbody> <tr> <td>IP1508A1</td> <td>POLYSTYREN E U SHAPED PROFILE 2000X60X60</td> <td>0.960</td> <td>M</td> </tr> <tr> <td>RC1200A0</td> <td>ED=4 WIRE D.=0.5 COMPRESSIO N SPRING</td> <td>2</td> <td>PZ</td> </tr> <tr> <td>SL1050A1</td> <td>3M TRANSFER ADHESIVE TAPE</td> <td>0.660</td> <td>M</td> </tr> <tr> <td>TB2306A0</td> <td>LMISS STEFANIA/ELE NA DOOR RIGHT COLUM</td> <td>2</td> <td>PZ</td> </tr> <tr> <td>VM1025A0</td> <td>Ø16 GREY NYLON LID</td> <td>2</td> <td>PZ</td> </tr> <tr> <td>VM1059A1</td> <td>HEAT SHRINK FILM H800</td> <td>1.300</td> <td>M</td> </tr> <tr> <td>VM1695A0</td> <td>HANDLE POSITION PIN</td> <td>2</td> <td>PZ</td> </tr> <tr> <td>VM1920A0</td> <td>INTERNAL GLASS CLOSING RIGHT PLATE</td> <td>1</td> <td>PZ</td> </tr> <tr> <td>VM1921A0</td> <td>INTERNAL GLASS CLOSING LEFT PLATE</td> <td>1</td> <td>PZ</td> </tr> <tr> <td>VM2062A0</td> <td>L.MISS 46X33 RIGHT UPPER DOOR COLUMN CAP</td> <td>1</td> <td>PZ</td> </tr> <tr> <td>VM2063A0</td> <td>L.MISS 46X33 LEFT UPPER DOOR COLUMN CAP</td> <td>1</td> <td>PZ</td> </tr> <tr> <td>VM2064A0</td> <td>L.MISS 46X33 RIGHT LOWER DOOR COLUMN CAP</td> <td>1</td> <td>PZ</td> </tr> <tr> <td>VM2065A0</td> <td>L.MISS 46X33 LEFT LOWER DOOR COLUMN CAP</td> <td>1</td> <td>PZ</td> </tr> <tr> <td>VT1056A2</td> <td>YELLOW SER GLASS 598X344X5</td> <td>1</td> <td>PZ</td> </tr> </tbody> </table>	Code	Description	Qty	UOM	IP1508A1	POLYSTYREN E U SHAPED PROFILE 2000X60X60	0.960	M	RC1200A0	ED=4 WIRE D.=0.5 COMPRESSIO N SPRING	2	PZ	SL1050A1	3M TRANSFER ADHESIVE TAPE	0.660	M	TB2306A0	LMISS STEFANIA/ELE NA DOOR RIGHT COLUM	2	PZ	VM1025A0	Ø16 GREY NYLON LID	2	PZ	VM1059A1	HEAT SHRINK FILM H800	1.300	M	VM1695A0	HANDLE POSITION PIN	2	PZ	VM1920A0	INTERNAL GLASS CLOSING RIGHT PLATE	1	PZ	VM1921A0	INTERNAL GLASS CLOSING LEFT PLATE	1	PZ	VM2062A0	L.MISS 46X33 RIGHT UPPER DOOR COLUMN CAP	1	PZ	VM2063A0	L.MISS 46X33 LEFT UPPER DOOR COLUMN CAP	1	PZ	VM2064A0	L.MISS 46X33 RIGHT LOWER DOOR COLUMN CAP	1	PZ	VM2065A0	L.MISS 46X33 LEFT LOWER DOOR COLUMN CAP	1	PZ	VT1056A2	YELLOW SER GLASS 598X344X5	1	PZ	KVT1052A	LM CRISTINA BLACK EXTERNAL GLASS KIT	<table border="1"> <thead> <tr> <th>Code</th> <th>Description</th> <th>Qty</th> <th>UOM</th> </tr> </thead> <tbody> <tr> <td>RC1200A0</td> <td>ED=4 WIRE D.=0.5 COMPRESSIO N SPRING</td> <td>2</td> <td>PZ</td> </tr> </tbody> </table>	Code	Description	Qty	UOM	RC1200A0	ED=4 WIRE D.=0.5 COMPRESSIO N SPRING	2	PZ
			Code	Description	Qty	UOM																																																																						
IP1508A1	POLYSTYREN E U SHAPED PROFILE 2000X60X60	0.960	M																																																																									
RC1200A0	ED=4 WIRE D.=0.5 COMPRESSIO N SPRING	2	PZ																																																																									
SL1050A1	3M TRANSFER ADHESIVE TAPE	0.660	M																																																																									
TB2306A0	LMISS STEFANIA/ELE NA DOOR RIGHT COLUM	2	PZ																																																																									
VM1025A0	Ø16 GREY NYLON LID	2	PZ																																																																									
VM1059A1	HEAT SHRINK FILM H800	1.300	M																																																																									
VM1695A0	HANDLE POSITION PIN	2	PZ																																																																									
VM1920A0	INTERNAL GLASS CLOSING RIGHT PLATE	1	PZ																																																																									
VM1921A0	INTERNAL GLASS CLOSING LEFT PLATE	1	PZ																																																																									
VM2062A0	L.MISS 46X33 RIGHT UPPER DOOR COLUMN CAP	1	PZ																																																																									
VM2063A0	L.MISS 46X33 LEFT UPPER DOOR COLUMN CAP	1	PZ																																																																									
VM2064A0	L.MISS 46X33 RIGHT LOWER DOOR COLUMN CAP	1	PZ																																																																									
VM2065A0	L.MISS 46X33 LEFT LOWER DOOR COLUMN CAP	1	PZ																																																																									
VT1056A2	YELLOW SER GLASS 598X344X5	1	PZ																																																																									
Code	Description	Qty	UOM																																																																									
RC1200A0	ED=4 WIRE D.=0.5 COMPRESSIO N SPRING	2	PZ																																																																									



+7(812)987-08-81

COMPONENT			SPARE PART																																																		
Code	Description	Image	Code	Description	Components list																																																
VM1920A	INTERNAL GLASS CLOSING RIGHT PLATE		KVT1052A	LM CRISTINA BLACK EXTERNAL GLASS KIT	<table border="1"> <thead> <tr> <th>Code</th> <th>Description</th> <th>Qty</th> <th>UOM</th> </tr> </thead> <tbody> <tr> <td>SL1050A1</td> <td>3M TRANSFER ADHESIVE TAPE</td> <td>0.660</td> <td>M</td> </tr> <tr> <td>TB2306A0</td> <td>LMISS STEFANIA/ELE NA DOOR RIGHT COLUM</td> <td>2</td> <td>PZ</td> </tr> <tr> <td>VM1025A0</td> <td>Ø16 GREY NYLON LID</td> <td>2</td> <td>PZ</td> </tr> <tr> <td>VM1695A0</td> <td>HANDLE POSITION PIN</td> <td>2</td> <td>PZ</td> </tr> <tr> <td>VM1920A0</td> <td>INTERNAL GLASS CLOSING RIGHT PLATE</td> <td>1</td> <td>PZ</td> </tr> <tr> <td>VM1921A0</td> <td>INTERNAL GLASS CLOSING LEFT PLATE</td> <td>1</td> <td>PZ</td> </tr> <tr> <td>VM2062A0</td> <td>L.MISS 46X33 RIGHT UPPER DOOR COLUMN CAP</td> <td>1</td> <td>PZ</td> </tr> <tr> <td>VM2063A0</td> <td>L.MISS 46X33 LEFT UPPER DOOR COLUMN CAP</td> <td>1</td> <td>PZ</td> </tr> <tr> <td>VM2064A0</td> <td>L.MISS 46X33 RIGHT LOWER DOOR COLUMN CAP</td> <td>1</td> <td>PZ</td> </tr> <tr> <td>VM2065A0</td> <td>L.MISS 46X33 LEFT LOWER DOOR COLUMN CAP</td> <td>1</td> <td>PZ</td> </tr> <tr> <td>VT1052A0</td> <td>478X344X5 EXTERNAL GLASS</td> <td>1</td> <td>PZ</td> </tr> </tbody> </table>	Code	Description	Qty	UOM	SL1050A1	3M TRANSFER ADHESIVE TAPE	0.660	M	TB2306A0	LMISS STEFANIA/ELE NA DOOR RIGHT COLUM	2	PZ	VM1025A0	Ø16 GREY NYLON LID	2	PZ	VM1695A0	HANDLE POSITION PIN	2	PZ	VM1920A0	INTERNAL GLASS CLOSING RIGHT PLATE	1	PZ	VM1921A0	INTERNAL GLASS CLOSING LEFT PLATE	1	PZ	VM2062A0	L.MISS 46X33 RIGHT UPPER DOOR COLUMN CAP	1	PZ	VM2063A0	L.MISS 46X33 LEFT UPPER DOOR COLUMN CAP	1	PZ	VM2064A0	L.MISS 46X33 RIGHT LOWER DOOR COLUMN CAP	1	PZ	VM2065A0	L.MISS 46X33 LEFT LOWER DOOR COLUMN CAP	1	PZ	VT1052A0	478X344X5 EXTERNAL GLASS	1	PZ
			Code	Description	Qty	UOM																																															
SL1050A1	3M TRANSFER ADHESIVE TAPE	0.660	M																																																		
TB2306A0	LMISS STEFANIA/ELE NA DOOR RIGHT COLUM	2	PZ																																																		
VM1025A0	Ø16 GREY NYLON LID	2	PZ																																																		
VM1695A0	HANDLE POSITION PIN	2	PZ																																																		
VM1920A0	INTERNAL GLASS CLOSING RIGHT PLATE	1	PZ																																																		
VM1921A0	INTERNAL GLASS CLOSING LEFT PLATE	1	PZ																																																		
VM2062A0	L.MISS 46X33 RIGHT UPPER DOOR COLUMN CAP	1	PZ																																																		
VM2063A0	L.MISS 46X33 LEFT UPPER DOOR COLUMN CAP	1	PZ																																																		
VM2064A0	L.MISS 46X33 RIGHT LOWER DOOR COLUMN CAP	1	PZ																																																		
VM2065A0	L.MISS 46X33 LEFT LOWER DOOR COLUMN CAP	1	PZ																																																		
VT1052A0	478X344X5 EXTERNAL GLASS	1	PZ																																																		
KVT1051A	LM CRISTINA YELLOW EXTERNAL GLASS KIT	<table border="1"> <thead> <tr> <th>Code</th> <th>Description</th> <th>Qty</th> <th>UOM</th> </tr> </thead> <tbody> <tr> <td>IP1385A1</td> <td>CORNER POLYSTYREN E PACKING 110X80X2000</td> <td>1.040</td> <td>M</td> </tr> <tr> <td>RC1200A0</td> <td>ED=4 WIRE D.=0.5 COMPRESSIO N SPRING</td> <td>2</td> <td>PZ</td> </tr> <tr> <td>SL1050A1</td> <td>3M TRANSFER ADHESIVE TAPE</td> <td>0.660</td> <td>M</td> </tr> <tr> <td>TB2306A0</td> <td>LMISS STEFANIA/ELE NA DOOR RIGHT COLUM</td> <td>2</td> <td>PZ</td> </tr> </tbody> </table>	Code	Description	Qty	UOM	IP1385A1	CORNER POLYSTYREN E PACKING 110X80X2000	1.040	M	RC1200A0	ED=4 WIRE D.=0.5 COMPRESSIO N SPRING	2	PZ	SL1050A1	3M TRANSFER ADHESIVE TAPE	0.660	M	TB2306A0	LMISS STEFANIA/ELE NA DOOR RIGHT COLUM	2	PZ																															
Code	Description	Qty	UOM																																																		
IP1385A1	CORNER POLYSTYREN E PACKING 110X80X2000	1.040	M																																																		
RC1200A0	ED=4 WIRE D.=0.5 COMPRESSIO N SPRING	2	PZ																																																		
SL1050A1	3M TRANSFER ADHESIVE TAPE	0.660	M																																																		
TB2306A0	LMISS STEFANIA/ELE NA DOOR RIGHT COLUM	2	PZ																																																		

+7(812)987-08-81

COMPONENT			SPARE PART																																														
Code	Description	Image	Code	Description	Components list																																												
VM1920A	INTERNAL GLASS CLOSING RIGHT PLATE		KVT1051A	LM CRISTINA YELLOW EXTERNAL GLASS KIT	<table border="1"> <thead> <tr> <th>Code</th> <th>Description</th> <th>Qty</th> <th>UOM</th> </tr> </thead> <tbody> <tr> <td>VM1025A0</td> <td>Ø16 GREY NYLON LID</td> <td>2</td> <td>PZ</td> </tr> <tr> <td>VM1059A1</td> <td>HEAT SHRINK FILM H800</td> <td>1.500</td> <td>M</td> </tr> <tr> <td>VM1695A0</td> <td>HANDLE POSITION PIN</td> <td>2</td> <td>PZ</td> </tr> <tr> <td>VM1920A0</td> <td>INTERNAL GLASS CLOSING RIGHT PLATE</td> <td>1</td> <td>PZ</td> </tr> <tr> <td>VM1921A0</td> <td>INTERNAL GLASS CLOSING LEFT PLATE</td> <td>1</td> <td>PZ</td> </tr> <tr> <td>VM2062A0</td> <td>L.MISS 46X33 RIGHT UPPER DOOR COLUMN CAP</td> <td>1</td> <td>PZ</td> </tr> <tr> <td>VM2063A0</td> <td>L.MISS 46X33 LEFT UPPER DOOR COLUMN CAP</td> <td>1</td> <td>PZ</td> </tr> <tr> <td>VM2064A0</td> <td>L.MISS 46X33 RIGHT LOWER DOOR COLUMN CAP</td> <td>1</td> <td>PZ</td> </tr> <tr> <td>VM2065A0</td> <td>L.MISS 46X33 LEFT LOWER DOOR COLUMN CAP</td> <td>1</td> <td>PZ</td> </tr> <tr> <td>VT1051A2</td> <td>YELLOW SER GLASS 478X344X5</td> <td>1</td> <td>PZ</td> </tr> </tbody> </table>	Code	Description	Qty	UOM	VM1025A0	Ø16 GREY NYLON LID	2	PZ	VM1059A1	HEAT SHRINK FILM H800	1.500	M	VM1695A0	HANDLE POSITION PIN	2	PZ	VM1920A0	INTERNAL GLASS CLOSING RIGHT PLATE	1	PZ	VM1921A0	INTERNAL GLASS CLOSING LEFT PLATE	1	PZ	VM2062A0	L.MISS 46X33 RIGHT UPPER DOOR COLUMN CAP	1	PZ	VM2063A0	L.MISS 46X33 LEFT UPPER DOOR COLUMN CAP	1	PZ	VM2064A0	L.MISS 46X33 RIGHT LOWER DOOR COLUMN CAP	1	PZ	VM2065A0	L.MISS 46X33 LEFT LOWER DOOR COLUMN CAP	1	PZ	VT1051A2	YELLOW SER GLASS 478X344X5	1	PZ
Code	Description	Qty	UOM																																														
VM1025A0	Ø16 GREY NYLON LID	2	PZ																																														
VM1059A1	HEAT SHRINK FILM H800	1.500	M																																														
VM1695A0	HANDLE POSITION PIN	2	PZ																																														
VM1920A0	INTERNAL GLASS CLOSING RIGHT PLATE	1	PZ																																														
VM1921A0	INTERNAL GLASS CLOSING LEFT PLATE	1	PZ																																														
VM2062A0	L.MISS 46X33 RIGHT UPPER DOOR COLUMN CAP	1	PZ																																														
VM2063A0	L.MISS 46X33 LEFT UPPER DOOR COLUMN CAP	1	PZ																																														
VM2064A0	L.MISS 46X33 RIGHT LOWER DOOR COLUMN CAP	1	PZ																																														
VM2065A0	L.MISS 46X33 LEFT LOWER DOOR COLUMN CAP	1	PZ																																														
VT1051A2	YELLOW SER GLASS 478X344X5	1	PZ																																														
VM1917A	LEFT UPPER COLUMN CAP		KVT1253A	XF195-EG- VT1253A EXTERNAL GLASS KIT	<table border="1"> <thead> <tr> <th>Code</th> <th>Description</th> <th>Qty</th> <th>UOM</th> </tr> </thead> <tbody> <tr> <td>IP1235B0</td> <td>POLYSTYREN E FLAT PACKING</td> <td>1</td> <td>PZ</td> </tr> <tr> <td>RC1200A0</td> <td>ED=4 WIRE D.=0.5 COMPRESSIO N SPRING</td> <td>2</td> <td>PZ</td> </tr> <tr> <td>SL1050A1</td> <td>3M TRANSFER ADHESIVE TAPE</td> <td>0.820</td> <td>M</td> </tr> <tr> <td>TB2301A0</td> <td>RIGHT COLUMN XVC105E 40X40X1</td> <td>2</td> <td>PZ</td> </tr> <tr> <td>TB3081A0</td> <td>LMISS ARIANNA/ROS SELLA DOOR LEFT COLUMN</td> <td>1</td> <td>PZ</td> </tr> <tr> <td>VM1025A0</td> <td>Ø16 GREY NYLON LID</td> <td>2</td> <td>PZ</td> </tr> </tbody> </table>	Code	Description	Qty	UOM	IP1235B0	POLYSTYREN E FLAT PACKING	1	PZ	RC1200A0	ED=4 WIRE D.=0.5 COMPRESSIO N SPRING	2	PZ	SL1050A1	3M TRANSFER ADHESIVE TAPE	0.820	M	TB2301A0	RIGHT COLUMN XVC105E 40X40X1	2	PZ	TB3081A0	LMISS ARIANNA/ROS SELLA DOOR LEFT COLUMN	1	PZ	VM1025A0	Ø16 GREY NYLON LID	2	PZ																
Code	Description	Qty	UOM																																														
IP1235B0	POLYSTYREN E FLAT PACKING	1	PZ																																														
RC1200A0	ED=4 WIRE D.=0.5 COMPRESSIO N SPRING	2	PZ																																														
SL1050A1	3M TRANSFER ADHESIVE TAPE	0.820	M																																														
TB2301A0	RIGHT COLUMN XVC105E 40X40X1	2	PZ																																														
TB3081A0	LMISS ARIANNA/ROS SELLA DOOR LEFT COLUMN	1	PZ																																														
VM1025A0	Ø16 GREY NYLON LID	2	PZ																																														



+7(812)987-08-81

COMPONENT			SPARE PART																																															
Code	Description	Image	Code	Description	Components list																																													
VM1917A	LEFT UPPER COLUMN CAP		KVT1253A	XF195-EG- VT1253A EXTERNAL GLASS KIT	<table border="1"> <thead> <tr> <th>Code</th> <th>Description</th> <th>Qty</th> <th>UOM</th> </tr> </thead> <tbody> <tr> <td>VM1695A0</td> <td>HANDLE POSITION PIN</td> <td>2</td> <td>PZ</td> </tr> <tr> <td>VM1916A0</td> <td>RIGHT UPPER COLUMN CAP</td> <td>1</td> <td>PZ</td> </tr> <tr> <td>VM1917A0</td> <td>LEFT UPPER COLUMN CAP</td> <td>1</td> <td>PZ</td> </tr> <tr> <td>VM1918A0</td> <td>RIGHT LOWER COLUMN CAP</td> <td>1</td> <td>PZ</td> </tr> <tr> <td>VM1919A0</td> <td>LEFT LOWER COLUMN CAP</td> <td>1</td> <td>PZ</td> </tr> <tr> <td>VM1920A0</td> <td>INTERNAL GLASS CLOSING RIGHT PLATE</td> <td>1</td> <td>PZ</td> </tr> <tr> <td>VM1921A0</td> <td>INTERNAL GLASS CLOSING LEFT PLATE</td> <td>1</td> <td>PZ</td> </tr> <tr> <td>VT1253A0</td> <td>XFT195 DOOR EXT. BLACK GLASS - ENGEFOOD</td> <td>1</td> <td>PZ</td> </tr> </tbody> </table>	Code	Description	Qty	UOM	VM1695A0	HANDLE POSITION PIN	2	PZ	VM1916A0	RIGHT UPPER COLUMN CAP	1	PZ	VM1917A0	LEFT UPPER COLUMN CAP	1	PZ	VM1918A0	RIGHT LOWER COLUMN CAP	1	PZ	VM1919A0	LEFT LOWER COLUMN CAP	1	PZ	VM1920A0	INTERNAL GLASS CLOSING RIGHT PLATE	1	PZ	VM1921A0	INTERNAL GLASS CLOSING LEFT PLATE	1	PZ	VT1253A0	XFT195 DOOR EXT. BLACK GLASS - ENGEFOOD	1	PZ									
			Code	Description	Qty	UOM																																												
VM1695A0	HANDLE POSITION PIN	2	PZ																																															
VM1916A0	RIGHT UPPER COLUMN CAP	1	PZ																																															
VM1917A0	LEFT UPPER COLUMN CAP	1	PZ																																															
VM1918A0	RIGHT LOWER COLUMN CAP	1	PZ																																															
VM1919A0	LEFT LOWER COLUMN CAP	1	PZ																																															
VM1920A0	INTERNAL GLASS CLOSING RIGHT PLATE	1	PZ																																															
VM1921A0	INTERNAL GLASS CLOSING LEFT PLATE	1	PZ																																															
VT1253A0	XFT195 DOOR EXT. BLACK GLASS - ENGEFOOD	1	PZ																																															
KVT1072A	L.M. ROSSELLA BLACK EXTERNAL GLASS KIT	<table border="1"> <thead> <tr> <th>Code</th> <th>Description</th> <th>Qty</th> <th>UOM</th> </tr> </thead> <tbody> <tr> <td>IP1385A1</td> <td>CORNER POLYSTYREN E PACKING 110X80X2000</td> <td>0.960</td> <td>M</td> </tr> <tr> <td>IP1508A0</td> <td></td> <td>1.280</td> <td>PZ</td> </tr> <tr> <td>IP1508A1</td> <td>POLYSTYREN E U SHAPED PROFILE 2000X60X60</td> <td>1.270</td> <td>M</td> </tr> <tr> <td>RC1200A0</td> <td>ED=4 WIRE D.=0.5 COMPRESSIO N SPRING</td> <td>2</td> <td>PZ</td> </tr> <tr> <td>SL1050A1</td> <td>3M TRANSFER ADHESIVE TAPE</td> <td>0.820</td> <td>M</td> </tr> <tr> <td>TB2301A0</td> <td>RIGHT COLUMN XVC105E 40X40X1</td> <td>2</td> <td>PZ</td> </tr> <tr> <td>TB3081A0</td> <td>LMISS ARIANNA/ROS SELLA DOOR LEFT COLUMN</td> <td>1</td> <td>PZ</td> </tr> <tr> <td>VM1025A0</td> <td>Ø16 GREY NYLON LID</td> <td>2</td> <td>PZ</td> </tr> <tr> <td>VM1059A1</td> <td>HEAT SHRINK FILM H800</td> <td>1.300</td> <td>M</td> </tr> <tr> <td>VM1695A0</td> <td>HANDLE POSITION PIN</td> <td>2</td> <td>PZ</td> </tr> <tr> <td>VM1916A0</td> <td>RIGHT UPPER COLUMN CAP</td> <td>1</td> <td>PZ</td> </tr> </tbody> </table>	Code	Description	Qty	UOM	IP1385A1	CORNER POLYSTYREN E PACKING 110X80X2000	0.960	M	IP1508A0		1.280	PZ	IP1508A1	POLYSTYREN E U SHAPED PROFILE 2000X60X60	1.270	M	RC1200A0	ED=4 WIRE D.=0.5 COMPRESSIO N SPRING	2	PZ	SL1050A1	3M TRANSFER ADHESIVE TAPE	0.820	M	TB2301A0	RIGHT COLUMN XVC105E 40X40X1	2	PZ	TB3081A0	LMISS ARIANNA/ROS SELLA DOOR LEFT COLUMN	1	PZ	VM1025A0	Ø16 GREY NYLON LID	2	PZ	VM1059A1	HEAT SHRINK FILM H800	1.300	M	VM1695A0	HANDLE POSITION PIN	2	PZ	VM1916A0	RIGHT UPPER COLUMN CAP	1	PZ
Code	Description	Qty	UOM																																															
IP1385A1	CORNER POLYSTYREN E PACKING 110X80X2000	0.960	M																																															
IP1508A0		1.280	PZ																																															
IP1508A1	POLYSTYREN E U SHAPED PROFILE 2000X60X60	1.270	M																																															
RC1200A0	ED=4 WIRE D.=0.5 COMPRESSIO N SPRING	2	PZ																																															
SL1050A1	3M TRANSFER ADHESIVE TAPE	0.820	M																																															
TB2301A0	RIGHT COLUMN XVC105E 40X40X1	2	PZ																																															
TB3081A0	LMISS ARIANNA/ROS SELLA DOOR LEFT COLUMN	1	PZ																																															
VM1025A0	Ø16 GREY NYLON LID	2	PZ																																															
VM1059A1	HEAT SHRINK FILM H800	1.300	M																																															
VM1695A0	HANDLE POSITION PIN	2	PZ																																															
VM1916A0	RIGHT UPPER COLUMN CAP	1	PZ																																															



+7(812)987-08-81

COMPONENT			SPARE PART																																																							
Code	Description	Image	Code	Description	Components list																																																					
VM1917A	LEFT UPPER COLUMN CAP		KVT1072A	L.M. ROSSELLA BLACK EXTERNAL GLASS KIT	<table border="1"> <thead> <tr> <th>Code</th> <th>Description</th> <th>Qty</th> <th>UOM</th> </tr> </thead> <tbody> <tr> <td>VM1917A0</td> <td>LEFT UPPER COLUMN CAP</td> <td>1</td> <td>PZ</td> </tr> <tr> <td>VM1918A0</td> <td>RIGHT LOWER COLUMN CAP</td> <td>1</td> <td>PZ</td> </tr> <tr> <td>VM1919A0</td> <td>LEFT LOWER COLUMN CAP</td> <td>1</td> <td>PZ</td> </tr> <tr> <td>VM1920A0</td> <td>INTERNAL GLASS CLOSING RIGHT PLATE</td> <td>1</td> <td>PZ</td> </tr> <tr> <td>VM1921A0</td> <td>INTERNAL GLASS CLOSING LEFT PLATE</td> <td>1</td> <td>PZ</td> </tr> <tr> <td>VT1072A0</td> <td>LINEMISS ROSSELLA BLACK EXTERNAL GLASS</td> <td>1</td> <td>PZ</td> </tr> </tbody> </table>	Code	Description	Qty	UOM	VM1917A0	LEFT UPPER COLUMN CAP	1	PZ	VM1918A0	RIGHT LOWER COLUMN CAP	1	PZ	VM1919A0	LEFT LOWER COLUMN CAP	1	PZ	VM1920A0	INTERNAL GLASS CLOSING RIGHT PLATE	1	PZ	VM1921A0	INTERNAL GLASS CLOSING LEFT PLATE	1	PZ	VT1072A0	LINEMISS ROSSELLA BLACK EXTERNAL GLASS	1	PZ																									
			Code	Description	Qty	UOM																																																				
VM1917A0	LEFT UPPER COLUMN CAP	1	PZ																																																							
VM1918A0	RIGHT LOWER COLUMN CAP	1	PZ																																																							
VM1919A0	LEFT LOWER COLUMN CAP	1	PZ																																																							
VM1920A0	INTERNAL GLASS CLOSING RIGHT PLATE	1	PZ																																																							
VM1921A0	INTERNAL GLASS CLOSING LEFT PLATE	1	PZ																																																							
VT1072A0	LINEMISS ROSSELLA BLACK EXTERNAL GLASS	1	PZ																																																							
KVT1071A	L.M. ROSSELLA EXTERNAL GLASS KIT	<table border="1"> <thead> <tr> <th>Code</th> <th>Description</th> <th>Qty</th> <th>UOM</th> </tr> </thead> <tbody> <tr> <td>IP1385A1</td> <td>CORNER POLYSTYREN E PACKING 110X80X2000</td> <td>0.960</td> <td>M</td> </tr> <tr> <td>IP1508A0</td> <td>POLYSTYREN E U SHAPED PROFILE 2000X60X60</td> <td>1.300</td> <td>PZ</td> </tr> <tr> <td>IP1508A1</td> <td>POLYSTYREN E U SHAPED PROFILE 2000X60X60</td> <td>2</td> <td>M</td> </tr> <tr> <td>RC1200A0</td> <td>ED=4 WIRE D.=0.5 COMPRESSIO N SPRING</td> <td>2</td> <td>PZ</td> </tr> <tr> <td>SL1050A1</td> <td>3M TRANSFER ADHESIVE TAPE</td> <td>0.820</td> <td>M</td> </tr> <tr> <td>TB2301A0</td> <td>RIGHT COLUMN XVC105E 40X40X1</td> <td>2</td> <td>PZ</td> </tr> <tr> <td>VM1025A0</td> <td>Ø16 GREY NYLON LID</td> <td>2</td> <td>PZ</td> </tr> <tr> <td>VM1059A1</td> <td>HEAT SHRINK FILM H800</td> <td>1.350</td> <td>M</td> </tr> <tr> <td>VM1695A0</td> <td>HANDLE POSITION PIN</td> <td>2</td> <td>PZ</td> </tr> <tr> <td>VM1916A0</td> <td>RIGHT UPPER COLUMN CAP</td> <td>1</td> <td>PZ</td> </tr> <tr> <td>VM1917A0</td> <td>LEFT UPPER COLUMN CAP</td> <td>1</td> <td>PZ</td> </tr> <tr> <td>VM1918A0</td> <td>RIGHT LOWER COLUMN CAP</td> <td>1</td> <td>PZ</td> </tr> <tr> <td>VM1919A0</td> <td>LEFT LOWER COLUMN CAP</td> <td>1</td> <td>PZ</td> </tr> </tbody> </table>	Code	Description	Qty	UOM	IP1385A1	CORNER POLYSTYREN E PACKING 110X80X2000	0.960	M	IP1508A0	POLYSTYREN E U SHAPED PROFILE 2000X60X60	1.300	PZ	IP1508A1	POLYSTYREN E U SHAPED PROFILE 2000X60X60	2	M	RC1200A0	ED=4 WIRE D.=0.5 COMPRESSIO N SPRING	2	PZ	SL1050A1	3M TRANSFER ADHESIVE TAPE	0.820	M	TB2301A0	RIGHT COLUMN XVC105E 40X40X1	2	PZ	VM1025A0	Ø16 GREY NYLON LID	2	PZ	VM1059A1	HEAT SHRINK FILM H800	1.350	M	VM1695A0	HANDLE POSITION PIN	2	PZ	VM1916A0	RIGHT UPPER COLUMN CAP	1	PZ	VM1917A0	LEFT UPPER COLUMN CAP	1	PZ	VM1918A0	RIGHT LOWER COLUMN CAP	1	PZ	VM1919A0	LEFT LOWER COLUMN CAP	1	PZ
Code	Description	Qty	UOM																																																							
IP1385A1	CORNER POLYSTYREN E PACKING 110X80X2000	0.960	M																																																							
IP1508A0	POLYSTYREN E U SHAPED PROFILE 2000X60X60	1.300	PZ																																																							
IP1508A1	POLYSTYREN E U SHAPED PROFILE 2000X60X60	2	M																																																							
RC1200A0	ED=4 WIRE D.=0.5 COMPRESSIO N SPRING	2	PZ																																																							
SL1050A1	3M TRANSFER ADHESIVE TAPE	0.820	M																																																							
TB2301A0	RIGHT COLUMN XVC105E 40X40X1	2	PZ																																																							
VM1025A0	Ø16 GREY NYLON LID	2	PZ																																																							
VM1059A1	HEAT SHRINK FILM H800	1.350	M																																																							
VM1695A0	HANDLE POSITION PIN	2	PZ																																																							
VM1916A0	RIGHT UPPER COLUMN CAP	1	PZ																																																							
VM1917A0	LEFT UPPER COLUMN CAP	1	PZ																																																							
VM1918A0	RIGHT LOWER COLUMN CAP	1	PZ																																																							
VM1919A0	LEFT LOWER COLUMN CAP	1	PZ																																																							



+7(812)987-08-81

COMPONENT			SPARE PART																																																															
Code	Description	Image	Code	Description	Components list																																																													
VM1917A	LEFT UPPER COLUMN CAP		KVT1071A	L.M. ROSSELLA EXTERNAL GLASS KIT	<table border="1"> <thead> <tr> <th>Code</th> <th>Description</th> <th>Qty</th> <th>UOM</th> </tr> </thead> <tbody> <tr> <td>VM1920A0</td> <td>INTERNAL GLASS CLOSING RIGHT PLATE</td> <td>1</td> <td>PZ</td> </tr> <tr> <td>VM1921A0</td> <td>INTERNAL GLASS CLOSING LEFT PLATE</td> <td>1</td> <td>PZ</td> </tr> <tr> <td>VT1071A2</td> <td>YELLOW SER GLASS 798X424X5</td> <td>1</td> <td>PZ</td> </tr> </tbody> </table>	Code	Description	Qty	UOM	VM1920A0	INTERNAL GLASS CLOSING RIGHT PLATE	1	PZ	VM1921A0	INTERNAL GLASS CLOSING LEFT PLATE	1	PZ	VT1071A2	YELLOW SER GLASS 798X424X5	1	PZ																																													
			Code	Description	Qty	UOM																																																												
VM1920A0	INTERNAL GLASS CLOSING RIGHT PLATE	1	PZ																																																															
VM1921A0	INTERNAL GLASS CLOSING LEFT PLATE	1	PZ																																																															
VT1071A2	YELLOW SER GLASS 798X424X5	1	PZ																																																															
KVT1067A	L.M. ELENA BLACK EXTERNAL GLASS KIT	<table border="1"> <thead> <tr> <th>Code</th> <th>Description</th> <th>Qty</th> <th>UOM</th> </tr> </thead> <tbody> <tr> <td>IP1385A1</td> <td>CORNER POLYSTYREN E PACKING 110X80X2000</td> <td>0.800</td> <td>M</td> </tr> <tr> <td>IP1508A0</td> <td></td> <td>1.710</td> <td>PZ</td> </tr> <tr> <td>IP1508A1</td> <td>POLYSTYREN E U SHAPED PROFILE 2000X60X60</td> <td>2</td> <td>M</td> </tr> <tr> <td>RC1200A0</td> <td>ED=4 WIRE D.=0.5 COMPRESSIO N SPRING</td> <td>2</td> <td>PZ</td> </tr> <tr> <td>SL1050A1</td> <td>3M TRANSFER ADHESIVE TAPE</td> <td>0.660</td> <td>M</td> </tr> <tr> <td>TB2306A0</td> <td>LMISS STEFANIA/ELE NA DOOR RIGHT COLUM</td> <td>2</td> <td>PZ</td> </tr> <tr> <td>TB3080A0</td> <td>LMISS STEFANIA/ELE NA DOOR LEFT COLUMN</td> <td>1</td> <td>PZ</td> </tr> <tr> <td>VM1025A0</td> <td>Ø16 GREY NYLON LID</td> <td>2</td> <td>PZ</td> </tr> <tr> <td>VM1059A1</td> <td>HEAT SHRINK FILM H800</td> <td>1.350</td> <td>M</td> </tr> <tr> <td>VM1695A0</td> <td>HANDLE POSITION PIN</td> <td>2</td> <td>PZ</td> </tr> <tr> <td>VM1916A0</td> <td>RIGHT UPPER COLUMN CAP</td> <td>1</td> <td>PZ</td> </tr> <tr> <td>VM1917A0</td> <td>LEFT UPPER COLUMN CAP</td> <td>1</td> <td>PZ</td> </tr> <tr> <td>VM1918A0</td> <td>RIGHT LOWER COLUMN CAP</td> <td>1</td> <td>PZ</td> </tr> <tr> <td>VM1919A0</td> <td>LEFT LOWER COLUMN CAP</td> <td>1</td> <td>PZ</td> </tr> <tr> <td>VM1920A0</td> <td>INTERNAL GLASS CLOSING RIGHT PLATE</td> <td>1</td> <td>PZ</td> </tr> </tbody> </table>	Code	Description	Qty	UOM	IP1385A1	CORNER POLYSTYREN E PACKING 110X80X2000	0.800	M	IP1508A0		1.710	PZ	IP1508A1	POLYSTYREN E U SHAPED PROFILE 2000X60X60	2	M	RC1200A0	ED=4 WIRE D.=0.5 COMPRESSIO N SPRING	2	PZ	SL1050A1	3M TRANSFER ADHESIVE TAPE	0.660	M	TB2306A0	LMISS STEFANIA/ELE NA DOOR RIGHT COLUM	2	PZ	TB3080A0	LMISS STEFANIA/ELE NA DOOR LEFT COLUMN	1	PZ	VM1025A0	Ø16 GREY NYLON LID	2	PZ	VM1059A1	HEAT SHRINK FILM H800	1.350	M	VM1695A0	HANDLE POSITION PIN	2	PZ	VM1916A0	RIGHT UPPER COLUMN CAP	1	PZ	VM1917A0	LEFT UPPER COLUMN CAP	1	PZ	VM1918A0	RIGHT LOWER COLUMN CAP	1	PZ	VM1919A0	LEFT LOWER COLUMN CAP	1	PZ	VM1920A0	INTERNAL GLASS CLOSING RIGHT PLATE	1	PZ
Code	Description	Qty	UOM																																																															
IP1385A1	CORNER POLYSTYREN E PACKING 110X80X2000	0.800	M																																																															
IP1508A0		1.710	PZ																																																															
IP1508A1	POLYSTYREN E U SHAPED PROFILE 2000X60X60	2	M																																																															
RC1200A0	ED=4 WIRE D.=0.5 COMPRESSIO N SPRING	2	PZ																																																															
SL1050A1	3M TRANSFER ADHESIVE TAPE	0.660	M																																																															
TB2306A0	LMISS STEFANIA/ELE NA DOOR RIGHT COLUM	2	PZ																																																															
TB3080A0	LMISS STEFANIA/ELE NA DOOR LEFT COLUMN	1	PZ																																																															
VM1025A0	Ø16 GREY NYLON LID	2	PZ																																																															
VM1059A1	HEAT SHRINK FILM H800	1.350	M																																																															
VM1695A0	HANDLE POSITION PIN	2	PZ																																																															
VM1916A0	RIGHT UPPER COLUMN CAP	1	PZ																																																															
VM1917A0	LEFT UPPER COLUMN CAP	1	PZ																																																															
VM1918A0	RIGHT LOWER COLUMN CAP	1	PZ																																																															
VM1919A0	LEFT LOWER COLUMN CAP	1	PZ																																																															
VM1920A0	INTERNAL GLASS CLOSING RIGHT PLATE	1	PZ																																																															



+7(812)987-08-81

COMPONENT			SPARE PART																																																																			
Code	Description	Image	Code	Description	Components list																																																																	
VM1917A	LEFT UPPER COLUMN CAP		KVT1067A	L.M. ELENA BLACK EXTERNAL GLASS KIT	<table border="1"> <thead> <tr> <th>Code</th> <th>Description</th> <th>Qty</th> <th>UOM</th> </tr> </thead> <tbody> <tr> <td>VM1921A0</td> <td>INTERNAL GLASS CLOSING LEFT PLATE</td> <td>1</td> <td>PZ</td> </tr> <tr> <td>VT1067A0</td> <td>LINEMISS ELENA BLACK EXTERNAL DOOR GLASS</td> <td>1</td> <td>PZ</td> </tr> </tbody> </table>	Code	Description	Qty	UOM	VM1921A0	INTERNAL GLASS CLOSING LEFT PLATE	1	PZ	VT1067A0	LINEMISS ELENA BLACK EXTERNAL DOOR GLASS	1	PZ																																																					
			Code	Description	Qty	UOM																																																																
VM1921A0	INTERNAL GLASS CLOSING LEFT PLATE	1	PZ																																																																			
VT1067A0	LINEMISS ELENA BLACK EXTERNAL DOOR GLASS	1	PZ																																																																			
KVT1066A	L.M. ELENA EXTERNAL GLASS KIT	<table border="1"> <thead> <tr> <th>Code</th> <th>Description</th> <th>Qty</th> <th>UOM</th> </tr> </thead> <tbody> <tr> <td>IP1385A1</td> <td>CORNER POLYSTYREN E PACKING 110X80X2000</td> <td>0.800</td> <td>M</td> </tr> <tr> <td>IP1508A0</td> <td></td> <td>1.710</td> <td>PZ</td> </tr> <tr> <td>IP1508A1</td> <td>POLYSTYREN E U SHAPED PROFILE 2000X60X60</td> <td>2</td> <td>M</td> </tr> <tr> <td>RC1200A0</td> <td>ED=4 WIRE D.=0.5 COMPRESSION SPRING</td> <td>2</td> <td>PZ</td> </tr> <tr> <td>SL1050A1</td> <td>3M TRANSFER ADHESIVE TAPE</td> <td>0.660</td> <td>M</td> </tr> <tr> <td>TB2306A0</td> <td>LMISS STEFANIA/ELENA DOOR RIGHT COLUMN</td> <td>2</td> <td>PZ</td> </tr> <tr> <td>VM1025A0</td> <td>Ø16 GREY NYLON LID</td> <td>2</td> <td>PZ</td> </tr> <tr> <td>VM1059A1</td> <td>HEAT SHRINK FILM H800</td> <td>1.350</td> <td>M</td> </tr> <tr> <td>VM1695A0</td> <td>HANDLE POSITION PIN</td> <td>2</td> <td>PZ</td> </tr> <tr> <td>VM1916A0</td> <td>RIGHT UPPER COLUMN CAP</td> <td>1</td> <td>PZ</td> </tr> <tr> <td>VM1917A0</td> <td>LEFT UPPER COLUMN CAP</td> <td>1</td> <td>PZ</td> </tr> <tr> <td>VM1918A0</td> <td>RIGHT LOWER COLUMN CAP</td> <td>1</td> <td>PZ</td> </tr> <tr> <td>VM1919A0</td> <td>LEFT LOWER COLUMN CAP</td> <td>1</td> <td>PZ</td> </tr> <tr> <td>VM1920A0</td> <td>INTERNAL GLASS CLOSING RIGHT PLATE</td> <td>1</td> <td>PZ</td> </tr> <tr> <td>VM1921A0</td> <td>INTERNAL GLASS CLOSING LEFT PLATE</td> <td>1</td> <td>PZ</td> </tr> <tr> <td>VT1066A2</td> <td>YELLOW SER 798X344X5</td> <td>1</td> <td>PZ</td> </tr> </tbody> </table>	Code	Description	Qty	UOM	IP1385A1	CORNER POLYSTYREN E PACKING 110X80X2000	0.800	M	IP1508A0		1.710	PZ	IP1508A1	POLYSTYREN E U SHAPED PROFILE 2000X60X60	2	M	RC1200A0	ED=4 WIRE D.=0.5 COMPRESSION SPRING	2	PZ	SL1050A1	3M TRANSFER ADHESIVE TAPE	0.660	M	TB2306A0	LMISS STEFANIA/ELENA DOOR RIGHT COLUMN	2	PZ	VM1025A0	Ø16 GREY NYLON LID	2	PZ	VM1059A1	HEAT SHRINK FILM H800	1.350	M	VM1695A0	HANDLE POSITION PIN	2	PZ	VM1916A0	RIGHT UPPER COLUMN CAP	1	PZ	VM1917A0	LEFT UPPER COLUMN CAP	1	PZ	VM1918A0	RIGHT LOWER COLUMN CAP	1	PZ	VM1919A0	LEFT LOWER COLUMN CAP	1	PZ	VM1920A0	INTERNAL GLASS CLOSING RIGHT PLATE	1	PZ	VM1921A0	INTERNAL GLASS CLOSING LEFT PLATE	1	PZ	VT1066A2	YELLOW SER 798X344X5	1	PZ
Code	Description	Qty	UOM																																																																			
IP1385A1	CORNER POLYSTYREN E PACKING 110X80X2000	0.800	M																																																																			
IP1508A0		1.710	PZ																																																																			
IP1508A1	POLYSTYREN E U SHAPED PROFILE 2000X60X60	2	M																																																																			
RC1200A0	ED=4 WIRE D.=0.5 COMPRESSION SPRING	2	PZ																																																																			
SL1050A1	3M TRANSFER ADHESIVE TAPE	0.660	M																																																																			
TB2306A0	LMISS STEFANIA/ELENA DOOR RIGHT COLUMN	2	PZ																																																																			
VM1025A0	Ø16 GREY NYLON LID	2	PZ																																																																			
VM1059A1	HEAT SHRINK FILM H800	1.350	M																																																																			
VM1695A0	HANDLE POSITION PIN	2	PZ																																																																			
VM1916A0	RIGHT UPPER COLUMN CAP	1	PZ																																																																			
VM1917A0	LEFT UPPER COLUMN CAP	1	PZ																																																																			
VM1918A0	RIGHT LOWER COLUMN CAP	1	PZ																																																																			
VM1919A0	LEFT LOWER COLUMN CAP	1	PZ																																																																			
VM1920A0	INTERNAL GLASS CLOSING RIGHT PLATE	1	PZ																																																																			
VM1921A0	INTERNAL GLASS CLOSING LEFT PLATE	1	PZ																																																																			
VT1066A2	YELLOW SER 798X344X5	1	PZ																																																																			



+7(812)987-08-81

COMPONENT			SPARE PART																														
Code	Description	Image	Code	Description	Components list																												
VM1917A	LEFT UPPER COLUMN CAP		KVM1917A	LMISS 60X40 LEFT UPPER DOOR COLUMN CAP	<table border="1"> <thead> <tr> <th>Code</th> <th>Description</th> <th>Qty</th> <th>UOM</th> </tr> </thead> <tbody> <tr> <td>VM1917A0</td> <td>LEFT UPPER COLUMN CAP</td> <td>1</td> <td>PZ</td> </tr> </tbody> </table>	Code	Description	Qty	UOM	VM1917A0	LEFT UPPER COLUMN CAP	1	PZ																				
Code	Description	Qty	UOM																														
VM1917A0	LEFT UPPER COLUMN CAP	1	PZ																														
CE1285A	EMI ROUND FERRITE MOD.2643801502																																
CE1275A	CONNECTION CABLE POWER - CONTROL		KCE1275A	CONNECTING CABLE KIT	<table border="1"> <thead> <tr> <th>Code</th> <th>Description</th> <th>Qty</th> <th>UOM</th> </tr> </thead> <tbody> <tr> <td>CE1285A0</td> <td>EMI ROUND FERRITE MOD.2643801502</td> <td>1</td> <td>PZ</td> </tr> <tr> <td>CE1290A0</td> <td>EXTRACTABLE FEMALE TERMINAL CPF 5/4</td> <td>1</td> <td>PZ</td> </tr> <tr> <td>CE1455A0</td> <td>TIP END FITTING</td> <td>4</td> <td>PZ</td> </tr> <tr> <td>CE1725A0</td> <td>ROBOTICS SILICON PIPE 4X0,5 MMQ</td> <td>3</td> <td>M</td> </tr> <tr> <td>CE1735A0</td> <td>MINIFIT FEMALE END FITTING</td> <td>4</td> <td>PZ</td> </tr> <tr> <td>CE1755A0</td> <td>4 WAYS MALE MINIFIT CONNECTOR</td> <td>1</td> <td>PZ</td> </tr> </tbody> </table>	Code	Description	Qty	UOM	CE1285A0	EMI ROUND FERRITE MOD.2643801502	1	PZ	CE1290A0	EXTRACTABLE FEMALE TERMINAL CPF 5/4	1	PZ	CE1455A0	TIP END FITTING	4	PZ	CE1725A0	ROBOTICS SILICON PIPE 4X0,5 MMQ	3	M	CE1735A0	MINIFIT FEMALE END FITTING	4	PZ	CE1755A0	4 WAYS MALE MINIFIT CONNECTOR	1	PZ
Code	Description	Qty	UOM																														
CE1285A0	EMI ROUND FERRITE MOD.2643801502	1	PZ																														
CE1290A0	EXTRACTABLE FEMALE TERMINAL CPF 5/4	1	PZ																														
CE1455A0	TIP END FITTING	4	PZ																														
CE1725A0	ROBOTICS SILICON PIPE 4X0,5 MMQ	3	M																														
CE1735A0	MINIFIT FEMALE END FITTING	4	PZ																														
CE1755A0	4 WAYS MALE MINIFIT CONNECTOR	1	PZ																														
MG1082A	HANDLE END PROFILE 20X20		MG1082A0	HANDLE END PROFILE 20X20																													



Зип Общепит
vsezip.ru

+7(812)987-08-81

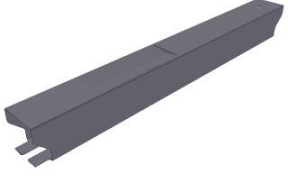
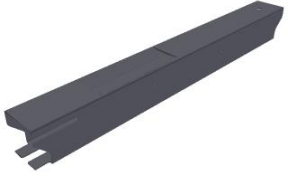
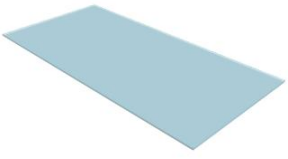
COMPONENT			SPARE PART																										
Code	Description	Image	Code	Description	Components list																								
PE1740C	CT BT CONTROL BOARD PE1705 + BOARD COVER		KPE1740C	UPDATE CHEF-BAKERTOP CONTROL BOARD KIT	<table border="1"> <thead> <tr> <th>Code</th> <th>Description</th> <th>Qty</th> <th>UOM</th> </tr> </thead> <tbody> <tr> <td>PE1740C0</td> <td>CT BT CONTROL BOARD PE1705 + BOARD COVE</td> <td>1</td> <td>PZ</td> </tr> <tr> <td>VM1794A0</td> <td>250X4.8 PA66 BLACK CLAMP</td> <td>2</td> <td>PZ</td> </tr> <tr> <td>VM2103A0</td> <td>CLAMP LOCK</td> <td>2</td> <td>PZ</td> </tr> </tbody> </table>	Code	Description	Qty	UOM	PE1740C0	CT BT CONTROL BOARD PE1705 + BOARD COVE	1	PZ	VM1794A0	250X4.8 PA66 BLACK CLAMP	2	PZ	VM2103A0	CLAMP LOCK	2	PZ								
Code	Description	Qty	UOM																										
PE1740C0	CT BT CONTROL BOARD PE1705 + BOARD COVE	1	PZ																										
VM1794A0	250X4.8 PA66 BLACK CLAMP	2	PZ																										
VM2103A0	CLAMP LOCK	2	PZ																										
TB2184B	AUTONOMOUS DECK OVEN RIGHT COLUMN		TB2184B0	AUTONOMOUS DECK OVEN RIGHT COLUMN																									
TB2183B	AUTONOMOUS DECK OVEN LEFT COLUMN		TB2183B0	AUTONOMOUS DECK OVEN LEFT COLUMN																									
VT1246A	DECK OVEN INTERNAL GLASS		KVT1246A	DECK OVEN INTERNAL GLASS KI	<table border="1"> <thead> <tr> <th>Code</th> <th>Description</th> <th>Qty</th> <th>UOM</th> </tr> </thead> <tbody> <tr> <td>ED1011A0</td> <td>GLASS LABEL</td> <td>1</td> <td>PZ</td> </tr> <tr> <td>IP1385A1</td> <td>CORNER POLYSTYREN E PACKING 110X80X2000</td> <td>0.980</td> <td>M</td> </tr> <tr> <td>IP1508A1</td> <td>POLYSTYREN E U SHAPED PROFILE 2000X60X60</td> <td>0.960</td> <td>M</td> </tr> <tr> <td>VM1059A1</td> <td>HEAT SHRINK FILM H800</td> <td>1</td> <td>M</td> </tr> <tr> <td>VT1246A0</td> <td>DECK OVEN INTERNAL GLASS</td> <td>1</td> <td>PZ</td> </tr> </tbody> </table>	Code	Description	Qty	UOM	ED1011A0	GLASS LABEL	1	PZ	IP1385A1	CORNER POLYSTYREN E PACKING 110X80X2000	0.980	M	IP1508A1	POLYSTYREN E U SHAPED PROFILE 2000X60X60	0.960	M	VM1059A1	HEAT SHRINK FILM H800	1	M	VT1246A0	DECK OVEN INTERNAL GLASS	1	PZ
Code	Description	Qty	UOM																										
ED1011A0	GLASS LABEL	1	PZ																										
IP1385A1	CORNER POLYSTYREN E PACKING 110X80X2000	0.980	M																										
IP1508A1	POLYSTYREN E U SHAPED PROFILE 2000X60X60	0.960	M																										
VM1059A1	HEAT SHRINK FILM H800	1	M																										
VT1246A0	DECK OVEN INTERNAL GLASS	1	PZ																										



+7(812)987-08-81

COMPONENT			SPARE PART																																										
Code	Description	Image	Code	Description	Components list																																								
0H6298A	LED HOLDING DOOR PLATE		0H6298A0	LED HOLDING DOOR PLATE																																									
LP1000A	LED LIGHTING BAR L100		KLP1000A	L100 LED BAR KIT	<table border="1"> <thead> <tr> <th>Code</th> <th>Description</th> <th>Qty</th> <th>UOM</th> </tr> </thead> <tbody> <tr> <td>LP1000A0</td> <td>LED LIGHTING BAR L100</td> <td>1</td> <td>PZ</td> </tr> <tr> <td>VM1620A0</td> <td>LED BAR LOWER SUPPORT</td> <td>1</td> <td>PZ</td> </tr> <tr> <td>VM1621A0</td> <td>LED BAR UPPER SUPPORT</td> <td>1</td> <td>PZ</td> </tr> </tbody> </table>	Code	Description	Qty	UOM	LP1000A0	LED LIGHTING BAR L100	1	PZ	VM1620A0	LED BAR LOWER SUPPORT	1	PZ	VM1621A0	LED BAR UPPER SUPPORT	1	PZ																								
Code	Description	Qty	UOM																																										
LP1000A0	LED LIGHTING BAR L100	1	PZ																																										
VM1620A0	LED BAR LOWER SUPPORT	1	PZ																																										
VM1621A0	LED BAR UPPER SUPPORT	1	PZ																																										
VM1620A	LED BAR LOWER SUPPORT		KLP1007A	L200 LED BAR KIT	<table border="1"> <thead> <tr> <th>Code</th> <th>Description</th> <th>Qty</th> <th>UOM</th> </tr> </thead> <tbody> <tr> <td>CE1455A0</td> <td>TIP END FITTING</td> <td>2</td> <td>PZ</td> </tr> <tr> <td>CE1730A0</td> <td>PVC CABLE NP 2 X AWG22 STYLE 2095</td> <td>4.500</td> <td>M</td> </tr> <tr> <td>CE1735A0</td> <td>MINIFIT FEMALE END FITTING</td> <td>2</td> <td>PZ</td> </tr> <tr> <td>CE1740A0</td> <td>MINIFIT MALE END FITTING</td> <td>4</td> <td>PZ</td> </tr> <tr> <td>CE1745A0</td> <td>2 WAYS FEMALE MINIFIT CONNECTOR</td> <td>2</td> <td>PZ</td> </tr> <tr> <td>CE1750A0</td> <td>3 WAYS MALE MINIFIT CONNECTOR</td> <td>1</td> <td>PZ</td> </tr> <tr> <td>LP1007A0</td> <td>LED LIGHT BAR L200</td> <td>1</td> <td>PZ</td> </tr> <tr> <td>VM1620A0</td> <td>LED BAR LOWER SUPPORT</td> <td>1</td> <td>PZ</td> </tr> <tr> <td>VM1621A0</td> <td>LED BAR UPPER SUPPORT</td> <td>1</td> <td>PZ</td> </tr> </tbody> </table>	Code	Description	Qty	UOM	CE1455A0	TIP END FITTING	2	PZ	CE1730A0	PVC CABLE NP 2 X AWG22 STYLE 2095	4.500	M	CE1735A0	MINIFIT FEMALE END FITTING	2	PZ	CE1740A0	MINIFIT MALE END FITTING	4	PZ	CE1745A0	2 WAYS FEMALE MINIFIT CONNECTOR	2	PZ	CE1750A0	3 WAYS MALE MINIFIT CONNECTOR	1	PZ	LP1007A0	LED LIGHT BAR L200	1	PZ	VM1620A0	LED BAR LOWER SUPPORT	1	PZ	VM1621A0	LED BAR UPPER SUPPORT	1	PZ
Code	Description	Qty	UOM																																										
CE1455A0	TIP END FITTING	2	PZ																																										
CE1730A0	PVC CABLE NP 2 X AWG22 STYLE 2095	4.500	M																																										
CE1735A0	MINIFIT FEMALE END FITTING	2	PZ																																										
CE1740A0	MINIFIT MALE END FITTING	4	PZ																																										
CE1745A0	2 WAYS FEMALE MINIFIT CONNECTOR	2	PZ																																										
CE1750A0	3 WAYS MALE MINIFIT CONNECTOR	1	PZ																																										
LP1007A0	LED LIGHT BAR L200	1	PZ																																										
VM1620A0	LED BAR LOWER SUPPORT	1	PZ																																										
VM1621A0	LED BAR UPPER SUPPORT	1	PZ																																										
			KLP1004B	L1000 LED BAR KIT	<table border="1"> <thead> <tr> <th>Code</th> <th>Description</th> <th>Qty</th> <th>UOM</th> </tr> </thead> <tbody> <tr> <td>CE1730A0</td> <td>PVC CABLE NP 2 X AWG22 STYLE 2095</td> <td>1</td> <td>M</td> </tr> <tr> <td>CE1735A0</td> <td>MINIFIT FEMALE END FITTING</td> <td>2</td> <td>PZ</td> </tr> <tr> <td>CE1740A0</td> <td>MINIFIT MALE END FITTING</td> <td>2</td> <td>PZ</td> </tr> </tbody> </table>	Code	Description	Qty	UOM	CE1730A0	PVC CABLE NP 2 X AWG22 STYLE 2095	1	M	CE1735A0	MINIFIT FEMALE END FITTING	2	PZ	CE1740A0	MINIFIT MALE END FITTING	2	PZ																								
Code	Description	Qty	UOM																																										
CE1730A0	PVC CABLE NP 2 X AWG22 STYLE 2095	1	M																																										
CE1735A0	MINIFIT FEMALE END FITTING	2	PZ																																										
CE1740A0	MINIFIT MALE END FITTING	2	PZ																																										



Зип Общепит
vsezip.ru

+7(812)987-08-81

COMPONENT			SPARE PART																																																																																									
Code	Description	Image	Code	Description	Components list																																																																																							
VM1620A	LED BAR LOWER SUPPORT		KLP1004B	L1000 LED BAR KIT	<table border="1"> <thead> <tr> <th>Code</th> <th>Description</th> <th>Qty</th> <th>UOM</th> </tr> </thead> <tbody> <tr> <td>CE1745A0</td> <td>2 WAYS FEMALE MINIFIT CONNECTOR</td> <td>1</td> <td>PZ</td> </tr> <tr> <td>CE1750A0</td> <td>3 WAYS MALE MINIFIT CONNECTOR</td> <td>1</td> <td>PZ</td> </tr> <tr> <td>IP1385A1</td> <td>CORNER POLYSTYREN E PACKING 110X80X2000</td> <td>2.200</td> <td>M</td> </tr> <tr> <td>LP1004B0</td> <td>LEB LIGHTING BAR L1000</td> <td>1</td> <td>PZ</td> </tr> <tr> <td>VM1059A1</td> <td>HEAT SHRINK FILM H800</td> <td>1.300</td> <td>M</td> </tr> <tr> <td>VM1620A0</td> <td>LED BAR LOWER SUPPORT</td> <td>1</td> <td>PZ</td> </tr> <tr> <td>VM1621A0</td> <td>LED BAR UPPER SUPPORT</td> <td>1</td> <td>PZ</td> </tr> <tr> <td>VM1794A0</td> <td>250X4.8 PA66 BLACK CLAMP</td> <td>2</td> <td>PZ</td> </tr> <tr> <td>VM2103A0</td> <td>CLAMP LOCK</td> <td>2</td> <td>PZ</td> </tr> </tbody> </table>	Code	Description	Qty	UOM	CE1745A0	2 WAYS FEMALE MINIFIT CONNECTOR	1	PZ	CE1750A0	3 WAYS MALE MINIFIT CONNECTOR	1	PZ	IP1385A1	CORNER POLYSTYREN E PACKING 110X80X2000	2.200	M	LP1004B0	LEB LIGHTING BAR L1000	1	PZ	VM1059A1	HEAT SHRINK FILM H800	1.300	M	VM1620A0	LED BAR LOWER SUPPORT	1	PZ	VM1621A0	LED BAR UPPER SUPPORT	1	PZ	VM1794A0	250X4.8 PA66 BLACK CLAMP	2	PZ	VM2103A0	CLAMP LOCK	2	PZ	KLP1003B	2017 LED BAR KIT	<table border="1"> <thead> <tr> <th>Code</th> <th>Description</th> <th>Qty</th> <th>UOM</th> </tr> </thead> <tbody> <tr> <td>CE1730A0</td> <td>PVC CABLE NP 2 X AWG22 STYLE 2095</td> <td>1</td> <td>M</td> </tr> <tr> <td>CE1735A0</td> <td>MINIFIT FEMALE END FITTING</td> <td>2</td> <td>PZ</td> </tr> <tr> <td>CE1740A0</td> <td>MINIFIT MALE END FITTING</td> <td>2</td> <td>PZ</td> </tr> <tr> <td>CE1745A0</td> <td>2 WAYS FEMALE MINIFIT CONNECTOR</td> <td>1</td> <td>PZ</td> </tr> <tr> <td>CE1750A0</td> <td>3 WAYS MALE MINIFIT CONNECTOR</td> <td>1</td> <td>PZ</td> </tr> <tr> <td>LP1003B0</td> <td>LED LIGHT BAR L600</td> <td>1</td> <td>PZ</td> </tr> <tr> <td>VM1620A0</td> <td>LED BAR LOWER SUPPORT</td> <td>1</td> <td>PZ</td> </tr> <tr> <td>VM1621A0</td> <td>LED BAR UPPER SUPPORT</td> <td>1</td> <td>PZ</td> </tr> <tr> <td>VM1794A0</td> <td>250X4.8 PA66 BLACK CLAMP</td> <td>2</td> <td>PZ</td> </tr> <tr> <td>VM2103A0</td> <td>CLAMP LOCK</td> <td>2</td> <td>PZ</td> </tr> </tbody> </table>	Code	Description	Qty	UOM	CE1730A0	PVC CABLE NP 2 X AWG22 STYLE 2095	1	M	CE1735A0	MINIFIT FEMALE END FITTING	2	PZ	CE1740A0	MINIFIT MALE END FITTING	2	PZ	CE1745A0	2 WAYS FEMALE MINIFIT CONNECTOR	1	PZ	CE1750A0	3 WAYS MALE MINIFIT CONNECTOR	1	PZ	LP1003B0	LED LIGHT BAR L600	1	PZ	VM1620A0	LED BAR LOWER SUPPORT	1	PZ	VM1621A0	LED BAR UPPER SUPPORT	1	PZ	VM1794A0	250X4.8 PA66 BLACK CLAMP	2	PZ	VM2103A0	CLAMP LOCK	2	PZ
			Code	Description	Qty	UOM																																																																																						
CE1745A0	2 WAYS FEMALE MINIFIT CONNECTOR	1	PZ																																																																																									
CE1750A0	3 WAYS MALE MINIFIT CONNECTOR	1	PZ																																																																																									
IP1385A1	CORNER POLYSTYREN E PACKING 110X80X2000	2.200	M																																																																																									
LP1004B0	LEB LIGHTING BAR L1000	1	PZ																																																																																									
VM1059A1	HEAT SHRINK FILM H800	1.300	M																																																																																									
VM1620A0	LED BAR LOWER SUPPORT	1	PZ																																																																																									
VM1621A0	LED BAR UPPER SUPPORT	1	PZ																																																																																									
VM1794A0	250X4.8 PA66 BLACK CLAMP	2	PZ																																																																																									
VM2103A0	CLAMP LOCK	2	PZ																																																																																									
Code	Description	Qty	UOM																																																																																									
CE1730A0	PVC CABLE NP 2 X AWG22 STYLE 2095	1	M																																																																																									
CE1735A0	MINIFIT FEMALE END FITTING	2	PZ																																																																																									
CE1740A0	MINIFIT MALE END FITTING	2	PZ																																																																																									
CE1745A0	2 WAYS FEMALE MINIFIT CONNECTOR	1	PZ																																																																																									
CE1750A0	3 WAYS MALE MINIFIT CONNECTOR	1	PZ																																																																																									
LP1003B0	LED LIGHT BAR L600	1	PZ																																																																																									
VM1620A0	LED BAR LOWER SUPPORT	1	PZ																																																																																									
VM1621A0	LED BAR UPPER SUPPORT	1	PZ																																																																																									
VM1794A0	250X4.8 PA66 BLACK CLAMP	2	PZ																																																																																									
VM2103A0	CLAMP LOCK	2	PZ																																																																																									



+7(812)987-08-81

COMPONENT			SPARE PART																																																		
Code	Description	Image	Code	Description	Components list																																																
VM1620A	LED BAR LOWER SUPPORT		KLP1002B	L400 LED BAR KIT	<table border="1"> <thead> <tr> <th>Code</th> <th>Description</th> <th>Qty</th> <th>UOM</th> </tr> </thead> <tbody> <tr> <td>CE1455A0</td> <td>TIP END FITTING</td> <td>2</td> <td>PZ</td> </tr> <tr> <td>CE1730A0</td> <td>PVC CABLE NP 2 X AWG22 STYLE 2095</td> <td>4.500</td> <td>M</td> </tr> <tr> <td>CE1735A0</td> <td>MINIFIT FEMALE END FITTING</td> <td>2</td> <td>PZ</td> </tr> <tr> <td>CE1740A0</td> <td>MINIFIT MALE END FITTING</td> <td>4</td> <td>PZ</td> </tr> <tr> <td>CE1745A0</td> <td>2 WAYS FEMALE MINIFIT CONNECTOR</td> <td>2</td> <td>PZ</td> </tr> <tr> <td>CE1750A0</td> <td>3 WAYS MALE MINIFIT CONNECTOR</td> <td>1</td> <td>PZ</td> </tr> <tr> <td>LP1002B0</td> <td>LED LIGHTING BAR L400</td> <td>1</td> <td>PZ</td> </tr> <tr> <td>VM1620A0</td> <td>LED BAR LOWER SUPPORT</td> <td>1</td> <td>PZ</td> </tr> <tr> <td>VM1621A0</td> <td>LED BAR UPPER SUPPORT</td> <td>1</td> <td>PZ</td> </tr> <tr> <td>VM1794A0</td> <td>250X4.8 PA66 BLACK CLAMP</td> <td>2</td> <td>PZ</td> </tr> <tr> <td>VM2103A0</td> <td>CLAMP LOCK</td> <td>2</td> <td>PZ</td> </tr> </tbody> </table>	Code	Description	Qty	UOM	CE1455A0	TIP END FITTING	2	PZ	CE1730A0	PVC CABLE NP 2 X AWG22 STYLE 2095	4.500	M	CE1735A0	MINIFIT FEMALE END FITTING	2	PZ	CE1740A0	MINIFIT MALE END FITTING	4	PZ	CE1745A0	2 WAYS FEMALE MINIFIT CONNECTOR	2	PZ	CE1750A0	3 WAYS MALE MINIFIT CONNECTOR	1	PZ	LP1002B0	LED LIGHTING BAR L400	1	PZ	VM1620A0	LED BAR LOWER SUPPORT	1	PZ	VM1621A0	LED BAR UPPER SUPPORT	1	PZ	VM1794A0	250X4.8 PA66 BLACK CLAMP	2	PZ	VM2103A0	CLAMP LOCK	2	PZ
			Code	Description	Qty	UOM																																															
CE1455A0	TIP END FITTING	2	PZ																																																		
CE1730A0	PVC CABLE NP 2 X AWG22 STYLE 2095	4.500	M																																																		
CE1735A0	MINIFIT FEMALE END FITTING	2	PZ																																																		
CE1740A0	MINIFIT MALE END FITTING	4	PZ																																																		
CE1745A0	2 WAYS FEMALE MINIFIT CONNECTOR	2	PZ																																																		
CE1750A0	3 WAYS MALE MINIFIT CONNECTOR	1	PZ																																																		
LP1002B0	LED LIGHTING BAR L400	1	PZ																																																		
VM1620A0	LED BAR LOWER SUPPORT	1	PZ																																																		
VM1621A0	LED BAR UPPER SUPPORT	1	PZ																																																		
VM1794A0	250X4.8 PA66 BLACK CLAMP	2	PZ																																																		
VM2103A0	CLAMP LOCK	2	PZ																																																		
KLP1001B	L300 LED BAR KIT	<table border="1"> <thead> <tr> <th>Code</th> <th>Description</th> <th>Qty</th> <th>UOM</th> </tr> </thead> <tbody> <tr> <td>CE1455A0</td> <td>TIP END FITTING</td> <td>2</td> <td>PZ</td> </tr> <tr> <td>CE1730A0</td> <td>PVC CABLE NP 2 X AWG22 STYLE 2095</td> <td>4.500</td> <td>M</td> </tr> <tr> <td>CE1735A0</td> <td>MINIFIT FEMALE END FITTING</td> <td>2</td> <td>PZ</td> </tr> <tr> <td>CE1740A0</td> <td>MINIFIT MALE END FITTING</td> <td>4</td> <td>PZ</td> </tr> <tr> <td>CE1745A0</td> <td>2 WAYS FEMALE MINIFIT CONNECTOR</td> <td>2</td> <td>PZ</td> </tr> <tr> <td>CE1750A0</td> <td>3 WAYS MALE MINIFIT CONNECTOR</td> <td>1</td> <td>PZ</td> </tr> <tr> <td>LP1001B0</td> <td>LED LIGHTING BAR L300</td> <td>1</td> <td>PZ</td> </tr> <tr> <td>VM1620A0</td> <td>LED BAR LOWER SUPPORT</td> <td>1</td> <td>PZ</td> </tr> <tr> <td>VM1621A0</td> <td>LED BAR UPPER SUPPORT</td> <td>1</td> <td>PZ</td> </tr> </tbody> </table>	Code	Description	Qty	UOM	CE1455A0	TIP END FITTING	2	PZ	CE1730A0	PVC CABLE NP 2 X AWG22 STYLE 2095	4.500	M	CE1735A0	MINIFIT FEMALE END FITTING	2	PZ	CE1740A0	MINIFIT MALE END FITTING	4	PZ	CE1745A0	2 WAYS FEMALE MINIFIT CONNECTOR	2	PZ	CE1750A0	3 WAYS MALE MINIFIT CONNECTOR	1	PZ	LP1001B0	LED LIGHTING BAR L300	1	PZ	VM1620A0	LED BAR LOWER SUPPORT	1	PZ	VM1621A0	LED BAR UPPER SUPPORT	1	PZ											
Code	Description	Qty	UOM																																																		
CE1455A0	TIP END FITTING	2	PZ																																																		
CE1730A0	PVC CABLE NP 2 X AWG22 STYLE 2095	4.500	M																																																		
CE1735A0	MINIFIT FEMALE END FITTING	2	PZ																																																		
CE1740A0	MINIFIT MALE END FITTING	4	PZ																																																		
CE1745A0	2 WAYS FEMALE MINIFIT CONNECTOR	2	PZ																																																		
CE1750A0	3 WAYS MALE MINIFIT CONNECTOR	1	PZ																																																		
LP1001B0	LED LIGHTING BAR L300	1	PZ																																																		
VM1620A0	LED BAR LOWER SUPPORT	1	PZ																																																		
VM1621A0	LED BAR UPPER SUPPORT	1	PZ																																																		



Зип Общепит
vsezip.ru

+7(812)987-08-81

COMPONENT			SPARE PART																																										
Code	Description	Image	Code	Description	Components list																																								
VM1620A	LED BAR LOWER SUPPORT		KLP1000A	L100 LED BAR KIT	<table border="1"> <thead> <tr> <th>Code</th> <th>Description</th> <th>Qty</th> <th>UOM</th> </tr> </thead> <tbody> <tr> <td>LP1000A0</td> <td>LED LIGHTING BAR L100</td> <td>1</td> <td>PZ</td> </tr> <tr> <td>VM1620A0</td> <td>LED BAR LOWER SUPPORT</td> <td>1</td> <td>PZ</td> </tr> <tr> <td>VM1621A0</td> <td>LED BAR UPPER SUPPORT</td> <td>1</td> <td>PZ</td> </tr> </tbody> </table>	Code	Description	Qty	UOM	LP1000A0	LED LIGHTING BAR L100	1	PZ	VM1620A0	LED BAR LOWER SUPPORT	1	PZ	VM1621A0	LED BAR UPPER SUPPORT	1	PZ																								
					Code	Description	Qty	UOM																																					
LP1000A0	LED LIGHTING BAR L100	1	PZ																																										
VM1620A0	LED BAR LOWER SUPPORT	1	PZ																																										
VM1621A0	LED BAR UPPER SUPPORT	1	PZ																																										
VM1621A	LED BAR UPPER SUPPORT		KLP1007A	L200 LED BAR KIT	<table border="1"> <thead> <tr> <th>Code</th> <th>Description</th> <th>Qty</th> <th>UOM</th> </tr> </thead> <tbody> <tr> <td>CE1455A0</td> <td>TIP END FITTING</td> <td>2</td> <td>PZ</td> </tr> <tr> <td>CE1730A0</td> <td>PVC CABLE NP 2 X AWG22 STYLE 2095</td> <td>4.500</td> <td>M</td> </tr> <tr> <td>CE1735A0</td> <td>MINIFIT FEMALE END FITTING</td> <td>2</td> <td>PZ</td> </tr> <tr> <td>CE1740A0</td> <td>MINIFIT MALE END FITTING</td> <td>4</td> <td>PZ</td> </tr> <tr> <td>CE1745A0</td> <td>2 WAYS FEMALE MINIFIT CONNECTOR</td> <td>2</td> <td>PZ</td> </tr> <tr> <td>CE1750A0</td> <td>3 WAYS MALE MINIFIT CONNECTOR</td> <td>1</td> <td>PZ</td> </tr> <tr> <td>LP1007A0</td> <td>LED LIGHT BAR L200</td> <td>1</td> <td>PZ</td> </tr> <tr> <td>VM1620A0</td> <td>LED BAR LOWER SUPPORT</td> <td>1</td> <td>PZ</td> </tr> <tr> <td>VM1621A0</td> <td>LED BAR UPPER SUPPORT</td> <td>1</td> <td>PZ</td> </tr> </tbody> </table>	Code	Description	Qty	UOM	CE1455A0	TIP END FITTING	2	PZ	CE1730A0	PVC CABLE NP 2 X AWG22 STYLE 2095	4.500	M	CE1735A0	MINIFIT FEMALE END FITTING	2	PZ	CE1740A0	MINIFIT MALE END FITTING	4	PZ	CE1745A0	2 WAYS FEMALE MINIFIT CONNECTOR	2	PZ	CE1750A0	3 WAYS MALE MINIFIT CONNECTOR	1	PZ	LP1007A0	LED LIGHT BAR L200	1	PZ	VM1620A0	LED BAR LOWER SUPPORT	1	PZ	VM1621A0	LED BAR UPPER SUPPORT	1	PZ
					Code	Description	Qty	UOM																																					
					CE1455A0	TIP END FITTING	2	PZ																																					
					CE1730A0	PVC CABLE NP 2 X AWG22 STYLE 2095	4.500	M																																					
					CE1735A0	MINIFIT FEMALE END FITTING	2	PZ																																					
					CE1740A0	MINIFIT MALE END FITTING	4	PZ																																					
					CE1745A0	2 WAYS FEMALE MINIFIT CONNECTOR	2	PZ																																					
					CE1750A0	3 WAYS MALE MINIFIT CONNECTOR	1	PZ																																					
					LP1007A0	LED LIGHT BAR L200	1	PZ																																					
					VM1620A0	LED BAR LOWER SUPPORT	1	PZ																																					
					VM1621A0	LED BAR UPPER SUPPORT	1	PZ																																					
					KLP1004B				L1000 LED BAR KIT	<table border="1"> <thead> <tr> <th>Code</th> <th>Description</th> <th>Qty</th> <th>UOM</th> </tr> </thead> <tbody> <tr> <td>CE1730A0</td> <td>PVC CABLE NP 2 X AWG22 STYLE 2095</td> <td>1</td> <td>M</td> </tr> <tr> <td>CE1735A0</td> <td>MINIFIT FEMALE END FITTING</td> <td>2</td> <td>PZ</td> </tr> <tr> <td>CE1740A0</td> <td>MINIFIT MALE END FITTING</td> <td>2</td> <td>PZ</td> </tr> <tr> <td>CE1745A0</td> <td>2 WAYS FEMALE MINIFIT CONNECTOR</td> <td>1</td> <td>PZ</td> </tr> <tr> <td>CE1750A0</td> <td>3 WAYS MALE MINIFIT CONNECTOR</td> <td>1</td> <td>PZ</td> </tr> </tbody> </table>	Code	Description	Qty	UOM	CE1730A0	PVC CABLE NP 2 X AWG22 STYLE 2095	1	M	CE1735A0	MINIFIT FEMALE END FITTING	2	PZ	CE1740A0	MINIFIT MALE END FITTING	2	PZ	CE1745A0	2 WAYS FEMALE MINIFIT CONNECTOR	1	PZ	CE1750A0	3 WAYS MALE MINIFIT CONNECTOR	1	PZ											
										Code	Description	Qty	UOM																																
										CE1730A0	PVC CABLE NP 2 X AWG22 STYLE 2095	1	M																																
CE1735A0	MINIFIT FEMALE END FITTING	2	PZ																																										
CE1740A0	MINIFIT MALE END FITTING	2	PZ																																										
CE1745A0	2 WAYS FEMALE MINIFIT CONNECTOR	1	PZ																																										
CE1750A0	3 WAYS MALE MINIFIT CONNECTOR	1	PZ																																										



Зип Общепит
vsezip.ru

+7(812)987-08-81

COMPONENT			SPARE PART																																											
Code	Description	Image	Code	Description	Components list																																									
VM1621A	LED BAR UPPER SUPPORT		KLP1004B	L1000 LED BAR KIT	<table border="1"> <thead> <tr> <th>Code</th> <th>Description</th> <th>Qty</th> <th>UOM</th> </tr> </thead> <tbody> <tr> <td>IP1385A1</td> <td>CORNER POLYSTYRENE PACKING 110X80X2000</td> <td>2.200</td> <td>M</td> </tr> <tr> <td>LP1004B0</td> <td>LED LIGHTING BAR L1000</td> <td>1</td> <td>PZ</td> </tr> <tr> <td>VM1059A1</td> <td>HEAT SHRINK FILM H800</td> <td>1.300</td> <td>M</td> </tr> <tr> <td>VM1620A0</td> <td>LED BAR LOWER SUPPORT</td> <td>1</td> <td>PZ</td> </tr> <tr> <td>VM1621A0</td> <td>LED BAR UPPER SUPPORT</td> <td>1</td> <td>PZ</td> </tr> <tr> <td>VM1794A0</td> <td>250X4.8 PA66 BLACK CLAMP</td> <td>2</td> <td>PZ</td> </tr> <tr> <td>VM2103A0</td> <td>CLAMP LOCK</td> <td>2</td> <td>PZ</td> </tr> </tbody> </table>	Code	Description	Qty	UOM	IP1385A1	CORNER POLYSTYRENE PACKING 110X80X2000	2.200	M	LP1004B0	LED LIGHTING BAR L1000	1	PZ	VM1059A1	HEAT SHRINK FILM H800	1.300	M	VM1620A0	LED BAR LOWER SUPPORT	1	PZ	VM1621A0	LED BAR UPPER SUPPORT	1	PZ	VM1794A0	250X4.8 PA66 BLACK CLAMP	2	PZ	VM2103A0	CLAMP LOCK	2	PZ									
			Code	Description	Qty	UOM																																								
			IP1385A1	CORNER POLYSTYRENE PACKING 110X80X2000	2.200	M																																								
LP1004B0	LED LIGHTING BAR L1000	1	PZ																																											
VM1059A1	HEAT SHRINK FILM H800	1.300	M																																											
VM1620A0	LED BAR LOWER SUPPORT	1	PZ																																											
VM1621A0	LED BAR UPPER SUPPORT	1	PZ																																											
VM1794A0	250X4.8 PA66 BLACK CLAMP	2	PZ																																											
VM2103A0	CLAMP LOCK	2	PZ																																											
KLP1003B	2017 LED BAR KIT	<table border="1"> <thead> <tr> <th>Code</th> <th>Description</th> <th>Qty</th> <th>UOM</th> </tr> </thead> <tbody> <tr> <td>CE1730A0</td> <td>PVC CABLE NP 2 X AWG22 STYLE 2095</td> <td>1</td> <td>M</td> </tr> <tr> <td>CE1735A0</td> <td>MINIFIT FEMALE END FITTING</td> <td>2</td> <td>PZ</td> </tr> <tr> <td>CE1740A0</td> <td>MINIFIT MALE END FITTING</td> <td>2</td> <td>PZ</td> </tr> <tr> <td>CE1745A0</td> <td>2 WAYS FEMALE MINIFIT CONNECTOR</td> <td>1</td> <td>PZ</td> </tr> <tr> <td>CE1750A0</td> <td>3 WAYS MALE MINIFIT CONNECTOR</td> <td>1</td> <td>PZ</td> </tr> <tr> <td>LP1003B0</td> <td>LED LIGHT BAR L600</td> <td>1</td> <td>PZ</td> </tr> <tr> <td>VM1620A0</td> <td>LED BAR LOWER SUPPORT</td> <td>1</td> <td>PZ</td> </tr> <tr> <td>VM1621A0</td> <td>LED BAR UPPER SUPPORT</td> <td>1</td> <td>PZ</td> </tr> <tr> <td>VM1794A0</td> <td>250X4.8 PA66 BLACK CLAMP</td> <td>2</td> <td>PZ</td> </tr> <tr> <td>VM2103A0</td> <td>CLAMP LOCK</td> <td>2</td> <td>PZ</td> </tr> </tbody> </table>	Code	Description	Qty	UOM	CE1730A0	PVC CABLE NP 2 X AWG22 STYLE 2095	1	M	CE1735A0	MINIFIT FEMALE END FITTING	2	PZ	CE1740A0	MINIFIT MALE END FITTING	2	PZ	CE1745A0	2 WAYS FEMALE MINIFIT CONNECTOR	1	PZ	CE1750A0	3 WAYS MALE MINIFIT CONNECTOR	1	PZ	LP1003B0	LED LIGHT BAR L600	1	PZ	VM1620A0	LED BAR LOWER SUPPORT	1	PZ	VM1621A0	LED BAR UPPER SUPPORT	1	PZ	VM1794A0	250X4.8 PA66 BLACK CLAMP	2	PZ	VM2103A0	CLAMP LOCK	2	PZ
Code	Description	Qty	UOM																																											
CE1730A0	PVC CABLE NP 2 X AWG22 STYLE 2095	1	M																																											
CE1735A0	MINIFIT FEMALE END FITTING	2	PZ																																											
CE1740A0	MINIFIT MALE END FITTING	2	PZ																																											
CE1745A0	2 WAYS FEMALE MINIFIT CONNECTOR	1	PZ																																											
CE1750A0	3 WAYS MALE MINIFIT CONNECTOR	1	PZ																																											
LP1003B0	LED LIGHT BAR L600	1	PZ																																											
VM1620A0	LED BAR LOWER SUPPORT	1	PZ																																											
VM1621A0	LED BAR UPPER SUPPORT	1	PZ																																											
VM1794A0	250X4.8 PA66 BLACK CLAMP	2	PZ																																											
VM2103A0	CLAMP LOCK	2	PZ																																											
KLP1002B	L400 LED BAR KIT	<table border="1"> <thead> <tr> <th>Code</th> <th>Description</th> <th>Qty</th> <th>UOM</th> </tr> </thead> <tbody> <tr> <td>CE1455A0</td> <td>TIP END FITTING</td> <td>2</td> <td>PZ</td> </tr> <tr> <td>CE1730A0</td> <td>PVC CABLE NP 2 X AWG22 STYLE 2095</td> <td>4.500</td> <td>M</td> </tr> <tr> <td>CE1735A0</td> <td>MINIFIT FEMALE END FITTING</td> <td>2</td> <td>PZ</td> </tr> </tbody> </table>	Code	Description	Qty	UOM	CE1455A0	TIP END FITTING	2	PZ	CE1730A0	PVC CABLE NP 2 X AWG22 STYLE 2095	4.500	M	CE1735A0	MINIFIT FEMALE END FITTING	2	PZ																												
Code	Description	Qty	UOM																																											
CE1455A0	TIP END FITTING	2	PZ																																											
CE1730A0	PVC CABLE NP 2 X AWG22 STYLE 2095	4.500	M																																											
CE1735A0	MINIFIT FEMALE END FITTING	2	PZ																																											





+7(812)987-08-81

COMPONENT			SPARE PART																																							
Code	Description	Image	Code	Description	Components list																																					
VM1621A	LED BAR UPPER SUPPORT		KLP1002B	L400 LED BAR KIT	<table border="1"> <thead> <tr> <th>Code</th> <th>Description</th> <th>Qty</th> <th>UOM</th> </tr> </thead> <tbody> <tr> <td>CE1740A0</td> <td>MINIFIT MALE END FITTING</td> <td>4</td> <td>PZ</td> </tr> <tr> <td>CE1745A0</td> <td>2 WAYS FEMALE MINIFIT CONNECTOR</td> <td>2</td> <td>PZ</td> </tr> <tr> <td>CE1750A0</td> <td>3 WAYS MALE MINIFIT CONNECTOR</td> <td>1</td> <td>PZ</td> </tr> <tr> <td>LP1002B0</td> <td>LED LIGHTING BAR L400</td> <td>1</td> <td>PZ</td> </tr> <tr> <td>VM1620A0</td> <td>LED BAR LOWER SUPPORT</td> <td>1</td> <td>PZ</td> </tr> <tr> <td>VM1621A0</td> <td>LED BAR UPPER SUPPORT</td> <td>1</td> <td>PZ</td> </tr> <tr> <td>VM1794A0</td> <td>250X4.8 PA66 BLACK CLAMP</td> <td>2</td> <td>PZ</td> </tr> <tr> <td>VM2103A0</td> <td>CLAMP LOCK</td> <td>2</td> <td>PZ</td> </tr> </tbody> </table>	Code	Description	Qty	UOM	CE1740A0	MINIFIT MALE END FITTING	4	PZ	CE1745A0	2 WAYS FEMALE MINIFIT CONNECTOR	2	PZ	CE1750A0	3 WAYS MALE MINIFIT CONNECTOR	1	PZ	LP1002B0	LED LIGHTING BAR L400	1	PZ	VM1620A0	LED BAR LOWER SUPPORT	1	PZ	VM1621A0	LED BAR UPPER SUPPORT	1	PZ	VM1794A0	250X4.8 PA66 BLACK CLAMP	2	PZ	VM2103A0	CLAMP LOCK	2	PZ	
			Code	Description	Qty	UOM																																				
			CE1740A0	MINIFIT MALE END FITTING	4	PZ																																				
CE1745A0	2 WAYS FEMALE MINIFIT CONNECTOR	2	PZ																																							
CE1750A0	3 WAYS MALE MINIFIT CONNECTOR	1	PZ																																							
LP1002B0	LED LIGHTING BAR L400	1	PZ																																							
VM1620A0	LED BAR LOWER SUPPORT	1	PZ																																							
VM1621A0	LED BAR UPPER SUPPORT	1	PZ																																							
VM1794A0	250X4.8 PA66 BLACK CLAMP	2	PZ																																							
VM2103A0	CLAMP LOCK	2	PZ																																							
KLP1001B	L300 LED BAR KIT	<table border="1"> <thead> <tr> <th>Code</th> <th>Description</th> <th>Qty</th> <th>UOM</th> </tr> </thead> <tbody> <tr> <td>CE1455A0</td> <td>TIP END FITTING</td> <td>2</td> <td>PZ</td> </tr> <tr> <td>CE1730A0</td> <td>PVC CABLE NP 2 X AWG22 STYLE 2095</td> <td>4.500</td> <td>M</td> </tr> <tr> <td>CE1735A0</td> <td>MINIFIT FEMALE END FITTING</td> <td>2</td> <td>PZ</td> </tr> <tr> <td>CE1740A0</td> <td>MINIFIT MALE END FITTING</td> <td>4</td> <td>PZ</td> </tr> <tr> <td>CE1745A0</td> <td>2 WAYS FEMALE MINIFIT CONNECTOR</td> <td>2</td> <td>PZ</td> </tr> <tr> <td>CE1750A0</td> <td>3 WAYS MALE MINIFIT CONNECTOR</td> <td>1</td> <td>PZ</td> </tr> <tr> <td>LP1001B0</td> <td>LED LIGHTING BAR L300</td> <td>1</td> <td>PZ</td> </tr> <tr> <td>VM1620A0</td> <td>LED BAR LOWER SUPPORT</td> <td>1</td> <td>PZ</td> </tr> <tr> <td>VM1621A0</td> <td>LED BAR UPPER SUPPORT</td> <td>1</td> <td>PZ</td> </tr> </tbody> </table>	Code	Description	Qty	UOM	CE1455A0	TIP END FITTING	2	PZ	CE1730A0	PVC CABLE NP 2 X AWG22 STYLE 2095	4.500	M	CE1735A0	MINIFIT FEMALE END FITTING	2	PZ	CE1740A0	MINIFIT MALE END FITTING	4	PZ	CE1745A0	2 WAYS FEMALE MINIFIT CONNECTOR	2	PZ	CE1750A0	3 WAYS MALE MINIFIT CONNECTOR	1	PZ	LP1001B0	LED LIGHTING BAR L300	1	PZ	VM1620A0	LED BAR LOWER SUPPORT	1	PZ	VM1621A0	LED BAR UPPER SUPPORT	1	PZ
Code	Description	Qty	UOM																																							
CE1455A0	TIP END FITTING	2	PZ																																							
CE1730A0	PVC CABLE NP 2 X AWG22 STYLE 2095	4.500	M																																							
CE1735A0	MINIFIT FEMALE END FITTING	2	PZ																																							
CE1740A0	MINIFIT MALE END FITTING	4	PZ																																							
CE1745A0	2 WAYS FEMALE MINIFIT CONNECTOR	2	PZ																																							
CE1750A0	3 WAYS MALE MINIFIT CONNECTOR	1	PZ																																							
LP1001B0	LED LIGHTING BAR L300	1	PZ																																							
VM1620A0	LED BAR LOWER SUPPORT	1	PZ																																							
VM1621A0	LED BAR UPPER SUPPORT	1	PZ																																							
KLP1000A	L100 LED BAR KIT	<table border="1"> <thead> <tr> <th>Code</th> <th>Description</th> <th>Qty</th> <th>UOM</th> </tr> </thead> <tbody> <tr> <td>LP1000A0</td> <td>LED LIGHTING BAR L100</td> <td>1</td> <td>PZ</td> </tr> <tr> <td>VM1620A0</td> <td>LED BAR LOWER SUPPORT</td> <td>1</td> <td>PZ</td> </tr> <tr> <td>VM1621A0</td> <td>LED BAR UPPER SUPPORT</td> <td>1</td> <td>PZ</td> </tr> </tbody> </table>	Code	Description	Qty	UOM	LP1000A0	LED LIGHTING BAR L100	1	PZ	VM1620A0	LED BAR LOWER SUPPORT	1	PZ	VM1621A0	LED BAR UPPER SUPPORT	1	PZ																								
Code	Description	Qty	UOM																																							
LP1000A0	LED LIGHTING BAR L100	1	PZ																																							
VM1620A0	LED BAR LOWER SUPPORT	1	PZ																																							
VM1621A0	LED BAR UPPER SUPPORT	1	PZ																																							



Зип Общепит
vsezip.ru

+7(812)987-08-81

COMPONENT			SPARE PART																																																						
Code	Description	Image	Code	Description	Components list																																																				
TB3058A	DECKOVEN HANDLE TUBE		TB3058A0	DECKOVEN HANDLE TUBE																																																					
VT1310A	INDEPENDENT DECKOVEN EXT GLASS 856X383		KVT1310A	MM INDEPENDENT DECKOVEN EXT GLASS	<table border="1"> <thead> <tr> <th>Code</th> <th>Description</th> <th>Qty</th> <th>UOM</th> </tr> </thead> <tbody> <tr> <td>IP1508A1</td> <td>POLYSTYREN E U SHAPED PROFILE 2000X60X60</td> <td>1</td> <td>M</td> </tr> <tr> <td>SL1155A1</td> <td>SILICON BICOMPONENT LOCTITE</td> <td>32</td> <td>ML</td> </tr> <tr> <td>TB2183B0</td> <td>AUTONOMOUS DECK OVEN LEFT COLUMN</td> <td>1</td> <td>PZ</td> </tr> <tr> <td>TB2184B0</td> <td>AUTONOMOUS DECK OVEN RIGHT COLUMN</td> <td>1</td> <td>PZ</td> </tr> <tr> <td>VI1728A0</td> <td>THREADED SCREW M6 FTR/E INOX</td> <td>8</td> <td>PZ</td> </tr> <tr> <td>VI1855A0</td> <td>5X25 SELF-TAPPING SCREW</td> <td>2</td> <td>PZ</td> </tr> <tr> <td>VM1025A0</td> <td>Ø16 GREY NYLON LID</td> <td>2</td> <td>PZ</td> </tr> <tr> <td>VM1059A1</td> <td>HEAT SHRINK FILM H800</td> <td>1</td> <td>M</td> </tr> <tr> <td>VM1145A1</td> <td>C.T. BOARD FRAME</td> <td>1</td> <td>PZ</td> </tr> <tr> <td>VM1916A0</td> <td>RIGHT UPPER COLUMN CAP</td> <td>1</td> <td>PZ</td> </tr> <tr> <td>VM1917A0</td> <td>LEFT UPPER COLUMN CAP</td> <td>1</td> <td>PZ</td> </tr> <tr> <td>VT1310A0</td> <td>INDEPENDENT DECKOVEN EXT GLASS 856X383</td> <td>1</td> <td>PZ</td> </tr> </tbody> </table>	Code	Description	Qty	UOM	IP1508A1	POLYSTYREN E U SHAPED PROFILE 2000X60X60	1	M	SL1155A1	SILICON BICOMPONENT LOCTITE	32	ML	TB2183B0	AUTONOMOUS DECK OVEN LEFT COLUMN	1	PZ	TB2184B0	AUTONOMOUS DECK OVEN RIGHT COLUMN	1	PZ	VI1728A0	THREADED SCREW M6 FTR/E INOX	8	PZ	VI1855A0	5X25 SELF-TAPPING SCREW	2	PZ	VM1025A0	Ø16 GREY NYLON LID	2	PZ	VM1059A1	HEAT SHRINK FILM H800	1	M	VM1145A1	C.T. BOARD FRAME	1	PZ	VM1916A0	RIGHT UPPER COLUMN CAP	1	PZ	VM1917A0	LEFT UPPER COLUMN CAP	1	PZ	VT1310A0	INDEPENDENT DECKOVEN EXT GLASS 856X383	1	PZ
Code	Description	Qty	UOM																																																						
IP1508A1	POLYSTYREN E U SHAPED PROFILE 2000X60X60	1	M																																																						
SL1155A1	SILICON BICOMPONENT LOCTITE	32	ML																																																						
TB2183B0	AUTONOMOUS DECK OVEN LEFT COLUMN	1	PZ																																																						
TB2184B0	AUTONOMOUS DECK OVEN RIGHT COLUMN	1	PZ																																																						
VI1728A0	THREADED SCREW M6 FTR/E INOX	8	PZ																																																						
VI1855A0	5X25 SELF-TAPPING SCREW	2	PZ																																																						
VM1025A0	Ø16 GREY NYLON LID	2	PZ																																																						
VM1059A1	HEAT SHRINK FILM H800	1	M																																																						
VM1145A1	C.T. BOARD FRAME	1	PZ																																																						
VM1916A0	RIGHT UPPER COLUMN CAP	1	PZ																																																						
VM1917A0	LEFT UPPER COLUMN CAP	1	PZ																																																						
VT1310A0	INDEPENDENT DECKOVEN EXT GLASS 856X383	1	PZ																																																						



Зип Общепит

ASM4070A/0.D00 General overview

vsezip.ru

+7(812)987-08-81

ASM4070A/0.D00 - General overview

FRONT

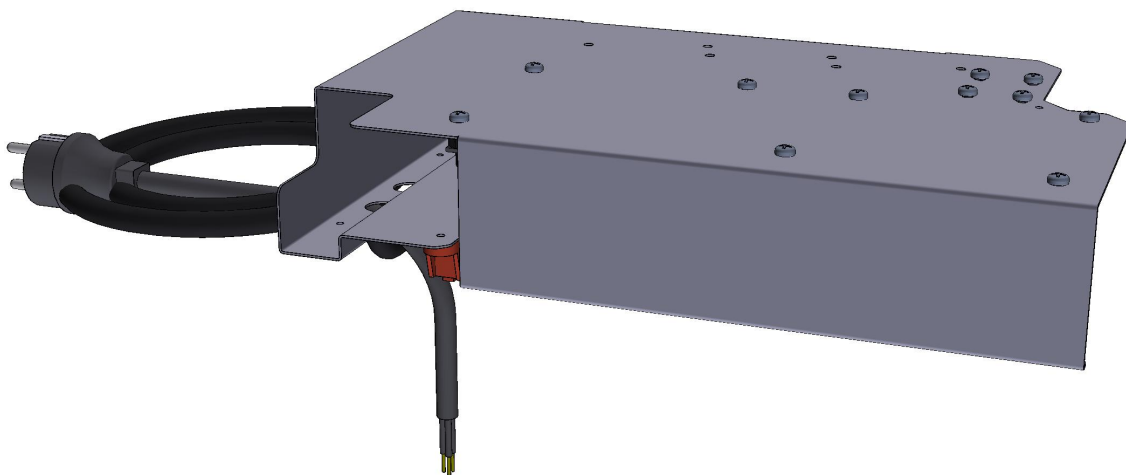



Зип Общепит

ASM4070A/0.D00 General overview

vsezip.ru

+7(812)987-08-81

ASM4070A/0.D00 - General overview

REAR

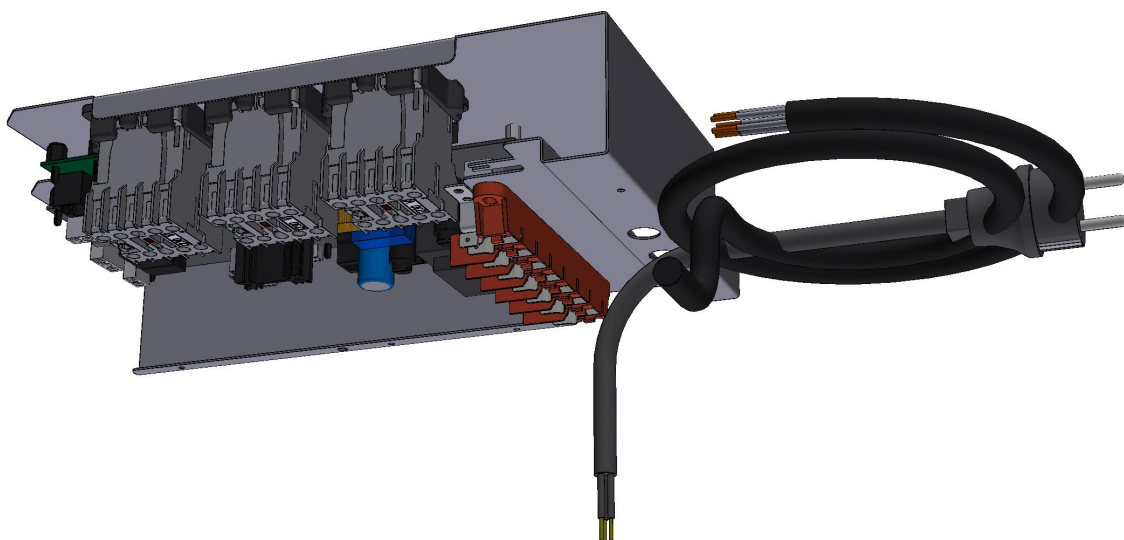







Зип Общепит

ASM4070A/0.D00 General overview

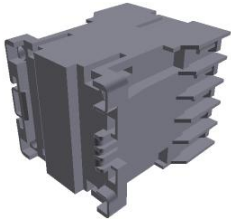
vsezip.ru

+7(812)987-08-81

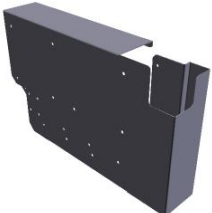
COMPONENT			SPARE PART														
Code	Description	Image	Code	Description	Components list												
VE1115A	20 A 230V 4 POLES MINICONTRACTOR		KVE1115A	20A 230V 4 POLES MINICONTRACTOR KI	<table border="1"> <thead> <tr> <th>Code</th> <th>Description</th> <th>Qty</th> <th>UOM</th> </tr> </thead> <tbody> <tr> <td>VE1115A0</td> <td>20 A 230V 4 POLES MINICONTRACTOR</td> <td>1</td> <td>PZ</td> </tr> <tr> <td>VM1075A1</td> <td>PLASTIC CLIP TO FIX CONTACTORS</td> <td>4</td> <td>PZ</td> </tr> </tbody> </table>	Code	Description	Qty	UOM	VE1115A0	20 A 230V 4 POLES MINICONTRACTOR	1	PZ	VM1075A1	PLASTIC CLIP TO FIX CONTACTORS	4	PZ
Code	Description	Qty	UOM														
VE1115A0	20 A 230V 4 POLES MINICONTRACTOR	1	PZ														
VM1075A1	PLASTIC CLIP TO FIX CONTACTORS	4	PZ														
VM1056A	SMALL CONTACTOR BRACKET VE1115A		VM1056A0	SMALL CONTACTOR BRACKET VE1115A													
MR1004A	41A 450V 7 POLES TERMINAL		KMR1004A	7FTW 1+2+3/4+5+6 TERMINAL BLOCK KIT	<table border="1"> <thead> <tr> <th>Code</th> <th>Description</th> <th>Qty</th> <th>UOM</th> </tr> </thead> <tbody> <tr> <td>MR1004A1</td> <td>41A 450V 7 POLES TERMINAL</td> <td>1</td> <td>PZ</td> </tr> </tbody> </table>	Code	Description	Qty	UOM	MR1004A1	41A 450V 7 POLES TERMINAL	1	PZ				
Code	Description	Qty	UOM														
MR1004A1	41A 450V 7 POLES TERMINAL	1	PZ														
CE1355A	CABLE 5 X 2,5 MMQ H07RNF L = 1,5 MT		KCE1355A	CONNECTOR KIT	<table border="1"> <thead> <tr> <th>Code</th> <th>Description</th> <th>Qty</th> <th>UOM</th> </tr> </thead> <tbody> <tr> <td>CE1355A1</td> <td>CABLE 5 X 2,5 MMQ H07RNF L = 1,5 MT</td> <td>1</td> <td>PZ</td> </tr> </tbody> </table>	Code	Description	Qty	UOM	CE1355A1	CABLE 5 X 2,5 MMQ H07RNF L = 1,5 MT	1	PZ				
Code	Description	Qty	UOM														
CE1355A1	CABLE 5 X 2,5 MMQ H07RNF L = 1,5 MT	1	PZ														
0H7508A	MM DECKOVEN COMPONENTS PANEL		0H7508A0	MM DECKOVEN COMPONENTS PANEL													



Зип Общепит

ASM4070A/0.D00 General overview

vsezip.ru

+7(812)987-08-81

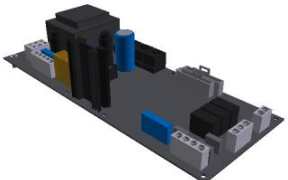
COMPONENT			SPARE PART																						
Code	Description	Image	Code	Description	Components list																				
PE1960B	POWER BOARD DECKTOP		KPE1960B	TSIC MECH. DECK OVEN POWER BOARD KIT	<table border="1"> <thead> <tr> <th>Code</th> <th>Description</th> <th>Qty</th> <th>UOM</th> </tr> </thead> <tbody> <tr> <td>PE1960B0</td> <td>POWER BOARD DECKTOP</td> <td>1</td> <td>PZ</td> </tr> <tr> <td>VI1850A0</td> <td>M4X6 NICKEL PLATED FIXING SCRE</td> <td>1</td> <td>PZ</td> </tr> <tr> <td>VM1745A0</td> <td>CARD SUPPORT</td> <td>1</td> <td>PZ</td> </tr> <tr> <td>VM2147A0</td> <td>ESD SPONGE PINK SMOOTH 410X343X15 M</td> <td>1</td> <td>PZ</td> </tr> </tbody> </table>	Code	Description	Qty	UOM	PE1960B0	POWER BOARD DECKTOP	1	PZ	VI1850A0	M4X6 NICKEL PLATED FIXING SCRE	1	PZ	VM1745A0	CARD SUPPORT	1	PZ	VM2147A0	ESD SPONGE PINK SMOOTH 410X343X15 M	1	PZ
Code	Description	Qty	UOM																						
PE1960B0	POWER BOARD DECKTOP	1	PZ																						
VI1850A0	M4X6 NICKEL PLATED FIXING SCRE	1	PZ																						
VM1745A0	CARD SUPPORT	1	PZ																						
VM2147A0	ESD SPONGE PINK SMOOTH 410X343X15 M	1	PZ																						



Зип Общепит

ASM1668A/0.D00 General overview

vsezip.ru

+7(812)987-08-81

ASM1668A/0.D00 - General overview

FRONT

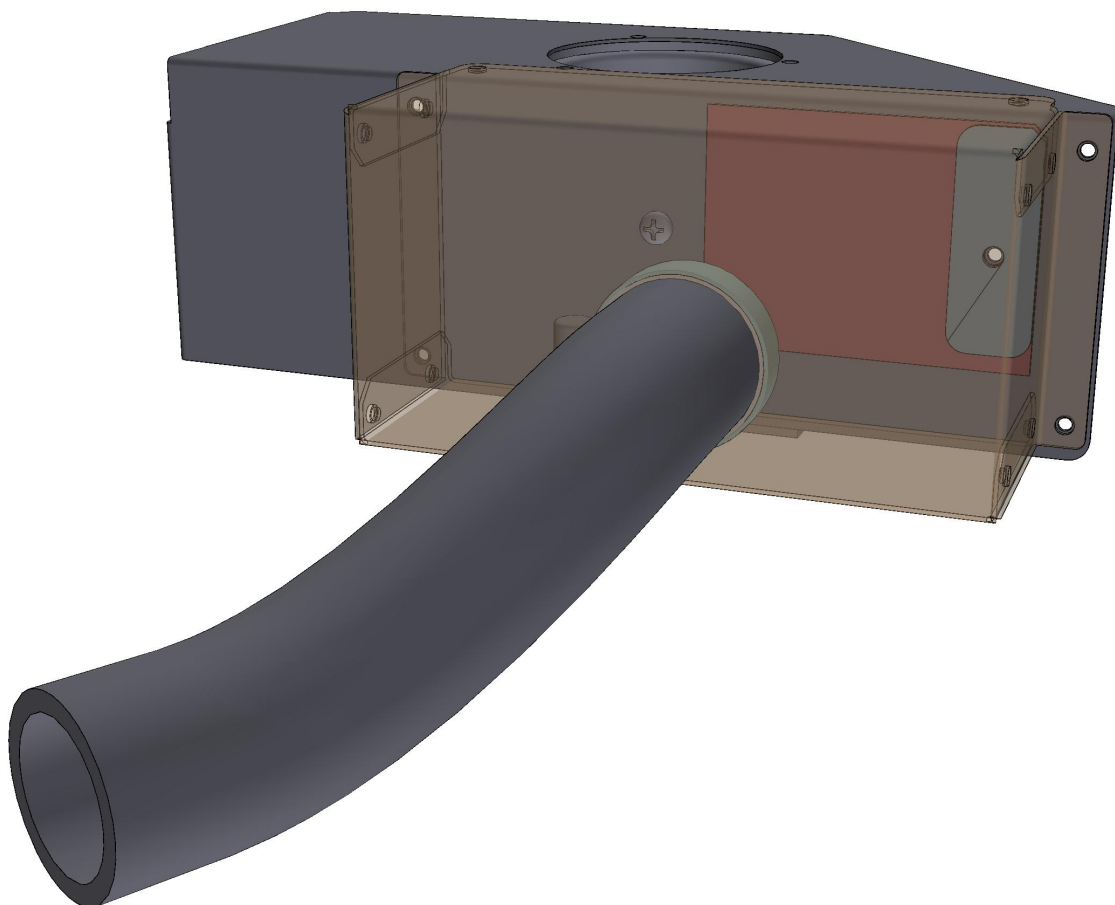



Зип Общепит

ASM1668A/0.D00 General overview

vsezip.ru

+7(812)987-08-81

ASM1668A/0.D00 - General overview

REAR

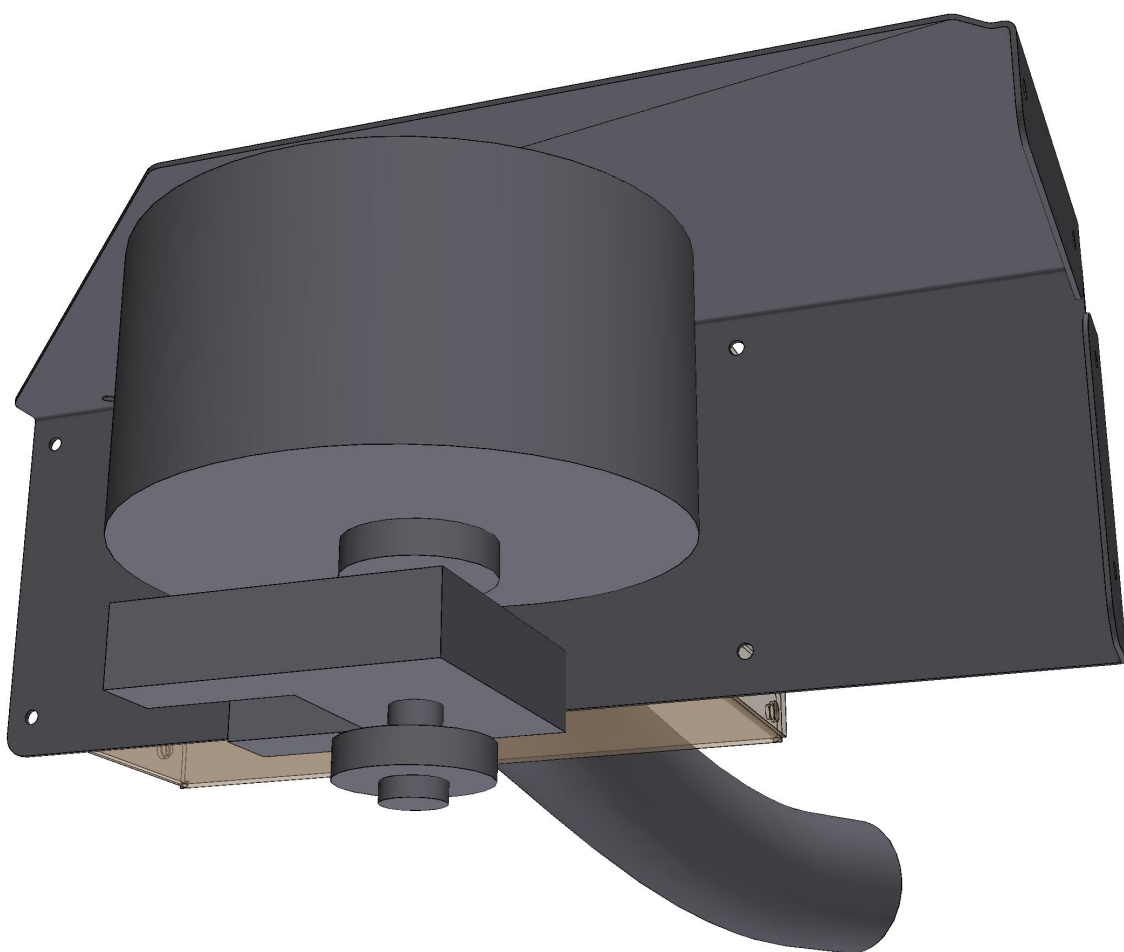



Зип Общепит

ASM1668A/0.D00 General overview

vsezip.ru

+7(812)987-08-81

COMPONENT

SPARE PART

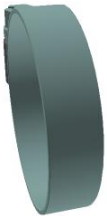
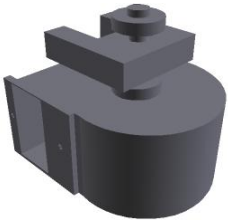
Code	Description	Image	Code	Description	Components list																																																								
RC1378A	HOSE CLAMP		KVE1135A	SERIES 5/5E VENTURI KIT	<table border="1"> <thead> <tr> <th>Code</th> <th>Description</th> <th>Qty</th> <th>UOM</th> </tr> </thead> <tbody> <tr> <td>GN1310A0</td> <td>VENTURI PIPE SEAL</td> <td>1</td> <td>PZ</td> </tr> <tr> <td>GN1556A0</td> <td>MM VENTURI SEAL</td> <td>1</td> <td>PZ</td> </tr> <tr> <td>RC1378A0</td> <td>HOSE CLAMP</td> <td>2</td> <td>PZ</td> </tr> <tr> <td>TB1520A0</td> <td>INT. Ø=38 TH=4 DRAIN BLACK RUBBER PIPE</td> <td>0.050</td> <td>M</td> </tr> <tr> <td>VE1135A0</td> <td>220 V 50/60 HZ VENTURI ACTUATOR</td> <td>1</td> <td>PZ</td> </tr> <tr> <td>VI1032A0</td> <td>SCREW M4X16 TCB+ INOX</td> <td>1</td> <td>PZ</td> </tr> <tr> <td>VI1511A0</td> <td>STAINLESS STEEL WASHER 4.2X12X1</td> <td>2</td> <td>PZ</td> </tr> <tr> <td>VI1850A0</td> <td>M4X6 NICKEL PLATED FIXING SCRE</td> <td>2</td> <td>PZ</td> </tr> <tr> <td>VI1865A0</td> <td>5X10 TCB+ SELF-THREADI NG SCREW</td> <td>3</td> <td>PZ</td> </tr> <tr> <td>VM1565B0</td> <td>VENTURI LOWER COIL SUPPORT</td> <td>1</td> <td>PZ</td> </tr> <tr> <td>VM1566A0</td> <td>VENTURI UPPER COIL SUPPORT</td> <td>1</td> <td>PZ</td> </tr> <tr> <td>VM1567A0</td> <td>VENTURI LOWER BUSHING</td> <td>1</td> <td>PZ</td> </tr> <tr> <td>VM1568A0</td> <td>VENTURI PLATE SPACE</td> <td>1</td> <td>PZ</td> </tr> </tbody> </table>	Code	Description	Qty	UOM	GN1310A0	VENTURI PIPE SEAL	1	PZ	GN1556A0	MM VENTURI SEAL	1	PZ	RC1378A0	HOSE CLAMP	2	PZ	TB1520A0	INT. Ø=38 TH=4 DRAIN BLACK RUBBER PIPE	0.050	M	VE1135A0	220 V 50/60 HZ VENTURI ACTUATOR	1	PZ	VI1032A0	SCREW M4X16 TCB+ INOX	1	PZ	VI1511A0	STAINLESS STEEL WASHER 4.2X12X1	2	PZ	VI1850A0	M4X6 NICKEL PLATED FIXING SCRE	2	PZ	VI1865A0	5X10 TCB+ SELF-THREADI NG SCREW	3	PZ	VM1565B0	VENTURI LOWER COIL SUPPORT	1	PZ	VM1566A0	VENTURI UPPER COIL SUPPORT	1	PZ	VM1567A0	VENTURI LOWER BUSHING	1	PZ	VM1568A0	VENTURI PLATE SPACE	1	PZ
Code	Description	Qty	UOM																																																										
GN1310A0	VENTURI PIPE SEAL	1	PZ																																																										
GN1556A0	MM VENTURI SEAL	1	PZ																																																										
RC1378A0	HOSE CLAMP	2	PZ																																																										
TB1520A0	INT. Ø=38 TH=4 DRAIN BLACK RUBBER PIPE	0.050	M																																																										
VE1135A0	220 V 50/60 HZ VENTURI ACTUATOR	1	PZ																																																										
VI1032A0	SCREW M4X16 TCB+ INOX	1	PZ																																																										
VI1511A0	STAINLESS STEEL WASHER 4.2X12X1	2	PZ																																																										
VI1850A0	M4X6 NICKEL PLATED FIXING SCRE	2	PZ																																																										
VI1865A0	5X10 TCB+ SELF-THREADI NG SCREW	3	PZ																																																										
VM1565B0	VENTURI LOWER COIL SUPPORT	1	PZ																																																										
VM1566A0	VENTURI UPPER COIL SUPPORT	1	PZ																																																										
VM1567A0	VENTURI LOWER BUSHING	1	PZ																																																										
VM1568A0	VENTURI PLATE SPACE	1	PZ																																																										
MT1015A	CENTRIFUGAL FAN DECK TOP		KMT1015A	DECK OVEN FAN MOTOR KIT	<table border="1"> <thead> <tr> <th>Code</th> <th>Description</th> <th>Qty</th> <th>UOM</th> </tr> </thead> <tbody> <tr> <td>IP1385A1</td> <td>CORNER POLYSTYREN E PACKING 110X80X2000</td> <td>0.430</td> <td>M</td> </tr> <tr> <td>MT1015A0</td> <td>CENTRIFUGAL FAN DECK TO</td> <td>1</td> <td>PZ</td> </tr> </tbody> </table>	Code	Description	Qty	UOM	IP1385A1	CORNER POLYSTYREN E PACKING 110X80X2000	0.430	M	MT1015A0	CENTRIFUGAL FAN DECK TO	1	PZ																																												
Code	Description	Qty	UOM																																																										
IP1385A1	CORNER POLYSTYREN E PACKING 110X80X2000	0.430	M																																																										
MT1015A0	CENTRIFUGAL FAN DECK TO	1	PZ																																																										



Зип Общепит

ASM1668A/0.D00 General overview

vsezip.ru

+7(812)987-08-81

COMPONENT			SPARE PART		
Code	Description	Image	Code	Description	Components list
0H6621A	XB262 DECK OVEN FAN BOX		0H6621A0	XB262 DECK OVEN FAN BOX	
GN1419A	DECK OVEN VENTURI FLAP		GN1419A0	DECK OVEN VENTURI FLAP	
0H6622A	XB262 DECK OVEN FLAP PRESS		0H6622A0	XB262 DECK OVEN FLAP PRESS	
TB1292A	PIPE CONNECTION VENTURI DECK TOP		TB1292A0	PIPE CONNECTION VENTURI DECK TOP	
0H6620A	DECKTOP FAN HOLDER		0H6620A0	DECKTOP FAN HOLDER	



Зип Общепит

ASM1603A/0.D03 Cooking chamber

vsezip.ru

+7(812)987-08-81

ASM1603A/0.D03 - Cooking chamber

FRONT





Зип Ощепит

ASM1603A/0.D03 Cooking chamber

vsezip.ru

+7(812)987-08-81

ASM1603A/0.D03 - Cooking chamber

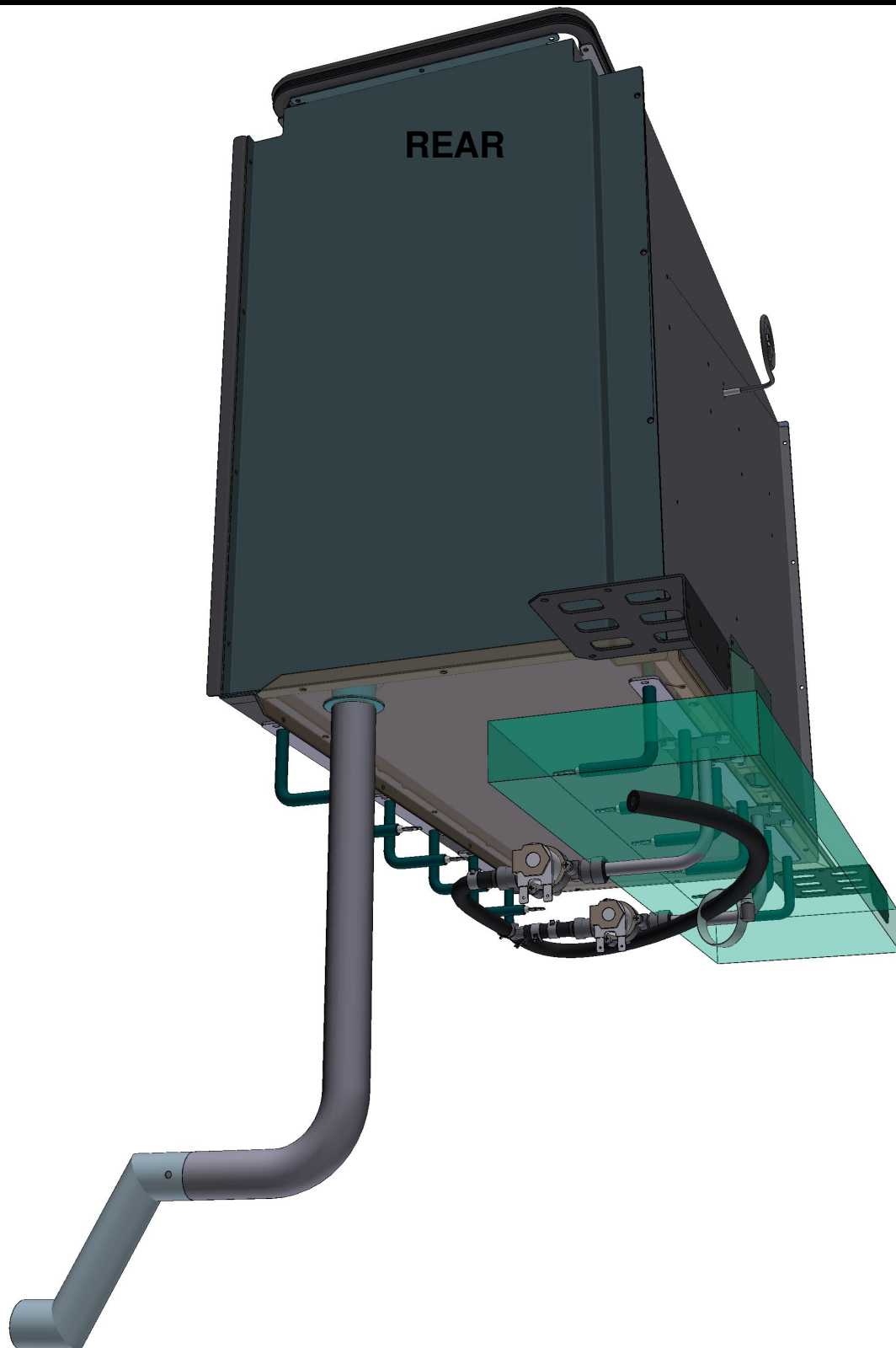





Зип Общепит



ASM1603A/0.D03 Cooking chamber

vsezip.ru

+7(812)987-08-81

COMPONENT			SPARE PART																																		
Code	Description	Image	Code	Description	Components list																																
0H4820A	BULB HOLDING BRACKET																																				
TR1105A	L=1000 PT1000 TEMPERATURE PROBE		KTR1105A	PT100 L1000 TEMPERATURE PROBE KIT	<table border="1"> <thead> <tr> <th>Code</th> <th>Description</th> <th>Qty</th> <th>UOM</th> </tr> </thead> <tbody> <tr> <td>GN1120A0</td> <td>TEMPERATUR E PROBE NTC SEAL</td> <td>1</td> <td>PZ</td> </tr> <tr> <td>GN1285A0</td> <td>NTC TEMPERATUR E PROBE SEALING</td> <td>1</td> <td>PZ</td> </tr> <tr> <td>SL1045A0</td> <td>S53 BLACK SILICONE - 80ML CARTRIDGE</td> <td>1</td> <td>PZ</td> </tr> <tr> <td>TR1105A3</td> <td>L=1000 PT1000 TEMPERATUR E PROBE</td> <td>1</td> <td>PZ</td> </tr> <tr> <td>TR1105A4</td> <td></td> <td>1</td> <td>PZ</td> </tr> <tr> <td>VI1220A1</td> <td>4,2X12 TCB SELF-TAPPIN G SCREW</td> <td>2</td> <td>PZ</td> </tr> <tr> <td>VM1465A0</td> <td>CHEFTOP TEMPERATUR E PROBE COVER</td> <td>1</td> <td>PZ</td> </tr> </tbody> </table>	Code	Description	Qty	UOM	GN1120A0	TEMPERATUR E PROBE NTC SEAL	1	PZ	GN1285A0	NTC TEMPERATUR E PROBE SEALING	1	PZ	SL1045A0	S53 BLACK SILICONE - 80ML CARTRIDGE	1	PZ	TR1105A3	L=1000 PT1000 TEMPERATUR E PROBE	1	PZ	TR1105A4		1	PZ	VI1220A1	4,2X12 TCB SELF-TAPPIN G SCREW	2	PZ	VM1465A0	CHEFTOP TEMPERATUR E PROBE COVER	1	PZ
Code	Description	Qty	UOM																																		
GN1120A0	TEMPERATUR E PROBE NTC SEAL	1	PZ																																		
GN1285A0	NTC TEMPERATUR E PROBE SEALING	1	PZ																																		
SL1045A0	S53 BLACK SILICONE - 80ML CARTRIDGE	1	PZ																																		
TR1105A3	L=1000 PT1000 TEMPERATUR E PROBE	1	PZ																																		
TR1105A4		1	PZ																																		
VI1220A1	4,2X12 TCB SELF-TAPPIN G SCREW	2	PZ																																		
VM1465A0	CHEFTOP TEMPERATUR E PROBE COVER	1	PZ																																		
GN1120A	TEMPERATURE PROBE NTC SEAL		KTR1106A	5-5E S. L2000 CHAMBER TEMP. PROBE KIT	<table border="1"> <thead> <tr> <th>Code</th> <th>Description</th> <th>Qty</th> <th>UOM</th> </tr> </thead> <tbody> <tr> <td>GN1285A0</td> <td>NTC TEMPERATUR E PROBE SEALING</td> <td>1</td> <td>PZ</td> </tr> <tr> <td>SL1045A0</td> <td>S53 BLACK SILICONE - 80ML CARTRIDGE</td> <td>1</td> <td>PZ</td> </tr> <tr> <td>TR1106A3</td> <td>PT100 L=2000 TEMPERATUR E PROBE</td> <td>1</td> <td>PZ</td> </tr> <tr> <td>VI1220A1</td> <td>4,2X12 TCB SELF-TAPPIN G SCREW</td> <td>2</td> <td>PZ</td> </tr> <tr> <td>VM1465A0</td> <td>CHEFTOP TEMPERATUR E PROBE COVER</td> <td>1</td> <td>PZ</td> </tr> </tbody> </table>	Code	Description	Qty	UOM	GN1285A0	NTC TEMPERATUR E PROBE SEALING	1	PZ	SL1045A0	S53 BLACK SILICONE - 80ML CARTRIDGE	1	PZ	TR1106A3	PT100 L=2000 TEMPERATUR E PROBE	1	PZ	VI1220A1	4,2X12 TCB SELF-TAPPIN G SCREW	2	PZ	VM1465A0	CHEFTOP TEMPERATUR E PROBE COVER	1	PZ								
Code	Description	Qty	UOM																																		
GN1285A0	NTC TEMPERATUR E PROBE SEALING	1	PZ																																		
SL1045A0	S53 BLACK SILICONE - 80ML CARTRIDGE	1	PZ																																		
TR1106A3	PT100 L=2000 TEMPERATUR E PROBE	1	PZ																																		
VI1220A1	4,2X12 TCB SELF-TAPPIN G SCREW	2	PZ																																		
VM1465A0	CHEFTOP TEMPERATUR E PROBE COVER	1	PZ																																		



COMPONENT			SPARE PART																														
Code	Description	Image	Code	Description	Components list																												
GN1120A	TEMPERATURE PROBE NTC SEAL		KTR1096A	NTC 150 L=1500 TEMPERATURE PROBE KIT	<table border="1"> <thead> <tr> <th>Code</th> <th>Description</th> <th>Qty</th> <th>UOM</th> </tr> </thead> <tbody> <tr> <td>GN1120A0</td> <td>TEMPERATUR E PROBE NTC SEAL</td> <td>1</td> <td>PZ</td> </tr> <tr> <td>GN1285A0</td> <td>NTC TEMPERATUR E PROBE SEALING</td> <td>2</td> <td>PZ</td> </tr> <tr> <td>SL1045A0</td> <td>S53 BLACK SILICONE - 80ML CARTRIDGE</td> <td>1</td> <td>PZ</td> </tr> <tr> <td>TR1096A0</td> <td>TEMPERATUR E PROBE NTC 150 L=1500</td> <td>1</td> <td>PZ</td> </tr> <tr> <td>VI1220A1</td> <td>4,2X12 TCB SELF-TAPPIN G SCREW</td> <td>2</td> <td>PZ</td> </tr> <tr> <td>VM1465A0</td> <td>CHEFTOP TEMPERATUR E PROBE COVER</td> <td>1</td> <td>PZ</td> </tr> </tbody> </table>	Code	Description	Qty	UOM	GN1120A0	TEMPERATUR E PROBE NTC SEAL	1	PZ	GN1285A0	NTC TEMPERATUR E PROBE SEALING	2	PZ	SL1045A0	S53 BLACK SILICONE - 80ML CARTRIDGE	1	PZ	TR1096A0	TEMPERATUR E PROBE NTC 150 L=1500	1	PZ	VI1220A1	4,2X12 TCB SELF-TAPPIN G SCREW	2	PZ	VM1465A0	CHEFTOP TEMPERATUR E PROBE COVER	1	PZ
			Code	Description	Qty	UOM																											
GN1120A0	TEMPERATUR E PROBE NTC SEAL	1	PZ																														
GN1285A0	NTC TEMPERATUR E PROBE SEALING	2	PZ																														
SL1045A0	S53 BLACK SILICONE - 80ML CARTRIDGE	1	PZ																														
TR1096A0	TEMPERATUR E PROBE NTC 150 L=1500	1	PZ																														
VI1220A1	4,2X12 TCB SELF-TAPPIN G SCREW	2	PZ																														
VM1465A0	CHEFTOP TEMPERATUR E PROBE COVER	1	PZ																														
KTR1095A	NTC 150 L=1050 TEMPERATURE PROBE KIT	<table border="1"> <thead> <tr> <th>Code</th> <th>Description</th> <th>Qty</th> <th>UOM</th> </tr> </thead> <tbody> <tr> <td>GN1120A0</td> <td>TEMPERATUR E PROBE NTC SEAL</td> <td>1</td> <td>PZ</td> </tr> <tr> <td>GN1285A0</td> <td>NTC TEMPERATUR E PROBE SEALING</td> <td>1</td> <td>PZ</td> </tr> <tr> <td>SL1045A0</td> <td>S53 BLACK SILICONE - 80ML CARTRIDGE</td> <td>1</td> <td>PZ</td> </tr> <tr> <td>TR1095A0</td> <td>TEMPERATUR E PROBE NTC 150 L=1050</td> <td>1</td> <td>PZ</td> </tr> <tr> <td>VI1220A1</td> <td>4,2X12 TCB SELF-TAPPIN G SCREW</td> <td>2</td> <td>PZ</td> </tr> <tr> <td>VM1465A0</td> <td>CHEFTOP TEMPERATUR E PROBE COVER</td> <td>1</td> <td>PZ</td> </tr> </tbody> </table>	Code	Description	Qty	UOM	GN1120A0	TEMPERATUR E PROBE NTC SEAL	1	PZ	GN1285A0	NTC TEMPERATUR E PROBE SEALING	1	PZ	SL1045A0	S53 BLACK SILICONE - 80ML CARTRIDGE	1	PZ	TR1095A0	TEMPERATUR E PROBE NTC 150 L=1050	1	PZ	VI1220A1	4,2X12 TCB SELF-TAPPIN G SCREW	2	PZ	VM1465A0	CHEFTOP TEMPERATUR E PROBE COVER	1	PZ			
Code	Description	Qty	UOM																														
GN1120A0	TEMPERATUR E PROBE NTC SEAL	1	PZ																														
GN1285A0	NTC TEMPERATUR E PROBE SEALING	1	PZ																														
SL1045A0	S53 BLACK SILICONE - 80ML CARTRIDGE	1	PZ																														
TR1095A0	TEMPERATUR E PROBE NTC 150 L=1050	1	PZ																														
VI1220A1	4,2X12 TCB SELF-TAPPIN G SCREW	2	PZ																														
VM1465A0	CHEFTOP TEMPERATUR E PROBE COVER	1	PZ																														
RS1273A	450W 77V 1 TURN FLAT ELEMENT		KRS1273A	XB262E FLAT HEATING ELEMENT KIT	<table border="1"> <thead> <tr> <th>Code</th> <th>Description</th> <th>Qty</th> <th>UOM</th> </tr> </thead> <tbody> <tr> <td>RS1273A0</td> <td>450W 77V 1 TURN FLAT ELEMENT</td> <td>1</td> <td>PZ</td> </tr> <tr> <td>SL1045A0</td> <td>S53 BLACK SILICONE - 80ML CARTRIDGE</td> <td>1</td> <td>PZ</td> </tr> </tbody> </table>	Code	Description	Qty	UOM	RS1273A0	450W 77V 1 TURN FLAT ELEMENT	1	PZ	SL1045A0	S53 BLACK SILICONE - 80ML CARTRIDGE	1	PZ																
Code	Description	Qty	UOM																														
RS1273A0	450W 77V 1 TURN FLAT ELEMENT	1	PZ																														
SL1045A0	S53 BLACK SILICONE - 80ML CARTRIDGE	1	PZ																														



Зип Общепит

ASM1603A/0.D03 Cooking chamber

vsezip.ru

+7(812)987-08-81

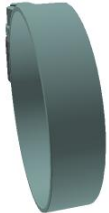
COMPONENT			SPARE PART																																																										
Code	Description	Image	Code	Description	Components list																																																								
RS1273A	450W 77V 1 TURN FLAT ELEMENT		KRS1273A	XB262E FLAT HEATING ELEMENT KIT	<table border="1"> <thead> <tr> <th>Code</th> <th>Description</th> <th>Qty</th> <th>UOM</th> </tr> </thead> <tbody> <tr> <td>VI1220A1</td> <td>4,2X12 TCB SELF-TAPPIN G SCREW</td> <td>2</td> <td>PZ</td> </tr> <tr> <td>VM1794A0</td> <td>250X4.8 PA66 BLACK CLAMP</td> <td>2</td> <td>PZ</td> </tr> <tr> <td>VM2103A0</td> <td>CLAMP LOCK</td> <td>2</td> <td>PZ</td> </tr> </tbody> </table>	Code	Description	Qty	UOM	VI1220A1	4,2X12 TCB SELF-TAPPIN G SCREW	2	PZ	VM1794A0	250X4.8 PA66 BLACK CLAMP	2	PZ	VM2103A0	CLAMP LOCK	2	PZ																																								
Code	Description	Qty	UOM																																																										
VI1220A1	4,2X12 TCB SELF-TAPPIN G SCREW	2	PZ																																																										
VM1794A0	250X4.8 PA66 BLACK CLAMP	2	PZ																																																										
VM2103A0	CLAMP LOCK	2	PZ																																																										
RC1378A	HOSE CLAMP		KVE1135A	SERIES 5/5E VENTURI KIT	<table border="1"> <thead> <tr> <th>Code</th> <th>Description</th> <th>Qty</th> <th>UOM</th> </tr> </thead> <tbody> <tr> <td>GN1310A0</td> <td>VENTURI PIPE SEAL</td> <td>1</td> <td>PZ</td> </tr> <tr> <td>GN1556A0</td> <td>MM VENTURI SEAL</td> <td>1</td> <td>PZ</td> </tr> <tr> <td>RC1378A0</td> <td>HOSE CLAMP</td> <td>2</td> <td>PZ</td> </tr> <tr> <td>TB1520A0</td> <td>INT. Ø=38 TH=4 DRAIN BLACK RUBBER PIPE</td> <td>0.050</td> <td>M</td> </tr> <tr> <td>VE1135A0</td> <td>220 V 50/60 HZ VENTURI ACTUATOR</td> <td>1</td> <td>PZ</td> </tr> <tr> <td>VI1032A0</td> <td>SCREW M4X16 TCB+ INOX</td> <td>1</td> <td>PZ</td> </tr> <tr> <td>VI1511A0</td> <td>STAINLESS STEEL WASHER 4.2X12X1</td> <td>2</td> <td>PZ</td> </tr> <tr> <td>VI1850A0</td> <td>M4X6 NICKEL PLATED FIXING SCRE</td> <td>2</td> <td>PZ</td> </tr> <tr> <td>VI1865A0</td> <td>5X10 TCB+ SELF-THREADI NG SCREW</td> <td>3</td> <td>PZ</td> </tr> <tr> <td>VM1565B0</td> <td>VENTURI LOWER COIL SUPPORT</td> <td>1</td> <td>PZ</td> </tr> <tr> <td>VM1566A0</td> <td>VENTURI UPPER COIL SUPPORT</td> <td>1</td> <td>PZ</td> </tr> <tr> <td>VM1567A0</td> <td>VENTURI LOWER BUSHING</td> <td>1</td> <td>PZ</td> </tr> <tr> <td>VM1568A0</td> <td>VENTURI PLATE SPACE</td> <td>1</td> <td>PZ</td> </tr> </tbody> </table>	Code	Description	Qty	UOM	GN1310A0	VENTURI PIPE SEAL	1	PZ	GN1556A0	MM VENTURI SEAL	1	PZ	RC1378A0	HOSE CLAMP	2	PZ	TB1520A0	INT. Ø=38 TH=4 DRAIN BLACK RUBBER PIPE	0.050	M	VE1135A0	220 V 50/60 HZ VENTURI ACTUATOR	1	PZ	VI1032A0	SCREW M4X16 TCB+ INOX	1	PZ	VI1511A0	STAINLESS STEEL WASHER 4.2X12X1	2	PZ	VI1850A0	M4X6 NICKEL PLATED FIXING SCRE	2	PZ	VI1865A0	5X10 TCB+ SELF-THREADI NG SCREW	3	PZ	VM1565B0	VENTURI LOWER COIL SUPPORT	1	PZ	VM1566A0	VENTURI UPPER COIL SUPPORT	1	PZ	VM1567A0	VENTURI LOWER BUSHING	1	PZ	VM1568A0	VENTURI PLATE SPACE	1	PZ
Code	Description	Qty	UOM																																																										
GN1310A0	VENTURI PIPE SEAL	1	PZ																																																										
GN1556A0	MM VENTURI SEAL	1	PZ																																																										
RC1378A0	HOSE CLAMP	2	PZ																																																										
TB1520A0	INT. Ø=38 TH=4 DRAIN BLACK RUBBER PIPE	0.050	M																																																										
VE1135A0	220 V 50/60 HZ VENTURI ACTUATOR	1	PZ																																																										
VI1032A0	SCREW M4X16 TCB+ INOX	1	PZ																																																										
VI1511A0	STAINLESS STEEL WASHER 4.2X12X1	2	PZ																																																										
VI1850A0	M4X6 NICKEL PLATED FIXING SCRE	2	PZ																																																										
VI1865A0	5X10 TCB+ SELF-THREADI NG SCREW	3	PZ																																																										
VM1565B0	VENTURI LOWER COIL SUPPORT	1	PZ																																																										
VM1566A0	VENTURI UPPER COIL SUPPORT	1	PZ																																																										
VM1567A0	VENTURI LOWER BUSHING	1	PZ																																																										
VM1568A0	VENTURI PLATE SPACE	1	PZ																																																										



Зип Общепит

ASM1603A/0.D03 Cooking chamber

vsezip.ru

+7(812)987-08-81

COMPONENT			SPARE PART																		
Code	Description	Image	Code	Description	Components list																
0H6919A	DECK OVEN VENTURI CHAMBER		0H6919A0	DECK OVEN VENTURI CHAMBER																	
VL1127A	T SHAPED BARBED FITTING D=6		KVL1127A	6MM BARBED T-SHAPED FITTING 10 PCS. KIT	<table border="1"> <thead> <tr> <th>Code</th> <th>Description</th> <th>Qty</th> <th>UOM</th> </tr> </thead> <tbody> <tr> <td>VL1127A0</td> <td>T SHAPED BARBED FITTING D=6</td> <td>10</td> <td>PZ</td> </tr> </tbody> </table>	Code	Description	Qty	UOM	VL1127A0	T SHAPED BARBED FITTING D=6	10	PZ								
Code	Description	Qty	UOM																		
VL1127A0	T SHAPED BARBED FITTING D=6	10	PZ																		
VL1047A	HOSE D6 TANG D8		KVL1047A	Ø6 PIPE HOLDER+Ø8 JG TERMINAL 10 PCS KIT	<table border="1"> <thead> <tr> <th>Code</th> <th>Description</th> <th>Qty</th> <th>UOM</th> </tr> </thead> <tbody> <tr> <td>VL1047A1</td> <td>D6 PIPE HOLDER - D8 J.G. TERMINAL</td> <td>10</td> <td>PZ</td> </tr> </tbody> </table>	Code	Description	Qty	UOM	VL1047A1	D6 PIPE HOLDER - D8 J.G. TERMINAL	10	PZ								
Code	Description	Qty	UOM																		
VL1047A1	D6 PIPE HOLDER - D8 J.G. TERMINAL	10	PZ																		
			KVL0016A	BRITA ADAPTOR KIT FOR MM CLEANING SYSTEM	<table border="1"> <thead> <tr> <th>Code</th> <th>Description</th> <th>Qty</th> <th>UOM</th> </tr> </thead> <tbody> <tr> <td>EL1185A0</td> <td>Ø8F - Ø8F ELBOW CONNECTION</td> <td>1</td> <td>PZ</td> </tr> <tr> <td>RC1018A0</td> <td>ZINC PLATED D12 ELASTIC CLAMP</td> <td>2</td> <td>PZ</td> </tr> <tr> <td>VL1047A1</td> <td>D6 PIPE HOLDER - D8 J.G. TERMINAL</td> <td>2</td> <td>PZ</td> </tr> </tbody> </table>	Code	Description	Qty	UOM	EL1185A0	Ø8F - Ø8F ELBOW CONNECTION	1	PZ	RC1018A0	ZINC PLATED D12 ELASTIC CLAMP	2	PZ	VL1047A1	D6 PIPE HOLDER - D8 J.G. TERMINAL	2	PZ
Code	Description	Qty	UOM																		
EL1185A0	Ø8F - Ø8F ELBOW CONNECTION	1	PZ																		
RC1018A0	ZINC PLATED D12 ELASTIC CLAMP	2	PZ																		
VL1047A1	D6 PIPE HOLDER - D8 J.G. TERMINAL	2	PZ																		
EL1250A	WATER SOLENOID VALVE 1-WAY RED		KEL1250A	1 WAY SOLENOID VALVE KIT J.G.D8 D1	<table border="1"> <thead> <tr> <th>Code</th> <th>Description</th> <th>Qty</th> <th>UOM</th> </tr> </thead> <tbody> <tr> <td>EL1250A0</td> <td>WATER SOLENOID VALVE 1-WAY RED</td> <td>1</td> <td>PZ</td> </tr> </tbody> </table>	Code	Description	Qty	UOM	EL1250A0	WATER SOLENOID VALVE 1-WAY RED	1	PZ								
Code	Description	Qty	UOM																		
EL1250A0	WATER SOLENOID VALVE 1-WAY RED	1	PZ																		





Зип Общепит

ASM1603A/0.D03 Cooking chamber

vsezip.ru

+7(812)987-08-81

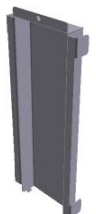
COMPONENT			SPARE PART														
Code	Description	Image	Code	Description	Components list												
GN1514A	XB264 DOOR GASKE		KG1514A	XB262-264 DOOR GASKET KIT	<table border="1"> <thead> <tr> <th>Code</th> <th>Description</th> <th>Qty</th> <th>UOM</th> </tr> </thead> <tbody> <tr> <td>GN1110A2</td> <td>LINE MISS/XVC105-055/XK/XL DOOR GASKE</td> <td>1.770</td> <td>M</td> </tr> <tr> <td>SL1025A0</td> <td>CLEAR SILICON DOW CORNING 734</td> <td>0.012</td> <td>PZ</td> </tr> </tbody> </table>	Code	Description	Qty	UOM	GN1110A2	LINE MISS/XVC105-055/XK/XL DOOR GASKE	1.770	M	SL1025A0	CLEAR SILICON DOW CORNING 734	0.012	PZ
Code	Description	Qty	UOM														
GN1110A2	LINE MISS/XVC105-055/XK/XL DOOR GASKE	1.770	M														
SL1025A0	CLEAR SILICON DOW CORNING 734	0.012	PZ														
TB1294B	DECK INTERNAL WIRING D8 PIPE		TB1294B0	DECK INTERNAL WIRING D8 PIPE													
0H7167A	L PLATE COMPENSATION FOR DECK STONE		0H7167A0	L PLATE COMPENSATION FOR DECK STONE													
0H1568A			0H1568A0														



Зип Общепит **ASM4038A/0.D01 External cover**

vsezip.ru

+7(812)987-08-81

ASM4038A/0.D01 - External cover

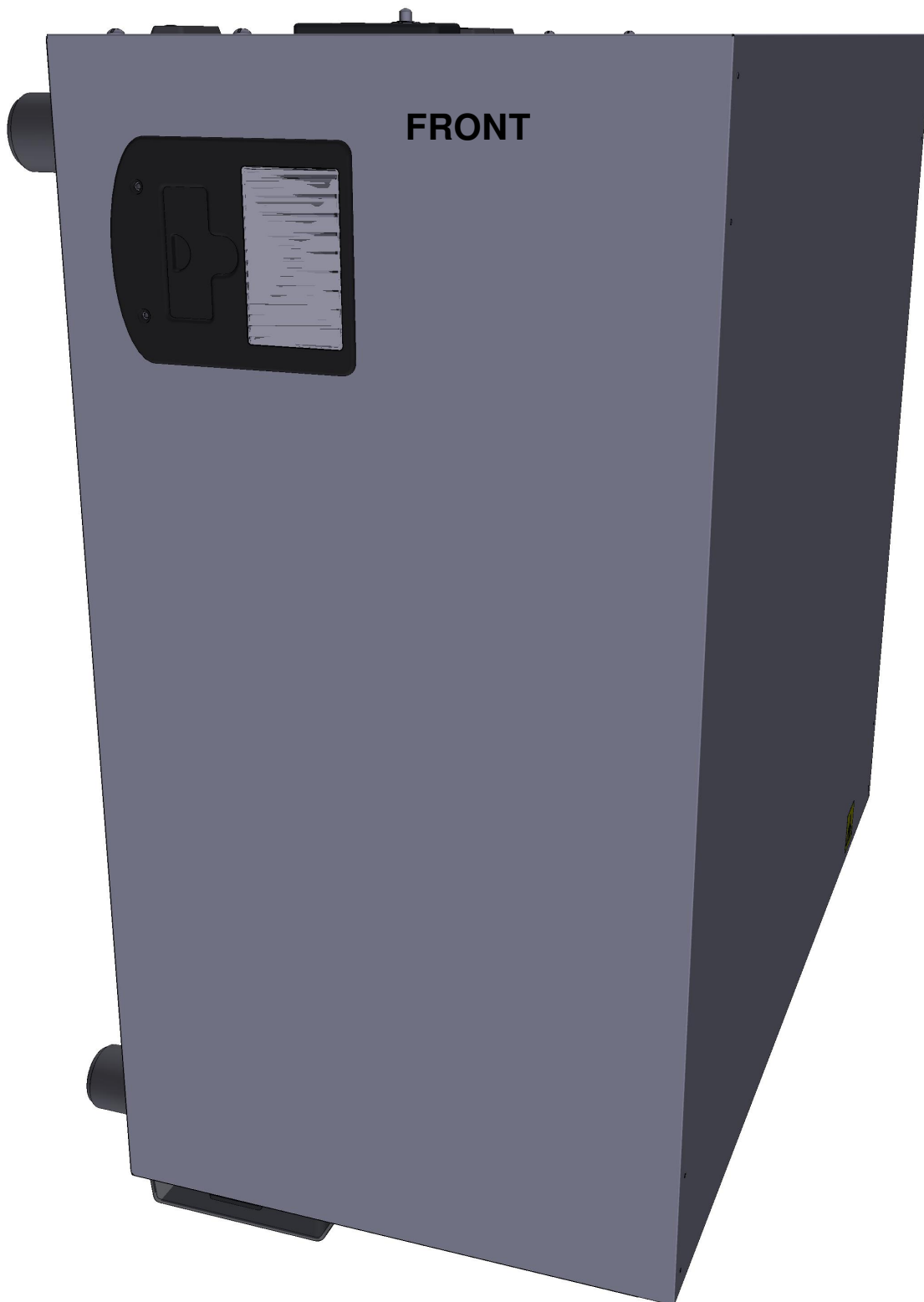



Зип Общепит **ASM4038A/0.D01 External cover**

vsezip.ru

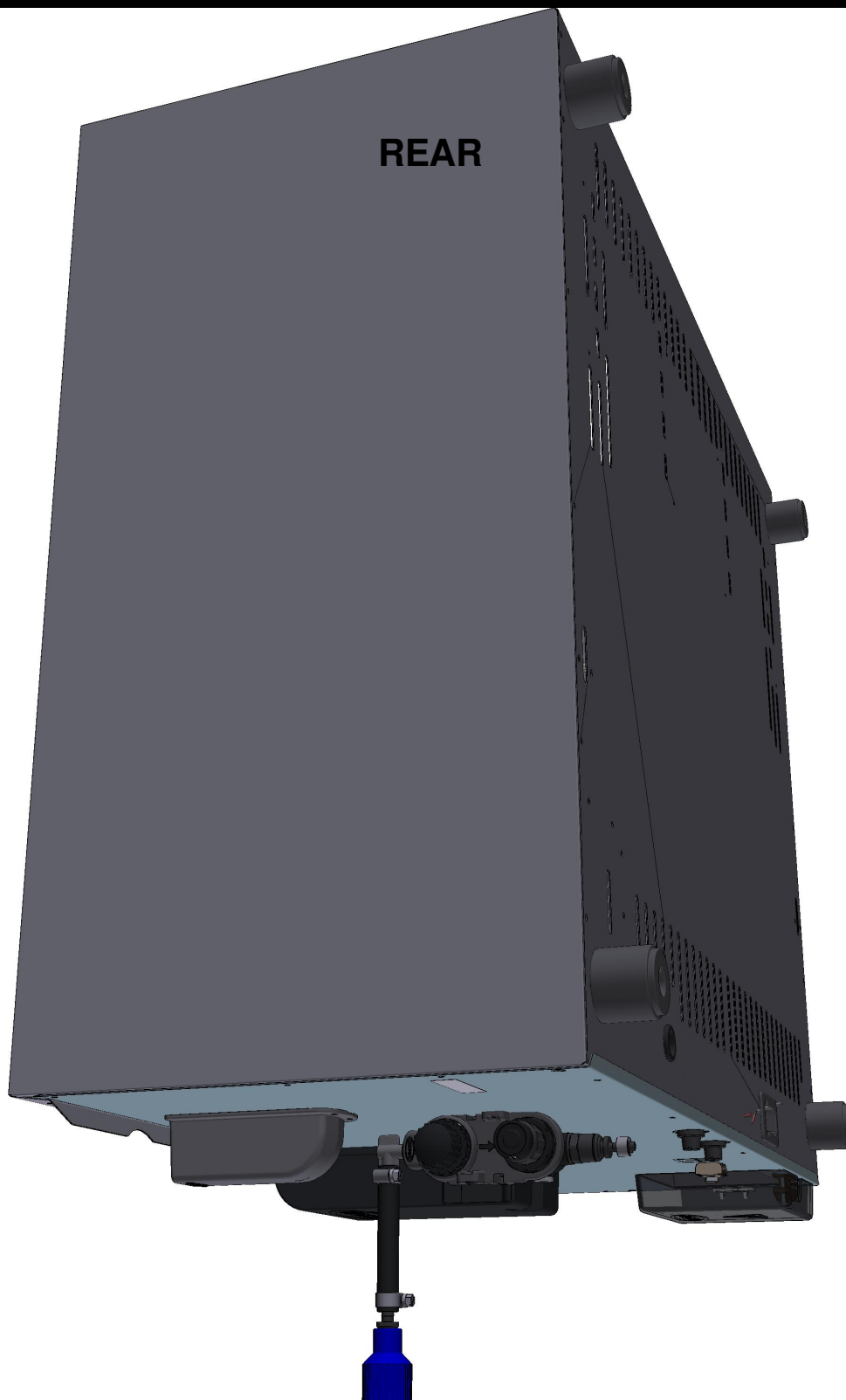

+7(812)987-08-81

ASM4038A/0.D01 - External cover



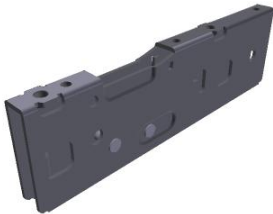

+7(812)987-08-81

COMPONENT			SPARE PART																										
Code	Description	Image	Code	Description	Components list																								
VM1951A	IP CHIMNEY COVER		KVM1065A	LINE MISS EXHAUST CHIMNEY COVER	<table border="1"> <thead> <tr> <th>Code</th> <th>Description</th> <th>Qty</th> <th>UOM</th> </tr> </thead> <tbody> <tr> <td>VM1065A0</td> <td>L.M. EXHAUST CHIMNEY COVER</td> <td>1</td> <td>PZ</td> </tr> </tbody> </table>	Code	Description	Qty	UOM	VM1065A0	L.M. EXHAUST CHIMNEY COVER	1	PZ																
Code	Description	Qty	UOM																										
VM1065A0	L.M. EXHAUST CHIMNEY COVER	1	PZ																										
TR1136A	330°C 1 POLE SAFETY THERMOSTAT		KTR1136A	330°C SAFETY THERMOSTAT KIT	<table border="1"> <thead> <tr> <th>Code</th> <th>Description</th> <th>Qty</th> <th>UOM</th> </tr> </thead> <tbody> <tr> <td>0H7030A0</td> <td>THERMOSTAT BULB INLET COVER</td> <td>1</td> <td>PZ</td> </tr> <tr> <td>GN1531A0</td> <td>THERMOSTAT BULB INLET SEALING</td> <td>1</td> <td>PZ</td> </tr> <tr> <td>SL1045A0</td> <td>S53 BLACK SILICONE - 80ML CARTRIDGE</td> <td>1</td> <td>PZ</td> </tr> <tr> <td>TR1136A0</td> <td>330°C 1 POLE SAFETY THERMOSTAT</td> <td>1</td> <td>PZ</td> </tr> <tr> <td>VI1220A1</td> <td>4,2X12 TCB SELF-TAPPING SCREW</td> <td>3</td> <td>PZ</td> </tr> </tbody> </table>	Code	Description	Qty	UOM	0H7030A0	THERMOSTAT BULB INLET COVER	1	PZ	GN1531A0	THERMOSTAT BULB INLET SEALING	1	PZ	SL1045A0	S53 BLACK SILICONE - 80ML CARTRIDGE	1	PZ	TR1136A0	330°C 1 POLE SAFETY THERMOSTAT	1	PZ	VI1220A1	4,2X12 TCB SELF-TAPPING SCREW	3	PZ
Code	Description	Qty	UOM																										
0H7030A0	THERMOSTAT BULB INLET COVER	1	PZ																										
GN1531A0	THERMOSTAT BULB INLET SEALING	1	PZ																										
SL1045A0	S53 BLACK SILICONE - 80ML CARTRIDGE	1	PZ																										
TR1136A0	330°C 1 POLE SAFETY THERMOSTAT	1	PZ																										
VI1220A1	4,2X12 TCB SELF-TAPPING SCREW	3	PZ																										
VM1750A	BRASS COMB CLAM		KVM1750A	COMB TERMINAL BLOCK KIT	<table border="1"> <thead> <tr> <th>Code</th> <th>Description</th> <th>Qty</th> <th>UOM</th> </tr> </thead> <tbody> <tr> <td>VM1750A0</td> <td>BRASS COMB CLAMP</td> <td>1</td> <td>PZ</td> </tr> </tbody> </table>	Code	Description	Qty	UOM	VM1750A0	BRASS COMB CLAMP	1	PZ																
Code	Description	Qty	UOM																										
VM1750A0	BRASS COMB CLAMP	1	PZ																										
CR1000A	HINGE LATCH L.M.		KCR1000A	LM HINGES LATCH KIT	<table border="1"> <thead> <tr> <th>Code</th> <th>Description</th> <th>Qty</th> <th>UOM</th> </tr> </thead> <tbody> <tr> <td>CR1000A0</td> <td>HINGE LATCH L.M.</td> <td>1</td> <td>PZ</td> </tr> <tr> <td>VI1875A0</td> <td>SCREW M5X10 TC1/2T INOX</td> <td>2</td> <td>PZ</td> </tr> </tbody> </table>	Code	Description	Qty	UOM	CR1000A0	HINGE LATCH L.M.	1	PZ	VI1875A0	SCREW M5X10 TC1/2T INOX	2	PZ												
Code	Description	Qty	UOM																										
CR1000A0	HINGE LATCH L.M.	1	PZ																										
VI1875A0	SCREW M5X10 TC1/2T INOX	2	PZ																										

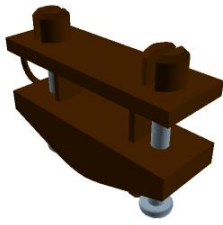

+7(812)987-08-81

COMPONENT			SPARE PART																		
Code	Description	Image	Code	Description	Components list																
VN1165A	230VAC 50/60HZ COOLING DOWN FA		KVN1165A	230V 120X120 COOLING FAN KIT	<table border="1"> <thead> <tr> <th>Code</th> <th>Description</th> <th>Qty</th> <th>UOM</th> </tr> </thead> <tbody> <tr> <td>V11099A0</td> <td>SELF-DRILLIN G SCREW 4.8X13 TCB+ Z</td> <td>4</td> <td>PZ</td> </tr> <tr> <td>VM1555A2</td> <td>CT BT COOLING FAN SUPPORT</td> <td>1</td> <td>PZ</td> </tr> <tr> <td>VN1165A0</td> <td>230VAC 50/60HZ COOLING DOWN FAN</td> <td>1</td> <td>PZ</td> </tr> </tbody> </table>	Code	Description	Qty	UOM	V11099A0	SELF-DRILLIN G SCREW 4.8X13 TCB+ Z	4	PZ	VM1555A2	CT BT COOLING FAN SUPPORT	1	PZ	VN1165A0	230VAC 50/60HZ COOLING DOWN FAN	1	PZ
Code	Description	Qty	UOM																		
V11099A0	SELF-DRILLIN G SCREW 4.8X13 TCB+ Z	4	PZ																		
VM1555A2	CT BT COOLING FAN SUPPORT	1	PZ																		
VN1165A0	230VAC 50/60HZ COOLING DOWN FAN	1	PZ																		
VM1556A	XBC-XVC COOLING FAN GUARD		KVM1556A	XBC-XVC COOLING FAN GUARD KIT	<table border="1"> <thead> <tr> <th>Code</th> <th>Description</th> <th>Qty</th> <th>UOM</th> </tr> </thead> <tbody> <tr> <td>VM1556A0</td> <td>XBC-XVC COOLING FAN GUARD</td> <td>1</td> <td>PZ</td> </tr> </tbody> </table>	Code	Description	Qty	UOM	VM1556A0	XBC-XVC COOLING FAN GUARD	1	PZ								
Code	Description	Qty	UOM																		
VM1556A0	XBC-XVC COOLING FAN GUARD	1	PZ																		
VM1555A	CT BT COOLING FAN SUPPORT																				
VE1075A	STRAIN RELIEF FV 268 RO + FIXING SCREWS		VE1075A0	STRAIN RELIEF FV 268 RO + FIXING SCREWS																	
VM1505A	WALL PASSING WITH DIAPHRAGM		KVM1505A	THROUGH-WALL CONNECTION+DIAP HRAGM KIT	<table border="1"> <thead> <tr> <th>Code</th> <th>Description</th> <th>Qty</th> <th>UOM</th> </tr> </thead> <tbody> <tr> <td>V11220A1</td> <td>4,2X12 TCB SELF-TAPPIN G SCREW</td> <td>1</td> <td>PZ</td> </tr> <tr> <td>VM1505A0</td> <td>WALL PASSING WITH DIAPHRAGM</td> <td>3</td> <td>PZ</td> </tr> <tr> <td>VM2055A0</td> <td>UPPER THROUGH-WA LL CONNECTION</td> <td>1</td> <td>PZ</td> </tr> </tbody> </table>	Code	Description	Qty	UOM	V11220A1	4,2X12 TCB SELF-TAPPIN G SCREW	1	PZ	VM1505A0	WALL PASSING WITH DIAPHRAGM	3	PZ	VM2055A0	UPPER THROUGH-WA LL CONNECTION	1	PZ
Code	Description	Qty	UOM																		
V11220A1	4,2X12 TCB SELF-TAPPIN G SCREW	1	PZ																		
VM1505A0	WALL PASSING WITH DIAPHRAGM	3	PZ																		
VM2055A0	UPPER THROUGH-WA LL CONNECTION	1	PZ																		



Зип Общепит ASM4038A/0.D01 External cover

vsezip.ru

+7(812)987-08-81

COMPONENT			SPARE PART														
Code	Description	Image	Code	Description	Components list												
VM1505A	WALL PASSING WITH DIAPHRAGM		KVM1505A	THROUGH-WALL CONNECTION+DIAPHRAGM KIT	<table border="1"> <thead> <tr> <th>Code</th> <th>Description</th> <th>Qty</th> <th>UOM</th> </tr> </thead> <tbody> <tr> <td>VM2056A0</td> <td>LOWER THROUGH-WALL CONNECTION</td> <td>1</td> <td>PZ</td> </tr> <tr> <td>VM2061A0</td> <td>ACCESSORIES CABLES WALL PASSING</td> <td>1</td> <td>PZ</td> </tr> </tbody> </table>	Code	Description	Qty	UOM	VM2056A0	LOWER THROUGH-WALL CONNECTION	1	PZ	VM2061A0	ACCESSORIES CABLES WALL PASSING	1	PZ
Code	Description	Qty	UOM														
VM2056A0	LOWER THROUGH-WALL CONNECTION	1	PZ														
VM2061A0	ACCESSORIES CABLES WALL PASSING	1	PZ														
VM2389A	DECK TOP FOOT H40 MM		VM2389A0	DECK TOP FOOT H40 MM													
0F1517A	DECKOVEN BACK PANEL		0F1517A0	DECKOVEN BACK PANEL													
VM1983A	CORNER PANEL GASKET R10		VM1983A0	CORNER PANEL GASKET R10													
VM1225A	PLATE WITH HOLES FOR ELECTRONIC		VM1225A1	PLATE WITH HOLES FOR ELECTRONIC													







+7(812)987-08-81

COMPONENT			SPARE PART														
Code	Description	Image	Code	Description	Components list												
VE1295A	MK 16A 230V DOOR MICROSWITCH		KVE1295A	16A 230V DOOR MICROSWITCH KIT	<table border="1"> <thead> <tr> <th>Code</th> <th>Description</th> <th>Qty</th> <th>UOM</th> </tr> </thead> <tbody> <tr> <td>VE1295A0</td> <td>MK 16A 230V DOOR MICROSWITC</td> <td>1</td> <td>PZ</td> </tr> </tbody> </table>	Code	Description	Qty	UOM	VE1295A0	MK 16A 230V DOOR MICROSWITC	1	PZ				
Code	Description	Qty	UOM														
VE1295A0	MK 16A 230V DOOR MICROSWITC	1	PZ														
VM1200A	DOOR MECHANIC MICROSWITCH SUPPORT PLATE		VM1200A0	DOOR MECHANIC MICROSWITCH SUPPORT PLATE													
VM1310A	COVER FOR TERMINAL BLOCK XB/XV/XVC/XG		VM1310A0	COVER FOR TERMINAL BLOCK XB/XV/XVC/XG													
0D2337A	INDEPENDENT DECKTOP 1EU EXTERNAL CASING		0D2337A0	INDEPENDENT DECKTOP 1EU EXTERNAL CASING													
PE1971B	UNOX.LINK MODBUS RJ45+USB		KPE1967B	S.5E UPDATE CT-BT UNOX.LINK CARD KI	<table border="1"> <thead> <tr> <th>Code</th> <th>Description</th> <th>Qty</th> <th>UOM</th> </tr> </thead> <tbody> <tr> <td>PE1971B0</td> <td>UNOX.LINK MODBUS RJ45+USB</td> <td>1</td> <td>PZ</td> </tr> <tr> <td>VM2147A0</td> <td>ESD SPONGE PINK SMOOTH 410X343X15 M</td> <td>1</td> <td>PZ</td> </tr> </tbody> </table>	Code	Description	Qty	UOM	PE1971B0	UNOX.LINK MODBUS RJ45+USB	1	PZ	VM2147A0	ESD SPONGE PINK SMOOTH 410X343X15 M	1	PZ
Code	Description	Qty	UOM														
PE1971B0	UNOX.LINK MODBUS RJ45+USB	1	PZ														
VM2147A0	ESD SPONGE PINK SMOOTH 410X343X15 M	1	PZ														

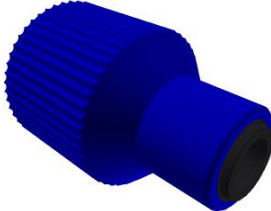

+7(812)987-08-81

COMPONENT			SPARE PART																										
Code	Description	Image	Code	Description	Components list																								
VM2061A	ACCESSORIES CABLES WALL PASSING		KVM1505A	THROUGH-WALL CONNECTION+DIAPHRAGM KIT	<table border="1"> <thead> <tr> <th>Code</th> <th>Description</th> <th>Qty</th> <th>UOM</th> </tr> </thead> <tbody> <tr> <td>VI1220A1</td> <td>4,2X12 TCB SELF-TAPPING SCREW</td> <td>1</td> <td>PZ</td> </tr> <tr> <td>VM1505A0</td> <td>WALL PASSING WITH DIAPHRAGM</td> <td>3</td> <td>PZ</td> </tr> <tr> <td>VM2055A0</td> <td>UPPER THROUGH-WALL CONNECTION</td> <td>1</td> <td>PZ</td> </tr> <tr> <td>VM2056A0</td> <td>LOWER THROUGH-WALL CONNECTION</td> <td>1</td> <td>PZ</td> </tr> <tr> <td>VM2061A0</td> <td>ACCESSORIES CABLES WALL PASSING</td> <td>1</td> <td>PZ</td> </tr> </tbody> </table>	Code	Description	Qty	UOM	VI1220A1	4,2X12 TCB SELF-TAPPING SCREW	1	PZ	VM1505A0	WALL PASSING WITH DIAPHRAGM	3	PZ	VM2055A0	UPPER THROUGH-WALL CONNECTION	1	PZ	VM2056A0	LOWER THROUGH-WALL CONNECTION	1	PZ	VM2061A0	ACCESSORIES CABLES WALL PASSING	1	PZ
Code	Description	Qty	UOM																										
VI1220A1	4,2X12 TCB SELF-TAPPING SCREW	1	PZ																										
VM1505A0	WALL PASSING WITH DIAPHRAGM	3	PZ																										
VM2055A0	UPPER THROUGH-WALL CONNECTION	1	PZ																										
VM2056A0	LOWER THROUGH-WALL CONNECTION	1	PZ																										
VM2061A0	ACCESSORIES CABLES WALL PASSING	1	PZ																										
ASM1591B	Water connection		ASM1591B0	Water connection																									
RC1365A	3/4"-10 JG FEMALE CONNECTION		KRC1365A	3/4"-10 OR 8 JG FEMALE CONNECTION KI	<table border="1"> <thead> <tr> <th>Code</th> <th>Description</th> <th>Qty</th> <th>UOM</th> </tr> </thead> <tbody> <tr> <td>GN1200A1</td> <td>3/4 CONNECTION SEAL D=24 RUBBER+NET</td> <td>1</td> <td>PZ</td> </tr> <tr> <td>RC1002A0</td> <td>JG 10M-8F TERMINAL REDUCTION FITTING</td> <td>1</td> <td>PZ</td> </tr> <tr> <td>RC1365A0</td> <td>3/4"-10 JG FEMALE CONNECTION</td> <td>1</td> <td>PZ</td> </tr> </tbody> </table>	Code	Description	Qty	UOM	GN1200A1	3/4 CONNECTION SEAL D=24 RUBBER+NET	1	PZ	RC1002A0	JG 10M-8F TERMINAL REDUCTION FITTING	1	PZ	RC1365A0	3/4"-10 JG FEMALE CONNECTION	1	PZ								
Code	Description	Qty	UOM																										
GN1200A1	3/4 CONNECTION SEAL D=24 RUBBER+NET	1	PZ																										
RC1002A0	JG 10M-8F TERMINAL REDUCTION FITTING	1	PZ																										
RC1365A0	3/4"-10 JG FEMALE CONNECTION	1	PZ																										
VM1054A	H7.8 PRESSURE REDUCER RING NUT		KVM1054A	H7.8 PRESSURE REDUCER DIAL KIT	<table border="1"> <thead> <tr> <th>Code</th> <th>Description</th> <th>Qty</th> <th>UOM</th> </tr> </thead> <tbody> <tr> <td>VM1054A0</td> <td>H7.8 PRESSURE REDUCER RING NUT</td> <td>1</td> <td>PZ</td> </tr> </tbody> </table>	Code	Description	Qty	UOM	VM1054A0	H7.8 PRESSURE REDUCER RING NUT	1	PZ																
Code	Description	Qty	UOM																										
VM1054A0	H7.8 PRESSURE REDUCER RING NUT	1	PZ																										
			KVL1117A	EUR MM 2016+LMT FILTER+PRESS. RED. KIT	<table border="1"> <thead> <tr> <th>Code</th> <th>Description</th> <th>Qty</th> <th>UOM</th> </tr> </thead> <tbody> <tr> <td>0H7472A1</td> <td>DISTRIBUTOR SUPPORT PLATE</td> <td>1</td> <td>PZ</td> </tr> <tr> <td>RC1004A0</td> <td>Ø10-Ø8-8 Y CONNECTION</td> <td>1</td> <td>PZ</td> </tr> </tbody> </table>	Code	Description	Qty	UOM	0H7472A1	DISTRIBUTOR SUPPORT PLATE	1	PZ	RC1004A0	Ø10-Ø8-8 Y CONNECTION	1	PZ												
Code	Description	Qty	UOM																										
0H7472A1	DISTRIBUTOR SUPPORT PLATE	1	PZ																										
RC1004A0	Ø10-Ø8-8 Y CONNECTION	1	PZ																										





Зип Общепит ASM4038A/0.D01 External cover

vsezip.ru

+7(812)987-08-81

COMPONENT

SPARE PART

Code	Description	Image	Code	Description	Components list																																												
VM1054A	H7.8 PRESSURE REDUCER RING NUT		KVL1117A	EUR MM 2016+LMT FILTER+PRESS. RED. KIT	<table border="1"> <thead> <tr> <th>Code</th> <th>Description</th> <th>Qty</th> <th>UOM</th> </tr> </thead> <tbody> <tr> <td>RC1243A0</td> <td>Ø10F-Ø10M ELBOW CONNECTION + JG END KIT</td> <td>1</td> <td>PZ</td> </tr> <tr> <td>RC1372A0</td> <td>Ø10M-1/4 M CIL. STRAIGHT FITTING</td> <td>2</td> <td>PZ</td> </tr> <tr> <td>VI1013A1</td> <td>30.5X39.5X3 NYLON FLAT WASHER</td> <td>1</td> <td>PZ</td> </tr> <tr> <td>VI1220A1</td> <td>4,2X12 TCB SELF-TAPPIN G SCREW</td> <td>2</td> <td>PZ</td> </tr> <tr> <td>VL1014A0</td> <td>PRESSURE REDUCER WITH DISTRIBUTOR</td> <td>1</td> <td>PZ</td> </tr> <tr> <td>VL1014B0</td> <td>PRESSURE REDUCER WITH DISTRIBUTOR</td> <td>1</td> <td>PZ</td> </tr> <tr> <td>VL1034C0</td> <td>MESH WATER FILTER D10</td> <td>1</td> <td>PZ</td> </tr> <tr> <td>VL1062C0</td> <td>PRESSURE REDUCER-FIL TER LOCKING FORK</td> <td>1</td> <td>PZ</td> </tr> <tr> <td>VM1053A0</td> <td>1/8" CAP + O-RING</td> <td>2</td> <td>PZ</td> </tr> <tr> <td>VM1054A0</td> <td>H7.8 PRESSURE REDUCER RING NUT</td> <td>1</td> <td>PZ</td> </tr> </tbody> </table>	Code	Description	Qty	UOM	RC1243A0	Ø10F-Ø10M ELBOW CONNECTION + JG END KIT	1	PZ	RC1372A0	Ø10M-1/4 M CIL. STRAIGHT FITTING	2	PZ	VI1013A1	30.5X39.5X3 NYLON FLAT WASHER	1	PZ	VI1220A1	4,2X12 TCB SELF-TAPPIN G SCREW	2	PZ	VL1014A0	PRESSURE REDUCER WITH DISTRIBUTOR	1	PZ	VL1014B0	PRESSURE REDUCER WITH DISTRIBUTOR	1	PZ	VL1034C0	MESH WATER FILTER D10	1	PZ	VL1062C0	PRESSURE REDUCER-FIL TER LOCKING FORK	1	PZ	VM1053A0	1/8" CAP + O-RING	2	PZ	VM1054A0	H7.8 PRESSURE REDUCER RING NUT	1	PZ
					Code	Description	Qty	UOM																																									
					RC1243A0	Ø10F-Ø10M ELBOW CONNECTION + JG END KIT	1	PZ																																									
					RC1372A0	Ø10M-1/4 M CIL. STRAIGHT FITTING	2	PZ																																									
					VI1013A1	30.5X39.5X3 NYLON FLAT WASHER	1	PZ																																									
					VI1220A1	4,2X12 TCB SELF-TAPPIN G SCREW	2	PZ																																									
					VL1014A0	PRESSURE REDUCER WITH DISTRIBUTOR	1	PZ																																									
					VL1014B0	PRESSURE REDUCER WITH DISTRIBUTOR	1	PZ																																									
					VL1034C0	MESH WATER FILTER D10	1	PZ																																									
					VL1062C0	PRESSURE REDUCER-FIL TER LOCKING FORK	1	PZ																																									
					VM1053A0	1/8" CAP + O-RING	2	PZ																																									
VM1054A0	H7.8 PRESSURE REDUCER RING NUT	1	PZ																																														
VL1034C	MESH WATER FILTER D10		KVL1117A	EUR MM 2016+LMT FILTER+PRESS. RED. KIT	<table border="1"> <thead> <tr> <th>Code</th> <th>Description</th> <th>Qty</th> <th>UOM</th> </tr> </thead> <tbody> <tr> <td>0H7472A1</td> <td>DISTRIBUTOR SUPPORT PLATE</td> <td>1</td> <td>PZ</td> </tr> <tr> <td>RC1004A0</td> <td>Ø10-Ø8-8 Y CONNECTION</td> <td>1</td> <td>PZ</td> </tr> <tr> <td>RC1243A0</td> <td>Ø10F-Ø10M ELBOW CONNECTION + JG END KIT</td> <td>1</td> <td>PZ</td> </tr> <tr> <td>RC1372A0</td> <td>Ø10M-1/4 M CIL. STRAIGHT FITTING</td> <td>2</td> <td>PZ</td> </tr> <tr> <td>VI1013A1</td> <td>30.5X39.5X3 NYLON FLAT WASHER</td> <td>1</td> <td>PZ</td> </tr> <tr> <td>VI1220A1</td> <td>4,2X12 TCB SELF-TAPPIN G SCREW</td> <td>2</td> <td>PZ</td> </tr> </tbody> </table>	Code	Description	Qty	UOM	0H7472A1	DISTRIBUTOR SUPPORT PLATE	1	PZ	RC1004A0	Ø10-Ø8-8 Y CONNECTION	1	PZ	RC1243A0	Ø10F-Ø10M ELBOW CONNECTION + JG END KIT	1	PZ	RC1372A0	Ø10M-1/4 M CIL. STRAIGHT FITTING	2	PZ	VI1013A1	30.5X39.5X3 NYLON FLAT WASHER	1	PZ	VI1220A1	4,2X12 TCB SELF-TAPPIN G SCREW	2	PZ																
					Code	Description	Qty	UOM																																									
					0H7472A1	DISTRIBUTOR SUPPORT PLATE	1	PZ																																									
					RC1004A0	Ø10-Ø8-8 Y CONNECTION	1	PZ																																									
					RC1243A0	Ø10F-Ø10M ELBOW CONNECTION + JG END KIT	1	PZ																																									
					RC1372A0	Ø10M-1/4 M CIL. STRAIGHT FITTING	2	PZ																																									
					VI1013A1	30.5X39.5X3 NYLON FLAT WASHER	1	PZ																																									
VI1220A1	4,2X12 TCB SELF-TAPPIN G SCREW	2	PZ																																														





Зип Общепит ASM4038A/0.D01 External cover

vsezip.ru

+7(812)987-08-81

COMPONENT

SPARE PART



Code	Description	Image	Code	Description	Components list																												
VL1034C	MESH WATER FILTER D10		KVL1117A	EUR MM 2016+LMT FILTER+PRESS. RED. KIT	<table border="1"> <thead> <tr> <th>Code</th> <th>Description</th> <th>Qty</th> <th>UOM</th> </tr> </thead> <tbody> <tr> <td>VL1014A0</td> <td>PRESSURE REDUCER WITH DISTRIBUTOR</td> <td>1</td> <td>PZ</td> </tr> <tr> <td>VL1014B0</td> <td>PRESSURE REDUCER WITH DISTRIBUTOR</td> <td>1</td> <td>PZ</td> </tr> <tr> <td>VL1034C0</td> <td>MESH WATER FILTER D10</td> <td>1</td> <td>PZ</td> </tr> <tr> <td>VL1062C0</td> <td>PRESSURE REDUCER-FIL TER LOCKING FORK</td> <td>1</td> <td>PZ</td> </tr> <tr> <td>VM1053A0</td> <td>1/8" CAP + O-RING</td> <td>2</td> <td>PZ</td> </tr> <tr> <td>VM1054A0</td> <td>H7.8 PRESSURE REDUCER RING NUT</td> <td>1</td> <td>PZ</td> </tr> </tbody> </table>	Code	Description	Qty	UOM	VL1014A0	PRESSURE REDUCER WITH DISTRIBUTOR	1	PZ	VL1014B0	PRESSURE REDUCER WITH DISTRIBUTOR	1	PZ	VL1034C0	MESH WATER FILTER D10	1	PZ	VL1062C0	PRESSURE REDUCER-FIL TER LOCKING FORK	1	PZ	VM1053A0	1/8" CAP + O-RING	2	PZ	VM1054A0	H7.8 PRESSURE REDUCER RING NUT	1	PZ
					Code	Description	Qty	UOM																									
VL1014A0	PRESSURE REDUCER WITH DISTRIBUTOR	1	PZ																														
VL1014B0	PRESSURE REDUCER WITH DISTRIBUTOR	1	PZ																														
VL1034C0	MESH WATER FILTER D10	1	PZ																														
VL1062C0	PRESSURE REDUCER-FIL TER LOCKING FORK	1	PZ																														
VM1053A0	1/8" CAP + O-RING	2	PZ																														
VM1054A0	H7.8 PRESSURE REDUCER RING NUT	1	PZ																														
KVL1034C	Ø8-Ø10 MESH100 WATER FILTER KIT	<table border="1"> <thead> <tr> <th>Code</th> <th>Description</th> <th>Qty</th> <th>UOM</th> </tr> </thead> <tbody> <tr> <td>RC1002A0</td> <td>JG 10M-8F TERMINAL REDUCTION FITTING</td> <td>2</td> <td>PZ</td> </tr> <tr> <td>VL1034C0</td> <td>MESH WATER FILTER D10</td> <td>1</td> <td>PZ</td> </tr> <tr> <td>VL1062C0</td> <td>PRESSURE REDUCER-FIL TER LOCKING FORK</td> <td>1</td> <td>PZ</td> </tr> </tbody> </table>	Code	Description	Qty	UOM	RC1002A0	JG 10M-8F TERMINAL REDUCTION FITTING	2	PZ	VL1034C0	MESH WATER FILTER D10	1	PZ	VL1062C0	PRESSURE REDUCER-FIL TER LOCKING FORK	1	PZ															
Code	Description	Qty	UOM																														
RC1002A0	JG 10M-8F TERMINAL REDUCTION FITTING	2	PZ																														
VL1034C0	MESH WATER FILTER D10	1	PZ																														
VL1062C0	PRESSURE REDUCER-FIL TER LOCKING FORK	1	PZ																														
VL1062C	PRESSURE REDUCER-FILTER LOCKING FORK		KVL1117A	EUR MM 2016+LMT FILTER+PRESS. RED. KIT	<table border="1"> <thead> <tr> <th>Code</th> <th>Description</th> <th>Qty</th> <th>UOM</th> </tr> </thead> <tbody> <tr> <td>0H7472A1</td> <td>DISTRIBUTOR SUPPORT PLATE</td> <td>1</td> <td>PZ</td> </tr> <tr> <td>RC1004A0</td> <td>Ø10-Ø8-8 Y CONNECTION</td> <td>1</td> <td>PZ</td> </tr> <tr> <td>RC1243A0</td> <td>Ø10F-Ø10M ELBOW CONNECTION + JG END KIT</td> <td>1</td> <td>PZ</td> </tr> <tr> <td>RC1372A0</td> <td>Ø10M-1/4 M CIL. STRAIGHT FITTING</td> <td>2</td> <td>PZ</td> </tr> <tr> <td>VI1013A1</td> <td>30.5X39.5X3 NYLON FLAT WASHER</td> <td>1</td> <td>PZ</td> </tr> <tr> <td>VI1220A1</td> <td>4,2X12 TCB SELF-TAPPIN G SCREW</td> <td>2</td> <td>PZ</td> </tr> </tbody> </table>	Code	Description	Qty	UOM	0H7472A1	DISTRIBUTOR SUPPORT PLATE	1	PZ	RC1004A0	Ø10-Ø8-8 Y CONNECTION	1	PZ	RC1243A0	Ø10F-Ø10M ELBOW CONNECTION + JG END KIT	1	PZ	RC1372A0	Ø10M-1/4 M CIL. STRAIGHT FITTING	2	PZ	VI1013A1	30.5X39.5X3 NYLON FLAT WASHER	1	PZ	VI1220A1	4,2X12 TCB SELF-TAPPIN G SCREW	2	PZ
					Code	Description	Qty	UOM																									
					0H7472A1	DISTRIBUTOR SUPPORT PLATE	1	PZ																									
					RC1004A0	Ø10-Ø8-8 Y CONNECTION	1	PZ																									
					RC1243A0	Ø10F-Ø10M ELBOW CONNECTION + JG END KIT	1	PZ																									
					RC1372A0	Ø10M-1/4 M CIL. STRAIGHT FITTING	2	PZ																									
					VI1013A1	30.5X39.5X3 NYLON FLAT WASHER	1	PZ																									
VI1220A1	4,2X12 TCB SELF-TAPPIN G SCREW	2	PZ																														



Зип Общепит ASM4038A/0.D01 External cover

vsezip.ru

+7(812)987-08-81

COMPONENT			SPARE PART																														
Code	Description	Image	Code	Description	Components list																												
VL1062C	PRESSURE REDUCER-FILTER LOCKING FORK		KVL1117A	EUR MM 2016+LMT FILTER+PRESS. RED. KIT	<table border="1"> <thead> <tr> <th>Code</th> <th>Description</th> <th>Qty</th> <th>UOM</th> </tr> </thead> <tbody> <tr> <td>VL1014A0</td> <td>PRESSURE REDUCER WITH DISTRIBUTOR</td> <td>1</td> <td>PZ</td> </tr> <tr> <td>VL1014B0</td> <td>PRESSURE REDUCER WITH DISTRIBUTOR</td> <td>1</td> <td>PZ</td> </tr> <tr> <td>VL1034C0</td> <td>MESH WATER FILTER D10</td> <td>1</td> <td>PZ</td> </tr> <tr> <td>VL1062C0</td> <td>PRESSURE REDUCER-FIL TER LOCKING FORK</td> <td>1</td> <td>PZ</td> </tr> <tr> <td>VM1053A0</td> <td>1/8" CAP + O-RING</td> <td>2</td> <td>PZ</td> </tr> <tr> <td>VM1054A0</td> <td>H7.8 PRESSURE REDUCER RING NUT</td> <td>1</td> <td>PZ</td> </tr> </tbody> </table>	Code	Description	Qty	UOM	VL1014A0	PRESSURE REDUCER WITH DISTRIBUTOR	1	PZ	VL1014B0	PRESSURE REDUCER WITH DISTRIBUTOR	1	PZ	VL1034C0	MESH WATER FILTER D10	1	PZ	VL1062C0	PRESSURE REDUCER-FIL TER LOCKING FORK	1	PZ	VM1053A0	1/8" CAP + O-RING	2	PZ	VM1054A0	H7.8 PRESSURE REDUCER RING NUT	1	PZ
Code	Description	Qty	UOM																														
VL1014A0	PRESSURE REDUCER WITH DISTRIBUTOR	1	PZ																														
VL1014B0	PRESSURE REDUCER WITH DISTRIBUTOR	1	PZ																														
VL1034C0	MESH WATER FILTER D10	1	PZ																														
VL1062C0	PRESSURE REDUCER-FIL TER LOCKING FORK	1	PZ																														
VM1053A0	1/8" CAP + O-RING	2	PZ																														
VM1054A0	H7.8 PRESSURE REDUCER RING NUT	1	PZ																														
VL1125A	BENDE FITTING M-M RUBBER-HOLDER D8-END		KVL1125A	BEND CONNECT-HOLD D8-CLIP D10 10PCS KIT	<table border="1"> <thead> <tr> <th>Code</th> <th>Description</th> <th>Qty</th> <th>UOM</th> </tr> </thead> <tbody> <tr> <td>VL1125A0</td> <td>BENDE FITTING M-M RUBBER-HOL DER D8-END</td> <td>10</td> <td>PZ</td> </tr> <tr> <td>VL1125A1</td> <td>BENDE FITTING M-M RUBBER-HOL DER D8-END</td> <td>10</td> <td>PZ</td> </tr> </tbody> </table>	Code	Description	Qty	UOM	VL1125A0	BENDE FITTING M-M RUBBER-HOL DER D8-END	10	PZ	VL1125A1	BENDE FITTING M-M RUBBER-HOL DER D8-END	10	PZ																
Code	Description	Qty	UOM																														
VL1125A0	BENDE FITTING M-M RUBBER-HOL DER D8-END	10	PZ																														
VL1125A1	BENDE FITTING M-M RUBBER-HOL DER D8-END	10	PZ																														
			KTB2237A	1,5M D10 TB2243A CONNECTION PIPE	<table border="1"> <thead> <tr> <th>Code</th> <th>Description</th> <th>Qty</th> <th>UOM</th> </tr> </thead> <tbody> <tr> <td>TB2243A0</td> <td>Ø10 PET PIPE</td> <td>1.500</td> <td>M</td> </tr> </tbody> </table>	Code	Description	Qty	UOM	TB2243A0	Ø10 PET PIPE	1.500	M																				
Code	Description	Qty	UOM																														
TB2243A0	Ø10 PET PIPE	1.500	M																														
VL1071A	PRESSURE REDUCER WITH DISTRIBUTOR		KVL1071A	KIT 5E US VERSION PRESSURE REDUCER KIT	<table border="1"> <thead> <tr> <th>Code</th> <th>Description</th> <th>Qty</th> <th>UOM</th> </tr> </thead> <tbody> <tr> <td>RC1003A0</td> <td>8M-1/8 BSPP FITTING</td> <td>2</td> <td>PZ</td> </tr> <tr> <td>RC1372A0</td> <td>Ø10M-1/4 M CIL. STRAIGHT FITTING</td> <td>1</td> <td>PZ</td> </tr> <tr> <td>VL1014A0</td> <td>PRESSURE REDUCER WITH DISTRIBUTOR</td> <td>1</td> <td>PZ</td> </tr> <tr> <td>VL1071A0</td> <td>PRESSURE REDUCER WITH DISTRIBUTOR</td> <td>1</td> <td>PZ</td> </tr> <tr> <td>VM2028A0</td> <td>20X10X4 RUBBER WASHER</td> <td>1</td> <td>PZ</td> </tr> <tr> <td>VM2059A0</td> <td>1/4" CAP WITH O-RING SEAL</td> <td>1</td> <td>PZ</td> </tr> </tbody> </table>	Code	Description	Qty	UOM	RC1003A0	8M-1/8 BSPP FITTING	2	PZ	RC1372A0	Ø10M-1/4 M CIL. STRAIGHT FITTING	1	PZ	VL1014A0	PRESSURE REDUCER WITH DISTRIBUTOR	1	PZ	VL1071A0	PRESSURE REDUCER WITH DISTRIBUTOR	1	PZ	VM2028A0	20X10X4 RUBBER WASHER	1	PZ	VM2059A0	1/4" CAP WITH O-RING SEAL	1	PZ
Code	Description	Qty	UOM																														
RC1003A0	8M-1/8 BSPP FITTING	2	PZ																														
RC1372A0	Ø10M-1/4 M CIL. STRAIGHT FITTING	1	PZ																														
VL1014A0	PRESSURE REDUCER WITH DISTRIBUTOR	1	PZ																														
VL1071A0	PRESSURE REDUCER WITH DISTRIBUTOR	1	PZ																														
VM2028A0	20X10X4 RUBBER WASHER	1	PZ																														
VM2059A0	1/4" CAP WITH O-RING SEAL	1	PZ																														



COMPONENT			SPARE PART																																						
Code	Description	Image	Code	Description	Components list																																				
VL1071A	PRESSURE REDUCER WITH DISTRIBUTOR		KVL1014A	5E PRESSURE REDUCER KIT	<table border="1"> <thead> <tr> <th>Code</th> <th>Description</th> <th>Qty</th> <th>UOM</th> </tr> </thead> <tbody> <tr> <td>EL1185A0</td> <td>Ø8F - Ø8F ELBOW CONNECTION</td> <td>1</td> <td>PZ</td> </tr> <tr> <td>EL1185B0</td> <td>Ø8F-Ø8F JG ELBOW CONNECTION</td> <td>1</td> <td>PZ</td> </tr> <tr> <td>RC1003A0</td> <td>8M-1/8 BSPP FITTING</td> <td>2</td> <td>PZ</td> </tr> <tr> <td>RC1372A0</td> <td>Ø10M-1/4 M CIL. STRAIGHT FITTING</td> <td>1</td> <td>PZ</td> </tr> <tr> <td>VL1014A0</td> <td>PRESSURE REDUCER WITH DISTRIBUTOR</td> <td>1</td> <td>PZ</td> </tr> <tr> <td>VL1071A0</td> <td>PRESSURE REDUCER WITH DISTRIBUTOR</td> <td>1</td> <td>PZ</td> </tr> <tr> <td>VM2028A0</td> <td>20X10X4 RUBBER WASHER</td> <td>1</td> <td>PZ</td> </tr> <tr> <td>VM2059A0</td> <td>1/4" CAP WITH O-RING SEAL</td> <td>1</td> <td>PZ</td> </tr> </tbody> </table>	Code	Description	Qty	UOM	EL1185A0	Ø8F - Ø8F ELBOW CONNECTION	1	PZ	EL1185B0	Ø8F-Ø8F JG ELBOW CONNECTION	1	PZ	RC1003A0	8M-1/8 BSPP FITTING	2	PZ	RC1372A0	Ø10M-1/4 M CIL. STRAIGHT FITTING	1	PZ	VL1014A0	PRESSURE REDUCER WITH DISTRIBUTOR	1	PZ	VL1071A0	PRESSURE REDUCER WITH DISTRIBUTOR	1	PZ	VM2028A0	20X10X4 RUBBER WASHER	1	PZ	VM2059A0	1/4" CAP WITH O-RING SEAL	1	PZ
			Code	Description	Qty	UOM																																			
			EL1185A0	Ø8F - Ø8F ELBOW CONNECTION	1	PZ																																			
EL1185B0	Ø8F-Ø8F JG ELBOW CONNECTION	1	PZ																																						
RC1003A0	8M-1/8 BSPP FITTING	2	PZ																																						
RC1372A0	Ø10M-1/4 M CIL. STRAIGHT FITTING	1	PZ																																						
VL1014A0	PRESSURE REDUCER WITH DISTRIBUTOR	1	PZ																																						
VL1071A0	PRESSURE REDUCER WITH DISTRIBUTOR	1	PZ																																						
VM2028A0	20X10X4 RUBBER WASHER	1	PZ																																						
VM2059A0	1/4" CAP WITH O-RING SEAL	1	PZ																																						
KVL0071A	USA MM PRESSURE REDUCER KIT	<table border="1"> <thead> <tr> <th>Code</th> <th>Description</th> <th>Qty</th> <th>UOM</th> </tr> </thead> <tbody> <tr> <td>RC1372A0</td> <td>Ø10M-1/4 M CIL. STRAIGHT FITTING</td> <td>2</td> <td>PZ</td> </tr> <tr> <td>VI1013A1</td> <td>30.5X39.5X3 NYLON FLAT WASHER</td> <td>1</td> <td>PZ</td> </tr> <tr> <td>VL1014A0</td> <td>PRESSURE REDUCER WITH DISTRIBUTOR</td> <td>1</td> <td>PZ</td> </tr> <tr> <td>VL1071A0</td> <td>PRESSURE REDUCER WITH DISTRIBUTOR</td> <td>1</td> <td>PZ</td> </tr> <tr> <td>VM1053A0</td> <td>1/8" CAP + O-RING</td> <td>2</td> <td>PZ</td> </tr> <tr> <td>VM1054A0</td> <td>H7.8 PRESSURE REDUCER RING NUT</td> <td>1</td> <td>PZ</td> </tr> </tbody> </table>	Code	Description	Qty	UOM	RC1372A0	Ø10M-1/4 M CIL. STRAIGHT FITTING	2	PZ	VI1013A1	30.5X39.5X3 NYLON FLAT WASHER	1	PZ	VL1014A0	PRESSURE REDUCER WITH DISTRIBUTOR	1	PZ	VL1071A0	PRESSURE REDUCER WITH DISTRIBUTOR	1	PZ	VM1053A0	1/8" CAP + O-RING	2	PZ	VM1054A0	H7.8 PRESSURE REDUCER RING NUT	1	PZ											
Code	Description	Qty	UOM																																						
RC1372A0	Ø10M-1/4 M CIL. STRAIGHT FITTING	2	PZ																																						
VI1013A1	30.5X39.5X3 NYLON FLAT WASHER	1	PZ																																						
VL1014A0	PRESSURE REDUCER WITH DISTRIBUTOR	1	PZ																																						
VL1071A0	PRESSURE REDUCER WITH DISTRIBUTOR	1	PZ																																						
VM1053A0	1/8" CAP + O-RING	2	PZ																																						
VM1054A0	H7.8 PRESSURE REDUCER RING NUT	1	PZ																																						
KVL0014A	EUR MIND.MAPS PRESSURE REDUCER KIT	<table border="1"> <thead> <tr> <th>Code</th> <th>Description</th> <th>Qty</th> <th>UOM</th> </tr> </thead> <tbody> <tr> <td>RC1372A0</td> <td>Ø10M-1/4 M CIL. STRAIGHT FITTING</td> <td>2</td> <td>PZ</td> </tr> <tr> <td>VL1014A0</td> <td>PRESSURE REDUCER WITH DISTRIBUTOR</td> <td>1</td> <td>PZ</td> </tr> </tbody> </table>	Code	Description	Qty	UOM	RC1372A0	Ø10M-1/4 M CIL. STRAIGHT FITTING	2	PZ	VL1014A0	PRESSURE REDUCER WITH DISTRIBUTOR	1	PZ																											
Code	Description	Qty	UOM																																						
RC1372A0	Ø10M-1/4 M CIL. STRAIGHT FITTING	2	PZ																																						
VL1014A0	PRESSURE REDUCER WITH DISTRIBUTOR	1	PZ																																						



COMPONENT			SPARE PART																																																											
Code	Description	Image	Code	Description	Components list																																																									
VL1071A	PRESSURE REDUCER WITH DISTRIBUTOR		KVL0014A	EUR MIND.MAPS PRESSURE REDUCER KIT	<table border="1"> <thead> <tr> <th>Code</th> <th>Description</th> <th>Qty</th> <th>UOM</th> </tr> </thead> <tbody> <tr> <td>VL1014B0</td> <td>PRESSURE REDUCER WITH DISTRIBUTOR</td> <td>1</td> <td>PZ</td> </tr> <tr> <td>VM1053A0</td> <td>1/8" CAP + O-RING</td> <td>2</td> <td>PZ</td> </tr> <tr> <td>VM1054A0</td> <td>H7.8 PRESSURE REDUCER RING NUT</td> <td>1</td> <td>PZ</td> </tr> </tbody> </table>	Code	Description	Qty	UOM	VL1014B0	PRESSURE REDUCER WITH DISTRIBUTOR	1	PZ	VM1053A0	1/8" CAP + O-RING	2	PZ	VM1054A0	H7.8 PRESSURE REDUCER RING NUT	1	PZ																																									
			Code	Description	Qty	UOM																																																								
VL1014B0	PRESSURE REDUCER WITH DISTRIBUTOR	1	PZ																																																											
VM1053A0	1/8" CAP + O-RING	2	PZ																																																											
VM1054A0	H7.8 PRESSURE REDUCER RING NUT	1	PZ																																																											
KVL0007A	BIG 5E S. CLEANING SYSTEM KIT	<table border="1"> <thead> <tr> <th>Code</th> <th>Description</th> <th>Qty</th> <th>UOM</th> </tr> </thead> <tbody> <tr> <td>0H6441A2</td> <td>DOUBLE VERTICAL WATER SUPPLY SUPPORT</td> <td>1</td> <td>PZ</td> </tr> <tr> <td>EL1020A0</td> <td>Ø8 INTERMEDIAT E "T" CONN. (NEW #PM0208E)</td> <td>6</td> <td>PZ</td> </tr> <tr> <td>EL1020A1</td> <td>D8 INTERMEDIAT E T-SHAPED FITTING</td> <td>6</td> <td>PZ</td> </tr> <tr> <td>EL1115A0</td> <td>Ø8 Y CONNECTION</td> <td>3</td> <td>PZ</td> </tr> <tr> <td>EL1180A0</td> <td>Ø8-Ø8 FEMALE NON-RETURN CONNECTION</td> <td>3</td> <td>PZ</td> </tr> <tr> <td>EL1185A0</td> <td>Ø8F - Ø8F ELBOW CONNECTION</td> <td>4</td> <td>PZ</td> </tr> <tr> <td>EL1185B0</td> <td>Ø8F-Ø8F JG ELBOW CONNECTION</td> <td>4</td> <td>PZ</td> </tr> <tr> <td>EL1195A0</td> <td>ELBOW UNION Ø8F-Ø8M</td> <td>8</td> <td>PZ</td> </tr> <tr> <td>EL1195B0</td> <td>Ø8F-Ø8M ELBOW CONNECTION</td> <td>8</td> <td>PZ</td> </tr> <tr> <td>EL1345A0</td> <td>CLIP TO FIX Ø8 MM CONNECTION JOINT</td> <td>4</td> <td>PZ</td> </tr> <tr> <td>EL1411A0</td> <td>SOLENOID VALVE WITH CHECK VALVE</td> <td>2</td> <td>PZ</td> </tr> <tr> <td>RC1003A0</td> <td>8M-1/8 BSPP FITTING</td> <td>2</td> <td>PZ</td> </tr> <tr> <td>RC1019A0</td> <td>D=10 ELASTIC CLAMP</td> <td>6</td> <td>PZ</td> </tr> <tr> <td>RC1130A0</td> <td>130X2,6 CLAM</td> <td>4</td> <td>PZ</td> </tr> </tbody> </table>	Code	Description	Qty	UOM	0H6441A2	DOUBLE VERTICAL WATER SUPPLY SUPPORT	1	PZ	EL1020A0	Ø8 INTERMEDIAT E "T" CONN. (NEW #PM0208E)	6	PZ	EL1020A1	D8 INTERMEDIAT E T-SHAPED FITTING	6	PZ	EL1115A0	Ø8 Y CONNECTION	3	PZ	EL1180A0	Ø8-Ø8 FEMALE NON-RETURN CONNECTION	3	PZ	EL1185A0	Ø8F - Ø8F ELBOW CONNECTION	4	PZ	EL1185B0	Ø8F-Ø8F JG ELBOW CONNECTION	4	PZ	EL1195A0	ELBOW UNION Ø8F-Ø8M	8	PZ	EL1195B0	Ø8F-Ø8M ELBOW CONNECTION	8	PZ	EL1345A0	CLIP TO FIX Ø8 MM CONNECTION JOINT	4	PZ	EL1411A0	SOLENOID VALVE WITH CHECK VALVE	2	PZ	RC1003A0	8M-1/8 BSPP FITTING	2	PZ	RC1019A0	D=10 ELASTIC CLAMP	6	PZ	RC1130A0	130X2,6 CLAM	4	PZ
Code	Description	Qty	UOM																																																											
0H6441A2	DOUBLE VERTICAL WATER SUPPLY SUPPORT	1	PZ																																																											
EL1020A0	Ø8 INTERMEDIAT E "T" CONN. (NEW #PM0208E)	6	PZ																																																											
EL1020A1	D8 INTERMEDIAT E T-SHAPED FITTING	6	PZ																																																											
EL1115A0	Ø8 Y CONNECTION	3	PZ																																																											
EL1180A0	Ø8-Ø8 FEMALE NON-RETURN CONNECTION	3	PZ																																																											
EL1185A0	Ø8F - Ø8F ELBOW CONNECTION	4	PZ																																																											
EL1185B0	Ø8F-Ø8F JG ELBOW CONNECTION	4	PZ																																																											
EL1195A0	ELBOW UNION Ø8F-Ø8M	8	PZ																																																											
EL1195B0	Ø8F-Ø8M ELBOW CONNECTION	8	PZ																																																											
EL1345A0	CLIP TO FIX Ø8 MM CONNECTION JOINT	4	PZ																																																											
EL1411A0	SOLENOID VALVE WITH CHECK VALVE	2	PZ																																																											
RC1003A0	8M-1/8 BSPP FITTING	2	PZ																																																											
RC1019A0	D=10 ELASTIC CLAMP	6	PZ																																																											
RC1130A0	130X2,6 CLAM	4	PZ																																																											



COMPONENT			SPARE PART																																																																																	
Code	Description	Image	Code	Description	Components list																																																																															
VL1071A	PRESSURE REDUCER WITH DISTRIBUTOR		KVL0007A	BIG 5E S. CLEANING SYSTEM KIT	<table border="1"> <thead> <tr> <th>Code</th> <th>Description</th> <th>Qty</th> <th>UOM</th> </tr> </thead> <tbody> <tr> <td>RC1372A0</td> <td>Ø10M-1/4 M CIL. STRAIGHT FITTING</td> <td>1</td> <td>PZ</td> </tr> <tr> <td>TB1815A0</td> <td>7,93X4,75 PE (JG #PE08100N) TRANSP. PIPE</td> <td>4.140</td> <td>M</td> </tr> <tr> <td>TB2820A0</td> <td>PIPE EPDM FOR WASHING SYSTEM</td> <td>0.130</td> <td>M</td> </tr> <tr> <td>VI1220A1</td> <td>4,2X12 TCB SELF-TAPPING SCREW</td> <td>2</td> <td>PZ</td> </tr> <tr> <td>VL1014A0</td> <td>PRESSURE REDUCER WITH DISTRIBUTOR</td> <td>1</td> <td>PZ</td> </tr> <tr> <td>VL1038A2</td> <td>VIBRATION PUMP</td> <td>2</td> <td>PZ</td> </tr> <tr> <td>VL1046A1</td> <td>D6 PIPE HOLDER - D6 J.G. TERMINAL</td> <td>1</td> <td>PZ</td> </tr> <tr> <td>VL1047A1</td> <td>D6 PIPE HOLDER - D6 J.G. TERMINAL</td> <td>5</td> <td>PZ</td> </tr> <tr> <td>VL1071A0</td> <td>PRESSURE REDUCER WITH DISTRIBUTOR</td> <td>1</td> <td>PZ</td> </tr> <tr> <td>VM1630A0</td> <td>INTERNAL GLASS PUSHING CAP</td> <td>2</td> <td>PZ</td> </tr> <tr> <td>VM1794A0</td> <td>250X4.8 PA66 BLACK CLAMP</td> <td>4</td> <td>PZ</td> </tr> <tr> <td>VM2028A0</td> <td>20X10X4 RUBBER WASHER</td> <td>1</td> <td>PZ</td> </tr> <tr> <td>VM2059A0</td> <td>1/4" CAP WITH O-RING SEAL</td> <td>1</td> <td>PZ</td> </tr> </tbody> </table>	Code	Description	Qty	UOM	RC1372A0	Ø10M-1/4 M CIL. STRAIGHT FITTING	1	PZ	TB1815A0	7,93X4,75 PE (JG #PE08100N) TRANSP. PIPE	4.140	M	TB2820A0	PIPE EPDM FOR WASHING SYSTEM	0.130	M	VI1220A1	4,2X12 TCB SELF-TAPPING SCREW	2	PZ	VL1014A0	PRESSURE REDUCER WITH DISTRIBUTOR	1	PZ	VL1038A2	VIBRATION PUMP	2	PZ	VL1046A1	D6 PIPE HOLDER - D6 J.G. TERMINAL	1	PZ	VL1047A1	D6 PIPE HOLDER - D6 J.G. TERMINAL	5	PZ	VL1071A0	PRESSURE REDUCER WITH DISTRIBUTOR	1	PZ	VM1630A0	INTERNAL GLASS PUSHING CAP	2	PZ	VM1794A0	250X4.8 PA66 BLACK CLAMP	4	PZ	VM2028A0	20X10X4 RUBBER WASHER	1	PZ	VM2059A0	1/4" CAP WITH O-RING SEAL	1	PZ	KVL0005A	5E SERIES CLEANING SYSTEM KIT	<table border="1"> <thead> <tr> <th>Code</th> <th>Description</th> <th>Qty</th> <th>UOM</th> </tr> </thead> <tbody> <tr> <td>0H6413A3</td> <td>WATER SYSTEM SUPPORT</td> <td>1</td> <td>PZ</td> </tr> <tr> <td>EL1020A0</td> <td>Ø8 INTERMEDIAT E "T" CONN. (NEW #PM0208E)</td> <td>1</td> <td>PZ</td> </tr> <tr> <td>EL1020A1</td> <td>D8 INTERMEDIAT E T-SHAPED FITTING</td> <td>1</td> <td>PZ</td> </tr> <tr> <td>EL1115A0</td> <td>Ø8 Y CONNECTION</td> <td>2</td> <td>PZ</td> </tr> </tbody> </table>	Code	Description	Qty	UOM	0H6413A3	WATER SYSTEM SUPPORT	1	PZ	EL1020A0	Ø8 INTERMEDIAT E "T" CONN. (NEW #PM0208E)	1	PZ	EL1020A1	D8 INTERMEDIAT E T-SHAPED FITTING	1	PZ	EL1115A0	Ø8 Y CONNECTION	2	PZ
			Code	Description	Qty	UOM																																																																														
RC1372A0	Ø10M-1/4 M CIL. STRAIGHT FITTING	1	PZ																																																																																	
TB1815A0	7,93X4,75 PE (JG #PE08100N) TRANSP. PIPE	4.140	M																																																																																	
TB2820A0	PIPE EPDM FOR WASHING SYSTEM	0.130	M																																																																																	
VI1220A1	4,2X12 TCB SELF-TAPPING SCREW	2	PZ																																																																																	
VL1014A0	PRESSURE REDUCER WITH DISTRIBUTOR	1	PZ																																																																																	
VL1038A2	VIBRATION PUMP	2	PZ																																																																																	
VL1046A1	D6 PIPE HOLDER - D6 J.G. TERMINAL	1	PZ																																																																																	
VL1047A1	D6 PIPE HOLDER - D6 J.G. TERMINAL	5	PZ																																																																																	
VL1071A0	PRESSURE REDUCER WITH DISTRIBUTOR	1	PZ																																																																																	
VM1630A0	INTERNAL GLASS PUSHING CAP	2	PZ																																																																																	
VM1794A0	250X4.8 PA66 BLACK CLAMP	4	PZ																																																																																	
VM2028A0	20X10X4 RUBBER WASHER	1	PZ																																																																																	
VM2059A0	1/4" CAP WITH O-RING SEAL	1	PZ																																																																																	
Code	Description	Qty	UOM																																																																																	
0H6413A3	WATER SYSTEM SUPPORT	1	PZ																																																																																	
EL1020A0	Ø8 INTERMEDIAT E "T" CONN. (NEW #PM0208E)	1	PZ																																																																																	
EL1020A1	D8 INTERMEDIAT E T-SHAPED FITTING	1	PZ																																																																																	
EL1115A0	Ø8 Y CONNECTION	2	PZ																																																																																	



COMPONENT			SPARE PART																																																																														
Code	Description	Image	Code	Description	Components list																																																																												
VL1071A	PRESSURE REDUCER WITH DISTRIBUTOR		KVL0005A	5E SERIES CLEANING SYSTEM KIT	<table border="1"> <thead> <tr> <th>Code</th> <th>Description</th> <th>Qty</th> <th>UOM</th> </tr> </thead> <tbody> <tr> <td>EL1180A0</td> <td>Ø8-Ø8 FEMALE NON-RETURN CONNECTION</td> <td>1</td> <td>PZ</td> </tr> <tr> <td>EL1185A0</td> <td>Ø8F - Ø8F ELBOW CONNECTION</td> <td>1</td> <td>PZ</td> </tr> <tr> <td>EL1195A0</td> <td>ELBOW UNION Ø8F-Ø8M</td> <td>2</td> <td>PZ</td> </tr> <tr> <td>EL1195B0</td> <td>Ø8F-Ø8M ELBOW CONNECTION</td> <td>2</td> <td>PZ</td> </tr> <tr> <td>EL1345A0</td> <td>CLIP TO FIX Ø8 MM CONNECTION JOINT</td> <td>2</td> <td>PZ</td> </tr> <tr> <td>EL1411A0</td> <td>SOLENOID VALVE WITH CHECK VALVE</td> <td>1</td> <td>PZ</td> </tr> <tr> <td>RC1003A0</td> <td>8M-1/8 BSPP FITTING</td> <td>2</td> <td>PZ</td> </tr> <tr> <td>RC1019A0</td> <td>D=10 ELASTIC CLAMP</td> <td>4</td> <td>PZ</td> </tr> <tr> <td>RC1130A0</td> <td>130X2,6 CLAM</td> <td>2</td> <td>PZ</td> </tr> <tr> <td>RC1369A0</td> <td>Ø8F-1/8" M CIL. STRAIGHT CONNECTION</td> <td>2</td> <td>PZ</td> </tr> <tr> <td>RC1372A0</td> <td>Ø10M-1/4 M CIL. STRAIGHT FITTING</td> <td>1</td> <td>PZ</td> </tr> <tr> <td>TB1815A0</td> <td>7,93X4,75 PE TRANSP. PIPE (JG #PE08100N)</td> <td>1.500</td> <td>M</td> </tr> <tr> <td>TB1816A0</td> <td>CLEAR POLYPROPYL ENE PIPE 6X4MM</td> <td>0.250</td> <td>M</td> </tr> <tr> <td>TB2820A0</td> <td>PIPE EPDM FOR WASHING SYSTEM</td> <td>0.270</td> <td>M</td> </tr> <tr> <td>VI1220A1</td> <td>4,2X12 TCB SELF-TAPPIN G SCREW</td> <td>1</td> <td>PZ</td> </tr> <tr> <td>VL1014A0</td> <td>PRESSURE REDUCER WITH DISTRIBUTOR</td> <td>1</td> <td>PZ</td> </tr> <tr> <td>VL1038A2</td> <td>VIBRATION PUMP</td> <td>1</td> <td>PZ</td> </tr> <tr> <td>VL1046A1</td> <td>D6 PIPE HOLDER - D6 J.G. TERMINAL</td> <td>1</td> <td>PZ</td> </tr> </tbody> </table>	Code	Description	Qty	UOM	EL1180A0	Ø8-Ø8 FEMALE NON-RETURN CONNECTION	1	PZ	EL1185A0	Ø8F - Ø8F ELBOW CONNECTION	1	PZ	EL1195A0	ELBOW UNION Ø8F-Ø8M	2	PZ	EL1195B0	Ø8F-Ø8M ELBOW CONNECTION	2	PZ	EL1345A0	CLIP TO FIX Ø8 MM CONNECTION JOINT	2	PZ	EL1411A0	SOLENOID VALVE WITH CHECK VALVE	1	PZ	RC1003A0	8M-1/8 BSPP FITTING	2	PZ	RC1019A0	D=10 ELASTIC CLAMP	4	PZ	RC1130A0	130X2,6 CLAM	2	PZ	RC1369A0	Ø8F-1/8" M CIL. STRAIGHT CONNECTION	2	PZ	RC1372A0	Ø10M-1/4 M CIL. STRAIGHT FITTING	1	PZ	TB1815A0	7,93X4,75 PE TRANSP. PIPE (JG #PE08100N)	1.500	M	TB1816A0	CLEAR POLYPROPYL ENE PIPE 6X4MM	0.250	M	TB2820A0	PIPE EPDM FOR WASHING SYSTEM	0.270	M	VI1220A1	4,2X12 TCB SELF-TAPPIN G SCREW	1	PZ	VL1014A0	PRESSURE REDUCER WITH DISTRIBUTOR	1	PZ	VL1038A2	VIBRATION PUMP	1	PZ	VL1046A1	D6 PIPE HOLDER - D6 J.G. TERMINAL	1	PZ
Code	Description	Qty	UOM																																																																														
EL1180A0	Ø8-Ø8 FEMALE NON-RETURN CONNECTION	1	PZ																																																																														
EL1185A0	Ø8F - Ø8F ELBOW CONNECTION	1	PZ																																																																														
EL1195A0	ELBOW UNION Ø8F-Ø8M	2	PZ																																																																														
EL1195B0	Ø8F-Ø8M ELBOW CONNECTION	2	PZ																																																																														
EL1345A0	CLIP TO FIX Ø8 MM CONNECTION JOINT	2	PZ																																																																														
EL1411A0	SOLENOID VALVE WITH CHECK VALVE	1	PZ																																																																														
RC1003A0	8M-1/8 BSPP FITTING	2	PZ																																																																														
RC1019A0	D=10 ELASTIC CLAMP	4	PZ																																																																														
RC1130A0	130X2,6 CLAM	2	PZ																																																																														
RC1369A0	Ø8F-1/8" M CIL. STRAIGHT CONNECTION	2	PZ																																																																														
RC1372A0	Ø10M-1/4 M CIL. STRAIGHT FITTING	1	PZ																																																																														
TB1815A0	7,93X4,75 PE TRANSP. PIPE (JG #PE08100N)	1.500	M																																																																														
TB1816A0	CLEAR POLYPROPYL ENE PIPE 6X4MM	0.250	M																																																																														
TB2820A0	PIPE EPDM FOR WASHING SYSTEM	0.270	M																																																																														
VI1220A1	4,2X12 TCB SELF-TAPPIN G SCREW	1	PZ																																																																														
VL1014A0	PRESSURE REDUCER WITH DISTRIBUTOR	1	PZ																																																																														
VL1038A2	VIBRATION PUMP	1	PZ																																																																														
VL1046A1	D6 PIPE HOLDER - D6 J.G. TERMINAL	1	PZ																																																																														



COMPONENT			SPARE PART																																										
Code	Description	Image	Code	Description	Components list																																								
VL1071A	PRESSURE REDUCER WITH DISTRIBUTOR		KVL0005A	5E SERIES CLEANING SYSTEM KIT	<table border="1"> <thead> <tr> <th>Code</th> <th>Description</th> <th>Qty</th> <th>UOM</th> </tr> </thead> <tbody> <tr> <td>VL1047A1</td> <td>D6 PIPE HOLDER - D8 J.G. TERMINAL</td> <td>2</td> <td>PZ</td> </tr> <tr> <td>VL1071A0</td> <td>PRESSURE REDUCER WITH DISTRIBUTOR</td> <td>1</td> <td>PZ</td> </tr> <tr> <td>VM1630A0</td> <td>INTERNAL GLASS PUSHING CAP</td> <td>2</td> <td>PZ</td> </tr> <tr> <td>VM1794A0</td> <td>250X4.8 PA66 BLACK CLAMP</td> <td>1</td> <td>PZ</td> </tr> <tr> <td>VM2028A0</td> <td>20X10X4 RUBBER WASHER</td> <td>1</td> <td>PZ</td> </tr> <tr> <td>VM2029A0</td> <td>RUBBER WASHER 20X8X4</td> <td>1</td> <td>PZ</td> </tr> <tr> <td>VM2059A0</td> <td>1/4" CAP WITH O-RING SEAL</td> <td>1</td> <td>PZ</td> </tr> <tr> <td>VM2147A0</td> <td>ESD SPONGE PINK SMOOTH 410X343X15 M</td> <td>1</td> <td>PZ</td> </tr> </tbody> </table>	Code	Description	Qty	UOM	VL1047A1	D6 PIPE HOLDER - D8 J.G. TERMINAL	2	PZ	VL1071A0	PRESSURE REDUCER WITH DISTRIBUTOR	1	PZ	VM1630A0	INTERNAL GLASS PUSHING CAP	2	PZ	VM1794A0	250X4.8 PA66 BLACK CLAMP	1	PZ	VM2028A0	20X10X4 RUBBER WASHER	1	PZ	VM2029A0	RUBBER WASHER 20X8X4	1	PZ	VM2059A0	1/4" CAP WITH O-RING SEAL	1	PZ	VM2147A0	ESD SPONGE PINK SMOOTH 410X343X15 M	1	PZ				
Code	Description	Qty	UOM																																										
VL1047A1	D6 PIPE HOLDER - D8 J.G. TERMINAL	2	PZ																																										
VL1071A0	PRESSURE REDUCER WITH DISTRIBUTOR	1	PZ																																										
VM1630A0	INTERNAL GLASS PUSHING CAP	2	PZ																																										
VM1794A0	250X4.8 PA66 BLACK CLAMP	1	PZ																																										
VM2028A0	20X10X4 RUBBER WASHER	1	PZ																																										
VM2029A0	RUBBER WASHER 20X8X4	1	PZ																																										
VM2059A0	1/4" CAP WITH O-RING SEAL	1	PZ																																										
VM2147A0	ESD SPONGE PINK SMOOTH 410X343X15 M	1	PZ																																										
RC1372A	Ø10M-1/4 M CIL. STRAIGHT FITTING		KVL1117A	EUR MM 2016+LMT FILTER+PRESS. RED. KIT	<table border="1"> <thead> <tr> <th>Code</th> <th>Description</th> <th>Qty</th> <th>UOM</th> </tr> </thead> <tbody> <tr> <td>0H7472A1</td> <td>DISTRIBUTOR SUPPORT PLATE</td> <td>1</td> <td>PZ</td> </tr> <tr> <td>RC1004A0</td> <td>Ø10-Ø8-8 Y CONNECTION</td> <td>1</td> <td>PZ</td> </tr> <tr> <td>RC1243A0</td> <td>Ø10F-Ø10M ELBOW CONNECTION + JG END KIT</td> <td>1</td> <td>PZ</td> </tr> <tr> <td>RC1372A0</td> <td>Ø10M-1/4 M CIL. STRAIGHT FITTING</td> <td>2</td> <td>PZ</td> </tr> <tr> <td>VI1013A1</td> <td>30.5X39.5X3 NYLON FLAT WASHER</td> <td>1</td> <td>PZ</td> </tr> <tr> <td>VI1220A1</td> <td>4,2X12 TCB SELF-TAPPING SCREW</td> <td>2</td> <td>PZ</td> </tr> <tr> <td>VL1014A0</td> <td>PRESSURE REDUCER WITH DISTRIBUTOR</td> <td>1</td> <td>PZ</td> </tr> <tr> <td>VL1014B0</td> <td>PRESSURE REDUCER WITH DISTRIBUTOR</td> <td>1</td> <td>PZ</td> </tr> <tr> <td>VL1034C0</td> <td>MESH WATER FILTER D10</td> <td>1</td> <td>PZ</td> </tr> </tbody> </table>	Code	Description	Qty	UOM	0H7472A1	DISTRIBUTOR SUPPORT PLATE	1	PZ	RC1004A0	Ø10-Ø8-8 Y CONNECTION	1	PZ	RC1243A0	Ø10F-Ø10M ELBOW CONNECTION + JG END KIT	1	PZ	RC1372A0	Ø10M-1/4 M CIL. STRAIGHT FITTING	2	PZ	VI1013A1	30.5X39.5X3 NYLON FLAT WASHER	1	PZ	VI1220A1	4,2X12 TCB SELF-TAPPING SCREW	2	PZ	VL1014A0	PRESSURE REDUCER WITH DISTRIBUTOR	1	PZ	VL1014B0	PRESSURE REDUCER WITH DISTRIBUTOR	1	PZ	VL1034C0	MESH WATER FILTER D10	1	PZ
Code	Description	Qty	UOM																																										
0H7472A1	DISTRIBUTOR SUPPORT PLATE	1	PZ																																										
RC1004A0	Ø10-Ø8-8 Y CONNECTION	1	PZ																																										
RC1243A0	Ø10F-Ø10M ELBOW CONNECTION + JG END KIT	1	PZ																																										
RC1372A0	Ø10M-1/4 M CIL. STRAIGHT FITTING	2	PZ																																										
VI1013A1	30.5X39.5X3 NYLON FLAT WASHER	1	PZ																																										
VI1220A1	4,2X12 TCB SELF-TAPPING SCREW	2	PZ																																										
VL1014A0	PRESSURE REDUCER WITH DISTRIBUTOR	1	PZ																																										
VL1014B0	PRESSURE REDUCER WITH DISTRIBUTOR	1	PZ																																										
VL1034C0	MESH WATER FILTER D10	1	PZ																																										



Зип Общепит ASM4038A/0.D01 External cover

vsezip.ru

+7(812)987-08-81

COMPONENT			SPARE PART																																																						
Code	Description	Image	Code	Description	Components list																																																				
RC1372A	Ø10M-1/4 M CIL. STRAIGHT FITTING		KVL1117A	EUR MM 2016+LMT FILTER+PRESS. RED. KIT	<table border="1"> <thead> <tr> <th>Code</th> <th>Description</th> <th>Qty</th> <th>UOM</th> </tr> </thead> <tbody> <tr> <td>VL1062C0</td> <td>PRESSURE REDUCER-FIL TER LOCKING FORK</td> <td>1</td> <td>PZ</td> </tr> <tr> <td>VM1053A0</td> <td>1/8" CAP + O-RING</td> <td>2</td> <td>PZ</td> </tr> <tr> <td>VM1054A0</td> <td>H7.8 PRESSURE REDUCER RING NUT</td> <td>1</td> <td>PZ</td> </tr> </tbody> </table>	Code	Description	Qty	UOM	VL1062C0	PRESSURE REDUCER-FIL TER LOCKING FORK	1	PZ	VM1053A0	1/8" CAP + O-RING	2	PZ	VM1054A0	H7.8 PRESSURE REDUCER RING NUT	1	PZ																																				
			Code	Description	Qty	UOM																																																			
VL1062C0	PRESSURE REDUCER-FIL TER LOCKING FORK	1	PZ																																																						
VM1053A0	1/8" CAP + O-RING	2	PZ																																																						
VM1054A0	H7.8 PRESSURE REDUCER RING NUT	1	PZ																																																						
KRC1372A	D 10M-1/4 M CIL STRAIGHT CONNECTION KIT	<table border="1"> <thead> <tr> <th>Code</th> <th>Description</th> <th>Qty</th> <th>UOM</th> </tr> </thead> <tbody> <tr> <td>RC1372A0</td> <td>Ø10M-1/4 M CIL. STRAIGHT FITTING</td> <td>1</td> <td>PZ</td> </tr> </tbody> </table>	Code	Description	Qty	UOM	RC1372A0	Ø10M-1/4 M CIL. STRAIGHT FITTING	1	PZ																																															
Code	Description	Qty	UOM																																																						
RC1372A0	Ø10M-1/4 M CIL. STRAIGHT FITTING	1	PZ																																																						
VL1014B	PRESSURE REDUCER WITH DISTRIBUTOR		KVL1117A	EUR MM 2016+LMT FILTER+PRESS. RED. KIT	<table border="1"> <thead> <tr> <th>Code</th> <th>Description</th> <th>Qty</th> <th>UOM</th> </tr> </thead> <tbody> <tr> <td>0H7472A1</td> <td>DISTRIBUTOR SUPPORT PLATE</td> <td>1</td> <td>PZ</td> </tr> <tr> <td>RC1004A0</td> <td>Ø10-Ø8-8 Y CONNECTION</td> <td>1</td> <td>PZ</td> </tr> <tr> <td>RC1243A0</td> <td>Ø10F-Ø10M ELBOW CONNECTION + JG END KIT</td> <td>1</td> <td>PZ</td> </tr> <tr> <td>RC1372A0</td> <td>Ø10M-1/4 M CIL. STRAIGHT FITTING</td> <td>2</td> <td>PZ</td> </tr> <tr> <td>VI1013A1</td> <td>30.5X39.5X3 NYLON FLAT WASHER</td> <td>1</td> <td>PZ</td> </tr> <tr> <td>VI1220A1</td> <td>4,2X12 TCB SELF-TAPPIN G SCREW</td> <td>2</td> <td>PZ</td> </tr> <tr> <td>VL1014A0</td> <td>PRESSURE REDUCER WITH DISTRIBUTOR</td> <td>1</td> <td>PZ</td> </tr> <tr> <td>VL1014B0</td> <td>PRESSURE REDUCER WITH DISTRIBUTOR</td> <td>1</td> <td>PZ</td> </tr> <tr> <td>VL1034C0</td> <td>MESH WATER FILTER D10</td> <td>1</td> <td>PZ</td> </tr> <tr> <td>VL1062C0</td> <td>PRESSURE REDUCER-FIL TER LOCKING FORK</td> <td>1</td> <td>PZ</td> </tr> <tr> <td>VM1053A0</td> <td>1/8" CAP + O-RING</td> <td>2</td> <td>PZ</td> </tr> <tr> <td>VM1054A0</td> <td>H7.8 PRESSURE REDUCER RING NUT</td> <td>1</td> <td>PZ</td> </tr> </tbody> </table>	Code	Description	Qty	UOM	0H7472A1	DISTRIBUTOR SUPPORT PLATE	1	PZ	RC1004A0	Ø10-Ø8-8 Y CONNECTION	1	PZ	RC1243A0	Ø10F-Ø10M ELBOW CONNECTION + JG END KIT	1	PZ	RC1372A0	Ø10M-1/4 M CIL. STRAIGHT FITTING	2	PZ	VI1013A1	30.5X39.5X3 NYLON FLAT WASHER	1	PZ	VI1220A1	4,2X12 TCB SELF-TAPPIN G SCREW	2	PZ	VL1014A0	PRESSURE REDUCER WITH DISTRIBUTOR	1	PZ	VL1014B0	PRESSURE REDUCER WITH DISTRIBUTOR	1	PZ	VL1034C0	MESH WATER FILTER D10	1	PZ	VL1062C0	PRESSURE REDUCER-FIL TER LOCKING FORK	1	PZ	VM1053A0	1/8" CAP + O-RING	2	PZ	VM1054A0	H7.8 PRESSURE REDUCER RING NUT	1	PZ
			Code	Description	Qty	UOM																																																			
			0H7472A1	DISTRIBUTOR SUPPORT PLATE	1	PZ																																																			
			RC1004A0	Ø10-Ø8-8 Y CONNECTION	1	PZ																																																			
			RC1243A0	Ø10F-Ø10M ELBOW CONNECTION + JG END KIT	1	PZ																																																			
			RC1372A0	Ø10M-1/4 M CIL. STRAIGHT FITTING	2	PZ																																																			
			VI1013A1	30.5X39.5X3 NYLON FLAT WASHER	1	PZ																																																			
			VI1220A1	4,2X12 TCB SELF-TAPPIN G SCREW	2	PZ																																																			
			VL1014A0	PRESSURE REDUCER WITH DISTRIBUTOR	1	PZ																																																			
			VL1014B0	PRESSURE REDUCER WITH DISTRIBUTOR	1	PZ																																																			
			VL1034C0	MESH WATER FILTER D10	1	PZ																																																			
			VL1062C0	PRESSURE REDUCER-FIL TER LOCKING FORK	1	PZ																																																			
			VM1053A0	1/8" CAP + O-RING	2	PZ																																																			
VM1054A0	H7.8 PRESSURE REDUCER RING NUT	1	PZ																																																						



COMPONENT			SPARE PART																																										
Code	Description	Image	Code	Description	Components list																																								
VL1014B	PRESSURE REDUCER WITH DISTRIBUTOR		KVL1014B	MIND. MAPS PRESSURE REDUCER KIT	<table border="1"> <thead> <tr> <th>Code</th> <th>Description</th> <th>Qty</th> <th>UOM</th> </tr> </thead> <tbody> <tr> <td>EL1185A0</td> <td>Ø8F - Ø8F ELBOW CONNECTION</td> <td>1</td> <td>PZ</td> </tr> <tr> <td>RC1003A0</td> <td>8M-1/8 BSPP FITTING</td> <td>2</td> <td>PZ</td> </tr> <tr> <td>RC1372A0</td> <td>Ø10M-1/4 M CIL. STRAIGHT FITTING</td> <td>1</td> <td>PZ</td> </tr> <tr> <td>RC1396A0</td> <td>JG D10-1/4 STRAIGHT END FITTING</td> <td>1</td> <td>PZ</td> </tr> <tr> <td>VL1014B0</td> <td>PRESSURE REDUCER WITH DISTRIBUTOR</td> <td>1</td> <td>PZ</td> </tr> <tr> <td>VL1071A0</td> <td>PRESSURE REDUCER WITH DISTRIBUTOR</td> <td>1</td> <td>PZ</td> </tr> <tr> <td>VM1054A0</td> <td>H7.8 PRESSURE REDUCER RING NUT</td> <td>1</td> <td>PZ</td> </tr> <tr> <td>VM2028A0</td> <td>20X10X4 RUBBER WASHER</td> <td>1</td> <td>PZ</td> </tr> <tr> <td>VM2059A0</td> <td>1/4" CAP WITH O-RING SEAL</td> <td>1</td> <td>PZ</td> </tr> </tbody> </table>	Code	Description	Qty	UOM	EL1185A0	Ø8F - Ø8F ELBOW CONNECTION	1	PZ	RC1003A0	8M-1/8 BSPP FITTING	2	PZ	RC1372A0	Ø10M-1/4 M CIL. STRAIGHT FITTING	1	PZ	RC1396A0	JG D10-1/4 STRAIGHT END FITTING	1	PZ	VL1014B0	PRESSURE REDUCER WITH DISTRIBUTOR	1	PZ	VL1071A0	PRESSURE REDUCER WITH DISTRIBUTOR	1	PZ	VM1054A0	H7.8 PRESSURE REDUCER RING NUT	1	PZ	VM2028A0	20X10X4 RUBBER WASHER	1	PZ	VM2059A0	1/4" CAP WITH O-RING SEAL	1	PZ
			Code	Description	Qty	UOM																																							
			EL1185A0	Ø8F - Ø8F ELBOW CONNECTION	1	PZ																																							
RC1003A0	8M-1/8 BSPP FITTING	2	PZ																																										
RC1372A0	Ø10M-1/4 M CIL. STRAIGHT FITTING	1	PZ																																										
RC1396A0	JG D10-1/4 STRAIGHT END FITTING	1	PZ																																										
VL1014B0	PRESSURE REDUCER WITH DISTRIBUTOR	1	PZ																																										
VL1071A0	PRESSURE REDUCER WITH DISTRIBUTOR	1	PZ																																										
VM1054A0	H7.8 PRESSURE REDUCER RING NUT	1	PZ																																										
VM2028A0	20X10X4 RUBBER WASHER	1	PZ																																										
VM2059A0	1/4" CAP WITH O-RING SEAL	1	PZ																																										
KVL0014B	EUR 2017 MIND.MAPS PRESSURE REDUCER KIT	<table border="1"> <thead> <tr> <th>Code</th> <th>Description</th> <th>Qty</th> <th>UOM</th> </tr> </thead> <tbody> <tr> <td>RC1372A0</td> <td>Ø10M-1/4 M CIL. STRAIGHT FITTING</td> <td>1</td> <td>PZ</td> </tr> <tr> <td>RC1396A0</td> <td>JG D10-1/4 STRAIGHT END FITTING</td> <td>1</td> <td>PZ</td> </tr> <tr> <td>VL1014B0</td> <td>PRESSURE REDUCER WITH DISTRIBUTOR</td> <td>1</td> <td>PZ</td> </tr> <tr> <td>VM1054A0</td> <td>H7.8 PRESSURE REDUCER RING NUT</td> <td>1</td> <td>PZ</td> </tr> </tbody> </table>	Code	Description	Qty	UOM	RC1372A0	Ø10M-1/4 M CIL. STRAIGHT FITTING	1	PZ	RC1396A0	JG D10-1/4 STRAIGHT END FITTING	1	PZ	VL1014B0	PRESSURE REDUCER WITH DISTRIBUTOR	1	PZ	VM1054A0	H7.8 PRESSURE REDUCER RING NUT	1	PZ																							
Code	Description	Qty	UOM																																										
RC1372A0	Ø10M-1/4 M CIL. STRAIGHT FITTING	1	PZ																																										
RC1396A0	JG D10-1/4 STRAIGHT END FITTING	1	PZ																																										
VL1014B0	PRESSURE REDUCER WITH DISTRIBUTOR	1	PZ																																										
VM1054A0	H7.8 PRESSURE REDUCER RING NUT	1	PZ																																										
KVL0014A	EUR MIND.MAPS PRESSURE REDUCER KIT	<table border="1"> <thead> <tr> <th>Code</th> <th>Description</th> <th>Qty</th> <th>UOM</th> </tr> </thead> <tbody> <tr> <td>RC1372A0</td> <td>Ø10M-1/4 M CIL. STRAIGHT FITTING</td> <td>2</td> <td>PZ</td> </tr> <tr> <td>VL1014A0</td> <td>PRESSURE REDUCER WITH DISTRIBUTOR</td> <td>1</td> <td>PZ</td> </tr> </tbody> </table>	Code	Description	Qty	UOM	RC1372A0	Ø10M-1/4 M CIL. STRAIGHT FITTING	2	PZ	VL1014A0	PRESSURE REDUCER WITH DISTRIBUTOR	1	PZ																															
Code	Description	Qty	UOM																																										
RC1372A0	Ø10M-1/4 M CIL. STRAIGHT FITTING	2	PZ																																										
VL1014A0	PRESSURE REDUCER WITH DISTRIBUTOR	1	PZ																																										



Зип Общепит **ASM4038A/0.D01 External cover**

vsezip.ru

+7(812)987-08-81



COMPONENT			SPARE PART																						
Code	Description	Image	Code	Description	Components list																				
VL1014B	PRESSURE REDUCER WITH DISTRIBUTOR		KVL0014A	EUR MIND.MAPS PRESSURE REDUCER KIT	<table border="1"> <thead> <tr> <th>Code</th> <th>Description</th> <th>Qty</th> <th>UOM</th> </tr> </thead> <tbody> <tr> <td>VL1014B0</td> <td>PRESSURE REDUCER WITH DISTRIBUTOR</td> <td>1</td> <td>PZ</td> </tr> <tr> <td>VM1053A0</td> <td>1/8" CAP + O-RING</td> <td>2</td> <td>PZ</td> </tr> <tr> <td>VM1054A0</td> <td>H7.8 PRESSURE REDUCER RING NUT</td> <td>1</td> <td>PZ</td> </tr> </tbody> </table>	Code	Description	Qty	UOM	VL1014B0	PRESSURE REDUCER WITH DISTRIBUTOR	1	PZ	VM1053A0	1/8" CAP + O-RING	2	PZ	VM1054A0	H7.8 PRESSURE REDUCER RING NUT	1	PZ				
			Code	Description	Qty	UOM																			
VL1014B0	PRESSURE REDUCER WITH DISTRIBUTOR	1	PZ																						
VM1053A0	1/8" CAP + O-RING	2	PZ																						
VM1054A0	H7.8 PRESSURE REDUCER RING NUT	1	PZ																						
KVL0010A	S.4 - 5 WATER PRESSURE REDUCER KIT	<table border="1"> <thead> <tr> <th>Code</th> <th>Description</th> <th>Qty</th> <th>UOM</th> </tr> </thead> <tbody> <tr> <td>EL1210A0</td> <td>J. GUEST STRAIGHT END CONNECTION</td> <td>2</td> <td>PZ</td> </tr> <tr> <td>VL1014A0</td> <td>PRESSURE REDUCER WITH DISTRIBUTOR</td> <td>1</td> <td>PZ</td> </tr> <tr> <td>VL1014B0</td> <td>PRESSURE REDUCER WITH DISTRIBUTOR</td> <td>1</td> <td>PZ</td> </tr> <tr> <td>VM1053A0</td> <td>1/8" CAP + O-RING</td> <td>2</td> <td>PZ</td> </tr> </tbody> </table>	Code	Description	Qty	UOM	EL1210A0	J. GUEST STRAIGHT END CONNECTION	2	PZ	VL1014A0	PRESSURE REDUCER WITH DISTRIBUTOR	1	PZ	VL1014B0	PRESSURE REDUCER WITH DISTRIBUTOR	1	PZ	VM1053A0	1/8" CAP + O-RING	2	PZ			
Code	Description	Qty	UOM																						
EL1210A0	J. GUEST STRAIGHT END CONNECTION	2	PZ																						
VL1014A0	PRESSURE REDUCER WITH DISTRIBUTOR	1	PZ																						
VL1014B0	PRESSURE REDUCER WITH DISTRIBUTOR	1	PZ																						
VM1053A0	1/8" CAP + O-RING	2	PZ																						
RC1396A	JG D10-1/4 STRAIGHT END FITTING		KVL0014B	EUR 2017 MIND.MAPS PRESSURE REDUCER KIT	<table border="1"> <thead> <tr> <th>Code</th> <th>Description</th> <th>Qty</th> <th>UOM</th> </tr> </thead> <tbody> <tr> <td>RC1372A0</td> <td>Ø10M-1/4 M CIL. STRAIGHT FITTING</td> <td>1</td> <td>PZ</td> </tr> <tr> <td>RC1396A0</td> <td>JG D10-1/4 STRAIGHT END FITTING</td> <td>1</td> <td>PZ</td> </tr> <tr> <td>VL1014B0</td> <td>PRESSURE REDUCER WITH DISTRIBUTOR</td> <td>1</td> <td>PZ</td> </tr> <tr> <td>VM1054A0</td> <td>H7.8 PRESSURE REDUCER RING NUT</td> <td>1</td> <td>PZ</td> </tr> </tbody> </table>	Code	Description	Qty	UOM	RC1372A0	Ø10M-1/4 M CIL. STRAIGHT FITTING	1	PZ	RC1396A0	JG D10-1/4 STRAIGHT END FITTING	1	PZ	VL1014B0	PRESSURE REDUCER WITH DISTRIBUTOR	1	PZ	VM1054A0	H7.8 PRESSURE REDUCER RING NUT	1	PZ
					Code	Description	Qty	UOM																	
					RC1372A0	Ø10M-1/4 M CIL. STRAIGHT FITTING	1	PZ																	
					RC1396A0	JG D10-1/4 STRAIGHT END FITTING	1	PZ																	
VL1014B0	PRESSURE REDUCER WITH DISTRIBUTOR	1	PZ																						
VM1054A0	H7.8 PRESSURE REDUCER RING NUT	1	PZ																						
VL1063A	HOSE D8 TANG D10		KVL1125A	BEND CONNECT-HOLD D8-CLIP D10 10PCS KIT	<table border="1"> <thead> <tr> <th>Code</th> <th>Description</th> <th>Qty</th> <th>UOM</th> </tr> </thead> <tbody> <tr> <td>VL1125A0</td> <td>BENDE FITTING M-M RUBBER-HOLDER D8-END</td> <td>10</td> <td>PZ</td> </tr> <tr> <td>VL1125A1</td> <td>BENDE FITTING M-M RUBBER-HOLDER D8-END</td> <td>10</td> <td>PZ</td> </tr> </tbody> </table>	Code	Description	Qty	UOM	VL1125A0	BENDE FITTING M-M RUBBER-HOLDER D8-END	10	PZ	VL1125A1	BENDE FITTING M-M RUBBER-HOLDER D8-END	10	PZ								
Code	Description	Qty	UOM																						
VL1125A0	BENDE FITTING M-M RUBBER-HOLDER D8-END	10	PZ																						
VL1125A1	BENDE FITTING M-M RUBBER-HOLDER D8-END	10	PZ																						



Зип Общепит ASM4038A/0.D01 External cover

vsezip.ru

+7(812)987-08-81

COMPONENT			SPARE PART										
Code	Description	Image	Code	Description	Components list								
VL1063A	HOSE D8 TANG D10		KVL1063A	Ø8 PIPE HOLDER+Ø10 JG TERMINAL 10PCS KI 1,5M D10 TB2243A CONNECTION PIPE KIT	<table border="1"> <thead> <tr> <th>Code</th> <th>Description</th> <th>Qty</th> <th>UOM</th> </tr> </thead> <tbody> <tr> <td>VL1063A0</td> <td>HOSE D8 TANG D10</td> <td>10</td> <td>PZ</td> </tr> </tbody> </table>	Code	Description	Qty	UOM	VL1063A0	HOSE D8 TANG D10	10	PZ
					Code	Description	Qty	UOM					
VL1063A0	HOSE D8 TANG D10	10	PZ										
<table border="1"> <thead> <tr> <th>Code</th> <th>Description</th> <th>Qty</th> <th>UOM</th> </tr> </thead> <tbody> <tr> <td>TB2243A0</td> <td>Ø10 PET PIPE</td> <td>1.500</td> <td>M</td> </tr> </tbody> </table>	Code	Description	Qty	UOM	TB2243A0	Ø10 PET PIPE	1.500	M					
Code	Description	Qty	UOM										
TB2243A0	Ø10 PET PIPE	1.500	M										
RC1046A	D10-16 H9 ST STEEL HOSE CLAMP		KTB2237A	1,5M D10 TB2243A CONNECTION PIPE KIT	<table border="1"> <thead> <tr> <th>Code</th> <th>Description</th> <th>Qty</th> <th>UOM</th> </tr> </thead> <tbody> <tr> <td>TB2243A0</td> <td>Ø10 PET PIPE</td> <td>1.500</td> <td>M</td> </tr> </tbody> </table>	Code	Description	Qty	UOM	TB2243A0	Ø10 PET PIPE	1.500	M
					Code	Description	Qty	UOM					
TB2243A0	Ø10 PET PIPE	1.500	M										
<table border="1"> <thead> <tr> <th>Code</th> <th>Description</th> <th>Qty</th> <th>UOM</th> </tr> </thead> <tbody> <tr> <td>RC1046A0</td> <td>D10-16 H9 ST STEEL HOSE CLAMP</td> <td>10</td> <td>PZ</td> </tr> </tbody> </table>	Code	Description	Qty	UOM	RC1046A0	D10-16 H9 ST STEEL HOSE CLAMP	10	PZ					
Code	Description	Qty	UOM										
RC1046A0	D10-16 H9 ST STEEL HOSE CLAMP	10	PZ										
VL1095A	FITTING M-M RUBBER HOLDER D7,8-D10		KVL1095A	STRAIGHT CONNECT-HOLDER D7-D10 10PCS KIT	<table border="1"> <thead> <tr> <th>Code</th> <th>Description</th> <th>Qty</th> <th>UOM</th> </tr> </thead> <tbody> <tr> <td>VL1095A0</td> <td>FITTING M-M RUBBER HOLDER D7,8-D10</td> <td>10</td> <td>PZ</td> </tr> </tbody> </table>	Code	Description	Qty	UOM	VL1095A0	FITTING M-M RUBBER HOLDER D7,8-D10	10	PZ
					Code	Description	Qty	UOM					
VL1095A0	FITTING M-M RUBBER HOLDER D7,8-D10	10	PZ										