



# pumps

## wash and rinse pumps

OLYMPIA

pumps



1

<b>GEV No.</b>	500521	<b>Ref. No.</b>	T33
<b>description</b>	pump inlet $\varnothing$ 1" IT outlet $\varnothing$ 26mm type T33 230V 50Hz 1 phase 0,25kW 0,34HP L 225mm rotation direction right capacitor 5 $\mu$ F auxiliary pressure connection 11mm supporting pressure closed OLYMPIA		
<b>spare parts for</b>	500521		
	<b>GEV No.</b>	<b>Ref. No.</b>	—
	365017		operating capacitor capacity 5 $\mu$ F 450V
	<b>GEV No.</b>	<b>Ref. No.</b>	N/A
	510693		mechanical shaft seal for shaft $\varnothing$ 12 mm
	<b>GEV No.</b>	<b>Ref. No.</b>	N/A
	521256		impellor $\varnothing$ 74 mm H 14 mm thread M10L shaft $\varnothing$ 12 mm
	<b>GEV No.</b>	<b>Ref. No.</b>	N/A
	521554		pump cover OLYMPIA inlet 1" $\varnothing$ 90 mm ID $\varnothing$ 66 mm
	<b>GEV No.</b>	<b>Ref. No.</b>	N/A
	521724		O-ring EPDM thickness 1,78 mm ID $\varnothing$ 72,75 mm
	<b>GEV No.</b>	<b>Ref. No.</b>	N/A
	528800		O-ring EPDM thickness 2,62 mm ID $\varnothing$ 75,87 mm

Зип Общепит

vsezip.ru

+7(812)987-08-81



1

<b>GEV No.</b>	500005	<b>Ref. No.</b>	T60
<b>description</b>	pump inlet $\varnothing$ 1" IT outlet $\varnothing$ 28mm type T60 230V 50Hz 1 phase 0,19kW 0,26HP L 210mm rotation direction left capacitor 5 $\mu$ F OLYMPIA		
<b>spare parts for</b>	500005		
	<b>GEV No.</b>	<b>Ref. No.</b>	—
	365017		operating capacitor capacity 5 $\mu$ F 450V
	<b>GEV No.</b>	<b>Ref. No.</b>	N/A
	509001		impellor $\varnothing$ 75 mm H 15 mm pump type type C
	<b>GEV No.</b>	<b>Ref. No.</b>	N/A
	509003		pump cover OLYMPIA inlet 1" outlet $\varnothing$ 28 mm
	<b>GEV No.</b>	<b>Ref. No.</b>	N/A
	510693		mechanical shaft seal for shaft $\varnothing$ 12 mm
	<b>GEV No.</b>	<b>Ref. No.</b>	N/A
	528800		O-ring EPDM thickness 2,62 mm ID $\varnothing$ 75,87 mm



1

<b>GEV No.</b>	499257	<b>Ref. No.</b>	T.45
<b>description</b>	pump inlet $\varnothing$ 1" IT outlet $\varnothing$ 30mm type L63.T45F_2V 230V 50Hz 1 phase 0,33kW L 230mm rotation direction left capacitor 8 $\mu$ F OLYMPIA		
<b>spare parts for</b>	499257		
	<b>GEV No.</b>	<b>Ref. No.</b>	—
	365013		operating capacitor capacity 8 $\mu$ F 400V
	<b>GEV No.</b>	<b>Ref. No.</b>	N/A
	509007		impellor $\varnothing$ 85 mm H 20 mm rotation direction left



Table continues overleaf







Зип Общепит

vsezip.ru





+7(812)987-08-81

spare parts for 499257			
GEV No.	510693	Ref. No.	N/A
	mechanical shaft seal for shaft $\varnothing$ 12 mm		
GEV No.	521167	Ref. No.	N/A
	pump cover OLYMPIA inlet $\varnothing$ 1"mm outlet $\varnothing$ 30/30mm		
GEV No.	521723	Ref. No.	N/A
	pump cover gasket EPDM thickness 2 mm ID $\varnothing$ 90 mm		



GEV No.	499131	Ref. No.	T.19DX
<b>description</b>	pump inlet $\varnothing$ 1" IT outlet $\varnothing$ 30mm type T.19DX 230V 50Hz 1 phase 0,19kW L 195mm rotation direction left capacitor 5 $\mu$ F OLYMPIA outlet $\varnothing$ 30mm		
spare parts for 499131			
	GEV No. 365017	Ref. No.	—
operating capacitor capacity 5 $\mu$ F 450V			
	GEV No. 510693	Ref. No.	N/A
mechanical shaft seal for shaft $\varnothing$ 12 mm			
	GEV No. 521168	Ref. No.	N/A
pump cover OLYMPIA inlet $\varnothing$ 1"mm outlet $\varnothing$ 30 mm			
	GEV No. 521169	Ref. No.	N/A
impeller $\varnothing$ 64 mm H 15 mm pump type T.19DX			
	GEV No. 521723	Ref. No.	N/A
pump cover gasket EPDM thickness 2 mm ID $\varnothing$ 90 mm			



GEV No.	499258	Ref. No.	R63.T33 PRS
<b>description</b>	pump inlet $\varnothing$ 15mm outlet $\varnothing$ 13mm type R63.T33 PRS 400V 50Hz 3 phase 0,25kW L 185mm rotation direction left OLYMPIA		
spare parts for 499258			
	GEV No. 510693	Ref. No.	N/A
mechanical shaft seal for shaft $\varnothing$ 12 mm			
	GEV No. 521165	Ref. No.	N/A
pump cover OLYMPIA inlet $\varnothing$ 15 mm outlet $\varnothing$ 13 mm			
	GEV No. 521166	Ref. No.	N/A
impeller $\varnothing$ 90 mm H 9 mm pump type R63.T33 PRS			
	GEV No. 525022	Ref. No.	N/A
O-ring EPDM thickness 1,78mm ID $\varnothing$ 75,92mm			

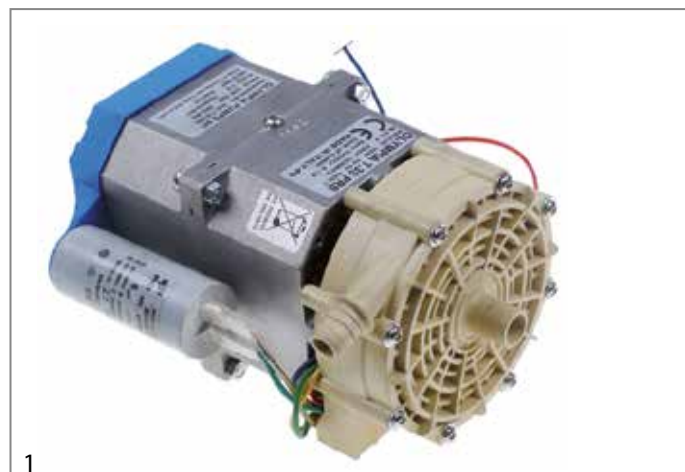



GEV No.	499095	Ref. No.	T.33PRS
<b>description</b>	pump inlet $\varnothing$ 15mm outlet $\varnothing$ 14mm type T.33PRS 230V 50Hz 1 phase 0,25kW L 185mm rotation direction right capacitor 8 $\mu$ F OLYMPIA		
spare parts for 499095			
	GEV No. 365013	Ref. No.	—
operating capacitor capacity 8 $\mu$ F 400V			
	GEV No. 510693	Ref. No.	N/A
mechanical shaft seal for shaft $\varnothing$ 12 mm			
	GEV No. 521165	Ref. No.	N/A
pump cover OLYMPIA inlet $\varnothing$ 15 mm outlet $\varnothing$ 13 mm			

Table continues overleaf

electric components





Зип Общепит

vsezip.ru

+7(812)987-08-81

spare parts for 499095





	GEV No.	521166	Ref. No.	N/A
impellor ø 90 mm H 9 mm pump type R63.T33 PRS				
	GEV No.	525022	Ref. No.	N/A
O-ring EPDM thickness 1,78mm ID ø 75,92mm				



1

<b>GEV No.</b>	499318	<b>Ref. No.</b>	L63.T19	
<b>description</b>	pump inlet ø 28mm outlet ø 28mm type L63.T19 230V 50Hz 1 phase 0,19kW L 185mm rotation direction right capacitor 5µF OLYMPIA inlet ø 28mm outlet ø 28mm			

spare parts for 499318





	GEV No.	365017	Ref. No.	—
operating capacitor capacity 5µF 450V				
	GEV No.	510693	Ref. No.	N/A
mechanical shaft seal for shaft ø 12 mm				
	GEV No.	521163	Ref. No.	N/A
pump cover OLYMPIA inlet ø 28 mm outlet ø 26 mm				
	GEV No.	521164	Ref. No.	N/A
impellor ø 64 mm H 15 mm pump type L63.T19				
	GEV No.	521724	Ref. No.	N/A
O-ring EPDM thickness 1,78 mm ID ø 72,75 mm				



1

<b>GEV No.</b>	500957	<b>Ref. No.</b>	T.25 Olympia	
<b>description</b>	pump inlet ø 28mm outlet ø 28mm type T25 230V 50Hz 1 phase 0,19kW 0,25HP L 190mm rotation direction left capacitor 6,3µF OLYMPIA			

spare parts for 500957

	GEV No.	365012	Ref. No.	—
operating capacitor capacity 6,3µF 450V				
	GEV No.	510248	Ref. No.	N/A
pump cover OLYMPIA inlet ø 28 mm outlet ø 28 mm				
	GEV No.	510249	Ref. No.	N/A
impellor ø 74 mm H 19 mm pump type T25				
	GEV No.	510693	Ref. No.	N/A
mechanical shaft seal for shaft ø 12 mm				
	GEV No.	528800	Ref. No.	N/A
O-ring EPDM thickness 2,62 mm ID ø 75,87 mm				



1

<b>GEV No.</b>	499229	<b>Ref. No.</b>	L63.T19	
<b>description</b>	pump inlet ø 28mm outlet ø 30mm type L63.T19 230V 50Hz 1 phase 0,19kW L 215mm rotation direction right capacitor 5µF OLYMPIA			

spare parts for 499229





	GEV No.	365017	Ref. No.	—
operating capacitor capacity 5µF 450V				
	GEV No.	510693	Ref. No.	N/A
mechanical shaft seal for shaft ø 12 mm				

Table continues overleaf

Зип Общепит

vsezip.ru

+7(812)987-08-81

<b>spare parts for</b> 499229			
	GEV No.	521164	Ref. No. N/A
impellor ø 64 mm H 15 mm pump type L63.T19			
	GEV No.	521170	Ref. No. N/A
pump cover OLYMPIA outlet ø 30 mm			
	GEV No.	521724	Ref. No. N/A
O-ring EPDM thickness 1,78 mm ID ø 72,75 mm			





1

<b>GEV No.</b>	499256	<b>Ref. No.</b>	L63.T40
<b>description</b>	pump inlet ø 28mm outlet ø 30mm type L63.T40 230V 50Hz 1 phase 0,4kW L 235mm rotation direction right capacitor 5µF OLYMPIA		
<b>spare parts for</b> 499256			
	GEV No.	365017	Ref. No. —
operating capacitor capacity 5µF 450V			
	GEV No.	510693	Ref. No. N/A
mechanical shaft seal for shaft ø 12 mm			
	GEV No.	521170	Ref. No. N/A
pump cover OLYMPIA outlet ø 30 mm			
	GEV No.	521171	Ref. No. N/A
impellor ø 74 mm H 16 mm pump type L63.T40			
	GEV No.	521724	Ref. No. N/A
O-ring EPDM thickness 1,78 mm ID ø 72,75 mm			



1

<b>GEV No.</b>	500522	<b>Ref. No.</b>	T41
<b>description</b>	pump inlet ø 29mm outlet ø 27mm type T41 230V 50Hz 1 phase 0,29kW 0,4HP L 200mm rotation direction left capacitor 8µF OLYMPIA		
<b>spare parts for</b> 500522			
	GEV No.	365013	Ref. No. —
operating capacitor capacity 8µF 400V			
	GEV No.	510693	Ref. No. N/A
mechanical shaft seal for shaft ø 12 mm			
	GEV No.	521259	Ref. No. N/A
impellor ø 94 mm H 11 mm rotation direction left			
	GEV No.	521555	Ref. No. N/A
pump cover OLYMPIA inlet ø 29 mm outlet ø 28 mm			
	GEV No.	521726	Ref. No. N/A
pump cover gasket EPDM thickness 2 mm ID ø 120 mm			



1



<b>GEV No.</b>	500000	<b>Ref. No.</b>	T4
<b>description</b>	pump inlet ø 29mm outlet ø 28mm type T 4 230V 50Hz 1 phase 0,29kW 0,39HP L 202mm rotation direction left capacitor 8µF OLYMPIA		
<b>spare parts for</b> 500000			
	GEV No.	365013	Ref. No. —
operating capacitor capacity 8µF 400V			
	GEV No.	510554	Ref. No. N/A
O-ring EPDM thickness 2 mm ID ø 120 mm Qty 1 pcs			

Table continues overleaf





Зип Общепит

vsezip.ru





+7(812)987-08-81

## spare parts for 500000





	GEV No.	510693	Ref. No.	N/A
mechanical shaft seal for shaft $\varnothing$ 12 mm				
	GEV No.	521176	Ref. No.	N/A
pump cover OLYMPIA inlet $\varnothing$ 1"mm outlet $\varnothing$ 28 mm				
	GEV No.	521257	Ref. No.	—
impellor $\varnothing$ 80 mm H 12 mm rotation direction left				



1

<b>GEV No.</b>	499296	<b>Ref. No.</b>	L71.T730_30 (590046)	
<b>description</b>	pump inlet $\varnothing$ 30mm outlet $\varnothing$ 30mm type L71.T730_30 230V 50Hz 1 phase 0,52kW L 230mm rotation direction right capacitor 12,5 $\mu$ F OLYMPIA			
<b>spare parts for</b>	499296			
	GEV No.	365014	Ref. No.	—
operating capacitor capacity 12,5 $\mu$ F 400V				
	GEV No.	510554	Ref. No.	N/A
O-ring EPDM thickness 2 mm ID $\varnothing$ 120 mm Qty 1 pcs				
	GEV No.	510693	Ref. No.	N/A
mechanical shaft seal for shaft $\varnothing$ 12 mm				
	GEV No.	521159	Ref. No.	N/A
pump cover OLYMPIA inlet 30 inlet $\varnothing$ 30 mm				
	GEV No.	521160	Ref. No.	N/A
impellor $\varnothing$ 97 mm H 22 mm thread M10L				

1

<b>GEV No.</b>	499295	<b>Ref. No.</b>	L71.T730_30 (590108)	
<b>description</b>	pump inlet $\varnothing$ 30mm outlet $\varnothing$ 30mm type L71.T730_30 230V 50Hz 1 phase 0,52kW L 230mm rotation direction right capacitor 12,5 $\mu$ F OLYMPIA inlet $\varnothing$ 30mm outlet $\varnothing$ 30mm			
<b>spare parts for</b>	499295			
	GEV No.	365014	Ref. No.	—
operating capacitor capacity 12,5 $\mu$ F 400V				
	GEV No.	510554	Ref. No.	N/A
O-ring EPDM thickness 2 mm ID $\varnothing$ 120 mm Qty 1 pcs				
	GEV No.	510693	Ref. No.	N/A
mechanical shaft seal for shaft $\varnothing$ 12 mm				
	GEV No.	521159	Ref. No.	N/A
pump cover OLYMPIA inlet 30 inlet $\varnothing$ 30 mm				
	GEV No.	521160	Ref. No.	N/A
impellor $\varnothing$ 97 mm H 22 mm thread M10L				









Зип Общепит

vsezip.ru

+7(812)987-08-81





1

<b>GEV No.</b>	500199	<b>Ref. No.</b>	T80
<b>description</b>	pump inlet $\varnothing$ 32mm outlet $\varnothing$ 30/24mm type T80 230V 50Hz 1 phase 0,25kW 0,34HP L 205mm rotation direction left capacitor 5 $\mu$ F OLYMPIA		
<b>spare parts for</b>	500199		
	<b>GEV No.</b>	365017	<b>Ref. No.</b> —
	operating capacitor capacity 5 $\mu$ F 450V		
	<b>GEV No.</b>	510693	<b>Ref. No.</b> N/A
	mechanical shaft seal for shaft $\varnothing$ 12 mm		
	<b>GEV No.</b>	521151	<b>Ref. No.</b> N/A
	impellor $\varnothing$ 71 mm H 19 mm pump type OLYMPIA		
	<b>GEV No.</b>	521178	<b>Ref. No.</b> N/A
	pump casing OLYMPIA outlet $\varnothing$ 30/24mm pump type T80		
	<b>GEV No.</b>	521552	<b>Ref. No.</b> N/A
	pump cover OLYMPIA inlet $\varnothing$ 32 mm outlet $\varnothing$ 30/24mm		
	<b>GEV No.</b>	521703	<b>Ref. No.</b> N/A
	pump cover gasket EPDM thickness 2,5 mm ID $\varnothing$ 75 mm		



1

<b>GEV No.</b>	499322	<b>Ref. No.</b>	L63.T33DX
<b>description</b>	pump inlet $\varnothing$ 33mm outlet $\varnothing$ 30/28mm type L63.T33DX 230V 50Hz 1 phase 0,26kW 0,33HP L 260mm rotation direction left capacitor 5 $\mu$ F OLYMPIA		
<b>spare parts for</b>	499322		
	<b>GEV No.</b>	365017	<b>Ref. No.</b> —
	operating capacitor capacity 5 $\mu$ F 450V		
	<b>GEV No.</b>	510693	<b>Ref. No.</b> N/A
	mechanical shaft seal for shaft $\varnothing$ 12 mm		
	<b>GEV No.</b>	521258	<b>Ref. No.</b> N/A
	impellor $\varnothing$ 80 mm H 13 mm thread M10R shaft $\varnothing$ 12 mm		
	<b>GEV No.</b>	521551	<b>Ref. No.</b> N/A
	pump cover OLYMPIA inlet $\varnothing$ 33 mm outlet $\varnothing$ 30 mm		
	<b>GEV No.</b>	521723	<b>Ref. No.</b> N/A
	pump cover gasket EPDM thickness 2 mm ID $\varnothing$ 90 mm		



1



<b>GEV No.</b>	500520	<b>Ref. No.</b>	T33
<b>description</b>	pump inlet $\varnothing$ 33mm outlet $\varnothing$ 30/28mm type T33 230V 50Hz 1 phase 0,25kW 0,34HP L 190mm rotation direction left capacitor 5 $\mu$ F OLYMPIA		
<b>spare parts for</b>	500520		
	<b>GEV No.</b>	365017	<b>Ref. No.</b> —
	operating capacitor capacity 5 $\mu$ F 450V		
	<b>GEV No.</b>	510693	<b>Ref. No.</b> N/A
	mechanical shaft seal for shaft $\varnothing$ 12 mm		

Table continues overleaf





Зип Общепит

vsezip.ru





+7(812)987-08-81

spare parts for 500520

	GEV No.	521151	Ref. No.	N/A
impellor ø 71 mm H 19 mm pump type OLYMPIA				
	GEV No.	521551	Ref. No.	N/A
pump cover OLYMPIA inlet ø 33 mm outlet ø 30 mm				
	GEV No.	521723	Ref. No.	N/A
pump cover gasket EPDM thickness 2 mm ID ø 90 mm				



1

GEV No.	500958	Ref. No.	T.45 Krupps	
description	pump inlet ø 33mm outlet ø 30/28mm type T45 230V 50Hz 1 phase 0,33kW 0,45HP L 215mm rotation direction left capacitor 8µF OLYMPIA			
spare parts for 500958				
	GEV No.	365013	Ref. No.	—
operating capacitor capacity 8µF 400V				
	GEV No.	510693	Ref. No.	N/A
mechanical shaft seal for shaft ø 12 mm				
	GEV No.	521257	Ref. No.	—
impellor ø 80 mm H 12 mm rotation direction left				
	GEV No.	521551	Ref. No.	N/A
pump cover OLYMPIA inlet ø 33 mm outlet ø 30 mm				
	GEV No.	521723	Ref. No.	N/A
pump cover gasket EPDM thickness 2 mm ID ø 90 mm				



1

GEV No.	499320	Ref. No.	L63.T20SX	
description	pump inlet ø 33mm outlet ø 30mm type L63.T20SX 230V 50Hz 1 phase 0,2kW L 200mm rotation direction right capacitor 5µF auxiliary pressure connection 10mm supporting pressure closed OLYMPIA			
spare parts for 499320				
	GEV No.	365017	Ref. No.	—
operating capacitor capacity 5µF 450V				
	GEV No.	510693	Ref. No.	N/A
mechanical shaft seal for shaft ø 12 mm				
	GEV No.	521173	Ref. No.	N/A
pump cover OLYMPIA inlet ø 33 mm outlet ø 30 mm				
	GEV No.	521174	Ref. No.	N/A
impellor ø 60 mm H 16 mm pump type L63.T20SX				
	GEV No.	521723	Ref. No.	N/A
pump cover gasket EPDM thickness 2 mm ID ø 90 mm				



1

GEV No.	500519	Ref. No.	T33	
description	pump inlet ø 33mm outlet ø 30mm type T33 230V 50Hz 1 phase 0,25kW 0,34HP L 195mm rotation direction left capacitor 5µF OLYMPIA			
spare parts for 500519				
	GEV No.	365017	Ref. No.	—
operating capacitor capacity 5µF 450V				





Table continues overleaf







Зип Общепит



vsezip.ru

+7(812)987-08-81

<b>spare parts for</b> 500519			
	GEV No.	510693	Ref. No. N/A
mechanical shaft seal for shaft $\varnothing$ 12 mm			
	GEV No.	521257	Ref. No. —
impellor $\varnothing$ 80 mm H 12 mm rotation direction left			
	GEV No.	521553	Ref. No. N/A
pump cover OLYMPIA inlet $\varnothing$ 33 mm outlet $\varnothing$ 30 mm			
	GEV No.	521723	Ref. No. N/A
pump cover gasket EPDM thickness 2 mm ID $\varnothing$ 90 mm			



<b>1</b>			
<b>GEV No.</b>	500152	<b>Ref. No.</b>	T90
<b>description</b>	pump inlet $\varnothing$ 44mm outlet $\varnothing$ 30mm type T90 230V 50Hz 1 phase 0,33kW 0,45HP L 220mm rotation direction left capacitor 8 $\mu$ F OLYMPIA		
<b>spare parts for</b> 500152			
	GEV No.	365013	Ref. No. —
operating capacitor capacity 8 $\mu$ F 400V			
	GEV No.	509007	Ref. No. N/A
impellor $\varnothing$ 85 mm H 20 mm rotation direction left			
	GEV No.	510693	Ref. No. N/A
mechanical shaft seal for shaft $\varnothing$ 12 mm			
	GEV No.	521550	Ref. No. N/A
pump cover OLYMPIA inlet $\varnothing$ 44 mm			
	GEV No.	521703	Ref. No. N/A
pump cover gasket EPDM thickness 2,5 mm ID $\varnothing$ 75 mm			

<b>1</b>			
<b>GEV No.</b>	500003	<b>Ref. No.</b>	T30
<b>description</b>	pump inlet $\varnothing$ 45mm outlet $\varnothing$ 32mm type T30 230V 50Hz 1 phase 0,29kW 0,39HP L 190mm rotation direction right capacitor 8 $\mu$ F OLYMPIA		
<b>spare parts for</b> 500003			
	GEV No.	365013	Ref. No. —
operating capacitor capacity 8 $\mu$ F 400V			
	GEV No.	510512	Ref. No. N/A
pump cover OLYMPIA inlet $\varnothing$ 45 mm outlet $\varnothing$ 31 mm			
	GEV No.	510554	Ref. No. N/A
O-ring EPDM thickness 2 mm ID $\varnothing$ 120 mm Qty 1 pcs			
	GEV No.	510615	Ref. No. N/A
impellor $\varnothing$ 90 mm H 22 mm rotation direction right			
	GEV No.	510693	Ref. No. N/A
mechanical shaft seal for shaft $\varnothing$ 12 mm			

→ electric components





Зип-Обслуживание

vsezip.ru

+7(812)987-08-81







<b>1</b>			
<b>GEV No.</b>	499208	<b>Ref. No.</b>	L80.T100_4540
<b>description</b>	pump inlet ø 45mm outlet ø 40mm type L80.T100 230V 50Hz 1 phase 0,75kW 1HP L 210mm rotation direction right capacitor 12,5µF OLYMPIA		
<b>spare parts for</b>	499208		
	<b>GEV No.</b>	365014	<b>Ref. No.</b> —
	operating capacitor capacity 12,5µF 400V		
	<b>GEV No.</b>	510693	<b>Ref. No.</b> N/A
	mechanical shaft seal for shaft ø 12 mm		



<b>1</b>			
<b>GEV No.</b>	499050	<b>Ref. No.</b>	MEC71.T75SX
<b>description</b>	pump inlet ø 45mm outlet ø 40mm type MEC71.T75SX 230V 50Hz 1 phase 0,55kW 0,75HP L 283mm rotation direction right capacitor 12,5µF OLYMPIA		
<b>spare parts for</b>	499050		
	<b>GEV No.</b>	365014	<b>Ref. No.</b> —
	operating capacitor capacity 12,5µF 400V		
	<b>GEV No.</b>	510554	<b>Ref. No.</b> N/A
	O-ring EPDM thickness 2 mm ID ø 120 mm Qty 1 pcs		
	<b>GEV No.</b>	510693	<b>Ref. No.</b> N/A
	mechanical shaft seal for shaft ø 12 mm		
	<b>GEV No.</b>	517368	<b>Ref. No.</b> N/A
	impellor ø 102 mm H 21 mm rotation direction right		

<b>spare parts for</b>	499050		
	<b>GEV No.</b>	521158	<b>Ref. No.</b> N/A
	pump cover OLYMPIA inlet 45 inlet ø 40 mm		



<b>1</b>			
<b>GEV No.</b>	500476	<b>Ref. No.</b>	T45
<b>description</b>	pump inlet ø 50mm outlet ø 30mm type T45 230V 50Hz 1 phase 0,33kW 0,45HP L 215mm rotation direction left capacitor 8µF OLYMPIA		
<b>spare parts for</b>	500476		
	<b>GEV No.</b>	365013	<b>Ref. No.</b> —
	operating capacitor capacity 8µF 400V		
	<b>GEV No.</b>	501312	<b>Ref. No.</b> —
	O-ring EPDM thickness 1,78 mm ID ø 88,62 mm		
	<b>GEV No.</b>	510693	<b>Ref. No.</b> N/A
	mechanical shaft seal for shaft ø 12 mm		
	<b>GEV No.</b>	521258	<b>Ref. No.</b> N/A
	impellor ø 80 mm H 13 mm thread M10R shaft ø 12 mm		



<b>1</b>			
<b>GEV No.</b>	500523	<b>Ref. No.</b>	T5
<b>description</b>	pump inlet ø 50mm outlet ø 30mm type T5 230V 50Hz 1 phase 0,35kW 0,48HP L 205mm rotation direction right capacitor 10µF auxiliary pressure connection 10mm supporting pressure open OLYMPIA		
<b>spare parts for</b>	500523		
	<b>GEV No.</b>	365015	<b>Ref. No.</b> —
	operating capacitor capacity 10µF 400V		

Table continues overleaf

Зип Общепит

vsezip.ru

+7(812)987-08-81

<b>spare parts for</b> 500523			
	GEV No.	510554	Ref. No. N/A
O-ring EPDM thickness 2 mm ID ø 120 mm Qty 1 pcs			
	GEV No.	510693	Ref. No. N/A
mechanical shaft seal for shaft ø 12 mm			
	GEV No.	521260	Ref. No. N/A
impellor ø 90 mm H 12 mm M10L type B			
	GEV No.	521556	Ref. No. N/A
pump cover OLYMPIA inlet ø 50 mm outlet ø 30 mm			



1

<b>GEV No.</b>	500524	<b>Ref. No.</b>	T6
<b>description</b>	pump inlet ø 50mm outlet ø 30mm type T6 230V 50Hz 1 phase 0,48kW 0,65HP L 215mm rotation direction right capacitor 10µF OLYMPIA		
<b>spare parts for</b> 500524			
	GEV No.	365015	Ref. No. —
operating capacitor capacity 10µF 400V			
	GEV No.	510554	Ref. No. N/A
O-ring EPDM thickness 2 mm ID ø 120 mm Qty 1 pcs			
	GEV No.	510693	Ref. No. N/A
mechanical shaft seal for shaft ø 12 mm			
	GEV No.	521262	Ref. No. N/A
impellor ø 102 mm H 19 mm rotation direction right			
	GEV No.	521556	Ref. No. N/A
pump cover OLYMPIA inlet ø 50 mm outlet ø 30 mm			



1

<b>GEV No.</b>	500525	<b>Ref. No.</b>	T7
<b>description</b>	pump inlet ø 50mm outlet ø 30mm type T7 230V 50Hz 1 phase 0,52kW 0,71HP L 230mm rotation direction right capacitor 12,5µF OLYMPIA		
<b>spare parts for</b> 500525			
	GEV No.	365014	Ref. No. —
operating capacitor capacity 12,5µF 400V			
	GEV No.	510554	Ref. No. N/A
O-ring EPDM thickness 2 mm ID ø 120 mm Qty 1 pcs			
	GEV No.	510693	Ref. No. N/A
mechanical shaft seal for shaft ø 12 mm			
	GEV No.	517368	Ref. No. N/A
impellor ø 102 mm H 21 mm rotation direction right			
	GEV No.	521556	Ref. No. N/A
pump cover OLYMPIA inlet ø 50 mm outlet ø 30 mm			

Зип-Обслуживание



spare parts for 499217





vsezip.ru

+7(812)987-08-81







1

<b>GEV No.</b>	500983	<b>Ref. No.</b>	T7
<b>description</b>	pump inlet ø 50mm outlet ø 30mm type T7 230V 50Hz 1 phase 0,52kW 0,7HP L 220mm rotation direction right capacitor 10µF OLYMPIA		
<b>spare parts for</b>	500983		
	<b>GEV No.</b>	365015	<b>Ref. No.</b> —
	operating capacitor capacity 10µF 400V		
	<b>GEV No.</b>	510554	<b>Ref. No.</b> N/A
	O-ring EPDM thickness 2 mm ID ø 120 mm Qty 1 pcs		
	<b>GEV No.</b>	510693	<b>Ref. No.</b> N/A
	mechanical shaft seal for shaft ø 12 mm		
	<b>GEV No.</b>	517368	<b>Ref. No.</b> N/A
	impellor ø 102 mm H 21 mm rotation direction right		
	<b>GEV No.</b>	521569	<b>Ref. No.</b> N/A
	pump cover OLYMPIA inlet ø 50 mm outlet ø 31 mm		

	<b>GEV No.</b>	510554	<b>Ref. No.</b>	N/A
	O-ring EPDM thickness 2 mm ID ø 120 mm Qty 1 pcs			
	<b>GEV No.</b>	510693	<b>Ref. No.</b>	N/A
	mechanical shaft seal for shaft ø 12 mm			
	<b>GEV No.</b>	517368	<b>Ref. No.</b>	N/A
	impellor ø 102 mm H 21 mm rotation direction right			
	<b>GEV No.</b>	521156	<b>Ref. No.</b>	N/A
	pump cover OLYMPIA inlet ø 50 mm outlet ø 40 mm			



1

<b>GEV No.</b>	500477	<b>Ref. No.</b>	T5
<b>description</b>	pump inlet ø 50mm outlet ø 40mm type T5 230V 50Hz 1 phase 0,35kW 0,48HP L 200mm rotation direction right capacitor 10µF OLYMPIA inlet ø 50mm outlet ø 40mm		
<b>spare parts for</b>	500477		
	<b>GEV No.</b>	365015	<b>Ref. No.</b> —
	operating capacitor capacity 10µF 400V		
	<b>GEV No.</b>	507458	<b>Ref. No.</b> —
	impellor ø 90 mm H 12 mm rotation direction right		
	<b>GEV No.</b>	510554	<b>Ref. No.</b> N/A
	O-ring EPDM thickness 2 mm ID ø 120 mm Qty 1 pcs		
	<b>GEV No.</b>	510693	<b>Ref. No.</b> N/A
	mechanical shaft seal for shaft ø 12 mm		



1

<b>GEV No.</b>	499217	<b>Ref. No.</b>	L80.T7_5040
<b>description</b>	pump inlet ø 50mm outlet ø 40mm type L80.T7_5040 230V 50Hz 1 phase 0,6kW 0,8HP L 205mm rotation direction right capacitor 12,5µF D 85 dgt OLYMPIA		
<b>spare parts for</b>	499217		
	<b>GEV No.</b>	365014	<b>Ref. No.</b> —
	operating capacitor capacity 12,5µF 400V		







Зип-Общество





vsezip.ru

+7(812)987-08-81







1

<b>GEV No.</b>	499314	<b>Ref. No.</b>	L71.T5_5040
<b>description</b>	pump inlet $\varnothing$ 50mm outlet $\varnothing$ 41mm type L71T5_5040 230V 50Hz 1 phase 0,38kW L 200mm rotation direction right capacitor 10 $\mu$ F OLYMPIA		
<b>spare parts for</b>	499314		
	<b>GEV No.</b>	365015	<b>Ref. No.</b> —
	operating capacitor capacity 10 $\mu$ F 400V		
	<b>GEV No.</b>	510554	<b>Ref. No.</b> N/A
	O-ring EPDM thickness 2 mm ID $\varnothing$ 120 mm Qty 1 pcs		
	<b>GEV No.</b>	510693	<b>Ref. No.</b> N/A
	mechanical shaft seal for shaft $\varnothing$ 12 mm		
	<b>GEV No.</b>	521156	<b>Ref. No.</b> N/A
	pump cover OLYMPIA inlet $\varnothing$ 50 mm outlet $\varnothing$ 40 mm		
	<b>GEV No.</b>	521157	<b>Ref. No.</b> N/A
	impellor $\varnothing$ 82 mm H 22 mm thread M10L		

<b>spare parts for</b> 499063			
	<b>GEV No.</b>	510693	<b>Ref. No.</b> N/A
	mechanical shaft seal for shaft $\varnothing$ 12 mm		
	<b>GEV No.</b>	521065	<b>Ref. No.</b> N/A
	pump cover OLYMPIA inlet $\varnothing$ 50 mm outlet $\varnothing$ 48 mm		
	<b>GEV No.</b>	521162	<b>Ref. No.</b> N/A
	impellor $\varnothing$ 106 mm H 22 mm pump type T75		
	<b>GEV No.</b>	521727	<b>Ref. No.</b> N/A
	pump cover gasket EPDM thickness 1,78 mm		



1

<b>GEV No.</b>	500475	<b>Ref. No.</b>	T75
<b>description</b>	pump inlet $\varnothing$ 50mm outlet $\varnothing$ 48mm type T75 230V 50Hz 1 phase 0,55kW 0,75HP L 237mm rotation direction right capacitor 12,5 $\mu$ F OLYMPIA		
<b>spare parts for</b>	500475		
	<b>GEV No.</b>	365014	<b>Ref. No.</b> —
	operating capacitor capacity 12,5 $\mu$ F 400V		
	<b>GEV No.</b>	510693	<b>Ref. No.</b> N/A
	mechanical shaft seal for shaft $\varnothing$ 12 mm		
	<b>GEV No.</b>	521161	<b>Ref. No.</b> N/A
	pump cover OLYMPIA inlet $\varnothing$ 50 mm outlet $\varnothing$ 48/31mm		
	<b>GEV No.</b>	521162	<b>Ref. No.</b> N/A
	impellor $\varnothing$ 106 mm H 22 mm pump type T75		
	<b>GEV No.</b>	521727	<b>Ref. No.</b> N/A
	pump cover gasket EPDM thickness 1,78 mm		



1

<b>GEV No.</b>	499063	<b>Ref. No.</b>	T15
<b>description</b>	pump inlet $\varnothing$ 50mm outlet $\varnothing$ 48mm type T15 230V 50Hz 1 phase 1,1kW L 295mm rotation direction right capacitor 16 $\mu$ F auxiliary pressure connection 10mm supporting pressure closed OLYMPIA		
<b>spare parts for</b>	499063		
	<b>GEV No.</b>	365021	<b>Ref. No.</b> —
	operating capacitor capacity 16 $\mu$ F 425V		





→ electric components





Зип-Общепит

vsezip.ru







+7(812)987-08-81



<b>1</b>			
<b>GEV No.</b>	499260	<b>Ref. No.</b>	A.4.5/2.6
<b>description</b>	pump inlet ø 60mm outlet ø 48mm type A.4.5/2.6 220-240/380-415V 50Hz 3 phase 1,12kW 1,5HP L 310mm rotation direction right OLYMPIA		
<b>spare parts for</b>	499260		
	<b>GEV No.</b>	510693	<b>Ref. No.</b> N/A
	mechanical shaft seal for shaft ø 12 mm		
	<b>GEV No.</b>	521175	<b>Ref. No.</b> N/A
	pump cover OLYMPIA inlet ø 60 mm outlet ø 48 mm		
	<b>GEV No.</b>	521262	<b>Ref. No.</b> N/A
	impellor ø 102 mm H 19 mm rotation direction right		
	<b>GEV No.</b>	521727	<b>Ref. No.</b> N/A
	pump cover gasket EPDM thickness 1,78 mm		

<b>spare parts for</b>	500529		
	<b>GEV No.</b>	510693	<b>Ref. No.</b> N/A
	mechanical shaft seal for shaft ø 12 mm		
	<b>GEV No.</b>	521010	<b>Ref. No.</b> N/A
	pump cover OLYMPIA inlet ø 60 mm outlet ø 48 mm		
	<b>GEV No.</b>	521559	<b>Ref. No.</b> N/A
	impellor ø 93 mm H 12 mm M10L blades 8		
	<b>GEV No.</b>	521559	<b>Ref. No.</b> N/A
	pump cover OLYMPIA inlet ø 60 mm outlet ø 48 mm		
	<b>GEV No.</b>	521727	<b>Ref. No.</b> N/A
	pump cover gasket EPDM thickness 1,78 mm		



<b>1</b>			
<b>GEV No.</b>	500530	<b>Ref. No.</b>	T15
<b>description</b>	pump inlet ø 60mm outlet ø 48mm type T15 230V 50Hz 1 phase 1,1kW 1,5HP L 305mm rotation direction right OLYMPIA		
<b>spare parts for</b>	500530		
	<b>GEV No.</b>	365021	<b>Ref. No.</b> —
	operating capacitor capacity 16µF 425V		
	<b>GEV No.</b>	510693	<b>Ref. No.</b> N/A
	mechanical shaft seal for shaft ø 12 mm		
	<b>GEV No.</b>	521039	<b>Ref. No.</b> —
	fanwheel cover ID ø 156mm ED ø 161mm H 76mm		
	<b>GEV No.</b>	521262	<b>Ref. No.</b> N/A
	impellor ø 102 mm H 19 mm rotation direction right		
	<b>GEV No.</b>	521559	<b>Ref. No.</b> N/A
	pump cover OLYMPIA inlet ø 60 mm outlet ø 48 mm		
	<b>GEV No.</b>	521727	<b>Ref. No.</b> N/A
	pump cover gasket EPDM thickness 1,78 mm		



<b>1</b>			
<b>GEV No.</b>	500529	<b>Ref. No.</b>	T12
<b>description</b>	pump inlet ø 60mm outlet ø 48mm type T12 230V 50Hz 1 phase 0,88kW 1,2HP L 270mm rotation direction right capacitor 16µF auxiliary pressure connection 10mm supporting pressure open OLYMPIA		
<b>spare parts for</b>	500529		
	<b>GEV No.</b>	365021	<b>Ref. No.</b> —
	operating capacitor capacity 16µF 425V		

Зип Общевит

vsezip.ru

+7(812)987-08-81



1

<b>GEV No.</b>	499291	<b>Ref. No.</b>	T.15 (6501)
<b>description</b>	pump inlet $\varnothing$ 60mm outlet $\varnothing$ 48mm type T15 230V 50Hz 1 phase 1,1kW L 310mm rotation direction right capacitor 16 $\mu$ F OLYMPIA		
<b>spare parts for</b>	499291		
	<b>GEV No.</b>	<b>Ref. No.</b>	—
	365021		operating capacitor capacity 16 $\mu$ F 425V
	<b>GEV No.</b>	<b>Ref. No.</b>	N/A
	510693		mechanical shaft seal for shaft $\varnothing$ 12 mm
	<b>GEV No.</b>	<b>Ref. No.</b>	N/A
	521162		impellor $\varnothing$ 106 mm H 22 mm pump type T75
	<b>GEV No.</b>	<b>Ref. No.</b>	N/A
	521175		pump cover OLYMPIA inlet $\varnothing$ 60 mm outlet $\varnothing$ 48 mm
	<b>GEV No.</b>	<b>Ref. No.</b>	N/A
	521727		pump cover gasket EPDM thickness 1,78 mm

<b>spare parts for</b> 500526			
	<b>GEV No.</b>	<b>Ref. No.</b>	N/A
	510693		mechanical shaft seal for shaft $\varnothing$ 12 mm
	<b>GEV No.</b>	<b>Ref. No.</b>	N/A
	521260		impellor $\varnothing$ 90 mm H 12 mm M10L type B
	<b>GEV No.</b>	<b>Ref. No.</b>	N/A
	521559		pump cover OLYMPIA inlet $\varnothing$ 60 mm outlet $\varnothing$ 48 mm
	<b>GEV No.</b>	<b>Ref. No.</b>	N/A
	521727		pump cover gasket EPDM thickness 1,78 mm



1

<b>GEV No.</b>	499338	<b>Ref. No.</b>	MEC71.T120SX
<b>description</b>	pump inlet $\varnothing$ 62mm outlet $\varnothing$ 50mm type MEC71.T120SX 220-240/380-415V 50Hz 3 phase 0,88kW 1,2HP L 310mm rotation direction right OLYMPIA		
<b>spare parts for</b>	499338		
	<b>GEV No.</b>	<b>Ref. No.</b>	N/A
	510693		mechanical shaft seal for shaft $\varnothing$ 12 mm
	<b>GEV No.</b>	<b>Ref. No.</b>	N/A
	521152		pump cover OLYMPIA inlet 62 $\varnothing$ 190 mm
	<b>GEV No.</b>	<b>Ref. No.</b>	N/A
	521153		pump casing OLYMPIA outlet $\varnothing$ 52 mm
	<b>GEV No.</b>	<b>Ref. No.</b>	N/A
	521154		O-ring ID $\varnothing$ 152,7 mm thickness 2,62 mm EPDM



1

<b>GEV No.</b>	500526	<b>Ref. No.</b>	T75
<b>description</b>	pump inlet $\varnothing$ 60mm outlet $\varnothing$ 48mm type T75 230V 50Hz 1 phase 0,55kW 0,75HP L 250mm rotation direction right capacitor 12,5 $\mu$ F auxiliary pressure connection 10mm supporting pressure open OLYMPIA		
<b>spare parts for</b>	500526		
	<b>GEV No.</b>	<b>Ref. No.</b>	—
	365014		operating capacitor capacity 12,5 $\mu$ F 400V

electric components

Зип-Обслуживание

vsezip.ru

+7(812)987-08-81



<b>GEV No.</b>	499259	<b>Ref. No.</b>	MEC71.T1200X
<b>description</b>	pump inlet ø 62mm outlet ø 52mm type MEC.T120DX 220-240/380-415V 50Hz 3 phase 0,89kW 1,2HP L 310mm rotation direction left OLYMPIA		
<b>spare parts for</b>	499259		
	<b>GEV No.</b>	510693	<b>Ref. No.</b> N/A
	mechanical shaft seal for shaft ø 12 mm		
	<b>GEV No.</b>	521152	<b>Ref. No.</b> N/A
	pump cover OLYMPIA inlet 62 ø 190 mm		
	<b>GEV No.</b>	521153	<b>Ref. No.</b> N/A
	pump casing OLYMPIA outlet ø 52 mm		
	<b>GEV No.</b>	521154	<b>Ref. No.</b> N/A
	O-ring ID ø 152,7 mm thickness 2,62 mm EPDM		
	<b>GEV No.</b>	521172	<b>Ref. No.</b> N/A
	impellor ø 107 mm H 28 mm pump type MEC.T120DX		



<b>GEV No.</b>	499226	<b>Ref. No.</b>	MEC80.T200SX
<b>description</b>	pump inlet ø 62mm outlet ø 52mm type MEC80.T200SX 230/400V 50Hz 3 phase 1,5kW 2HP L 340mm rotation direction right OLYMPIA		
<b>spare parts for</b>	499226		
	<b>GEV No.</b>	510693	<b>Ref. No.</b> N/A
	mechanical shaft seal for shaft ø 12 mm		
	<b>GEV No.</b>	521152	<b>Ref. No.</b> N/A
	pump cover OLYMPIA inlet 62 ø 190 mm		

<b>spare parts for</b>	499226		
	<b>GEV No.</b>	521153	<b>Ref. No.</b> N/A
	pump casing OLYMPIA outlet ø 52 mm		
	<b>GEV No.</b>	521154	<b>Ref. No.</b> N/A
	O-ring ID ø 152,7 mm thickness 2,62 mm EPDM		
	<b>GEV No.</b>	521155	<b>Ref. No.</b> N/A
	impellor ø 117 mm H 31 mm pump type OLYMPIA		
<b>accessories for</b>	499226		
	<b>GEV No.</b>	542157	<b>Ref. No.</b> —
	bracket for wash pump L 267mm W 132mm H 43mm		



<b>GEV No.</b>	499290	<b>Ref. No.</b>	8801
<b>description</b>	pump inlet ø 63mm outlet ø 51mm type MEC80.T220SX 380-415V 50Hz 3 phase 1,64kW 2,2HP L 330mm rotation direction right OLYMPIA		
<b>spare parts for</b>	499290		
	<b>GEV No.</b>	510693	<b>Ref. No.</b> N/A
	mechanical shaft seal for shaft ø 12 mm		
	<b>GEV No.</b>	517650	<b>Ref. No.</b> N/A
	impellor ø 107 mm H 31 mm pump type MEC80.T220SX		
	<b>GEV No.</b>	521152	<b>Ref. No.</b> N/A
	pump cover OLYMPIA inlet 62 ø 190 mm		
	<b>GEV No.</b>	521153	<b>Ref. No.</b> N/A
	pump casing OLYMPIA outlet ø 52 mm		
	<b>GEV No.</b>	521154	<b>Ref. No.</b> N/A
	O-ring ID ø 152,7 mm thickness 2,62 mm EPDM		





Зип Общепит

vsezip.ru

+7(812)987-08-81



1

<b>GEV No.</b>	500535	<b>Ref. No.</b>	T70
<b>description</b>	pump inlet ø outlet ø 27mm type T70 230V 50Hz 1 phase 0,3kW 0,4HP L 130mm rotation direction right capacitor 6,3µF OLYMPIA		
<b>spare parts for</b>	500535		
	<b>GEV No.</b>	365012	<b>Ref. No.</b> —
	operating capacitor capacity 6,3µF 450V		
	<b>GEV No.</b>	510556	<b>Ref. No.</b> N/A
	O-ring EPDM thickness 1,78 mm ID ø 94,97 mm		
	<b>GEV No.</b>	510693	<b>Ref. No.</b> N/A
	mechanical shaft seal for shaft ø 12 mm		
	<b>GEV No.</b>	521254	<b>Ref. No.</b> N/A
	impellor ø 81 mm H 11 mm thread M8L shaft ø 12 mm		

spare parts and accessories

mechanical shaft seals



1

<b>GEV No.</b>	510693	<b>Ref. No.</b>	N/A
<b>description</b>	mechanical shaft seal for shaft ø 12mm slide ring ext. ø 24mm slide ring H 15,5mm slide ring int. ø 11mm counter ring mounting ø 24mm height counter ring 8mm counter ring int. ø 14mm		



1

<b>GEV No.</b>	521262	<b>Ref. No.</b>	N/A
<b>description</b>	impellor ø 102mm H 19mm rotation direction right thread M10L blades 6		



1

<b>GEV No.</b>	517368	<b>Ref. No.</b>	N/A
<b>description</b>	impellor ø 102mm H 21mm rotation direction right thread M10L suitable for Dihr blades 8		



1

<b>GEV No.</b>	521162	<b>Ref. No.</b>	N/A
<b>description</b>	impellor ø 106mm H 22mm pump type T75 thread M10L		



1

<b>GEV No.</b>	521172	<b>Ref. No.</b>	N/A
<b>description</b>	impellor ø 107mm H 28mm pump type MEC.T120DX thread M8R		



Зип Общепит

vsezip.ru

+7(812)987-08-81



1

<b>GEV No.</b>	517650	<b>Ref. No.</b>	N/A
<b>description</b>	impeller ø 107mm H 31mm pump type MEC80.T220SX shaft intake ø 12mm rotation direction right thread M8L blades 6		



1

<b>GEV No.</b>	521155	<b>Ref. No.</b>	N/A
<b>description</b>	impeller ø 117mm H 31mm pump type OLYMPIA thread M8L blades 6		



1

<b>GEV No.</b>	521174	<b>Ref. No.</b>	N/A
<b>description</b>	impeller ø 60mm H 16mm pump type L63.T20SX shaft ø 12mm shaft length 8mm		



1

<b>GEV No.</b>	521164	<b>Ref. No.</b>	N/A
<b>description</b>	impeller ø 64mm H 15mm pump type L63.T19 thread M7L shaft ø 12mm shaft length 30mm		



1

<b>GEV No.</b>	521169	<b>Ref. No.</b>	N/A
<b>description</b>	impeller ø 64mm H 15mm pump type T.19DX thread M7R shaft ø 12mm shaft length 30mm		



1

<b>GEV No.</b>	521151	<b>Ref. No.</b>	N/A
<b>description</b>	impeller ø 71mm H 19mm pump type OLYMPIA thread M10R shaft ø 12mm shaft length 8mm		



1

<b>GEV No.</b>	521256	<b>Ref. No.</b>	N/A
<b>description</b>	impeller ø 74mm H 14mm thread M10L shaft ø 12mm shaft length 7,5mm blades 8		



1

<b>GEV No.</b>	521171	<b>Ref. No.</b>	N/A
<b>description</b>	impeller ø 74mm H 16mm pump type L63.T40 thread M10L		

Зип Общепит

vsezip.ru

+7(812)987-08-81



1

<b>GEV No.</b>	510249	<b>Ref. No.</b>	N/A
<b>description</b>	impellor ø 74mm H 19mm pump type T25 rotation direction left thread M10R shaft ø 12mm shaft length 8mm blades 6		



1

<b>GEV No.</b>	521157	<b>Ref. No.</b>	N/A
<b>description</b>	impellor ø 82mm H 22mm thread M10L		



1

<b>GEV No.</b>	509001	<b>Ref. No.</b>	N/A
<b>description</b>	impellor ø 75mm H 15mm pump type type C rotation direction left thread M6R shaft ø 11/12mm shaft length 25mm blades 4		



1

<b>GEV No.</b>	509007	<b>Ref. No.</b>	N/A
<b>description</b>	impellor ø 85mm H 20mm rotation direction left thread M10R shaft ø 12mm shaft length 7,5mm blades 12		



1

<b>GEV No.</b>	521258	<b>Ref. No.</b>	N/A
<b>description</b>	impellor ø 80mm H 13mm thread M10R shaft ø 12mm shaft length 7,5mm blades 6		



1

<b>GEV No.</b>	521260	<b>Ref. No.</b>	N/A
<b>description</b>	impellor ø 90mm H 12mm M10L type B		



1

<b>GEV No.</b>	521254	<b>Ref. No.</b>	N/A
<b>description</b>	impellor ø 81mm H 11mm thread M8L shaft ø 12mm shaft length 28mm blades 6		



1

<b>GEV No.</b>	510615	<b>Ref. No.</b>	N/A
<b>description</b>	impellor ø 90mm H 22mm rotation direction right thread M10L blades 4		



Зип-Общепит

vsezip.ru

+7(812)987-08-81

1



<b>GEV No.</b>	521166	<b>Ref. No.</b>	N/A
<b>description</b>	impellor ø 90mm H 9mm pump type R63.T33 PRS thread M10R shaft ø 12mm shaft length 8mm		

1



<b>GEV No.</b>	521259	<b>Ref. No.</b>	N/A
<b>description</b>	impellor ø 94mm H 11mm rotation direction left thread M10R blades 6		

1



<b>GEV No.</b>	521160	<b>Ref. No.</b>	N/A
<b>description</b>	impellor ø 97mm H 22mm thread M10L		

1



<b>GEV No.</b>	521010	<b>Ref. No.</b>	N/A
<b>description</b>	impellor ø 98mm H 12mm M10L blades 8		

1



<b>GEV No.</b>	521178	<b>Ref. No.</b>	N/A
<b>description</b>	pump casing OLYMPIA outlet ø 30/24mm pump type T80		

1



<b>GEV No.</b>	521153	<b>Ref. No.</b>	N/A
<b>description</b>	pump casing OLYMPIA outlet ø 52mm		

1



<b>GEV No.</b>	521554	<b>Ref. No.</b>	N/A
<b>description</b>	pump cover OLYMPIA inlet 1" ø 90mm ID ø 66mm inner height 5mm		

1



<b>GEV No.</b>	509003	<b>Ref. No.</b>	N/A	
<b>description</b>	pump cover OLYMPIA inlet 1" outlet ø 28mm pump type T60			
<b>accessories for</b>	509003			
	<b>GEV No.</b>	528800	<b>Ref. No.</b>	N/A
	O-ring EPDM thickness 2,62 mm ID ø 75,87 mm			



Зип Общепит

vsezip.ru

+7(812)987-08-81



1

<b>GEV No.</b>	521159	<b>Ref. No.</b>	N/A
<b>description</b>	pump cover OLYMPIA inlet 30 inlet ø 30mm auxiliary pressure connection 10mm pump type L71.T730_30		



1

<b>GEV No.</b>	521168	<b>Ref. No.</b>	N/A
<b>description</b>	pump cover OLYMPIA inlet ø 14mm outlet ø 30mm pump type T.19DX		



1

<b>GEV No.</b>	521158	<b>Ref. No.</b>	N/A
<b>description</b>	pump cover OLYMPIA inlet 45 inlet ø 40mm pump type MEC71.T75SX		



1

<b>GEV No.</b>	521165	<b>Ref. No.</b>	N/A
<b>description</b>	pump cover OLYMPIA inlet ø 15mm outlet ø 13mm pump type R63.T33 PRS		



1

<b>GEV No.</b>	521152	<b>Ref. No.</b>	N/A
<b>description</b>	pump cover OLYMPIA inlet 62 ø 190mm		



1

<b>GEV No.</b>	521163	<b>Ref. No.</b>	N/A
<b>description</b>	pump cover OLYMPIA inlet ø 28mm outlet ø 26mm pump type L63.T19		



1

<b>GEV No.</b>	521176	<b>Ref. No.</b>	N/A
<b>description</b>	pump cover OLYMPIA inlet ø 14mm outlet ø 28mm pump type T 4		



1

<b>GEV No.</b>	510248	<b>Ref. No.</b>	N/A
<b>description</b>	pump cover OLYMPIA inlet ø 28mm outlet ø 28mm auxiliary pressure connection 10,5mm supporting pressure closed turn direction left ø 100mm ID ø 83mm inner height 25mm		



1

<b>GEV No.</b>	521167	<b>Ref. No.</b>	N/A
<b>description</b>	pump cover OLYMPIA inlet ø 14mm outlet ø 30/30mm ID ø 94mm		

→ electric components

Зип Общепит

vsezip.ru

+7(812)987-08-81



1

<b>GEV No.</b>	521555	<b>Ref. No.</b>	N/A
<b>description</b>	pump cover OLYMPIA inlet $\varnothing$ 29mm outlet $\varnothing$ 28mm $\varnothing$ 132mm ID $\varnothing$ 123mm inner height 18mm		



1

<b>GEV No.</b>	521553	<b>Ref. No.</b>	N/A
<b>description</b>	pump cover OLYMPIA inlet $\varnothing$ 33mm outlet $\varnothing$ 30mm turn direction left $\varnothing$ 103mm ID $\varnothing$ 93mm inner height 25mm		



1

<b>GEV No.</b>	521552	<b>Ref. No.</b>	N/A
<b>description</b>	pump cover OLYMPIA inlet $\varnothing$ 32mm outlet $\varnothing$ 30/24mm $\varnothing$ 103mm ID $\varnothing$ 93mm		



1

<b>GEV No.</b>	521550	<b>Ref. No.</b>	N/A
<b>description</b>	pump cover OLYMPIA inlet $\varnothing$ 44mm supporting pressure M8 supporting pressure closed $\varnothing$ 103mm ID $\varnothing$ 93mm		



1

<b>GEV No.</b>	521173	<b>Ref. No.</b>	N/A
<b>description</b>	pump cover OLYMPIA inlet $\varnothing$ 33mm outlet $\varnothing$ 30mm auxiliary pressure connection 10mm pump type L63.T20SX		



1

<b>GEV No.</b>	510512	<b>Ref. No.</b>	N/A
<b>description</b>	pump cover OLYMPIA inlet $\varnothing$ 45mm outlet $\varnothing$ 31mm outlet 2 $\varnothing$ 24 turn direction right $\varnothing$ 130mm ID $\varnothing$ 124mm inner height 20mm		



1

<b>GEV No.</b>	521551	<b>Ref. No.</b>	N/A
<b>description</b>	pump cover OLYMPIA inlet $\varnothing$ 33mm outlet $\varnothing$ 30mm outlet 2 $\varnothing$ 28 turn direction left $\varnothing$ 103mm ID $\varnothing$ 93mm inner height 30mm		



1

<b>GEV No.</b>	521556	<b>Ref. No.</b>	N/A
<b>description</b>	pump cover OLYMPIA inlet $\varnothing$ 50mm outlet $\varnothing$ 30mm outlet 2 $\varnothing$ 30 auxiliary pressure connection 10mm supporting pressure open turn direction right $\varnothing$ 130mm ID $\varnothing$ 124mm inner height 20mm		

Зип Общепит

vsezip.ru

+7(812)987-08-81



1

<b>GEV No.</b>	521569	<b>Ref. No.</b>	N/A
<b>description</b>	pump cover OLYMPIA inlet $\varnothing$ 50mm outlet $\varnothing$ 31mm auxiliary pressure connection 10mm supporting pressure closed $\varnothing$ 130mm ID $\varnothing$ 124mm inner high 20mm		



1

<b>GEV No.</b>	521175	<b>Ref. No.</b>	N/A
<b>description</b>	pump cover OLYMPIA inlet $\varnothing$ 60mm outlet $\varnothing$ 48mm outlet 2 $\varnothing$ 31 auxiliary pressure connection 10mm		



1

<b>GEV No.</b>	521156	<b>Ref. No.</b>	N/A
<b>description</b>	pump cover OLYMPIA inlet $\varnothing$ 50mm outlet $\varnothing$ 40mm pump type L71T5_5040		



1

<b>GEV No.</b>	521559	<b>Ref. No.</b>	N/A
<b>description</b>	pump cover OLYMPIA inlet $\varnothing$ 60mm outlet $\varnothing$ 48mm outlet 2 $\varnothing$ 31 auxiliary pressure connection 10mm supporting pressure open turn direction right $\varnothing$ 170mm ID $\varnothing$ 150mm inner high 22mm		



1

<b>GEV No.</b>	521161	<b>Ref. No.</b>	N/A
<b>description</b>	pump cover OLYMPIA inlet $\varnothing$ 50mm outlet $\varnothing$ 48/31mm auxiliary pressure connection 10mm pump type T75		



1

<b>GEV No.</b>	521170	<b>Ref. No.</b>	N/A
<b>description</b>	pump cover OLYMPIA outlet $\varnothing$ 30mm auxiliary pressure connection 11mm pump type L63.T19		



1

<b>GEV No.</b>	521065	<b>Ref. No.</b>	N/A
<b>description</b>	pump cover OLYMPIA inlet $\varnothing$ 50mm outlet $\varnothing$ 48mm pump type T15 turn direction right $\varnothing$ 170mm ID $\varnothing$ 150mm inner high 34mm		

pump cover gaskets

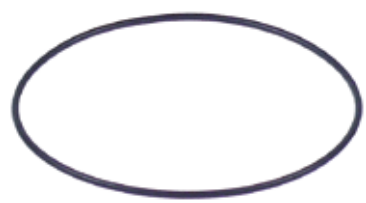

1

<b>GEV No.</b>	521724	<b>Ref. No.</b>	N/A
<b>description</b>	O-ring EPDM thickness 1,78mm ID $\varnothing$ 72,75mm Qty 1 pcs		



Зип Общепит  
vsezip.ru  
+7(812)987-08-81



1

<b>GEV No.</b>	525022	<b>Ref. No.</b>	N/A
<b>description</b>	O-ring EPDM thickness 1,78mm ID ø 75,92mm Qty 1 pcs		

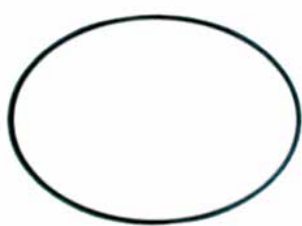

1

<b>GEV No.</b>	510556	<b>Ref. No.</b>	N/A
<b>description</b>	O-ring EPDM thickness 1,78mm ID ø 94,97mm Qty 1 pcs pump type T110		



1

<b>GEV No.</b>	528800	<b>Ref. No.</b>	N/A
<b>description</b>	O-ring EPDM thickness 2,62mm ID ø 75,87mm Qty 1 pcs		

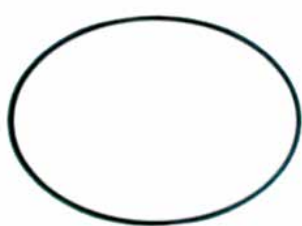

1

<b>GEV No.</b>	510554	<b>Ref. No.</b>	N/A
<b>description</b>	O-ring EPDM thickness 2mm ID ø 120mm Qty 1 pcs		



1

<b>GEV No.</b>	521154	<b>Ref. No.</b>	N/A
<b>description</b>	O-ring ID ø 152,7mm thickness 2,62mm EPDM Qty 1 pcs		



1

<b>GEV No.</b>	521727	<b>Ref. No.</b>	N/A
<b>description</b>	pump cover gasket EPDM thickness 1,78mm ID ø 145mm Qty 1 pcs		



1

<b>GEV No.</b>	521703	<b>Ref. No.</b>	N/A
<b>description</b>	pump cover gasket EPDM thickness 2,5mm ID ø 75mm Qty 1 pcs		



1

<b>GEV No.</b>	521726	<b>Ref. No.</b>	N/A
<b>description</b>	pump cover gasket EPDM thickness 2mm ID ø 120mm Qty 1 pcs		



1

<b>GEV No.</b>	521723	<b>Ref. No.</b>	N/A
<b>description</b>	pump cover gasket EPDM thickness 2mm ID ø 90mm Qty 1 pcs		