

Key

app.	application	L5	length 5
AT max.	ambient temperature max.	L6	length 6
B1	width 1	L7	length 7
BA	blade angle	L8	length 8
cap.	capillary pipe length	LCT	laminated core thickness
cap.ins.	capillary pipe length insulated	MD	mounting distance
CL	cable length	MD1	mounting distance 1
color I	flow regulating valve color inlet	MD2	mounting distance 2
color O	flow regulating valve color outlet	MM	mounting measurements
CS	cross section	MP	mounting position
D	fan wheel diameter	NP	number of poles
DEF Probe	defrost temperature probe	NS	nominal size
DEF Relay	defrost relay DEF	∅	diameter
DEF time	defrosting time	P	power
def.int.	defrosting interval	Qty	quantity
dif. HR	difference high range	RA	rotation angle
dif. LR	difference low range	reset HP	reset high pressure
DigiIN1	digital input 1	reset LP	reset low pressure
DigiIN2	digital input 2	RL	roller length
DigiIN3	digital input 3	RoomTempIN	room temperature probe input
DigiIN4	digital input 4	SC	switching capacity
FAN Relais	fan relay	SD HP	switching difference at high pressure
FM	front measurements	SD LP	switching difference at low pressure
F∅	flange diameter	SP/400V	switch power at 400V
FR	flow rate	T	thickness
freq.	frequency	T.max.	temperature max.
H	height	t.range	operating temperature range
H1	height 1	temp.	temperature range
HD	hole distance	Temp.Res.	temperature resistance
H∅	hole diameter	TempIN3	temperature probe 3
L	length	TrTy	instantaneous tripping current type
L1	length 1	TS	thread size
L2	length 2	volt.	voltage
L3	length 3	W	width
L4	length 4	WS	wrench size



Зип Общепит

vsezip.ru

+7(812)987-08-81

heating elements

heating elements for refrigeration

heating elements for defrost

universal

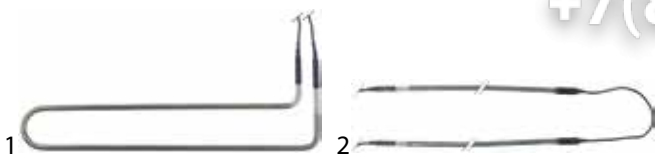

fig.	GEV No.	P (W)	volt. (V)	L (mm)	W (mm)
1	417609	300	230	320	140
1	417610	500	230	400	130
1	417611	750	230	635	135
2	417591	500W (2x250W)	230V (2x115V)	2X800	-
2	417592	660W (2x330W)	230V (2x115V)	2X1000	-
2	417593	1750W (2x875W)	230V (2x115V)	2X2100	-
2	417594	2200W (2x1100W)	230V (2x115V)	2X2550	-
2	417595	2600W (2x1300W)	230V (2x115V)	2x3000	-

Afnox



fig.	GEV No.	P (W)	volt. (V)	L (mm)	W (mm)	Ref. No.
1	417597	400	230	375	190	73636302

Desmon



fig.	GEV No.	P (W)	volt. (V)	L (mm)	W (mm)	Ref. No.
1	417587	350	230	380	-	R35-0070

Electrolux



fig.	GEV No.	P (W)	volt. (V)	L (mm)	W (mm)	Ref. No.
1	420449	160	220	370	60	082733
2	419025	400	230	440	70	083530
2	419101	450	230	380	37	0A9683

fig.	GEV No.	P (W)	volt. (V)	L (mm)	W (mm)	Ref. No.
3	420452	540	220	305	695	082279

Fagor



fig.	GEV No.	P (W)	volt. (V)	L (mm)	W (mm)	Ref. No.
1	417221	350	230	360	114	12034637

Frenox



fig.	GEV No.	P (W)	volt. (V)	L (mm)	W (mm)	Ref. No.
1	419196	55	220	410	50	B00REZ100
2	419195	2x100	2x115	380	-	B00REZ116

IARP



fig.	GEV No.	P (W)	volt. (V)	L (mm)	W (mm)	Ref. No.
1	417669	233	230	195	122	0205376

Lohberger



fig.	GEV No.	P (W)	volt. (V)	L (mm)	W (mm)	Ref. No.
1	419208	250	230	420	50	PO1666250



Зип Общепит

vsezip.ru

+7(812)987-08-81

Mondial



fig.	GEV No.	P (W)	volt. (V)	L (mm)	W (mm)	Ref. No.
1	417587	350	230	380	-	TDE072220



fig.	GEV No.	description	Ref. No.
1	420170	heating element 95W 230V L 400mm W 60mm cable length 4000mm tube ø 6,2mm	BN1666096

Polaris

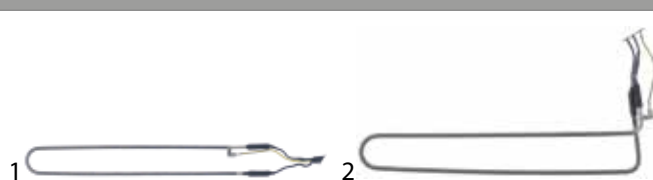

fig.	GEV No.	P (W)	volt. (V)	L (mm)	W (mm)	Ref. No.
1	419208	250	230	420	50	BN1666250
2	419209	270	230	380	120	BN1666400

Zanussi



fig.	GEV No.	description	Ref. No.
1	418996	heating element 95W 220V L 435mm W 56mm H 28mm cable length 3000mm tube ø 6,25mm	0A8134

Whirlpool



fig.	GEV No.	P (W)	volt. (V)	L (mm)	W (mm)	Ref. No.
1	420449	160	220	370	60	182733
2	419025	400	230	440	70	183530
2	419101	450	230	380	37	208017

condensing trays heated



fig.	GEV No.	L (mm)	W (mm)	H (mm)	P (W)	volt. (V)
1	750003	240	240	75	650	230
1	750004	380	240	75	750	230





fig.	GEV No.	P (W)	volt. (V)	L (mm)	W (mm)	Ref. No.
3	420452	540	220	305	695	182279

heating cables

connection on both sides
with wire end ferrules



pos.	GEV No.	P (W)	volt. (V)	L (mm)	L1 (unheated) (mm)	L2 (heated) (mm)
1	420372	54	230	5000	2x1000	3000
2	420373	72	230	6000	2x1000	4000
3	420374	90	230	7000	2x1000	5000
4	420375	108	230	8000	2x1000	6000
5	420376	126	230	9000	2x1000	7000
6	420377	144	230	10000	2x1000	8000

Zanussi





fig.	GEV No.	P (W)	volt. (V)	L (mm)	W (mm)	Ref. No.
1	419025	400	230	440	70	083530

with male fastons



pos.	GEV No.	P (W)	volt. (V)	L (mm)	pos.	GEV No.	P (W)	volt. (V)	L (mm)
1	418807	18	230	4750	3	418339	600	230	9900
2	418809	41	220	6250					

heating elements for condensate evaporation

Electrolux





fig.	GEV No.	description	Ref. No.
1	418996	heating element 95W 220V L 435mm W 56mm H 28mm cable length 3000mm tube ø 6,25mm	0A8134



connection on both sides (metal braided)

Зип.Общепит
for heating elements



pos.	GEV No.	P (W)	volt. (V)	L (mm)	L1 (unheated) (mm)	L2 (heated) (mm)
1	416330	26	230	2100	2x540	1020
2	416324	43	230	6000	2x1500	3000
3	416331	53	230	3100	2x540	2020
4	416332	95	230	4600	2x550	3500
5	416333	130	230	6000	2x520	4960
6	419109	150	220	7000	1000	6000
7	416334	188	230	8080	2x540	7000
8	416335	272	230	11000	2x540	9920

connection single-sided



pos.	GEV No.	P (W)	volt. (V)	L (mm)	L1 (unheated) (mm)	L2 (heated) (mm)
1	416336	16	230	2900	2400	500
2	416337	25	230	2900	1900	1000
3	417518	50	230	2000	1000	1000
4	416338	55	230	2500	500	2000
5	417519	100	230	3000	1000	2000
6	417520	150	230	4000	1000	3000
7	417521	200	230	5000	1000	4000
8	417522	250	230	6000	1000	5000
9	417523	300	230	7000	1000	6000

supplied by meter



pos.	GEV No.	volt. (V)	Ohm/meter (Ohm/m)	ø (mm)	cable material	Qty
1	416365	230	105	3	silicone	MTR
2	418405	230	205	3	silicone	MTR
3	416340	230	365	3	silicone	MTR

heating cartridges



fig.	GEV No.	P (W)	volt. (V)	ø (mm)	L (mm)	TS	CL (mm)
1	417227	90	230	12	124	3/8"	4000
1	417570	110	230	12	120	3/8"	1000
1	417577	190	230	12	180	3/8"	300
1	419212	190	230	12	180	3/8"	1000
1	417571	230	230	12	180	3/8"	1000
1	420223	240	230	12	240	3/8"	3000
1	418892	300	230	12	240	3/8"	2000
1	417572	330	230	12	240	3/8"	1000
1	419218	400	230	11	240	3/8"	550
1	417612	400	230	12.2	283	3/8"	1500



fig.	GEV No.	P (W)	volt. (V)	L (mm)	W (mm)	t.max. (°C)	suitable for
1	417660	80	230	240	130	-	—



fig.	GEV No.	P (W)	volt. (V)	L (mm)	W (mm)	t.max. (°C)	suitable for
2	418855	100	220	210	58	130	Infrico





fig.	GEV No.	P (W)	volt. (V)	L (mm)	W (mm)	t.max. (°C)	suitable for
3	418856	200	220	210	116	130	Infrico

thermostats

control and safety thermostats

IMIT / TEMPOMATIC / ARTERMO

control thermostats



technical data:
operating temperature range 64-210°C
probe diameter 5mm
probe length 100mm
capillary pipe length 1000mm
capillary pipe length insulated -mm
shaft length 19mm

fig.	GEV No.	t.max. (°C)	NP (-pole)	function	SC (A)
1	390008	210	1	1CO	16

Зип Общепит

vsezip.ru

+7(812)987-08-81

remote thermostats



fig.	GEV No.	t.range (°C)	dif. LR (°C)	dif. HR (°C)	probe ø (mm)	probe L (mm)	cap. (mm)
1	390335	-18 up to +13	1.7-7	3-12	9.5	38	2000
1	390334	-35 up to -7	1.7-7	3-12	9.5	38	2000
1	390336	-5 up to +25	1.7-7	3-12	9.5	38	2000
2	390333	-34 up to +32	8-22	4.0/25	9.5	150	1800
3	390337	-5 up to +25	1.7-7	3-12	14.5	140	1800

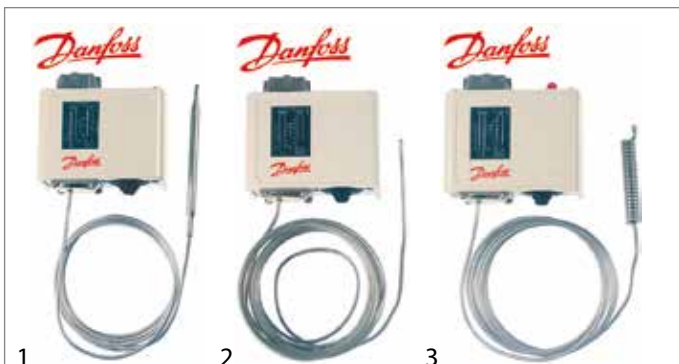

fig.	GEV No.	t.range (°C)	dif. LR (°C)	dif. HR (°C)	probe ø (mm)	probe L (mm)	cap. (mm)
1	390493	0 up to +35	3.5-16	2.5-12	9.5	115	2000
1	390492	-25 up to +15	12-70	8-25	6.4	95	2000
1	390490	-5 up to +20	3-10	2.2-9	9.5	115	2000
1	390491	-5 up to +20	fixed 3	fixed 3	9.5	115	2000
2	390486	-30 up to +15	5.5-23	1.5-7	2.5	500	5000
3	390487	-30 up to +15	5.5-23	1.5-7	9.5	70	2000
3	390489	-5 up to +35	4.5-25	1.8-7	9.5	70	2000
3	390488	-50 up to +10	10-70	2.7-8	9.5	70	2000

room thermostats



fig.	GEV No.	type	t.range (°C)	dif. LR (°C)	dif. HR (°C)
1	390881	O16	+10 up to +40	fixed 1	fixed 1.5
1	390330	O16	-18 up to +13	fixed 1	fixed 1.5
1	390426	O16	-35 up to -7	fixed 1	fixed 1.5
1	390332	O16	-5 up to +25	1-6	2-10



fig.	GEV No.	type	t.range (°C)	dif. LR (°C)	dif. HR (°C)
1	390494	KP 62	-30 up to +15	6-23	1.5-7

refrigeration thermostats

universal without housing



technical data:
probe ø6x110mm

fig.	GEV No.	t.range (°C)	cap. (mm)	producer
1	390673	0 up to +40	1500	-
1	390535	0 up to +40	1500	PRODIGY
1	390010	-35 up to +35	1500	-
1	390534	-35 up to +35	1800	PRODIGY

universal with housing



fig.	GEV No.	t.range (°C)	probe	cap. (mm)	producer
1	390674	0 up to +40	ø6x110mm	1500	-
1	390537	0 up to +40	ø6x110mm	1500	PRODIGY
1	390012	-35 up to +35	ø6x110mm	1500	-
1	390536	-35 up to +35	ø6x110mm	1500	PRODIGY
2	390011	-35 up to +35	ø6x110mm	-	-
2	390538	-35 up to +35	ø6x110mm	-	PRODIGY



DANFOSS

service thermostats DANFOSS

All Danfoss thermostats are supplied with fastening material application:

- 390552 - **fridges
- 390553 - **Refrigerators with defrosting push button
- 390554 - **/**Refrigerators with automatic defrosting
- 390555 - absorption refrigerators
- 390557 - Deep cooler with active signal
- 390558 - Freezing with passive signal
- 390559 - bottle cooler 390559



fig.	GEV No.	type	cap. (mm)	t.range (°C)
1	390553	077B7002	1300	-21 up to 0
2	390552	077B7001	1300	-25 up to +2
2	390555	077B7004	1500	-11 up to +3.5
2	390554	077B7003	1600	-27.5 up to +3.5
2	390559	077B7008	2000	-8.5 up to +11.5
2	390557	077B7006	2300	-34.5 up to -10
2	390558	077B7007	2300	-35.5 up to -10

control thermostats



pos.	GEV No.	type	cap. (mm)	t.range (°C)
1	391001	077B0804L	810	+6 up to +15
2	390218	077B0052L	1200	-16 up to +6
3	390220	077B0082L	1200	-5 up to +15
4	390677	077B0028	1200	-4.5 up to +10.5
5	390269	077B2033	2000	-34 up to -15
6	390669	077B0303L	2000	-8.5 up to -1
7	390774	077B3317L	2000	-13.6 up to -30.0

Зип-Общепит

RANCO

service thermostats RANCO Varifix

All Ranco Varifix thermostats are supplied with mounting hardware application:

- 390557 - **fridges
- 390560 - **fridges
- 390563 - **Refrigerators with defrosting push button
- 390568 - ***Refrigerators with defrosting push button
- 390569 - **/**Refrigerators with automatic defrosting
- 390561 - absorption refrigerators
- 390562 - Deep freezer without signal
- 390564 - Deep cooler with active signal
- 390565 - bottle coolers
- 390566 - refrigerator with defrost cycle



fig.	GEV No.	type	cap. (mm)	t.range (°C)
1	390561	VA102 K50-H1105	1200	-18 up to +3.5
1	390560	VC101 K50-H1104	1200	-22.5 up to +2
1	390567	VC110 K50-H1108	2000	-12 up to +4
1	390565	VB107 K50-H1107	2000	-3 up to +12.5
1	390562	VF103 K50-H1106	2000	-32 up to -12
2	390569	VI112 K59-H2805	1500	-28 up to +5
2	390566	VI109 K59-H1303	2000	-21 up to +4.5
2	390564	VS105 K54-H1404	2000	-34 up to -12
3	390563	VP104 K60-L2024	1600	-19 up to -1

K22 series



fig.	GEV No.	type	cap. (mm)	suitable for	Ref. No.
1	390587	K22L1069		Brema	23447
1	390202	K22L2025	1500	Angelo-Po	32Z7450
1	390207	K22L2030	2000	Angelo-Po GIGA Mach Migel Scotsman Simag	32Z3890 I62026414 80001LT092 1LT020 62026414 Z1EL011
1	390961	K22L2082	2000	Migel	1LT112
1	390201	K22L2021	2500	Simag	Z1EL012
2	390577	K22-L2084	1200	ITV	273
3	390582	K22-L1529	1400	Icematic SF-Maschinen	CM19797025/0 I-238
3	390345	K22L1034	2500	Intimpex	1006
3	390775	K22L2088	2500	IARP	0225105
3	390261	K22L2557	2550	Friulinox Mareno	FR995352 FR995352

Table continues overleaf



Зип Ообщепит

vsezip.ru

+7(812)987-08-81

fig.	GEV No.	type	cap. (mm)	suitable for	Ref. No.
4	390291	K22 S1096	1500	ITV	153
5	391000	K22L1067	1500	IARP	I3305084
6	391003	K22L1067	1500	IARP	0225008

fig.	GEV No.	type	cap. (mm)	suitable for	Ref. No.
7	390524	K22L1082	2000	Brema	R23591
				Brice Italia	926081
				Cookmax	23591
				Electrolux	087969
				Fagor	12033335
				Geofrigor	RFS0B893
				NTF	N23591
Rancilio	68023591				
8	390589	K22L1083	2300	Brema	R23597
				Electrolux	087804
				NTF	23597

fig.	GEV No.	type	cap. (mm)	suitable for	Ref. No.
1	390274	K22L2554	2000	—	—

fig.	GEV No.	type	cap. (mm)	suitable for	Ref. No.
1	391007	K22-L8103	1500	IARP	3304241

fig.	GEV No.	type	cap. (mm)	suitable for	Ref. No.
1	390983	K50-L3420	500	Tefcold	1022600059
1	390990	K50B-S3528	800	IARP	I0225186
1	391005	K50-L3425	1000	IARP	3303610
1	390545	K50P1125	1200	—	—
1	390546	K50P1127	1200	Öztiyakiler	6268.00013.01
1	390548	K50L3081	1200	—	—
1	390872	K50-L3421	1200	Tefcold	1022600019
1	390270	K50L3019	1250	Brice Italia	RF000610
				Geofrigor	RF000610
1	390292	K50P1118	1250	Emmepi	828317
				IME Turbo	TKS015
				Mareno	MA2523500
				Telme	F05.002.R
1	376068	K50-L3459	1500	Ugur	A0804000066
1	390278	K50L3207	1500	Angelo-Po	32Z6360
				Sagi	32Z6360
1	390757	K50-L3337	1500	IARP	0225090
1	390988	K50B-S3508	1500	Mondial	1101031
1	390224	K50L3199	2000	Electrolux	0A8728
				Zanussi	0A8728
1	390271	K50L3078	2000	Dexion	013475-00
				Electrolux	0A8089
				MBM-Italia	013475-00
1	390272	K50P1117	2000	Dexion	013477-00R
				Electrolux	0A8135
				IME Turbo	TKS014
				MBM-Italia	013477-00R
1	390285	K50P1115/007	2000	—	—
1	390619	K50P6073/001	2000	Cookmax	6151995
				Liebherr	6151995
1	390254	K50P1135	2500	Angelo-Po	32V4270
				Scotsman	62020900
1	390760	K50-L3210	2500	IARP	3301323
2	391002	K50-L3319	1000	IARP	I3306115
3	390849	K50-L3231/002	1200	Cornelius	04.BA0031.001
				GBG	SL37AAL3231
				Sencotel	SL37AAL3231
				SPM	04.BA0031.001
				Staff Ice System	SL37AAL3231
4	390642	K50-L3218	1230	Icematic	CM19797019/0
				SF-Maschinen	I-1058
				Ugolini	21087-00000
4	390340	K50L3209	2000	Intimpex	1068

electric components

Зип-Общепит

vsezip.ru

+7(812)987-08-81



fig.	GEV No.	type	cap. (mm)	suitable for	Ref. No.
5	390286	K50L3383	1500	Brema Brice Italia Cookmax Electrolux Geofrigor Kastel	23005 926080 23005 085283 RF50B892 K00079
5	390208	K50L3006	2000	Angelo-Po GIGA Scotsman	3034730 I620209100 620209.00
5	390581	K50-S3595	2000	Foster Icematic Scotsman SF-Maschinen	15315803 CM19797026/0 63000500 I-35
5	390288	K50L3163	2100	Brema Electrolux NTF	23034 085314 NR23034
5	390588	K50L3274	3000	Brema Electrolux NTF	23421 089078 NR23421
6	391004	K50-L3313	1500	IARP	3300683
6	390290	K50S3493	2000	ITV	274

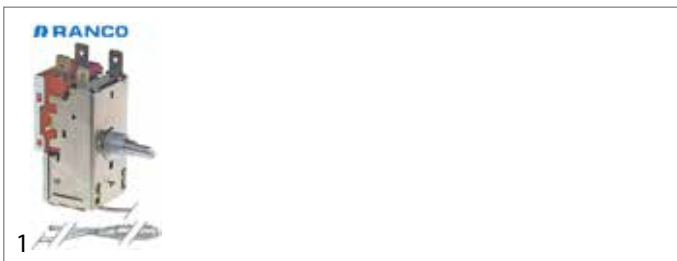

fig.	GEV No.	type	cap. (mm)	suitable for	Ref. No.
1	390273	K50L3194	1870	Dexion MBM-Italia	01347100R 01347100R



fig.	GEV No.	type	cap. (mm)	suitable for	Ref. No.
1	391006	K50L7201	900	IARP	0225185
2	390547	K50H2005	1500	Mareno	MA2478500



fig.	GEV No.	type	cap. (mm)	suitable for	Ref. No.
1	390873	K54-L1870	1000	—	—
1	390782	K54L2097	900	Mondial	1001118

K55 series

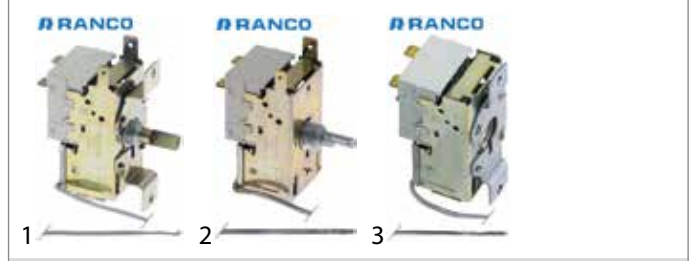

fig.	GEV No.	type	cap. (mm)	suitable for	Ref. No.
1	390551	K55L5014	700	—	—
2	390217	K55L5080	2000	Electrolux Zanussi	083147 083147
2	390248	K55L5079	2000	Electrolux Zanussi	083135 083135
2	390250	K55L5078	2000	Electrolux	083125
2	390251	K55L5027	2000	Electrolux Zanussi	081689 081689
2	390275	K55L5047	2000	Friulinox	FR995385
2	390542	K55P5851	2500	Electrolux Zanussi	087516 087516
3	390252	K55L5070	2500	Angelo-Po Electrolux	32Z7580 082985

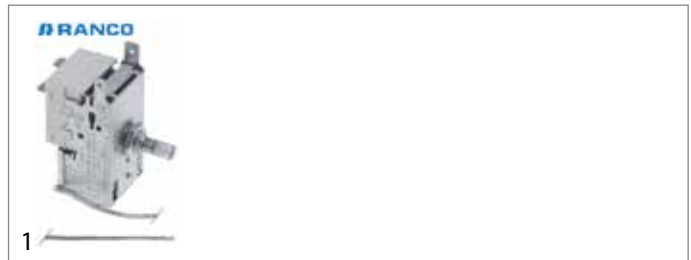

fig.	GEV No.	type	cap. (mm)	suitable for	Ref. No.
1	375962	K55-L5106	2500	Electrolux	085889

Зип Общепит

vsezip.ru

+7(812)987-08-81

K57 series

fig.	GEV No.	type	cap. (mm)	suitable for	Ref. No.
1	390665	K57-L2852	1200	IARP	3304195
2	390617	K57-L2866	2000	Cookmax Liebherr	6151753 6151753

fig.	GEV No.	type	cap. (mm)	suitable for	Ref. No.
2	390344	K61L1505	1500	Intimpex	0950
2	390287	K61L1506	2300	Brema	23004
3	390586	K61L1504	1800	Electrolux Icematic Scotsman Zanussi	086288 CM19797031/0 620264-11 086288
4	379516	K61L1508	1800	Icematic Scotsman Simag Wega-CMA	CMCF62026416 62026402 62026416 WY31F62026416
4	390591	K61L1509	2250	Scotsman Simag	62026415 62026415

K59 series

fig.	GEV No.	type	cap. (mm)	suitable for	Ref. No.
1	390960	K59L1045	2000	Migel	1LT019

K60 series

fig.	GEV No.	type	cap. (mm)	suitable for	Ref. No.
1	390400	K60L2058	1200	—	—
1	390247	K60L2112	2000	Electrolux	083177
1	390246	K60L2141	830	Electrolux	083178

K61 series

fig.	GEV No.	type	cap. (mm)	suitable for	Ref. No.
1	390212	K61L1500	750	Icematic Scotsman SF-Maschinen	CM29090002/0 62026410 I-352
1	390206	K61L1501	1800	GIGA Scotsman	I62026400 620264.00
2	390289	K61L1502	2150	Luxia	L4750

ATEA

fig.	GEV No.	type	cap. (mm)	suitable for	Ref. No.
1	390522	A01 0716	1200	CAB	1025
2	390781	A01 0791	2500	Mondial	1101029
3	390211	A03 0045	700	Philips Whirlpool	481927128578 481927128578

miscellaneous producers

fig.	GEV No.	description	suitable for	Ref. No.
1	390996	thermostat probe \varnothing 2 mm capillary pipe 2250 mm type	Kastel	K00080
1	390762	thermostat probe \varnothing 2mm capillary pipe 2000mm type for evaporator	Manitowoc	20-0883-3



switches and momentary switches

rocker/momentary rocker switches

27.8x25mm



fig.	GEV No.	description	function	volt. (V)	SC (A)	connection
1	345278 ¹	switch	2NO	250	16	F6.3
2	345013 ¹	switch	2NO	250	16	F6.3
3	301245 ¹	switch	2NO	250	16	F6.3
4	345277 ¹	switch	2NO	250	16	F6.3

¹illuminated

30x22mm



fig.	GEV No.	description	function	volt. (V)	SC (A)	connection
1	347791	switch	2NO	230	20	F6.3
2	347973	switch	2NO	250	20	F6.3
3	347974	switch	2NO	250	20	F6.3
4	347207	switch	2NO	250	20	F6.3
5	301202 ¹	switch	2NO	230	20	F6.3

¹non-illuminated



fig.	GEV No.	description	function	volt. (V)	SC (A)	connection
1	347531	switch	2NO	250	20	F6.3
2	347774	switch	2NO	250	20	F6.3
3	347775	switch	2NO	250	20	F6.3
4	347956	switch	2NO	250	20	F6.3
5	347814 ¹	switch	2NO	250	20	F6.3

¹non-illuminated



fig.	GEV No.	description	function	volt. (V)	SC (A)	connection
1	301000	switch	2NO	250	16	F6.3
2	301003	switch	2NO	250	16	F6.3
3	301002	switch	2NO	250	16	F6.3
4	301001	switch	2NO	250	16	F6.3
5	301009	switch	2NO	250	16	F6.3

Зип Общепит

vsezip.ru

+7(812)987-08-81

fig.	GEV No.	description
1	301036	protective cover internal size 30x22mm

push/momentary push switches

30x22mm



fig.	GEV No.	description	function	volt. (V)	SC (A)	connection
1	301086	switch	2NO	250	12	F6.3
2	301082	switch	2NO	250	12	F6.3
3	301083	switch	2NO	250	12	F6.3
4	301084	switch	2NO	250	12	F6.3



fig.	GEV No.	description
1	301036	protective cover internal size 30x22mm

timers

programme timers



fig.	GEV No.	description	suitable for	Ref. No.
1	360368	timer CDC 11904 engines 1 chambers 4 operation time 10min 230V	Kastel	K00257
1	360525	timer CDC 11904 engines 1 chambers 4 operation time 10min 230V	Brema Emmepi Fagor NTF	23247 809346 12030573 N23247
1	360567	timer CDC 11904 engines 1 chambers 4 operation time 10min 230V 50/60Hz	Brema	23632
1	360367	timer CDC 11904 engines 1 chambers 4 operation time 12min 230V	Kastel	K00075
1	360524	timer CDC 11904 engines 1 chambers 4 operation time 12min 230V	Brema Brice Italia Electrolux Geofrigo NTF Rancilio	23222 926070 OKL019 RFS0B869 N23222 68023222

Table continues overleaf

Зип ОБЩЕПИТ
defrost timers

BIGATTI
vsezip.ru

+7(812)987-08-81

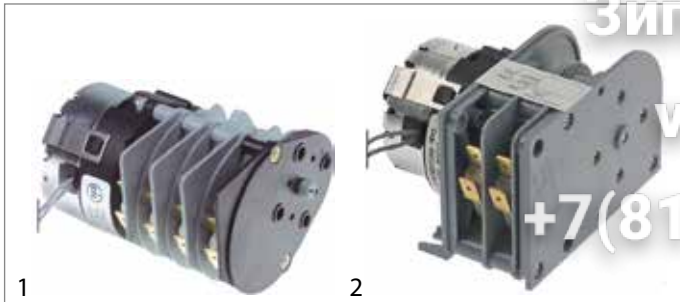

fig.	GEV No.	description	suitable for	Ref. No.
1	360566	timer CDC 11904 engines 1 chambers 4 operation time 15min 115V 60Hz	Brema Electrolux Fagor NTF	23259 099423 12030499 N23259
1	360609	timer CDC 11904 engines 1 chambers 4 operation time 15min 230V	Brice Italia Geofrigor	926203 RFS0C111
1	360550	timer CDC 11904 engines 1 chambers 4 operation time 15min 230V 50/60Hz	Brema Brice Italia	23248 926071
1	360565	timer CDC 11904 engines 1 chambers 4 operation time 18min 230V 50/60Hz	Brema NTF	23780 N23780
1	360549	timer CDC 11904 engines 1 chambers 4 operation time 8min 230V 50/60Hz	Brema NTF	23635 N23635
2	360695	timer CDC 4902C1 engines 1 chambers 2 operation time 15min manuf. no.	ITV	4864C
2	360628	timer CDC 4902C1 engines 1 chambers 2 operation time 20min 230V	ITV	380C

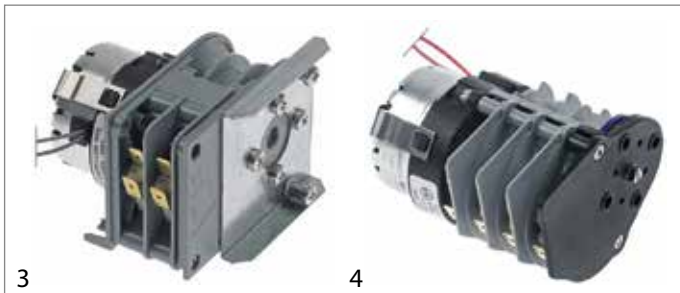

fig.	GEV No.	description	suitable for	Ref. No.
3	360665 ¹	timer CDC kit engines 1 chambers 2 operation time 12min 230V 50-60Hz	lcematic	CM81414562/0
4	360620	timer CDC operation time 8min engines 1 chambers 4 230V manuf. no. 23472/1 motor type M48R ATS	Brema Brema	23472 23472/1

¹with cable kit

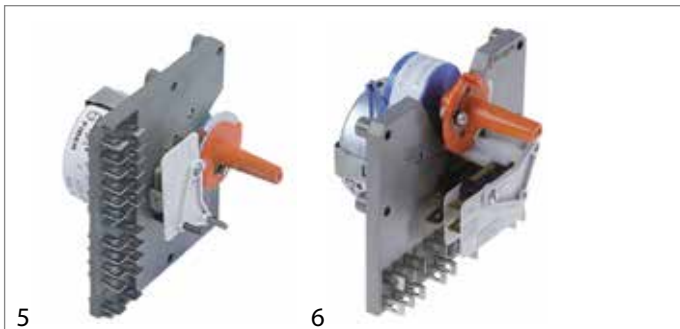

fig.	GEV No.	description	suitable for	Ref. No.
5	360079	timer FIBER P23 engines 1 chambers 1 operation time 12min 230V shaft L 30mm	Scotsman	62024413
5	360163	timer FIBER P23 engines 1 chambers 1 operation time 15min 230V shaft L 30mm	Electrolux GIGA Scotsman Simag	086213 162024402 620244.02 620244.02
6	360052	timer FIBER P23 engines 1 chambers 2 operation time 15min 230V manuf. no. P235JR1J707	GIGA Scotsman	162024404 620244.04

fig.	GEV No.	type	def.int.	DEF time (min)	fan delay (min)	supply (V)
1	360055	SB3.81	1-12x in 24h	2-54	-	230
1	360058	SB3.82	1-12x in 24h	2-54	0-15	230

CDC

fig.	GEV No.	type	def.int.	DEF time (min)	fan delay (min)	supply (V)
1	360193	13102	1-12x in 24h	2-50	0-10	230

FLASH

fig.	GEV No.	type	def.int.	DEF time (min)	fan delay (min)	supply (V)
1	360426	MONOMAT	1-96 in 24h	15	-	230
1	360425	MONOMAT	1-96 in 24h	15	-	230
2	360262	MONOTRON 124	1-20 in 24h	1-1430	-	230

fig.	GEV No.	type	def.int.	DEF time (min)	fan delay (min)	supply (V)
3	360292	MONOTRON 200	1-20 in 24h	1-1430	-	230
4	360414 ¹	MONOTRON 300CS	1-56 in 24h	1-60	1-60	230

¹with fan delay 1-60min



Зип.Общепит

MINI

vsezip.ru

+7(812)987-08-81

GUAITANI



1

fig.	GEV No.	type	def.int.	DEF time (min)	fan delay (min)	supply (V)
1	360171	R4/1	2/4	4-60	3	230
1	360157	R4/2	2/4	0-40	3	230

1

fig.	GEV No.	type	def.int.	DEF time (min)	fan delay (min)
1	360150	3611	1-48x per 24h	15-144 min	-

LEGRAND



1

2

fig.	GEV No.	type	def.int.	DEF time (min)	fan delay (min)	supply (V)
1	360423	ALPHAREX D21	1-56 in 24h	1-60	-	230
1	360424	ALPHAREX D22	1-28 in 24h	1-60	-	230
2	360422	MICROREX QT31F	1-48 in 24h	30	-	230
2	360421	MICROREX T31F	1-48 in 24h	1-60	-	230

miscellaneous



1

2

fig.	GEV No.	type	def.int.	DEF time (min)	fan delay (min)
1	360186	FM/1 STUZ	1-48x per 24h	-	-
2	360187	RZ-2001-21	4H	15	5

transformers

encapsulated transformers

PMA



1

fig.	GEV No.	primary	secondary	power (VA)	secondary (A)
1	379054	230VAC	12VAC	3	0.25
1	379195	230VAC	12VAC	5	0.4
1	401174	230VAC	12VAC	6	0.5
1	379196	230VAC	12VAC	10	0.8



3

fig.	GEV No.	type	def.int.	DEF time (min)	fan delay (min)	supply (V)
3	360419 ¹	POLARREX KKT	1-48 in 24h	1-60	1-60	230
3	360417	POLARREX KT	1-48 in 24h	1-60	-	230
3	360420 ¹	POLARREX QKKT	1-48 in 24h	1-60	1-60	230
3	360418	POLARREX QKT	1-48 in 24h	1-60	-	230

¹with fan delay 1-60min



electronic controllers

Зип Общепит

AKO

vsezip.ru

universal controllers

built-in version

+7(812)987-08-81



fig.	GEV No.	type	supply (V)	voltage	relay outputs	relay output 1	relay output 2	relay output 3	input 1	input 2	interface RS485
1	378428	D14726-C	90-240	AC	2	CO-8A(4)	CO-8A(4)	-	NTC/PTC/Pt100/TC(J,K)/mA	DI	X
1	378429	D14727	12/24	AC/DC	2	CO-8A(4)	CO-8A(4)	-	NTC/PTC/Pt100/TC(J,K)/mA	DI	-
1	378430	D14729	230	AC	2	CO-8A(4)	CO-8A(4)	-	NTC/PTC/Pt100/TC(J,K)/mA	DI	-
1	378431	D14729-C	90-240	AC	2	CO-8A(4)	CO-8A(4)	-	NTC/PTC/Pt100/TC(J,K)/mA	DI	X
1	379926	D14724	12/24	AC/DC	2	CO-8A(4)	NO-8A(4)	-	NTC/PTC/Pt100/TC(J,K)/mA	DI	-
1	379927	D14726	230	AC	2	CO-8A(4)	NO-8A(4)	-	NTC/PTC/Pt100/TC(J,K)/mA	DI	-

refrigeration controllers

built-in version



fig.	GEV No.	type	supply (V)	voltage	relay outputs	relay output 1	relay output 2	relay output 3	relay output 4	input 1	input 2	input 3	input 4	interface RS485
1	379357 ¹	13112	12	AC/DC	1	NO-12A(9)	-	-	-	NTC	-	-	-	-
1	379358 ¹	13123	230	AC	1	NO-12A(9)	-	-	-	NTC	-	-	-	-
2	378424 ¹	D14123-2-RC	90-240	AC	1	CO-16A(10)	-	-	-	NTC/PTC	NTC/PTC/DI	DI	-	X
2	379507 ¹	D14123-2	230	AC	1	CO-16A(10)	-	-	-	NTC/PTC	NTC/PTC/DI	DI	-	-
2	379591 ¹	D14112	12/24	AC/DC	1	CO-12A(9)	-	-	-	NTC/PTC	NTC/PTC/DI	DI	-	X
2	379797 ¹	D14212	12	AC/DC	2	CO-12A(9)	CO-8A(4)	-	-	NTC	NTC/DI	DI	-	X
2	379314 ¹	D14223	230	AC	2	CO-12A(9)	CO-8A(4)	-	-	NTC/PTC	NTC/PTC/DI	DI	-	X
2	378425 ¹	D14323-C	90-240	AC	3	CO-12A(9)	NO-5A(4)	NO-8A(4)	-	NTC/PTC	NTC/PTC/DI	DI	-	X
2	379456 ¹	D14323	230	AC	3	CO-12A(9)	NO-5A(4)	NO-8A(4)	-	NTC/PTC	NTC/PTC/DI	DI	-	-
2	379514 ²	D14323	230	AC	3	CO-12A(9)	NO-5A(4)	NO-8A(4)	-	NTC/PTC	NTC/PTC/DI	DI	-	-
2	379742 ¹	D14312	12	AC/DC	3	CO-12A(9)	NO-5A(4)	NO-8A(4)	-	NTC/PTC	NTC/PTC/DI	DI	-	-
2	378426 ¹	D14423	230	AC	4	NO-5A(4)	NO-5A(4)	NO-5A(4)	NO-5A(4)	NTC/PTC	NTC/PTC/DI	NTC/PTC/DI	-	-
2	379508 ¹	D14423-RC	90-240	AC	4	NO-5A(4)	NO-5A(4)	NO-5A(4)	NO-5A(4)	NTC/PTC	NTC/PTC/DI	NTC/PTC/DI	-	X
2	379737 ¹	D14412-RC	12	AC/DC	4	NO-5A(4)	NO-5A(4)	NO-5A(4)	NO-5A(4)	NTC/PTC	NTC/PTC/DI	NTC/PTC/DI	-	X
3	379408 ²	D14125	230	AC	1	NO-12A(9)	-	-	-	NTC/PTC	-	-	-	-
3	379460 ¹	D14123	230	AC	1	NO-12A(9)	-	-	-	NTC/PTC	-	-	-	-

¹incl. 1x NTC probe ²without probe

Зип Общепит
vsezip.ru
+7(812)987-08-81



4

5

fig.	GEV No.	type	supply (V)	voltage	relay outputs	relay output 1	relay output 2	relay output 3	relay output 4	input 1	input 2	input 3	input 4	interface RS485
4	378310 ¹	D10123	230	AC	1	CO-12A(9)	-	-	-	NTC/PTC	DI	DI	-	-
4	378427 ¹	D10223	230	AC	2	CO-12A(9)	CO-8A(4)	-	-	NTC/PTC	NTC/PTC/DI	DI	-	-
4	379811 ¹	D10323	230	AC	3	CO-12A(9)	NO-5A(4)	NO-8A(4)	-	NTC/PTC	NTC/PTC/DI	DI	-	-
5	379861 ¹	10123	230	AC	2	NO-12A(9)	CO-8A(4)	-	-	NTC	DI	-	-	-
5	379862 ¹	10223	230	AC	3	NO-12A(9)	NO-8A(3)	CO-8A(4)	-	NTC	NTC/DI	DI	-	-
5	379863 ¹	10323	230	AC	4	NO-12A(9)	CO-8A(4)	NO-8A(4)	CO-8A(4)	NTC	NTC/DI	DI	-	-

¹incl. 1x NTC probe

DIN rail



1

fig.	GEV No.	type	supply (V)	voltage	relay outputs	relay output 1	relay output 2	relay output 3	relay output 4	input 1	input 2	input 3	input 4	HACCP	real time clock	buzzer internal
1	379360 ¹	AKOTIM-21TE	230	AC	1	NO-12A(9)	-	-	-	NTC	NTC	NTC	DI	-	-	-
1	379379 ¹	AKOTIM-22TE	230	AC	2	NO-12A(9)	CO-8A(4)	-	-	NTC	NTC	NTC	DI	-	-	-
1	379380 ¹	AKOTIM-21ARTEB	230	AC	2	NO-12A(9)	NO-5A(4)	-	-	NTC	NTC	DI	-	X	X	X
1	379361 ¹	AKOTIM-23TE	230	AC	3	NO-12A(9)	CO-8A(4)	NO-5A(4)	-	NTC	NTC	NTC	DI	-	-	X
1	379381 ¹	AKOTIM-22ARTEB	230	AC	3	NO-12A(9)	CO-8A(4)	NO-5A(4)	-	NTC	NTC	NTC	DI	X	X	X
1	379362 ¹	AKOTIM-23ATE	230	AC	4	NO-12A(9)	CO-8A(4)	NO-5A(4)	NO-5A(4)	NTC	NTC	NTC	DI	-	-	X

¹incl. 1x NTC probe



Зип Общепит

vsezip.ru

+7(812)987-08-81

wall-mounted



fig.	GEV No.	type	supply (VAC)	relay outputs	relay output 1	relay output 2	relay output 3	relay output 4	relay output 5	relay output 6	input 1	input 2	input 3	input 4	input 5	HACCP	buzzer internal	interface RS485	printer
1	379127 ¹	14615	230	1	NO-12A(9)	-	-	-	-	-	NTC	-	-	-	-	-	-	-	-
2	378042 ¹	D14610	230	1	NO-12A(9)	-	-	-	-	-	NTC/PTC	-	-	-	-	-	-	-	-
2	378432 ¹	D14622	230	2	NO-12A(9)	NO-5A(4)	-	-	-	-	NTC/PTC	-	-	-	-	-	-	-	-
2	378433 ¹	D14622-C	90-240	2	NO-16A(12)	NO-6A(4)	-	-	-	-	NTC/PTC	DI	DI	-	-	-	-	X	-
2	378434 ¹	D14632-C	230	3	NO-12A(9)	CO-8A(4)	NO-12A(4)	-	-	-	NTC/PTC	NTC/PTC	NTC/PTC/DI	DI	-	-	-	X	-
2	378041 ¹	D14632	230	3	NO-12A(9)	CO-8A(4)	NO-5A(4)	-	-	-	NTC/PTC	NTC/PTC/DI	DI	-	-	-	-	-	-
2	378052 ¹	D14642	230	4	NO-12A(9)	CO-8A(4)	NO-5A(4)	NO-5A(4)	-	-	NTC/PTC	NTC/PTC	DI	DI	-	-	-	-	-
2	378435 ¹	D14642-C	90-240	4	NO-12A(9)	CO-8A(4)	NO-5A(4)	NO-5A(4)	-	-	NTC	NTC	DI	DI	-	X	-	X	-

¹incl. 1x NTC probe



fig.	GEV No.	type	supply (VAC)	relay outputs	relay output 1	relay output 2	relay output 3	relay output 4	relay output 5	relay output 6	input 1	input 2	input 3	input 4	input 5	HACCP	buzzer internal	interface RS485	printer
3	378053 ¹	15613	230	3	NO-16A	NO-16A	CO-8A	-	-	-	NTC/PTC	DI	DI	-	-	X	X	X	-
3	378055 ¹	15633	230	6	NO-16A	CO-16A	NO-8A	NO-16A	NO-16A	CO-8A	NTC	NTC	NTC	DI	DI	X	X	X	-
4	378054 ¹	156131	100-240	3	NO-16A	NO-16A	CO-8A	-	-	-	NTC/PTC	DI	DI	-	-	X	X	X	X
4	378049 ¹	156331	100-240	6	NO-16A	CO-16A	NO-8A	NO-16A	NO-16A	CO-8A	NTC	NTC	NTC	DI	DI	X	X	X	X

¹incl. 1x NTC probe

→ electric components



data loggers

Зип Общепит

vsezip.ru

+7(812)987-08-81

AKO



174 x 94mm

1

AKO



214 x 214mm

2

fig.	GEV No.	type	supply (VAC)	probe type	alarm outputs	alarm relay	inputs	HACCP	real time clock	buzzer internal	interface RS485	printer
1	379845 ¹	15724	220-240	NTC/mA/DI	1	CO-8A(4)	2 channels	-	-	X	-	-
1	379846 ¹	15725	220-240	NTC/mA/DI	1	CO-8A(4)	2 channels	-	-	X	X	-
2	378448 ²	15780	100-240	NTC/Pt100/Pt1000/mA/DI	2	CO-8A(4)	2 channels	-	-	X	X	-
2	378056 ³	15750	220-240	NTC/Pt100/Pt1000/mA/DI	2	CO-8A(4)	5 channels	-	-	X	X	-
2	378058 ³	15740	100-240	NTC/PT1000/mA/DI	2	CO-8A(4)	10 channels	-	-	X	X	-

¹NTC probe/SD card/USB reader ²incl. 2x NTC probe ³incl. 5x NTC probe

AKO

214 x 214mm



3

fig.	GEV No.	type	supply (VAC)	probe type	alarm outputs	alarm relay	inputs	HACCP	real time clock	buzzer internal	interface RS485	printer
3	378449 ¹	15782	100-240	NTC/Pt100/Pt1000/mA/DI	2	CO-8A(4)	2 channels	-	-	X	X	X
3	378057 ²	15752	100-240	NTC/Pt100/Pt1000/mA/DI	2	CO-8A(4)	5 channels	-	-	X	X	X
3	378059 ²	15742	100-240	NTC/PT1000/mA/DI	2	CO-8A(4)	10 channels	-	-	X	X	X

¹incl. 2x NTC probe ²incl. 5x NTC probe



Зип Общепит

data loggers with control function

vsezip.ru

+7(812)987-08-81



1



2

fig.	GEV No.	type	supply (VAC)	relay outputs	relay output 1	relay output 2	relay output 3	relay output 4	relay output 5	relay output 6	input 1	input 2	input 3	input 4	input 5	HACCP	real time clock	buzzer internal	interface RS485	printer
1	378053 ¹	15613	230	3	NO-16A	NO-16A	CO-8A	-	-	-	NTC/PTC	DI	DI	-	-	X	X	X	X	-
1	378055 ¹	15633	230	6	NO-16A	CO-16A	NO-8A	NO-16A	NO-16A	CO-8A	NTC	NTC	NTC	DI	DI	X	X	X	X	-
2	378054 ¹	156131	100-240	3	NO-16A	NO-16A	CO-8A	-	-	-	NTC/PTC	DI	DI	-	-	X	X	X	X	X
2	378049 ¹	156331	100-240	6	NO-16A	CO-16A	NO-8A	NO-16A	NO-16A	CO-8A	NTC	NTC	NTC	DI	DI	X	X	X	X	X

¹incl. 1x NTC probe

accessories



1



2

fig.	GEV No.	description
1	379189	thermal paper AKO type AKO-15703 suitable for AKO data logger
2	379815	software AKO type AKO-5010 AKONET for electronic controller with converter USB/RS485



3



4

fig.	GEV No.	description
3	403162	software AKO type SOFTRegis version 1.0.22
4	378078	transducer type AKO-80004A inlet Pt100 outlet 4-20mA AKO 6-32V voltage DC



5

fig.	GEV No.	description
5	401019	GSM module AKO type AKO-52043 suitable for AKO/Universal GSM/GPRS Modem 4

→ electric components



Зип Общепит

vsezip.ru

+7(812)987-08-81



fig.	GEV No.	Description
1	403139	transducer AKO type AKO-80039 inlet RS485 outlet USB suitable for AKO

fig.	GEV No.	Description
1	379159	transformer primary 230V secondary 24VDC type 80014A AKO output current 1A

CAREL

refrigeration controllers

built-in version



fig.	GEV No.	type	supply (V)	voltage	relay outputs	relay output 1	relay output 2	relay output 3	relay output 4	input 1	input 2	input 3	input 4	HACCP	buzzer internal
1	378474	PJEZS0P0E0	230	AC	1	CO-12A(2)	-	-	-	NTC	-	-	-	-	X
1	378473	PJEZS000E0	230	AC	1	CO-8A(4)	-	-	-	NTC	-	-	-	-	X
1	378475	PJEZC0P000	230	AC	3	NO-12A(2)	CO-8A(4)	NO-8A(4)	-	NTC	NTC	-	-	-	X
2	378476	IR33S0EHA0	230	AC	1	CO-16A(4)	-	-	-	NTC	NTC	DI	-	-	X
2	378643	IR33S0EP00	230	AC	1	CO-16A(4)	-	-	-	NTC	DI	-	-	X	X
2	378477	IR33Y0EHA0	230	AC	2	NO-12A(10)	CO-8A(4)	-	-	NTC	NTC	DI	-	-	X
2	378478	IR33F0HN00	115/230	AC	3	CO-12A(2)	CO-8A(4)	CO-8A(4)	-	NTC	NTC	DI	DI	-	X
2	378145 ¹	IR33C0HB00	115/230	AC	4	CO-12A(2)	CO-8A(4)	CO-8A(4)	CO-8A(4)	NTC	NTC	DI	DI	X	X
3	378521	IREVS0EA00	230	AC	2	NO-8A(4)	NO-8A(4)	-	-	NTC	NTC	DI	-	-	X
3	378522	IREVF0EC00	230	AC	3	NO-8A(4)	NO-8A(4)	NO-5A(1)	-	NTC	NTC	DI	-	X	X
3	378523	IREVC0HN00	115/230	AC	4	NO-12A(2)	NO-8A(4)	CO-8A(4)	NO-8A(4)	NTC	NTC	DI	DI	-	X

¹with IR/RS-485 interface

fig.	GEV No.	type	supply (V)	voltage	relay outputs	relay output 1	relay output 2	relay output 3	relay output 4	input 1	input 2	input 3	input 4	HACCP	buzzer internal
4	378479	PB00S0EA00	230	AC	2	CO-8A(4)	CO-8A(4)	-	-	NTC	NTC	DI	DI	-	X
4	378480	PB00F0HA00	115-230	AC	4	CO-12A(2)	CO-8A(4)	NO-8A(4)	NO-8A(4)	NTC	NTC	DI	DI	-	X
4	378481	PB00C0HB00	115-230	AC	4	NO-10A(10)	CO-12A(2)	NO-8A(4)	CO-8A(4)	NTC	NTC	DI	DI	X	X



Зип Общепит

built-in version 2-piece

CAREL



1

CAREL



2

vsezip.ru
+7(812)987-08-81

CAREL



3

fig.	GEV No.	type	supply (V)	voltage	relay outputs	relay output 1	relay output 2	relay output 3	relay output 4	input 1	input 2	input 3	input 4	HACCP	buzzer internal
1	378505	PST00LR400	-	-	-	-	-	-	-	-	-	-	-	-	-
2	378465	PSB0001000	230	AC	4	NO-16A(12)	CO-16A(12)	NO-10A(4)	NO-16A(12)	NTC	NTC	DI	DI	X	X
3	403607	connection cable CAREL													

DIN rail

CAREL

70 x 110mm



1

technical data:
supply 115-230V
voltage type AC

fig.	GEV No.	type	relay outputs	relay output 1	relay output 2	relay output 3	relay output 4	input 1	input 2	input 3	input 4	buzzer internal	interface RS485
1	378482	DN33S0HA00	2	NO-10A(10)	CO-8A(4)	-	-	NTC	NTC	DI	DI	X	-
1	378483	DN33C0HB00	4	NO-10A(10)	CO-12A(2)	CO-8A(4)	CO-8A(4)	NTC	DI	DI	DI	X	IR/RS-485

→ electric components



controllers for walk-in fridges

Зип Общепит

vsezip.ru

+7(812)987-08-81

CAREL

200 x 240mm



1

CAREL

200 x 240mm



2

fig.	GEV No.	type	supply (V)	voltage	relay outputs	relay output 1	relay output 2	relay output 3	relay output 4	relay output 5	input 1	input 2	input 3	input 4	buzzer internal	interface RS485
1	378146	MD33D5FB00	230	AC	5	CO-30A(12)	CO-16A(8)	CO-10A(5)	CO-10A(5)	CO-16A(3)	NTC	DI	DI	DI	X	IR/RS-485
2	378176	MD33D5EN00	230	AC	5	CO-30A(12)	CO-16A(8)	CO-10A(5)	CO-10A(5)	CO-16A(3)	NTC	DI	DI	DI	X	-

CAREL

128 x 290mm



3

CAREL

200 x 290mm



4

fig.	GEV No.	type	supply (V)	voltage	relay outputs	relay output 1	relay output 2	relay output 3	relay output 4	relay output 5	input 1	input 2	input 3	input 4	buzzer internal	interface RS485
3	378549	SmartCella	115-230	AC	4	NO-10A(10)	CO-10A(4)	CO-8A(4)	CO-8A(4)	-	NTC	NTC	NTC/DI	NTC/DI	-	X
4	378548	UltraCella	230	AC	6	NO-12A(10)	NO-12A(10)	NO-10A	NO-10A	CO-8A(4)	NTC/PT1000	NTC/PT1000	NTC/PT1000	NTC/V	X	-

DANFOSS

Зип Общепит

universal controllers



1



2

vsezip.ru

+7(812)987-08-81

fig.	GEV No.	type	supply (V)	voltage	relay outputs	relay output 1	relay output 2	relay output 3	relay output 4	relay output 5	input 1	input 2	input 3	input 4	buzzer internal	interface RS485
1	379821	ERC211	230	AC	1	CO-16A	-	-	-	-	NTC/PTC/Pt1000	-	-	-	-	X
2	381375	EKC102B	230	AC	2	CO-10A(6)	CO-10A(6)	-	-	-	NTC/PTC/Pt1000	NTC/PTC/Pt1000	DI	-	-	-
2	381369	EKC202B	230	AC	3	CO-10A(6)	NO-10A(6)	NO-6A(3)	-	-	NTC/PTC/Pt1000	NTC/PTC/Pt1000	DI	-	-	X
2	381374	EKC202C	230	AC	4	CO-10A(6)	NO-10A(6)	NO-6A(3)	CO-4A(1)	-	NTC/PTC/Pt1000	NTC/PTC/Pt1000	DI	-	-	X

DIXELL

universal controllers



1

fig.	GEV No.	type	supply (V)	voltage	relay outputs	relay output 1	relay output 2	input 1	input 2	input 3
1	381408	UNIVERSAL-R4	230/12	AC/DC	4	CO-8A(3)	CO-8A(3)	NTC/PTC	NTC/PTC	NTC/PTC/DI

refrigeration controllers

built-in version



1



2



3

fig.	GEV No.	type	supply (V)	voltage	relay output 1	relay output 2	relay output 3	relay output 4	relay output 5	relay output 6	input 1	input 2	input 3	input 4	buzzer internal
1	378267	XR02CX-5N0C1	230	AC	NO-20A(8)	-	-	-	-	-	NTC	DI	-	-	-
2	378532	XR20CH-5N0C1	230	AC	NO-20A(8)	-	-	-	-	-	NTC/PTC	NTC/PTC/DI	-	-	-
2	378558	XR30CH-5N0C1	230	AC	CO-8A(3)	NO-8A(3)	-	-	-	-	NTC/PTC	DI	-	-	-
2	378533	XR60CH-5N0C1	230	AC	NO-20A(8)	CO-8A(3)	NO-5A(1)	-	-	-	NTC/PTC	NTC/PTC	NTC/PTC/DI	-	-
3	379468	XR20CX-0P1C1	12	AC/DC	NO-20A(8)	-	-	-	-	-	NTC/PTC	DI	-	-	X
3	379661	XR20CX-0N0C0	12	AC/DC	CO-8A(3)	-	-	-	-	-	NTC/PTC	DI	-	-	-
3	379996	XR20CX-5N0C0	230	AC	CO-8A(3)	-	-	-	-	-	NTC/PTC	DI	-	-	-
3	378000	XR20CX-5N0C1	230	AC	NO-20A(8)	-	-	-	-	-	NTC/PTC	NTC/PTC/DI	-	-	-

Table continues overleaf



3



4

Зип Общепит

vsezip.ru

+7(812)987-08-81

fig.	GEV No.	type	supply (V)	voltage	relay output 1	relay output 2	relay output 3	relay output 4	relay output 5	relay output 6	input 1	input 2	input 3	input 4	buzzer internal
3	378384	XR40CX-5N0C1	230	AC	NO-20A(8)	CO-8A(3)	-	-	-	-	NTC/PTC	NTC/PTC	DI	-	-
3	379665	XR30CX-5N0C1	230	AC	NO-20A(8)	CO-8A(3)	-	-	-	-	NTC/PTC	DI	-	-	-
3	379664	XR30CX-5N0C0	230	AC	NO-8A(3)	CO-8A(3)	-	-	-	-	NTC/PTC	DI	-	-	-
3	378363	XR06CX-5R0C1	230	AC	NO-20A(8)	CO-8A(3)	NO-5A(2)	-	-	-	NTC	NTC	DI	-	-
3	402144	XR60CX-5N0C1	230	AC	NO-20A(8)	CO-8A(3)	NO-5A(2)	-	-	-	NTC/PTC	NTC/PTC	DI	-	-
3	378112	XR60CX-0N0C0	12	AC/DC	NO-8A(3)	CO-8A(3)	NO-8A(3)	-	-	-	NTC/PTC	NTC/PTC	DI	-	-
3	378224	XR60CX-5N0C0	230	AC	NO-8A(3)	CO-8A(3)	NO-8A(3)	-	-	-	NTC/PTC	NTC/PTC	DI	-	-
3	378221	XR70CX-5N0C3	230	AC	NO-16A(5)	CO-8A(3)	NO-5A(2)	NO-8A(3)	-	-	NTC/PTC	NTC/PTC	DI	-	-
4	378388	XW220L-5N0C1	230	AC	NO-20A(8)	NO-16A(5)	-	-	-	-	NTC	NTC	DI	DI	X
4	378228	XW20L-5N0C1	230	AC	NO-20A(8)	CO-8A(3)	-	-	-	-	NTC/PTC	DI	-	-	-
4	379655	XW40L-5N0C1	230	AC	NO-20A(8)	CO-8A(3)	NO-8A(3)	-	-	-	NTC/PTC	NTC/PTC	DI	DI	-
4	378389	XW230L-5N0C0	230	AC	NO-20A(8)	NO-16A(5)	NO-8A(3)	NO-16A(5)	-	-	NTC	NTC	DI	DI	X
4	378229	XW60L-5N0C1	230	AC	CO-20A(8)	CO-8A(3)	NO-8A(3)	NO-8A(3)	-	-	NTC/PTC	NTC/PTC	DI	-	-
4	402036	XW260L-5N0C0	230	AC	NO-20A(8)	NO-8A(3)	NO-8A(3)	NO-16A(5)	-	-	NTC	NTC	DI	DI	X
4	378386	XW264L-5N0C5	230	AC	NO-20A(8)	CO-8A(3)	CO-8A(3)	NO-8A(3)	NO-16A(5)	-	NTC	NTC	DI	DI	X
4	378456	XB570L-5N1C1-X	230	AC	NO-20A(12)	NO-8A(3)	NO-8A(3)	NO-16A(3)	NO-16A(3)	NO-8A(3)	NTC/PTC	NTC/PTC	NTC/PTC	NTC/PTC	X
4	378254	XB570L-5R0C1-X	230	AC	NO-20A(8)	NO-8A(3)	NO-8A(3)	NO-16A(5)	NO-8A(3)	NO-16A(5)	NTC	NTC	DI	DI	X
4	379657	XW271L-5N0C0	230	AC	NO-20A(8)	NO-8A(3)	NO-8A(3)	NO-16A(5)	NO-8A(3)	NO-16A(5)	NTC	NTC	NTC	DI	-



5



6



7

fig.	GEV No.	type	supply (V)	voltage	relay output 1	relay output 2	relay output 3	relay output 4	relay output 5	relay output 6	input 1	input 2	input 3	input 4	buzzer internal
5	378222	XW20LS-5N0C1	230	AC	NO-20A(8)	NO-8A(3)	-	-	-	-	NTC/PTC	DI	-	-	-
5	378387	XW40LS-5N0C1	230	AC	NO-20A(8)	NO-8A(3)	NO-8A(3)	-	-	-	NTC/PTC	NTC/PTC	DI	-	-
5	378223	XW60LS-5N0C1	230	AC	NO-20A(8)	NO-8A(3)	NO-8A(3)	-	-	-	NTC/PTC	NTC/PTC	DI	-	-
5	402193	XW30L	230	AC	NO-20A(8)	NO-8A(3)	NO-8A(3)	-	-	-	NTC/PTC	NTC/PTC	-	-	-
6	378556	XB590L-5N1C1R	230	AC	NO-20A(8)	NO-16A(6)	NO-16A(6)	NO-8A(3)	NO-8A(3)	NO-8A(3)	NTC	NTC	NTC	NTC	X
7	378377	XW20VS-5N0C0	230	AC	NO-16A(8)	CO-16A(5)	-	-	-	-	NTC/PTC	DI	-	-	-
7	378422	XW60VS-5N0C0	230	AC	NO-16A(8)	CO-16A(5)	NO-8A(3)	-	-	-	NTC/PTC	NTC/PTC	NTC/PTC	DI	-
7	378423	XW60V-5N0C1	230	AC	NO-20A(8)	CO-8A(3)	NO-8A(3)	NO-16A(5)	-	-	NTC/PTC	NTC/PTC	DI	-	-



Зип Общепит

built-in version 2-piece



fig.	GEV No.	type	supply (V)	voltage	relay outputs	relay output 1	relay output 2	relay output 3	relay output 4	input 1	input 2	input 3	input 4
1	379658	T620-000C0	-	-	-	-	-	-	-	-	-	-	-
2	378225	XW260K-5N0C0	230	AC	4	NO-20A(8)	NO-16A(5)	NO-16A(5)	NO-16A(5)	NTC	NTC	DI	DI
3	379660	XW220K-5N0C0	230	AC	2	NO-20A(8)	NO-16A(5)	-	-	NTC	NTC	DI	DI



fig.	GEV No.	type	supply (V)	voltage	relay outputs	relay output 1	relay output 2	relay output 3	relay output 4	input 1	input 2	input 3	input 4
1	378226	V620-000C0	-	-	-	-	-	-	-	-	-	-	-
2	378225	XW260K-5N0C0	230	AC	4	NO-20A(8)	NO-16A(5)	NO-16A(5)	NO-16A(5)	NTC	NTC	DI	DI
3	379660	XW220K-5N0C0	230	AC	2	NO-20A(8)	NO-16A(5)	-	-	NTC	NTC	DI	DI



fig.	GEV No.	type	supply (V)	voltage	relay outputs	relay output 1	relay output 2	relay output 3	relay output 4	input 1	input 2	input 3	input 4
1	378640	CX620-000N0	-	-	-	-	-	-	-	-	-	-	-
2	378226	V620-000C0	-	-	-	-	-	-	-	-	-	-	-
3	378553	XW20K-5N2C0	230	AC	2	NO-20A(8)	NO-16A(5)	-	-	NTC	NTC	NTC	DI
3	378554	XW40K-5N2C0	230	AC	3	NO-20A(8)	NO-16A(5)	NO-16A(5)	-	NTC	NTC	NTC	NTC
3	378555	XW60K-5N2C0	230	AC	4	NO-20A(8)	NO-16A(5)	NO-16A(5)	NO-8A(3)	NTC	NTC	NTC	NTC

→ electric components



controllers for walk-in fridges

Зип Общепит

dixell

230 x 210mm

vsezip.ru

+7(812)987-08-81



1

fig.	GEV No.	type	supply (V)	voltage	relay outputs	relay output 1	relay output 2	relay output 3	relay output 4	input 1	input 2	input 3	input 4	buzzer internal
1	378525	XLR170-5N1C2	230	AC	6	NO-20A(8)	NO-20A(8)	CO-16A(6)	NO-16A(6)	NTC	NTC	NTC	-	X

accessories



1



2



3



4

fig.	GEV No.	description
1	378551	adapter for reducer mounting measurements 71x29mm
2	378557	housing C-BOX wall-mounted version

fig.	GEV No.	description
3	403226	interface converter XJ485CX
4	402818	programming key 4K for electronic controller



5

fig.	GEV No.	description
5	378227	wall mounting kit V-KIT/W

EKTRON

Зип Общепит

refrigeration controllers

built-in version

vsezip.ru

+7(812)987-08-81



fig.	GEV No.	type	supply (V)	voltage	relay outputs	relay output 1	relay output 2	relay output 3	input 1	input 2
1	378034	REK31ED-0021	230	AC	1	CO-8A(4)	-	-	NTC/PTC	NTC/PTC
1	378118	REK33-1021	230	AC	3	NO-8A(4)	NO-8A(4)	NO-8A(4)	PTC	PTC
1	402020	REK33-0020	12	AC/DC	3	NO-8A(4)	NO-8A(4)	NO-8A(4)	PTC	PTC
2	379542	TEK31-0010	12	AC/DC	1	CO-8A(4)	-	-	PTC	-
2	379397	DEK31-1000A	12	AC/DC	2	CO-8A(4)	NO-8A(4)	-	Pt100	-

ELIWELL

universal controllers

built-in version



fig.	GEV No.	type	supply (V)	voltage	relay outputs	relay output 1	relay output 2	input 1	input 2
1	379689	ICPlus902	12	AC/DC	1	CO-15A(8)	-	NTC/PTC	-

refrigeration controllers

built-in version



fig.	GEV No.	type	supply (V)	voltage	relay outputs	relay output 1	relay output 2	relay output 3	relay output 4	input 1	input 2	input 3	input 4
1	378644	IDPlus 902	12	AC/DC	1	CO-8A	-	-	-	NTC/PTC/Pt1000	DI	-	-
1	378298	IDPlus 961	230	AC	1	NO-12A(12)	-	-	-	NTC/PTC/Pt1000	-	-	-
1	379837	IDPlus 961	12	AC/DC	1	NO-12A(12)	-	-	-	NTC/PTC/Pt1000	-	-	-
1	378380	ICPlus915	230	AC	2	CO-8A(3)	CO-8A(3)	-	-	mA	-	-	-

Table continues overleaf



Зип Общепит

vsezip.ru

+7(812)987-08-81



1

2

3

fig.	GEV No.	type	supply (V)	voltage	relay outputs	relay output 1	relay output 2	relay output 3	relay output 4	input 1	input 2	input 3	input 4
1	378304	IDPlus 971	230	AC	2	NO-12A(12)	CO-8A(4)	-	-	NTC/PTC/Pt1000	NTC/PTC/Pt1000	DI	-
1	378437	IDPlus 971	12	AC/DC	2	NO-12A(12)	CO-8A(4)	-	-	NTC/PTC/Pt1000	NTC/PTC/Pt1000	DI	-
1	378299	IDPlus 974	230	AC	3	NO-12A(12)	CO-8A(4)	NO-5A(2)	-	NTC/PTC/Pt1000	NTC/PTC/Pt1000	NTC/PTC/Pt1000	DI
1	379836	IDPlus 974	12	AC/DC	3	NO-12A(12)	CO-8A(4)	NO-5A(2)	-	NTC/PTC/Pt1000	NTC/PTC/Pt1000	NTC/PTC/Pt1000	DI
1	378436	IDPlus 978	230	AC	4	NO-12A(12)	CO-8A(4)	NO-5A(2)	NO-5A(2)	NTC/PTC/Pt1000	NTC/PTC/Pt1000	DI	-
2	379573	ID970	230	AC	2	NO-8A(3)	CO-8A(3)	-	-	NTC/PTC	-	-	-
2	379580	ID985LX	12	AC/DC	4	CO-8A(3)	NO-8A(3)	NO-8A(3)	NO-5A(2)	NTC/PTC	NTC/PTC	DI	DI
2	378136	ID975LX	12	AC/DC	4	NO-8A(3)	NO-8A(3)	NO-5A(2)	NO-5A(2)	NTC/PTC	NTC/PTC	-	-
3	378142	IWC720JST	230	AC	2	NO-20A(12)	NO-8A(3)	-	-	NTC/PTC	NTC/PTC	DI	-
3	378141	IWC730	230	AC	3	NO-20A(12)	NO-8A(3)	NO-8A(3)	-	NTC/PTC	NTC/PTC	DI	-
3	379884	IWC740	230	AC	4	NO-20A(12)	CO-12A(8)	NO-8A(3)	NO-8A(3)	NTC	NTC	DI	-
3	378520	IWC750	230	AC	5	NO-24A	CO-8A(3)	NO-8A(3)	NO-8A(3)	NTC	NTC	DI	-
3	378139	IWC750	230	AC	5	NO-12A(12)	CO-12A(8)	NO-8A(3)	NO-8A(3)	NTC/PTC	NTC/PTC	DI	-

built-in version 2-piece



1

2

3

fig.	GEV No.	type	relay outputs	relay output 1	relay output 2	relay output 3	relay output 4	relay output 5	relay output 6	input 1	input 2	input 3	input 4	buzzer internal	interface RS485
1	378200	IWK	-	-	-	-	-	-	-	-	-	-	-	-	-
2	378218 ¹	IWP750LX	5	NO-20A	CO-16A	NO-8A(3)	NO-8A(3)	NO-8A(3)	-	NTC/PTC	NTC/PTC	NTC/PTC	4xDI	X	X
2	378211 ¹	IWP760LX	6	NO-20A	CO-16A	NO-8A(3)	NO-8A(3)	NO-8A(3)	NO-8A(3)	NTC/PTC	NTC/PTC	NTC/PTC	4xDI	X	X
3	379191	connection cable L 2000mm 3-pole													

¹without probe, free relays allocation



Зип Общепит
108 x 160mm

vsezip.ru

+7(812)987-08-81



fig.	GEV No.	type	relay outputs	relay output 1	relay output 2	relay output 3	relay output 4	relay output 5	relay output 6	input 1	input 2	input 3	input 4	buzzer internal	interface RS485
1	378216	IWK	-	-	-	-	-	-	-	-	-	-	-	-	-
2	378218 ¹	IWP750LX	5	NO-20A	CO-16A	NO-8A(3)	NO-8A(3)	NO-8A(3)	-	NTC/PTC	NTC/PTC	NTC/PTC	4xDI	X	X
2	378211 ¹	IWP760LX	6	NO-20A	CO-16A	NO-8A(3)	NO-8A(3)	NO-8A(3)	NO-8A(3)	NTC/PTC	NTC/PTC	NTC/PTC	4xDI	X	X
3	379191														

¹without probe, free relais allocation



fig.	GEV No.	type	relay outputs	relay output 1	relay output 2	relay output 3	relay output 4	relay output 5	relay output 6	input 1	input 2	input 3	input 4	buzzer internal	interface RS485
1	378138	IS974LX	-	-	-	-	-	-	-	DI	-	-	-	-	-
2	378140	EWEM243	4	NO-15A(12)	CO-10A(7)	NO-16A(8)	NO-16A(8)	-	-	NTC/PTC	NTC/PTC	-	-	-	X
3	381400	connection cable L 3000mm 10-pole													



Зип Общепит

vsezip.ru

+7(812)987-08-81



fig.	GEV No.	type	relay outputs	relay output 1	relay output 2	relay output 3	relay output 4	relay output 5	relay output 6	input 1	input 2	input 3	input 4	buzzer internal	interface RS485
1	379398	IS972LX	-	-	-	-	-	-	-	DI	-	-	-	-	-
2	379533	EWEM233	3	NO-15A(12)	CO-10A(7)	NO-16A(8)	-	-	-	NTC/PTC	NTC/PTC	-	-	-	X
3	379534	EC0000110	connection cable type EC0000110 connection RJ45												

DIN rail



fig.	GEV No.	type	supply (V)	voltage	relay outputs	relay output 1	relay output 2	relay output 3	relay output 4	input 1	input 2	input 3	input 4	HACCP	real time clock	buzzer internal	interface RS485
1	378205	EWDR981	230	AC	1	CO-15A(12)	-	-	-	NTC/PTC	NTC/PTC	DI	DI	-	-	-	-
1	378378	EWDR983/CSLX	230	AC	2	CO-15A(12)	CO-8A(3)	-	-	NTC/PTC	NTC/PTC	DI	DI	-	-	-	X
1	378206	EWDR985	230	AC	4	CO-15A(12)	CO-8A(3)	NO-8A(3)	NO-8A(3)	NTC/PTC	NTC/PTC	NTC/PTC	DI	-	-	-	-
1	378379	EWDR985/CSLX	230	AC	4	CO-15A(12)	CO-8A(3)	NO-8A(3)	NO-8A(3)	NTC/PTC	NTC/PTC	NTC/PTC	DI	-	-	-	X



Зип Общепит

vsezip.ru

+7(812)987-08-81

wall-mounted



124 x 85mm



1

fig.	GEV No.	type	supply (V)	voltage	relay outputs	relay output 1	input 1	input 2
1	378217	WM961/A	230	AC	1	CO-15A(12)	NTC/PTC	DI

controllers for walk-in fridges



213 x 318mm



1



213 x 318mm



2

technical data:

type EWRC 500 NT 2HP
supply 230V
voltage type AC

fig.	GEV No.	relay outputs	relay output 1	relay output 2	relay output 3	relay output 4	relay output 5	input 1	input 2	input 3	input 4	input 5	H/ACCP	real time clock	interface RS485
1	378447	5	NO-12A(12)	NO-16A(8)	CO-8A(3)	NO-16A(8)	CO-8A(3)	NTC/PTC	NTC/PTC	NTC/PTC	DI	DI	X	X	X
2	378406	5	NO-12A(12)	NO-8A(4)	NO-8A(4)	NO-8A(8)	NO-8A(4)	NTC/PTC	NTC/PTC	NTC/PTC	DI	DI	-	-	-
2	378316	5	NO-12A(12)	NO-8A(8)	NO-8A(4)	NO-8A(4)	NO-8A(4)	NTC/PTC	NTC/PTC	NTC/PTC	DI	DI	-	-	-



electronic thermometers

Зип Общепит

vsezip.ru

+7(812)987-08-81



1

fig.	GEV No.	type	volt. (V)	voltage	measuring range (°C)	probe type
1	378635	EMPLUS 600	12	AC/DC	-50 to +140	NTC/PTC
1	378638	EMPLUS 600	230	AC	-150 to 1350°C	J/K/PT100
1	378637	EMPLUS 600	230	AC	-1999 up to +1999	V/I
1	378636	EMPLUS 600	230	AC	-50 to +140	NTC/PTC

accessories

protective covers



1

fig.	GEV No.	description	suitable for	Ref. No.
1	379804	protection for electronic controller 71x29 L 93mm	—	—

accessories



1

fig.	GEV No.	description	type	application
1	403648	programming key	COPYCARD STD V1.0	for electronic controller



EVCO - EVERY CONTROL

Зип Общепит

refrigeration controllers

vsezip.ru

built-in version



1



2



3

+7(812)987-08-81

fig.	GEV No.	type	supply (V)	voltage	relay outputs	relay output 1	relay output 2	relay output 3	relay output 4	input 1	input 2	input 3	input 4	HACCP	buzzer internal
1	379647	EVKB21N7VCXS	230	AC	1	CO-16A(5)	-	-	-	NTC	DI	-	-	-	-
1	378126	EVK201N7	230	AC	1	CO-16A(5)	-	-	-	NTC/PTC	-	-	-	-	-
1	378147	EVK211N3VXBS	12/24	AC/DC	1	CO-16A(5)	-	-	-	PTC/NTC	-	-	-	-	X
1	378148	EVK211N7VXBS	230	AC	1	CO-16A(5)	-	-	-	PTC/NTC	-	-	-	-	X
1	379648	EVKB31N7VCXS	230	AC	1	NO-30A(12)	-	-	-	NTC	DI	-	-	-	-
1	378149	EVK212N3VXBS	12/24	AC/DC	2	NO-16A(5)	CO-8A(4)	-	-	NTC/PTC	NTC/PTC	DI	-	-	X
1	378150	EVK202N7VXBS	230	AC	2	NO-16A(5)	CO-8A(4)	-	-	NTC/PTC	NTC/PTC	-	-	-	X
1	378113	EVK213N2	12/24	AC/DC	3	NO-16A(5)	CO-8A(4)	NO-8A(4)	-	NTC/PTC	NTC/PTC	DI	-	-	-
1	378153	EVK213N3VXBS	12/24	AC/DC	3	NO-16A(5)	CO-8A(4)	NO-8A(4)	-	NTC/PTC	NTC/PTC	DI	-	-	X
1	378154	EVK203N7VXBS	230	AC	3	NO-16A(5)	CO-8A(4)	NO-8A(4)	-	NTC/PTC	NTC/PTC	DI	-	-	X
1	379649	EVKB33N7VXXS	230	AC	3	NO-30A(12)	CO-8A(4)	NO-8A(4)	-	NTC	NTC	DI	-	-	-
1	378308	EVKB23N7	230	AC	3	NO-8A(4)	CO-8A(4)	NO-5A(4)	-	NTC	NTC	DI	-	-	-
2	378443	EV3X21N7 Touch	230	AC	1	NO-16A(5)	-	-	-	NTC	DI	-	-	-	-
2	378444	EV3B31N7 Touch	230	AC	1	NO-30A(12)	-	-	-	NTC	DI	-	-	-	-
2	378445	EV3B33N7 Touch	230	AC	3	NO-30A(12)	CO-8A(4)	NO-5A(2)	-	NTC	NTC	DI	-	-	-
3	378631	EV3294N9	115-230	AC	4	NO-16A	NO-8A	NO-5A	NO-5A	NTC/PTC	NTC/PTC	NTC/PTC/DI	DI	X	X



4

fig.	GEV No.	type	supply (V)	voltage	relay outputs	relay output 1	relay output 2	relay output 3	relay output 4	input 1	input 2	input 3	input 4	HACCP	buzzer internal
4	378360	EVR232N7	230	AC	2	NO-30A(12)	CO-8A(4)	-	-	NTC/PTC	NTC/PTC	DI	-	-	-
4	378357	EVR204N7	230	AC	4	NO-16A(5)	CO-8A(4)	NO-8A(4)	NO-8A(4)	NTC/PTC	NTC/PTC	DI	-	-	-

Зип Общепит

vsezip.ru

+7(812)987-08-81

DIN rail



1

fig.	GEV No.	type	supply (V)	voltage	relay outputs	relay output 1	relay output 2	relay output 3	input 1	input 2	input 3	buzzer internal
1	378157	EV6221P7VXBS	230	AC	1	CO-16A(5)	-	-	NTC/PTC	DI	DI	X
1	378160	EV6223P7VXBS	230	AC	3	NO-16A(5)	CO-8A(4)	CO-8A(4)	NTC/PTC	NTC/PTC	DI	X

controllers for walk-in fridges



1



2

fig.	GEV No.	type	supply (V)	voltage	relay outputs	relay output 1	relay output 2	relay output 3	relay output 4	relay output 5	relay output 6	input 1	input 2	input 3	input 4	interface RS485
1	378354 ¹	EVB1206N9	230	AC	6	NO-16A(5)	NO-30A(12)	NO-16A(5)	CO-8A(4)	NO-30A(12)	NO-8A(4)	NTC/PTC/Pt1000	NTC/PTC/Pt1000	DI	DI	X
2	379842	ASQX214000	230	AC	4	CO-8A(4)	NO-8A(4)	NO-8A(4)	NO-30A(12)	-	-	NTC/PTC	NTC/PTC	DI	DI	-

¹no residual-current device (RCD)



data loggers Зип Общепит



vsezip.ru
+7(812)987-08-81

1

fig.	GEV No.	type	supply (V)	voltage	relay outputs	relay output 1	relay output 2	relay output 3	input 1	input 2	HACCP	real time clock	buzzer internal	interface RS485
1	378446 ^{1,2}	EVB1216N9XLC	230	AC	6	NO-16A(5)	NO-30A(12)	CO-8A(4)	NTC/PTC/Pt1000	NTC/PTC/Pt1000	X	X	X	X

¹data logger, incl. 2x NTC probes ²data logger incl. control function

data loggers with Bluetooth interface

EV-CONNECT KIT
HACCP professional solution bluetooth connection
*Download the EVCONNECT APP in Google Play



1

fig.	GEV No.	type	supply (V)	voltage	relay outputs	relay output 1	relay output 2	relay output 3	input 1	input 2	HACCP	real time clock	buzzer internal	interface RS485
1	378633	EV-CONNECT-KIT	115-230	AC	4	NO-16A	NO-8A	NO-5A	NTC/PTC	NTC/PTC	X	X	X	

accessories



1

fig.	GEV No.	description
1	378632	bluetooth interface EVCO type EVIF25TBX



1

fig.	GEV No.	description
1	378265	programming key EVERY CONTROL EVKEY



1

fig.	GEV No.	description
1	381303	adapter for conversion of 150x30mm to 138x29mm mounting pos. inner

Зип Общепит

vsezip.ru

+7(812)987-08-81

EVCO
Every Control Group

1

fig.	GEV No.	description
1	378634	housing EVCO type mounting measurements 240x97mm protection IP65

LAE

refrigeration controllers

built-in version



1

2

fig.	GEV No.	type	supply (V)	voltage	relay outputs	relay output 1	relay output 2	relay output 3	relay output 4	relay output 5	input 1	input 2	input 3	input 4	input 5	interface RS485
1	378419	AT1-5AS1E-G	230	AC	1	NO-16A(4)	-	-	-	-	NTC/PTC	-	-	-	-	-
1	379762	AT1-5AS5E-G	230	AC	1	NO-16A(8)	-	-	-	-	NTC/PTC	-	-	-	-	-
1	378420	AT1-5AS2E-G	230	AC	2	NO-16A(4)	NO-7A(2)	-	-	-	NTC/PTC	-	-	-	-	-
1	378290	AT1-5BS6E-BG	230	AC	2	NO-16A(8)	NO-7A(2)	-	-	-	NTC/PTC	NTC/PTC	DI	-	-	X
1	379852	AT1-5AS4D-G	12	AC/DC	2	NO-16A(5)	NO-4A(1)	-	-	-	NTC/PTC	-	-	-	-	-
1	379763	AT1-5BS4E-BG	230	AC	2	NO-16A(5)	NO-7A(2)	-	-	-	NTC/PTC	NTC/PTC	DI	-	-	X
1	379764	AT2-5BS4E-AG	230	AC	3	NO-16A(5)	NO-7A(2)	NO-7A(2)	-	-	NTC/PTC	NTC/PTC	DI	-	-	-
1	379760	AR2-5C24W-BG	115-230	AC	4	NO-12A(5)	NO-7A(2)	NO-7A(2)	NO-7A(2)	-	NTC/PTC	NTC/PTC	NTC/PTC	DI	DI	X
2	378184	LCD32Q4E-C	230	AC	4	NO-20A(6)	NO-12A(4)	NO-8A(3)	CO-8A(3)	-	NTC	NTC	DI	DI	-	X
2	379772	AD-32S35W-B	230	AC	5	CO-16A(5)	NO-16A(4)	NO-7A(2)	NO-7A(2)	NO-7A(2)	NTC	NTC	DI	DI	-	X



Зип Общепит

vsezip.ru

+7(812)987-08-81

built-in version 2-piece



fig.	GEV No.	type	supply (V)	voltage	relay outputs	relay output 1	relay output 2	relay output 3	relay output 4	relay output 5	relay output 6	input 1	input 2	input 3	real time clock	interface RS485
1	379771	LCD5-S	-	-	-	-	-	-	-	-	-	-	-	-	-	-
2	403458	BIT25B1S3E-A	230	AC	3	NO-20A(8)	NO-16A(4)	NO-7A(2)	-	-	-	NTC	NTC	DI	-	X
3	403459	FC06-20M01	connection cable LAE type FC06-20M01													



fig.	GEV No.	type	supply (V)	voltage	relay outputs	relay output 1	relay output 2	relay output 3	relay output 4	relay output 5	relay output 6	input 1	input 2	input 3	real time clock	interface RS485
1	381380	DU5S	-	-	-	-	-	-	-	-	-	-	-	-	-	-
2	378253	BD1-28C1S5W-B	230	AC	5	NO-16A(12)	NO-16A(4)	NO-16A(4)	NO-7A(2)	NO-7A(2)	-	NTC	NTC	DI	-	X
2	379803	BR1-28C1S5W-B	230	AC	5	NO-16A(12)	NO-16A(4)	NO-16A(4)	NO-7A(2)	NO-7A(2)	-	NTC	NTC	DI	X	X
3	403598	FC04-20P01	connection cable LAE type FC04-20P01													



fig.	GEV No.	type	supply (V)	voltage	relay outputs	relay output 1	relay output 2	relay output 3	relay output 4	relay output 5	relay output 6	input 1	input 2	input 3	real time clock	interface RS485
1	379483	SMD34RU	-	-	-	-	-	-	-	-	-	-	-	-	-	-
2	379484	SSD90B35E-C	230	AC	6	NO-20A(6)	CO-12A(4)	NO-8A(3)	NO-8A(3)	CO-8A(3)	NO-7A(2)	PTC	PTC	DI	-	X
3	403465	FC10-20M01	connection cable LAE type FC10-20M01													

electric components



Зип Общепит

vsezip.ru

+7(812)987-08-81

DIN rail



1

fig.	GEV No.	type	supply (V)	voltage	relay outputs	relay output 1	relay output 2	relay output 3	relay output 4	relay output 5	input 1	input 2	input 3	input 4	interface RS485
1	379761	AR2-27C15E-BG	230	AC	5	NO-15A(5)	NO-7A(2)	NO-7A(2)	CO-7A(2)	NO-7A(2)	NTC/PTC	NTC/PTC	DI	DI	X

wall-mounted



1

fig.	GEV No.	type	supply (V)	voltage	relay output 1	relay output 2	input 1	interface RS485
1	379769	LDU2W2E-EG	230	AC	NO-16A(4)	CO-8A(3)	NTC	X

SHANGFANG

refrigeration controllers

built-in version



1



2



3



4

fig.	GEV No.	type	supply (V)	voltage	relay outputs	relay output 1	relay output 2	relay output 3	input 1	input 2	alarm	defr. funct.
1	402150 ¹	SF-101S-2	12	AC	1	12VDC	-	-	NTC	-	X	X
1	403544 ¹	SF-101S	12	AC	1	12VDC	-	-	NTC	-	-	X
2	403705	SF-101	230	AC	1	250VAC	-	-	NTC	-	-	X
3	402156	SF-821	230	AC	1	NO-16A	-	-	NTC	-	-	X
4	403545 ¹	SF-104S	12	AC	3	12VDC	12VDC	12VDC	NTC	NTC	-	X

¹without relay, cable harness, probe and transformer



Зип Общепит

built-in version 2-piece



fig.	GEV No.	type	supply (V)	voltage	relay outputs	relay output 1	relay output 2	relay output 3	input 1	input 2	alarm	defr. funct.
1	379849 ¹	SF-101S	230	AC	1	NO-30A	-	-	NTC	-	-	X
1	403073 ¹	SF-101S-2	230	AC	1	NO-30A	-	-	NTC	-	X	X
2	402148 ¹	SF-104S	230	AC	2	NO-30A	NO-30A	-	NTC	NTC	-	X
3	403074 ¹	SF-104S-2	230	AC	2	NO-30A	NO-30A	-	NTC	NTC	-	X

¹incl. relay, cable harness, probe and transformer

accessories



fig.	GEV No.	description
1	379054	transformer primary 230VAC secondary 12VAC 3VA secondary 0,25A H 40mm L 45mm W 50mm

STÖRK-TRONIC

universal controllers

built-in version



fig.	GEV No.	type	supply (V)	voltage	relay outputs	relay output 1	relay output 2	relay output 3	relay output 4	input 1	input 2	input 3
1	378161	ST710-JB1JA.10	230	AC	1	CO-12A(2,2)	-	-	-	Pt100	DI	-
1	378162	ST710-JB1JA.10	230	AC	1	CO-12A(2,2)	-	-	-	PTC	DI	-
2	378109	ST58-GB1TA.10	230	AC	1	CO-12A(2,2)	-	-	-	PTC/Pt100	-	-
3	379304	ST64-31.10	230	AC	1	NO-12A(6)	-	-	-	Pt100	-	-
3	379305	ST64-31.10	230	AC	1	NO-12A(6)	-	-	-	PTC	-	-
4	379515	ST73-31.10	230	AC	1	NO-12A(6)	-	-	-	PTC	-	-
4	379339	ST73-31.10	230	AC	1	NO-12A(6)	-	-	-	Pt100	-	-

Зип Общепит

vsezip.ru

+7(812)987-08-81



5



6

fig.	GEV No.	type	supply (V)	voltage	relay outputs	relay output 1	relay output 2	relay output 3	relay output 4	input 1	input 2	input 3
5	378164	ST501-JA1TA.10	230	AC	1	NO-12A(6)	-	-	-	PTC/Pt100	-	-
6	378163	ST121-JA1TA.10	230	AC	1	NO-16A(6)	-	-	-	PTC/Pt100	-	-

refrigeration controllers

built-in version



1



2



3



4

fig.	GEV No.	type	supply (V)	voltage	relay outputs	relay output 1	relay output 2	relay output 3	input 1	input 2	input 3
1	378109	ST58-GB1TA.10	230	AC	1	CO-12A(2.2)	-	-	PTC/Pt100	-	-
2	379304	ST64-31.10	230	AC	1	NO-12A(6)	-	-	Pt100	-	-
2	379305	ST64-31.10	230	AC	1	NO-12A(6)	-	-	PTC	-	-
3	379339	ST73-31.10	230	AC	1	NO-12A(6)	-	-	Pt100	-	-
3	379515	ST73-31.10	230	AC	1	NO-12A(6)	-	-	PTC	-	-
4	378161	ST710-JB1JA.10	230	AC	1	CO-12A(2.2)	-	-	Pt100	DI	-
4	378162	ST710-JB1JA.10	230	AC	1	CO-12A(2.2)	-	-	PTC	DI	-
4	379626	ST710-KSKA.12	230	AC	2	NO-12A(2.2)	NO-5A(1.5)	-	PTC	PTC	-



5



6



7

fig.	GEV No.	type	supply (V)	voltage	relay outputs	relay output 1	relay output 2	relay output 3	input 1	input 2	input 3
5	379703	ST70-36.11	12/24	AC/DC	1	NO-7A(1)	-	-	PTC	-	-
5	379704	ST70-36.13	12/24	AC/DC	3	NO-5A(1.5)	NO-5A(1.5)	NO-5A(1.5)	PTC	PTC	DI
6	378163	ST121-JA1TA.10	230	AC	1	NO-16A(6)	-	-	PTC/Pt100	-	-
7	378164	ST501-JA1TA.10	230	AC	1	NO-12A(6)	-	-	PTC/Pt100	-	-



TECNOLOGIC

Зип Общепит

universal controllers

built-in version

vsezip.ru

+7(812)987-08-81



1

fig.	GEV No.	type	supply (V)	voltage	relay outputs	relay output 1	relay output 2	input 1	input 2
1	378459	TLZ11HS----P	100-240	AC	1	CO-16A(6)	-	NTC/PTC/Pt1000	DI
1	379266	TLZ12FS-----	12	AC/DC	1	CO-16A(8)	-	NTC/PTC	-
1	379207	TLZ11HS-----	100-240	AC	1	CO-16A(8)	-	NTC/PTC	DI

refrigeration controllers

built-in version



1



2



3

fig.	GEV No.	type	supply (V)	voltage	relay outputs	relay output 1	relay output 2	relay output 3	relay output 4	input 1	input 2	input 3
1	379264	E51-DNS	230	AC	1	CO-16A(6)	-	-	-	NTC	-	-
2	378459	TLZ11HS----P	100-240	AC	1	CO-16A(6)	-	-	-	NTC/PTC/Pt1000	DI	-
2	378438	TLE20DHK	230	AC	1	NO-20A(12)	-	-	-	NTC/PTC	-	-
2	378232	TLE20	230	AC	1	CO-16A(6)	-	-	-	NTC/PTC	-	-
2	379207	TLZ11HS-----	100-240	AC	1	CO-16A(8)	-	-	-	NTC/PTC	DI	-
2	379266	TLZ12FS-----	12	AC/DC	1	CO-16A(8)	-	-	-	NTC/PTC	-	-
2	379209	TLY28F	12	AC/DC	2	NO-16A(6)	CO-8A(3)	-	-	NTC/PTC	NTC/PTC	DI
2	379363	TLY28H	100-240	AC	2	NO-16A(6)	CO-8A(3)	-	-	NTC/PTC	NTC/PTC	DI
2	379210	TLY29F	12	AC/DC	3	NO-16A(6)	CO-8A(3)	CO-5A(2)	-	NTC/PTC	NTC/PTC	DI
2	379329	TLY29H	100-240	AC	3	NO-16A(6)	CO-8A(3)	CO-5A(2)	-	NTC/PTC	NTC/PTC	DI
2	378439	TLY25H	100-240	AC/DC	4	NO-16A(6)	NO-5A(2)	NO-5A(2)	NO-5A(2)	NTC/PTC	NTC/PTC	DI
2	379991	TLY26---R	12	AC/DC	4	NO-16A(6)	CO-8A(3)	CO-8A(3)	CO-8A(3)	NTC/PTC	NTC/PTC	DI
3	378458 ¹	Y39S-HRRRB--A-E----	100-240	AC	3	NO-16A(9)	CO-8A(3)	NO-5A(2)	-	NTC/PTC	NTC/PTC	DI

¹application by touchscreen

Зип Общепит

vsezip.ru

+7(812)987-08-81



4

fig.	GEV No.	type	supply (V)	voltage	relay outputs	relay output 1	relay output 2	relay output 3	relay output 4	input 1	input 2	input 3
4	378440	TLW24	100-240	AC	1	NO-16A(15)	-	-	-	NTC/PTC	DI	DI
4	378441	TLW24RRS	100-240	AC	4	NO-16A(15)	CO-8A(3)	NO-8A(3)	NO-16A(6)	NTC/PTC	NTC/PTC	DI

DIN rail



1

fig.	GEV No.	type	supply (V)	voltage	relay outputs	relay output 1	relay output 2	relay output 3	relay output 4	input 1	input 2	input 3
1	379501	TLY35HSR	100-240	AC	4	CO-16A(6)	CO-8A(3)	CO-8A(3)	NO-8A(3)	NTC/PTC	NTC/PTC	DI

wall-mounted



1

fig.	GEV No.	type	supply (V)	voltage	relay outputs	relay output 1	relay output 2	relay output 3	input 1	input 2	input 3
1	378233	W09 HRB	100-240	AC	1	CO-8A(3)	-	-	NTC/PTC	-	-
1	378234	W09YHRRRB	100-240	AC	3	NO-14A(6)	CO-8A(3)	NO-4A(2)	NTC/PTC	NTC/PTC	DI

miscellaneous

Зип Общепит

data loggers

vsezip.ru

+7(812)987-08-81



fig.	GEV No.	description
1	378539	<p>Temperature and humidity data logger</p> <p>This new data logger for air temperature, humidity and temperature measurements uses two k-type sensors, impresses with its long recording time and four simultaneously recorded measurements with precise date and time stamp. With the enclosed software, all parameters can be set before recording, such as the desired measurement rate, high and low alarm or also the measurement units. In addition, the maximum recording time is shown depending on the measurement rate. The recorded measurement values can then be analysed with the PC software, and for example, shown as a diagramme or stored as an excel table. For this, the data logger is an important auxiliary means in the analysis of room climate and living area, as well as for industrial, agricultural or cooling systems.</p> <ul style="list-style-type: none"> - Relative air humidity 0 % ... 100 % ; +/- 3.5 % - Air temperature -40 °C ... 70 °C (-40 ... 78°F); 0.1 °C / °F; +/- 1 °C (+/- 3.6°F) - Measurement range (type K) -200 °C ... 1300 °C; 0.1 °C ; +/- 0.15% +1°C (-328 °F ... 2372 °F; 0.1 °F; +/-0.5% +3.6 °F) - Data logger with internal storage up to 67,000 measurements per measurement function - Simultaneously recording air humidity, air temperature and two additional type K temperature sensors - Multi-row LED display with warning LEDs - Measurement rate of 1 second up to 12 hours - Recording time up to 3 months - Operating voltage, 3.6 V lithium battery - Dimensions (WxHxT) 50 x 94 x 32 mm - Weight 91 g <p>Scope of delivery Software for Windows 2000/XP/Vista/7/8.1/10, 2 pieces temperature sensor, wall holder, operating manual Language menu: German, English, French, Spanish, Italian</p>
2	378540	<p>Temperature and air humidity USB data logger</p> <p>New series of handy USB data loggers for air temperature and humidity, temperature measurements via k-type sensors or the measurement of direct voltage with an internal LCD display. With the enclosed software, all desired parameters can be set before recording, such as the desired measurement rate, the start function also according to time and date or a password for safe access to measurement data. The recorded measurements can be subsequently analysed using the PC software, such as shown as a diagramme or stored as an excel table, text or image. - Relative air humidity 0.0% ... 100% +/- 3% R.H.</p> <ul style="list-style-type: none"> - Air temperature -40.0 °C ... 125.0 °C (-40 ... 257°F) +/- 0.3 °C (+/- 0.5°F) - Data logger with internal storage up to 32,000 measurements - Simultaneous recording of air humidity, and air temperature - LCD display for measurement display - Measurement rate adjustable from 2 secs up to 24 hours. - Recording time up to 2 years at 1 measurement / min - Operating voltage 3.6 V lithium battery 1200 mAh - Protection class IP66 - Dimensions (WxHxT) 38 x 122 x 22 mm - Weight approx. 60g <p>Scope of delivery: Software for Windows XP / Vista / 7 / 8 humidity sensor, wall holder, protective cap, operating manual Language menu: German, English, French, Spanish, Italian</p>
3	378528	<p>Temperature USB data logger</p> <p>With integrated lithium battery for recording of 16,382 temperature measurements. The stored measurements can be read out via a USB interface and graphically analysed with the supplied software, or can be exported for further processing by other programmes.</p> <p>Simplest initialisation by Windows software (current software available as a download)</p> <p>Status display (logger active, storage full, alarm, low bat(via LEDs)</p> <p>Time controlled start</p> <p>Freely definable alarm thresholds</p> <p>Recording interval of 10 seconds up to 12 hours can be set</p> <p>Measurement range - 35 to + 80 °C</p> <p>Waterproof (IP67)</p> <p>Alarm when programmable limit value is exceeded</p> <p>Scope of delivery: Lithium battery type 1/2AA, manual Language menu: German, English, French, Spanish, Italian</p>

Зип-Общепит

www.vsezip.ru

+7(812)987-08-84

electric components

probes

universal probes

temperature probes



technical data:
probe type NTC 2kOhm

fig.	GEV No.	cable	probe (°C)	probe	CL (m)
1	379784	TP	-40 up to +110	ø6x35mm	2



technical data:
probe type NTC 10kOhm

fig.	GEV No.	cable	probe (°C)	probe	CL (m)
1	379342	PVC	-20 up to +80	ø6x25mm	1.5
1	379057	PVC	-20 up to +80	ø6x25mm	3
1	378194	PVC	-20 up to +80	ø7x24.5mm	1.5



technical data:
probe type NTC 10kOhm

fig.	GEV No.	cable	probe (°C)	probe	CL (m)
2	379860	PVC	-20 up to +80	ø6x40mm	1.5
2	379458	silicone	-40 up to +110	ø6x40mm	1.5
2	379343	silicone	-40 up to +110	ø6x40mm	3



technical data:
probe type NTC 10kOhm

fig.	GEV No.	cable	probe (°C)	probe	CL (m)
3	379160	TP	-40 up to +110	ø6x14mm	1.5
3	379169	TP	-40 up to +110	ø6x14mm	2
3	379630	TP	-40 up to +110	ø6x14mm	2.5
3	379161	TP	-40 up to +110	ø6x14mm	3
3	379162	TP	-40 up to +110	ø6x14mm	6



technical data:
probe type NTC 10kOhm

fig.	GEV No.	cable	probe (°C)	probe	CL (m)
4	378261	TP	-40 up to +110	ø6x35mm	3



technical data:
probe type NTC 47kOhm

fig.	GEV No.	cable	probe (°C)	probe	CL (m)
1	379149 ¹	glass fibre	-40 up to +125	ø6x35mm	1.45

¹with coded plug for thermometer 379262

technical data:
probe type Pt100

fig.	GEV No.	cable	probe (°C)	probe	CL (m)
1	379785	silicone	-100 up to 450	ø6x100mm	1.5
1	379786	silicone	-100 up to 450	ø6x100mm	3

technical data:
probe type Pt100

fig.	GEV No.	cable	probe (°C)	probe	CL (m)
2	379058 ¹	silicone	-100 up to 450	ø6x100mm	2.8

¹3-wire

technical data:
probe type Pt100

fig.	GEV No.	cable	probe (°C)	probe	CL (m)
3	379439	silicone	-50 up to +250	ø6x50mm	2.5

technical data:
probe type Pt1000

fig.	GEV No.	cable	probe (°C)	probe	CL (m)
1	381407		-50 up to +110	ø5x20mm	3

technical data:
probe type PTC 1kOhm

fig.	GEV No.	cable	probe (°C)	probe	CL (m)
1	379142	PVC	-50 up to +150	ø6x30mm	1.5
1	379199	PVC	-50 up to +150	ø6x30mm	5
1	379637	PVC	-50 up to +150	ø6x35mm	2
1	379052	silicone	-50 up to +150	ø6x40mm	1.5
1	379064	silicone	-50 up to +150	ø6x40mm	3

technical data:
probe type PTC 1kOhm

fig.	GEV No.	cable	probe (°C)	probe	CL (m)
2	379053	PVC	-50 up to +150	ø6x30mm	3

technical data:
probe type PTC 1kOhm

fig.	GEV No.	cable	probe (°C)	probe	CL (m)
3	379783	PVC	-50 up to +150	ø6x35mm	2



Зип Общепит
vsezin.ru
+7(812)987-08-81

4



technical data:
probe type PTC 1kOhm

fig.	GEV No.	cable	probe (°C)	probe	CL (m)
4	378067	silicone	-50 up to +150	ø6x40mm	2
4	378068	silicone	-50 up to +150	ø6x40mm	7
4	378069	silicone	-50 up to +150	ø6x40mm	15
4	378070	silicone	-50 up to +150	ø6x40mm	30

4



technical data:
outlet 4-20mA

fig.	GEV No.	humidity range (%)	supply (VDC)	probe	CL (m)
4	378076	5-95	8-24	ø20x180mm	1.5

5



technical data:
probe type PTC 1kOhm

fig.	GEV No.	cable	probe (°C)	probe	CL (m)
5	379781	TP	-50 up to +150	ø6x14mm	1.5
5	379782	TP	-50 up to +150	ø6x14mm	3

pressure probes

1





fig.	GEV No.	pressure (bar)	supply (VDC)	outlet	TS	CL (m)
1	379118	0.5-8	8-28	4-20mA	7/16"	2
1	379119	0-30	8-28	4-20mA	7/16"	2

humidity probes

1



2



technical data:
outlet 4-20mA

fig.	GEV No.	humidity range (%)	supply (VDC)	probe	CL (m)
1	403390	0-99	9-28	ø17.5x120mm	-
2	379174	10-95	8-35	ø17.5x120mm	-

2



fig.	GEV No.	pressure (bar)	supply (VDC)	outlet	TS	CL (m)
2	378381	0.5-8	8-32	4-20mA	1/4"	2
2	378382	0-30	8-32	4-20mA	1/4"	2

3



technical data:
outlet 4-20mA

fig.	GEV No.	humidity range (%)	supply (VDC)	probe	CL (m)
3	378383	15-90	8-28	ø24x105mm	1.5

core probes

1

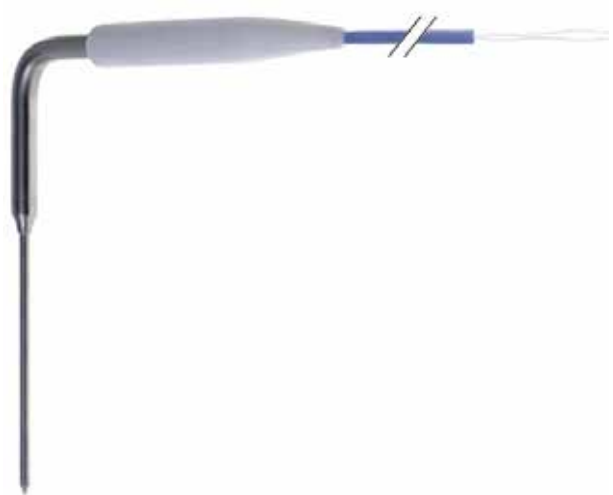

technical data:
cable PVC

fig.	GEV No.	probe type	probe (°C)	probe	CL (m)
1	378391	NTC 10kOhm	-40 up to +120	ø4x100mm	5
1	378393	Pt100	-40 up to +120	ø4x100mm	5
1	378392	Pt1000	-40 up to +120	ø4x100mm	5
1	378390	PTC 1kOhm	-50 up to +150	ø4x100mm	5

1 electric components



Зип Общепит

vsezip.ru

+7(812)987-08-81



2

technical data:
cable PVC

fig.	GEV No.	probe type	probe (°C)	probe	CL (m)
2	378396 ¹	Pt100	-40 up to +120	ø4x100mm	5
2	378395 ¹	Pt1000	-40 up to +120	ø4x100mm	5
2	378394 ¹	PTC 1kOhm	-40 up to +120	ø4x100mm	5

¹heated



4

technical data:
cable PVC

fig.	GEV No.	probe type	probe (°C)	probe	CL (m)
4	378398 ^{1,2}	PTC 1kOhm	-40 up to +120	ø5.5x100mm	5

¹with conical tip ²heated

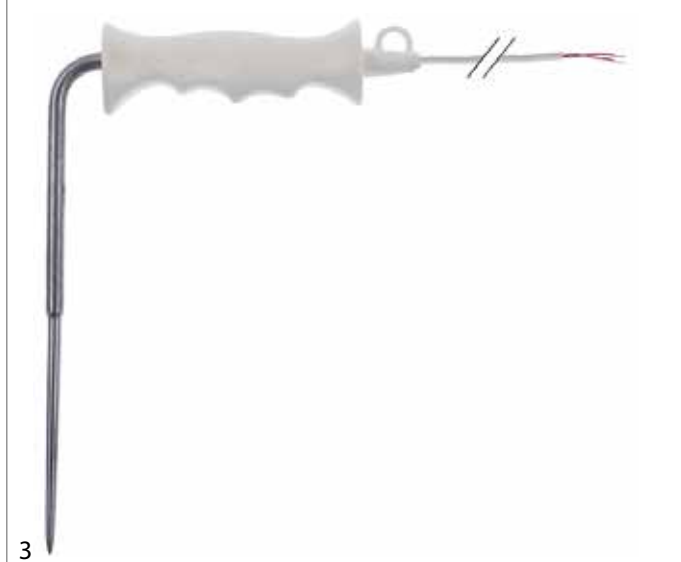

3

technical data:
cable PVC

fig.	GEV No.	probe type	probe (°C)	probe	CL (m)
3	378397 ¹	PTC 1kOhm	-40 up to +120	ø5.5x100mm	5

¹with conical tip



5

technical data:
cable PVC

fig.	GEV No.	probe type	probe (°C)	probe	CL (m)
5	379549	PTC 1kOhm	-50 up to +150	ø6x110mm	3.5



Зип Общепит

vsezip.ru

+7(812)987-08-81

producer-specific probes

core probes

Afinox



1

fig.	GEV No.	description	Ref. No.
1	379707	core temperature probe cable silicone cable -50 up to +180°C connection 2-wire	74700998



2

fig.	GEV No.	description	Ref. No.
2	523049	core temperature probe NTC cable silicone probe -40 up to +110°C cable -50 up to +180°C	74700124



3

fig.	GEV No.	description	Ref. No.
3	379759	core temperature probe Pt100 cable silicone probe -40 up to +120°C cable -50 up to +180°C	74700112

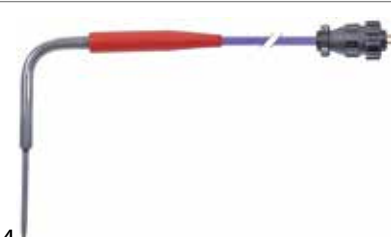

4

fig.	GEV No.	description	Ref. No.
4	378364	core temperature probe PTC cable silicone probe -40 up to +120°C cable -50 up to +180°C	74700116

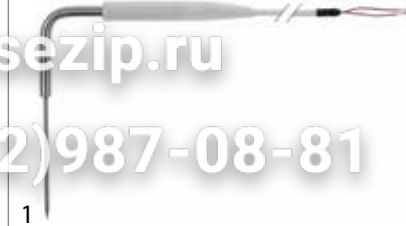

1

fig.	GEV No.	description	Ref. No.
1	378550	core temperature probe NTC 10kOhm cable silicone probe -40 up to +120°C cable -50 up to +180°C	32V8360



2

fig.	GEV No.	description	Ref. No.
2	378402 ¹	core temperature probe Pt100 cable silicone probe -40 up to +120°C cable -50 up to +180°C	32V7960

¹multipoint probe



3

fig.	GEV No.	description	Ref. No.
3	378186	core temperature probe PTC 1kOhm cable silicone probe -40 up to +120°C cable -50 up to +180°C	32V0441

Bertos



1

fig.	GEV No.	description	Ref. No.
1	379350 ¹	core temperature probe PTC 1kOhm cable silicone probe -40 up to +120°C cable -50 up to +180°C	70404

¹multipoint probe



Зип Общепит

fig.	GEV No.	description	Ref. No.
2	374185	temperature probe PTC 1kOhm cable silicone probe -50 up to +150°C cable -50 up to +180°C	083582

Everant



fig.	GEV No.	description	Ref. No.
1	378516	temperature probe PTC 1kOhm cable silicone probe -50 up to +150°C cable -50 up to +180°C	61723

Fagor



fig.	GEV No.	description	Ref. No.
1	379167	core temperature probe PTC cable silicone probe -50 up to +150°C cable -50 up to +180°C	12028770

Foinox



fig.	GEV No.	description	Ref. No.
1	379350 ¹	core temperature probe PTC 1kOhm cable silicone probe -40 up to +120°C cable -50 up to +180°C	70404

¹multipoint probe



fig.	GEV No.	description	Ref. No.
2	379662 ¹	core temperature probe PTC 1kOhm cable silicone probe -40 up to +120°C cable -50 up to +180°C	70402A
2	379806 ¹	core temperature probe PTC 1kOhm cable silicone probe -40 up to +120°C cable -50 up to +180°C	70405A

¹multipoint probe

Coldline



fig.	GEV No.	description	Ref. No.
1	378407	core temperature probe PTC cable silicone probe -40 up to +120°C cable -50 up to +180°C	E043673510

Dexion



fig.	GEV No.	description	Ref. No.
1	378408	core temperature probe PTC cable silicone probe -40 up to +120°C cable -50 up to +180°C	019064-00R

Electrolux



fig.	GEV No.	description	Ref. No.
1	401944	core temperature probe NTC 10kOhm cable silicone probe -40 up to +120°C cable -50 up to +180°C	092704



Зип Общепит

vsezip.ru

+7(812)987-08-81

2

fig.	GEV No.	description	Ref. No.
2	379662 ¹	core temperature probe PTC 1kOhm cable silicone probe -40 up to +120°C cable -50 up to +180°C	70402A
2	379806 ¹	core temperature probe PTC 1kOhm cable silicone probe -40 up to +120°C cable -50 up to +180°C	70405A

¹ multipoint probe

1

fig.	GEV No.	description	Ref. No.
1	379549	core temperature probe PTC 1kOhm cable PVC probe -50 up to +150°C cable -10 up to 100°C	CM33580149/0

Foster

1

fig.	GEV No.	description	Ref. No.
1	378452	core temperature probe NTC 2kOhm cable PVC probe -40 up to +120°C cable -10 up to 100°C	00-554451

Ilsa

1

fig.	GEV No.	description	Ref. No.
1	379549	core temperature probe PTC 1kOhm cable PVC probe -50 up to +150°C cable -10 up to 100°C	31155

Friulinox

1

fig.	GEV No.	description	Ref. No.
1	401756	core temperature probe PTC 1kOhm cable silicone probe -40 up to +120°C cable -50 up to +180°C	FR996070

2

fig.	GEV No.	description	Ref. No.
2	379547	core temperature probe PTC 1kOhm cable silicone probe -40 up to +120°C cable -50 up to +180°C	30600

Hobart

1

fig.	GEV No.	description	Ref. No.
1	378452	core temperature probe NTC 2kOhm cable PVC probe -40 up to +120°C cable -10 up to 100°C	F15247515

3

fig.	GEV No.	description	Ref. No.
3	379548	core temperature probe PTC 1kOhm cable silicone probe -50 up to +150°C cable -50 up to +180°C	30599



Зип-Общепит

4

fig.	GEV No.	description	Ref. No.
4	379543	core temperature probe Pt1000 cable silicone probe -40 up to +120°C cable -50 up to +180°C	3801020

I-OVENS

1

fig.	GEV No.	description	Ref. No.
1	379350 ¹	core temperature probe PTC 1kOhm cable silicone probe -40 up to +120°C cable -50 up to +180°C	70404

¹multipoint probe

2

fig.	GEV No.	description	Ref. No.
2	379662 ¹	core temperature probe PTC 1kOhm cable silicone probe -40 up to +120°C cable -50 up to +180°C	70402A
2	379806 ¹	core temperature probe PTC 1kOhm cable silicone probe -40 up to +120°C cable -50 up to +180°C	70405A

¹multipoint probe

Irinox

1

fig.	GEV No.	description	Ref. No.
1	378237	core temperature probe Pt100 cable silicone probe -40 up to +120°C cable -50 up to +180°C	3803051

2

fig.	GEV No.	description	Ref. No.
2	378238	core temperature probe Pt100 cable silicone probe -40 up to +120°C cable -50 up to +180°C	3805010

3

fig.	GEV No.	description	Ref. No.
3	379755	core temperature probe Pt100 cable silicone probe -40 up to +120°C cable -50 up to +180°C	3801050

Lambda

1

fig.	GEV No.	description	Ref. No.
1	379544	core temperature probe Pt1000 cable silicone probe -40 up to +120°C cable -50 up to +180°C	SIRRA930013

2

fig.	GEV No.	description	Ref. No.
2	379757	core temperature probe Pt1000 cable silicone probe -40 up to +120°C cable -50 up to +180°C	SIRRA930014

3

fig.	GEV No.	description	Ref. No.
3	379663	core temperature probe PTC 1kOhm cable silicone probe -40 up to +120°C cable -50 up to +180°C	SIRRA930010



Зип Общепит

vsezip.ru

+7(812)987-08-81

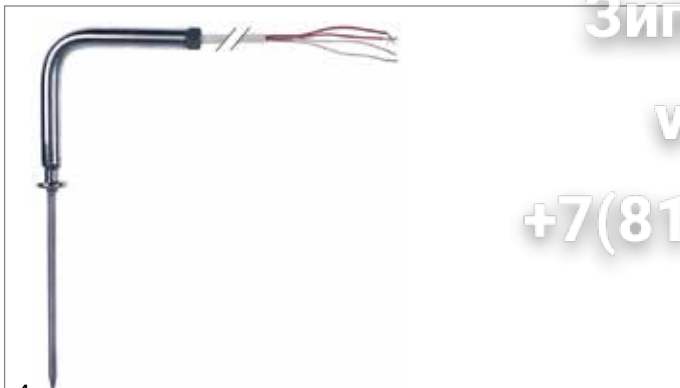

4

fig.	GEV No.	description	Ref. No.
4	401693	core temperature probe PTC 1kOhm cable silicone probe -40 up to +120°C cable -50 up to +180°C	SIRRA930002



1

fig.	GEV No.	description	Ref. No.
1	401756	core temperature probe PTC 1kOhm cable silicone probe -40 up to +120°C cable -50 up to +180°C	FR996070

Lohberger

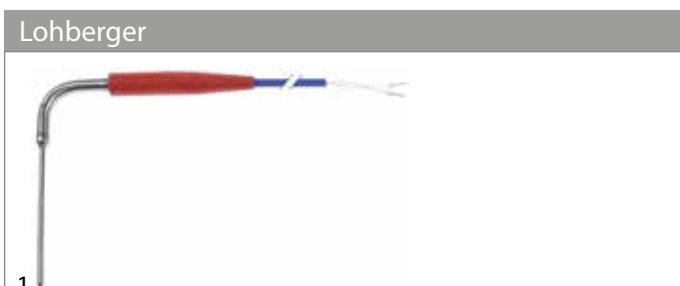

1

fig.	GEV No.	description	Ref. No.
1	401756	core temperature probe PTC 1kOhm cable silicone probe -40 up to +120°C cable -50 up to +180°C	PO167230

Repagas

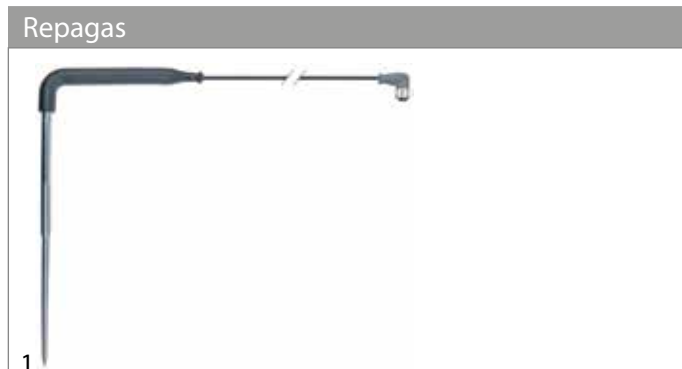

1

fig.	GEV No.	description	Ref. No.
1	379350 ¹	core temperature probe PTC 1kOhm cable silicone probe -40 up to +120°C cable -50 up to +180°C	44300003

¹multipoint probe

Mareno

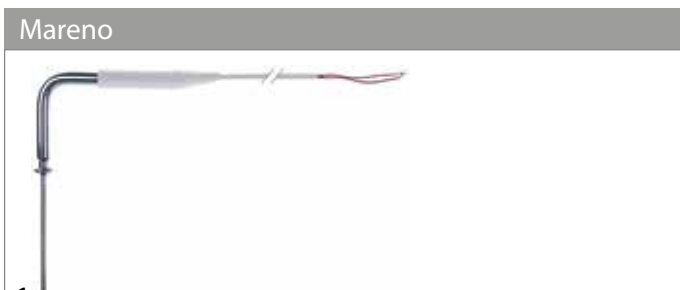

1

fig.	GEV No.	description	Ref. No.
1	379544	core temperature probe Pt1000 cable silicone probe -40 up to +120°C cable -50 up to +180°C	SIRRA930013



2

fig.	GEV No.	description	Ref. No.
2	379662 ¹	core temperature probe PTC 1kOhm cable silicone probe -40 up to +120°C cable -50 up to +180°C	44200002

¹multipoint probe

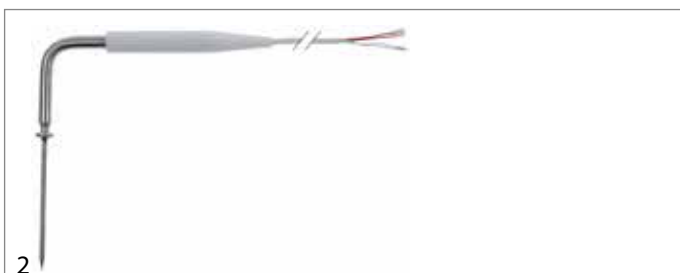

2

fig.	GEV No.	description	Ref. No.
2	379757	core temperature probe Pt1000 cable silicone probe -40 up to +120°C cable -50 up to +180°C	SIRRA930014

Sagi

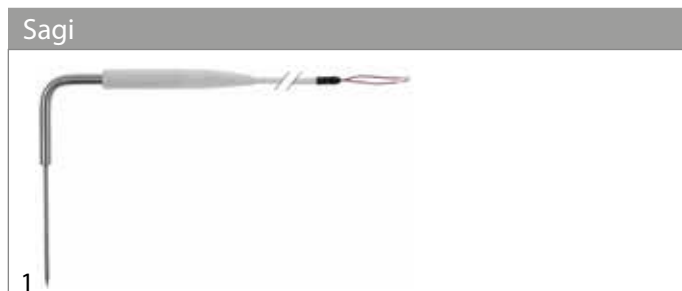

1

fig.	GEV No.	description	Ref. No.
1	378550	core temperature probe NTC 10kOhm cable silicone probe -40 up to +120°C cable -50 up to +180°C	32V8360



Зип-Общепит

vsezip.ru

+7(812)987-08-81



2

fig.	GEV No.	description	Ref. No.
2	378402 ¹	core temperature probe Pt100 cable silicone probe -40 up to +120°C cable -50 up to +180°C	32V7960

¹multipoint probe



3

fig.	GEV No.	description	Ref. No.
3	378186	core temperature probe PTC 1kOhm cable silicone probe -40 up to +120°C cable -50 up to +180°C	32V8600

Silko

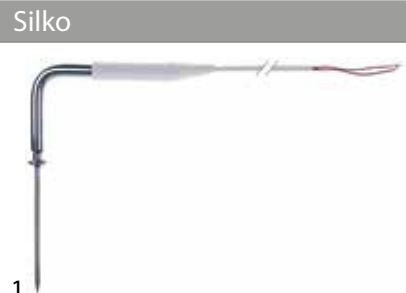

1

fig.	GEV No.	description	Ref. No.
1	379544	core temperature probe Pt1000 cable silicone probe -40 up to +120°C cable -50 up to +180°C	SIRRA930013



2

fig.	GEV No.	description	Ref. No.
2	379757	core temperature probe Pt1000 cable silicone probe -40 up to +120°C cable -50 up to +180°C	SIRRA930014



1

fig.	GEV No.	description	Ref. No.
1	379707	core temperature probe cable silicone cable -50 up to +180°C connection 2-wire	AF74700998

Tecnodom



1

fig.	GEV No.	description	Ref. No.
1	379549	core temperature probe PTC 1kOhm cable PVC probe -50 up to +150°C cable -10 up to 100°C	SONCU

Whirlpool

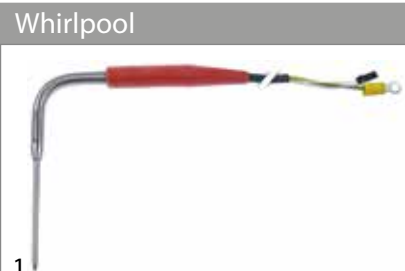

1

fig.	GEV No.	description	Ref. No.
1	401944	core temperature probe NTC 10kOhm cable silicone probe -40 up to +120°C cable -50 up to +180°C	771985011103



2

fig.	GEV No.	description	Ref. No.
2	379548	core temperature probe PTC 1kOhm cable silicone probe -50 up to +150°C cable -50 up to +180°C	483286000033



Зип Общепит

vsezip.ru

+7(812)987-08-81

Zanussi



1

fig.	GEV No.	description	Ref. No.
1	401944	core temperature probe NTC 10kOhm cable silicone probe -40 up to +120°C cable -50 up to +180°C	092704

2



fig.	GEV No.	description	Ref. No.
2	378185	temperature probe PTC 1kOhm cable silicone probe -50 up to +150°C cable -50 up to +180°C	083582

1

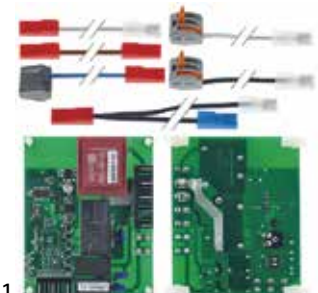

fig.	GEV No.	description	Ref. No.
1	403125	PCB L 175mm W 99mm for ice-cube maker	76-2782-3

electronics

PCBs

Angelo-Po



1

fig.	GEV No.	description	Ref. No.
1	403687	electronic timer 230 mounting measurements 90x70mm Simag for ice maker	3034260

Icematic

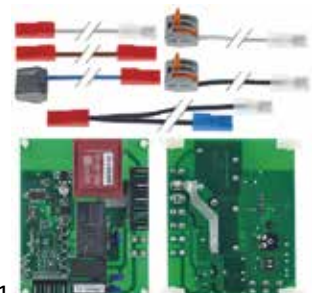

1

fig.	GEV No.	description	Ref. No.
1	403687	electronic timer 230 mounting measurements 90x70mm Simag for ice maker	CMCS62044100

Franke

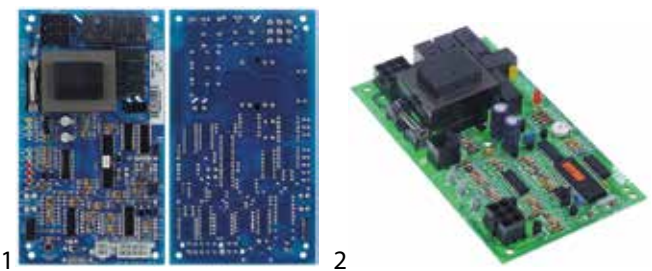

1

fig.	GEV No.	description	Ref. No.
1	403123	PCB ice cube maker L 175mm W 99mm	719.391.063
2	403125	PCB L 175mm W 99mm for ice-cube maker	719.391.097

Manitowoc

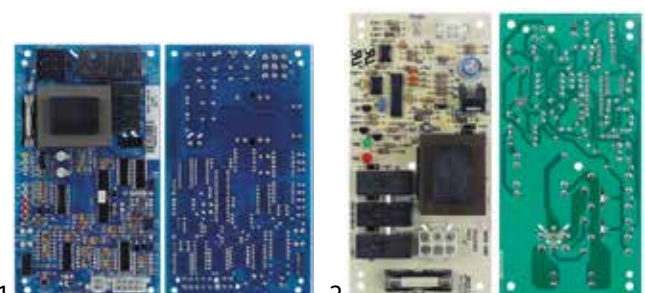

1

fig.	GEV No.	description	Ref. No.
1	403123	PCB ice cube maker L 175mm W 99mm	MA2006199
2	403124	PCB ice maker L 153mm W 77mm	MA-7629073

3



fig.	GEV No.	description	Ref. No.
3	403125	PCB L 175mm W 99mm for ice-cube maker	MA-7627823

electric components



Зип Общепит solenoid valves

solenoid valves (water) vsezip.ru

+7(812)987-08-81



technical data:
voltage 230V
inlet 3/4"

fig.	GEV No.	version	outlet (mm)	output (l/min)	NS	suitable for	Ref. No.
1	373013	single	11.5	2.5	DN10	Mach Migel	80002DR064 2DR064
1	370186	single	11.5	0.25	DN10	ITV	329
1	370459	single	11.5	2	DN10	Simag	Z1ID003
1	370431	single	11.5	2	DN10	Angelo-Po Icematic Migel Scotsman	33D2780 CM19865518/0 2DR028 65010552
1	373001	single	11.5	2	DN10	Electrolux Hatco Icematic Scotsman	0T4545 65010554 nicht in Preisliste 65010554
2	370400	single	11.5	1.5	DN10	Kastel	K01213
2	370654	single	14	20	DN10	Electrolux	048898



technical data:
voltage 230V
inlet 3/4"

fig.	GEV No.	version	outlet (mm)	output (l/min)	NS	suitable for	Ref. No.
3	370414	single	11.5	2		Icematic Scotsman SF-Maschinen	CM19865502/0 CM19865502 I-173



technical data:
voltage 230V
inlet 3/4"
outlet 11,5mm

fig.	GEV No.	version	output (l/min)	NS	suitable for	Ref. No.
1	370461	double	-/4,7	DN10	Icematic Scotsman SF-Maschinen Simag	CM19865509/0 CM19865509 I-174 CM19865509
2	370462	double	0,5/-	DN10	Icematic	CM19865538/0
2	370433	double	2/2.5	DN10	Icematic Scotsman Simag	65010551 65010551 65010551
2	370421	double	1/-	DN10	Simag	Z1CW030
2	370526	double	2/2	DN10	Electrolux Icematic Scotsman	0KM722 nicht in Preisliste 65010553

Migel



fig.	GEV No.	description	Ref. No.
1	360678	timer PCB MIGEL	1LT199

Scotsman

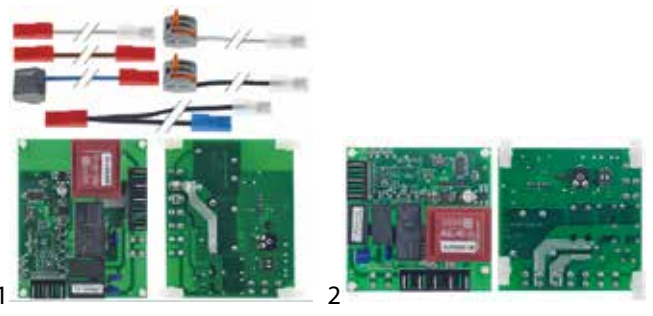

fig.	GEV No.	description	Ref. No.
1	403687	electronic timer 230 mounting measurements 90x70mm Simag for ice maker	06076900
2	403486	electronic timer L 73mm W 73mm suitable for Simag H 30mm timer	62050700



fig.	GEV No.	description	Ref. No.
3	403478	PCB ice maker L 90mm W 72mm suitable for Simag H 30mm	620507.01

Simag

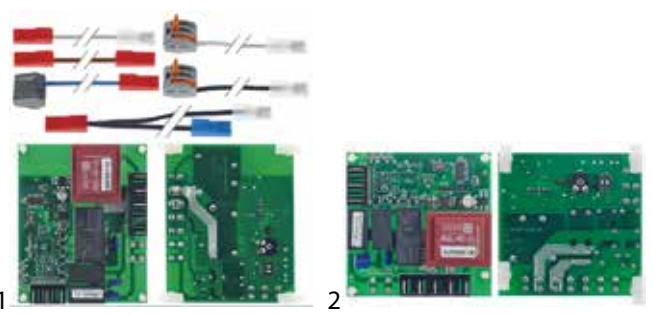

fig.	GEV No.	description	Ref. No.
1	403687	electronic timer 230 mounting measurements 90x70mm Simag for ice maker	06076900
2	403486	electronic timer L 73mm W 73mm suitable for Simag H 30mm timer	62050700



fig.	GEV No.	description	Ref. No.
3	403478	PCB ice maker L 90mm W 72mm suitable for Simag H 30mm	620507.01



Зип Общепит

vsezip.ru

+7(812)987-08-81

ELTEK

technical data:
voltage 230V
inlet 3/4" outlet 11,5mm
nominal size DN10

fig.	GEV No.	version	input (l/min)	output (l/min)	suitable for	Ref. No.
1	370779	single	7	1.2	Migel	2DR025
2	370781	double	7	-	Migel	2DR027
3	370780	double	7	1x1.2-1x2.5	Migel	2DR067
3	370778	double	7	2x1.2	Migel	2DR026

fig.	GEV No.	version	volt. (V)	inlet	outlet (mm)	NS
1	370015	single	230	3/4"	11.5	DN10
1	370016	single	230	3/4"	14	DN10
2	370019	double	230	3/4"	11.5	DN10
2	370020	double	230	3/4"	14	DN10
3	370023	triple	230	3/4"	11.5	DN10
3	370024	triple	230	3/4"	14	DN10

RPE

special outlet

technical data:
voltage 230V
inlet 3/4" outlet 11,5mm

fig.	GEV No.	version	volt. (V)	inlet (mm)	outlet (mm)	suitable for	Ref. No.
1	370453	single	230	11.5	11.5	Icmatic Scotsman	CM19865598/0 62046000

solenoid valves with reducers

technical data:
voltage 230V
inlet 3/4" outlet 11,5mm

fig.	GEV No.	version	input (l/min)	output (l/min)	NS	suitable for	Ref. No.
1	370449	single	2.5	-	DN10	Brema NTF	23220 23220
1	370426	single	-	0.6	DN10	Brema Cookmax	23497 23497
1	370399	single	-	0.8	DN10	Brema Brice Italia Cookmax Kastel NTF	23115 926093 23115 K01212 N23115
1	370427	single	-	1.2	DN10	Brema Brice Italia Cookmax Electrolux Fagor La-Spaziale Luxia NTF Rancilio	23001 926132 23001 0KK221 12033258 3345 L4690 N23001 68023001
2	370434	double	-	2,5/2,5	DN10	Brema	23157
2	370437	double	10	1,2/1,2	DN10	Brema Cookmax Coven NTF Rancilio	23010 23010 EMUA2RPE N23010 68023010
2	370436	double	-	0.6/0.6	DN10	Brema Cookmax Electrolux	23498 23498 085274
2	370395	double	-	0.8/0.8	DN10	Brema Brice Italia Cookmax Electrolux Kastel NTF	23116 926137 23116 085310 K01045 N23116
2	370397	double	-	1.5/2.5	DN10	Brice Italia Kastel	926032 K01322

TP

fig.	GEV No.	version	volt. (V)	inlet	outlet (mm)	NS
1	370017	single	230	3/4"	11.5	DN10
1	370018	single	230	3/4"	14	DN10
2	370021	double	230	3/4"	11.5	DN10
2	370022	double	230	3/4"	14	DN10
3	370025	triple	230	3/4"	11.5	DN10
3	370026	triple	230	3/4"	14	DN10

electric components

Зип.Общепит

vsezip.ru

+7(812)987-08-81



technical data:
voltage 230V
inlet 3/4"
outlet 11,5mm

fig.	GEV No.	version	input (l/min)	output (l/min)	NS	suitable for	Ref. No.
3	370187	double	10	-/3.4	DN10	ITV	928
4	370416	double	-	1.2/1.2	DN10	Icematic Scotsman SF-Maschinen Simag	CM19865530/0 CM19865530 I-170 CM19865530
4	370188	double	10	1/0.25	DN10	ITV	404
4	370468	double	10	3.4/3.4	DN10	ITV	293



technical data:
voltage 230V
inlet 3/4"
outlet 11,5mm

fig.	GEV No.	description
1	370650	solenoid valve single angled 220/240V outlet 11mm inlet 12,4mm 50/60Hz



technical data:
voltage 230V
inlet 3/4"
outlet 11,5mm

fig.	GEV No.	version	input (l/min)	output (l/min)	NS	suitable for	Ref. No.
5	370189	triple	12	1/3.4/3.4	DN10	ITV	1430
6	370635	triple	10	3.4/1/3.4	DN10	ITV	1913

drain valves





fig.	GEV No.	volt. (V)	inlet (mm)	outlet (mm)	suitable for
1	371106	208/230	17.5	16	Icematic Scotsman
2	370691	220-240	17.5	16	Icematic

spare parts and accessories

reducers

outlet side



technical data:
tolerance ±25%

fig.	GEV No.	flow rate (l/min)	colour
1	371230	0.25	red
1	371233	0.8	white
1	371234	1	light blue
1	371235	1.2	brown
1	371236	1.5	light brown
1	371237	2.5	yellow
1	371238	3.4	dark green
1	371239	5	black

solenoid valves (refrigeration)

CASTEL

valve bodies

STANDARD series

suitable for refrigerants R22, R134a, R404A, R407C, R410A, R507



technical data:
type NC
pressure max 45bar
temperature range -35 up to +105°C

pos.	GEV No.	type	connection	DN (mm)
1	370151	1028/2 S	1/4" soldering connection	2.2
2	370382	1028/M10S	10mm soldering connection	3
3	370383	1068/M10S	10mm soldering connection	7
4	370384	1068/M12S	12mm soldering connection	7
5	370385	1078/M12S	12mm soldering connection	12.5
6	370386	1078/5S	16mm soldering connection	12.5
7	370387	1079/7S	22mm soldering connection	12.5

inlet side



technical data:
tolerance ±15%

fig.	GEV No.	flow rate (l/min)	colour	fig.	GEV No.	flow rate (l/min)	colour
1	371220	3	red	1	371223	10	white
1	371221	5.5	yellow	1	371224	12	blue
1	371222	6	grey				



Зип Общепит

vsezip.ru

+7(812)987-08-81



technical data:
type NC
pressure max 45bar
temperature range -35 up to +105°C

pos.	GEV No.	type	connection	DN (mm)
1	370153	1070/4 S	1/2" SAE	12.5
2	370150	1020/2 S	1/4" SAE	2.5
3	370154	1090/6 S	3/4" SAE	16.5
4	370788	1020/3S	3/8" SAE	2.5
5	370152	1064/3 S	3/8" SAE	7
6	370381	1090/5 S	5/8" SAE	16.5



fig.	GEV No.	description	plug type	connector
1	371305	power socket	DIN 43650A	cable 2000mm
2	371090	power socket	DIN 43650A	screw
3	371304	power socket	DIN 43650A	screw

GO GREEN series

hydrocarbons (HC liquids) and carbon dioxide (R744)



technical data:
type NC
pressure max 35bar
temperature range -20 up to +105°C

pos.	GEV No.	type	connection
1	370807	1028V/M10S	M18x1.5 (tube ø 12mm)
2	370804	1028V/2S	1/4" soldering connection
3	370805	1028V/2S.E	1/4" soldering connection
4	370806	1028V/3S	3/8" soldering connection
5	370809	1068V/M10S	ODF 10mm
6	370808	1068V/3S	ODF 3/8"
7	370811	1068V/4S	ODS 1/2"
8	370810	1068V/M12S	ODS 12mm

DANFOSS

valves



technical data:
type NC
temperature range -40° up to 105°C

pos.	GEV No.	type	p max (bar)	connection	DN (mm)
1	370293	EVR 3	45.2	6mm soldering connection	3.2
2	370294	EVR 6	35	10mm soldering connection	6
3	370295	EVR 10	35	12mm soldering connection	9.5
4	370296	EVR 15	32	16mm soldering connection	14

spare parts and accessories



technical data:
power 8VA
frequency 50/60Hz

fig.	GEV No.	description	supply	connection
1	371303	solenoid coil	24VAC	cable 1000mm
1	371084	solenoid coil	230VAC	cable 1000mm



technical data:
power 8VA
frequency 50/60Hz

fig.	GEV No.	description	supply	connection
2	371301	solenoid coil	110VAC	DIN 43650A



technical data:
type NC
temperature range -40° up to 105°C

pos.	GEV No.	type	p max (bar)	connection	DN (mm)
1	370292	EVR 3	45.2	6mm, 7/16 UNF	3.2
2	370298	EVR 10	35	3/4" UNF (12mm)	14
3	370299	EVR 15	32	7/8" UNF (16mm)	14



Зип.Общепит

spare parts and accessories

vsezip.ru

+7(812)987-08-81

valve bodies



technical data:
type NC
temperature range -40° up to 105°C

pos.	GEV No.	type	p max (bar)	connection	DN (mm)
1	370286	EVR 3	45.2	10mm soldering connection	3.2
2	370160	EVR 3	45.2	6mm soldering connection	3.2
3	370287	EVR 6	35	10mm soldering connection	6
4	370288	EVR 6	35	12mm soldering connection	6
5	370289	EVR 10	35	12mm soldering connection	9.5
6	370290	EVR 10	35	16mm soldering connection	9.5
7	370291	EVR 10	35	16mm soldering connection	14



technical data:
type NC
temperature range -40° up to 105°C

pos.	GEV No.	type	p max (bar)	connection	DN (mm)
1	370159	EVR 3	45.2	7/16" UNF (1/4" SAE)	3.2
2	370162	EVR 6	35	3/4" UNF (1/2" SAE)	9.5
3	370161	EVR 6	35	5/8" UNF (3/8" SAE)	6
4	370163	EVR 10	35	7/8" UNF	10



technical data:
type NC
pressure max 35bar
temperature range -10 up to +80°C

fig.	GEV No.	type	connection	DN (mm)
1	370664	EV210B	G1/4 (Whitworth pipe thread)	1.5



fig.	GEV No.	description
1	371046	console for solenoid valve for EVR2,3,6,10
2	371004	solenoid coil DANFOSS 220/230V voltage AC 10VA



fig.	GEV No.	description
3	371040	solenoid coil DANFOSS type EVR 230V 10VA

PARKER

valves

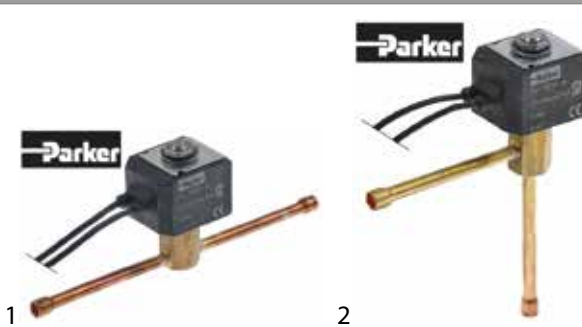

fig.	GEV No.	volt. (V)	connection
1	370782	230	16mm soldering connection
2	370783	230	6mm soldering connection

SANHUA

valves



technical data:
pressure max 45bar
temperature range -30 up to +105°C

fig.	GEV No.	type	connection
1	370757	MDF-A03-6H001	10mm soldering connection



Зип Общепит
pressure switches
vsezip.ru
DANFOSS

+7(812)98708-81

valve bodies



1

technical data:
pressure max 31bar
temperature range -30 up to +105°C

fig.	GEV No.	type	type	connection
1	370826	MDF10	MDF-A03-10H005	12mm ODF
1	370823	MDF3	MDF-A03-3H005	6mm ODF
1	370824	MDF6	MDF-A03-6H005	8mm ODF

spare parts and accessories



1

fig.	GEV No.	supply	power (VA)	seat ø (mm)	coil type
1	370825	220/240VAC	12/10	25.4	MQ-A0322G-000001

accessories

union nuts



1

2

3

fig.	GEV No.	type	size	pipe ø	Int. Code
1	750050	7010/22	1/4" SAE	1/4" - 6mm	NS4-4
1	750460	7010/33	3/8" SAE	3/8"	NS4-6
1	750463	7010/44	1/2" SAE	1/2"	NS4-8
1	750065	7010/55	5/8" SAE	5/8" - 16mm	NS4-10
2	750057	7020/32	3/8" SAE	1/4" - 6mm	NRS4-64
2	750462	7020/43	1/2" SAE	3/8"	NRS4-86
2	750461	7020/54	5/8" SAE	1/2"	NRS4-108
3	750051	7030/3M8	3/8" SAE	8mm	-
3	750052	7030/3M10	3/8" SAE	10mm	-
3	750053	7030/4M10	1/2" SAE	10mm	-
3	750054	7030/4M12	1/2" SAE	12mm	-
3	750063	7030/5M12	5/8" SAE	12mm	-
3	750064	7030/5M14	5/8" SAE	14mm	-
3	750055	7030/6M14	3/4" SAE	14mm	-
3	750056	7030/6M18	3/4" SAE	18mm	-

for refrigeration



1

technical data:
connection 7/16" UNF (1/4" SAE)

fig.	GEV No.	type	reset	switching diff. (bar)	pressure range (bar)
1	541464	KP1 60-1101	automatic	0.7 - 4.0	-0.2 up to +7.5
1	541466	KP2 60-1120	automatic	0.4-1.5	-0.2 up to +5.0
1	541462	KP5 60-1171	automatic	1.8-6	8-32
1	541468	KP7B60-1191	manual	4	8-32
1	541467	KP7W60-1190	automatic	4-10	8-32



1

technical data:
connection switching difference at high pressure 4bar
operable temperature range low pressure -0.2 up to +7.5bar
operable temperature range high pressure 8-32bar
switching difference at low pressure 0.7 - 4.0bar

fig.	GEV No.	type	reset HP	reset LP
1	541470	KP17B60-1268	manual	automatic
1	541469	KP17W60-1275	automatic	automatic

electric components



Зип Общепит

vsezip.ru

+7(812)987-08-81

RANCO

O16 series



technical data:
reset automatic
connection 7/16" UNF (1/4" SAE)

fig.	GEV No.	type	switching diff. (bar)	pressure range (bar)
1	541121	O16-H6703	0.6-4	-0.3-7
1	541123	O16-H6750	2.5-8	7-30



technical data:
reset manual
connection 7/16" UNF (1/4" SAE)

fig.	GEV No.	type	switching diff. (bar)	pressure range (bar)
1	541122	O16-H6705	0.6	-0.7-6.4
1	541124	O16-H6751	3.2	7-30

O17 series



technical data:
connection 7/16" UNF (1/4" SAE)
operable temperature range low pressure -0.3-7bar
operable temperature range high pressure 7-30bar
switching difference at high pressure 3,5bar
switching difference at low pressure 0.6-4bar

fig.	GEV No.	type	reset HP	reset LP
1	541125	017H4758.101 PED	automatic	automatic
1	541126	O17-H4703	manual	manual
1	541127	O17-H4705	manual	automatic

DWFK series



fig.	GEV No.	switching diff. (bar)	pressure range (bar)	suitable for	Ref. No.
1	541853	-	17.5	Aristarco Kastel	K00077 K02908
2	542133	1	9-10	Mach Migel Migel	8001LT075 1LT075 1LT136

fig.	GEV No.	switching diff. (bar)	pressure range (bar)	suitable for	Ref. No.
3	542132	2	17-19	Mach	80001LT093

SAGI NO MIYA



technical data:
reset manual

fig.	GEV No.	type	connection	suitable for	Ref. No.
1	541480	FTB-3UC37	F6.3	Brema Electrolux NTF	23342 087803 N23342

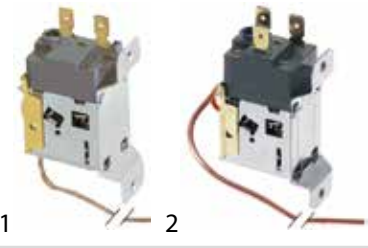

technical data:
reset automatic

fig.	GEV No.	type	connection	suitable for	Ref. No.
1	541112	HTB-X3UC29	7/16" UNF (1/4" SAE)	ITV	2507
1	539002	HTB-3UA12	2.4mm	Scotsman Simag	620075.02 620075.02
1	541479	HTB-X114	2.4mm	Brema Brice Italia Cookmax Electrolux Fagor NTF Staff Ice System	23175 926069 23175 0KK218 12031100 N23175 4006013000
2	541113	HTB-X326	7/16" UNF (1/4" SAE)	ITV	2683

JOHNSON CONTROLS



technical data:
version HD
pressure range 7-29bar
pressure max 38bar
connection soldering connection 6.35mm

fig.	GEV No.	switch pressure (bar)	reset	switching diff. (bar)	suitable for	Ref. No.
1	541116	10	automatic	1.1	Electrolux GIGA Icematic Scotsman Simag Zanussi	086039 162007500 CMXP62007500 62007500 62049901 086039



Зип Общепит

vsezip.ru

+7(812)987-08-81

miscellaneous



technical data:
 version HD
 temperature range -30 up to +85°C
 pressure connection soldering connection 6.35mmmm
 connection male faston 6.35mm

pos.	GEV No.	reset	type	suitable for	ref. No.
1	541118	automatic	ACB-DBM2142	ITV	334

refrigeration power packs



technical data:
 voltage 220-240V
 phases 1
 frequency 50Hz

fig.	GEV No.	application	coolant	compressor type	P (HP)	cylinder capacity (cm ³)	size	weight (kg)	inlet ø	outlet ø	power at -30°C (W)	power at -25°C (W)	power at -20°C (W)	power at -10°C (W)	power at -5°C (W)	power at 0°C (W)	power at +10°C (W)
1	605222	HBP	R134a	EMT6144Z	1/5	5.19	500x340xH270mm	17	3/8" -10mm	1/4"-6mm	-	-	-	294	367	395	661
1	605223	HBP	R134a	EMT6160Z	1/4	6.76	500x340xH270mm	18	3/8" -11mm	1/4"-7mm	-	-	-	412	513	630	910
1	605224	HBP	R134a	EMT6170Z	1/4	7.69	500x340xH270mm	18.5	3/8" -11mm	1/4"-7mm	-	-	-	358	448	550	982
1	605225	HBP	R134a	NEK6187Z	1/2	10	500x340xH270mm	20.5	3/8" -10mm	1/4"-6mm	-	-	-	482	624	791	1201
1	605191	HBP	R134a	NEK6214Z	1/2	16.8	500X340XH300mm	24	3/8" -10mm	1/4" - 6mm	-	-	-	824	1032	1275	1860
1	605192	HBP	R134a	NJ6226Z	1	34.37	540x400xH350mm	39	1/2" -12mm	3/8" -10mm	-	-	-	1497	1892	2340	3438
1	605228	HMBP	R404A	EMT6152GK	1/5	4.5	500x340xH270mm	17	3/8" -10mm	1/4"-6mm	-	-	267	351	437	535	769
1	605229	HMBP	R404A	EMT6165GK	1/4	5.19	500x340xH270mm	22.5	3/8" -10mm	1/4"-6mm	-	-	-	384	477	570	808
1	605230	HMBP	R404A	NEK6181GK	1/4	7.28	500x340xH270mm	22.5	3/8" -10mm	1/4"-6mm	-	-	456	676	824	998	1423
1	605232	HMBP	R404A	NEK6210GK	1/3	8.78	500x340xH270mm	24	3/8" -10mm	1/4"-6mm	-	-	565	816	989	1193	1707
1	605233	LBP	R404A	NEK2130GK	1/6	7.37	500x340xH270mm	20	3/8" -11mm	1/4"-7mm	257	386	422	524	640	-	-
1	605234	LBP	R404A	NEK2134GK	1/2	8.77	500x340xH270mm	26	3/8" -10mm	1/4"-6mm	353	457	579	879	-	-	-
1	605226	MBP	R134a	NT6220Z	3/4	22.4	540x400xH330mm	35	1/2" -12mm	3/8" -10mm	-	-	-	1254	1506	1892	3070
1	605217	MBP	R404A	EMT6144GK	1/6	3.97	500x340xH270mm	17	3/8" -10mm	1/4" - 6mm	-	-	246	377	459	552	774

Зип-Общепит

R407a, R134a

compressors

ACC/ZEL

R134A

LBP single phase

Lower evaporation temperature below -20°C



1

technical data:
voltage 220-240V
frequency 50Hz
motor system RSIR

fig.	GEV No.	type	P (HP)	cylinder capacity (cm ³)	power at -30°C (W)	power at -25°C (W)	power at -20°C (W)	power at -15°C (W)
1	605062	GL80AA	1/5	7.39	102	144	196	256

LBP single phase

Lower evaporation temperature below -20°C



1

technical data:
voltage 220-240V
frequency 50Hz

fig.	GEV No.	type	P (HP)	cylinder capacity (cm ³)	motor system	power at -30°C (W)	power at -25°C (W)	power at -20°C (W)	power at -15°C (W)
1	605073	MP14FB	1/2	14	CSIR	439	584	746	926
1	605127	MX18FB	5/8	18.4	CSR	575	750	985	1219

HMBP single phase

High/Medium evaporation temperature above -20/-15 °C



1

technical data:
voltage 220-240V
frequency 50Hz
motor system CSIR

fig.	GEV No.	type	P (HP)	cylinder capacity (cm ³)	power at -10°C (W)	power at -5°C (W)	power at 0°C (W)	power at +5°C (W)
1	605006	GD40MB	1/8	4.1	153	196	245	301
1	605012	GL45TB	1/6	4.5	175	223	278	342
1	605007	GL60TB	1/5	5.7	222	284	355	437
1	605008	GL80TB	1/5	7.6	390	500	615	727
1	605009	GL90TB	1/4	8.8	339	432	539	661
1	605010	GP12TB	3/8	12	339	432	539	661
1	605011	GP14TB	3/8	14	497	643	810	999

HMBP single phase

High/Medium evaporation temperature above -20/-15 °C



1

technical data:
voltage 220-240V
frequency 50Hz

fig.	GEV No.	type	P (HP)	cylinder capacity (cm ³)	motor system	power at -10°C (W)	power at -5°C (W)	power at 0°C (W)	power at +5°C (W)
1	605020	ML40TB	1/6	4.04	CSIR	342	416	499	589
1	605068	ML45TB	1/5	4.5	CSIR	382	465	557	659
1	605014	ML80TB	3/8	7.57	CSIR	561	691	835	993
1	605028	ML90TB	3/8	8.85	CSIR	666	819	990	1181
1	605072	MX18TB	7/8	18.4	CSR	1350	1663	2013	2400
1	605093	MX21TB	1	20.73	CSR	970	1046	1121	1195

Зип Общепит

vsezip.ru

+7(812)987-08-81

R600A

LBP single phase

Lower evaporation temperature below -20°C



technical data:
voltage 220-240V
frequency 50Hz
motor system RSIR

fig.	GEV No.	type	P (HP)	cylinder capacity (cm ³)	power at -30°C (W)	power at -25°C (W)	power at -20°C (W)	power at -15°C (W)
1	605241	HSR050AA	1/14	3.67	31	45	60	75
1	605242	HMK12AA	1/5	11.2	137	181	233	291

High/Medium evaporation temperature above -20/-15 °C



technical data:
voltage 220-240V
frequency 50Hz

fig.	GEV No.	type	P (HP)	cylinder capacity (cm ³)	motor system	power at -10°C (W)	power at -5°C (W)	power at 0°C (W)	power at +5°C (W)
1	605196	GD36MB	1/10	3.62	CSIR	118	130	144	160
1	605170	GP16TB	3/8	16.15	CSIR	688	878	1093	1323
1	605182	GX18TB	1/2	18.39	CSIR	944	1182	1449	1744
1	605212	GX23TB	5/8	23.2	CSIR	887	1132	1413	1730

CUBIGEL

R134A

LBP single phase

Lower evaporation temperature below -20°C



technical data:
voltage 220-240V
frequency 50Hz
motor system RSIR

fig.	GEV No.	type	P (HP)	cylinder capacity (cm ³)	power at -30°C (W)	power at -25°C (W)	power at -20°C (W)	power at -15°C (W)
1	605197	GL60AA	1/6	5.99	98	135	178	227
1	605185	GL90AA	1/4	8.1	148	200	261	330



technical data:
voltage 220-240V
frequency 50Hz

fig.	GEV No.	type	P (HP)	cylinder capacity (cm ³)	motor system	power at -10°C (W)	power at -5°C (W)	power at 0°C (W)	power at +5°C (W)
2	605211	GS34TB	1	34.4	CSR	1580	2042	2559	3131



Зип-Общепит

H/M/MP single phase

R404a/R507

LBP single phase

Lower evaporation temperature below -20°C



technical data:
voltage 220-240V
frequency 50Hz

fig.	GEV No.	type	P (HP)	cylinder capacity (cm ³)	motor system	power at -30°C (W)	power at -25°C (W)	power at -20°C (W)	power at -15°C (W)
1	605207	ML80FB	1/4	8.1	CSIR	276	314	356	401
1	605176	ML90FB	1/3	8.85	CSIR	305	394	495	606
1	605138	MP12FB	3/8	12	CSIR	381	510	657	819
1	605180	MX23FB	1	23.2	CSR	749	982	1246	1541

High/Medium evaporation temperature above -20/-15 °C

vsezip.ru

+7(812)987-08-81



technical data:
voltage 220-240V
frequency 50Hz

fig.	GEV No.	type	P (HP)	cylinder capacity (cm ³)	motor system	power at -10°C (W)	power at -5°C (W)	power at 0°C (W)	power at +5°C (W)
1	605013	ML60TB	1/4	5.68	CSIR	511	628	760	906
1	605029	MP12RB	1/2	12	CSR	1157	1407	1681	1982
1	605067	MPT14RA	1/2	14.32	CSR	720	775	829	882



technical data:
voltage 220-240V
frequency 50Hz

fig.	GEV No.	type	P (HP)	cylinder capacity (cm ³)	motor system	power at -30°C (W)	power at -25°C (W)	power at -20°C (W)	power at -15°C (W)
2	605195	MS34FB	1	34.42	CSR	1267	1733	2259	2843

R600A

LBP single phase

Lower evaporation temperature below -20°C



technical data:
voltage 220-240V
frequency 50Hz
motor system RSIR

fig.	GEV No.	type	P (HP)	cylinder capacity (cm ³)	power at -30°C (W)	power at -25°C (W)	power at -20°C (W)	power at -15°C (W)
1	605220	HPY14AA_A	1/5	14.31	123	141	161	183

EMBRACO / ASPERA

R134A

LBP single phase

Lower evaporation temperature below -20°C

embraco



1

technical data:
voltage 220-240V
frequency 50Hz

fig.	GEV No.	type	P (HP)	cylinder capacity (cm ³)	motor system	power at -30°C (W)	power at -25°C (W)	power at -20°C (W)	power at -15°C (W)
1	605017	EMT36HLP	1/10	3.97	RSIR	71	94	123	160
1	605231	EMT43HLP	1/8	4.85	RSIR/RSCR	89	118	153	195
1	605061	EMT49HLP	1/6	5.56	RSIR	98	131	170	217
1	605119	NE2121Z	1/4	9.26	CSIR	163	217	285	368

High/Medium evaporation temperature above -20/-15 °C



1

technical data:
voltage 220-240V
frequency 50Hz
motor system CSIR

fig.	GEV No.	type	P (HP)	cylinder capacity (cm ³)	power at -10°C (W)	power at -5°C (W)	power at 0°C (W)	power at +5°C (W)
1	605016	EM65HHR	1/6	5.54	287	389	499	617

HBP single phase

High evaporation temperature above -15°C

embraco



1

technical data:
voltage 220-240V
frequency 50Hz

fig.	GEV No.	type	P (HP)	cylinder capacity (cm ³)	motor system	power at -15°C (W)	power at -10°C (W)	power at -5°C (W)	power at 0°C (W)	power at +5°C (W)
1	605086	EMT45HDR	1/8	3.97	CSIR	162	207	256	314	383
1	605181	EMT50HDP	1/6	4.5	RSIR	161	207	261	324	396
1	605189	EMT6160Z	1/4	6.76	CSIR	325	412	513	630	762
1	605135	EMT6170Z	1/6	7.69	CSIR	281	358	448	550	663
1	605001	NEK6170Z	1/4	8.4	CSIR	367	461	576	714	874
1	605209	NEK6187Z-A	1/3	10	CSIR	365	482	624	791	983
1	605208	NEK6210Z-A	1/3	12.1	CSIR	364	485	636	818	1030
1	605210	NEK6212Z-A	1/2	14.28	CSIR	413	561	739	945	1181
1	605237	NEK6214Z	1/2	16.8	CSIR	648	824	1032	1275	1550
1	605079	NT6215Z	1/2	17.4	CSIR	484	646	843	1071	1326
1	605115	T6217Z	1/2	22.4	CSIR	718	973	1275	1624	2020
1	605254	NJ6220Z-A	1	26.2	CSIR	962	1263	1638	2087	2610
1	605175	NJ6226Z	1 1/4	34.37	CSR	1144	1497	1892	2340	2852

R22

HBP single phase

High evaporation temperature above -15°C

embraco



1

technical data:
voltage 220/240V
frequency 50/60Hz
motor system CSIR

fig.	GEV No.	type	P (HP)	cylinder capacity (cm ³)	power at -15°C (W)	power at -10°C (W)	power at -5°C (W)	power at 0°C (W)	power at +5°C (W)
1	605066	L40TN	1/6	4.04	195	248	309	380	458



Зип-Общепит

HB single phase

R290A

LBP single phase

Lower evaporation temperature below -20°C



technical data:
frequency 50Hz

fig.	GEV No.	type	volt. (V)	P (HP)	cylinder capacity (cm ³)	motor system	power at -30°C (W)	power at -25°C (W)	power at -20°C (W)	power at -15°C (W)
1	605215	EMT2121U	220-240	1/5	5.57	CSIR	188	238	297	364
1	605258	EMTE2134U	220-240	3/8	9.5	CSIR	250	278	305	330
1	605214	NEK2150U	220/240	1/2	13.54	CSIR	403	515	650	804
1	605243	NEU2155U	220-240	3/4	13.54	CSIR	463	744	916	1110
1	605204	NEK2160U	220-240	3/4	16.8	CSR	508	646	808	995
1	605202	NT2170U	220-240	3/4	20.44	CSR	544	698	883	1097
1	605199	NT2180U	220-240	1	22.4	CSR	653	835	1047	1290
1	605203	NT2210U	220-240	1 1/4	27.8	CSR	798	1024	1301	1627

vsezip.ru

+7(812)987-08-81

High evaporation temperature above -15°C



technical data:
voltage 220-240V
frequency 50Hz
motor system CSIR

fig.	GEV No.	type	P (HP)	cylinder capacity (cm ³)	power at -15°C (W)	power at -10°C (W)	power at -5°C (W)	power at 0°C (W)	power at +5°C (W)
1	605198	EMT6165U	1/3	5.96	402	485	580	690	822

MBP single phase

Medium evaporation temperature above -20°C



technical data:
voltage 220-240V
frequency 50Hz
motor system CSIR

fig.	GEV No.	type	P (HP)	cylinder capacity (cm ³)	power at -10°C (W)	power at -5°C (W)	power at 0°C (W)	power at +5°C (W)
1	605200	EMT6144U	1/6	4.5	342	416	502	598
1	605201	EMT6152U	1/5	5.2	418	500	595	710

R404a/R507

LBP single phase

Lower evaporation temperature below -20°C



technical data:
voltage 220-240V
frequency 50Hz

fig.	GEV No.	type	P (HP)	cylinder capacity (cm ³)	motor system	power at -30°C (W)	power at -25°C (W)	power at -20°C (W)	power at -15°C (W)
1	605213	EMT2121GK	1/3	5.2	CSIR	204	258	322	398
1	605206	EMT2125GK	1/3	5.96	CSIR	238	301	373	462
1	605152	NEK2134GK	1/2	8.77	CSIR	302	394	501	621
1	605018	NE2125GK	1/3	8.78	CSIR	213	278	354	439
1	605144	NEK2168GK	3/4	14.28	CSR	454	587	742	921
1	605164	NT2178GK	1	17.4	CSR	610	808	1032	1285
1	605078	T2180GK	1	22.4	CSR	639	873	1147	1460
1	605174	NJ2192GK	1 1/4	26.2	CSR	989	1342	1745	2196
1	605235	NT2212GK	1 1/4	27.8	CSR	876	1125	1421	1770
1	605081	NJ2212GK	1 1/2	34	CSR	1269	1738	2289	2921



Зип ОБЩЕПИТ

vsozip.ru

+7(812)987-08-81



embraco

2

technical data:
voltage 220-240V
frequency 50Hz

fig.	GEV No.	type	P (HP)	cylinder capacity (cm ³)	motor system	power at -30°C (W)	power at -25°C (W)	power at -20°C (W)	power at -15°C (W)
2	605186	NEK2150GK	1/2	12.12	CSIR	408	522	657	814



embraco

1

technical data:
voltage 220-240V
frequency 50Hz

fig.	GEV No.	type	P (HP)	cylinder capacity (cm ³)	motor system	power at -30°C (W)	power at -25°C (W)	power at -20°C (W)	power at -15°C (W)
1	605246	EMT26CLP	1/10	5.19	RSIR	54	73	95	120
1	605257	EMD46CLT		7.96	RSCR	88	118	154	196
1	605247	NBT1114Y	1/5	10	RSIR	103	143	193	253

HMBP single phase
High/Medium evaporation temperature above -20/-15 °C



embraco

1

technical data:
frequency 50Hz

fig.	GEV No.	type	volt. (V)	P (HP)	cylinder capacity (cm ³)	motor system	power at -15°C (W)	power at -10°C (W)	power at -5°C (W)	power at 0°C (W)	power at +5°C (W)
1	605004	EMT6152GK	220-240	1/5	4.5	CSIR	332	351	437	535	646
1	605149	NEK6144GK	220-240	1/6	4.51	CSIR	326	395	480	580	694
1	605139	EMT6165GK	220-240	1/4	5.19	CSIR	315	384	477	570	689
1	605162	NEK6181GK	220-240	1/4	7.28	CSIR	533	677	826	1000	1198
1	605161	NEK6210GK	220-240	3/8	8.78	CSIR	674	815	988	1195	1435
1	605125	NEK6213GK	220-240	1/2	12.12	CSIR	884	1093	1333	1600	1894
1	605178	NEK6217GK	220-240	5/8	14.3	CSR	954	955	1171	1386	1651
1	605227	NT6220GK	220-240	3/4	14.5	CSIR	1245	1540	1890	2300	2770
1	605132	NT6222GK	200-240	1	17.39	CSR	1032	1040	1174	1307	1583
1	605030	NJ9226GK	220-240	1	21.7	CSR	1764	2249	2819	3472	4210
1	605165	NT6226GK	220-240	1	22.4	CSR	1650	2058	2532	3068	3658
1	605190	NJ9232GK	220-240	1 1/4	26.2	CSR	1470	1911	2413	2973	3588
1	605177	NJ9238GK	220-240	1 1/2	32.7	CSR	2640	3315	4045	4830	5668

HBP single phase
High evaporation temperature above -15°C



embraco

1

technical data:
voltage 220-240V
frequency 50Hz

fig.	GEV No.	type	P (HP)	cylinder capacity (cm ³)	motor system	power at -15°C (W)	power at -10°C (W)	power at -5°C (W)	power at 0°C (W)	power at +5°C (W)
1	605083	EMT30CDP	1/8	4.5	RSIR	112	142	180	222	268
1	605248	NEK6160Y	1/4	12.11	CSIR	267	338	425	528	641

→ electric components



L'UNITE HERMETIQUE / TECUMSEH

Зип-Общепит

R134A

HBP single phase

High evaporation temperature above -15°C



technical data:
voltage 220-240V
frequency 50Hz
motor system CSIR

fig.	GEV No.	type	P (HP)	cylinder capacity (cm ³)	power at -15°C (W)	power at -10°C (W)	power at -5°C (W)	power at 0°C (W)	power at +5°C (W)
1	605184	THB4419YFZ	1/6	5.2	195	245	300	362	408
1	605095	AE4450Y-FZ	3/8	13.2	526	672	843	1042	1273

HMBP single phase

High/Medium evaporation temperature above -20/-15 °C



technical data:
voltage 220-240V
frequency 50Hz

fig.	GEV No.	type	P (HP)	cylinder capacity (cm ³)	motor system	power at -10°C (W)	power at -5°C (W)	power at 0°C (W)	power at +5°C (W)
1	605249	AE4425Y	1/5	6.7	CSIR	265	348	443	552
1	605173	AE4430Y-FZ1A	1/4	8	CSIR	382	488	613	760
1	605188	AE4440Y-FZ	1/3	10.33	CSIR	508	637	790	968
1	605167	AE4456Y-FZ	1/2	14.51	CSIR	737	921	1133	1380
1	605098	AE4460Y-FZ	1/2	15.09	CSR	838	1040	1280	1540
1	605172	CAJ4492Y-F	3/4	25.95	CSIR	871	1215	1617	2078
1	605171	CAJ4511Y-F	1	32.7	CSR	1474	1895	2382	3218

R407A

LBP single phase

Lower evaporation temperature below -20°C



technical data:
voltage 220-240V
frequency 50Hz

fig.	GEV No.	type	P (HP)	cylinder capacity (cm ³)	motor system	power at -30°C (W)	power at -25°C (W)	power at -20°C (W)	power at -15°C (W)
1	605183	AE2420Z	3/8	9.35	CSIR	404	522	661	824
1	605157	CAJ2428Z	5/8	15.2	CSR	434	589	773	991
1	605134	CAJ2446Z	1.2	26.1	CSR	797	1110	1423	1821
1	605136	CAJ2464Z	1.5	34.5	CSR	1108	1579	1850	2317



technical data:
voltage 220-240V
frequency 50Hz

fig.	GEV No.	type	P (HP)	cylinder capacity (cm ³)	motor system	power at -30°C (W)	power at -25°C (W)	power at -20°C (W)	power at -15°C (W)
2	605238	CAJ2432Z	5/8	18.3	CSR	542	738	971	1247

+7(812)987-08-81

Зип Общепит



vsezip.ru

+7(812)987-08-81

LBP 3-phase

Lower evaporation temperature below -20°C



1

technical data:
voltage 400V
frequency 50/60Hz

fig.	GEV No.	type	P (HP)	cylinder capacity (cm ³)	power at -30°C (W)	power at -25°C (W)	power at -20°C (W)	power at -15°C (W)
1	605187	TAJ2464Z	1.5	34.4	1108	1579	1850	2317

HMBP single phase

High/Medium evaporation temperature above -20/-15 °C



1

technical data:
voltage 220-240V
frequency 50Hz

fig.	GEV No.	type	P (HP)	cylinder capacity (cm ³)	motor system	power at -10°C (W)	power at -5°C (W)	power at 0°C (W)	power at +5°C (W)
1	605021	AEZ4425Z	1/5	4.5	CSIR	263	341	432	537
1	605025	AE4430Z-FZ	1/4	5.7	CSIR	346	441	550	682
1	605151	AE4440Z-FZ	1/3	6.69	CSIR	546	676	826	1000
1	605023	AE4450Z	3/8	8.85	CSIR	567	734	927	1270
1	605219	AE4460Z-FZ	1/2	10.33	CSIR	875	1062	1275	1519
1	605158	AE4470Z	1/2	12	CSR	1035	1251	1495	1773
1	605027	CAJ4517Z	1.2	25.95	CSR	1987	2451	2971	3536



2

technical data:
voltage 220-240V
frequency 50Hz

fig.	GEV No.	type	P (HP)	cylinder capacity (cm ³)	motor system	power at -10°C (W)	power at -5°C (W)	power at 0°C (W)	power at +5°C (W)
2	605026	CAJ9480Z	3/4	15.2	CSR	1009	1284	1607	1989
2	605032	CAJ9510Z	1	18.3	CSR	1252	1583	1972	2437
2	605070	CAJ9513Z	1.1	24.2	CSR	1654	2086	2568	3096
2	605065	CAJ4519Z	1.5	34.4	CSR	2353	3009	3756	4360

HMBP 3-phase

High/Medium evaporation temperature above -20/-15 °C



1

technical data:
voltage 400V
frequency 50/60Hz
motor system three-phase

fig.	GEV No.	type	P (HP)	cylinder capacity (cm ³)	power at -10°C (W)	power at -5°C (W)	power at 0°C (W)	power at +5°C (W)
1	605236	TAJ9513Z-T	1	24.2	2341	2911	3562	4303

SECOP DANFOSS

R134A

LBP single phase

Lower evaporation temperature below -20°C



technical data:
voltage 220-240V
frequency 50Hz
motor system RSIR/CSIR

fig.	GEV No.	type	P (HP)	cylinder capacity (cm ³)	power at -30°C (W)	power at -25°C (W)	power at -20°C (W)	power at -15°C (W)
1	605052	TL5G	1/6	5.08	69	97	132	172

Зип-Общепит

HBP single phase

High evaporation temperature above -15°C

vsezip.ru

+7(812)987-08-81



technical data:
voltage 220-240V
frequency 50Hz
motor system RSIR/CSIR

fig.	GEV No.	type	P (HP)	cylinder capacity (cm ³)	power at -15°C (W)	power at -10°C (W)	power at -5°C (W)	power at 0°C (W)	power at +5°C (W)
1	605052	TL5G	1/6	5.08	172	220	277	345	423

MBP single phase

Medium evaporation temperature above -20°C



technical data:
voltage 220-240V
frequency 50/60Hz
motor system RSIR/CSIR

fig.	GEV No.	type	P (HP)	cylinder capacity (cm ³)	power at -10°C (W)	power at -5°C (W)	power at 0°C (W)	power at +5°C (W)
1	605059	NL6.1MF	1/6	6.13	271	345	432	533
1	605063	NL7.3MF	1/5	7.27	336	425	530	652
1	605060	NL10MF	1/3	10.1	487	611	758	930

HMBP single phase

High/Medium evaporation temperature above -20/-15 °C



technical data:
voltage 220-240V
frequency 50Hz

fig.	GEV No.	type	P (HP)	cylinder capacity (cm ³)	motor system	power at -10°C (W)	power at -5°C (W)	power at 0°C (W)	power at +5°C (W)
1	605123	TL4G	1/8	3.86	CSIR	173	222	280	347
1	605088	FR7.5G	1/5	6.93	RSIR/CSIR	254	325	408	505
1	605091	FR8.5G	1/4	7.95	RSIR/CSIR	298	381	478	592
1	605089	NL8.4MF	1/4	8.35	RSIR/CSIR	390	491	610	749
1	605221	SC10G	1/4	10.29	RSIR/CSIR	395	486	618	764
1	605205	FR11G	1/4	11.15	RSIR/CSIR	395	501	628	780
1	605193	NL11MF	1/3	11.15	RSIR/CSIR	534	670	832	1020
1	605087	SC12G	1/3	12.9	RSIR/CSIR	574	746	951	1191
1	605077	SC15G	3/8	15.3	CSIR	703	901	1124	1377
1	605076	SC18G	1/2	17.7	CSIR	844	1074	1343	1655
1	605194	SC21G	5/8	20.95	CSR	977	1250	1568	1931



Зип Общепит

vsezip.ru

+7(812)987-08-81

R404a/R507

LBP single phase

Low evaporation temperature below -20°C



technical data:
voltage 220-240V
frequency 50Hz

fig.	GEV No.	type	P (HP)	cylinder capacity (cm ³)	motor system	power at -30°C (W)	power at -25°C (W)	power at -20°C (W)	power at -15°C (W)
1	605080	FR8,5CL HST	1 1/2	7.95	CSIR	259	338	434	546
1	605179	SC10CLX	1/3	10.29	CSIR	300	424	569	737
1	605057	SC12CL	3/8	12.87	CSIR	410	568	754	971
1	605058	SC15CL	1/2	15.28	CSIR	486	637	813	1017
1	605056	SC18CLX.2	5/8	17.69	CSR	562	691	881	1095
1	605082	SC21CL	7/8	20.95	CSR	719	947	1215	1524

LBP 3-phase

Lower evaporation temperature below -20°C



technical data:
voltage 380-415/380-460V
frequency 50/60Hz
motor system

fig.	GEV No.	type	P (HP)	cylinder capacity (cm ³)	power at -30°C (W)	power at -25°C (W)	power at -20°C (W)	power at -15°C (W)
1	605255	NTZ048A4LR1A	2	48	1239	1700	2236	2856

High/Medium evaporation temperature above -20/-15 °C



technical data:
voltage 220-240V
frequency 50Hz

fig.	GEV No.	type	P (HP)	cylinder capacity (cm ³)	motor system	power at -10°C (W)	power at -5°C (W)	power at 0°C (W)	power at +5°C (W)
1	605146	SC15MLX	3/4	15.28	CSIR	1183	1458	1780	2155
1	605113	SC18MLX.3	1	17.68	CSR	1454	1780	2162	2606

miscellaneous

R134A



technical data:
producer HuaGuang
refrigerant R134a
voltage 220-240V

fig.	GEV No.	type	freq. (Hz)	weight (kg)	P (HP)	cylinder capacity (cm ³)	motor system	power at -25°C (W)	power at -20°C (W)	power at -15°C (W)	power at -10°C (W)	power at -5°C (W)	power at 0°C (W)	power at +5°C (W)	power at +10°C (W)
1	605240	AN150ML	50	10.5	1/2	15.1	CSIR	-	-	-	-	-	-	-	-

Зип.Общепит

universal

vsezip.ru

+7(812)987-08-81



technical data:
producer HuaGuang
refrigerant R134a
voltage 220-240V

fig.	GEV No.	type	freq. (Hz)	weight (kg)	P (HP)	cylinder capacity (cm ³)	motor system	power at -25°C (W)	power at -20°C (W)	power at -15°C (W)	power at -10°C (W)	power at -5°C (W)	power at 0°C (W)	power at +5°C (W)	power at +10°C (W)
2	605239	ANA90	50	10.5	-	-	-	-	-	-	-	-	-	-	-
2	605245	ATA72XL	50/60	7.2	1/5	7	-	-	-	-	-	-	-	-	-

accessories

heating elements



fig.	GEV No.	P (W)	volt. (V)	CL (mm)	ID ø (mm)
1	696599	35	230	1000	110-180
1	696600	45	230	1000	150-290
1	696601	65	230	1000	210-330

evaporation and condensing trays

condensing trays heated

producer-specific



fig.	GEV No.	L (mm)	W (mm)	H (mm)	volt. (V)	P (W)	suitable for
1	750003	240	240	75	230	650	CF-Cenedese Cookmax Mafiroi
1	750004	380	240	75	230	750	CF-Cenedese Cookmax Mafiroi

1

fig.	GEV No.	L (mm)	W (mm)	H (mm)	volt. (V)	P (W)
1	750001	320	120	75	230	160
1	750002	320	120	75	230	300

condensing trays



1 2

fig.	GEV No.	L (mm)	W (mm)	H (mm)	capacity (l)
1	750430	295	35	200	1.6
2	750431	300	140	100	2.8

heating cartridges



1

fig.	GEV No.	P (W)	volt. (V)	ø (mm)	L (mm)	TS	CL (mm)
1	417227	90	230	12	124	3/8"	4000
1	417570	110	230	12	120	3/8"	1000
1	417577	190	230	12	180	3/8"	300
1	417571	230	230	12	180	3/8"	1000
1	418892	300	230	12	240	3/8"	2000
1	417572	330	230	12	240	3/8"	1000



fans

axial fans

ebm-papst



pos.	GEV No.	L (mm)	W (mm)	H (mm)	voltage	P (W)	manuf. no.
1	601496 ¹	60	60	25	12VDC	0.8	612NME
2	601826 ¹	80	80	38	230VAC	12	8556 V
3	601038 ¹	80	80	38	230VAC	12	8556N
4	601908 ²	80	80	38	230VAC	12	8550N
5	601120 ¹	92	92	25	12VDC	0.8	3412
6	601074 ¹	92	92	25	24VDC	2.3	3414N
7	601632 ²	92	92	25	24VDC	2.3	3414NG
8	601082 ¹	92	92	25	230VAC	9/11	3956
9	601633 ¹	92	92	38	230VAC	12	3656
10	601634 ¹	119	119	25	230VAC	14	9956
11	601121 ¹	119	119	38	12VDC	4.5	4182NX
12	601656 ¹	119	119	38	24VDC	12.5	4114NHH
13	601754 ¹	119	119	38	230VAC	13	4856Z
14	601727 ²	119	119	38	230VAC	13	4580Z
15	601482 ¹	119	119	38	230VAC	13	4580ZW
16	601030 ¹	119	119	38	230VAC	18	4656Z
17	601715 ¹	119	119	38	230VAC	18	4656ZW
18	601458 ¹	119	119	38	230VAC	19	4656N
19	601089 ²	119	119	38	230VAC	19	4650N
20	601752 ¹	127	127	38	12VDC	21	DV5212N
21	601635 ¹	127	127	38	230VAC	18	5958
22	601481 ²	127	127	38	230VAC	18	5950W
23	601793 ¹	135	135	38	230VAC	30	5656 S

²with slide bearings

Зип Общежит

vsezip.ru

+7(812)987-08-81

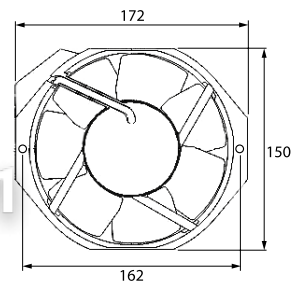

pos.	GEV No.	L (mm)	W (mm)	H (mm)	voltage	P (W)	manuf. no.
1	601723	172	150	38	230VAC	13/14	W2E142-CC15-16
2	601113 ¹	172	150	38	230VAC	27/28	7056ES

¹with ball bearings



pos.	GEV No.	ø (mm)	H (mm)	voltage	P (W)	manuf. no.
1	601755 ¹	172	51	230VAC	24	6058ES

¹with ball bearings



fig.	GEV No.	D (mm)	volt. (V)	blades	P (W)	speed (rpm)	manuf. no.
1	601821	110	230	5	19	2650	4656TZR

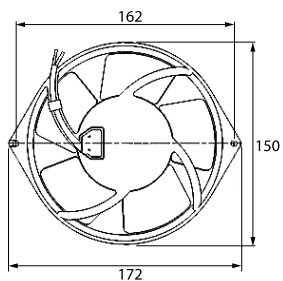

pos.	GEV No.	L (mm)	W (mm)	H (mm)	voltage	P (W)	manuf. no.
1	601631 ¹	172	150	55	230VAC	47	7450ES
2	601088 ¹	172	150	55	230VAC	39/45	7855ES
3	601806 ¹	172	150	55	230VAC	45/39	W2S130-AB03-15

¹with ball bearings



import



pos.	GEV No.	L (mm)	W (mm)	H (mm)	voltage	P (W)	connection
1	601154 ¹	60	60	25	12VDC	2.28	cable 300mm
2	601155 ¹	60	60	25	24VDC	2.88	cable 320mm
3	601670 ¹	80	80	25	12VDC	1.8	cable 300mm
4	601439 ¹	80	80	25	24VDC	1.9	cable 300mm
5	601130 ¹	80	80	25	230VAC	13/14	F2.8
6	601081 ¹	80	80	38	230VAC	14/13.5	F2.8
7	601747 ¹	92	92	25	12VDC	2.3	cable 300mm
8	601680 ¹	92	92	25	24VDC	2.4	cable 300mm
9	601055 ¹	92	92	25	230VAC	14.5/14	F2.8
10	601158 ¹	119	119	25	12VDC	5.4	cable 300mm
11	601159 ¹	119	119	25	24VDC	5	cable 350mm
12	601131 ¹	119	119	25	230VAC	19/18	F2.8
13	601080 ¹	119	119	38	230VAC	23/20	F2.8
14	601604 ²	119	119	38	230VAC	17/15	cable 300mm
15	601712 ¹	120	120	38	12VDC	10	cable 320mm
16	601705 ¹	120	120	38	24VDC	9.2	cable 300mm
17	601457 ¹	127	127	38	12VDC	12.72	cable 300mm

²with slide bearings

ebmpapst

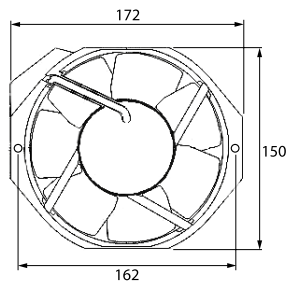

pos.	GEV No.	L (mm)	W (mm)	H (mm)	voltage	P (W)	connection
1	601706 ¹	172	150	51	230VAC	39	F3.2

¹with ball bearings

Зип-Общепит

accessories

fan guards

vsezip.ru

+7(812)987-08-81



pos.	GEV No.	ø (mm)	MD (mm)	for axial fan (mm)	pos.	GEV No.	ø (mm)	MD (mm)	for axial fan (mm)
1	691102	75	71	80	3	691104	115	105	119
2	691103	90	83	92					

connecting cables



fig.	GEV No.	CL (mm)	connection
1	550898	2000	F 2.8

refrigeration fans

refrigeration motors universal

ebmpapst

IQ series

ebmpapst



technical data:

voltage 230V
 cable length 1500mm
 speed 1300rpm
 version 5 mounting options
 bearing ball bearing

pos.	GEV No.	P (W)	type	pos.	GEV No.	P (W)	type
1	601893	10	IQ3612	2	601894	20	IQ3620

multi fit fan motors



technical data:
voltage 230V
cable length 1500mm
speed 1300/1550rpm
version 5 mounting options
bearing slide bearing

pos.	GEV No.	P (W)	type
1	601756	5	M4Q045-BD01-75
2	601757	10	M4Q045-CA03-75
3	601758	16	M4Q045-CF01-75
4	601759	18	M4Q045-DA01-75
5	601760	25	M4Q045-EA01-75
6	601761	34	M4Q045-EF01-75



fig.	GEV No.	description
1	601872	connector cable ELCO cable length 1500mm 0,75mm ² protection P42 for Plug In

N series - standard



technical data:
voltage 230V
connection cable 500mm
speed 1300/1550rpm
version 3 mounting options
bearing ball bearing

fig.	GEV No.	P (W)	type
1	601762	10	VN10-20/1456
1	601763	16	VN16-25/1457
1	601764	25	VN25-40/1458

ELCO

N series - multi fit



technical data:
voltage 230V
frequency 50/60Hz
bearing slide bearing
connection cable 500mm
speed 1300/1550rpm
version 5 mounting options

fig.	GEV No.	P (W)	type
1	601430	5	VNT5-13/027
1	601427	10	VNT10-20/028
1	601528	16	VNT16-25/029
1	602057	18	VNT18-30/312
1	601529	25	VNT25-40/030
1	601530	34	VNT34-45/031

IQ series



technical data:
voltage 230V
cable length 1000mm
speed 1400rpm
version 3 mounting options
bearing ball bearing

pos.	GEV No.	P (W)	type	pos.	GEV No.	P (W)	type
1	601886	14	IQ motor	2	601887	25	IQ motor

N series - plug In



technical data:
voltage 230V
connection Plug In
speed 1300/1550rpm
version 3 mounting options
bearing slide bearing

fig.	GEV No.	P (W)	type
1	601890 ¹	10	VN10-20/079
1	601891 ¹	16	VNT16-25/110

¹with coded connector

RE series



technical data:
voltage 230/240V
frequency 50/60Hz
cable length 1000mm
speed 2600rpm
version 3 mounting options
bearing slide bearing

pos.	GEV No.	P (W)	type
1	601608	18	R18-25/010



BT series - capacitor motors



fig.	GEV No.	P (W)	type
1	601420 ¹	45	3FBT 50-40/15

¹incl. capacitor

technical data:
voltage 230V
cable length 500mm
speed 1300rpm
version 3 mounting options
bearing slide bearing

Zip-Общепит



fig.	GEV No.	P (W)	freq. (Hz)	fig.	GEV No.	P (W)	freq. (Hz)
1	601984	10	50	1	601986	30	50
1	601985	20	50				

technical data:
voltage 220-240V
cable length 500mm
speed 1300rpm
type YZF
version 3 mounting options
bearing slide bearing

IMPORT

multi fit fan motors



pos.	GEV No.	P (W)	type
1	601020	5	YZF5-13-18/26
2	601022	10	YZF10-20-18/26
3	601023	16	YZF16-25-18/26
4	601024	25	YZF25-40-18/26
5	601050	34	YZF34-45-18/26

technical data:
voltage 230V
cable length 500mm
speed 1300rpm
version 5 mounting options
bearing slide bearing

IQ series



pos.	GEV No.	P (W)	pos.	GEV No.	P (W)	pos.	GEV No.	P (W)
1	601877	7	2	601878	24	3	601879	32

technical data:
voltage 220-240V
cable length 400mm
speed 1300rpm
type IQ motor
version 3 mounting options
bearing ball bearing

accessories

fan wheels

aluminium



pos.	GEV No.	ø (mm)	BA (°)	pos.	GEV No.	ø (mm)	BA (°)
1	601566	154	28	5	601567	250	28
2	601553	172	28	6	601284	254	28
3	601070	200	28	7	601410	300	28
4	601283	230	28				

aluminium

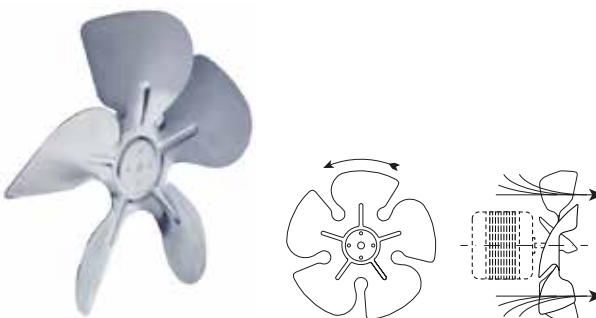

pos.	GEV No.	ø (mm)	BA (°)	pos.	GEV No.	ø (mm)	BA (°)
1	601568	154	28	5	601572	250	28
2	601569	172	28	6	601573	254	28
3	601570	200	28	7	601574	300	28
4	601571	230	28				

Зип Общежит

cold air circulating fans (complete)

vsezip.ru

+7(812)987-08-81

mounting rings



technical data:
version sucking
height 49mm

pos.	GEV No.	for fan wheel ø (mm)	ø (mm)	MD1 (mm)
1	601585	154	200	190
2	601586	172	220	208
3	601587	200	246	236
4	601588	230	278	266
5	601589	254	303	290
6	601590	300	378	365

feet



pos.	GEV No.	H (mm)	MD (mm)	pos.	GEV No.	H (mm)	MD (mm)
1	601597	39	78	4	601577	84	81
2	601575	55	81	5	601578	109	78
3	601576	72	81				

fan guards

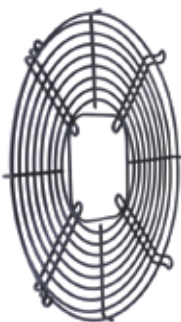

pos.	GEV No.	for fan wheel ø (mm)	H (mm)	MD1 (mm)
1	601579	154	11	190
2	601580	172	11	208
3	601581	200	25	236
4	601582	230	27	266
5	601583	254	17	290
6	601584	300	17	344

ebmpapst

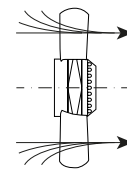
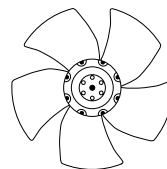

1

fig.	GEV No.	type	D (mm)	blades	volt. (V)	P (W)	speed (rpm)
1	601959	A2E250-AE65-02	250	5	230	115/165	2550/2750
1	601707	A2E300-AC47-02	300	5	230	140/190	2900

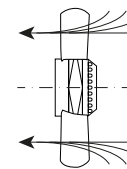
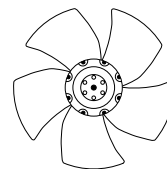

1

fig.	GEV No.	type	D (mm)	blades	volt. (V)	P (W)	speed (rpm)
1	601535	A2E200-AH38-01	200	9	230	78	2600
1	601663 ¹	A2E200-AI38-10	200	9	230	64	2600
1	601750	A2E250-AL06-09	250	7	230	120/160	2500
1	601960	A2E250-AM06-13	250	9	230	120	2500

¹incl. capacitor and guard

A3G series

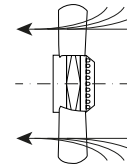
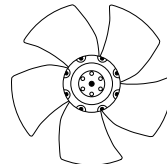

1

fig.	GEV No.	type	D (mm)	blades	volt. (V)	P (W)	speed (rpm)
1	602050	A3G300-AH13-10	300	5	230	77	1640



Зип-Общепит

vsezip.ru

+7(812)987-08-81

A4D series

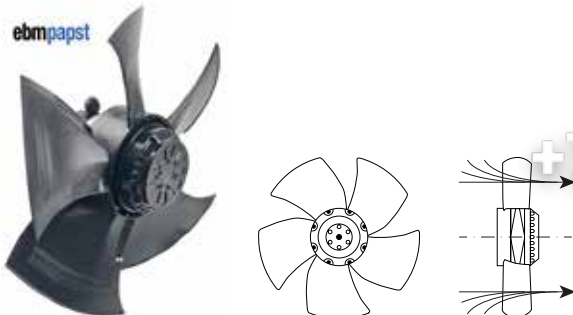

1

fig.	GEV No.	type	D (mm)	blades	volt. (V)	P (W)	speed (rpm)
1	601628	A4D500-AM03-01	500	5	400	720	1390



1

fig.	GEV No.	type	D (mm)	blades	volt. (V)	P (W)	speed (rpm)
1	601617	R2E190-A026-66	190	6	230	58	2500
1	601536	R2E190-A026-73	190	6	230	58/75	2700

A4E series

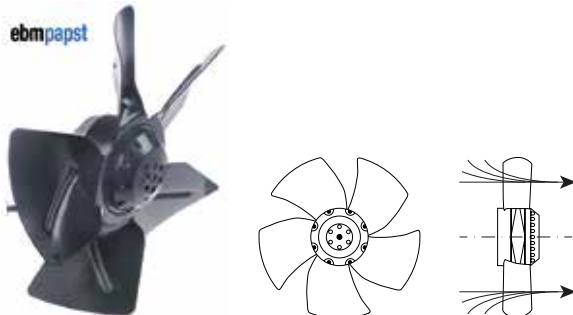

1

fig.	GEV No.	type	D (mm)	blades	volt. (V)	P (W)	speed (rpm)
1	601622	A4E315-AC08-18	315	5	230	95	1370
1	601684	A4E350-AA06-54	350	5	230	145	1380/1540

S6E series

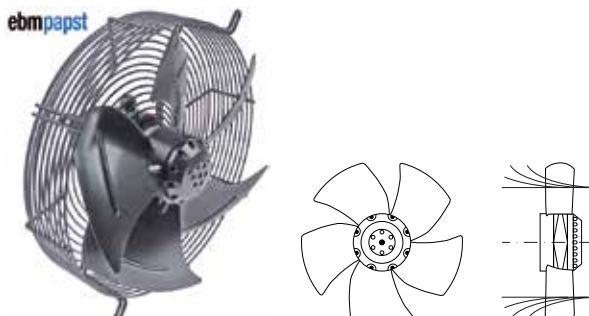

1

fig.	GEV No.	type	D (mm)	blades	volt. (V)	P (W)	speed (rpm)
1	601624	S6E330-AP02-34	330	5	230	65	940

accessories

fan guards



1

fig.	GEV No.	for fan wheel ø (mm)	ø (mm)	HD (mm)	H (mm)
1	601954	250	280	300	55
1	601949	300	330	368	65
1	601955	315	330	371	65
1	602087	350	380	270	85
1	601950	350	385	422	85
1	601951	400	430	470	85
1	601956	400	440	490	85
1	601957	450	480	522	85
1	601953	500	530	565	112

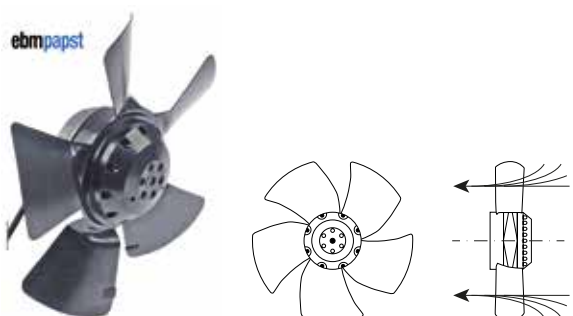

1

fig.	GEV No.	type	D (mm)	blades	volt. (V)	P (W)	speed (rpm)
1	601618	A4E250-AA04-01	250	5	230	32	1420
1	601620	A4E300-AB01-38	300	5	230	58	1300
1	601619	A4E300-AP26-01	300	5	230	68	1400
1	601621	A4E315-AA05-01	315	5	230	148	1490
1	601623	A4E315-AC08-19	315	5	230	95	1370
1	601625	A4E330-AP18-01	330	5	230	110	1400
1	601422	A4E350-AA06-01	350	5	230	140	1390
1	601626	A4E350-AN19-01	350	5	230	158/200	1270
1	601627	A4E400-AP02-01	392	5	230	160	940

Зип Общепит

vsezip.ru

+7(812)987-08-81

ZIEHL-ABEGG

1

fig.	GEV No.	type	D (mm)	volt. (V)	P (W)	speed (rpm)
1	601973	FB045-4EK.4F.V4P	450	230	390/550	1320/1450
1	601974	FB045-VDK.4C.V4P	450	400	450/340	1360/1040
1	601976	FB050-VDK.4I.V4P	500	400	650/440	1340/960
1	601977	FN063-SDK.4I.V7P1	630	400	620/440	900/720

2

fig.	GEV No.	type	D (mm)	volt. (V)	freq. (Hz)	P (W)
2	601811	R09R-3030HP-4M-2543	300	230	50/60	65/90

ZIEHL-ABEGG

2

fig.	GEV No.	type	D (mm)	volt. (V)	P (W)	speed (rpm)
2	601972	FN040-EK.0F.V7P1	400	230	240/330	1340/1480
2	601975	FN050-VDK.4I.V7P1	500	400	770/490	1300/1025

1

fig.	GEV No.	type	D (mm)	volt. (V)	freq. (Hz)	P (W)
1	602011	R09R-2525A-2M-3539	250	230	50/60	95/130
1	601980	R09R-2525A-4M-2516	250	230	50/60	48/55
1	602009	R09R-3530HA-4M-4237	350	230	50/60	130/165

HIDRIA

1

fig.	GEV No.	type	D (mm)	volt. (V)	freq. (Hz)	P (W)
1	602043	R09E-2026P-2M-1611	200	230	50/60	45

IMPORT

pos.	GEV No.	D (mm)	volt. (V)	P (W)	speed (rpm)
1	601880	300	230	90/105	1380/1600
2	601881	315	230	95/135	1380/1500
3	601882	330	230	100/130	1350/1500
4	601883	350	230	130/160	1450/1650
5	601884	400	230	180/250	1380/1550
6	601885	450	230	150	920



Зип-Общепит

miscellaneous

vsezip.ru

+7(812)987-08-81

COPREL

AX series

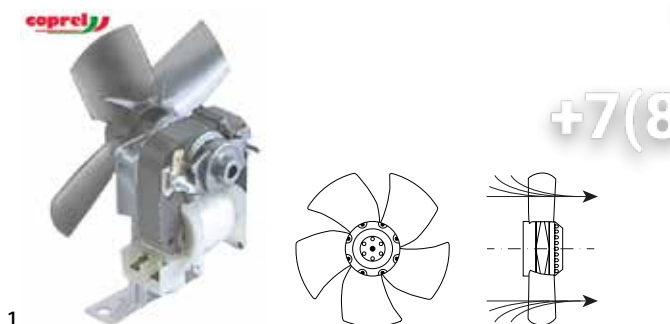

fig.	GEV No.	volt. (V)	P (W)	freq. (Hz)	D (mm)	connection
1	601078	230	18	50	130	left

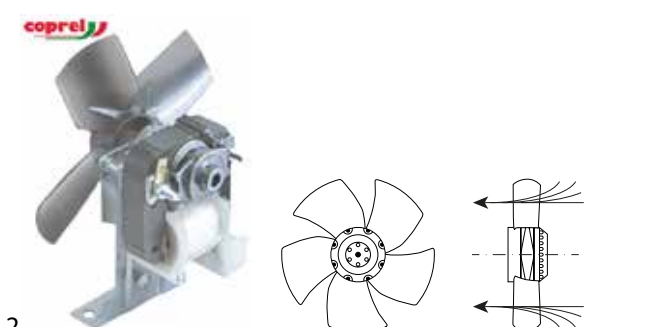

fig.	GEV No.	volt. (V)	P (W)	freq. (Hz)	D (mm)	connection
2	601079	230	18	50	130	right

MAP series

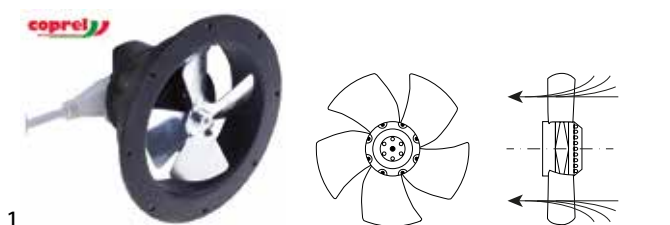

fig.	GEV No.	volt. (V)	P (W)	freq. (Hz)	D (mm)
1	601039	230	9	50/60	96

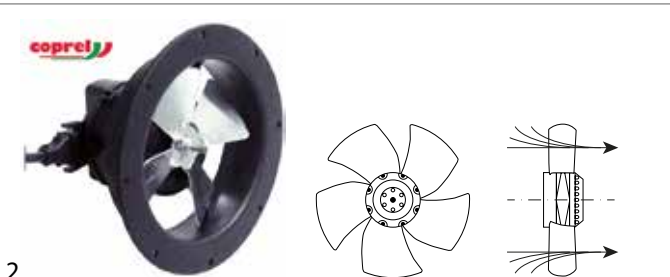

fig.	GEV No.	volt. (V)	P (W)	freq. (Hz)	D (mm)
2	601056	230	9	50/60	96



fig.	GEV No.	volt. (V)	freq. (Hz)	P (W)	D (mm)	suitable for	Ref. No.
1	601858	230	50/60	52	190	Friulinox Polaris	FR6671580 FR6671580

cold air circulating fans (other)



fig.	GEV No.	volt. (V)	freq. (Hz)	P (W)	W (mm)	H (mm)	D (mm)	shaft L (mm)	shaft ø (mm)	suitable for
1	601554	230	50-60	100	105	105	220	80	12	Icematic

cross flow fans

ebmpapst



technical data:
supply 230V/50Hz
application refrigeration
bearing rubber
temperature range 0 up to +60°C

fig.	GEV No.	roller ø (mm)	RL (mm)	LCT (mm)	MP	P (W)	connection
1	601000	45	60	13	left	15	F6.3
1	601895	45	120	13	left	17	F6.3
1	601907	45	180	18	left	26	F6.3
1	601898	45	240	24	left	32	F6.3
1	601900	45	300	24	left	32	F6.3



technical data:
supply 230V/50Hz
application refrigeration
bearing rubber
temperature range 0 up to +60°C

2

fig.	GEV No.	roller ø (mm)	RL (mm)	LCT (mm)	MP	P (W)	connection
2	601896	45	60	13	right	15	F6.3
2	601034	45	120	13	right	17	F6.3
2	601052	45	180	18	right	26	F6.3
2	601899	45	240	24	right	32	F6.3
2	601901	45	300	24	right	32	F6.3



technical data:
motor position centre
supply 230V/50Hz
application refrigeration
bearing rubber
temperature range -10 up to +60°C

1

fig.	GEV No.	roller ø (mm)	RL (mm)	LCT (mm)	P (W)	connection
1	602091	60	180	30	38	F6.3



technical data:
supply 230V/50Hz
application refrigeration
bearing rubber
temperature range 0 up to +60°C

3

fig.	GEV No.	roller ø (mm)	RL (mm)	LCT (mm)	MP	P (W)	connection
3	601988	60	60	13	left	15	F6.3
3	601989	60	120	13	left	20	F6.3
3	601650	60	180	18	left	30	F6.3
3	601902	60	180	24	left	33	F6.3
3	601651	60	240	30	left	38	F6.3
3	601904	60	300	38	left	45	F6.3

with standard coil



technical data:
supply 230V/50Hz
application refrigeration
bearing rubber
temperature range -10 up to +60°C

1

fig.	GEV No.	roller ø (mm)	RL (mm)	LCT (mm)	MP	P (W)	connection
1	602092	60	180	20	left	27	F6.3



technical data:
supply 230V/50Hz
application refrigeration
bearing rubber
temperature range 0 up to +60°C

4

fig.	GEV No.	roller ø (mm)	RL (mm)	LCT (mm)	MP	P (W)	connection
4	601047	60	60	13	right	17	F6.3
4	601990	60	120	13	right	20	F6.3
4	601437	60	180	18	right	28	F6.3
4	601991	60	180	24	right	33	F6.3
4	601903	60	240	30	right	33	F6.3
4	601905	60	300	38	right	45	F6.3



technical data:
supply 230V/50Hz
application refrigeration
bearing rubber
temperature range -10 up to +60°C

2

fig.	GEV No.	roller ø (mm)	RL (mm)	LCT (mm)	MP	P (W)	connection
2	602094	60	180	20	right	27	F6.3
2	602095	60	270	30	right	38	F6.3

with moulded coils



technical data:
supply 230V/50Hz
application refrigeration
bearing rubber
temperature range -10 up to +60°C

1

fig.	GEV No.	roller ø (mm)	RL (mm)	LCT (mm)	MP	P (W)	connection
1	602093	60	270	30	left	38	F6.3

COPREL

with standard coil



technical data:
supply 230V/50Hz
application refrigeration
bearing rubber

fig.	GEV No.	roller ø (mm)	RL (mm)	LCT (mm)	MP	P (W)	connection	temp. (°C)
1	601033	60	90	15	right	18	F6.3	-10 up to +60
1	601028	60	120	15	right	19	F6.3	-10 up to +60
1	601025	60	180	15	right	19	F6.3	-10 up to +60
1	601105	60	180	30	right	37	F6.3	-10 up to +60
1	601106	60	240	30	right	40	F6.3	-10 up to +60
1	601107	60	270	30	right	40	F6.3	-10 up to +60
1	601108	60	360	35	right	50	F6.3	-10 up to +60



technical data:
supply 230V/50Hz
application refrigeration
bearing rubber

fig.	GEV No.	roller ø (mm)	RL (mm)	LCT (mm)	MP	P (W)	connection	temp. (°C)
2	601032	60	180	15	left	19	F6.3	-10 up to +60
2	601671	60	240	30	left	37	F6.3	-10 up to +60
2	601101	60	300	30	left	43	F6.3	-10 up to +60



technical data:
supply 230V/50Hz
application refrigeration
bearing rubber

fig.	GEV No.	roller ø (mm)	RL (mm)	LCT (mm)	MP	P (W)	connection	temp. (°C)
3	602044	60	180	20	right	27	F6.3	-30 bis +60



technical data:
supply 230V/50-60Hz
application universal
bearing silicone
temperature range -10 up to +50°C

fig.	GEV No.	roller ø (mm)	RL (mm)	LCT (mm)	MP	P (W)	connection
1	602102	60	240	19	right	25	F6.3

Зип Общепит

vsezip.ru

+7(812)987-08-81



technical data:
supply 230V/50-60Hz
application universal
bearing silicone
temperature range -10 up to +50°C

fig.	GEV No.	roller ø (mm)	RL (mm)	LCT (mm)	MP	P (W)	connection
2	602106	60	240	30	right	33	F6.3

with moulded coils



technical data:
supply 230V/50Hz
application refrigeration
bearing rubber
temperature range -10 up to +60°C

fig.	GEV No.	roller ø (mm)	RL (mm)	LCT (mm)	MP	P (W)	connection
1	601640	60	90	15	left	18	cable 2000mm
1	601641	60	120	15	left	19	cable 2000mm
1	601176	60	180	20	left	25	cable 1200mm
1	601642	60	240	20	left	25	cable 2000mm
1	601643	60	270	30	left	33	cable 2000mm
1	601644	60	300	30	left	43	cable 2000mm



technical data:
supply 230V/50Hz
application refrigeration
bearing rubber
temperature range -10 up to +60°C

fig.	GEV No.	roller ø (mm)	RL (mm)	LCT (mm)	MP	P (W)	connection
2	601547	60	90	15	right	18	cable 1000mm
2	601637	60	120	15	right	19	cable 2000mm
2	601636	60	180	20	right	25	cable 2000mm
2	601638	60	240	20	right	25	cable 2000mm
2	601639	60	270	30	right	33	cable 2000mm
2	601434	60	300	30	right	43	cable 1800mm



technical data:
supply 230V/50Hz
application refrigeration
bearing rubber
temperature range -10 up to +60°C

fig.	GEV No.	roller ø (mm)	RL (mm)	LCT (mm)	MP	P (W)	connection
3	601398	60	180	20	left	25	cable 2400mm
3	601399	60	270	35	left	49	cable 2700mm

Зип Общепит
vsezip.ru
+7(812)987-08-81



technical data:
supply 230V/50Hz
application refrigeration
bearing rubber
temperature range -10 up to -6 °C

fig.	GEV No.	roller ø (mm)	RL (mm)	LCT (mm)	MP	P (W)	connection
4	601057	60	270	20	left	26	cable 1500mm
4	601058	60	300	20	left	34	cable 1500mm



technical data:
motor position centre
supply 230V/50-60Hz
application refrigeration
bearing rubber

fig.	GEV No.	roller ø (mm)	RL (mm)	LCT (mm)	P (W)	connection	temp. (°C)
2	601645	60	2x180	43	43	F6.3	-10 up to +50



technical data:
supply 230V/50-60Hz
application universal
bearing silicone
temperature range -10 up to +50°C

fig.	GEV No.	roller ø (mm)	RL (mm)	LCT (mm)	MP	P (W)	connection
1	602103	45	240	15	left	16	cable 3000mm



technical data:
motor position centre
supply 230V/50-60Hz
application universal
bearing silicone
temperature range -10 up to +50°C

fig.	GEV No.	roller ø (mm)	RL (mm)	LCT (mm)	P (W)	connection
1	602108	60	2x180	30	45	cable 1600mm
1	602107	60	2x300	30	35	cable 1600mm



technical data:
supply 230V/50-60Hz
application universal
bearing silicone
temperature range -10 up to +50°C

fig.	GEV No.	roller ø (mm)	RL (mm)	LCT (mm)	MP	P (W)	connection
2	602105	45	240	15	right	16	cable 3000mm



technical data:
supply 230V/50-60Hz
application universal
bearing silicone
temperature range -10 up to +50°C

fig.	GEV No.	roller ø (mm)	RL (mm)	LCT (mm)	MP	P (W)	connection
3	602104	60	240	20	left	26	cable 500mm

motors

gear motors

for ice-cube maker

for paddles







fig.	GEV No.	description	suitable for	Ref. No.
1	501472	gear motor CROUZET type SP-1905-40 3W 230V 50-60Hz 2rpm shaft ø 5x4mm groove width 17mm shaft ø 4,7mm	Scotsman Simag	IOM916103101 IOM916103101
2	500991	gear motor FIBER type GE15JAMAD00 3,9W 230V 50/60Hz 50rpm shaft ø 12mm	—	—

double fans



technical data:
motor position centre
supply 230V/50-60Hz
application refrigeration
bearing rubber

fig.	GEV No.	roller ø (mm)	RL (mm)	LCT (mm)	P (W)	connection	temp. (°C)
1	601026	60	2x180	35	42	F6.3	-10 up to +60





fig.	GEV No.	description	suitable for	Ref. No.
3	501451	motor FIBER type G025JAMAF00 3,9W 230V 50/60Hz 40rpm shaft ø 12mm for ice-cube maker	—	—
4	500422	gear motor ITV type 3,5W 230V 50Hz 30rpm shaft ø 6mm L 64mm W 51mm H 40mm	ITV Kastel	5364 606003



Зип Общепит

vsezip.ru

+7(812)987-08-81

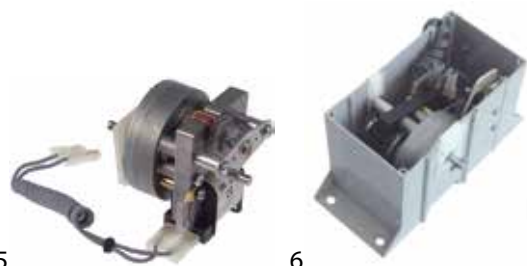

fig.	GEV No.	description	suitable for	Ref. No.
5	500792	gear motor KELVIN 230V 50Hz shaft \varnothing 6mm L 69mm W 69mm H 70mm	ITV	5291
6	500424	gear motor KELVIN type K15 230V 50Hz shaft \varnothing 6mm L 178mm W 75mm H 95mm for ice-cube maker	ITV	5201



fig.	GEV No.	description	suitable for	Ref. No.
3	500425	gear motor 230V 50Hz shaft \varnothing 10mm W 115mm H 100mm tilting motor complete incl. fastening plate	ITV	5200
4	500411	gear motor BITRON type 97103 11W 230V 50Hz 0,7rpm shaft \varnothing 7mm shaft length 30mm W 72mm H 60mm	Icematic Scotsman SF-Maschinen Simag	CM19440057/0 CM19440057 I-305 CM19440057



fig.	GEV No.	description	suitable for	Ref. No.
7	500407	gear motor LIP type 123MR 8W 220/240V voltage AC 50/60Hz 50rpm turn direction counterclockwise	Brice Italia Electrolux Geofrigor Icematic Kastel Migel NuovaSimonelli Scotsman SF-Maschinen Simag	RG000636 OT3960 RG000636 CM19440059/1 601039 1LT078 16000018 CM19440059 I-184 CM19440059



fig.	GEV No.	description	suitable for	Ref. No.
5	500423	gear motor CROUZET type 80336505 3,5W 230V 50Hz shaft \varnothing 10mm W 110mm H 85mm L 130mm	ITV	5363
6	500402	gear motor KENTA type IC9113065 69W 230V 50Hz 2rpm shaft \varnothing 14mm W 60mm H 150mm L 150mm	Staff Ice System	90/82020000



fig.	GEV No.	description	suitable for	Ref. No.
7	500756	gear motor LIP type 10 11W 230V voltage AC 50Hz 0,7rpm shaft \varnothing 8mm W 118mm H 88mm for ice maker	Icematic SF-Maschinen	CM81442072/0 I-306
8	501480	gear motor type ST0676 11W 220/240V voltage AC 50/60Hz 1rpm shaft \varnothing 8mm W 80mm D 93mm H 112mm	Icematic Kastel	CM81400006/0 81400006/0

for sumps



fig.	GEV No.	description	suitable for	Ref. No.
1	500410	float motor LIP 010 11W 230V 50Hz 0,7rpm shaft \varnothing 7mm shaft length 20mm W 72mm H 110mm	Icematic Scotsman SF-Maschinen Simag	CM19440065/0 CM19440065 I-309 CM19440065
1	500409	float motor LIP type 001 11W 220/240V voltage 50/60 0,7rpm shaft \varnothing 7mm shaft length 20mm	Icematic Scotsman SF-Maschinen Simag	CM19440063/0 CM19440063 I-303 CM19440063
1	500688	gear motor LIP type 068 11W 230V voltage AC 50Hz 1rpm shaft \varnothing 7mm shaft length 20mm W 75mm D 80mm	Brice Italia Geofrigor	926060 RG000640
2	500786	float motor LIP 11W 230V 50Hz 1rpm shaft \varnothing 8mm W 100mm H 90mm for ice maker L 130mm	Icematic Scotsman SF-Maschinen Simag	CM81404024/0 CM81404024 I-308 CM81404024



Зип Общепит

vsezip.ru

+7(812)987-08-81

miscellaneous



fig.	GEV No.	description	suitable for	Ref. No.
1	601967	gear motor LIP type 123MR 11W 220/240V voltage AC 50/60Hz 1rpm shaft ø 7mm	Mach Migel	80001LT079 1LT079



fig.	GEV No.	P (W)	volt. (V)	freq. (Hz)	outlet ø (mm)	L (mm)	type	Ref. No.
1	500047	30	230	50	12.7	135	MH30F1	FR.62043300

pumps

drain pumps

GRE



fig.	GEV No.	inlet ø (mm)	outlet ø (mm)	P (W)	volt. (V)
1	500039	24	24	190	230
2	500051	22/30	22	100	230

HANNING



fig.	GEV No.	P (W)	volt. (V)	inlet ø (mm)	outlet ø (mm)	type
1	499345	83-99	220-240	24	24	MIP 2

pumps for ice machines

Angelo-Po



fig.	GEV No.	P (W)	volt. (V)	freq. (Hz)	outlet ø (mm)	L (mm)	type	Ref. No.
1	500047	30	230	50	12.7	135	MH30F1	32M6310

Brema

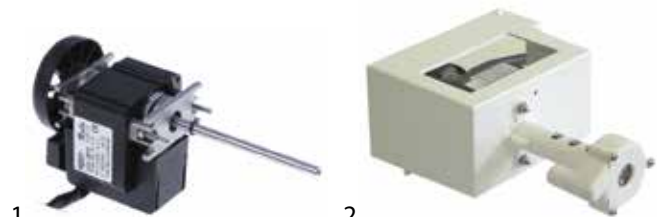

fig.	GEV No.	P (W)	volt. (V)	freq. (Hz)	outlet ø (mm)	L (mm)	type	Ref. No.
1	500970	55	230	50	-	205	-	23073
2	500161	55	230	50	17	110	NR40	C23076



fig.	GEV No.	P (W)	volt. (V)	freq. (Hz)	outlet ø (mm)	L (mm)	type	Ref. No.
3	500164	55	220/240	50	17	113	NR40	C23254
4	499117	60	220/240	50	-	81	-	23600

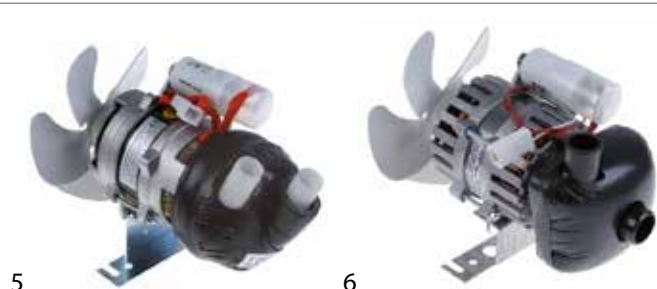

fig.	GEV No.	P (W)	volt. (V)	freq. (Hz)	outlet ø (mm)	L (mm)	type	Ref. No.
5	500590	120	230	50/60	22	240	4240.2300	C23377
6	500165	120	230	50/60	26	180	63/35	C23002
6	500166	150	230	50/60	26	200	63/45	C23068

electric components



Зип Общепит

vsezip.ru

+7(812)987-08-81

Cookmax

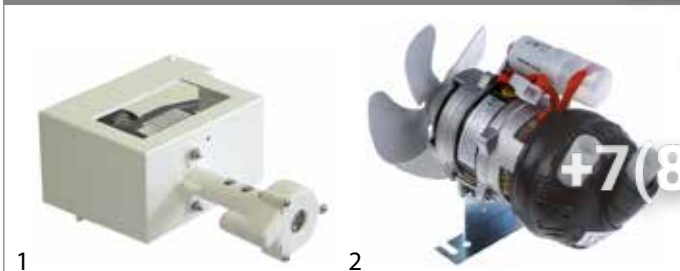

fig.	GEV No.	P (W)	volt. (V)	freq. (Hz)	outlet ø (mm)	L (mm)	type	Ref. No.
1	500161	55	230	50	17	110	NR40	C23076
2	500590	120	230	50/60	22	240	4240.2300	23377



fig.	GEV No.	P (W)	volt. (V)	freq. (Hz)	outlet ø (mm)	L (mm)	type	Ref. No.
5	500970	55	230	50	-	205	-	087810
6	500161	55	230	50	17	110	NR40	0KK204

Dexion



fig.	GEV No.	P (W)	volt. (V)	freq. (Hz)	outlet ø (mm)	L (mm)	type	Ref. No.
1	499003	100	230	50	23	170	-	2DR093



fig.	GEV No.	P (W)	volt. (V)	freq. (Hz)	outlet ø (mm)	L (mm)	type	Ref. No.
7	500204	60	230	50	19	125	MH50F	OKM679
8	500203	60	230	50	21	110	MH50F	OKM739

Electrolux



fig.	GEV No.	P (W)	volt. (V)	freq. (Hz)	outlet ø (mm)	L (mm)	type	Ref. No.
1	500763	25	230	50/60	19	120	U21B	086510
2	500047	30	230	50	12.7	135	MH30F1	086054



fig.	GEV No.	P (W)	volt. (V)	freq. (Hz)	outlet ø (mm)	L (mm)	type	Ref. No.
9	500597	60	230	50	21	110	MH50F	086545
10	500045	100	230	50	21	150	-	OKM744

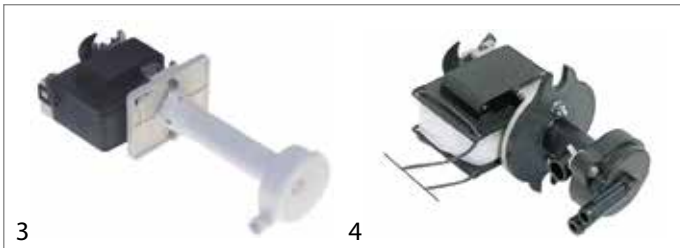

fig.	GEV No.	P (W)	volt. (V)	freq. (Hz)	outlet ø (mm)	L (mm)	type	Ref. No.
3	500761	30	230	50	13	135	MH30F1	086389
4	500046	40	230	50	12	75	NR40	086091

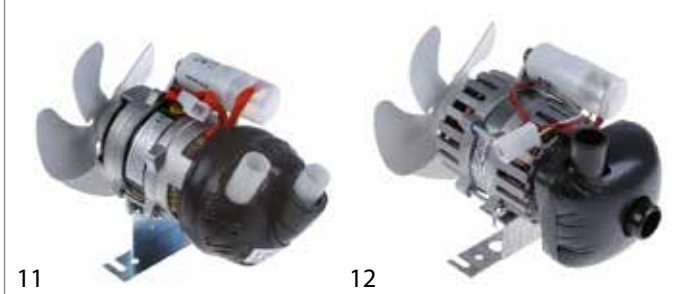

fig.	GEV No.	P (W)	volt. (V)	freq. (Hz)	outlet ø (mm)	L (mm)	type	Ref. No.
11	500590	120	230	50/60	22	240	4240.2300	089699
12	500165	120	230	50/60	26	180	63/35	085322
12	500166	150	230	50/60	26	200	63/45	085340

Зип Общепит

vsezip.ru

+7(812)987-08-81

Emmeri

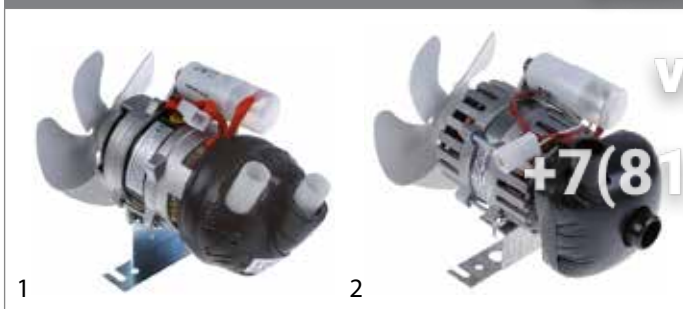

fig.	GEV No.	P (W)	volt. (V)	freq. (Hz)	outlet ø (mm)	L (mm)	type	Ref. No.
1	500590	120	230	50/60	22	240	4240.2300	8C1356
2	500165	120	230	50/60	26	180	63/35	808236

Faema



fig.	GEV No.	P (W)	volt. (V)	freq. (Hz)	outlet ø (mm)	L (mm)	type	Ref. No.
1	500047	30	230	50	12.7	135	MH30F1	889125070

Fagor

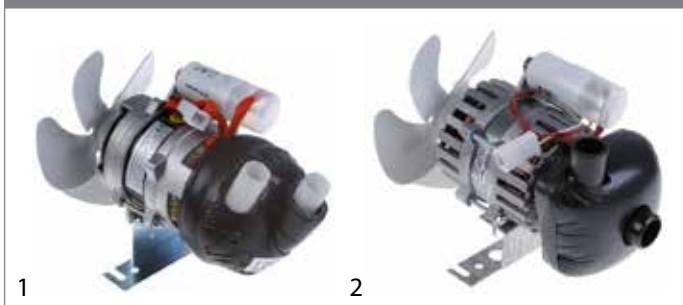

fig.	GEV No.	P (W)	volt. (V)	freq. (Hz)	outlet ø (mm)	L (mm)	type	Ref. No.
1	500590	120	230	50/60	22	240	4240.2300	12028429
2	500165	120	230	50/60	26	180	63/35	12028445
2	500166	150	230	50/60	26	200	63/45	12028448

GIGA



fig.	GEV No.	P (W)	volt. (V)	freq. (Hz)	outlet ø (mm)	L (mm)	type	Ref. No.
1	500047	30	230	50	12.7	135	MH30F1	I6204330
2	500046	40	230	50	12	75	NR40	I67003606



fig.	GEV No.	P (W)	volt. (V)	freq. (Hz)	outlet ø (mm)	L (mm)	type	Ref. No.
3	500204	60	230	50	19	125	MH50F	I67000206
4	500203	60	230	50	21	110	MH50F	I67000212

Hatco



fig.	GEV No.	P (W)	volt. (V)	freq. (Hz)	outlet ø (mm)	L (mm)	type	Ref. No.
1	499122		208-240	50/60	26	210	YSP6PJDVF2	7626013

Hoshizaki



fig.	GEV No.	P (W)	volt. (V)	freq. (Hz)	outlet ø (mm)	L (mm)	type	Ref. No.
1	499332	25/29	230	50/60	14	140	LMP-25CP	P02132-01

Icematic



fig.	GEV No.	P (W)	volt. (V)	freq. (Hz)	outlet ø (mm)	L (mm)	type	Ref. No.
1	500763	25	230	50/60	19	120	U21B	nicht in Preisliste
2	500047	30	230	50	12.7	135	MH30F1	CM19550113/0

electric components



Зип Общепит

vsezip.ru

+7(812)987-08-81

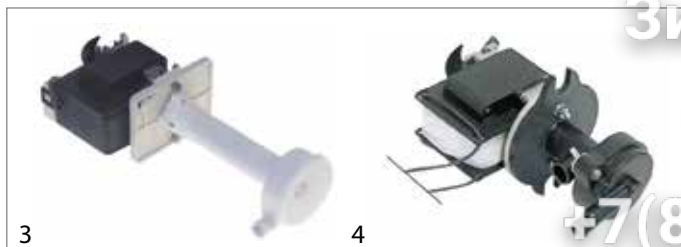

fig.	GEV No.	P (W)	volt. (V)	freq. (Hz)	outlet ø (mm)	L (mm)	type	Ref. No.
3	500761	30	230	50	13	135	MH30F1	CM19535157/0
4	500046	40	230	50	12	75	NR40	nicht in Preisliste



fig.	GEV No.	P (W)	volt. (V)	freq. (Hz)	outlet ø (mm)	L (mm)	type	Ref. No.
3	500755	52	230	50	17	110	DP140	5400
4	499167	52	230	50	17	110	G DP90-D DP90	5407

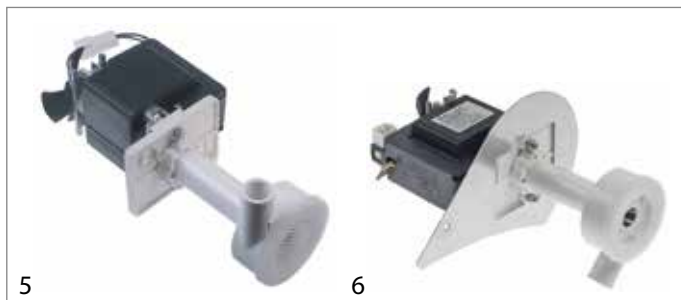

fig.	GEV No.	P (W)	volt. (V)	freq. (Hz)	outlet ø (mm)	L (mm)	type	Ref. No.
5	500746	60	230	50	20	110	MH50F	—
6	500203	60	230	50	21	110	MH50F	67000212



fig.	GEV No.	P (W)	volt. (V)	freq. (Hz)	outlet ø (mm)	L (mm)	type	Ref. No.
7	500597	60	230	50	21	110	MH50F	CM19550109/0
8	499005	75	240	50/60	12	120	U21B	nicht in Preisliste

ITV

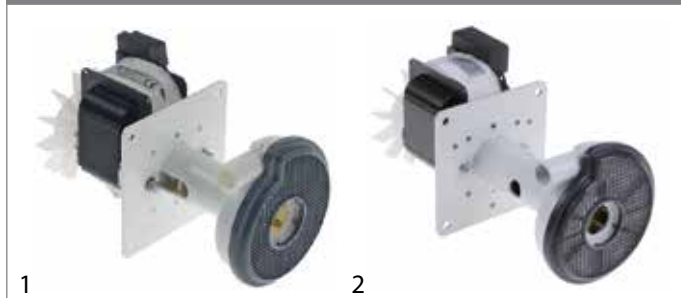

fig.	GEV No.	P (W)	volt. (V)	freq. (Hz)	outlet ø (mm)	L (mm)	type	Ref. No.
1	500223	35	230	50/60	17	85	DP20-30	5125
2	500974	50	230	50/60	17	110	DP40-55-60-70-80	5113

Kastel

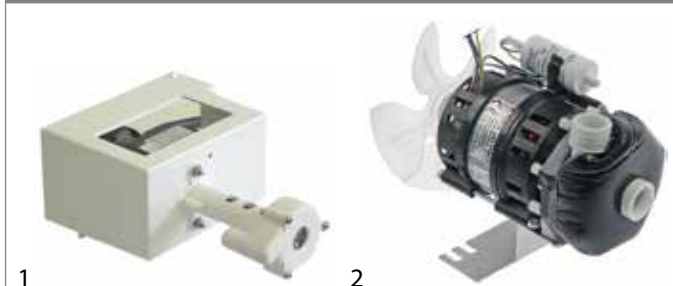

fig.	GEV No.	P (W)	volt. (V)	freq. (Hz)	outlet ø (mm)	L (mm)	type	Ref. No.
1	500161	55	230	50	17	110	NR40	600062
2	500587	190	230	50	26	200	L63.T19ICE	K00553

Mach



fig.	GEV No.	P (W)	volt. (V)	freq. (Hz)	outlet ø (mm)	L (mm)	type	Ref. No.
1	499003	100	230	50	23	170	-	2DR093
2	501501	100	230	50	25	200	M01	800022DR200

Manitowoc



fig.	GEV No.	P (W)	volt. (V)	freq. (Hz)	outlet ø (mm)	L (mm)	type	Ref. No.
1	499194		230	50	27	120	MSP2	MA-2008949
2	499122		208-240	50/60	26	210	YSP6PJDVF2	76-26013



Зип Ощепит

vsezip.ru

+7(812)987-08-81



fig.	GEV No.	P (W)	volt. (V)	freq. (Hz)	outlet ø (mm)	L (mm)	type	Ref. No.
3	499195	14	208-240	50/60	27	140	MSP	MA-1480279
4	499118	30	220-240	50	24	130	DP025-258	040000038



fig.	GEV No.	P (W)	volt. (V)	freq. (Hz)	outlet ø (mm)	L (mm)	type	Ref. No.
3	500164	55	220/240	50	17	113	NR40	NC23254
4	500590	120	230	50/60	22	240	4240.2300	NC23377

MBM-Italia



fig.	GEV No.	P (W)	volt. (V)	freq. (Hz)	outlet ø (mm)	L (mm)	type	Ref. No.
1	499003	100	230	50	23	170	-	2DR093
2	500165	120	230	50/60	26	180	63/35	RIC0002004



fig.	GEV No.	P (W)	volt. (V)	freq. (Hz)	outlet ø (mm)	L (mm)	type	Ref. No.
5	500165	120	230	50/60	26	180	63/35	NC23002
5	500166	150	230	50/60	26	200	63/45	NC23068

Migel



fig.	GEV No.	P (W)	volt. (V)	freq. (Hz)	outlet ø (mm)	L (mm)	type	Ref. No.
1	499003	100	230	50	23	170	-	2DR093
2	501501	100	230	50	25	200	M01	2DR200

Philips



fig.	GEV No.	P (W)	volt. (V)	freq. (Hz)	outlet ø (mm)	L (mm)	type	Ref. No.
1	501476	50	220	50	14	105	T3400	481936178251

NTF

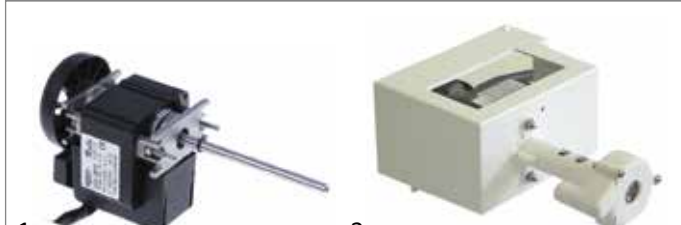

fig.	GEV No.	P (W)	volt. (V)	freq. (Hz)	outlet ø (mm)	L (mm)	type	Ref. No.
1	500970	55	230	50	-	205	-	N23073
2	500161	55	230	50	17	110	NR40	NC23076

Rancilio



fig.	GEV No.	P (W)	volt. (V)	freq. (Hz)	outlet ø (mm)	L (mm)	type	Ref. No.
1	500161	55	230	50	17	110	NR40	68023076
2	500590	120	230	50/60	22	240	4240.2300	68023377

→ electric components

Зип Общепит

vsezip.ru

+7(812)987-08-81



fig.	GEV No.	P (W)	volt. (V)	freq. (Hz)	outlet ø (mm)	L (mm)	type	Ref. No.
3	500165	120	230	50/60	26	180	63/35	68023002



fig.	GEV No.	P (W)	volt. (V)	freq. (Hz)	outlet ø (mm)	L (mm)	type	Ref. No.
7	500761	30	230	50	13	135	MH30F1	62043302
8	500046	40	230	50	12	75	NR40	1103065S&P

Scotsman



fig.	GEV No.	P (W)	volt. (V)	freq. (Hz)	outlet ø (mm)	L (mm)	type	Ref. No.
1	500772		230	50/60	19	120	U21B	1200258625
2	500758		230	50/60	25	120	U62	1200258221



fig.	GEV No.	P (W)	volt. (V)	freq. (Hz)	outlet ø (mm)	L (mm)	type	Ref. No.
9	500204	60	230	50	19	125	MH50F	67000206
10	500746	60	230	50	20	110	MH50F	1103499S&P



fig.	GEV No.	P (W)	volt. (V)	freq. (Hz)	outlet ø (mm)	L (mm)	type	Ref. No.
3	500760	11	115	60	16	120	U21	1200258621
4	500776	11	115	60	19	124	U21	1200258624



fig.	GEV No.	P (W)	volt. (V)	freq. (Hz)	outlet ø (mm)	L (mm)	type	Ref. No.
11	500203	60	230	50	21	110	MH50F	1103067S&P
12	500597	60	230	50	21	110	MH50F	62043003



fig.	GEV No.	P (W)	volt. (V)	freq. (Hz)	outlet ø (mm)	L (mm)	type	Ref. No.
5	500763	25	230	50/60	19	120	U21B	1103544
6	500047	30	230	50	12.7	135	MH30F1	62043300



fig.	GEV No.	P (W)	volt. (V)	freq. (Hz)	outlet ø (mm)	L (mm)	type	Ref. No.
13	501471	60	220-240	50	18.5	136	MH50F	79311324R
14	499005	75	240	50/60	12	120	U21B	1103590



fig.	GEV No.	P (W)	volt. (V)	freq. (Hz)	outlet ø (mm)	L (mm)	type	Ref. No.
15	501470	100	230	50	13	137	-	1103494
16	500045	100	230	50	21	150	-	62041500

Зип Ощепит

vsezip.ru

+7(812)987-08-81

electric components

SF-Maschinen



fig.	GEV No.	P (W)	volt. (V)	freq. (Hz)	outlet ø (mm)	L (mm)	type	Ref. No.
1	500761	30	230	50	13	135	MH30F1	I-364



fig.	GEV No.	P (W)	volt. (V)	freq. (Hz)	outlet ø (mm)	L (mm)	type	Ref. No.
7	500203	60	230	50	21	110	MH50F	060523.00
8	500597	60	230	50	21	110	MH50F	62043003

Simag



fig.	GEV No.	P (W)	volt. (V)	freq. (Hz)	outlet ø (mm)	L (mm)	type	Ref. No.
1	500772		230	50/60	19	120	U21B	—
2	500047	30	230	50	12.7	135	MH30F1	62043300



fig.	GEV No.	P (W)	volt. (V)	freq. (Hz)	outlet ø (mm)	L (mm)	type	Ref. No.
9	501471	60	220-240	50	18.5	136	MH50F	—
10	501470	100	230	50	13	137	-	620423.00



fig.	GEV No.	P (W)	volt. (V)	freq. (Hz)	outlet ø (mm)	L (mm)	type	Ref. No.
3	500761	30	230	50	13	135	MH30F1	620433.07
4	500046	40	230	50	12	75	NR40	—



fig.	GEV No.	P (W)	volt. (V)	freq. (Hz)	outlet ø (mm)	L (mm)	type	Ref. No.
11	500045	100	230	50	21	150	-	62041500

Staff Ice System



fig.	GEV No.	P (W)	volt. (V)	freq. (Hz)	outlet ø (mm)	L (mm)	type	Ref. No.
5	500204	60	230	50	19	125	MH50F	67000206
6	500746	60	230	50	20	110	MH50F	620430.06



fig.	GEV No.	P (W)	volt. (V)	freq. (Hz)	outlet ø (mm)	L (mm)	type	Ref. No.
1	501465	110	230	50/60	17	210	4262/48	9082101000

Star10



fig.	GEV No.	P (W)	volt. (V)	freq. (Hz)	outlet ø (mm)	L (mm)	type	Ref. No.
1	500047	30	230	50	12.7	135	MH30F1	FR.62043300



Зип Общедит equipment-specific units

for ice-cube maker pan mechanics

Brema sumps
+7(812)987-08-81

Whirlpool



fig.	GEV No.	P (W)	volt. (V)	freq. (Hz)	outlet ø (mm)	L (mm)	type	Ref. No.
1	500047	30	230	50	12.7	135	MH30F1	186389
2	501476	50	220	50	14	105	T3400	48400000908



fig.	GEV No.	P (W)	volt. (V)	freq. (Hz)	outlet ø (mm)	L (mm)	type	Ref. No.
3	500203	60	230	50	21	110	MH50F	186166
4	500597	60	230	50	21	110	MH50F	186545



fig.	GEV No.	P (W)	volt. (V)	freq. (Hz)	outlet ø (mm)	L (mm)	type	Ref. No.
5	500166	150	230	50/60	26	200	63/45	185340

Zanussi

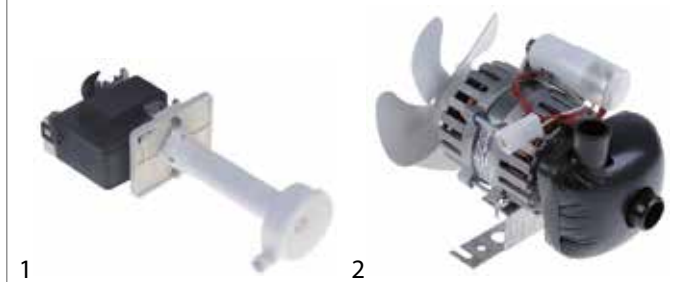

fig.	GEV No.	P (W)	volt. (V)	freq. (Hz)	outlet ø (mm)	L (mm)	type	Ref. No.
1	500761	30	230	50	13	135	MH30F1	086389
2	500165	120	230	50/60	26	180	63/35	085322



fig.	GEV No.	L (mm)	W (mm)	H (mm)	colour	Ref. No.
1	694439	227	175	100		C10484

Brice Italia sumps

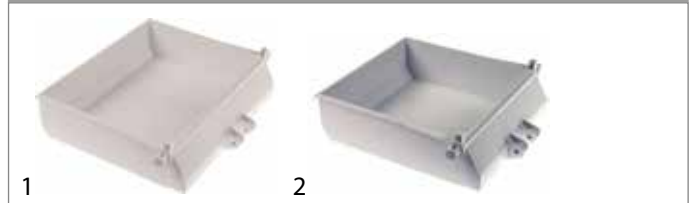

fig.	GEV No.	L (mm)	W (mm)	H (mm)	colour	Ref. No.
1	695358	180	140	60	white	910003
1	695360	180	245	60	white	910005
2	695359	180	180	60		RH00A005

spare parts and accessories



fig.	GEV No.	description	Ref. No.
1	695032	paddle short ø 135mm shaft intake ø 6mm 1	RH000675
2	695366	wheel for pan tilting ø 100mm	910012

Geofrigor sumps

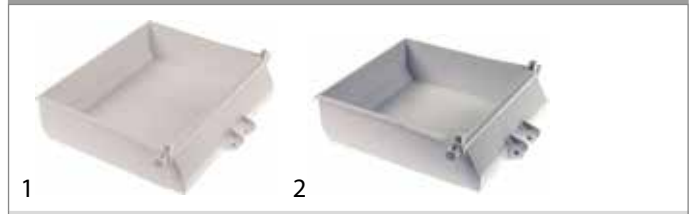

fig.	GEV No.	L (mm)	W (mm)	H (mm)	colour	Ref. No.
1	695358	180	140	60	white	RH00A004
1	695360	180	245	60	white	RH00A006
2	695359	180	180	60		RH00A005