



Зип Ощепит

vsezip.ru

Spare Parts for

+7(812)987-08781 **Combi Ovens**



Spare parts suitable for

GIORIK

2017

Find the complete and up-to-date range of products in our GEV Webshop



heating elements

immersion heating elements

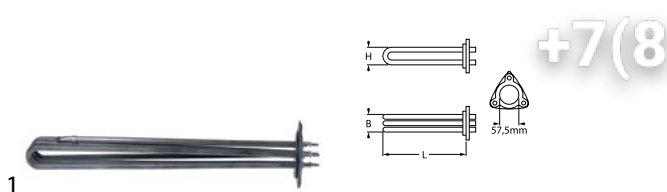

3 hole flange ø57.5mm

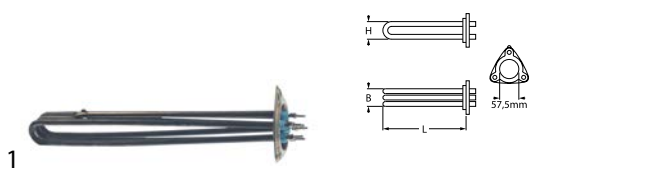

| | | | |
|---|--|-----------------|-------------------|
| GEV No. | 418085 | Ref. No. | 6003295 |
| description | heating element 10000W 230V mounting ø 57.5mm heating circuits 3 L 393mm W 38mm H 52mm number of thermostat sleeves 1 thermostat sleeves ø 7mm length thermostat sleeves 350mm thermostat sleeve not clinging tube ø 8.5mm hole distance 73mm hole ø 8mm connection length 33mm connection M4 3 hole flange immersion heater | | |
| For models: | VE20EC, VE20MX | | |
| spare parts for | 418085 | | |
|  | GEV No. | 510409 | Ref. No. — |
| | O-ring EPDM thickness 5.34mm ID ø 56.52mm Qty 1 pcs | | |

| | | | | |
|--|--|--------|-----------------|---------|
|  | GEV No. | 418084 | Ref. No. | 6003290 |
| description | heating element 7599W 230V mounting ø 57.5mm heating circuits 3 L 340mm W 36mm H 42mm number of thermostat sleeves 1 thermostat sleeves ø 7mm length thermostat sleeves 270mm thermostat sleeve clinging tube ø 8.5mm hole distance 72mm hole ø 8mm connection M4 3 hole flange immersion heater | | | |
| For models: | EN10VE-EC-ESN1033, VE06EC, VE06MX, VE102EC, VE102MX, VE10EC, VE10MX | | | |

heating elements for convection

| | | | | |
|---|---|--------|-----------------|---------|
|  | GEV No. | 418087 | Ref. No. | 6002125 |
| description | heating element 15000W 230/400V heating circuits 3 ID ø 398mm ED ø 415mm L 452mm H 121mm L1 32mm W1 105mm H1 80mm H2 25mm flange length 142mm flange width 25mm hole distance 126mm connection M4 tube ø 8.5mm convection heating element hole ø 6mm rectangular flange | | | |
| For models: | CE10MX, CE20MX, DE10EC, DE10ES, DE10MX, EF10GM, EF8PM, VE10EC, VE10MX, VE20EC, VE20MX | | | |
| accessories for | 418087 | | | |
|  | GEV No. | 550548 | Ref. No. | 2005173 |
| | gasket L 144mm W 25.5mm thickness 2.2mm for heating element suitable for GIORIK equiv. no. 2005173 | | | |



Зип Общепит

vsezip.ru

+7(812)987-08-81

| | | | | |
|--|---|--------|-----------------|---------|
|  | GEV No. | 418088 | Ref. No. | 6002121 |
| description | heating element 25000W 400V heating circuits 3 ID ø 388mm ED ø 406mm L 452mm H 150mm L1 35mm W1 105mm H1 21mm H2 130mm flange length 142mm flange width 25mm hole distance 126mm connection M4 connection length 72mm tube ø 8.5mm convection heating element hole ø 6mm rectangular flange | | | |
| For models: | CE102MX, DE102EC, DE102MX, VE102EC, VE102MX | | | |
| accessories for | 418088 | | | |
|  | GEV No. | 550548 | Ref. No. | 2005173 |
| | gasket L 144mm W 25.5mm thickness 2.2mm for heating element suitable for GIORIK equiv. no. 2005173 | | | |

| | | | | |
|--|---|--------|-----------------|---------|
|  | GEV No. | 418858 | Ref. No. | 6002100 |
| description | heating element 7350W 230V heating circuits 3 ID ø 215mm ED ø 230mm L 267mm H 85mm L1 38mm W1 102mm H1 5mm H2 80mm flange length 142mm flange width 25mm hole distance 63mm cable length 1000mm convection heating element hole ø 6mm | | | |
| For models: | EF4PM, EF5GM | | | |

| | | | | |
|--|---|--------|-----------------|---------|
|  | GEV No. | 418086 | Ref. No. | 6002001 |
| description | heating element 8400W 230V heating circuits 3 ID ø 218mm ED ø 235mm L 275mm H 112mm L1 40mm W1 105mm H1 32mm H2 80mm flange length 142mm flange width 25mm hole distance 64mm connection M4 tube ø 8.5mm convection heating element hole ø 6mm rectangular flange | | | |
| For models: | CE06MX, DE06EC, DE06ES, DE06MX, VE06EC, VE06MX | | | |
| accessories for | 418086 | | | |
|  | GEV No. | 550548 | Ref. No. | 2005173 |
| | gasket L 144mm W 25.5mm thickness 2.2mm for heating element suitable for GIORIK equiv. no. 2005173 | | | |



Зип.Общепит
thermostats

vsezip.ru
+7(812)987-08-81

accessories

flange gaskets



| | | | |
|--------------------|--|-----------------|---------|
| GEV No. | 550548 | Ref. No. | 2005173 |
| description | gasket L 144mm W 25.5mm thickness 2.2mm for heating element suitable for GIORIK equiv. no. 2005173 | | |
| For models: | CE06MX, CE102MX, CE10MX, CE20MX, DE06EC, DE06ES, DE06MX, DE102EC, DE102MX, DE10EC, DE10ES, DE10MX, EF10GM, EF4PM, EF5GM, EF8PM, VE06EC, VE06MX, VE102EC, VE102MX, VE10EC, VE10MX, VE20EC, VE20MX | | |



| | | | |
|--------------------|--|-----------------|---------|
| GEV No. | 510368 | Ref. No. | 2005174 |
| description | gasket L 70mm W 23.5mm hole ø 5mm hole distance 56mm FIBER thickness 2mm for heating element | | |
| For models: | EF4, EF6PM, EF7GM, EN10VE-EC-ESN1033 | | |

energy regulators

EGO

1-circuit





| | | | |
|--------------------|---|-----------------|-------------------------------|
| GEV No. | 380015 | Ref. No. | 6031020 6031023 6031024 |
| description | energy regulator 230V 13A single-circuit turn direction right shaft ø 6x4.6mm shaft L 23mm mounting thread M4 power release 6-100% no. 50.57021.010 | | |
| For models: | DE06ES, DE06MX, DE102MX, DE10ES, DE10MX, DG06ES, DG06MX, DG102MX, DG10ES, DG10MX, EF10GM, EF4PM, EF5GM, EF6PM, EF7GM, EF8PM, GF10GM, GF4PM, GF5GM, GF6PM, GF7GM, GF8PM, S505, S505R, S510, S510S, S511, S511S, SR512R, VE06MX, VE102MX, VE10MX, VE20MX, VG06MX, VG102MX, VG10MX, VG20MX | | |

control and safety thermostats

EGO
control thermostats
55.13_series



| | | | | |
|---|---|-----------------|-----------------|---|
| GEV No. | 375007 | Ref. No. | 6010015 | |
| description | thermostat t.max. 110°C temperature range 30-110°C 1-pole 1NO 16A probe ø 6mm probe L 113mm capillary pipe 870mm capillary pipe isolatedmm gland nut M9x1 shaft L 25mm shaft position upper rotation 270° | | | |
| For models: | BME46, BME66, CP1BM, CPG1BM, SPE46 | | | |
| accessories for | 375007 | | | |
|  | GEV No. | 110119 | Ref. No. | — |
| | knob thermostat t.max. 110°C ø 50mm shaft ø 6x4.6mm shaft flat upper black temperature range 30-110°C rotation 270° | | | |
|  | GEV No. | 110241 | Ref. No. | — |
| | knob thermostat t.max. 110°C ø 50mm shaft ø 6x4.6mm shaft flat upper black temperature range 30-110°C | | | |

safety thermostats

55.10/19_series



| | | | |
|--------------------|---|-----------------|---------|
| GEV No. | 375968 | Ref. No. | 6010026 |
| description | safety thermostat switch-off temp. 360°C 1-pole 1NC 16A probe ø 6mm probe L 77mm capillary pipe 870mm capillary pipe isolated 660mm gland nut M10x1 probe probe material SS M8x1 | | |
| For models: | CG102MX, CG10MX, DG06EC, DG06ES, DG06MX, DG102EC, DG102MX, DG10EC, DG10ES, DG10MX, EF4, GF10GM, GF4PM, GF5GM, GF6PM, GF7GM, GF8PM, VG06EC, VG06MX, VG102EC, VG102MX, VG10EC, VG10MX | | |



Зип Общежит

accessories

55.32_series

E-G-O

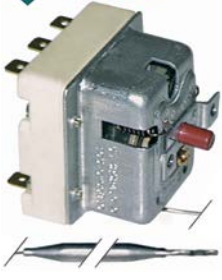

1

| | | | |
|--------------------|--|-----------------|---------|
| GEV No. | 375277 | Ref. No. | 6010002 |
| description | safety thermostat switch-off temp. 150°C 3-pole 3NC 20A probe ϕ 6mm probe L 79mm capillary pipe 900mm capillary pipe isolated 700mm gland nut probe | | |
| For models: | 22CP, 23CP, 2CP, 3CP, CP1, CP1BM, CPE66, EN10VE-EC-ESN1033, VE06EC, VE06MX, VE10EC, VE10MX, VG06EC, VG06MX, VG102EC, VG102MX, VG10EC, VG10MX, VG20EC, VG20MX | | |

E-G-O

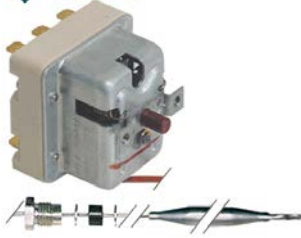

1

| | | | |
|--------------------|---|-----------------|---------|
| GEV No. | 375628 | Ref. No. | 6010008 |
| description | safety thermostat switch-off temp. 350°C 3-pole 20A probe ϕ 4mm probe L 120mm capillary pipe 900mm capillary pipe isolated 670mm gland nut M10x1 probe SS | | |
| For models: | CE06MX, CE102MX, CE10MX, CE20MX, CG06MX, CG20MX, DE06EC, DE06ES, DE06MX, DE102EC, DE102MX, DE10EC, DE10ES, DE10MX, EF10GM, EF4PM, EF5GM, EF6PM, EF7GM, EF8PM, EN10VE-EC-ESN1033, VE06EC, VE06MX, VE102EC, VE102MX, VE10EC, VE10MX, VE20EC, VE20MX, VG20EC, VG20MX | | |

E-G-O

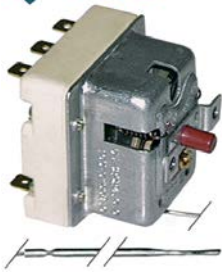

1

| | | | |
|--------------------|---|-----------------|---------|
| GEV No. | 390142 | Ref. No. | 5910029 |
| description | safety thermostat switch-off temp. 360°C 3-pole 20A probe ϕ 3.1mm probe L 188mm capillary pipe 1490mm capillary pipe isolated 800mm gland nut probe SS | | |

gland nut accessories

bolts with slot

+7(812)987-08-81

1

| | | | |
|--------------------|--|-----------------|---------|
| GEV No. | 520244 | Ref. No. | 6030024 |
| description | bolt with slot thread M10x1 Qty 10 pcs nickel-plated brass | | |
| For models: | FTR10 | | |

connecting bows

1



| | | | |
|--------------------|---|-----------------|---------|
| GEV No. | 550060 | Ref. No. | 6030016 |
| description | connecting bow long for thermostat Qty 1 pcs | | |
| For models: | FRE46F, FRE46R, FRE66F, FRE66R, FT3N, FT5, FTE100, FTE107, FTE46, FTE46B, FTE46R, FTE47L, FTE66L, FTE66LB, FTE66LM, FTE66LMB, FTE66R, FTE66RM, FTR26F, FTR6F, SPE46 | | |

switches and momentary switches

rocker/momentary rocker switches

30x22mm

1





| | | | | |
|---|---|-----------------|-----------------|---|
| GEV No. | 346377 | Ref. No. | 6032030 | |
| description | rocker switch mounting measurements 30x22mm black 2CO 230V 16A 0-I connection male faston 6.3mm ambient temperature max. 125/55°C protection IP40 | | | |
| accessories for | 346377 | | | |
|  | GEV No. | 301036 | Ref. No. | — |
| | protective cover internal size 30x22mm for rocker switch mounting measurementsmm | | | |



push/momentary push switches

ø16mm



| | | | |
|---|--|-----------------|-------------------------|
| GEV No. | 346345 | Ref. No. | 6032020 |
| description | momentary push switch mounting ø 16mm black 1NO 250V 3A connection male faston 2.8mm ambient temperature max. 85°C protection IP40 | | |
| For models: | CE06MX, CE102MX, CE10MX, CE20MX, CG06MX, CG102MX, CG10MX, CG20MX, DE06MX, DE102MX, DE10MX, DG06MX, DG102MX, DG10MX, VE06MX, VE102MX, VE10MX, VE20MX, VG06MX, VG102MX, VG10MX, VG20MX | | |
| accessories for | 346345 | | |
|  | GEV No. | 346343 | Ref. No. 6032021 |
| | protective cover | | |
|  | GEV No. | 346344 | Ref. No. 6032022 |
| | ring for protecting cover | | |



| | | | |
|--------------------|---|-----------------|---------|
| GEV No. | 346346 | Ref. No. | 6032038 |
| description | momentary push switch mounting ø 16mm red 1NO/indicator light 250V 3A connection male faston 2.8mm ambient temperature max. 125/55°C protection IP40 | | |
| For models: | CG20MX, DG06EC, DG06ES, DG06MX, DG102EC, DG102MX, DG10EC, DG10ES, DG10MX, GF10GM, GF4PM, GF5GM, GF6PM, GF7GM, GF8PM, VG06EC, VG06MX, VG102EC, VG102MX, VG10EC, VG10MX, VG20EC, VG20MX | | |

accessories

protective covers



| | | | |
|---|--|-----------------|-------------------------|
| GEV No. | 346343 | Ref. No. | 6032021 |
| description | protective cover | | |
| For models: | CE06MX, CE102MX, CE10MX, CE20MX, CG06MX, CG102MX, CG10MX, CG20MX, DE06MX, DE102MX, DE10MX, DG06EC, DG06MX, DG102EC, DG102MX, DG10EC, DG10MX, VE06MX, VE102MX, VE10MX, VE20MX, VG06EC, VG06MX, VG102EC, VG102MX, VG10EC, VG10MX, VG20EC, VG20MX | | |
| accessories for | 346343 | | |
|  | GEV No. | 346344 | Ref. No. 6032022 |
| | ring for protecting cover | | |

Зип Общепит

vsezip.ru

+7(812)987-08-81

| | | | |
|---|--|-----------------|-------------------------|
| GEV No. | 346344 | Ref. No. | 6032022 |
| description | ring for protecting cover | | |
| For models: | CE06MX, CE102MX, CE10MX, CE20MX, CG06MX, CG102MX, CG10MX, CG20MX, DE06MX, DE102MX, DE10MX, DG06EC, DG06MX, DG102EC, DG102MX, DG10EC, DG10MX, VE06MX, VE102MX, VE10MX, VE20MX, VG06EC, VG06MX, VG102EC, VG102MX, VG10EC, VG10MX, VG20EC, VG20MX | | |
| accessories for | 346344 | | |
|  | GEV No. | 346343 | Ref. No. 6032021 |
| | protective cover | | |

microswitches

lever actuated



| | | | |
|--------------------|---|-----------------|---------|
| GEV No. | 345773 | Ref. No. | 6043085 |
| description | microswitch with lever 250V 16A 1CO connection male faston 6.3mm L 60mm ambient temperature max. 125°C mounting distance 22mm actuating force: 65g lever length 51mm | | |
| For models: | 15FE, 15FEC, 20FE, 20FEC, 210FE, 210FEC, 215FE, 215FEC, 220FE, 220FEC, 920FE, 920FEC, 922FE, 922FEC, 940FE, 940FEC, F10CL, F10L, F15CL, F15L, F215CL, F215L, FP18NS, FP18S, FP27S, FRE46, FRE46R, FRE66, FRE66R, SH510P, SH560P | | |

pin-plunger actuated

M10



| | | | |
|--------------------|---|-----------------|---------|
| GEV No. | 346347 | Ref. No. | 6043088 |
| description | microswitch with plunger thread M10x0.75 thread L 14mm 250V 6A 2NO connection male faston 6.3mm stroke 4mm mounting distance 22mm ambient temperature max. 85°C actuating force: 100g | | |
| For models: | CE06MX, CE102MX, CE10MX, CE20MX, CG06MX, CG102MX, CG10MX, CG20MX, DE06EC, DE06ES, DE06MX, DE102EC, DE102MX, DE10EC, DE10ES, DE10MX, DG06EC, DG06ES, DG06MX, DG102EC, DG102MX, DG10EC, DG10ES, DG10MX, VE06EC, VE06MX, VE102EC, VE102MX, VE10EC, VE10MX, VE20EC, VE20MX, VG06EC, VG06MX, VG102MX, VG10EC, VG10MX, VG20EC, VG20MX | | |



| | | | |
|--------------------|---|-----------------|---------|
| GEV No. | 345032 | Ref. No. | 6043080 |
| description | microswitch with plunger thread M10x1 thread L 12mm 250V 16A 1CO connection male faston 6.3mm stroke 7mm mounting distance 22mm L 28mm ambient temperature max. 125°C type SP9603 actuating force: 180g | | |

electric components



cam switches

on/off

E-G-O



1

| | | | |
|--------------------|--|-----------------|---------|
| GEV No. | 300129 | Ref. No. | 6030007 |
| description | cam switch 2 operating positions 2NO sequence 0-1 16A shaft \varnothing 6x4.6mm shaft L 23mm connection male faston 6.3mm ceramic | | |
| For models: | 13FGC, 17FGC, 207FGC, 213FGC, 217FGC, 917FGC, 927FGC, 934FGC, BM711, BM721, BM911, BM921, BME46, BME66, CE06MX, CE102MX, CE10MX, CE20MX, CG06MX, CG102MX, CG10MX, CG20MX, EF10GM, EF4PM, EF5GM, EF6PM, EF7GM, EF8PM, EN10VE-EC-ESN1033, FG07CL, FG213CL, GF10GM, GF4PM, GF5GM, GF6PM, GF7GM, GF8PM | | |



1

| | | | |
|--------------------|---|-----------------|---------|
| GEV No. | 300139 | Ref. No. | 6030012 |
| description | cam switch ON-OFF connection male faston | | |
| For models: | 210FEC, 922FEC, EF4, F10CL, F15CL, F215CL, FP18NS, FP18S, FP27S, FTR10, SH505R, SH510P, SH510R, SH520G, SH520GM, SH560P | | |

7-position

E-G-O



1

| | | | |
|--------------------|---|-----------------|---------|
| GEV No. | 300106 | Ref. No. | 6030001 |
| description | cam switch 7 operating positions 1NO/2CO sequence 0-1-2-3-4-5-6 32A shaft \varnothing 6x4.6mm shaft L 23mm connection screw 7-position shaft flat upper | | |

Зип-Общепит

4 operating positions

vsezip.ru

+7(812)987-08-81

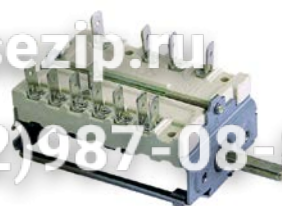

1

| | | | |
|--------------------|---|-----------------|-----------------------|
| GEV No. | 300010 | Ref. No. | 6030018 6030018OBS |
| description | cam switch 4 operating positions 2NO/2CO sequence 0-1-2-3 16A shaft \varnothing 6x4.6mm shaft L 23mm connection male faston 6.3mm ceramic | | |

operation switches

E-G-O



1

| | | | |
|--------------------|---|-----------------|---------|
| GEV No. | 300002 | Ref. No. | 6030019 |
| description | cam switch 2 operating positions 4NO 16A sequence 0-1 shaft \varnothing 6x4.6mm shaft L 23mm connection male faston 6.3mm ceramic | | |

E-G-O



1

| | | | |
|--------------------|---|-----------------|---------|
| GEV No. | 300200 | Ref. No. | 6030015 |
| description | operation switch 2 operating positions 2NO 16A sequence 0-1 shaft \varnothing 6x4.6mm shaft L 23mm connection male faston 6.3mm operation switch ceramic | | |
| For models: | 13FG, 17FG, 207FG, 213FG, 217FG, 917FG, 927FG, 934FG, CP1BM, CPG1BM, FRE46F, FRE66F, FT3N, FT5, FTE100, FTE107, FTE46, FTE46B, FTE46R, FTE47L, FTE66LM, FTE66LMB, FTE66RM, FTR26F, FTR6F, SPE46 | | |

rotary switches

BREMAS

A1600 series





1

| | | | |
|--------------------|---|-----------------|---------|
| GEV No. | 346342 | Ref. No. | 6030031 |
| description | rotary switch 7 1-2-3-4-5-6-7 sets of contacts 9 type CS0169137 400V 16A shaft \varnothing 4x5mm shaft L 20mm shaft square connection screw | | |
| For models: | VE06MX, VE102MX, VE10MX, VE20MX, VG06MX, VG102MX, VG10MX, VG20MX | | |





Зип-Общепит
vsezip.ru
7(812)987-08-81

| | | | |
|---|---|-----------------|---------|
|  | | | |
| 1 | | | |
| GEV No. | 346341 | Ref. No. | 6030030 |
| description | rotary switch 8 1-2-3-4-5-6-7-8 sets of contacts 10 type CS0169134 400V 16A shaft ø 4x5mm shaft L 20mm shaft square connection screw | | |
| For models: | DE06EC, DE06ES, DE06MX, DE102EC, DE10EC, DE10ES, DE10MX, DG06EC, DG06ES, DG06MX, DG102EC, DG102MX, DG10EC, DG10ES, DG10MX, VE06EC, VE102EC, VE10EC, VE20EC, VG06EC, VG102EC, VG10EC, VG20EC | | |

| | | | |
|---|--|-----------------|---------|
| indicator lamp with socket type SRZ / SDK / SDY / SFK | | | |
| 1 | | | |
| GEV No. | 359430 | Ref. No. | 6061067 |
| description | indicator lamp 230V clear connection cable 400mm | | |
| For models: | EF4, FP18NS, FP18S, FP27S, FT3N, FT5, FTR10, FTR26F, FTR26T, FTR6F, FTR6T, S505, S505R, S510, S510S, S511, S511S | | |
| accessories for | 359430 | | |
| |  | GEV No. | 359260 |
| | | Ref. No. | — |
| | indicator light housings mounting measurements ø12mm yellow round Qty 1 pcs | | |

encoders and potentiometers

| | | | |
|---|---|-----------------|---------|
|  | | | |
| 1 | | | |
| GEV No. | 401169 | Ref. No. | 6010102 |
| description | encoder cable length 125mm | | |
| For models: | DE06EC, DE102EC, DE10EC, DG06EC, DG102EC, DG10EC, SH505R, SH510P, SH510R, SH520G, SH520GM, SH560P, VE06EC, VE102EC, VE10EC, VE20EC, VG06EC, VG102EC, VG10EC, VG20EC | | |

| | | | |
|---|--|-----------------|---------|
|  | | | |
| 1 | | | |
| GEV No. | 359431 | Ref. No. | 6061068 |
| description | indicator lamp 230V green connection cable 400mm cable material silicone | | |
| For models: | EF4, FP18NS, FP18S, FP27S, FT3N, FT5, FTR10, FTR26F, FTR26T, FTR6F, FTR6T, SR512, SR512R | | |

| | | | |
|--|--|-----------------|---------|
|  | | | |
| 1 | | | |
| GEV No. | 300187 | Ref. No. | 6010097 |
| description | potentiometer 4.7KOhm rotation 310° shaft ø 0.6x4.5mm shaft L 20mm cable length 650mm | | |
| For models: | CE06MX, CE102MX, CE10MX, CE20MX, CG06MX, CG102MX, CG10MX, CG20MX, DE06ES, DE06MX, DE102MX, DE10ES, DE10MX, DG06ES, DG06MX, DG102MX, DG10ES, DG10MX, EF10GM, EF4PM, EF5GM, EF6PM, EF7GM, EF8PM, GF10GM, GF4PM, GF5GM, GF6PM, GF7GM, GF8PM, VE06MX, VE102MX, VE10MX, VE20MX, VG06MX, VG102MX, VG10MX, VG20MX | | |

| | | | |
|---|---|-----------------|---------|
| indicator lights (complete) | | | |
| ø12mm | | | |
| with screw socket | | | |
|  | | | |
| 1 | | | |
| GEV No. | 359048 | Ref. No. | 6061051 |
| description | indicator light ø 12mm 230V yellow connection male faston 6.3mm | | |

| | | | |
|---|--|-----------------|---------|
|  | | | |
| 1 | | | |
| GEV No. | 359291 | Ref. No. | 6061050 |
| description | indicator light ø 12mm 400V green connection male faston 6.3mm | | |

lamps

indicator lights

indicator lights 2-piece (lens and indicator lamp)

indicator light lenses

ø13mm (type SFK-3)

| | | | |
|---|--|-----------------|---------|
|  | | | |
| 1 | | | |
| GEV No. | 359225 | Ref. No. | 6061069 |
| description | indicator light housings mounting measurements ø13mm clear Qty 1 pcs | | |
| For models: | EF4, FP18NS, FP18S, FP27S, FT3N, FT5, FTR10, FTR26F, FTR26T, FTR6F, FTR6T, S505, S505R, S510, S510S, S511, S511S | | |

screw-on/push-on fit

light bulbs

for ovens

| | | | |
|--|--|-----------------|---------|
|  | | | |
| 1 | | | |
| GEV No. | 359610 | Ref. No. | 6061052 |
| description | light bulb t.max. 300°C socket E14 15W 230V ø 22mm L 47mm lens L 20mm for oven lamp type Philips | | |

1 electric components



PHILIPS



1

| | | | |
|--------------------|--|-----------------|---------|
| GEV No. | 359612 | Ref. No. | 6061053 |
| description | light bulb t.max. 300°C socket E14 25W 230V ø 25mm L 56mm lens L 30mm for oven lamp type Philips | | |
| For models: | EN10VE-EC-ESN1033 | | |

halogen lamp

for socket G4 / G6.35 / G9



1

| | | | |
|--------------------|--|-----------------|---------|
| GEV No. | 359599 | Ref. No. | 6061054 |
| description | halogen lamp socket G4 12V 20W temp.-resist. 500°C | | |
| For models: | CE06MX, CE102MX, CE10MX, CE20MX, CG06MX, CG102MX, CG10MX, CG20MX, DE06EC, DE06ES, DE06MX, DE102EC, DE102MX, DE10EC, DE10ES, DE10MX, DG06EC, DG06ES, DG06MX, DG102EC, DG102MX, DG10EC, DG10ES, DG10MX, VE06EC, VE06MX, VE102EC, VE102MX, VE10EC, VE10MX, VE20EC, VE20MX, VG06EC, VG06MX, VG102EC, VG102MX, VG10EC, VG10MX, VG20EC, VG20MX | | |



oven lamps

universal oven lamps

mounting diameter 35.5mm



1

| | | | | |
|---|--|-----------------|-----------------|---|
| GEV No. | 359718 | Ref. No. | 6063072 | |
| description | oven lamp mounting ø 35.5mm 230V 15W socket E14 temp.-resist. 300°C connection male faston 6.3mm hard glas | | | |
| spare parts for | 359718 | | | |
|  | GEV No. | 359701 | Ref. No. | — |
| | lamp socket socket E14 220-230V mounting ø 35.5mm connection male faston 6.3mm 15W | | | |
|  | GEV No. | 359740 | Ref. No. | — |
| | light bulb t.max. 300°C socket E14 15W 230V ø 22mm L 48mm lens L 20mm for oven lamp IMPORT | | | |

Зип Общепит



vsezip.ru

+7(812)987-08-81

mounting diameter 47.8mm



1

| | | | | |
|---|--|-----------------|-----------------|---------|
| GEV No. | 359499 | Ref. No. | 6060055 | |
| description | lamp socket socket E14 mounting ø 47.8mm connection male faston 6.3mm | | | |
| For models: | EF10GM, EF4PM, EF5GM, EF6PM, EF7GM, EF8PM, GF10GM, GF4PM, GF5GM, GF6PM, GF7GM, GF8PM | | | |
| accessories for | 359499 | | | |
|  | GEV No. | 359612 | Ref. No. | 6061053 |
| | light bulb t.max. 300°C socket E14 25W 230V ø 25mm L 56mm lens L 30mm for oven lamp type Philips | | | |
|  | GEV No. | 359725 | Ref. No. | — |
| | oven lamp glass thread ø 44mm H 43mm ø 54mm hard glas temp.-resist. 350°C | | | |

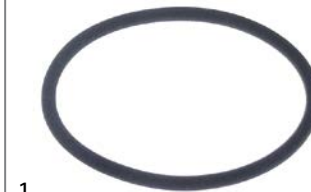

1

| | | | |
|--------------------|--|-----------------|---------|
| GEV No. | 525313 | Ref. No. | 6090140 |
| description | O-ring Viton ID ø 60.33mm thickness 3.53mm Qty 1 pcs | | |
| For models: | EF10GM, EF4PM, EF5GM, EF6PM, EF7GM, EF8PM, GF10GM, GF4PM, GF5GM, GF6PM, GF7GM, GF8PM | | |

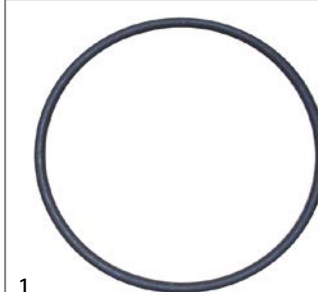

1

| | | | |
|--------------------|--|-----------------|---------|
| GEV No. | 532649 | Ref. No. | 6090141 |
| description | O-ring Viton ID ø 63.17mm thickness 2.62mm Qty 1 pcs | | |
| For models: | EF10GM, EF4PM, EF5GM, EF6PM, EF7GM, EF8PM, GF10GM, GF4PM, GF5GM, GF6PM, GF7GM, GF8PM | | |

Зип Общепит

vsezip.ru

+7(812)987-08-81

30x70mm

1



| | | | |
|--------------------|--|-----------------|---------|
| GEV No. | 359338 | Ref. No. | 6063077 |
| description | lamp glass | | |
| For models: | CE06MX, CE102MX, CE10MX, CE20MX, CG06MX, CG102MX, CG10MX, CG20MX, DE06EC, DE06ES, DE06MX, DE102EC, DE102MX, DE10EC, DE10ES, DE10MX, DG06EC, DG06ES, DG06MX, DG102EC, DG102MX, DG10EC, DG10ES, DG10MX, VE06EC, VE06MX, VE102EC, VE102MX, VE10EC, VE10MX, VE20EC, VE20MX, VG06EC, VG06MX, VG102EC, VG102MX, VG10EC, VG10MX, VG20EC, VG20MX | | |

2



| | | | |
|------------------------|--|-----------------|-------------------------|
| GEV No. | 359337 | Ref. No. | 6063075 |
| description | oven lamp socket G4 cable length 800mm connection Faston 6.3mm L 70mm W 29mm | | |
| For models: | CE06MX, CE102MX, CE10MX, CE20MX, CG06MX, CG102MX, CG10MX, CG20MX, DE06EC, DE06ES, DE06MX, DE102EC, DE102MX, DE10EC, DE10ES, DE10MX, DG06EC, DG06ES, DG06MX, DG102EC, DG102MX, DG10EC, DG10ES, DG10MX, VE06EC, VE06MX, VE102EC, VE102MX, VE10EC, VE10MX, VE20EC, VE20MX, VG06EC, VG06MX, VG102EC, VG102MX, VG10EC, VG10MX, VG20EC, VG20MX | | |
| accessories for | 359337 | | |
| |  GEV No. | 359599 | Ref. No. 6061054 |
| | halogen lamp socket G4 12V 20W temp.-resist. 500°C | | |

55x70mm

1



| | | | |
|--------------------|------------|-----------------|---------|
| GEV No. | 359368 | Ref. No. | 6063074 |
| description | lamp glass | | |

55x100mm





1



| | | | |
|--------------------|--|-----------------|---------|
| GEV No. | 359714 | Ref. No. | 6063070 |
| description | gasket silicone L 140mm W 75mm for bulb socket | | |

1



| | | | |
|--|--|-----------------|---------|
| GEV No. | 101372 | Ref. No. | 6063069 |
| description | oven lamp complete L 100mm W 55mm 230V 25W socket E14 rectangular temp.-resist. 300°C connection male faston 6.3mm | | |
| spare parts for | 101372 | | |
|  GEV No. | 359612 | Ref. No. | 6061053 |
| | light bulb t.max. 300°C socket E14 25W 230V ø 25mm L 56mm lens L 30mm for oven lamp type Philips | | |
|  GEV No. | 359698 | Ref. No. | — |
| | lamp socket L 100mm W 55mm socket E14 connection male faston 6.3mm | | |
|  GEV No. | 359714 | Ref. No. | 6063070 |
| | gasket silicone L 140mm W 75mm for bulb socket | | |
|  GEV No. | 359715 | Ref. No. | — |
| | lamp glass L 110mm W 65mm thickness 5mm | | |
|  GEV No. | 359716 | Ref. No. | — |
| | frame for bulb socket | | |

lamps

light bulbs

1



| | | | |
|--------------------|--|-----------------|---------|
| GEV No. | 359610 | Ref. No. | 6061052 |
| description | light bulb t.max. 300°C socket E14 15W 230V ø 22mm L 47mm lens L 20mm for oven lamp type Philips | | |

1



| | | | |
|--------------------|--|-----------------|---------|
| GEV No. | 359612 | Ref. No. | 6061053 |
| description | light bulb t.max. 300°C socket E14 25W 230V ø 25mm L 56mm lens L 30mm for oven lamp type Philips | | |
| For models: | EN10VE-EC-ESN1033 | | |



Зип-Общепит

mechanical timers

halogen lamps

for socket G4 / G6.35 / G9



| | | | |
|--------------------|--|-----------------|---------|
| GEV No. | 359599 | Ref. No. | 6061054 |
| description | halogen lamp socket G4 12V 20W temp.-resist. 500°C | | |
| For models: | CE06MX, CE102MX, CE10MX, CE20MX, CG06MX, CG102MX, CG10MX, CG20MX, DE06EC, DE06ES, DE06MX, DE102EC, DE102MX, DE10EC, DE10ES, DE10MX, DG06EC, DG06ES, DG06MX, DG102EC, DG102MX, DG10EC, DG10ES, DG10MX, VE06EC, VE06MX, VE102EC, VE102MX, VE10EC, VE10MX, VE20EC, VE20MX, VG06EC, VG06MX, VG102EC, VG102MX, VG10EC, VG10MX, VG20EC, VG20MX | | |

timers

electric timers



| | | | |
|--------------------|--|-----------------|--------------------|
| GEV No. | 350135 | Ref. No. | 6032042 6032059 |
| description | timer M565 operation time 120min time spreadmin 1CO/2NO at 250V 16A permanent position yes time range 0-120min impulse electric shaft ø 6x4.6mm shaft L 21mm mounting distance 28mm connection male faston 6.3mm screw mounting 250V voltage AC 50Hz | | |

with time spread





| | | | |
|--------------------|---|-----------------|---------|
| GEV No. | 350074 | Ref. No. | 6032047 |
| description | timer M565 operation time 120min time spread 30min 1CO/2NO/1NC at 250V 16A permanent position yes impulse electric shaft ø 6x4.6mm shaft L 22mm mounting distance 28mm connection lateral Invensys 4-pole shaft position lower* | | |
| For models: | CE06MX, CE102MX, CE10MX, CE20MX, CG06MX, CG102MX, CG10MX, CG20MX, DE06ES, DE06MX, DE102MX, DE10ES, DE10MX, DG06ES, DG06MX, DG102MX, DG10ES, DG10MX, EF10GM, EF4, EF4PM, EF5GM, EF6PM, EF7GM, EF8PM, GF10GM, GF4PM, GF5GM, GF6PM, GF7GM, GF8PM, VE06MX, VE102MX, VE10MX, VE20MX, VG06MX, VG102MX, VG10MX, VG20MX | | |

vsezip.ru

+7(812)987-08-81



| | | | | |
|---|---|-----------------|-----------------|---|
| GEV No. | 350003 | Ref. No. | 6032040 | |
| description | timer M2 with bell 2-pole operation time 120min impulse mechanical 2NO at 250V 16A permanent position no shaft ø 6x4.6mm shaft 6x4.6mm shaft L 23mm mounting distance 28mm connection lateral | | | |
| accessories for | 350003 | | | |
|  | GEV No. | 110366 | Ref. No. | — |
| | knob switch zero mark t.max.°C°C ø 44mm shaft ø 6x4.6mm shaft flat upper black | | | |
|  | GEV No. | 111199 | Ref. No. | — |
| | dial plate graduation 120min permanent position no rotation 0-330° ø 60mm timers knob ø 45mm | | | |

alarm devices

buzzer boards



| | | | |
|--------------------|--|-----------------|---------|
| GEV No. | 401062 | Ref. No. | 6010090 |
| description | buzzer board 230VAC L 48mm W 45mm connection Faston 6.3mm | | |
| For models: | CE06MX, CE102MX, CE10MX, CE20MX, CG06MX, CG102MX, CG10MX, CG20MX, DE06MX, DE102MX, DE10MX, DG06MX, DG102MX, DG10MX, EF10GM, EF4PM, EF5GM, EF6PM, EF7GM, EF8PM, GF10GM, GF4PM, GF5GM, GF6PM, GF7GM, GF8PM | | |

contactors

ABB

power contactors



| | | | |
|--------------------|--|-----------------|---------|
| GEV No. | 380100 | Ref. No. | 6046045 |
| description | power contactor resistive load 20A 230VAC (AC3/400V) 12A/5.5kW main contacts 3NO auxiliary contacts 1NO connection screw connection type B6-30-10 / B7-30-10 | | |

Зип Общепит

vsezip.ru

+7(812)987-08-81

auxiliary contacts



| | | | |
|--------------------|--|-----------------|---------|
| GEV No. | 381028 | Ref. No. | 6046145 |
| description | auxiliary contact contacts 1NO/1NC AC1 6A AC15 3A connection screw connection for contactors B6/B7/VB7 | | |

GENERAL ELECTRIC (AEG)

power contactors



| | | | |
|--------------------|--|-----------------|---------|
| GEV No. | 380244 | Ref. No. | 6046043 |
| description | power contactor resistive load 25A 230VAC (AC3/400V) 9A/4kW main contacts 3NO auxiliary contacts 1NO connection screw connection type AEG LS4K 10A type GE CL00A 310 | | |
| For models: | F10CL, F10L, F15CL, F15L, F215CL, F215L, FP18NS, FP18S, FP27S, FRE46, FRE66 | | |

ISKRA (FANAL)

power contactors



| | | | |
|--------------------|---|-----------------|--------------------|
| GEV No. | 380204 | Ref. No. | 6046033 6046038 |
| description | power contactor resistive load 25A 230VAC (AC3/400V) 9A/4kW main contacts 3NO auxiliary contacts 1NO connection screw connection type Fanal DSL9 10 type ISKRA KNL9 10 | | |
| For models: | 15FE, 15FEC, 20FEC, 210FE, 210FEC, 215FE, 215FEC, 220FEC, 920FEC, 922FE, 922FEC, 940FEC, CE06MX, CE102MX, CE10MX, CE20MX, CG06MX, CG102MX, CG10MX, CG20MX, DE06EC, DE06ES, DE06MX, DE102EC, DE102MX, DE10EC, DE10ES, DE10MX, DG06ES, DG06MX, DG102MX, DG10ES, DG10MX, EF10GM, EF4, EF4PM, EF5GM, EF6PM, EF7GM, EF8PM, EN10VE-EC-ESN1033, GF10GM, GF4PM, GF5GM, GF6PM, GF7GM, GF8PM, VE06EC, VE06MX, VE102EC...(Other models you can see in the webshop) | | |



| | | | |
|---|---|-----------------|-----------------|
| GEV No. | 380424 | Ref. No. | 6046041 |
| description | power contactor resistive load 35A 230VAC (AC3/400V) 32A/15kW main contacts 3NO connection screw connection type Fanal DSL30 type ISKRA KNL30 | | |
| accessories for | 380424 | | |
|  | GEV No. | 381378 | Ref. No. |
| | | | — |
| | overload switch connection screw setting range 24,5-30A for contactors KNL30 type BR30 24.5-30A | | |

relays

power relays

with DIN rail mounting

lateral



| | | | |
|--------------------|---|-----------------|---------|
| GEV No. | 380379 | Ref. No. | 6041013 |
| description | power relays SCHRACK 230VAC 25A 2CO connection male faston 6.3mm DIN rail manuf. no. RM809730 | | |
| For models: | SH505R, SH510R | | |

with bracket mounting



| | | | |
|--------------------|---|-----------------|---------|
| GEV No. | 380702 | Ref. No. | 6041008 |
| description | power relays FINDER 230VAC 16A 3NO connection male faston 6.3mm flange dimensions 36x38x68mm manuf. no. 62.83.8.230.0300 230V | | |



plug-in/print relays

Зип Общепит

level relays

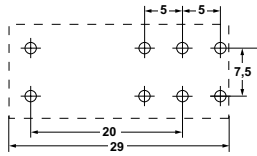

1

| | | | |
|------------------------|---|-----------------|---------|
| GEV No. | 380333 | Ref. No. | 6041009 |
| description | print relay 230VAC 2CO at 250V 8A connection pins raster size 5mm FINDER manuf. no. 40.52.8.230.0000 95.65/95.75 | | |
| accessories for | 380333 | | |
| | GEV No. | Ref. No. | — |
| | 380340 | | |
| | relay socket dimensions 62x36x15mm 250V voltage AC 10A Italiana Relè manuf. no. ZMEM/5 | | |
| | GEV No. | Ref. No. | — |
| | 380505 | | |
| | relay socket 2CO 40.52 dimensions 81.9x15.5x75mm 250V voltage AC 10A FINDER manuf. no. 95.95.3 | | |
| | GEV No. | Ref. No. | 6040015 |
| | 381181 | | |
| | relay socket 2-pole 40.51/40.52/40.61 connection screw clamp dimensions 15.8x78.6mm 250V voltage AC 10A FINDER manuf. no. 95.75 | | |

relay sockets



1

| | | | |
|------------------------|---|-----------------|---------|
| GEV No. | 381181 | Ref. No. | 6040015 |
| description | relay socket 2-pole 40.51/40.52/40.61 connection screw clamp dimensions 15.8x78.6mm 250V voltage AC 10A FINDER manuf. no. 95.75 | | |
| accessories for | 381181 | | |
| | GEV No. | Ref. No. | — |
| | 381455 | | |
| | support bracket | | |

GICAR
vsezip.ru

+7(812)987-08-81



1

| | | | |
|--------------------|---|-----------------|---------|
| GEV No. | 401173 | Ref. No. | 6041043 |
| description | level relay 230V connection F6.3 type RL30/3ES/F | | |
| For models: | EN10VE-EC-ESN1033, VE06EC, VE06MX, VE102EC, VE102MX, VE10EC, VE10MX, VE20EC, VE20MX, VG06EC, VG06MX, VG102EC, VG102MX, VG10EC, VG10MX, VG20EC, VG20MX | | |

time relays

time relays



1

| | | | |
|--------------------|--|-----------------|---------|
| GEV No. | 381119 | Ref. No. | 6042049 |
| description | time relay LOVATO TM D time range 0.06-180s | | |
| For models: | VE06EC, VE06MX, VE102EC, VE102MX, VE10EC, VE10MX, VE20EC, VE20MX, VG06EC, VG06MX, VG102EC, VG102MX, VG10EC, VG10MX, VG20EC, VG20MX | | |



1

| | | | |
|--------------------|--|-----------------|---------|
| GEV No. | 380607 | Ref. No. | 6042054 |
| description | time relay LOVATO TM M1 time range 0s-10 days 12-24V AC/DC 8A 1CO connection grip connection | | |
| For models: | VE06MX, VE102MX, VE10MX, VE20MX, VG06MX, VG102MX, VG10MX, VG20MX | | |



Зип Обществит
electronic controllers

vsezip.ru

+7(812)987-08-81



1

| | | | |
|--------------------|---|-----------------|---------|
| GEV No. | 380606 | Ref. No. | 6042056 |
| description | time relay LOVATO TM PL time range 2x 0.1s-100 days 12-240V AC/DC 8A 1CO connection grip connection | | |
| For models: | DE06ES, DE06MX, DE102MX, DE10ES, DE10MX, DG06ES, DG06MX, DG102MX, DG10ES, DG10MX | | |

transformers

encapsulated transformers

PMA



1

| | | | |
|--------------------|---|-----------------|---------|
| GEV No. | 379054 | Ref. No. | 6010086 |
| description | transformer primary 230VAC secondary 12VAC 3VA secondary 0.25A H 40mm L 45mm W 50mm connection screw 50/60Hz type 153/M | | |
| For models: | SH505R, SH510R, SH520G, SH520GM | | |



1

| | | | |
|--------------------|---|-----------------|---------|
| GEV No. | 401174 | Ref. No. | 6010079 |
| description | transformer primary 230VAC secondary 12VAC 6VA secondary 0.5A connection screw 50Hz | | |
| For models: | DE06EC, DE102EC, DE10EC, DG06EC, DG102EC, DG10EC, EN10VE-EC-ESN1033, SH510P, SH560P, VE06EC, VE102EC, VE10EC, VE20EC, VG06EC, VG102EC, VG10EC, VG20EC | | |

for lighting



1

| | | | |
|--------------------|--|-----------------|---------|
| GEV No. | 401175 | Ref. No. | 6041065 |
| description | transformer primary 230V secondary 11.5V 90VA | | |
| For models: | CE06MX, CE102MX, CE10MX, CE20MX, CG06MX, CG102MX, CG10MX, CG20MX, DE06EC, DE06ES, DE06MX, DE102EC, DE102MX, DE10EC, DE10ES, DE10MX, DG06EC, DG06ES, DG06MX, DG102EC, DG102MX, DG10EC, DG10ES, DG10MX, VE06EC, VE06MX, VE102EC, VE102MX, VE10EC, VE10MX, VE20EC, VE20MX, VG06EC, VG06MX, VG102EC, VG102MX, VG10EC, VG10MX, VG20EC, VG20MX | | |

EVCO - EVERY CONTROL

universal controllers

built-in version

66,5 x 66,5mm



1

| | | | |
|------------------------|--|-----------------|--------------------|
| GEV No. | 378169 | Ref. No. | 6011125 6011130 |
| description | electronic controller EVERY CONTROL EV7401 mounting measurements 66.5x66.5mm built-in depth 90mm 24/230V voltage AC NTC/PTC/Pt100/TC(J,K)/mA relay outputs 1 CO-8A(3) NTC/PTC/Pt100/TC(J,K)/mA yes protection IP54 dependend on probe°C display 4 digits | | |
| accessories for | 378169 | | |
| | GEV No. | Ref. No. | — |
| | temperature probe PTC 1kOhm cable PVC probe -50 up to +150°C cable -10 up to 100°C probe ø6x30mm cable length 3m without screw connection 2-wire | | |
| | GEV No. | Ref. No. | — |
| | temperature probe thermocouple J (Fe-CuNi) cable Vetrotex probe -50 up to +750°C cable -50 up to +350°C probe ø6x50mm cable length 3m without screw connection 2-wire | | |
| | GEV No. | Ref. No. | — |
| | temperature probe PTC 1kOhm cable silicone probe -50 up to +150°C cable -50 up to +180°C probe ø6x40mm cable length 3m without screw connection 2-wire | | |
| | GEV No. | Ref. No. | — |
| | temperature probe Pt100 cable Vetrotex probe -200 up to +600°C cable -50 up to +350°C probe ø6x85mm cable length 3m without screw connection 3-wire resistance at 0°C 100Ohm | | |
| | GEV No. | Ref. No. | — |
| | temperature probe NTC 10kOhm cable thermoplastic probe -40 up to +110°C cable -40 up to +110°C probe ø6x14mm cable length 3m without screw connection 2-wire | | |



SHANGFANG

Зип.Общепит electronics

frequency converters

vsezip.ru

+7(812)987-08-81

accessories



1

| | | | |
|--------------------|---|-----------------|---------|
| GEV No. | 379054 | Ref. No. | 6010086 |
| description | transformer primary 230VAC secondary 12VAC 3VA secondary 0.25A H 40mm L 45mm W 50mm connection screw 50/60Hz type 153/M | | |
| For models: | SH505R, SH510R, SH520G, SH520GM | | |

1

| | | | |
|--------------------|--|-----------------|--------------------|
| GEV No. | 403841 | Ref. No. | 6010130 6010131 |
| description | frequency converter with heat sink for combi-steamer L 135mm W 135mm 800W ECS P0010205-0 | | |

probes

universal probes

temperature probes

1



| | | | |
|--------------------|--|-----------------|---------|
| GEV No. | 379860 | Ref. No. | 6000100 |
| description | temperature probe NTC 10kOhm cable PVC probe -20 up to +80°C cable -10 up to 100°C probe ø6x40mm cable length 1.5m without screw connection 2-wire | | |

1



| | | | |
|--------------------|---|-----------------|---------|
| GEV No. | 379222 ¹ | Ref. No. | 6000083 |
| description | temperature probe Pt100 cable Vetrotex probe -200 up to +600°C cable -50 up to +350°C probe ø4x110mm cable length 1.4m 3-wire | | |
| For models: | CE06MX, CE102MX, CE10MX, CE20MX, CG06MX, CG102MX, CG10MX, CG20MX, DE06ES, DE06MX, DE102MX, DE10ES, DE10MX, DG06ES, DG06MX, DG102MX, DG10ES, DG10MX, VE06MX, VE102EC, VE102MX, VE10MX, VE20MX, VG06MX, VG102MX, VG10MX, VG20MX | | |

¹3-wire

1



| | | | |
|--------------------|--|-----------------|---------|
| GEV No. | 379050 ¹ | Ref. No. | 6000085 |
| description | temperature probe Pt100 cable Vetrotex probe -200 up to +600°C cable -50 up to +350°C probe ø6x100mm cable length 2.7m without screw connection 3-wire | | |
| For models: | EF10GM, EF4PM, EF5GM, EF6PM, EF7GM, EF8PM, EN10VE-EC-ESN1033, GF10GM, GF4PM, GF5GM, GF6PM, GF7GM, GF8PM | | |

¹3-wire

PCBs

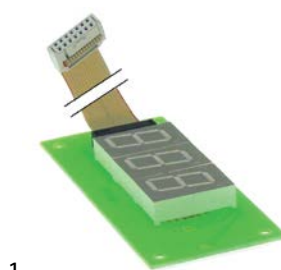

1

| | | | |
|--------------------|--|-----------------|---------|
| GEV No. | 401166 | Ref. No. | 6010095 |
| description | display | | |
| For models: | CE06MX, CE102MX, CE20MX, CG06MX, CG102MX, CG10MX, CG20MX, DE06ES, DE06MX, DE102MX, DE10ES, DE10MX, DG06ES, DG06MX, DG102MX, DG10ES, DG10MX, EF10GM, EF4PM, EF5GM, EF6PM, EF7GM, EF8PM, GF10GM, GF4PM, GF5GM, GF6PM, GF7GM, GF8PM, VE06MX, VE102MX, VE10MX, VE20MX, VG06MX, VG102MX, VG10MX, VG20MX | | |

1

| | | | |
|--------------------|--|-----------------|---------|
| GEV No. | 401168 | Ref. No. | 6010100 |
| description | PCB | | |
| For models: | DE06EC, DE102EC, DE10EC, DG06EC, DG102EC, DG10EC, VE06EC, VE102EC, VE10EC, VE20EC, VG06EC, VG102EC, VG10EC, VG20EC | | |



Зип Обществит
solenoid valves

vsezip.ru

+7(812)987-08-81



1

| | | | |
|--------------------|--|-----------------|---------|
| GEV No. | 401170 | Ref. No. | 6010101 |
| description | PCB | | |
| For models: | DE06EC, DE102EC, DE10EC, DG06EC, DG102EC, DG10EC, VE06EC, VE102EC, VE10EC, VE20EC, VG06EC, VG102EC, VG10EC | | |



1

| | | | |
|--------------------|--|-----------------|---------|
| GEV No. | 401172 | Ref. No. | 6010093 |
| description | PCB combi-steamer VE 06/10 | | |
| For models: | VE06EC, VE06MX, VE102EC, VE102MX, VE10EC, VE10MX, VE20EC, VE20MX, VG06EC, VG06MX, VG102EC, VG102MX, VG10EC, VG10MX, VG20EC, VG20MX | | |



1

| | | | |
|---|--|-----------------|-------------------------|
| GEV No. | 401167 | Ref. No. | 6010096 |
| description | PCB combi-steamer VE 06/10 230V 50/60Hz | | |
| For models: | CE06MX, CE102MX, CE10MX, CE20MX, CG06MX, CG102MX, CG10MX, CG20MX, DE06ES, DE06MX, DE102MX, DE10ES, DE10MX, DG06ES, DG06MX, DG102MX, DG10ES, DG10MX, EF10GM, EF4PM, EF5GM, EF6PM, EF7GM, EF8PM, GF10GM, GF4PM, GF5GM, GF6PM, GF7GM, GF8PM, VE06MX, VE102MX, VE10MX, VE20MX, VG06MX, VG102MX, VG10MX, VG20EC, VG20MX | | |
| accessories for | 401167 | | |
|  | GEV No. | 401062 | Ref. No. 6010090 |
| | buzzer board 230VAC L 48mm W 45mm connection Faston 6.3mm | | |

solenoid valves (water)

RPE



1

| | | | |
|--------------------|--|-----------------|---------|
| GEV No. | 374021 | Ref. No. | 6042071 |
| description | solenoid valve double straight 230VAC inlet 3/4" outlet 10mm DN10 RPE | | |
| For models: | CE20MX, CG20MX, VE06EC, VE06MX, VE102EC, VE102MX, VE10EC, VE10MX, VE20EC, VE20MX, VG06EC, VG06MX, VG102EC, VG102MX, VG10EC, VG10MX, VG20EC, VG20MX | | |



1

| | | | |
|--------------------|---|-----------------|---------|
| GEV No. | 374017 | Ref. No. | 6042070 |
| description | solenoid valve single straight 230VAC inlet 3/4" outlet 10mm input 6l/min DN10 RPE polyamide flow regulating valve inlet white membranes NBR pressure range 0.2-10bar | | |
| For models: | CE06MX, CE102MX, CE10MX, CG06MX, CG102MX, CG10MX, DE06EC, DE06ES, DE06MX, DE102EC, DE102MX, DE10EC, DE10ES, DE10MX, DG06EC, DG06ES, DG06MX, DG102EC, DG102MX, DG10EC, DG10ES, DG10MX, EF10GM, EF4, EF4PM, EF5GM, EF6PM, EF7GM, EF8PM, GF10GM, GF4PM, GF5GM, GF6PM, GF7GM, GF8PM | | |



1

| | | | |
|--------------------|---|-----------------|---------|
| GEV No. | 374025 | Ref. No. | 6042080 |
| description | solenoid valve triple straight 230VAC inlet 3/4" outlet 10mm DN10 RPE | | |

reducers

outlet side



1

| | | | |
|--------------------|--|-----------------|---------|
| GEV No. | 371269 | Ref. No. | 6042091 |
| description | reducer flow rate 0.07-0.14l/min brown | | |



1

| | | | |
|--------------------|--|-----------------|---------|
| GEV No. | 371265 | Ref. No. | 6042097 |
| description | reducer flow rate 3l/min black | | |
| For models: | VE06EC, VE06MX, VE102EC, VE102MX, VE10EC, VE10MX, VE20EC, VE20MX, VG06EC, VG06MX, VG102EC, VG102MX, VG10EC, VG10MX, VG20EC, VG20MX | | |

Зип.Общепит
pressure switches

for gas equipment
vsezip.ru

+7(812)987-08-81

various



| | | | |
|--------------------|---|-----------------|---------|
| 1 | | | |
| GEV No. | 371264 | Ref. No. | 6042095 |
| description | reducer flow rate 0.25l/min | | |
| For models: | CE06MX, CE102MX, CE10MX, CE20MX, CG06MX, CG102MX, CG10MX, CG20MX, EF4, VE06EC, VE06MX, VE102EC, VE102MX, VE10EC, VE10MX, VE20EC, VE20MX, VG06EC, VG06MX, VG102EC, VG102MX, VG10EC, VG10MX, VG20EC, VG20MX | | |

metal

CEME

solenoid valves



| | | | |
|--------------------|--|-----------------|---------|
| 1 | | | |
| GEV No. | 370352 | Ref. No. | 6042075 |
| description | solenoid valve 2-ways 230VAC inlet 1/2" IT outlet 1/2" IT L 55mm p max 0.5bar brass | | |
| For models: | VE06EC, VE06MX, VE102EC, VE102MX, VE10EC, VE10MX, VE20EC, VE20MX, VG06EC, VG06MX, VG102EC, VG102MX, VG10EC, VG10MX, VG20EC, VG20MX | | |

| | | | |
|--------------------|---|-----------------|---------|
| 1 | | | |
| GEV No. | 541073 | Ref. No. | 7050012 |
| description | pressure control ø 45mm pressure range adjustable 5-20mbar pressure connection vertical gas technology connection 1/4" pressure connection ø 1/4"mm | | |

for combi-steamers



| | | | |
|---|---|-----------------|---------|
| 1 | | | |
| GEV No. | 541806 | Ref. No. | 7050008 |
| description | pressure control ø 38mm pressure range 0.2-3.0bar connection 1/8" 250V 10A GP600 pressure connection 1/8" | | |
| accessories for | 541806 | | |
| | GEV No. | Ref. No. | — |
|  | protection cap for pressure switch EPDM XP600 | | |

ball valves electric



| | | | |
|--------------------|--|-----------------|---------|
| 1 | | | |
| GEV No. | 401139 | Ref. No. | 6042073 |
| description | ball valve inlet 3/4" IT outlet 3/4" IT with plug 230V L 65mm 50/60Hz closed off-current mode of operation electric connection cable 200mm | | |

electrodes



| | | | |
|--------------------|--|-----------------|---------|
| 1 | | | |
| GEV No. | 401161 | Ref. No. | 6000089 |
| description | level electrode 1/4" total length 210mm probe L 184mm insulated probe length 26mm connection male faston 6.3mm stainless steel ø 2.5mm | | |

fans

axial fans

ebm-papst



1

| | | | |
|------------------------|--|-----------------|-------------------|
| GEV No. | 601030 ¹ | Ref. No. | 6033175 |
| description | axial fan L 119mm W 119mm H 38mm 230VAC 50Hz 18W bearing ball bearing manif. no. 4656Z metal connection male faston 2.8mm ebm-papst fan wheel ø 110mm temp.-resist. 75°C | | |
| accessories for | 601030 | | |
| | GEV No. | 550898 | Ref. No. — |
| | connecting cable cable length 2000mm connection F 2.8 connection distance 7.9mm for axial flow fan | | |
| | GEV No. | 692497 | Ref. No. — |
| | guard ø 105mm mounting distance 150mm for axial fan ebm-papst-mm | | |

¹with ball bearings



1

| | | | |
|------------------------|--|-----------------|-------------------|
| GEV No. | 601633 ¹ | Ref. No. | 6033172 |
| description | axial fan L 92mm W 92mm H 38mm 230VAC 50Hz 12W bearing ball bearing manif. no. 3656 connection cable 310mm ebm-papst | | |
| accessories for | 601633 | | |
| | GEV No. | 691103 | Ref. No. — |
| | guard ø 90mm mounting distance 83mm for axial fan 92mm | | |

¹with ball bearings

Зип Общежит
hot air motors

vsezip.ru

+7(812)987-08-81

1

| | | | |
|--------------------|--|-----------------|-------------------------------|
| GEV No. | 602014 | Ref. No. | 2017945 6032115 6033153 |
| description | fan motor 208-240V 1 phase 50/60Hz 0.19-0.26/0.34-0.35kW 2800/3450rpm speeds 2 L1 98mm L2 33mm D1 ø 8mm M5 1-1.2/1.7-1.5A type MFA80 | | |

1

| | | | |
|--------------------|---|-----------------|---------|
| GEV No. | 500641 | Ref. No. | 6033155 |
| description | fan motor 220/380V 3 phase 50Hz 0.75kW 1420rpm speeds 1 L1 166mm L2 47mm L3 65mm D1 ø 24mm D2 ø 20mm M6R IT 1.4/2.4A Cos(φ) 0.83 at 50Hz 220/380V at 60Hz 240/415V type ST80/4 no. 643515 mounting distance 150mm | | |

1

| | | | |
|------------------------|---|-----------------|-------------------|
| GEV No. | 500640 | Ref. No. | 6032122 |
| description | fan motor 220-240V 1 phase 50Hz 0.05/0.25HP 1400/2700rpm speeds 2 L1 145mm L2 65mm L3 35mm D1 ø 15mm D2 ø 12mm M10L ET 1.1/0.55A suitable capacitor 12.5µF/450V at 50Hz 1400/2700rpm type 2758D2253 no. 6032122 | | |
| For models: | CE06MX, CG06MX, DE06EC, DE06ES, DE06MX, DG06EC, DG06ES, DG06MX, VE06EC, VE06MX, VG06EC, VG06MX | | |
| spare parts for | 500640 | | |
| | GEV No. | 560280 | Ref. No. — |
| | nut thread M10L H 8mm WS 17 SS DIN/ISO DIN 934 / ISO 4032/8673 Qty 1 pcs | | |

Зип Общепит

vsezip.ru

+7(812)987-08-81

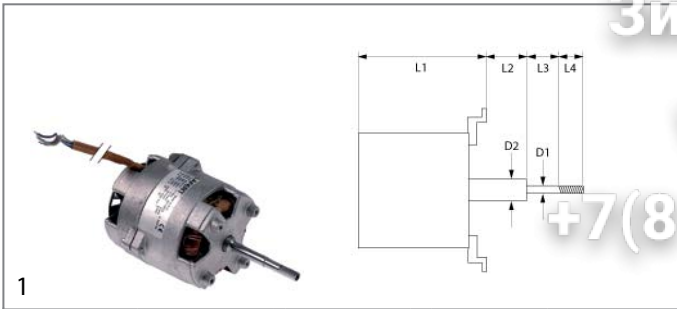

| | | | |
|------------------------|---|-----------------|---------|
| GEV No. | 601354 | Ref. No. | 6032128 |
| description | fan motor 220-240V 1 phase 50Hz 0.11kW 2760rpm speeds 1 L1 130mm L2 32mm L3 30mm L4 18mm D1 \varnothing 7/8mm D2 \varnothing 9mm M4R IT 0.9A at 50Hz 230V at 50Hz 2760rpm suitable capacitor 4 μ F type LM63 shaft flat length 17mm | | |
| accessories for | 601354 | | |
| GEV No. | 365031 | Ref. No. | — |
| description | operating capacitor capacity 4 μ F 450V tolerance 5% 50/60Hz ambient temperature max. -25 to +85°C \varnothing 31mm L 58mm M8 plastic connection male faston 6.3mm protection | | |
| GEV No. | 601061 | Ref. No. | — |
| description | fan wheel D1 \varnothing 160mm H1 60mm blades 15 D2 \varnothing 18mm D3 \varnothing 18mm H2 35mm | | |

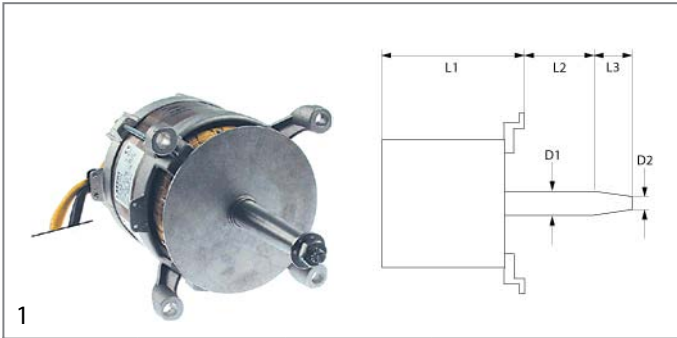

| | | | |
|--------------------|---|-----------------|---------|
| GEV No. | 500643 | Ref. No. | 6034348 |
| description | fan motor 230V 1 phase 50Hz 0.25/0.75kW 670/1370rpm speeds 2 L1 195mm L2 47mm L3 70mm D1 \varnothing 24mm D2 \varnothing 20mm M6R IT 1.5/4.7A suitable capacitor 50/20 μ F Cos(phi) 0.53/0.7 at 50Hz 670/1370rpm 4P/8P type FB100L no. 677325 | | |
| For models: | CE102MX, CE20MX, CG102MX, CG20MX, DE102EC, DE102MX, DG102EC, DG102MX, VE102EC, VE102MX, VE20EC, VE20MX, VG102EC, VG102MX, VG20EC, VG20MX | | |

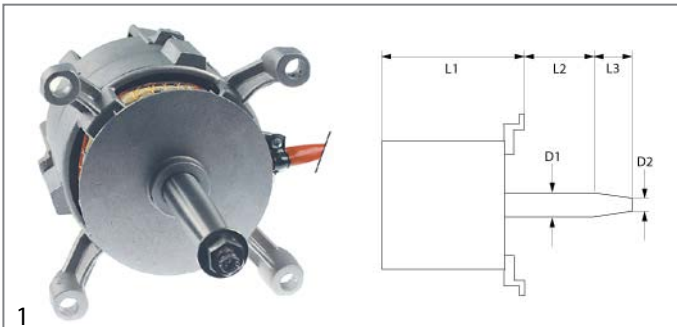

| | | | |
|--------------------|---|-----------------|---------|
| GEV No. | 500642 | Ref. No. | 6033145 |
| description | fan motor 380-415V 3 phase 50Hz 0.22/0.75kW 700/1400rpm speeds 2 L1 166mm L2 45mm L3 67mm D1 \varnothing 24mm D2 \varnothing 20mm M6R ITA at 50Hz 380-415V at 50Hz 700/1400rpm type FB80 4/8 no. 629764 | | |
| For models: | DE102EC, DE10EC, DG102EC, EF6PM, EF8PM, VE10EC, VE20EC, VG20EC | | |



| | | | |
|--------------------|--|-----------------|---------|
| GEV No. | 602135 | Ref. No. | 5901101 |
| description | fan wheel blades 12 D1 \varnothing 180mm D2 \varnothing 8mm D3 \varnothing 6x9mm H1 100mm H2 27mm H3mm | | |



| | | | |
|--------------------|---|-----------------|---------|
| GEV No. | 601202 | Ref. No. | 5901006 |
| description | fan wheel D1 \varnothing 180mm H1 100mm blades 16 D2 \varnothing 11.5mm D3 \varnothing 16mm H2 30mm | | |
| For models: | CE06MX, CG06MX, DE06EC, DE06ES, DE06MX, DG06EC, DG06ES, DG06MX, VE06EC, VE06MX, VG06EC, VG06MX | | |



| | | | |
|--------------------|--|-----------------|---------|
| GEV No. | 601060 | Ref. No. | 5900896 |
| description | fan wheel D1 \varnothing 180mm H1 60mm blades 16 D2 \varnothing 11mm D3 \varnothing 16mm H2 30mm | | |



| | | | |
|--------------------|--|-----------------|---------|
| GEV No. | 601246 | Ref. No. | 5901003 |
| description | fan wheel D1 \varnothing 180mm H1 77mm blades 12 D2 \varnothing 8mm D3 \varnothing 6mm H2 25.5mm | | |



Зип Обществит

vsezip.ru

+7(812)987-08-81



1

| | | | |
|--------------------|--|-----------------|---------|
| GEV No. | 601203 | Ref. No. | 5901010 |
| description | fan wheel D1 ø 310mm H1 100mm blades 30 D2 ø 19.5mm D3 ø 23mm H2 46mm | | |
| For models: | CE10MX, CG10MX, DE10EC, DE10ES, DE10MX, DG10EC, DG10ES, DG10MX, VE10EC, VE10MX, VG10EC, VG10MX | | |



1

| | | | |
|--------------------|---|-----------------|---------|
| GEV No. | 601204 | Ref. No. | 5901022 |
| description | fan wheel D1 ø 350mm H1 135mm blades 30 D2 ø 19.5mm D3 ø 23mm H2 46mm | | |
| For models: | CE102MX, DE102EC, VE102EC, VE102MX | | |

pumps

booster pumps II

accessories



1

| | | | |
|--------------------|--|-----------------|---------|
| GEV No. | 365017 | Ref. No. | 6090015 |
| description | operating capacitor capacity 5µF 450V tolerance 5% 50/60Hz ambient temperature max. -25 to +85°C ø 28mm L 54mm M8 plastic connection male faston 6.3mm 16.10.08 protection | | |

condensators & interference sup-
pression filters

operating capacitors

plastic



1

| | | | |
|--------------------|--|-----------------|---------|
| GEV No. | 365017 | Ref. No. | 6090015 |
| description | operating capacitor capacity 5µF 450V tolerance 5% 50/60Hz ambient temperature max. -25 to +85°C ø 28mm L 54mm M8 plastic connection male faston 6.3mm 16.10.08 protection | | |

filters

interference suppression filters



1

| | | | |
|--------------------|--|-----------------|---------|
| GEV No. | 365044 | Ref. No. | 6090050 |
| description | interference suppression filter type FC701Y2F 250V 50-60Hz conductor 2 with E connection cable 200mm L 42mm ø 23mm Hmm Wmm plastic Qty 1 pcs | | |

gas valves and ignition boxes

gas control valves

SIT

ELETTROSIT



1



| | | | |
|---|---|-----------------|-------------------------|
| GEV No. | 101126 | Ref. No. | 7020060 |
| description | gas valve SIT type ELETTROSIT 230V gas inlet 1/2" gas outlet 1/2" thermocouple connection M9x1 pilot connection M10x1 bottom equiv. no. 0.810.136 | | |
| spare parts for | 101126 | | |
|  | GEV No. | 101312 | Ref. No. 6010054 |
| | microswitch | | |
|  | GEV No. | 101352 | Ref. No. — |
| | solenoid coil 230V 50Hz suitable for ELETTROSIT | | |

Table continues overleaf







1 electric components



Зип-Общепит







vsezi.ru





+7(812)987-08-81

| accessories for 101126 | | | |
|---|---------|--------|------------------|
|  | GEV No. | 100006 | Ref. No. — |
| piezoelectric igniter suitable for ELETTROSIT body plastic blowing connection ø2.4mm ø 14mm | | | |
|  | GEV No. | 100904 | Ref. No. — |
| locking screw M10x1 for pipe ø 4mm Qty 1 pcs | | | |
|  | GEV No. | 100905 | Ref. No. 70500z0 |
| locking screw M10x1 for pipe ø 6mm Qty 1 pcs | | | |
|  | GEV No. | 101301 | Ref. No. — |
| gas connection thread 1/2" straight ELETTROSIT screw with O-ring | | | |
|  | GEV No. | 101303 | Ref. No. — |
| gas connection straight thread 3/4" ELETTROSIT | | | |
|  | GEV No. | 101309 | Ref. No. — |
| extension | | | |



NOVASIT





| | | | |
|---|---|----------|------------------|
| 1 |  | | |
| GEV No. | 101956 | Ref. No. | 7020070 |
| description | gas valve SIT series Novasit 820 230V 50Hz gas inlet 1/2" gas outlet 1/2" thermocouple connection M9x1 pilot connection M10x1 ignition pressurebar pressure range 5-50mbar pressure regulator connection blind equiv. no. 0.820.031 | | |
| For models: | 13FG, 13FGC, 17FG, 17FGC, 207FG, 207FGC, 213FG, 213FGC, 217FG, 217FGC, 917FG, 917FGC, 927FG, 927FGC, 934FG, 934FGC, FG07CL, FG213CL | | |
| spare parts for | 101956 | | |
|  | GEV No. | 101065 | Ref. No. — |
| magnet unit with cable L 44mm D1 ø 30mm D2 ø 20mm suitable for NOVASIT | | | |
|  | GEV No. | 101313 | Ref. No. — |
| solenoid coil 230V 50Hz | | | |
| accessories for 101956 | | | |
|  | GEV No. | 100006 | Ref. No. — |
| piezoelectric igniter suitable for ELETTROSIT body plastic blowing connection ø2.4mm ø 14mm | | | |
|  | GEV No. | 101305 | Ref. No. — |
| gas connection straight 1/2" flange 45x45mm ELETTROSIT/V4400/4600/4605 suitable for SIT/HONEYWELL hole distance 36x36mm | | | |
|  | GEV No. | 101306 | Ref. No. 7020011 |
| gas connection angled flange 45x45mm hole distance 36x36mm 1/2" ELETTROSIT/V4400/4600/4605 screw with O-ring suitable for SIT/HONEYWELL | | | |
|  | GEV No. | 101307 | Ref. No. — |
| gas connection straight flange 45x45mm hole distance 36x36mm 3/4" ELETTROSIT/V4400/4600/4605 screw with O-ring suitable for SIT/HONEYWELL | | | |

| accessories for 101956 | | | |
|---|---------|--------|------------------|
|  | GEV No. | 101308 | Ref. No. — |
| gas connection angled flange 45x45mm hole distance 36x36mm 3/4" ELETTROSIT/V4400/4600/4605 screw with O-ring suitable for SIT/HONEYWELL | | | |
|  | GEV No. | 101312 | Ref. No. 6010054 |
| microswitch | | | |
|  | GEV No. | 101314 | Ref. No. — |
| solenoid coil 24V 50Hz | | | |
|  | GEV No. | 101317 | Ref. No. — |
| plug with cable L 1000mm suitable for NOVASIT | | | |
|  | GEV No. | 101318 | Ref. No. — |
| cover cap for solenoid coil suitable for NOVASIT | | | |

accessories

| | | | |
|---|---|----------|------------|
| 1 |  | | |
| GEV No. | 101306 | Ref. No. | 7020011 |
| description | gas connection angled flange 45x45mm hole distance 36x36mm 1/2" ELETTROSIT/V4400/4600/4605 screw with O-ring suitable for SIT/HONEYWELL | | |
| spare parts for | 101306 | | |
|  | GEV No. | 517104 | Ref. No. — |
| O-ring EPDM thickness 2.62mm ID ø 31.42mm Qty 1 pcs | | | |

| | | | |
|-------------|---|----------|---------|
| 1 |  | | |
| GEV No. | 100905 | Ref. No. | 7050020 |
| description | locking screw M10x1 for pipe ø 6mm Qty 1 pcs | | |

| | | | |
|-------------|--|----------|---------|
| 1 |  | | |
| GEV No. | 101312 | Ref. No. | 6010054 |
| description | microswitch | | |



Зип-Общепит
ignition boxes

vsezip.ru

+7(812)987-08-81

TANDEM



1

| | | | |
|---|--|-----------------|-------------------------|
| GEV No. | 101881 | Ref. No. | 7020080 |
| description | gas valve 230V 50Hz gas inlet 1/2" gas outlet 1/2" pilot connection level slow ignition ignition times pressure range 3-50mbar power supply for modulator equiv. no. 0.830.041 suitable for Tandem | | |
| For models: | CG06MX, CG102MX, CG10MX, CG20MX, DG06EC, DG06ES, DG06MX, DG102EC, DG102MX, DG10EC, DG10ES, DG10MX, GF10GM, GF4PM, GF5GM, GF6PM, GF7GM, GF8PM, VG06EC, VG06MX, VG102EC, VG102MX, VG10EC, VG10MX, VG20EC, VG20MX | | |
| spare parts for | 101881 | | |
|  | GEV No. | 101379 | Ref. No. — |
| | solenoid coil 230V 50Hz suitable for Tandem | | |
| accessories for | 101881 | | |
|  | GEV No. | 101274 | Ref. No. 7070036 |
| | olive for pipe ø 16mm Qty 1 pcs | | |
|  | GEV No. | 101275 | Ref. No. — |
| | union screw thread 1/2" for pipe ø 16mm Qty 1 pcs | | |
|  | GEV No. | 101925 | Ref. No. — |
| | plug with O-ring thread M10x1 for pilot burner suitable for NOVASIT | | |
|  | GEV No. | 102845 | Ref. No. — |
| | gas connection angled 1/2" flange 32x32mm hole distance 24x24mm Tandem | | |
|  | GEV No. | 102846 | Ref. No. — |
| | gas connection straight 1/2" flange 32x32mm hole distance 24x24mm suitable for Tandem | | |
|  | GEV No. | 102847 | Ref. No. — |
| | O-ring | | |

SIT



1

| | | | |
|--------------------|--|-----------------|---------|
| GEV No. | 101685 | Ref. No. | 7020085 |
| description | ignition box SIT type 503EFD electrodes 2 waiting time 1.5s safety time 10s 220/240V 10VA 50-60Hz protection IP40 | | |
| For models: | CG06MX, CG102MX, CG10MX, CG20MX, DG06EC, DG06ES, DG06MX, DG102EC, DG102MX, DG10EC, DG10ES, DG10MX, GF10GM, GF4PM, GF5GM, GF6PM, GF7GM, GF8PM, VG06EC, VG06MX, VG102EC, VG102MX, VG10EC, VG10MX, VG20EC, VG20MX | | |



1

| | | | |
|--------------------|---|-----------------|---------|
| GEV No. | 107837 | Ref. No. | 7020206 |
| description | ignition box SIT type 579DBC for combi-steamer suitable for GIORIK equiv. no. 0.579.418 electrodes 2 waiting time 1.5s safety time 5s 220/240V 12VA 50/60Hz | | |

miscellaneous



1

| | | | |
|--------------------|---|-----------------|---------|
| GEV No. | 401171 | Ref. No. | 6010084 |
| description | ignition box | | |
| For models: | CE06MX, CE102MX, CE10MX, CE20MX, CG06MX, CG102MX, CG10MX, CG20MX, DE06EC, DE06ES, DE06MX, DE102EC, DE102MX, DE10EC, DE10ES, DE10MX, DG06EC, DG06ES, DG06MX, DG102EC, DG102MX, DG10EC, DG10ES, DG10MX, EF4, EF4PM, EF6PM, EF8PM, GF4PM, GF6PM, GF8PM, VE06EC, VE06MX, VE102EC, VE102MX, VE10EC, VE10MX, VE20EC, VE20MX, VG06EC, VG06MX, VG102EC, VG102MX, VG10EC, VG10MX, VG20EC, VG20MX | | |

2 gas components

ignition parts

pilot burners

SIT

100 series



| | | | |
|------------------------|---|-----------------|-----------------------------|
| GEV No. | 106906 | Ref. No. | 7090022 |
| description | pilot burner SIT type 100 series 3 flames nozzle ø 0.2mm gas connection 6mm | | |
| For models: | FG07CL, FG07L, FG13L, FG213CL, FG213L, SG608 | | |
| spare parts for | 106906 | | |
| | GEV No. | 100245 | Ref. No. 7042005 |
| | pilot burner nozzle LPG code 20 bore ø 0.2mm Qty 1 pcs thread M8x0.75 | | |
| | GEV No. | 100855 | Ref. No. — |
| | pilot burner bracket triple | | |
| | GEV No. | 100885 | Ref. No. 7070014 7090007 |
| | air mixing sleeve for pilot burner Qty 1 pcs | | |
| | GEV No. | 100916 | Ref. No. — |
| | compression spring for pilot burner Qty 1 pcs | | |
| | GEV No. | 100917 | Ref. No. — |
| | gasket for pilot burner Qty 1 pcs aluminium | | |
| | GEV No. | 100918 | Ref. No. — |
| | screw for pilot burner | | |
| | GEV No. | 107162 | Ref. No. 7090002 |
| | pilot burner cap SIT 3 flames Hmm Lmm Qty 1 pcs | | |
| | GEV No. | 107701 | Ref. No. — |
| | pilot burner bottom part SIT 100 series nozzle ø 0.2mm | | |
| accessories for | 106906 | | |
| | GEV No. | 100245 | Ref. No. 7042005 |
| | pilot burner nozzle LPG code 20 bore ø 0.2mm Qty 1 pcs thread M8x0.75 | | |
| | GEV No. | 100246 | Ref. No. 7042006 |
| | pilot burner nozzle natural gas bore ø 0.35mm Qty 1 pcs thread M8x0.75 | | |
| | GEV No. | 100904 | Ref. No. — |
| | locking screw M10x1 for pipe ø 4mm Qty 1 pcs | | |
| | GEV No. | 100905 | Ref. No. 7050020 |
| | locking screw M10x1 for pipe ø 6mm Qty 1 pcs | | |
| | GEV No. | 102110 | Ref. No. — |
| | pilot tube copper pipe ø 4mm thickness 1mm L 3000mm | | |
| | GEV No. | 102111 | Ref. No. — |
| | pilot tube copper pipe ø 6mm thickness 1mm L 3000mm | | |

| | | | | |
|--|--|--------|----------|---|
| | GEV No. | 107171 | Ref. No. | — |
| | pilot burner nozzle SIT natural/liquid gas bore ø 0.25mm Qty 1 pcs | | | |
| | GEV No. | 107700 | Ref. No. | — |
| | pilot burner bottom part SIT 100 series nozzle ø 0.25mm | | | |
| | GEV No. | 107702 | Ref. No. | — |
| | pilot burner bottom part SIT 100 series nozzle ø 0.35mm | | | |

| | | | | |
|------------------------|--|--|-----------------|--------------------|
| | GEV No. | 106907 | Ref. No. | 7090023 |
| | description | pilot burner SIT type 100 series 3 flames nozzle ø 0.35mm gas connection 6mm | | |
| | For models: | 13FG, 13FGC, 17FG, 17FGC, 207FG, 207FGC, 213FG, 213FGC, 217FG, 217FGC, 917FG, 917FGC, 927FG, 927FGC, 934FG, 934FGC | | |
| | spare parts for | 106907 | | |
| | GEV No. | 100246 | Ref. No. | 7042006 |
| | pilot burner nozzle natural gas bore ø 0.35mm Qty 1 pcs thread M8x0.75 | | | |
| | GEV No. | 100855 | Ref. No. | — |
| | pilot burner bracket triple | | | |
| | GEV No. | 100885 | Ref. No. | 7070014 7090007 |
| | air mixing sleeve for pilot burner Qty 1 pcs | | | |
| | GEV No. | 100916 | Ref. No. | — |
| | compression spring for pilot burner Qty 1 pcs | | | |
| | GEV No. | 100917 | Ref. No. | — |
| | gasket for pilot burner Qty 1 pcs aluminium | | | |
| | GEV No. | 100918 | Ref. No. | — |
| | screw for pilot burner | | | |
| | GEV No. | 107162 | Ref. No. | 7090002 |
| | pilot burner cap SIT 3 flames Hmm Lmm Qty 1 pcs | | | |
| | GEV No. | 107702 | Ref. No. | — |
| | pilot burner bottom part SIT 100 series nozzle ø 0.35mm | | | |
| accessories for | 106907 | | | |
| | GEV No. | 100245 | Ref. No. | 7042005 |
| | pilot burner nozzle LPG code 20 bore ø 0.2mm Qty 1 pcs thread M8x0.75 | | | |
| | GEV No. | 100904 | Ref. No. | — |
| | locking screw M10x1 for pipe ø 4mm Qty 1 pcs | | | |
| | GEV No. | 100905 | Ref. No. | 7050020 |
| | locking screw M10x1 for pipe ø 6mm Qty 1 pcs | | | |
| | GEV No. | 102110 | Ref. No. | — |
| | pilot tube copper pipe ø 4mm thickness 1mm L 3000mm | | | |

Table continues overleaf





gas components





Зип-Общепит

vsezip.ru

+7(812)987-08-81

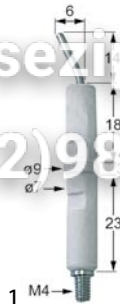
| accessories for | | 106907 | | |
|---|--|--------|----------|---|
|  | GEV No. | 102111 | Ref. No. | — |
| | pilot tube copper pipe \varnothing 6mm thickness 1mm L 3000mm | | | |
|  | GEV No. | 107171 | Ref. No. | — |
| | pilot burner nozzle SIT natural/liquid gas bore \varnothing 0.25mm Qty 1 pcs | | | |
|  | GEV No. | 107700 | Ref. No. | — |
| | pilot burner bottom part SIT 100 series nozzle \varnothing 0.25mm | | | |
|  | GEV No. | 107701 | Ref. No. | — |
| | pilot burner bottom part SIT 100 series nozzle \varnothing 0.2mm | | | |



| accessories for | | 100706 | Ref. No. | 6010046 |
|---|--|--|----------|---------|
|  | description | ignition electrode connection M4 Qty 1 pcs | | |
| For models: | 13FG, 13FGC, 17FG, 17FGC, 207FG, 207FGC, 213FG, 213FGC, 217FG, 217FGC, 917FG, 917FGC, 927FG, 927FGC, 934FG, 934FGC, FG07CL, FG07L, FG13L, FG213CL, FG213L, SG608 | | | |

| accessories | | | | |
|---|-------------|---|----------|---------|
| pilot burner caps | | | | |
|  | | | | |
| 1 | GEV No. | 107162 | Ref. No. | 7090002 |
| | description | pilot burner cap SIT 3 flames Hmm Lmm Qty 1 pcs | | |

| miscellaneous | | | | |
|---|-------------|--|----------|--------------------|
|  | | | | |
| 1 | GEV No. | 100885 | Ref. No. | 7070014 7090007 |
| | description | air mixing sleeve for pilot burner Qty 1 pcs | | |

| pilot burner brackets | | | | |
|---|-------------|-----------------------------|----------|---------|
| universal | | | | |
|  | | | | |
| 1 | GEV No. | 100888 | Ref. No. | 7090006 |
| | description | screw bolt for pilot burner | | |

| 140 - 145 - 150 series | | | | |
|--|--|--|----------|---------|
|  | | | | |
| 1 | GEV No. | 107114 ¹ | Ref. No. | 7090028 |
| | description | pilot burner SIT type 140 series 2 flames nozzle \varnothing mm gas connectionmm | | |
| For models: | CG740, CG780, GG940, GG980 | | | |
| spare parts for | 107114 | | | |
|  | GEV No. | 100907 | Ref. No. | 5900318 |
| | screw connection thread M10x1 Qty 1 pcs type SEF 1 \varnothing mm for thermocouple | | | |
| accessories for | 107114 | | | |
|  | GEV No. | 100204 | Ref. No. | 7042014 |
| | pilot burner nozzle SIT LPG code 14 bore \varnothing 0.18/0.20mm Qty 1 pcs suitable for 140 series | | | |
|  | GEV No. | 100205 | Ref. No. | — |
| | pilot burner nozzle SIT LPG code 19 bore \varnothing 0.23/0.26mm Qty 1 pcs suitable for SIT 150 series | | | |
|  | GEV No. | 100206 | Ref. No. | — |
| | pilot burner nozzle SIT natural gas code 36 bore \varnothing 0.60/0.55mm Qty 1 pcs suitable for SIT 150 series | | | |
|  | GEV No. | 100207 | Ref. No. | 7042013 |
| | pilot burner nozzle SIT natural gas code 27 bore \varnothing 0.40/0.38mm suitable for SIT 140 series | | | |
|  | GEV No. | 100216 | Ref. No. | — |
| | pilot burner nozzle SIT natural gas code 38 bore \varnothing 0.45mm Qty 1 pcs suitable for SIT 150 series | | | |
|  | GEV No. | 100701 | Ref. No. | 6010087 |
| | ignition electrode connection M4 Qty 1 pcs | | | |

| pilot burner nozzles | | | | |
|---|-------------|--|----------|---------|
|  | | | | |
| 1 | GEV No. | 100245 | Ref. No. | 7042005 |
| | description | pilot burner nozzle LPG code 20 bore \varnothing 0.2mm Qty 1 pcs thread M8x0.75 | | |
|  | | | | |
| 1 | GEV No. | 100246 | Ref. No. | 7042006 |
| | description | pilot burner nozzle natural gas bore \varnothing 0.35mm Qty 1 pcs thread M8x0.75 | | |

¹incl. thermocouple fitting
Table continues overleaf

Зип-Общепит

vsezip.ru







+7(812)987-08-81

gas components

| accessories for | | 107114 | |
|---|---------|--------|-----------------------------|
|  | GEV No. | 100801 | Ref. No. — |
| gasket for pilot burner Qty 1 pcs | | | |
|  | GEV No. | 100897 | Ref. No. — |
| olive for pipe ø 4mm Qty 1 pcs for pilot burner | | | |
|  | GEV No. | 100898 | Ref. No. 7070045 |
| olive for pipe ø 6mm Qty 1 pcs for pilot burner | | | |
|  | GEV No. | 100906 | Ref. No. 5900317 7050028 |
| screw connection thread M10x1 for ignition electrode brass Qty 1 pcs WS 10 | | | |
|  | GEV No. | 100908 | Ref. No. — |
| union screw thread M10x1 for pipe ø 4mm Qty 1 pcs | | | |
|  | GEV No. | 100909 | Ref. No. 7050029 |
| union screw thread M10x1 for pipe ø 6mm Qty 1 pcs | | | |
|  | GEV No. | 102110 | Ref. No. — |
| pilot tube copper pipe ø 4mm thickness 1mm L 3000mm | | | |
|  | GEV No. | 102111 | Ref. No. — |
| pilot tube copper pipe ø 6mm thickness 1mm L 3000mm | | | |

POLIDORO
pilot burners



| | | | |
|---|---|-----------------|-----------------------------|
| GEV No. | 100051 | Ref. No. | 7090026 |
| description | pilot burner POLIDORO 3 flames code gas connectionmm | | |
| For models: | 22CPG, 23CPG, 2CPG, 3CPG, CPG1, CPG1BM, CPG66, FTG100, FTG46, FTG46B, FTG46R, FTG66L, FTG66LG, FTG66R, GG66 | | |
| spare parts for | 100051 | | |
|  | GEV No. | 100907 | Ref. No. 5900318 |
| screw connection thread M10x1 Qty 1 pcs type SEF 1 0mm for thermocouple | | | |
| accessories for | 100051 | | |
|  | GEV No. | 100000 | Ref. No. — |
| pilot burner nozzle POLIDORO LPG code 22 bore ø 0.22mm Qty 1 pcs | | | |
|  | GEV No. | 100208 | Ref. No. — |
| pilot burner nozzle POLIDORO LPG code 20 bore ø 0.2mm Qty 1 pcs | | | |
|  | GEV No. | 100209 | Ref. No. — |
| pilot burner nozzle POLIDORO natural gas code 40 bore ø 0.4mm Qty 1 pcs | | | |
|  | GEV No. | 100701 | Ref. No. 6010087 |
| ignition electrode connection M4 Qty 1 pcs | | | |
|  | GEV No. | 100906 | Ref. No. 5900317 7050028 |
| screw connection thread M10x1 for ignition electrode brass Qty 1 pcs WS 10 | | | |

| accessories for | | 100051 | |
|--|---------|--------|------------------|
|  | GEV No. | 100907 | Ref. No. 5900318 |
| screw connection thread M10x1 Qty 1 pcs type SEF 1 0mm for thermocouple | | | |
|  | GEV No. | 100908 | Ref. No. — |
| union screw thread M10x1 for pipe ø 4mm Qty 1 pcs | | | |
|  | GEV No. | 100909 | Ref. No. 7050029 |
| union screw thread M10x1 for pipe ø 6mm Qty 1 pcs | | | |
|  | GEV No. | 102110 | Ref. No. — |
| pilot tube copper pipe ø 4mm thickness 1mm L 3000mm | | | |
|  | GEV No. | 102111 | Ref. No. — |
| pilot tube copper pipe ø 6mm thickness 1mm L 3000mm | | | |
|  | GEV No. | 102508 | Ref. No. — |
| union screw thread M10x1 for pipe ø 4mm Qty 5 pcs | | | |
|  | GEV No. | 102509 | Ref. No. — |
| union screw thread M10x1 for pipe ø 6mm Qty 5 pcs | | | |
|  | GEV No. | 102699 | Ref. No. — |
| pilot burner nozzle POLIDORO natural gas code 25.2 bore ø 2x0.25mm Qty 1 pcs 2 bores | | | |
|  | GEV No. | 102795 | Ref. No. — |
| olive for pipe ø 4mm Qty 1 pcs | | | |
|  | GEV No. | 102797 | Ref. No. — |
| olive for pipe ø 6mm Qty 1 pcs | | | |
|  | GEV No. | 106703 | Ref. No. 7042008 |
| pilot burner nozzle POLIDORO natural gas code 27.2 bore ø 2x0.27mm Qty 1 pcs | | | |
|  | GEV No. | 106704 | Ref. No. — |
| pilot burner nozzle POLIDORO LPG code 16.2 bore ø 2x0.16mm Qty 1 pcs | | | |
|  | GEV No. | 106763 | Ref. No. — |
| pilot burner nozzle POLIDORO natural gas code 27.2A bore ø 2x 0.27mm Qty 1 pcs | | | |
|  | GEV No. | 106859 | Ref. No. — |
| pilot burner nozzle POLIDORO LPG code 24 bore ø 0.24mm Qty 1 pcs | | | |



| | | | | |
|--|----------------|--------|-----------------|---------|
|  | GEV No. | 100076 | Ref. No. | 7090024 |
| description pilot burner POLIDORO 3 flames natural gas code 29.2 gas connection 6mm | | | | |
| spare parts for 100076 | | | | |
|  | GEV No. | 100907 | Ref. No. | 5900318 |
| screw connection thread M10x1 Qty 1 pcs type SEF 1 0mm for thermocouple | | | | |
| accessories for 100076 | | | | |
|  | GEV No. | 100000 | Ref. No. | — |
| pilot burner nozzle POLIDORO LPG code 22 bore ø 0.22mm Qty 1 pcs | | | | |

Table continues overleaf





















Зип Общежит

electrodes

vsezip.ru

+7(812)987-08-81

| accessories for | | 100076 | |
|--|--------|--------------------|--|
| GEV No. | | Ref. No. | |
|  | 100208 | — | |
| pilot burner nozzle POLIDORO LPG code 20 bore \varnothing 0.2mm Qty 1 pcs | | | |
|  | 100209 | — | |
| pilot burner nozzle POLIDORO natural gas code 40 bore \varnothing 0.4mm Qty 1 pcs | | | |
|  | 100701 | 6010087 | |
| ignition electrode connection M4 Qty 1 pcs | | | |
|  | 100906 | 5900317 7050028 | |
| screw connection thread M10x1 for ignition electrode brass Qty 1 pcs WS 10 | | | |
|  | 100907 | 5900318 | |
| screw connection thread M10x1 Qty 1 pcs type SEF 1 \varnothing mm for thermocouple | | | |
|  | 100908 | — | |
| union screw thread M10x1 for pipe \varnothing 4mm Qty 1 pcs | | | |
|  | 100909 | 7050029 | |
| union screw thread M10x1 for pipe \varnothing 6mm Qty 1 pcs | | | |
|  | 102110 | — | |
| pilot tube copper pipe \varnothing 4mm thickness 1mm L 3000mm | | | |
|  | 102111 | — | |
| pilot tube copper pipe \varnothing 6mm thickness 1mm L 3000mm | | | |
|  | 102508 | — | |
| union screw thread M10x1 for pipe \varnothing 4mm Qty 5 pcs | | | |
|  | 102509 | — | |
| union screw thread M10x1 for pipe \varnothing 6mm Qty 5 pcs | | | |
|  | 102699 | — | |
| pilot burner nozzle POLIDORO natural gas code 25.2 bore \varnothing 2x0.25mm Qty 1 pcs 2 bores | | | |
|  | 102795 | — | |
| olive for pipe \varnothing 4mm Qty 1 pcs | | | |
|  | 102797 | — | |
| olive for pipe \varnothing 6mm Qty 1 pcs | | | |
|  | 106703 | 7042008 | |
| pilot burner nozzle POLIDORO natural gas code 27.2 bore \varnothing 2x0.27mm Qty 1 pcs | | | |
|  | 106704 | — | |
| pilot burner nozzle POLIDORO LPG code 16.2 bore \varnothing 2x0.16mm Qty 1 pcs | | | |
|  | 106763 | — | |
| pilot burner nozzle POLIDORO natural gas code 27.2A bore \varnothing 2x 0.27mm Qty 1 pcs | | | |
|  | 106859 | — | |
| pilot burner nozzle POLIDORO LPG code 24 bore \varnothing 0.24mm Qty 1 pcs | | | |

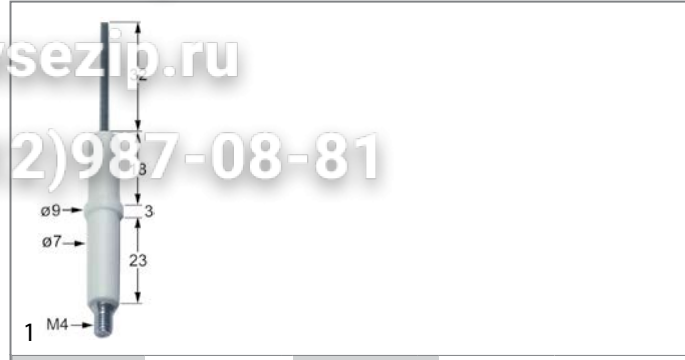

| GEV No. | 100701 | Ref. No. | 6010087 |
|---|--|----------|-----------------------------|
| description | ignition electrode connection M4 Qty 1 pcs | | |
| For models: | SG520 | | |
| accessories for | 100701 | | |
|  | GEV No. | 100906 | Ref. No. 5900317 7050028 |
| screw connection thread M10x1 for ignition electrode brass Qty 1 pcs WS 10 | | | |



| GEV No. | 100706 | Ref. No. | 6010046 |
|--------------------|--|----------|---------|
| description | ignition electrode connection M4 Qty 1 pcs | | |
| For models: | 13FG, 13FGC, 17FG, 17FGC, 207FG, 207FGC, 213FG, 213FGC, 217FG, 217FGC, 917FG, 917FGC, 927FG, 927FGC, 934FG, 934FGC, FG07CL, FG07L, FG13L, FG213CL, FG213L, SG608 | | |

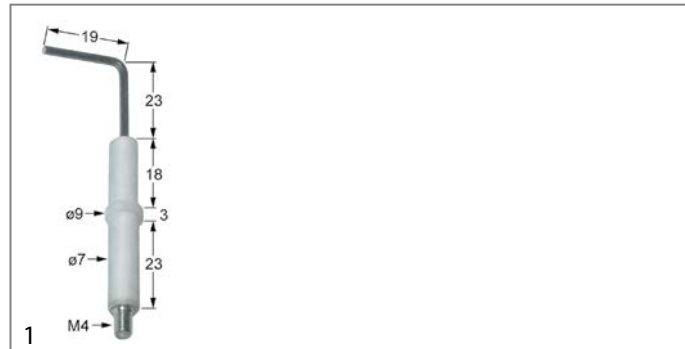

| GEV No. | 102333 | Ref. No. | 2012111 |
|--------------------|---|----------|---------|
| description | ignition electrode D1 \varnothing 7mm D2 \varnothing 9mm connection M4 L1 23mm L2 19mm BL1 18mm BL2 3mm BL3 23mm to clip | | |
| For models: | CG06MX, CG102MX, CG10MX, CG20MX, DG06EC, DG06ES, DG06MX, DG102EC, DG102MX, DG10EC, DG10ES, DG10MX, VG06EC, VG06MX, VG102EC, VG102MX, VG10EC, VG10MX, VG20EC, VG20MX | | |

gas components

Зип Общепит

vsezip.ru

+7(812)987-08-81



| | | | |
|--------------------|--|-----------------|---------|
| GEV No. | 102331 | Ref. No. | 2012109 |
| description | ignition electrode D1 ø 7mm D2 ø 9mm connection M4 L1 34mm L2 40mm L3 14mm BL1 18mm BL2 3mm BL3 23mm to clip | | |
| For models: | VG06EC, VG06MX, VG102EC, VG10EC, VG10MX | | |



| | | | |
|--------------------|--|-----------------|---------|
| GEV No. | 102332 | Ref. No. | 2012108 |
| description | ignition electrode D1 ø 7mm D2 ø 9mm connection M4 L1 40mm L2 46mm BL1 18mm BL2 3mm BL3 23mm to clip | | |
| For models: | VG06EC, VG06MX, VG102EC, VG102MX, VG10EC, VG10MX, VG20EC, VG20MX | | |



| | | | |
|--------------------|---|-----------------|---------|
| GEV No. | 102334 | Ref. No. | 2012110 |
| description | ignition electrode D1 ø 7mm D2 ø 9mm connection M4 L1 9mm L2 12mm L3 62mm BL1 18mm BL2 3mm BL3 23mm to clip | | |
| For models: | CG06MX, CG102MX, CG10MX, CG20MX, DG06EC, DG06ES, DG06MX, DG102EC, DG102MX, DG10EC, DG10ES, DG10MX, VG06EC, VG06MX, VG102EC, VG102MX, VG10EC, VG10MX, VG20EC, VG20MX | | |



| | | | |
|--------------------|--|-----------------|--------------------|
| GEV No. | 100906 | Ref. No. | 5900317 7050028 |
| description | screw connection thread M10x1 for ignition electrode brass Qty 1 pcs WS 10 | | |

ignition cables

pre-assembled cables



| | | | |
|--------------------|---|-----------------|---------|
| GEV No. | 100140 | Ref. No. | 6050051 |
| description | ignition cable cable length 400mm connection ø2.4mm / ø4mm | | |
| For models: | 13FG, 13FGC, 17FG, 17FGC, 207FG, 213FG, 213FGC, 217FG, 217FGC, 22CPG, 23CPG, 2CPG, 3CPG, 917FG, 917FGC, 927FG, 927FGC, 934FG, 934FGC, CPG66, FG07CL, FG213CL, FRG46, FRG66, SG608 | | |



| | | | |
|--------------------|--|-----------------|---------|
| GEV No. | 100025 | Ref. No. | 6050065 |
| description | ignition cable cable length 600mm connection ø4mm / F6.3mm | | |
| For models: | FG07L, FG13L, FG213L | | |



| | | | |
|--------------------|--|-----------------|---------|
| GEV No. | 100019 | Ref. No. | 6050610 |
| description | ignition cable cable length 900mm connection ø2.4mm / ø4mm | | |

piezoelectric igniters

mounting diameter 22mm



| | | | |
|--------------------|--|-----------------|---------|
| GEV No. | 100013 | Ref. No. | 6010047 |
| description | piezoelectric igniter body plastic blowing mounting ø 22mm connection ø2.4mm cable lengthmm | | |
| For models: | 22CPG, 23CPG, 2CPG, 3CPG, CG740, CG780, CPG1, CPG1BM, CPG66, FPG18, FRG46, FRG66, FTG100, FTG46, FTG46B, FTG46R, FTG66L, FTG66LG, FTG66R, GG66, GG940, GG980, PCG46, PCG66, SG520, SG608 | | |

| | | | | | |
|------------------------|--------|----------------|--------|-----------------|--|
| accessories for | 100013 | GEV No. | 100023 | Ref. No. | — |
| | | | | | female bullet size 2.3mm 0.5-1.5mm ² CuZn t.max. 125°C Qty 20 pcs |

2 gas components



ignition units

| | | | |
|---|---|-----------------|---------|
|  | | | |
| 1 | | | |
| GEV No. | 101002 | Ref. No. | 6041056 |
| description | ignition unit outputs 2 230VAC dimensions 88x23x34mm mounting distance 73mm inlet F6.3x0.8 outlet F2.8x0.8 0.6VA 50/60Hz | | |
| For models: | 13FG, 13FGC, 17FG, 17FGC, 207FG, 207FGC, 213FG, 213FGC, 217FG, 217FGC, 917FG, 917FGC, 927FG, 927FGC, 934FG, 934FGC, FG07CL, FG213CL | | |

Зип Общежит

vsezip.ru
+7(812)987-08-81

thermocouples with a unimised tip

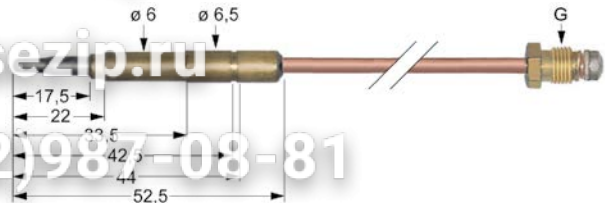
| | | | |
|--|---|-----------------|---------|
|  | | | |
| 1 | | | |
| GEV No. | 102034 | Ref. No. | 6010063 |
| description | thermocouple M8x1 L 600mm plug connection $\varnothing 6.0(6.5)$ mm | | |

thermocouples

plug-in thermocouples

plug-in thermocouples standard

with barrel socket $\varnothing 6(6.5)$ mm

thermocouples SIT

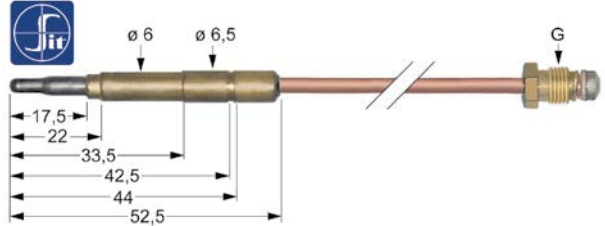
| | | | |
|---|--|-----------------|---------|
|  | | | |
| 1 | | | |
| GEV No. | 107614 | Ref. No. | 6010056 |
| description | thermocouple SIT M9x1 L 1500mm plug connection $\varnothing 6.0(6.5)$ mm | | |

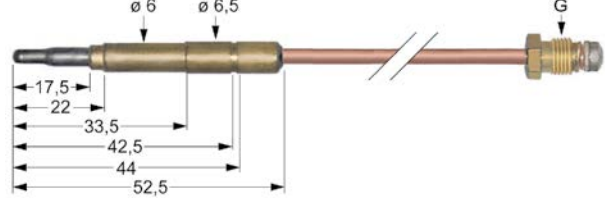
| | | | |
|--|---|-----------------|---------|
|  | | | |
| 1 | | | |
| GEV No. | 102040 | Ref. No. | 6010058 |
| description | thermocouple M9x1 L 500mm plug connection $\varnothing 6.0(6.5)$ mm | | |

plug-in thermocouples with interruption

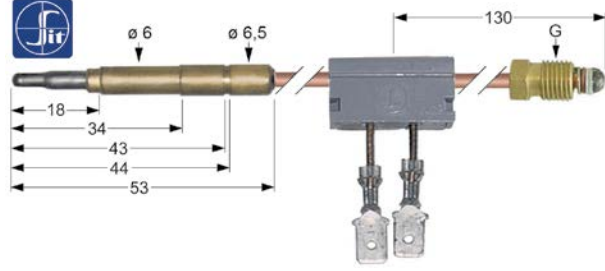
| | | | |
|---|---|-----------------|---------|
|  | | | |
| 1 | | | |
| GEV No. | 107177 | Ref. No. | 6010065 |
| description | thermocouple SIT with interrupter M9x1 L 600mm plug connection $\varnothing 6.0$ mm F 6.3mm | | |

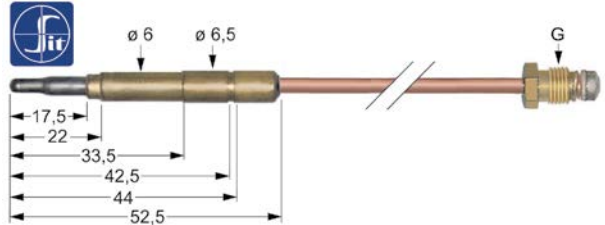
| | | | |
|---|---|-----------------|---------|
|  | | | |
| 1 | | | |
| GEV No. | 107609 | Ref. No. | 6010055 |
| description | thermocouple SIT M9x1 L 600mm plug connection $\varnothing 6.0(6.5)$ mm | | |
| For models: | 13FG, 17FG, 207FG, 213FG, 917FG, 917FGC, 927FG, 927FGC, 934FG, 934FGC, CG740, CG780, FG07L, FG13L, FG213L, FTG100, FTG46, FTG46B, FTG46R, FTG66L, FTG66LG, FTG66R, GG66, GG940, GG980, SG520, SG608 | | |

extensions

| | | | |
|--|---|-----------------|---------|
|  | | | |
| 1 | | | |
| GEV No. | 102811 | Ref. No. | 6010052 |
| description | thermocouple extension thread M9x1 - M9x1 L 600mm | | |

accessories

display adapters

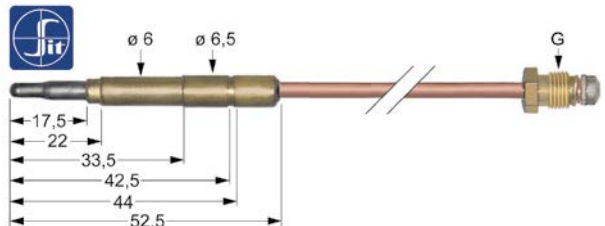
| | | | |
|---|---|-----------------|---------|
|  | | | |
| 1 | | | |
| GEV No. | 107611 | Ref. No. | 6010057 |
| description | thermocouple SIT M9x1 L 850mm plug connection $\varnothing 6.0(6.5)$ mm | | |
| For models: | 22CPG, 23CPG, 2CPG, 3CPG, CPG66 | | |

| | | | |
|---|-----------------------------|-----------------|---------|
|  | | | |
| 1 | | | |
| GEV No. | 101337 | Ref. No. | 7050032 |
| description | display adapter thread M9x1 | | |

gas components



Зип.Общепит

gas nozzles

pilot burner nozzles

vsezip.ru

pilot burner nozzles POLIDORO

+7(812)987-08-81

displays



1

| | | | |
|--------------------|------------------------------|-----------------|---------|
| GEV No. | 101414 | Ref. No. | 6010064 |
| description | display soldering connection | | |

1

| | | | |
|--------------------|--|-----------------|---------|
| GEV No. | 106703 | Ref. No. | 7042008 |
| description | pilot burner nozzle POLIDORO natural gas code 27.2 bore \varnothing 2x0.27mm Qty 1 pcs | | |

gas burners

bar burners

bar burners



1

| | | | |
|--------------------|---|-----------------|---------|
| GEV No. | 105776 | Ref. No. | 7090100 |
| description | bar burner \varnothing 50mm Wmm Hmm L 305mm with bolt M5x12 flange width 52mm convection oven flange \varnothing 75mm | | |
| For models: | CG06MX, DG06EC, DG06ES, DG06MX, VG06EC, VG06MX | | |

pilot burner nozzles SIT

100 series



1

| | | | |
|--------------------|---|-----------------|---------|
| GEV No. | 100245 | Ref. No. | 7042005 |
| description | pilot burner nozzle LPG code 20 bore \varnothing 0.2mm Qty 1 pcs thread M8x0.75 | | |



1

| | | | |
|--------------------|--|-----------------|---------|
| GEV No. | 100246 | Ref. No. | 7042006 |
| description | pilot burner nozzle natural gas bore \varnothing 0.35mm Qty 1 pcs thread M8x0.75 | | |

140/150 series



1

| | | | |
|--------------------|--|-----------------|---------|
| GEV No. | 100204 | Ref. No. | 7042014 |
| description | pilot burner nozzle SIT LPG code 14 bore \varnothing 0.18/0.20mm Qty 1 pcs suitable for 140 series | | |



1

| | | | |
|--------------------|--|-----------------|---------|
| GEV No. | 100207 | Ref. No. | 7042013 |
| description | pilot burner nozzle SIT natural gas code 27 bore \varnothing 0.40/0.38mm suitable for SIT 140 series | | |

screw connections

olives



1



| | | | |
|--------------------|--------|-----------------|---------|
| GEV No. | 106426 | Ref. No. | 7070025 |
| description | olive | | |





Зип Общепит

vsezip.ru

+7(812)987-08-81

| | | | |
|---|---|-----------------|-----------------|
|  | | | |
| 1 | | | |
| GEV No. | 101274 | Ref. No. | 7070036 |
| description | olive for pipe ø 16mm Qty 1 pcs | | |
| accessories for | 101274 | | |
|  | GEV No. | 101275 | Ref. No. |
| | | | — |
| | union screw thread 1/2" for pipe ø 16mm Qty 1 pcs | | |

| | | | |
|---|---|-----------------|-----------------|
|  | | | |
| 1 | | | |
| GEV No. | 100898 | Ref. No. | 7070045 |
| description | olive for pipe ø 6mm Qty 1 pcs for pilot burner | | |
| accessories for | 100898 | | |
|  | GEV No. | 100909 | Ref. No. |
| | | | 7050029 |
| | union screw thread M10x1 for pipe ø 6mm Qty 1 pcs | | |

| | | | |
|---|---|-----------------|-----------------|
|  | | | |
| 1 | | | |
| GEV No. | 100909 | Ref. No. | 7050029 |
| description | union screw thread M10x1 for pipe ø 6mm Qty 1 pcs | | |
| accessories for | 100909 | | |
|  | GEV No. | 100898 | Ref. No. |
| | | | 7070045 |
| | olive for pipe ø 6mm Qty 1 pcs for pilot burner | | |
|  | GEV No. | 101286 | Ref. No. |
| | | | — |
| | olive ID ø 6mm Qty 1 pcs | | |
|  | GEV No. | 101287 | Ref. No. |
| | | | — |
| | olive for pipe ø 6mm Qty 1 pcs | | |
|  | GEV No. | 101288 | Ref. No. |
| | | | — |
| | olive for pipe ø 6mm L 6mm aluminium Qty 1 pcs ED ø 8.5mm | | |

union screws

| | | | |
|--|--|-----------------|---------|
|  | | | |
| 1 | | | |
| GEV No. | 100905 | Ref. No. | 7050020 |
| description | locking screw M10x1 for pipe ø 6mm Qty 1 pcs | | |

| | | | |
|---|--|-----------------|--------------------|
|  | | | |
| 1 | | | |
| GEV No. | 100906 | Ref. No. | 5900317 7050028 |
| description | screw connection thread M10x1 for ignition electrode brass Qty 1 pcs WS 10 | | |

| | | | |
|---|---|-----------------|---------|
|  | | | |
| 1 | | | |
| GEV No. | 100907 | Ref. No. | 5900318 |
| description | screw connection thread M10x1 Qty 1 pcs type SEF 1 ømm for thermocouple | | |

pressure switches

| | | | |
|--|---|-----------------|---------|
|  | | | |
| 1 | | | |
| GEV No. | 541073 | Ref. No. | 7050012 |
| description | pressure control ø 45mm pressure range adjustable 5-20mbar pressure connection vertical gas technology connection 1/4" pressure connection ø 1/4"mm | | |

doors

| | | | |
|--|--|-----------------|---------|
|  | | | |
| 1 | | | |
| GEV No. | 690585 | Ref. No. | 2011212 |
| description | bush for door mechanism L 35mm ED ø 36mm int. ø 1 31mm int. ø 2 13mm mounting distance 28mm brass | | |
| For models: | CE06MX, CE102MX, CE10MX, CE20MX, CG06MX, CG102MX, CG10MX, CG20MX, DE06EC, DE06ES, DE06MX, DE102EC, DE102MX, DE10EC, DE10ES, DE10MX, DG06EC, DG06ES, DG06MX, DG102EC, DG102MX, DG10EC, DG10ES, DG10MX, VE06EC, VE06MX, VE102EC, VE102MX, VE10EC, VE10MX, VE20EC, VE20MX, VG06EC, VG06MX, VG102EC, VG102MX, VG10EC, VG10MX, VG20EC, VG20MX | | |

2 gas components

door mechanics

miscellaneous



| | | | |
|--------------------|--|-----------------|---------|
| GEV No. | 690585 | Ref. No. | 2011212 |
| description | bush for door mechanism L 35mm ED ø 36mm int. ø 1 31mm int. ø 2 13mm mounting distance 28mm brass | | |
| For models: | CE06MX, CE102MX, CE10MX, CE20MX, CG06MX, CG102MX, CG10MX, CG20MX, DE06EC, DE06ES, DE06MX, DE102EC, DE102MX, DE10EC, DE10ES, DE10MX, DG06EC, DG06ES, DG06MX, DG102EC, DG102MX, DG10EC, DG10ES, DG10MX, VE06EC, VE06MX, VE102EC, VE102MX, VE10EC, VE10MX, VE20EC, VE20MX, VG06EC, VG06MX, VG102EC, VG102MX, VG10EC, VG10MX, VG20EC, VG20MX | | |

knoobs

producer-specific knobs

GIORIK



| | | | |
|--------------------|--|-----------------|---------|
| GEV No. | 112265 | Ref. No. | 2008671 |
| description | knob gas tap with ignition flame t.max.°C ø 76mm shaft ø 10x8mm shaft flat upper black | | |
| For models: | 22CPG, 23CPG, 2CPG, 3CPG, CG740, CG780, CPG1, CPG1BM, CPG66, GG66, GG940, GG980 | | |



| | | | |
|--------------------|--|-----------------|---------|
| GEV No. | 111738 | Ref. No. | 2012261 |
| description | knob switch zero mark ø 50mm shaft ø 6x4.6mm shaft flat left black | | |
| For models: | CE06MX, CE102MX, CE10MX, CE20MX, CG06MX, CG102MX, CG10MX, CG20MX, DE06EC, DE06ES, DE06MX, DE102EC, DE102MX, DE10EC, DE10ES, DE10MX, DG06EC, DG06ES, DG06MX, DG102EC, DG102MX, DG10EC, DG10ES, DG10MX, SH510P, SH560P, VE06EC, VE06MX, VE102EC, VE102MX, VE10EC, VE10MX, VE20EC, VE20MX, VG06EC, VG06MX, VG102EC, VG102MX, VG10EC, VG10MX, VG20EC, VG20MX | | |



| | | | |
|--------------------|---|-----------------|---------|
| GEV No. | 111508 | Ref. No. | 2006823 |
| description | knob switch zero mark ø 50mm shaft ø 6x4.6mm shaft flat left white | | |
| For models: | 13FGC, 15FEC, 17FGC, 207FGC, 20FEC, 210FEC, 213FGC, 215FEC, 217FGC, 220FEC, 917FGC, 920FEC, 922FEC, 927FGC, 934FGC, 940FEC, EF10GM, EF5GM, EF7GM, EN10VE-EC-ESN1033, F10CL, F15CL, F215CL, FG07CL, FG213CL, GF10GM, GF5GM, GF7GM, SH505R, SH510R, SH520G, SH520GM | | |

Зип Общепит

vsezip.ru

+7(812)987-08-81

| | | | |
|--------------------|--|-----------------|---------|
| GEV No. | 111739 | Ref. No. | 2012260 |
| description | knob universal ø 50mm shaft ø 6x4.6mm shaft flat vertical universal | | |
| For models: | DE06EC, DE102EC, DE10EC, DG06EC, DG102EC, DG10EC, SH510P, VE06EC, VE102EC, VE10EC, VE20EC, VG06EC, VG102EC, VG10EC, VG20EC | | |

accessories

button springs



| | | | |
|--------------------|--|-----------------|---------|
| GEV No. | 550965 | Ref. No. | 5900242 |
| description | knob spring ø 6x4.6mm Qty 1 pcs | | |
| For models: | BME46, BME66, CPE66, FRE46, FRE46F, FRE46R, FRE46T, FRE66, FRE66F, FRE66R, FRE66T, FTE100, FTE107, FTE46, FTE46B, FTE46R, FTE47L, FTE66L, FTE66LB, FTE66LM, FTE66LMB, FTE66R, FTE66RM, FTE67L, FTE67LM, PCE46, PCE66M, PCE66T, PCG46, PCG66, SPE46 | | |



| | | | |
|--------------------|----------------------------------|-----------------|--------|
| GEV No. | 550132 | Ref. No. | 550965 |
| description | knob spring ø 6x4.6mm Qty 10 pcs | | |

locks

handle latches

universal

outside fixing

locks





| | | | | |
|---|---|-----------------|-----------------|---|
| GEV No. | 694065 | Ref. No. | 5900125 | |
| description | door handle for headed units L 145mm W 40mm H 62mm spring length 33mm outer black | | | |
| spare parts for | 694065 | | | |
|  | GEV No. | 514390 | Ref. No. | — |
| | spring for door handle ø 6mm L 54mm W 27.5mm | | | |
|  | GEV No. | 694734 | Ref. No. | — |
| | door handle L 165mm W 40mm H 25mm black | | | |

Table continues overleaf





Зип Общепит

product specific

vsezip.ru

7(812)987-08-81

| | | | |
|--|-----------------------|-----------------|---------|
| spare parts for 694065 | | | |
|  | GEV No. 694735 | Ref. No. | — |
| cap ø 32mm black | | | |
| accessories for 694065 | | | |
|  | GEV No. 694066 | Ref. No. | |
| door catch with spigot 2-stage L 28mm W 14mm H 15mm, H1 16mm total length 51mm thread M8 thread L 23mm stainless steel | | | |
|  | GEV No. 694067 | Ref. No. | 5900124 |
| door catch with spigot 1-stage L 26mm total length 51mm thread M8 | | | |

snap locks

universal

| | | | |
|--|-----------------------|-----------------|---------|
|  | GEV No. 690596 | Ref. No. | 2000160 |
| description snap lock L 60mm W 15mm H 36mm mounting distance 48/28mm spring thickness 1.5mm complete with door catch zamak | | | |

espagnolette locks

universal

| | | | |
|---|-----------------------|-----------------|---------|
|  | GEV No. 690041 | Ref. No. | 5900121 |
| description cam L 148mm mounting distance 32mm | | | |

| | | | |
|---|-----------------------|-----------------|---------|
|  | GEV No. 690040 | Ref. No. | 5900122 |
| description door catch with roller H 42mm L 40mm W 40mm zinc die cast mounting distance 26mm type 0751 series | | | |
| For models: CE06MX, CE102MX, CE10MX, CE20MX, CG06MX, CG102MX, CG10MX, CG20MX, DE06EC, DE06ES, DE06MX, DE102EC, DE102MX, DE10EC, DE10ES, DE10MX, DG06EC, DG06ES, DG06MX, DG102EC, DG102MX, DG10EC, DG10ES, DG10MX, VE06EC, VE06MX, VE102EC, VE102MX, VE10EC, VE10MX, VE20EC, VE20MX, VG06EC, VG06MX, VG102EC, VG102MX, VG10EC, VG10MX, VG20EC, VG20MX | | | |

| | | | |
|---|-----------------------|-----------------|---------|
|  | GEV No. 700771 | Ref. No. | 5900123 |
| description latch gear opening to the left shaft intake ø 8x8mm L 170mm W 40mm H 40mm | | | |

| | | | |
|---|-----------------------|-----------------|---------|
|  | GEV No. 690585 | Ref. No. | 2011212 |
| description bush for door mechanism L 35mm ED ø 36mm int. ø 1 31mm int. ø 2 13mm mounting distance 28mm brass | | | |
| For models: CE06MX, CE102MX, CE10MX, CE20MX, CG06MX, CG102MX, CG10MX, CG20MX, DE06EC, DE06ES, DE06MX, DE102EC, DE102MX, DE10EC, DE10ES, DE10MX, DG06EC, DG06ES, DG06MX, DG102EC, DG102MX, DG10EC, DG10ES, DG10MX, VE06EC, VE06MX, VE102EC, VE102MX, VE10EC, VE10MX, VE20EC, VE20MX, VG06EC, VG06MX, VG102EC, VG102MX, VG10EC, VG10MX, VG20EC, VG20MX | | | |

| | | | |
|--|-----------------------|-----------------|---------|
|  | GEV No. 690041 | Ref. No. | 5900121 |
| description cam L 148mm mounting distance 32mm | | | |

| | | | |
|---|-----------------------|-----------------|---------|
|  | GEV No. 690040 | Ref. No. | 5900122 |
| description door catch with roller H 42mm L 40mm W 40mm zinc die cast mounting distance 26mm type 0751 series | | | |
| For models: CE06MX, CE102MX, CE10MX, CE20MX, CG06MX, CG102MX, CG10MX, CG20MX, DE06EC, DE06ES, DE06MX, DE102EC, DE102MX, DE10EC, DE10ES, DE10MX, DG06EC, DG06ES, DG06MX, DG102EC, DG102MX, DG10EC, DG10ES, DG10MX, VE06EC, VE06MX, VE102EC, VE102MX, VE10EC, VE10MX, VE20EC, VE20MX, VG06EC, VG06MX, VG102EC, VG102MX, VG10EC, VG10MX, VG20EC, VG20MX | | | |

| | | | |
|---|-----------------------|-----------------|---------|
|  | GEV No. 690584 | Ref. No. | 2013218 |
| description door handle L 190mm W 41.5mm metal mounting distance 55mm flange 45x72mm shaft 8x8mm shaft L 47mm | | | |

miscellaneous

| | | | |
|--|-----------------------|-----------------|---------|
|  | GEV No. 511482 | Ref. No. | 2006619 |
| description pressure pin L 52mm thread M10x1.5 | | | |
| For models: EF10GM, EF4PM, EF5GM, EF6PM, EF7GM, EF8PM, EN10VE-EC-ESN1033, GF10GM, GF4PM, GF5GM, GF6PM, GF7GM, GF8PM | | | |

mechanical components, equipment accessories

gaskets

gaskets for heated units

window seals

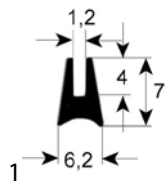

| | | | |
|--------------------|--|-----------------|---------|
| GEV No. | 900440 | Ref. No. | 7070167 |
| description | window gasket profile 1520 Qty supplied by meter | | |
| For models: | CE06MX, CE102MX, CE10MX, CE20MX, CG06MX, CG102MX, CG10MX, CG20MX, DE06EC, DE06MX, DE102EC, DE102MX, DE10EC, DE10MX, DG06EC, DG06MX, DG102EC, DG102MX, DG10EC, DG10MX, VE06EC, VE06MX, VE102EC, VE102MX, VE10EC, VE10MX, VE20EC, VE20MX, VG06EC, VG06MX, VG102EC, VG102MX, VG10EC, VG10MX, VG20EC, VG20MX | | |

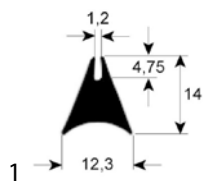

| | | | |
|--------------------|--|-----------------|---------|
| GEV No. | 900058 | Ref. No. | 7070161 |
| description | window gasket profile 1620 Qty supplied by meter | | |

door seals

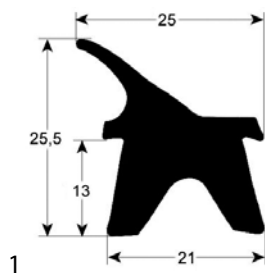

| | | | |
|--------------------|---|-----------------|--|
| GEV No. | 900348 | Ref. No. | 7070162 7070170 7070172 7070185 |
| description | door seal profile 2402 Qty supplied by meter | | |
| For models: | EF10GM, EF4, EF4PM, EF5GM, EF8PM, GF10GM, GF4PM, GF5GM, GF8PM | | |

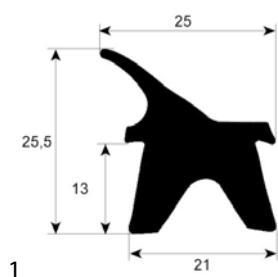

| | | | |
|--------------------|--|-----------------|---------|
| GEV No. | 901351 | Ref. No. | 7070173 |
| description | door seal profile 2402 W 490mm L 635mm external size | | |

Зип Общепит

vsezip.ru

+7(812)987-08-81

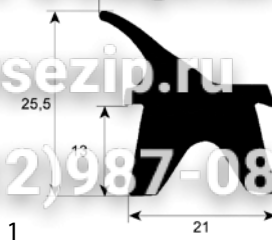

| | | | |
|--------------------|--|-----------------|---------|
| GEV No. | 901158 | Ref. No. | 7070174 |
| description | door seal profile 2402 W 640mm L 740mm | | |
| For models: | EN10VE-EC-ESN1033 | | |

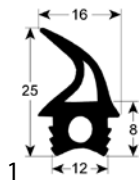

| | | | |
|--------------------|--|-----------------|---------|
| GEV No. | 902409 | Ref. No. | 7070100 |
| description | door seal profile 2714 Qty supplied by meter suitable for GIORIK | | |

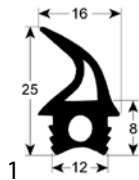

| | | | |
|--------------------|--|-----------------|---------|
| GEV No. | 902410 | Ref. No. | 7070194 |
| description | door seal profile 2714 W 438mm L 778mm suitable for GIORIK | | |

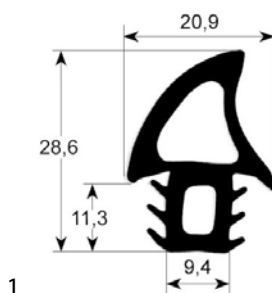

| | | | |
|--------------------|--|-----------------|---------|
| GEV No. | 900439 | Ref. No. | 7070166 |
| description | door seal profile 2750 Qty supplied by meter | | |
| For models: | CE06MX, CE102MX, CE10MX, CE20MX, CG06MX, CG102MX, CG10MX, CG20MX, DE06EC, DE06ES, DE06MX, DE102EC, DE102MX, DE10EC, DE10ES, DE10MX, DG06EC, DG06ES, DG06MX, DG102EC, DG102MX, DG10EC, DG10ES, DG10MX, VE06EC, VE06MX, VE102EC, VE102MX, VE10EC, VE10MX, VE20EC, VE20MX, VG06EC, VG06MX, VG102EC, VG102MX, VG10EC, VG10MX, VG20EC, VG20MX | | |

mechanical components, equipment accessories



Зип Общепит

vsezip.ru

+7(812)987-08-81

O-rings

EPDM

ø1.78mm

1

| | | | |
|--------------------|--|-----------------|---------|
| GEV No. | 505045 | Ref. No. | 5900381 |
| description | O-ring EPDM thickness 1.78mm ID ø 5.28mm Qty 1 pcs | | |

1

| | | | |
|--------------------|--|-----------------|---------|
| GEV No. | 550550 | Ref. No. | 7070151 |
| description | shaft sealing for fan motor | | |
| For models: | CE102MX, CE10MX, CE20MX, CG102MX, CG10MX, CG20MX, DE102EC, DE102MX, DE10EC, DE10ES, DE10MX, DG102EC, DG102MX, DG10EC, DG10ES, DG10MX, VE102EC, VE102MX, VE10EC, VE10MX, VE20EC, VE20MX, VG102EC, VG102MX, VG10EC, VG10MX, VG20EC, VG20MX | | |

Viton

ø2.62mm

1

| | | | |
|--------------------|--|-----------------|---------|
| GEV No. | 532649 | Ref. No. | 6090141 |
| description | O-ring Viton ID ø 63.17mm thickness 2.62mm Qty 1 pcs | | |
| For models: | EF10GM, EF4PM, EF5GM, EF6PM, EF7GM, EF8PM, GF10GM, GF4PM, GF5GM, GF6PM, GF7GM, GF8PM | | |

hose reels and spray guns

spray guns

1

| | | | |
|--------------------|--|-----------------|---------|
| GEV No. | 542964 | Ref. No. | 7080010 |
| description | spray gun for appliances 1/2" ET L 135mm | | |

ø3.53mm

1

| | | | |
|--------------------|--|-----------------|---------|
| GEV No. | 525313 | Ref. No. | 6090140 |
| description | O-ring Viton ID ø 60.33mm thickness 3.53mm Qty 1 pcs | | |
| For models: | EF10GM, EF4PM, EF5GM, EF6PM, EF7GM, EF8PM, GF10GM, GF4PM, GF5GM, GF6PM, GF7GM, GF8PM | | |

hoses

industrial hoses

PE hoses

1

| | | | |
|--------------------|---|-----------------|--------------------|
| GEV No. | 520549 ¹ | Ref. No. | 7090128 7090130 |
| description | hose Lm operating p. 6bar burst p. 10bar t.max. 65°C LLDPE transparent ID ø 6mm ED ø 8mm John Guest supplied by meter | | |

¹by the meter

shaft gaskets

shaft gaskets

1

| | | | |
|--------------------|--|-----------------|---------|
| GEV No. | 550549 | Ref. No. | 7070150 |
| description | shaft sealing for fan motor | | |
| For models: | CE06MX, CG06MX, DE06EC, DE06ES, DE06MX, DG06EC, DG06ES, DG06MX, VE06EC, VE06MX, VG06EC, VG06MX | | |

PVC hoses

PVC braided hoses

1

| | | | |
|--------------------|--|-----------------|---------|
| GEV No. | 520544 | Ref. No. | 7090122 |
| description | PVC braided hose ID ø 19mm ED ø 27mm L 5m thickness 4mm operating p. 10bar burst p. 30bar t.max. 60°C PVC warewashing Qty 5m | | |

mechanical components, equipment accessories



silicone hoses

with fabric

with monofilament braid

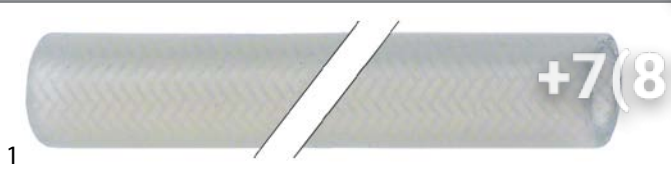

1

| | | | |
|--------------------|--|-----------------|---------|
| GEV No. | 530693 | Ref. No. | 7090112 |
| description | silicone hose with monofilament braid ID ø 10mm ED ø 17mm L 1m thickness 3.5mm operating p. 4bar t.max. 200°C Qty 1m | | |

Зип.Общепит
fastening material

screws

hexagonal screws



1

| | | | |
|--------------------|---|-----------------|---------|
| GEV No. | 550682 | Ref. No. | 5111109 |
| description | hexagonal screw thread M8 thread L 20mm SS WS 13 Qty 1 pcs DIN 933 / ISO 4017 | | |

fittings, hose and pipe connectors

fittings

angle pieces

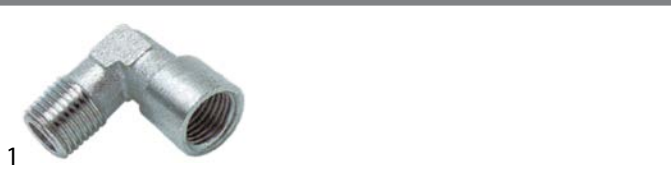

1

| | | | |
|--------------------|--|-----------------|---------|
| GEV No. | 520824 | Ref. No. | 7050374 |
| description | angle piece thread 1/8" ET - 1/8" IT nickel-plated brass | | |

valves and tank inlets

ball valves

ball valves electric

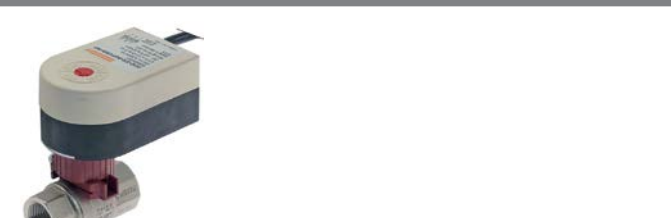

1

| | | | |
|--------------------|--|-----------------|---------|
| GEV No. | 401139 | Ref. No. | 6042073 |
| description | ball valve inlet 3/4" IT outlet 3/4" IT with plug 230V L 65mm 50/60Hz closed off-current mode of operation electric connection cable 200mm | | |

Зип Общепит

vsezip.ru

+7(812)987-08-81

| | | | |
|---|--------|----------------------------------|--------|
| A | | | |
| alarm devices | 10 | indicator lights (complete) | 7 |
| axial fans | 17 | industrial hoses | 33 |
| B | | L | |
| ball valves | 34 | lamps | 7 |
| ball valves electric | 16, 34 | light bulbs | 7 |
| bar burners | 28 | M | |
| booster pumps II | 19 | mechanical timers | 10 |
| C | | microswitches | 5 |
| cam switches | 6 | O | |
| condensators & interference suppression filters | 19 | operating capacitors | 19 |
| contactors | 10 | O-rings | 33 |
| control thermostats | 3 | oven lamps | 8 |
| D | | P | |
| door seals | 32 | PE hoses | 33 |
| E | | piezoelectric igniters | 26 |
| electric timers | 10 | pilot burners | 22 |
| electrodes | 16 | pressure switches | 16, 29 |
| electronic controllers | 13 | probes | 14 |
| energy regulators | 3 | pumps | 19 |
| espagnolette locks | 31 | push/momentary push switches | 5 |
| F | | PVC hoses | 33 |
| fans | 17 | R | |
| fastening material | 34 | relays | 11 |
| filters | 19 | rocker/momentary rocker switches | 4 |
| fittings | 34 | rotary switches | 6 |
| G | | S | |
| gas burners | 28 | safety thermostats | 3 |
| gas control valves | 19 | screws | 34 |
| gas nozzles | 28 | shaft gaskets | 33 |
| gaskets for heated units | 32 | silicone hoses | 34 |
| H | | snap locks | 31 |
| halogen lamp | 8 | solenoid valves | 15 |
| heating elements | 2 | spray guns | 33 |
| heating elements for convection | 2 | spray guns with external thread | 33 |
| hexagonal screws | 34 | switches and momentary switches | 4 |
| hoses | 33 | T | |
| hot air motors | 17 | temperature probes | 14 |
| I | | thermocouples | 27 |
| ignition boxes | 21 | thermostats | 3 |
| ignition cables | 26 | time relays | 12 |
| ignition units | 27 | timers | 10 |
| immersion heating elements | 2 | transformers | 13 |
| indicator lights | 7 | U | |
| | | universal probes | 14 |

Зип Общепит**V**

valves and tank inlets

34

vsezip.ru**W**

window seals

+7(812)987-08-81