



Зип Ощепит

vsezip.ru

Spare Parts for

+7(812)987-08781 **Combi Ovens**



Spare parts suitable for

**GIORIK**

2017

Find the complete and up-to-date range of products in our GEV Webshop



## heating elements

## immersion heating elements

## 3 hole flange ø57.5mm

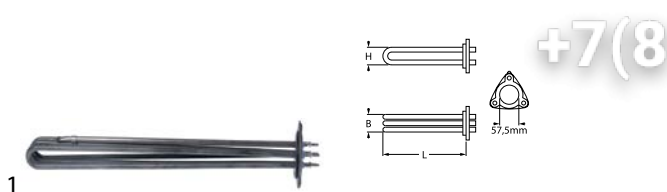

<b>GEV No.</b>	418085	<b>Ref. No.</b>	6003295
<b>description</b>	heating element 10000W 230V mounting ø 57.5mm heating circuits 3 L 393mm W 38mm H 52mm number of thermostat sleeves 1 thermostat sleeves ø 7mm length thermostat sleeves 350mm thermostat sleeve not clinging tube ø 8.5mm hole distance 73mm hole ø 8mm connection length 33mm connection M4 3 hole flange immersion heater		
<b>For models:</b>	VE20EC, VE20MX		
<b>spare parts for</b>	418085		
	<b>GEV No.</b>	510409	<b>Ref. No.</b> —
	O-ring EPDM thickness 5.34mm ID ø 56.52mm Qty 1 pcs		

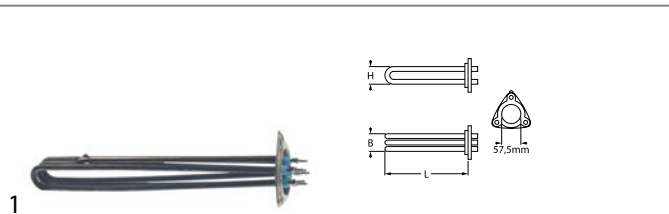

<b>GEV No.</b>	418084	<b>Ref. No.</b>	6003290
<b>description</b>	heating element 7599W 230V mounting ø 57.5mm heating circuits 3 L 340mm W 36mm H 42mm number of thermostat sleeves 1 thermostat sleeves ø 7mm length thermostat sleeves 270mm thermostat sleeve clinging tube ø 8.5mm hole distance 72mm hole ø 8mm connection M4 3 hole flange immersion heater		
<b>For models:</b>	EN10VE-EC-ESN1033, VE06EC, VE06MX, VE102EC, VE102MX, VE10EC, VE10MX		

## heating elements for convection



<b>GEV No.</b>	418087	<b>Ref. No.</b>	6002125
<b>description</b>	heating element 15000W 230/400V heating circuits 3 ID ø 398mm ED ø 415mm L 452mm H 121mm L1 32mm W1 105mm H1 80mm H2 25mm flange length 142mm flange width 25mm hole distance 126mm connection M4 tube ø 8.5mm convection heating element hole ø 6mm rectangular flange		
<b>For models:</b>	CE10MX, CE20MX, DE10EC, DE10ES, DE10MX, EF10GM, EF8PM, VE10EC, VE10MX, VE20EC, VE20MX		
<b>accessories for</b>	418087		
	<b>GEV No.</b>	550548	<b>Ref. No.</b> 2005173
	gasket L 144mm W 25.5mm thickness 2.2mm for heating element suitable for GIORIK equiv. no. 2005173		

Зип Общепит

vsezip.ru

+7(812)987-08-81

<b>GEV No.</b>	418088	<b>Ref. No.</b>	6002121
<b>description</b>	heating element 25000W 400V heating circuits 3 ID ø 388mm ED ø 406mm L 452mm H 150mm L1 35mm W1 105mm H1 21mm H2 130mm flange length 142mm flange width 25mm hole distance 126mm connection M4 connection length 72mm tube ø 8.5mm convection heating element hole ø 6mm rectangular flange		
<b>For models:</b>	CE102MX, DE102EC, DE102MX, VE102EC, VE102MX		
<b>accessories for</b>	418088		
	<b>GEV No.</b>	550548	<b>Ref. No.</b> 2005173
	gasket L 144mm W 25.5mm thickness 2.2mm for heating element suitable for GIORIK equiv. no. 2005173		



<b>GEV No.</b>	418858	<b>Ref. No.</b>	6002100
<b>description</b>	heating element 7350W 230V heating circuits 3 ID ø 215mm ED ø 230mm L 267mm H 85mm L1 38mm W1 102mm H1 5mm H2 80mm flange length 142mm flange width 25mm hole distance 63mm cable length 1000mm convection heating element hole ø 6mm		
<b>For models:</b>	EF4PM, EF5GM		



<b>GEV No.</b>	418086	<b>Ref. No.</b>	6002001
<b>description</b>	heating element 8400W 230V heating circuits 3 ID ø 218mm ED ø 235mm L 275mm H 112mm L1 40mm W1 105mm H1 32mm H2 80mm flange length 142mm flange width 25mm hole distance 64mm connection M4 tube ø 8.5mm convection heating element hole ø 6mm rectangular flange		
<b>For models:</b>	CE06MX, DE06EC, DE06ES, DE06MX, VE06EC, VE06MX		
<b>accessories for</b>	418086		
	<b>GEV No.</b>	550548	<b>Ref. No.</b> 2005173
	gasket L 144mm W 25.5mm thickness 2.2mm for heating element suitable for GIORIK equiv. no. 2005173		



Зип.Общепит  
thermostats

vsezip.ru  
+7(812)987-08-81

accessories

flange gaskets



<b>GEV No.</b>	550548	<b>Ref. No.</b>	2005173
<b>description</b>	gasket L 144mm W 25.5mm thickness 2.2mm for heating element suitable for GIORIK equiv. no. 2005173		
<b>For models:</b>	CE06MX, CE102MX, CE10MX, CE20MX, DE06EC, DE06ES, DE06MX, DE102EC, DE102MX, DE10EC, DE10ES, DE10MX, EF10GM, EF4PM, EF5GM, EF8PM, VE06EC, VE06MX, VE102EC, VE102MX, VE10EC, VE10MX, VE20EC, VE20MX		



<b>GEV No.</b>	510368	<b>Ref. No.</b>	2005174
<b>description</b>	gasket L 70mm W 23.5mm hole ø 5mm hole distance 56mm FIBER thickness 2mm for heating element		
<b>For models:</b>	EF4, EF6PM, EF7GM, EN10VE-EC-ESN1033		

energy regulators

EGO

1-circuit





<b>GEV No.</b>	380015	<b>Ref. No.</b>	6031020 6031023 6031024
<b>description</b>	energy regulator 230V 13A single-circuit turn direction right shaft ø 6x4.6mm shaft L 23mm mounting thread M4 power release 6-100% no. 50.57021.010		
<b>For models:</b>	DE06ES, DE06MX, DE102MX, DE10ES, DE10MX, DG06ES, DG06MX, DG102MX, DG10ES, DG10MX, EF10GM, EF4PM, EF5GM, EF6PM, EF7GM, EF8PM, GF10GM, GF4PM, GF5GM, GF6PM, GF7GM, GF8PM, S505, S505R, S510, S510S, S511, S511S, SR512R, VE06MX, VE102MX, VE10MX, VE20MX, VG06MX, VG102MX, VG10MX, VG20MX		

control and safety thermostats

control thermostats

55\_13\_series



<b>GEV No.</b>	375007	<b>Ref. No.</b>	6010015	
<b>description</b>	thermostat t.max. 110°C temperature range 30-110°C 1-pole 1NO 16A probe ø 6mm probe L 113mm capillary pipe 870mm capillary pipe isolatedmm gland nut M9x1 shaft L 25mm shaft position upper rotation 270°			
<b>For models:</b>	BME46, BME66, CP1BM, CPG1BM, SPE46			
<b>accessories for</b>	375007			
	<b>GEV No.</b>	110119	<b>Ref. No.</b>	—
	knob thermostat t.max. 110°C ø 50mm shaft ø 6x4.6mm shaft flat upper black temperature range 30-110°C rotation 270°			
	<b>GEV No.</b>	110241	<b>Ref. No.</b>	—
	knob thermostat t.max. 110°C ø 50mm shaft ø 6x4.6mm shaft flat upper black temperature range 30-110°C			

safety thermostats

55.10/19\_series



<b>GEV No.</b>	375968	<b>Ref. No.</b>	6010026
<b>description</b>	safety thermostat switch-off temp. 360°C 1-pole 1NC 16A probe ø 6mm probe L 77mm capillary pipe 870mm capillary pipe isolated 660mm gland nut M10x1 probe probe material SS M8x1		
<b>For models:</b>	CG102MX, CG10MX, DG06EC, DG06ES, DG06MX, DG102EC, DG102MX, DG10EC, DG10ES, DG10MX, EF4, GF10GM, GF4PM, GF5GM, GF6PM, GF7GM, GF8PM, VG06EC, VG06MX, VG102EC, VG102MX, VG10EC, VG10MX		

electric components



Зип Общежит

accessories

55.32\_series

E-G-O

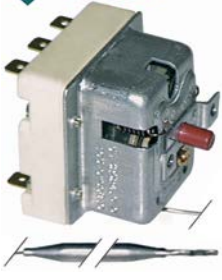

1

<b>GEV No.</b>	375277	<b>Ref. No.</b>	6010002
<b>description</b>	safety thermostat switch-off temp. 150°C 3-pole 3NC 20A probe $\phi$ 6mm probe L 79mm capillary pipe 900mm capillary pipe isolated 700mm gland nut probe		
<b>For models:</b>	22CP, 23CP, 2CP, 3CP, CP1, CP1BM, CPE66, EN10VE-EC-ESN1033, VE06EC, VE06MX, VE10EC, VE10MX, VG06EC, VG06MX, VG102EC, VG102MX, VG10EC, VG10MX, VG20EC, VG20MX		

E-G-O

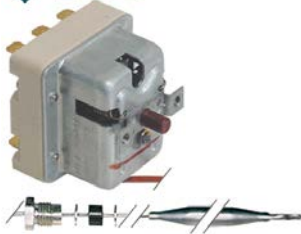

1

<b>GEV No.</b>	375628	<b>Ref. No.</b>	6010008
<b>description</b>	safety thermostat switch-off temp. 350°C 3-pole 20A probe $\phi$ 4mm probe L 120mm capillary pipe 900mm capillary pipe isolated 670mm gland nut M10x1 probe SS		
<b>For models:</b>	CE06MX, CE102MX, CE10MX, CE20MX, CG06MX, CG20MX, DE06EC, DE06ES, DE06MX, DE102EC, DE102MX, DE10EC, DE10ES, DE10MX, EF10GM, EF4PM, EF5GM, EF6PM, EF7GM, EF8PM, EN10VE-EC-ESN1033, VE06EC, VE06MX, VE102EC, VE102MX, VE10EC, VE10MX, VE20EC, VE20MX, VG20EC, VG20MX		

E-G-O

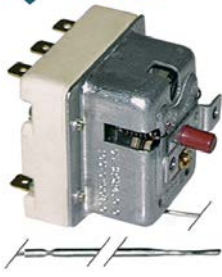

1

<b>GEV No.</b>	390142	<b>Ref. No.</b>	5910029
<b>description</b>	safety thermostat switch-off temp. 360°C 3-pole 20A probe $\phi$ 3.1mm probe L 188mm capillary pipe 1490mm capillary pipe isolated 800mm gland nut probe SS		

gland nut accessories

bolts with slot

+7(812)987-08-81

1

<b>GEV No.</b>	520244	<b>Ref. No.</b>	6030024
<b>description</b>	bolt with slot thread M10x1 Qty 10 pcs nickel-plated brass		
<b>For models:</b>	FTR10		

connecting bows

1



<b>GEV No.</b>	550060	<b>Ref. No.</b>	6030016
<b>description</b>	connecting bow long for thermostat Qty 1 pcs		
<b>For models:</b>	FRE46F, FRE46R, FRE66F, FRE66R, FT3N, FT5, FTE100, FTE107, FTE46, FTE46B, FTE46R, FTE47L, FTE66L, FTE66LB, FTE66LM, FTE66LMB, FTE66R, FTE66RM, FTR26F, FTR6F, SPE46		

switches and momentary switches

rocker/momentary rocker switches

30x22mm

1



<b>GEV No.</b>	346377	<b>Ref. No.</b>	6032030	
<b>description</b>	rocker switch mounting measurements 30x22mm black 2CO 230V 16A 0-I connection male faston 6.3mm ambient temperature max. 125/55°C protection IP40			
<b>accessories for</b>	346377			
	<b>GEV No.</b>	301036	<b>Ref. No.</b>	—
	protective cover internal size 30x22mm for rocker switch mounting measurementsmm			







push/momentary push switches

ø16mm



<b>GEV No.</b>	346345	<b>Ref. No.</b>	6032020
<b>description</b>	momentary push switch mounting ø 16mm black 1NO 250V 3A connection male faston 2.8mm ambient temperature max. 85°C protection IP40		
<b>For models:</b>	CE06MX, CE102MX, CE10MX, CE20MX, CG06MX, CG102MX, CG10MX, CG20MX, DE06MX, DE102MX, DE10MX, DG06MX, DG102MX, DG10MX, VE06MX, VE102MX, VE10MX, VE20MX, VG06MX, VG102MX, VG10MX, VG20MX		
<b>accessories for</b>	346345		
	<b>GEV No.</b>	346343	<b>Ref. No.</b> 6032021
	protective cover		
	<b>GEV No.</b>	346344	<b>Ref. No.</b> 6032022
	ring for protecting cover		



<b>GEV No.</b>	346346	<b>Ref. No.</b>	6032038
<b>description</b>	momentary push switch mounting ø 16mm red 1NO/indicator light 250V 3A connection male faston 2.8mm ambient temperature max. 125/55°C protection IP40		
<b>For models:</b>	CG20MX, DG06EC, DG06ES, DG06MX, DG102EC, DG102MX, DG10EC, DG10ES, DG10MX, GF10GM, GF4PM, GF5GM, GF6PM, GF7GM, GF8PM, VG06EC, VG06MX, VG102EC, VG102MX, VG10EC, VG10MX, VG20EC, VG20MX		

accessories

protective covers



<b>GEV No.</b>	346343	<b>Ref. No.</b>	6032021
<b>description</b>	protective cover		
<b>For models:</b>	CE06MX, CE102MX, CE10MX, CE20MX, CG06MX, CG102MX, CG10MX, CG20MX, DE06MX, DE102MX, DE10MX, DG06EC, DG06MX, DG102EC, DG102MX, DG10EC, DG10MX, VE06MX, VE102MX, VE10MX, VE20MX, VG06EC, VG06MX, VG102EC, VG102MX, VG10EC, VG10MX, VG20EC, VG20MX		
<b>accessories for</b>	346343		
	<b>GEV No.</b>	346344	<b>Ref. No.</b> 6032022
	ring for protecting cover		

Зип Общепит

vsezip.ru

+7(812)987-08-81

<b>GEV No.</b>	346344	<b>Ref. No.</b>	6032022
<b>description</b>	ring for protecting cover		
<b>For models:</b>	CE06MX, CE102MX, CE10MX, CE20MX, CG06MX, CG102MX, CG10MX, CG20MX, DE06MX, DE102MX, DE10MX, DG06EC, DG06MX, DG102EC, DG102MX, DG10EC, DG10MX, VE06MX, VE102MX, VE10MX, VE20MX, VG06EC, VG06MX, VG102EC, VG102MX, VG10EC, VG10MX, VG20EC, VG20MX		
<b>accessories for</b>	346344		
	<b>GEV No.</b>	346343	<b>Ref. No.</b> 6032021
	protective cover		

microswitches

lever actuated



<b>GEV No.</b>	345773	<b>Ref. No.</b>	6043085
<b>description</b>	microswitch with lever 250V 16A 1CO connection male faston 6.3mm L 60mm ambient temperature max. 125°C mounting distance 22mm actuating force: 65g lever length 51mm		
<b>For models:</b>	15FE, 15FEC, 20FE, 20FEC, 210FE, 210FEC, 215FE, 215FEC, 220FE, 220FEC, 920FE, 920FEC, 922FE, 922FEC, 940FE, 940FEC, F10CL, F10L, F15CL, F15L, F215CL, F215L, FP18NS, FP18S, FP27S, FRE46, FRE46R, FRE66, FRE66R, SH510P, SH560P		

pin-plunger actuated

M10



<b>GEV No.</b>	346347	<b>Ref. No.</b>	6043088
<b>description</b>	microswitch with plunger thread M10x0.75 thread L 14mm 250V 6A 2NO connection male faston 6.3mm stroke 4mm mounting distance 22mm ambient temperature max. 85°C actuating force: 100g		
<b>For models:</b>	CE06MX, CE102MX, CE10MX, CE20MX, CG06MX, CG102MX, CG10MX, CG20MX, DE06EC, DE06ES, DE06MX, DE102EC, DE102MX, DE10EC, DE10ES, DE10MX, DG06EC, DG06ES, DG06MX, DG102EC, DG102MX, DG10EC, DG10ES, DG10MX, VE06EC, VE06MX, VE102EC, VE102MX, VE10EC, VE10MX, VE20EC, VE20MX, VG06EC, VG06MX, VG102MX, VG10EC, VG10MX, VG20EC, VG20MX		



<b>GEV No.</b>	345032	<b>Ref. No.</b>	6043080
<b>description</b>	microswitch with plunger thread M10x1 thread L 12mm 250V 16A 1CO connection male faston 6.3mm stroke 7mm mounting distance 22mm L 28mm ambient temperature max. 125°C type SP9603 actuating force: 180g		

electric components



## cam switches

on/off



1

<b>GEV No.</b>	300129	<b>Ref. No.</b>	6030007
<b>description</b>	cam switch 2 operating positions 2NO sequence 0-1 16A shaft $\phi$ 6x4.6mm shaft L 23mm connection male faston 6.3mm ceramic		
<b>For models:</b>	13FGC, 17FGC, 207FGC, 213FGC, 217FGC, 917FGC, 927FGC, 934FGC, BM711, BM721, BM911, BM921, BME46, BME66, CE06MX, CE102MX, CE10MX, CE20MX, CG06MX, CG102MX, CG10MX, CG20MX, EF10GM, EF4PM, EF5GM, EF6PM, EF7GM, EF8PM, EN10VE-EC-ESN1033, FG07CL, FG213CL, GF10GM, GF4PM, GF5GM, GF6PM, GF7GM, GF8PM		



1

<b>GEV No.</b>	300139	<b>Ref. No.</b>	6030012
<b>description</b>	cam switch ON-OFF connection male faston		
<b>For models:</b>	210FEC, 922FEC, EF4, F10CL, F15CL, F215CL, FP18NS, FP18S, FP27S, FTR10, SH505R, SH510P, SH510R, SH520G, SH520GM, SH560P		

## 7-position



1

<b>GEV No.</b>	300106	<b>Ref. No.</b>	6030001
<b>description</b>	cam switch 7 operating positions 1NO/2CO sequence 0-1-2-3-4-5-6 32A shaft $\phi$ 6x4.6mm shaft L 23mm connection screw 7-position shaft flat upper		

## Зип Общежит

4 operating positions



1

<b>GEV No.</b>	300010	<b>Ref. No.</b>	6030018 6030018OBS
<b>description</b>	cam switch 4 operating positions 2NO/2CO sequence 0-1-2-3 16A shaft $\phi$ 6x4.6mm shaft L 23mm connection male faston 6.3mm ceramic		

## operation switches



1

<b>GEV No.</b>	300002	<b>Ref. No.</b>	6030019
<b>description</b>	cam switch 2 operating positions 4NO 16A sequence 0-1 shaft $\phi$ 6x4.6mm shaft L 23mm connection male faston 6.3mm ceramic		



1

<b>GEV No.</b>	300200	<b>Ref. No.</b>	6030015
<b>description</b>	operation switch 2 operating positions 2NO 16A sequence 0-1 shaft $\phi$ 6x4.6mm shaft L 23mm connection male faston 6.3mm operation switch ceramic		
<b>For models:</b>	13FG, 17FG, 207FG, 213FG, 217FG, 917FG, 927FG, 934FG, CP1BM, CPG1BM, FRE46F, FRE66F, FT3N, FT5, FTE100, FTE107, FTE46, FTE46B, FTE46R, FTE47L, FTE66LM, FTE66LMB, FTE66RM, FTR26F, FTR6F, SPE46		

## rotary switches

BREMAS

A1600 series





1

<b>GEV No.</b>	346342	<b>Ref. No.</b>	6030031
<b>description</b>	rotary switch 7 1-2-3-4-5-6-7 sets of contacts 9 type CS0169137 400V 16A shaft $\phi$ 4x5mm shaft L 20mm shaft square connection screw		
<b>For models:</b>	VE06MX, VE102MX, VE10MX, VE20MX, VG06MX, VG102MX, VG10MX, VG20MX		





Зип-Общепит  
vsezip.ru  
7(812)987-08-81

			
1			
<b>GEV No.</b>	346341	<b>Ref. No.</b>	6030030
<b>description</b>	rotary switch 8 1-2-3-4-5-6-7-8 sets of contacts 10 type CS0169134 400V 16A shaft ø 4x5mm shaft L 20mm shaft square connection screw		
<b>For models:</b>	DE06EC, DE06ES, DE06MX, DE102EC, DE10EC, DE10ES, DE10MX, DG06EC, DG06ES, DG06MX, DG102EC, DG102MX, DG10EC, DG10ES, DG10MX, VE06EC, VE102EC, VE10EC, VE20EC, VG06EC, VG102EC, VG10EC, VG20EC		

indicator lamp with socket type SRZ / SDK / SDY / SFK			
1			
<b>GEV No.</b>	359430	<b>Ref. No.</b>	6061067
<b>description</b>	indicator lamp 230V clear connection cable 400mm		
<b>For models:</b>	EF4, FP18NS, FP18S, FP27S, FT3N, FT5, FTR10, FTR26F, FTR26T, FTR6F, FTR6T, S505, S505R, S510, S510S, S511, S511S		
<b>accessories for</b>	359430		
		<b>GEV No.</b>	359260
		<b>Ref. No.</b>	—
	indicator light housings mounting measurements ø12mm yellow round Qty 1 pcs		

## encoders and potentiometers

			
1			
<b>GEV No.</b>	401169	<b>Ref. No.</b>	6010102
<b>description</b>	encoder cable length 125mm		
<b>For models:</b>	DE06EC, DE102EC, DE10EC, DG06EC, DG102EC, DG10EC, SH505R, SH510P, SH510R, SH520G, SH520GM, SH560P, VE06EC, VE102EC, VE10EC, VE20EC, VG06EC, VG102EC, VG10EC, VG20EC		

			
1			
<b>GEV No.</b>	359431	<b>Ref. No.</b>	6061068
<b>description</b>	indicator lamp 230V green connection cable 400mm cable material silicone		
<b>For models:</b>	EF4, FP18NS, FP18S, FP27S, FT3N, FT5, FTR10, FTR26F, FTR26T, FTR6F, FTR6T, SR512, SR512R		

			
1			
<b>GEV No.</b>	300187	<b>Ref. No.</b>	6010097
<b>description</b>	potentiometer 4.7KOhm rotation 310° shaft ø 0.6x4.5mm shaft L 20mm cable length 650mm		
<b>For models:</b>	CE06MX, CE102MX, CE10MX, CE20MX, CG06MX, CG102MX, CG10MX, CG20MX, DE06ES, DE06MX, DE102MX, DE10ES, DE10MX, DG06ES, DG06MX, DG102MX, DG10ES, DG10MX, EF10GM, EF4PM, EF5GM, EF6PM, EF7GM, EF8PM, GF10GM, GF4PM, GF5GM, GF6PM, GF7GM, GF8PM, VE06MX, VE102MX, VE10MX, VE20MX, VG06MX, VG102MX, VG10MX, VG20MX		

indicator lights (complete)			
ø12mm			
with screw socket			
			
1			
<b>GEV No.</b>	359048	<b>Ref. No.</b>	6061051
<b>description</b>	indicator light ø 12mm 230V yellow connection male faston 6.3mm		

			
1			
<b>GEV No.</b>	359291	<b>Ref. No.</b>	6061050
<b>description</b>	indicator light ø 12mm 400V green connection male faston 6.3mm		

## lamps

### indicator lights

#### indicator lights 2-piece (lens and indicator lamp)

#### indicator light lenses

ø13mm (type SFK-3)

			
1			
<b>GEV No.</b>	359225	<b>Ref. No.</b>	6061069
<b>description</b>	indicator light housings mounting measurements ø13mm clear Qty 1 pcs		
<b>For models:</b>	EF4, FP18NS, FP18S, FP27S, FT3N, FT5, FTR10, FTR26F, FTR26T, FTR6F, FTR6T, S505, S505R, S510, S510S, S511, S511S		

### screw-on/push-on fit

#### light bulbs

for ovens

			
1			
<b>GEV No.</b>	359610	<b>Ref. No.</b>	6061052
<b>description</b>	light bulb t.max. 300°C socket E14 15W 230V ø 22mm L 47mm lens L 20mm for oven lamp type Philips		



PHILIPS



1

<b>GEV No.</b>	359612	<b>Ref. No.</b>	6061053
<b>description</b>	light bulb t.max. 300°C socket E14 25W 230V ø 25mm L 56mm lens L 30mm for oven lamp type Philips		
<b>For models:</b>	EN10VE-EC-ESN1033		

## halogen lamp

for socket G4 / G6.35 / G9



1

<b>GEV No.</b>	359599	<b>Ref. No.</b>	6061054
<b>description</b>	halogen lamp socket G4 12V 20W temp.-resist. 500°C		
<b>For models:</b>	CE06MX, CE102MX, CE10MX, CE20MX, CG06MX, CG102MX, CG10MX, CG20MX, DE06EC, DE06ES, DE06MX, DE102EC, DE102MX, DE10EC, DE10ES, DE10MX, DG06EC, DG06ES, DG06MX, DG102EC, DG102MX, DG10EC, DG10ES, DG10MX, VE06EC, VE06MX, VE102EC, VE102MX, VE10EC, VE10MX, VE20EC, VE20MX, VG06EC, VG06MX, VG102EC, VG102MX, VG10EC, VG10MX, VG20EC, VG20MX		



## oven lamps

## universal oven lamps

mounting diameter 35.5mm



1

<b>GEV No.</b>	359718	<b>Ref. No.</b>	6063072	
<b>description</b>	oven lamp mounting ø 35.5mm 230V 15W socket E14 temp.-resist. 300°C connection male faston 6.3mm hard glas			
<b>spare parts for</b>	359718			
	<b>GEV No.</b>	359701	<b>Ref. No.</b>	—
	lamp socket socket E14 220-230V mounting ø 35.5mm connection male faston 6.3mm 15W			
	<b>GEV No.</b>	359740	<b>Ref. No.</b>	—
	light bulb t.max. 300°C socket E14 15W 230V ø 22mm L 48mm lens L 20mm for oven lamp IMPORT			

Зип Общепит



vsezip.ru

+7(812)987-08-81

mounting diameter 47.8mm



1

<b>GEV No.</b>	359499	<b>Ref. No.</b>	6060055	
<b>description</b>	lamp socket socket E14 mounting ø 47.8mm connection male faston 6.3mm			
<b>For models:</b>	EF10GM, EF4PM, EF5GM, EF6PM, EF7GM, EF8PM, GF10GM, GF4PM, GF5GM, GF6PM, GF7GM, GF8PM			
<b>accessories for</b>	359499			
	<b>GEV No.</b>	359612	<b>Ref. No.</b>	6061053
	light bulb t.max. 300°C socket E14 25W 230V ø 25mm L 56mm lens L 30mm for oven lamp type Philips			
	<b>GEV No.</b>	359725	<b>Ref. No.</b>	—
	oven lamp glass thread ø 44mm H 43mm ø 54mm hard glas temp.-resist. 350°C			

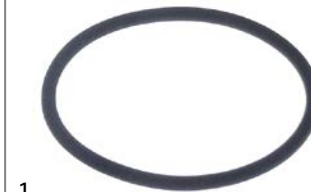

1

<b>GEV No.</b>	525313	<b>Ref. No.</b>	6090140
<b>description</b>	O-ring Viton ID ø 60.33mm thickness 3.53mm Qty 1 pcs		
<b>For models:</b>	EF10GM, EF4PM, EF5GM, EF6PM, EF7GM, EF8PM, GF10GM, GF4PM, GF5GM, GF6PM, GF7GM, GF8PM		



1

<b>GEV No.</b>	532649	<b>Ref. No.</b>	6090141
<b>description</b>	O-ring Viton ID ø 63.17mm thickness 2.62mm Qty 1 pcs		
<b>For models:</b>	EF10GM, EF4PM, EF5GM, EF6PM, EF7GM, EF8PM, GF10GM, GF4PM, GF5GM, GF6PM, GF7GM, GF8PM		



Зип Общепит

vsezip.ru

+7(812)987-08-81

30x70mm

1



<b>GEV No.</b>	359338	<b>Ref. No.</b>	6063077
<b>description</b>	lamp glass		
<b>For models:</b>	CE06MX, CE102MX, CE10MX, CE20MX, CG06MX, CG102MX, CG10MX, CG20MX, DE06EC, DE06ES, DE06MX, DE102EC, DE102MX, DE10EC, DE10ES, DE10MX, DG06EC, DG06ES, DG06MX, DG102EC, DG102MX, DG10EC, DG10ES, DG10MX, VE06EC, VE06MX, VE102EC, VE102MX, VE10EC, VE10MX, VE20EC, VE20MX, VG06EC, VG06MX, VG102EC, VG102MX, VG10EC, VG10MX, VG20EC, VG20MX		

2



<b>GEV No.</b>	359337	<b>Ref. No.</b>	6063075
<b>description</b>	oven lamp socket G4 cable length 800mm connection Faston 6.3mm L 70mm W 29mm		
<b>For models:</b>	CE06MX, CE102MX, CE10MX, CE20MX, CG06MX, CG102MX, CG10MX, CG20MX, DE06EC, DE06ES, DE06MX, DE102EC, DE102MX, DE10EC, DE10ES, DE10MX, DG06EC, DG06ES, DG06MX, DG102EC, DG102MX, DG10EC, DG10ES, DG10MX, VE06EC, VE06MX, VE102EC, VE102MX, VE10EC, VE10MX, VE20EC, VE20MX, VG06EC, VG06MX, VG102EC, VG102MX, VG10EC, VG10MX, VG20EC, VG20MX		
<b>accessories for</b>	359337		
	<b>GEV No.</b>	359599	<b>Ref. No.</b> 6061054
		halogen lamp socket G4 12V 20W temp.-resist. 500°C	

55x70mm

1



<b>GEV No.</b>	359368	<b>Ref. No.</b>	6063074
<b>description</b>	lamp glass		

55x100mm





1



<b>GEV No.</b>	359714	<b>Ref. No.</b>	6063070
<b>description</b>	gasket silicone L 140mm W 75mm for bulb socket		

1



<b>GEV No.</b>	101372	<b>Ref. No.</b>	6063069
<b>description</b>	oven lamp complete L 100mm W 55mm 230V 25W socket E14 rectangular temp.-resist. 300°C connection male faston 6.3mm		
<b>spare parts for</b>	101372		
	<b>GEV No.</b>	359612	<b>Ref. No.</b> 6061053
	light bulb t.max. 300°C socket E14 25W 230V ø 25mm L 56mm lens L 30mm for oven lamp type Philips		
	<b>GEV No.</b>	359698	<b>Ref. No.</b> —
	lamp socket L 100mm W 55mm socket E14 connection male faston 6.3mm		
	<b>GEV No.</b>	359714	<b>Ref. No.</b> 6063070
	gasket silicone L 140mm W 75mm for bulb socket		
	<b>GEV No.</b>	359715	<b>Ref. No.</b> —
	lamp glass L 110mm W 65mm thickness 5mm		
	<b>GEV No.</b>	359716	<b>Ref. No.</b> —
	frame for bulb socket		

lamps

light bulbs

1



<b>GEV No.</b>	359610	<b>Ref. No.</b>	6061052
<b>description</b>	light bulb t.max. 300°C socket E14 15W 230V ø 22mm L 47mm lens L 20mm for oven lamp type Philips		

1



<b>GEV No.</b>	359612	<b>Ref. No.</b>	6061053
<b>description</b>	light bulb t.max. 300°C socket E14 25W 230V ø 25mm L 56mm lens L 30mm for oven lamp type Philips		
<b>For models:</b>	EN10VE-EC-ESN1033		



## Зип-Общепит

mechanical timers

## halogen lamps

for socket G4 / G6.35 / G9



<b>GEV No.</b>	359599	<b>Ref. No.</b>	6061054
<b>description</b>	halogen lamp socket G4 12V 20W temp.-resist. 500°C		
<b>For models:</b>	CE06MX, CE102MX, CE10MX, CE20MX, CG06MX, CG102MX, CG10MX, CG20MX, DE06EC, DE06ES, DE06MX, DE102EC, DE102MX, DE10EC, DE10ES, DE10MX, DG06EC, DG06ES, DG06MX, DG102EC, DG102MX, DG10EC, DG10ES, DG10MX, VE06EC, VE06MX, VE102EC, VE102MX, VE10EC, VE10MX, VE20EC, VE20MX, VG06EC, VG06MX, VG102EC, VG102MX, VG10EC, VG10MX, VG20EC, VG20MX		

## timers

## electric timers



<b>GEV No.</b>	350135	<b>Ref. No.</b>	6032042 6032059
<b>description</b>	timer M565 operation time 120min time spreadmin 1CO/2NO at 250V 16A permanent position yes time range 0-120min impulse electric shaft ø 6x4.6mm shaft L 21mm mounting distance 28mm connection male faston 6.3mm screw mounting 250V voltage AC 50Hz		



## with time spread



<b>GEV No.</b>	350074	<b>Ref. No.</b>	6032047
<b>description</b>	timer M565 operation time 120min time spread 30min 1CO/2NO/1NC at 250V 16A permanent position yes impulse electric shaft ø 6x4.6mm shaft L 22mm mounting distance 28mm connection lateral Invensys 4-pole shaft position lower*		
<b>For models:</b>	CE06MX, CE102MX, CE10MX, CE20MX, CG06MX, CG102MX, CG10MX, CG20MX, DE06ES, DE06MX, DE102MX, DE10ES, DE10MX, DG06ES, DG06MX, DG102MX, DG10ES, DG10MX, EF10GM, EF4, EF4PM, EF5GM, EF6PM, EF7GM, EF8PM, GF10GM, GF4PM, GF5GM, GF6PM, GF7GM, GF8PM, VE06MX, VE102MX, VE10MX, VE20MX, VG06MX, VG102MX, VG10MX, VG20MX		

vsezip.ru

+7(812)987-08-81

<b>GEV No.</b>	350003	<b>Ref. No.</b>	6032040	
<b>description</b>	timer M2 with bell 2-pole operation time 120min impulse mechanical 2NO at 250V 16A permanent position no shaft ø 6x4.6mm shaft 6x4.6mm shaft L 23mm mounting distance 28mm connection lateral			
<b>accessories for</b>	350003			
	<b>GEV No.</b>	110366	<b>Ref. No.</b>	—
	knob switch zero mark t.max. °C°C ø 44mm shaft ø 6x4.6mm shaft flat upper black			
	<b>GEV No.</b>	111199	<b>Ref. No.</b>	—
	dial plate graduation 120min permanent position no rotation 0-330° ø 60mm timers knob ø 45mm			

## alarm devices

## buzzer boards



<b>GEV No.</b>	401062	<b>Ref. No.</b>	6010090
<b>description</b>	buzzer board 230VAC L 48mm W 45mm connection Faston 6.3mm		
<b>For models:</b>	CE06MX, CE102MX, CE10MX, CE20MX, CG06MX, CG102MX, CG10MX, CG20MX, DE06MX, DE102MX, DE10MX, DG06MX, DG102MX, DG10MX, EF10GM, EF4PM, EF5GM, EF6PM, EF7GM, EF8PM, GF10GM, GF4PM, GF5GM, GF6PM, GF7GM, GF8PM		

## contactors

## ABB

## power contactors



<b>GEV No.</b>	380100	<b>Ref. No.</b>	6046045
<b>description</b>	power contactor resistive load 20A 230VAC (AC3/400V) 12A/5.5kW main contacts 3NO auxiliary contacts 1NO connection screw connection type B6-30-10 / B7-30-10		

Зип Общепит

vsezip.ru

+7(812)987-08-81

auxiliary contacts



1	<b>GEV No.</b>	381028	<b>Ref. No.</b>	6046145
<b>description</b> auxiliary contact contacts 1NO/1NC AC1 6A AC15 3A connection screw connection for contactors B6/B7/VB7				

GENERAL ELECTRIC (AEG)

power contactors



1	<b>GEV No.</b>	380244	<b>Ref. No.</b>	6046043
<b>description</b> power contactor resistive load 25A 230VAC (AC3/400V) 9A/4kW main contacts 3NO auxiliary contacts 1NO connection screw connection type AEG LS4K 10A type GE CL00A 310				
<b>For models:</b> F10CL, F10L, F15CL, F15L, F215CL, F215L, FP18NS, FP18S, FP27S, FRE46, FRE66				

ISKRA (FANAL)

power contactors



1	<b>GEV No.</b>	380204	<b>Ref. No.</b>	6046033 6046038
<b>description</b> power contactor resistive load 25A 230VAC (AC3/400V) 9A/4kW main contacts 3NO auxiliary contacts 1NO connection screw connection type Fanal DSL9 10 type ISKRA KNL9 10				
<b>For models:</b> 15FE, 15FEC, 20FEC, 210FE, 210FEC, 215FE, 215FEC, 220FEC, 920FEC, 922FE, 922FEC, 940FEC, CE06MX, CE102MX, CE10MX, CE20MX, CG06MX, CG102MX, CG10MX, CG20MX, DE06EC, DE06ES, DE06MX, DE102EC, DE102MX, DE10EC, DE10ES, DE10MX, DG06ES, DG06MX, DG102MX, DG10ES, DG10MX, EF10GM, EF4, EF4PM, EF5GM, EF6PM, EF7GM, EF8PM, EN10VE-EC-ESN1033, GF10GM, GF4PM, GF5GM, GF6PM, GF7GM, GF8PM, VE06EC, VE06MX, VE102EC...(Other models you can see in the webshop)				



1	<b>GEV No.</b>	380424	<b>Ref. No.</b>	6046041					
<b>description</b> power contactor resistive load 35A 230VAC (AC3/400V) 32A/15kW main contacts 3NO connection screw connection type Fanal DSL30 type ISKRA KNL30									
<b>accessories for</b> 380424									
<table border="1"> <tr> <td></td> <td><b>GEV No.</b></td> <td>381378</td> <td><b>Ref. No.</b></td> <td>—</td> </tr> </table>						<b>GEV No.</b>	381378	<b>Ref. No.</b>	—
	<b>GEV No.</b>	381378	<b>Ref. No.</b>	—					
overload switch connection screw setting range 24,5-30A for contactors KNL30 type BR30 24.5-30A									

relays

power relays

with DIN rail mounting

lateral



1	<b>GEV No.</b>	380379	<b>Ref. No.</b>	6041013
<b>description</b> power relays SCHRACK 230VAC 25A 2CO connection male faston 6.3mm DIN rail manuf. no. RM809730				
<b>For models:</b> SH505R, SH510R				

with bracket mounting



1	<b>GEV No.</b>	380702	<b>Ref. No.</b>	6041008
<b>description</b> power relays FINDER 230VAC 16A 3NO connection male faston 6.3mm flange dimensions 36x38x68mm manuf. no. 62.83.8.230.0300 230V				



## plug-in/print relays

Зип Общепит

level relays

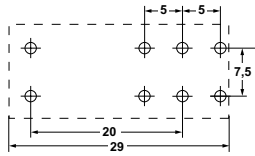

1

<b>GEV No.</b>	380333	<b>Ref. No.</b>	6041009
----------------	--------	-----------------	---------

**description** print relay 230VAC 2CO at 250V 8A connection pins raster size 5mm FINDER manuf. no. 40.52.8.230.0000 95.65/95.75

**accessories for** 380333



<b>GEV No.</b>	380340	<b>Ref. No.</b>	—
----------------	--------	-----------------	---

relay socket dimensions 62x36x15mm 250V voltage AC 10A Italiana Relè manuf. no. ZMEM/5



<b>GEV No.</b>	380505	<b>Ref. No.</b>	—
----------------	--------	-----------------	---

relay socket 2CO 40.52 dimensions 81.9x15.5x75mm 250V voltage AC 10A FINDER manuf. no. 95.95.3



<b>GEV No.</b>	381181	<b>Ref. No.</b>	6040015
----------------	--------	-----------------	---------

relay socket 2-pole 40.51/40.52/40.61 connection screw clamp dimensions 15.8x78.6mm 250V voltage AC 10A FINDER manuf. no. 95.75

## relay sockets



1

<b>GEV No.</b>	381181	<b>Ref. No.</b>	6040015
----------------	--------	-----------------	---------

**description** relay socket 2-pole 40.51/40.52/40.61 connection screw clamp dimensions 15.8x78.6mm 250V voltage AC 10A FINDER manuf. no. 95.75

**accessories for** 381181



<b>GEV No.</b>	381455	<b>Ref. No.</b>	—
----------------	--------	-----------------	---

support bracket

GICAR  
vsezip.ru

+7(812)987-08-81



1

<b>GEV No.</b>	401173	<b>Ref. No.</b>	6041043
----------------	--------	-----------------	---------

**description** level relay 230V connection F6.3 type RL30/3ES/F

**For models:** EN10VE-EC-ESN1033, VE06EC, VE06MX, VE102EC, VE102MX, VE10EC, VE10MX, VE20EC, VE20MX, VG06EC, VG06MX, VG102EC, VG102MX, VG10EC, VG10MX, VG20EC, VG20MX

## time relays

## time relays



1

<b>GEV No.</b>	381119	<b>Ref. No.</b>	6042049
----------------	--------	-----------------	---------

**description** time relay LOVATO TM D time range 0.06-180s

**For models:** VE06EC, VE06MX, VE102EC, VE102MX, VE10EC, VE10MX, VE20EC, VE20MX, VG06EC, VG06MX, VG102EC, VG102MX, VG10EC, VG10MX, VG20EC, VG20MX



1

<b>GEV No.</b>	380607	<b>Ref. No.</b>	6042054
----------------	--------	-----------------	---------

**description** time relay LOVATO TM M1 time range 0s-10 days 12-24V AC/DC 8A 1CO connection grip connection

**For models:** VE06MX, VE102MX, VE10MX, VE20MX, VG06MX, VG102MX, VG10MX, VG20MX



Зип Общепит electronic controllers

vsezip.ru

+7(812)987-08-81



1

<b>GEV No.</b>	380606	<b>Ref. No.</b>	6042056
<b>description</b>	time relay LOVATO TM PL time range 2x 0.1s-100 days 12-240V AC/DC 8A 1CO connection grip connection		
<b>For models:</b>	DE06ES, DE06MX, DE102MX, DE10ES, DE10MX, DG06ES, DG06MX, DG102MX, DG10ES, DG10MX		

EVCO - EVERY CONTROL universal controllers

built-in version 66,5 x 66,5mm



1

<b>GEV No.</b>	378169	<b>Ref. No.</b>	6011125 6011130
<b>description</b>	electronic controller EVERY CONTROL EV7401 mounting measurements 66.5x66.5mm built-in depth 90mm 24/230V voltage AC NTC/PTC/Pt100/TC(J,K)/mA relay outputs 1 CO-8A(3) NTC/PTC/Pt100/TC(J,K)/mA yes protection IP54 dependent on probe°C display 4 digits		
<b>accessories for</b>	378169		

transformers

encapsulated transformers

PMA



1

<b>GEV No.</b>	379054	<b>Ref. No.</b>	6010086
<b>description</b>	transformer primary 230VAC secondary 12VAC 3VA secondary 0.25A H 40mm L 45mm W 50mm connection screw 50/60Hz type 153/M		
<b>For models:</b>	SH505R, SH510R, SH520G, SH520GM		



1

<b>GEV No.</b>	401174	<b>Ref. No.</b>	6010079
<b>description</b>	transformer primary 230VAC secondary 12VAC 6VA secondary 0.5A connection screw 50Hz		
<b>For models:</b>	DE06EC, DE102EC, DE10EC, DG06EC, DG102EC, DG10EC, EN10VE-EC-ESN1033, SH510P, SH560P, VE06EC, VE102EC, VE10EC, VE20EC, VG06EC, VG102EC, VG10EC, VG20EC		

<b>GEV No.</b>	379053	<b>Ref. No.</b>	—
<b>description</b>	temperature probe PTC 1kOhm cable PVC probe -50 up to +150°C cable -10 up to 100°C probe ø6x30mm cable length 3m without screw connection 2-wire		
<b>GEV No.</b>	379062	<b>Ref. No.</b>	—
<b>description</b>	temperature probe thermocouple J (Fe-CuNi) cable Vetrotex probe -50 up to +750°C cable -50 up to +350°C probe ø6x50mm cable length 3m without screw connection 2-wire		
<b>GEV No.</b>	379064	<b>Ref. No.</b>	—
<b>description</b>	temperature probe PTC 1kOhm cable silicone probe -50 up to +150°C cable -50 up to +180°C probe ø6x40mm cable length 3m without screw connection 2-wire		
<b>GEV No.</b>	379131	<b>Ref. No.</b>	—
<b>description</b>	temperature probe Pt100 cable Vetrotex probe -200 up to +600°C cable -50 up to +350°C probe ø6x85mm cable length 3m without screw connection 3-wire resistance at 0°C 100Ohm		
<b>GEV No.</b>	379161	<b>Ref. No.</b>	—
<b>description</b>	temperature probe NTC 10kOhm cable thermoplastic probe -40 up to +110°C cable -40 up to +110°C probe ø6x14mm cable length 3m without screw connection 2-wire		

for lighting



1

<b>GEV No.</b>	401175	<b>Ref. No.</b>	6041065
<b>description</b>	transformer primary 230V secondary 11.5V 90VA		
<b>For models:</b>	CE06MX, CE102MX, CE10MX, CE20MX, CG06MX, CG102MX, CG10MX, CG20MX, DE06EC, DE06ES, DE06MX, DE102EC, DE102MX, DE10EC, DE10ES, DE10MX, DG06EC, DG06ES, DG06MX, DG102EC, DG102MX, DG10EC, DG10ES, DG10MX, VE06EC, VE06MX, VE102EC, VE102MX, VE10EC, VE10MX, VE20EC, VE20MX, VG06EC, VG06MX, VG102EC, VG102MX, VG10EC, VG10MX, VG20EC, VG20MX		

electric components





## SHANGFANG

Зип.Общепит electronics

## accessories



1

<b>GEV No.</b>	379054	<b>Ref. No.</b>	6010086
<b>description</b>	transformer primary 230VAC secondary 12VAC 3VA secondary 0.25A H 40mm L 45mm W 50mm connection screw 50/60Hz type 153/M		
<b>For models:</b>	SH505R, SH510R, SH520G, SH520GM		

## frequency converters



1

<b>GEV No.</b>	403841	<b>Ref. No.</b>	6010130 6010131
<b>description</b>	frequency converter with heat sink for combi-steamer L 135mm W 135mm 800W ECS P0010205-0		

## probes

## universal probes

## temperature probes



1

<b>GEV No.</b>	379860	<b>Ref. No.</b>	6000100
<b>description</b>	temperature probe NTC 10kOhm cable PVC probe -20 up to +80°C cable -10 up to 100°C probe ø6x40mm cable length 1.5m without screw connection 2-wire		



1

<b>GEV No.</b>	379222 <sup>1</sup>	<b>Ref. No.</b>	6000083
<b>description</b>	temperature probe Pt100 cable Vetrotex probe -200 up to +600°C cable -50 up to +350°C probe ø4x110mm cable length 1.4m 3-wire		
<b>For models:</b>	CE06MX, CE102MX, CE10MX, CE20MX, CG06MX, CG102MX, CG10MX, CG20MX, DE06ES, DE06MX, DE102MX, DE10ES, DE10MX, DG06ES, DG06MX, DG102MX, DG10ES, DG10MX, VE06MX, VE102EC, VE102MX, VE10MX, VE20MX, VG06MX, VG102MX, VG10MX, VG20MX		

<sup>1</sup>3-wire

1

<b>GEV No.</b>	379050 <sup>1</sup>	<b>Ref. No.</b>	6000085
<b>description</b>	temperature probe Pt100 cable Vetrotex probe -200 up to +600°C cable -50 up to +350°C probe ø6x100mm cable length 2.7m without screw connection 3-wire		
<b>For models:</b>	EF10GM, EF4PM, EF5GM, EF6PM, EF7GM, EF8PM, EN10VE-EC-ESN1033, GF10GM, GF4PM, GF5GM, GF6PM, GF7GM, GF8PM		

<sup>1</sup>3-wire

## PCBs

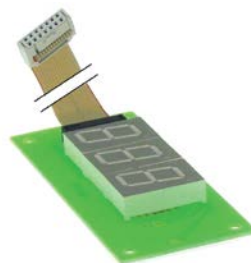

1

<b>GEV No.</b>	401166	<b>Ref. No.</b>	6010095
<b>description</b>	display		
<b>For models:</b>	CE06MX, CE102MX, CE20MX, CG06MX, CG102MX, CG10MX, CG20MX, DE06ES, DE06MX, DE102MX, DE10ES, DE10MX, DG06ES, DG06MX, DG102MX, DG10ES, DG10MX, EF10GM, EF4PM, EF5GM, EF6PM, EF7GM, EF8PM, GF10GM, GF4PM, GF5GM, GF6PM, GF7GM, GF8PM, VE06MX, VE102MX, VE10MX, VE20MX, VG06MX, VG102MX, VG10MX, VG20MX		

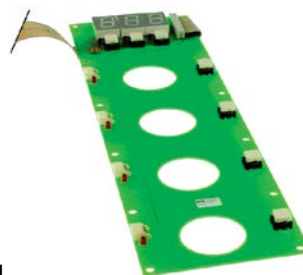

1

<b>GEV No.</b>	401168	<b>Ref. No.</b>	6010100
<b>description</b>	PCB		
<b>For models:</b>	DE06EC, DE102EC, DE10EC, DG06EC, DG102EC, DG10EC, VE06EC, VE102EC, VE10EC, VE20EC, VG06EC, VG102EC, VG10EC, VG20EC		



Зип Обществит

solenoid valves

vsezip.ru

+7(812)987-08-81



1

<b>GEV No.</b>	401170	<b>Ref. No.</b>	6010101
<b>description</b>	PCB		
<b>For models:</b>	DE06EC, DE102EC, DE10EC, DG06EC, DG102EC, DG10EC, VE06EC, VE102EC, VE10EC, VE20EC, VG06EC, VG102EC, VG10EC		



1

<b>GEV No.</b>	401172	<b>Ref. No.</b>	6010093
<b>description</b>	PCB combi-steamer VE 06/10		
<b>For models:</b>	VE06EC, VE06MX, VE102EC, VE102MX, VE10EC, VE10MX, VE20EC, VE20MX, VG06EC, VG06MX, VG102EC, VG102MX, VG10EC, VG10MX, VG20EC, VG20MX		



1

<b>GEV No.</b>	401167	<b>Ref. No.</b>	6010096
<b>description</b>	PCB combi-steamer VE 06/10 230V 50/60Hz		
<b>For models:</b>	CE06MX, CE102MX, CE10MX, CE20MX, CG06MX, CG102MX, CG10MX, CG20MX, DE06ES, DE06MX, DE102MX, DE10ES, DE10MX, DG06ES, DG06MX, DG102MX, DG10ES, DG10MX, EF10GM, EF4PM, EF5GM, EF6PM, EF7GM, EF8PM, GF10GM, GF4PM, GF5GM, GF6PM, GF7GM, GF8PM, VE06MX, VE102MX, VE10MX, VE20MX, VG06MX, VG102MX, VG10MX, VG20EC, VG20MX		
<b>accessories for</b>	401167		
	<b>GEV No.</b>	401062	<b>Ref. No.</b> 6010090
	buzzer board 230VAC L 48mm W 45mm connection Faston 6.3mm		

solenoid valves (water)

RPE



1

<b>GEV No.</b>	374021	<b>Ref. No.</b>	6042071
<b>description</b>	solenoid valve double straight 230VAC inlet 3/4" outlet 10mm DN10 RPE		
<b>For models:</b>	CE20MX, CG20MX, VE06EC, VE06MX, VE102EC, VE102MX, VE10EC, VE10MX, VE20EC, VE20MX, VG06EC, VG06MX, VG102EC, VG102MX, VG10EC, VG10MX, VG20EC, VG20MX		



1

<b>GEV No.</b>	374017	<b>Ref. No.</b>	6042070
<b>description</b>	solenoid valve single straight 230VAC inlet 3/4" outlet 10mm input 6l/min DN10 RPE polyamide flow regulating valve inlet white membranes NBR pressure range 0.2-10bar		
<b>For models:</b>	CE06MX, CE102MX, CE10MX, CG06MX, CG102MX, CG10MX, DE06EC, DE06ES, DE06MX, DE102EC, DE102MX, DE10EC, DE10ES, DE10MX, DG06EC, DG06ES, DG06MX, DG102EC, DG102MX, DG10EC, DG10ES, DG10MX, EF10GM, EF4, EF4PM, EF5GM, EF6PM, EF7GM, EF8PM, GF10GM, GF4PM, GF5GM, GF6PM, GF7GM, GF8PM		



1

<b>GEV No.</b>	374025	<b>Ref. No.</b>	6042080
<b>description</b>	solenoid valve triple straight 230VAC inlet 3/4" outlet 10mm DN10 RPE		

reducers

outlet side



1

<b>GEV No.</b>	371269	<b>Ref. No.</b>	6042091
<b>description</b>	reducer flow rate 0.07-0.14l/min brown		



1

<b>GEV No.</b>	371265	<b>Ref. No.</b>	6042097
<b>description</b>	reducer flow rate 3l/min black		
<b>For models:</b>	VE06EC, VE06MX, VE102EC, VE102MX, VE10EC, VE10MX, VE20EC, VE20MX, VG06EC, VG06MX, VG102EC, VG102MX, VG10EC, VG10MX, VG20EC, VG20MX		

electric components

Зип.Общепит  
pressure switches

for gas equipment  
vsezip.ru

+7(812)987-08-81

various



1			
<b>GEV No.</b>	371264	<b>Ref. No.</b>	6042095
<b>description</b>	reducer flow rate 0.25l/min		
<b>For models:</b>	CE06MX, CE102MX, CE10MX, CE20MX, CG06MX, CG102MX, CG10MX, CG20MX, EF4, VE06EC, VE06MX, VE102EC, VE102MX, VE10EC, VE10MX, VE20EC, VE20MX, VG06EC, VG06MX, VG102EC, VG102MX, VG10EC, VG10MX, VG20EC, VG20MX		

metal

CEME

solenoid valves



1			
<b>GEV No.</b>	370352	<b>Ref. No.</b>	6042075
<b>description</b>	solenoid valve 2-ways 230VAC inlet 1/2" IT outlet 1/2" IT L 55mm p max 0.5bar brass		
<b>For models:</b>	VE06EC, VE06MX, VE102EC, VE102MX, VE10EC, VE10MX, VE20EC, VE20MX, VG06EC, VG06MX, VG102EC, VG102MX, VG10EC, VG10MX, VG20EC, VG20MX		

1			
<b>GEV No.</b>	541073	<b>Ref. No.</b>	7050012
<b>description</b>	pressure control ø 45mm pressure range adjustable 5-20mbar pressure connection vertical gas technology connection 1/4" pressure connection ø 1/4"mm		

for combi-steamers



1			
<b>GEV No.</b>	541806	<b>Ref. No.</b>	7050008
<b>description</b>	pressure control ø 38mm pressure range 0.2-3.0bar connection 1/8" 250V 10A GP600 pressure connection 1/8"		
<b>accessories for</b>	541806		
	<b>GEV No.</b>	541814	<b>Ref. No.</b>
			—
	protection cap for pressure switch EPDM XP600		

ball valves electric



1			
<b>GEV No.</b>	401139	<b>Ref. No.</b>	6042073
<b>description</b>	ball valve inlet 3/4" IT outlet 3/4" IT with plug 230V L 65mm 50/60Hz closed off-current mode of operation electric connection cable 200mm		

electrodes



1			
<b>GEV No.</b>	401161	<b>Ref. No.</b>	6000089
<b>description</b>	level electrode 1/4" total length 210mm probe L 184mm insulated probe length 26mm connection male faston 6.3mm stainless steel ø 2.5mm		



fans

axial fans

ebm-papst



1

<b>GEV No.</b>	601030 <sup>1</sup>	<b>Ref. No.</b>	6033175
<b>description</b>	axial fan L 119mm W 119mm H 38mm 230VAC 50Hz 18W bearing ball bearing manif. no. 4656Z metal connection male faston 2.8mm ebm-papst fan wheel ø 110mm temp.-resist. 75°C		
<b>accessories for</b>	601030		
	<b>GEV No.</b>	550898	<b>Ref. No.</b> —
	connecting cable cable length 2000mm connection F 2.8 connection distance 7.9mm for axial flow fan		
	<b>GEV No.</b>	692497	<b>Ref. No.</b> —
	guard ø 105mm mounting distance 150mm for axial fan ebm-papst-mm		

<sup>1</sup>with ball bearings



1

<b>GEV No.</b>	601633 <sup>1</sup>	<b>Ref. No.</b>	6033172
<b>description</b>	axial fan L 92mm W 92mm H 38mm 230VAC 50Hz 12W bearing ball bearing manif. no. 3656 connection cable 310mm ebm-papst		
<b>accessories for</b>	601633		
	<b>GEV No.</b>	691103	<b>Ref. No.</b> —
	guard ø 90mm mounting distance 83mm for axial fan 92mm		

<sup>1</sup>with ball bearings

Зип Общежит

hot air motors

vsezip.ru

+7(812)987-08-81

1

<b>GEV No.</b>	602014	<b>Ref. No.</b>	2017945 6032115 6033153
<b>description</b>	fan motor 208-240V 1 phase 50/60Hz 0.19-0.26/0.34-0.35kW 2800/3450rpm speeds 2 L1 98mm L2 33mm D1 ø 8mm M5 1-1.2/1.7-1.5A type MFA80		

1

<b>GEV No.</b>	500641	<b>Ref. No.</b>	6033155
<b>description</b>	fan motor 220/380V 3 phase 50Hz 0.75kW 1420rpm speeds 1 L1 166mm L2 47mm L3 65mm D1 ø 24mm D2 ø 20mm M6R IT 1.4/2.4A Cos(φ) 0.83 at 50Hz 220/380V at 60Hz 240/415V type ST80/4 no. 643515 mounting distance 150mm		

1

<b>GEV No.</b>	500640	<b>Ref. No.</b>	6032122
<b>description</b>	fan motor 220-240V 1 phase 50Hz 0.05/0.25HP 1400/2700rpm speeds 2 L1 145mm L2 65mm L3 35mm D1 ø 15mm D2 ø 12mm M10L ET 1.1/0.55A suitable capacitor 12.5µF/450V at 50Hz 1400/2700rpm type 2758D2253 no. 6032122		
<b>For models:</b>	CE06MX, CG06MX, DE06EC, DE06ES, DE06MX, DG06EC, DG06ES, DG06MX, VE06EC, VE06MX, VG06EC, VG06MX		
<b>spare parts for</b>	500640		
	<b>GEV No.</b>	560280	<b>Ref. No.</b> —
	nut thread M10L H 8mm WS 17 SS DIN/ISO DIN 934 / ISO 4032/8673 Qty 1 pcs		

electric components

Зип Общепит

vsezip.ru

+7(812)987-08-81

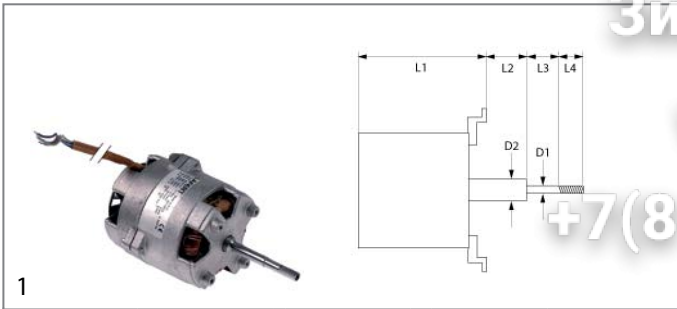

<b>GEV No.</b>	601354	<b>Ref. No.</b>	6032128
<b>description</b>	fan motor 220-240V 1 phase 50Hz 0.11kW 2760rpm speeds 1 L1 130mm L2 32mm L3 30mm L4 18mm D1 $\varnothing$ 7/8mm D2 $\varnothing$ 9mm M4R IT 0.9A at 50Hz 230V at 50Hz 2760rpm suitable capacitor 4 $\mu$ F type LM63 shaft flat length 17mm		
<b>accessories for</b>	601354		
<b>GEV No.</b>	365031	<b>Ref. No.</b>	—
<b>description</b>	operating capacitor capacity 4 $\mu$ F 450V tolerance 5% 50/60Hz ambient temperature max. -25 to +85°C $\varnothing$ 31mm L 58mm M8 plastic connection male faston 6.3mm protection		
<b>GEV No.</b>	601061	<b>Ref. No.</b>	—
<b>description</b>	fan wheel D1 $\varnothing$ 160mm H1 60mm blades 15 D2 $\varnothing$ 18mm D3 $\varnothing$ 18mm H2 35mm		

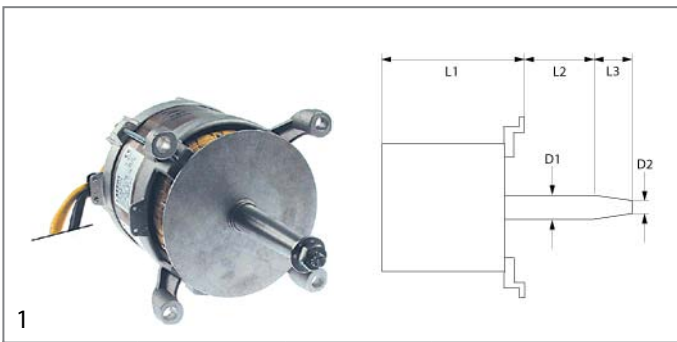

<b>GEV No.</b>	500643	<b>Ref. No.</b>	6034348
<b>description</b>	fan motor 230V 1 phase 50Hz 0.25/0.75kW 670/1370rpm speeds 2 L1 195mm L2 47mm L3 70mm D1 $\varnothing$ 24mm D2 $\varnothing$ 20mm M6R IT 1.5/4.7A suitable capacitor 50/20 $\mu$ F Cos(f) 0.53/0.7 at 50Hz 670/1370rpm 4P/8P type FB100L no. 677325		
<b>For models:</b>	CE102MX, CE20MX, CG102MX, CG20MX, DE102EC, DE102MX, DG102EC, DG102MX, VE102EC, VE102MX, VE20EC, VE20MX, VG102EC, VG102MX, VG20EC, VG20MX		

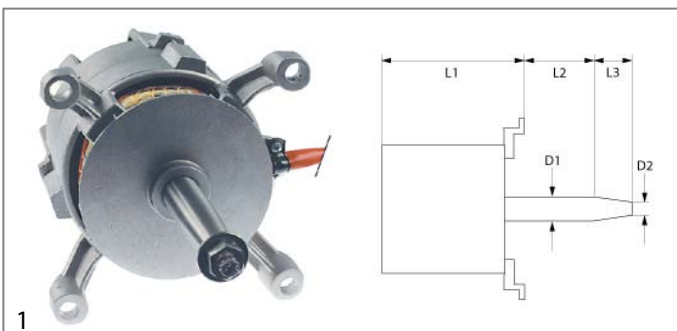

<b>GEV No.</b>	500642	<b>Ref. No.</b>	6033145
<b>description</b>	fan motor 380-415V 3 phase 50Hz 0.22/0.75kW 700/1400rpm speeds 2 L1 166mm L2 45mm L3 67mm D1 $\varnothing$ 24mm D2 $\varnothing$ 20mm M6R ITA at 50Hz 380-415V at 50Hz 700/1400rpm type FB80 4/8 no. 629764		
<b>For models:</b>	DE102EC, DE10EC, DG102EC, EF6PM, EF8PM, VE10EC, VE20EC, VG20EC		



<b>GEV No.</b>	602135	<b>Ref. No.</b>	5901101
<b>description</b>	fan wheel blades 12 D1 $\varnothing$ 180mm D2 $\varnothing$ 8mm D3 $\varnothing$ 6x9mm H1 100mm H2 27mm H3mm		



<b>GEV No.</b>	601202	<b>Ref. No.</b>	5901006
<b>description</b>	fan wheel D1 $\varnothing$ 180mm H1 100mm blades 16 D2 $\varnothing$ 11.5mm D3 $\varnothing$ 16mm H2 30mm		
<b>For models:</b>	CE06MX, CG06MX, DE06EC, DE06ES, DE06MX, DG06EC, DG06ES, DG06MX, VE06EC, VE06MX, VG06EC, VG06MX		



<b>GEV No.</b>	601060	<b>Ref. No.</b>	5900896
<b>description</b>	fan wheel D1 $\varnothing$ 180mm H1 60mm blades 16 D2 $\varnothing$ 11mm D3 $\varnothing$ 16mm H2 30mm		



<b>GEV No.</b>	601246	<b>Ref. No.</b>	5901003
<b>description</b>	fan wheel D1 $\varnothing$ 180mm H1 77mm blades 12 D2 $\varnothing$ 8mm D3 $\varnothing$ 6mm H2 25.5mm		





Зип Обществит  
vsezip.ru

+7(812)987-08-81



1

<b>GEV No.</b>	601203	<b>Ref. No.</b>	5901010
<b>description</b>	fan wheel D1 ø 310mm H1 100mm blades 30 D2 ø 19.5mm D3 ø 23mm H2 46mm		
<b>For models:</b>	CE10MX, CG10MX, DE10EC, DE10ES, DE10MX, DG10EC, DG10ES, DG10MX, VE10EC, VE10MX, VG10EC, VG10MX		



1

<b>GEV No.</b>	601204	<b>Ref. No.</b>	5901022
<b>description</b>	fan wheel D1 ø 350mm H1 135mm blades 30 D2 ø 19.5mm D3 ø 23mm H2 46mm		
<b>For models:</b>	CE102MX, DE102EC, VE102EC, VE102MX		

pumps

booster pumps II

accessories



1

<b>GEV No.</b>	365017	<b>Ref. No.</b>	6090015
<b>description</b>	operating capacitor capacity 5µF 450V tolerance 5% 50/60Hz ambient temperature max. -25 to +85°C ø 28mm L 54mm M8 plastic connection male faston 6.3mm 16.10.08 protection		

condensators & interference sup-  
pression filters  
operating capacitors

plastic



1

<b>GEV No.</b>	365017	<b>Ref. No.</b>	6090015
<b>description</b>	operating capacitor capacity 5µF 450V tolerance 5% 50/60Hz ambient temperature max. -25 to +85°C ø 28mm L 54mm M8 plastic connection male faston 6.3mm 16.10.08 protection		

filters

interference suppression filters



1

<b>GEV No.</b>	365044	<b>Ref. No.</b>	6090050
<b>description</b>	interference suppression filter type FC701Y2F 250V 50-60Hz conductor 2 with E connection cable 200mm L 42mm ø 23mm Hmm Wmm plastic Qty 1 pcs		

gas valves and ignition boxes

gas control valves

SIT

ELETTROSIT



1



<b>GEV No.</b>	101126	<b>Ref. No.</b>	7020060
<b>description</b>	gas valve SIT type ELETTROSIT 230V gas inlet 1/2" gas outlet 1/2" thermocouple connection M9x1 pilot connection M10x1 bottom equiv. no. 0.810.136		
<b>spare parts for</b>	101126		
	<b>GEV No.</b>	101312	<b>Ref. No.</b> 6010054
	microswitch		
	<b>GEV No.</b>	101352	<b>Ref. No.</b> —
	solenoid coil 230V 50Hz suitable for ELETTROSIT		







Table continues overleaf



Зип-Общепит







vsezi.ru





+7(812)987-08-81

accessories for 101126			
	GEV No.	100006	Ref. No. —
piezoelectric igniter suitable for ELETTROSIT body plastic blowing connection ø2.4mm ø 14mm			
	GEV No.	100904	Ref. No. —
locking screw M10x1 for pipe ø 4mm Qty 1 pcs			
	GEV No.	100905	Ref. No. 70500z0
locking screw M10x1 for pipe ø 6mm Qty 1 pcs			
	GEV No.	101301	Ref. No. —
gas connection thread 1/2" straight ELETTROSIT screw with O-ring			
	GEV No.	101303	Ref. No. —
gas connection straight thread 3/4" ELETTROSIT			
	GEV No.	101309	Ref. No. —
extension			



NOVASIT





1			
GEV No.	101956	Ref. No.	7020070
description	gas valve SIT series Novasit 820 230V 50Hz gas inlet 1/2" gas outlet 1/2" thermocouple connection M9x1 pilot connection M10x1 ignition pressurebar pressure range 5-50mbar pressure regulator connection blind equiv. no. 0.820.031		
For models:	13FG, 13FGC, 17FG, 17FGC, 207FG, 207FGC, 213FG, 213FGC, 217FG, 217FGC, 917FG, 917FGC, 927FG, 927FGC, 934FG, 934FGC, FG07CL, FG213CL		
spare parts for	101956		
	GEV No.	101065	Ref. No. —
magnet unit with cable L 44mm D1 ø 30mm D2 ø 20mm suitable for NOVASIT			
	GEV No.	101313	Ref. No. —
solenoid coil 230V 50Hz			
accessories for 101956			
	GEV No.	100006	Ref. No. —
piezoelectric igniter suitable for ELETTROSIT body plastic blowing connection ø2.4mm ø 14mm			
	GEV No.	101305	Ref. No. —
gas connection straight 1/2" flange 45x45mm ELETTROSIT/V4400/4600/4605 suitable for SIT/HONEYWELL hole distance 36x36mm			
	GEV No.	101306	Ref. No. 7020011
gas connection angled flange 45x45mm hole distance 36x36mm 1/2" ELETTROSIT/V4400/4600/4605 screw with O-ring suitable for SIT/HONEYWELL			
	GEV No.	101307	Ref. No. —
gas connection straight flange 45x45mm hole distance 36x36mm 3/4" ELETTROSIT/V4400/4600/4605 screw with O-ring suitable for SIT/HONEYWELL			

accessories for 101956			
	GEV No.	101308	Ref. No. —
gas connection angled flange 45x45mm hole distance 36x36mm 3/4" ELETTROSIT/V4400/4600/4605 screw with O-ring suitable for SIT/HONEYWELL			
	GEV No.	101312	Ref. No. 6010054
microswitch			
	GEV No.	101314	Ref. No. —
solenoid coil 24V 50Hz			
	GEV No.	101317	Ref. No. —
plug with cable L 1000mm suitable for NOVASIT			
	GEV No.	101318	Ref. No. —
cover cap for solenoid coil suitable for NOVASIT			

accessories

1			
GEV No.	101306	Ref. No.	7020011
description	gas connection angled flange 45x45mm hole distance 36x36mm 1/2" ELETTROSIT/V4400/4600/4605 screw with O-ring suitable for SIT/HONEYWELL		
spare parts for	101306		
	GEV No.	517104	Ref. No. —
O-ring EPDM thickness 2.62mm ID ø 31.42mm Qty 1 pcs			

1			
GEV No.	100905	Ref. No.	7050020
description	locking screw M10x1 for pipe ø 6mm Qty 1 pcs		

1			
GEV No.	101312	Ref. No.	6010054
description	microswitch		

gas components



Зип-Общепит  
ignition boxes

vsezip.ru

+7(812)987-08-81

TANDEM



1

<b>GEV No.</b>	101881	<b>Ref. No.</b>	7020080
<b>description</b>	gas valve 230V 50Hz gas inlet 1/2" gas outlet 1/2" pilot connection level slow ignition ignition times pressure range 3-50mbar power supply for modulator equiv. no. 0.830.041 suitable for Tandem		
<b>For models:</b>	CG06MX, CG102MX, CG10MX, CG20MX, DG06EC, DG06ES, DG06MX, DG102EC, DG102MX, DG10EC, DG10ES, DG10MX, GF10GM, GF4PM, GF5GM, GF6PM, GF7GM, GF8PM, VG06EC, VG06MX, VG102EC, VG102MX, VG10EC, VG10MX, VG20EC, VG20MX		
<b>spare parts for</b>	101881		
	<b>GEV No.</b>	101379	<b>Ref. No.</b> —
	solenoid coil 230V 50Hz suitable for Tandem		
<b>accessories for</b>	101881		
	<b>GEV No.</b>	101274	<b>Ref. No.</b> 7070036
	olive for pipe ø 16mm Qty 1 pcs		
	<b>GEV No.</b>	101275	<b>Ref. No.</b> —
	union screw thread 1/2" for pipe ø 16mm Qty 1 pcs		
	<b>GEV No.</b>	101925	<b>Ref. No.</b> —
	plug with O-ring thread M10x1 for pilot burner suitable for NOVASIT		
	<b>GEV No.</b>	102845	<b>Ref. No.</b> —
	gas connection angled 1/2" flange 32x32mm hole distance 24x24mm Tandem		
	<b>GEV No.</b>	102846	<b>Ref. No.</b> —
	gas connection straight 1/2" flange 32x32mm hole distance 24x24mm suitable for Tandem		
	<b>GEV No.</b>	102847	<b>Ref. No.</b> —
	O-ring		

SIT



1

<b>GEV No.</b>	101685	<b>Ref. No.</b>	7020085
<b>description</b>	ignition box SIT type 503EFD electrodes 2 waiting time 1.5s safety time 10s 220/240V 10VA 50-60Hz protection IP40		
<b>For models:</b>	CG06MX, CG102MX, CG10MX, CG20MX, DG06EC, DG06ES, DG06MX, DG102EC, DG102MX, DG10EC, DG10ES, DG10MX, GF10GM, GF4PM, GF5GM, GF6PM, GF7GM, GF8PM, VG06EC, VG06MX, VG102EC, VG102MX, VG10EC, VG10MX, VG20EC, VG20MX		

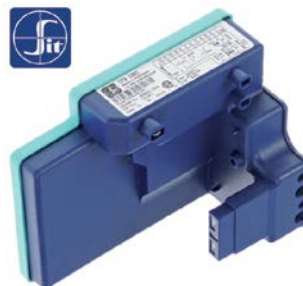

1

<b>GEV No.</b>	107837	<b>Ref. No.</b>	7020206
<b>description</b>	ignition box SIT type 579DBC for combi-steamer suitable for GIORIK equiv. no. 0.579.418 electrodes 2 waiting time 1.5s safety time 5s 220/240V 12VA 50/60Hz		

miscellaneous



1

<b>GEV No.</b>	401171	<b>Ref. No.</b>	6010084
<b>description</b>	ignition box		
<b>For models:</b>	CE06MX, CE102MX, CE10MX, CE20MX, CG06MX, CG102MX, CG10MX, CG20MX, DE06EC, DE06ES, DE06MX, DE102EC, DE102MX, DE10EC, DE10ES, DE10MX, DG06EC, DG06ES, DG06MX, DG102EC, DG102MX, DG10EC, DG10ES, DG10MX, EF4, EF4PM, EF6PM, EF8PM, GF4PM, GF6PM, GF8PM, VE06EC, VE06MX, VE102EC, VE102MX, VE10EC, VE10MX, VE20EC, VE20MX, VG06EC, VG06MX, VG102EC, VG102MX, VG10EC, VG10MX, VG20EC, VG20MX		

2 gas components

ignition parts

pilot burners

SIT

100 series



<b>GEV No.</b>	106906	<b>Ref. No.</b>	7090022
<b>description</b>	pilot burner SIT type 100 series 3 flames nozzle $\varnothing$ 0.2mm gas connection 6mm		
<b>For models:</b>	FG07CL, FG07L, FG13L, FG213CL, FG213L, SG608		
<b>spare parts for</b>	106906		
	GEV No.	100245	Ref. No. 7042005
	pilot burner nozzle LPG code 20 bore $\varnothing$ 0.2mm Qty 1 pcs thread M8x0.75		
	GEV No.	100855	Ref. No. —
	pilot burner bracket triple		
	GEV No.	100885	Ref. No. 7070014 7090007
	air mixing sleeve for pilot burner Qty 1 pcs		
	GEV No.	100916	Ref. No. —
	compression spring for pilot burner Qty 1 pcs		
	GEV No.	100917	Ref. No. —
	gasket for pilot burner Qty 1 pcs aluminium		
	GEV No.	100918	Ref. No. —
	screw for pilot burner		
	GEV No.	107162	Ref. No. 7090002
	pilot burner cap SIT 3 flames Hmm Lmm Qty 1 pcs		
	GEV No.	107701	Ref. No. —
	pilot burner bottom part SIT 100 series nozzle $\varnothing$ 0.2mm		
<b>accessories for</b>	106906		
	GEV No.	100245	Ref. No. 7042005
	pilot burner nozzle LPG code 20 bore $\varnothing$ 0.2mm Qty 1 pcs thread M8x0.75		
	GEV No.	100246	Ref. No. 7042006
	pilot burner nozzle natural gas bore $\varnothing$ 0.35mm Qty 1 pcs thread M8x0.75		
	GEV No.	100904	Ref. No. —
	locking screw M10x1 for pipe $\varnothing$ 4mm Qty 1 pcs		
	GEV No.	100905	Ref. No. 7050020
	locking screw M10x1 for pipe $\varnothing$ 6mm Qty 1 pcs		
	GEV No.	102110	Ref. No. —
	pilot tube copper pipe $\varnothing$ 4mm thickness 1mm L 3000mm		
	GEV No.	102111	Ref. No. —
	pilot tube copper pipe $\varnothing$ 6mm thickness 1mm L 3000mm		

	GEV No.	107171	Ref. No.	—
	pilot burner nozzle SIT natural/liquid gas bore $\varnothing$ 0.25mm Qty 1 pcs			
	GEV No.	107700	Ref. No.	—
	pilot burner bottom part SIT 100 series nozzle $\varnothing$ 0.25mm			
	GEV No.	107702	Ref. No.	—
	pilot burner bottom part SIT 100 series nozzle $\varnothing$ 0.35mm			

	<b>GEV No.</b>	106907	<b>Ref. No.</b>	7090023
	<b>description</b>	pilot burner SIT type 100 series 3 flames nozzle $\varnothing$ 0.35mm gas connection 6mm		
	<b>For models:</b>	13FG, 13FGC, 17FG, 17FGC, 207FG, 207FGC, 213FG, 213FGC, 217FG, 217FGC, 917FG, 917FGC, 927FG, 927FGC, 934FG, 934FGC		
	<b>spare parts for</b>	106907		
	GEV No.	100246	Ref. No.	7042006
	pilot burner nozzle natural gas bore $\varnothing$ 0.35mm Qty 1 pcs thread M8x0.75			
	GEV No.	100855	Ref. No.	—
	pilot burner bracket triple			
	GEV No.	100885	Ref. No.	7070014 7090007
	air mixing sleeve for pilot burner Qty 1 pcs			
	GEV No.	100916	Ref. No.	—
	compression spring for pilot burner Qty 1 pcs			
	GEV No.	100917	Ref. No.	—
	gasket for pilot burner Qty 1 pcs aluminium			
	GEV No.	100918	Ref. No.	—
	screw for pilot burner			
	GEV No.	107162	Ref. No.	7090002
	pilot burner cap SIT 3 flames Hmm Lmm Qty 1 pcs			
	GEV No.	107702	Ref. No.	—
	pilot burner bottom part SIT 100 series nozzle $\varnothing$ 0.35mm			
<b>accessories for</b>	106907			
	GEV No.	100245	Ref. No.	7042005
	pilot burner nozzle LPG code 20 bore $\varnothing$ 0.2mm Qty 1 pcs thread M8x0.75			
	GEV No.	100904	Ref. No.	—
	locking screw M10x1 for pipe $\varnothing$ 4mm Qty 1 pcs			
	GEV No.	100905	Ref. No.	7050020
	locking screw M10x1 for pipe $\varnothing$ 6mm Qty 1 pcs			
	GEV No.	102110	Ref. No.	—
	pilot tube copper pipe $\varnothing$ 4mm thickness 1mm L 3000mm			





Table continues overleaf





Зип-Общепит

vsezip.ru

+7(812)987-08-81

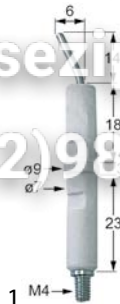
accessories for		106907		
	GEV No.	102111	Ref. No.	—
	pilot tube copper pipe $\varnothing$ 6mm thickness 1mm L 3000mm			
	GEV No.	107171	Ref. No.	—
	pilot burner nozzle SIT natural/liquid gas bore $\varnothing$ 0.25mm Qty 1 pcs			
	GEV No.	107700	Ref. No.	—
	pilot burner bottom part SIT 100 series nozzle $\varnothing$ 0.25mm			
	GEV No.	107701	Ref. No.	—
	pilot burner bottom part SIT 100 series nozzle $\varnothing$ 0.2mm			



accessories for		100706	Ref. No.	6010046
	description	ignition electrode connection M4 Qty 1 pcs		
<b>For models:</b>	13FG, 13FGC, 17FG, 17FGC, 207FG, 207FGC, 213FG, 213FGC, 217FG, 217FGC, 917FG, 917FGC, 927FG, 927FGC, 934FG, 934FGC, FG07CL, FG07L, FG13L, FG213CL, FG213L, SG608			

accessories				
pilot burner caps				
	GEV No.	107162	Ref. No.	7090002
	description pilot burner cap SIT 3 flames Hmm Lmm Qty 1 pcs			

miscellaneous				
	GEV No.	100885	Ref. No.	7070014 7090007
	description air mixing sleeve for pilot burner Qty 1 pcs			

pilot burner brackets				
universal				
	GEV No.	100888	Ref. No.	7090006
	description screw bolt for pilot burner			

140 - 145 -150 series				
	GEV No.	107114 <sup>1</sup>	Ref. No.	7090028
	description pilot burner SIT type 140 series 2 flames nozzle $\varnothing$ mm gas connectionmm			
<b>For models:</b>	CG740, CG780, GG940, GG980			
<b>spare parts for</b>	107114			
	GEV No.	100907	Ref. No.	5900318
	description screw connection thread M10x1 Qty 1 pcs type SEF 1 $\varnothing$ mm for thermocouple			
<b>accessories for</b>	107114			
	GEV No.	100204	Ref. No.	7042014
	description pilot burner nozzle SIT LPG code 14 bore $\varnothing$ 0.18/0.20mm Qty 1 pcs suitable for 140 series			
	GEV No.	100205	Ref. No.	—
	description pilot burner nozzle SIT LPG code 19 bore $\varnothing$ 0.23/0.26mm Qty 1 pcs suitable for SIT 150 series			
	GEV No.	100206	Ref. No.	—
	description pilot burner nozzle SIT natural gas code 36 bore $\varnothing$ 0.60/0.55mm Qty 1 pcs suitable for SIT 150 series			
	GEV No.	100207	Ref. No.	7042013
	description pilot burner nozzle SIT natural gas code 27 bore $\varnothing$ 0.40/0.38mm suitable for SIT 140 series			
	GEV No.	100216	Ref. No.	—
	description pilot burner nozzle SIT natural gas code 38 bore $\varnothing$ 0.45mm Qty 1 pcs suitable for SIT 150 series			
	GEV No.	100701	Ref. No.	6010087
	description ignition electrode connection M4 Qty 1 pcs			

pilot burner nozzles				
	GEV No.	100245	Ref. No.	7042005
	description pilot burner nozzle LPG code 20 bore $\varnothing$ 0.2mm Qty 1 pcs thread M8x0.75			
	GEV No.	100246	Ref. No.	7042006
	description pilot burner nozzle natural gas bore $\varnothing$ 0.35mm Qty 1 pcs thread M8x0.75			

<sup>1</sup>incl. thermocouple fitting  
Table continues overleaf



Зип-Общепит

vsezip.ru

+7(812)987-08-81

gas components

accessories for		107114	
	GEV No.	100801	Ref. No. —
gasket for pilot burner Qty 1 pcs			
	GEV No.	100897	Ref. No. —
olive for pipe ø 4mm Qty 1 pcs for pilot burner			
	GEV No.	100898	Ref. No. 7070045
olive for pipe ø 6mm Qty 1 pcs for pilot burner			
	GEV No.	100906	Ref. No. 5900317 7050028
screw connection thread M10x1 for ignition electrode brass Qty 1 pcs WS 10			
	GEV No.	100908	Ref. No. —
union screw thread M10x1 for pipe ø 4mm Qty 1 pcs			
	GEV No.	100909	Ref. No. 7050029
union screw thread M10x1 for pipe ø 6mm Qty 1 pcs			
	GEV No.	102110	Ref. No. —
pilot tube copper pipe ø 4mm thickness 1mm L 3000mm			
	GEV No.	102111	Ref. No. —
pilot tube copper pipe ø 6mm thickness 1mm L 3000mm			

**POLIDORO**  
pilot burners



<b>GEV No.</b>	100051	<b>Ref. No.</b>	7090026
<b>description</b>	pilot burner POLIDORO 3 flames code gas connectionmm		
<b>For models:</b>	22CPG, 23CPG, 2CPG, 3CPG, CPG1, CPG1BM, CPG66, FTG100, FTG46, FTG46B, FTG46R, FTG66L, FTG66LG, FTG66R, GG66		
<b>spare parts for</b>	100051		
	GEV No.	100907	Ref. No. 5900318
screw connection thread M10x1 Qty 1 pcs type SEF 1 ømm for thermocouple			
<b>accessories for</b>	100051		
	GEV No.	100000	Ref. No. —
pilot burner nozzle POLIDORO LPG code 22 bore ø 0.22mm Qty 1 pcs			
	GEV No.	100208	Ref. No. —
pilot burner nozzle POLIDORO LPG code 20 bore ø 0.2mm Qty 1 pcs			
	GEV No.	100209	Ref. No. —
pilot burner nozzle POLIDORO natural gas code 40 bore ø 0.4mm Qty 1 pcs			
	GEV No.	100701	Ref. No. 6010087
ignition electrode connection M4 Qty 1 pcs			
	GEV No.	100906	Ref. No. 5900317 7050028
screw connection thread M10x1 for ignition electrode brass Qty 1 pcs WS 10			

accessories for		100051	
	GEV No.	100907	Ref. No. 5900318
screw connection thread M10x1 Qty 1 pcs type SEF 1 ømm for thermocouple			
	GEV No.	100908	Ref. No. —
union screw thread M10x1 for pipe ø 4mm Qty 1 pcs			
	GEV No.	100909	Ref. No. 7050029
union screw thread M10x1 for pipe ø 6mm Qty 1 pcs			
	GEV No.	102110	Ref. No. —
pilot tube copper pipe ø 4mm thickness 1mm L 3000mm			
	GEV No.	102111	Ref. No. —
pilot tube copper pipe ø 6mm thickness 1mm L 3000mm			
	GEV No.	102508	Ref. No. —
union screw thread M10x1 for pipe ø 4mm Qty 5 pcs			
	GEV No.	102509	Ref. No. —
union screw thread M10x1 for pipe ø 6mm Qty 5 pcs			
	GEV No.	102699	Ref. No. —
pilot burner nozzle POLIDORO natural gas code 25.2 bore ø 2x0.25mm Qty 1 pcs 2 bores			
	GEV No.	102795	Ref. No. —
olive for pipe ø 4mm Qty 1 pcs			
	GEV No.	102797	Ref. No. —
olive for pipe ø 6mm Qty 1 pcs			
	GEV No.	106703	Ref. No. 7042008
pilot burner nozzle POLIDORO natural gas code 27.2 bore ø 2x0.27mm Qty 1 pcs			
	GEV No.	106704	Ref. No. —
pilot burner nozzle POLIDORO LPG code 16.2 bore ø 2x0.16mm Qty 1 pcs			
	GEV No.	106763	Ref. No. —
pilot burner nozzle POLIDORO natural gas code 27.2A bore ø 2x 0.27mm Qty 1 pcs			
	GEV No.	106859	Ref. No. —
pilot burner nozzle POLIDORO LPG code 24 bore ø 0.24mm Qty 1 pcs			

	<b>GEV No.</b>	100076	<b>Ref. No.</b>	7090024
1				
<b>description</b> pilot burner POLIDORO 3 flames natural gas code 29.2 gas connection 6mm				
<b>spare parts for</b> 100076				
	GEV No.	100907	Ref. No.	5900318
screw connection thread M10x1 Qty 1 pcs type SEF 1 ømm for thermocouple				
<b>accessories for</b> 100076				
	GEV No.	100000	Ref. No.	—
pilot burner nozzle POLIDORO LPG code 22 bore ø 0.22mm Qty 1 pcs				

Table continues overleaf





















Зип Общежит

electrodes

vsezip.ru

+7(812)987-08-81

accessories for		100076	
GEV No.		Ref. No.	
	100208	—	
pilot burner nozzle POLIDORO LPG code 20 bore $\varnothing$ 0.2mm Qty 1 pcs			
	100209	—	
pilot burner nozzle POLIDORO natural gas code 40 bore $\varnothing$ 0.4mm Qty 1 pcs			
	100701	6010087	
ignition electrode connection M4 Qty 1 pcs			
	100906	5900317 7050028	
screw connection thread M10x1 for ignition electrode brass Qty 1 pcs WS 10			
	100907	5900318	
screw connection thread M10x1 Qty 1 pcs type SEF 1 $\varnothing$ mm for thermocouple			
	100908	—	
union screw thread M10x1 for pipe $\varnothing$ 4mm Qty 1 pcs			
	100909	7050029	
union screw thread M10x1 for pipe $\varnothing$ 6mm Qty 1 pcs			
	102110	—	
pilot tube copper pipe $\varnothing$ 4mm thickness 1mm L 3000mm			
	102111	—	
pilot tube copper pipe $\varnothing$ 6mm thickness 1mm L 3000mm			
	102508	—	
union screw thread M10x1 for pipe $\varnothing$ 4mm Qty 5 pcs			
	102509	—	
union screw thread M10x1 for pipe $\varnothing$ 6mm Qty 5 pcs			
	102699	—	
pilot burner nozzle POLIDORO natural gas code 25.2 bore $\varnothing$ 2x0.25mm Qty 1 pcs 2 bores			
	102795	—	
olive for pipe $\varnothing$ 4mm Qty 1 pcs			
	102797	—	
olive for pipe $\varnothing$ 6mm Qty 1 pcs			
	106703	7042008	
pilot burner nozzle POLIDORO natural gas code 27.2 bore $\varnothing$ 2x0.27mm Qty 1 pcs			
	106704	—	
pilot burner nozzle POLIDORO LPG code 16.2 bore $\varnothing$ 2x0.16mm Qty 1 pcs			
	106763	—	
pilot burner nozzle POLIDORO natural gas code 27.2A bore $\varnothing$ 2x 0.27mm Qty 1 pcs			
	106859	—	
pilot burner nozzle POLIDORO LPG code 24 bore $\varnothing$ 0.24mm Qty 1 pcs			



GEV No.	100701	Ref. No.	6010087
<b>description</b>	ignition electrode connection M4 Qty 1 pcs		
<b>For models:</b>	SG520		
<b>accessories for</b>	100701		
	GEV No.	100906	Ref. No. 5900317 7050028
screw connection thread M10x1 for ignition electrode brass Qty 1 pcs WS 10			



GEV No.	100706	Ref. No.	6010046
<b>description</b>	ignition electrode connection M4 Qty 1 pcs		
<b>For models:</b>	13FG, 13FGC, 17FG, 17FGC, 207FG, 207FGC, 213FG, 213FGC, 217FG, 217FGC, 917FG, 917FGC, 927FG, 927FGC, 934FG, 934FGC, FG07CL, FG07L, FG13L, FG213CL, FG213L, SG608		

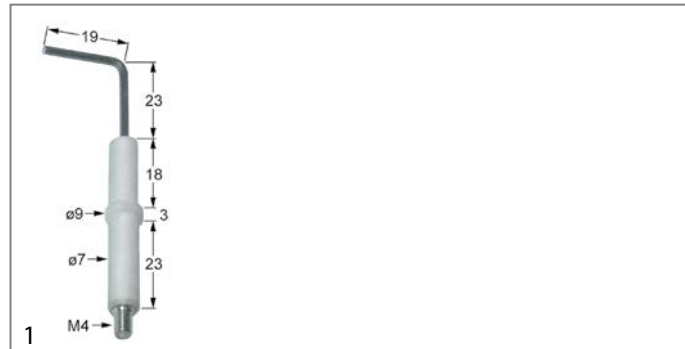

GEV No.	102333	Ref. No.	2012111
<b>description</b>	ignition electrode D1 $\varnothing$ 7mm D2 $\varnothing$ 9mm connection M4 L1 23mm L2 19mm BL1 18mm BL2 3mm BL3 23mm to clip		
<b>For models:</b>	CG06MX, CG102MX, CG10MX, CG20MX, DG06EC, DG06ES, DG06MX, DG102EC, DG102MX, DG10EC, DG10ES, DG10MX, VG06EC, VG06MX, VG102EC, VG102MX, VG10EC, VG10MX, VG20EC, VG20MX		

gas components

Зип Общепит

vsezip.ru

+7(812)987-08-81



1

<b>GEV No.</b>	102331	<b>Ref. No.</b>	2012109
<b>description</b>	ignition electrode D1 ø 7mm D2 ø 9mm connection M4 L1 34mm L2 40mm L3 14mm BL1 18mm BL2 3mm BL3 23mm to clip		
<b>For models:</b>	VG06EC, VG06MX, VG102EC, VG10EC, VG10MX		

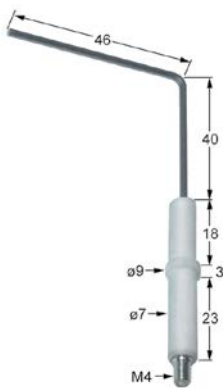

1

<b>GEV No.</b>	102332	<b>Ref. No.</b>	2012108
<b>description</b>	ignition electrode D1 ø 7mm D2 ø 9mm connection M4 L1 40mm L2 46mm BL1 18mm BL2 3mm BL3 23mm to clip		
<b>For models:</b>	VG06EC, VG06MX, VG102EC, VG102MX, VG10EC, VG10MX, VG20EC, VG20MX		



1

<b>GEV No.</b>	102334	<b>Ref. No.</b>	2012110
<b>description</b>	ignition electrode D1 ø 7mm D2 ø 9mm connection M4 L1 9mm L2 12mm L3 62mm BL1 18mm BL2 3mm BL3 23mm to clip		
<b>For models:</b>	CG06MX, CG102MX, CG10MX, CG20MX, DG06EC, DG06ES, DG06MX, DG102EC, DG102MX, DG10EC, DG10ES, DG10MX, VG06EC, VG06MX, VG102EC, VG102MX, VG10EC, VG10MX, VG20EC, VG20MX		



<b>GEV No.</b>	100906	<b>Ref. No.</b>	5900317 7050028
<b>description</b>	screw connection thread M10x1 for ignition electrode brass Qty 1 pcs WS 10		

ignition cables

pre-assembled cables



<b>GEV No.</b>	100140	<b>Ref. No.</b>	6050051
<b>description</b>	ignition cable cable length 400mm connection ø2.4mm / ø4mm		
<b>For models:</b>	13FG, 13FGC, 17FG, 17FGC, 207FG, 213FG, 213FGC, 217FG, 217FGC, 22CPG, 23CPG, 2CPG, 3CPG, 917FG, 917FGC, 927FG, 927FGC, 934FG, 934FGC, CPG66, FG07CL, FG213CL, FRG46, FRG66, SG608		



<b>GEV No.</b>	100025	<b>Ref. No.</b>	6050065
<b>description</b>	ignition cable cable length 600mm connection ø4mm / F6.3mm		
<b>For models:</b>	FG07L, FG13L, FG213L		



<b>GEV No.</b>	100019	<b>Ref. No.</b>	6050610
<b>description</b>	ignition cable cable length 900mm connection ø2.4mm / ø4mm		

piezoelectric igniters

mounting diameter 22mm



1

<b>GEV No.</b>	100013	<b>Ref. No.</b>	6010047
<b>description</b>	piezoelectric igniter body plastic blowing mounting ø 22mm connection ø2.4mm cable lengthmm		
<b>For models:</b>	22CPG, 23CPG, 2CPG, 3CPG, CG740, CG780, CPG1, CPG1BM, CPG66, FPG18, FRG46, FRG66, FTG100, FTG46, FTG46B, FTG46R, FTG66L, FTG66LG, FTG66R, GG66, GG940, GG980, PCG46, PCG66, SG520, SG608		

<b>accessories for</b>	100013	<b>GEV No.</b>	100023	<b>Ref. No.</b>	—
					female bullet size 2.3mm 0.5-1.5mm <sup>2</sup> CuZn t.max. 125°C Qty 20 pcs



2 gas components



ignition units

			
1			
<b>GEV No.</b>	101002	<b>Ref. No.</b>	6041056
<b>description</b>	ignition unit outputs 2 230VAC dimensions 88x23x34mm mounting distance 73mm inlet F6.3x0.8 outlet F2.8x0.8 0.6VA 50/60Hz		
<b>For models:</b>	13FG, 13FGC, 17FG, 17FGC, 207FG, 207FGC, 213FG, 213FGC, 217FG, 217FGC, 917FG, 917FGC, 927FG, 927FGC, 934FG, 934FGC, FG07CL, FG213CL		

Зип Общепит

thermocouples with a uninished tip

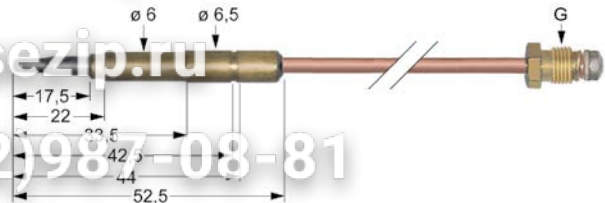
			
1			
<b>GEV No.</b>	102034	<b>Ref. No.</b>	6010063
<b>description</b>	thermocouple M8x1 L 600mm plug connection $\varnothing 6.0(6.5)$ mm		

thermocouples

plug-in thermocouples

plug-in thermocouples standard

with barrel socket  $\varnothing 6(6.5)$ mm

thermocouples SIT

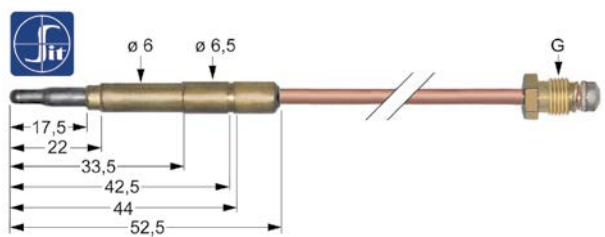
			
1			
<b>GEV No.</b>	107614	<b>Ref. No.</b>	6010056
<b>description</b>	thermocouple SIT M9x1 L 1500mm plug connection $\varnothing 6.0(6.5)$ mm		

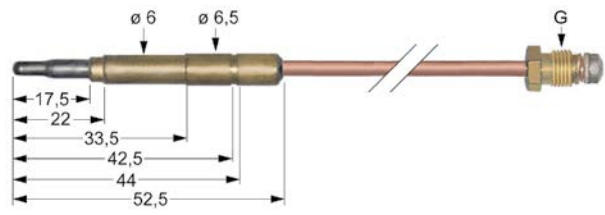
			
1			
<b>GEV No.</b>	102040	<b>Ref. No.</b>	6010058
<b>description</b>	thermocouple M9x1 L 500mm plug connection $\varnothing 6.0(6.5)$ mm		

plug-in thermocouples with interruption

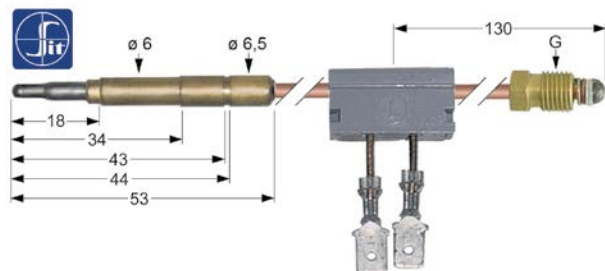
			
1			
<b>GEV No.</b>	107177	<b>Ref. No.</b>	6010065
<b>description</b>	thermocouple SIT with interrupter M9x1 L 600mm plug connection $\varnothing 6.0$ mm F 6.3mm		

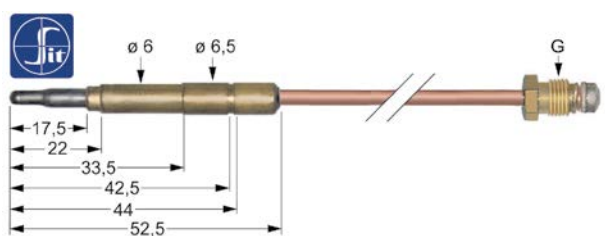
			
1			
<b>GEV No.</b>	107609	<b>Ref. No.</b>	6010055
<b>description</b>	thermocouple SIT M9x1 L 600mm plug connection $\varnothing 6.0(6.5)$ mm		
<b>For models:</b>	13FG, 17FG, 207FG, 213FG, 917FG, 917FGC, 927FG, 927FGC, 934FG, 934FGC, CG740, CG780, FG07L, FG13L, FG213L, FTG100, FTG46, FTG46B, FTG46R, FTG66L, FTG66LG, FTG66R, GG66, GG940, GG980, SG520, SG608		

extensions

			
1			
<b>GEV No.</b>	102811	<b>Ref. No.</b>	6010052
<b>description</b>	thermocouple extension thread M9x1 - M9x1 L 600mm		

accessories

display adapters

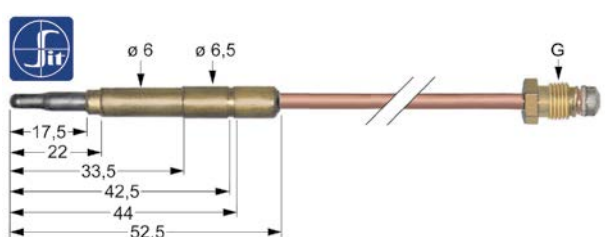
			
1			
<b>GEV No.</b>	107611	<b>Ref. No.</b>	6010057
<b>description</b>	thermocouple SIT M9x1 L 850mm plug connection $\varnothing 6.0(6.5)$ mm		
<b>For models:</b>	22CPG, 23CPG, 2CPG, 3CPG, CPG66		

			
1			
<b>GEV No.</b>	101337	<b>Ref. No.</b>	7050032
<b>description</b>	display adapter thread M9x1		

gas components

Зип.Общепит  
vsezip.ru

+7(812)987-08-81

## displays



1

<b>GEV No.</b>	101414	<b>Ref. No.</b>	6010064
<b>description</b>	display soldering connection		

## gas burners

## bar burners

## bar burners



1

<b>GEV No.</b>	105776	<b>Ref. No.</b>	7090100
<b>description</b>	bar burner ø 50mm Wmm Hmm L 305mm with bolt M5x12 flange width 52mm convection oven flange ø 75mm		
<b>For models:</b>	CG06MX, DG06EC, DG06ES, DG06MX, VG06EC, VG06MX		



1

<b>GEV No.</b>	105775	<b>Ref. No.</b>	7090101
<b>description</b>	bar burner ø 50mm Wmm Hmm L 425mm with bolt M5x12 flange width 52mm convection oven flange ø 75mm		
<b>For models:</b>	CG102MX, CG10MX, CG20MX, DG102EC, DG102MX, DG10EC, DG10ES, DG10MX, VG102EC, VG102MX, VG10EC, VG10MX, VG20EC, VG20MX		



1

<b>GEV No.</b>	105774	<b>Ref. No.</b>	7090102
<b>description</b>	bar burner ø 60mm Wmm Hmm L 245mm with bolt M5x12 flange width 67mm flange length 67mm convection oven		
<b>For models:</b>	VG06EC, VG06MX, VG102EC, VG102MX, VG10EC, VG10MX, VG20EC, VG20MX		

## pilot burner nozzles

## pilot burner nozzles POLIDORO



1

<b>GEV No.</b>	106703	<b>Ref. No.</b>	7042008
<b>description</b>	pilot burner nozzle POLIDORO natural gas code 27.2 bore ø 2x0.27mm Qty 1 pcs		

## pilot burner nozzles SIT

## 100 series



1

<b>GEV No.</b>	100245	<b>Ref. No.</b>	7042005
<b>description</b>	pilot burner nozzle LPG code 20 bore ø 0.2mm Qty 1 pcs thread M8x0.75		



1

<b>GEV No.</b>	100246	<b>Ref. No.</b>	7042006
<b>description</b>	pilot burner nozzle natural gas bore ø 0.35mm Qty 1 pcs thread M8x0.75		

## 140/150 series



1

<b>GEV No.</b>	100204	<b>Ref. No.</b>	7042014
<b>description</b>	pilot burner nozzle SIT LPG code 14 bore ø 0.18/0.20mm Qty 1 pcs suitable for 140 series		



1

<b>GEV No.</b>	100207	<b>Ref. No.</b>	7042013
<b>description</b>	pilot burner nozzle SIT natural gas code 27 bore ø 0.40/0.38mm suitable for SIT 140 series		

## screw connections

## olives



1

<b>GEV No.</b>	106426	<b>Ref. No.</b>	7070025
<b>description</b>	olive		









Зип Общепит

vsezip.ru

+7(812)987-08-81

			
1			
<b>GEV No.</b>	101274	<b>Ref. No.</b>	7070036
<b>description</b>	olive for pipe ø 16mm Qty 1 pcs		
<b>accessories for</b>	101274		
	<b>GEV No.</b>	101275	<b>Ref. No.</b>
			—
	union screw thread 1/2" for pipe ø 16mm Qty 1 pcs		

			
1			
<b>GEV No.</b>	100898	<b>Ref. No.</b>	7070045
<b>description</b>	olive for pipe ø 6mm Qty 1 pcs for pilot burner		
<b>accessories for</b>	100898		
	<b>GEV No.</b>	100909	<b>Ref. No.</b>
			7050029
	union screw thread M10x1 for pipe ø 6mm Qty 1 pcs		

			
1			
<b>GEV No.</b>	100909	<b>Ref. No.</b>	7050029
<b>description</b>	union screw thread M10x1 for pipe ø 6mm Qty 1 pcs		
<b>accessories for</b>	100909		
	<b>GEV No.</b>	100898	<b>Ref. No.</b>
			7070045
	olive for pipe ø 6mm Qty 1 pcs for pilot burner		
	<b>GEV No.</b>	101286	<b>Ref. No.</b>
			—
	olive ID ø 6mm Qty 1 pcs		
	<b>GEV No.</b>	101287	<b>Ref. No.</b>
			—
	olive for pipe ø 6mm Qty 1 pcs		
	<b>GEV No.</b>	101288	<b>Ref. No.</b>
			—
	olive for pipe ø 6mm L 6mm aluminium Qty 1 pcs ED ø 8.5mm		

union screws

			
1			
<b>GEV No.</b>	100905	<b>Ref. No.</b>	7050020
<b>description</b>	locking screw M10x1 for pipe ø 6mm Qty 1 pcs		

			
1			
<b>GEV No.</b>	100906	<b>Ref. No.</b>	5900317 7050028
<b>description</b>	screw connection thread M10x1 for ignition electrode brass Qty 1 pcs WS 10		

			
1			
<b>GEV No.</b>	100907	<b>Ref. No.</b>	5900318
<b>description</b>	screw connection thread M10x1 Qty 1 pcs type SEF 1 ømm for thermocouple		

pressure switches

			
1			
<b>GEV No.</b>	541073	<b>Ref. No.</b>	7050012
<b>description</b>	pressure control ø 45mm pressure range adjustable 5-20mbar pressure connection vertical gas technology connection 1/4" pressure connection ø 1/4"mm		

doors

			
1			
<b>GEV No.</b>	690585	<b>Ref. No.</b>	2011212
<b>description</b>	bush for door mechanism L 35mm ED ø 36mm int. ø 1 31mm int. ø 2 13mm mounting distance 28mm brass		
<b>For models:</b>	CE06MX, CE102MX, CE10MX, CE20MX, CG06MX, CG102MX, CG10MX, CG20MX, DE06EC, DE06ES, DE06MX, DE102EC, DE102MX, DE10EC, DE10ES, DE10MX, DG06EC, DG06ES, DG06MX, DG102EC, DG102MX, DG10EC, DG10ES, DG10MX, VE06EC, VE06MX, VE102EC, VE102MX, VE10EC, VE10MX, VE20EC, VE20MX, VG06EC, VG06MX, VG102EC, VG102MX, VG10EC, VG10MX, VG20EC, VG20MX		

2 gas components

door mechanics

miscellaneous



<b>GEV No.</b>	690585	<b>Ref. No.</b>	2011212
<b>description</b>	bush for door mechanism L 35mm ED ø 36mm int. ø 1 31mm int. ø 2 13mm mounting distance 28mm brass		
<b>For models:</b>	CE06MX, CE102MX, CE10MX, CE20MX, CG06MX, CG102MX, CG10MX, CG20MX, DE06EC, DE06ES, DE06MX, DE102EC, DE102MX, DE10EC, DE10ES, DE10MX, DG06EC, DG06ES, DG06MX, DG102EC, DG102MX, DG10EC, DG10ES, DG10MX, VE06EC, VE06MX, VE102EC, VE102MX, VE10EC, VE10MX, VE20EC, VE20MX, VG06EC, VG06MX, VG102EC, VG102MX, VG10EC, VG10MX, VG20EC, VG20MX		

knobs

producer-specific knobs

GIORIK



<b>GEV No.</b>	112265	<b>Ref. No.</b>	2008671
<b>description</b>	knob gas tap with ignition flame t.max.°C ø 76mm shaft ø 10x8mm shaft flat upper black		
<b>For models:</b>	22CPG, 23CPG, 2CPG, 3CPG, CG740, CG780, CPG1, CPG1BM, CPG66, GG66, GG940, GG980		



<b>GEV No.</b>	111738	<b>Ref. No.</b>	2012261
<b>description</b>	knob switch zero mark ø 50mm shaft ø 6x4.6mm shaft flat left black		
<b>For models:</b>	CE06MX, CE102MX, CE10MX, CE20MX, CG06MX, CG102MX, CG10MX, CG20MX, DE06EC, DE06ES, DE06MX, DE102EC, DE102MX, DE10EC, DE10ES, DE10MX, DG06EC, DG06ES, DG06MX, DG102EC, DG102MX, DG10EC, DG10ES, DG10MX, SH510P, SH560P, VE06EC, VE06MX, VE102EC, VE102MX, VE10EC, VE10MX, VE20EC, VE20MX, VG06EC, VG06MX, VG102EC, VG102MX, VG10EC, VG10MX, VG20EC, VG20MX		



<b>GEV No.</b>	111508	<b>Ref. No.</b>	2006823
<b>description</b>	knob switch zero mark ø 50mm shaft ø 6x4.6mm shaft flat left white		
<b>For models:</b>	13FGC, 15FEC, 17FGC, 207FGC, 20FEC, 210FEC, 213FGC, 215FEC, 217FGC, 220FEC, 917FGC, 920FEC, 922FEC, 927FGC, 934FGC, 940FEC, EF10GM, EF5GM, EF7GM, EN10VE-EC-ESN1033, F10CL, F15CL, F215CL, FG07CL, FG213CL, GF10GM, GF5GM, GF7GM, SH505R, SH510R, SH520G, SH520GM		

Зип Общепит

vsezip.ru

+7(812)987-08-81

<b>GEV No.</b>	111739	<b>Ref. No.</b>	2012260
<b>description</b>	knob universal ø 50mm shaft ø 6x4.6mm shaft flat vertical universal		
<b>For models:</b>	DE06EC, DE102EC, DE10EC, DG06EC, DG102EC, DG10EC, SH510P, VE06EC, VE102EC, VE10EC, VE20EC, VG06EC, VG102EC, VG10EC, VG20EC		

accessories

button springs



<b>GEV No.</b>	550965	<b>Ref. No.</b>	5900242
<b>description</b>	knob spring ø 6x4.6mm Qty 1 pcs		
<b>For models:</b>	BME46, BME66, CPE66, FRE46, FRE46F, FRE46R, FRE46T, FRE66, FRE66F, FRE66R, FRE66T, FTE100, FTE107, FTE46, FTE46B, FTE46R, FTE47L, FTE66L, FTE66LB, FTE66LM, FTE66LMB, FTE66R, FTE66RM, FTE67L, FTE67LM, PCE46, PCE66M, PCE66T, PCG46, PCG66, SPE46		



<b>GEV No.</b>	550132	<b>Ref. No.</b>	550965
<b>description</b>	knob spring ø 6x4.6mm Qty 10 pcs		

locks

handle latches

universal

outside fixing

locks





<b>GEV No.</b>	694065	<b>Ref. No.</b>	5900125	
<b>description</b>	door handle for headed units L 145mm W 40mm H 62mm spring length 33mm outer black			
<b>spare parts for</b>	694065			
	<b>GEV No.</b>	514390	<b>Ref. No.</b>	—
	spring for door handle ø 6mm L 54mm W 27.5mm			
	<b>GEV No.</b>	694734	<b>Ref. No.</b>	—
	door handle L 165mm W 40mm H 25mm black			

Table continues overleaf





Зип Общепит

product specific

vsezip.ru

+7(812)987-08-81

<b>spare parts for</b> 694065			
	<b>GEV No.</b> 694735	<b>Ref. No.</b>	—
cap ø 32mm black			
<b>accessories for</b> 694065			
	<b>GEV No.</b> 694066	<b>Ref. No.</b>	
door catch with spigot 2-stage L 28mm W 14mm H 15mm, H1 16mm total length 51mm thread M8 thread L 23mm stainless steel			
	<b>GEV No.</b> 694067	<b>Ref. No.</b>	5900124
door catch with spigot 1-stage L 26mm total length 51mm thread M8			

snap locks

universal

	<b>GEV No.</b> 690596	<b>Ref. No.</b>	2000160
description snap lock L 60mm W 15mm H 36mm mounting distance 48/28mm spring thickness 1.5mm complete with door catch zamak			

espagnolette locks

universal

	<b>GEV No.</b> 690041	<b>Ref. No.</b>	5900121
description cam L 148mm mounting distance 32mm			

	<b>GEV No.</b> 690040	<b>Ref. No.</b>	5900122
description door catch with roller H 42mm L 40mm W 40mm zinc die cast mounting distance 26mm type 0751 series			
<b>For models:</b> CE06MX, CE102MX, CE10MX, CE20MX, CG06MX, CG102MX, CG10MX, CG20MX, DE06EC, DE06ES, DE06MX, DE102EC, DE102MX, DE10EC, DE10ES, DE10MX, DG06EC, DG06ES, DG06MX, DG102EC, DG102MX, DG10EC, DG10ES, DG10MX, VE06EC, VE06MX, VE102EC, VE102MX, VE10EC, VE10MX, VE20EC, VE20MX, VG06EC, VG06MX, VG102EC, VG102MX, VG10EC, VG10MX, VG20EC, VG20MX			

	<b>GEV No.</b> 700771	<b>Ref. No.</b>	5900123
description latch gear opening to the left shaft intake ø 8x8mm L 170mm W 40mm H 40mm			

	<b>GEV No.</b> 690585	<b>Ref. No.</b>	2011212
description bush for door mechanism L 35mm ED ø 36mm int. ø 1 31mm int. ø 2 13mm mounting distance 28mm brass			
<b>For models:</b> CE06MX, CE102MX, CE10MX, CE20MX, CG06MX, CG102MX, CG10MX, CG20MX, DE06EC, DE06ES, DE06MX, DE102EC, DE102MX, DE10EC, DE10ES, DE10MX, DG06EC, DG06ES, DG06MX, DG102EC, DG102MX, DG10EC, DG10ES, DG10MX, VE06EC, VE06MX, VE102EC, VE102MX, VE10EC, VE10MX, VE20EC, VE20MX, VG06EC, VG06MX, VG102EC, VG102MX, VG10EC, VG10MX, VG20EC, VG20MX			

	<b>GEV No.</b> 690041	<b>Ref. No.</b>	5900121
description cam L 148mm mounting distance 32mm			

	<b>GEV No.</b> 690040	<b>Ref. No.</b>	5900122
description door catch with roller H 42mm L 40mm W 40mm zinc die cast mounting distance 26mm type 0751 series			
<b>For models:</b> CE06MX, CE102MX, CE10MX, CE20MX, CG06MX, CG102MX, CG10MX, CG20MX, DE06EC, DE06ES, DE06MX, DE102EC, DE102MX, DE10EC, DE10ES, DE10MX, DG06EC, DG06ES, DG06MX, DG102EC, DG102MX, DG10EC, DG10ES, DG10MX, VE06EC, VE06MX, VE102EC, VE102MX, VE10EC, VE10MX, VE20EC, VE20MX, VG06EC, VG06MX, VG102EC, VG102MX, VG10EC, VG10MX, VG20EC, VG20MX			

	<b>GEV No.</b> 690584	<b>Ref. No.</b>	2013218
description door handle L 190mm W 41.5mm metal mounting distance 55mm flange 45x72mm shaft 8x8mm shaft L 47mm			

miscellaneous

	<b>GEV No.</b> 511482	<b>Ref. No.</b>	2006619
description pressure pin L 52mm thread M10x1.5			
<b>For models:</b> EF10GM, EF4PM, EF5GM, EF6PM, EF7GM, EF8PM, EN10VE-EC-ESN1033, GF10GM, GF4PM, GF5GM, GF6PM, GF7GM, GF8PM			

mechanical components, equipment accessories

## gaskets

## gaskets for heated units

## window seals

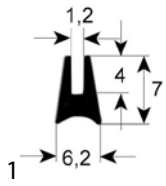

<b>GEV No.</b>	900440	<b>Ref. No.</b>	7070167
----------------	--------	-----------------	---------

<b>description</b>	window gasket profile 1520 Qty supplied by meter
--------------------	--

<b>For models:</b>	CE06MX, CE102MX, CE10MX, CE20MX, CG06MX, CG102MX, CG10MX, CG20MX, DE06EC, DE06MX, DE102EC, DE102MX, DE10EC, DE10MX, DG06EC, DG06MX, DG102EC, DG102MX, DG10EC, DG10MX, VE06EC, VE06MX, VE102EC, VE102MX, VE10EC, VE10MX, VE20EC, VE20MX, VG06EC, VG06MX, VG102EC, VG102MX, VG10EC, VG10MX, VG20EC, VG20MX
--------------------	--

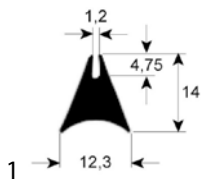

<b>GEV No.</b>	900058	<b>Ref. No.</b>	7070161
----------------	--------	-----------------	---------

<b>description</b>	window gasket profile 1620 Qty supplied by meter
--------------------	--

## door seals

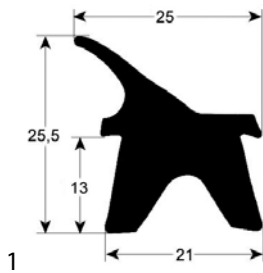

<b>GEV No.</b>	900348	<b>Ref. No.</b>	7070162 7070170 7070172 7070185
----------------	--------	-----------------	--

<b>description</b>	door seal profile 2402 Qty supplied by meter
--------------------	--

<b>For models:</b>	EF10GM, EF4, EF4PM, EF5GM, EF8PM, GF10GM, GF4PM, GF5GM, GF8PM
--------------------	---

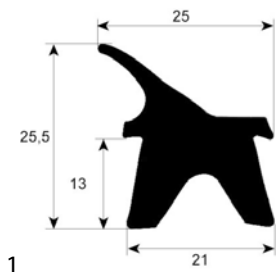

<b>GEV No.</b>	901351	<b>Ref. No.</b>	7070173
----------------	--------	-----------------	---------

<b>description</b>	door seal profile 2402 W 490mm L 635mm external size
--------------------	--

Зип Общепит

vsezip.ru

+7(812)987-08-81



<b>GEV No.</b>	901158	<b>Ref. No.</b>	7070174
----------------	--------	-----------------	---------

<b>description</b>	door seal profile 2402 W 640mm L 740mm
--------------------	--

<b>For models:</b>	EN10VE-EC-ESN1033
--------------------	-------------------

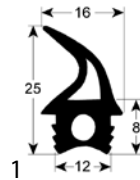

<b>GEV No.</b>	902409	<b>Ref. No.</b>	7070100
----------------	--------	-----------------	---------

<b>description</b>	door seal profile 2714 Qty supplied by meter suitable for GIORIK
--------------------	--

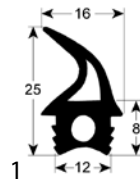

<b>GEV No.</b>	902410	<b>Ref. No.</b>	7070194
----------------	--------	-----------------	---------

<b>description</b>	door seal profile 2714 W 438mm L 778mm suitable for GIORIK
--------------------	--

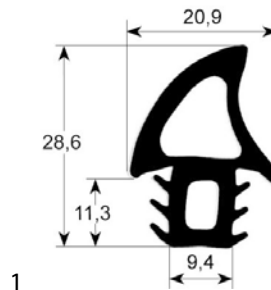

<b>GEV No.</b>	900439	<b>Ref. No.</b>	7070166
----------------	--------	-----------------	---------

<b>description</b>	door seal profile 2750 Qty supplied by meter
--------------------	--

<b>For models:</b>	CE06MX, CE102MX, CE10MX, CE20MX, CG06MX, CG102MX, CG10MX, CG20MX, DE06EC, DE06ES, DE06MX, DE102EC, DE102MX, DE10EC, DE10ES, DE10MX, DG06EC, DG06ES, DG06MX, DG102EC, DG102MX, DG10EC, DG10ES, DG10MX, VE06EC, VE06MX, VE102EC, VE102MX, VE10EC, VE10MX, VE20EC, VE20MX, VG06EC, VG06MX, VG102EC, VG102MX, VG10EC, VG10MX, VG20EC, VG20MX
--------------------	--



3ип Общепит

vsezip.ru

+7(812)987-08-81

### O-rings

EPDM

ø1.78mm

1

<b>GEV No.</b>	505045	<b>Ref. No.</b>	5900381
<b>description</b>	O-ring EPDM thickness 1.78mm ID ø 5.28mm Qty 1 pcs		

1

<b>GEV No.</b>	550550	<b>Ref. No.</b>	7070151
<b>description</b>	shaft sealing for fan motor		
<b>For models:</b>	CE102MX, CE10MX, CE20MX, CG102MX, CG10MX, CG20MX, DE102EC, DE102MX, DE10EC, DE10ES, DE10MX, DG102EC, DG102MX, DG10EC, DG10ES, DG10MX, VE102EC, VE102MX, VE10EC, VE10MX, VE20EC, VE20MX, VG102EC, VG102MX, VG10EC, VG10MX, VG20EC, VG20MX		

### Viton

ø2.62mm

1

<b>GEV No.</b>	532649	<b>Ref. No.</b>	6090141
<b>description</b>	O-ring Viton ID ø 63.17mm thickness 2.62mm Qty 1 pcs		
<b>For models:</b>	EF10GM, EF4PM, EF5GM, EF6PM, EF7GM, EF8PM, GF10GM, GF4PM, GF5GM, GF6PM, GF7GM, GF8PM		

## hose reels and spray guns

### spray guns

1

<b>GEV No.</b>	542964	<b>Ref. No.</b>	7080010
<b>description</b>	spray gun for appliances 1/2" ET L 135mm		

ø3.53mm

1

<b>GEV No.</b>	525313	<b>Ref. No.</b>	6090140
<b>description</b>	O-ring Viton ID ø 60.33mm thickness 3.53mm Qty 1 pcs		
<b>For models:</b>	EF10GM, EF4PM, EF5GM, EF6PM, EF7GM, EF8PM, GF10GM, GF4PM, GF5GM, GF6PM, GF7GM, GF8PM		

## hoses

### industrial hoses

### PE hoses

1

<b>GEV No.</b>	520549 <sup>1</sup>	<b>Ref. No.</b>	7090128 7090130
<b>description</b>	hose 1m operating p. 6bar burst p. 10bar t.max. 65°C LLDPE transparent ID ø 6mm ED ø 8mm John Guest supplied by meter		

<sup>1</sup>by the meter

## shaft gaskets

### shaft gaskets

1

<b>GEV No.</b>	550549	<b>Ref. No.</b>	7070150
<b>description</b>	shaft sealing for fan motor		
<b>For models:</b>	CE06MX, CG06MX, DE06EC, DE06ES, DE06MX, DG06EC, DG06ES, DG06MX, VE06EC, VE06MX, VG06EC, VG06MX		

### PVC hoses

### PVC braided hoses

1

<b>GEV No.</b>	520544	<b>Ref. No.</b>	7090122
<b>description</b>	PVC braided hose ID ø 19mm ED ø 27mm L 5m thickness 4mm operating p. 10bar burst p. 30bar t.max. 60°C PVC warewashing Qty 5m		

mechanical components, equipment accessories





silicone hoses

with fabric

with monofilament braid

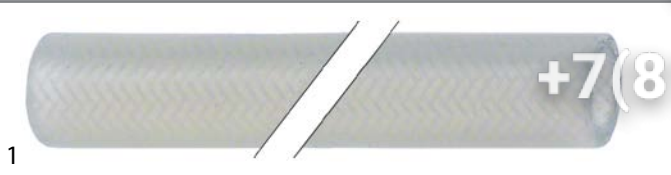

1

<b>GEV No.</b>	530693	<b>Ref. No.</b>	7090112
<b>description</b>	silicone hose with monofilament braid ID ø 10mm ED ø 17mm L 1m thickness 3.5mm operating p. 4bar t.max. 200°C Qty 1m		

Зип.Общепит  
fastening material

screws

hexagonal screws



1

<b>GEV No.</b>	550682	<b>Ref. No.</b>	5111109
<b>description</b>	hexagonal screw thread M8 thread L 20mm SS WS 13 Qty 1 pcs DIN 933 / ISO 4017		

## fittings, hose and pipe connectors

### fittings

angle pieces

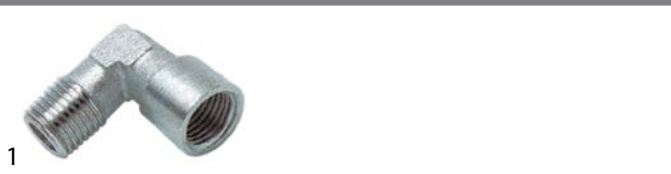

1

<b>GEV No.</b>	520824	<b>Ref. No.</b>	7050374
<b>description</b>	angle piece thread 1/8" ET - 1/8" IT nickel-plated brass		

## valves and tank inlets

### ball valves

ball valves electric

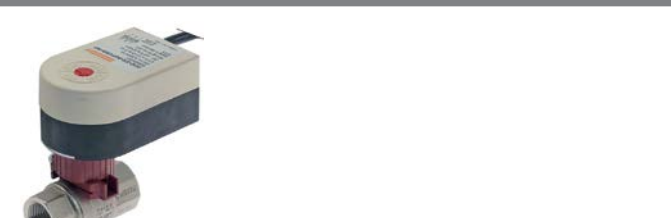

1

<b>GEV No.</b>	401139	<b>Ref. No.</b>	6042073
<b>description</b>	ball valve inlet 3/4" IT outlet 3/4" IT with plug 230V L 65mm 50/60Hz closed off-current mode of operation electric connection cable 200mm		

Зип Общепит

vsezip.ru

+7(812)987-08-81

<b>A</b>			
alarm devices	10	indicator lights (complete)	7
axial fans	17	industrial hoses	33
<b>B</b>		<b>L</b>	
ball valves	34	lamps	7
ball valves electric	16, 34	light bulbs	7
bar burners	28	<b>M</b>	
booster pumps II	19	mechanical timers	10
<b>C</b>		microswitches	5
cam switches	6	<b>O</b>	
condensators & interference suppression filters	19	operating capacitors	19
contactors	10	O-rings	33
control thermostats	3	oven lamps	8
<b>D</b>		<b>P</b>	
door seals	32	PE hoses	33
<b>E</b>		piezoelectric igniters	26
electric timers	10	pilot burners	22
electrodes	16	pressure switches	16, 29
electronic controllers	13	probes	14
energy regulators	3	pumps	19
espagnolette locks	31	push/momentary push switches	5
<b>F</b>		PVC hoses	33
fans	17	<b>R</b>	
fastening material	34	relays	11
filters	19	rocker/momentary rocker switches	4
fittings	34	rotary switches	6
<b>G</b>		<b>S</b>	
gas burners	28	safety thermostats	3
gas control valves	19	screws	34
gas nozzles	28	shaft gaskets	33
gaskets for heated units	32	silicone hoses	34
<b>H</b>		snap locks	31
halogen lamp	8	solenoid valves	15
heating elements	2	spray guns	33
heating elements for convection	2	spray guns with external thread	33
hexagonal screws	34	switches and momentary switches	4
hoses	33	<b>T</b>	
hot air motors	17	temperature probes	14
<b>I</b>		thermocouples	27
ignition boxes	21	thermostats	3
ignition cables	26	time relays	12
ignition units	27	timers	10
immersion heating elements	2	transformers	13
indicator lights	7	<b>U</b>	
		universal probes	14

**Зип Общепит****V**

valves and tank inlets

34

**vsezip.ru****W**

window seals

**+7(812)987-08-81**