



Зип Ощепит

vsezip.ru

Spare Parts for

+7(812)987-08781 **Combi Ovens**



Spare parts suitable for

INOXTREND

2017

Find the complete and up-to-date range of products in our GEV Webshop



heating elements

contact heaters



1

GEV No.	419036	Ref. No.	C2063-00
description	contact heater 1100W 230V heating circuits 1 L 137mm W 120mm H 10mm for combi-steamer connection distance 44mm hole \varnothing 7.5mm		



1

GEV No.	418024	Ref. No.	C5451-00 RRC5451-00
description	hot plate 2200W 230V heating circuits 2 L 194mm H 27mm \varnothing 170mm steam generator dry heating element		

heating elements for convection



1

GEV No.	418021	Ref. No.	C2431-00 C2538-00 RRC2431-00 RRC2538-00
description	heating element 11000W 230V heating circuits 3 ID \varnothing 298mm ED \varnothing 314mm L 355mm H 105mm L1 34mm W1 104mm H1 28mm H2 87mm flange length 142mm flange width 25mm hole distance 64mm connection M4 tube \varnothing 8.5mm convection heating element hole \varnothing 6mm rectangular flange		



1

GEV No.	418023	Ref. No.	C7172-00 RRC7172-00
description	heating element 12000W 230V heating circuits 3 ID \varnothing 408mm ED \varnothing 425mm L 451mm H 134mm L1 18mm W1 105mm H1 46mm H2 88mm flange length 142mm flange width 25mm hole distance 63mm connection M4 tube \varnothing 8.5mm convection heating element hole \varnothing 6mm flange 142 x 25mm		

Зип Общепит

vsezip.ru

+7(812)987-08-81



GEV No.	418022	Ref. No.	C7170-00 RRC7170-00
description	heating element 14000W 230V heating circuits 3 ID \varnothing 368mm ED \varnothing 388mm L 420mm H 128mm L1 35mm W1 105mm H1 38mm H2 90mm flange length 142mm flange width 25mm hole distance 126mm connection M4 connection length 80mm tube \varnothing 6.3mm dry heating element hole \varnothing 6mm rectangular flange		



1

GEV No.	418018	Ref. No.	C6015-00 RRC6015-00
description	heating element 2800W 230V heating circuits 1 ID \varnothing 192mm L 290mm H 37mm L1 85mm W1 59mm flange length 100mm flange width 22mm hole distance 86mm ED \varnothing 210mm connection M4 connection length 22mm tube \varnothing 6.3mm convection heating element hole \varnothing 5mm rectangular flange		



1

GEV No.	418019	Ref. No.	C3616-00 RRC3616-00
description	heating element 3900W 230V heating circuits 3 ID \varnothing 206mm ED \varnothing 218mm L 275mm H 40mm L1 48mm W1 104mm H1 10mm H2 24mm flange length 142mm flange width 25mm hole distance 62.5mm connection M4 connection length 62mm tube \varnothing 6mm convection heating element hole \varnothing 6.5mm rectangular flange		
For models:	CS-5		



1

GEV No.	418020	Ref. No.	C2036-00 C3090-00 LC-001 RRC2036-00 RRC3090-00
description	heating element 7800W 230V heating circuits 3 ID \varnothing 264mm ED \varnothing 277mm L 315mm H 100mm L1 35mm W1 101mm H1 29mm H2 67mm flange length 142mm flange width 23mm hole distance 63mm connection M4 connection length 75mm tube \varnothing 6.3mm convection heating element mounting thread M4 rectangular flange		
For models:	CVE-10 +KTE		

Зип Общепит

control and safety thermostats

vsezip.ru

55.10/19 series

+7(812)987-08-81

			
GEV No.	418905	Ref. No.	C9013-00 LC-002 LC-002-22 RRC9013-00 RRLC-002
description	heating element 8000W 230V heating circuits 3 ID ø 302mm ED ø 319mm L 370mm H 60mm L1 54mm W1 104mm H1 22mm H2 38mm flange length 142mm flange width 25mm hole distance 63mm connection M4 connection length 58mm tube ø 8.5mm convection heating element		

energy regulators

EGO

1-circuit

			
GEV No.	380015	Ref. No.	C2192-00 RRC2192-00
description	energy regulator 230V 13A single-circuit turn direction right shaft ø 6x4.6mm shaft L 23mm mounting thread M4 power release 6-100% no. 50.57021.010		

thermostats

bi-metal thermostats

bi-metal thermostats

			
GEV No.	375611	Ref. No.	C2065-00 RRC2065-00
description	bi-metal thermostat hole distance 34mm switch-off temp. 180°C 2NC 2-pole 16A connection F6.3 2 hole fixing		

			
GEV No.	375608	Ref. No.	C2190-00 RRC2190-00
description	thermostat t.max. 265°C temperature range 50-265°C 1-pole 1NO 16A probe ø 3mm probe L 219mm capillary pipe 900mm capillary pipe isolated 800mm gland nut M9x1 shaft ø 6x4.6mm shaft L 23mm shaft position upper rotation 270°		

			
GEV No.	390815	Ref. No.	LC352
description	thermostat t.max. 273°C temperature range 57-273°C 1-pole 1NO 16A probe ø 3.1mm probe L 226mm capillary pipe 1470mm capillary pipe isolated 1250mm gland nut M9x1 shaft ø 6x4.6mm shaft L 23mm shaft position upper rotation 270°		

			
GEV No.	375231	Ref. No.	FX0187-00
description	thermostat t.max. 90°C temperature range 30-90°C 1-pole 1NO 16A probe ø 6mm probe L 130mm capillary pipe 900mm capillary pipe isolated 600mm gland nut M9x1 shaft L 18mm shaft position upper rotation 270°		



55.13_series

E·G·O



1

GEV No.	375954	Ref. No.	C2218-00 RRC2218-00
description	thermostat t.max. 109°C 1-pole 1CO 16A probe ø 3.03mm probe L 198mm capillary pipe 900mm capillary pipe isolated 610mm gland nut M9x1 shaft ømm shaft Lmm shaft position° shaft position rotation°		

safety thermostats

55.14_series

E·G·O



1

GEV No.	375610	Ref. No.	C2198-00 RRC2198-00
description	safety thermostat switch-off temp. 340°C 1-pole 16A probe ø 3.03mm probe L 144mm capillary pipe 880mm capillary pipe isolated 750mm gland nut M9x1 probe		
For models:	CVE 10-R, MDP-6G		

55.32_series

E·G·O



1

GEV No.	375649	Ref. No.	LC-351 RRLC-351
description	safety thermostat switch-off temp. 160°C 3-pole 20A probe ø 6mm probe L 87mm capillary pipe 890mm capillary pipe isolated 880mm gland nut probe SS		

Зип-Общепит

C2218

control thermostats

vsezip.ru

+7(812)987-08-81

GEV No.	375609	Ref. No.	C2185-00 RRC2185-00
description	thermostat t.max. 90°C temperature range 30-90°C 1-pole 1CO 16A probe ø 6mm probe L 95mm capillary pipe 1600mm capillary pipe isolated 1550mm shaft ø 6x4.6mm rotation 270°		
For models:	MDP-6G		

switches and momentary switches

rocker/momentary rocker switches

30x11mm



1

GEV No.	301013	Ref. No.	C2206-00 RRC2206-00
description	rocker switch mounting measurements 30x11mm black 1CO 250V 16A connection male faston 6.3mm ambient temperature max. 85/125°C protection IP40		

push/momentary push switches

ø16mm



1

GEV No.	346320	Ref. No.	C5420-00 RRC5420-00
description	momentary push switch mounting ø 16mm red 1NO/indicator light 250V 3A ignition connection male faston 6.3mm ambient temperature max. 85°C protection IP40		
For models:	MDP-6G		

ø25mm



1

GEV No.	346094	Ref. No.	AZ129-00 C8252-00 RRC8252-00
description	push switch mounting ø 25mm orange 2NO/indicator light 250V 16A with rubber collar connection male faston 6.3mm ambient temperature max. 85°C protection IP65		

microswitches

pin-plunger actuated

M10



1

GEV No.	345032	Ref. No.	C2207-00 C6018-00 RRC2207-00 RRC6018-00
description	microswitch with plunger thread M10x1 thread L 12mm 250V 16A 1CO connection male faston 6.3mm stroke 7mm mounting distance 22mm L 28mm ambient temperature max. 125°C type SP9603 actuating force: 180g		
For models:	MDP-6G		

M12



1

GEV No.	345360	Ref. No.	C2911-00 RRC2911-00
description	microswitch with plunger mounting distance 25.4mm thread M12x1 thread L 15mm 250V 10A 1CO connection screw stroke 5mm ambient temperature max. 125°C type Highly D5000 actuating force: 200g		

cam switches

on/off



1

GEV No.	301115	Ref. No.	FX0189-12
description	cam switch 2 operating positions 2NO sequence 0-1 16A shaft ϕ 6x4.6mm shaft L 23mm connection male faston 6.3mm		

4 operating positions

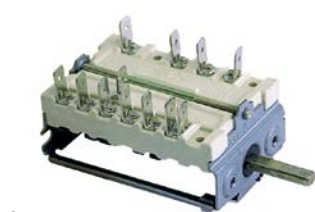

1

GEV No.	300010	Ref. No.	C2214-00 RRC2214-00
description	cam switch 4 operating positions 2NO/2CO sequence 0-1-2-3 16A shaft ϕ 6x4.6mm shaft L 23mm connection male faston 6.3mm ceramic		

5 operating positions

5 operating positions

vsezip.ru

+7(812)987-08-81



1

GEV No.	301297	Ref. No.	C8160-00 RRC8160-00
description	cam switch 5 operating positions 1-0-2-3-4 sequence 8NO 16A shaft ϕ 6x4.6mm shaft L 23mm connection male faston 6.3mm plastic		

rotary switches

TECNOMATIC



1

GEV No.	346304	Ref. No.	C6074-00 RRC6074-00
description	rotary switch 2 0-1 momentary sets of contacts 1 type HD1201RR000 600V 12A shaft ϕ 6x6mm shaft L 23mm shaft round momentary connection male faston 6.3mm		



1

GEV No.	347369	Ref. No.	C6070-12 RRC6070-12
description	rotary switch 3 0-1-2 sets of contacts 4 type HD16X148R000 600V 16A shaft ϕ 6mm shaft L 22mm shaft round connection male faston 6.3mm		



1

GEV No.	346305	Ref. No.	C2241-00 RRC2241-00
description	rotary switch 3 1-0-1 sets of contacts 2 type HD1241ER000 600V 12A shaft ϕ 6x5mm shaft L 22mm shaft square connection screw		



1

GEV No.	347610	Ref. No.	C5500-12
description	rotary switch 4 0-1-2-3 sets of contacts 6 type HD16X143AR000 600V 16A shaft ϕ 6mm shaft L 22mm shaft round connection male faston 6.3mm		



Зип Общежит

magnetic switches

vsezip.ru

+7(812)987-08-81



1

GEV No.	347993	Ref. No.	C3652-12 RRC3652-12
description	rotary switch 5 0-1-2-3-4 sets of contacts 6 type HD12X167R000 600V 12A shaft \varnothing 6x4.6mm shaft L 21mm connection male faston 6.3mm 5 operating positions		



1

GEV No.	346307	Ref. No.	C5390-00 C5390-12 RRC5390-00
description	rotary switch 5 0-1-2-3-4 sets of contacts 8 type HD12X152R000 600V 12A shaft \varnothing 6mm shaft L 22mm shaft round connection male faston 6.3mm		



1

GEV No.	347598	Ref. No.	C6200-12
description	rotary switch 5 8 groups sets of contacts 8 type HD16X167AR000 600V 16A shaft \varnothing 6mm shaft L 22mm shaft round connection male faston 6.3mm		



1

GEV No.	346308	Ref. No.	C5395-00 C5395-01 C5395A-00 RRC5395-00
description	rotary switch 6 1-0-1-2-3-4 sets of contacts 16 type HD16X173R000 600V 16A shaft \varnothing 6mm shaft L 21mm shaft square connection male faston 6.3mm		



1

GEV No.	346102	Ref. No.	C8162-00 RRC8162-00
description	rotary switch 6 2-1-0-3-4-5 sets of contacts 10 type HD12X303R000 600V 12A shaft \varnothing 6mm shaft L 22mm shaft round connection male faston 6.3mm		

37x16mm

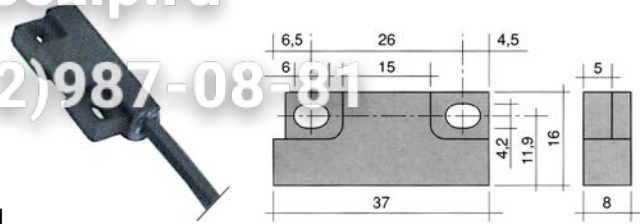

1

GEV No.	345600	Ref. No.	C8310-00
description	magnetic switch L 37mm W 16mm 1NO 250V 0.2A P max. 50W connection cable cable length 960mm		
accessories for	345600		
	GEV No.	519049	Ref. No. —
	magnet \varnothing mm L 63mm H 10.7mm W 18.8mm hole distance 52mm M2 hole \varnothing 2mm		

lamps

indicator lights

indicator lights (complete)

 \varnothing 9mm

1

GEV No.	359136	Ref. No.	C5410-00 RRC5410-00
description	indicator light \varnothing 9mm 230V green connection male faston 6.3mm temp.-resist. 120°C		



1

GEV No.	359137	Ref. No.	C5411-00 RRC5411-00
description	indicator light \varnothing 9mm 230V yellow connection male faston 6.3mm temp.-resist. 120°C with lens		

 \varnothing 12mm

with screw socket



1

GEV No.	359048	Ref. No.	C2189-00 RRC2189-00
description	indicator light \varnothing 12mm 230V yellow connection male faston 6.3mm		

Зип Общепит

oven lamps

vsezip.ru

+7(812)987-08-81

			
1			
GEV No.	359027	Ref. No.	C2205-00 RRC2205-00
description	indicator light ø 12mm 250V green connection male faston 6.3mm		

screw-on/push-on fit

light bulbs

for ovens

			
1			
GEV No.	359610	Ref. No.	C6085-05 RRC6085-05
description	light bulb t.max. 300°C socket E14 15W 230V ø 22mm L 47mm lens L 20mm for oven lamp type Philips		

			
1			
GEV No.	359612	Ref. No.	C2104-03 C6073E-00 RRC2104-03 RRC6073E-00
description	light bulb t.max. 300°C socket E14 25W 230V ø 25mm L 56mm lens L 30mm for oven lamp type Philips		

halogen lamp





for socket G4 / G6.35 / G9

			
1			
GEV No.	359074	Ref. No.	C5252-00 RRC5252-00
description	halogen lamp socket G6.35 12V 35W temp.-resist. 500°C		





			
1			
GEV No.	359946	Ref. No.	LC-051
description	halogen lamp socket G9 230V 40W temp.-resist. 300°C		

universal oven lamps

mounting diameter 35.5mm

				
1				
GEV No.	359701	Ref. No.	C6085-01 RRC6085-01	
description	lamp socket socket E14 220-230V mounting ø 35.5mm connection male faston 6.3mm 15W			
accessories for	359701			
	GEV No.	359705	Ref. No.	—
	oven lamp glass thr.ø 33.5mm ø 52mm hard glas temp.-resist. 350°C			
	GEV No.	359709	Ref. No.	—
	oven lamp glass thr.ø 33.5mm ø 42mm hard glas temp.-resist. 350°C			
	GEV No.	359721	Ref. No.	—
	gasket silicone ED ø 48mm ID ø 39.5mm thickness 5mm Qty 1 pcs			
	GEV No.	359942	Ref. No.	—
	oven lamp glass thr.ø 33.5mm ø 41mm hard glas temp.-resist. 350°C			

55x70mm

				
1				
GEV No.	357105	Ref. No.	LC-050	
description	lamp socket socket G9 250V mounting measurements 55x70mm connection male faston 6.3mm H 32mm			
accessories for	357105			
	GEV No.	359297	Ref. No.	C6073D-00
	frame L 95mm W 81mm mounting distance 68/83mm thickness 6mm			
	GEV No.	359299	Ref. No.	C6073F-00 RRC6073F-00
	gasket L 91mm W 77mm hole ø 3mm for oven lamp			
	GEV No.	359937	Ref. No.	—
	lamp glass L 80mm W 65mm mounting measurements 52x67mm			
	GEV No.	359945	Ref. No.	—
	halogen lamp socket G9 230V 25W temp.-resist. 300°C			





Зип-Общепит

55x70mm





vsezip.ru











+7(812)987-08-81

			
1			
GEV No.	359297	Ref. No.	C6073D-00
description	frame L 95mm W 81mm mounting distance 68/83mm thickness 6mm		
accessories for	359297		
	GEV No.	359299	Ref. No. C6073F-00 RRC6073F-00
gasket L 91mm W 77mm hole ø 3mm for oven lamp			

			
1			
GEV No.	359299	Ref. No.	C6073F-00 RRC6073F-00
description	gasket L 91mm W 77mm hole ø 3mm for oven lamp		

			
1			
GEV No.	359296	Ref. No.	C6073C-00 RRC6073C-00
description	lamp glass L 74mm W 58mm thickness 3mm		

			
1			
GEV No.	357105	Ref. No.	LC-050
description	lamp socket socket G9 250V mounting measurements 55x70mm connection male faston 6.3mm H 32mm		
accessories for	357105		
	GEV No.	359297	Ref. No. C6073D-00
frame L 95mm W 81mm mounting distance 68/83mm thickness 6mm			
	GEV No.	359299	Ref. No. C6073F-00 RRC6073F-00
gasket L 91mm W 77mm hole ø 3mm for oven lamp			
	GEV No.	359937	Ref. No. —
lamp glass L 80mm W 65mm mounting measurements 52x67mm			
	GEV No.	359945	Ref. No. —
halogen lamp socket G9 230V 25W temp.-resist. 300°C			

			
1			
GEV No.	359698	Ref. No.	C2272-01 RRC2272-01
description	lamp socket L 100mm W 55mm socket E14 connection male faston 6.3mm		
spare parts for	359698		
	GEV No.	358119	Ref. No. —
frame L 118mm W 72mm mounting distance 143mm for bulb socket			
	GEV No.	358122	Ref. No. —
gasket L 112mm W 68mm silicone thickness 3mm for bulb socket			
	GEV No.	358123	Ref. No. —
lamp glass L 112mm W 68mm			
	GEV No.	359612	Ref. No. C2104-03 C6073E-00 RRC2104-03 RRC6073E-00
light bulb t.max. 300°C socket E14 25W 230V ø 25mm L 56mm lens L 30mm for oven lamp type Philips			
	GEV No.	359714	Ref. No. C2104-32 RRC2104-32
gasket silicone L 140mm W 75mm for bulb socket			
	GEV No.	359715	Ref. No. C2104-22 RRC2104-22
lamp glass L 110mm W 65mm thickness 5mm			
	GEV No.	359716	Ref. No. C2104-12 RRC2104-12
frame for bulb socket			
accessories for	359698		
	GEV No.	359612	Ref. No. C2104-03 C6073E-00 RRC2104-03 RRC6073E-00
light bulb t.max. 300°C socket E14 25W 230V ø 25mm L 56mm lens L 30mm for oven lamp type Philips			
	GEV No.	359938	Ref. No. —
borosilicate glass L 115mm W 69mm			

			
1			
GEV No.	359716	Ref. No.	C2104-12 RRC2104-12
description	frame for bulb socket		

Зип-Общепит

vsezip.ru

+7(812)987-08-81

			
1			
GEV No.	359714	Ref. No.	C2104-32 RRC2104-32
description	gasket silicone L 140mm W 75mm for bulb socket		

			
1			
GEV No.	359715	Ref. No.	C2104-22 RRC2104-22
description	lamp glass L 110mm W 65mm thickness 5mm		

			
1			
GEV No.	359698	Ref. No.	C2272-01 RRC2272-01
description	lamp socket L 100mm W 55mm socket E14 connection male faston 6.3mm		

spare parts for	359698		
------------------------	--------	--	--

	GEV No.	358119	Ref. No.	—
	frame L 118mm W 72mm mounting distance 143mm for bulb socket			

	GEV No.	358122	Ref. No.	—
	gasket L 112mm W 68mm silicone thickness 3mm for bulb socket			

	GEV No.	358123	Ref. No.	—
	lamp glass L 112mm W 68mm			

	GEV No.	359612	Ref. No.	C2104-03 C6073E-00 RRC2104-03 RRC6073E-00
	light bulb t.max. 300°C socket E14 25W 230V ø 25mm L 56mm lens L 30mm for oven lamp type Philips			

	GEV No.	359714	Ref. No.	C2104-32 RRC2104-32
	gasket silicone L 140mm W 75mm for bulb socket			

	GEV No.	359715	Ref. No.	C2104-22 RRC2104-22
	lamp glass L 110mm W 65mm thickness 5mm			

	GEV No.	359716	Ref. No.	C2104-12 RRC2104-12
	frame for bulb socket			

accessories for	359698		
------------------------	--------	--	--

	GEV No.	359612	Ref. No.	C2104-03 C6073E-00 RRC2104-03 RRC6073E-00
	light bulb t.max. 300°C socket E14 25W 230V ø 25mm L 56mm lens L 30mm for oven lamp type Philips			

accessories for	359698		
------------------------	--------	--	--

	GEV No.	359612	Ref. No.	C2104-03 C6073E-00 RRC2104-03 RRC6073E-00
	light bulb t.max. 300°C socket E14 25W 230V ø 25mm L 56mm lens L 30mm for oven lamp type Philips			

accessories for	359698		
------------------------	--------	--	--

GEV No.	359938	Ref. No.	—
description	borosilicate glass L 115mm W 69mm		

lamps light bulbs

			
1			
GEV No.	359610	Ref. No.	C6085-05 RRC6085-05
description	light bulb t.max. 300°C socket E14 15W 230V ø 22mm L 47mm lens L 20mm for oven lamp type Philips		

			
1			
GEV No.	359612	Ref. No.	C2104-03 C6073E-00 RRC2104-03 RRC6073E-00
description	light bulb t.max. 300°C socket E14 25W 230V ø 25mm L 56mm lens L 30mm for oven lamp type Philips		

halogen lamps for socket G4 / G6.35 / G9

			
1			
GEV No.	359074	Ref. No.	C5252-00 RRC5252-00
description	halogen lamp socket G6.35 12V 35W temp.-resist. 500°C		

			
1			
GEV No.	359946	Ref. No.	LC-051
description	halogen lamp socket G9 230V 40W temp.-resist. 300°C		

sockets G4 / G5,3 / G6,35

			
1			
GEV No.	359369	Ref. No.	C5251-00 C5259-00 C5259-00A RRC5251-00
description	lamp socket socket G4/G5.3/G6.35 24V ø 17mm H 10mm connection cable 120mm mounting distance 11.5mm for halogen lamp cable length 730mm		
For models:	MDP-6G		



+7(812)987-08-81

timers

programme timers



1

GEV No.	360752	Ref. No.	C3056-00 RRC3056-00
description	timer CDC 4902F1 engines 1 chambers 2 operation time 8min 230V shaft ømm shaft Lmm		

electric timers

with time spread





1

GEV No.	350074	Ref. No.	C5365-00 RRC5365-00
description	timer MS65 operation time 120min time spread 30min 1CO/2NO/1NC at 250V 16A permanent position yes impulse electric shaft ø 6x4.6mm shaft L 22mm mounting distance 28mm connection lateral Invensys 4-pole shaft position lower*		

mechanical timers



1

GEV No.	350040	Ref. No.	C2191-00 RRC2191-00
description	timer M2 with bell 2-pole operation time 60min impulse mechanical 2NO at 250V 16A permanent position yes shaft ø 6x4.6mm shaft 6x4.6mm shaft L 23mm mounting distance 28mm connection lateral		
accessories for	350040		
	GEV No.	110366	Ref. No. —
	knob switch zero mark t.max.°C ø 44mm shaft ø 6x4.6mm shaft flat upper black		
	GEV No.	111202	Ref. No. —
	dial plate graduation 60min permanent position yes rotation 0-300° ø 60mm timers knob ø 45mm with permanent position		

buzzer boards



1

GEV No.	401062	Ref. No.	C5366-00 RRC5366-00
description	buzzer board 230VAC L 48mm W 45mm connection Faston 6.3mm		

contactors

LOVATO

power contactors



1

GEV No.	380705	Ref. No.	LC-310 RRLC-310
description	power contactor resistive load 20A 230VAC (AC3/400V) 9A/4kW main contacts 3NO auxiliary contacts 1NO connection screw connection type 11BG0910A230		

accessories for 380705

GEV No.	380057	Ref. No.	LC-315 RRLC-315
description	auxiliary contact contacts 1NO/1NC AC1 10A for contactors BG series connection screw type BGX1011		



1

GEV No.	380855	Ref. No.	C2201-00 RRC2201-00
description	power contactor resistive load 25A 230VAC (AC3/400V) 4.2kW main contacts 3NO auxiliary contacts 1NO		

For models: CVE 10-R**accessories for** 380855

GEV No.	380055	Ref. No.	LC-313 RRLC-313
description	RC circuit voltage AC/DC suitable for BF09-32 rated 240V		



GEV No.	380118	Ref. No.	C3618-00 RRC3618-00
description	auxiliary contact contacts 1NO/1NC AC1 10A for contactors BF series connection screw type G480/11		

auxiliary contacts



1

GEV No.	380118	Ref. No.	C3618-00 RRC3618-00
description	auxiliary contact contacts 1NO/1NC AC1 10A for contactors BF series connection screw type G480/11		



1

GEV No.	380057	Ref. No.	LC-315 RRLC-315
description	auxiliary contact contacts 1NO/1NC AC1 10A for contactors BG series connection screw type BGX1011		

miscellaneous

RC circuits



1

GEV No.	380056	Ref. No.	MC-800 RRMC-800
description	RC circuit 250V		
For models:	MDP-6G		

relays

plug-in/print relays



1

GEV No.	381153	Ref. No.	AZ019-00	
description	print relay 230VAC 2CO at 250V 8A raster size 5mm with socket			
spare parts for	381153			
	GEV No.	381168	Ref. No.	—
	print relay 230VAC 2CO 2-pole at 250V 8A connection pins raster size 5mm SCHRACK manuf. no. RT424730 95.65/95.75			

Зип Общепит

level relays

GICAR.

vsezip.ru

+7(812)987-08-81



1

GEV No.	400018	Ref. No.	HC-055 RRHC-055
description	level relay 230V voltage AC connection F6.3 type RL30/3ES/F/G		

miscellaneous



1

GEV No.	401138	Ref. No.	HC-050 RRHC-050
description	level relay		

transformers

open transformers

with clamp terminal



1

GEV No.	401128	Ref. No.	LC-434 RRLC-434
description	transformer primary 230V secondary 12V 100VA		



1

GEV No.	401135	Ref. No.	LC-436 RRLC-436
description	transformer primary 230V secondary 12V 120VA secondary 10A ambient temperature max. 50°C		

Зип Общепит
encapsulated transformers

multiple connections



+7(812)987-08-81



1	GEV No.	401065	Ref. No.	LC-449 RRLC-449
description transformer primary 230V secondary 12V 120VA secondary 7.5A+2.5A connection screw 50/60Hz				

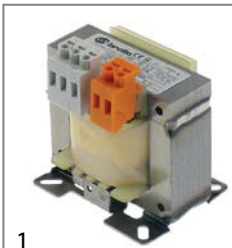

1	GEV No.	401229	Ref. No.	LC-488
description transformer primary 230V secondary 12V 63VA				
For models: MDP-6G				



1	GEV No.	403117	Ref. No.	LC-493
description transformer primary 440V secondary 254V 1000VA connection screw clamp 50/60Hz				



1	GEV No.	403118	Ref. No.	LC-494
description transformer primary 440V secondary 254V 500VA connection screw clamp 50/60Hz				

1	GEV No.	401137	Ref. No.	C2563-00 LC-442 RRC2563-00 RRLC-442
description transformer primary 230V secondary 12V 12VA				



1	GEV No.	401136	Ref. No.	LC-444 RRLC-444
description transformer primary 230V secondary 12V 60VA				



1	GEV No.	401087	Ref. No.	LC-445 RRLC-445
description transformer primary 230V secondary 24V 60VA secondary 2.5A connection male faston 6.3mm 50/60Hz				

PMA



1	GEV No.	379054	Ref. No.	FX0149-00 RRFX149-00
description transformer primary 230VAC secondary 12VAC 3VA secondary 0.25A H 40mm L 45mm W 50mm connection screw 50/60Hz type 153/M				



electronic controllers

EKTRON

refrigeration controllers

built-in version



1			
GEV No.	379397	Ref. No.	C2196-00 RRC2196-00
description	electronic controller EKTRON type DEK31-1000A mounting measurements 71x29mm 12V voltage AC/DC Pt100 relay outputs 2 CO-8A(4) NO-8A(4) Pt100 built-in depth 71mm -99 to +999°C display 3½ digits		

SHANGFANG

accessories



1			
GEV No.	379054	Ref. No.	FX0149-00 RRFX149-00
description	transformer primary 230VAC secondary 12VAC 3VA secondary 0.25A H 40mm L 45mm W 50mm connection screw 50/60Hz type 153/M		

probes

producer-specific probes

probes



1			
GEV No.	378047	Ref. No.	C8248-00 C8248-12 RRC8248-00
description	temperature probe NTC 100kOhm cable TPE probe -40 up to +110°C cable -40 up to +110°C connection male faston thread probe ø5x20mm cable length 0.9m		



1			
GEV No.	379596	Ref. No.	C2471-00 RRC2471-00
description	temperature probe Pt100 cable PTFE probe -100 up to 450°C cable -40 up to +250°C connection 2-wire thread probe ø4x60mm cable length 0.6m		
For models:	MDP-6G		

Зип Общепит

core probes

1			
GEV No.	379597	Ref. No.	C2209-00 C2209-22 RRC2209-00
description	core temperature probe Pt100 cable PTFE probe -40 up to +250°C cable -40 up to +250°C connection 2-wire probe ø4x100mm thread cable length 1.7m handle ø 10mm handle length 80mm		
For models:	MDP-6G		

1			
GEV No.	379505	Ref. No.	C8250-22
description	core temperature probe Pt1000 cable PTFE probe -40 up to +250°C cable -40 up to +250°C connection 2-wire probe ø4x100mm thread cable length 1.7m handle ø 10mm handle length 80mm		

electronics

EPROMS



1			
GEV No.	401107	Ref. No.	C2474-00 RRC2474-00
description	micro processor		
For models:	MDP-6G		

PCBs



1			
GEV No.	401063	Ref. No.	C8165-00 RRC8165-00
description	keypad PCB		

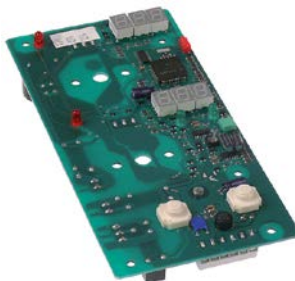

1			
GEV No.	401103	Ref. No.	C2561-00 RRC2561-00
description	keypad PCB		

1 electric components



Зип Общепит
vsezip.ru
+7(812)987-08-81



1

GEV No.	401104	Ref. No.	C2467-00 RRC2467-00
description	keypad PCB		
For models:	MDP-6G		



1

GEV No.	401106	Ref. No.	MC-865 RRMC-865
description	keypad PCB with display		



1

GEV No.	401101	Ref. No.	C2560-00 RRC2560-00
description	keypad PCB L 200mm W 95mm		



1

GEV No.	401061	Ref. No.	C5956-00 RRC5956-00
description	PCB for fan		

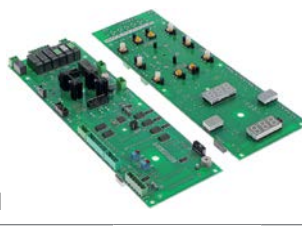

1

GEV No.	403597	Ref. No.	C8164-00 RRC8164-00
description	keypad PCB L 310mm W 105mm		



1

GEV No.	401058	Ref. No.	C8167-00 RRC8167-00
description	PCB suitable for programmable key pad F-Series controller		



1

GEV No.	401064	Ref. No.	C8166-00 RRC8166-00
description	keypad PCB programmable key pad F-Series encoder		

keypads

front foils



1

GEV No.	401097	Ref. No.	C6054-00/BI RRC6054-00/BI
description	front foil		



1

GEV No.	401105	Ref. No.	C2468-00 RRC2468-00
description	keypad PCB with display		
For models:	MDP-6G		



1

GEV No.	401098	Ref. No.	C6057-00/BI RRC6057-00/BI
description	front foil		



Зип Общежит

vsezip.ru

(812)987-08-81

1			
GEV No.	401099	Ref. No.	C3654-00/B RRC3654-00/B
description	front foil		

1			
GEV No.	401125	Ref. No.	C5706-00/R RRC5706-00/R
description	front foil		

1			
GEV No.	401112	Ref. No.	C5521-00/B RRC5521-00/B
description	front foil		

1			
GEV No.	403826	Ref. No.	C2245-00 RRC2245-00
description	front foil		

1			
GEV No.	401113	Ref. No.	C5506-00/B RRC5506-00/B
description	front foil		

1			
GEV No.	403019	Ref. No.	C5278-00/B
description	front foil blue suitable for INOXTREND L 496mm W 115mm		

1			
GEV No.	401114	Ref. No.	C5508-00/B RRC5508-00/B
description	front foil		

1			
GEV No.	401100	Ref. No.	C3655-00/B RRC3655-00/B
description	keypad foil		

1			
GEV No.	401116	Ref. No.	C5298-00/B RRC5298-00/B
description	front foil		

1			
GEV No.	401117	Ref. No.	C5510-00/B RRC5510-00/B
description	keypad foil		

1			
GEV No.	401124	Ref. No.	C5704-00/R RRC5704-00/R
description	front foil		

1			
GEV No.	401118	Ref. No.	C5512-00/B RRC5512-00/B
description	keypad foil		

1			
GEV No.	401119	Ref. No.	C5273-00/B RRC5273-00/B
description	keypad foil		

electric components

Зип-Общепит

keypad units

vsezip.ru

+7(812)987-08-81



GEV No.	401120	Ref. No.	C5293-00/B RRC5293-00/B
description	keypad foil		



GEV No.	401121	Ref. No.	C5272-00/B RRC5272-00/B
description	keypad foil		
For models:	MDP-6G		

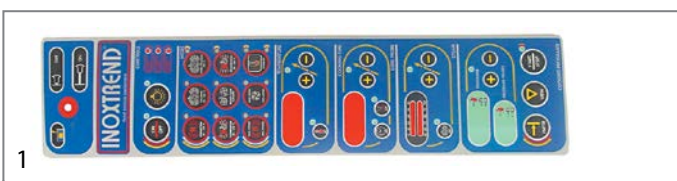

GEV No.	401122	Ref. No.	C5527-00/B RRC5527-00/B
description	keypad foil		

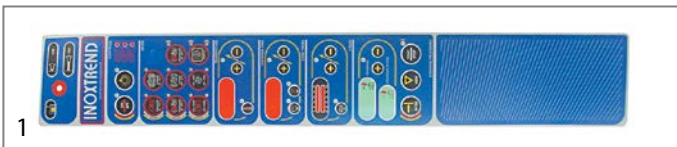

GEV No.	401123	Ref. No.	C5292-00/A C5292-00/B RRC5292-00/A RRC5292-00/B
description	keypad foil		

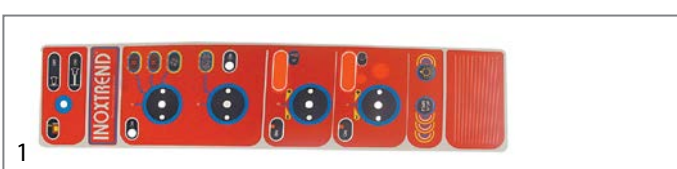

GEV No.	401126	Ref. No.	C5700-00/R RRC5700-00/R
description	keypad foil		



GEV No.	401127	Ref. No.	C5702-00/R RRC5702-00/R
description	keypad foil		



GEV No.	401110	Ref. No.	MC-852 RRCMC-852
description	keypad unit		

solenoid valves

solenoid valves (water)

ROBERTSHAW/INVENSYS

medium temperature: 90°C 90°C 60°C
 ambient temperature: 60°C 25°C 60°C
 duty cycle: 40% 100% 100%



GEV No.	372025	Ref. No.	C2088-00 RRC2088-00
----------------	--------	-----------------	------------------------

description solenoid valve triple straight 230VAC inlet 3/4" outlet 11.5mm DN10 EATON (INVENSYS)

For models: MDP-6G

accessories for 372025

	GEV No.	371250	Ref. No.	C1707-00
--	----------------	--------	-----------------	----------

reducer type EATON (INVENSYS) flow rate 0.25l/min pressure range 0 up to 10bar tolerance ±15/25% white

spare parts and accessories

reducers

outlet side



GEV No.	371250	Ref. No.	C1707-00
----------------	--------	-----------------	----------

description reducer type EATON (INVENSYS) flow rate 0.25l/min pressure range 0 up to 10bar tolerance ±15/25% white

RPE

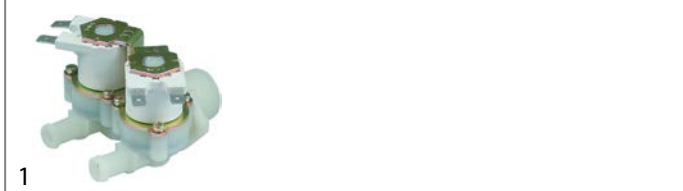

GEV No.	374021	Ref. No.	C2087-00 RRC2087-00
----------------	--------	-----------------	------------------------

description solenoid valve double straight 230VAC inlet 3/4" outlet 10mm DN10 RPE



Зип-Общепит

vsezip.ru





(812) 987-08-81















			
GEV No.	374017	Ref. No.	C3057-00 RRC3057-00
description	solenoid valve single straight 230VAC inlet 3/4" outlet 10mm input 6l/min DN10 RPE polyamide flow regulating valve inlet white membranes NBR pressure range 0.2-10bar		

			
GEV No.	374027	Ref. No.	C2089-00 RRC2089-00
description	solenoid valve 4-fold angled 230VAC inlet 3/4" outlet 10mm DN10 RPE		

solenoid valves with reducers

2-fold			
			
GEV No.	374035	Ref. No.	C2082-00 RRC2082-00
description	solenoid valve double straight 230VAC inlet 3/4" outlet 11.5mm input 10-12l/min t.max. 60°C duty cycle 100% plastic		

TP			
			
GEV No.	370017	Ref. No.	AZ005-00
description	solenoid valve single straight 230VAC inlet 3/4" outlet 11.5mm DN10 TP p max 10bar		
spare parts for	370017		
	GEV No.	371013	Ref. No. —
solenoid coil TP 230VAC 50/60Hz			
accessories for	370017		
	GEV No.	371220	Ref. No. —
reducer TP flow rate 3l/min red tolerance ±15%			
	GEV No.	371221	Ref. No. —
reducer TP flow rate 5.5l/min yellow tolerance ±15%			
	GEV No.	371222	Ref. No. —
reducer TP flow rate 6l/min grey tolerance ±15%			

accessories for	370017		
	GEV No.	371223	Ref. No. —
reducer TP flow rate 10l/min white tolerance ±15%			
	GEV No.	371224	Ref. No. —
reducer TP flow rate 12l/min bronze tolerance ±15%			
	GEV No.	371225	Ref. No. —
reducer TP flow rate 16l/min light brown tolerance ±15%			
	GEV No.	371226	Ref. No. —
reducer TP flow rate 20l/min red tolerance ±15%			
	GEV No.	371230	Ref. No. —
reducer TP flow rate 0.25l/min red tolerance ±25%			
	GEV No.	371231	Ref. No. —
reducer TP flow rate 0.35l/min violet tolerance ±25%			
	GEV No.	371232	Ref. No. —
reducer TP flow rate 0.5l/min orange tolerance ±25%			
	GEV No.	371233	Ref. No. —
reducer TP flow rate 0.8l/min white tolerance ±25%			
	GEV No.	371234	Ref. No. —
reducer TP flow rate 1l/min light blue tolerance ±25%			
	GEV No.	371235	Ref. No. —
reducer TP flow rate 1.2l/min brown tolerance ±25%			
	GEV No.	371236	Ref. No. —
reducer TP flow rate 1.5l/min light brown tolerance ±25%			
	GEV No.	371237	Ref. No. —
reducer TP flow rate 2.5l/min yellow tolerance ±25%			
	GEV No.	371238	Ref. No. —
reducer TP flow rate 3.4l/min dark green tolerance ±25%			
	GEV No.	371239	Ref. No. —
reducer TP flow rate 5l/min black tolerance ±25%			
	GEV No.	371240	Ref. No. —
reducer TP flow rate 8l/min blue tolerance ±20%			

electric components

Зип.Общелит
pressure switches

for coffee machines
vsezip.ru
Ø 38mm

+7(812)987-08-81

metal

solenoid valves (various)



1

GEV No.	370338	Ref. No.	C2072-00 RRC2072-00
description	solenoid valve 2-ways 230VAC connection 1/8" DN 6mm		



1

GEV No.	370319	Ref. No.	LC-455 RRLC-455
description	solenoid valve 2-ways 230VAC inlet 1/4" outlet 1/4" p max 13bar p min 0.1bar 50Hz 230V brass		
spare parts for	370319		
	GEV No.	371188	Ref. No. —
	solenoid coil 50Hz 230V H 35mm seat Ø 13mm type H 17VA series 688		

for coffee machines

Ø 38mm



1

GEV No.	541340	Ref. No.	C2074-00 RRC2074-00
description	pressure control Ø 38mm pressure range 0.5-1.2bar pressure connection vertical preset at 0.9bar coffee machine parts connection male faston 6.3mm pressure connection 1/8"		



1

GEV No.	541341	Ref. No.	C2076-00 RRC2076-00
description	pressure control Ø 38mm pressure range 1.5-4bar pressure connection vertical preset at 3bar 16A 250V coffee machine parts connection 1/8" pressure connection 1/8"		

for steam control



1

GEV No.	541581	Ref. No.	C2075-00 RRC2075-00
description	pressure control Ø 38mm pressure range fixed 1.6bar connection 1/8" 1CO 16A preset at 1.6barbar pressure connection 1/8" ET		

electrodes



1

GEV No.	401086	Ref. No.	HC-054 RRHC-054
description	level electrode 1/4" total length 70mm probe L 44mm insulated probe length 39mm PTFE insulated connection male faston 6.3mm stainless steel Ø 2.5mm		

ball valves electric



1

GEV No.	401085	Ref. No.	LC-500 RRLC-500
description	ball valve inlet 1/2" IT outlet 1/2" IT 230V L 60mm 50/60Hz closed off-current mode of operation electric connection cable 400mm cable 3-pole		



fans

axial fans

import



1

GEV No.	601080 ¹	Ref. No.	FX0068-00 RRFX0068-00
description	axial fan L 119mm W 119mm H 38mm 230VAC 50/60Hz 23/20W bearing ball bearing connection male faston 2.8mm metal ADDA fan wheel ø 110mm temp.-resist. 70°C		
For models:	MDP-6G		
accessories for	601080		
	GEV No.	550898	Ref. No. —
	connecting cable cable length 2000mm connection F 2.8 connection distance 7.9mm for axial flow fan		
	GEV No.	692519	Ref. No. —
	guard L 120mm W 120mm plastic		

¹with ball bearings

hot air motors



1

GEV No.	550049	Ref. No.	C2029-00 RRC2029-00
description	counterflange for fan motor ED ø 60mm int. ø 1 27.3mm int. ø 2 18.5mm thickness 5.8mm brass		



1

GEV No.	511585	Ref. No.	C2027-00 RRC2027-00
description	engine shaft gasket ID ø 17mm ED ø 21.5mm thickness 3.5mm conical		
For models:	MDP-6G		

Зип Общепит

vsezip.ru

+7(812)987-08-81



1

GEV No.	500629	Ref. No.	C3610-00 RRC3610-00
description	fan motor 220-240V 1 phase 50/60Hz 0.045/0.0765kW 2800/3400rpm speeds 1 L1 95mm L2 33mm L3 19mm D1 ø 8mm D2 ø 10mm 0.35A suitable capacitor 2.5µF/400V type 1048		



1

GEV No.	500630	Ref. No.	C2015-00 C2901-00 RRC2901-00
description	fan motor 230/400V 3 phase 50Hz 0.37kW 2600rpm speeds 1 L1 175mm L2 50mm L3 28mm D1 ø 17mm D2 ø 12mm M8R IT 1.1/1.9A Cos(φ) 0.75 at 50Hz 2600rpm type 1020.5450		
For models:	CVE-10E		



1

GEV No.	500631	Ref. No.	C7160-00 C7161-00 RRC7160-00
description	fan motor 230/400V 3 phase 50Hz 0.55kW 2800rpm speeds 1 L1 185mm L2 45mm L3 47mm D1 ø 24mm D2 ø 20mm M8L IT 2.6/1.5A Cos(φ) 0.8 at 50Hz 2800rpm type 3011B4050		



Зип Общепит

vsezip.ru

+7(812)987-08-81



1

GEV No.	601816	Ref. No.	C9011-00 C9011-12 RRC9011-00
description	fan motor 230V 1 phase 50Hz 0.25kW 2600rpm speeds 1 L1 90mm L2 38mm L3 24mm D1 \varnothing 12mm D2 \varnothing 10mm M6 1.5A Cos(fi) 0.98 suitable capacitor 10 μ F/450V		

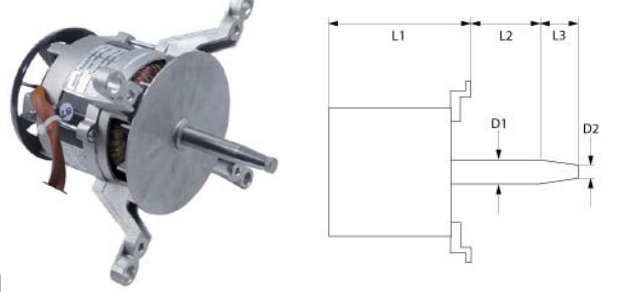

1

GEV No.	601721	Ref. No.	C2900-00
description	fan motor 230V 1 phase 50Hz 0.37kW 2800rpm L1 172mm L2 53mm L3 33mm D1 \varnothing 17mm D2 \varnothing 12mm M8x1.25 2.5A suitable capacitor 10 Cos(fi) 0.95 type 1020.2350		



1

GEV No.	514257	Ref. No.	C3612-00 RRC3612-00
description	fan wheel D1 \varnothing 164mm H1 38mm blades 36 D2 \varnothing 8mm D3 \varnothing 8mm H2 28mm		



1

GEV No.	514261	Ref. No.	C2030-00 C2037-00 RRC2030-00
description	fan wheel D1 \varnothing 210mm H1 100mm blades 20 D2 \varnothing 11mm D3 \varnothing 16mm H2 30mm		
For models:	MDP-6G		



1

GEV No.	514265	Ref. No.	C3067-00 C3068-00 RRC3068-00
description	fan wheel D1 \varnothing 210mm H1 100mm blades 20 D2 \varnothing 11mm D3 \varnothing 16mm H2 30mm		



1

GEV No.	601817	Ref. No.	C7535-00 C7535-00K
description	fan wheel D1 \varnothing 240mm H1 43mm blades 55 D2 \varnothing 9mm D3 \varnothing 11mm H2 23mm		



1

GEV No.	541580	Ref. No.	C2430-11 RRC2430-11
description	fan wheel D1 \varnothing 250mm H1 120mm blades 26 D2 \varnothing 11.5mm D3 \varnothing 16.5mm H2 29mm		



1

GEV No.	514262	Ref. No.	C2430-00 C2430-11K RRC2430-00
description	fan wheel D1 \varnothing 250mm H1 120mm blades 26 D2 \varnothing 11mm D3 \varnothing 16mm H2 30mm		



Зип Обществит
condensators & interference sup-
pression filters
vsezip.ru

+7(812)987-08-81



1

GEV No.	514264	Ref. No.	C7167-00 RRC7167-00
description	fan wheel D1 ø 270mm H1 120mm blades 24 D2 ø 19.5mm D3 ø 23mm H2 46mm		



1

GEV No.	514263	Ref. No.	C7165-00 C7168-00 RRC7165-00
description	fan wheel D1 ø 300mm H1 120mm blades 24 D2 ø 19.5mm D3 ø 23.5mm H2 46mm		

pumps

vibration pumps



1

GEV No.	500564	Ref. No.	C5770-00 RRC5770-00
description	vibration pump type EP 5 230V 48W 50Hz inlet ø 6 outlet ø 1/8" IT ULKA L 123mm		



1

GEV No.	500563	Ref. No.	C6115-00 C6175-00 RRC6115-00 RRC6175-00
description	vibration pump type NME Typ2 230V 16W 50Hz inlet ø 4 outlet ø 6 ULKA L 76mm 110cc/min		



1

GEV No.	365090	Ref. No.	C2470-00 LC-317 RRC2470-00
description	interference suppression filter 250V 50/60Hz capacity 0.47µF(X2)+2X0.027µF(Y2)+2x1mH+0.68MµF		
For models:	MDP-6G		

RC circuits



1

GEV No.	380056	Ref. No.	MC-800 RRMC-800
description	RC circuit 250V		
For models:	MDP-6G		



1

GEV No.	380738	Ref. No.	LC-312 RRLC-312
description	RC circuit type 11BGX79240 suitable for BG series rated 125-240VACV		



1

GEV No.	380055	Ref. No.	LC-313 RRLC-313
description	RC circuit voltage AC/DC suitable for BF09-32 rated 240V		

Зип.Общепит
electronic components

vsezip.ru

+7(812)987-08-81

fuses

fine fuses

			
1			
GEV No.	358532	Ref. No.	LC-422
description	fine fuse size ø5x20mm 2A fast-acting rated 250V Qty 10 pcs		

			
1			
GEV No.	358594	Ref. No.	LC-426
description	fine fuse size ø5x20mm 0.16A slow-acting rated 250V Qty 10 pcs		

electric accessories

cables

ribbon cables

group 1

			
1			
GEV No.	401111	Ref. No.	MC-853 RRMC-853
description	ribbon cable 16-pole L 600mm plug type FC-16P raster size 2.54mm		

terminals

connection terminals with screw/faston connections

			
1			
GEV No.	550411	Ref. No.	FX0144-00
description	power terminal block 6-pole max. 40A max 450V connection ø6mm ² / F6.3 temp.-resist. 150°C cross section 6mm ²		

electronic magnets

			
1			
GEV No.	691625	Ref. No.	LC-370 RRLC-370
description	electronic magnet 230V 50Hz duty cycle 100% L 57mm W 46mm H 32mm		



miscellaneous

			
1			
GEV No.	401109	Ref. No.	MC-851 RRMC-851
description	control box		

gas valves and ignition boxes

gas control valves

HONEYWELL

				
1				
GEV No.	106012	Ref. No.	C5960-00 RRC5960-00	
description	gas valve type VK4115V 220-240V 50/60Hz gas inlet flange 32x32mm gas outlet flange 32x32mm thermocouple connection pilot connection pressure range 15-60mbar max 60mbar operator type HONEYWELL flange 32x32mm			
accessories for	106012			
	GEV No.	102845	Ref. No.	—
	gas connection angled 1/2" flange 32x32mm hole distance 24x24mm Tandem			
	GEV No.	102846	Ref. No.	—
	gas connection straight 1/2" flange 32x32mm hole distance 24x24mm suitable for Tandem			



Зип Общепит

vsezip.ru







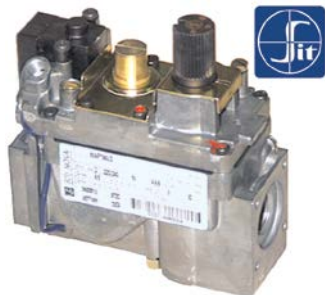



+7(812)987-08-81

SIT











NOVASIT



1

GEV No.	101162	Ref. No.	C2225-00 RRC2225-00
description	gas valve SIT series Novasit 820 230V 50Hz gas inlet 1/2" gas outlet 1/2" thermocouple connection M9x1 pilot connection M10x1 ignition pressure 3-5mbar pressure range 3-30mbar pressure regulator connection blind equiv. no. 0.820.010		
spare parts for	101162		
	GEV No.	101065	Ref. No. —
	magnet unit with cable L 44mm D1 ø 30mm D2 ø 20mm suitable for NOVASIT		
	GEV No.	101313	Ref. No. —
	solenoid coil 230V 50Hz		
accessories for	101162		
	GEV No.	100006	Ref. No. —
	piezoelectric igniter suitable for ELETTROSIT body plastic blowing connection ø2.4mm ø 14mm		
	GEV No.	101305	Ref. No. —
	gas connection straight 1/2" flange 45x45mm ELETTROSIT/V4400/4600/4605 suitable for SIT/HONEYWELL hole distance 36x36mm		
	GEV No.	101306	Ref. No. —
	gas connection angled flange 45x45mm hole distance 36x36mm 1/2" ELETTROSIT/V4400/4600/4605 screw with O-ring suitable for SIT/HONEYWELL		
	GEV No.	101307	Ref. No. —
	gas connection straight flange 45x45mm hole distance 36x36mm 3/4" ELETTROSIT/V4400/4600/4605 screw with O-ring suitable for SIT/HONEYWELL		
	GEV No.	101308	Ref. No. —
	gas connection angled flange 45x45mm hole distance 36x36mm 3/4" ELETTROSIT/V4400/4600/4605 screw with O-ring suitable for SIT/HONEYWELL		
	GEV No.	101312	Ref. No. —
	microswitch		
	GEV No.	101314	Ref. No. —
	solenoid coil 24V 50Hz		
	GEV No.	101317	Ref. No. —
	plug with cable L 1000mm suitable for NOVASIT		
	GEV No.	101318	Ref. No. —
	cover cap for solenoid coil suitable for NOVASIT		

1

GEV No.	101967	Ref. No.	C5350-00 RRC5350-00
description	gas valve SIT series Novasit 822 230V 50Hz gas inlet 1/2" gas outlet 1/2" thermocouple connection pilot connection M10x1 ignition pressure 3-5mbar pressure range 3-30mbar pressure regulator connection perforated equiv. no. 0.822.110		
spare parts for	101967		
	GEV No.	101313	Ref. No. —
	solenoid coil 230V 50Hz		
	GEV No.	101542	Ref. No. —
	solenoid coil 50Hz NOVA 822/826/827 suitable for NOVASIT 230V		
accessories for	101967		
	GEV No.	100904	Ref. No. —
	locking screw M10x1 for pipe ø 4mm Qty 1 pcs		
	GEV No.	100905	Ref. No. —
	locking screw M10x1 for pipe ø 6mm Qty 1 pcs		
	GEV No.	101305	Ref. No. —
	gas connection straight 1/2" flange 45x45mm ELETTROSIT/V4400/4600/4605 suitable for SIT/HONEYWELL hole distance 36x36mm		
	GEV No.	101306	Ref. No. —
	gas connection angled flange 45x45mm hole distance 36x36mm 1/2" ELETTROSIT/V4400/4600/4605 screw with O-ring suitable for SIT/HONEYWELL		
	GEV No.	101307	Ref. No. —
	gas connection straight flange 45x45mm hole distance 36x36mm 3/4" ELETTROSIT/V4400/4600/4605 screw with O-ring suitable for SIT/HONEYWELL		
	GEV No.	101308	Ref. No. —
	gas connection angled flange 45x45mm hole distance 36x36mm 3/4" ELETTROSIT/V4400/4600/4605 screw with O-ring suitable for SIT/HONEYWELL		
	GEV No.	101503	Ref. No. —
	O-ring EPDM thickness 2mm ID ø 32mm Qty 1 pcs		
	GEV No.	101924	Ref. No. —
	plug with cable L 1090mm suitable for NOVA 822/826/827		







Зип-Общепит
ignition boxes

HONEYWELL
vsezip.ru
Honeywell

+7(812)987-08-81



1

GEV No.	106001	Ref. No.	C2226-00 RRC2226-00
description	gas valve SIT series Novasit 826 230V 50Hz gas inlet 1/2" gas outlet 1/2" thermocouple connection pilot connection closed ignition pressure 3-5mbar pressure range 2-50mbar pressure regulator connection standard equiv. no. 0.826.011 power supply for modulator 230VAC rectified		
For models:	MDP-6G		
spare parts for	106001		
	GEV No.	101542	Ref. No. —
	solenoid coil 50Hz NOVA 822/826/827 suitable for NOVASIT 230V		
accessories for	106001		
	GEV No.	101305	Ref. No. —
	gas connection straight 1/2" flange 45x45mm ELETTROSIT/V4400/4600/4605 suitable for SIT/HONEYWELL hole distance 36x36mm		
	GEV No.	101306	Ref. No. —
	gas connection angled flange 45x45mm hole distance 36x36mm 1/2" ELETTROSIT/V4400/4600/4605 screw with O-ring suitable for SIT/HONEYWELL		
	GEV No.	101307	Ref. No. —
	gas connection straight flange 45x45mm hole distance 36x36mm 3/4" ELETTROSIT/V4400/4600/4605 screw with O-ring suitable for SIT/HONEYWELL		
	GEV No.	101308	Ref. No. —
	gas connection angled flange 45x45mm hole distance 36x36mm 3/4" ELETTROSIT/V4400/4600/4605 screw with O-ring suitable for SIT/HONEYWELL		
	GEV No.	101859	Ref. No. C2226-01 RRC2226-01
	panel-mounted inlet with cable L 1000mm for rectifier suitable for NOVASIT		

accessories



1

GEV No.	101859	Ref. No.	C2226-01 RRC2226-01
description	panel-mounted inlet with cable L 1000mm for rectifier suitable for NOVASIT		
For models:	MDP-6G		



1

GEV No.	102367	Ref. No.	C5965-00 C5965-12 RRC5965-00
description	ignition box HONEYWELL type S4565A 2092 1 electrodes 3 waiting times safety time 10s 220-240V 4VA 50/60Hz		

ignition parts

electrodes



1

GEV No.	100701	Ref. No.	C2235-00
description	ignition electrode connection M4 Qty 1 pcs		
accessories for	100701		
	GEV No.	100906	Ref. No. —
	screw connection thread M10x1 for ignition electrode brass Qty 1 pcs WS 10		



Зип Общепит

vsezip.ru

+7(812)987-08-81

1

GEV No.	102315	Ref. No.	C2497-00 RRC2497-00
description	ignition electrode flange length 23mm flange width 15mm D1 ø 7mm L1 5mm BL1 30mm BL2 23mm connection F 2.8x0.8mm fixing dimensions ø5x4mm with flange		
For models:	MDP-6G		

1

GEV No.	102293	Ref. No.	C5907-00 RRC5907-00
description	ignition electrode flange length 51mm flange width 23mm cable length 440mm		

1

GEV No.	102316	Ref. No.	C2494-00 RRC2494-00
description	ignition electrode flange length 23mm flange width 15mm D1 ø 7mm L1 5mm BL1 30mm BL2 24mm connection F 6.3 cable length 800mm fixing dimensions ø5x4mm with flange		
For models:	MDP-6G		

1

GEV No.	107657	Ref. No.	C9309-13 C9309-32 RRC9309-13
description	ignition electrode flange length 56mm flange width 22mm D1 ø 9.4mm L1 45mm L2 38/25mm L3 45/30mm BL1 57mm BL2 33mm connection male faston 4.8mm/6.3mm cable length 650mm screw		

gas components



gas burners

bar burners

bar burners



GEV No.	105663	Ref. No.	C2297-00 RRC2297-00
description	bar burner ø 40mm Wmm Hmm L 458mm flange width 43mm flange length 43mm combi-steamer		
For models:	MDP-6G		



GEV No.	105664	Ref. No.	C2480-00 RRC2480-00
description	bar burner ø 50mm Wmm Hmm L 548mm flange width 57mm flange length 57mm combi-steamer		



GEV No.	105665	Ref. No.	C7188-00 RRC7188-00
description	bar burner ø 60mm Wmm Hmm L 548mm flange width 67mm flange length 67mm combi-steamer		

gas nozzles

main nozzles

gas nozzles M10x1



GEV No.	100639	Ref. No.	C1866-00
description	gas injector thread M10x1 WS 11 bore ø 1.25mm inner peaked		



GEV No.	106291	Ref. No.	C1770-00 RRC1770-00
description	gas injector thread M10x1 WS 11 bore ø 1.95mm inner peaked		

3ип Общепит

pilot burner nozzles

pilot burner nozzles SIT

140/150 series



GEV No.	100205	Ref. No.	C2231-00
description	pilot burner nozzle SIT LPG code 19 bore ø 0.23/0.26mm Qty 1 pcs suitable for SIT 150 series		



GEV No.	100206	Ref. No.	C2232-00
description	pilot burner nozzle SIT natural gas code 36 bore ø 0.60/0.55mm Qty 1 pcs suitable for SIT 150 series		

steam generators

steam generators



GEV No.	693319	Ref. No.	C5450-90 RRC5450-00
description	steam generator complete ø 215mm 2200W 240V		

injection nozzles





GEV No.	691627	Ref. No.	C1715-00 C1715-13 RRC1715-00
description	injection nozzle bore ø 0.4mm D1 ø 6mm D2 ø 11.5mm L 35mm WS 14 brass		

Зип-Общепит
knobs

producer-specific knobs
INOXTREND

(812)987-08-81

			
1			
GEV No.	691628	Ref. No.	C1717-00 C1717-12 RRC1717-00
description	injection nozzle bore \varnothing 0.5mm D1 \varnothing 6mm D2 \varnothing 10.5mm L 35mm WS 14 brass		

			
1			
GEV No.	691629	Ref. No.	C1418-00 C1418-12 C1418-21 RRC1418-00 RRC1418-12
description	injection nozzle bore \varnothing 0.7mm D1 \varnothing 6mm D2 \varnothing 11.5mm L 38mm WS 14 brass thread 1/8"		

cleaning system

nozzles

			
1			
GEV No.	510000	Ref. No.	C7285-00 RRC7285-00
description	nozzle \varnothing 1.5/2.8mm H 13mm thread 1/8" ET WS 13		

for dishwashers

washing and rinsing systems

			
1			
GEV No.	510000	Ref. No.	C7285-00 RRC7285-00
description	nozzle \varnothing 1.5/2.8mm H 13mm thread 1/8" ET WS 13		

			
1			
GEV No.	111000	Ref. No.	C5779B-00 RRC5779B-00
description	knob \varnothing 60mm shaft \varnothing 18.5x18.5mm for safety valve		

			
1			
GEV No.	111683	Ref. No.	C5385-00 RRC5385-00
description	knob switch zero mark \varnothing 40mm shaft \varnothing 6x4.6mm shaft flat upper black		

			
1			
GEV No.	111072	Ref. No.	C8119-00 C8119-22 RRC8119-00
description	knob switch zero mark \varnothing 55mm shaft \varnothing 6x4.6mm shaft flat upper silver		

			
1			
GEV No.	111003 ¹	Ref. No.	C8124-00 RRC8124-00
description	knob switch zero mark \varnothing 55mm shaft \varnothing 6x4.6mm shaft flat upper silver deepend shaft intake		

¹deepend shaft intake

handles and hand wheels

bracket handles



1

GEV No.	691626	Ref. No.	C2417-00 RRC2417-00
description	pull handle L 140mm H 73mm handle M5		

locks

edgmount latches

handle latches

CAFF/FERMOD

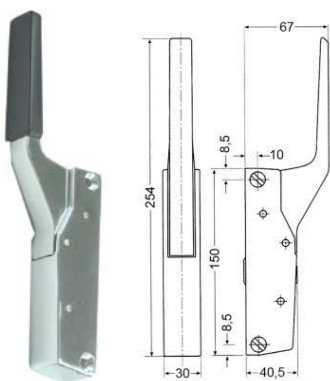

1

GEV No.	690488	Ref. No.	C2210-01 RRC2210-01
description	catch		

producer-specific

INOXTREND



1

GEV No.	690536	Ref. No.	C8118-00 C8118-00CR RRC8118-00
description	catch L 172mm mounting distance 133mm non lockable chrome-plated 6200 total length 248mm		
accessories for	690536		
	GEV No.	690123	Ref. No. —
	door catch H 69mm D 37mm W 20mm mounting distance 43mm with roller		



Зип Общепит

vsezip.ru

+7(812)987-08-81





1

GEV No.	690146	Ref. No.	C2211-01 RRC2211-01
description	handle latch L 172mm mounting distance 134mm non lockable heated units 6200 H 65mm type DUPLO total length 248mm		
For models:	MDP-6G		
accessories for	690146		
	GEV No.	690123	Ref. No. —
	door catch H 69mm D 37mm W 20mm mounting distance 43mm with roller		
	GEV No.	693777	Ref. No. —
	gasket H 6.6mm L 105mm W 45mm L1 78mm W1 25mm for handle		
	GEV No.	693778	Ref. No. —
	door catch		

MODULAR







1

GEV No.	690146	Ref. No.	C2211-01 RRC2211-01
description	handle latch L 172mm mounting distance 134mm non lockable heated units 6200 H 65mm type DUPLO total length 248mm		
For models:	MDP-6G		
accessories for	690146		
	GEV No.	690123	Ref. No. —
	door catch H 69mm D 37mm W 20mm mounting distance 43mm with roller		
	GEV No.	693777	Ref. No. —
	gasket H 6.6mm L 105mm W 45mm L1 78mm W1 25mm for handle		
	GEV No.	693778	Ref. No. —
	door catch		

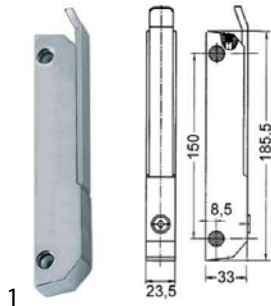
RAHRBACH

6188 ERGO series



GEV No.	700081	Ref. No.	C8050-00 RRC8050-00
description	handle latch L 185mm mounting distance 150mm chrome-plated non lockable refrigeration units 6188		
accessories for	700081		
	GEV No.	690110	Ref. No. —
	base plate H 1mm L 38mm W 11mm mounting distance 26mm plastic		
	GEV No.	690111	Ref. No. —
	base plate H 2mm L 38mm W 11mm mounting distance 26mm plastic		
	GEV No.	690114	Ref. No. —
	base plate H 3.5mm L 185mm W 30mm mounting distance 150mm with inclination thread M5		
	GEV No.	700082	Ref. No. C1447-00
	door catch L 38mm W 18mm mounting distance 26mm		

door catches



GEV No.	690487	Ref. No.	C2211-02 RRC2211-02
description	door catch H 41mm L 70mm W 21mm mounting distance 40mm nickel-plated brass with roller rollerø 8mm		
For models:	MDP-6G		



GEV No.	700082	Ref. No.	C1447-00
description	door catch L 38mm W 18mm mounting distance 26mm		

Зип Общепит

vsezip.ru

+7(812)987-08-81

GEV No.	700061	Ref. No.	C2210-02 RRC2210-02
description	door catch L 58mm W 20mm H 35mm mounting distance 42mm chrome-plated brass for headed units		
accessories for	700061		
	GEV No.	690414	Ref. No. —
	handle latch L 150mm mounting distance 133mm non lockable refrigeration units G 791		

snap locks

universal



GEV No.	700428	Ref. No.	C4038-00 RRC4038-00
description	snap lock L 60mm W 14mm H 30mm mounting distance 47/25mm spring thickness 1mm complete with door catch zamak		



GEV No.	690903	Ref. No.	C8110-00
description	snap lock L 69mm W 13mm H 20mm mounting distance 57mm complete with door catch nickel-plated brass		

espagnolette locks

universal



GEV No.	690041	Ref. No.	HC-027
description	cam L 148mm mounting distance 32mm		



GEV No.	690040	Ref. No.	HC-029 RRHC-029
description	door catch with roller H 42mm L 40mm W 40mm zinc die cast mounting distance 26mm type 0751 series		

Зип.Общепит

gaskets
vsezip.ru
window seals

+7(812)987-08-81

pullouts

rollers

rollers



GEV No.	690692	Ref. No.	C2418-00 RRC2418-00
description	roller rollerø 55mm B1 10mm overall width 14mm A 55mm B 10mm C 14mm SS bore ø 12mm		

equipment feet and end caps

equipment feet

with screw mounting



GEV No.	701092	Ref. No.	C2407-00
description	equipment foot tube ø 50mm thread M10 thread L 23mm H 113/160mm SS Qty 1 pcs		

bullet feet

plastic



GEV No.	700108	Ref. No.	C1446-00 RRC1446-00
description	equipment foot pipe type 40x40 thickness 1-1.2mm H 17-55mm plastic Qty 1 pcs		

spare parts for 700108

GEV No.	511512	Ref. No.	—
description	O-ring EPDM thickness 2.62mm ID ø 18.72mm Qty 10 pcs		

gaskets for heated units

GEV No.	901315	Ref. No.	C7572-00
description	window gasket profile 1577 L 1420mm Qty 1		

GEV No.	900416	Ref. No.	C5214-00 C5218-00 C5223-00 RRC5214-00 RRC5218-00 RRC5223-00
description	window gasket profile 1580 L 1800mm Qty 1 mounting pos. inner		
For models:	MDP-6G		

GEV No.	900419	Ref. No.	C5219-00 RRC5219-00
description	window gasket profile 1580 L 2500mm Qty 1 mounting pos. inner		

GEV No.	900427	Ref. No.	C6515-00 RRC6515-00
description	window gasket profile 1580 L 2900mm Qty 1 mounting pos. inner		

mechanical components, equipment accessories

Зип Общепит

vsezip.ru

+7(812)987-08-81

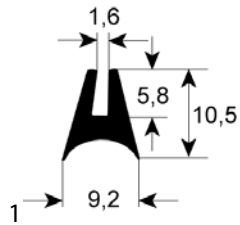

GEV No.	900797	Ref. No.	C5216-00 C5227-00 RRC5216-00 RRC5227-00
description	window gasket profile 1580 L 450mm Qty 1		
For models:	MDP-6G		



GEV No.	900430	Ref. No.	C7117-00 RRC7117-00
description	window gasket profile 1885 L 3250mm Qty 1		

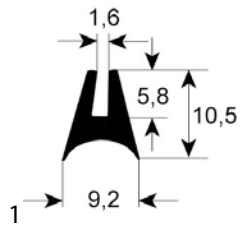

GEV No.	900827	Ref. No.	C5247-00 RRC5247-00
description	window gasket profile 1580 L 990mm Qty 1		

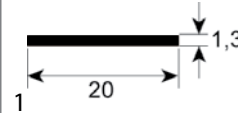

GEV No.	900826	Ref. No.	C6516-00 RRC6516-00
description	window gasket profile 1886 L 600mm Qty 1 external size mounting pos. horizontal		

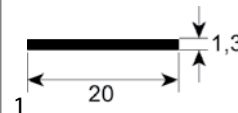

GEV No.	900825	Ref. No.	C6517-00 RRC6517-00
description	window gasket profile 1886 L 800mm Qty 1 external size mounting pos. vertical		

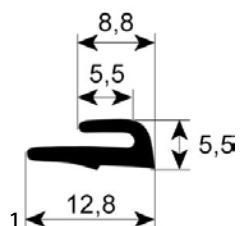

GEV No.	900426	Ref. No.	C6513-00 RRC6513-00
description	window gasket profile 1885 L 2300mm Qty 1		

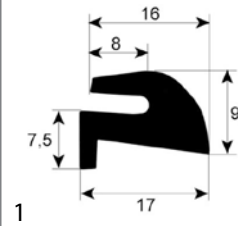

GEV No.	900425	Ref. No.	C6512-00 RRC6512-00
description	window gasket profile 1890 L 2370mm Qty 1 mounting pos. outer		

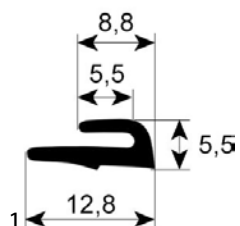

GEV No.	900828	Ref. No.	C5572-00 RRC5572-00
description	window gasket profile 1885 L 2430mm Qty 1		

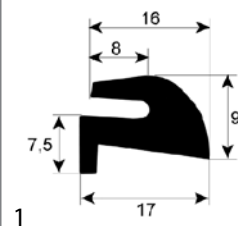

GEV No.	900429	Ref. No.	C7121-01 RRC7121-01
description	window gasket profile 1890 L 3500mm Qty 1 mounting pos. outer		

Зип.Общепит

vsezip.ru

7(812)987-08-81

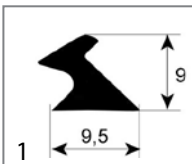

GEV No.	900415	Ref. No.	C5209-00 RRC5209-00
description	window gasket profile 1895 L 3000mm Qty 1 mounting pos. outer		

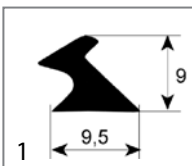

GEV No.	900421	Ref. No.	C5735-00 RRC5735-00
description	window gasket profile 1895 L 3000mm Qty 1 mounting pos. outer		

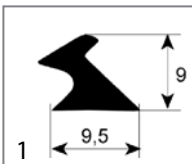

GEV No.	900423	Ref. No.	C5736-00 RRC5736-00
description	window gasket profile 1895 L 3500mm Qty 1 mounting pos. outer		

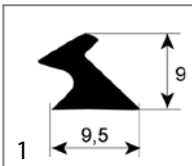

GEV No.	900824	Ref. No.	C5211-00 RRC5211-00
description	window gasket profile 1895 L 3570mm Qty 1 mounting pos. inner		

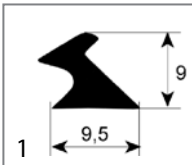

GEV No.	900418	Ref. No.	C5217-00 RRC5217-00
description	window gasket profile 1895 L 3700mm Qty 1 mounting pos. outer		

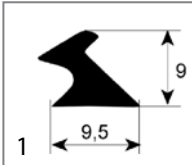

GEV No.	900431	Ref. No.	C7116-00 RRC7116-00
description	window gasket profile 1895 L 4600mm Qty 1 mounting pos. inner		



GEV No.	900348	Ref. No.	C2215-03
description	door seal profile 2402 Qty supplied by meter		

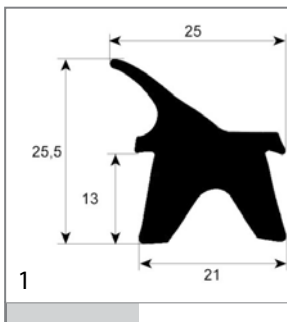

GEV No.	900414	Ref. No.	C2215-06 RRC2215-06
description	door seal profile 2402 W 385mm L 425mm external size Qty 1		

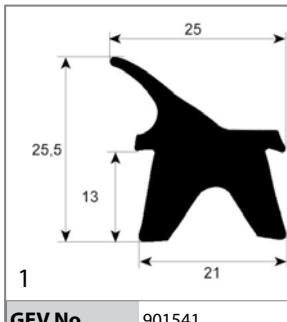

GEV No.	901541	Ref. No.	C2215-04
description	door seal profile 2402 W 430mm L 665mm external size Qty 1 suitable for INOXTREND 4-piece		

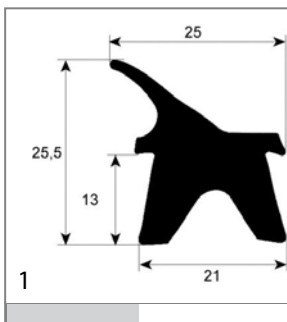

GEV No.	901311	Ref. No.	C2215-01 RRC2215-01
description	door seal profile 2402 W 555mm L 395mm plug size Qty 1 4-piece		
For models:	CVE 6-E		

mechanical components, equipment accessories



Зип Общепит

vsezip.ru

+7(812)987-08-81

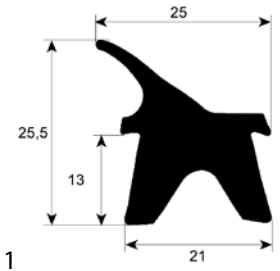
			
GEV No.	901129	Ref. No.	C2215-02 RRC2215-02
description	door seal profile 2402 W 580mm L 765mm Qty 1 4-piece		

			
GEV No.	901540	Ref. No.	C7625-00
description	door seal profile 2458 L 2225mm Qty 1 suitable for INOXTREND		

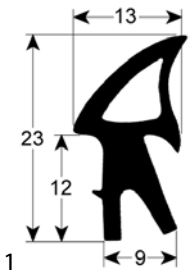
			
GEV No.	900412	Ref. No.	C6013-00 RRC6013-00
description	door seal profile 2458 L 1400mm Qty 1		

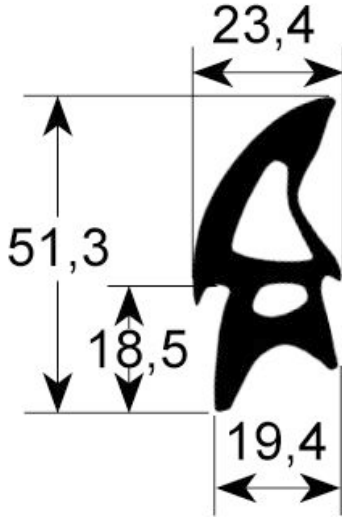
			
GEV No.	900432	Ref. No.	C7115-00 RRC7115-00
description	door seal profile 2460 L 4560mm Qty 1		

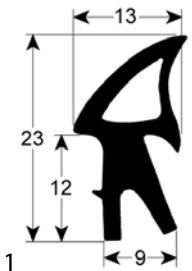
			
GEV No.	900413	Ref. No.	C6090-00 RRC6090-00
description	door seal profile 2458 L 1400mm Qty 1		

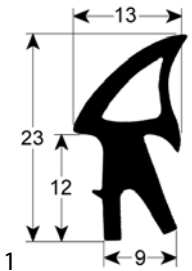
			
GEV No.	901449	Ref. No.	C7562-00 RRC7562-00
description	door seal profile 2458 L 1600mm		

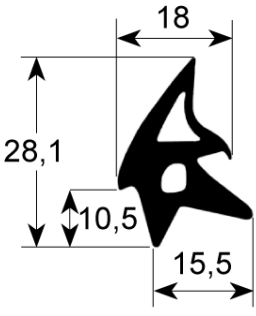
			
GEV No.	901384	Ref. No.	C9031-00 RRC9031-00
description	door seal profile 2470 L 2100mm Qty 1		



Зип Общепит

vsezip.ru

+7(812)987-08-81

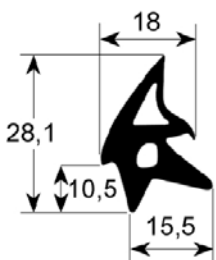

GEV No.	900417	Ref. No.	C5220-00 RRC5220-00
description	door seal profile 2470 L 2300mm Qty 1		
For models:	MDP-6G		



GEV No.	900428	Ref. No.	C6510-00 RRC6510-00
description	door seal profile 2470 L 3600mm Qty 1		

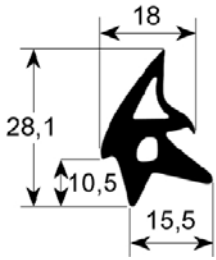

GEV No.	900422	Ref. No.	C5737-00 RRC5737-00
description	door seal profile 2470 L 2630mm Qty 1		

door seals with fixing hook

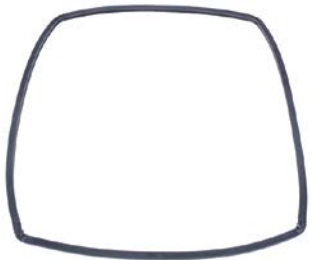

GEV No.	901310	Ref. No.	C1608 -00
description	door seal L 330mm W 450mm with 4 mounting clips external size		

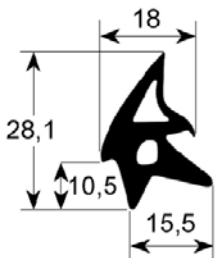

GEV No.	900420	Ref. No.	C5221-00 RRC5221-00
description	door seal profile 2470 L 2850mm Qty 1		

special gaskets

sealing discs



GEV No.	901539	Ref. No.	C9032-00
description	gasket ø 16mm thickness 2.7mm rubber Qty 1 pcs		

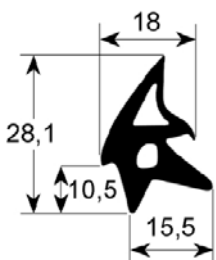

GEV No.	900424	Ref. No.	C5738-00 RRC5738-00
description	door seal profile 2470 L 3250mm Qty 1		

hose reels and spray guns

spray guns



GEV No.	549332	Ref. No.	C2380-00
description	spray gun for appliances 1/2" IT L 215mm type ZANUSSI		
accessories for	549332		
	GEV No.	520168	Ref. No. —
	double nipple nickel-plated brass thread 1/2" - 1/2" Qty 1 pcs		

mechanical components, equipment accessories



hoses

for dishwashers

miscellaneous



GEV No.	511467	Ref. No.	C2181-00
description	pressure hose L 1000mm		

fittings, hose and pipe connectors

fittings

T-pieces

nickel-plated brass



GEV No.	520812	Ref. No.	HR-040
description	T-piece thread 1/8" ET - 1/8" IT - 1/8" IT nickel-plated brass L 37mm		

hose connectors

producer-specific



GEV No.	520336	Ref. No.	HR-598 RRHR-598
description	hose connector thread 1/4" grommet \varnothing 12mm ID \varnothing 8mm grommet length 19mm WS 14 total length 35mm thread L 10mm		



GEV No.	520337	Ref. No.	HR-595 RRHR-595
description	hose connector thread 1/4" grommet \varnothing 7mm ID \varnothing 4.5mm grommet length 19mm WS 14 total length 35mm thread L 10mm		

3ип Общежит
valves and tank inlets

ball valves

ball valves electric



GEV No.	401085	Ref. No.	LC-500 RRLC-500
description	ball valve inlet 1/2" IT outlet 1/2" IT 230V L 60mm 50/60Hz closed off-current mode of operation electric connection cable 400mm cable 3-pole		

water cycle components

pressure reduction valves

pressure reduction valves

producer-specific



GEV No.	520329	Ref. No.	C2090-00 RRC2090-00
description	pressure reduction valve connection 1/2" brass		
For models:	MDP-6G		

measuring equipment

thermometers

built-in thermometers

 \varnothing 60mm

GEV No.	379855	Ref. No.	C2186-00 RRC2186-00
description	thermometer mounting \varnothing 60mm t.max. 350°C +50 up to +350°C probe \varnothing 6mm probe L 20mm capillary pipe 1030mm		
For models:	CE 5, CE10, CE20, CG 5, CG10, CG20, CVE 5, CVE10, CVE20, CVG 5, CVG10, CVG20		

Зип Общепит

vsezip.ru

+7(812)987-08-81



GEV No.	358594	Ref. No.	LC-426
description	fine fuse size ø5x20mm 0.16A slow-acting rated 250V Qty 10 pcs		

fastening material

screws

hexagonal screws



1

GEV No.	550682	Ref. No.	C3069-00 RRC3069-00
description	hexagonal screw thread M8 thread L 20mm SS WS 13 Qty 1 pcs DIN 933 / ISO 4017		
For models:	MDP-6G		

consumables

fuses

fine fuses



1

GEV No.	358532	Ref. No.	LC-422
description	fine fuse size ø5x20mm 2A fast-acting rated 250V Qty 10 pcs		

Зип Общепит

vsezip.ru

+7(812)987-08-81

A			
alarm devices	10	heating elements for convection	2
axial fans	19	hexagonal screws	36
		hose connectors	35
B		hoses	35
ball valves	35	hot air motors	19
ball valves electric	18, 35	I	
bar burners	26	ignition boxes	24
bi-metal thermostats	3, 3	indicator lights	6
		indicator lights (complete)	6
C		L	
cables	22	lamps	6
cam switches	5	light bulbs	7
condensators & interference suppression filters	21	M	
consumables	36	magnetic switches	6
contact heaters	2	measuring equipment	35
contactors	10	mechanical timers	10
control thermostats	3	microswitches	5
D		O	
door catches	29	oven lamps	7
door seals	32	P	
door seals with fixing hook	34	pressure reduction valves	35, 35
E		pressure switches	18
edgemount latches	28	probes	13
electric accessories	22	programme timers	10
electric timers	10	pumps	21
electrodes	18	push/momentary push switches	4
electronic controllers	13	R	
electronic magnets	22	relays	11
energy regulators	3	ribbon cables	22
espagnolette locks	29	rocker/momentary rocker switches	4
F		rotary switches	5
fans	19	S	
fastening material	36	safety thermostats	4
filters	21	screws	36
fine fuses	36	sealing discs	34
fittings	35	snap locks	29
fuses	22, 36	solenoid valves	16
G		spray guns	34
gas burners	26	switches and momentary switches	4
gas control valves	22	T	
gas nozzles	26	terminals	22
gaskets for heated units	30	thermostats	3
H		timers	10
halogen lamp	7	transformers	11
handle latches	28		
heating elements	2		

Зип Общепит**vsezip.ru****+7(812)987-08-81****V**

valves and tank inlets 35
vibration pumps 21

W

water cycle components 35
window seals 30