



heating elements

heating elements for convection



1

GEV No.	418087	Ref. No.	RCK6002125
description	heating element 15000W 230/400V heating circuits 3 ID ϕ 398mm ED ϕ 415mm L 452mm H 121mm L1 32mm W1 105mm H1 80mm H2 25mm flange length 142mm flange width 25mm hole distance 126mm connection M4 tube ϕ 8.5mm convection heating element hole ϕ 6mm rectangular flange		
accessories for	418087		
	GEV No.	550548	Ref. No. RCK2005173
	gasket L 144mm W 25.5mm thickness 2.2mm for heating element suitable for GIORIK equiv. no. 2005173		



1

GEV No.	415251	Ref. No.	00568 RC00568000
description	heating element 2500W 230V heating circuits 1 ID ϕ 178mm ED ϕ 190mm L 242mm H 35mm L1 46mm W1 31mm H1 10mm H2 25mm flange length 70mm flange width 22mm hole distance 56mm connection male faston 6.3mm horizontal tube ϕ 6.3mm convection heating element hole ϕ 5mm rectangular flange		
spare parts for	415251		
	GEV No.	510368	Ref. No. —
	gasket L 70mm W 23.5mm hole ϕ 5mm hole distance 56mm FIBER thickness 2mm for heating element		



1

GEV No.	418086	Ref. No.	RCK6002001
description	heating element 8400W 230V heating circuits 3 ID ϕ 218mm ED ϕ 235mm L 275mm H 112mm L1 40mm W1 105mm H1 32mm H2 80mm flange length 142mm flange width 25mm hole distance 64mm connection M4 tube ϕ 8.5mm convection heating element hole ϕ 6mm rectangular flange		
accessories for	418086		
	GEV No.	550548	Ref. No. RCK2005173
	gasket L 144mm W 25.5mm thickness 2.2mm for heating element suitable for GIORIK equiv. no. 2005173		

Зип-Общепит

accessories

vsezip.ru

+7(812)987-08-81

flange gaskets

GEV No.	550548	Ref. No.	RCK2005173
description	gasket L 144mm W 25.5mm thickness 2.2mm for heating element suitable for GIORIK equiv. no. 2005173		

energy regulators

EGO

1-circuit



1

GEV No.	380015	Ref. No.	00012 00937 06501 RC00006501 RC00012000 RC00937000
description	energy regulator 230V 13A single-circuit turn direction right shaft ϕ 6x4.6mm shaft L 23mm mounting thread M4 power release 6-100% no. 50.57021.010		

thermostats

control and safety thermostats

EGO

control thermostats

55.10/19_series



1

GEV No.	375002	Ref. No.	00569 RC00569000
description	thermostat t.max. 320°C temperature range 55-320°C 1-pole 1NO 16A probe ϕ 3.1mm probe L 226mm capillary pipe 870mm capillary pipe isolated 850mm gland nut shaft L 23mm shaft position upper rotation 270°		

Зип Общежит

vsezip.ru

+7(812)987-08-81



GEV No.	375437	Ref. No.	RC40100042
description	thermostat t.max. 324°C temperature range 66-324°C 1-pole 1NO 16A probe ø 4mm probe L 124mm capillary pipe 1470mm capillary pipe isolatedmm gland nut shaft ø 6x4.6mm shaft L 23mm shaft position upper rotation 270°		



GEV No.	375220	Ref. No.	00238 RC00238000
description	safety thermostat switch-off temp. 330°C 3-pole 20A probe ø 11mm probe L 18.5mm capillary pipe 900mm capillary pipe isolated 900mm gland nut probe screw-in probe probe thread M14x1		

55.34_series



GEV No.	375183	Ref. No.	00285 RC00285000
description	thermostat t.max. 298°C temperature range 50-298°C 3-pole 3NO 16A probe ø 3mm probe L 219mm capillary pipe 900mm capillary pipe isolatedmm gland nut shaft ø 6x4.6mm shaft L 23mm shaft position upper rotation 318°		



GEV No.	375628	Ref. No.	RCK6010008
description	safety thermostat switch-off temp. 350°C 3-pole 20A probe ø 4mm probe L 120mm capillary pipe 900mm capillary pipe isolated 670mm gland nut M10x1 probe SS		

safety thermostats

55.10/19_series



GEV No.	375250	Ref. No.	00427 RC00427000
description	safety thermostat capillary pipe 870mm probe ø 6mm 1-pole probe L 129mm 16A capillary pipe isolatedmm gland nut switch-off temp. 130°C probe SS		
spare parts for	375250		
	GEV No.	551083	Ref. No. —
	cap for safety thermostat thread M8x1		



GEV No.	390142	Ref. No.	00305 RC00305000
description	safety thermostat switch-off temp. 360°C 3-pole 20A probe ø 3.1mm probe L 188mm capillary pipe 1490mm capillary pipe isolated 800mm gland nut probe SS		



switches and momentary switches

rocker/momentary rocker switches

30x22mm



1

GEV No.	301003	Ref. No.	00021 04702 RC00004702 RC00021000
description	rocker switch mounting measurements 30x22mm green 2NO 250V 16A illuminated 0-1 connection male faston 6.3mm ambient temperature max. 125/55°C protection IP65		
accessories for	301003		
	GEV No.	301036	Ref. No. —
	protective cover internal size 30x22mm for rocker switch mounting measurementsmm		

push/momentary push switches

ø16mm



1

GEV No.	346346	Ref. No.	RCK6032038
description	momentary push switch mounting ø 16mm red 1NO/indicator light 250V 3A connection male faston 2.8mm ambient temperature max. 125/55°C protection IP40		

microswitches

lever actuated



1

GEV No.	345107	Ref. No.	00204 RC00204000
description	microswitch with lever 250V 16A 1CO connection male faston 6.3mm L 98mm ambient temperature max. 125°C mounting distance 22mm actuating force: 30g lever length 90mm		

pin-plunger actuated

M10



1

GEV No.	347216	Ref. No.	RC01853000
description	microswitch with plunger thread M10x0.75 thread L 14mm 250V 10A 1CO connection male faston 6.3mm stroke 7.5mm mounting distance 22mm L 28mm ambient temperature max. 125°C type NR6K5 actuating force: 260g		

Зип Общепит

vsezip.ru

+7(812)987-08-81

	GEV No.	346347	Ref. No.	RCK6043088
description	microswitch with plunger thread M10x0.75 thread L 14mm 250V 6A 2NO connection male faston 6.3mm stroke 4mm mounting distance 22mm ambient temperature max. 85°C actuating force: 100g			

cam switches

on/off



1

GEV No.	300129	Ref. No.	RCK6030007
description	cam switch 2 operating positions 2NO sequence 0-1 16A shaft ø 6x4.6mm shaft L 23mm connection male faston 6.3mm ceramic		

7-position



1

GEV No.	300106	Ref. No.	RC01482000
description	cam switch 7 operating positions 1NO/2CO sequence 0-1-2-3-4-5-6 32A shaft ø 6x4.6mm shaft L 23mm connection screw 7-position shaft flat upper		

operation switches



1

GEV No.	300002	Ref. No.	00070 RC00070000
description	cam switch 2 operating positions 4NO 16A sequence 0-1 shaft ø 6x4.6mm shaft L 23mm connection male faston 6.3mm ceramic		



Зип-Общепит

vsezip.ru

+7(812)987-08-81



1

GEV No.	300080	Ref. No.	RC40100006
description	cam switch 2 operating positions 4NO 16A sequence 0-1 shaft \varnothing 6x4.6mm shaft L 23mm connection screw operation switch ceramic ambient temperature max. 150°C		
accessories for	300080		
	GEV No.	Ref. No.	—
	551456		
description	gasket for switch ED \varnothing 14mm ID \varnothing 2.5mm thickness 3.5mm white		



1

GEV No.	300200	Ref. No.	00037 RC00037000
description	operation switch 2 operating positions 2NO 16A sequence 0-1 shaft \varnothing 6x4.6mm shaft L 23mm connection male faston 6.3mm operation switch ceramic		

rotary switches

BREMAS

A1600 series



1

GEV No.	346341	Ref. No.	RCK6030030
description	rotary switch 8 1-2-3-4-5-6-7-8 sets of contacts 10 type CS0169134 400V 16A shaft \varnothing 4x5mm shaft L 20mm shaft square connection screw		

encoders and potentiometers



1

GEV No.	300187	Ref. No.	RCK6010097
description	potentiometer 4.7KOhm rotation 310° shaft \varnothing 0.6x4.5mm shaft L 20mm cable length 650mm		

indicator lights

indicator lights 2-piece (lens and indicator lamp)
indicator light lenses
 \varnothing 10mm (type SR2.3)



1

GEV No.	359123	Ref. No.	00053 RC00053000
description	indicator light housings mounting measurements \varnothing 10mm green round Qty 1 pcs		
accessories for	359123		
	GEV No.	Ref. No.	00052 RC01782000
	359132		
description	indicator lamp green 250V connection male faston 6.3mm protection IP54 ambient temperature max. 85°C		



1

GEV No.	359124	Ref. No.	00319 RC00319000
description	indicator light housings mounting measurements \varnothing 10mm yellow round Qty 1 pcs		
accessories for	359124		
	GEV No.	Ref. No.	00052 RC01782000
	359132		
description	indicator lamp green 250V connection male faston 6.3mm protection IP54 ambient temperature max. 85°C		

indicator lamps for socket type SRZ / SDK / SDY / SFK



1

GEV No.	359130	Ref. No.	RC00052000
description	indicator lamp 230V clear connection male faston 6.3mm \varnothing 8mm		



1

GEV No.	359132	Ref. No.	00052 RC01782000
description	indicator lamp green 250V connection male faston 6.3mm protection IP54 ambient temperature max. 85°C		

indicator lights (complete)

\varnothing 6mm



1

GEV No.	359031	Ref. No.	00011 RC00011000
description	indicator light \varnothing 6mm 230V green		



Зип-Общепит

oven lamps

ø12mm

with screw socket



1

GEV No.	359048	Ref. No.	RC40200150
description	indicator light ø 12mm 230V yellow connection male faston 6.3mm		

screw-on/push-on fit

light bulbs

for ovens



1

GEV No.	359610	Ref. No.	00566 RC00566000
description	light bulb t.max. 300°C socket E14 15W 230V ø 22mm L 47mm lens L 20mm for oven lamp type Philips		

halogen lamp

for socket G4 / G6.35 / G9



1

GEV No.	357191	Ref. No.	RCE00C4396
description	halogen lamp socket G4 12V 10W temp.-resist. 300°C OSRAM HALOSTAR OVEN		



1

GEV No.	359599	Ref. No.	RCK6061054
description	halogen lamp socket G4 12V 20W temp.-resist. 500°C		



1



GEV No.	359946	Ref. No.	RC01856000
description	halogen lamp socket G9 230V 40W temp.-resist. 300°C		

universal oven lamps

mounting diameter 35.5mm



1

GEV No.	359718	Ref. No.	00805 RC00805000	
description	oven lamp mounting ø 35.5mm 230V 15W socket E14 temp.-resist. 300°C connection male faston 6.3mm hard glas			
spare parts for	359718			
	GEV No.	359701	Ref. No.	—
	lamp socket socket E14 220-230V mounting ø 35.5mm connection male faston 6.3mm 15W			
	GEV No.	359740	Ref. No.	—
	light bulb t.max. 300°C socket E14 15W 230V ø 22mm L 48mm lens L 20mm for oven lamp IMPORT			

30x70mm



1

GEV No.	359338	Ref. No.	RCK6063077
description	lamp glass		



1

GEV No.	359337	Ref. No.	RCK6063075	
description	oven lamp socket G4 cable length 800mm connection Faston 6.3mm L 70mm W 29mm			
accessories for	359337			
	GEV No.	359599	Ref. No.	RCK6061054
	halogen lamp socket G4 12V 20W temp.-resist. 500°C			

55x70mm



1

GEV No.	359659	Ref. No.	00275 RC00275000
description	oven lamp complete 230V 25W socket E14 L 70mm W 55mm mounting measurements 55x70mm temp.-resist. 300°C connection male faston 6.3mm		





Зип.Общепит
timers

vsezip.ru
with time spread

(812) 987-08-81

			
1			
GEV No.	359299	Ref. No.	RC02027000
description	gasket L 91mm W 77mm hole ø 3mm for oven lamp		



lamps			
light bulbs			
			
1			
GEV No.	359610	Ref. No.	00566 RC00566000
description	light bulb t.max. 300°C socket E14 15W 230V ø 22mm L 47mm lens L 20mm for oven lamp type Philips		

halogen lamps			
for socket G4 / G6.35 / G9			
			
1			
GEV No.	357191	Ref. No.	RCE00C4396
description	halogen lamp socket G4 12V 10W temp.-resist. 300°C OSRAM HALOSTAR OVEN		

			
1			
GEV No.	359599	Ref. No.	RCK6061054
description	halogen lamp socket G4 12V 20W temp.-resist. 500°C		

			
1			
GEV No.	359946	Ref. No.	RC01856000
description	halogen lamp socket G9 230V 40W temp.-resist. 300°C		

electric timers			
with time spread			
			
1			
GEV No.	350074	Ref. No.	RCK6032047
description	timer MS65 operation time 120min time spread 30min 1CO/2NO/1NC at 250V 16A permanent position yes impulse electric shaft ø 6x4.6mm shaft L 22mm mounting distance 28mm connection lateral Invensys 4-pole shaft position lower°		

mechanical timers			
			
1			
GEV No.	350049	Ref. No.	RC01261000
description	timer M2 with bell 2-pole operation time 30min impulse mechanical 2NO at 250V 16A permanent position yes shaft ø 6x4.6mm shaft 6x4.6mm shaft L 23mm mounting distance 28mm connection lateral		
accessories for	350049		
	GEV No.	110366	Ref. No. —
	knob switch zero mark t.max.°C ø 44mm shaft ø 6x4.6mm shaft flat upper black		
	GEV No.	111205	Ref. No. —
	dial plate graduation 30min permanent position yes rotation 30-300° ø 60mm		

			
1			
GEV No.	350040	Ref. No.	RC00576000
description	timer M2 with bell 2-pole operation time 60min impulse mechanical 2NO at 250V 16A permanent position yes shaft ø 6x4.6mm shaft 6x4.6mm shaft L 23mm mounting distance 28mm connection lateral		
accessories for	350040		
	GEV No.	110366	Ref. No. —
	knob switch zero mark t.max.°C ø 44mm shaft ø 6x4.6mm shaft flat upper black		
	GEV No.	111202	Ref. No. —
	dial plate graduation 60min permanent position yes rotation 0-300° ø 60mm timers knob ø 45mm with permanent position		

→ electric components



+7(812)987-08-81

alarm devices

buzzers



1

GEV No.	350080	Ref. No.	RCK6010103
description	buzzer buzzer		

contactors

ISKRA (FANAL)

power contactors



1

GEV No.	380204	Ref. No.	06208 RC00006208
description	power contactor resistive load 25A 230VAC (AC3/400V) 9A/4kW main contacts 3NO auxiliary contacts 1NO connection screw connection type Fanal DSL9 10 type ISKRA KNL9 10		



1

GEV No.	380424	Ref. No.	RCK6046041
description	power contactor resistive load 35A 230VAC (AC3/400V) 32A/15kW main contacts 3NO connection screw connection type Fanal DSL30 type ISKRA KNL30		

accessories for

	GEV No.	381378	Ref. No.	—
	overload switch connection screw setting range 24,5-30A for contactors KNL30 type BR30 24.5-30A			

power relays

with bracket mounting



1

GEV No.	380403	Ref. No.	00774 01213 RC00001213 RC00774000
----------------	--------	-----------------	--

description power relays FINDER 230VAC 16A 3CO connection F6.3 bracket mounting manuf. no. 62.83.8.230.0500

time relays

time relays



1

GEV No.	381119	Ref. No.	RCK6042049
----------------	--------	-----------------	------------

description time relay LOVATO TM D time range 0.06-180s



1

GEV No.	380607	Ref. No.	RCK6042054
----------------	--------	-----------------	------------

description time relay LOVATO TM M1 time range 0s-10 days 12-24V AC/DC 8A 1CO connection grip connection



1

GEV No.	380606	Ref. No.	RCK6042056
----------------	--------	-----------------	------------

description time relay LOVATO TM PL time range 2x 0.1s-100 days 12-240V AC/DC 8A 1CO connection grip connection



transformers

for lighting

1			
GEV No.	401175	Ref. No.	RCK6041J65
description	transformer primary 230V secondary 11.5V 90VA		

probes

universal probes

temperature probes

1			
GEV No.	379860	Ref. No.	RCK6000100
description	temperature probe NTC 10kOhm cable PVC probe -20 up to +80°C cable -10 up to 100°C probe ø6x40mm cable length 1.5m without screw connection 2-wire		

1			
GEV No.	379222 ¹	Ref. No.	RCK6000083
description	temperature probe Pt100 cable Vetrotex probe -200 up to +600°C cable -50 up to +350°C probe ø4x110mm cable length 1.4m 3-wire		

¹3-wire

electronics

PCBs

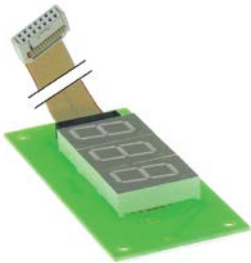
1			
GEV No.	401166	Ref. No.	RCK6010095
description	display		

1			
GEV No.	401172	Ref. No.	RCK6010093
description	PCB combi-steamer VE 06/10		

Зип Общепит

vsezip.ru

+7(812)987-08-81

1			
GEV No.	401167	Ref. No.	RCK6010096
description	PCB combi-steamer VE 06/10 230V 50/60Hz		
accessories for	401167		
GEV No.	401062	Ref. No.	—
description	buzzer board 230VAC L 48mm W 45mm connection Faston 6.3mm		

solenoid valves

solenoid valves (water)

1			
GEV No.	374017	Ref. No.	RCK6042070
description	solenoid valve single straight 230VAC inlet 3/4" outlet 10mm input 6l/min DN10 RPE polyamide flow regulating valve inlet white membranes NBR pressure range 0.2-10bar		

1			
GEV No.	370768 ¹	Ref. No.	RC01964000
description	solenoid valve single straight 230VAC inlet 3/4" outlet 10mm input/ min output/ min DN10 t.max. 90°C duty cycle 100% RPE		

¹cylindrical outlet

pressure switches

for steam control

1			
GEV No.	541074	Ref. No.	RC01842000
description	pressure control ø 45mm triggering pressure 0.5bar reset pressure 0.35bar pressure connection vertical steam control pressure range 0.35/0.51 bar connection 1/8" pressure connection 1/8"		



fans

axial fans

import



1	GEV No.	601604 ¹	Ref. No.	RC01863000
description axial fan L 119mm W 119mm H 38mm 230VAC 50/60Hz 17/15W bearing slide bearing manuf. no. AA1282HS-AT connection cable 300mm fan wheel ø 110mm temp.-resist. 70°C input current 0.1A airflow 130m ³ /h 2600rpm				

¹with slide bearings

hot air motors

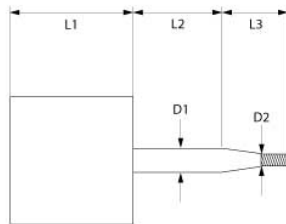

1	GEV No.	500640	Ref. No.	RCK6032122
description fan motor 220-240V 1 phase 50Hz 0.05/0.25HP 1400/2700rpm speeds 2 L1 145mm L2 65mm L3 35mm D1 ø 15mm D2 ø 12mm M10L ET 1.1/0.55A suitable capacitor 12.5µF/450V at 50Hz 1400/2700rpm type 2758D2253 no. 6032122				
spare parts for 500640				
	GEV No.	560280	Ref. No.	—
nut thread M10L H 8mm WS 17 SS DIN/ISO DIN 934 / ISO 4032/8673 Qty 1 pcs				

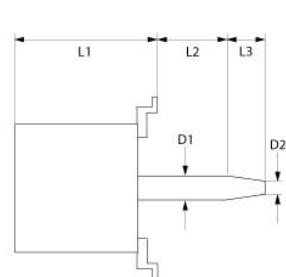

1	GEV No.	500642	Ref. No.	RCK6033145
description fan motor 380-415V 3 phase 50Hz 0.22/0.75kW 700/1400rpm speeds 2 L1 166mm L2 45mm L3 67mm D1 ø 24mm D2 ø 20mm M6R ITA at 50Hz 380-415V at 50Hz 700/1400rpm type FB80 4/8 no. 629764				

Зип Общепит

vsezip.ru

+7(812)987-08-81



1	GEV No.	601202	Ref. No.	RCK5901006
description fan wheel D1 ø 180mm H1 100mm blades 16 D2 ø 11.5mm D3 ø 16mm H2 30mm				



1	GEV No.	601203	Ref. No.	RCK5901010
description fan wheel D1 ø 310mm H1 100mm blades 30 D2 ø 19.5mm D3 ø 23mm H2 46mm				

hot air fans

miscellaneous



1	GEV No.	601011	Ref. No.	00565 RC00565000
description hot air fan 220-240V 40W 50/60Hz L1 65mm L2 15mm L3 25mm L4 87mm fan wheel ø 150mm FIME type C25R8023CLH				
accessories for 601011				
	GEV No.	550879	Ref. No.	—
insulation ø 130mm thickness 3mm hole ø 18mm for hot air fan				

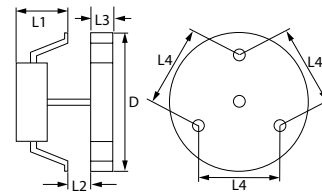

Table continues overleaf



Зип-Общепит

fuses



vsezip.ru

+7(812)987-08-81

accessories for	601011			
	GEV No.	601260	Ref. No.	—
	nut thread M6L IT for hot air fan			

pumps

vibration pumps

				
1				
GEV No.	500568	Ref. No.	RC01969000	
description	vibration pump 230V 32W 50Hz inlet ø 7 outlet ø 1/8" IT CEME type E512/A32			
spare parts for	500568			
	GEV No.	390698	Ref. No.	—
	thermal fuse switch-off temp. 110°C suitable for ULKA pump			
	GEV No.	520153	Ref. No.	—
	bracket rubber dimensions 53x34x28mm			

condensators & interference suppression filters

operating capacitors

plastic			
			
1			
GEV No.	365014	Ref. No.	LF3068081 RCK2013001
description	operating capacitor capacity 12.5µF 450V tolerance 5%Hz ambient temperature max. -25 to +85°C ø 35mm L 70mm M8 plastic connection male faston 6.3mm 45S.C3DS.12.5 protection		

filters

interference suppression filters

			
1			
GEV No.	365044	Ref. No.	RCK6090050
description	interference suppression filter type FC701Y2F 250V 50-60Hz conductor 2 with E connection cable 200mm L 42mm ø 23mm Hmm Wmm plastic Qty 1 pcs		

fine fuses

			
1			
GEV No.	358677	Ref. No.	RC01861000
description	fine fuse size ø5x20mm 4A fast-acting rated 250V Qty 10 pcs		

electric accessories

cables

accessories			
cable glands			
threaded cable glands			
screw connections			
			
1			
GEV No.	550571	Ref. No.	RC00241000
description	cable gland thread PG16 cable ø 12.0-14.0mm mounting ø 21.5mm nickel-plated brass Qty 1 pcs		

terminals

connection terminals with screw/faston connections			
			
1			
GEV No.	550977 ¹	Ref. No.	RC00194000
description	power terminal block 6-pole max. 40A max 450V connection ø6mm ² / F6.3 temp.-resist. 150°C cross section 6mm ² with ground lug		

¹with ground lug

+7(812)987-08-81

gas thermostats

PEL

25ST series

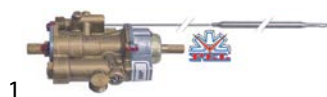

GEV No.	101172	Ref. No.	01133 RC01133000
description	gas thermostat PEL type 25ST 100-300°C gas inlet M16x1.5 (tube ø 10mm) bypass nozzle ø 0.35mm gas outlet M16x1.5 (tube ø 10/8mm) thermocouple connection M9x1 pilot connection M10x1 capillary pipe 1200mm probe ø 6mm probe L 100mm shaft ø 8x6.5mm shaft L 21/15mm shaft flat upper		
spare parts for	101172		
	GEV No.	100259	Ref. No. —
	bypass nozzle type PEL22 bore ø 0.35mm thread M6x0.5		
	GEV No.	101060	Ref. No. —
	magnet unit standard L 39mm D1 ø 15.4mm D2 ø 11mm suitable for PEL20-21/JUNKERS/EGA		
	GEV No.	106200	Ref. No. —
	nut thread M9x1 suitable for PEL 24/255		
accessories for	101172		
	GEV No.	100908	Ref. No. —
	union screw thread M10x1 for pipe ø 4mm Qty 1 pcs		
	GEV No.	100909	Ref. No. —
	union screw thread M10x1 for pipe ø 6mm Qty 1 pcs		
	GEV No.	101246	Ref. No. —
	olive for pipe ø 4mm Qty 1 pcs		
	GEV No.	101278	Ref. No. —
	olive for pipe ø 10mm Qty 1 pcs		
	GEV No.	101286	Ref. No. —
	olive ID ø 6mm Qty 1 pcs		
	GEV No.	101300	Ref. No. —
	union nut thread M16x1.5 tube ø 10mm		
	GEV No.	101450	Ref. No. —
	olive for pipe ø 8mm L 12.7mm Qty 1 pcs ED ø 10mm		
	GEV No.	101451	Ref. No. —
	union nut thread M16x1.5 tube ø 8mm		
	GEV No.	110079	Ref. No. —
	knob dial plate gas thermostat 1-8 silver		
	GEV No.	110081	Ref. No. RC05001300
	knob ø 70mm shaft ø 8x6.5mm shaft flat universal		

gas control valves

TANDEM



GEV No.	101881	Ref. No.	RCK7020080
description	gas valve 230V 50Hz gas inlet 1/2" gas outlet 1/2" pilot connection level slow ignition ignition times pressure range 3-50mbar power supply for modulator equiv. no. 0.830.041 suitable for Tandem		
spare parts for	101881		
	GEV No.	101379	Ref. No. —
	solenoid coil 230V 50Hz suitable for Tandem		
accessories for	101881		
	GEV No.	101274	Ref. No. RCK7070036
	olive for pipe ø 16mm Qty 1 pcs		
	GEV No.	101275	Ref. No. —
	union screw thread 1/2" for pipe ø 16mm Qty 1 pcs		
	GEV No.	101925	Ref. No. —
	plug with O-ring thread M10x1 for pilot burner suitable for NOVASIT		
	GEV No.	102845	Ref. No. —
	gas connection angled 1/2" flange 32x32mm hole distance 24x24mm Tandem		
	GEV No.	102846	Ref. No. —
	gas connection straight 1/2" flange 32x32mm hole distance 24x24mm suitable for Tandem		
	GEV No.	102847	Ref. No. —
	O-ring		



ignition boxes

SIT



1

GEV No.	101685	Ref. No.	RCK7020085
description	ignition box SIT type 503EFD electrodes 2 waiting time 1.5s safety time 10s 220/240V 10VA 50-60Hz protection IP40		

miscellaneous



1

GEV No.	401171	Ref. No.	RCK6010084
description	ignition box		

ignition parts





pilot burners

SIT

100 series



1

GEV No.	106906	Ref. No.	00445 RC00445000
description	pilot burner SIT type 100 series 3 flames nozzle ø 0.2mm gas connection 6mm		
spare parts for	106906		
	GEV No.	100245	Ref. No. 00435 RC00435000
	pilot burner nozzle LPG code 20 bore ø 0.2mm Qty 1 pcs thread M8x0.75		
	GEV No.	100855	Ref. No. 00411 RC00411000
	pilot burner bracket triple		
	GEV No.	100885	Ref. No. —
	air mixing sleeve for pilot burner Qty 1 pcs		
	GEV No.	100916	Ref. No. —
	compression spring for pilot burner Qty 1 pcs		

spare parts for 106906



GEV No.	100917	Ref. No.	—
----------------	--------	-----------------	---

o-ring for pilot burner Qty 1 pcs aluminium



GEV No.	100918	Ref. No.	—
----------------	--------	-----------------	---

screw for pilot burner



GEV No.	107162	Ref. No.	—
----------------	--------	-----------------	---

pilot burner cap SIT 3 flames Hmm Lmm Qty 1 pcs



GEV No.	107701	Ref. No.	—
----------------	--------	-----------------	---

pilot burner bottom part SIT 100 series nozzle ø 0.2mm

accessories for 106906



GEV No.	100245	Ref. No.	00435 RC00435000
----------------	--------	-----------------	---------------------

pilot burner nozzle LPG code 20 bore ø 0.2mm Qty 1 pcs thread M8x0.75



GEV No.	100246	Ref. No.	00436 RC00436000
----------------	--------	-----------------	---------------------

pilot burner nozzle natural gas bore ø 0.35mm Qty 1 pcs thread M8x0.75



GEV No.	100904	Ref. No.	—
----------------	--------	-----------------	---

locking screw M10x1 for pipe ø 4mm Qty 1 pcs



GEV No.	100905	Ref. No.	—
----------------	--------	-----------------	---

locking screw M10x1 for pipe ø 6mm Qty 1 pcs



GEV No.	102110	Ref. No.	—
----------------	--------	-----------------	---

pilot tube copper pipe ø 4mm thickness 1mm L 3000mm



GEV No.	102111	Ref. No.	—
----------------	--------	-----------------	---

pilot tube copper pipe ø 6mm thickness 1mm L 3000mm



GEV No.	107171	Ref. No.	—
----------------	--------	-----------------	---

pilot burner nozzle SIT natural/liquid gas bore ø 0.25mm Qty 1 pcs



GEV No.	107700	Ref. No.	—
----------------	--------	-----------------	---

pilot burner bottom part SIT 100 series nozzle ø 0.25mm



GEV No.	107702	Ref. No.	—
----------------	--------	-----------------	---

pilot burner bottom part SIT 100 series nozzle ø 0.35mm



1













GEV No.	106907	Ref. No.	RC30100005
description	pilot burner SIT type 100 series 3 flames nozzle ø 0.35mm gas connection 6mm		
spare parts for	106907		
	GEV No.	100246	Ref. No. 00436 RC00436000
	pilot burner nozzle natural gas bore ø 0.35mm Qty 1 pcs thread M8x0.75		
	GEV No.	100855	Ref. No. 00411 RC00411000
	pilot burner bracket triple		



Table continues overleaf



Зип-Общепит

vsezip.ru

+7(812)987-08-81

spare parts for		106907	
	GEV No.	100885	Ref. No. —
air mixing sleeve for pilot burner Qty 1 pcs			
	GEV No.	100916	Ref. No. —
compression spring for pilot burner Qty 1 pcs			
	GEV No.	100917	Ref. No. —
gasket for pilot burner Qty 1 pcs aluminium			
	GEV No.	100918	Ref. No. —
screw for pilot burner			
	GEV No.	107162	Ref. No. —
pilot burner cap SIT 3 flames Hmm Lmm Qty 1 pcs			
	GEV No.	107702	Ref. No. —
pilot burner bottom part SIT 100 series nozzle ø 0.35mm			
accessories for		106907	
	GEV No.	100245	Ref. No. 00435 RC00435000
pilot burner nozzle LPG code 20 bore ø 0.2mm Qty 1 pcs thread M8x0.75			
	GEV No.	100904	Ref. No. —
locking screw M10x1 for pipe ø 4mm Qty 1 pcs			
	GEV No.	100905	Ref. No. —
locking screw M10x1 for pipe ø 6mm Qty 1 pcs			
	GEV No.	102110	Ref. No. —
pilot tube copper pipe ø 4mm thickness 1mm L 3000mm			
	GEV No.	102111	Ref. No. —
pilot tube copper pipe ø 6mm thickness 1mm L 3000mm			
	GEV No.	107171	Ref. No. —
pilot burner nozzle SIT natural/liquid gas bore ø 0.25mm Qty 1 pcs			
	GEV No.	107700	Ref. No. —
pilot burner bottom part SIT 100 series nozzle ø 0.25mm			
	GEV No.	107701	Ref. No. —
pilot burner bottom part SIT 100 series nozzle ø 0.2mm			

accessories			
pilot burner brackets			
universal			
	1		
GEV No.	100855	Ref. No.	00411 RC00411000
description pilot burner bracket triple			
accessories for 100855			
	GEV No.	100855	Ref. No. 00411 RC00411000
pilot burner bracket triple			

accessories for		100855	
	GEV No.	100886	Ref. No. —
pilot burner bracket suitable for 100 series 3-piece			
	GEV No.	100888	Ref. No. —
screw bolt for pilot burner			

pilot burner nozzles			
	1		
GEV No.	100245	Ref. No.	00435 RC00435000
description pilot burner nozzle LPG code 20 bore ø 0.2mm Qty 1 pcs thread M8x0.75			

	1		
GEV No.	100246	Ref. No.	00436 RC00436000
description pilot burner nozzle natural gas bore ø 0.35mm Qty 1 pcs thread M8x0.75			

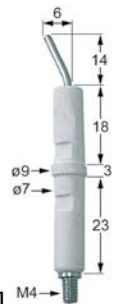
ignition electrodes			
	1		
GEV No.	100706	Ref. No.	00120 RC00120000
description ignition electrode connection M4 Qty 1 pcs			

140 - 145 -150 series			
	1		
GEV No.	107114 ¹	Ref. No.	RCK7090028
description pilot burner SIT type 140 series 2 flames nozzle ømm gas connectionmm			
spare parts for 107114			
	GEV No.	100907	Ref. No. —
screw connection thread M10x1 Qty 1 pcs type SEF 1 ømm for thermocouple			
accessories for 107114			
	GEV No.	100204	Ref. No. RC01219000
pilot burner nozzle SIT LPG code 14 bore ø 0.18/0.20mm Qty 1 pcs suitable for 140 series			
	GEV No.	100205	Ref. No. —
pilot burner nozzle SIT LPG code 19 bore ø 0.23/0.26mm Qty 1 pcs suitable for SIT 150 series			













¹incl. thermocouple fitting
Table continues overleaf



Зип Общепит

vsezip.ru





+7(812)98708081

accessories for		107114	
	GEV No.	100206	Ref. No. —
	pilot burner nozzle SIT natural gas code 36 bore \varnothing 0.60/0.55mm Qty 1 pcs suitable for SIT 150 series		
	GEV No.	100207	Ref. No. RCK7042013
	pilot burner nozzle SIT natural gas code 27 bore \varnothing 0.40/0.38mm suitable for SIT 140 series		
	GEV No.	100216	Ref. No. —
	pilot burner nozzle SIT natural gas code 38 bore \varnothing 0.45mm Qty 1 pcs suitable for SIT 150 series		
	GEV No.	100701	Ref. No. 01168 RC01168000
	ignition electrode connection M4 Qty 1 pcs		
	GEV No.	100801	Ref. No. —
	gasket for pilot burner Qty 1 pcs		
	GEV No.	100897	Ref. No. —
	olive for pipe \varnothing 4mm Qty 1 pcs for pilot burner		
	GEV No.	100898	Ref. No. —
	olive for pipe \varnothing 6mm Qty 1 pcs for pilot burner		
	GEV No.	100906	Ref. No. RCK7050028
	screw connection thread M10x1 for ignition electrode brass Qty 1 pcs WS 10		
	GEV No.	100908	Ref. No. —
	union screw thread M10x1 for pipe \varnothing 4mm Qty 1 pcs		
	GEV No.	100909	Ref. No. —
	union screw thread M10x1 for pipe \varnothing 6mm Qty 1 pcs		
	GEV No.	102110	Ref. No. —
	pilot tube copper pipe \varnothing 4mm thickness 1mm L 3000mm		
	GEV No.	102111	Ref. No. —
	pilot tube copper pipe \varnothing 6mm thickness 1mm L 3000mm		

accessories for		100051	
	GEV No.	100209	Ref. No. —
	pilot burner nozzle POLIDORO natural gas code 40 bore \varnothing 0.4mm Qty 1 pcs		
	GEV No.	100701	Ref. No. 01168 RC01168000
	ignition electrode connection M4 Qty 1 pcs		
	GEV No.	100906	Ref. No. RCK7050028
	screw connection thread M10x1 for ignition electrode brass Qty 1 pcs WS 10		
	GEV No.	100907	Ref. No. —
	screw connection thread M10x1 Qty 1 pcs type SEF 1 \varnothing mm for thermocouple		
	GEV No.	100908	Ref. No. —
	union screw thread M10x1 for pipe \varnothing 4mm Qty 1 pcs		
	GEV No.	100909	Ref. No. —
	union screw thread M10x1 for pipe \varnothing 6mm Qty 1 pcs		
	GEV No.	102110	Ref. No. —
	pilot tube copper pipe \varnothing 4mm thickness 1mm L 3000mm		
	GEV No.	102111	Ref. No. —
	pilot tube copper pipe \varnothing 6mm thickness 1mm L 3000mm		
	GEV No.	102508	Ref. No. —
	union screw thread M10x1 for pipe \varnothing 4mm Qty 5 pcs		
	GEV No.	102509	Ref. No. —
	union screw thread M10x1 for pipe \varnothing 6mm Qty 5 pcs		
	GEV No.	102699	Ref. No. —
	pilot burner nozzle POLIDORO natural gas code 25.2 bore \varnothing 2x0.25mm Qty 1 pcs 2 bores		
	GEV No.	102795	Ref. No. —
	olive for pipe \varnothing 4mm Qty 1 pcs		
	GEV No.	102797	Ref. No. —
	olive for pipe \varnothing 6mm Qty 1 pcs		
	GEV No.	106703	Ref. No. RCK7042008
	pilot burner nozzle POLIDORO natural gas code 27.2 bore \varnothing 2x0.27mm Qty 1 pcs		
	GEV No.	106704	Ref. No. —
	pilot burner nozzle POLIDORO LPG code 16.2 bore \varnothing 2x0.16mm Qty 1 pcs		
	GEV No.	106763	Ref. No. —
	pilot burner nozzle POLIDORO natural gas code 27.2A bore \varnothing 2x0.27mm Qty 1 pcs		
	GEV No.	106859	Ref. No. —
	pilot burner nozzle POLIDORO LPG code 24 bore \varnothing 0.24mm Qty 1 pcs		

POLIDORO

pilot burners

	1		
GEV No.	100051	Ref. No.	RCK7090026
description	pilot burner POLIDORO 3 flames code gas connectionmm		
spare parts for	100051		
	GEV No.	100907	Ref. No. —
	screw connection thread M10x1 Qty 1 pcs type SEF 1 \varnothing mm for thermocouple		
accessories for	100051		
	GEV No.	100000	Ref. No. —
	pilot burner nozzle POLIDORO LPG code 22 bore \varnothing 0.22mm Qty 1 pcs		
	GEV No.	100208	Ref. No. —
	pilot burner nozzle POLIDORO LPG code 20 bore \varnothing 0.2mm Qty 1 pcs		





Зип Общепит

vsezip.ru

+7(812)987-08-81

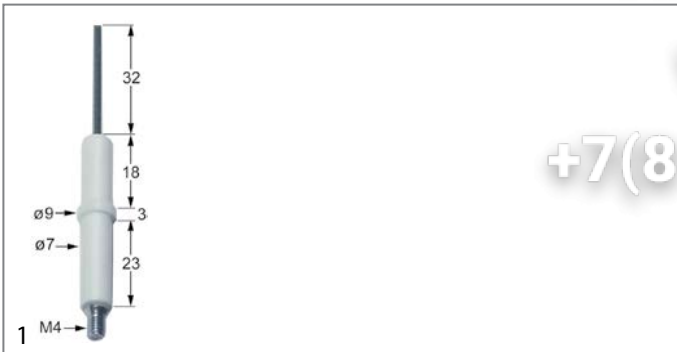
electrodes



GEV No.	100701	Ref. No.	01168 RC01168000
description	ignition electrode connection M4 Qty 1 pcs		
accessories for	100701		
	GEV No.	100906	Ref. No. RCK7050028
	screw connection thread M10x1 for ignition electrode brass Qty 1 pcs WS 10		



GEV No.	100706	Ref. No.	00120 RC00120000
description	ignition electrode connection M4 Qty 1 pcs		



GEV No.	102333	Ref. No.	RCK2012111
description	ignition electrode D1 ø 7mm D2 ø 9mm connection M4 L1 23mm L2 19mm BL1 18mm BL2 3mm BL3 23mm to clip		

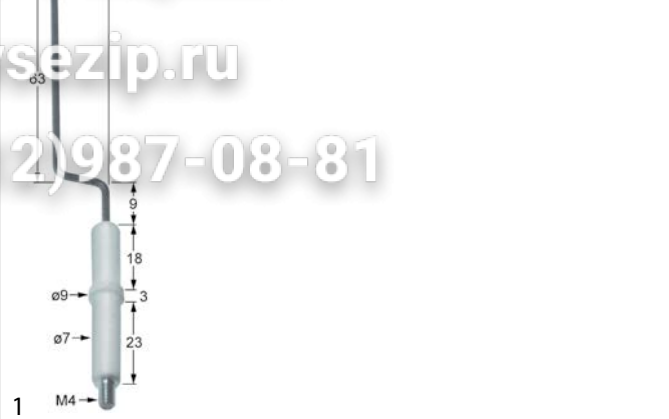

GEV No.	102334	Ref. No.	RCK2012110
description	ignition electrode D1 ø 7mm D2 ø 9mm connection M4 L1 9mm L2 12mm L3 62mm BL1 18mm BL2 3mm BL3 23mm to clip		

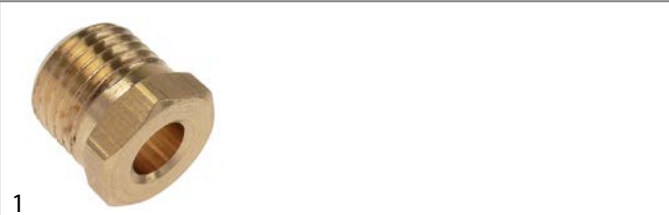

GEV No.	100906	Ref. No.	RCK7050028
description	screw connection thread M10x1 for ignition electrode brass Qty 1 pcs WS 10		

ignition cables

pre-assembled cables



GEV No.	100176	Ref. No.	RCK6050610
description	ignition cable cable length 1000mm connection ø2.4mm / ø4mm permanent temperature 200°C		



GEV No.	100140	Ref. No.	RCK6050051
description	ignition cable cable length 400mm connection ø2.4mm / ø4mm		



GEV No.	100018	Ref. No.	00123 RC00123000
description	ignition cable cable length 600mm connection ø2.4mm / ø4mm permanent temperature 200°C		

2 gas components



ignition units

Зип Общепит

vsezip.ru

+7(812)987-08-81



1

GEV No.	102485	Ref. No.	RC00862000 RCK6041059
description	ignition unit outputs 2 220-240VAC 0.6VA 50-60Hz		



1

GEV No.	101002	Ref. No.	00862
description	ignition unit outputs 2 230VAC dimensions 88x23x34mm mounting distance 73mm inlet F6.3x0.8 outlet F2.8x0.8 0.6VA 50/60Hz		

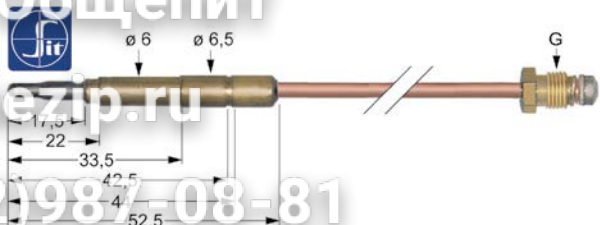

GEV No.	107609	Ref. No.	00118 RC00118000
description	thermocouple SIT M9x1 L 600mm plug connection $\varnothing 6.0(6.5)$ mm		

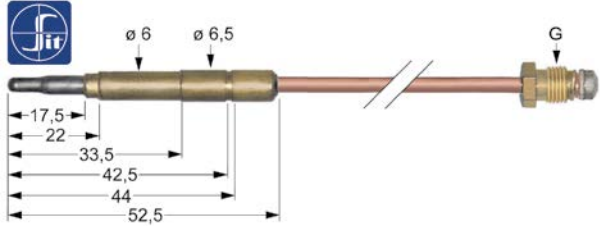

GEV No.	107611	Ref. No.	RC40400110 RCK6010057
description	thermocouple SIT M9x1 L 850mm plug connection $\varnothing 6.0(6.5)$ mm		

thermocouples

plug-in thermocouples

plug-in thermocouples standard

with barrel socket $\varnothing 6(6.5)$ mm

thermocouples SIT

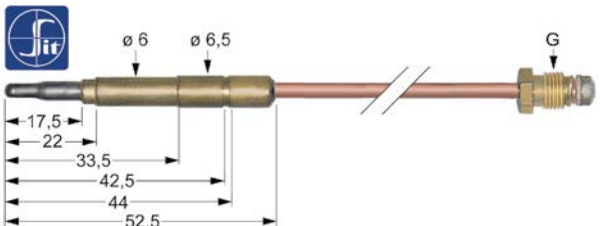

GEV No.	107605	Ref. No.	RC01483000
description	thermocouple SIT M8x1 L 1500mm plug connection $\varnothing 6.0(6.5)$ mm		

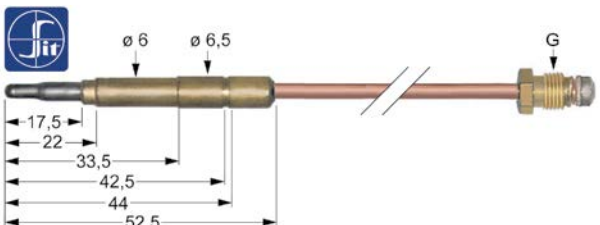

GEV No.	107613	Ref. No.	RC40400100
description	thermocouple SIT M9x1 L 1200mm plug connection $\varnothing 6.0(6.5)$ mm		

threaded thermocouples

threaded thermocouples standard

with socket with thread M8x1

SIT

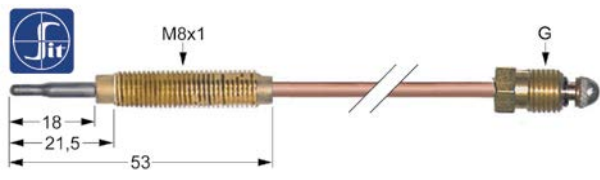

GEV No.	107634	Ref. No.	00864 RC00864000	
description	thermocouple SIT M8x1 L 1500mm M8x1			
accessories for	107634			
	GEV No.	102067	Ref. No.	00865 RC00865000
	nut thread M8x1 H 3mm brass Qty 1 pcs type SEF 1			

accessories

nuts



1

GEV No.	102067	Ref. No.	00865 RC00865000
description	nut thread M8x1 H 3mm brass Qty 1 pcs type SEF 1		

gas components

Зип Общепит

vsezip.ru

+7(812)987-08-81

interrupters



1

GEV No.	101265	Ref. No.	RC00460000
description	interrupter thread M9x1		

pilot burner nozzles

pilot burner nozzles POLIDORO



GEV No.	106703	Ref. No.	RCK7042008
description	pilot burner nozzle POLIDORO natural gas code 27.2 bore ø 2x0.27mm Qty 1 pcs		

gas burners

bar burners

bar burners



1

GEV No.	105776	Ref. No.	RCK7090100
description	bar burner ø 50mm Wmm Hmm L 305mm with bolt M5x12 flange width 52mm convection oven flange ø 75mm		

pilot burner nozzles SIT

100 series



1

GEV No.	100245	Ref. No.	00435 RC00435000
description	pilot burner nozzle LPG code 20 bore ø 0.2mm Qty 1 pcs thread M8x0.75		



1

GEV No.	100246	Ref. No.	00436 RC00436000
description	pilot burner nozzle natural gas bore ø 0.35mm Qty 1 pcs thread M8x0.75		

140/150 series



1

GEV No.	100204	Ref. No.	RC01219000
description	pilot burner nozzle SIT LPG code 14 bore ø 0.18/0.20mm Qty 1 pcs suitable for 140 series		



1

GEV No.	100207	Ref. No.	RCK7042013
description	pilot burner nozzle SIT natural gas code 27 bore ø 0.40/0.38mm suitable for SIT 140 series		

gas nozzles

main nozzles

gas nozzles M10x1



1

GEV No.	100477	Ref. No.	01195
description	gas injector thread M10x1 WS 12 bore ø 1.65mm		

screw connections

olives



1

GEV No.	101274	Ref. No.	RCK7070036
description	olive for pipe ø 16mm Qty 1 pcs		

accessories for 101274



GEV No.	101275	Ref. No.	—
description	union screw thread 1/2" for pipe ø 16mm Qty 1 pcs		



Зип-Общепит

vsezip.ru

+7(812)987-08-81

union screws

 <p>1</p>			
GEV No.	100906	Ref. No.	RCK7050028
description	screw connection thread M10x1 for ignition electrode brass Qty 1 pcs WS 10		

doors



 <p>1</p>			
GEV No.	690585	Ref. No.	RCK2011212
description	bush for door mechanism L 35mm ED ϕ 36mm int. ϕ 1 31mm int. ϕ 2 13mm mounting distance 28mm brass		

door mechanics

miscellaneous

 <p>1</p>			
GEV No.	690585	Ref. No.	RCK2011212
description	bush for door mechanism L 35mm ED ϕ 36mm int. ϕ 1 31mm int. ϕ 2 13mm mounting distance 28mm brass		

vibration pumps

 <p>1</p>			
GEV No.	500568	Ref. No.	RC01969000
description	vibration pump 230V 32W 50Hz inlet ϕ 7 outlet ϕ 1/8" IT CEME type E512/A32		
spare parts for	500568		
	GEV No.	390698	Ref. No. —
	thermal fuse switch-off temp. 110°C suitable for ULKA pump		
	GEV No.	520153	Ref. No. —
	bracket rubber dimensions 53x34x28mm		

handle latches

producer-specific

TECNOINOX

 <p>1</p>			
GEV No.	694067	Ref. No.	RC01940000
description	door catch with spigot 1-stage L 26mm total length 51mm thread M8		

espagnolette locks

universal

 <p>1</p>			
GEV No.	690041	Ref. No.	RCK5900121
description	cam L 148mm mounting distance 32mm		

 <p>1</p>			
GEV No.	690040	Ref. No.	RCK5900122
description	door catch with roller H 42mm L 40mm W 40mm zinc die cast mounting distance 26mm type 0751 series		

 <p>1</p>			
GEV No.	700771	Ref. No.	RCK5900123
description	latch gear opening to the left shaft intake ϕ 8x8mm L 170mm W 40mm H 40mm		

gaskets

gaskets for heated units

door seals

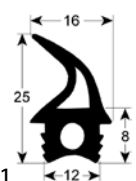
 <p>1</p>			
GEV No.	902409	Ref. No.	RCK7070100
description	door seal profile 2714 Qty supplied by meter suitable for GIORIK		



Зип Общежит

shaft gaskets

shaft gaskets
vsezip.ru

+7(812)987-08-81

1

GEV No.	900439	Ref. No.	RCK7070166
description	door seal profile 2750 Qty supplied by meter		

door seals with fixing hook

1

GEV No.	901434	Ref. No.	RC70044040
description	door seal W 600mm with 6 mounting clips H 400mm		

1

GEV No.	901371	Ref. No.	RC70044030
description	oven gasket L 540mm W 390mm with 6 mounting clips		

O-rings

EPDM

ø1.78mm

1

GEV No.	510824	Ref. No.	RC00007811
description	O-ring EPDM thickness 1.78mm ID ø 20.35mm Qty 1 pcs		

shaft gaskets

1

GEV No.	550549	Ref. No.	RCK7070150
description	shaft sealing for fan motor		

1

GEV No.	550550	Ref. No.	RCK7070151
description	shaft sealing for fan motor		

fittings, hose and pipe connectors

fittings

angle pieces

1

GEV No.	520824	Ref. No.	RCK7050374
description	angle piece thread 1/8" ET - 1/8" IT nickel-plated brass		

push-in fittings

JOHN GUEST

1

GEV No.	520494	Ref. No.	RC01922000	
description	push-in fitting John Guest angled pipe connection ø10mm - ø10mm			
accessories for	520494			
	GEV No.	520973	Ref. No.	—
	hose John Guest thickness 1.5mm LLDPE blue ID ø 7mm ED ø 10mm			

mechanical components, equipment accessories



Зип-Общепит

consumables



1

GEV No.	520495	Ref. No.	RC01927000
description	push-in fitting John Guest straight thread 1/8" BSP stub ø 8mm		
accessories for	520495		
	GEV No.	520971	Ref. No.
	hose thickness 1mm LLDPE blue ID ø 4mm ED ø 6mm operating pressure at 20°C 16bar		

fuses

fine fuses



1

GEV No.	358677	Ref. No.	RC01861000
description	fine fuse size ø5x20mm 4A fast-acting rated 250V Qty 10 pcs		

fastening material

nuts

hexagonal nuts

hexagonal nuts metric (without norm)



1

GEV No.	102067	Ref. No.	00865 RC00865000
description	nut thread M8x1 H 3mm brass Qty 1 pcs type SEF 1		

Зип Общепит

vsezip.ru

+7(812)987-08-81

Зип Общепит

vsezip.ru

+7(812)987-08-81

A				
alarm devices	8	ignition units		17
axial fans	10	indicator lights		5
		indicator lights (complete)		5
B		L		
bar burners	18	lamps		5
		light bulbs		6
C		M		
cable glands	11	mechanical timers		7
cables	11	microswitches		4
cam switches	4			
condensators & interference suppression filters	11	N		
consumables	21	nuts		21
contactors	8			
control thermostats	2	O		
D		operating capacitors		11
door seals	19	O-rings		20
door seals with fixing hook	20	oven lamps		6
E		P		
electric accessories	11	pilot burners		13
electric timers	7	pressure switches		9
energy regulators	2	probes		9
espagnolette locks	19	pumps		11
		push/momentary push switches		4
F		push-in fittings		20
fans	10	R		
fastening material	21	relays		8
filters	11	rocker/momentary rocker switches		4
fine fuses	21	rotary switches		5
fittings	20	S		
fuses	11, 21	safety thermostats		3
G		shaft gaskets		20
gas burners	18	solenoid valves		9
gas control valves	12	switches and momentary switches		4
gas nozzles	18	T		
gas thermostats	12	temperature probes		9
gaskets for heated units	19	terminals		11
H		thermocouples		17
halogen lamp	6	thermostats		2
heating elements	2	threaded cable glands		11
heating elements for convection	2	time relays		8
hexagonal nuts	21	timers		7
hot air fans	10	transformers		9
hot air motors	10	U		
I		universal probes		9
ignition boxes	13			
ignition cables	16			

Зип Общепит**V**

vibration pumps

11

vsezip.ru**+7(812)987-08-81**