



Зип Ощепит

vsezip.ru

Spare Parts for

+7(812)987-08781 **Combi Ovens**



Spare parts suitable for

HOUNÖ

2017

Find the complete and up-to-date range of products in our GEV Webshop



heating elements

immersion heating elements

with compression flange 50 x 26mm

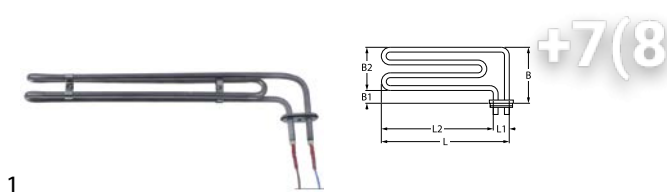

GEV No.	419129	Ref. No.	072406 20720278
----------------	--------	-----------------	--------------------

description heating element 1300W 230V heating circuits 1 flange 50x26mm L 380mm W 60mm L1 31mm L2 345mm W1 20mm W2 33mm compression flange cable length 1500mm tube ø 8.5mm fittings

accessories for 419129



GEV No.	520562	Ref. No.	070101
----------------	--------	-----------------	--------

description gasket L 44mm W 21mm D1 ø 9mm D2 ø 9mm hole ø 5.5mm thickness 4mm for heating element suitable for HOUNÖ

with expansion flange 70 x 18mm



GEV No.	419165	Ref. No.	072415
----------------	--------	-----------------	--------

description heating element 5000W 235V heating circuits 2 flange 70x18mm L 325mm W 63mm connection male faston 6.3mm tube ø 8.5mm expansion flange



GEV No.	419131	Ref. No.	031917
----------------	--------	-----------------	--------

description heating element 5000W 235V heating circuits 2 flange 70x18mm L 325mm W 63mm with probe K 1100 connection male faston 6.3mm tube ø 8.5mm expansion flange connection length 35mm

miscellaneous



GEV No.	511653	Ref. No.	20600007
----------------	--------	-----------------	----------

description gasket silicone L 82mm W 82mm thickness 3mm

Зип Общепит

vsezip.ru

+7(812)987-08-81



GEV No.	420371	Ref. No.	20700045 20700047 30720643
----------------	--------	-----------------	----------------------------------

description heating element 7500W 240-415V heating circuits 3 L 200mm W 40mm H 65mm number of thermostat sleeves 2 thermostat sleeves ø 5.6mm length thermostat sleeves 200mm thermostat sleeve upper hole distance 600mm hole ø 6.6mm cable length 590mm connection cable immersion heater flange width 820mm flange length 820mm SS included

accessories for 420371



GEV No.	511653	Ref. No.	20600007
----------------	--------	-----------------	----------

description gasket silicone L 82mm W 82mm thickness 3mm



GEV No.	420582	Ref. No.	30720642
----------------	--------	-----------------	----------

description heating element 9000W 208V heating circuits 3 L 205mm W 40mm H 74mm number of thermostat sleeves 2 thermostat sleeves ø 6mm length thermostat sleeves 185mm thermostat sleeve eccentric, clinging tube ø 6.5mm hole distance 64mm hole ø 6mm cable length 600mm connection cable 4 hole flange steam generator flange width 82mm flange length 82mm with gasket



GEV No.	420575	Ref. No.	30720641
----------------	--------	-----------------	----------

description heating element 9000W 240/415V heating circuits 3 L 203mm W 38mm H 66mm number of thermostat sleeves 2 thermostat sleeves ø 6mm length thermostat sleeves 185mm thermostat sleeve eccentric, clinging tube ø 6.5mm hole distance 64mm hole ø 6.5mm cable length 620mm flange steam generator flange width 82mm flange length 82mm



GEV No.	420148	Ref. No.	20700028
----------------	--------	-----------------	----------

description heating element 9000W 240V heating circuits 3 L 202mm W 38mm H 66mm number of thermostat sleeves 2 thermostat sleeves ø 5.4mm length thermostat sleeves 180mm thermostat sleeve eccentric, clinging tube ø 6.3mm hole distance 60/64mm hole ø 6.5mm cable length 590mm connection cable flange immersion heater flange width 82mm flange length 82mm

accessories for 420148



GEV No.	511653	Ref. No.	20600007
----------------	--------	-----------------	----------

description gasket silicone L 82mm W 82mm thickness 3mm



heating elements for convection

Зип Общепит

vsezip.ru

+7(812)987-08-81



1

GEV No.	417767	Ref. No.	20700062
description	heating element 12000W 240V heating circuits 3 ID \varnothing 390mm ED \varnothing 400mm L 435mm H 120mm W1 140mm H1 35mm H2 80mm flange length 155mm flange width 25mm hole distance 23mm connection male faston 6.3mm connection length 80mm tube \varnothing 6.5mm dry heating element hole \varnothing 6.5mm mounting pos. inner rectangular flange		



1

GEV No.	417768	Ref. No.	20700060
description	heating element 9000W 240V heating circuits 3 ID \varnothing 460mm ED \varnothing 470mm L 520mm H 135mm W1 145mm H1 50mm H2 85mm flange length 155mm flange width 25mm hole distance 23mm connection male faston 6.3mm connection length 80mm tube \varnothing 6.5mm dry heating element hole \varnothing 6.5mm mounting pos. inner rectangular flange		



1

GEV No.	417762	Ref. No.	30700076
description	heating element 6900-9200W 208-240V heating circuits 2 ID \varnothing 225mm ED \varnothing 270mm L 295mm H 68mm L1 15mm W1 63mm H1 8mm H2 57mm flange length 142mm flange width 25mm connection male faston 6.3mm tube \varnothing 8.5mm convection heating element mounting thread M5 hole \varnothing 5mm rectangular flange with thread bolt		



1

GEV No.	417766	Ref. No.	20700061
description	heating element 9000W 240V heating circuits 3 ID \varnothing 540mm ED \varnothing 530mm L 580mm H 120mm W1 140mm H1 30mm H2 90mm flange length 155mm flange width 25mm hole distance 23mm connection male faston 6.3mm connection length 80mm tube \varnothing 6.5mm dry heating element hole \varnothing 6.5mm mounting pos. inner rectangular flange		



1

GEV No.	420419	Ref. No.	20700009 20700059
description	heating element 9000W 240V heating circuits 3 ID \varnothing 395mm ED \varnothing 405mm L 422mm H 120mm W1 148mm H1 50mm H2 87mm flange length 156mm flange width 25mm hole distance 25mm connection F6.3 hole \varnothing 6.1mm		



1

GEV No.	420174	Ref. No.	072403
description	heating element 1650W 230V heating circuits 1 L 285mm W 100mm L1 32mm L2 250mm W2 83mm flange length 50mm flange width 26mm tube \varnothing 8mm cable length 1500mm W1 23mm convection heating element		



1

GEV No.	420175	Ref. No.	072404
description	heating element 1650W 230V heating circuits 1 L 565mm W 55mm L1 32mm L2 530mm W2 30mm flange length 50mm flange width 26mm tube \varnothing 8mm cable length 1500mm W1 23mm convection heating element		

1 electric components

accessories

flange gaskets



1

GEV No.	698523	Ref. No.	20700008
description	gasket L 155mm W 24.5mm D2 ø 7mm hole ø 9mm hole distance 12mm 13 holes graphite thickness 2.2mm		



1

GEV No.	520562	Ref. No.	070101
description	gasket L 44mm W 21mm D1 ø 9mm D2 ø 9mm hole ø 5.5mm thickness 4mm for heating element suitable for HOUNO		

thermostats

bi-metal thermostats

bi-metal thermostats



1

GEV No.	390963	Ref. No.	20800087
description	bi-metal thermostat hole distancemm switch-off temp. 120°C 1NC 1-pole 10A 250V connection F6.3 M4		

control and safety thermostats

EGO

safety thermostats

55.32_series



1

GEV No.	375988	Ref. No.	062550
description	safety thermostat switch-off temp. 305°C 3-pole probe ø 6mm probe L 77mm capillary pipe isolatedmm gland nut starting temperature 20°C		

safety thermostats

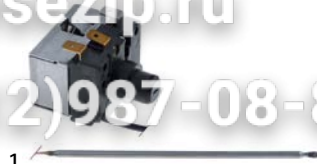

1

GEV No.	375969	Ref. No.	20800022
description	safety thermostat switch-off temp. 135°C 1-pole 1CO 16A probe ø 4mm probe L 150mm capillary pipe 1500mm capillary pipe isolated 580mm shaft ø 5.4mm		



1

GEV No.	370763	Ref. No.	20800011 20820011 30820046 602031/80
description	safety thermostat switch-off temp. 350°C 1-pole 1CO 2.5A probe ø 5mm probe L 48mm capillary pipe 950mm capillary pipe isolated 500mm gland nut probe SS copper screw connection M12 230V 602031/80		

switches and momentary switches

magnetic switches

ø 4mm



1

GEV No.	381268	Ref. No.	20820012 20820014
description	magnetic switch probe L 57mm 1NO connection plug cable length 800mm Reed		



Зип Общепит

vsezip.ru

+7(812)987-08-81

miscellaneous



1

GEV No.	348039	Ref. No.	30800016
description	magnetic switch 1NO connection cable L 65mm L1 38mm L2 64mm mounting distance 50mm for door		

producer-specific oven lamps

1

GEV No.	699627	Ref. No.	20100107
description	gasket suitable for HOUNO combi-steamer mounting pos. for lens ED ø 65mm ID ø 53mm graphite thickness 0.6mm		

encoders and potentiometers



1

GEV No.	403484	Ref. No.	20900026 30900064
description	encoder shaft L 10mm cable length 90mm shaft 6mm		



1

GEV No.	699628	Ref. No.	20100106 30100147
description	gasket suitable for HOUNO combi-steamer mounting pos. for lens ED ø 83mm ID ø 52mm Viton thickness 3mm		

lamps

screw-on/push-on fit

light bulbs

for ovens



1

GEV No.	359610	Ref. No.	065010
description	light bulb t.max. 300°C socket E14 15W 230V ø 22mm L 47mm lens L 20mm for oven lamp type Philips		



1

GEV No.	360762	Ref. No.	014576
description	glass panel ø 63mm thickness 3.5mm		



1

GEV No.	360618	Ref. No.	20120131
description	lamp glass with rubber gasket mounting ø 85mm		

halogen lamp

for socket G4 / G6.35 / G9



1

GEV No.	359596	Ref. No.	065016 065044
description	halogen lamp socket G4 12V 10W temp.-resist. 500°C		



1

GEV No.	357092	Ref. No.	066019 066020
description	lamp socket socket G4 ø 17mm H 9mm with 2 hole fixing mounting distance 12mm cord length 450mm		



1

GEV No.	359599	Ref. No.	065012
description	halogen lamp socket G4 12V 20W temp.-resist. 500°C		



1

GEV No.	694503	Ref. No.	014575
description	gasket ø 82mm hole ø 51mm for lamp lenses		





Зип-Общепит

alarm devices

alarm units
vsezip.ru

+7(812)987-08-81

			
1			
GEV No.	694502	Ref. No.	037519
description	lamp glass metal glas with frame and gasket ø 85mm		
accessories for	694502		
	GEV No.	694503	Ref. No. 014575
description	gasket ø 82mm hole ø 51mm for lamp lenses		

			
1			
GEV No.	353000	Ref. No.	30800047
description	alarm device 2 hole fixing		

contactors

ABB

power contactors

			
1			
GEV No.	381262	Ref. No.	061625
description	power contactor resistive load 20A 24VAC (AC3/400V) 12A/4kW main contacts 2x3NO auxiliary contacts 2x1NO connection screw connection type VB6-30-10 / VB7-30-10		

			
1			
GEV No.	380107	Ref. No.	061624
description	power contactor resistive load 25A 24VAC (AC3/400V) 9A/4kW main contacts 3NO auxiliary contacts 1NC connection screw connection type A9-30-01		

			
1			
GEV No.	381263	Ref. No.	061246
description	power contactor resistive load 30A 24VAC (AC3/400V) 17A/7.5kW main contacts 4NO auxiliary contacts connection screw connection type A16-40-00		

lamps

light bulbs

			
1			
GEV No.	359610	Ref. No.	065010
description	light bulb t.max. 300°C socket E14 15W 230V ø 22mm L 47mm lens L 20mm for oven lamp type Philips		

halogen lamps

for socket G4 / G6.35 / G9

			
1			
GEV No.	359596	Ref. No.	065016 065044
description	halogen lamp socket G4 12V 10W temp.-resist. 500°C		

			
1			
GEV No.	359599	Ref. No.	065012
description	halogen lamp socket G4 12V 20W temp.-resist. 500°C		



Зип Общепит
solid state relays

vsezip.ru

+7(812)987-08-81



1

GEV No.	381264	Ref. No.	61248
description	power contactor resistive load 40A 24VAC (AC3/400V) 26A/11kW main contacts 4NO auxiliary contacts connection screw connection type A26-40-00		



1

GEV No.	381265	Ref. No.	61265
description	power contactor resistive load 55A 24VAC (AC3/400V) 30A/15kW main contacts 3NO auxiliary contacts 1NO connection screw connection type A30-30-10		



1

GEV No.	381266	Ref. No.	61247
description	power contactor resistive load 70A 24VAC (AC3/400V) 45A/18.5kW main contacts 4NO auxiliary contacts connection screw connection type A45-40		

auxiliary contacts



1

GEV No.	380126	Ref. No.	61626
description	auxiliary contact contacts 1NC AC1 16A AC15 3A connection screw connection for contactors A9-A50		

CELDUC



1

GEV No.	402974	Ref. No.	20800086 30800037 30820013
description	solid state relay CELDUC 2 phase 50A 24-600V 10-30VDC L 58mm W 45mm plug screw type SOB965660		

transformers

encapsulated transformers

with plug connection



1

GEV No.	403661	Ref. No.	20800023
description	transformer primary 200-480V secondary 24V H 100mm L 105mm W 105mm 50/60Hz type 14458-7		

probes

producer-specific probes

probes



1

GEV No.	379777	Ref. No.	062500
description	temperature probe Pt100 cable silicone probe -100 up to 450°C cable -50 up to +180°C connection 2-wire thread 5/16 probe ø4x75mm cable length 1.2m		



1

GEV No.	381229	Ref. No.	20800174
description	temperature probe Pt100 cable Vetrotex probe -100 up to 450°C cable -50 up to +350°C connection 2-wire thread probe ø3.5x170mm cable length 0.4m -50 up to +350°C		



Зип Общепит

vsezip.ru

+7(812)987-08-81

core probes



1	GEV No.	381267 ¹	Ref. No.	30800053
description core temperature probe Pt100 cable PTFE probe -40 up to +250°C cable -40 up to +250°C connection plug probe ø4x100mm thread cable length 1m handle ømm handle length 50mm				

¹multipoint probe



1	GEV No.	381228 ¹	Ref. No.	30800054
description core temperature probe thermocouple K (NiCr-Ni) cable PTFE probe -50 up to 1150°C cable -40 up to +250°C connection plug probe ø4x-128mm thread cable length 1.5m handle ømm handle length 50mm				

¹multipoint probe



1	GEV No.	403482	Ref. No.	20800084
description frequency converter with heat sink 200-240V 50/60Hz output frequency 0-250Hz 10.8A output current 4.3A				

PCBs



1	GEV No.	404020	Ref. No.	3090002 30900059
description display combi-steamer Slim/Visual Cooking L 10.4mm W 144mm TFT				
accessories for 404020				

	GEV No.	698525	Ref. No.	30900013
ribbon cable L 120mm for display				



1	GEV No.	404022	Ref. No.	30900014
description display PCB combi-steamer Visual Cooking L 133mm W 139mm				



1	GEV No.	403913	Ref. No.	30900054
description display PCB L 140mm W 135mm suitable for HOUNO B/C/K Ver3.51				

electronics

frequency converters



1	GEV No.	403483	Ref. No.	20800211
description frequency converter 200-240V 50/60Hz L 125mm W 43mm H 144mm output frequency 0-250Hz 6.9A output current 2.2A				



Зип Обществит

solenoid valves

vsezip.ru

+7(812)987-08-81

1 

GEV No.	403912	Ref. No.	30900069
description	display PCB L 140mm W 135mm suitable for HOUNO CombiSteamer C Ver9.14		

1 

GEV No.	404024	Ref. No.	20900002
description	main PCB combi-steamer Visual Cooking L 348mm W 100mm type 20 90 0002 Rev:2.2		

1 

GEV No.	404023	Ref. No.	30900006
description	PCB combi-steamer Visual Cooking for combi-steamer		

1 

GEV No.	404021	Ref. No.	30900008
description	PCB combi-steamer Visual Cooking W 140mm for combi-steamer H 140mm type Ver 1.67		

1 

GEV No.	403733	Ref. No.	033908
description	PCB L 340mm W 135mm		

solenoid valves (water)

1 

GEV No.	370760	Ref. No.	30520037	
description	solenoid valve double straight 24VAC inlet 3/4" outlet 10mm DN10 t.max. 90°C plastic output B yesl/min flow regulating valve outlet B white			
spare parts for	370760			
	GEV No.	370774	Ref. No.	—
	solenoid coil RPE 24VAC			

1 

GEV No.	370758	Ref. No.	30520192	
description	solenoid valve double straight 24VAC inlet 3/4" outlet 10mm input 10-12l/min DN10 t.max. 90°C plastic output B 1-1.25l/min flow regulating valve outlet B white			
spare parts for	370758			
	GEV No.	370774	Ref. No.	—
	solenoid coil RPE 24VAC			

special outlet

1 

GEV No.	371228	Ref. No.	20720230
description	solenoid valve double 24V outlet 6.5mm inlet 3/4"		

1 

GEV No.	371229	Ref. No.	20720228
description	solenoid valve single 24V inlet 3/4mm outlet 6.5mm input 10l/min RPE inlet 3/4"		

electric components

Зип Общепит
vsezip.ru
+7(812)987-0988

			
1			
GEV No.	371227	Ref. No.	20720254
description	solenoid valve triple 24V outlet 6.5mm DN10 RPE inlet 3/4"		

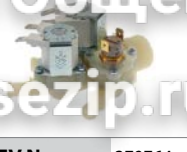
			
1			
GEV No.	370764	Ref. No.	30520180
description	solenoid valve triple straight 24V inlet 3/4" outlet 10mm DN10 t.max. 60°C TTP output C 1.2l/min flow regulating valve outlet C white		

solenoid valves with reducers			
single			
			
1			
GEV No.	370761	Ref. No.	30520034
description	solenoid valve single straight 24VAC inlet 3/4" outlet 11mm DN10 t.max. 90°C plastic output A yesl/min flow regulating valve outlet B white		

4-fold			
			
1			
GEV No.	370762	Ref. No.	30500054 30520181
description	solenoid valve 4-fold with sensor 24V inlet 3/4" outlet 10.5mm t.max. 90°C reducer output D 1.20l/min flow regulating valve outlet D white		

2-fold			
			
1			
GEV No.	374003	Ref. No.	032112
description	solenoid valve 2-fold, with reducer straight 24V inlet 3/4" outlet 14mm t.max. 60°C RPE plastic output A 1.2l/min flow regulating valve outlet A white		

pressure switches for combi-steamers

			
1			
GEV No.	543032	Ref. No.	32720056
description	differential pressure switch pressure range 0.2-1.5mbar pressure connection ø 4.7mm DUNGS protection IP54 ambient temperature max. -10 up to +85°C		

			
1			
GEV No.	374008	Ref. No.	032110
description	solenoid valve double straight 24V inlet 3/4" outlet 14mm input 10-12l/min RPE plastic output A 1.2l/min output B 1.2l/min inlet 3/4"mm		

			
1			
GEV No.	348047	Ref. No.	071138 30220071
description	pressure control pressure range 0-3mbar complete connection 6mm p max 0.025bar pressure connection 6mm		

3-fold			
			
1			
GEV No.	374002	Ref. No.	032111
description	solenoid valve 3-fold, with reducer straight 24V inlet 3/4" outlet 14mm t.max. 60°C output A 1.2l/min output B 1.2l/min flow regulating valve outlet A white flow regulating valve outlet B white		

			
1			
GEV No.	543023	Ref. No.	308000145 62565
description	pressure control reset pressure 1.5bar connection 1/8" suitable for HOUNO 1NC		





fans

axial fans

import



1

GEV No.	601080 ¹	Ref. No.	60211
description	axial fan L 119mm W 119mm H 38mm 230VAC 50/60Hz 23/20W bearing ball bearing connection male faston 2.8mm metal ADDA fan wheel ø 110mm temp.-resist. 70°C		
accessories for	601080		
	GEV No.	550898	Ref. No. —
	connecting cable cable length 2000mm connection F 2.8 connection distance 7.9mm for axial flow fan		
	GEV No.	692519	Ref. No. —
	guard L 120mm W 120mm plastic		

¹with ball bearings



1

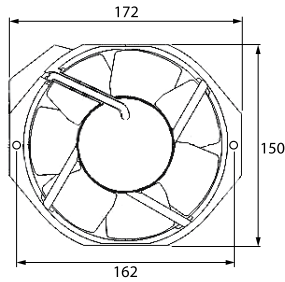

GEV No.	601706 ¹	Ref. No.	N/A
description	axial fan L 172mm W 150mm H 51mm 230VAC 50/60Hz 69W bearing ball bearing connection male faston 3.2mm ADDA fan wheel ø 140mm		
accessories for	601706		
	GEV No.	550898	Ref. No. —
	connecting cable cable length 2000mm connection F 2.8 connection distance 7.9mm for axial flow fan		

¹with ball bearings

hot air motors



1

GEV No.	696843	Ref. No.	30700022
description	bush with spring ø 14mm ED ø 20mm H 12mm ID ø 8mm		

Зип Общепит

vsezip.ru

+7(812)987-08-81

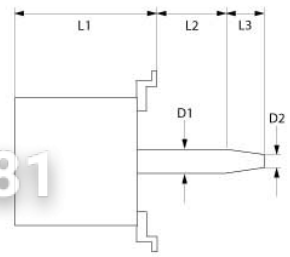

1

GEV No.	601352	Ref. No.	60201
description	fan motor 380-400V 3 phase 50Hz 0.02/0.16kW 710/1390rpm speeds 2 L1 140mm L2 27mm L3 35mm M10R IT 0.2/0.5A power input 60/250W at 50Hz 710/1390rpm Y/YY type L7mw84D-148 no. T1 D1 ø 17mm D2 ø 13mm		



1

GEV No.	602004	Ref. No.	60306
description	fan wheel blades 12 D1 ø 350mm D2 ø 13mm D3 ø 16mm H1 133mm H2 14mm H3 32mm		

motors

gear motors

for ovens

for flues



1

GEV No.	501469	Ref. No.	20700012
description	ventilation valve FIBER type P255201B4T1 24V 50Hz 6rpm shaft ø 6mm L 88mm W 56mm H 55mm motor type M51B20R0000		

Зип-Общепит

vsezip.ru

+7(812)987-08-81

pumps

drain pumps

HANNING



1			
GEV No.	501441	Ref. No.	20520270 20700034
description	drain pump 38W 200-240V inlet ø 24mm outlet ø 24mm 50/60Hz HANNING max. 15min reinforced version break time 45min input current 0.4A		

fuses

fine fuses

fine fuse holders



1			
GEV No.	358192	Ref. No.	20800115
description	fuse holder suitable fuse 5x20/5x25mm 6.3A rated 250V		

line circuit breakers

miscellaneous

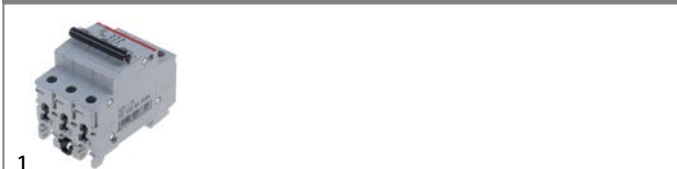

1			
GEV No.	358114	Ref. No.	061407
description	line circuit breaker 3-pole 6A tripping type C rated 400V connection screw		

electric accessories

cables

ribbon cables

group 10



1			
GEV No.	698525	Ref. No.	30900013
description	ribbon cable L 120mm for display		

rail-mounted terminals

miscellaneous



1			
GEV No.	551281	Ref. No.	20800122
description	rail-mounted terminal max 400V connection plug-in connection 4-pole max. 10A cross section 4mm ²		

miscellaneous

service kits



1			
GEV No.	698520	Ref. No.	033531 033608 066025 20120203
description	service kit for lighting for combi-steamer		

ignition parts

ignition units

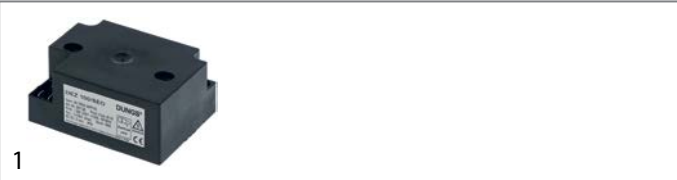

1			
GEV No.	107895	Ref. No.	32700166
description	ignition unit outputs 1 220-240VAC dimensions 84x62x38mm mounting distance 58mm inlet F6.3x0.8 outlet 4 type TRK2-30PFVD 69VA 50/60Hz protection IP54		



gas burners

accessories

gaskets



1

GEV No.	514531	Ref. No.	32700045
description	gasket graphite ED ø 117mm ID ø 94mm thickness 1.7mm Qty 1 pcs		

accessories



1

GEV No.	107896	Ref. No.	32700090
description	manifold gas L 118mm brass thread conical suitable for HOUNO combi-steamer		

drain units

drip rails



1

GEV No.	696848	Ref. No.	30410005
description	drip rail L 500mm stainless steel W 26mm for combi-steamer		



1

GEV No.	696819	Ref. No.	20420022 30420152
description	drip rail L 553mm stainless steel W 26mm for combi-steamer		



1

GEV No.	696818	Ref. No.	30410026
description	drip rail L 760mm stainless steel W 26mm for combi-steamer		

Зип Общедит

injection nozzles



GEV No.	542437	Ref. No.	059216 30500400
description	injection nozzle bore ø 1.1mm D1 ø 11mm L 23mm WS 12 SS for combi-steamer thread 1/8" ET conical		



GEV No.	542436	Ref. No.	059257
description	injection nozzle L 20mm WS 12 stainless steel for combi-steamer thread 1/8" ET conical JAU 1310		

pipes



1

GEV No.	521199	Ref. No.	30500013
description	pipe L 360mm ø 25mm for combi-steamer stainless steel		

doors



1

GEV No.	698527	Ref. No.	2042008
description	door glass inner suitable for HOUNO 1.06 H 579mm W 518mm		

gas components

Зип.Общепит

vsezip.ru

+7(812)987-08-81



1

GEV No.	698528	Ref. No.	30420020
description	door glass suitable for HOUNO H 584mm W 692mm		

door mechanics

accessories



1

GEV No.	696816	Ref. No.	014043
description	buffer for glass plate ø 13mm rubber L 17mm		



1

GEV No.	696817	Ref. No.	30400048
description	cover W 25mm hole ø 6.2mm L 70mm		



1

GEV No.	701648	Ref. No.	064872
description	gas tension spring for combi-steamer 150N D1 ø 15mm D2 ø 6mm hole distance 255mm hole ø 6mm L 265mm		



1

GEV No.	701649	Ref. No.	064874
description	gas tension spring for combi-steamer 250N D1 ø 15mm D2 ø 6mm hole distance 255mm hole ø 6mm L 268mm		



1

GEV No.	542439	Ref. No.	30400027
description	torsion spring ø 13mm L2 12mm wire gauge ø 2mm L1 12mm L3 12mm Qty 1 pcs		



1

GEV No.	692213	Ref. No.	032400
description	mechanicsm for switch L 530mm thread 1/4" W 50mm ø 8mm hole ø 11.6mm		



1

GEV No.	698521	Ref. No.	20400238
description	plug L 35.4mm ø 13mm		

locks

handle latches

producer-specific

HOUNÖ



1

GEV No.	694607	Ref. No.	20400207 20410019 20420227 20420262 20420313 30400030 30400032 30410004 30420013 30420853 30420854 30421088
description	catch for combi-steamer mounting distance 50mm HOUNO		

spare parts for 694607

GEV No.	694848	Ref. No.	30420245 30420840
description	door catch with spigot 2-stage L 70mm W 25mm H 44mm mounting distance 50mm		





GEV No.	694851	Ref. No.	069022 30400031 30400034 30420694 30420849 30420850 30420864 30421087
description	catch kit		





Зип Общепит edge mount latches



handle latches
produce specific

HOUNÖ (812)987-08-81

 <p>1</p>							
GEV No.	694851	Ref. No.	069022 30420034 30420694 30420849 30420850 30420864 30421087				
description	catch kit						
spare parts for	694851						
 <table border="1"> <tr> <td>GEV No.</td> <td>694848</td> <td>Ref. No.</td> <td>30420245 30420840</td> </tr> </table> <p>door catch with spigot 2-stage L 70mm W 25mm H 44mm mounting distance 50mm</p>				GEV No.	694848	Ref. No.	30420245 30420840
GEV No.	694848	Ref. No.	30420245 30420840				

 <p>1</p>			
GEV No.	694066	Ref. No.	069020
description	door catch with spigot 2-stage L 28mm W 14mm H 15mm H1 16mm total length 51mm thread M8 thread L 23mm stainless steel		

 <p>1</p>			
GEV No.	694848	Ref. No.	30420245 30420840
description	door catch with spigot 2-stage L 70mm W 25mm H 44mm mounting distance 50mm		

 <p>1</p>							
GEV No.	701415	Ref. No.	30420698				
description	door handle L 171mm W 40mm handle ø 25mm spring length 38mm SS mounting thread M5 flange ø 39mm						
spare parts for	701415						
 <table border="1"> <tr> <td>GEV No.</td> <td>514390</td> <td>Ref. No.</td> <td>069023</td> </tr> </table> <p>spring for door handle ø 6mm L 54mm W 27.5mm</p>				GEV No.	514390	Ref. No.	069023
GEV No.	514390	Ref. No.	069023				

 <p>1</p>			
GEV No.	514390	Ref. No.	069023
description	spring for door handle ø 6mm L 54mm W 27.5mm		

 <p>1</p>							
GEV No.	694784	Ref. No.	034317				
description	catch L 172mm mounting distance 124/133mm chrome-plated non lockable heated units 6200 H 65mm type DUPLO total length 248mm						
accessories for	694784						
 <table border="1"> <tr> <td>GEV No.</td> <td>690123</td> <td>Ref. No.</td> <td>037967 069012</td> </tr> </table> <p>door catch H 69mm D 37mm W 20mm mounting distance 43mm with roller</p>				GEV No.	690123	Ref. No.	037967 069012
GEV No.	690123	Ref. No.	037967 069012				

<p>door catches</p>  <p>1</p>			
GEV No.	690123	Ref. No.	037967 069012
description	door catch H 69mm D 37mm W 20mm mounting distance 43mm with roller		

gaskets
gaskets for heated units

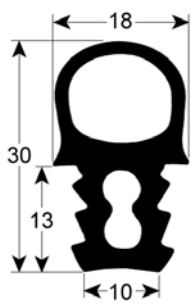
<p>door seals</p>  <p>1</p>			
GEV No.	902542	Ref. No.	037064
description	door seal profile 2073 W 484mm L 676mm outer plug size Qty 1		

mechanical components, equipment accessories



Зип Общепит

vsezip.ru

+7(812)987-08-81

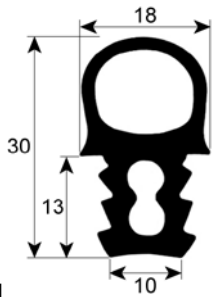

GEV No.	901499	Ref. No.	037068
description	door seal profile 2073 W 490mm L 1465mm external size Qty 1 suitable for HOUNO 1.20-99		



GEV No.	901853	Ref. No.	32903
description	door seal profile 2073 W 530mm L 605mm outer plug size suitable for HOUNO		

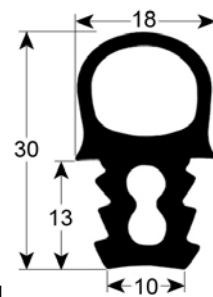

GEV No.	901440	Ref. No.	037063
description	door seal profile 2073 W 490mm L 560mm external size Qty 1 suitable for HOUNO 1.06-99		

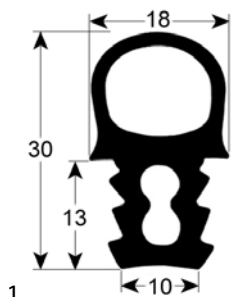

GEV No.	901670	Ref. No.	032904
description	door seal profile 2073 W 535mm L 835mm external size Qty 1		

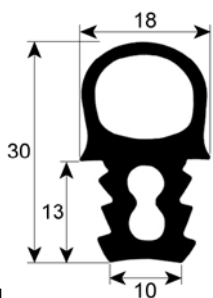

GEV No.	901459	Ref. No.	037065
description	door seal profile 2073 W 490mm L 810mm external size Qty 1		

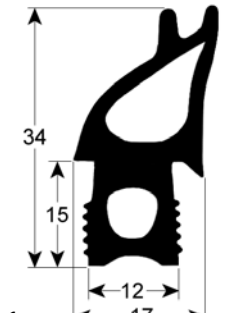

GEV No.	901387	Ref. No.	20300234 30300134
description	door seal profile 2735 W 490mm L 550mm external size Qty 1 dark grey		

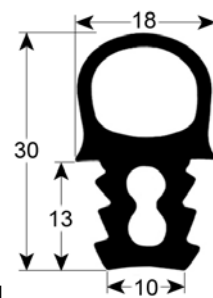

GEV No.	901652	Ref. No.	037066
description	door seal profile 2073 W 495mm L 955mm external size Qty 1		

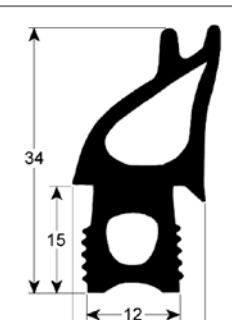

GEV No.	902106	Ref. No.	20300235 30300135
description	door seal profile 2735 W 490mm L 690mm external size Qty 1		

mechanical components, equipment accessories



Зип Общепит

vsezip.ru

+7(812)987-08-81

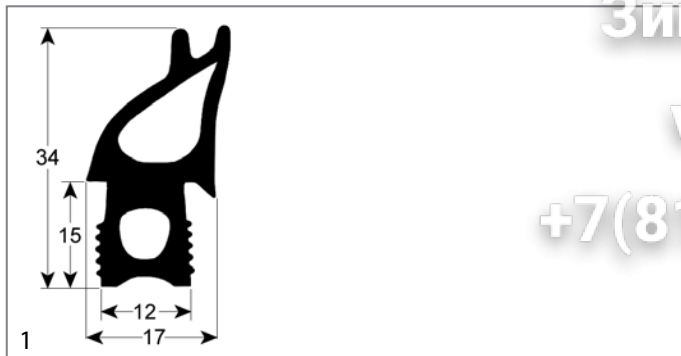

GEV No.	901386	Ref. No.	20300236 30300136
description	door seal profile 2735 W 490mm L 820mm external size Qty 1		



GEV No.	901855	Ref. No.	30300108 30300142
description	door seal profile 2735 W 682mm L 1470mm Qty 1 suitable for HOUNO		

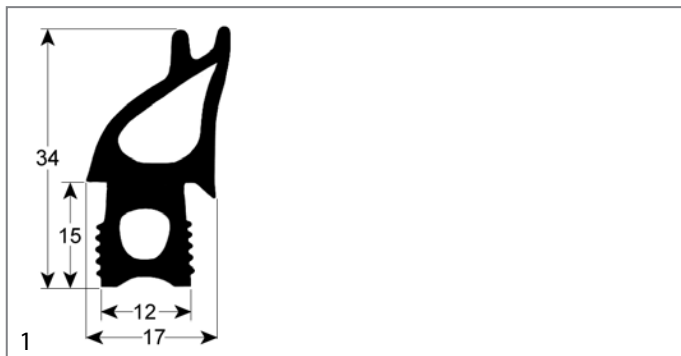

GEV No.	902540	Ref. No.	20300239 30300137
description	door seal profile 2735 W 491mm L 947mm outer plug size Qty 1		

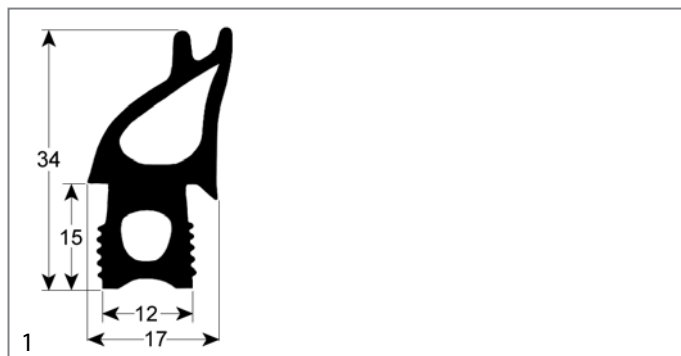

GEV No.	902538	Ref. No.	30300141
description	door seal profile 2735 W 683mm L 1080mm outer plug size Qty 1		

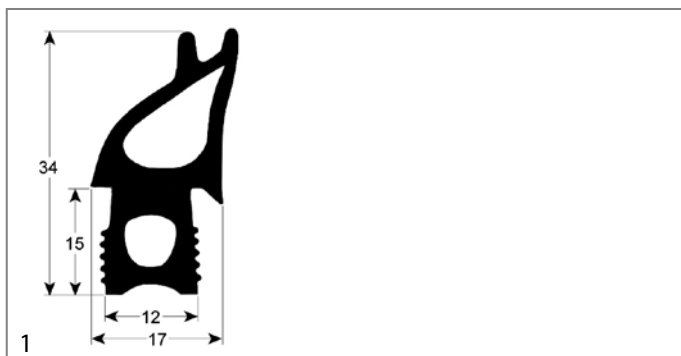

GEV No.	901854	Ref. No.	20300241 30300139
description	door seal profile 2735 W 495mm L 1470mm outer plug size suitable for HOUNO		

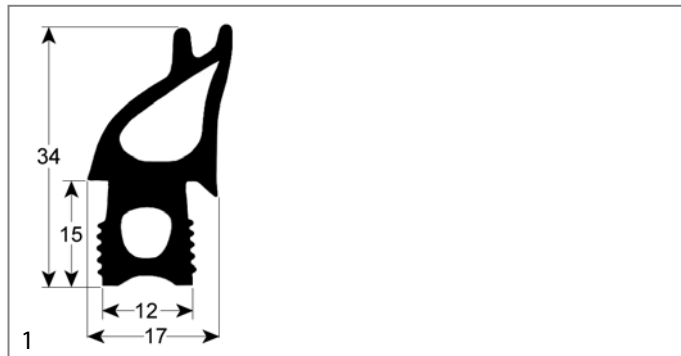

GEV No.	902537	Ref. No.	20300237 30300140
description	door seal profile 2735 W 683mm L 819mm outer plug size Qty 1		

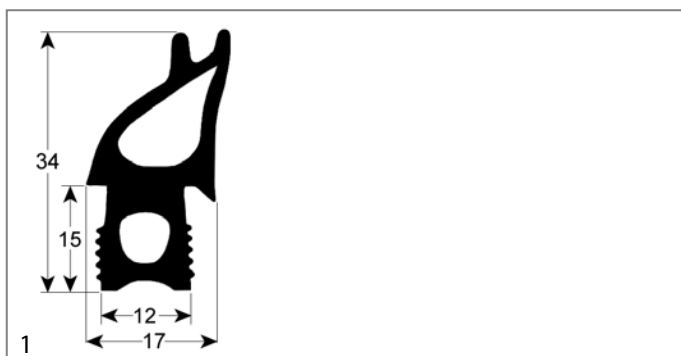

GEV No.	902536	Ref. No.	30300187
description	door seal profile 2735 W 558mm L 683mm outer plug size Qty 1		

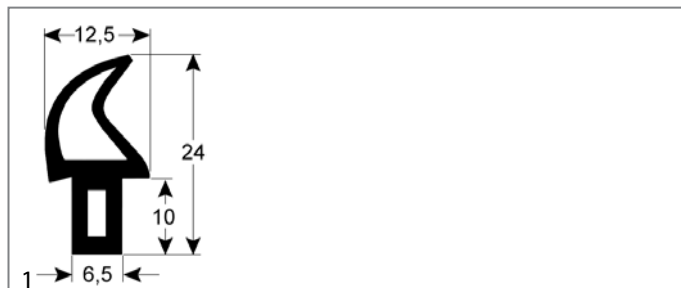

GEV No.	902534	Ref. No.	30300182
description	door seal profile 2739 L 1464mm Qty 1 suitable for HOUNO		

mechanical components, equipment accessories

Зип-Общепит

O-rings

EPDM
Ø 21.89mm

+7(812)987-08-81

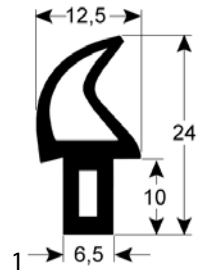

GEV No.	902535	Ref. No.	30300183
description	door seal profile 2739 L 1845mm Qty 1 suitable for HOUNO		

gaskets for tray rack trolleys

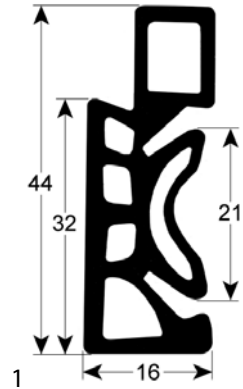

GEV No.	902529	Ref. No.	30400325
description	tray rack trolley gasket profile 4150 L 540mm suitable for 1.16/1.20 roll-in Qty 1		

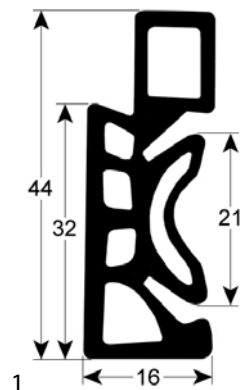

GEV No.	902530	Ref. No.	30400281
description	tray rack trolley gasket profile 4150 L 760mm suitable for 2.20 roll-in Qty 1		



GEV No.	902521	Ref. No.	30420224 30420767
description	tray rack trolley gasket with front panel L 760mm Qty 1 suitable for combi-steamer HOUNO 2.20		



GEV No.	532453	Ref. No.	32700106
description	O-ring EPDM thickness 2.62mm ID ø 21.89mm Qty 1 pcs		

sealing washers

graphite gaskets



GEV No.	514531	Ref. No.	32700045
description	gasket graphite ED ø 117mm ID ø 94mm thickness 1.7mm Qty 1 pcs		

foam rubber gaskets



GEV No.	505406	Ref. No.	30300363
description	foam rubber gasket W 10mm thickness 4mm self-adhesive Qty supplied by meter		

special gaskets

for combi-steamers



GEV No.	699627	Ref. No.	20100107
description	gasket suitable for HOUNO combi-steamer mounting pos. for lens ED ø 65mm ID ø 53mm graphite thickness 0.6mm		



GEV No.	699628	Ref. No.	20100106 30100147
description	gasket suitable for HOUNO combi-steamer mounting pos. for lens ED ø 83mm ID ø 52mm Viton thickness 3mm		



Зип Общепит
vsezip.ru
+7(812)987-08-81

miscellaneous



1	GEV No. 514531	Ref. No. 32700045
description gasket graphite ED ø 117mm ID ø 94mm thickness 1.7mm Qty 1 pcs		



1	GEV No. 511653	Ref. No. 20600007
description gasket silicone L 82mm W 82mm thickness 3mm		



1	GEV No. 698524	Ref. No. 32700059
description gasket W 37.2mm L 60mm combi-steamer suitable for HOUNO thickness 4mm		

springs

torsion springs



1	GEV No. 542439	Ref. No. 30400027
description torsion spring ø 13mm L2 12mm wire gauge ø 2mm L1 12mm L3 12mm Qty 1 pcs		

gas tension springs

gas tension springs



1	GEV No. 701648	Ref. No. 064872
description gas tension spring for combi-steamer 150N D1 ø 15mm D2 ø 6mm hole distance 255mm hole ø 6mm L 265mm		



1	GEV No. 701649	Ref. No. 064874
description gas tension spring for combi-steamer 250N D1 ø 15mm D2 ø 6mm hole distance 255mm hole ø 6mm L 268mm		

hose reels and spray guns

spray guns



1	GEV No. 542075	Ref. No. 041063
description spray gun for appliances hose ø 7mm		



1	GEV No. 542038	Ref. No. 059959
description spray gun for appliances 3/8" IT L 135mm		

hoses

industrial hoses

nylon hoses



1	GEV No. 570146	Ref. No. 059003 30500498
description nylon hose ID ø 4mm ED ø 6mm L 1m operating p. 10bar burst p. 50bar t.max. 100°C blue		

silicone hoses

with fabric

with monofilament braid



1	GEV No. 530542	Ref. No. 059963 30500065
description silicone hose with monofilament braid ID ø 10mm ED ø 17mm L 5m thickness 3.5mm operating p. 4bar burst pressure at 95°C non definedbar burst pressure 130°C non definedbar t.max. 200°C Qty 5m		

mechanical components, equipment accessories

formed hoses

straight



1			
GEV No.	504871	Ref. No.	30500012 30500500
description	formed hose ext. ø 34 ID ø 24mm rubber black Qty 1		

fittings, hose and pipe connectors

fittings

T-pieces

brass



1			
GEV No.	698522	Ref. No.	59122
description	T-piece thread 1/4" brass 1x external thread 2x internal thread L 38mm		

hose connectors

stainless steel



1			
GEV No.	542438	Ref. No.	059147
description	hose connector thread 1/8" hose ø 6mm SS		

fastening material

screws

countersunk screws



1			
GEV No.	560337	Ref. No.	055620
description	countersunk screw thread M6 L 20mm WS 4 SS DIN 7991/ISO 10642 Qty 1 pcs intake hexagonal		

hexagonal screws



1			
GEV No.	560089	Ref. No.	55618
description	hexagonal screw thread M6 thread L 20mm SS WS 10 Qty 20 pcs DIN 933 / ISO 4017		

cylinder head bolts

DIN 912/ISO 4762



1			
GEV No.	560652	Ref. No.	055503
description	cylinder head bolt thread M5 L 35mm thread L 24mm WS 4 A2-70 Qty 1 pcs head ø 8mm DIN 912/ISO 4762		

side bolts



1			
GEV No.	560052	Ref. No.	055511 055514
description	side bolts thread M5 L 10mm SS Qty 20 pcs intake slotted head ø 12.5mm		

nuts

hexagonal nuts

DIN 934 / ISO 4032/8673



1			
GEV No.	560129	Ref. No.	056500
description	hexagonal nut thread M5 H 4mm WS 8 SS DIN/ISO DIN 934 / ISO 4032/8673 Qty 1 pcs		

washers

spring rings



1			
GEV No.	560123	Ref. No.	57601
description	lock washer ID ø 6.3mm ED ø 11mm SS DIN127 Qty 20 pcs for thread M6		



consumables

Зип Общепит

vsezip.ru

+7(812)987-08-81

fuses			
fine fuses			
fine fuse holders			
			
1			
GEV No.	358192	Ref. No.	20800115
description	fuse holder suitable fuse 5x20/5x25mm 6.3A rated 250V		

Зип Общепит

vsezip.ru

+7(812)987-08-81

Зип Общепит

vsezip.ru

+7(812)987-08-81

A		L	
alarm devices	6	lamps	5
axial fans	11	light bulbs	5
B		M	
bi-metal thermostats	4, 4	magnetic switches	4
C		N	
cables	12	nuts	20
consumables	21	nylon hoses	19
contactors	6	O	
countersunk screws	20	O-rings	18
cylinder head bolts	20	oven lamps	5
D		P	
door catches	15	pressure switches	10
door seals	15	probes	7
drain pumps	12	pumps	12
E		R	
edgemount latches	15	ribbon cables	12
electric accessories	12	S	
F		safety thermostats	
fans	11	4, 4	
fastening material	20	screws	
fine fuses	21	20	
fittings	20	sealing washers	
foam rubber gaskets	18	18	
formed hoses	20	side bolts	
fuses	12, 21	20	
G		silicone hoses	
gas burners	13	19	
gaskets for heated units	15	solenoid valves	
gaskets for tray rack trolleys	18	9	
H		solid state relays	
halogen lamp	5	7	
handle latches	15	spray guns	
heating elements	2	19	
heating elements for convection	3	spray guns with external thread	
hexagonal nuts	20	19	
hexagonal screws	20	spring rings	
hose connectors	20	20	
hoses	19	switches and momentary switches	
hot air motors	11	4	
I		T	
ignition units	12	terminals	
immersion heating elements	2	12	
industrial hoses	19	thermostats	
		4	
		transformers	
		7	