



Зип Ощепит

vsezip.ru

Spare Parts for

+7(812)987-08-81 Dishwashing

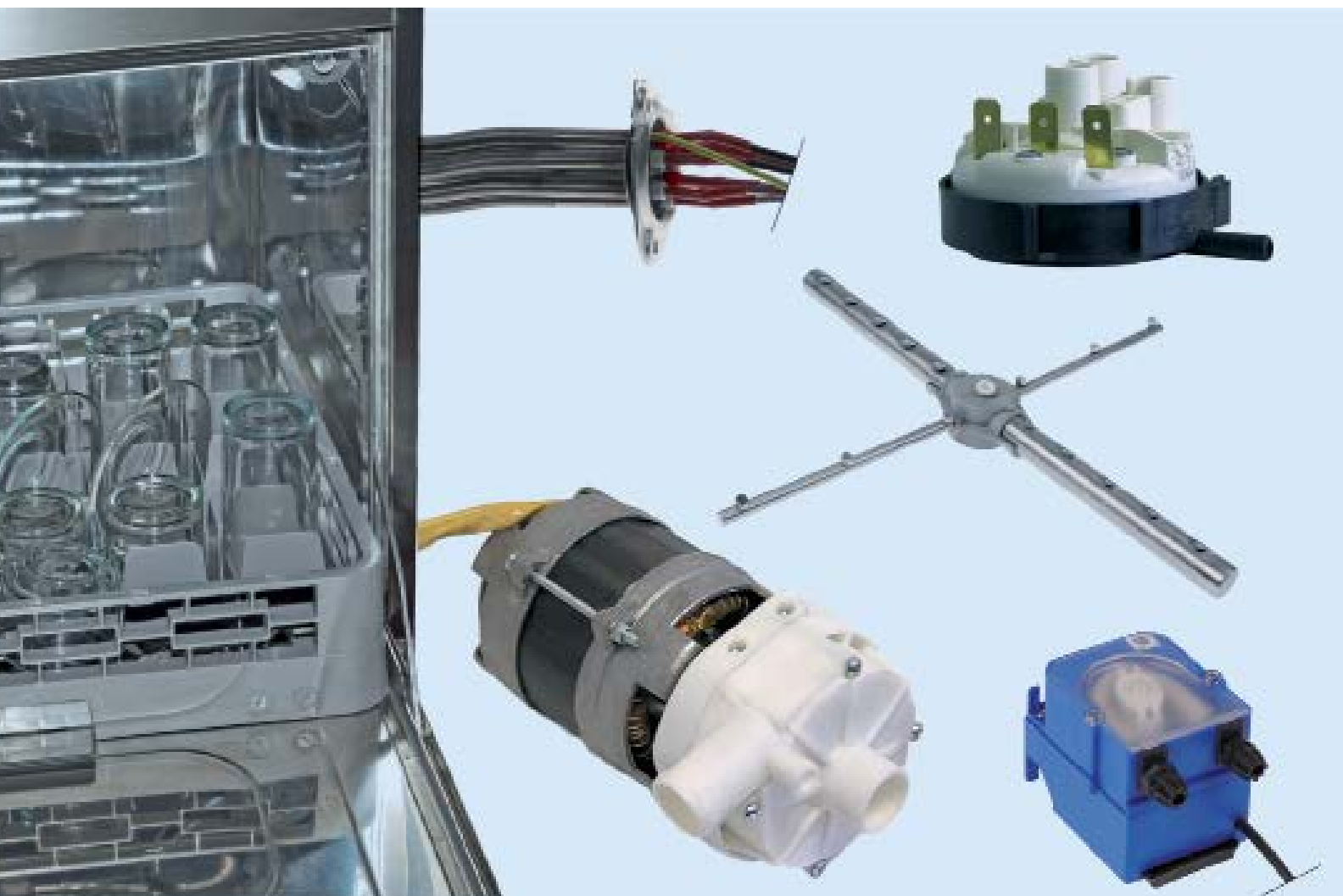

Spare parts suitable for

MEIKO

2018

Find the complete and up-to-date range of products in our GEV Webshop



heating elements

dry heating elements for dishwashers



GEV No.	419058	Ref. No.	0101082
description	heating element 1000W 240V heating circuits 1 L 424mm W 37mm connection length 37mm tube \varnothing 8.5mm connection M4 dry heating element 2 hole fixing thread M14x1.5 mounting distance 29mm		

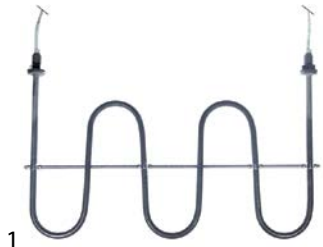

GEV No.	420052	Ref. No.	0101136
description	heating element 2000W 230V heating circuits 1 L 175mm W 295mm connection length 40mm tube \varnothing 6.5mm cable length 230mm dry heating element dishwasher 2 hole fixing thread M10x1 INCOLOY-800 mounting distance 289mm		

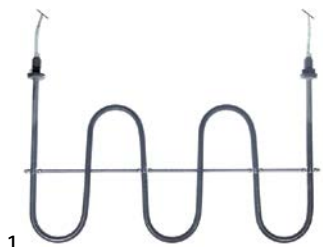

GEV No.	419059	Ref. No.	0101156
description	heating element 2000W 254V heating circuits 1 L 175mm W 298mm connection length 30mm tube \varnothing 6.3mm cable length 230mm dry heating element 2 hole fixing thread M10x1 mounting distance 169mm		



GEV No.	418852	Ref. No.	0101135
description	heating element 3000W 230V heating circuits 1 L 170mm W 295mm tube \varnothing 6.5mm thread M10x1 cable length 220mm convection heating element mounting distance 290mm bridge length 310mm		

Зип-Общепит immersion heating elements

3 hole flange \varnothing 47.5mm

GEV No.	420368	Ref. No.	9605102
description	heating element 10500W 230V mounting \varnothing 47.5mm heating circuits 3 L 490mm W 42mm H 42mm number of thermostat sleeves 1 thermostat sleeves \varnothing 7mm length thermostat sleeves 150mm thermostat sleeve centre tube \varnothing 8.5mm hole distance 64mm hole \varnothing 8/10mm connection length 22mm connection screw clamp 3 hole flange immersion heater INCOLOY		



GEV No.	420158	Ref. No.	0101195 0101195+0101197
description	heating element 3600W 230V mounting \varnothing 47.5mm heating circuits 3 L 270mm W 28mm H 34mm number of thermostat sleeves 2 thermostat sleeves \varnothing 7.5mm length thermostat sleeves 100mm thermostat sleeve eccentric, non clinging tube \varnothing 6.1mm hole distance 62mm hole \varnothing 10mm connection length 17mm connection male faston 6.3mm 3 hole flange immersion heater		



GEV No.	420541	Ref. No.	9632938
description	heating element 4000W 380V mounting \varnothing 47.5mm heating circuits 3 L 235mm W 34mm H 40mm number of thermostat sleeves 1 thermostat sleeves \varnothing 8.5mm length thermostat sleeves 155mm tube \varnothing 8.5mm connection F6.3		

spare parts for	420541		
GEV No.	510408	Ref. No.	0101176

O-ring EPDM thickness 5.34mm ID \varnothing 47mm Qty 1 pcs



Зип Общепит

vsezip.ru

+7(812)987-08-81



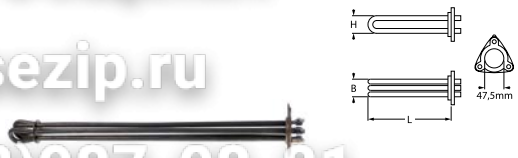

1

GEV No.	418773	Ref. No.	9519587
description	heating element 4500W 240V mounting \varnothing 47.5mm heating circuits 3 L 260mm W 33mm H 36mm number of thermostat sleeves 1 thermostat sleeves \varnothing 7mm length thermostat sleeves 150mm thermostat sleeve centre not clinging tube \varnothing 8.5mm connection screw with integrated fuse		
For models:	FV40.2, FV40.2 AB 2002, FV40.2 AB 2003, FV40.2M, FV40.2MIKE2, FV40.2M-MIKE2		
accessories for	418773		
	GEV No.	510408	Ref. No. 0101176
	O-ring EPDM thickness 5.34mm ID \varnothing 47mm Qty 1 pcs		
	GEV No.	560395	Ref. No. —
	flat-headed bolt thread M4 thread L 8mm SS DIN 84/ISO 1207 Qty 1 pcs intake slotted head \varnothing 7mm head thickness 2.5mm		



1

GEV No.	418877	Ref. No.	9519591
description	heating element 9000/9800W 230/240V mounting \varnothing 47.5mm heating circuits 3 L 485mm W 30mm H 32mm number of thermostat sleeves 1 thermostat sleeves \varnothing 7mm length thermostat sleeves 120mm thermostat sleeve centre not clinging tube \varnothing 8.5mm hole distance 62mm hole \varnothing 8mm connection length 20mm connection M4 immersion heater		
spare parts for	418877		
	GEV No.	510408	Ref. No. 0101176
	O-ring EPDM thickness 5.34mm ID \varnothing 47mm Qty 1 pcs		



1

GEV No.	419041	Ref. No.	9519588
description	heating element 6000/6530W 230/240V mounting \varnothing 47.5mm heating circuits 3 L 330mm W 42mm H 42mm number of thermostat sleeves 1 thermostat sleeves \varnothing 7mm length thermostat sleeves 120mm thermostat sleeve centre tube \varnothing 8.5mm hole \varnothing 10x8mm connection screw 3 hole flange immersion heater		
For models:	FV40.2, FV40.2MIKE2, FV40.2M-MIKE2		
accessories for	419041		
	GEV No.	510408	Ref. No. 0101176
	O-ring EPDM thickness 5.34mm ID \varnothing 47mm Qty 1 pcs		

3 hole flange \varnothing 57.5mm





1

GEV No.	420369	Ref. No.	9615641
description	heating element 10500W 230V mounting \varnothing 57.5mm heating circuits 3 L 650mm W 44mm H 37mm tube \varnothing 8.5mm hole distance 72mm hole \varnothing 8/10mm connection length 80mm connection screw clamp 3 hole flange immersion heater with threaded rod INCOLOY-800		
spare parts for	420369		
	GEV No.	532000	Ref. No. 0401048
	O-ring EPDM thickness 7mm ID \varnothing 57mm Qty 1 pcs		



1

GEV No.	418772	Ref. No.	9519590
description	heating element 7500W 240V mounting \varnothing 47.5mm heating circuits 3 L 405mm W 32mm H 37mm thermostat sleeves \varnothing 7mm length thermostat sleeves 150mm thermostat sleeve centre tube \varnothing 8.5mm hole distance 63mm hole \varnothing 8mm connection screw		
For models:	FV40.2, FV40.2MIKE2, FV40.2M-MIKE2		
accessories for	418772		
	GEV No.	510408	Ref. No. 0101176
	O-ring EPDM thickness 5.34mm ID \varnothing 47mm Qty 1 pcs		



1

GEV No.	418769	Ref. No.	0101186 0101186+0401048
description	heating element 11000W 240V mounting \varnothing 57.5mm heating circuits 3 L 502mm W 38mm H 73mm H1 38mm H2 35mm tube \varnothing 8.5mm hole distance 73mm 3 hole flange immersion heater		
accessories for	418769		
	GEV No.	532000	Ref. No. 0401048
	O-ring EPDM thickness 7mm ID \varnothing 57mm Qty 1 pcs		



Зип Общепит

vsezip.ru

+7(812)98108881

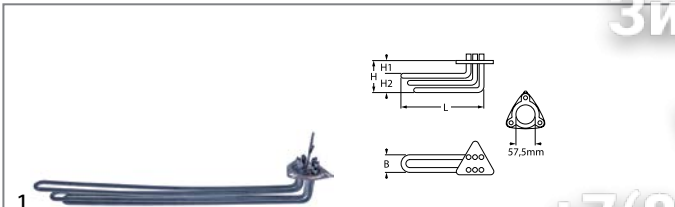

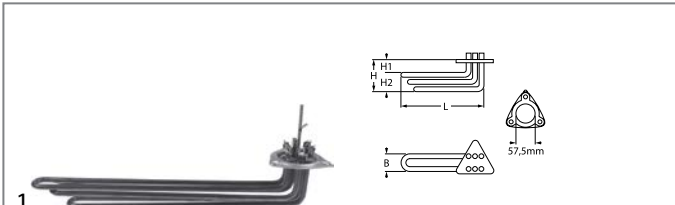

GEV No.	418770	Ref. No.	0101185 0101185+0401048
description	heating element 15000W 230V mounting ϕ 57.5mm heating circuits 3 L 580mm W 40mm H 73mm H1 39mm H2 34mm tube ϕ 8.5mm hole distance 72mm hole ϕ 8mm 3 hole flange immersion heater		





GEV No.	419057	Ref. No.	0101187 0101187 + 0401048
description	heating element 8000W 240V mounting ϕ 57.5mm heating circuits 3 L 414mm W 40mm H 75mm H1 40mm H2 35mm tube ϕ 8.5mm hole distance 72mm hole ϕ 8mm connection length 80mm connection screw clamp 3 hole flange immersion heater		
accessories for	419057		
	GEV No.	532000	Ref. No. 0401048
	O-ring EPDM thickness 7mm ID ϕ 57mm Qty 1 pcs		

with compression flange (miscellaneous)



GEV No.	415507	Ref. No.	0101152 9708856
description	heating element 2000W 230V heating circuits 1 L 250mm W 35mm H 25mm connection male faston 6.3mm tube ϕ 8.5mm immersion heater special fixing mounting distance 21mm		
For models:	DV120T, DV40N, DV40T, DV40T FA, DV80T, ECO STAR 430F, ECO STAR 530F, ECO STAR 545D, FR30G, FR30G AB 1992, FR40G AB 1980, FR40G AB 1983, FR40GUS AB 1980, FR40GUS AB 1983, FV110G, FV20N, FV20T, FV25G AB 1986, FV25G AB 1992, FV28G AB 1994, FV28G AB 1997, FV28GFA, FV30GS, FV40.2, FV40.2 AB 2003, FV40N AB 1980, FV40N AB 1983, FV40N AB 1992, FV40T, FV40TFA, FV60E AB 1983, FV60E AB 1988, FV70T		
spare parts for	415507		
	GEV No.	510364	Ref. No. 0101175
	gasket Lmm Wmm ϕ 36mm for heating element thickness 3mm with 4 screw holes		
	GEV No.	510365	Ref. No. —
	counterflange ϕ 36mm Lmm Wmm		









GEV No.	419018	Ref. No.	0101184 0101184 + 0408229
description	heating element 36000W 415V heating circuits 12 L 420mm W 90mm H 30mm immersion heater		
For models:	DV221		
accessories for	419018		
	GEV No.	501383	Ref. No. 0408229
	flat gasket ID ϕ 102mm ED ϕ 144mm hole distance 33mm hole ϕ 6mm EPDM for heating element thickness 3mm		

with round flange ϕ 47.5mm



GEV No.	419257	Ref. No.	9519586
description	heating element 3000/3265W 230/240V heating circuits 3 mounting ϕ 47.5mm L 185mm W 37mm H 30mm round flange connection screw cable lengthmm immersion heater tube ϕ 8.5mm thermostat sleeves ϕ 7mm number of thermostat sleeves 1 length thermostat sleeves 120mm thermostat sleeve centre not clinging		
For models:	FV40.2, FV40.2 AB 2002, FV40.2 AB 2003, FV40.2M, FV40.2MIKE2, FV40.2M-MIKE2		







GEV No.	415693	Ref. No.	0101150 9504228 9504228+0101176
description	heating element 3000W 230V heating circuits 3 mounting ϕ 47.5mm L 220mm W 30mm H 30mm round flange connection male faston 6.3mm immersion heater tube ϕ 6.5mm connection length 40mm thermostat sleeves ϕ 6.5mm number of thermostat sleeves 2 length thermostat sleeves 170mm thermostat sleeve centre		
For models:	DV120B, DV120T, DV40 AB 1992, DV40T, DV40T FA, DV80T, ECO STAR 430F, ECO STAR 530F, ECO STAR 545D, FR30G AB 1992, FV110G, FV130B, FV20N, FV20T, FV25G AB 1992, FV28G AB 1994, FV28G AB 1997, FV28GFA, FV30GS, FV40N AB 1992, FV40TFA, FV60E AB 1988, FV70TD		
accessories for	415693		
	GEV No.	510408	Ref. No. 0101176
	O-ring EPDM thickness 5.34mm ID ϕ 47mm Qty 1 pcs		
	GEV No.	510562	Ref. No. —
	O-ring silicone thickness 5.34mm ID ϕ 47mm Qty 1 pcs		
	GEV No.	520235	Ref. No. —
	3 hole flange hole distance 70.5mm perforation ϕ 6.5mm ID ϕ 53.5mm		
	GEV No.	520236	Ref. No. —
	flange for heating element ID ϕ 50mm ED ϕ 90mm hole ϕ 6.5mm 3 holes		
	GEV No.	550002	Ref. No. 0101183
	tension strap H 10mm L 21mm W 10mm hole ϕ 6.5mm for heating element		
	GEV No.	550362	Ref. No. —
	blind flange ϕ 64mm mounting ϕ 47.5mm		















Зип Общепит
vsezip.ru
+7(812)98708481

			
1			
GEV No.	415508	Ref. No.	0101151
description	heating element 3000W 230V heating circuits 3 mounting \varnothing 47.5mm L 380mm W 125mm H 25mm tube \varnothing 6.3mm round flange with thread bolt connection male faston 6.3mm immersion heater connection length 30mm H1 15mm		
For models:	DV100 AB 1980, DV100 AB 1983, DV120B, DV160 AB 1980, DV240B AB 1980, DV40 AB 1983, DV40 AB 1992, DV80, DV80 AB 1980, DV80 AB 1983, DV80 AB 1992		
accessories for	415508		
	GEV No.	510562	Ref. No. —
	O-ring silicone thickness 5.34mm ID \varnothing 47mm Qty 1 pcs		
	GEV No.	521012	Ref. No. —
	gasket graphite ED \varnothing 15mm ID \varnothing 5mm thickness 1.2mm Qty 1 pcs		
	GEV No.	550002	Ref. No. 0101183
	tension strap H 10mm L 21mm W 10mm hole \varnothing 6.5mm for heating element		









			
1			
GEV No.	420365	Ref. No.	0101180
description	heating element 3600W 230V heating circuits 3 mounting \varnothing 47.5mm L 270mm W 38mm H 29mm round flange connection male faston 6.3mm immersion heater tube \varnothing 6.3mm thermostat sleeves \varnothing 6.5mm number of thermostat sleeves 2 length thermostat sleeves 100mm thermostat sleeve eccentric, non clinging		
accessories for	420365		
	GEV No.	510408	Ref. No. 0101176
	O-ring EPDM thickness 5.34mm ID \varnothing 47mm Qty 1 pcs		
	GEV No.	510562	Ref. No. —
	O-ring silicone thickness 5.34mm ID \varnothing 47mm Qty 1 pcs		







			
1			
GEV No.	417535	Ref. No.	0101163 9504234 9708867
description	heating element 4500W 230V heating circuits 3 mounting \varnothing 47.5mm L 345mm W 33mm H 40mm thermostat sleeves \varnothing 8.5mm number of thermostat sleeves 2 length thermostat sleeves 20.5mm thermostat sleeve eccentric, non clinging		
For models:	ECO STAR 430F, ECO STAR 530F, ECO STAR 545D, FV110G, FV20N, FV40N AB 1992, FV40T, FV40TFA, FV60E AB 1988, FV70TD		
accessories for	417535		
	GEV No.	510408	Ref. No. 0101176
	O-ring EPDM thickness 5.34mm ID \varnothing 47mm Qty 1 pcs		

			
1			
GEV No.	415509	Ref. No.	0101158
description	heating element 6000W 230V heating circuits 3 mounting \varnothing 47.5mm L 145mm W 374mm H 25mm H1 5mm H2 20mm tube \varnothing 6.4mm round flange with thread bolt connection male faston 6.3mm immersion heater connection length 30mm		
For models:	DV160 AB 1983, DV160 AB 1996, DV240B AB 1983, DV240B AB 1996, DV260B, FV120B AB 1980, FV120B AB 1983, FV130B, FV240B AB 1980, FV240B AB 1983, FV70TD		
accessories for	415509		
	GEV No.	510408	Ref. No. 0101176
	O-ring EPDM thickness 5.34mm ID \varnothing 47mm Qty 1 pcs		
	GEV No.	510562	Ref. No. —
	O-ring silicone thickness 5.34mm ID \varnothing 47mm Qty 1 pcs		
	GEV No.	550002	Ref. No. 0101183
	tension strap H 10mm L 21mm W 10mm hole \varnothing 6.5mm for heating element		

			
1			
GEV No.	415663	Ref. No.	0101143 9504236
description	heating element 6000W 230V heating circuits 3 mounting \varnothing 47.5mm L 400mm W 40mm H 28mm round flange connection M4 immersion heater tube \varnothing 6.3mm thermostat sleeves \varnothing 7mm number of thermostat sleeves 2 length thermostat sleeves 150mm thermostat sleeve not clinging		
For models:	DV120B, DV120T, DV40 AB 1992, DV40T, DV40T FA, DV80 AB 1992, DV80T, ECO STAR 545D, FV130B, FV40N AB 1992, FV40TFA, FV60E AB 1988, FV70TD		
spare parts for	415663		
	GEV No.	510408	Ref. No. 0101176
	O-ring EPDM thickness 5.34mm ID \varnothing 47mm Qty 1 pcs		
accessories for	415663		
	GEV No.	510408	Ref. No. 0101176
	O-ring EPDM thickness 5.34mm ID \varnothing 47mm Qty 1 pcs		
	GEV No.	510562	Ref. No. —
	O-ring silicone thickness 5.34mm ID \varnothing 47mm Qty 1 pcs		
	GEV No.	520235	Ref. No. —
	3 hole flange hole distance 70.5mm perforation \varnothing 6.5mm ID \varnothing 53.5mm		
	GEV No.	520236	Ref. No. —
	flange for heating element ID \varnothing 50mm ED \varnothing 90mm hole \varnothing 6.5mm 3 holes		
	GEV No.	550002	Ref. No. 0101183
	tension strap H 10mm L 21mm W 10mm hole \varnothing 6.5mm for heating element		
	GEV No.	550362	Ref. No. —
	blind flange \varnothing 64mm mounting \varnothing 47.5mm		

electric components

			
GEV No.	415873	Ref. No.	0101167 9504237
description	heating element 7500W 230V heating circuits 3 mounting ø 47.5mm L 415mm W 30mm H 47mm round flange connection M4 immersion heater tube ø 6.5mm connection length 24mm thermostat sleeves 2 length thermostat sleeves 210mm thermostat sleeve not clinging		
For models:	DV120B, DV120T, DV40T, DV40T FA, DV80T, FV110G, FV130B, FV20N, FV40N AB 1992, FV40TFA, FV60E AB 1988, FV70T, FV70TD		
spare parts for	415873		
	GEV No.	510408	Ref. No. 0101176
	O-ring EPDM thickness 5.34mm ID ø 47mm Qty 1 pcs		
accessories for	415873		
	GEV No.	510408	Ref. No. 0101176
	O-ring EPDM thickness 5.34mm ID ø 47mm Qty 1 pcs		
	GEV No.	510562	Ref. No. —
	O-ring silicone thickness 5.34mm ID ø 47mm Qty 1 pcs		
	GEV No.	520235	Ref. No. —
	3 hole flange hole distance 70.5mm perforation ø 6.5mm ID ø 53.5mm		
	GEV No.	520236	Ref. No. —
	flange for heating element ID ø 50mm ED ø 90mm hole ø 6.5mm 3 holes		
	GEV No.	550002	Ref. No. 0101183
	tension strap H 10mm L 21mm W 10mm hole ø 6.5mm for heating element		
	GEV No.	550362	Ref. No. —
	blind flange ø 64mm mounting ø 47.5mm		

			
GEV No.	415692	Ref. No.	0101166 9504240
description	heating element 9000W 230V heating circuits 3 mounting ø 47.5mm L 485mm W 34mm H 24mm round flange connection M4 immersion heater tube ø 6.3mm thermostat sleeves ø 7mm number of thermostat sleeves 2 length thermostat sleeves 170mm thermostat sleeve not clinging		
For models:	DV120B, DV120T, DV40T, DV40T FA, DV80 AB 1992, DV80T, ECO STAR 545D, FV130B		
spare parts for	415692		
	GEV No.	510408	Ref. No. 0101176
	O-ring EPDM thickness 5.34mm ID ø 47mm Qty 1 pcs		
accessories for	415692		
	GEV No.	510562	Ref. No. —
	O-ring silicone thickness 5.34mm ID ø 47mm Qty 1 pcs		
	GEV No.	520235	Ref. No. —
	3 hole flange hole distance 70.5mm perforation ø 6.5mm ID ø 53.5mm		
	GEV No.	520236	Ref. No. —
	flange for heating element ID ø 50mm ED ø 90mm hole ø 6.5mm 3 holes		
	GEV No.	550002	Ref. No. 0101183
	tension strap H 10mm L 21mm W 10mm hole ø 6.5mm for heating element		







Зип-Общепит

vsezip.ru

812)987-08-81

			
GEV No.	550362	Ref. No.	—
description	blind flange ø 64mm mounting ø 47.5mm		

with round flange (miscellaneous)			
			
GEV No.	420367	Ref. No.	9533178
description	heating element 2000W 440V heating circuits 1 mounting ø 33mm L 270mm W 38mm H 29mm round flange connection male faston 6.3mm immersion heater tube ø 8.5mm		

1½"			
			
GEV No.	415506	Ref. No.	0101140
description	heating element 3000W 230V heating circuits 3 thread 1½" L 230mm W 29mm H 25mm tube ø 6.3mm connection male faston 6.3mm immersion heater connection length 15mm flange with thread		
For models:	DV40 AB 1983, EE60, EE90, FR30G, FR40G AB 1983, FR40GUS AB 1983, FR60, FV25G AB 1986, FV40N AB 1983		
accessories for	415506		
	GEV No.	510406	Ref. No. 0408020
	flat gasket fibre ED ø 60mm ID ø 48mm thickness 3mm for thread 1½" Qty 1 pcs		
	GEV No.	510424	Ref. No. 0409008
	gasket copper ED ø 55mm ID ø 48mm thickness 2.2mm Centellen for thread 1½"		
	GEV No.	520211	Ref. No. —
	reducer thread 2" ET - 1½" IT brass		
	GEV No.	520212	Ref. No. —
	hexagonal nut thread 1½" brass WS 60 H 8mm		
	GEV No.	550361	Ref. No. —
	blind flange ø 58mm thread 1½"		





			
GEV No.	416221	Ref. No.	9502869
description	heating element 3000W 230V heating circuits 3 thread 1½" L 235mm W 33mm H 26mm thermostat sleeves ø 7mm length thermostat sleeves 202mm thermostat sleeve centre not clinging tube ø 6.3mm connection male faston immersion heater connection length 16mm flange with thread number of thermostat sleeves 1		
accessories for	416221		
	GEV No.	510406	Ref. No. 0408020
	flat gasket fibre ED ø 60mm ID ø 48mm thickness 3mm for thread 1½" Qty 1 pcs		
	GEV No.	510424	Ref. No. 0409008
	gasket copper ED ø 55mm ID ø 48mm thickness 2.2mm Centellen for thread 1½"		
	GEV No.	520211	Ref. No. —
	reducer thread 2" ET - 1½" IT brass		



Table continues overleaf









Зип Общепит
vsezip.ru

+7(812)987038-81

electric components

accessories for	416221		
	GEV No.	520212	Ref. No. —
	hexagonal nut thread 1½" brass WS 60 H 8mm		
	GEV No.	550361	Ref. No. —
	blind flange ø 58mm thread 1½"		

			
1	GEV No.	415502	Ref. No. 0101142
description	heating element 4500W 230V heating circuits 3 thread 1½" L 370mm W 34mm H 26mm tube ø 6.5mm immersion heater flange with thread		
For models:	DR70, DR90E, DV100 AB 1983, DV111, DV111E, DV120B, DV80, DV80 AB 1975, DV80 AB 1980, EE60, EE90, FV30, FV40N AB 1983, FV50, FV60E AB 1983		
accessories for	415502		
	GEV No.	510406	Ref. No. 0408020
	flat gasket fibre ED ø 60mm ID ø 48mm thickness 3mm for thread 1½" Qty 1 pcs		
	GEV No.	510424	Ref. No. 0409008
	gasket copper ED ø 55mm ID ø 48mm thickness 2.2mm Centellen for thread 1½"		
	GEV No.	520211	Ref. No. —
	reducer thread 2" ET - 1½" IT brass		
	GEV No.	520212	Ref. No. —
	hexagonal nut thread 1½" brass WS 60 H 8mm		
	GEV No.	550361	Ref. No. —
	blind flange ø 58mm thread 1½"		

			
1	GEV No.	416222	Ref. No. 9502870
description	heating element 6000W 230V heating circuits 3 thread 1½" L 415mm W 33mm H 26mm thermostat sleeves ø 7mm length thermostat sleeves 230mm thermostat sleeve centre not clinging connection M4 immersion heater flange with thread number of thermostat sleeves 1		
accessories for	416222		
	GEV No.	510406	Ref. No. 0408020
	flat gasket fibre ED ø 60mm ID ø 48mm thickness 3mm for thread 1½" Qty 1 pcs		
	GEV No.	510424	Ref. No. 0409008
	gasket copper ED ø 55mm ID ø 48mm thickness 2.2mm Centellen for thread 1½"		
	GEV No.	520211	Ref. No. —
	reducer thread 2" ET - 1½" IT brass		
	GEV No.	520212	Ref. No. —
	hexagonal nut thread 1½" brass WS 60 H 8mm		
	GEV No.	550361	Ref. No. —
	blind flange ø 58mm thread 1½"		

			
1	GEV No.	415503	Ref. No. 0101144
description	heating element 6000W 230V heating circuits 3 thread 1½" L 415mm W 36mm H 26mm thermostat sleeves ømm length thermostat sleevesmm thermostat sleeve tube ø 6.3mm cable lengthmm connection M4 immersion heater connection lengthmm flange with thread WS 60 H 8mm		
accessories for	415503		
	GEV No.	510406	Ref. No. 0408020
	flat gasket fibre ED ø 60mm ID ø 48mm thickness 3mm for thread 1½" Qty 1 pcs		
	GEV No.	510424	Ref. No. 0409008
	gasket copper ED ø 55mm ID ø 48mm thickness 2.2mm Centellen for thread 1½"		
	GEV No.	520211	Ref. No. —
	reducer thread 2" ET - 1½" IT brass		
	GEV No.	520212	Ref. No. —
	hexagonal nut thread 1½" brass WS 60 H 8mm		
	GEV No.	550361	Ref. No. —
	blind flange ø 58mm thread 1½"		

			
1	GEV No.	416220	Ref. No. 0101145
description	heating element 6000W 230V heating circuits 3 thread 1½" L 415mm W 36mm H 75mm H1 48mm H2 27mm tube ø 6.3mm connection grip connection immersion heater flange with thread		
accessories for	416220		
	GEV No.	510406	Ref. No. 0408020
	flat gasket fibre ED ø 60mm ID ø 48mm thickness 3mm for thread 1½" Qty 1 pcs		
	GEV No.	510424	Ref. No. 0409008
	gasket copper ED ø 55mm ID ø 48mm thickness 2.2mm Centellen for thread 1½"		
	GEV No.	520211	Ref. No. —
	reducer thread 2" ET - 1½" IT brass		
	GEV No.	520212	Ref. No. —
	hexagonal nut thread 1½" brass WS 60 H 8mm		
	GEV No.	550361	Ref. No. —
	blind flange ø 58mm thread 1½"		









			
1	GEV No.	415510	Ref. No. 0101149
description	heating element 9000W 230V heating circuits 3 thread 1½" L 420mm W 39mm H 65mm H1 40mm H2 25mm tube ø 6.3mm connection M4 immersion heater flange with thread		
spare parts for	415510		
	GEV No.	560080	Ref. No. —
	hexagonal screw thread M4 thread L 8mm SS WS 7 Qty 20 pcs DIN 933 / ISO 4017		

Table continues overleaf



accessories for		415510	
	GEV No.	510406	Ref. No. 0408020
	flat gasket fibre ED ϕ 60mm ID ϕ 48mm thickness 3mm for thread 1½" Qty 1 pcs		
	GEV No.	510424	Ref. No. 0409008
	gasket copper ED ϕ 55mm ID ϕ 48mm thickness 2.2mm Centellen for thread 1½"		
	GEV No.	520211	Ref. No. —
	reducer thread 2" ET - 1½" IT brass		
	GEV No.	520212	Ref. No. —
	hexagonal nut thread 1½" brass WS 60 H 8mm		
	GEV No.	550361	Ref. No. —
	blind flange ϕ 58mm thread 1½"		

			
1	GEV No.	416223	Ref. No. 9502872
	heating element 9000W 230V heating circuits 3 thread 1½" L 485mm W 26mm H 26mm thermostat sleeves ϕ 7mm length thermostat sleeves 200mm thermostat sleeve centre not clinging tube ϕ 6.3mm connection male faston 6.3mm immersion heater number of thermostat sleeves 1		
accessories for		416223	
	GEV No.	510406	Ref. No. 0408020
	flat gasket fibre ED ϕ 60mm ID ϕ 48mm thickness 3mm for thread 1½" Qty 1 pcs		
	GEV No.	510424	Ref. No. 0409008
	gasket copper ED ϕ 55mm ID ϕ 48mm thickness 2.2mm Centellen for thread 1½"		
	GEV No.	520211	Ref. No. —
	reducer thread 2" ET - 1½" IT brass		
	GEV No.	520212	Ref. No. —
	hexagonal nut thread 1½" brass WS 60 H 8mm		
	GEV No.	550361	Ref. No. —
	blind flange ϕ 58mm thread 1½"		

			
1	GEV No.	420072	Ref. No. 9546104
	heating element 1000/1500W 200/250V heating circuits 1 L 184mm W 130mm H 20mm L1 60mm L2 34mm L3 90mm thread M14x1.5 mounting distance 121.5mm tube ϕ 8.5mm immersion heater		
For models:		FV40.2M-MIKE2	

Зип Общепит

vsezip.ru

+7(812)987-08-81

GEV No.	418878	Ref. No.	9546105
description	heating element 2000W 230V heating circuits 1 L 184mm W 131mm H 19mm L1 55mm L2 39mm L3 90mm thread M14x1.5 mounting distance 123mm tube ϕ 8.5mm connection length 40mm 2 hole fixing connection M4 immersion heater		
For models:	FV40.2M-MIKE2		

accessories

sealing washers

fibre gaskets

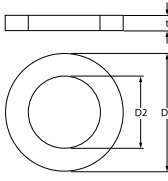
			
1			
GEV No.	510406	Ref. No.	0408020
description	flat gasket fibre ED ϕ 60mm ID ϕ 48mm thickness 3mm for thread 1½" Qty 1 pcs		
For models:	DV100 AB 1983, DV120B, DV160 AB 1983, DV160 AB 1996, DV240B AB 1983, DV240B AB 1996, DV40 AB 1983, DV40 AB 1992, DV80, DV80 AB 1983, DV80 AB 1992, FR30G, FR30G AB 1992, FR40G AB 1983, FR40GUS AB 1983, FV130B, FV25G AB 1986, FV25G AB 1992, FV30GS, FV40N AB 1983, FV40N AB 1992, FV60E AB 1983, FV60E AB 1988		

copper gaskets

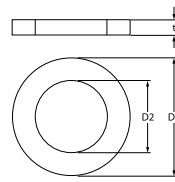
			
1			
GEV No.	510424	Ref. No.	0409008
description	gasket copper ED ϕ 55mm ID ϕ 48mm thickness 2.2mm Centellen for thread 1½"		
For models:	DV100 AB 1980, DV100 AB 1983, DV120B, DV160 AB 1980, DV160 AB 1983, DV160 AB 1996, DV240B AB 1980, DV240B AB 1983, DV240B AB 1996, DV260B, DV270B AB 1992, DV40 AB 1983, DV80, DV80 AB 1983, DV80 AB 1992, EE60, EE90, FR30G, FR40G AB 1976, FR40G AB 1980, FR40G AB 1983, FR40GUS AB 1976, FR40GUS AB 1980, FR40GUS AB 1983, FR60, FV120B AB 1980, FV120B AB 1983, FV200B, FV240B AB 1980, FV240B AB 1983, FV250B AB 1992, FV25G AB 1986, FV30, FV40N AB 1980, FV40N AB 1983, FV50, FV50 M, FV60 AB 1973, FV60 AB 1976, FV60E AB 1983		



Зип Общепит

vsezip.ru

+7(812)987-08-81

O-rings

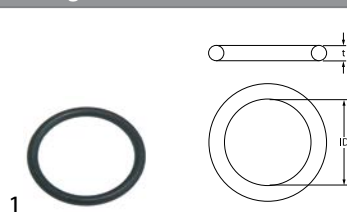

GEV No.	510408	Ref. No.	0101176
description	O-ring EPDM thickness 5.34mm ID ø 47mm Qty 1 pcs		
For models:	DV120.2, DV120B, DV120T, DV160 AB 1996, DV240B AB 1996, DV40 AB 1992, DV40T, DV40T FA, DV80 AB 1992, DV80T, ECO STAR 430F, ECO STAR 530F, ECO STAR 545D, FR30G AB 1992, FV110G, FV130B, FV20N, FV20T, FV25G AB 1992, FV28G AB 1994, FV28G AB 1997, FV28GFA, FV30GS, FV40.2, FV40.2 AB 2002, FV40.2 AB 2003, FV40.2M, FV40.2MIKE2, FV40.2M-MIKE2, FV40N AB 1992, FV40T, FV40TFA, FV60E AB 1988, FV70T, FV70TD		

miscellaneous

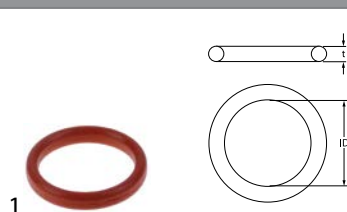



GEV No.	511661	Ref. No.	0101197
description	gasket silicone thickness 6mm ID ø 46mm Qty 1 pcs for heating element thickness 6mm H 9mm D1 ø 58mm D2 ø 46mm		

flange gaskets



GEV No.	501383	Ref. No.	0408229
description	flat gasket ID ø 102mm ED ø 144mm hole distance 33mm hole ø 6mm EPDM for heating element thickness 3mm		



GEV No.	510364	Ref. No.	0101175
description	gasket Lmm Wmm ø 36mm for heating element thickness 3mm with 4 screw holes		
For models:	DV120T, DV40N, DV40T, DV40T FA, DV80T, ECO STAR 430F, ECO STAR 530F, ECO STAR 545D, FR30G AB 1992, FV110G, FV20N, FV20T, FV25G AB 1992, FV28G AB 1994, FV28G AB 1997, FV28GFA, FV30GS, FV40.2, FV40.2 AB 2003, FV40N AB 1983, FV40N AB 1992, FV40T, FV40TFA, FV60E AB 1988, FV70T		
accessories for	510364		
	GEV No.	Ref. No.	—
	510365		
	counterflange ø 36mm Lmm Wmm		



GEV No.	550002	Ref. No.	0101183
description	tension strap H 10mm L 21mm W 10mm hole ø 6.5mm for heating element		
For models:	DV120B, DV120T, DV40 AB 1992, DV40T, DV40T FA, DV80 AB 1992, DV80T, ECO STAR 430F, ECO STAR 530F, ECO STAR 545D, FR30G AB 1992, FV110G, FV130B, FV20N, FV20T, FV25G AB 1992, FV28G AB 1994, FV28G AB 1997, FV28GFA, FV30GS, FV40N AB 1992, FV40T, FV40TFA, FV60E AB 1988, FV70T, FV70TD		



GEV No.	550002	Ref. No.	0101183
description	tension strap H 10mm L 21mm W 10mm hole ø 6.5mm for heating element		
For models:	DV120B, DV120T, DV40 AB 1992, DV40T, DV40T FA, DV80 AB 1992, DV80T, ECO STAR 430F, ECO STAR 530F, ECO STAR 545D, FR30G AB 1992, FV110G, FV130B, FV20N, FV20T, FV25G AB 1992, FV28G AB 1994, FV28G AB 1997, FV28GFA, FV30GS, FV40N AB 1992, FV40T, FV40TFA, FV60E AB 1988, FV70T, FV70TD		

protection caps



GEV No.	501120	Ref. No.	8400056
description	protection cap		
For models:	DR70, DR90E, DV111, DV111E, DV120B, DV160 AB 1996, DV240B AB 1996, DV270B AB 1992, DV80, DV80 AB 1975, DV80 AB 1980, FR60, FV250B AB 1992, FV30, FV50, FV60 AB 1976		



GEV No.	520328	Ref. No.	0620316 9532401
description	protection cap for heating element		



GEV No.	501084	Ref. No.	0620312
description	protection cap ø 66.5mm mounting distance 93mm		
For models:	DV40T FA, DV80 AB 1992, FV28GFA, FV40TFA		

electric components



thermostats

bi-metal thermostats

safety bi-metal thermostats



1

GEV No.	390171	Ref. No.	0108043
description	bi-metal safety thermostat hole distance mm switch-off temp. 110°C 1NC 1-pole 16A connection F6.3		
For models:	DV120T, DV40N, DV40T, DV40T FA, ECO STAR 430F, ECO STAR 530F, ECO STAR 545D, FV20N, FV20T, FV28GFA, FV40.2, FV40.2 AB 2003, FV40N AB 1992, FV40T, FV40TFA, FV70T, FV70TD		
accessories for	390171		
	GEV No.	510362	Ref. No. 0108040
	gasket for thermostat ED ø 40mm ID ø 19mm suitable for COMENDA, MEIKO equiv. no. 630511/0108040		

bi-metal thermostats



1

GEV No.	390123	Ref. No.	0108053
description	bi-metal thermostat hole distance 23.8mm switch-off temp. 50°C 1NC 1-pole 16A 250V connection F6.3 2 hole fixing		
For models:	DV120T, DV160 AB 1996, DV240B AB 1996, DV40N, DV40T, DV80T, ECO STAR 430F, ECO STAR 530F, FV110G, FV130B, FV20N, FV20T, FV28GFA, FV40N AB 1983, FV40N AB 1992, FV40T, FV70T		



1

GEV No.	390103	Ref. No.	0108047
description	bi-metal thermostat hole distance mm switch-off temp. 59°C 1NC 1-pole 16A connection F6.3		
For models:	DV100 AB 1980, DV100 AB 1983, DV120B, DV120T, DV160 AB 1980, DV160 AB 1983, DV160 AB 1996, DV240B AB 1980, DV240B AB 1983, DV240B AB 1996, DV270B AB 1992, DV40 AB 1983, DV40 AB 1992, DV40N, DV40T, DV80, DV80 AB 1980, DV80 AB 1983, DV80 AB 1992, DV80T, ECO STAR 430F, ECO STAR 530F, FR30G, FR40G AB 1976, FR40G AB 1980, FR40G AB 1983, FR40GUS AB 1976, FR40GUS AB 1980, FR40GUS AB 1983, FV110G, FV130B, FV20N, FV20T, FV250B AB 1992, FV25G AB 1986, FV28G AB 1994, FV28G AB 1997, FV28GFA, FV30, FV40N AB 1980, FV40N AB 1983, FV40N AB 1992, FV40T, FV50, FV50 M, FV60E AB 1983, FV70T		
accessories for	390103		
	GEV No.	510362	Ref. No. 0108040
	gasket for thermostat ED ø 40mm ID ø 19mm suitable for COMENDA, MEIKO equiv. no. 630511/0108040		

3ип Общежит
control and safety thermostatsEGO
safety thermostats

55.32 series

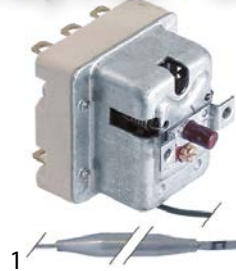

1

GEV No.	390244	Ref. No.	9502526
description	safety thermostat switch-off temp. 120°C 3-pole 20A probe ø 6mm probe L 94mm capillary pipe 540mm capillary pipe isolated 500mm gland nut probe SS		
For models:	ECO STAR 430F, ECO STAR 530F, ECO STAR 545D, FV28GFA		



1

GEV No.	375861	Ref. No.	9500473
description	safety thermostat switch-off temp. 150°C 3-pole 16A probe ø 6mm probe L 98mm capillary pipe 480mm capillary pipe isolated mm gland nut probe		



1

GEV No.	390928	Ref. No.	9502027
description	thermostat switch-off temp. 196°C 3-pole 3NC 20A probe ø 6mm probe L 87mm capillary pipe 890mm capillary pipe isolated 350mm gland nut probe		



Зип Общепит

vsezip.ru

+7(812)987-08-81

CAMPINI

safety thermostats

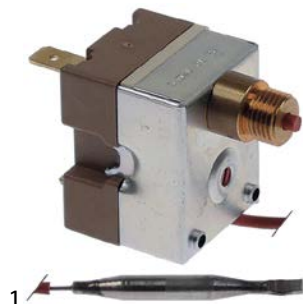

GEV No.	381386	Ref. No.	0108085
description	safety thermostat switch-off temp. 176°C temperature range°C 1-pole 1NC 16A probe ø 5mm probe L 77mm capillary pipe 955mm capillary pipe isolated 350mm gland nut shaft ømm 250VACV		

RATHGEBER

control thermostats



GEV No.	390243	Ref. No.	0108041
description	thermostat t.max. 90°C temperature range 0-90°C 1-pole 1CO 16A probe ø 6mm probe L 140mm capillary pipe 3000mm capillary pipe isolated 50mm gland nut shaft Lmm rotation 270°		



GEV No.	390127	Ref. No.	0108030 0108036
description	thermostat t.max. 95°C temperature range 0-95°C 1-pole 1CO 16A probe ø 6mm probe L 145mm capillary pipe 480mm capillary pipe isolated 430mm gland nut shaft ø 6x4.6mm shaft L 17mm shaft position lower° rotation 270°		
For models:	DV270B AB 1988, DV40 AB 1983, FR30G, FR40G AB 1980, FR40G AB 1983, FR40GUS AB 1980, FR40GUS AB 1983, FV250B AB 1988, FV25G AB 1986, FV40N AB 1980, FV40N AB 1983, FV60E AB 1983		



GEV No.	390242	Ref. No.	0108037
description	thermostat t.max. 95°C temperature range 0-95°C 1-pole 1CO 16A probe ø 6mm probe L 150mm capillary pipe 480mm capillary pipe isolated 420mm gland nut shaft Lmm rotation 270°		
For models:	DV120B, DV120T, DV160 AB 1996, DV240B AB 1996, DV270B AB 1992, DV40 AB 1992, DV40T, DV80 AB 1992, DV80T, ECO STAR 430F, ECO STAR 530F, FR30G AB 1992, FV110G, FV130B, FV20N, FV20T, FV250B AB 1992, FV25G AB 1992, FV28G AB 1994, FV28G AB 1997, FV28GFA, FV30GS, FV40N AB 1992, FV40T, FV60E AB 1988, FV70T		

control thermostats



GEV No.	390245	Ref. No.	0108039
description	thermostat t.max. 90°C temperature range 0-70/20-90°C 2-pole 2CO 16A probe ø 6mm probe L 145mm capillary pipe 480mm capillary pipe isolated 250mm rotation 315°		
For models:	DV120T, DV40T, DV80T, FV130B		

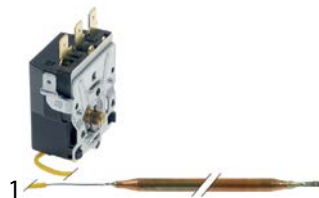

GEV No.	390933	Ref. No.	9500086 9637704
description	thermostat t.max. 95°C temperature range 0-95°C 1CO probe ø 6mm probe L 145mm capillary pipe 470mm capillary pipe isolated 440mm shaft ø 6mm shaft L 3mm rotation 270° 24V contacts male faston 6.3mm Qty 1 pcs		

rod thermostats

rod thermostats



GEV No.	390108	Ref. No.	0108004 9539518
description	rod thermostat temperature range 0-100°C 1CO 1-pole 6A probe ø 1/2"mm probe L 200mm		
For models:	DR90, DR90E, DV100 AB 1980, DV100 AB 1983, DV111, DV111E, DV120B, DV160 AB 1980, DV160 AB 1983, DV221, DV240B AB 1980, DV240B AB 1983, DV250B, DV260B, DV80, DV80 AB 1983, DV80 AB 1992, EE60, EE90, FV120B AB 1980, FV120B AB 1983, FV200B, FV240B AB 1980		



GEV No.	390986	Ref. No.	9521606
description	rod thermostat temperature range 0-120°C 1CO probe ø 1/2"mm probe L 90mm		

electric components



accessories

plunger sockets



1

GEV No.	501213	Ref. No.	8000005 8400025
description	thermowell thread M14x1 L 147mm SS single ø 7mm		
For models:	DV40 AB 1983, FR30G, FV40N AB 1983, FV60E AB 1983		

switches and momentary switches

microswitches

universal



1

GEV No.	345043	Ref. No.	0122106
description	lever set 5-piece		
accessories for	345043		



GEV No.	345042	Ref. No.	0122103 0122105 0122108 9544800
description	microswitch with plunger 250V 16A 1CO connection male faston 6.3mm L 28mm ambient temperature max. 125°C mounting distance 22mm type EF83161.3 actuating force: 75g blue/black		



GEV No.	347217	Ref. No.	—
description	microswitch with plunger 250V 4A 1CO connection male faston 6.3mm L 28mm ambient temperature max. 125°C mounting distance 22mm type EF83161.5 actuating force: 20g blue/black		



1

GEV No.	345042	Ref. No.	0122103 0122105 0122108 9544800
description	microswitch with plunger 250V 16A 1CO connection male faston 6.3mm L 28mm ambient temperature max. 125°C mounting distance 22mm type EF83161.3 actuating force: 75g blue/black		
For models:	DV120T, DV160 AB 1996, DV240B AB 1996, DV270B AB 1992, DV40N, DV40T, DV40T FA, DV80T, FR30G AB 1992, FV130B, FV20T, FV250B AB 1992, FV25G AB 1986, FV25G AB 1992, FV28GFA, FV40.2, FV40.2 AB 2003, FV40.2MIKE2, FV40.2M-MIKE2, FV40N AB 1992, FV40T, FV40TFA, FV70T, FV70TD		
accessories for	345042		
	GEV No.	345043	Ref. No. 0122106
	lever set 5-piece		

Зип.Общепит

pin plunger actuated

vsezip.ru

+7(812)987-08-81

1

GEV No.	345060	Ref. No.	0122007
description	microswitch with plunger 250V 16A 1NO connection male faston 6.3mm ambient temperature max. 85°C mounting distance 22mm type BS1010 actuating force: 350g red stroke 9mm		
For models:	DV120B, DV160 AB 1983, DV160 AB 1996, DV221, DV240B AB 1980, DV240B AB 1983, DV240B AB 1996, DV270B AB 1988, DV270B AB 1992, DV40 AB 1983, DV40 AB 1992, DV80, DV80 AB 1983, DV80 AB 1992, FR30G, FR40G AB 1976, FR40G AB 1980, FR40G AB 1983, FR40GUS AB 1976, FR40GUS AB 1980, FR40GUS AB 1983, FV110G, FV130B, FV250B AB 1992, FV25G AB 1986, FV30, FV40GE, FV40N AB 1980, FV40N AB 1983, FV50, FV50 M, FV60E AB 1983		

1

GEV No.	345062	Ref. No.	0122017
description	microswitch with plunger 250V 16A 1NO/1NC connection male faston 6.3mm ambient temperature max. 85°C mounting distance 22mm type BS1012 actuating force: 350g red stroke 8mm		

1

GEV No.	345247	Ref. No.	0122016
description	microswitch with plunger 250V 6A 2NO connection male faston 6.3mm ambient temperature max. 85°C mounting distance 22mm type 3SE4305 actuating force: 350g black		
For models:	DV100 AB 1980, DV120B, DV160 AB 1980, DV160 AB 1983, DV240B AB 1980, DV240B AB 1983, DV260B, DV40 AB 1992, DV80, DV80 AB 1980, DV80 AB 1983, DV80 AB 1992, FR40G AB 1980, FR40GUS AB 1980, FV120B AB 1980, FV120B AB 1983, FV240B AB 1980, FV240B AB 1983		

1

GEV No.	347161	Ref. No.	9520085 9622932
description	microswitch with plunger 250V 0.1A 1NO connection male faston 6.3mm ambient temperature max. 125°C mounting distance 22mm white		
For models:	FV40.2, FV40.2MIKE2, FV40.2M-MIKE2		







Зип Общепит

position switches

vsezip.ru

7(812)987-08-81



 			
1			
GEV No.	345042	Ref. No.	0122103 0122105 0122108 9544800
description	microswitch with plunger 250V 16A 1CO connection male faston 6.3mm L 28mm ambient temperature max. 125°C mounting distance 22mm type EF83161.3 actuating force: 75g blue/black		
For models:	DV120T, DV160 AB 1996, DV240B AB 1996, DV270B AB 1992, DV40N, DV40T, DV40T FA, DV80T, FR30G AB 1992, FV130B, FV20T, FV250B AB 1992, FV25G AB 1986, FV25G AB 1992, FV28GFA, FV40.2, FV40.2 AB 2003, FV40.2MIKE2, FV40.2M-MIKE2, FV40N AB 1992, FV40T, FV40TFA, FV70T, FV70TD		
accessories for	345042		
	GEV No.	345043	Ref. No. 0122106
	 lever set 5-piece		

			
1			
GEV No.	347965	Ref. No.	9520115
description	position switch with handle with a switch 1NO/1NC 240V 3A L 108mm W 36mm H 33mm protection IP65 actuating force: 1000g screw connection M20 mounting distance 25mm		

TELEMECANIQUE (EFA)			
			
1			
GEV No.	346207	Ref. No.	9500490
description	position switch with plunger 2NC L 70mm W 30mm H 30mm protection IP65		

accessories			
			
1			
GEV No.	501282	Ref. No.	8000425
description	bush for door contact switch		
For models:	FV25G AB 1986		

float switches			
			
1			
GEV No.	347959	Ref. No.	0130023
description	float switch thread 1/4" NPT 1NO \varnothing 53mm L 90mm mounting \varnothing 14mm 250V 0.4A cable cable length 600mm		

			
1			
GEV No.	345043	Ref. No.	0122106
description	lever set 5-piece		
accessories for	345043		
	GEV No.	345042	Ref. No. 0122103 0122105 0122108 9544800
	 microswitch with plunger 250V 16A 1CO connection male faston 6.3mm L 28mm ambient temperature max. 125°C mounting distance 22mm type EF83161.3 actuating force: 75g blue/black		
	GEV No.	347217	Ref. No. —
	 microswitch with plunger 250V 4A 1CO connection male faston 6.3mm L 28mm ambient temperature max. 125°C mounting distance 22mm type EF83161.5 actuating force: 20g blue/black		

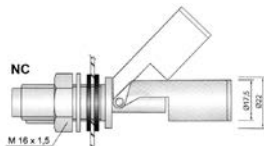
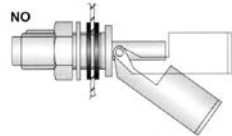
			
1			
			
			
GEV No.	345484	Ref. No.	0130028 9503380 9526211
description	float switch thread M16x1.5 1NO or 1NC \varnothing 17.5mm L 92mm mounting \varnothing 16mm 250V 1A cable cable length 2000mm		
For models:	DV40T FA, FV28GFA		

			
1			
GEV No.	501280	Ref. No.	8000421
description	pressure pin for door contact switch		
For models:	FV25G AB 1986		

electric components

Зип Общепит
rotary switches

ENTRELEC
vsezip.ru

+7(812)987-08-81



1

GEV No.	346208	Ref. No.	9519580 9622935
description	float switch 1NC ø 85mm L 90mm mounting ømm 240V 16A male faston 6.3mm cable lengthmm		
For models:	FV40.2, FV40.2MIKE2, FV40.2M-MIKE2		
spare parts for	346208		



GEV No.	347161	Ref. No.	9520085 9622932
description	microswitch with plunger 250V 0.1A 1NO connection male faston 6.3mm ambient temperature max. 125°C mounting distance 22mm white		

floats



1

GEV No.	347967	Ref. No.	9537131
description	float with magnet for float switch ø 42.5mm L 43mm Wmm Hmm SS		



1

GEV No.	347246	Ref. No.	0620351
description	float with magnet ø 40mm L 99mm Wmm Hmm PVC		



1

GEV No.	345478	Ref. No.	0123001
description	rotary switch 4 0-1-2-3 sets of contacts 6 400V 12A connection screw		
For models:	DR90, DV100 AB 1980, DV100 AB 1983, DV111, DV111E, DV160 AB 1980, DV221, DV80 AB 1980, FR60, FV120B AB 1980, FV120B AB 1983, FV200B, FV240B AB 1980, FV240B AB 1983, FV60 AB 1973, FV60 AB 1976, FV60E AB 1983		

KRAUS & NAIMER
rotary switches



1

GEV No.	345475	Ref. No.	0123260 0123271
description	rotary switch 2 0-1 sets of contacts 1 type CH6 A290-600 FS1 400V 20A shaft ø 6x4.6mm shaft L 21mm with knob connection screw		
For models:	DV120B, DV160 AB 1983, DV240B AB 1980, DV240B AB 1983, DV270B AB 1988, DV40 AB 1983, DV80, DV80 AB 1983, FV250B AB 1988, FV40N AB 1980		



1

GEV No.	345476	Ref. No.	0123261 0123272
description	rotary switch 2 0-1 sets of contacts 2 type CH6-AT08F183 400V 20A shaft ø 6x4.6mm shaft L 21mm with knob connection screw code 26/000100 marking A291		
For models:	DV40 AB 1983, FV40N AB 1983		



1

GEV No.	345474	Ref. No.	0123259 0123273
description	rotary switch 3 0-1-2 sets of contacts 3 type CH6-A230 400V 20A shaft ø 6x4.6mm shaft L 21mm with knob connection screw		
For models:	DV120B, DV240B AB 1980, DV240B AB 1983, DV80		



1

GEV No.	345477	Ref. No.	0123270
description	rotary switch 3 0-1-2 sets of contacts 4 400V 20A shaft ø 6x4.6mm shaft L 21mm connection screw		



touch sensitive light switches

Зип Общепит

vsezip.ru

+7(812)987-08-81



1

GEV No.	403109	Ref. No.	9612566+9616164
description	light barrier 15/264V L 75mm W 25mm H 18mm cable length 2000mm		

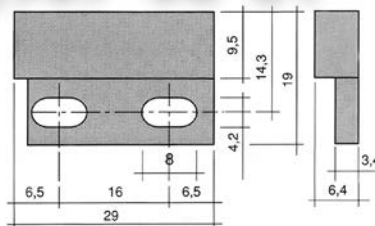

GEV No.	347960	Ref. No.	8302780
description	magnetic switch L 29mm W 19mm 1NO 12V 0.05A P max. 0.6W connection cable cable length 290mm		

magnetic switches

29x19mm



1

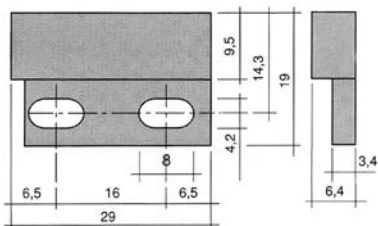

GEV No.	347966	Ref. No.	9500385
description	magnetic switch L 29mm W 19mm 1CO 12V 0.05A P max. 0.6W connection cable cable length 5000mm		

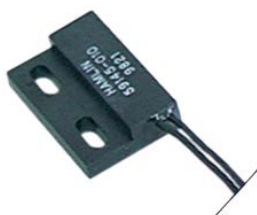

1

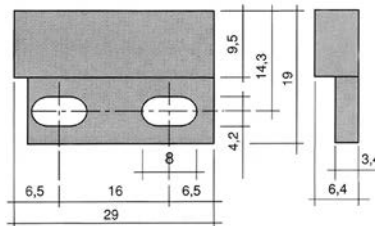

GEV No.	345248	Ref. No.	0122070
description	magnetic switch L 29mm W 19mm 1NO 24V 0.01A P max. 0.24W connection cable cable length 300mm		
For models:	DV120B, DV120T, DV160 AB 1996, DV240B AB 1996, DV270B AB 1992, DV40 AB 1992, DV40N, DV40T, DV40T FA, DV80 AB 1992, DV80T, ECO STAR 430F, ECO STAR 545D, FR30G AB 1992, FV110G, FV130B, FV20N, FV20T, FV250B AB 1992, FV25G AB 1992, FV28G AB 1994, FV28G AB 1997, FV28GFA, FV30GS, FV40.2, FV40.2 AB 2002, FV40.2MIKE2, FV40N AB 1992, FV40T, FV40TFA, FV60E AB 1988, FV70T, FV70TD		



1

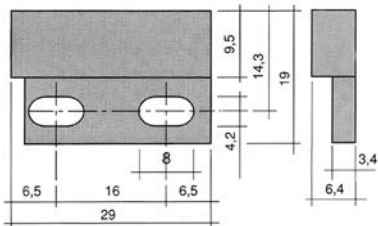

GEV No.	345808	Ref. No.	0122053
description	magnetic switch L 29mm W 19mm 1CO 150V 0.5A P max. 10W connection cable cable length 1000mm		



1

GEV No.	345802	Ref. No.	0122057
description	magnetic switch L 29mm W 19mm 1NO 250V 0.04A connection cable 10W		



Зип Общепит

vsezip.ru

+7(812)987-08-81

46x26mm

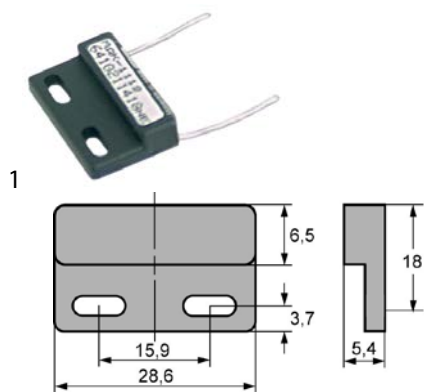

GEV No.	345807	Ref. No.	0122037
----------------	--------	-----------------	---------

description	magnetic switch L 29mm W 18mm 24V		
--------------------	-----------------------------------	--	--

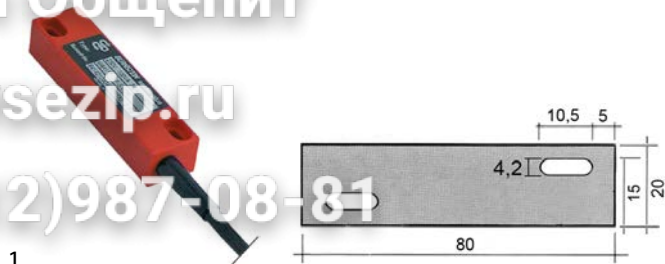

GEV No.	345801	Ref. No.	0122024 0122056
----------------	--------	-----------------	--------------------

description	magnetic switch L 80mm W 20mm 1NO 250V 3A P max. 100W connection cable length 5000mm		
--------------------	--	--	--

For models:	DV270B AB 1988, FV250B AB 1988		
--------------------	--------------------------------	--	--

80x30mm

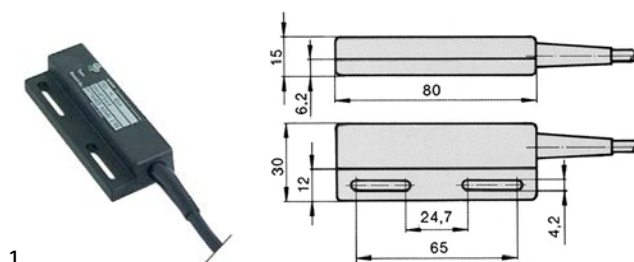

GEV No.	345806	Ref. No.	0122050
----------------	--------	-----------------	---------

description	magnetic switch L 80mm W 30mm 1CO 250V 1A P max. 80W connection cable length 7500mm		
--------------------	---	--	--

ø 6mm



GEV No.	347972	Ref. No.	9542983 MAK-3013-X-5
----------------	--------	-----------------	-------------------------

description	magnetic switch 100V 0.5A P max. 20W probe L 29mm 1CO connection cable length 5000mm		
--------------------	--	--	--

80x20mm

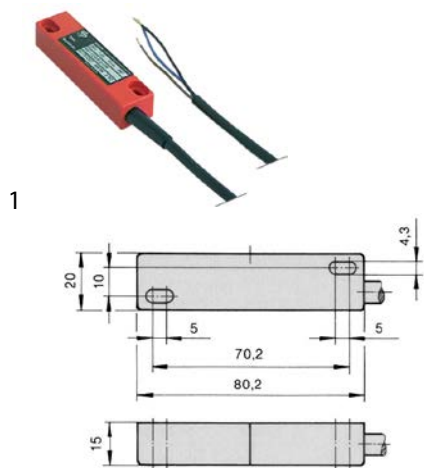

GEV No.	345803	Ref. No.	0122021
----------------	--------	-----------------	---------

description	magnetic switch L 80mm W 20mm 1CO 250V 1A connection cable 80W		
--------------------	--	--	--

accessories

magnets



GEV No.	347572	Ref. No.	9620695
----------------	--------	-----------------	---------

description	magnet H 18mm ID ø 5.3mm ED ø 34mm plastic-coated		
--------------------	---	--	--





Зип Общепит

vsezip.ru

+7(812)987-08-81

			
1			
GEV No.	365138	Ref. No.	0140206
description	magnet ID ø 5.3mm ED ø 31mm H 15mm		

			
1			
GEV No.	699285	Ref. No.	0140200
description	magnet L 49mm H 8mm W 24mm		
For models:	FR40G AB 1976, FR40G AB 1980, FR40GUS AB 1976, FR40GUS AB 1980, FV240B AB 1980, FV250B AB 1992, FV30, FV50, FV50 M		

			
1			
GEV No.	345486	Ref. No.	0122013
description	magnet ø 20mm Lmm H 6mm Wmm ID ø 3.25mm ED ø 20mm M3		
For models:	DV120T, DV40T, DV40T FA, DV80T, FV130B, FV20T, FV250B AB 1992, FV28GFA, FV40T, FV40TFA, FV70T, FV70TD		

magnetic holders

			
1			
GEV No.	699280	Ref. No.	0620420
description	magnet holder internal size 25x49mm H 11mm		

control equipment



SIEMENS

3SB series ø22mm new



push buttons

			
1			
GEV No.	347570	Ref. No.	0150026 9604403
description	momentary push switch mounting measurements ø22mm white		



			
1			
GEV No.	345671	Ref. No.	9555317
description	push button mounting measurements ø22mm black		

				
1				
GEV No.	347569	Ref. No.	0121023 0121036	
description	push button mounting measurements ø22mm EMERGENCY SHUT-DOWN red			
accessories for	347569			
	GEV No.	347571	Ref. No.	0121037
	sticker for emergency shut-down switch yellow ID ø 22.3mm ED ø 60mm			

momentary mushroom switches

				
1				
GEV No.	347478	Ref. No.	9604418	
description	emergency stop switch mounting measurements ø22mm red series 3SB			
accessories for	347478			
	GEV No.	346630	Ref. No.	—
	contact block SIEMENS 3SB3400-0B 1NO max 400V 10A black			
	GEV No.	346631	Ref. No.	—
	contact block SIEMENS 3SB3400-0C 1NC max 400V 10A black			

accessories

				
1				
GEV No.	347571	Ref. No.	0121037	
description	sticker for emergency shut-down switch yellow ID ø 22.3mm ED ø 60mm			
accessories for	347571			
	GEV No.	347569	Ref. No.	0121023 0121036
	push button mounting measurements ø22mm EMERGENCY SHUT-DOWN red			



lamps

indicator lights

indicator lights 3-piece (housing, lens and bulb)

lamps

light bulbs



1

GEV No.	359656	Ref. No.	0150214
description	light bulb socket Ba9s 130V 2W ø 10mm L 28mm		

indicator lights (complete)

ø13mm

with plug-in socket



1

GEV No.	359141	Ref. No.	0150001
description	indicator light ø 13mm red 230V connection male faston 6.3mm temp.-resist. 120°C Qty 1 pcs		



1

GEV No.	359143	Ref. No.	0150000
description	indicator light ø 13mm yellow 230V connection male faston 6.3mm temp.-resist. 120°C Qty 1 pcs		
For models:	DV100 AB 1980, DV100 AB 1983, DV120B, DV160 AB 1980, DV160 AB 1983, DV221, DV240B AB 1980, DV240B AB 1983, DV260B, DV270B AB 1988, DV40 AB 1983, DV80, DV80 AB 1980, DV80 AB 1983, DV80 AB 1992, FR30G, FR40G AB 1980, FR40G AB 1983, FR40GUS AB 1980, FR40GUS AB 1983, FV120B AB 1980, FV120B AB 1983, FV240B AB 1980, FV240B AB 1983, FV250B AB 1988, FV25G AB 1986, FV30, FV40N AB 1980, FV40N AB 1983, FV50, FV50 M, FV60E AB 1983		

screw-on/push-on fit

light bulbs

for indicator lights



1

GEV No.	359656	Ref. No.	0150214
description	light bulb socket Ba9s 130V 2W ø 10mm L 28mm		

Зип.Общепит

timers

programme timers

vsezip.ru

+7(812)987-08-81



1

GEV No.	360198	Ref. No.	0124036
description	timer chambers 3 operation time 162s		
For models:	DV40 AB 1983, FV40N AB 1980, FV40N AB 1983		



1

GEV No.	360199	Ref. No.	0124040 0124090
description	timer chambers 3 operation time 85s		
For models:	DR70, DV100 AB 1980, DV160 AB 1980, DV160 AB 1983, DV80 AB 1975, DV80 AB 1980, DV80 AB 1983		



1

GEV No.	360241	Ref. No.	0124045
description	timer chambers 4 operation time 8min		
For models:	DV260B, DV270B AB 1988, FV120B AB 1980, FV120B AB 1983, FV240B AB 1980, FV240B AB 1983, FV250B AB 1988		



1

GEV No.	360240	Ref. No.	0124031
description	timer operation time 120s		
For models:	FR40G AB 1976, FR40G AB 1980, FR40G AB 1983, FR40GUS AB 1976, FR40GUS AB 1980, FR40GUS AB 1983		



Зип Общепит

vsezip.ru

+7(812)987-08-81



1

GEV No.	360064	Ref. No.	0124039
description	timer operation time 56s		
For models:	DV120B, DV240B AB 1980, DV240B AB 1983, DV80		

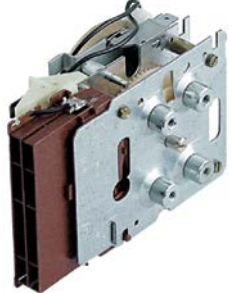

1

GEV No.	360239	Ref. No.	0124080
description	timer run-time 120s		
For models:	FR30G, FV25G AB 1986		



1

GEV No.	380219	Ref. No.	0135202 0135207 9520023 9520024
description	power contactor resistive load 25A 230VAC (AC3/400V) 17A/7.5kW main contacts 3NO auxiliary contacts 1NC connection screw connection type Fanal DSL16 01 type ISKRA KNL16 01		
For models:	DV120B, DV120T, DV160 AB 1983, DV160 AB 1996, DV240B AB 1983, DV240B AB 1996, DV270B AB 1988, DV40N, DV40T, DV40T FA, DV80 AB 1992, DV80T, ECO STAR 430F, ECO STAR 545D, FV120B AB 1983, FV130B, FV200B, FV240B AB 1983, FV250B AB 1988, FV28GFA, FV70TD		
accessories for	380219		
	GEV No.	381379	Ref. No. —
	overload switch connection screw setting range 11.3-16A for contactors KNL16 type BR16 11.3-16A		

contactors

ISKRA (FANAL)

power contactors



1

GEV No.	380212	Ref. No.	0135209
description	power contactor resistive load 20A 230VAC (AC3/400V) 8.5A/5.5kW main contacts 3NO auxiliary contacts 1NC connection screw connection type Fanal K07M 01 type ISKRA DSL7 01		
For models:	DV120B, DV120T, DV160 AB 1996, DV240B AB 1996, DV40 AB 1992, DV40N, DV40T, DV40T FA, DV80 AB 1983, DV80T, ECO STAR 430F, ECO STAR 545D, FR30G AB 1992, FV110G, FV130B, FV20N, FV20T, FV25G AB 1992, FV28GFA, FV30GS, FV40.2, FV40.2 AB 2003, FV40N AB 1992, FV40T, FV40TFA, FV60E AB 1988, FV70T, FV70TD		



1

GEV No.	380224	Ref. No.	0135205 0135208 9518557 9518558 9520028 9520031
description	power contactor resistive load 25A 230VAC (AC3/400V) 17A/7.5kW main contacts 3NO auxiliary contacts 1NO connection screw connection type Fanal DSL16 10 type ISKRA KNL16 10		
For models:	DR70, DR90, DV111, DV111E, DV160 AB 1983, DV160 AB 1996, DV221, DV240B AB 1983, DV240B AB 1996, DV250B, DV260B, DV270B AB 1988, DV80 AB 1975, EE60, EE90, FR60, FV120B AB 1980, FV120B AB 1983, FV200B, FV240B AB 1980, FV240B AB 1983, FV250B AB 1988, FV30, FV50, FV50 M, FV60 AB 1973, FV60 AB 1976		



1

GEV No.	380203	Ref. No.	0135204 9520025
description	power contactor resistive load 25A 230VAC (AC3/400V) 9A/4kW main contacts 3NO auxiliary contacts 1NC connection screw connection type Fanal DSL9 01 type ISKRA KNL9 01 230V		
For models:	DV270B AB 1992, DV40T FA, ECO STAR 430F, ECO STAR 545D, FV250B AB 1992, FV28GFA, FV70TD		



Зип-Общедит

ТМР УС (L1, M, C1)

small relay switches
vsezip.ru

+7(812)987-08-81



1

GEV No.	380204	Ref. No.	0135206 9518556 9520026
description	power contactor resistive load 25A 230VAC (AC3/400V) 9A/4kW main contacts 3NO auxiliary contacts 1NO connection screw connection type Fanal DSL9 10 type ISKRA KNL9 10		
For models:	DR90, DV111, DV111E, DV160 AB 1983, DV221, DV240B AB 1983, DV260B, DV270B AB 1992, EE60, EE90, FR60, FV120B AB 1983, FV240B AB 1983, FV250B AB 1992, FV50 M, FV60 AB 1973, FV60 AB 1976		

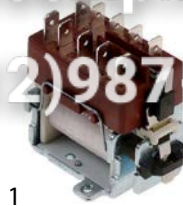

1

GEV No.	380119	Ref. No.	0135223 0135511 0135512
description	small relay switch 230V main contacts 2NO/2NC connection Faston 6.3mm resistive load 16A		
For models:	DR70, DV100 AB 1980, DV100 AB 1983, DV120B, DV160 AB 1980, DV160 AB 1996, DV240B AB 1980, DV240B AB 1996, DV80, DV80 AB 1975, DV80 AB 1980, DV80 AB 1983, FR30G, FR40G AB 1980, FR40G AB 1983, FR40GUS AB 1980, FR40GUS AB 1983, FV25G AB 1986, FV30, FV40N AB 1980, FV40N AB 1983, FV50, FV60E AB 1983		

SIEMENS

power contactors



1

GEV No.	380880	Ref. No.	9542897
description	power contactor resistive load 40A 24VDC (AC3/400V) 9A/4kW main contacts 3NO auxiliary contacts connection screw connection type 3RT1023-1BB40 50Hz		

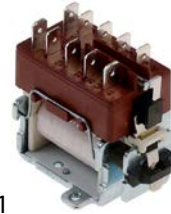

1

GEV No.	380121	Ref. No.	0135221
description	small relay switch 230V main contacts 3NO/1NC auxiliary contacts knob ø70mm (227-piece) connection Faston 6.3mm type E3250 resistive load 16A		
For models:	DV100 AB 1980, DV100 AB 1983, DV120B, DV160 AB 1980, DV240B AB 1980, DV80, DV80 AB 1980, DV80 AB 1983, FV40GE, FV60E AB 1983		

ABL SURSUM

motor protection circuit breakers



1

GEV No.	380303	Ref. No.	9540602
description	motor protection circuit breaker type Mbs25-063 setting range 4-6.3A (AC3/400V) 3kW		

miscellaneous

RC circuits



1

GEV No.	381218	Ref. No.	0138214 0142006 0142010 9006825 9530873 9543320 9548739 9548957 9549559
description	RC circuit 275V cable length 200mm MKP class X2 voltage AC 1000Ohm capacity 0.47µF		



relays

Зип.Общепит

vsezip.ru

+7(812)987-08-81

time relays

time relays



1

GEV No.	381217	Ref. No.	0125004 0125041 0125111 9536506 9536544 9551647 9657575
description	time relay DOLD MK7850N.82/210/61 time range 0.02s-300h 12-240V AC/DC 5A mounting measurements 35mm multi-functional connection screw clamp ambient temperature max. 60°C with jumper wire X2-X3		



1

GEV No.	381199	Ref. No.	0125052
description	time relay WIELAND KZL91 time range 0.1s-120h 24-230V AC/DC 5A mounting measurements DIN railmm connection screw clamp		

miscellaneous



1

GEV No.	381219	Ref. No.	9551020
description	power relays 1CO voltage AC/DC 1/3A connection screw clamp		

universal probes

temperature probes



GEV No.	378275	Ref. No.	9660867
description	temperature probe PTC 1kOhm cable silicone probe -50 up to +150°C cable -50 up to +180°C probe ø6x50mm cable length 8.4m cable colours white/brown 2-wire		

producer-specific probes

probes



GEV No.	379696	Ref. No.	0180635
description	probe Pt1000 cable silicone probe -50 up to +250°C cable -50 up to +180°C connection 1-wire thread probe ø4.6x5mm cable length 8.5m		



GEV No.	379151	Ref. No.	0180681
description	temperature probe NTC 10kOhm cable PVC probe -40 up to +110°C cable -10 up to 100°C connection 2-wire thread probe ø4x30mm cable length 2m		



GEV No.	379551	Ref. No.	0180683
description	temperature probe NTC 2.2kOhm cable PVC probe -40 up to +110°C cable -10 up to 100°C connection 2-wire thread probe ø6x17mm cable length 3m		
For models:	DV40T FA, FV40TFA, FV70TD		



GEV No.	378514	Ref. No.	9656863 9724904
description	temperature probe Pt1000 cable PTFE probe -50 up to +350°C cable -40 up to +250°C connection coded plug thread probe ø3x23mm cable length 0.4m		



GEV No.	378512	Ref. No.	8303815
description	temperature probe Pt1000 cable PVC probe -50 up to +150°C cable -20 up to +80°C connection coded plug thread probe ø6x45mm cable length 0.75m		

electric components



Зип Общежит

vsezip.ru

(812) 987 03 01



1			
GEV No.	379822	Ref. No.	9640338
description	temperature probe Pt1000 cable PVC probe -50 up to +250°C cable -10 up to 100°C connection coded plug thread probe $\varnothing 7 \times 32$ mm cable length 0.5m		



1			
GEV No.	378513	Ref. No.	9656868 9697140
description	temperature probe Pt1000 cable PVC probe -50 up to +250°C cable -20 up to +80°C connection coded plug thread probe $\varnothing 7 \times 25$ mm cable length 0.5m		



1			
GEV No.	379152	Ref. No.	0180682
description	temperature probe PTC 1kOhm cable PVC probe -50 up to +150°C cable -10 up to 100°C connection 2-wire thread 1/4" probe $\varnothing 6 \times 35$ mm cable length 2.2m		
For models:	DV120T, DV40T, DV40T FA, DV80T, ECO STAR 545D, FV20T, FV28GFA, FV40T, FV40TFA, FV70T, FV70TD		



1			
GEV No.	379153	Ref. No.	9500236
description	temperature probe PTC 1kOhm cable silicone probe -50 up to +150°C cable -50 up to +180°C connection 2-wire thread probe $\varnothing 6 \times 35$ mm cable length 2.2m		
For models:	DV120T, DV40T, DV40T FA, DV80T, ECO STAR 545D, FV20T, FV28GFA, FV40T, FV40TFA, FV70T		



1			
GEV No.	378353	Ref. No.	8303881
description	temperature probe PTC 1kOhm cable silicone probe -50 up to +150°C cable -50 up to +180°C connection coded plug thread probe $\varnothing 6 \times 50$ mm cable length 1.7m		



1			
GEV No.	379795	Ref. No.	9548993 9614610 9614768 9640339 9642324
description	temperature probe PTC 1kOhm cable silicone probe -50 up to +150°C cable -50 up to +180°C connection coded plug thread probe $\varnothing 7 \times 32$ mm cable length 0.5m		
For models:	FV40.2MIKE2, FV40.2M-MIKE2		



1			
GEV No.	379150	Ref. No.	0180680
description	temperature probe thermocouple K (NiCr-Ni) cable silicone probe -50 up to 1150°C cable -50 up to +180°C connection 2-wire thread probe $\varnothing 4 \times 50$ mm cable length 1.7m		



1			
GEV No.	378276	Ref. No.	9544007 9545533 9649173
description	upgrade kit PTC 1kOhm cable silicone probe -50 up to +150°C cable -50 up to +180°C connection 2-wire thread probe $\varnothing 7 \times 32$ mm cable length 0.5m		
For models:	FV40.2MIKE2, FV40.2M-MIKE2		

electronics

EPROMS



1			
GEV No.	403785	Ref. No.	9537736 9615751
description	EEPROM type Mike2-EE1		



1			
GEV No.	400243	Ref. No.	0124205
description	EPROM		
For models:	DV40 AB 1992, DV80 AB 1992, FR30G AB 1992, FV20N, FV25G AB 1992, FV30GS, FV40N AB 1992		



1			
GEV No.	400720	Ref. No.	0124201
description	EPROM		
For models:	DV120B, FV20T, FV40T, FV60E AB 1988, FV70T		

Зип Общепит

vsezip.ru

+7(812)987-08-81

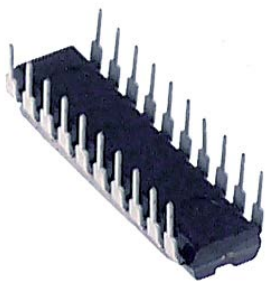

1

GEV No.	400722	Ref. No.	0124225
description	EPROM		
For models:	DV40N, FV20N, FV40T		

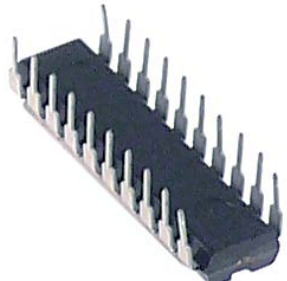

1

GEV No.	400723	Ref. No.	0124231
description	EPROM		
For models:	FV20N, FV20T, FV70T		



1

GEV No.	400822	Ref. No.	0124124
description	EPROM		
For models:	DV120T, DV40T, DV40T FA, DV80T, FV20T, FV28GFA, FV40T, FV40TFA, FV70T, FV70TD		

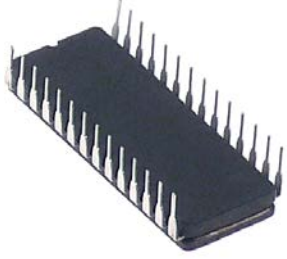

1

GEV No.	400824	Ref. No.	0124352
description	EPROM		
For models:	DV120T, DV40T, DV40T FA, DV80T, FV20T, FV28GFA, FV40T, FV40TFA, FV70T, FV70TD		



1

GEV No.	400826	Ref. No.	0124203
description	EPROM		

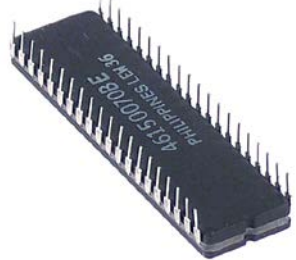

1

GEV No.	400827	Ref. No.	0124210
description	EPROM		
For models:	DV160 AB 1996, DV240B AB 1996, DV270B AB 1992, FV110G, FV130B, FV250B AB 1992		

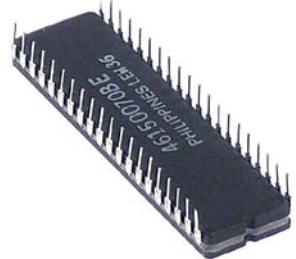

1

GEV No.	400828	Ref. No.	0124214
description	EPROM		
For models:	DV160 AB 1996, DV240B AB 1996, DV270B AB 1992, FV110G, FV130B, FV250B AB 1992		

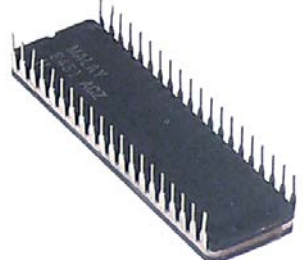

1

GEV No.	400829	Ref. No.	0124227
description	EPROM		
For models:	DV160 AB 1996, DV240B AB 1996, DV270B AB 1992, FV110G, FV130B, FV20T, FV250B AB 1992, FV40T, FV70T		

Зип Общепит

vsezip.ru

+7(812)987-03-81



1			
GEV No.	400830	Ref. No.	0124228
description	EPROM		
For models:	DV160 AB 1996, DV240B AB 1996, DV270B AB 1992, FV110G, FV130B, FV250B AB 1992, FV70T		

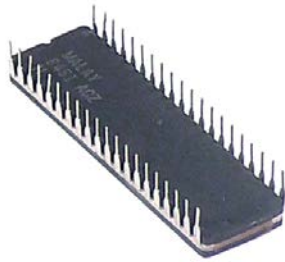

1			
GEV No.	400831	Ref. No.	0124229
description	EPROM		
For models:	DV160 AB 1996, DV240B AB 1996, DV270B AB 1992, FV110G, FV130B, FV250B AB 1992, FV40T		

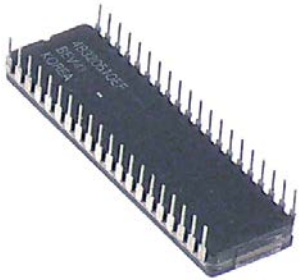

1			
GEV No.	400832	Ref. No.	0124230
description	EPROM		
For models:	DV160 AB 1996, DV240B AB 1996, DV270B AB 1992, FV110G, FV130B, FV20T, FV250B AB 1992		

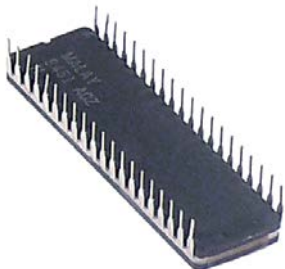

1			
GEV No.	400833	Ref. No.	0124243
description	EPROM		
For models:	DV160 AB 1996, DV240B AB 1996, DV270B AB 1992, FV110G, FV130B, FV250B AB 1992		



1			
GEV No.	400834	Ref. No.	0124236
description	EPROM		
For models:	DV160 AB 1996, DV240B AB 1996, DV270B AB 1992, FV110G, FV130B, FV250B AB 1992		



1			
GEV No.	400836	Ref. No.	0124237
description	EPROM		
For models:	DV160 AB 1996, DV240B AB 1996, DV270B AB 1992, FV110G, FV130B, FV250B AB 1992		

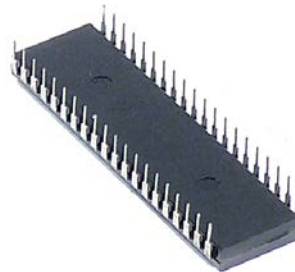

1			
GEV No.	400837	Ref. No.	0124245
description	EPROM		
For models:	DV160 AB 1996, DV240B AB 1996, DV270B AB 1992, FV110G, FV130B, FV250B AB 1992		



1			
GEV No.	400838	Ref. No.	0124223
description	EPROM		
For models:	DV160 AB 1996, DV240B AB 1996, DV270B AB 1992, DV40N, FV110G, FV130B, FV250B AB 1992		



1			
GEV No.	400840	Ref. No.	0124246
description	EPROM		
For models:	FV28G AB 1994, FV28G AB 1997		



Зип Общепит

vsezip.ru

+7(812)987-08-81

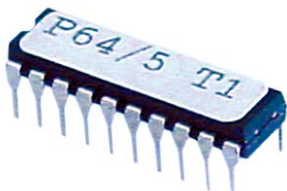

1

GEV No.	400847	Ref. No.	9505865
description	EPROM		
For models:	ECO STAR 430F		



1

GEV No.	403786	Ref. No.	9621015
description	EPROM type ECOSTAR GK V2.2B		

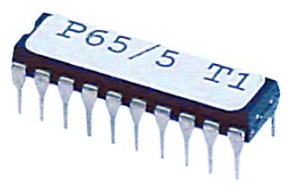

1

GEV No.	400848	Ref. No.	9505866
description	EPROM		
For models:	ECO STAR 430F		



1

GEV No.	400825	Ref. No.	0124123 9534803
description	EPROM type M1-6-EE CODE 9534803		
For models:	DV120T, DV40T, DV40T FA, DV80T, ECO STAR 545D, FV20T, FV28GFA, FV40.2, FV40.2 AB 2003, FV40T, FV40TFA, FV70T, FV70TD		



1

GEV No.	400835	Ref. No.	0124239
description	EPROM CODE P59/5		
For models:	DV120B, DV160 AB 1996, DV240B AB 1996, DV270B AB 1992, DV40N, FV110G, FV130B, FV250B AB 1992		

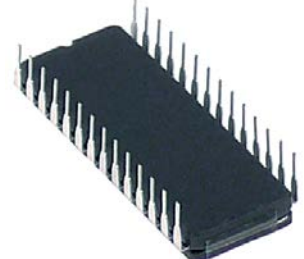

1

GEV No.	401706	Ref. No.	9520591
description	EPROM type M1-6-FA2		
For models:	FV40.2		



1

GEV No.	400839	Ref. No.	0124222
description	EPROM CODE SPÜL3/4EW		
For models:	DV120T, DV40N, DV40T, DV80T		



1

GEV No.	400823	Ref. No.	0124351
description	EPROM type MSPL6-P-STD CODE 124351		
For models:	DV120T, DV40T, DV40T FA, DV80T, ECO STAR 545D, FV20T, FV28GFA, FV40T, FV40TFA, FV70T, FV70TD		

→ electric components



Зип Общепит

vsezip.ru

+7(812)987-08-81

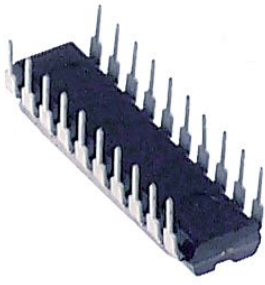

1

GEV No.	401707	Ref. No.	9511252
description	EPROM type SPUL3 P67/5		



1

GEV No.	400221	Ref. No.	0124190
description	control PCB dishwasher DV40, DV80, DV120B		
For models:	DV120T, DV160 AB 1996, DV240B AB 1996, DV270B AB 1992, DV40N, DV40T, DV80T, FV110G, FV130B, FV20T, FV250B AB 1992, FV40T, FV70T		

rectifiers



1

GEV No.	400851	Ref. No.	0140070
description	rectifier 420V 10A		



1

GEV No.	400959	Ref. No.	0124091 9500250
description	control PCB dishwasher FV28G, ECOstar 430F 230V		
For models:	FV28G AB 1994, FV28G AB 1997		

PCBs



1

GEV No.	400220	Ref. No.	0124185 0124187
description	control PCB		
For models:	DV40 AB 1992, DV40N, DV80 AB 1992, ECO STAR 430F, FV20N, FV20T, FV25G AB 1992, FV30GS, FV40N AB 1992, FV40T		



1

GEV No.	400960	Ref. No.	9500251
description	control PCB for dosing pump 230V 230V		
For models:	FV28G AB 1997		



1

GEV No.	400811	Ref. No.	0124092
description	control PCB		
For models:	FV28G AB 1994, FV28G AB 1997		

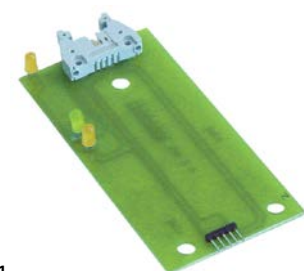

1

GEV No.	400210	Ref. No.	0124186
description	display PCB		
For models:	DV40 AB 1992, DV40N, DV80 AB 1992, FR30G AB 1992, FV20N, FV20T, FV25G AB 1992, FV30GS, FV40N AB 1992, FV40T, FV70T		



Зип Общепит

vsezip.ru

+7(812)987-08-81

electric components



1

GEV No.	400211	Ref. No.	0124196
description	display PCB dishwasher DV40, DV80, DV120B		
For models:	DV120B, DV120T, DV160 AB 1996, DV240B AB 1996, DV270B AB 1992, DV40N, DV40T, DV80T, FV110G, FV130B, FV20T, FV250B AB 1992, FV40T, FV60E AB 1988, FV70T		



1

GEV No.	403014	Ref. No.	9533502 9626264 9643652
description	net board dishwasher FV40.2/EcoStar530F L 81mm W 80mm 80W type MIKE-NET1		
For models:	FV40.2MIKE2, FV40.2M-MIKE2		



1

GEV No.	400799	Ref. No.	9532115
description	display PCB dishwasher ECO STAR		
For models:	ECO STAR 545D, FV130B, FV40.2		



1

GEV No.	361273	Ref. No.	0124056 0124057
description	PCB		
For models:	DV100 AB 1980, DV120B, DV160 AB 1980, DV240B AB 1980, DV80, DV80 AB 1980, FR40G AB 1980, FR40GUS AB 1980, FV120B AB 1980, FV240B AB 1980, FV40N AB 1980		



1

GEV No.	403114	Ref. No.	9617233
description	display PCB for dishwasher L 141mm W 55mm cable length 140mm with housing		



1

GEV No.	401710	Ref. No.	9520149
description	PCB		
For models:	FV40.2		



1

GEV No.	403115	Ref. No.	9542049
description	display PCB for dishwasher L 141mm W 55mm cable length 140mm with housing		
For models:	FV40.2MIKE2, FV40.2M-MIKE2		



1

GEV No.	403228	Ref. No.	9533501 9617235 9645493 9678638 9735526
description	PCB dishwasher FV40.2/EcoStar530F L 150mm W 75mm type MIKE2-E/A1		
For models:	FV40.2M-MIKE2		



Зип Общежит

central units

vsezip.ru

+7(812)987-08-81



1

GEV No.	403227	Ref. No.	9533503 9541525 9608942
description	PCB dishwasher L 210mm W 55mm with housing type MIKE2-CPU1		
For models:	FV40.2MIKE2, FV40.2M-MIKE2		



1

GEV No.	400721	Ref. No.	0124217
description	PCB		
For models:	FV28G AB 1994, FV28G AB 1997		

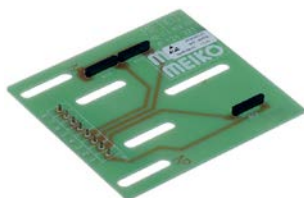

1

GEV No.	402944	Ref. No.	0124323 M2-III-CE3 NIV2 A
description	PCB dishwasher M2-III-CE3 NIV2 A L 97mm W 89mm level control		



1

GEV No.	402921	Ref. No.	0124287 M2-III-NIV A
description	PCB for dishwasher type M2-III-NIV A		



1

GEV No.	400047	Ref. No.	0125035
description	PCB time delay 6-39s		
For models:	DV120B, DV240B AB 1980, DV240B AB 1983, DV80		



1

GEV No.	401571	Ref. No.	9552914
description	power PCB		

keypads

front foils



1

GEV No.	402958	Ref. No.	9537365
description	keypad foil dishwasher FV130.2/250.2 DV270.2 suitable for MEIKO L 335mm W 60mm buttons 5		



1

GEV No.	504366	Ref. No.	0467230
description	keypad foil for dishwasher with cable grey suitable for MEIKO L 217mm W 120mm buttons 14		

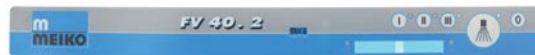

1

GEV No.	403229	Ref. No.	9542137
description	membrane keypad dishwasher FV46 suitable for MEIKO L 560mm W 54mm buttons 5 Qty 1 pcs		
For models:	FV40.2MIKE2, FV40.2M-MIKE2		















membrane keypads



1

GEV No.	403620	Ref. No.	0467226
description	keypad foil disinfection device TOPIC L 71mm W 52mm		

Зип-Общепит
vsezip.ru
+7(812)9871618

	GEV No. 400726	Ref. No. 0467225	GEV No. 400195	Ref. No. 0467221
description membrane keypad	description membrane keypad dishwasher DV40, DV80			
	For models: DV40 AB 1992, DV40N, DV80 AB 1992, FR30G AB 1992, FV20N, FV20T, FV25G AB 1992, FV30CS, FV40N AB 1992, FV40T, FV70T			
	GEV No. 400727	Ref. No. 0467212		GEV No. 403787
description membrane keypad	description membrane keypad dishwasher DV80.2 L 560mm W 53mm			
	GEV No. 400728	Ref. No. 0467220		GEV No. 403788
description membrane keypad	description membrane keypad dishwasher ECO545 / ECOStar545 L 560mm W 53mm			
	GEV No. 400729	Ref. No. 0467328		GEV No. 403617
description membrane keypad	description membrane keypad disinfection device KD10-40 buttons 2 suitable for MEIKO L 215mm W 71mm			
For models: DV120T, DV40T, DV40T FA, DV80T, FV20T, FV28GFA, FV40T, FV40TFA, FV70T, FV70TD				
	GEV No. 400819	Ref. No. 0467208		GEV No. 403616
description membrane keypad	description membrane keypad disinfection device KD10-40 buttons 3 suitable for MEIKO L 215mm W 71mm			
For models: FV28G AB 1994, FV28G AB 1997				
	GEV No. 400820	Ref. No. 0467207		GEV No. 504367
description membrane keypad	description membrane keypad for dishwasher with cable buttons 1 suitable for MEIKO L 60mm W 30mm			
For models: FV28G AB 1994, FV28G AB 1997				
	GEV No. 400843	Ref. No. 9503065		GEV No. 400725
description membrane keypad 1. generation suitable for ECOSTAR 530F L 540mm W 50mm	description membrane keypad warewashing			
For models: ECO STAR 430F				
	GEV No. 402896	Ref. No. 9542136		GEV No. 400196
description membrane keypad dishwasher buttons 7 suitable for MEIKO L 562mm W 54mm	description membrane keypad warewashing DV120			
For models: FV40.2MIKE2, FV40.2M-MIKE2	For models: DV120B, DV120T, DV270B AB 1988, DV40N, DV40T, DV40T FA, DV80T, FV20T, FV250B AB 1988, FV28GFA, FV40T, FV40TFA, FV60E AB 1988, FV70T, FV70TD			



Зип.Общепит
solenoid valves

solenoid valves (water)
LLBI

straight
vsezip.ru
(812)987-08-81



GEV No.	373018	Ref. No.	9505869
description	solenoid valve single straight 230VAC inlet 3/4" outlet 14mm DN10 ELBI		
spare parts for	373018		
	GEV No.	370467	Ref. No. 9506228
	solenoid valve filter suitable for ELBI		

MÜLLER

medium temperature: 90°C
duty cycle: 100%

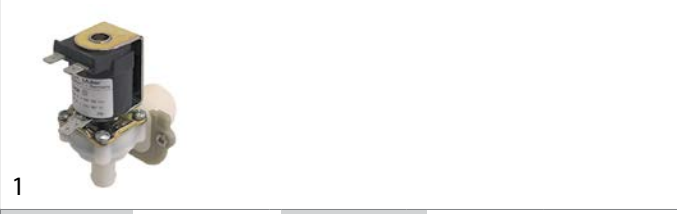











GEV No.	370001	Ref. No.	0113001 0113200
description	solenoid valve single angled 230VAC inlet 3/4" outlet 14.5mm DN10 t.max. 90°C duty cycle 100% MÜLLER		
For models:	DV100 AB 1980, DV100 AB 1983, DV120B, DV160 AB 1980, DV221, DV240B AB 1980, DV40 AB 1983, DV40 AB 1992, DV80 AB 1975, DV80 AB 1980, DV80 AB 1983, DV80 AB 1992, FR30G, FR30G AB 1992, FR40G AB 1976, FR40G AB 1980, FR40G AB 1983, FR40GUS AB 1976, FR40GUS AB 1980, FR40GUS AB 1983, FR60, FV120B AB 1980, FV130B, FV240B AB 1980, FV25G AB 1986, FV25G AB 1992, FV28G AB 1994, FV28G AB 1997, FV30, FV30GS, FV40GE, FV40N AB 1980, FV40N AB 1983, FV40N AB 1992, FV50, FV50 M, FV60 AB 1976, FV60E AB 1983, FV60E AB 1988		
spare parts for	370001		
	GEV No.	370126	Ref. No. 9500402
	solenoid valve body single angled inlet 3/4" outlet 14.5mm DN10 t.max. 90°C duty cycle 100% MÜLLER plastic		
	GEV No.	371002	Ref. No. —
	solenoid valve holder MÜLLER flange support		
	GEV No.	371009	Ref. No. 0113224
	compression spring for solenoïd coil		
	GEV No.	371011	Ref. No. —
	spare parts kit membrane with long star star hight 8mm MÜLLER		
	GEV No.	371017	Ref. No. 0113223
	solenoid coil MÜLLER 230VAC connection male faston 6.3mm		
	GEV No.	371122	Ref. No. 0113098
	solenoid valve filter ø 19mm H 10mm suitable for MÜLLER		

Table continues overleaf

	GEV No.	400197	Ref. No.	0467249
description	membrane keypad warewashing DV120			
For models:	DV120T, DV160 AB 1996, DV240B AB 1996, DV270B AB 1992, DV40T, DV40T FA, DV80T, FV110G, FV130B, FV20T, FV250B AB 1992, FV28GFA, FV40T, FV40TFA, FV70T, FV70TD			

	GEV No.	400724	Ref. No.	0467211
description	membrane keypad warewashing DV120T			
For models:	DV120T, DV40T, DV40T FA, DV80T, FV20T, FV28GFA, FV40T, FV40TFA, FV70T, FV70TD			

	GEV No.	400842	Ref. No.	9503064
description	membrane keypad warewashing ECO STAR 430 L 430mm W 46mm			
For models:	ECO STAR 430F			

	GEV No.	403618	Ref. No.	0467258
description	membrane keypad warewashing suitable for MEIKO L 198mm W 52mm			





	GEV No.	403619	Ref. No.	9639828
description	membrane keypad warewashing TOPIC suitable for MEIKO L 185mm W 155mm			



Зип Общепит

vsezip.ru



+7(812)987-08-81

spare parts for 370001				
	GEV No.	501161	Ref. No.	0113207
tap head for solenoid valve holder for solenoid coils				
accessories for 370001				
	GEV No.	371010	Ref. No.	
solenoid coil 230VAC connection with cable cable length 2000mm				
	GEV No.	371037	Ref. No.	0113128
solenoid coil 24VAC 50/60Hz connection male faston 6.3mm				
	GEV No.	371038	Ref. No.	0113256
solenoid coil 230VAC connection appliance plug				

				
1				
GEV No.	370179	Ref. No.	0113222	
description	solenoid valve body single straight inlet 3/4" outlet 3/4" DN17 t.max. 90°C duty cycle 100% MÜLLER 230V L 98mm			
For models:	DV160 AB 1983, DV160 AB 1996, DV240B AB 1983, DV240B AB 1996, DV260B, DV270B AB 1988, DV270B AB 1992, FV120B AB 1983, FV240B AB 1983, FV250B AB 1988, FV250B AB 1992			

spare parts and accessories

valve bodies

				
1				
GEV No.	374024	Ref. No.	0113127	
description	solenoid valve body double straight inlet 3/4" outlet 14.5mm DN10 t.max. 90°C duty cycle 100%			
accessories for 374024				
	GEV No.	371037	Ref. No.	0113128
solenoid coil 24VAC 50/60Hz connection male faston 6.3mm				



				
1				
GEV No.	370131	Ref. No.	0113261	
description	solenoid valve body triple straight inlet 3/4" outlet 14.5mm DN10 t.max. 90°C duty cycle 100% MÜLLER 230V			

				
1				
GEV No.	370812 ¹	Ref. No.	9519103	
description	solenoid valve body double angled 90° inlet 3/4" outlet 20mm input/min output/min DN13 MÜLLER plasticV voltage			

¹pressure max 0.2-3 bar

				
1				
GEV No.	370129	Ref. No.	0113215	
description	solenoid valve body double straight inlet 3/4" outlet 14.5mm DN10 t.max. 90°C duty cycle 100% MÜLLER 230V			

				
1				
GEV No.	370128	Ref. No.	0113125 0113210	
description	solenoid valve body double angled inlet 3/4" outlet 14.5mm DN10 t.max. 90°C duty cycle 100% MÜLLER 230V double-ways			

				
1				
GEV No.	370667	Ref. No.	0113220	
description	solenoid valve body single straight inlet 3/4" outlet 3/4" DN10 t.max. 90°C duty cycle 100% plastic			
accessories for 370667				
	GEV No.	371009	Ref. No.	0113224
compression spring for solenoid coil				
	GEV No.	371017	Ref. No.	0113223
solenoid coil MÜLLER 230VAC connection male faston 6.3mm				

				
1				
GEV No.	370126	Ref. No.	9500402	
description	solenoid valve body single angled inlet 3/4" outlet 14.5mm DN10 t.max. 90°C duty cycle 100% MÜLLER plastic			

Зип Общепит
vsezip.ru
+7(812)987-08-81



GEV No.	370813 ¹	Ref. No.	9518635 MEI9518635
description	solenoid valve body single angled inlet 3/4" outlet 20mm DN13 t.max. 90°C duty cycle 100% MÜLLER plastic		

¹pressure max 0.2-3 bar



GEV No.	370130	Ref. No.	0113260
description	solenoid valve body triple angled inlet 3/4" outlet 14.5mm DN10 t.max. 90°C duty cycle 100% MÜLLER 230V triple-ways		

solenoid coils

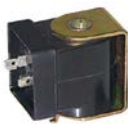

GEV No.	371038	Ref. No.	0113256
description	solenoid coil 230VAC connection appliance plug		
For models:	FV240B AB 1983		
accessories for	371038		
	GEV No.	371090	Ref. No. —
	power socket plug type DIN 43650A screw		



GEV No.	371037	Ref. No.	0113128
description	solenoid coil 24VAC 50/60Hz connection male faston 6.3mm		



GEV No.	370814	Ref. No.	9552884 9705364
description	solenoid coil 24VDC pressure range 0.3-10bar coil type 8466 connection F6.3		



GEV No.	371017	Ref. No.	0113223
description	solenoid coil MULLER 230VAC connection male faston 6.3mm		
For models:	DV100 AB 1983, DV120B, DV120T, DV160 AB 1983, DV160 AB 1996, DV240B AB 1983, DV240B AB 1996, DV260B, DV270B AB 1988, DV270B AB 1992, DV40 AB 1983, DV40 AB 1992, DV40N, DV40T, DV40T FA, DV80, DV80 AB 1983, DV80 AB 1992, DV80T, FR30G, FR30G AB 1992, FR40G AB 1980, FR40G AB 1983, FR40GUS AB 1980, FR40GUS AB 1983, FV110G, FV120B AB 1983, FV130B, FV20N, FV20T, FV240B AB 1983, FV250B AB 1988, FV250B AB 1992, FV25G AB 1986, FV25G AB 1992, FV28G AB 1994, FV28G AB 1997, FV30, FV30GS, FV40N AB 1983, FV40N AB 1992, FV40T, FV40TFA, FV50, FV60E AB 1983, FV60E AB 1988, FV70T, FV70TD		

reducers

inlet side



GEV No.	371207	Ref. No.	0113235
description	reducer MÜLLER type MR04 flow rate 18l/min mounting measurements 19mm nominal flow at 4bar pressure range 1-10bar approval KTW tolerance ±15% brown		



GEV No.	371123	Ref. No.	0113236 9534217
description	reducer MÜLLER type MR19 flow rate 5l/min ø 19mm mounting measurements 19mm pressure range 1-10bar tolerance ±15%		
For models:	DV40T FA, FV40TFA, FV70TD		

filters



GEV No.	370551	Ref. No.	0113218
description	screen for solenoid valve ø 12mm L 24mm		



GEV No.	371122	Ref. No.	0113098
description	solenoid valve filter ø 19mm H 10mm suitable for MÜLLER		
For models:	DV100 AB 1980, DV100 AB 1983, DV120B, DV120T, DV160 AB 1980, DV160 AB 1983, DV160 AB 1996, DV240B AB 1980, DV240B AB 1983, DV240B AB 1996, DV260B, DV40 AB 1983, DV40 AB 1992, DV40N, DV40T, DV40T FA, DV80, DV80 AB 1983, DV80 AB 1992, DV80T, ECO STAR 430F, ECO STAR 530F, ECO STAR 545D, FR30G, FR30G AB 1992, FR40G AB 1980, FR40G AB 1983, FR40GUS AB 1980, FR40GUS AB 1983, FV110G, FV120B AB 1983, FV130B, FV20N, FV20T, FV240B AB 1983, FV250B AB 1992, FV25G AB 1992, FV28G AB 1994, FV28G AB 1997, FV30GS, FV40N AB 1983, FV40N AB 1992, FV40T, FV40TFA, FV60E AB 1983, FV60E AB 1988, FV70T, FV70TD		





Зип Общежит

vsezip.ru

+7(812)987-08-81

miscellaneous			
			
GEV No.	371309	Ref. No.	9519704
description	compression spring for membrane for DN10		

			
GEV No.	371009	Ref. No.	0113224
description	compression spring for solenoid coil		
For models:	DV100 AB 1983, DV120B, DV120T, DV160 AB 1983, DV160 AB 1996, DV240B AB 1983, DV240B AB 1996, DV260B, DV270B AB 1988, DV270B AB 1992, DV40 AB 1983, DV40 AB 1992, DV40N, DV40T, DV40T FA, DV80, DV80 AB 1983, DV80 AB 1992, DV80T, FR30G, FR30G AB 1992, FR40G AB 1980, FR40G AB 1983, FR40GUS AB 1980, FR40GUS AB 1983, FV110G, FV120B AB 1983, FV130B, FV20N, FV20T, FV240B AB 1983, FV250B AB 1988, FV250B AB 1992, FV25G AB 1986, FV25G AB 1992, FV28G AB 1994, FV28G AB 1997, FV30, FV30GS, FV40N AB 1983, FV40N AB 1992, FV40T, FV40TFA, FV50, FV60E AB 1983, FV60E AB 1988, FV70T, FV70TD		

			
GEV No.	501161	Ref. No.	0113207
description	tap head for solenoid valve holder for solenoid coils		
For models:	DV100 AB 1983, DV120B, DV160 AB 1983, DV260B, DV40 AB 1983, DV80, DV80 AB 1983, FR30G, FR40G AB 1983, FR40GUS AB 1983, FV120B AB 1983, FV240B AB 1983, FV25G AB 1986, FV40N AB 1983, FV60E AB 1983		



ROBERTSHAW/INVENSYS

medium temperature: 90°C 90°C 60°C
 ambient temperature: 60°C 25°C 60°C
 duty cycle: 40% 100% 100%

			
GEV No.	370753	Ref. No.	9544641 9727359
description	solenoid valve single straight 24VAC/DC inlet 3/4" outlet 6mm DN10 plastic		
For models:	FV40.2MIKE2, FV40.2M-MIKE2		

solenoid valves with reducers			
single			
			
GEV No.	371219	Ref. No.	9510710
description	solenoid valve single angled 230VAC inlet 3/4" outlet 14.5mm input 5l/min DN10 t.max. 90°C Invensys plastic flow regulating valve inlet black		

			
GEV No.	372027	Ref. No.	9625747 9686158
description	solenoid valve single angled 24VDC inlet 3/4" outlet 11.5mm input 10l/min output 0.25l/min flow regulating valve inlet brown		

			
GEV No.	372047	Ref. No.	0113202
description	solenoid valve single straight 230VAC inlet 3/4" outlet 14mm input 15l/min t.max. 90°C EATON (INVENSYS) plastic flow regulating valve inlet grey		
For models:	DV120T, DV40N, DV40T, DV40T FA, DV80T, FV110G, FV20N, FV20T, FV40T, FV40TFA, FV70T, FV70TD		
spare parts for	372047		
	GEV No.	370467	Ref. No. 9506228
	 solenoid valve filter suitable for ELBI		

2-fold			
			
GEV No.	370754	Ref. No.	9623793
description	solenoid valve double angled 24VAC/DC inlet 3/4" outlet 14.5mm Invensys plastic flow regulating valve inlet pink		











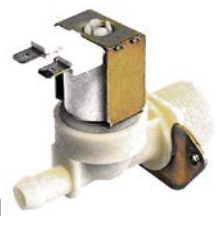





1 electric components







Зип-Общепит

vsezip.ru

+7(812)987-08-81

TP			
			
GEV No.	370029	Ref. No.	9623108 9686159
description	solenoid valve single straight 24VAC inlet 3/4" outlet 11.5mm DN10 TP flow regulating valve inlet white		
spare parts for	370029		
	GEV No.	371035	Ref. No. —
	solenoid coil 24VAC		
accessories for	370029		
	GEV No.	371220	Ref. No. —
	reducer TP flow rate 3l/min red tolerance ±15%		
	GEV No.	371221	Ref. No. —
	reducer TP flow rate 5.5l/min yellow tolerance ±15%		
	GEV No.	371222	Ref. No. —
	reducer TP flow rate 6l/min grey tolerance ±15%		
	GEV No.	371223	Ref. No. —
	reducer TP flow rate 10l/min white tolerance ±15%		
	GEV No.	371224	Ref. No. —
	reducer TP flow rate 12l/min bronze tolerance ±15%		
	GEV No.	371225	Ref. No. —
	reducer TP flow rate 16l/min light brown tolerance ±15%		
	GEV No.	371226	Ref. No. —
	reducer TP flow rate 20l/min red tolerance ±15%		
	GEV No.	371230	Ref. No. —
	reducer TP flow rate 0.25l/min red tolerance ±25%		
	GEV No.	371231	Ref. No. —
	reducer TP flow rate 0.35l/min violet tolerance ±25%		
	GEV No.	371232	Ref. No. —
	reducer TP flow rate 0.5l/min orange tolerance ±25%		
	GEV No.	371233	Ref. No. —
	reducer TP flow rate 0.8l/min white tolerance ±25%		
	GEV No.	371234	Ref. No. —
	reducer TP flow rate 1l/min light blue tolerance ±25%		
	GEV No.	371235	Ref. No. —
	reducer TP flow rate 1.2l/min brown tolerance ±25%		
	GEV No.	371236	Ref. No. —
	reducer TP flow rate 1.5l/min light brown tolerance ±25%		

	GEV No.	371237	Ref. No.	—
	reducer TP flow rate 2.5l/min yellow tolerance ±25%			
	GEV No.	371238	Ref. No.	—
	reducer TP flow rate 3.4l/min dark green tolerance ±25%			
	GEV No.	371239	Ref. No.	—
	reducer TP flow rate 5l/min black tolerance ±25%			
	GEV No.	371240	Ref. No.	—
	reducer TP flow rate 8l/min blue tolerance ±20%			





















TP			
			
GEV No.	370016	Ref. No.	9000006
description	solenoid valve single angled 230VAC inlet 3/4" outlet 14mm DN10 TP		
For models:	ECO STAR 430F, ECO STAR 530F, ECO STAR 545D		
spare parts for	370016		
	GEV No.	371013	Ref. No. —
	solenoid coil TP 230VAC 50/60Hz		
accessories for	370016		
	GEV No.	371220	Ref. No. —
	reducer TP flow rate 3l/min red tolerance ±15%		
	GEV No.	371221	Ref. No. —
	reducer TP flow rate 5.5l/min yellow tolerance ±15%		
	GEV No.	371222	Ref. No. —
	reducer TP flow rate 6l/min grey tolerance ±15%		
	GEV No.	371223	Ref. No. —
	reducer TP flow rate 10l/min white tolerance ±15%		
	GEV No.	371224	Ref. No. —
	reducer TP flow rate 12l/min bronze tolerance ±15%		
	GEV No.	371225	Ref. No. —
	reducer TP flow rate 16l/min light brown tolerance ±15%		
	GEV No.	371226	Ref. No. —
	reducer TP flow rate 20l/min red tolerance ±15%		
	GEV No.	371230	Ref. No. —
	reducer TP flow rate 0.25l/min red tolerance ±25%		
	GEV No.	371231	Ref. No. —
	reducer TP flow rate 0.35l/min violet tolerance ±25%		
	GEV No.	371232	Ref. No. —
	reducer TP flow rate 0.5l/min orange tolerance ±25%		

Table continues overleaf







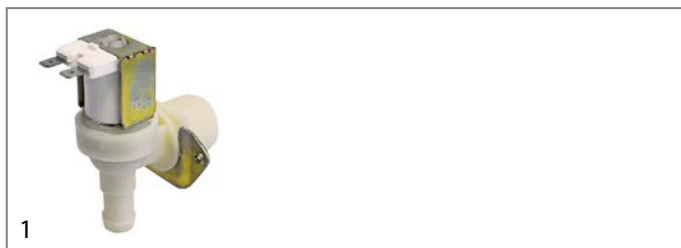

Зип-Общепит
vsezip.ru







+7(812)987-08-81

accessories for		370016	
GEV No.	Ref. No.	GEV No.	Ref. No.
	371233	—	—
reducer TP flow rate 0.8l/min white tolerance ±25%			
	371234	—	—
reducer TP flow rate 1l/min light blue tolerance ±25%			
	371235	—	—
reducer TP flow rate 1.2l/min brown tolerance ±25%			
	371236	—	—
reducer TP flow rate 1.5l/min light brown tolerance ±25%			
	371237	—	—
reducer TP flow rate 2.5l/min yellow tolerance ±25%			
	371238	—	—
reducer TP flow rate 3.4l/min dark green tolerance ±25%			
	371239	—	—
reducer TP flow rate 5l/min black tolerance ±25%			
	371240	—	—
reducer TP flow rate 8l/min blue tolerance ±20%			
	503139	—	—
solenoid valve filter ø 19.5mm H 16mm			



1

GEV No.	370031	Ref. No.	9623762
description	solenoid valve single angled 24VAC inlet 3/4" outlet 14mm DN10 TP		
spare parts for	370031		
	GEV No. 371035	Ref. No.	—
solenoid coil 24VAC			
accessories for	370031		
	GEV No. 371220	Ref. No.	—
reducer TP flow rate 3l/min red tolerance ±15%			
	GEV No. 371221	Ref. No.	—
reducer TP flow rate 5.5l/min yellow tolerance ±15%			
	GEV No. 371222	Ref. No.	—
reducer TP flow rate 6l/min grey tolerance ±15%			
	GEV No. 371223	Ref. No.	—
reducer TP flow rate 10l/min white tolerance ±15%			
	GEV No. 371224	Ref. No.	—
reducer TP flow rate 12l/min bronze tolerance ±15%			
	GEV No. 371225	Ref. No.	—
reducer TP flow rate 16l/min light brown tolerance ±15%			

accessories for		370031	
GEV No.	Ref. No.	GEV No.	Ref. No.
	371226	—	—
reducer TP flow rate 20l/min red tolerance ±15%			
	371230	—	—
reducer TP flow rate 0.2l/min red tolerance ±25%			
	371231	—	—
reducer TP flow rate 0.35l/min violet tolerance ±25%			
	371232	—	—
reducer TP flow rate 0.5l/min orange tolerance ±25%			
	371233	—	—
reducer TP flow rate 0.8l/min white tolerance ±25%			
	371234	—	—
reducer TP flow rate 1l/min light blue tolerance ±25%			
	371235	—	—
reducer TP flow rate 1.2l/min brown tolerance ±25%			
	371236	—	—
reducer TP flow rate 1.5l/min light brown tolerance ±25%			
	371237	—	—
reducer TP flow rate 2.5l/min yellow tolerance ±25%			
	371238	—	—
reducer TP flow rate 3.4l/min dark green tolerance ±25%			
	371239	—	—
reducer TP flow rate 5l/min black tolerance ±25%			
	371240	—	—
reducer TP flow rate 8l/min blue tolerance ±20%			

various

	1		
GEV No.	370668	Ref. No.	9545436
description	solenoid valve single 24V outlet 14mm 10 t.max. 60°C MÜLLER 19.010.278 plastic inlet 24mm		
For models:	FV40.2MIKE2, FV40.2M-MIKE2		

1 electric components

Зип-Общепит

solenoid valves (various)

vsezip.ru

+7(812)987-08-81



GEV No.	370482	Ref. No.	9519728
description	solenoid valve single straight 230VAC outlet 6mm plastic inlet 3/4"mm		
For models:	FV40.2		

metal

ASCO

2-way



GEV No.	370124	Ref. No.	0113246
description	solenoid valve 2-way-ways 230VAC inlet 1/2" outlet 1/2" L 69mm DN 16mm slide-on receptacle DIN -20° up to 85°C Asco coil type 400325-110 membranes NBR (water) p max 10bar p min 0.35bar valve set C 50/60Hz		
spare parts for	370124		
	GEV No.	Ref. No.	0113249
	solenoid coil Asco 230VAC pressure range 0.35-10bar connection DIN		

spare parts and accessories

solenoid coils



GEV No.	371129	Ref. No.	0113251
description	solenoid coil Asco 230VAC coil type 400325-117		



GEV No.	371307	Ref. No.	0113249
description	solenoid coil Asco 230VAC pressure range 0.35-10bar connection DIN		



GEV No.	372040	Ref. No.	0113050
description	solenoid valve 2-ways 230VAC inlet 3/8" outlet 3/8" L 48mm body brass DN 6mm slide-on receptacle DIN type series SV04 coil type M20 p max 4bar 10W		

Solenoid valve - accessories

filters



GEV No.	371122	Ref. No.	0113098
description	solenoid valve filter ø 19mm H 10mm suitable for MÜLLER		
For models:	DV100 AB 1980, DV100 AB 1983, DV120B, DV120T, DV160 AB 1980, DV160 AB 1983, DV160 AB 1996, DV240B AB 1980, DV240B AB 1983, DV240B AB 1996, DV260B, DV40 AB 1983, DV40 AB 1992, DV40N, DV40T, DV40T FA, DV80, DV80 AB 1983, DV80 AB 1992, DV80T, ECO STAR 430F, ECO STAR 530F, ECO STAR 545D, FR30G, FR30G AB 1992, FR40G AB 1980, FR40G AB 1983, FR40GUS AB 1980, FR40GUS AB 1983, FV110G, FV120B AB 1983, FV130B, FV20N, FV20T, FV240B AB 1983, FV250B AB 1992, FV25G AB 1992, FV28G AB 1994, FV28G AB 1997, FV30GS, FV40N AB 1983, FV40N AB 1992, FV40T, FV40TFA, FV60E AB 1983, FV60E AB 1988, FV70T, FV70TD		



GEV No.	370467	Ref. No.	9506228
description	solenoid valve filter suitable for ELBI		



GEV No.	370755	Ref. No.	8000009 8004068 9546133
description	reducer L 20mm ø 13.3mm		
For models:	ECO STAR 545D		





Зип Общепит

vsezip.ru

+7(812)987-08-81

			
GEV No.	370135	Ref. No.	0113250
description	spare parts kit size 1/2"		

			
GEV No.	370136	Ref. No.	0113252
description	spare parts kit size 3/4"		

			
GEV No.	501161	Ref. No.	0113207
description	tap head for solenoid valve holder for solenoid coils		
For models:	DV100 AB 1983, DV120B, DV160 AB 1983, DV260B, DV40 AB 1983, DV80, DV80 AB 1983, FR30G, FR40G AB 1983, FR40GUS AB 1983, FV120B AB 1983, FV240B AB 1983, FV25G AB 1986, FV40N AB 1983, FV60E AB 1983		

pressure switches

for warewashing

ø 58mm with male faston 6.3mm

with connection vertical

			
GEV No.	541163	Ref. No.	0130010 8002014
description	pressure control		
For models:	DV40 AB 1983, FV40N AB 1980, FV40N AB 1983, FV60E AB 1983		

			
GEV No.	541146	Ref. No.	0130026
description	pressure control pressure range 40/15mbar connection 6mm ø 58mm pressure connection vertical warewashing pressure connection ø 6mm		
For models:	DV120.2, ECO STAR 530F, FV110G, FV20N, FV28GFA, FV40.2, FV40.2 AB 2002, FV40.2M, FV40.2MIKE2, FV40.2M-MIKE2, FV40TFA, FV70TD		

			
GEV No.	541050	Ref. No.	0130009 0130019
description	pressure control pressure range 50/30mbar connection 6mm ø 58mm pressure connection vertical warewashing pressure connection ø 6mm		
For models:	FR30G, FR30G AB 1992, FR40G AB 1980, FR40G AB 1983, FR40GUS AB 1980, FR40GUS AB 1983, FV120B AB 1980, FV120B AB 1983, FV240B AB 1980, FV25G AB 1986, FV25G AB 1992, FV28G AB 1994, FV28G AB 1997, FV40T, FV60E AB 1983, FV60E AB 1988, FV70T		

			
GEV No.	541041	Ref. No.	0130008 0130014
description	pressure control pressure range 62/30mbar connection 6mm ø 58mm pressure connection vertical warewashing pressure connection ø 6mm		
For models:	DV100 AB 1980, DV100 AB 1983, DV120B, DV160 AB 1980, DV160 AB 1983, DV160 AB 1996, DV240B AB 1980, DV240B AB 1983, DV240B AB 1996, DV260B, DV270B AB 1988, DV270B AB 1992, DV40 AB 1992, DV80, DV80 AB 1980, DV80 AB 1983, DV80 AB 1992, FR30G AB 1992, FV130B, FV250B AB 1988, FV250B AB 1992, FV25G AB 1992, FV30GS, FV40N AB 1992		

			
GEV No.	541145	Ref. No.	0130027
description	pressure control pressure range 90/25mbar connection 6mm ø 58mm pressure connection vertical warewashing pressure connection ø 6mm		
For models:	DV120T, DV40N, DV40T, DV40T FA, DV80T, ECO STAR 545D		

pressure transmitters

			
GEV No.	541149	Ref. No.	9537961
description	pressure transmitter pressure range 0-30mbar output voltage 0.5-3.5VDC input voltage 5VDC max 200mbar		
For models:	FV40.2MIKE2, FV40.2M-MIKE2		





Зип Общепит

vsezip.ru

+7(812)987-08-81

miscellaneous

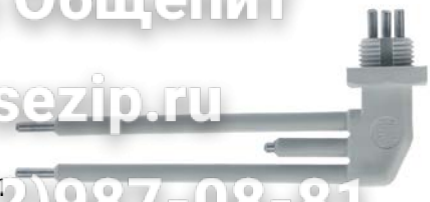

			
1			
GEV No.	541983	Ref. No.	9520592 9547086
description	pressure control digital ø 58mm 5V voltage DC pressure connection ø 5.5mm pressure range 0.1-1bar		
For models:	FV40.2		

			
1			
GEV No.	541677	Ref. No.	9519033 9622898 9683764 9683764+0401014
description	pressure control pressure rangembar connection 15x20mm		
For models:	DV120.2, FV40.2, FV40.2 AB 2002, FV40.2 AB 2003, FV40.2M, FV40.2MIKE2, FV40.2M-MIKE2		
accessories for	541677		
	GEV No.	528928	Ref. No. 0401014
	O-ring EPDM ID ø 18mm thickness 2mm Qty 1 pcs		

			
GEV No.	403314	Ref. No.	9500435
description	level electrode 1/2" total length 150mm probe L 125mm insulated probe length 110mm connection bullet connector		

fans

axial fans



<p>import</p>			
			
1			
GEV No.	601080 ¹	Ref. No.	0190032
description	axial fan L 119mm W 119mm H 38mm 230VAC 50/60Hz 23/20W bearing ball bearing connection male faston 2.8mm metal ADDA fan wheel ø 110mm temp.-resist. 70°C		
accessories for	601080		
	GEV No.	550898	Ref. No. —
	connecting cable cable length 2000mm connection F 2.8 connection distance 7.9mm for axial flow fan		
	GEV No.	692519	Ref. No. —
	guard L 120mm W 120mm plastic		

¹with ball bearings

			
1			
GEV No.	601809	Ref. No.	0550057 9615004
description	axial fan ø 365mm H 118mm 230/400VAC 50/60Hz 110/170W connection cable 1500mm manuf. no. FC031-4DH.2A.V6 ZIEHL-ABEGG fan wheel ø 308mm for drying		

electrodes

			
1			
GEV No.	361274	Ref. No.	8000014
description	conductivity probe mounting ø 17mm		
For models:	DR90, DV111, DV111E		

			
1			
GEV No.	361245	Ref. No.	0620437
description	conductivity probe with thread mounting ø 17mm		
accessories for	361245		
	GEV No.	501289	Ref. No. 0217432
	flat gasket rubber ED ø 24mm ID ø 14mm thickness 2mm Qty 1 pcs		
	GEV No.	501290	Ref. No. 0620162
	nut thread 3/8" H 8mm WS 24 plastic Qty 1 pcs		



motors

accessories

miscellaneous



GEV No.	501087	Ref. No.	0620333
description	flange for motor		
For models:	DV270B AB 1992, FV250B AB 1992		

Зип-Общепит

accessories for	500287
GEV No.	551286
Ref. No.	—
description	adapter L 120mm 4-pole for Meiko pump suitable for 500038 plug type dependent on equipment

+7(812)987-08-81

pumps

wash and rinse pumps

FIR

pumps



GEV No.	500287	Ref. No.	0501135 9604594
description	pump for Meiko inlet \varnothing 45mm outlet \varnothing 40mm 230V type 2256.1420 50Hz 0.73kW 1HP L 200mm rotation direction right capacitor 16 μ F 1 phase FIR		
spare parts for	500287		
	GEV No.	Ref. No.	0501136
	365021		
	operating capacitor capacity 16 μ F 425V tolerance 5% 50/60Hz ambient temperature max. -25 to +85°C \varnothing 35mm L 73mm single M8 plastic connection male faston 6.3mm 416.10.99 protection		
	GEV No.	Ref. No.	0501138 9537022 9621793
	501313		
	impeller \varnothing 103mm H 28mm shaft intake \varnothing 9/8mm		
	GEV No.	Ref. No.	—
	502007		
	pump cover gasket		
	GEV No.	Ref. No.	—
	502014		
	pump cover FIR inlet \varnothing 45mm outlet \varnothing 40mm		
	GEV No.	Ref. No.	0501095 0501162
	510692		
	mechanical shaft seal for shaft \varnothing 11mm slide ring ext. \varnothing 24mm slide ring H 13mm counter ring mounting \varnothing 26mm height counter ring 8mm counter ring int. \varnothing 14mm		



GEV No.	500274	Ref. No.	0501166 9534805
description	pump inlet \varnothing 33mm outlet \varnothing 30mm type B221A1500 230V 50Hz 1 phase 0.15kW 0.2HP L 195mm rotation direction left capacitor 6.3 μ F FIR		
For models:	DV40T FA, FV40TFA, FV70TD		
spare parts for	500274		
	GEV No.	Ref. No.	0501173
	365012		
	operating capacitor capacity 6.3 μ F 450V tolerance 5% 50Hz ambient temperature max. -25 to +85°C \varnothing 30mm L 61mm M8 plastic connection male faston 6.3mm protection		
	GEV No.	Ref. No.	0501170
	501309		
	impeller \varnothing 80mm H 19mm M7R pump type type D1		
	GEV No.	Ref. No.	—
	510693		
	mechanical shaft seal for shaft \varnothing 12mm slide ring ext. \varnothing 24mm slide ring H 15.5mm slide ring int. \varnothing 11mm counter ring mounting \varnothing 24mm height counter ring 8mm counter ring int. \varnothing 13.5mm		
	GEV No.	Ref. No.	0501169
	521500		
	pump cover		
	GEV No.	Ref. No.	0501171
	521700		
	pump cover gasket		

electric components





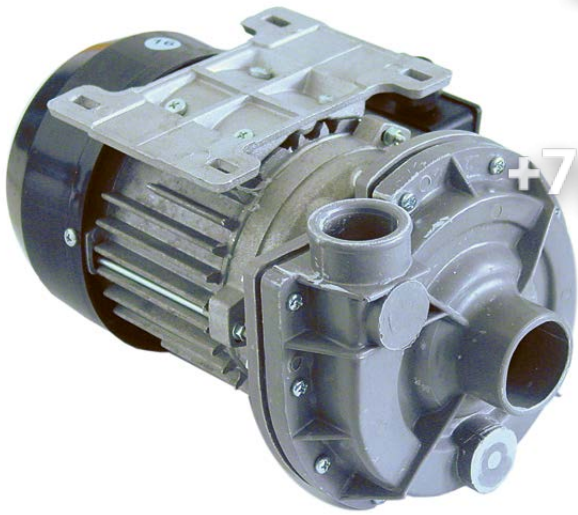

Зип Общепит

vsezip.ru

+7(812)987-08-81



1

GEV No.	500289	Ref. No.	0501088 0501147 0501163
description	pump inlet ø 45mm outlet ø 40mm type 1276.2530 230/400V 50Hz 3 phase 0.55kW 0.75HP L 270mm rotation direction right FIR		
For models:	DR70, DV80 AB 1975		
spare parts for	500289		
	GEV No.	501314	Ref. No. 0501081
	impellor ø 75mm		
	GEV No.	502007	Ref. No. —
	pump cover gasket		
	GEV No.	502014	Ref. No. —
	pump cover FIR inlet ø 45mm outlet ø 40mm		
	GEV No.	510692	Ref. No. 0501095 0501162
	mechanical shaft seal for shaft ø 11mm slide ring ext. ø 24mm slide ring H 13mm counter ring mounting ø 26mm height counter ring 8mm counter ring int. ø 14mm		



1

GEV No.	499216	Ref. No.	9621706
description	pump inlet ø 45mm outlet ø 40mm type 2256T2550 180-253V 50Hz 1 phase 0.75kW 1HP L 250mm rotation direction right capacitor 20µF FIR		
spare parts for	499216		
	GEV No.	365019	Ref. No. 9606122
	operating capacitor capacity 20µF 400V tolerance 5% 50/60Hz ambient temperature max. -25 to +85°C ø 39.5mm L 70mm M8 plastic connection male faston 6.3mm 16.10.25. protection		
	GEV No.	501313	Ref. No. 0501138 9537022 9621793
	impellor ø 103mm H 28mm shaft intake ø 9/8mm		
	GEV No.	502007	Ref. No. —
	pump cover gasket		
	GEV No.	502014	Ref. No. —
	pump cover FIR inlet ø 45mm outlet ø 40mm		
	GEV No.	510692	Ref. No. 0501095 0501162
	mechanical shaft seal for shaft ø 11mm slide ring ext. ø 24mm slide ring H 13mm counter ring mounting ø 26mm height counter ring 8mm counter ring int. ø 14mm		

Зип Общепит

vsezip.ru

+7(812)987-08-81



1

GEV No.	499335	Ref. No.	0501125
description	pump inlet ø 45mm outlet ø 40mm type 3911K1513 230V 50Hz 1 phase 0.55kW 0.75HP L 205mm rotation direction right capacitor 12.5µF FIR		
spare parts for	499335		
	GEV No.	365014	Ref. No. 0501090
	operating capacitor capacity 12.5µF 450V tolerance 5%Hz ambient temperature max. -25 to +85°C ø 35mm L 70mm M8 plastic connection male faston 6.3mm 45S.C3DS.12.5 protection		
	GEV No.	510508	Ref. No. 0501091 9500311
	pump cover FIR inlet ø 45mm outlet ø 40mm pump type PU 0.5/3911 turn direction right ø 160mm ID ø 125mm inner height 25mm		
	GEV No.	510610	Ref. No. —
	impellor ø 95.5mm H 23mm shaft intake ø 9/8mm rotation direction right seat ø 16mm blades 6		
	GEV No.	510692	Ref. No. 0501095 0501162
	mechanical shaft seal for shaft ø 11mm slide ring ext. ø 24mm slide ring H 13mm counter ring mounting ø 26mm height counter ring 8mm counter ring int. ø 14mm		
	GEV No.	521702	Ref. No. —
	pump cover gasket thickness 3.5x4.5mm Qty 1 pcs		

1

GEV No.	501502	Ref. No.	0501126 9547992 9623417
description	pump inlet ø 45mm outlet ø 40mm type 3911K2530 180-253V 50Hz 1 phase 0.55kW 0.75HP L 205mm rotation direction right capacitor 10µF FIR		
spare parts for	501502		
	GEV No.	365014	Ref. No. 0501090
	operating capacitor capacity 12.5µF 450V tolerance 5%Hz ambient temperature max. -25 to +85°C ø 35mm L 70mm M8 plastic connection male faston 6.3mm 45S.C3DS.12.5 protection		
	GEV No.	501316	Ref. No. 0501092 0501137
	impellor ø 96mm H 23mm pump type pump 0.55kW shaft intake ø 9x8mm rotation direction right seat ø 16mm Spezial blades 6		
	GEV No.	510508	Ref. No. 0501091 9500311
	pump cover FIR inlet ø 45mm outlet ø 40mm pump type PU 0.5/3911 turn direction right ø 160mm ID ø 125mm inner height 25mm		
	GEV No.	510552	Ref. No. 0501094
	pump cover gasket pump type 1292-2/3942/3981/3911/3983		
	GEV No.	510692	Ref. No. 0501095 0501162
	mechanical shaft seal for shaft ø 11mm slide ring ext. ø 24mm slide ring H 13mm counter ring mounting ø 26mm height counter ring 8mm counter ring int. ø 14mm		

Зип Общепит

vsezip.ru

+7(812)987-08-81









1

GEV No.	499207	Ref. No.	0501085 0501120 9623861
description	pump inlet ø 45mm outlet ø 40mm type 3911K2533 180-253V 50Hz 1 phase 0.55kW 0.75HP L 205mm rotation direction right capacitor 12.5µF FIR		
For models:	DV40 AB 1983, DV40 AB 1992, DV40N, DV40T, DV40T FA, ECO STAR 430F, ECO STAR 530F, FR30G, FR30G AB 1992, FR40G AB 1980, FR40G AB 1983, FR40GUS AB 1980, FR40GUS AB 1983, FV110G, FV20N, FV20T, FV25G AB 1986, FV25G AB 1992, FV28G AB 1994, FV28G AB 1997, FV28GFA, FV30GS, FV40N AB 1980, FV40N AB 1983, FV40N AB 1992, FV40T, FV40TFA, FV60E AB 1988, FV70T, FV70TD		
spare parts for	499207		
	GEV No.	Ref. No.	0501090
	operating capacitor capacity 12.5µF 450V tolerance 5%Hz ambient temperature max. -25 to +85°C ø 35mm L 70mm M8 plastic connection male faston 6.3mm 45S.C3DS.12.5 protection		
	GEV No.	Ref. No.	0501091 9500311
	pump cover FIR inlet ø 45mm outlet ø 40mm pump type PU 0.5/3911 turn direction right ø 160mm ID ø 125mm inner height 25mm		
	GEV No.	Ref. No.	—
	impeller ø 95.5mm H 23mm shaft intake ø 9/8mm rotation direction right seat ø 16mm blades 6		
	GEV No.	Ref. No.	0501095 0501162
	mechanical shaft seal for shaft ø 11mm slide ring ext. ø 24mm slide ring H 13mm counter ring mounting ø 26mm height counter ring 8mm counter ring int. ø 14mm		
	GEV No.	Ref. No.	—
	pump cover gasket thickness 3.5x4.5mm Qty 1 pcs		



1

GEV No.	499128	Ref. No.	0501167
description	pump inlet ø 45mm outlet ø 40mm type 4228.1503 230V 50Hz 0.55kW L 207mm rotation direction right capacitor 12.5µF FIR		
spare parts for	499128		
	GEV No.	Ref. No.	0501090
	operating capacitor capacity 12.5µF 450V tolerance 5%Hz ambient temperature max. -25 to +85°C ø 35mm L 70mm M8 plastic connection male faston 6.3mm 45S.C3DS.12.5 protection		
	GEV No.	Ref. No.	0501091 9500311
	pump cover FIR inlet ø 45mm outlet ø 40mm pump type PU 0.5/3911 turn direction right ø 160mm ID ø 125mm inner height 25mm		
	GEV No.	Ref. No.	—
	mechanical shaft seal for shaft ø 12mm slide ring ext. ø 24mm slide ring H 15.5mm slide ring int. ø 11mm counter ring mounting ø 24mm height counter ring 8mm counter ring int. ø 13.5mm		
	GEV No.	Ref. No.	—
	pump cover gasket thickness 3.5x4.5mm Qty 1 pcs		
	GEV No.	Ref. No.	9533822
	impeller ø 96mm H 23mm shaft intake ø M7Lmm rotation direction right suitable for MEIKO shaft ø 12mm shaft length 9mm blades 6		
accessories for	499128		
	GEV No.	Ref. No.	—
	adapter L 120mm 4-pole for Meiko pump suitable for 500038 plug type dependent on equipment		

Зип Общепит

vsezip.ru

+7(812)987-08-81



GEV No.	500278	Ref. No.	0501032
description	pump inlet \varnothing 57mm outlet \varnothing 49mm type AF90L/2C-12 400V 50Hz 3 phase 2.7kW 3.7HP L 400mm rotation direction right FIR inlet \varnothing 57mm outlet \varnothing 49mm		
For models:	DV120B, DV240B AB 1980, DV240B AB 1983, DV260B, DV80, FV120B AB 1980, FV120B AB 1983, FV130B, FV240B AB 1980, FV240B AB 1983, FV30, FV50		
spare parts for	500278		
	GEV No.	507558	Ref. No. 9523844 9543778 9662632
	mechanical shaft seal for shaft \varnothing 7mm height counter ring 5mm ID \varnothing 6.75mm ED \varnothing 20mm mounting \varnothing counter ring 18.5/slide ring 20mm		
	GEV No.	510683	Ref. No. 9523260 9543781
	O-ring EPDM thickness 3mm ID \varnothing 79mm Qty 1 pcs		



GEV No.	500029	Ref. No.	0501084 0501089 0501118
description	pump inlet \varnothing 63mm outlet \varnothing 47mm type 1295.2503 230/400V 50Hz 3 phase 0.88kW 1.2HP L 305mm rotation direction right FIR		
For models:	DV100 AB 1980, DV100 AB 1983, DV160 AB 1980, DV160 AB 1983, DV80 AB 1980, DV80 AB 1983, DV80 AB 1992, FV60E AB 1983		
spare parts for	500029		
	GEV No.	510693	Ref. No. —
	mechanical shaft seal for shaft \varnothing 12mm slide ring ext. \varnothing 24mm slide ring H 15.5mm slide ring int. \varnothing 11mm counter ring mounting \varnothing 24mm height counter ring 8mm counter ring int. \varnothing 13.5mm		
	GEV No.	521213	Ref. No. —
	impellor \varnothing 117mm H 24mm M8L		

spare parts for	500029		
	GEV No.	521513	Ref. No. —
	pump cover FIR inlet \varnothing 63mm outlet \varnothing 47mm turn direction right ID \varnothing 150mm inner height 32mm		
	GEV No.	524416	Ref. No. —
	pump cover gasket thickness 4x4mm Qty 1 pcs		



GEV No.	500031	Ref. No.	0501082 0501086
description	pump inlet \varnothing 63mm outlet \varnothing 53mm type 1205.2528 230/400V 50Hz 3 phase 2kW 2.7HP L 330mm rotation direction left FIR		
For models:	DV120B, DV240B AB 1980, DV240B AB 1983, DV260B, DV80, FV120B AB 1980, FV120B AB 1983, FV130B, FV240B AB 1980, FV240B AB 1983, FV30, FV50		
spare parts for	500031		
	GEV No.	510357	Ref. No. —
	impellor \varnothing 124mm H 34/16mm thread M8R blades 6		
	GEV No.	510523	Ref. No. —
	fan wheel \varnothing 142mm shaft intake \varnothing 15mm blades 12		
	GEV No.	510531	Ref. No. 0501097
	pump cover FIR inlet \varnothing 63mm outlet \varnothing 53mm auxiliary pressure connection M16x1.5mm supporting pressure open turn direction left \varnothing 185mm ID \varnothing 150mm inner height 37mm		
	GEV No.	510693	Ref. No. —
	mechanical shaft seal for shaft \varnothing 12mm slide ring ext. \varnothing 24mm slide ring H 15.5mm slide ring int. \varnothing 11mm counter ring mounting \varnothing 24mm height counter ring 8mm counter ring int. \varnothing 13.5mm		
	GEV No.	524416	Ref. No. —
	pump cover gasket thickness 4x4mm Qty 1 pcs		





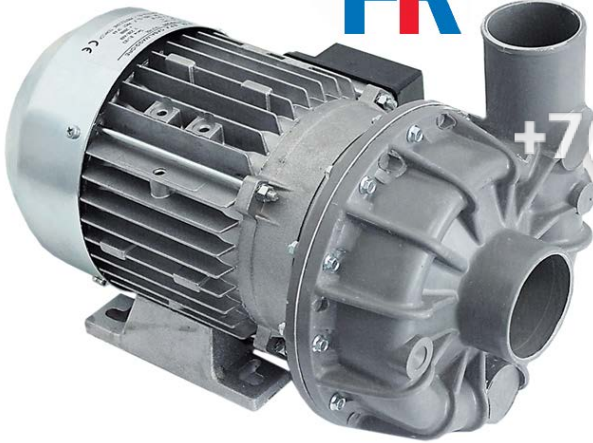

Зип Общепит

vsezip.ru

+7(812)987-08-81





1

GEV No.	500111	Ref. No.	0501129 0501131 0501146
description	pump inlet \varnothing 63mm outlet \varnothing 53mm type 1241.2500 230/400V 50Hz 3 phase 1.1kW 1.5HP L 330mm rotation direction left FIR		
For models:	DV120B, DV120T, DV240B AB 1996		
spare parts for	500111		
	GEV No.	510531	Ref. No. 0501097
	pump cover FIR inlet \varnothing 63mm outlet \varnothing 53mm auxiliary pressure connection M16x1.5mm supporting pressure open turn direction left \varnothing 185mm ID \varnothing 150mm inner height 37mm		
	GEV No.	510612	Ref. No. —
	impellor \varnothing 110mm H 34mm M8R		
	GEV No.	510693	Ref. No. —
	mechanical shaft seal for shaft \varnothing 12mm slide ring ext. \varnothing 24mm slide ring H 15.5mm slide ring int. \varnothing 11mm counter ring mounting \varnothing 24mm height counter ring 8mm counter ring int. \varnothing 13.5mm		
	GEV No.	524416	Ref. No. —
	pump cover gasket thickness 4x4mm Qty 1 pcs		



1

GEV No.	501454	Ref. No.	4273P1850 9540609 9621709
description	pump inlet \varnothing outlet \varnothing type 4273P1850 180-253V 50Hz 1 phase 0.75kW L 190mm rotation direction right capacitor 16 μ F		
spare parts for	501454		
	GEV No.	510695	Ref. No. 9519539
	mechanical shaft seal height counter ring 5.5mm ID \varnothing 11mm		
	GEV No.	521061	Ref. No. 9540713 9621796
	impellor \varnothing 93mm H 27mm shaft intake \varnothing 9x8mm rotation direction left blades 6		
accessories for	501454		
	GEV No.	501000	Ref. No. 9515339
	O-ring EPDM thickness 4mm ID \varnothing 145mm Qty 1 pcs		



1

GEV No.	500698	Ref. No.	9519527 9544294 9621710
description	pump type 4273.2350 230V 50Hz 1 phase 0.55kW 0.75HP L 170mm rotation direction left capacitor 12.5 μ F FIR		
For models:	FV40.2		
spare parts for	500698		
	GEV No.	365014	Ref. No. 0501090
	operating capacitor capacity 12.5 μ F 450V tolerance 5%Hz ambient temperature max. -25 to +85°C \varnothing 35mm L 70mm M8 plastic connection male faston 6.3mm 45S.C3DS.12.5 protection		

Table continues overleaf

Зип Общепит

vsezip.ru

77(812)987-08-81

spare parts for 500698				
	GEV No.	510695	Ref. No.	9519539
mechanical shaft seal height counter ring 5.5mm ID ø 11mm				
	GEV No.	512437	Ref. No.	9519529 9621794
impellor ø 85mm H 27mm rotation direction right shaft ø 9mm blades 6				



1

GEV No.	499066	Ref. No.	9517934 9638047
description	pump inlet ø 28mm outlet ø 24mm type UP60-393 200-240V 50Hz 1 phase 0.25kW L 190mm HANNING		
For models:	FV40.2, FV40.2MIKE2, FV40.2M-MIKE2		
spare parts for 499066			
	GEV No.	365017	Ref. No. —
operating capacitor capacity 5µF 450V tolerance 5% 50/60Hz ambient temperature max. -25 to +85°C ø 28mm L 54mm M8 plastic connection male faston 6.3mm 16.10.08 protection			
	GEV No.	507558	Ref. No. 9523844 9543778 9662632
mechanical shaft seal for shaft ø 7mm height counter ring 5mm ID ø 6.75mm ED ø 20mm mounting ø counter ring 18.5/slide ring 20mm			
	GEV No.	532644	Ref. No. —
O-ring EPDM thickness 3mm ID ø 78mm Qty 1 pcs			

HANNING pumps



1

GEV No.	500700	Ref. No.	9544228 9638029
description	pump inlet ø 28mm outlet ø 24mm type UP60-386 230V 50Hz 1 phase 0.19kW L 190mm capacitor 5µF HANNING		
For models:	DV120.2, FV40.2, FV40.2 AB 2002, FV40.2 AB 2003, FV40.2M, FV40.2MIKE2, FV40.2M-MIKE2		
spare parts for 500700			
	GEV No.	365131	Ref. No. 9520030
capacitor capacity 5µF 450V tolerance 5% 50/60Hz ambient temperature max. -25 to +85°C ø 30mm L 60mm M8 aluminium connection male faston 6.3mm protection			
	GEV No.	507558	Ref. No. 9523844 9543778 9662632
mechanical shaft seal for shaft ø 7mm height counter ring 5mm ID ø 6.75mm ED ø 20mm mounting ø counter ring 18.5/slide ring 20mm			
	GEV No.	524695	Ref. No. 9523267 9643336
impellor ø 72mm H 24mm rotation direction left thread M6L suitable for HANNING blades 6			
	GEV No.	532644	Ref. No. —
O-ring EPDM thickness 3mm ID ø 78mm Qty 1 pcs			



1

GEV No.	499164	Ref. No.	9638051
description	pump inlet ø 28mm outlet ø 24mm type UP60-397 400V 50Hz 1 phase L 190mm		



Зип Общежит

wash pump motors

vsezip.ru

+7(812)987-08-81





1

GEV No.	500982	Ref. No.	9535710 9638041
description	pump inlet ø 28mm outlet ø 26mm type UP60-388 200/240V 50Hz 1 phase 0.22kW L 190mm rotation direction left capacitor 5µF HANNING pump rate 160l/min with metal impellor discharge pressure 0.77bar		
spare parts for	500982		
	GEV No.	365131	Ref. No. 9520030
	capacitor capacity 5µF 450V tolerance 5% 50/60Hz ambient temperature max. -25 to +85°C ø 30mm L 60mm M8 aluminium connection male faston 6.3mm protection		



1

GEV No.	499129	Ref. No.	9532002 9607881 9638050
description	pump type UP60-396 240V 50Hz 1 phase 0.18kW L 166mm rotation direction left capacitor 5µF p max 0.75bar Qmax. 150l/min HANNING without lid		
For models:	FV40.2, FV40.2MIKE2, FV40.2M-MIKE2		
spare parts for	499129		
	GEV No.	524695	Ref. No. 9523267 9643336
	impellor ø 72mm H 24mm rotation direction left thread M6L suitable for HANNING blades 6		
	GEV No.	532644	Ref. No. —
	O-ring EPDM thickness 3mm ID ø 78mm Qty 1 pcs		



1

GEV No.	500288	Ref. No.	0501040
description	pump motor ATB type PF112M/6/4P-11A 2200/4000W 400V 50/60Hz 3 phase L 390mm W 210mm H 270mm 1400/1700rpm shaft ø 20mm		
For models:	DV270B AB 1988, DV270B AB 1992, FV250B AB 1988, FV250B AB 1992		
spare parts for	500288		
	GEV No.	501071	Ref. No. 0403003 9721612
	mechanical shaft seal for shaft ø 25mm ED ø 41mm H 26mm Viton		
	GEV No.	501072	Ref. No. 0403009 9721613
	boot suitable for friction ring ID ø 30mm ED ø 40mm H 7mm		
	GEV No.	501073	Ref. No. 0403010
	slide ring H 8mm ED ø 38mm ID ø 25.7mm ceramic		
	GEV No.	501087	Ref. No. 0620333
	flange for motor		
	GEV No.	501117	Ref. No. 8100217
	nut for wash pump WS 32		
	GEV No.	501118	Ref. No. 8100218
	impellor		
	GEV No.	501119	Ref. No. 8101063
	flange with bolt		



1

GEV No.	500286	Ref. No.	0501024
description	pump motor ATB type RF0.75/4-7 750W 230/400V 50Hz 3 phase L 260mm W 200mm H 190mm 1380rpm shaft ø 19mm		
For models:	DV221		



booster pumps I

Зип Общепит

vsezip.ru

+7(812)987-08-81



1

GEV No.	500060	Ref. No.	0535056
description	pump inlet ø 1" outlet ø 1" type PQM60 230V 50Hz 1 phase 0.37kW PEDRELLO		
accessories for	500060		
	GEV No.	365015	Ref. No. —
	operating capacitor capacity 10µF 400V tolerance 5%Hz ambient temperature max. -25 to +85°C ø 35.5mm L 59mm M8 plastic connection male faston 6.3mm protection		



1

GEV No.	500042	Ref. No.	0535502 0535505 0535509 9624073
description	drain pump 80W 230V inlet ø 24mm outlet ø 24mm 50Hz type KD22B3-679 HANNING		
For models:	DV40T FA, ECO STAR 530F, FR40G AB 1980, FR40GUS AB 1980, FV28G AB 1994, FV28G AB 1997, FV28GFA, FV40GE, FV40N AB 1980, FV40T-FA, FV70TD		
spare parts for	500042		
	GEV No.	510168	Ref. No. —
	fan wheel shaft intake ø 5mm ø 62mm H 14mm		

drain pumps

HANNING





1

GEV No.	501510	Ref. No.	9614202
description	drain pump 200-240V inlet ø 24mm outlet ø 24mm 50/60Hz type BE22B5-052 HANNING coded plug		



1

GEV No.	499307	Ref. No.	9626210
description	drain pump 90W 400V inlet ø 24mm outlet ø 24mm 50Hz type BE22B3-191 HANNING 2600rpm input current 0.4A		
spare parts for	499307		
	GEV No.	510168	Ref. No. —
	fan wheel shaft intake ø 5mm ø 62mm H 14mm		



1

GEV No.	500699	Ref. No.	9515059 9544233
description	drain pump 70W 230V inlet ø 24mm outlet ø 24mm 50Hz type BE22B3-174 HANNING		
For models:	DV120.2, FV40.2, FV40.2 AB 2002, FV40.2 AB 2003, FV40.2M, FV40.2M-MIKE2		
spare parts for	500699		
	GEV No.	510168	Ref. No. —
	fan wheel shaft intake ø 5mm ø 62mm H 14mm		

electric components



booster pumps II

accessories



1	GEV No.	365012	Ref. No.	0501173
description operating capacitor capacity 6.3µF 450V tolerance 5% 50Hz ambient temperature max. -25 to +85°C ø 30mm L 61mm M8 plastic connection male faston 6.3mm protection				
For models: DV40T FA, FV28GFA, FV40TFA, FV70TD				

condensators & interference suppression filters

operating capacitors

plastic



1	GEV No.	365014	Ref. No.	0501090
description operating capacitor capacity 12.5µF 450V tolerance 5% 50Hz ambient temperature max. -25 to +85°C ø 35mm L 70mm M8 plastic connection male faston 6.3mm 45S.C3DS.12.5 protection				
For models: DR70, DV40 AB 1983, DV40 AB 1992, DV40N, DV40T, DV40T FA, DV80 AB 1975, ECO STAR 430F, ECO STAR 530F, FR30G, FR30G AB 1992, FR40G AB 1980, FR40G AB 1983, FR40GUS AB 1980, FR40GUS AB 1983, FV110G, FV20N, FV20T, FV25G AB 1986, FV25G AB 1992, FV28G AB 1994, FV28G AB 1997, FV28GFA, FV40.2, FV40.2 AB 2002, FV40.2 AB 2003, FV40.2M, FV40.2MIKE2, FV40.2M-MIKE2, FV40N AB 1980, FV40N AB 1983, FV40T, FV40TFA, FV70T, FV70TD				



1	GEV No.	365021	Ref. No.	0501136
description operating capacitor capacity 16µF 425V tolerance 5% 50/60Hz ambient temperature max. -25 to +85°C ø 35mm L 73mm single M8 plastic connection male faston 6.3mm 416.10.99 protection				
For models: DV160 AB 1996, DV80 AB 1992, DV80T				

Зип Общепит

vsezip.ru

+7(812)987-08-81

1	GEV No.	365019	Ref. No.	9606122
description operating capacitor capacity 20µF 400V tolerance 5% 50/60Hz ambient temperature max. -25 to +85°C ø 39.5mm L 70mm M8 plastic connection male faston 6.3mm 16.10.25. protection				

1	GEV No.	365012	Ref. No.	0501173
description operating capacitor capacity 6.3µF 450V tolerance 5% 50Hz ambient temperature max. -25 to +85°C ø 30mm L 61mm M8 plastic connection male faston 6.3mm protection				
For models: DV40T FA, FV28GFA, FV40TFA, FV70TD				

metal

1	GEV No.	365131	Ref. No.	9520030
description capacitor capacity 5µF 450V tolerance 5% 50/60Hz ambient temperature max. -25 to +85°C ø 30mm L 60mm M8 aluminium connection male faston 6.3mm protection				
For models: DV120.2, FV40.2, FV40.2 AB 2002, FV40.2 AB 2003, FV40.2M, FV40.2MIKE2, FV40.2M-MIKE2				

filters

RC circuits

1	GEV No.	381218	Ref. No.	0138214 0142006 0142010 9006825 9530873 9543320 9548739 9548957 9549559
description RC circuit 275V cable length 200mm MKP class X2 voltage AC 100Ohm capacity 0.47µF				

electric components



fuses

fine fuses

Зип Общепит

vsezip.ru

+7(812)9879831



1

GEV No.	358699	Ref. No.	0145000
description	fine fuse size ø5x20mm 10A medium lag rated 250V Qty 10 pcs		
For models:	DV120B, DV120T, DV40 AB 1992, DV40N, DV40T, DV40T FA, DV80 AB 1992, DV80T, ECO STAR 430F, ECO STAR 545D, FR30G AB 1992, FV110G, FV20N, FV20T, FV25G AB 1992, FV28GFA, FV30GS, FV40.2, FV40.2 AB 2003, FV40N AB 1992, FV40T, FV40TFA, FV60E AB 1988, FV70T, FV70TD		



1

GEV No.	358696	Ref. No.	0145013
description	fine fuse size ø5x20mm 4A medium lag rated 250V Qty 10 pcs		
For models:	DV120B, DV120T, DV160 AB 1996, DV240B AB 1996, DV270B AB 1992, DV40N, DV40T, DV40T FA, DV80 AB 1992, DV80T, ECO STAR 430F, ECO STAR 545D, FV130B, FV250B AB 1992, FV28GFA, FV70TD		



1

GEV No.	358598	Ref. No.	0145049
description	fine fuse size ø5x20mm 0.63A slow-acting rated 250V Qty 10 pcs		
For models:	DR70, DV100 AB 1980, DV120B, DV160 AB 1980, DV240B AB 1980, DV80, DV80 AB 1975, DV80 AB 1980		

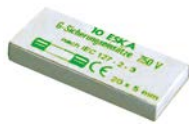

1

GEV No.	358601	Ref. No.	0145048
description	fine fuse size ø5x20mm 1.25A slow-acting rated 250V Qty 10 pcs		
For models:	DR70, DV80 AB 1975		



1

GEV No.	358602	Ref. No.	0145046
description	fine fuse size ø5x20mm 1.6A slow-acting rated 250V Qty 10 pcs		



1

GEV No.	358600	Ref. No.	0145045
description	fine fuse size ø5x20mm 1A slow-acting rated 250V Qty 10 pcs		
For models:	FV28G AB 1994, FV28G AB 1997		



GEV No.	358603	Ref. No.	0145047
description	fine fuse size ø5x20mm 2A slow-acting rated 250V Qty 10 pcs		
For models:	FV40.2M, FV40.2M-MIKE2		



GEV No.	358607	Ref. No.	0145001
description	fine fuse size ø5x20mm 6.3A slow-acting rated 250V Qty 10 pcs		
For models:	DV120B, FV30, FV50		

line circuit breakers

ABL SURSUM



GEV No.	358214	Ref. No.	0145093
description	line circuit breaker 1-pole 10A tripping type K rated 240/415V		
For models:	DV160 AB 1996, DV240B AB 1996, FV130B		



GEV No.	358104	Ref. No.	0145089
description	line circuit breaker 1-pole 16A tripping type B rated 240/415V nominal 16A		
For models:	DV160 AB 1996, DV240B AB 1996, FV130B		



GEV No.	358216	Ref. No.	0145074
description	line circuit breaker 1-pole 16A tripping type K rated 240/415V		



GEV No.	358105	Ref. No.	0145090
description	line circuit breaker 1-pole 20A tripping type B rated 240/415V		
For models:	DV160 AB 1996, DV240B AB 1996, DV270B AB 1992, FV250B AB 1992		

1 electric components



Зип Общепит

GEV No.	400841	Ref. No.	0180503
description	ribbon cable 20-pole L 800mm plug type FC-20P raster size 2.54mm		
For models:	DV120B, DV120T, DV160 AB 1996, DV240B AB 1996, DV270B AB 1992, DV40N, DV40T, DV80T, FV110G, FV130B, FV20T, FV250B AB 1992, FV40T, FV60E AB 1988, FV70T		



GEV No.	358217	Ref. No.	0145094
description	line circuit breaker 1-pole 20A tripping type K rated 240/415V		
For models:	DV270B AB 1992, FV250B AB 1992		



GEV No.	358106	Ref. No.	0145091
description	line circuit breaker 1-pole 25A tripping type B rated 240/415V nominal 25A		



GEV No.	358210	Ref. No.	0145092
description	line circuit breaker 1-pole 4A tripping type K rated 240/415V		

group 4			
GEV No.	400845	Ref. No.	9503172
description	ribbon cable 10-pole L 1800mm		
For models:	ECO STAR 430F		

GEV No.	400846	Ref. No.	9503170
description	ribbon cable 10-pole L 800mm		
For models:	ECO STAR 430F		

electronic magnets

GEV No.	400850	Ref. No.	0140055
description	lifting magnet		

GEV No.	698676	Ref. No.	0457042
description	lifting magnet 24V voltage DC L 55mm W 26mm H 68mm		

intake valves accessories miscellaneous

GEV No.	528422	Ref. No.	0420080
description	ball ø 8mm SS		

electric accessories

cables

ribbon cables

group 1

GEV No.	400816	Ref. No.	0180502
description	ribbon cable 10-pole L 800mm plug type FC-10P raster size 2.54mm		
For models:	DV40 AB 1992, DV40N, DV80 AB 1992, FR30G AB 1992, FV20N, FV20T, FV25G AB 1992, FV30GS, FV40N AB 1992, FV40T, FV70T		

GEV No.	401708	Ref. No.	0180507 9519723
description	ribbon cable 14-pole L 2500mm plug type FC-14P raster size 2.54mm		
For models:	DV120T, DV40T, DV40T FA, DV80T, ECO STAR 545D, FV20T, FV28GFA, FV40T, FV40TFA, FV70T, FV70TD		

GEV No.	400818	Ref. No.	0180558
description	ribbon cable 20-pole L 1800mm plug type FC-20P raster size 2.54mm		
For models:	FV28G AB 1994, FV28G AB 1997		



for cleaning and disinfection machines **3ип Общепит**

connection pieces



1

GEV No.	698694	Ref. No.	0113129
description	connecting fitting ø 35mm 3/4" H 25mm L 35mm W 35mm		



1

GEV No.	698690	Ref. No.	0620367
description	connection angle ø 32mm hose ø 12mm 1/4" H 28mm L 62mm W 32mm		



1

GEV No.	698689	Ref. No.	0620464
description	connection angle ø 32mm hose ø 14mm 3/8" H 20mm L 50mm W 50mm		



1

GEV No.	698685	Ref. No.	0620463
description	connection angle ø 42mm hose ø 20mm 3/4" H 42mm L 70mm W 32mm		

various



1

GEV No.	698725	Ref. No.	9520736
description	bearing ø 8.5mm L 11mm W 8mm H 8mm for reel		
For models:	FV40.2, FV40.2MIKE2, FV40.2M-MIKE2		



1

GEV No.	504792	Ref. No.	9625221
description	cap ø 38mm ID ø 26mm H 22mm 3/4"		



1

GEV No.	698695	Ref. No.	9602351 9705766
description	flap ø 42.4mm L 31mm W 42.4mm H 42.4mm		



1

GEV No.	689005	Ref. No.	9603328 9621469
description	funnel ø 20mm L 56.2mm W 20mm H 30mm M6 content 2kg		



1

GEV No.	698696	Ref. No.	8300670
description	pipe ø 40mm aperture 7mm L 55mm W 40mm H 40mm M6		



1

GEV No.	698722	Ref. No.	0650065
description	rubber sleeve ø 50mm ID ø 40mm H 20mm EPDM for tank		



1

GEV No.	698733	Ref. No.	9500307
description	sealing ring ø 25mm ID ø 11mm H 6.5mm		



1

GEV No.	698724	Ref. No.	9679702
description	set ø 26mm ID ø 4.5mm for U-bend		



1

GEV No.	698728	Ref. No.	0620232
description	spacer bush ø 12.5mm ID ø 8.5mm L 13mm W 12.5mm		

mechanical components, equipment accessories

Зип.Общепит

nozzle holders



1

GEV No.	698732	Ref. No.	8302477
description	spacer ring \varnothing 19mm ID \varnothing 5mm H 5.5mm		

nozzles



1

GEV No.	698734	Ref. No.	9600911
description	injection nozzle \varnothing 26mm ID \varnothing 1mm L 21mm W 22mm 1/8"		



1

GEV No.	698686	Ref. No.	8303773
description	jet \varnothing 30mm W 14mm steam stainless steel 1/2"		



1

GEV No.	699281	Ref. No.	9550394
description	nozzle \varnothing 12.5mm ID \varnothing 6.5mm aperture 2x3.5mm L 69mm		



1

GEV No.	698682	Ref. No.	8304572
description	nozzle \varnothing 13mm ID \varnothing 9.5mm aperture 14x1mm L 67mm W 18mm H 17mm 145° 1/4"		



1

GEV No.	698681	Ref. No.	8304431
description	nozzle \varnothing 13mm ID \varnothing 9.5mm aperture 14x1mm L 73mm W 18mm H 17mm 150° 1/4"		



1

GEV No.	698680	Ref. No.	0620469
description	nozzle \varnothing 80mm ID \varnothing 24mm aperture 6/8mm H 31mm grey		



1

GEV No.	598688	Ref. No.	0620467
description	nozzle holder \varnothing 10mm ID \varnothing 9mm aperture 4.5mm L 35mm W 29.2mm H 24mm 3/8"		



1

GEV No.	698691	Ref. No.	9601608
description	nozzle holder \varnothing 10mm ID \varnothing 9mm aperture 4.5mm L 38mm W 24mm H 29.5mm 3/8"		



1

GEV No.	698684	Ref. No.	0620470
description	nozzle holder \varnothing 24mm ID \varnothing 18mm L 40mm W 45mm H 36mm		

pipes



1

GEV No.	698692	Ref. No.	8304006
description	overflow pipe \varnothing 25mm L 433mm H 155mm		



1

GEV No.	698726	Ref. No.	8300113
description	pipe \varnothing 8mm ID \varnothing 6mm L 40mm W 8mm for ventilation		



1

GEV No.	698735	Ref. No.	8302895
description	retaining ring \varnothing 32mm ID \varnothing 28.5mm H 4mm		



1

GEV No.	698727	Ref. No.	9613045
description	spacer ring \varnothing 34mm ID \varnothing 32mm L 24mm		



door mechanics

			
1			
GEV No.	698697	Ref. No.	830458
description	catch L 98mm W 60mm H 23mm for door		

screw connections

			
1			
GEV No.	698729	Ref. No.	9643458
description	screw connection for wash jet L 14.5mm W 24mm H 30mm grey 3/8"-1/4"		

			
1			
GEV No.	698730	Ref. No.	9654017
description	screw connection L 14.5mm W 24mm H 30mm grey 3/8"		

for dishwashers

drain and intake components

MEIKO

drain /intake bodies





			
1			
GEV No.	501079	Ref. No.	0431051
description	clamping ring ø 125mm		
For models:	DV160 AB 1996, DV240B AB 1996, DV40 AB 1992, DV80 AB 1983, DV80 AB 1992, FR30G AB 1992, FV130B, FV25G AB 1986, FV25G AB 1992, FV30GS, FV40N AB 1992, FV60E AB 1988		

			
1			
GEV No.	501300	Ref. No.	8002887
description	drain fitting complete thread 1 1/2" ED ø 69mm ID ø 40mm		
For models:	DV160 AB 1996, DV240B AB 1996, DV40 AB 1992, DV80 AB 1992, FR30G AB 1992, FV130B, FV25G AB 1992, FV30GS, FV40N AB 1992, FV60E AB 1988		



Зип Общепит

vsezip.ru

+7(812)987-0881

			
1			
GEV No.	522000	Ref. No.	0620219
description	drain fitting thread 1 1/2" ID ø 40mm		
For models:	DV100 AB 1980, DV100 AB 1983, DV120B, DV160 AB 1980, DV160 AB 1983, DV160 AB 1996, DV240B AB 1980, DV240B AB 1983, DV240B AB 1996, DV40 AB 1983, DV40 AB 1992, DV80, DV80 AB 1980, DV80 AB 1983, DV80 AB 1992, FR30G, FR30G AB 1992, FR40G AB 1983, FR40GUS AB 1983, FV130B, FV25G AB 1986, FV25G AB 1992, FV30GS, FV40N AB 1980, FV40N AB 1983, FV40N AB 1992, FV60E AB 1983, FV60E AB 1988		
accessories for	522000		
	GEV No.	501320	Ref. No. —
	flat gasket rubber ED ø 68mm ID ø 48mm thickness 2mm Qty 1 pcs		
	GEV No.	510406	Ref. No. 0408020
	flat gasket fibre ED ø 60mm ID ø 48mm thickness 3mm for thread 1 1/2" Qty 1 pcs		
	GEV No.	522003	Ref. No. 0212005
	hexagonal nut thread 1 1/2" brass		

			
1			
GEV No.	501065	Ref. No.	0237003
description	drain fitting thread 2"		
For models:	DV270B AB 1992, FV120B AB 1980, FV200B, FV240B AB 1980		
accessories for	501065		
	GEV No.	501066	Ref. No. 0237009 0408224
	flat gasket rubber ED ø 85mm ID ø 59.5mm thickness 2mm Qty 1 pcs		
	GEV No.	501123	Ref. No. 8650064
	overflow pipe L 217mm ø 47mm		
	GEV No.	501301	Ref. No. 0237008
	nut stand pipe thread 2" H 16.5mm		

			
1			
GEV No.	501428	Ref. No.	0237100
description	drain fitting thread 2"		
accessories for	501428		
	GEV No.	501066	Ref. No. 0237009 0408224
	flat gasket rubber ED ø 85mm ID ø 59.5mm thickness 2mm Qty 1 pcs		

mechanical components, equipment accessories

Зип Общепит
vsezip.ru
+7(812)987-08-81



1

GEV No.	501165	Ref. No.	0237028
description	drain fitting with safety nut thread 2" ED ø 80mm ID ø 53mm		
For models:	DV260B, FV120B AB 1983, FV240B AB 1983		



1

GEV No.	501299	Ref. No.	8660464
description	hexagonal nut thread 1/2" H 5mm SS WS 27 Qty 1 pcs		
For models:	DV120T, DV40N, DV40T, DV40T FA, DV80T		



1

GEV No.	510406	Ref. No.	0408020
description	flat gasket fibre ED ø 60mm ID ø 48mm thickness 3mm for thread 1½" Qty 1 pcs		
For models:	DV100 AB 1983, DV120B, DV160 AB 1983, DV160 AB 1996, DV240B AB 1983, DV240B AB 1996, DV40 AB 1983, DV40 AB 1992, DV80, DV80 AB 1983, DV80 AB 1992, FR30G, FR30G AB 1992, FR40G AB 1983, FR40GUS AB 1983, FV130B, FV25G AB 1986, FV25G AB 1992, FV30GS, FV40N AB 1983, FV40N AB 1992, FV60E AB 1983, FV60E AB 1988		



GEV No.	522003	Ref. No.	0212005
description	hexagonal nut thread 1½" brass		
For models:	DV100 AB 1980, DV100 AB 1983, DV120B, DV160 AB 1980, DV160 AB 1983, DV160 AB 1996, DV240B AB 1980, DV240B AB 1983, DV240B AB 1996, DV270B AB 1992, DV40 AB 1983, DV40 AB 1992, DV80, DV80 AB 1980, DV80 AB 1983, DV80 AB 1992, FR30G, FR30G AB 1992, FR40G AB 1980, FR40G AB 1983, FR40GUS AB 1980, FR40GUS AB 1983, FV130B, FV250B AB 1992, FV25G AB 1986, FV25G AB 1992, FV30GS, FV40N AB 1980, FV40N AB 1983, FV40N AB 1992, FV60E AB 1983, FV60E AB 1988		



1

GEV No.	510875	Ref. No.	0408214
description	flat gasket rubber ED ø 68mm ID ø 48mm thickness 2mm Qty 1 pcs		
For models:	DV100 AB 1980, DV100 AB 1983, DV120B, DV160 AB 1980, DV160 AB 1983, DV160 AB 1996, DV240B AB 1980, DV240B AB 1983, DV240B AB 1996, DV40 AB 1983, DV40 AB 1992, DV80, DV80 AB 1980, DV80 AB 1983, DV80 AB 1992, FR30G, FR30G AB 1992, FR40G AB 1980, FR40G AB 1983, FR40GUS AB 1980, FR40GUS AB 1983, FV130B, FV25G AB 1986, FV25G AB 1992, FV30GS, FV40N AB 1980, FV40N AB 1983, FV40N AB 1992, FV60E AB 1983, FV60E AB 1988		



1

GEV No.	501054	Ref. No.	8000194 8001008
description	intake body		
For models:	FV25G AB 1986, FV25G AB 1992		



1

GEV No.	501066	Ref. No.	0237009 0408224
description	flat gasket rubber ED ø 85mm ID ø 59.5mm thickness 2mm Qty 1 pcs		
For models:	DV270B AB 1992		



1

GEV No.	501146	Ref. No.	8002263
description	intake body		
For models:	ECO STAR 430F, ECO STAR 530F, FV28GFA		



1

GEV No.	504465	Ref. No.	9515234
description	gasket suitable for MEIKO for air valve ED ø 14mm ID ø 9mm EPDM thickness 1.6mm		
For models:	FV40.2, FV40.2M-MIKE2		



1

GEV No.	501147	Ref. No.	8002264
description	intake body		
For models:	ECO STAR 430F, ECO STAR 530F		



1

GEV No.	501148 ¹	Ref. No.	8002534
description	intake body		
For models:	ECO STAR 430F, ECO STAR 530F, FV28G AB 1994		

¹for drain pump





Зип Общепит

vsezip.ru

8 (812) 987-08-81

			
1			
GEV No.	501215	Ref. No.	8000021
description	intake body		
For models:	FR30G, FR30G AB 1992, FR40G AB 1983, FR40GUS AB 1983		

			
1			
GEV No.	501218	Ref. No.	8000032
description	intake body ED ø 128mm hose ø 40mm		
For models:	FV40N AB 1983, FV40N AB 1992, FV60E AB 1988		

			
1			
GEV No.	501232	Ref. No.	8000056
description	intake body		

			
1			
GEV No.	501112	Ref. No.	8000855
description	intake body ED ø 130mm ID ø 55mm hose ø 55mm		
For models:	FV130B		

			
1			
GEV No.	501233	Ref. No.	8000065
description	intake body		
For models:	DV160 AB 1996, DV240B AB 1996, DV40 AB 1983, DV40 AB 1992, DV80 AB 1983, DV80 AB 1992		

			
1			
GEV No.	501058	Ref. No.	8003301
description	intake body inlet fitting equiv. no. 8003301		
For models:	DV40T FA, ECO STAR 430F, ECO STAR 530F		

			
1			
GEV No.	501254	Ref. No.	8002176
description	intake body		
For models:	FV30GS		

			
1			
GEV No.	501243	Ref. No.	8000082
description	intake body kit		
For models:	DV120B, DV240B AB 1983, DV80		

			
1			
GEV No.	501152	Ref. No.	8003831
description	intake body angled		
For models:	ECO STAR 430F, ECO STAR 530F, FV28GFA, FV70TD		

			
1			
GEV No.	501155	Ref. No.	8004844
description	intake body pump sump		
For models:	ECO STAR 530F, FV20N, FV20T, FV40T, FV40TFA, FV70T, FV70TD		

			
1			
GEV No.	501157	Ref. No.	8004985
description	intake body angled		
For models:	ECO STAR 430F, ECO STAR 530F, FV28GFA, FV40TFA, FV70TD		

mechanical components, equipment accessories

Зип-Общепит

vsezip.ru

+7(812)987-08-81



			
GEV No.	501199	Ref. No.	0620430
description	intake body pump sump ED ø 160mm ID ø 41mm hose ø 21mm		
For models:	ECO STAR 430F, FV28G AB 1994, FV28G AB 1997, FV28GFA		

			
GEV No.	501149	Ref. No.	8003639
description	intake body pump sump with stand pipe		
For models:	FV110G, FV20N, FV20T, FV40T, FV70T, FV70TD		

			
GEV No.	501150	Ref. No.	8003669
description	intake body pump sump with stand pipe		
For models:	DV40 AB 1992, DV80 AB 1992		

			
GEV No.	501151	Ref. No.	8003787
description	intake body pump sump with stand pipe		
For models:	DV120B		

			
GEV No.	501258	Ref. No.	8004721
description	intake body with electrodes thread 1½" ID ø 55mm hose ø 63mm		
For models:	DV120T		

			
GEV No.	501063	Ref. No.	8004720
description	intake body without electrodes thread 1¼" ID ø 35mm hose ø 40mm		
For models:	DV40N, DV40T, DV40T FA, DV80T, ECO STAR 545D		
accessories for	501063		
	GEV No.	501009	Ref. No. 0401061
	O-ring EPDM thickness 3.53mm ID ø 206.5mm Qty 1 pcs		
	GEV No.	501037	Ref. No. 0620457
	overflow pipe L 255mm ø 33mm		

accessories for 501035			
GEV No.	501205	Ref. No.	0620447 8070117
ø overflow pipe L 214mm ø 33mm			

			
GEV No.	501301	Ref. No.	0237008
description	nut stand pipe thread 2" H 16.5mm		
For models:	DV270B AB 1992		

			
GEV No.	501094	Ref. No.	8000022
description	opposite support ED ø 117mm ID ø 61mm thickness 1.4mm 9 holes hole ø 7mm		
For models:	DV100 AB 1983, DV120B, DV160 AB 1983, DV160 AB 1996, DV240B AB 1983, DV240B AB 1996, DV260B, DV40 AB 1983, DV40 AB 1992, DV80, DV80 AB 1983, DV80 AB 1992, FR30G, FR30G AB 1992, FR40G AB 1983, FR40GUS AB 1983, FV120B AB 1983, FV130B, FV240B AB 1983, FV25G AB 1986, FV25G AB 1992, FV30GS, FV40N AB 1983, FV40N AB 1992, FV60E AB 1983, FV60E AB 1988		

			
GEV No.	100809	Ref. No.	0401016
description	O-ring EPDM thickness 2mm ID ø 21mm Qty 1 pcs		
For models:	DV120.2, DV120T, DV40N, DV40T, DV40T FA, DV80T, ECO STAR 545D, FV40.2, FV40.2 AB 2002, FV40.2M, FV40.2M-MIKE2		

			
GEV No.	501009	Ref. No.	0401061
description	O-ring EPDM thickness 3.53mm ID ø 206.5mm Qty 1 pcs		
For models:	DV120.2, DV120B, DV120T, DV40 AB 1992, DV40N, DV40T, DV40T FA, DV80 AB 1992, DV80T, ECO STAR 530F, ECO STAR 545D, FV110G, FV20N, FV20T, FV40T, FV40TFA, FV70T, FV70TD		

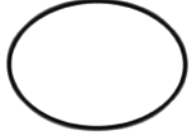
			
GEV No.	501173	Ref. No.	0401070
description	O-ring EPDM thickness 3mm ID ø 122mm Qty 1 pcs		
For models:	ECO STAR 430F, FV28G AB 1994, FV28G AB 1997, FV28GFA		





Зип Общепит

vsezip.ru

+7(812)987-08-81

 <p>1</p>			
GEV No.	501008	Ref. No.	0401045
description	O-ring EPDM thickness 3mm ID ø 64mm Qty 1 pcs		
For models:	DV100 AB 1983, DV120B, DV160 AB 1983, DV160 AB 1996, DV240 AB 1983, DV240B AB 1996, DV260B, DV40 AB 1983, DV40 AB 1992, DV80, DV80 AB 1983, DV80 AB 1992, FR30G, FR30G AB 1992, FR40G AB 1983, FR40GUS AB 1983, FV120B AB 1983, FV130B, FV240B AB 1983, FV25G AB 1986, FV25G AB 1992, FV30GS, FV40N AB 1983, FV40N AB 1992, FV60E AB 1983, FV60E AB 1988		

 <p>1</p>			
GEV No.	532682	Ref. No.	9600791
description	O-ring EPDM thickness 4mm ID ø 188mm Qty 1 pcs Shore 70°		

 <p>1</p>			
GEV No.	501107	Ref. No.	8000471
description	reinforcing ring ED ø 56mm ID ø 53mm L 20mm thickness 1.5mm stainless steel		
For models:	DV120B, DV80, FV130B		

filters			
 <p>1</p>			
GEV No.	698625	Ref. No.	9607788
description	cover cap for filter ø 74mm H 36mm		
For models:	FV40.2, FV40.2M-MIKE2		

 <p>1</p>			
GEV No.	524338	Ref. No.	0620358
description	drain filter for overflow pipe ø 61mm H 98mm		

 <p>1</p>			
GEV No.	517770	Ref. No.	9540851
description	flat filter for dishwasher H 11mm L 294mm W 300mm SS		

 <p>1</p>			
GEV No.	517771	Ref. No.	9540865
description	flat filter for dishwasher H 33mm L 300mm W 286mm SS		

 <p>1</p>			
GEV No.	507559	Ref. No.	0251102 9547242 9637803
description	flat filter L 298mm W 286mm		

 <p>1</p>			
GEV No.	501437	Ref. No.	9612003
description	intake filter ø 195mm H 170mm		

 <p>1</p>			
GEV No.	501438	Ref. No.	9612087
description	intake filter ø 230mm H 360mm		

 <p>1</p>			
GEV No.	501181	Ref. No.	9514944 961199 9611991
description	round filters ø 125mm H 125mm		
For models:	FV40.2, FV40.2MIKE2, FV40.2M-MIKE2		

 <p>1</p>			
GEV No.	517731	Ref. No.	8001109
description	round filters ø 135mm H 70mm		

mechanical components, equipment accessories

Зип Общепит

vsezip.ru

+7(812)987-08-81



1

GEV No.	501200	Ref. No.	0620431
description	round filters ø 160mm H 56mm		
For models:	ECO STAR 430F, FV28G AB 1994, FV28G AB 1997, FV28GFA		



1

GEV No.	517769	Ref. No.	9538626
description	round filters ø 190mm H 170mm plastic hole ø 26mm		



1

GEV No.	501023	Ref. No.	0620346
description	round filters ø 200mm H 94mm		
For models:	DV120B, DV120T, DV40 AB 1992, DV40N, DV40T, DV40T FA, DV80 AB 1992, DV80T, ECO STAR 530F, ECO STAR 545D, FV110G, FV20N, FV20T, FV40T, FV40TFA, FV70T, FV70TD		



1

GEV No.	507557 ¹	Ref. No.	9502656 9502657 9502667 9630597
description	round filters ø 80mm H 56mm		

¹for drain pump

1

GEV No.	501053	Ref. No.	8000193
description	round filters suction		
For models:	FV25G AB 1986		



1

GEV No.	501207	Ref. No.	0620500
description	round filters suction ø 133mm H 45mm		
For models:	DV100 AB 1983, DV120B, DV160 AB 1983, DV160 AB 1996, DV240B AB 1983, DV240B AB 1996, DV40 AB 1983, DV40 AB 1992, DV80, DV80 AB 1983, DV80 AB 1992, FR30G, FR30G AB 1992, FR40G AB 1983, FR40GUS AB 1983, FV25G AB 1992, FV30GS, FV40N AB 1983, FV40N AB 1992, FV60E AB 1983, FV60E AB 1988		



1

GEV No.	501091	Ref. No.	0620501
description	round filters suction ø 135mm H 100mm		
For models:	FV130B		



1

GEV No.	501124	Ref. No.	8680031
description	round filters suction/ with locking ring H 101mm		
For models:	DV260B, FV120B AB 1983, FV240B AB 1983		

overflow pipes



1

GEV No.	524815	Ref. No.	0620456
description	extension for overflow pipe ø 45mm ID ø 41mm L 132mm		



1

GEV No.	501038	Ref. No.	0620600
description	overflow pipe L 100mm ø 40mm		
For models:	FR30G, FR30G AB 1992, FR40G AB 1983, FR40GUS AB 1983, FV25G AB 1992		



Зип Общепит

vsezip.ru

+7(812)987-08-81



1

GEV No.	501208	Ref. No.	0620601
description	overflow pipe L 120mm ø 40mm		
For models:	FR30G AB 1992, FV30GS, FV40N AB 1980, FV40N AB 1983, FV40N AB 1992, FV60E AB 1983, FV60E AB 1988		



1

GEV No.	501122	Ref. No.	8650009
description	overflow pipe L 195mm ø 40mm		
For models:	DR90, DV111, DV111E, FR30G AB 1992, FV130B		



1

GEV No.	501092	Ref. No.	0620602
description	overflow pipe L 130mm ø 40mm		
For models:	FR30G AB 1992, FR40G AB 1980, FR40GUS AB 1980		



1

GEV No.	501205	Ref. No.	0620447 8070117
description	overflow pipe L 214mm ø 33mm		
For models:	DV40N, DV40T, DV40T FA		



1

GEV No.	501132	Ref. No.	0620347
description	overflow pipe L 140mm ø 30mm		
For models:	ECO STAR 430F, ECO STAR 530F, FV110G, FV20N, FV20T, FV28G AB 1994, FV28G AB 1997, FV28GFA, FV40T, FV40TFA, FV70T, FV70TD		



1

GEV No.	501123	Ref. No.	8650064
description	overflow pipe L 217mm ø 47mm		
For models:	DV270B AB 1992, FV250B AB 1992		



1

GEV No.	501209	Ref. No.	0620603
description	overflow pipe L 140mm ø 40mm		
For models:	DV100 AB 1983, DV120B, DV160 AB 1983, DV160 AB 1996, DV240B AB 1983, DV240B AB 1996, DV40 AB 1983, DV40 AB 1992, DV80, DV80 AB 1983, DV80 AB 1992, FR30G AB 1992		



1

GEV No.	501037	Ref. No.	0620457
description	overflow pipe L 255mm ø 33mm		
For models:	DV120T, DV40N, DV40T, DV40T FA, ECO STAR 545D		



1

GEV No.	501133	Ref. No.	0620348
description	overflow pipe L 175mm ø 30mm		
For models:	DV120B, DV40 AB 1992, DV80 AB 1992		



1

GEV No.	524375	Ref. No.	8101478
description	overflow pipe L 300mm ø 50mm		

mechanical components, equipment accessories

Зип.Общепит

dosing containers

vsezip.ru

7(812)987-08-81



1

GEV No.	517732	Ref. No.	8255595
description	overflow pipe L 365mm ø 50mm		



1

GEV No.	517772	Ref. No.	9514931
description	standpipe ø 50mm L 150mm		

containers

container lids



1

GEV No.	501185	Ref. No.	0620127
description	cap		
For models:	DR90, DV111, DV111E, DV250B, FV60 AB 1973		



1

GEV No.	501386	Ref. No.	9500040
description	cap ø 62.5mm suitable for MEIKO		



1

GEV No.	501257	Ref. No.	8004424
description	cleaner container		
For models:	ECO STAR 545D, FV28G AB 1994, FV28G AB 1997, FV28GFA		



1

GEV No.	501067	Ref. No.	0260028
description	dosing container		
For models:	DV100 AB 1980, DV100 AB 1983, DV120B, DV160 AB 1980, DV240B AB 1980, DV260B, DV40 AB 1983, DV80, DV80 AB 1980, DV80 AB 1983, FR40G AB 1976, FR40G AB 1980, FR40G AB 1983, FR40GUS AB 1976, FR40GUS AB 1980, FR40GUS AB 1983, FV120B AB 1980, FV120B AB 1983, FV240B AB 1980, FV240B AB 1983, FV30, FV40N AB 1980, FV40N AB 1983, FV40N AB 1992, FV50, FV50 M, FV60E AB 1983, FV60E AB 1988		



Зип Общепит

vsezip.ru

+7(812)987-08-81



1

GEV No.	501002	Ref. No.	0260040
description	rinse aid container		



1

GEV No.	501059	Ref. No.	8003830
description	rinse aid container		
For models:	DV120T, DV160 AB 1996, DV240B AB 1996, DV40N, DV40T, DV40T FA, DV80T, ECO STAR 430F, ECO STAR 530F, ECO STAR 545D, FR30G AB 1992, FV110G, FV130B, FV20N, FV20T, FV250B AB 1992, FV28G AB 1994, FV28G AB 1997, FV28GFA, FV40T, FV40TFA, FV70T, FV70TD		

salt tanks









1

GEV No.	524177	Ref. No.	9532505	
description	lid ø 69mm H 20mm for salt tank ID ø 50mm			
accessories for	524177			
	GEV No.	524148	Ref. No.	—
	O-ring EPDM thickness 3.53mm ID ø 40.86mm Qty 1 pcs			



1

GEV No.	510929	Ref. No.	0270106	
description	salt tank ø 120mm H 117mm hose ø 10mm mounting ø 70mm overall height 157mm			
For models:	ECO STAR 545D			
spare parts for	510929			
	GEV No.	506015	Ref. No.	—
	O-ring EPDM thickness 3.53mm ID ø 39.69mm Qty 1 pcs			
	GEV No.	510018	Ref. No.	—
	nut ø 92mm H 10.5mm for salt tank ID ø 64mm			
	GEV No.	524177	Ref. No.	9532505
	lid ø 69mm H 20mm for salt tank ID ø 50mm			
accessories for	510929			
	GEV No.	510071	Ref. No.	—
	flat gasket rubber ED ø 81mm ID ø 68mm thickness 3mm for salt tank Qty 1 pcs			
	GEV No.	510654	Ref. No.	—
	gasket H 6mm D1 ø 82mm D2 ø 68mm			
	GEV No.	510883	Ref. No.	9500825
	gasket rubber ED ø 86mm ID ø 66mm thickness 2mm for salt tank Qty 1 pcs			

accessories



1

GEV No.	510883	Ref. No.	9500825
description	gasket rubber ED ø 86mm ID ø 66mm thickness 2mm for salt tank Qty 1 pcs		
For models:	ECO STAR 545D		

boilers

boilers for dishwashers



1

GEV No.	501159	Ref. No.	8400304 8400328 8400338
description	boiler		
For models:	FV40TFA, FV70TD		



1

GEV No.	501260	Ref. No.	8400112
description	boiler		
For models:	FV40N AB 1992, FV60E AB 1988		



1

GEV No.	501261	Ref. No.	8400122
description	boiler		
For models:	FR30G AB 1992, FV25G AB 1992, FV30GS		



1

GEV No.	501265	Ref. No.	8400172 8400271 8400271/8004085/90
description	boiler		



1

GEV No.	501266	Ref. No.	8400208
description	boiler		
For models:	DV40 AB 1992		

Зип Общепит

vsezip.ru

+7(812)987-08-81



1

GEV No.	501268	Ref. No.	8400280
description	boiler		
For models:	FV28G AB 1994, FV28G AB 1997		



1

GEV No.	501279	Ref. No.	8400267
description	boiler		
For models:	FV110G, FV20N, FV20T, FV40T, FV70T		



1

GEV No.	501285	Ref. No.	8400030 8400269
description	boiler		
For models:	DV120B, DV120T, DV80 AB 1983, DV80 AB 1992, DV80T, ECO STAR 545D, FV130B		



1

GEV No.	501304	Ref. No.	8400316 8400357
description	boiler		
For models:	DV40T FA		



1

GEV No.	501305	Ref. No.	9505183 9506370
description	boiler 3000W		
For models:	ECO STAR 430F, ECO STAR 530F		



Зип Общепит

vsezip.ru

+7(812)987-08-81

 <p>1</p>			
GEV No.	501306	Ref. No.	9505184 9506365 9684165
description	boiler 4500W ø 150mm L 450mm		
For models:	ECO STAR 430F, ECO STAR 530F		

 <p>1</p>			
GEV No.	501170	Ref. No.	0270063
description	softener 8 row L 385mm W 435mm		

accessories			
 <p>1</p>			
GEV No.	508420	Ref. No.	9601016
description	flap for steam generator rubber ø 37mm ID ø 25mm thickness 5mm built-in version		

housing and bezels			
miscellaneous			
 <p>1</p>			
GEV No.	524575	Ref. No.	0620455
description	spacer for cover plastic L 22mm ID ø 4.5mm ED ø 12mm		

 <p>1</p>			
GEV No.	501113	Ref. No.	8000978
description	T-piece		

hood mechanics for dishwashers			
bolts			
 <p>1</p>			
GEV No.	524774	Ref. No.	8000220
description	bolt ED ø 12mm L 51mm thread M8x1.25 for hood mechanics WS 17		

softener cartridges			
softening columns			
 <p>1</p>			
GEV No.	530006	Ref. No.	0270062
description	softener		

 <p>1</p>			
GEV No.	501238	Ref. No.	8000071
description	bolt hood mechanics		
For models:	DR70, DV100 AB 1983, DV120, DV120B, DV160 AB 1983, DV160 AB 1996, DV240B AB 1983, DV240B AB 1996, DV260B, DV40 AB 1983, DV40 AB 1992, DV80, DV80 AB 1975, DV80 AB 1980, DV80 AB 1983, DV80 AB 1992		

 <p>1</p>			
GEV No.	530000	Ref. No.	0270064
description	softener 4-fold L 380mm W 180mm		

spring holders			
 <p>1</p>			
GEV No.	524818	Ref. No.	8004144
description	bracket for spring for hood mechanics		

mechanical components, equipment accessories

springs



1

GEV No.	517736	Ref. No.	0431067
description	roller spring W 40mm ID ø 36mm lug length 26.75mm mounting distance 20mm		



1

GEV No.	517737	Ref. No.	0431069
description	roller spring W 40mm ID ø 41mm lug length 29mm mounting distance 20mm		
For models:	FV130B		

guide bars



1

GEV No.	501390	Ref. No.	8000161
description	guide bar L 506mm for hood for dishwasher		



1

GEV No.	524336	Ref. No.	0463053
description	guide bar L 627mm mounting pos. left for hood mechanics		

Зип Общепит

vsezip.ru

+7(812)987-08-81



1

GEV No.	524337	Ref. No.	0463052
description	guide bar L 627mm mounting pos. right for hood mechanics		

linkage

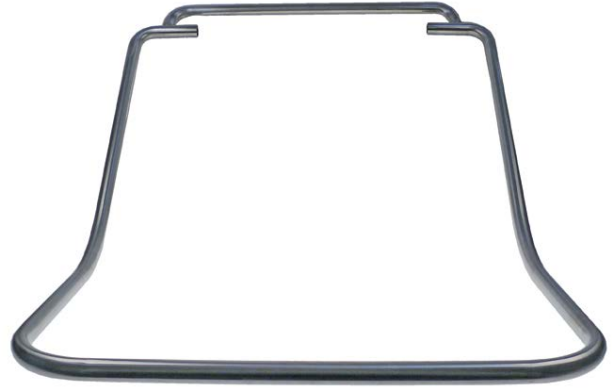

1

GEV No.	501276	Ref. No.	0251103 8004146
description	linkage hood mechanics		
For models:	DV120.2, DV120T, DV40N, DV40T, DV40T FA, DV80T, ECO STAR 545D		

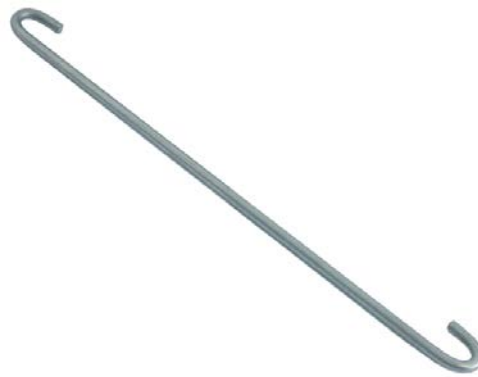

1

GEV No.	501239	Ref. No.	8000072
description	tie bar hood mechanics		
For models:	DR70, DR90, DV100 AB 1983, DV111, DV111E, DV120, DV120B, DV160 AB 1983, DV160 AB 1996, DV240B AB 1983, DV240B AB 1996, DV40 AB 1983, DV40 AB 1992, DV80, DV80 AB 1975, DV80 AB 1980, DV80 AB 1983, DV80 AB 1992		



Зип Общепит

vsezip.ru

+7(812)987-08-81

hood handles

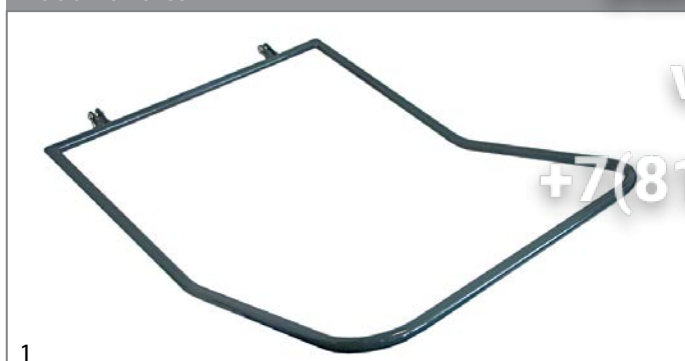

1	GEV No.	501237	Ref. No.	8000070
	description	hood handle		
	For models:	DR70, DR90, DV100 AB 1983, DV111, DV111E, DV80 AB 1975		

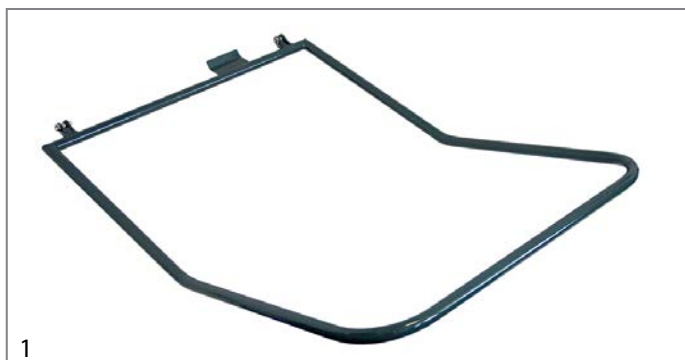

1	GEV No.	501250	Ref. No.	8000716
	description	hood handle		
	For models:	DV120, DV120B, DV40 AB 1983, DV40 AB 1992, DV80, DV80 AB 1980, DV80 AB 1983, DV80 AB 1992		

rollers

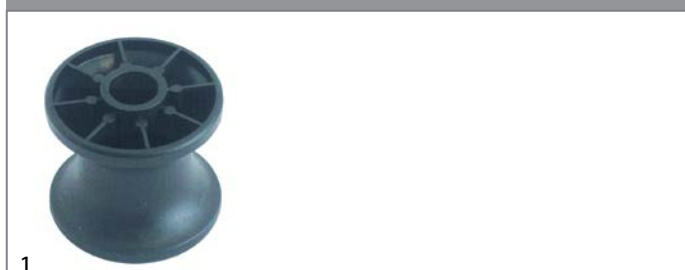

1	GEV No.	501036	Ref. No.	0620451
	description	roller hood mechanics		
	For models:	DV120.2, DV120T, DV40N, DV40T, DV40T FA, DV80T, ECO STAR 545D		



1	GEV No.	501188	Ref. No.	0620148
	description	roller hood mechanics		
	For models:	DR70, DR90, DV111, DV111E, DV120, DV120B, DV160 AB 1983, DV160 AB 1996, DV240B AB 1983, DV240B AB 1996, DV250B, DV260B, DV40 AB 1983, DV40 AB 1992, DV80, DV80 AB 1975, DV80 AB 1980, DV80 AB 1983, DV80 AB 1992		

1	GEV No.	511596	Ref. No.	0620149
	description	roller ø 30mm H 16mm plastic cream hole ø 8.5mm		

miscellaneous



1	GEV No.	501035	Ref. No.	0620449
	description	bearing for hood linkage		
	For models:	DV120.2, DV120T, DV40N, DV40T, DV40T FA, DV80T, ECO STAR 545D		



1	GEV No.	524775	Ref. No.	8004480
	description	lid for hood mechanics ED ø 32mm stainless steel H 1.7mm		



1	GEV No.	501034	Ref. No.	0620445
	description	slide bearing hood mechanics		
	For models:	DV120.2, DV120T, DV40N, DV40T, DV40T FA, DV80T, ECO STAR 545D		



1	GEV No.	501187	Ref. No.	0620146
	description	slide bearing hood mechanics		
	For models:	DR70, DR90, DV100 AB 1980, DV100 AB 1983, DV111, DV111E, DV120, DV120B, DV160 AB 1980, DV160 AB 1983, DV160 AB 1996, DV221, DV240B AB 1980, DV240B AB 1983, DV240B AB 1996, DV40 AB 1983, DV40 AB 1992, DV80, DV80 AB 1975, DV80 AB 1980, DV80 AB 1983, DV80 AB 1992		

mechanical components, equipment accessories

Зип-Общепит

air trap accessories

basket guides

miscellaneous



1

GEV No.	699282	Ref. No.	9501104
description	guide for basket transport L 70mm W 30mm H 30mm		

air traps

air traps



1

GEV No.	501018	Ref. No.	0620244
description	air trap		

For models: DV100 AB 1980, DV100 AB 1983, DV120B, DV120T, DV160 AB 1980, DV160 AB 1983, DV160 AB 1996, DV240B AB 1980, DV240B AB 1983, DV240B AB 1996, DV260B, DV270B AB 1988, DV270B AB 1992, DV40 AB 1983, DV40 AB 1992, DV40N, DV40T, DV40T FA, DV80, DV80 AB 1980, DV80 AB 1983, DV80 AB 1992, DV80T, ECO STAR 530F, FR30G, FR30G AB 1992, FR40G AB 1980, FR40G AB 1983, FR40GUS AB 1980, FR40GUS AB 1983, FV110G, FV120B AB 1980, FV120B AB 1983, FV130B, FV20N, FV20T, FV240B AB 1980, FV250B AB 1988, FV250B AB 1992, FV25G AB 1986, FV25G AB 1992, FV28G AB 1994, FV28G AB 1997, FV28GFA, FV30GS, FV40N AB 1980, FV40N AB 1983, FV40N AB 1992, FV40T, FV40TFA...(Other models you can see in the webshop)

accessories for 501018



rubber sleeve



1

GEV No.	501179	Ref. No.	9515955
description	air trap L 52mm W 19mm H 56mm thread 3/8" hose ø 6mm plastic		
For models:	FV40.2, FV40.2MIKE2, FV40.2M-MIKE2		

accessories for 501179



flat gasket rubber ED ø 26mm ID ø 18mm thickness 2mm Qty 1 pcs



nut thread 3/8" H 6mm brass WS 22 Qty 1 pcs

vsezip.ru

+7(812)987-08-81

GEV No.	501043	Ref. No.	0650001
----------------	--------	-----------------	---------

description rubber sleeve

For models: DV100 AB 1980, DV100 AB 1983, DV120B, DV160 AB 1980, DV160 AB 1983, DV160 AB 1996, DV240B AB 1980, DV240B AB 1983, DV240B AB 1996, DV260B, DV270B AB 1988, DV270B AB 1992, DV40 AB 1983, DV40 AB 1992, DV40N, DV40T, DV40T FA, DV80, DV80 AB 1983, DV80 AB 1992, DV80T, ECO STAR 530F, FR30G, FR30G AB 1992, FR40G AB 1980, FR40G AB 1983, FR40GUS AB 1980, FR40GUS AB 1983, FV110G, FV120B AB 1980, FV120B AB 1983, FV130B, FV20N, FV20T, FV240B AB 1980, FV250B AB 1988, FV250B AB 1992, FV25G AB 1986, FV25G AB 1992, FV28G AB 1994, FV28G AB 1997, FV28GFA, FV30GS, FV40GE, FV40N AB 1980, FV40N AB 1983, FV40T, FV40TFA, FV60E AB 1983, FV60E AB 1988...(Other models you can see in the webshop)

mechanics for flight type dishwashers



1

GEV No.	524563	Ref. No.	9501778
description	bolt for transport system L 26mm ø 6mm suitable for MEIKO		

accessories for 524563



GEV No.	104447	Ref. No.	0341050
description	clamping washer nominal-ø 5.7mm ED ø 11.7mm spring steel thickness 0.4mm		



1

GEV No.	511662	Ref. No.	8100868
description	bracket for roller spring L 95mm W 65mm H 60mm		



1

GEV No.	524554	Ref. No.	0620311 9500364
description	clip for round belt L 25mm W 25mm H 10mm suitable for MEIKO		



1

GEV No.	524551	Ref. No.	0620111
description	connector for tappet L 123mm W 20mm H 29mm hole ø 9mm suitable for COMENDA, MEIKO		



1

GEV No.	524339	Ref. No.	8132347
description	guide for transport system L 115mm W 30.6mm H 30.5mm hole ø 6mm suitable for MEIKO		



Зип Общепит

vsezip.ru

+7(812)987-08-81

	1
GEV No.	524559
Ref. No.	8231181
description	guide roller ID ø 20mm ED ø 33mm

	1
GEV No.	694464 ¹
Ref. No.	0440011
description	round belt ø 10mm Lmm Qty supplied by meter



¹by the meter

	1
GEV No.	501365
Ref. No.	0620223
description	tappet for dishwasher

	1
GEV No.	524549
Ref. No.	0620271
description	tappet for dishwasher L 126mm W 51mm H 73mm hole ø 9mm suitable for MEIKO

	1
GEV No.	524550
Ref. No.	0620270
description	tappet for dishwasher L 126mm W 52mm H 73mm hole ø 9mm suitable for MEIKO

	1
GEV No.	524566
Ref. No.	8130077-02
description	tappet for dishwasher L 45mm W 38mm H 50mm hole ø 6mm suitable for MEIKO

	1
GEV No.	524564
Ref. No.	8130035
description	tappet for dishwasher L 50mm W 32mm hole ø 6.5mm thickness 6mm suitable for MEIKO
accessories for	524564
	GEV No. 104447 Ref. No. 0341050
	clamping washer nominal-ø 5.7mm ED ø 11.7mm spring steel thickness 0.4mm
	GEV No. 524563 Ref. No. 9501778
	bolt for transport system L 26mm ø 6mm suitable for MEIKO

	1
GEV No.	524565
Ref. No.	9527672-03
description	tappet for dishwasher rotary L 84mm H 50mm thickness 11mm suitable for MEIKO

pulleys	
	1
GEV No.	524560
Ref. No.	8230575 9647983
description	V-belt pulley single disc ø 170mm shaft intake ø 20mm groove depth 14mm disc width 29mm groove width 24mm overall width 60mm plastic for dishwasher

backflow preventers	
backflow preventers	
	1
GEV No.	501135
Ref. No.	0620460 9001435
description	backflow preventer
For models:	DV40T FA, FV28GFA, FV40TFA, FV70TD
accessories for	501135
	GEV No. 501137 Ref. No. 0650076
	sealing ring

mechanical components, equipment accessories

Зип Общепит

vsezip.ru

+7(812)987-08-81



1

GEV No.	524814	Ref. No.	9523195
description	backflow preventer		
For models:	FV40.2, FV40.2M-MIKE2		



1

GEV No.	501020	Ref. No.	0620334
description	backflow preventer connection 13 dishwasher		
For models:	DV120B, DV120T, DV160 AB 1996, DV240B AB 1996, DV40 AB 1992, DV40N, DV40T, DV80 AB 1992, DV80T, ECO STAR 430F, ECO STAR 530F, ECO STAR 545D, FR30G AB 1992, FV110G, FV130B, FV20N, FV20T, FV25G AB 1992, FV28G AB 1994, FV28G AB 1997, FV30GS, FV40N AB 1992, FV40T, FV60E AB 1988, FV70T		



1

GEV No.	501088	Ref. No.	0620349
description	backflow preventer connection 3/4" dishwasher		
For models:	DV270B AB 1992, FV250B AB 1992		



1

GEV No.	508411	Ref. No.	8002732
description	backflow preventer hose ø 12mm		



1

GEV No.	508412	Ref. No.	8002731
description	backflow preventer hose ø 13mm		

non-return valves



1

GEV No.	501585	Ref. No.	9541002
description	conversion kit FV40.2 hose ø 6mm		

miscellaneous



1

GEV No.	524556	Ref. No.	9500892
description	bracket for guide plastic L 63mm W 25mm H 22mm for MEIKO		



1

GEV No.	501554	Ref. No.	8003003
description	brush for MEIKO		



1

GEV No.	501278	Ref. No.	8000423
description	gasket		



Зип Общепит
vsezip.ru
7(812)9810800

		
1		
GEV No.	501082	Ref. No. 0620287
description	hose connector plastic thread 3/8" Qty 1 pcs for hose ID 13-13mm angled	
For models:	DV120B, DV160 AB 1983, DV160 AB 1996, DV240B AB 1983, DV240B AB 1996, DV270B AB 1992, DV40 AB 1983, DV40 AB 1992, DV80, DV80 AB 1983, DV80 AB 1992, FV130B, FV250B AB 1992	

		
1		
GEV No.	524562	Ref. No. 0650066
description	sleeve for suction connection 8511EPDMspez H 20mm D1 ø 60mm D2 ø 45mm	

		
1		
GEV No.	524571	Ref. No. 9539613
description	terminal for bearing plastic L 38mm W 17mm H 10mm for MEIKO	

		
1		
GEV No.	524570	Ref. No. 9539607
description	tray for bearing plastic L 37.5mm W 35mm H 10mm for MEIKO	

door mechanics

springs

tension springs

		
1		
GEV No.	519555	Ref. No. 9547710
description	tension spring ø 15.5mm L1 30mm wire gauge ø 1.4mm L2 11.5mm L3 11.5mm total length 51mm	

		
1		
GEV No.	519554	Ref. No. 9614265
description	tension spring ø 20mm L1 140mm wire gauge ø 2.5mm L2 17mm L3 17mm total length 174mm for door mechanism	

		
1		
GEV No.	519497	Ref. No. 0124170 9521470 9521764
description	tension spring ø 21.6mm wire gauge ø 1.7mm total length 111mm for door mechanism with plate strap	
For models:	FV40.2, FV40.2MIKE2, FV40.2M-MIKE2	

		
1		
GEV No.	519553	Ref. No. 9601272
description	tension spring ø 30mm L1 200mm wire gauge ø 2.5mm L2 19mm L3 19mm total length 276mm for door mechanism with plate strap	

rollers

		
1		
GEV No.	501180	Ref. No. 9520672 9600964
description	roller ED ø 30mm ID ø 8.5mm H 10mm	
For models:	FV40.2, FV40.2MIKE2, FV40.2M-MIKE2	
spare parts for	501180	
		
	GEV No. 698725	Ref. No. 9520736
	bearing ø 8.5mm L 11mm W 8mm H 8mm for reel	

		
1		
GEV No.	501358	Ref. No. 0620284
description	roller ED ø 36mm shaft diameter 8.8mm W 27mm	

		
1		
GEV No.	501329	Ref. No. 0620398
description	roller K397 for door mechanism	
For models:	ECO STAR 430F, FV28G AB 1994, FV28G AB 1997, FV28GFA	

		
1		
GEV No.	501325	Ref. No. 0621085 8003675
description	roller long for door mechanism	
For models:	FV20N, FV20T, FV40N AB 1992, FV40T, FV40TFA, FV70T, FV70TD	

mechanical components, equipment accessories

Зип Общепит

vsezip.ru

+7(812)987-08-81



1

GEV No.	501324	Ref. No.	0621084 8003677
description	roller short for door mechanism		
For models:	FV20N, FV20T, FV40N AB 1992, FV40T, FV40TFA, FV70T, FV70TD		

hinges



1

GEV No.	501323	Ref. No.	8003681
description	door hinge door bearing, left mounting pos. left		
For models:	ECO STAR 530F, FV110G, FV20N, FV20T, FV40N AB 1992, FV40T, FV40TFA, FV70T, FV70TD		



1

GEV No.	501328	Ref. No.	8003985
description	door hinge door bearing, left mounting pos. left		
For models:	ECO STAR 430F, FV28G AB 1994, FV28G AB 1997, FV28GFA		



1

GEV No.	501322	Ref. No.	8003600
description	door hinge door bearing, right mounting pos. right		
For models:	ECO STAR 530F, FV110G, FV20N, FV20T, FV40N AB 1992, FV40T, FV40TFA, FV70T, FV70TD		



1

GEV No.	501327	Ref. No.	8004426
description	door hinge door bearing, right mounting pos. right		
For models:	ECO STAR 430F, FV28G AB 1994, FV28G AB 1997, FV28GFA		

door guides



1

GEV No.	699287	Ref. No.	9501665
description	guide bar L 690mm W 7mm H 30mm mounting pos. left/right		

miscellaneous



1

GEV No.	524817	Ref. No.	8002834 9661700
description	bearing for door left-hand thread ø 8.3mm L 40mm		



1

GEV No.	501331	Ref. No.	0435151
description	hauling cable polyamide ø 4mm L 310mm DIN 83331 hauling cable		
For models:	ECO STAR 430F, FV28G AB 1994, FV28G AB 1997, FV28GFA, FV40.2, FV40.2 AB 2002, FV40.2 AB 2003, FV40.2M, FV40.2MIKE2, FV40.2M-MIKE2		



1

GEV No.	501330	Ref. No.	0435150
description	hook for hauling cable rope hook		
For models:	ECO STAR 430F, FV28G AB 1994, FV28G AB 1997, FV28GFA, FV40.2, FV40.2 AB 2002, FV40.2 AB 2003, FV40.2M, FV40.2MIKE2, FV40.2M-MIKE2		



Зип Общепит

vsezip.ru

+7(812)987-08-81

screw connections



1

GEV No.	501396	Ref. No.	0620422
description	cap H 16mm Qty 1 pcs		



1

GEV No.	524524	Ref. No.	0225050
description	cap thread 3/4" H 26mm plastic Qty 1 pcs with gasket		



1

GEV No.	501387	Ref. No.	9517398
description	nut thread 3/4" H 13mm WS 30 Qty 1 pcs		
For models:	DV120.2, FV40.2, FV40.2 AB 2002, FV40.2 AB 2003, FV40.2M, FV40.2M-MIKE2		



1

GEV No.	501290	Ref. No.	0620162
description	nut thread 3/8" H 8mm WS 24 plastic Qty 1 pcs		
For models:	DR90		

curtains

curtains



1

GEV No.	533010	Ref. No.	9502517
description	curtain W 610mm H 480mm complete PVC for dishwasher		



1

GEV No.	698623	Ref. No.	9608811
description	curtain W 620mm H 360mm plastic thickness 2mm		



1

GEV No.	698615	Ref. No.	9502516
description	curtain W 650mm H 420mm plastic thickness 2mm		



1

GEV No.	533011	Ref. No.	8132550
description	curtain W 650mm H 445mm complete PVC for dishwasher		



1

GEV No.	533000	Ref. No.	9502513
description	curtain W 650mm H 475mm		

mechanical components, equipment accessories



Зип Общепит

vsezip.ru

+7(812)987-08-81

mechanical components, equipment accessories

1 

GEV No.	699288	Ref. No.	9510269
description	curtain W 650mm H 480mm mounting pos. front thickness 1.5mm		

1 

GEV No.	533171	Ref. No.	8101679
description	curtain W 700mm H 400mm warewashing for outlet W1 690mm		

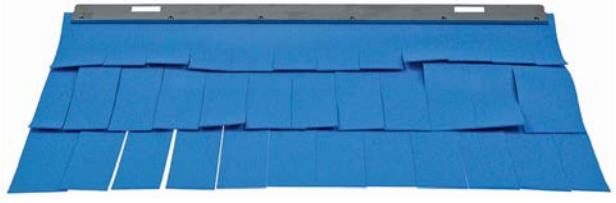
1 

GEV No.	533170	Ref. No.	8102531
description	curtain W 660mm H 400mm warewashing for inlet		

1 

GEV No.	533165	Ref. No.	8100245
description	curtain W 700mm H 420mm warewashing for outlet W1 690mm		

1 

GEV No.	533169	Ref. No.	8101676
description	curtain W 660mm H 400mm warewashing for inlet/drying W1 640mm		

1 

GEV No.	533166	Ref. No.	8100242
description	curtain W 730mm H 420mm warewashing for inlet W1 720mm		

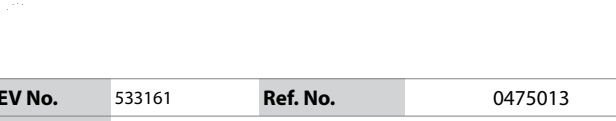
1 

GEV No.	533161	Ref. No.	0475013
description	curtain W 75mm H 250mm		

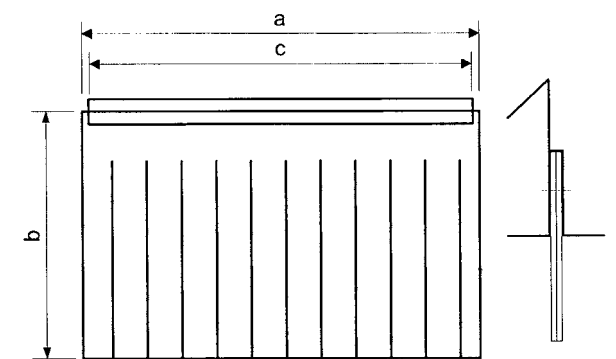
1 

GEV No.	533164	Ref. No.	8100244
description	curtain W 660mm H 420mm warewashing for drying W1 640mm		

1 

GEV No.	533173	Ref. No.	8101682
description	curtain W 770mm H 325mm warewashing for wash area W1 760mm		

1 

GEV No.	533174	Ref. No.	8101673
description	curtain W 770mm H 400mm warewashing for wash area W1 760mm		



Зип Общепит

vsezip.ru

+7(812)987-08-81

			
1			
GEV No.	533168	Ref. No.	8100243
description	curtain W 770mm H 420mm warewashing for wash area W1 760mm		

			
1			
GEV No.	524773	Ref. No.	9550206
description	cap for wash pipe thread 1/2" L 25mm WS 27		

washing and rinsing systems

			
1			
GEV No.	501204	Ref. No.	0620446
description	adapter for wash arm support		
For models:	ECO STAR 430F, FV28G AB 1994, FV28G AB 1997, FV28GFA		

			
1			
GEV No.	501049	Ref. No.	8000189
description	centring star		
For models:	FV25G AB 1986		

			
1			
GEV No.	524558	Ref. No.	0620161
description	adapter for wash jet ID ø 21mm ED ø 28mm plastic		

			
1			
GEV No.	501126	Ref. No.	0620233
description	centring star		
For models:	DV120T, DV40N, DV40T, DV40T FA, DV80T, ECO STAR 545D, FV120B AB 1980, FV240B AB 1980		

			
1			
GEV No.	501389	Ref. No.	9522439
description	bearing for rinse arm ø 24mm H 6.5mm		
For models:	DV120.2, FV40.2, FV40.2 AB 2002, FV40.2 AB 2003, FV40.2M, FV40.2M-MIKE2		

			
1			
GEV No.	501127	Ref. No.	0620264
description	centring star		
For models:	DV100 AB 1983, DV120B, DV160 AB 1983, DV160 AB 1996, DV240B AB 1983, DV240B AB 1996, DV40 AB 1983, DV40 AB 1992, DV80, DV80 AB 1983, DV80 AB 1992		

			
1			
GEV No.	524816	Ref. No.	9600763
description	bush for wash arm ø 45mm thickness 2mm H 33mm ID ø 41.5mm		

			
1			
GEV No.	501144	Ref. No.	0620381 8001736
description	centring star		
For models:	DV40N, DV40T, DV40T FA, ECO STAR 530F, FV110G, FV28G AB 1994, FV28G AB 1997, FV70TD		

mechanical components, equipment accessories

Зип Общепит

vsezip.ru

8(812)987-08-81



1

GEV No.	501251	Ref. No.	0620392 8001737
description	centring star		
For models:	ECO STAR 430F		



1

GEV No.	501222	Ref. No.	8000039
description	centring star mounting pos. lower		
For models:	FV40N AB 1983, FV60E AB 1983		



1

GEV No.	501221	Ref. No.	8000038
description	centring star mounting pos. upper		
For models:	FV40N AB 1983, FV60E AB 1983		



1

GEV No.	501097	Ref. No.	8000086
description	centring star mounting pos. upper L 58mm		
For models:	FV120B AB 1983, FV240B AB 1983		



1

GEV No.	524569	Ref. No.	9500043
description	coupling back part for rinse arm ø 55mm		



1

GEV No.	524552	Ref. No.	9500042
description	coupling front part for rinse arm ø 56mm		
accessories for	524552		



1

GEV No.	524553	Ref. No.	9500057
description	gasket for rinse arm ø 25mm ID ø 10mm thickness 8mm		



1

GEV No.	501194	Ref. No.	0620298
description	coupling piece for wash arm support		
For models:	FR30G, FR30G AB 1992, FR40G AB 1983, FR40GUS AB 1983		



1

GEV No.	501044	Ref. No.	8000049
description	flange left-hand thread		
For models:	DR90, DV100 AB 1983, DV111, DV111E, DV120B, DV120T, DV160 AB 1983, DV160 AB 1996, DV221, DV240B AB 1983, DV240B AB 1996, DV260B, DV270B AB 1992, DV40 AB 1983, DV40N, DV40T, DV40T FA, DV80, DV80 AB 1983, DV80 AB 1992, DV80T, ECO STAR 545D, FV120B AB 1983, FV130B, FV240B AB 1983, FV250B AB 1992, FV40N AB 1983, FV60E AB 1983		



1

GEV No.	501095	Ref. No.	8000048
description	flange right-hand thread		
For models:	DR90, DV100 AB 1983, DV111, DV111E, DV120B, DV120T, DV160 AB 1983, DV160 AB 1996, DV221, DV240B AB 1983, DV240B AB 1996, DV260B, DV270B AB 1992, DV40 AB 1983, DV40N, DV40T, DV40T FA, DV80, DV80 AB 1983, DV80 AB 1992, DV80T, ECO STAR 545D, FV120B AB 1983, FV130B, FV240B AB 1983, FV250B AB 1992, FV25G AB 1986, FV40N AB 1983, FV60E AB 1983		





Зип Общепит

vsezip.ru

+7(812)987-08-81

			
1			
GEV No.	501191	Ref. No.	0620295
description	flow control valve		
For models:	FR30G, FR30G AB 1992, FR40G AB 1983, FR40GUS AB 1983		

			
1			
GEV No.	501017	Ref. No.	0620235
description	rinse arm support mounting pos. upper		
For models:	DV120B, DV160 AB 1983, DV160 AB 1996, DV240B AB 1983, DV240B AB 1996, DV260B, DV270B AB 1992, DV40 AB 1983, DV40 AB 1992, DV80, DV80 AB 1983, DV80 AB 1992, ECO STAR 430F, FV110G, FV120B AB 1983, FV130B, FV240B AB 1983, FV250B AB 1992, FV28G AB 1994, FV28G AB 1997, FV28GFA		

			
1			
GEV No.	501206	Ref. No.	0620448
description	flow control valve		
For models:	ECO STAR 430F, FV20N, FV20T, FV28G AB 1994, FV28G AB 1997, FV28GFA, FV30GS, FV40N AB 1992, FV40T, FV40TFA, FV60E AB 1988, FV70T		

			
1			
GEV No.	501046	Ref. No.	8000181
description	rinse arm support mounting pos. upper		
For models:	FV25G AB 1986		

			
1			
GEV No.	524553	Ref. No.	9500057
description	gasket for rinse arm ø 25mm ID ø 10mm thickness 8mm		

			
1			
GEV No.	501142	Ref. No.	8000174
description	rinse pipe		
For models:	DV120T, DV40N, DV40T, DV40T FA, DV80T, ECO STAR 545D		

			
1			
GEV No.	501047	Ref. No.	8000182
description	knurled nut		
For models:	FV25G AB 1986		

			
1			
GEV No.	501223	Ref. No.	8000040
description	rinse pipe		
For models:	FV40N AB 1983, FV60E AB 1983		

			
1			
GEV No.	698624	Ref. No.	9543879
description	pump hose D1 ø 85mm L 45mm int. ø 1 79mm		

			
1			
GEV No.	501224	Ref. No.	8000041
description	rinse pipe		
For models:	FV40N AB 1983, FV60E AB 1983		

			
1			
GEV No.	501016	Ref. No.	0620211
description	rinse arm support 1/2		
For models:	DV100 AB 1983, DV120B, DV120T, DV160 AB 1983, DV160 AB 1996, DV240B AB 1983, DV240B AB 1996, DV260B, DV270B AB 1992, DV40 AB 1983, DV40T, DV40T FA, DV80, DV80 AB 1983, DV80 AB 1992, DV80T, ECO STAR 545D, FV120B AB 1980, FV120B AB 1983, FV130B, FV240B AB 1980, FV240B AB 1983, FV250B AB 1992, FV25G AB 1986, FV30, FV40N AB 1980, FV40N AB 1983, FV50, FV50 M, FV60E AB 1983		

mechanical components, equipment accessories

Зип Общежит

vsezip.ru

+7(812)987-08-81



1

GEV No.	501234	Ref. No.	8000056
description	rinse pipe		
For models:	DV100 AB 1983, DV120B, DV160 AB 1983, DV40 AB 1983, DV80, DV80 AB 1983		



1

GEV No.	501110	Ref. No.	8000680
description	rinse pipe mounting pos. upper		
For models:	DV270B AB 1992, FV130B, FV250B AB 1992		



1

GEV No.	501235	Ref. No.	8000067
description	rinse pipe		
For models:	DV100 AB 1983, DV120B, DV160 AB 1983, DV240B AB 1983, DV40 AB 1983, DV80, DV80 AB 1983		



1

GEV No.	501098	Ref. No.	8000087
description	rinse pipe mounting pos. upper left-hand thread		
For models:	FV120B AB 1983, FV240B AB 1983		



1

GEV No.	501111	Ref. No.	8000681
description	rinse pipe mounting pos. lower		
For models:	DV270B AB 1992, FV130B, FV250B AB 1992		



1

GEV No.	501248	Ref. No.	8000173
description	rinse pipe mounting pos. upper left-hand thread		
For models:	DV120B, DV160 AB 1983, DV160 AB 1996, DV240B AB 1983, DV240B AB 1996, DV40 AB 1983, DV80, DV80 AB 1983, DV80 AB 1992		



1

GEV No.	501048	Ref. No.	8000188
description	rinse pipe mounting pos. lower right-hand thread		
For models:	FV25G AB 1986		



1

GEV No.	524572	Ref. No.	0650010
description	rubber grommet for wash pipe ø 25mm		



1

GEV No.	501247	Ref. No.	8000172
description	rinse pipe mounting pos. lower right-hand thread		
For models:	DV120B, DV160 AB 1983, DV160 AB 1996, DV240B AB 1983, DV240B AB 1996, DV40 AB 1983, DV80, DV80 AB 1983, DV80 AB 1992		



1

GEV No.	501027	Ref. No.	0620384
description	screw cap		
For models:	DV40 AB 1992, DV40N, DV40T, DV40T FA, ECO STAR 430F, ECO STAR 530F, FV110G, FV20N, FV20T, FV28G AB 1994, FV28G AB 1997, FV28GFA, FV30GS, FV40N AB 1992, FV40T, FV40TFA, FV60E AB 1988, FV70T, FV70TD		





Зип Общепит

vsezip.ru

+7 (812) 987-08-81

			
1			
GEV No.	501061	Ref. No.	8001408
description	shim		
For models:	DV120.2, DV120T, DV40N, DV40T, DV40T FA, ECO STAR 545D		

			
1			
GEV No.	524574	Ref. No.	9517408 9604483
description	shim for rinse arm ø 30mm thread M12x1 WS 27		
For models:	DV120.2, FV40.2, FV40.2M, FV40.2M-MIKE2		

			
1			
GEV No.	524357	Ref. No.	9520931 9679658
description	slide ring for wash arm mounting pos. lower ED ø 50.6mm ID ø 42.3mm		
For models:	DV120.2, FV40.2, FV40.2 AB 2002, FV40.2 AB 2003, FV40.2M, FV40.2M-MIKE2		

			
1			
GEV No.	501074	Ref. No.	0403303
description	slide ring PTFE mounting measurements 17x26x1mm ø 13.3mm		
For models:	DR90, DV100 AB 1980, DV100 AB 1983, DV111, DV111E, DV120B, DV120T, DV160 AB 1980, DV160 AB 1983, DV160 AB 1996, DV221, DV240B AB 1980, DV240B AB 1983, DV240B AB 1996, DV260B, DV270B AB 1992, DV40 AB 1983, DV40 AB 1992, DV40N, DV40T, DV40T FA, DV80, DV80 AB 1975, DV80 AB 1980, DV80 AB 1983, DV80 AB 1992, DV80T, ECO STAR 545D, FV120B AB 1980, FV120B AB 1983, FV130B, FV200B, FV240B AB 1980, FV240B AB 1983, FV250B AB 1992, FV25G AB 1986, FV30, FV40N AB 1980, FV40N AB 1983, FV50, FV50 M, FV60 AB 1973, FV60 AB 1976		

			
1			
GEV No.	501256	Ref. No.	8004179
description	throttle disc		
For models:	ECO STAR 430F, FV28G AB 1994, FV28G AB 1997, FV28GFA		

			
1			
GEV No.	510112	Ref. No.	0310010
description	Thumb screw thread M10 thread L 10mm ø 22mm H 4.5mm SS		
For models:	DV40 AB 1992, DV40N, DV40T, DV40T FA, ECO STAR 430F, ECO STAR 530F, FV110G, FV20N, FV20T, FV28G AB 1994, FV28G AB 1997, FV28GFA, FV30GS, FV40N AB 1992, FV40T, FV40TFA, FV60E AB 1988, FV70T, FV70TD		

			
1			
GEV No.	501190	Ref. No.	0620294
description	wash arm support mounting pos. upper and bottom		
For models:	FR30G, FR30G AB 1992, FR40G AB 1983, FR40GUS AB 1983		

washing and rinsing systems (sorted by producer)

MEIKO

			
1			
GEV No.	501384	Ref. No.	9517399 9547257
description	rinse arm L 490mm nozzles 6 mounting ø 24.5mm mounting pos. upper/lower		
For models:	DV120.2, FV40.2, FV40.2M, FV40.2M-MIKE2		

			
1			
GEV No.	501141	Ref. No.	8000147
description	wash arm L 500mm nozzles 10 mounting ø 21/51mm mounting pos. lower		
For models:	DV120B, DV120T, DV160 AB 1983, DV160 AB 1996, DV240B AB 1983, DV240B AB 1996, DV40 AB 1983, DV40N, DV40T, DV40T FA, DV80, DV80 AB 1983, DV80 AB 1992, DV80T, ECO STAR 545D, FV40N AB 1983, FV60E AB 1983		

mechanical components, equipment accessories

Зип Общепит

vsezip.ru

+7(812)98708800



1

GEV No.	501140	Ref. No.	8000146
description	wash arm L 500mm nozzles 10 mounting ø 21/51mm mounting pos. upper		
For models:	DV120B, DV120T, DV160 AB 1983, DV160 AB 1996, DV240B AB 1983, DV240B AB 1996, DV40 AB 1983, DV40N, DV40T, DV40T FA, DV80, DV80 AB 1983, DV80 AB 1992, DV80T, ECO STAR 545D, FV40N AB 1983, FV60E AB 1983		



1

GEV No.	501385	Ref. No.	9517391 9517393
description	wash arm L 500mm nozzles 11 mounting ø 16/42.5mm mounting pos. upper/lower		
For models:	DV120.2, FV40.2, FV40.2 AB 2003, FV40.2M, FV40.2M-MIKE2		

spare parts for 501385



GEV No.	501387	Ref. No.	9517398
description	nut thread 3/4" H 13mm WS 30 Qty 1 pcs		



GEV No.	501388	Ref. No.	9517397 9671628
description	bearing for wash arm ø 22mm H 34.5mm		



GEV No.	524357	Ref. No.	9520931 9679658
description	slide ring for wash arm mounting pos. lower ED ø 50.6mm ID ø 42.3mm		



1

GEV No.	501293	Ref. No.	8000187
description	wash arm L 200mm nozzles 15 mounting pos. lower complete/3-armed		
For models:	FV25G AB 1986		



1

GEV No.	501015	Ref. No.	0620163
description	end cap		
For models:	DR90, DV100 AB 1980, DV100 AB 1983, DV111, DV111E, DV120B, DV160 AB 1983, DV160 AB 1993, DV221, DV240B AB 1980, DV240B AB 1983, DV260B, DV40 AB 1983, DV80, DV80 AB 1975, DV80 AB 1980, DV80 AB 1983, DV80 AB 1992, FR40G AB 1976, FR40G AB 1980, FR40GUS AB 1976, FR40GUS AB 1980, FV120B AB 1980, FV200B, FV240B AB 1980, FV25G AB 1986, FV30, FV40N AB 1980, FV40N AB 1983, FV50, FV50 M, FV60 AB 1976, FV60E AB 1983		



1

GEV No.	501553	Ref. No.	8000321
description	wash arm		
For models:	FV25G AB 1986		
accessories for	501553		
GEV No.	501083	Ref. No.	0620292
description	end cap		



1

GEV No.	501045	Ref. No.	8000093
description	wash arm boss mounting pos. lower ø 20.4mm		
For models:	DV260B, FV120B AB 1983, FV240B AB 1983, FV25G AB 1986		



1

GEV No.	501051	Ref. No.	8000191
description	rinse arm L 365mm nozzles 3 mounting ø 16mm mounting pos. lower		
For models:	FV25G AB 1986		



1

GEV No.	501052	Ref. No.	8000192
description	rinse arm L 367mm nozzles 3 mounting ø 12mm mounting pos. upper/lower		
For models:	FV25G AB 1986		





Зип Общепит
vsezip.ru



(812)987-08-81

 <p>1</p>			
GEV No.	501019	Ref. No.	0620286 8002880
description	rinse arm boss		
For models:	DV100 AB 1983, DV120B, DV120T, DV160 AB 1983, DV160 AB 1996, DV240B AB 1983, DV240B AB 1996, DV260B, DV270B AB 1992, DV40 AB 1983, DV40N, DV40T, DV40T FA, DV80, DV80 AB 1983, DV80T, ECO STAR 545D, FV120B AB 1983, FV130B, FV240B AB 1983, FV250B AB 1992, FV25G AB 1986, FV40N AB 1980, FV40N AB 1983, FV60E AB 1983		

 <p>1</p>			
GEV No.	501249	Ref. No.	8000231
description	rinse arm boss		
For models:	FV25G AB 1986		

 <p>1</p>			
GEV No.	501012	Ref. No.	0472031 8000124
description	rinse jet		
For models:	FR30G, FR30G AB 1992, FR40G AB 1983, FR40GUS AB 1983, FV120B AB 1983, FV240B AB 1983, FV25G AB 1986		

 <p>1</p>			
GEV No.	501333	Ref. No.	9542559
description	rinse arm L 470mm nozzles 4 mounting ø 15.7mm mounting pos. lower complete		
For models:	ECO STAR 545D		
spare parts for	501333		
	 <p>GEV No.</p>	501259	<p>Ref. No.</p> <p>9517405 9517406</p>
	rinse jet		

 <p>1</p>			
GEV No.	501332	Ref. No.	9542558
description	rinse arm L 475mm nozzles 4 mounting ø 15.5mm mounting pos. upper complete		
For models:	ECO STAR 545D		
spare parts for	501332		
	 <p>GEV No.</p>	501259	<p>Ref. No.</p> <p>9517405 9517406</p>
	rinse jet		

 <p>1</p>			
GEV No.	507556	Ref. No.	9601025
description	rinse arm L 620mm nozzles 6 mounting pos. lower		

 <p>1</p>			
GEV No.	507572	Ref. No.	9600672
description	rinse arm L 716mm nozzles 8 mounting ø 19mm mounting pos. upper/lower complete		

 <p>1</p>			
GEV No.	501019	Ref. No.	0620286 8002880
description	rinse arm boss		
For models:	DV100 AB 1983, DV120B, DV120T, DV160 AB 1983, DV160 AB 1996, DV240B AB 1983, DV240B AB 1996, DV260B, DV270B AB 1992, DV40 AB 1983, DV40N, DV40T, DV40T FA, DV80, DV80 AB 1983, DV80T, ECO STAR 545D, FV120B AB 1983, FV130B, FV240B AB 1983, FV250B AB 1992, FV25G AB 1986, FV40N AB 1980, FV40N AB 1983, FV60E AB 1983		

mechanical components, equipment accessories



Зип Общепит

vsezip.ru

+7(812)987-08-81

			
1			
GEV No.	501259	Ref. No.	9517405 9517406
description	rinse jet		
For models:	ECO STAR 545D, FV40.2, FV40.2 AB 2003		

			
1			
GEV No.	523051	Ref. No.	9600673
description	wash arm bearing 4 holes hole ø 19mm seat ø 10mm H 50mm		

			
1			
GEV No.	501292	Ref. No.	8000097 9542572
description	rinse arm L 530mm nozzles 4 mounting ø 15.7mm mounting pos. upper		
For models:	DR90, DV111, DV111E, DV260B, DV270B AB 1988, DV270B AB 1992, FV120B AB 1983, FV130B, FV240B AB 1983, FV250B AB 1988, FV250B AB 1992		
spare parts for	501292		
	GEV No.	501259	Ref. No.
			9517405 9517406
			rinse jet

			
1			
GEV No.	501291	Ref. No.	8000096 9542573
description	rinse arm L 535mm nozzles 4 mounting ø 15.7mm mounting pos. lower		
For models:	DR90, DV111, DV111E, DV260B, DV270B AB 1988, DV270B AB 1992, FV120B AB 1983, FV130B, FV240B AB 1983, FV250B AB 1988, FV250B AB 1992		

			
1			
GEV No.	501010	Ref. No.	0620286 8002880
description	rinse arm boss		
For models:	DV100 AB 1983, DV120B, DV120T, DV160 AB 1983, DV160 AB 1996, DV240B AB 1983, DV240B AB 1996, DV260B, DV270B AB 1992, DV40 AB 1983, DV40N, DV40T, DV40T FA, DV80, DV80 AB 1983, DV80T, ECO STAR 545D, FV120B AB 1983, FV130B, FV240B AB 1983, FV250B AB 1992, FV25G AB 1986, FV40N AB 1980, FV40N AB 1983, FV60E AB 1983		

			
1			
GEV No.	501014	Ref. No.	0620157
description	rinse jet		
For models:	DR70, DR90, DV100 AB 1980, DV100 AB 1983, DV111, DV111E, DV120B, DV120T, DV160 AB 1980, DV160 AB 1983, DV160 AB 1996, DV221, DV240B AB 1980, DV240B AB 1983, DV240B AB 1996, DV260B, DV270B AB 1988, DV270B AB 1992, DV40 AB 1983, DV40 AB 1992, DV40N, DV40T, DV40T FA, DV80, DV80 AB 1975, DV80 AB 1980, DV80 AB 1983, DV80 AB 1992, DV80T, ECO STAR 430F, ECO STAR 530F, EE60, EE90, FV110G, FV120B AB 1980, FV120B AB 1983, FV130B, FV200B, FV20N, FV20T, FV240B AB 1980, FV240B AB 1983, FV250B AB 1988, FV250B AB 1992, FV28G AB 1994, FV28G AB 1997, FV28GFA, FV30, FV30GS, FV40N AB 1980...(Other models you can see in the webshop)		

			
1			
GEV No.	501013	Ref. No.	0620121
description	swirl		
For models:	DR70, DR90, DV100 AB 1980, DV100 AB 1983, DV111, DV111E, DV120B, DV120T, DV160 AB 1980, DV160 AB 1983, DV160 AB 1996, DV221, DV240B AB 1980, DV240B AB 1983, DV240B AB 1996, DV260B, DV270B AB 1988, DV270B AB 1992, DV40 AB 1983, DV40 AB 1992, DV40N, DV40T, DV40T FA, DV80, DV80 AB 1975, DV80 AB 1980, DV80 AB 1983, DV80 AB 1992, DV80T, ECO STAR 430F, ECO STAR 530F, EE60, EE90, FV110G, FV120B AB 1980, FV120B AB 1983, FV130B, FV200B, FV20N, FV20T, FV240B AB 1980, FV240B AB 1983, FV250B AB 1988, FV250B AB 1992, FV28G AB 1994, FV28G AB 1997, FV28GFA, FV30, FV30GS, FV40N AB 1980...(Other models you can see in the webshop)		

			
1			
GEV No.	501015	Ref. No.	0620163
description	end cap		
For models:	DR90, DV100 AB 1980, DV100 AB 1983, DV111, DV111E, DV120B, DV160 AB 1980, DV160 AB 1983, DV221, DV240B AB 1980, DV240B AB 1983, DV260B, DV40 AB 1983, DV80, DV80 AB 1975, DV80 AB 1980, DV80 AB 1983, DV80 AB 1992, FR40G AB 1976, FR40G AB 1980, FR40GUS AB 1976, FR40GUS AB 1980, FV120B AB 1980, FV200B, FV240B AB 1980, FV25G AB 1986, FV30, FV40N AB 1980, FV40N AB 1983, FV50, FV50 M, FV60 AB 1976, FV60E AB 1983		





Зип Общепит

vsezip.ru

+7(812)987-08-81

			
1			
GEV No.	501099	Ref. No.	8000088
description	wash arm mounting pos. lower number 1		
For models:	FV120B AB 1983, FV240B AB 1983		

			
1			
GEV No.	501100	Ref. No.	8000089
description	wash arm mounting pos. lower number 2		
For models:	FV120B AB 1983, FV240B AB 1983		

			
1			
GEV No.	501101	Ref. No.	8000090
description	wash arm mounting pos. lower number 3		
For models:	FV120B AB 1983, FV240B AB 1983		

			
1			
GEV No.	501102	Ref. No.	8000091
description	wash arm mounting pos. upper number 1+3		
For models:	FV120B AB 1983, FV240B AB 1983		

			
1			
GEV No.	501103	Ref. No.	8000092
description	wash arm mounting pos. upper number 2		
For models:	FV120B AB 1983, FV240B AB 1983		

			
1			
GEV No.	501045	Ref. No.	8000093
description	wash arm boss mounting pos. lower ø 20.4mm		
For models:	DV260B, FV120B AB 1983, FV240B AB 1983, FV25G AB 1986		

			
1			
GEV No.	501104	Ref. No.	8000094
description	wash arm boss mounting pos. upper		
For models:	DV260B, FV120B AB 1983, FV240B AB 1983		

			
1			
GEV No.	501015	Ref. No.	0620163
description	end cap		
For models:	DR90, DV100 AB 1980, DV100 AB 1983, DV111, DV111E, DV120B, DV160 AB 1980, DV160 AB 1983, DV221, DV240B AB 1980, DV240B AB 1983, DV260B, DV40 AB 1983, DV80, DV80 AB 1975, DV80 AB 1980, DV80 AB 1983, DV80 AB 1992, FR40G AB 1976, FR40G AB 1980, FR40GUS AB 1976, FR40GUS AB 1980, FV120B AB 1980, FV200B, FV240B AB 1980, FV25G AB 1986, FV30, FV40N AB 1980, FV40N AB 1983, FV50, FV50 M, FV60 AB 1976, FV60E AB 1983		

			
1			
GEV No.	501225	Ref. No.	8000042
description	wash arm		
For models:	DV40 AB 1983, DV80 AB 1983, FV30, FV40N AB 1983, FV50		

			
1			
GEV No.	501226	Ref. No.	8000043 800043
description	wash arm		
For models:	DV40 AB 1983, DV80 AB 1983, FV40N AB 1983		

			
1			
GEV No.	501230	Ref. No.	8000052
description	wash arm		
For models:	DV100 AB 1983, DV120B, DV160 AB 1983, DV240B AB 1983, DV80, FV60E AB 1983		

			
1			
GEV No.	501231	Ref. No.	8000053
description	wash arm		
For models:	DV100 AB 1983, DV120B, DV160 AB 1983, DV240B AB 1983, DV80, FV60E AB 1983		

Зип Общепит

vsezip.ru

+7(812)987-08-81



1

GEV No.	501227	Ref. No.	8000044
description	wash arm boss		
For models:	DV100 AB 1983, DV120B, DV160 AB 1983, DV240B AB 1983, DV40 AB 1983, DV80, DV80 AB 1983, FV40N AB 1983, FV60E AB 1983		



1

GEV No.	501228	Ref. No.	8000045
description	wash arm boss		
For models:	DV100 AB 1983, DV120B, DV160 AB 1983, DV240B AB 1983, DV40 AB 1983, DV80, DV80 AB 1983, FV40N AB 1983, FV60E AB 1983		



1

GEV No.	501272	Ref. No.	8001813
description	wash and rinse arm wash arm L 395mm rinse arm L 320mm w. jets 5 r. jets 3 mounting ø 16/51mm mounting pos. upper/lower 2 wash arms/ 2 rinse arms		
For models:	FV30GS		
spare parts for	501272		
	GEV No.	501013	Ref. No. 0620121
swirl			
	GEV No.	501014	Ref. No. 0620157
rinse jet			
	GEV No.	501025	Ref. No. 0620380
wash arm boss mounting pos. upper			
	GEV No.	501027	Ref. No. 0620384
screw cap			
	GEV No.	501031	Ref. No. 0620390
rinse arm L 155mm			
	GEV No.	501195	Ref. No. 0620387
wash arm short			
	GEV No.	510112	Ref. No. 0310010
Thumb screw thread M10 thread L 10mm ø 22mm H 4.5mm SS			



1









GEV No.	501307	Ref. no.	8004683
description	wash and rinse arm wash arm L 400mm rinse arm L 320mm w. jets 10 r. jets 3 mounting ø 16/51mm mounting pos. upper/lower 2 wash arms/ 2 rinse arms		
For models:	ECO STAR 430F, FV28G AB 1994, FV28G AB 1997		
spare parts for	501307		
	GEV No.	501004	Ref. No. —
Thumb screw thread M10 thread L 10mm ø 22mm H 4.5mm SS			
	GEV No.	501013	Ref. No. 0620121
swirl			
	GEV No.	501014	Ref. No. 0620157
rinse jet			
	GEV No.	501017	Ref. No. 0620235
rinse arm support mounting pos. upper			
	GEV No.	501027	Ref. No. 0620384
screw cap			
	GEV No.	501031	Ref. No. 0620390
rinse arm L 155mm			
	GEV No.	501032	Ref. No. 0620394
rinse arm boss			
	GEV No.	501153	Ref. No. 8004008
rinse arm shaft			
	GEV No.	501196	Ref. No. 0620388
wash arm short			
	GEV No.	501197	Ref. No. 0620391
rinse arm L 111mm			
	GEV No.	501256	Ref. No. 8004179
throttle disc			





Зип Общепит

vsezip.ru

+7(812)98700881

 <p>1</p>			
GEV No.	501270	Ref. No.	8001814
description	wash and rinse arm wash arm L 495mm rinse arm L 415mm w. jets 10 r. jets 4 mounting ø 16/51mm mounting pos. upper/lower 2 wash arms/ 2 rinse arms		
For models:	DV40 AB 1992, DV40T, DV40T FA, ECO STAR 530F, FV110G, FV20N, FV20T, FV40N AB 1992, FV40T, FV40TFA, FV60E AB 1988, FV70T, FV70TD		
spare parts for	501270		
	GEV No.	501004	Ref. No. —
	Thumb screw thread M10 thread L 10mm ø 22mm H 4.5mm SS		
	GEV No.	501013	Ref. No. 0620121
	swirl		
	GEV No.	501014	Ref. No. 0620157
	rinse jet		
	GEV No.	501025	Ref. No. 0620380
	wash arm boss mounting pos. upper		
	GEV No.	501027	Ref. No. 0620384
	screw cap		
	GEV No.	501029	Ref. No. 0620386
	wash arm L 225mm mounting ø 30mm		
	GEV No.	501031	Ref. No. 0620390
	rinse arm L 155mm		

 <p>1</p>			
GEV No.	501031	Ref. No.	0620390
description	rinse arm L 155mm		
For models:	DV40 AB 1992, DV40N, DV40T, DV40T FA, ECO STAR 430F, ECO STAR 530F, FV110G, FV20N, FV20T, FV28G AB 1994, FV28G AB 1997, FV28GFA, FV30GS, FV40N AB 1992, FV40T, FV40TFA, FV60E AB 1988, FV70T, FV70TD		

 <p>1</p>			
GEV No.	501014	Ref. No.	0620157
description	rinse jet		
For models:	DR70, DR90, DV100 AB 1980, DV100 AB 1983, DV111, DV111E, DV120B, DV120T, DV160 AB 1980, DV160 AB 1983, DV160 AB 1996, DV221, DV240B AB 1980, DV240B AB 1983, DV240B AB 1996, DV260B, DV270B AB 1988, DV270B AB 1992, DV40 AB 1983, DV40 AB 1992, DV40N, DV40T, DV40T FA, DV80, DV80 AB 1975, DV80 AB 1980, DV80 AB 1983, DV80 AB 1992, DV80T, ECO STAR 430F, ECO STAR 530F, EE60, EE90, FV110G, FV120B AB 1980, FV120B AB 1983, FV130B, FV200B, FV20N, FV20T, FV240B AB 1980, FV240B AB 1983, FV250B AB 1988, FV250B AB 1992, FV28G AB 1994, FV28G AB 1997, FV28GFA, FV30, FV30GS, FV40N AB 1980...(Other models you can see in the webshop)		

 <p>1</p>			
GEV No.	501013	Ref. No.	0620121
description	swirl		
For models:	DR70, DR90, DV100 AB 1980, DV100 AB 1983, DV111, DV111E, DV120B, DV120T, DV160 AB 1980, DV160 AB 1983, DV160 AB 1996, DV221, DV240B AB 1980, DV240B AB 1983, DV240B AB 1996, DV260B, DV270B AB 1988, DV270B AB 1992, DV40 AB 1983, DV40 AB 1992, DV40N, DV40T, DV40T FA, DV80, DV80 AB 1975, DV80 AB 1980, DV80 AB 1983, DV80 AB 1992, DV80T, ECO STAR 430F, ECO STAR 530F, EE60, EE90, FV110G, FV120B AB 1980, FV120B AB 1983, FV130B, FV200B, FV20N, FV20T, FV240B AB 1980, FV240B AB 1983, FV250B AB 1988, FV250B AB 1992, FV28G AB 1994, FV28G AB 1997, FV28GFA, FV30, FV30GS, FV40N AB 1980...(Other models you can see in the webshop)		

 <p>1</p>			
GEV No.	501030	Ref. No.	0620389
description	rinse arm		
For models:	DV40 AB 1992, DV40N, DV40T, DV40T FA, ECO STAR 530F, FV110G, FV20N, FV20T, FV40N AB 1992, FV40T, FV40TFA, FV60E AB 1988, FV70T, FV70TD		

 <p>1</p>			
GEV No.	501028	Ref. No.	0620385
description	wash arm L 225mm mounting ø 30mm		
For models:	DV40 AB 1992, DV40N, DV40T, DV40T FA, ECO STAR 530F, FV110G, FV20N, FV20T, FV40N AB 1992, FV40T, FV40TFA, FV60E AB 1988, FV70T, FV70TD		

 <p>1</p>			
GEV No.	501197	Ref. No.	0620391
description	rinse arm L 111mm		
For models:	ECO STAR 430F, FV28G AB 1994, FV28G AB 1997, FV28GFA, FV30GS		

 <p>1</p>			
GEV No.	501029	Ref. No.	0620386
description	wash arm L 225mm mounting ø 30mm		
For models:	DV40 AB 1992, DV40N, DV40T, DV40T FA, ECO STAR 530F, FV110G, FV20N, FV20T, FV40N AB 1992, FV40T, FV40TFA, FV60E AB 1988, FV70T, FV70TD		

mechanical components, equipment accessories

Зип Общепит

vsezip.ru

+7(812)987-08-81



1

GEV No.	501195	Ref. No.	0620387
description	wash arm short		
For models:	ECO STAR 430F, FV28G AB 1994, FV28G AB 1997, FV28GFA, FV30GS		



1

GEV No.	501196	Ref. No.	0620388
description	wash arm short		
For models:	ECO STAR 430F, FV28G AB 1994, FV28G AB 1997, FV28GFA, FV30GS		



1

GEV No.	501334	Ref. No.	8004635
description	wash arm boss mounting pos. lower		
For models:	ECO STAR 430F, FV28GFA		



1

GEV No.	501025	Ref. No.	0620380
description	wash arm boss mounting pos. upper		
For models:	DV40 AB 1992, DV40T, DV40T FA, ECO STAR 530F, FV110G, FV20N, FV20T, FV28G AB 1994, FV28G AB 1997, FV30GS, FV40N AB 1992, FV40T, FV40TFA, FV60E AB 1988, FV70T, FV70TD		



1

GEV No.	501295	Ref. No.	8000678 9525861
description	wash arm mounting pos. lower		
For models:	DV270B AB 1992, FV130B, FV250B AB 1992		



1

GEV No.	501294	Ref. No.	8000677 9525862
description	wash arm mounting pos. upper		
For models:	DV270B AB 1992, FV130B, FV250B AB 1992		



1

GEV No.	501083	Ref. No.	0620292
description	end cap		
For models:	DV270B AB 1988, DV270B AB 1992, FV130B, FV250B AB 1988, FV250B AB 1992		



1

GEV No.	501089	Ref. No.	0620392 9525702
description	wash arm boss mounting pos. lower		
For models:	DV270B AB 1992, FV130B, FV250B AB 1992		



1

GEV No.	501090	Ref. No.	0620393 9525703
description	wash arm boss mounting pos. upper		
For models:	DV270B AB 1992, FV130B, FV250B AB 1992		



1

GEV No.	501271	Ref. No.	8003886
description	rinse arm L 290mm nozzles 3 mounting ø 16mm mounting pos. upper complete		
For models:	ECO STAR 430F, FV28G AB 1994, FV28G AB 1997		





Зип Общепит

vsezip.ru

+7(812)98

 <p>1</p>			
GEV No.	501286	Ref. No.	8003968
description	rinse arm L 395mm nozzles 4 mounting ø 16mm mounting pos. upper complete		
For models:	FV110G		

 <p>1</p>			
GEV No.	501014	Ref. No.	0620157
description	rinse jet		
For models:	DR70, DR90, DV100 AB 1980, DV100 AB 1983, DV111, DV111E, DV120B, DV120T, DV160 AB 1980, DV160 AB 1983, DV160 AB 1996, DV221, DV240 AB 1980, DV240B AB 1983, DV240B AB 1996, DV260B, DV270B AB 1988, DV270B AB 1992, DV40 AB 1983, DV40 AB 1992, DV40N, DV40T, DV40T FA, DV80, DV80 AB 1975, DV80 AB 1980, DV80 AB 1983, DV80 AB 1992, DV80T, ECO STAR 430F, ECO STAR 530F, EE60, EE90, FV110G, FV120B AB 1980, FV120B AB 1983, FV130B, FV200B, FV20N, FV20T, FV240B AB 1980, FV240B AB 1983, FV250B AB 1988, FV250B AB 1992, FV28G AB 1994, FV28G AB 1997, FV28GFA, FV30, FV30GS, FV40N AB 1980...(Other models you can see in the webshop)		

 <p>1</p>			
GEV No.	501030	Ref. No.	0620389
description	rinse arm		
For models:	DV40 AB 1992, DV40N, DV40T, DV40T FA, ECO STAR 530F, FV110G, FV20N, FV20T, FV40N AB 1992, FV40T, FV40TFA, FV60E AB 1988, FV70T, FV70TD		

 <p>1</p>			
GEV No.	501013	Ref. No.	0620121
description	swirl		
For models:	DR70, DR90, DV100 AB 1980, DV100 AB 1983, DV111, DV111E, DV120B, DV120T, DV160 AB 1980, DV160 AB 1983, DV160 AB 1996, DV221, DV240B AB 1980, DV240B AB 1983, DV240B AB 1996, DV260B, DV270B AB 1988, DV270B AB 1992, DV40 AB 1983, DV40 AB 1992, DV40N, DV40T, DV40T FA, DV80, DV80 AB 1975, DV80 AB 1980, DV80 AB 1983, DV80 AB 1992, DV80T, ECO STAR 430F, ECO STAR 530F, EE60, EE90, FV110G, FV120B AB 1980, FV120B AB 1983, FV130B, FV200B, FV20N, FV20T, FV240B AB 1980, FV240B AB 1983, FV250B AB 1988, FV250B AB 1992, FV28G AB 1994, FV28G AB 1997, FV28GFA, FV30, FV30GS, FV40N AB 1980...(Other models you can see in the webshop)		

 <p>1</p>			
GEV No.	501197	Ref. No.	0620391
description	rinse arm L 111mm		
For models:	ECO STAR 430F, FV28G AB 1994, FV28G AB 1997, FV28GFA, FV30GS		

 <p>1</p>			
GEV No.	501366	Ref. No.	9510612
description	rinse arm L 490mm nozzles 6 mounting ø 16mm mounting pos. lower straight/short		

 <p>1</p>			
GEV No.	501031	Ref. No.	0620390
description	rinse arm L 155mm		
For models:	DV40 AB 1992, DV40N, DV40T, DV40T FA, ECO STAR 430F, ECO STAR 530F, FV110G, FV20N, FV20T, FV28G AB 1994, FV28G AB 1997, FV28GFA, FV30GS, FV40N AB 1992, FV40T, FV40TFA, FV60E AB 1988, FV70T, FV70TD		

 <p>1</p>			
GEV No.	501367	Ref. No.	8133096
description	rinse arm L 555mm nozzles 3 mounting ø 16mm mounting pos. upper straight/long		

 <p>1</p>			
GEV No.	501032	Ref. No.	0620394
description	rinse arm boss		
For models:	ECO STAR 430F, FV110G, FV28G AB 1994, FV28G AB 1997, FV28GFA		

mechanical components, equipment accessories

Зип Общепит

1		GEV No.	501203	Ref. No.	0620436
		description	swirl H 13mm ø 14.5mm 4mm		
		For models:	ECO STAR 430F, FV28G AB 1994, FV28G AB 1997, FV28GFA		

1		GEV No.	501202	Ref. No.	0620435
		description	wash jet		
		For models:	ECO STAR 430F, FV28G AB 1994, FV28G AB 1997, FV28GFA		

1		GEV No.	501192	Ref. No.	0620296
		description	wash arm mounting pos. upper/lower L 230mm nozzles 6 mounting ø 25mm suitable for wash pipe no. 0620294		
		For models:	FR30G, FR30G AB 1992, FR40G AB 1983, FR40GUS AB 1983		

1		GEV No.	501193	Ref. No.	0620297
		description	end cap		
		For models:	FR30G, FR30G AB 1992, FR40G AB 1983, FR40GUS AB 1983		

1		GEV No.	501216	Ref. No.	8000023
		description	rinse arm H 490mm L 225mm nozzles 6 mounting pos. right		
		For models:	FR30G, FR30G AB 1992, FR40G AB 1976, FR40G AB 1980, FR40G AB 1983, FR40GUS AB 1976, FR40GUS AB 1980, FR40GUS AB 1983		

1		GEV No.	501012	Ref. No.	0472031 8000124
		description	rinse jet		
		For models:	FR30G, FR30G AB 1992, FR40G AB 1983, FR40GUS AB 1983, FV120B AB 1983, FV240B AB 1983, FV25G AB 1986		

1		GEV No.	501368	Ref. No.	8133099
		description	rinse arm L 590mm nozzles 6 mounting ø 16mm mounting pos. lower straight/long		

1		GEV No.	517775	Ref. No.	9520203
		description	wash arm mounting pos. lower L 670mm nozzles 5		

1		GEV No.	501198	Ref. No.	0620429
		description	wash arm		
		For models:	ECO STAR 430F, FV28G AB 1994, FV28G AB 1997, FV28GFA		

1		GEV No.	501001	Ref. No.	0217433
		description	flat gasket rubber ED ø 24mm ID ø 17mm thickness 2mm Qty 1 pcs		
		For models:	DV120B, DV120T, DV160 AB 1983, DV160 AB 1996, DV240B AB 1983, DV240B AB 1996, DV260B, DV270B AB 1992, DV40 AB 1983, DV40 AB 1992, DV40N, DV40T, DV80, DV80 AB 1983, DV80 AB 1992, DV80T, ECO STAR 430F, ECO STAR 530F, ECO STAR 545D, FR30G AB 1992, FV110G, FV120B AB 1983, FV130B, FV20N, FV20T, FV240B AB 1983, FV250B AB 1992, FV25G AB 1992, FV28G AB 1994, FV28G AB 1997, FV28GFA, FV30GS, FV40N AB 1992, FV40T, FV60E AB 1988, FV70T		

1		GEV No.	501172	Ref. No.	0360211 8660239
		description	nut thread M16x1.5 H 5mm WS 22 SS Qty 1 pcs		
		For models:	ECO STAR 430F, ECO STAR 530F, ECO STAR 545D, FV28G AB 1994, FV28G AB 1997, FV28GFA		





Зип Общепит

vsezip.ru

+7(812)987-08-81

miscellaneous

			
1			
GEV No.	524568	Ref. No.	9600446
description	end cap for wash arm ø 45mm H 45mm		

			
1			
GEV No.	517739	Ref. No.	0620468
description	nozzle insert hole ø 10mm H 20mm ø 32.5mm		

			
1			
GEV No.	517733	Ref. No.	8103318
description	rinse arm mounting pos. lower L 710mm nozzles 4		



			
1			
GEV No.	517734	Ref. No.	8103317
description	rinse arm mounting pos. upper L 655mm nozzles 3		





			
1			
GEV No.	501182	Ref. No.	0472032
description	rinse jet		

			
1			
GEV No.	524573	Ref. No.	0472030
description	rinse jet ø 0.3mm H 9.5mm thread 1/16" NPT WS 10		

			
1			
GEV No.	524557	Ref. No.	0472035
description	rinse jet ø 11.5mm H 9.6mm thread 1/16" NPT WS 10 hole ø 2mm		

			
1			
GEV No.	517773	Ref. No.	9520201
description	wash arm L 670mm nozzles 5		

			
1			
GEV No.	524555	Ref. No.	0620205
description	wash jet H 23.5mm ø 27mm		
accessories for	524555		
	GEV No.	524558	Ref. No. 0620161
	adapter for wash jet ID ø 21mm ED ø 28mm plastic		

			
1			
GEV No.	501418	Ref. No.	8004451
description	wash arm support complete mounting pos. lower		
spare parts for	501418		
	GEV No.	501033	Ref. No. 0620443
	wash arm support mounting pos. lower		
	GEV No.	501126	Ref. No. 0620233
	centring star		
	GEV No.	501142	Ref. No. 8000174
	rinse pipe		
accessories for	501418		
	GEV No.	501007	Ref. No. 0401030
	O-ring EPDM thickness 1.5mm ID ø 50mm Qty 1 pcs		

			
1			
GEV No.	501033	Ref. No.	0620443
description	wash arm support mounting pos. lower		
For models:	DV120T, DV40N, DV40T, DV40T FA, DV80T, ECO STAR 545D		

			
1			
GEV No.	501050	Ref. No.	8000190
description	wash arm support mounting pos. lower		
For models:	FV25G AB 1986		

mechanical components, equipment accessories

Зип Общепит
vsezip.ru
+7(812)987-08-01



1

GEV No.	501130	Ref. No.	0620285
description	wash arm support mounting pos. lower		
For models:	ECO STAR 530F, FV110G, FV20N, FV20T, FV30GS, FV40T, FV40TFA, FV60E AB 1988, FV70T, FV70TD		



1

GEV No.	501201	Ref. No.	0620432
description	wash arm support mounting pos. lower		
For models:	ECO STAR 430F, FV28G AB 1994, FV28G AB 1997, FV28GFA		



1

GEV No.	501297	Ref. No.	8000034 8000036
description	wash arm support mounting pos. lower		
For models:	FV40N AB 1983, FV60E AB 1983		



1

GEV No.	501128	Ref. No.	0620281
description	wash arm support mounting pos. lower D1 ø 28mm H 26mm ID ø 20.5mm flange 54x54mm		
For models:	DV120B, DV120T, DV160 AB 1983, DV160 AB 1996, DV240B AB 1983, DV240B AB 1996, DV40 AB 1983, DV40N, DV40T, DV40T FA, DV80, DV80 AB 1983, DV80 AB 1992, DV80T, ECO STAR 545D, FV40N AB 1983, FV60E AB 1983		



1

GEV No.	506231	Ref. No.	9538625
description	wash arm support mounting pos. lower D1 ø 55mm D2 ø 70mm H 90mm		



1

GEV No.	501096	Ref. No.	8000085
description	wash arm support mounting pos. upper		
For models:	FV120B AB 1983, FV240B AB 1983		



1

GEV No.	501131	Ref. No.	0620288 8000037 8000968
description	wash arm support mounting pos. upper		
For models:	ECO STAR 530F, FV20N, FV20T, FV30GS, FV40N AB 1983, FV40N AB 1992, FV40T, FV40TFA, FV60E AB 1983, FV60E AB 1988, FV70TD		



1

GEV No.	501129	Ref. No.	0620282
description	wash arm support mounting pos. upper H 26mm D1 ø 28mm ID ø 21mm flange 54x54mm		
For models:	DV120B, DV120T, DV160 AB 1983, DV160 AB 1996, DV240B AB 1983, DV240B AB 1996, DV40 AB 1983, DV40N, DV40T, DV40T FA, DV80, DV80 AB 1983, DV80 AB 1992, DV80T, ECO STAR 545D, FV40N AB 1983		



1

GEV No.	501388	Ref. No.	9517397 9671628
description	bearing for wash arm ø 22mm H 34.5mm		
For models:	DV120.2, FV40.2, FV40.2 AB 2002, FV40.2 AB 2003, FV40.2M, FV40.2M-MIKE2		

rinse arm shafts



1

GEV No.	501026	Ref. No.	8004195
description	rinse arm shaft		
For models:	ECO STAR 430F, FV28GFA		



1

GEV No.	501062	Ref. No.	0620505 8004475	
description	rinse arm shaft			
accessories for	501062			
	GEV No.	100809	Ref. No.	0401016
	GEV No.	501061	Ref. No.	8004468
	GEV No.	501299	Ref. No.	8660464



Зип-Общепит

knobs

MEIKO

producer-specific knobs

vsezip.ru

+7(812)987-08-81

			
1			
GEV No.	501153	Ref. No.	8004008
description	rinse arm shaft		
For models:	ECO STAR 430F, FV28G AB 1994, FV28G AB 1997, FV28GFA		

			
1			
GEV No.	501253	Ref. No.	8002125
description	rinse arm shaft		
For models:	DV40 AB 1992		

			
1			
GEV No.	501298	Ref. No.	8003957
description	rinse arm shaft		
For models:	FV110G		

			
1			
GEV No.	501134	Ref. No.	0620383
description	rinse arm shaft centring star mounting pos. upper		
For models:	ECO STAR 530F, FV20N, FV20T, FV30GS, FV40N AB 1992, FV40T, FV40T-FA, FV60E AB 1988, FV70T, FV70TD		

			
1			
GEV No.	501154	Ref. No.	0620506 8004469
description	rinse arm shaft centring star mounting pos. upper ø 26mm H 108mm		
For models:	DV120T, DV40N, DV40T, DV40T FA, DV80T, ECO STAR 545D		

			
1			
GEV No.	524567	Ref. No.	9517409
description	rinse arm shaft ø 24mm H 36.6mm thread M12x1		
For models:	DV120.2, FV40.2, FV40.2 AB 2002, FV40.2 AB 2003, FV40.2M, FV40.2M-MIKE2		

			
1			
GEV No.	501085	Ref. No.	0620320
description	knob black		
For models:	DV100 AB 1983, DV260B, DV270B AB 1988, FR40G AB 1983, FR40GUS AB 1983, FV120B AB 1983, FV240B AB 1983, FV60E AB 1983		

			
1			
GEV No.	112744	Ref. No.	0108018
description	knob zero mark ø 42mm shaft ø 6x4.6mm shaft flat upper black		
For models:	DV40 AB 1983, FR30G, FR40G AB 1976, FR40G AB 1980, FR40G AB 1983, FR40GUS AB 1976, FR40GUS AB 1980, FR40GUS AB 1983, FV25G AB 1986, FV40GE, FV40N AB 1980, FV40N AB 1983, FV60E AB 1983		

accessories

rosettes

			
1			
GEV No.	501086	Ref. No.	0620321
description	rosette black		
For models:	DV100 AB 1983, DV260B, FR40G AB 1983, FR40GUS AB 1983, FV60E AB 1983		

miscellaneous

			
1			
GEV No.	501080	Ref. No.	0620138
description	octagonal nut thread 1 1/2"		
For models:	DV100 AB 1980, DV100 AB 1983, DV160 AB 1980, DV221, DV260B, DV270B AB 1988, DV80 AB 1980, FR40G AB 1976, FR40G AB 1980, FR40G AB 1983, FR40GUS AB 1976, FR40GUS AB 1980, FR40GUS AB 1983, FR60, FV120B AB 1983, FV240B AB 1980, FV240B AB 1983, FV40N AB 1980, FV60 AB 1976, FV60E AB 1983		

mechanical components, equipment accessories

equipment feet and end caps

bullet feet

plastic



1

GEV No.	700108	Ref. No.	0621003 9702221
description	equipment foot pipe type 40x40 thickness 1-1.2mm H 17-55mm plastic Qty 1 pcs		
For models:	DV100 AB 1980, DV120B, DV120T, DV160 AB 1980, DV160 AB 1983, DV160 AB 1996, DV240B AB 1980, DV240B AB 1983, DV240B AB 1996, DV260B, DV270B AB 1992, DV40 AB 1983, DV40 AB 1992, DV40N, DV40T, DV40T FA, DV80, DV80 AB 1980, DV80 AB 1992, DV80T, FV120B AB 1983, FV130B, FV240B AB 1983, FV250B AB 1992		
spare parts for	700108		
	GEV No.	511512	Ref. No. —
	O-ring EPDM thickness 2.62mm ID ø 18.72mm Qty 10 pcs		

gaskets

O-rings

EPDM

ø1.50mm

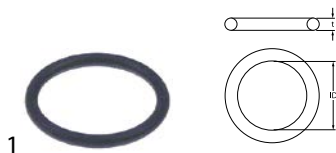

1

GEV No.	532605	Ref. No.	0401011
description	O-ring EPDM thickness 1.5mm ID ø 12mm Qty 1 pcs		

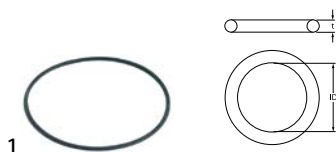

1

GEV No.	501007	Ref. No.	0401030
description	O-ring EPDM thickness 1.5mm ID ø 50mm Qty 1 pcs		
For models:	DV120T, DV40N, DV40T, DV40T FA, DV80T, ECO STAR 430F, ECO STAR 530F, ECO STAR 545D, FV110G, FV20N, FV20T, FV28G AB 1994, FV28G AB 1997, FV28GFA, FV30GS, FV40N AB 1992, FV40T, FV40TFA, FV60E AB 1988, FV70T, FV70TD		

Зип-Общепит

ø 1.78mm



1

GEV No.	528815	Ref. No.	0401038
description	O-ring EPDM thickness 1.78mm ID ø 3.69mm Qty 1 pcs		
For models:	FV25G AB 1986		

ø2.00mm

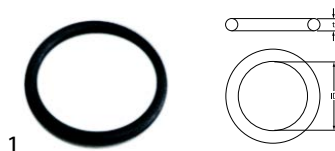

1

GEV No.	361080	Ref. No.	0260051
description	O-ring EPDM thickness 2mm ID ø 16mm Qty 1 pcs		
For models:	DV120B, DV120T, DV40 AB 1992, DV40N, DV40T, DV80 AB 1992, DV80T, ECO STAR 430F, ECO STAR 530F, FR30G, FR30G AB 1992, FV110G, FV130B, FV20N, FV20T, FV25G AB 1986, FV25G AB 1992, FV28G AB 1994, FV28G AB 1997, FV30GS, FV40N AB 1992, FV40T, FV60E AB 1988, FV70T		



1

GEV No.	100809	Ref. No.	0401016
description	O-ring EPDM thickness 2mm ID ø 21mm Qty 1 pcs		
For models:	DV120.2, DV120T, DV40N, DV40T, DV40T FA, DV80T, ECO STAR 545D, FV40.2, FV40.2 AB 2002, FV40.2M, FV40.2M-MIKE2		



1

GEV No.	361311	Ref. No.	9541531
description	O-ring EPDM thickness 2mm ID ø 6mm Qty 1 pcs for type N6		

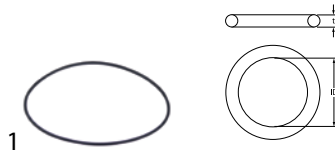

1

GEV No.	501419	Ref. No.	0401065
description	O-ring EPDM thickness 2mm ID ø 84mm Qty 1 pcs		



Зип Общепит

vsezip.ru

77(812)987-08-81

GEV No.	361085	Ref. No.	0260053
description	O-ring EPDM thickness 2mm ID ø 8mm Qty 1 pcs		
For models:	DV120B, DV120T, DV40 AB 1992, DV40N, DV40T, DV80 AB 1992, DV80T, ECO STAR 430F, ECO STAR 530F, FR30G AB 1992, FV110G, FV130B, FV20N, FV20T, FV25G AB 1992, FV28G AB 1994, FV28G AB 1997, FV30GS, FV40N AB 1992, FV40T, FV60E AB 1988, FV70T		

GEV No.	532675	Ref. No.	0401023
description	O-ring EPDM thickness 3mm ID ø 26mm Qty 1 pcs		

ø2.50mm

GEV No.	532680	Ref. No.	9541791
description	O-ring EPDM thickness 2.5mm ID ø 12mm Qty 1 pcs		

GEV No.	532676	Ref. No.	9515336
description	O-ring EPDM thickness 3mm ID ø 37.2mm Qty 1 pcs		
For models:	FV40.2, FV40.2M-MIKE2		

ø3.00mm

GEV No.	501173	Ref. No.	0401070
description	O-ring EPDM thickness 3mm ID ø 122mm Qty 1 pcs		
For models:	ECO STAR 430F, FV28G AB 1994, FV28G AB 1997, FV28GFA		

GEV No.	518113	Ref. No.	9541533
description	O-ring EPDM thickness 3mm ID ø 46mm Qty 1 pcs		
For models:	DV120.2		

GEV No.	532636	Ref. No.	9500177
description	O-ring EPDM thickness 3mm ID ø 160mm Qty 1 pcs		

GEV No.	532677	Ref. No.	9541532
description	O-ring EPDM thickness 3mm ID ø 54.5mm Qty 1 pcs		
For models:	DV120.2		

GEV No.	532637	Ref. No.	9500178
description	O-ring EPDM thickness 3mm ID ø 228mm Qty 1 pcs		

GEV No.	501008	Ref. No.	0401045
description	O-ring EPDM thickness 3mm ID ø 64mm Qty 1 pcs		
For models:	DV100 AB 1983, DV120B, DV160 AB 1983, DV160 AB 1996, DV240B AB 1983, DV240B AB 1996, DV260B, DV40 AB 1983, DV40 AB 1992, DV80, DV80 AB 1983, DV80 AB 1992, FR30G, FR30G AB 1992, FR40G AB 1983, FR40GUS AB 1983, FV120B AB 1983, FV130B, FV240B AB 1983, FV25G AB 1986, FV25G AB 1992, FV30GS, FV40N AB 1983, FV40N AB 1992, FV60E AB 1983, FV60E AB 1988		

GEV No.	527561	Ref. No.	0401066
description	O-ring EPDM thickness 3mm ID ø 22mm Qty 1 pcs		

GEV No.	532678	Ref. No.	9533155
description	O-ring EPDM thickness 3mm ID ø 66mm Qty 1 pcs		
For models:	FV40.2, FV40.2MIKE2, FV40.2M-MIKE2		

mechanical components, equipment accessories

Зип Общепит

vsezip.ru

7(812)987-08-81

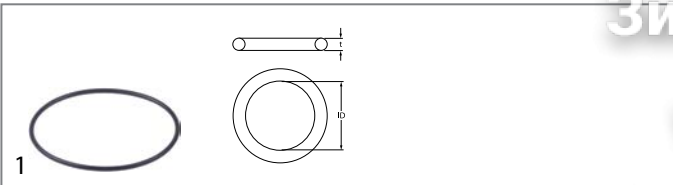

GEV No.	510683	Ref. No.	9523260 9545781
description	O-ring EPDM thickness 3mm ID \varnothing 79mm Qty 1 pcs		
For models:	FV40.2, FV40.2MIKE2, FV40.2M-MIKE2		

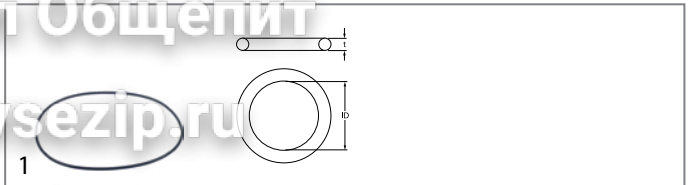

GEV No.	532082	Ref. No.	9600791
description	O-ring EPDM thickness 4mm ID \varnothing 188mm Qty 1 pcs Shore 70°		

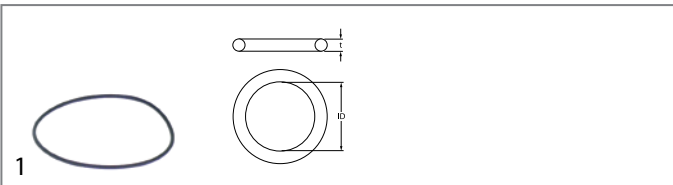

GEV No.	532496	Ref. No.	9515338
description	O-ring EPDM thickness 3mm ID \varnothing 96mm Qty 1 pcs		
For models:	FV40.2, FV40.2MIKE2, FV40.2M-MIKE2		

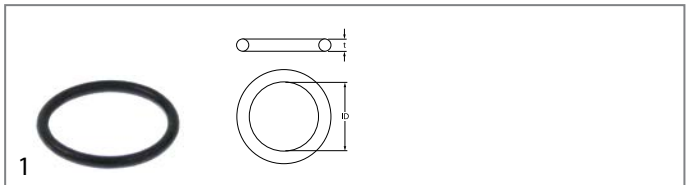

GEV No.	532634	Ref. No.	9601007
description	O-ring EPDM thickness 4mm ID \varnothing 38mm Qty 1 pcs		

ø3.53mm

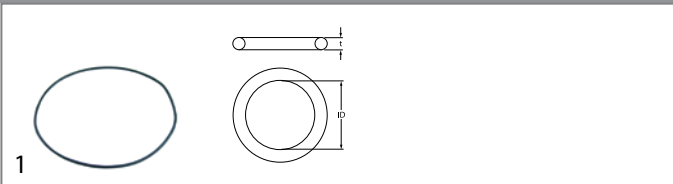

GEV No.	501009	Ref. No.	0401061
description	O-ring EPDM thickness 3.53mm ID \varnothing 206.5mm Qty 1 pcs		
For models:	DV120.2, DV120B, DV120T, DV40 AB 1992, DV40N, DV40T, DV40T FA, DV80 AB 1992, DV80T, ECO STAR 530F, ECO STAR 545D, FV110G, FV20N, FV20T, FV40T, FV40TFA, FV70T, FV70TD		

ø5,00mm

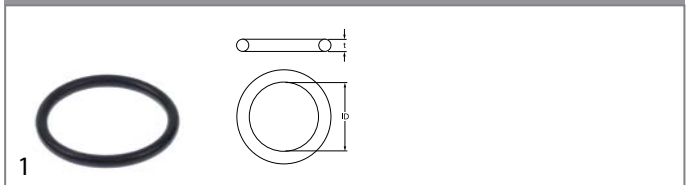

GEV No.	532632	Ref. No.	0401031
description	O-ring EPDM thickness 5mm ID \varnothing 47mm Qty 1 pcs		

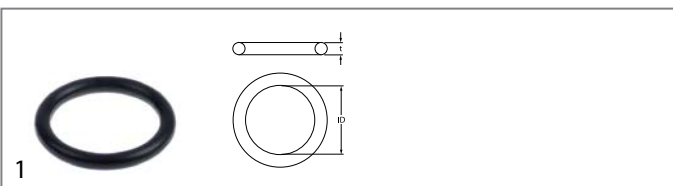

GEV No.	501352	Ref. No.	0401018
description	O-ring EPDM thickness 3.53mm ID \varnothing 21.82mm Qty 1 pcs		

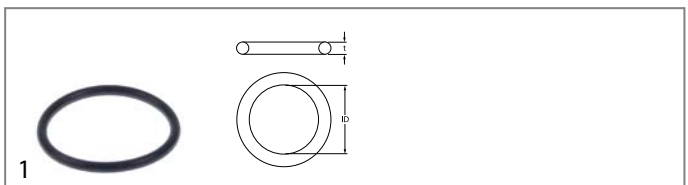

GEV No.	532633	Ref. No.	9532356
description	O-ring EPDM thickness 5mm ID \varnothing 58mm Qty 1 pcs		

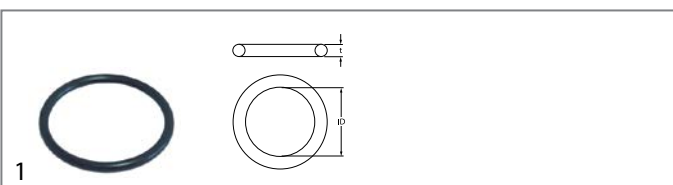

GEV No.	510895	Ref. No.	0401029 9659174
description	O-ring EPDM thickness 3.53mm ID \varnothing 34.52mm Qty 1 pcs		

ø5.34mm

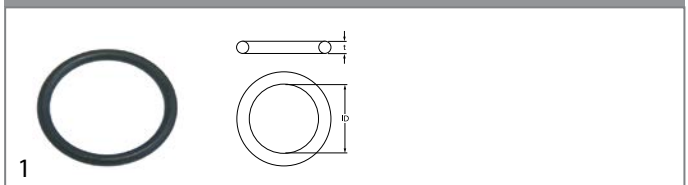

GEV No.	510408	Ref. No.	0101176
description	O-ring EPDM thickness 5.34mm ID \varnothing 47mm Qty 1 pcs		
For models:	DV120.2, DV120B, DV120T, DV160 AB 1996, DV240B AB 1996, DV40 AB 1992, DV40T, DV40T FA, DV80 AB 1992, DV80T, ECO STAR 430F, ECO STAR 530F, ECO STAR 545D, FR30G AB 1992, FV110G, FV130B, FV20N, FV20T, FV25G AB 1992, FV28G AB 1994, FV28G AB 1997, FV28GFA, FV30GS, FV40.2, FV40.2 AB 2002, FV40.2 AB 2003, FV40.2M, FV40.2MIKE2, FV40.2M-MIKE2, FV40N AB 1992, FV40T, FV40TFA, FV60E AB 1988, FV70T, FV70TD		

ø4.00mm

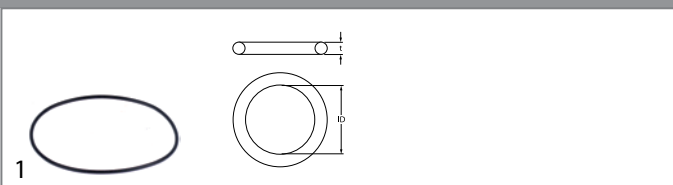

GEV No.	501000	Ref. No.	9515339
description	O-ring EPDM thickness 4mm ID \varnothing 145mm Qty 1 pcs		
For models:	DV120.2, FV40.2, FV40.2 AB 2002, FV40.2 AB 2003, FV40.2M, FV40.2MIKE2, FV40.2M-MIKE2		



Зип Общепит

vsezip.ru

+7(812)987-08-81

ø6,00mm

GEV No.	532679	Ref. No.	9500176
description	O-ring EPDM thickness 6mm ID ø 78mm Qty 1 pcs		

NBR

GEV No.	532635	Ref. No.	9523850
description	O-ring NBR thickness 3mm ID ø 48mm Qty 1 pcs		
For models:	FV40.2, FV40.2M-MIKE2		

ø7,00mm

GEV No.	532000	Ref. No.	0401048
description	O-ring EPDM thickness 7mm ID ø 57mm Qty 1 pcs		

sealing washers

fibre gaskets

GEV No.	501176	Ref. No.	0408003
description	flat gasket FIBER ED ø 24mm ID ø 17mm thickness 1.5mm Qty 1 pcs		
For models:	DR90, FR30G, FR30G AB 1992, FR40G AB 1983, FR40GUS AB 1983, FV110G		

miscellaneous

GEV No.	501398	Ref. No.	0401021
description	O-ring EPDM thickness 12mm ID ø 25mm Qty 1 pcs		

GEV No.	510406	Ref. No.	0408020
description	flat gasket fibre ED ø 60mm ID ø 48mm thickness 3mm for thread 1½" Qty 1 pcs		
For models:	DV100 AB 1983, DV120B, DV160 AB 1983, DV160 AB 1996, DV240B AB 1983, DV240B AB 1996, DV40 AB 1983, DV40 AB 1992, DV80, DV80 AB 1983, DV80 AB 1992, FR30G, FR30G AB 1992, FR40G AB 1983, FR40GUS AB 1983, FV130B, FV25G AB 1986, FV25G AB 1992, FV30GS, FV40N AB 1983, FV40N AB 1992, FV60E AB 1983, FV60E AB 1988		

GEV No.	532714	Ref. No.	0401008
description	O-ring thickness 2.4mm ID ø 9.3mm Qty 1 pcs		

GEV No.	501075	Ref. No.	0408006
description	sealing ring ED ø 30mm ID ø 21mm thickness 1.5mm Qty 1 pcs		
For models:	DR70, DR90E, DV111, DV111E, DV160 AB 1996, DV240B AB 1996, DV260B, DV270B AB 1992, DV80 AB 1975, DV80 AB 1980, FR40G AB 1980, FR40GUS AB 1980, FV120B AB 1983, FV240B AB 1983, FV250B AB 1992		

silicone

ø3.00mm

GEV No.	532713	Ref. No.	9657016
description	O-ring silicone thickness 3mm ID ø 22mm Qty 1 pcs		

rubber gaskets

GEV No.	511660	Ref. No.	0408226
description	flat gasket EPDM ED ø 37.2mm ID ø 28mm thickness 1.5mm Qty 1 pcs		

ø4.50mm

GEV No.	532712	Ref. No.	9657014
description	O-ring silicone thickness 4.5mm ID ø 80mm Qty 1 pcs		

mechanical components, equipment accessories

Зип Общепит

vsezip.ru

+7(812)987-0888

			
1			
GEV No.	501010	Ref. No.	0408008
description	flat gasket FIBER ED ø 25mm ID ø 14mm thickness 1.5mm Qty 1 pcs		
For models:	DV120.2, DV120B, DV120T, DV40T, DV80T, ECO STAR 545D, FV100, FV130B, FV20N, FV20T, FV28G AB 1994, FV28G AB 1997, FV40.2M, FV40.2M-MIKE2, FV40T, FV70T		

			
1			
GEV No.	501106	Ref. No.	9515964
description	flat gasket rubber ED ø 26mm ID ø 18mm thickness 2mm Qty 1 pcs		
For models:	FV40.2, FV40.2M-MIKE2, FV40.2M-MIKE2		

			
1			
GEV No.	501177	Ref. No.	0408227
description	flat gasket rubber ED ø 19mm ID ø 13mm thickness 1.5mm Qty 1 pcs		
For models:	DV40T FA, ECO STAR 545D, FV40TFA, FV70TD		

			
1			
GEV No.	510875	Ref. No.	0408214
description	flat gasket rubber ED ø 68mm ID ø 48mm thickness 2mm Qty 1 pcs		
For models:	DV100 AB 1980, DV100 AB 1983, DV120B, DV160 AB 1980, DV160 AB 1983, DV160 AB 1996, DV240B AB 1980, DV240B AB 1983, DV240B AB 1996, DV40 AB 1983, DV40 AB 1992, DV80, DV80 AB 1980, DV80 AB 1983, DV80 AB 1992, FR30G, FR30G AB 1992, FR40G AB 1980, FR40G AB 1983, FR40GUS AB 1980, FR40GUS AB 1983, FV130B, FV25G AB 1986, FV25G AB 1992, FV30GS, FV40N AB 1980, FV40N AB 1983, FV40N AB 1992, FV60E AB 1983, FV60E AB 1988		

			
1			
GEV No.	510764	Ref. No.	0408225
description	flat gasket rubber ED ø 24mm ID ø 12mm thickness 2mm Qty 1 pcs		
For models:	FV40.2, FV40.2M-MIKE2		

			
1			
GEV No.	501066	Ref. No.	0237009 0408224
description	flat gasket rubber ED ø 85mm ID ø 59.5mm thickness 2mm Qty 1 pcs		
For models:	DV270B AB 1992		

			
1			
GEV No.	501289	Ref. No.	0217432
description	flat gasket rubber ED ø 24mm ID ø 14mm thickness 2mm Qty 1 pcs		
For models:	FV40.2, FV40.2 AB 2002, FV40.2 AB 2003, FV40.2MIKE2		

			
1			
GEV No.	510883	Ref. No.	9500825
description	gasket rubber ED ø 86mm ID ø 66mm thickness 2mm for salt tank Qty 1 pcs		
For models:	ECO STAR 545D		

			
1			
GEV No.	505199	Ref. No.	9612484
description	flat gasket rubber ED ø 24mm ID ø 14mm thickness 3mm Qty 1 pcs		

plastic gaskets			
			
1			
GEV No.	501076	Ref. No.	0411005
description	gasket plastic ED ø 29.5mm ID ø 16mm thickness 6mm for thread M16 Qty 1 pcs		
For models:	DV260B, DV40 AB 1983, FV120B AB 1983, FV240B AB 1983		

			
1			
GEV No.	501001	Ref. No.	0217433
description	flat gasket rubber ED ø 24mm ID ø 17mm thickness 2mm Qty 1 pcs		
For models:	DV120B, DV120T, DV160 AB 1983, DV160 AB 1996, DV240B AB 1983, DV240B AB 1996, DV260B, DV270B AB 1992, DV40 AB 1983, DV40 AB 1992, DV40N, DV40T, DV80, DV80 AB 1983, DV80 AB 1992, DV80T, ECO STAR 430F, ECO STAR 530F, ECO STAR 545D, FR30G AB 1992, FV110G, FV120B AB 1983, FV130B, FV20N, FV20T, FV240B AB 1983, FV250B AB 1992, FV25G AB 1992, FV28G AB 1994, FV28G AB 1997, FV28GFA, FV30GS, FV40N AB 1992, FV40T, FV60E AB 1988, FV70T		



Зип Общежит shaft gaskets

vsezip.ru

+7(812)987-08-81

copper gaskets

DIN-7603-A



GEV No.	506247	Ref. No.	0409000
description	flat gasket copper ED ø 8mm ID ø 4mm thickness 1mm Qty 1 pcs		
For models:	DV120T, DV40N, DV40T, DV40T FA, DV80T, ECO STAR 430F, ECO STAR 545D, FV110G, FV20N, FV20T, FV25G AB 1986, FV28G AB 1994, FV28G AB 1997, FV28GFA, FV30GS, FV40N AB 1992, FV40T, FV40TFA, FV60E AB 1988, FV70T, FV70TD		

DIN-7603-C



GEV No.	510420	Ref. No.	0108019
description	gasket copper ED ø 19.9mm ID ø 14.3mm thickness 2mm Qty 1 pcs		
For models:	DV40 AB 1983, FR30G, FR40G AB 1976, FR40G AB 1983, FR40GUS AB 1976, FR40GUS AB 1983, FR60, FV25G AB 1986, FV40N AB 1983, FV50, FV60 AB 1976, FV60E AB 1983		



GEV No.	510424	Ref. No.	0409008
description	gasket copper ED ø 55mm ID ø 48mm thickness 2.2mm Centellen for thread 1½"		
For models:	DV100 AB 1980, DV100 AB 1983, DV120B, DV160 AB 1980, DV160 AB 1983, DV160 AB 1996, DV240B AB 1980, DV240B AB 1983, DV240B AB 1996, DV260B, DV270B AB 1992, DV40 AB 1983, DV80, DV80 AB 1983, DV80 AB 1992, EE60, EE90, FR30G, FR40G AB 1976, FR40G AB 1980, FR40G AB 1983, FR40GUS AB 1976, FR40GUS AB 1980, FR40GUS AB 1983, FR60, FV120B AB 1980, FV120B AB 1983, FV200B, FV240B AB 1980, FV240B AB 1983, FV250B AB 1992, FV25G AB 1986, FV30, FV40N AB 1980, FV40N AB 1983, FV50, FV50 M, FV60 AB 1973, FV60 AB 1976, FV60E AB 1983		

PTFE gaskets



GEV No.	512401	Ref. No.	9603787
description	flat gasket PTFE ED ø 16mm ID ø 10mm thickness 2mm Qty 1 pcs		
For models:	FV40.2M-MIKE2		



GEV No.	501175	Ref. No.	0403302
description	flat gasket PTFE ED ø 16mm ID ø 7mm thickness 1mm Qty 1 pcs		

shaft gaskets



GEV No.	698455	Ref. No.	9541786
description	shaft sealing set ID ø 18mm ED ø 26mm thickness 10.5mm		

special gaskets

door seals for dishwashers

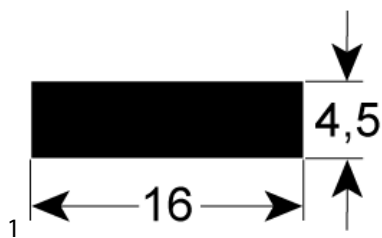

GEV No.	504456	Ref. No.	0650080
description	door seal L 430mm W 16mm H 4.5mm rubber suitable for MEIKO		

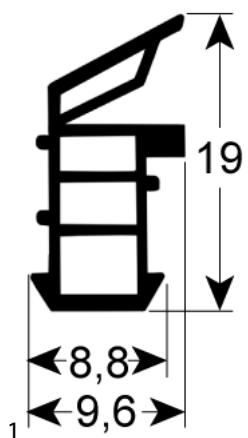

GEV No.	902061	Ref. No.	0415028 9503848 9650780
description	door seal L 480mm black		

miscellaneous

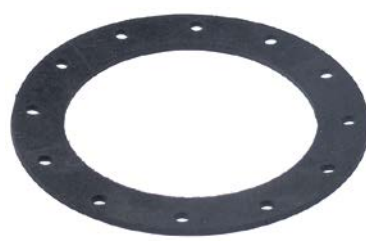

GEV No.	501383	Ref. No.	0408229
description	flat gasket ID ø 102mm ED ø 144mm hole distance 33mm hole ø 6mm EPDM for heating element thickness 3mm		

mechanical components, equipment accessories

Зип-Общепит

drive belts

round belts
vsezip.ru

+7(812)987-08-81

1

GEV No.	694464 ¹	Ref. No.	0440011
description	round belt ø 10mm Lmm Qty supplied by meter		

¹by the meter

springs

torsion springs



1

GEV No.	524359	Ref. No.	0431211
description	torsion spring ø 8mm wire gauge ø 1.3mm Qty 1 pcs warewashing		



1

GEV No.	502215	Ref. No.	9501866
description	torsion spring ø 9mm wire gauge ø 1.6mm Qty 1 pcs for magnetic switch		

spring compressors



1

GEV No.	501060	Ref. No.	8004425
description	spring compressor		
For models:	DV120.2, DV120T, DV40N, DV40T, DV40T FA, DV80T, ECO STAR 545D		



1

GEV No.	501240	Ref. No.	8000073
description	spring compressor		
For models:	DR90, DV100 AB 1983, DV111, DV111E, DV120, DV120B, DV160 AB 1983, DV160 AB 1996, DV221, DV240B AB 1983, DV240B AB 1996, DV40 AB 1983, DV40 AB 1992, DV80, DV80 AB 1980, DV80 AB 1983, DV80 AB 1992		



1

GEV No.	504465	Ref. No.	9515234
description	gasket suitable for MEIKO for air valve ED ø 14mm ID ø 9mm EPDM thickness 1.6mm		
For models:	FV40.2, FV40.2M-MIKE2		

thermostat gaskets



1

GEV No.	510362	Ref. No.	0108040
description	gasket for thermostat ED ø 40mm ID ø 19mm suitable for COMENDA, MEIKO equiv. no. 630511/0108040		
For models:	DV100 AB 1980, DV100 AB 1983, DV120B, DV120T, DV160 AB 1980, DV160 AB 1983, DV160 AB 1996, DV240B AB 1980, DV240B AB 1983, DV240B AB 1996, DV270B AB 1992, DV40 AB 1983, DV40N, DV40T, DV40T FA, DV80, DV80 AB 1980, DV80 AB 1983, DV80 AB 1992, DV80T, ECO STAR 430F, ECO STAR 530F, ECO STAR 545D, FR30G, FR30G AB 1992, FR40G AB 1976, FR40G AB 1980, FR40G AB 1983, FR40GUS AB 1976, FR40GUS AB 1980, FR40GUS AB 1983, FV110G, FV130B, FV20N, FV20T, FV250B AB 1992, FV25G AB 1986, FV25G AB 1992, FV28G AB 1994, FV28G AB 1997, FV28GFA, FV30, FV30GS, FV40.2, FV40.2 AB 2003, FV40N AB 1980, FV40N AB 1983, FV40N AB 1992, FV40T, FV40T-FA...(Other models you can see in the webshop)		

gaskets for wash arm support



1

GEV No.	501070	Ref. No.	9515334
description	gasket D1 ø 58mm D2 ø 42mm thickness 2.5mm		
For models:	FV40.2, FV40.2M-MIKE2		

transmission technology and ball bearings

ball bearings

flange bearings



1

GEV No.	694470	Ref. No.	8230515
description	flange bearing type SA204 shaft ø 20mm W 68mm hole distance 70mm H 25mm		



Зип Общепит

vsezip.ru

+7(812)987-08-81

gas tension springs

gas tension springs



1			
GEV No.	501077	Ref. No.	0431040
description	gas tension spring 150N		
For models:	DV270B AB 1988, FV120B AB 1980, FV120B AB 1983, FV240B AB 1980, FV240B AB 1983, FV250B AB 1988, FV250B AB 1992		



1			
GEV No.	501078	Ref. No.	0431041
description	gas tension spring 75N		
For models:	FV120B AB 1980, FV120B AB 1983, FV130B, FV240B AB 1980, FV240B AB 1983, FV250B AB 1992		

accessories



1			
GEV No.	694469	Ref. No.	8003243
description	bearing for gas tension spring L 50mm W 16mm H 30mm hole ø 8mm		

roller springs

roller springs



1			
GEV No.	501255	Ref. No.	0431070
description	roller spring type 5-1 L 870mm W 40mm ID ø 36mm		

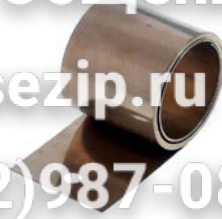

GEV No.	501395	Ref. No.	0431073
description	roller spring type 5-2 L 970mm W 40mm ID ø 36mm lug length 72mm		

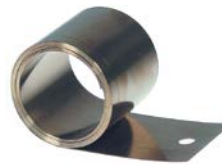

1			
GEV No.	501403	Ref. No.	0431071
description	roller spring type 7-1 L 870mm W 40mm ID ø 36mm lug length 52mm		

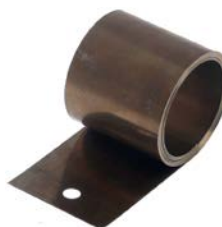

1			
GEV No.	501392	Ref. No.	9504018
description	roller spring type 7-1A L 920mm W 40mm ID ø 36mm lug length 52mm		

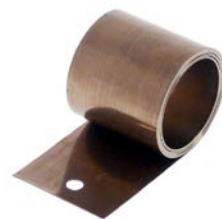

1			
GEV No.	501394	Ref. No.	0431074
description	roller spring type 7-2 L 970mm W 40mm ID ø 36mm lug length 72mm		



1			
GEV No.	501391	Ref. No.	9504017
description	roller spring W 40mm ID ø 35mm lug length 50mm		

mechanical components, equipment accessories

Зип-Общепит

vsezip.ru

+7(812)987-08-81

mechanical components, equipment accessories

			
1			
GEV No.	501406	Ref. No.	0431075
description	roller spring W 40mm ID ø 35mm lug length 50mm		

			
1			
GEV No.	517736	Ref. No.	0431067
description	roller spring W 40mm ID ø 36mm lug length 26.75mm mounting distance 20mm		

			
1			
GEV No.	517737	Ref. No.	0431069
description	roller spring W 40mm ID ø 41mm lug length 29mm mounting distance 20mm		
For models:	FV130B		

			
1			
GEV No.	518599	Ref. No.	0431081
description	roller spring with hole type 94		

accessories

bolts

			
1			
GEV No.	694468	Ref. No.	8100910
description	bearing bolt for roller spring ø 8mm L 79mm		

			
1			
GEV No.	511662	Ref. No.	8100868
description	bracket for roller spring L 95mm W 65mm H 60mm		

tension springs

			
1			
GEV No.	519556	Ref. No.	9549548
description	tension spring ø 1.2mm total length 63mm wire gauge ø 1.6mm L1 63mm L2 8mm L3 8mm		

			
1			
GEV No.	501326	Ref. No.	0430025
description	tension spring ø 14mm total length 80mm wire gauge ø 1.1mm		
For models:	ECO STAR 430F, ECO STAR 530F, FV110G, FV20N, FV20T, FV28G AB 1994, FV28G AB 1997, FV28GFA, FV40N AB 1992, FV40T, FV40TFA, FV70T, FV70TD		

			
1			
GEV No.	701013	Ref. No.	9682387
description	tension spring ø 21.6mm total length 123mm wire gauge ø 1.6mm		

			
1			
GEV No.	699286	Ref. No.	9601445 9682398
description	tension spring ø 27mm total length 150mm wire gauge ø 2mm L1 4mm L2 142mm L3 4mm for door		

			
1			
GEV No.	501057	Ref. No.	0430006 8001613
description	tension spring total length 385mm D1 ø 45mm D2 ø 6.5mm		
For models:	DR70, DV100 AB 1980, DV100 AB 1983, DV111, DV111E, DV120, DV120.2, DV120B, DV120T, DV160 AB 1980, DV160 AB 1983, DV160 AB 1996, DV221, DV240B AB 1980, DV240B AB 1983, DV240B AB 1996, DV260B, DV270B AB 1992, DV40 AB 1983, DV40 AB 1992, DV40N, DV40T, DV40T FA, DV80, DV80 AB 1975, DV80 AB 1980, DV80 AB 1992, DV80T, ECO STAR 545D		



dosing pumps

peristaltic dosing pumps





ASF/THOMAS

built-in version

without control







1

GEV No.	361272	Ref. No.	0535620
description	dosing pump ASF/THOMAS without control 12l/h 230VAC detergent hose ø 4x7mm hose silicone type SR25 dimensions 63x124x101mm		
spare parts for	361272		
	GEV No.	361333	Ref. No. 0535676
	pump hose SR25 detergent hose ø 4x1.5mm hose type silicone		
	GEV No.	361335	Ref. No. 0535657
	hose guide SR25 for detergent hose type hose ø 6mm plastic 1-way/h		
	GEV No.	361336	Ref. No. 0535658
	closing clamp type SR25		
	GEV No.	361470	Ref. No. —
	roller assembly type SR25 12l/h		



1

GEV No.	361248	Ref. No.	0535624
description	dosing pump ASF/THOMAS without control 2l/h 230VAC detergent hose ø 4x7mm hose silicone type SR25 dimensions 63x124x101mm		
spare parts for	361248		
	GEV No.	361333	Ref. No. 0535676
	pump hose SR25 detergent hose ø 4x1.5mm hose type silicone		
	GEV No.	361335	Ref. No. 0535657
	hose guide SR25 for detergent hose type hose ø 6mm plastic 1-way/h		
	GEV No.	361336	Ref. No. 0535658
	closing clamp type SR25		
	GEV No.	361469	Ref. No. —
	roller assembly type SR25 2/4/6l/h		



Зип Общепит

vsezip.ru

+7(812)987-08-81



1

GEV No.	361324	Ref. No.	0535682
description	dosing pump ASF/THOMAS without control 4l/h 12VDC detergent hose ø 2x5.2mm hose Pharmed type SR10/50 for short duty cycle dimensions 63x124x101mm		
For models:	FV28G AB 1994		
spare parts for	361324		
	GEV No.	361296	Ref. No. 0535694
	pump hose SR10/50 detergent hose length 250mm hose ø 2x1.6mm hose type Pharmed		
	GEV No.	361327	Ref. No. 0535692
	pump head SR10/50 detergent hose type Pharmed 4l/h		





1

GEV No.	361968	Ref. No.	0535696
description	dosing pump ASF/THOMAS without control 4l/h 12VDC rinse aid hose ø 2.5x5.7mm hose silicone type SR10/50 for short duty cycle dimensions 63x124x101mm		



1

GEV No.	361330	Ref. No.	0535680
description	dosing pump ASF/THOMAS without control 4l/h 12VDC rinse aid hose ø 2x5.2mm hose silicone type SR10/50 for short duty cycle dimensions 63x124x101mm		
spare parts for	361330		
	GEV No.	361292	Ref. No. 0535685 9520558
	pump head SR10/50 rinse aid hose type silicone 4l/h		
	GEV No.	361294	Ref. No. 0535688
	pump hose SR10/50 rinse aid hose length 190mm hose ø 2x5.2mm hose type silicone		

water and beverage technology



Зип Общепит

vsezip.ru

+7(812)987-08-81



1

GEV No.	361249	Ref. No.	0535625
description	dosing pump ASF/THOMAS without control 4l/h 230VAC detergent hose ø 4x7mm hose silicone type SR25 dimensions 63x124x101mm		
For models:	DV100 AB 1980, DV120B, DV160 AB 1980, DV240B AB 1980, DV80, DV80 AB 1980, FV120B AB 1980, FV240B AB 1980, FV40N AB 1980		
spare parts for	361249		
	GEV No.	361333	Ref. No. 0535676
	pump hose SR25 detergent hose ø 4x1.5mm hose type silicone		
	GEV No.	361335	Ref. No. 0535657
	hose guide SR25 for detergent hose type hose ø 6mm plastic 1-way/h		
	GEV No.	361336	Ref. No. 0535658
	closing clamp type SR25		
	GEV No.	361469	Ref. No. —
	roller assembly type SR25 2/4/6l/h		





1

GEV No.	361917	Ref. No.	0535697 9615179
description	dosing pump ASF/THOMAS without control 6l/h 12VDC rinse aid hose ø 2.5x1.6mm hose silicone type SR10/50 hose length 55/85mm		



1

GEV No.	361331	Ref. No.	0535681
description	dosing pump ASF/THOMAS without control 6l/h 12VDC rinse aid hose ø 2.5x5.7mm hose silicone type SR10/50 for short duty cycle dimensions 63x124x101mm		
spare parts for	361331		
	GEV No.	361293	Ref. No. 0535686 9500290
	pump head SR10/50 rinse aid hose type silicone 6l/h		
	GEV No.	361295	Ref. No. 0535690
	pump hose SR10/50 rinse aid hose length 190mm hose ø 2.5x1.6mm hose type silicone		







1

GEV No.	361325	Ref. No.	0535683
description	dosing pump ASF/THOMAS without control 6l/h 12VDC detergent hose ø 2.4x5.6mm hose Pharmed type SR10/50 for short duty cycle dimensions 63x124x101mm 20500702		
For models:	FV28G AB 1994		
spare parts for	361325		
	GEV No.	361297	Ref. No. 0535695
	pump hose SR10/50 detergent hose length 190mm hose ø 2.4x1.6mm hose type Pharmed		
	GEV No.	361328	Ref. No. 0535693
	pump head SR10/50 detergent hose type Pharmed 6l/h		



1

GEV No.	361271	Ref. No.	0535613
description	dosing pump ASF/THOMAS without control 6l/h 230VAC detergent hose ø 5x8mm hose silicone type SR25 dimensions 63x124x101mm		
spare parts for	361271		
	GEV No.	361334	Ref. No. 0535664
	pump hose SR25 detergent hose ø 5x8mm hose type silicone		
	GEV No.	361335	Ref. No. 0535657
	hose guide SR25 for detergent hose type hose ø 6mm plastic 1-way/h		
	GEV No.	361336	Ref. No. 0535658
	closing clamp type SR25		
	GEV No.	361469	Ref. No. —
	roller assembly type SR25 2/4/6l/h		



Зип Общепит

vsezip.ru

77(812)987-08-81

spare parts			
1			
GEV No.	361297	Ref. No.	0535695
description	pump hose SR10/50 detergent hose length 190mm hose ø 2.4x1.6mm hose type Pharmed		
1			
GEV No.	361296	Ref. No.	0535694
description	pump hose SR10/50 detergent hose length 250mm hose ø 2x1.6mm hose type Pharmed		
1			
GEV No.	361295	Ref. No.	0535690
description	pump hose SR10/50 rinse aid hose length 190mm hose ø 2.5x1.6mm hose type silicone		
1			
GEV No.	361294	Ref. No.	0535688
description	pump hose SR10/50 rinse aid hose length 190mm hose ø 2x5.2mm hose type silicone		
1			
GEV No.	361333	Ref. No.	0535676
description	pump hose SR25 detergent hose ø 4x1.5mm hose type silicone		
1			
GEV No.	361334	Ref. No.	0535664
description	pump hose SR25 detergent hose ø 5x8mm hose type silicone		
1			
GEV No.	361335	Ref. No.	0535657
description	hose guide SR25 for detergent hose type hose ø 6mm plastic 1-way/h		

1			
GEV No.	361327	Ref. No.	0535692
description	pump head SR10/50 detergent hose type Pharmed 4l/h		
For models:	FV28G AB 1994		

1			
GEV No.	361328	Ref. No.	0535693
description	pump head SR10/50 detergent hose type Pharmed 6l/h		
For models:	FV28G AB 1994		

1			
GEV No.	361292	Ref. No.	0535685 9520558
description	pump head SR10/50 rinse aid hose type silicone 4l/h		

1			
GEV No.	361293	Ref. No.	0535686 9500290
description	pump head SR10/50 rinse aid hose type silicone 6l/h		



Зип-Общепит

SEKO

vsezip.ru



+7(812)987-08-81

SAIER

built-in version

without control



GEV No.	361329	Ref. No.	9500049 9531928
description	dosing pump SAIER without control 10l/h 230VAC detergent hose ø 5x8mm type DSP9911E duty cycle 25%		
For models:	FV28G AB 1997		
spare parts for	361329		
	GEV No.	361332	Ref. No. 9500092
	pump hose detergent hose type PS 140 hose ø 4,8x1,6 (8)mm L 140mm		
	GEV No.	361671	Ref. No. —
	hose holder type 9911 hose ø 4.8mm		
	GEV No.	361672	Ref. No. —
	roller assembly type 8811		

spare parts

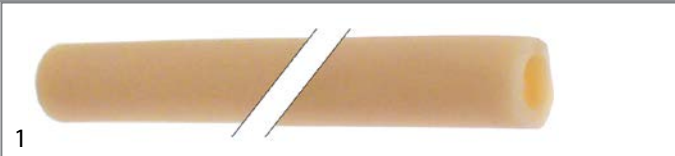





GEV No.	361332	Ref. No.	9500092
description	pump hose detergent hose type PS 140 hose ø 4,8x1,6 (8)mm L 140mm		
For models:	FV28G AB 1997		

wall-mounted version

with speed control



GEV No.	361246	Ref. No.	9503331
description	dosing pump SEKO speed control 0.5-1l/h 230VAC rinse aid hose ø 6mm hose type C hose Sekobril suction level 1.5m type PR dimensions 103x82x92mm		
For models:	ECO STAR 545D, FV28GFA		
spare parts for	361246		
	GEV No.	361136	Ref. No. —
	roller assembly for dosing pump hole ø 4.8x4mm		
	GEV No.	361890	Ref. No. 9505652
	pump hose SEKO rinse aid hose ø 3x8mm hose length 128mm hose ø 6mm hose type C hose Sekobril		
accessories for	361246		
	GEV No.	361511	Ref. No. —
	mounting set detergent hose type 6x9mm hose length 2m PVC 2x hose/container filter/tank intake transparent		
	GEV No.	520252	Ref. No. —
	nylon hose ID ø 6mm ED ø 8mm L 5m thickness 1mm operating p. 10bar burst p. 50bar t.max. 100°C white		
	GEV No.	520278	Ref. No. —
	PVC hose ID ø 6mm ED ø 8mm L 2m thickness 1mm t.max. 60°C transparent		





GEV No.	361247	Ref. No.	9504802 9511667 9533323
description	dosing pump SEKO speed control 1-7l/h 230VAC detergent hose ø 6mm hose type I hose Santoprene suction level 1.5m type PR dimensions 103x82x92mm		
spare parts for	361247		
	GEV No.	361136	Ref. No. —
	roller assembly for dosing pump hole ø 4.8x4mm		
	GEV No.	361238	Ref. No. 9505651 9511675
	pump hose SEKO detergent hose ø 6x10mm hose length 135mm hose ø 6mm hose type I hose Santoprene		





Table continues overleaf













Зип Общепит



vsezip.ru



+7(812)987-08-81

spare parts for 361247			
	GEV No.	361562	Ref. No. —
pump cover for dosing pump yellow			
accessories for 361247			
	GEV No.	361511	Ref. No. —
mounting set detergent hose type 6x9mm hose length 2m PVC hose/container filter/tank intake transparent			
	GEV No.	520252	Ref. No. —
nylon hose ID ø 6mm ED ø 8mm L 5m thickness 1mm operating p. 10bar burst p. 50bar t.max. 100°C white			
	GEV No.	520278	Ref. No. —
PVC hose ID ø 6mm ED ø 8mm L 2m thickness 1mm t.max. 60°C transparent			

1			
	GEV No.	361322 ¹	Ref. No. 9544293
description dosing pump SEKO without control 1l/h 24VDC rinse aid hose ø 6mm hose type B hose Sekobril suction level 1.5m horizontal/vertical type PP built-in version			
For models: DV120.2, FV40.2 AB 2002, FV40.2M, FV40.2MIKE2, FV40.2M-MIKE2			
spare parts for 361322			
	GEV No.	361136	Ref. No. —
roller assembly for dosing pump hole ø 4.8x4mm			
	GEV No.	361882	Ref. No. 9544088
pump hose SEKO rinse aid hose ø 3x7.4mm hose length 135mm hose ø 6mm hose type B hose Sekobril			
accessories for 361322			
	GEV No.	361144	Ref. No. —
mounting set rinse aid hose type 4x6mm hose length 2m PVC/nylon hose container filter/non-return valve transparent			
	GEV No.	520090	Ref. No. —
PVC hose ID ø 4mm ED ø 6mm L 2m thickness 1mm t.max. 60°C transparent			
	GEV No.	520091	Ref. No. —
nylon hose ID ø 4mm ED ø 6mm L 2m thickness 1mm operating p. 10bar burst p. 50bar t.max. 100°C transparent			

built-in version			
without control			
1			
	GEV No.	361772 ¹	Ref. No. 9518514
description dosing pump SEKO without control 0.4l/h 230VAC rinse aid hose ø 4x6mm hose type D hose Sekobril suction level 1.5m type PG peristaltic pump			
For models: FV40.2, FV40.2 AB 2003			
spare parts for 361772			
	GEV No.	361135	Ref. No. —
pump hose SEKO rinse aid hose ø 3x8mm hose ø 4x6mm hose type D hose Sekobril			
	GEV No.	361136	Ref. No. —
roller assembly for dosing pump hole ø 4.8x4mm			
	GEV No.	361562	Ref. No. —
pump cover for dosing pump yellow			

with accessories			
1			
	GEV No.	361771 ¹	Ref. No. 9518513
description dosing pump SEKO without control 3l/h 230VAC detergent hose ø 6mm hose type K hose Santoprene suction level 1.5m type PG			
For models: FV40.2, FV40.2 AB 2003			
spare parts for 361771			
	GEV No.	361815	Ref. No. —
pump hose detergent hose ø 6x10mm hose ø 4x6mm hose type K hose Santoprene type SEKO			

with accessories			
1			
	GEV No.	361884 ¹	Ref. No. 9625978
description dosing pump SEKO without control 1.25l/h 24VDC rinse aid hose ø 6mm hose type A hose Sekobril suction level 1.5m type PP 3.5W CODE PPP0001D2002			
spare parts for 361884			
	GEV No.	361239	Ref. No. —
pump hose rinse aid hose ø 3x7mm hose ø 6mm hose type A hose Sekobril			

with accessories

with accessories

water and beverage technology









Зип Общепит

vsezip.ru



+7(812)987-08-81



GEV No.	361321 ¹	Ref. No.	9544292
description	dosing pump SEKO without control 7l/h 24VDC detergent hose ø 6mm hose type I hose Santoprene suction level 1.5m horizontal/vertical type PP built-in version		
For models:	DV120.2, FV40.2 AB 2002, FV40.2M, FV40.2MIKE2, FV40.2M-MIKE2		
spare parts for	361321		
	GEV No.	361136	Ref. No. —
	roller assembly for dosing pump hole ø 4.8x4mm		
	GEV No.	361238	Ref. No. 9505651 9511675
	pump hose SEKO detergent hose ø 6x10mm hose length 135mm hose ø 6mm hose type I hose Santoprene		
	GEV No.	361562	Ref. No. —
	pump cover for dosing pump yellow		
accessories for	361321		
	GEV No.	361142	Ref. No. —
	mounting set detergent hose type 4x6mm hose length 2m PVC 2x hose/container filter/tank intake transparent		
	GEV No.	520090	Ref. No. —
	PVC hose ID ø 4mm ED ø 6mm L 2m thickness 1mm t.max. 60°C transparent		
	GEV No.	520091	Ref. No. —
	nylon hose ID ø 4mm ED ø 6mm L 2m thickness 1mm operating p. 10bar burst p. 50bar t.max. 100°C transparent		

¹with accessories

spare parts

			
			
GEV No.	361238	Ref. No.	9505651 9511675
description	pump hose SEKO detergent hose ø 6x10mm hose length 135mm hose ø 6mm hose type I hose Santoprene		
For models:	DV120.2, ECO STAR 545D, FV28GFA, FV40.2, FV40.2 AB 2002, FV40.2 AB 2003, FV40.2M, FV40.2MIKE2, FV40.2M-MIKE2		
spare parts for	361238		
	GEV No.	361639	Ref. No. —
	pump hose ED ø 10mm ID ø 6mm Shore 64° Santoprene dosing Qty 5m		

			
GEV No.	361382	Ref. No.	9544088
description	pump hose SEKO rinse aid hose ø 3x7.4mm hose length 135mm hose ø 6mm hose type B hose Sekobril		
For models:	DV120.2, FV40.2, FV40.2 AB 2002, FV40.2 AB 2003, FV40.2M, FV40.2MIKE2, FV40.2M-MIKE2		

			
GEV No.	361890	Ref. No.	9505652
description	pump hose SEKO rinse aid hose ø 3x8mm hose length 128mm hose ø 6mm hose type C hose Sekobril		
For models:	ECO STAR 545D, FV28GFA, FV40.2, FV40.2 AB 2003		

various



built-in version

			
GEV No.	501407	Ref. No.	9609173 9665425
description	dosing pump 24VDC detergent hose ø 6mm		

membrane dosing pumps

electric dosing pumps

Delta

			
GEV No.	361023 ¹	Ref. No.	0260024
description	dosing pump ASF/THOMAS 230V rinse aid/detergent duty cycle 100% type DELTA valve lips/SS valve		
For models:	DR70, DV100 AB 1980, DV100 AB 1983, DV120B, DV160 AB 1980, DV160 AB 1996, DV221, DV240B AB 1980, DV240B AB 1996, DV260B, DV270B AB 1988, DV270B AB 1992, DV40 AB 1983, DV40T FA, DV80, DV80 AB 1975, DV80 AB 1980, DV80 AB 1983, DV80 AB 1992, FR40G AB 1976, FR40G AB 1983, FR40GUS AB 1976, FR40GUS AB 1983, FR60, FV120B AB 1980, FV120B AB 1983, FV200B, FV240B AB 1980, FV240B AB 1983, FV250B AB 1988, FV250B AB 1992, FV30, FV40N AB 1980, FV40TFA, FV50, FV50 M, FV60 AB 1976, FV60E AB 1983, FV70TD		
spare parts for	361023		
	GEV No.	361122	Ref. No. 0260016
	lip valve type DELTA		
	GEV No.	361123	Ref. No. —
	membrane type DELTA		

¹lip valve SS
Table continues overleaf





water and beverage technology





Зип Общепит

vsezip.ru

+7(812)987-08-81

spare parts for 361023			
	GEV No.	361168	Ref. No. 0260027
valve type DELTA			
	GEV No.	361169	Ref. No. 0260021
hose connector type DELTA			
	GEV No.	361188	Ref. No. —
disc type DELTA			
	GEV No.	361319	Ref. No. 0260013
flat gasket rubber ID ø 9mm ED ø 14.5mm thickness 1mm type DELTA			

	GEV No.	361168	Ref. No.	0260027
description valve type DELTA				
DV100 AB 1980, DV100 AB 1983, DV120B, DV160 AB 1980, DV160 AB 1996, DV240B AB 1980, DV240B AB 1996, DV260B, DV270B AB 1992, DV40 AB 1983, DV40T FA, DV80, DV80 AB 1980, DV80 AB 1983, FR40G AB 1980, FR40G AB 1983, FR40GUS AB 1980, FR40GUS AB 1983, FV120B AB 1980, FV120B AB 1983, FV240B AB 1980, FV240B AB 1983, FV250B AB 1992, FV40N AB 1980, FV40N AB 1983, FV40TFA, FV60E AB 1983, FV70TD				
For models:				

spare parts			
	1		
GEV No.	361319	Ref. No.	0260013
description flat gasket rubber ID ø 9mm ED ø 14.5mm thickness 1mm type DELTA			
For models: DV100 AB 1980, DV100 AB 1983, DV120B, DV160 AB 1980, DV160 AB 1996, DV240B AB 1980, DV240B AB 1996, DV260B, DV270B AB 1992, DV40 AB 1983, DV40T FA, DV80, DV80 AB 1980, DV80 AB 1983, FR40G AB 1983, FR40GUS AB 1983, FV120B AB 1980, FV120B AB 1983, FV240B AB 1980, FV240B AB 1983, FV250B AB 1992, FV40N AB 1983, FV40TFA, FV60E AB 1983, FV70TD			

	1		
GEV No.	361169	Ref. No.	0260021
description hose connector type DELTA			
For models: DR70, DV100 AB 1980, DV100 AB 1983, DV120B, DV160 AB 1980, DV160 AB 1996, DV221, DV240B AB 1980, DV240B AB 1996, DV260B, DV270B AB 1992, DV40 AB 1983, DV40T FA, DV80, DV80 AB 1975, DV80 AB 1980, DV80 AB 1983, DV80 AB 1992, FR40G AB 1976, FR40G AB 1980, FR40G AB 1983, FR40GUS AB 1976, FR40GUS AB 1980, FR40GUS AB 1983, FR60, FV120B AB 1980, FV120B AB 1983, FV200B, FV240B AB 1980, FV240B AB 1983, FV250B AB 1992, FV30, FV40N AB 1980, FV40N AB 1983, FV40TFA, FV50, FV50 M, FV60 AB 1976, FV60E AB 1983, FV70TD			

	1		
GEV No.	361122	Ref. No.	0260016
description lip valve type DELTA			
For models: DR70, DV100 AB 1980, DV100 AB 1983, DV120B, DV160 AB 1980, DV160 AB 1996, DV221, DV240B AB 1980, DV240B AB 1996, DV260B, DV270B AB 1992, DV40 AB 1983, DV40T FA, DV80, DV80 AB 1975, DV80 AB 1980, DV80 AB 1983, DV80 AB 1992, FR40G AB 1976, FR40G AB 1980, FR40G AB 1983, FR40GUS AB 1976, FR40GUS AB 1980, FR40GUS AB 1983, FR60, FV120B AB 1980, FV120B AB 1983, FV200B, FV240B AB 1980, FV240B AB 1983, FV250B AB 1992, FV30, FV40N AB 1980, FV40TFA, FV50, FV50 M, FV60 AB 1976, FV60E AB 1983, FV70TD			

self-priming

LANG





	1		
GEV No.	361032	Ref. No.	0260070
description dosing pump type N6 membrane dosing pump rinse aid pressure connection ø angled, 4x6mm suction connection ø angled, 4x6mm			
For models: DV120B, DV120T, DV40 AB 1992, DV40N, DV40T, DV80 AB 1992, DV80T, ECO STAR 430F, ECO STAR 530F, FR30G AB 1992, FV110G, FV130B, FV20N, FV20T, FV25G AB 1986, FV25G AB 1992, FV28G AB 1994, FV28G AB 1997, FV30GS, FV40N AB 1992, FV40T, FV60E AB 1988, FV70T			

spare parts for 361032				
	GEV No.	361079	Ref. No.	0260047
spring for type N5/N6 for ball				

	GEV No.	361080	Ref. No.	0260051
O-ring EPDM thickness 2mm ID ø 16mm Qty 1 pcs				

	GEV No.	361085	Ref. No.	0260053
O-ring EPDM thickness 2mm ID ø 8mm Qty 1 pcs				

	GEV No.	361309	Ref. No.	—
ball for type N5/N6				

	GEV No.	361310	Ref. No.	—
bracket for type N6 ball guide				

	GEV No.	361311	Ref. No.	9541531
O-ring EPDM thickness 2mm ID ø 6mm Qty 1 pcs for type N6				

	GEV No.	361314	Ref. No.	—
valve ring for type N6 holder for O-ring				

	GEV No.	361317	Ref. No.	—
sealing disc for type N6				

	GEV No.	361886	Ref. No.	—
non-return valve inletmm outletmm outlet ø 12.4mm L 12.7mm				

water and beverage technology



Зип.Общепит

accessories

vsezip.ru

+7(812)987-08-81



1

GEV No.	361916	Ref. No.	9671455
description	dosing pump type N6 rinse aid pressure connection ø angled, 6mm suction connection ø angled, 6mm LANG		

spare parts



1

GEV No.	361311	Ref. No.	9541531
description	O-ring EPDM thickness 2mm ID ø 6mm Qty 1 pcs for type N6		



1

GEV No.	361079	Ref. No.	0260047
description	spring for type N5/N6 for ball		
For models:	FR30G		

accessories



1

GEV No.	361086	Ref. No.	0260050
description	hose connector with union nut elbow connection		
For models:	FR30G, FR30G AB 1992, FV25G AB 1986, FV25G AB 1992, FV30GS		



1

GEV No.	361313	Ref. No.	0260052
description	union nut spring adapter		
For models:	DV120B, DV120T, DV40 AB 1992, DV40N, DV40T, DV80 AB 1992, DV80T, ECO STAR 430F, ECO STAR 530F, FR30G, FR30G AB 1992, FV110G, FV130B, FV20N, FV20T, FV25G AB 1986, FV25G AB 1992, FV28G AB 1994, FV28G AB 1997, FV30GS, FV40N AB 1992, FV40T, FV60E AB 1988, FV70T		

electrodes for conductivity control



1

GEV No.	361274	Ref. No.	8000014
description	conductivity probe mounting ø 17mm		
For models:	DR90, DV111, DV111E		

intake lances



1

GEV No.	361790	Ref. No.	8005372
description	intake lance with filter L 430mm SS tube ø 6mm hose ø mm cable length mm		

hose couplings

plastic



1

GEV No.	362029	Ref. No.	0621204
description	hose connector hose ø 5x8mm plastic connection 1/8"		

hoses

supply hoses

PVC supply hoses

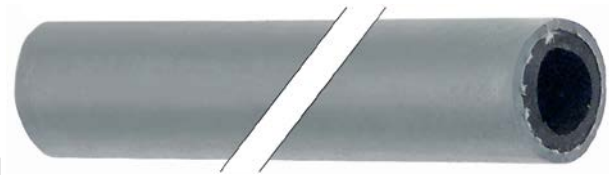

1

GEV No.	520015	Ref. No.	0640030 9608607
description	supply hose ID ø 10mm ED ø 17mm L 5m operating p. 20bar burst p. 60bar t.max. 95°C grey Qty 5m		
For models:	FV40.2, FV40.2MIKE2		
accessories for	520015		



GEV No.	504377	Ref. No.	—
description	hose connector grommet ø 23mm grommet length 25mm total length 55mm for water filling		



Зип-Общепит
industrial hoses

PVC hoses
PVC hoses without fabric

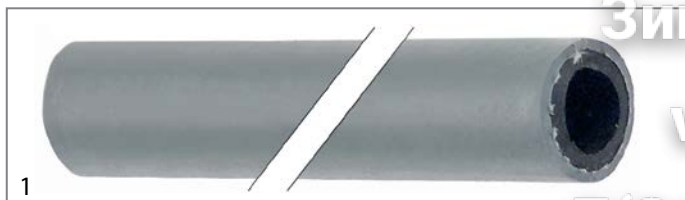

GEV No.	520017	Ref. No.	0640012 8002419 9608600 9637774
description	supply hose ID ø 13mm ED ø 20mm L 5m operating p. 20bar burst p. 60bar t.max. 95°C grey Qty 5m		
For models:	DV120B, DV120T, DV160 AB 1983, DV160 AB 1996, DV221, DV240B AB 1983, DV240B AB 1996, DV270B AB 1992, DV40 AB 1983, DV40 AB 1992, DV40N, DV40T, DV40T FA, DV80, DV80 AB 1983, DV80 AB 1992, DV80T, ECO STAR 430F, ECO STAR 530F, ECO STAR 545D, FR30G AB 1992, FV110G, FV130B, FV20N, FV20T, FV250B AB 1992, FV25G AB 1986, FV25G AB 1992, FV28G AB 1994, FV28G AB 1997, FV28GFA, FV30GS, FV40.2, FV40.2 AB 2002, FV40.2 AB 2003, FV40.2MIKE2, FV40N AB 1992, FV40T, FV40TFA, FV60E AB 1988, FV70T, FV70TD		



GEV No.	520545	Ref. No.	0260006
description	PVC hose ID ø 5mm ED ø 8mm L 10m thickness 1.5mm t.max. 60°C transparent warewashing		
For models:	DR90, DV100 AB 1980, DV100 AB 1983, DV111, DV111E, DV120.2, DV120B, DV120T, DV160 AB 1980, DV160 AB 1983, DV160 AB 1996, DV240B AB 1980, DV240B AB 1983, DV240B AB 1996, DV260B, DV270B AB 1992, DV40 AB 1983, DV40 AB 1992, DV40N, DV40T, DV40T FA, DV80, DV80 AB 1980, DV80 AB 1983, DV80 AB 1992, DV80T, ECO STAR 530F, ECO STAR 545D, FR30G, FR30G AB 1992, FR40G AB 1980, FR40G AB 1983, FR40GUS AB 1980, FR40GUS AB 1983, FV110G, FV120B AB 1980, FV120B AB 1983, FV130B, FV20N, FV20T, FV240B AB 1980, FV250B AB 1992, FV25G AB 1986, FV25G AB 1992, FV28G AB 1994, FV28G AB 1997, FV28GFA, FV30GS, FV40.2, FV40.2 AB 2002... (Other models you can see in the webshop)		

with aquastop

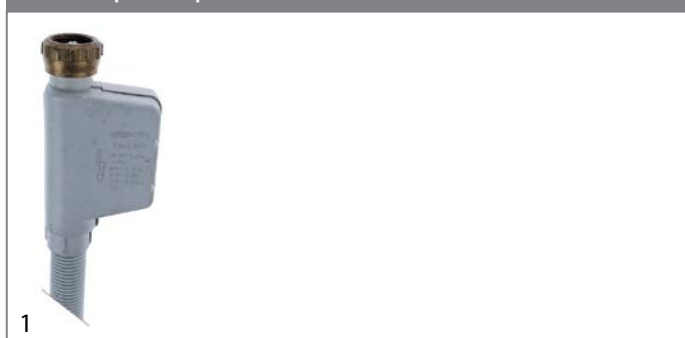

GEV No.	501125	Ref. No.	9517775
description	supply hose with Aquastop thread 3/4" ext. ø 25 L 1300mm 220-240V voltage AC 50/60Hz t.max. 60°C p max 10bar grey		
For models:	FV40.2		



GEV No.	520279	Ref. No.	0260007
description	PVC hose ID ø 6mm ED ø 9mm L 2m thickness 1.5mm t.max. 60°C transparent		
For models:	FV40.2, FV40.2MIKE2, FV40.2M-MIKE2		



GEV No.	524561	Ref. No.	9543975
description	supply hose with Aquastop thread 3/4" ext. ø 25 L 1300mm 24V voltage DC t.max. 60°C p max 10bar grey		
For models:	FV40.2MIKE2, FV40.2M-MIKE2		

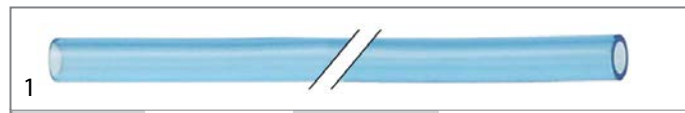

GEV No.	570554	Ref. No.	9538712
description	PVC hose ID ø 6mm ED ø 9mm thickness 1.5mm blue		
For models:	FV40.2, FV40.2MIKE2, FV40.2M-MIKE2		

drain hoses

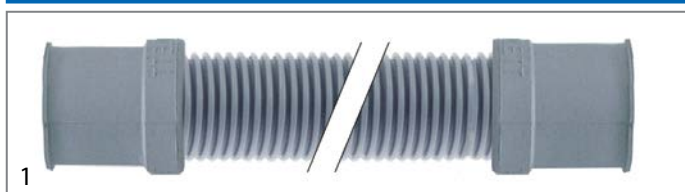

GEV No.	501136	Ref. No.	0640037
description	drain hose DN19 L 2500mm A int. ø 19mm A ext. ø 24mm B int. ø 21mm B ext. ø 28mm outer hose ø 24mm		
For models:	DV40T FA, ECO STAR 430F, ECO STAR 530F, FV28G AB 1994, FV28G AB 1997, FV28GFA, FV40.2, FV40.2 AB 2002, FV40.2 AB 2003, FV40.2MIKE2, FV40TFA, FV70TD		

hoses wire reinforced

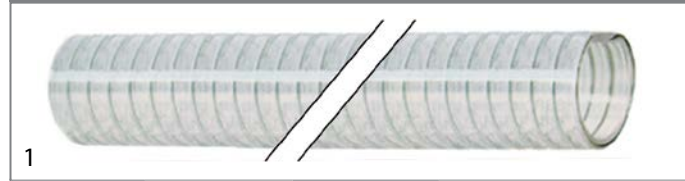

GEV No.	524356	Ref. No.	0640045
description	drain hose ID ø 22mm ED ø 28mm L 2m PVC wire reinforced		

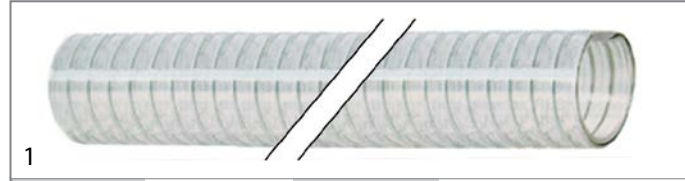

GEV No.	520920	Ref. No.	9641540
description	drain hose ID ø 22mm ED ø 28mm L 5m wire reinforced		

water and beverage technology



pressure hoses (other)



GEV No.	501042	Ref. No.	0640007
description	hose ID ø 40mm ED ø 49mm warewashing black Qty 1m		
For models:	DV160 AB 1996, DV40 AB 1983, DV40 AB 1992, DV40N, DV40T, DV40T FA, DV80 AB 1992, DV80T, ECO STAR 430F, ECO STAR 530F, ECO STAR 545D, FR30G AB 1992, FR40G AB 1980, FR40G AB 1983, FR40GUS AB 1980, FR40GUS AB 1983, FV110G, FV20N, FV20T, FV25G AB 1992, FV28G AB 1994, FV28G AB 1997, FV28GFA, FV30GS, FV40N AB 1983, FV40N AB 1992, FV40T, FV40TFA, FV60E AB 1988, FV70T, FV70TD		

Зип-Общепит
for dishwashers

miscellaneous



GEV No.	501042	Ref. No.	0640007
description	hose ID ø 40mm ED ø 49mm warewashing black Qty 1m		
For models:	DV160 AB 1996, DV40 AB 1983, DV40 AB 1992, DV40N, DV40T, DV40T FA, DV80 AB 1992, DV80T, ECO STAR 430F, ECO STAR 530F, ECO STAR 545D, FR30G AB 1992, FR40G AB 1980, FR40G AB 1983, FR40GUS AB 1980, FR40GUS AB 1983, FV110G, FV20N, FV20T, FV25G AB 1992, FV28G AB 1994, FV28G AB 1997, FV28GFA, FV30GS, FV40N AB 1983, FV40N AB 1992, FV40T, FV40TFA, FV60E AB 1988, FV70T, FV70TD		

formed hoses

straight



GEV No.	501041	Ref. No.	0630209
description	formed hose PVC dishwasher straight Qty 1m hose ext. ø 45mm hose int. ø 35mm		
For models:	DR70, DV40 AB 1983, DV80 AB 1975, FR30G, FR40G AB 1983, FR40GUS AB 1983, FV25G AB 1986, FV30, FV40N AB 1980, FV40N AB 1983, FV40N AB 1992, FV50, FV50 M, FV60 AB 1973, FV60 AB 1976, FV60E AB 1983		

fittings, hose and pipe connectors

hose connectors

without screw connection



GEV No.	501212	Ref. No.	0621072
description	hose connector plastic hose ø 13-13mm 2-way		
For models:	FV28G AB 1994, FV28G AB 1997		

form L



GEV No.	530530	Ref. No.	0650008
description	formed hose end piece A ext. ø 56mm end piece A int. ø 46mm AD2 ø 46mm ø end piece B 34mm L 135mm		



GEV No.	501210	Ref. No.	0621040
description	Y-piece plastic hose ø 10-10-10mm		
For models:	ECO STAR 545D		

miscellaneous



GEV No.	524970	Ref. No.	9602750
description	formed hose ext. ø 27 D1 ø 37mm D2 ø 44mm L 720mm EPDM warewashing black		



GEV No.	501040	Ref. No.	0621036
description	Y-piece plastic hose ø 13-13-13mm 3-way		
For models:	DV120T, DV40T, DV40T FA, DV80T, ECO STAR 530F, ECO STAR 545D, FV40N AB 1983, FV40TFA, FV60E AB 1983, FV70TD		



Зип Общежит
angle pieces

vsezip.ru

+7(812)987-08-81

			
1			
GEV No.	501211	Ref. No.	0621070
description	Y-piece plastic hose ø 19-19-19mm 3-way		
For models:	ECO STAR 430F, FV28G AB 1994, FV28G AB 1997, FV28GFA		

			
1			
GEV No.	501162	Ref. No.	0206022
description	angle piece thread 1/4" ET - 1/4" ET nickel-plated brass pipe connection ø 10mm		
For models:	DV100 AB 1983, DV120B, DV160 AB 1983, DV240B AB 1983, DV80, DV80 AB 1983		

*incl. olive 10mm and union nut

			
1			
GEV No.	510685	Ref. No.	9601255
description	T-piece plastic hose ø 14-23-14mm		
For models:	FV40.2MIKE2, FV40.2M-MIKE2		

hose connectors

plastic

			
1			
GEV No.	528985	Ref. No.	0621026 9505201
description	hose connector plastic angled thread 3/4" hose ø 13mm Qty 1 pcs		

*incl. flat rubber gasket

miscellaneous

			
1			
GEV No.	501156	Ref. No.	8004877
description	hose connector		
For models:	DV40T FA, FV28GFA, FV40TFA, FV70TD		

stainless steel

			
1			
GEV No.	501121	Ref. No.	8400250
description	hose connector thread 1/2" straight hose ø 19mm SS Qty 1 pcs		
For models:	DV160 AB 1996, DV240B AB 1996, FV250B AB 1992		

fittings

reducers

			
1			
GEV No.	501244	Ref. No.	8000077
description	reducer		
For models:	DV100 AB 1983, DV120B, DV240B AB 1983, DV80, DV80 AB 1983		

			
1			
GEV No.	501005	Ref. No.	0360202
description	hose connector thread M14x1 straight hose ø 13mm SS Qty 1 pcs		
For models:	DV120B, DV120T, DV40T, DV80T, ECO STAR 545D, FV110G, FV130B, FV20N, FV20T, FV28G AB 1994, FV28G AB 1997, FV40T, FV70T		

producer-specific

			
1			
GEV No.	501186	Ref. No.	0620129
description	connecting piece angled plastic ø 18mm		
For models:	ECO STAR 430F, ECO STAR 530F, FV28G AB 1994, FV28G AB 1997, FV28GFA		

Зип.Общепит
valves and tank inlets

float valves
float valves



GEV No.	501021	Ref. No.	0620342 1002.3557
description	hose connector		
For models:	DV120B, DV120T, DV160 AB 1996, DV240B AB 1996, DV270B AB 1992, DV40 AB 1992, DV40N, DV40T, DV80 AB 1992, DV80T, ECO STAR 430F, ECO STAR 530F, ECO STAR 545D, FR30G AB 1992, FV110G, FV130B, FV20N, FV20T, FV250B AB 1992, FV25G AB 1992, FV28G AB 1994, FV28G AB 1997, FV30GS, FV40N AB 1992, FV40T, FV60E AB 1988, FV70T		



GEV No.	501024	Ref. No.	0620373
description	hose connector for hose ID 13-6-13mm plastic Qty 1 pcs		
For models:	DV111, DV111E, DV120T, DV40T, DV80T, ECO STAR 545D, FV110G, FV130B, FV20N, FV20T, FV28G AB 1994, FV28G AB 1997, FV40T, FV70T		



GEV No.	501093	Ref. No.	0621028
description	hose connector straight connection 3/4"x19mm		
For models:	DV160 AB 1996, DV240B AB 1996, DV270B AB 1992, FV250B AB 1992		



GEV No.	501022	Ref. No.	0620343
description	manifold double plastic		
For models:	DV120B, DV120T, DV160 AB 1996, DV240B AB 1996, DV40 AB 1992, DV40N, DV40T, DV80 AB 1992, DV80T, ECO STAR 430F, ECO STAR 530F, ECO STAR 545D, FR30G AB 1992, FV110G, FV130B, FV20N, FV20T, FV25G AB 1992, FV28G AB 1994, FV28G AB 1997, FV30GS, FV40N AB 1992, FV40T, FV60E AB 1988, FV70T		



GEV No.	501113	Ref. No.	8000978
description	T-piece		



GEV No.	501397	Ref. No.	9507283
description	float valve inlet 3/4" outlet 13.5mm input 9l/min output/min pressure range 0.3-10bar MÜLLER type 21.010.115 for water container flow regulating valve inlet orange flow regulating valve outlet		

water cycle components

supply filters



GEV No.	520129	Ref. No.	0113219
description	supply filter thread 3/4" ET - 3/4" IT total length 87mm plastic type 03		
spare parts for	520129		
	GEV No.	370545	Ref. No. —
	screen ø 11mm H 24mm suitable for supply filter Meiko 3/4"		

ancillary products

clamps

hose clamps

DIN 3017 - W2



GEV No.	520111	Ref. No.	0233036
description	hose clamp ø 10-16mm width 9mm Qty 10 pcs DIN 3017		
For models:	DV100 AB 1980, DV100 AB 1983, DV120.2, DV120B, DV120T, DV160 AB 1980, DV160 AB 1983, DV160 AB 1996, DV240B AB 1980, DV240B AB 1983, DV240B AB 1996, DV260B, DV270B AB 1992, DV40 AB 1983, DV40 AB 1992, DV40N, DV40T, DV40T FA, DV80, DV80 AB 1980, DV80 AB 1983, DV80 AB 1992, DV80T, ECO STAR 430F, ECO STAR 530F, ECO STAR 545D, FR30G, FR30G AB 1992, FR40G AB 1976, FR40G AB 1980, FR40G AB 1983, FR40GUS AB 1976, FR40GUS AB 1980, FR40GUS AB 1983, FV110G, FV120B AB 1980, FV120B AB 1983, FV130B, FV200B, FV20T, FV240B AB 1980, FV240B AB 1983, FV250B AB 1992, FV25G AB 1986, FV25G AB 1992, FV28G AB 1994, FV28G AB 1997, FV28GFA, FV30GS, FV40.2...(Other models you can see in the webshop)		





Зип Общепит
vsezip.ru

 <p>1</p>			
GEV No.	520112	Ref. No.	0233035 0233043
description	hose clamp ø 12-20mm width 9mm Qty 10 pcs DIN 3017		
For models:	DV120T, DV160 AB 1996, DV240B AB 1996, DV270B AB 1992, DV40N, DV40T, DV40T FA, DV80T, ECO STAR 430F, ECO STAR 530F, ECO STAR 545D, FV110G, FV20N, FV250B AB 1992, FV28G AB 1994, FV28G AB 1997, FV28GFA, FV40.2, FV40.2 AB 2002, FV40.2MIKE2, FV40TFA, FV70TD		

 <p>1</p>			
GEV No.	520116	Ref. No.	0233046
description	hose clamp ø 32-50mm width 9mm Qty 5 pcs DIN 3017		
For models:	DR70, DV120B, DV120T, DV160 AB 1996, DV240B AB 1996, DV40 AB 1983, DV40 AB 1992, DV40N, DV40T, DV40T FA, DV80 AB 1975, DV80 AB 1992, DV80T, ECO STAR 430F, ECO STAR 530F, ECO STAR 545D, FR30G, FR30G AB 1992, FR40G AB 1980, FR40G AB 1983, FR40GUS AB 1980, FR40GUS AB 1983, FV110G, FV120B AB 1980, FV120B AB 1983, FV20N, FV20T, FV240B AB 1980, FV240B AB 1983, FV25G AB 1986, FV25G AB 1992, FV28G AB 1994, FV28G AB 1997, FV28GFA, FV30, FV30GS, FV40N AB 1980, FV40N AB 1983, FV40N AB 1992, FV40T, FV40TFA, FV50, FV50 M, FV60E AB 1983, FV60E AB 1988, FV70T, FV70TD		

 <p>1</p>			
GEV No.	520113	Ref. No.	0233037
description	hose clamp ø 16-27mm width 9mm Qty 10 pcs DIN 3017		
For models:	DV100 AB 1980, DV100 AB 1983, DV120B, DV120T, DV160 AB 1980, DV240B AB 1980, DV260B, DV40 AB 1983, DV40 AB 1992, DV40T, DV40T FA, DV80, DV80 AB 1980, DV80 AB 1983, DV80 AB 1992, DV80T, ECO STAR 430F, ECO STAR 530F, ECO STAR 545D, FR30G, FR30G AB 1992, FR40G AB 1976, FR40G AB 1980, FR40G AB 1983, FR40GUS AB 1976, FR40GUS AB 1980, FR40GUS AB 1983, FV110G, FV120B AB 1980, FV120B AB 1983, FV130B, FV200B, FV20N, FV20T, FV240B AB 1980, FV240B AB 1983, FV25G AB 1986, FV25G AB 1992, FV28G AB 1994, FV28G AB 1997, FV28GFA, FV30, FV30GS, FV40N AB 1980, FV40N AB 1983, FV40N AB 1992, FV40T, FV40TFA, FV50, FV50 M...(Other models you can see in the webshop)		

 <p>1</p>			
GEV No.	520118	Ref. No.	0233047
description	hose clamp ø 50-70mm width 9mm Qty 5 pcs DIN 3017		
For models:	DV100 AB 1980, DV100 AB 1983, DV120B, DV120T, DV160 AB 1980, DV160 AB 1983, DV240B AB 1980, DV240B AB 1983, DV240B AB 1996, DV80, DV80 AB 1980, DV80 AB 1983, FR40G AB 1980, FR40GUS AB 1980, FV120B AB 1980, FV120B AB 1983, FV240B AB 1980, FV240B AB 1983, FV60E AB 1983		

 <p>1</p>			
GEV No.	520114	Ref. No.	0233045
description	hose clamp ø 20-32mm width 9mm Qty 10 pcs DIN 3017		
For models:	FV40.2, FV40.2MIKE2, FV40.2M-MIKE2		

 <p>1</p>			
GEV No.	520117	Ref. No.	0233041
description	hose clamp stainless steel ø 40-60mm width 9mm Qty 5 pcs DIN 3017		
For models:	DV120B, DV160 AB 1996, DV240B AB 1996, DV40 AB 1983, DV40 AB 1992, DV40N, DV40T, DV40T FA, DV80 AB 1975, DV80 AB 1992, DV80T, ECO STAR 430F, ECO STAR 530F, ECO STAR 545D, FR30G, FR30G AB 1992, FR40G AB 1983, FR40GUS AB 1983, FV110G, FV20N, FV20T, FV25G AB 1986, FV25G AB 1992, FV28G AB 1994, FV28G AB 1997, FV28GFA, FV30, FV30GS, FV40N AB 1980, FV40N AB 1983, FV40N AB 1992, FV40T, FV40TFA, FV50, FV50 M, FV60E AB 1988, FV70T, FV70TD		

 <p>1</p>			
GEV No.	520115	Ref. No.	0233039
description	hose clamp ø 25-40mm width 9mm Qty 10 pcs DIN 3017		
For models:	DV40T FA, FV200B, FV28GFA, FV40.2 AB 2003, FV40TFA, FV70TD		

<p>double wire clamps</p>  <p>1</p>			
GEV No.	513268	Ref. No.	9500044 9500045
description	hose clamp ø 8-10mm wire gauge ø 1mm Qty 1 pcs		
For models:	FV40.2, FV40.2MIKE2, FV40.2M-MIKE2		



Зип-Общепит

security hose clamps

SS/brass



GEV No.	520065	Ref. No.	0233055
description	hose clamp SS/brass ø 5-10mm width 10mm Qty 5 pcs		
For models:	DV100 AB 1980, DV100 AB 1983, DV120B, DV160 AB 1980, DV160 AB 1983, DV240B AB 1980, DV240B AB 1983, DV260B, DV40 AB 1983, DV80, DV80 AB 1980, DV80 AB 1983, FR30G, FR40G AB 1980, FR40G AB 1983, FR40GUS AB 1980, FR40GUS AB 1983, FV120B AB 1980, FV120B AB 1983, FV200B, FV240B AB 1980, FV25G AB 1986, FV40N AB 1980, FV40N AB 1983, FV60E AB 1983		

pipe clamps



GEV No.	501068	Ref. No.	0296002
description	tube connector ø 50mm SS Qty 1 pcs		
For models:	DV100 AB 1980, DV100 AB 1983, DV120B, DV120T, DV160 AB 1980, DV160 AB 1983, DV240B AB 1980, DV240B AB 1983, DV240B AB 1996, DV260B, DV80, DV80 AB 1980, DV80 AB 1983, DV80 AB 1992, FV120B AB 1980, FV120B AB 1983, FV130B, FV240B AB 1980, FV240B AB 1983, FV60E AB 1983		

one ear clamps



GEV No.	560487	Ref. No.	0233070 0233073
description	one ear clamp ø 19.4-22.6mm Qty 1 pcs zinc-coated steel		
For models:	DV120B, DV120T, DV160 AB 1996, DV240B AB 1996, DV270B AB 1992, DV40 AB 1992, DV40N, DV40T, DV40T FA, DV80 AB 1992, DV80T, ECO STAR 430F, ECO STAR 530F, ECO STAR 545D, FR30G AB 1992, FV110G, FV130B, FV20N, FV20T, FV250B AB 1992, FV25G AB 1992, FV28G AB 1994, FV28G AB 1997, FV30GS, FV40N AB 1992, FV40T, FV40TFA, FV60E AB 1988, FV70T, FV70TD		

fastening material

screws

sheet metal screws



GEV No.	560108	Ref. No.	0330020
description	sheet metal screws ø 4.2mm L 13mm SS Qty 20 pcs DIN 7981/ISO 7049 head ø 8.2mm oval head		
For models:	FV40.2, FV40.2MIKE2, FV40.2M-MIKE2		

countersunk screws



GEV No.	560075	Ref. No.	0306005
description	countersunk screw thread M4 L 6mm SS DIN 963/ISO 2009 Qty 20 pcs intake slotted head ø 7.5mm		
For models:	DR90, DV100 AB 1983, DV111, DV111E, DV120B, DV120T, DV160 AB 1983, DV160 AB 1996, DV240B AB 1983, DV240B AB 1996, DV260B, DV270B AB 1992, DV40 AB 1983, DV40N, DV40T, DV40T FA, DV80, DV80 AB 1975, DV80 AB 1983, DV80 AB 1992, DV80T, ECO STAR 545D, FV120B AB 1983, FV130B, FV200B, FV240B AB 1983, FV250B AB 1992, FV25G AB 1986, FV30, FV40N AB 1983, FV50, FV50 M, FV60 AB 1973, FV60 AB 1976, FV60E AB 1983		



GEV No.	560324	Ref. No.	0233076 0233078
description	one ear clamp ø 8.5-10mm Qty 1 pcs stainless steel		
For models:	DV120B, DV120T, DV160 AB 1996, DV240B AB 1996, DV270B AB 1992, DV40 AB 1992, DV40N, DV40T, DV40T FA, DV80 AB 1992, DV80T, FR30G AB 1992, FV110G, FV130B, FV20N, FV20T, FV250B AB 1992, FV25G AB 1992, FV28G AB 1994, FV28G AB 1997, FV30GS, FV40N AB 1992, FV40T, FV40TFA, FV60E AB 1988, FV70T, FV70TD		



GEV No.	501069	Ref. No.	0306014
description	countersunk screw thread M5 L 8mm SS DIN 963/ISO 2009 Qty 100 pcs		
For models:	DV100 AB 1983, DV120B, DV160 AB 1983, DV240B AB 1983, DV260B, DV270B AB 1992, DV40 AB 1983, DV80, DV80 AB 1983, FV120B AB 1983, FV130B, FV240B AB 1983, FV250B AB 1992, FV25G AB 1986, FV40N AB 1983, FV60E AB 1983		

water and beverage technology





Зип Общежит

vsezip.ru

+7(812)987-08-81

			
1			
GEV No.	560450	Ref. No.	0306006 0306115
description	countersunk screw thread M4 L 8mm SS DIN 965/ISO 7046 Qty 1 pcs intake Phillips head ø 7.3mm		
For models:	DV120B, DV120T, DV160 AB 1983, DV160 AB 1996, DV240B AB 1983, DV240B AB 1996, DV40 AB 1983, DV40N, DV40T, DV40T FA, DV80, DV80 AB 1983, DV80 AB 1992, DV80T, ECO STAR 545D, FV30, FV50, FV50 M		

hexagonal nuts			
DIN 934 / ISO 4032/8673			
			
1			
GEV No.	560129	Ref. No.	0335008
description	hexagonal nut thread M5 H 4mm WS 8 SS DIN/ISO DIN 934 / ISO 4032/8673 Qty 1 pcs		
For models:	FV40.2, FV40.2MIKE2, FV40.2M-MIKE2		

hexagonal screws			
			
1			
GEV No.	560086	Ref. No.	0302000
description	hexagonal screw thread M6 thread L 10mm SS WS 10 Qty 20 pcs DIN 933 / ISO 4017		
For models:	DV40 AB 1983		

			
1			
GEV No.	501303	Ref. No.	0335019
description	nut thread M10 H 8mm WS 17 brass DIN/ISO DIN 934 / ISO 4032/8673 Qty 1 pcs		
For models:	DV100 AB 1980, DV100 AB 1983, DV120.2, DV120B, DV160 AB 1980, DV240B AB 1980, DV260B, DV40 AB 1983, DV80, DV80 AB 1983, ECO STAR 545D, FR40G AB 1983, FR40GUS AB 1983, FV120B AB 1983, FV240B AB 1983, FV25G AB 1986, FV28GFA, FV40.2 AB 2002, FV40.2M, FV40.2MIKE2, FV40.2M-MIKE2, FV40N AB 1983, FV40N AB 1992, FV60E AB 1983, FV60E AB 1988		

			
1			
GEV No.	560087	Ref. No.	0302001
description	hexagonal screw thread M6 thread L 16mm SS WS 10 Qty 20 pcs DIN 933 / ISO 4017		

DIN 985			
			
1			
GEV No.	560142	Ref. No.	0337001
description	hexagonal nut thread M6 H 6mm SS WS 10 Qty 20 pcs DIN/ISO DIN 985 self-locking		

knurled screws			
			
1			
GEV No.	510112	Ref. No.	0310010
description	Thumb screw thread M10 thread L 10mm ø 22mm H 4.5mm SS		
For models:	DV40 AB 1992, DV40N, DV40T, DV40T FA, ECO STAR 430F, ECO STAR 530F, FV110G, FV20N, FV20T, FV28G AB 1994, FV28G AB 1997, FV28GFA, FV30GS, FV40N AB 1992, FV40T, FV40TFA, FV60E AB 1988, FV70T, FV70TD		

hexagonal nuts metric (without norm)			
			
1			
GEV No.	501172	Ref. No.	0360211 8660239
description	nut thread M16x1.5 H 5mm WS 22 SS Qty 1 pcs		
For models:	ECO STAR 430F, ECO STAR 530F, ECO STAR 545D, FV28G AB 1994, FV28G AB 1997, FV28GFA		

nuts			
cap nuts			
			
1			
GEV No.	560135	Ref. No.	0336001
description	cap nuts thread M4 WS 7 SS Qty 20 pcs DIN/ISO DIN 1587		
For models:	DV120T, DV40N, DV40T, DV40T FA, DV80T, ECO STAR 430F, ECO STAR 530F, ECO STAR 545D, FV110G, FV120B AB 1983, FV20N, FV20T, FV240B AB 1983, FV25G AB 1986, FV28G AB 1994, FV28G AB 1997, FV28GFA, FV30GS, FV40N AB 1983, FV40N AB 1992, FV40T, FV40TFA, FV60E AB 1983, FV60E AB 1988, FV70T, FV70TD		

hexagonal nuts inch thread			
			
1			
GEV No.	501299	Ref. No.	8660464
description	hexagonal nut thread 1/2" H 5mm SS WS 27 Qty 1 pcs		
For models:	DV120T, DV40N, DV40T, DV40T FA, DV80T		

4 tools, fastening materials, consumables

Зип-Общепит

washers



1

GEV No.	501319	Ref. No.	800025
description	nut thread 1/2" H 8mm brass WS 27 Qty 1 pcs		
For models:	DV260B, FV120B AB 1983, FV240B AB 1983		



1

GEV No.	501318	Ref. No.	0212012
description	nut thread 1/4" H 6.5mm SS WS 22 Qty 1 pcs		
For models:	DV40T FA, ECO STAR 545D, FV40TFA, FV70TD		



1

GEV No.	503042	Ref. No.	9515957
description	nut thread 3/8" H 6mm brass WS 22 Qty 1 pcs		
For models:	FV40.2, FV40.2MIKE2, FV40.2M-MIKE2		



1

GEV No.	501288	Ref. No.	8000024 8660045
description	nut thread 3/8" H 8mm brass WS 22 Qty 1 pcs		
For models:	DV260B, FR30G, FR40G AB 1983, FR40GUS AB 1983, FV120B AB 1983, FV240B AB 1983		



1

GEV No.	522003	Ref. No.	0212005
description	hexagonal nut thread 1 1/2" brass		
For models:	DV100 AB 1980, DV100 AB 1983, DV120B, DV160 AB 1980, DV160 AB 1983, DV160 AB 1996, DV240B AB 1980, DV240B AB 1983, DV240B AB 1996, DV270B AB 1992, DV40 AB 1983, DV40 AB 1992, DV80, DV80 AB 1980, DV80 AB 1983, DV80 AB 1992, FR30G, FR30G AB 1992, FR40G AB 1980, FR40G AB 1983, FR40GUS AB 1980, FR40GUS AB 1983, FV130B, FV250B AB 1992, FV25G AB 1986, FV25G AB 1992, FV30GS, FV40N AB 1980, FV40N AB 1983, FV40N AB 1992, FV60E AB 1983, FV60E AB 1988		

washers

vsezip.ru

DIN 125A

1

GEV No.	560312	Ref. No.	0340005
description	plain washer ID ø 10.5mm ED ø 20mm thickness 2mm SS Qty 1 pcs DIN 125A for thread M10		
For models:	FV40.2MIKE2		

DIN 9021

1

GEV No.	560116	Ref. No.	0340020
description	plain washer ID ø 5.3mm ED ø 15mm thickness 1.5mm SS Qty 20 pcs DIN 9021 for thread M5		
For models:	FV40.2, FV40.2MIKE2, FV40.2M-MIKE2		

fasteners

clamps

hose clamps

DIN 3017 - W2

1

GEV No.	520111	Ref. No.	0233036
description	hose clamp ø 10-16mm width 9mm Qty 10 pcs DIN 3017		
For models:	DV100 AB 1980, DV100 AB 1983, DV120.2, DV120B, DV120T, DV160 AB 1980, DV160 AB 1983, DV160 AB 1996, DV240B AB 1980, DV240B AB 1983, DV240B AB 1996, DV260B, DV270B AB 1992, DV40 AB 1983, DV40 AB 1992, DV40N, DV40T, DV40T FA, DV80, DV80 AB 1980, DV80 AB 1983, DV80 AB 1992, DV80T, ECO STAR 430F, ECO STAR 530F, ECO STAR 545D, FR30G, FR30G AB 1992, FR40G AB 1976, FR40G AB 1980, FR40G AB 1983, FR40GUS AB 1976, FR40GUS AB 1980, FR40GUS AB 1983, FV110G, FV120B AB 1980, FV120B AB 1983, FV130B, FV200B, FV20T, FV240B AB 1980, FV240B AB 1983, FV250B AB 1992, FV25G AB 1986, FV25G AB 1992, FV28G AB 1994, FV28G AB 1997, FV28GFA, FV30GS, FV40.2...(Other models you can see in the webshop)		



Зип Общепит
vsezip.ru

1



GEV No.	520112	Ref. No.	0233035 0233043
description	hose clamp ø 12-20mm width 9mm Qty 10 pcs DIN 3017		
For models:	DV120T, DV160 AB 1996, DV240B AB 1996, DV270B AB 1992, DV40N, DV40T, DV40T FA, DV80T, ECO STAR 430F, ECO STAR 530F, ECO STAR 545D, FV110G, FV20N, FV250B AB 1992, FV28G AB 1994, FV28G AB 1997, FV28GFA, FV40.2, FV40.2 AB 2002, FV40.2MIKE2, FV40TFA, FV70TD		

1



GEV No.	520116	Ref. No.	0233046
description	hose clamp ø 32-50mm width 9mm Qty 5 pcs DIN 3017		
For models:	DR70, DV120B, DV120T, DV160 AB 1996, DV240B AB 1996, DV40 AB 1983, DV40 AB 1992, DV40N, DV40T, DV40T FA, DV80 AB 1975, DV80 AB 1992, DV80T, ECO STAR 430F, ECO STAR 530F, ECO STAR 545D, FR30G, FR30G AB 1992, FR40G AB 1980, FR40G AB 1983, FR40GUS AB 1980, FR40GUS AB 1983, FV110G, FV120B AB 1980, FV120B AB 1983, FV20N, FV20T, FV240B AB 1980, FV240B AB 1983, FV25G AB 1986, FV25G AB 1992, FV28G AB 1994, FV28G AB 1997, FV28GFA, FV30, FV30GS, FV40N AB 1980, FV40N AB 1983, FV40N AB 1992, FV40T, FV40TFA, FV50, FV50 M, FV60E AB 1983, FV60E AB 1988, FV70T, FV70TD		

2



GEV No.	520113	Ref. No.	0233037
description	hose clamp ø 16-27mm width 9mm Qty 10 pcs DIN 3017		
For models:	DV100 AB 1980, DV100 AB 1983, DV120B, DV120T, DV160 AB 1980, DV240B AB 1980, DV260B, DV40 AB 1983, DV40 AB 1992, DV40T, DV40T FA, DV80, DV80 AB 1980, DV80 AB 1983, DV80 AB 1992, DV80T, ECO STAR 430F, ECO STAR 530F, ECO STAR 545D, FR30G, FR30G AB 1992, FR40G AB 1976, FR40G AB 1980, FR40G AB 1983, FR40GUS AB 1976, FR40GUS AB 1980, FR40GUS AB 1983, FV110G, FV120B AB 1980, FV120B AB 1983, FV130B, FV200B, FV20N, FV20T, FV240B AB 1980, FV240B AB 1983, FV25G AB 1986, FV25G AB 1992, FV28G AB 1994, FV28G AB 1997, FV28GFA, FV30, FV30GS, FV40N AB 1980, FV40N AB 1983, FV40N AB 1992, FV40T, FV40TFA, FV50, FV50 M...(Other models you can see in the webshop)		

1



GEV No.	520118	Ref. No.	0233047
description	hose clamp ø 50-70mm width 9mm Qty 5 pcs DIN 3017		
For models:	DV100 AB 1980, DV100 AB 1983, DV120B, DV120T, DV160 AB 1980, DV160 AB 1983, DV240B AB 1980, DV240B AB 1983, DV240B AB 1996, DV80, DV80 AB 1980, DV80 AB 1983, FR40G AB 1980, FR40GUS AB 1980, FV120B AB 1980, FV120B AB 1983, FV240B AB 1980, FV240B AB 1983, FV60E AB 1983		

1



GEV No.	520114	Ref. No.	0233045
description	hose clamp ø 20-32mm width 9mm Qty 10 pcs DIN 3017		
For models:	FV40.2, FV40.2MIKE2, FV40.2M-MIKE2		

1



GEV No.	520117	Ref. No.	0233041
description	hose clamp stainless steel ø 40-60mm width 9mm Qty 5 pcs DIN 3017		
For models:	DV120B, DV160 AB 1996, DV240B AB 1996, DV40 AB 1983, DV40 AB 1992, DV40N, DV40T, DV40T FA, DV80 AB 1975, DV80 AB 1992, DV80T, ECO STAR 430F, ECO STAR 530F, ECO STAR 545D, FR30G, FR30G AB 1992, FR40G AB 1983, FR40GUS AB 1983, FV110G, FV20N, FV20T, FV25G AB 1986, FV25G AB 1992, FV28G AB 1994, FV28G AB 1997, FV28GFA, FV30, FV30GS, FV40N AB 1980, FV40N AB 1983, FV40N AB 1992, FV40T, FV40TFA, FV50, FV50 M, FV60E AB 1988, FV70T, FV70TD		

1



GEV No.	520115	Ref. No.	0233039
description	hose clamp ø 25-40mm width 9mm Qty 10 pcs DIN 3017		
For models:	DV40T FA, FV200B, FV28GFA, FV40.2 AB 2003, FV40TFA, FV70TD		

security hose clamps

SS/brass

1



GEV No.	520065	Ref. No.	0233055
description	hose clamp SS/brass ø 5-10mm width 10mm Qty 5 pcs		
For models:	DV100 AB 1980, DV100 AB 1983, DV120B, DV160 AB 1980, DV160 AB 1983, DV240B AB 1980, DV240B AB 1983, DV260B, DV40 AB 1983, DV80, DV80 AB 1980, DV80 AB 1983, FR30G, FR40G AB 1980, FR40G AB 1983, FR40GUS AB 1980, FR40GUS AB 1983, FV120B AB 1980, FV120B AB 1983, FV200B, FV240B AB 1980, FV25G AB 1986, FV40N AB 1980, FV40N AB 1983, FV60E AB 1983		



Зип-Общепит

double wire clamps



1

GEV No.	513268	Ref. No.	9500044 9500045
description	hose clamp ø 8-10mm wire gauge ø 1mm Qty 1 pcs		
For models:	FV40.2, FV40.2MIKE2, FV40.2M-MIKE2		

one ear clamps



1

GEV No.	560487	Ref. No.	0233070 0233073
description	one ear clamp ø 19.4-22.6mm Qty 1 pcs zinc-coated steel		
For models:	DV120B, DV120T, DV160 AB 1996, DV240B AB 1996, DV270B AB 1992, DV40 AB 1992, DV40N, DV40T, DV40T FA, DV80 AB 1992, DV80T, ECO STAR 430F, ECO STAR 530F, ECO STAR 545D, FR30G AB 1992, FV110G, FV130B, FV20N, FV20T, FV250B AB 1992, FV25G AB 1992, FV28G AB 1994, FV28G AB 1997, FV30GS, FV40N AB 1992, FV40T, FV40TFA, FV60E AB 1988, FV70T, FV70TD		



1

GEV No.	560324	Ref. No.	0233076 0233078
description	one ear clamp ø 8.5-10mm Qty 1 pcs stainless steel		
For models:	DV120B, DV120T, DV160 AB 1996, DV240B AB 1996, DV270B AB 1992, DV40 AB 1992, DV40N, DV40T, DV40T FA, DV80 AB 1992, DV80T, FR30G AB 1992, FV110G, FV130B, FV20N, FV20T, FV250B AB 1992, FV25G AB 1992, FV28G AB 1994, FV28G AB 1997, FV30GS, FV40N AB 1992, FV40T, FV40TFA, FV60E AB 1988, FV70T, FV70TD		

pipe clamps



1

GEV No.	501068	Ref. No.	0296002
description	tube connector ø 50mm SS Qty 1 pcs		
For models:	DV100 AB 1980, DV100 AB 1983, DV120B, DV120T, DV160 AB 1980, DV160 AB 1983, DV240B AB 1980, DV240B AB 1983, DV240B AB 1996, DV260B, DV80, DV80 AB 1980, DV80 AB 1983, DV80 AB 1992, FV120B AB 1980, FV120B AB 1983, FV130B, FV240B AB 1980, FV240B AB 1983, FV60E AB 1983		

retaining rings

DIN 471



1

GEV No.	512260	Ref. No.	0341020
description	retaining ring shaft ø 14mm thickness 1.2mm steel DIN 471		

DIN 6799



1

GEV No.	518557	Ref. No.	9655750
description	retaining ring E D1 ø 5mm D2 ø 11mm SS DIN 6799 thickness 0.7mm		

cotter pins



1

GEV No.	551304	Ref. No.	0351004
description	cotter pin ø 2mm L 20mm SS Qty 20 pcs		
For models:	DV100 AB 1983, DV120, DV120B, DV160 AB 1983, DV160 AB 1996, DV240B AB 1983, DV240B AB 1996, DV260B, DV270B AB 1992, DV40 AB 1983, DV40 AB 1992, DV80, DV80 AB 1980, DV80 AB 1983		

pins



1

GEV No.	694465	Ref. No.	0354000
description	grooved pin ø 2mm L 20mm SS		
For models:	DV100 AB 1983, DV120B, DV120T, DV160 AB 1983, DV160 AB 1996, DV240B AB 1983, DV240B AB 1996, DV260B, DV270B AB 1992, DV40 AB 1983, DV40N, DV40T, DV40T FA, DV80, DV80 AB 1983, DV80 AB 1992, DV80T, ECO STAR 545D, FV120B AB 1983, FV130B, FV240B AB 1983, FV250B AB 1992, FV40N AB 1983, FV60E AB 1983		

consumables

fuses

fine fuses





1

GEV No.	358699	Ref. No.	0145000
description	fine fuse size ø5x20mm 10A medium lag rated 250V Qty 10 pcs		
For models:	DV120B, DV120T, DV40 AB 1992, DV40N, DV40T, DV40T FA, DV80 AB 1992, DV80T, ECO STAR 430F, ECO STAR 545D, FR30G AB 1992, FV110G, FV20N, FV20T, FV25G AB 1992, FV28GFA, FV30GS, FV40.2, FV40.2 AB 2003, FV40N AB 1992, FV40T, FV40TFA, FV60E AB 1988, FV70T, FV70TD		





Зип Общепит
vsezip.ru
8(812)9870881

			
1			
GEV No.	358696	Ref. No.	0145013
description	fine fuse size ø5x20mm 4A medium lag rated 250V Qty 10 pcs		
For models:	DV120B, DV120T, DV160 AB 1996, DV240B AB 1996, DV270B AB 1992, DV40N, DV40T, DV40T FA, DV80 AB 1992, DV80T, ECO STAR 430F, ECO STAR 545D, FV130B, FV250B AB 1992, FV28GFA, FV70TD		

			
1			
GEV No.	358600	Ref. No.	0145045
description	fine fuse size ø5x20mm 1A slow-acting rated 250V Qty 10 pcs		
For models:	FV28G AB 1994, FV28G AB 1997		

			
1			
GEV No.	358598	Ref. No.	0145049
description	fine fuse size ø5x20mm 0.63A slow-acting rated 250V Qty 10 pcs		
For models:	DR70, DV100 AB 1980, DV120B, DV160 AB 1980, DV240B AB 1980, DV80, DV80 AB 1975, DV80 AB 1980		

			
1			
GEV No.	358603	Ref. No.	0145047
description	fine fuse size ø5x20mm 2A slow-acting rated 250V Qty 10 pcs		
For models:	FV40.2M, FV40.2M-MIKE2		

			
1			
GEV No.	358601	Ref. No.	0145048
description	fine fuse size ø5x20mm 1.25A slow-acting rated 250V Qty 10 pcs		
For models:	DR70, DV80 AB 1975		

			
1			
GEV No.	358607	Ref. No.	0145001
description	fine fuse size ø5x20mm 6.3A slow-acting rated 250V Qty 10 pcs		
For models:	DV120B, FV30, FV50		

			
1			
GEV No.	358602	Ref. No.	0145046
description	fine fuse size ø5x20mm 1.6A slow-acting rated 250V Qty 10 pcs		

Зип Общепит

vsezip.ru

+7(812)987-08-81

Зип Общепит

vsezip.ru

+7(812)987-08-81

A		hose couplings	106
axial fans	38	hoses	106
		hose wire reinforced	107
B		immersion heating elements	2
bi-metal thermostats	10, 10	indicator lights	18
booster pumps I	47	indicator lights (complete)	18
booster pumps II	48	industrial hoses	107
		intake lances	106
C		K	
cables	50	knurled screws	113
cap nuts	113	L	
clamps	110, 114	lamps	18
condensators & interference suppression filters	48	light bulbs	18
consumables	116	M	
contactors	19	magnetic switches	15
control equipment	17	microswitches	12
cotter pins	116	motors	39
countersunk screws	112	N	
		nuts	113
D		O	
door seals for dishwashers	95	one ear clamps	112, 116
dosing pumps	99	operating capacitors	48
double wire clamps	111, 116	O-rings	90
drain hoses	107	P	
drain pumps	47	pins	116
		pipe clamps	112, 116
E		plunger sockets	12
electric accessories	50	position switches	13
electrodes	38	pressure switches	37
electronic magnets	50	probes	21
		programme timers	18
F		pumps	39
fans	38	PVC hoses	107
fasteners	114	PVC supply hoses	106
fastening material	112	R	
filters	48	reducers	109
fine fuses	116	relays	21
fittings	109	retaining rings	116
float switches	13	ribbon cables	50
float valves	110	rod thermostats	11, 11
formed hoses	108	rotary switches	14
fuses	49, 116	S	
		safety bi-metal thermostats	10
G			
gaskets for wash arm support	96		
H			
heating elements	2		
hexagonal nuts	113		
hexagonal screws	113		
hose clamps	110, 114		
hose connectors	108, 109		

Зип Общепит

vsezip.ru

+7(812)987-08-81

safety thermostats	10
screws	112
sealing washers	93
security hose clamps	112, 115
shaft gaskets	95
sheet metal screws	112
solenoid valves	30
supply filters	110, 110
supply hoses	106
switches and momentary switches	12

T

temperature probes	21
thermostat gaskets	96
thermostats	10
time relays	21
timers	18
touch sensitive light switches	15

U

universal probes	21
------------------	----

V

valves and tank inlets	110
------------------------	-----

W

wash and rinse pumps	39
wash pump motors	46
washers	114
water cycle components	110