



Зип Ощепит

vsezip.ru

Spare Parts for

+7(812)987-08-80 Dishwashing

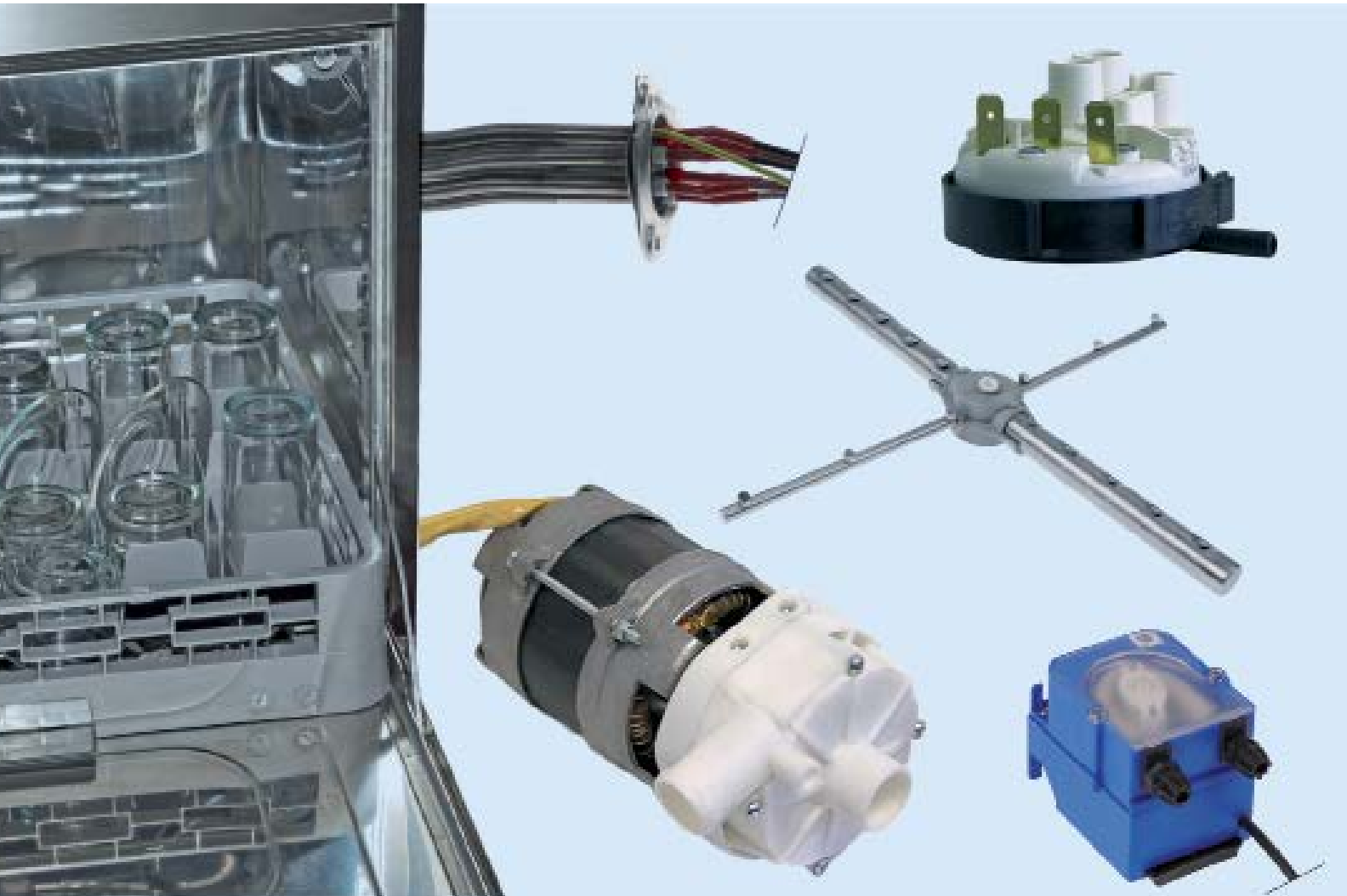

Spare parts suitable for

MACH

2018



Find the complete and up-to-date range of products in our GEV Webshop

heating elements



immersion heating elements

3 hole flange ø47.5mm



GEV No.	416205	Ref. No.	512019800 80001953
description	heating element 3000W 230V heating circuits 1 L 260mm W 29mm H 35mm number of thermostat sleeves 1 thermostat sleeves ø 10mm length thermostat sleeves 214mm tube ø 6.2mm hole distance 65mm hole ø 8mm connection M4 immersion heater		
For models:	GL220, GL250, MB235LI, MB240LI, MB510E, MB510ER, MB520, MB520K, MB530, MB530K, MB535, MB630, MB630PS, MB920E, MB920ER, MB930, MB930K, MB930PS, MB930T, MB9501, MGL40, MS350, MS350PS, MS350TRI, MS351, MS353, MS400B, MS400E, MS400T, MS450, MS450E, MS450PS, MS451, MS453, MS500B, MS500E, MS500PPB, MS500T, MS700E, MS905, MS9401, MS9451, MS9453		
spare parts for	416205		
	GEV No.	510408	Ref. No. —
	O-ring EPDM thickness 5.34mm ID ø 47mm Qty 1 pcs		
accessories for	416205		
	GEV No.	510562	Ref. No. —
	O-ring silicone thickness 5.34mm ID ø 47mm Qty 1 pcs		







GEV No.	416204	Ref. No.	512060200 80001977
description	heating element 3000W 230V mounting ø 47.5mm heating circuits 3 L 205mm W 26mm H 44mm number of thermostat sleeves 1 thermostat sleeves ø 8.7mm length thermostat sleeves 175mm thermostat sleeve not clinging tube ø 6.3mm hole distance 62mm hole ø 8mm connection M4 3 hole flange immersion heater		
For models:	MLP50, MS1100, MS1100E, MS1100T, MS350, MS350TRI, MS351, MS353, MS450, MS450E, MS450PS, MS451, MS453, MS700, MS900, MS900E, MS900T		
spare parts for	416204		
	GEV No.	510562	Ref. No. —
	O-ring silicone thickness 5.34mm ID ø 47mm Qty 1 pcs		
accessories for	416204		
	GEV No.	510408	Ref. No. —
	O-ring EPDM thickness 5.34mm ID ø 47mm Qty 1 pcs		

Зип Общепит



vsezip.ru

+7(812)987-08-81



GEV No.	416206	Ref. No.	512004310 80001979
description	heating element 4500W 230V mounting ø 47.5mm heating circuits 3 L 377mm W 27mm H 36mm number of thermostat sleeves 1 thermostat sleeves ø 9mm length thermostat sleeves 250mm thermostat sleeve not clinging tube ø 6.5mm hole distance 64mm hole ø 8mm connection M4 3 hole flange immersion heater		
For models:	MB9500, MB9503, MGL500, MLP50, MS1100, MS1100E, MS1100P, MS1100T, MS1300, MS1300E, MS1300P, MS1300T, MS351, MS353, MS400B, MS400T, MS450, MS450E, MS450PS, MS451, MS453, MS500B, MS500PPB, MS500T, MS700, MS900, MS900E, MS900T, MS9400, MS9403, MS9451, MS9453		
spare parts for	416206		
	GEV No.	510408	Ref. No. —
	O-ring EPDM thickness 5.34mm ID ø 47mm Qty 1 pcs		
accessories for	416206		
	GEV No.	510408	Ref. No. —
	O-ring EPDM thickness 5.34mm ID ø 47mm Qty 1 pcs		
	GEV No.	510562	Ref. No. —
	O-ring silicone thickness 5.34mm ID ø 47mm Qty 1 pcs		



GEV No.	416207	Ref. No.	512004410 80001981
description	heating element 6000W 230V mounting ø 47.5mm heating circuits 3 L 400mm W 24mm H 42mm number of thermostat sleeves 1 thermostat sleeves ø 9mm length thermostat sleeves 245mm thermostat sleeve not clinging tube ø 6.3mm hole distance 62mm hole ø 8mm connection M4 3 hole flange immersion heater		
For models:	MGL500, MLP140, MLP50, MLP56, MLP60, MLP60E, MS1100, MS1100E, MS1100P, MS1100T, MS1300, MS1300E, MS1300P, MS1300T, MS400B, MS400T, MS450, MS450E, MS450PS, MS500B, MS500PPB, MS500T, MS700, MS700E, MS800B, MS800E, MS800T, MS900, MS900E, MS900T, MS905		
spare parts for	416207		
	GEV No.	510408	Ref. No. —
	O-ring EPDM thickness 5.34mm ID ø 47mm Qty 1 pcs		
accessories for	416207		
	GEV No.	510408	Ref. No. —
	O-ring EPDM thickness 5.34mm ID ø 47mm Qty 1 pcs		
	GEV No.	510562	Ref. No. —
	O-ring silicone thickness 5.34mm ID ø 47mm Qty 1 pcs		



Зип Общежит

vsezip.ru

+7(812)987-0997

1			
GEV No.	416208	Ref. No.	512004510 512004520 80001983
description	heating element 9000W 230V mounting ϕ 47.5mm heating circuits 3 L 395mm W 32mm H 36mm number of thermostat sleeves 1 thermostat sleeves ϕ 9mm length thermostat sleeves 240mm thermostat sleeve eccentric, non clinging tube ϕ 8.5mm hole distance 63mm hole ϕ 8mm connection M4 3 hole flange immersion heater with gasket		
For models:	MLP140, MLP70, MLP80, MS1100, MS1100E, MS1100P, MS1100T, MS1300, MS1300E, MS1300P, MS1300T, MS800B, MS800E, MS800T, MS900, MS900E, MS900T, MS905		
spare parts for	416208		
	GEV No.	510408	Ref. No. —
O-ring EPDM thickness 5.34mm ID ϕ 47mm Qty 1 pcs			

1			
GEV No.	416203	Ref. No.	512036300 80001951
description	heating element 2600W 230V mounting ϕ 47.5mm heating circuits 1 L 250mm W 35mm H 24mm number of thermostat sleeves 1 thermostat sleeves ϕ 8.5mm length thermostat sleeves 235mm thermostat sleeve not clinging tube ϕ 6.3mm hole distance 62mm hole ϕ 8mm connection M4 3 hole flange immersion heater		
For models:	GL220, GL250, MB235LI, MB240LI, MB510E, MB510ER, MB520, MB520K, MB530, MB530K, MB535, MB630, MB630PS, MB920E, MB920ER, MB9235, MB9240, MB930, MB930K, MB930PS, MB930T, MB9510, MB9510R, MB9920, MB9920R		
spare parts for	416203		
	GEV No.	510408	Ref. No. —
O-ring EPDM thickness 5.34mm ID ϕ 47mm Qty 1 pcs			
accessories for	416203		
	GEV No.	510408	Ref. No. —
O-ring EPDM thickness 5.34mm ID ϕ 47mm Qty 1 pcs			
	GEV No.	510562	Ref. No. —
O-ring silicone thickness 5.34mm ID ϕ 47mm Qty 1 pcs			

with 3 hole flange ϕ 57.5mm			
1			
GEV No.	415264	Ref. No.	2761 80002761
description	heating element 6000W 230V heating circuits 3 mounting ϕ 57.5mm L 480mm W 35mm H 42mm round flange connection M5 immersion heater tube ϕ 8.5mm connection length 19mm thermostat sleeves ϕ 7.5mm number of thermostat sleeves 1 length thermostat sleeves 268mm thermostat sleeve not clinging		
For models:	MLP55, MLP80		
accessories for	415264		
	GEV No.	550002	Ref. No. —
tension strap H 10mm L 21mm W 10mm hole ϕ 6.5mm for heating element			

1			
GEV No.	419166	Ref. No.	512054600 80004609
description	heating element 1400W 230V heating circuits 1 L 235mm W 50mm H 30mm thread M10x1 tube ϕ 6.3mm connection male faston 6.3mm		
For models:	MB9235, MB9240, MB9510, MB9510R, MB9920, MB9920R, MGL500, MLP50, MLP56, MS400B, MS400E, MS400T, MS500B, MS500E, MS500PPB, MS500T, MS800B, MS800E, MS800T		

1			
GEV No.	420364	Ref. No.	512077900
description	heating element 2500W 230V heating circuits 1 L 270mm W 145mm H 35mm W1 54mm W2 43mm thread M12x1 mounting distance 35mm tube ϕ 8.5mm 2 hole fixing connection male faston 6.3mm immersion heater		
For models:	MB9500, MB9501, MB9503, MLP50, MS9400, MS9401, MS9403, MS9451, MS9453		

1			
GEV No.	416201	Ref. No.	512049900 80004269
description	heating element 2600W 230V heating circuits 1 L 275mm W 85mm H 26mm L1 65mm L2 210mm W1 23mm W2 40mm thread M10x1 mounting distance 33mm tube ϕ 6.3mm connection male faston 6.3mm immersion heater 2 hole fixing		
For models:	GL250, MB235LI, MB240LI, MB630, MB630PS, MB930, MB930K, MB930PS, MB930T, MGL40		
accessories for	416201		
	GEV No.	510416	Ref. No. —
flat gasket fibre ED ϕ 19mm ID ϕ 10.5mm thickness 1.5mm for thread M10 Qty 1 pcs			
	GEV No.	521129	Ref. No. —
nut thread M10 H 6mm SS W5 17 Qty 1 pcs DIN/ISO DIN 439			

electric components



flow heaters

Зип Общежит
control and safety thermostats

1

GEV No.	417708	Ref. No.	512081400
description	flow heater 3000W 230V ø 60mm L 225mm dishwasher		

accessories

sealing washers

O-rings

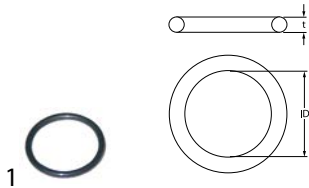

1

GEV No.	510072	Ref. No.	512013100 513013100 80002243
description	O-ring EPDM thickness 3.53mm ID ø 32.93mm Qty 1 pcs		
For models:	GL250, MB510E, MB510ER, MB630, MB920E, MB920ER, MB930, MB930K, MB930T, MGL40		



1

GEV No.	532158	Ref. No.	512006800 80004231
description	O-ring EPDM thickness 5.34mm ID ø 47mm Qty 10 pcs		

thermostats

bi-metal thermostats

bi-metal thermostats



1

GEV No.	390441	Ref. No.	500065000 80004277
description	bi-metal thermostat hole distance 38mm switch-off temp. 55°C 1NC 1-pole 16A connection F6.3 2 hole fixing		
For models:	GL250, MB235LI, MB240LI, MB630, MB930, MB930K, MS400B, MS400T, MS500B, MS500PPB, MS500T		

EGO
control thermostats

55.10/19 series



1

GEV No.	390924	Ref. No.	500070700
description	thermostat t.max. 90°C temperature range 30-90°C 1-pole 1CO 16A probe ø 20mm probe L 12mm capillary pipe 1500mm capillary pipe isolatedmm gland nut shaft Lmm shaft position° shaft position		
For models:	MB235LI, MB240LI, MB630, MB930, MB930K, MLP50, MLP56, MS400B, MS400E, MS500B, MS500E, MS800B, MS800E		



1

GEV No.	375948	Ref. No.	500063900 500087600 80004311
description	thermostat t.max. 90°C temperature range 30-90°C 1-pole 1CO 16A probe ø 6mm probe L 102mm capillary pipe 1000mm capillary pipe isolated 960mm gland nut shaft Lmm shaft position rotation 180°		
For models:	MB235LI, MB240LI, MB510E, MB510ER, MB520, MB520K, MB530, MB530K, MB535, MB630, MB630PS, MB920E, MB920ER, MB9235, MB9240, MB930, MB930K, MB930PS, MB930T, MB9500, MB9501, MB9503, MB9510, MB9510R, MB9920, MB9920R, MLP140, MLP50, MLP56, MLP60, MLP60E, MLP70, MLP80, MS1100, MS1100E, MS1100P, MS1300, MS1300E, MS1300P, MS350, MS350TRI, MS351, MS353, MS400B, MS400E, MS400T, MS450, MS450E, MS451, MS453...(Other models you can see in the webshop)		



3 in 1 Общепит switches and momentary switches

vsezip.ru
28.5x28.5mm

+7(812)987-08-81

safety thermostats

55.10/19_ series



GEV No.	375902	Ref. No.	500064000 80004309
description	safety thermostat switch-off temp. 125°C 1-pole 1NC 16A probe ø 6mm probe L 77mm capillary pipe 870mm capillary pipe isolated 700mm gland nut probe probe material SS screw connection M8x1		
For models:	MB235LI, MB240LI, MB510E, MB510ER, MB520, MB520K, MB530, MB530K, MB535, MB630, MB630PS, MB920E, MB920ER, MB9235, MB9240, MB930, MB930K, MB930PS, MB930T, MB9500, MB9501, MB9503, MB9510, MB9510R, MB9920, MB9920R, MGL40, MGL500, MLP140, MLP50, MLP56, MLP60, MLP60E, MLP70, MLP80, MS1100, MS1100E, MS1100P, MS1100T, MS1300, MS1300E, MS1300P, MS1300T, MS350, MS350TRI, MS351, MS353, MS400B, MS400E, MS400T...(Other models you can see in the webshop)		

IMIT / TEMPOMATIC / ARTHERMO

control thermostats

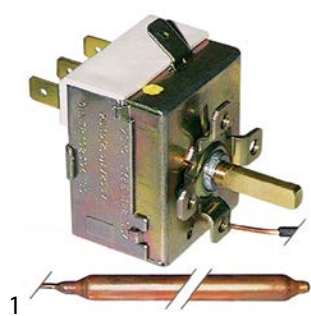

GEV No.	390192	Ref. No.	500000100 80001177
description	thermostat t.max. 90°C temperature range 0-90°C 1-pole 1CO 16A probe ø 6.5mm probe L 95mm capillary pipe 2000mm capillary pipe isolated 2000mm gland nut shaft ø 6x4.6mm shaft L 19mm shaft position upper° rotation 270° probe material copper		
For models:	GL220, GL250, MB510E, MB520, MB520K, MB530, MB530K, MB535, MB630, MB920E, MB930, MB930K, MLP140, MLP60, MLP60E, MLP70, MLP80, MS1100, MS1300, MS350, MS350PS, MS450, MS450E, MS450PS, MS700, MS700E, MS900		

accessories

plunger sockets



GEV No.	504139	Ref. No.	513135500 80002979
description	thermowell thread 3/8" L 38mm SS single ø 6.5mm		
For models:	MGL40, MS400T, MS500PPB, MS500T		

push/momentary push switches

GEV No.	345550	Ref. No.	500005400 80001547
description	momentary push switch mounting measurements 28.5x28.5mm yellow 1NO 250V 16A connection male faston 6.3mm ambient temperature max. 85°C protection IP40		
For models:	MB235LI, MB240LI, MB535, MB9235, MB9240, MS1100, MS1100E, MS1100P, MS1300, MS1300E, MS1300P, MS350, MS350PS, MS350TRI, MS351, MS353, MS400E, MS450E, MS450PS, MS451, MS453, MS500E, MS700E, MS900, MS900E		

GEV No.	345553	Ref. No.	500017800 80001955
description	push switch mounting measurements 28.5x28.5mm green 2NO 250V 16A connection male faston 6.3mm ambient temperature max. 150°C protection IP40		
For models:	MB235LI, MB240LI, MB535, MB9235, MB9240, MLP140, MLP60, MLP60E, MLP70, MLP80, MS351, MS353, MS400E, MS451, MS453, MS500E		

28.5x77.5mm

GEV No.	347621	Ref. No.	500074600
description	double momentary switch latching/momentary mounting measurements 28.5x77.5mm green/blue/yellow 2CO/2NO/2NO 250V 16A connection male faston 6.3mm ambient temperature max. 85°C protection IP40		

GEV No.	345555	Ref. No.	500040900 80001995
description	switch combination latching mounting measurements 28.5x77.5mm green/white/blue 2NO/2CO/2CO 250V 16A connection male faston 6.3mm ambient temperature max. 85°C protection IP40		
For models:	MS1100, MS1100E, MS1100P, MS1300, MS1300E, MS1300P, MS350, MS350PS, MS350TRI, MS450E, MS450PS, MS700E, MS900, MS900E		

electric components



Зип Общепит

vsezip.ru

7(812)987-08-81

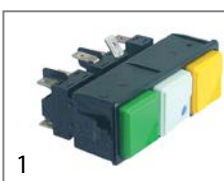

GEV No.	345554	Ref. No.	80001513 800087000
description	switch combination latching/latching/momentary mounting measurements 28.5x77.5mm green/white/yellow 2NO/2CO/1NO 250V 16A connection male faston 6.3mm ambient temperature max. 85°C protection IP40		
For models:	MB510E, MB520, MB520K, MB530, MB530K, MB630, MB920E, MB930, MB930K, MLP55, MLP60E, MLP80, MS350, MS350PS, MS350TRI		

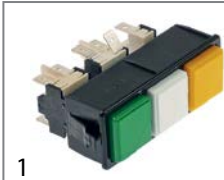

GEV No.	348018	Ref. No.	500005300
description	switch combination latching/latching/momentary mounting measurements 28.5x77.5mm green/white/yellow 2NO/2CO/1NO 250V 16A connection male faston 6.3mm ambient temperature max. 85°C protection IP40		
For models:	MLP50, MLP60E		

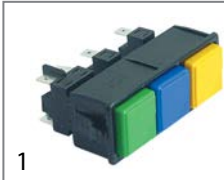

GEV No.	345556	Ref. No.	500074500 80002973 80004381
description	switch combination latching/momentary mounting measurements 28.5x77.5mm green/blue/yellow 2NO/1NO/1NO 250V 16A connection male faston 6.3mm ambient temperature max. 85°C protection IP40		
For models:	MB510E, MB510ER, MB520, MB520K, MB530, MB530K, MB630, MB630PS, MB920E, MB920ER, MB930, MB930K, MB930PS, MB930T, MB9510, MB9510R, MB9920, MB9920R, MGL40, MGL500, MLP50, MS1100, MS1100E, MS1100P, MS1100T, MS1300, MS1300E, MS1300P, MS1300T, MS400B, MS400T, MS500B, MS500PPB, MS500T, MS800B, MS800T, MS900, MS900E, MS900T		



GEV No.	347957	Ref. No.	500017900 500083100
description	switch combination mounting measurements 28.5x77.5mm yellow/green 2NO/1NO/1NO 250V 16A connection male faston 6.3mm ambient temperature max. 150°C 4-pole		
For models:	MS800E, MS905		

PIZZATO

PK Series



GEV No.	347958	Ref. No.	500036300 80001877
description	position switch plastic 2NO 400V 3A L 75mm W 31mm H 31mm protection IP67 actuating force: 350g screw connection PG13.5 mounting distance 22mm FR1001		
For models:	MS1100, MS1300, MS900		

magnetic switches

65x20mm

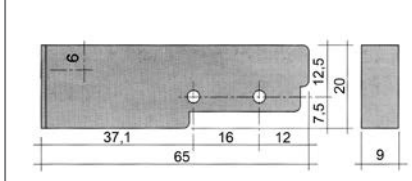

GEV No.	345116	Ref. No.	500046000 80002117
description	magnetic switch L 65mm W 20mm 1NO 250V 0.4A P max. 100W connection cable cable length 3000mm		
For models:	GL220, GL250, MB235LI, MB240LI, MB510E, MB510ER, MB520, MB520K, MB530, MB530K, MB535, MB630, MB630PS, MB920E, MB920ER, MB9235, MB9240, MB930, MB930K, MB930PS, MB930T, MB9500, MB9501, MB9503, MB9510, MB9510R, MB9920, MB9920R, MGL40, MGL500, MLP140, MLP50, MLP56, MLP60, MLP60E, MLP70, MLP80, MS1100, MS1100E, MS1100P, MS1100T, MS1300, MS1300E, MS1300P, MS1300T, MS350, MS350PS, MS350TRI, MS351, MS353... (Other models you can see in the webshop)		
accessories for	345116		

GEV No.	345399	Ref. No.	—
description	magnet ø 3.3mm L 40mm H 8mm W 13mm hole distance 30mm M3		



Зип.Общепит
timers

vsezip.ru
+7(812)987-08-81

accessories

magnets

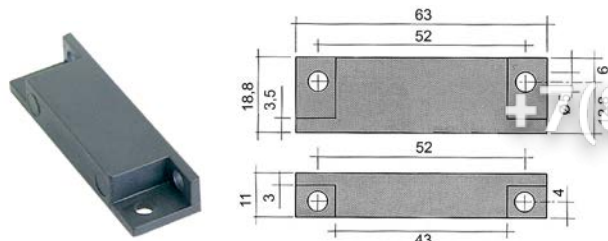

1

GEV No.	345336	Ref. No.	500046100
description	magnet ø 4.8mm L 63mm H 11mm W 18.8mm hole distance 51mm M4		
For models:	MB235LI, MB240LI, MB510E, MB510ER, MB520, MB520K, MB530, MB530K, MB535, MB630, MB630PS, MB920E, MB920ER, MB9235, MB9240, MB930, MB930K, MB930PS, MB930T, MB9500, MB9501, MB9503, MB9510, MB9510R, MB9920, MB9920R, MGL40, MGL500, MLP140, MLP50, MLP56, MLP60, MLP60E, MLP70, MLP80, MS1100, MS1100E, MS1100P, MS1100T, MS1300, MS1300E, MS1300P, MS1300T, MS351, MS353, MS400B, MS400E, MS400T, MS451, MS453...(Other models you can see in the webshop)		

lamps

indicator lights

indicator lights 2-piece (lens and indicator lamp)

indicator light lenses

ø 6mm (type SQ-20)



1

GEV No.	359804	Ref. No.	500064800
description	indicator light lens yellow Qty 1 pcs ø 6mm		
For models:	MB235LI, MB240LI, MB510E, MB510ER, MB520, MB520K, MB530, MB530K, MB535, MB630, MB630PS, MB920E, MB920ER, MB9235, MB9240, MB930, MB930K, MB930PS, MB930T, MB9500, MB9501, MB9503, MB9510, MB9510R, MB9920, MB9920R, MLP50, MLP56, MLP60E, MS1100, MS1100E, MS1100P, MS1300, MS1300E, MS1300P, MS351, MS353, MS400B, MS400E, MS451, MS453, MS500B, MS500E, MS800B, MS800E, MS900, MS900E, MS905, MS9400, MS9401...(Other models you can see in the webshop)		

programme timers



1

GEV No.	360737	Ref. No.	500068800 80004981
description	timer CDC 11901F1 engines 1 chambers 1 operation time 60s 230V		
For models:	MLP50		



1

GEV No.	360721	Ref. No.	500000900
description	timer CDC 4905MDV engines 2 chambers 5 operation time 6s / 3min 230V shaft ømm shaft Lmm manuf. no. 4905MDVAPE000.1000		
For models:	MS400B, MS500B		



1

GEV No.	360202	Ref. No.	500001000 80002359
description	timer FIBER P25 engines 1 chambers 4 operation time 4min 230V shaft ømm shaft Lmm manuf. no. P255J04H699 motor type M51B-J0R6400		
For models:	MS350, MS350PS, MS350TRI		

spare parts for	360202	GEV No.	360673	Ref. No.	—
	motor kit pinion ø 6.8mm teeth 15 230V voltage AC 50/60Hz turn direction clockwise motor ø 48mm H 18.5mm motor type UDS-40NE1RNZ165 cable length 150mm with holder				

→ electric components



Зип Общепит

vsezip.ru

+7(812)987-08-81



1

GEV No.	360203	Ref. No.	500016900 80001553
description	timer FIBER P26 engines 1 chambers 3 operation time 20min 230V shaft ømm shaft Lmm manuf. no. P265J03L103 motor type M61B40R6400		
For models:	MB520K, MB530K, MB930K, MS1300		



GEV No.	380213	Ref. No.	500035100 80001857 80001LT029
description	power contactor resistive load 20A 230VAC (AC3/400V) 8.5A/5.5kW main contacts 3NO auxiliary contacts 1NO connection screw connection type Fanal DSL7 10 type ISKRA K07M 10		
For models:	MB510E, MB510ER, MB520, MB520K, MB530, MB530K, MB535, MB630, MB920E, MB920ER, MB930, MB930K, MB930T, MB9500, MB9503, MGL40, MGL500, MLP140, MLP50, MLP55, MLP56, MLP60, MLP60E, MLP70, MLP80, MS1100, MS1100E, MS1100P, MS1100T, MS1300, MS1300E, MS1300P, MS1300T, MS350, MS350PS, MS350TRI, MS351, MS353, MS400B, MS400T, MS450, MS450E, MS450PS, MS451, MS453, MS500B, MS500PPB, MS500T, MS700, MS700E...(Other models you can see in the webshop)		



1

GEV No.	360344	Ref. No.	4603 500068300 80004603
description	timer FIBER PWE engines 1 chambers 3 operation time 150s 230V shaft ømm shaft Lmm manuf. no. PWE5J03H408 motor type M51B-J0R6400		
For models:	GL220, GL250, MB235LI, MB240LI, MB510E, MB510ER, MB520, MB520K, MB530, MB530K, MB535, MB630, MB920E, MB920ER, MB930, MB930K, MS351, MS353, MS400E, MS451, MS453, MS500E		
spare parts for	360344		
	GEV No.	360673	Ref. No. —
	motor kit pinion ø 6.8mm teeth 15 230V voltage AC 50/60Hz turn direction clockwise motor ø 48mm H 18.5mm motor type UDS-40NE1RNZ165 cable length 150mm with holder		

relays

power relays

with bracket mounting



1

GEV No.	380312	Ref. No.	1LT080 80001LT080
description	power relays FINDER 230VAC 10A 3CO connection male faston 4.8mm bracket mounting dimensions 52x32.2x36.5mm manuf. no. 60.63.8.230.0000		
For models:	IMP25, IMP35, IMP45, IMP55, IMP70, IMP85		

contactors

ISKRA (FANAL)

power contactors



1

GEV No.	380212	Ref. No.	500000600 80001173
description	power contactor resistive load 20A 230VAC (AC3/400V) 8.5A/5.5kW main contacts 3NO auxiliary contacts 1NC connection screw connection type Fanal K07M 01 type ISKRA DSL7 01		
For models:	GL220, GL250, MGL40, MLP140, MLP60, MLP60E, MLP70, MLP80, MS1100, MS1100E, MS1100P, MS1300, MS1300E, MS1300P, MS350, MS350TRI, MS450, MS450E, MS450PS, MS700, MS700E, MS900, MS900E		



1

GEV No.	380368	Ref. No.	500019000 500019100 80004105 80004251
description	power relays ZETTLER ELECTRONICS 230VAC 30A 1NO/1NC connection male faston 6.3mm bracket mounting manuf. no. AZ 2280-1A-240AF AZ2280-1C-240AF		
For models:	MB235LI, MB240LI, MB930T, MGL500, MLP140, MLP50, MLP60, MLP60E, MLP70, MLP80, MS1100, MS1100E, MS1100P, MS1300, MS1300E, MS1300P, MS350, MS350TRI, MS351, MS353, MS400B, MS400E, MS400T, MS450, MS450E, MS451, MS453, MS500B, MS500E, MS500PPB, MS500T, MS700, MS700E, MS800B, MS800E, MS800T, MS900, MS900E, MS905		



electronic controllers

EVCO - EVERY CONTROL

electronic thermometers

built-in version



GEV No.	400754	Ref. No.	512063000
description	thermometer EVERY CONTROL type TM103T N7 mounting measurements 58x25.5mm 230V voltage AC -40 up to +110°C measuring input NTC front measurements 31x64mm protection IP54 accuracy 1%		
For models:	MGL40, MGL500, MLP140, MLP60, MLP70, MLP80		
accessories for	400754		
	GEV No.	379161	Ref. No.
			—
	temperature probe NTC 10kOhm cable thermoplastic probe -40 up to +110°C cable -40 up to +110°C probe ø6x14mm cable length 3m without screw connection 2-wire		

miscellaneous

universal controllers



GEV No.	400710	Ref. No.	500017100 80003939
description	electronic controller type 9.5.17.90 00G 230V		
For models:	MLP140, MLP60, MLP60E, MLP70, MLP80		

probes

universal probes

temperature probes



GEV No.	379458	Ref. No.	512063100
description	temperature probe NTC 10kOhm cable silicone probe -40 up to +110°C cable -50 up to +180°C probe ø6x40mm cable length 1.5m without screw connection 2-wire		
For models:	MGL40, MGL500, MLP140, MLP60, MLP70, MLP80		



GEV No.	379052	Ref. No.	512042300 80002959
description	temperature probe PTC 1kOhm cable silicone probe -50 up to +150°C cable -50 up to +180°C probe ø6x40mm cable length 1.5m without screw connection 2-wire		
For models:	MGL40, MGL500		

Зип Общепит
product-specific probes

probes



GEV No.	400714	Ref. No.	500054800 80002963
description	temperature probe NTC 100kOhm cable PVC probe -40 up to +125°C cable -10 up to 100°C connection male faston thread probe ø7x25mm cable length 3m		
For models:	MB930T, MGL40, MGL500, MS1100T, MS1300T, MS400T, MS500PPB, MS500T, MS800T, MS900T		

electronics

PCBs



GEV No.	402953	Ref. No.	500086900
description	control PCB dishwasher MB630/930 L 133mm W 82mm		
For models:	MB630, MB630PS, MB9235, MB9240, MB930, MB930K, MB930PS, MB930T, MB9500, MB9501, MB9503, MB9510, MB9510R, MB9920, MB9920R, MLP50, MLP56, MS9400, MS9401, MS9403, MS9451, MS9453		



GEV No.	400717	Ref. No.	500055900 50055900 80002967
description	PCB		
For models:	MB930T, MGL40, MGL500, MS1100T, MS1300T, MS400T, MS500PPB, MS500T, MS800T, MS900T		

Зип Общепит

vsezip.ru

+7(812)987-08-81



1

GEV No.	403892	Ref. No.	500095100
description	PCB L 135mm W 85mm		



1

GEV No.	504155	Ref. No.	512048600 80003863
description	keypad foil		
For models:	MLP60, MLP60E		

keypads

front foils



1

GEV No.	504117	Ref. No.	512027600 512028500 80002511
description	keypad foil		
For models:	GL220, MB510E, MB510ER, MB520, MB520K, MB530, MB530K		



1

GEV No.	504172	Ref. No.	512040000 80004013
description	keypad foil		
For models:	MLP140, MLP70, MLP80		



1

GEV No.	504119	Ref. No.	512027500 80002543
description	keypad foil		
For models:	MB535		



1

GEV No.	504201	Ref. No.	512050700 80004289
description	keypad foil		
For models:	MLP60, MLP60E		



1

GEV No.	504129	Ref. No.	512044800 80002921
description	keypad foil		
For models:	MB630, MB930, MB930K, MB930PS, MB930T, MGL40		



1

GEV No.	504108	Ref. No.	512027800 512028600 80002431
description	keypad foil dishwasher MB920/930		
For models:	MB630, MB920E, MB920ER, MB930, MB930K		

membrane keypads



1

GEV No.	504146	Ref. No.	512046000 80003827
description	keypad foil		
For models:	MLP140		



1

GEV No.	400712	Ref. No.	500032400 80001799
description	membrane keypad warewashing MS1100		
For models:	MS1100, MS1100E, MS1300, MS1300E, MS450, MS450E, MS450PS, MS700, MS900, MS900E		

keypad units



1

GEV No.	504147	Ref. No.	512048500 80003829
description	keypad foil		
For models:	MLP80		



1

GEV No.	400711	Ref. No.	500017600 80003941
description	keypad unit		
For models:	MLP140, MLP60, MLP60E, MLP70, MLP80		



control panel

Зип-Общепит

vsezip.ru

+7(812)987-08-81



GEV No.	504384	Ref. No.	600007100
description	control panel W 650mm H 600mm complete		

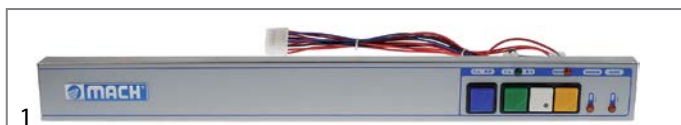

GEV No.	504338	Ref. No.	600064500
description	switch panel MS/450 and MS/700 L 595mm W 65mm edition until year of construction 05/1995		

solenoid valves

solenoid valves (water)

RPE

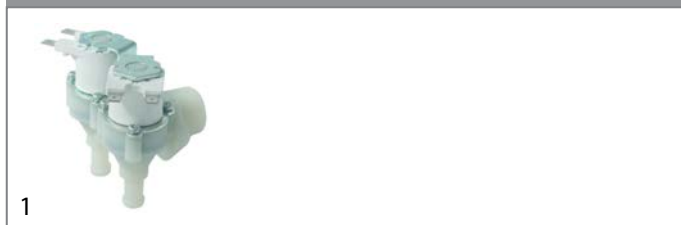

GEV No.	374020	Ref. No.	500001300 80004479
description	solenoid valve double angled 230VAC inlet 3/4" outlet 13mm DN10 RPE		
For models:	GL220, GL250, MB510E, MB510ER, MB520, MB520K, MB530, MB530K, MB535, MB630, MB630PS, MB920E, MB920ER, MB930, MB930K, MB930PS, MB930T, MB9510, MB9510R, MB9920, MB9920R, MGL40, MLP140, MLP50, MLP60, MLP60E, MLP70, MLP80, MS1100, MS1100E, MS1100P, MS1100T, MS1300, MS1300E, MS1300P, MS1300T, MS350, MS350TRI, MS400B, MS400T, MS450, MS450E, MS500B, MS500PPB, MS500T, MS700, MS700E, MS800B, MS800T, MS900...(Other models you can see in the webshop)		

GEV No.	370021	Ref. No.	500047800 80001537
description	solenoid valve double straight 230VAC inlet 3/4" outlet 11.5mm DN10 TP flow regulating valve inlet white		
For models:	GL220, GL250, MB510E, MB510ER, MB520, MB520K, MB530, MB530K, MB535, MB630, MB920E, MB930, MB930K, MGL40, MLP140, MLP60, MLP60E, MLP70, MLP80, MS1100, MS1300, MS350, MS350PS, MS450, MS450E, MS450PS, MS700, MS700E, MS900		
spare parts for	370021		
	GEV No.	371013	Ref. No. —
	solenoid coil TP 230VAC 50/60Hz		
accessories for	370021		
	GEV No.	371220	Ref. No. —
	reducer TP flow rate 3l/min red tolerance ±15%		
	GEV No.	371221	Ref. No. —
	reducer TP flow rate 5.5l/min yellow tolerance ±15%		
	GEV No.	371222	Ref. No. —
	reducer TP flow rate 6l/min grey tolerance ±15%		
	GEV No.	371223	Ref. No. —
	reducer TP flow rate 10l/min white tolerance ±15%		
	GEV No.	371224	Ref. No. —
	reducer TP flow rate 12l/min bronze tolerance ±15%		
	GEV No.	371225	Ref. No. —
	reducer TP flow rate 16l/min light brown tolerance ±15%		
	GEV No.	371226	Ref. No. —
	reducer TP flow rate 20l/min red tolerance ±15%		
	GEV No.	371230	Ref. No. —
	reducer TP flow rate 0.25l/min red tolerance ±25%		
	GEV No.	371231	Ref. No. —
	reducer TP flow rate 0.35l/min violet tolerance ±25%		
	GEV No.	371232	Ref. No. —
	reducer TP flow rate 0.5l/min orange tolerance ±25%		
	GEV No.	371233	Ref. No. —
	reducer TP flow rate 0.8l/min white tolerance ±25%		
	GEV No.	371234	Ref. No. —
	reducer TP flow rate 1l/min light blue tolerance ±25%		
	GEV No.	371235	Ref. No. —
	reducer TP flow rate 1.2l/min brown tolerance ±25%		





Table continues overleaf











electric components

Зип-Общепит

vsezip.ru

+7(812)987-08-81

accessories for 370021			
GEV No.	371236	Ref. No.	—
			
reducer TP flow rate 1.5l/min light brown tolerance ±25%			
GEV No.	371237	Ref. No.	—
			
reducer TP flow rate 2.5l/min yellow tolerance ±25%			
GEV No.	371238	Ref. No.	—
			
reducer TP flow rate 3.4l/min dark green tolerance ±25%			
GEV No.	371239	Ref. No.	—
			
reducer TP flow rate 5l/min black tolerance ±25%			
GEV No.	371240	Ref. No.	—
			
reducer TP flow rate 8l/min blue tolerance ±20%			

  1			
GEV No.	370017	Ref. No.	500081300 80004267
description	solenoid valve single straight 230VAC inlet 3/4" outlet 11.5mm DN10 TP p max 10bar		
For models:	MB235LI, MB240LI, MB9235, MB9240, MB9500, MB9501, MB9503, MLP50, MLP56, MS351, MS353, MS400E, MS451, MS453, MS500E, MS800E, MS905, MS9400, MS9401, MS9403, MS9451, MS9453		
spare parts for	370017		
	GEV No.	371013	Ref. No. —
solenoid coil TP 230VAC 50/60Hz			
accessories for	370017		
	GEV No.	371220	Ref. No. —
reducer TP flow rate 3l/min red tolerance ±15%			
	GEV No.	371221	Ref. No. —
reducer TP flow rate 5.5l/min yellow tolerance ±15%			
	GEV No.	371222	Ref. No. —
reducer TP flow rate 6l/min grey tolerance ±15%			
	GEV No.	371223	Ref. No. —
reducer TP flow rate 10l/min white tolerance ±15%			
	GEV No.	371224	Ref. No. —
reducer TP flow rate 12l/min bronze tolerance ±15%			
	GEV No.	371225	Ref. No. —
reducer TP flow rate 16l/min light brown tolerance ±15%			
	GEV No.	371226	Ref. No. —
reducer TP flow rate 20l/min red tolerance ±15%			
	GEV No.	371230	Ref. No. —
reducer TP flow rate 0.25l/min red tolerance ±25%			

accessories for 370017			
GEV No.	371231	Ref. No.	—
			
reducer TP flow rate 0.35l/min violet tolerance ±25%			
GEV No.	371232	Ref. No.	—
			
reducer TP flow rate 0.5l/min orange tolerance ±25%			
GEV No.	371233	Ref. No.	—
			
reducer TP flow rate 0.8l/min white tolerance ±25%			
GEV No.	371234	Ref. No.	—
			
reducer TP flow rate 1l/min light blue tolerance ±25%			
GEV No.	371235	Ref. No.	—
			
reducer TP flow rate 1.2l/min brown tolerance ±25%			
GEV No.	371236	Ref. No.	—
			
reducer TP flow rate 1.5l/min light brown tolerance ±25%			
GEV No.	371237	Ref. No.	—
			
reducer TP flow rate 2.5l/min yellow tolerance ±25%			
GEV No.	371238	Ref. No.	—
			
reducer TP flow rate 3.4l/min dark green tolerance ±25%			
GEV No.	371239	Ref. No.	—
			
reducer TP flow rate 5l/min black tolerance ±25%			
GEV No.	371240	Ref. No.	—
			
reducer TP flow rate 8l/min blue tolerance ±20%			







  1			
GEV No.	370025	Ref. No.	500001200 80001195
description	solenoid valve triple straight 230VAC inlet 3/4" outlet 11.5mm DN10 TP		
For models:	MB520K, MB530K, MB930K, MGL500		
spare parts for	370025		
	GEV No.	371013	Ref. No. —
solenoid coil TP 230VAC 50/60Hz			
accessories for	370025		
	GEV No.	371220	Ref. No. —
reducer TP flow rate 3l/min red tolerance ±15%			
	GEV No.	371221	Ref. No. —
reducer TP flow rate 5.5l/min yellow tolerance ±15%			
	GEV No.	371222	Ref. No. —
reducer TP flow rate 6l/min grey tolerance ±15%			
	GEV No.	371223	Ref. No. —
reducer TP flow rate 10l/min white tolerance ±15%			





Table continues overleaf



Зип Общепит

vsezip.ru

+7(812)987-08-81

accessories for		370025	
	GEV No.	371224	Ref. No. —
reducer TP flow rate 12l/min bronze tolerance ±15%			
	GEV No.	371225	Ref. No. —
reducer TP flow rate 16l/min light brown tolerance ±15%			
	GEV No.	371226	Ref. No. —
reducer TP flow rate 20l/min red tolerance ±15%			
	GEV No.	371230	Ref. No. —
reducer TP flow rate 0.25l/min red tolerance ±25%			
	GEV No.	371231	Ref. No. —
reducer TP flow rate 0.35l/min violet tolerance ±25%			
	GEV No.	371232	Ref. No. —
reducer TP flow rate 0.5l/min orange tolerance ±25%			
	GEV No.	371233	Ref. No. —
reducer TP flow rate 0.8l/min white tolerance ±25%			
	GEV No.	371234	Ref. No. —
reducer TP flow rate 1l/min light blue tolerance ±25%			
	GEV No.	371235	Ref. No. —
reducer TP flow rate 1.2l/min brown tolerance ±25%			
	GEV No.	371236	Ref. No. —
reducer TP flow rate 1.5l/min light brown tolerance ±25%			
	GEV No.	371237	Ref. No. —
reducer TP flow rate 2.5l/min yellow tolerance ±25%			
	GEV No.	371238	Ref. No. —
reducer TP flow rate 3.4l/min dark green tolerance ±25%			
	GEV No.	371239	Ref. No. —
reducer TP flow rate 5l/min black tolerance ±25%			
	GEV No.	371240	Ref. No. —
reducer TP flow rate 8l/min blue tolerance ±20%			

	GEV No.	504133	Ref. No.	511042400 80002937
description solenoid valve connection T-shape thread 1¼"				
For models: MGL40				

pressure switches

for warewashing

ø 58mm with male faston 6.3mm

with connection horizontal

	GEV No.	541142	Ref. No.	50000500 80002283 80002285 80002287
description pressure control pressure range 123/75mbar connection 6mm ø 58mm pressure connection horizontal warewashing				
For models: MLP50, MS1100, MS1100E, MS1100P, MS1300, MS1300E, MS1300P, MS700, MS700E, MS900, MS900E, MS905				

	GEV No.	542428	Ref. No.	500043700
description pressure control pressure range 200/60mbar connection 6mm ø 58mm pressure connection horizontal warewashing				
For models: MLP140, MLP60, MLP60E, MLP70, MLP80				

	GEV No.	541001	Ref. No.	500042700 80002273 80002289
description pressure control pressure range 35/17mbar connection 6mm ø 58mm pressure connection horizontal warewashing				
For models: GL220, MB235LI, MB240LI, MB510E, MB510ER, MB520, MB520K, MB530, MB530K, MB535, MB630, MB630PS, MB920E, MB920ER, MB9235, MB9240, MB930, MB930K, MB930PS, MB930T, MB9510, MB9510R, MB9920, MB9920R, MGL500, MLP140, MLP50, MLP60, MLP60E, MLP70, MLP80				

Solenoid valve - accessories

	GEV No.	504132	Ref. No.	511042300 80002935
description solenoid valve connection thread 1¼"				
For models: MGL40				





Зип.Общепит pumps

wash and rinse pumps
vsezip.ru

electric components

			
1			
GEV No.	541159	Ref. No.	500000400 80002277 80002279 80002281
description	pressure control pressure range 56/25mbar connection 6mm ø 58mm pressure connection horizontal warewashing pressure connection ø 6mm		
For models:	GL250, MB235LI, MB240LI, MB510E, MB510ER, MB630, MB920E, MB920ER, MB930, MB930K, MB9500, MB9501, MB9503, MLP50, MLP56, MS1100E, MS1100P, MS1100T, MS1300E, MS1300P, MS1300T, MS350, MS350PS, MS350TRI, MS351, MS353, MS400B, MS400E, MS400T, MS450, MS450E, MS450PS, MS451, MS453, MS500B, MS500E, MS500T, MS800B, MS800E, MS800T, MS900E, MS900T, MS905, MS9400, MS9401, MS9403, MS9451, MS9453		

accessories			
			
1			
GEV No.	504112	Ref. No.	513060600 80002463
description	bracket for pressure switch		
For models:	GL220, GL250, MB510E, MB520, MB520K, MB530, MB530K, MB535, MB630, MB930, MB930K, MLP140, MLP60, MLP60E, MLP70, MLP80, MS1100, MS1100E, MS1100P, MS1100T, MS1300, MS1300E, MS1300P, MS1300T, MS350, MS350PS, MS450, MS450E, MS450PS, MS700, MS700E, MS900, MS900E, MS900T, MS905		

electrodes			
			
1			
GEV No.	504138	Ref. No.	513135200 80002975
description	level electrode M10 total length 56mm probe L 30mm insulated probe length 26mm connection bullet connector ø 14mm		
For models:	MGL40, MGL500, MLP140, MLP70, MLP80		

pumps			
			
1			
GEV No.	500333	Ref. No.	512040200 512044300 512046400 80004015
description	pump inlet ø 1 1/4" IT outlet ø 1" type CDXHM/A 70/5 230V 50Hz 0.37kW capacitor 12.5µF EBARA 0.5HP		
For models:	MLP140, MLP70, MLP80		
accessories for	500333		
	GEV No.	365014	Ref. No. —
	operating capacitor capacity 12.5µF 450V tolerance 5%Hz ambient temperature max. -25 to +85°C ø 35mm L 70mm M8 plastic connection male faston 6.3mm 45S.C3DS.12.5 protection		





FIR			
pumps			
			
1			
GEV No.	500037	Ref. No.	512073800
description	pump inlet ø 28mm outlet ø 26mm type 2211.1410 230V 50Hz 1 phase 0.074kW 0.1HP L 190mm rotation direction left capacitor 5µF FIR		
spare parts for	500037		
	GEV No.	365017	Ref. No. —
	operating capacitor capacity 5µF 450V tolerance 5% 50/60Hz ambient temperature max. -25 to +85°C ø 28mm L 54mm M8 plastic connection male faston 6.3mm 16.10.08 protection		
	GEV No.	510384	Ref. No. —
	pump cover inlet ø 28mm outlet ø 26mm ø 100mm ID ø 76mm		
	GEV No.	510695	Ref. No. 512014800 80001523
	mechanical shaft seal height counter ring 5.5mm ID ø 11mm		

Table continues overleaf

Зип Общепит







vsezip.ru

+7(812)987-08-81

spare parts for 500037				
	GEV No.	521203	Ref. No.	—
	impellor ø 72mm H 18mm thread M7 shaft ø 11mm shaft length 32mm blades 3			
	GEV No.	521703	Ref. No.	—
	pump cover gasket EPDM thickness 2.5mm ID ø 75mm Qt. 1 pcs			









1

GEV No.	500331	Ref. No.	512012300 512026300 80002261 80002865
description	pump inlet ø 30mm outlet ø 30mm type B286.1650 230V 50Hz 1 phase 0.37kW 0.53HP L 195mm rotation direction right capacitor 12.5µF FIR		
For models:	GL250, MB630, MB930, MB930K, MB930T, MGL40		
spare parts for 500331			
	GEV No.	365014	Ref. No. —
	operating capacitor capacity 12.5µF 450V tolerance 5%Hz ambient temperature max. -25 to +85°C ø 35mm L 70mm M8 plastic connection male faston 6.3mm 45S.C3DS.12.5 protection		
	GEV No.	510607	Ref. No. —
	impellor ø 85mm H 29mm shaft intake ø 9x8mm rotation direction right blades 6		
	GEV No.	510695	Ref. No. 512014800 80001523
	mechanical shaft seal height counter ring 5.5mm ID ø 11mm		
	GEV No.	521571	Ref. No. 512012700
	pump cover FIR inlet ø 30mm outlet ø 30mm turn direction right ø 128mm ID ø 100mm inner hight 21mm		
	GEV No.	521701	Ref. No. 512014700 80002157
	pump cover gasket		
	GEV No.	521707	Ref. No. —
	pump cover gasket		



1

GEV No.	500327	Ref. No.	512012200 80001511
description	pump inlet ø 30mm outlet ø 30mm type B287.1650 230V 50Hz 1 phase 0.24kW 0.33HP L 180mm rotation direction right capacitor 10µF FIR		
For models:	GL220, MB510E, MB510ER, MB520, MB520K, MB530, MB530K, MB535, MB630, MB630PS, MB920E, MB920ER, MB930, MB930K, MB930PS, MB930T		
spare parts for 500327			
	GEV No.	365015	Ref. No. 512008200 80001509
	operating capacitor capacity 10µF 400V tolerance 5%Hz ambient temperature max. -25 to +85°C ø 35.5mm L 59mm M8 plastic connection male faston 6.3mm protection		
	GEV No.	510607	Ref. No. —
	impellor ø 85mm H 29mm shaft intake ø 9x8mm rotation direction right blades 6		
	GEV No.	510695	Ref. No. 512014800 80001523
	mechanical shaft seal height counter ring 5.5mm ID ø 11mm		
	GEV No.	521571	Ref. No. 512012700
	pump cover FIR inlet ø 30mm outlet ø 30mm turn direction right ø 128mm ID ø 100mm inner hight 21mm		
	GEV No.	521701	Ref. No. 512014700 80002157
	pump cover gasket		
	GEV No.	521707	Ref. No. —
	pump cover gasket		







Зип Общепит

vsezip.ru

+7(812)987-08-81



1

GEV No.	500038	Ref. No.	512074800
description	pump inlet ø 45mm outlet ø 40mm type 3911.1425 230V 50Hz 1 phase 0.55kW 0.75HP L 205mm rotation direction right capacitor 10µF FIR		
spare parts for	500038		
	GEV No.	510508	Ref. No. —
	pump cover FIR inlet ø 45mm outlet ø 40mm pump type PU 0.5/3911 turn direction right ø 160mm ID ø 125mm inner height 25mm		
	GEV No.	510610	Ref. No. 512012000 80001287
	impeller ø 95.5mm H 23mm shaft intake ø 9/8mm rotation direction right seat ø 16mm blades 6		
	GEV No.	510692	Ref. No. 512012100 80001285
	mechanical shaft seal for shaft ø 11mm slide ring ext. ø 24mm slide ring H 13mm counter ring mounting ø 26mm height counter ring 8mm counter ring int. ø 14mm		
	GEV No.	521702	Ref. No. 512013500 80001289
	pump cover gasket thickness 3.5x4.5mm Qty 1 pcs		
accessories for	500038		
	GEV No.	365015	Ref. No. 512008200 80001509
	operating capacitor capacity 10µF 400V tolerance 5%Hz ambient temperature max. -25 to +85°C ø 35.5mm L 59mm M8 plastic connection male faston 6.3mm protection		
	GEV No.	551286	Ref. No. —
	adapter L 120mm 4-pole for Meiko pump suitable for 500038 plug type dependent on equipment		



1

GEV No.	500981	Ref. No.	512055400
description	pump inlet ø 45mm outlet ø 40mm type 4281.2350 230V 50Hz 1 phase 0.55kW 0.75HP L 230mm rotation direction right capacitor 12.5µF FIR		
For models:	MGL500, MS400B, MS400T, MS500B, MS500T		



1

GEV No.	499362	Ref. No.	512080700 512080800
description	pump inlet ø 63 outlet ø 48 type 4295.2351 230V 50Hz 1 phase 0.9kW L 270mm rotation direction right capacitor 16µF FIR with mounting angle 2800rpm nominal 4.2A		





Зип-Общепит



vsezip.ru

+7(812)987-08-81







1

GEV No.	500023	Ref. No.	512032400 80002409
description	pump inlet ø 63mm outlet ø 47mm type 1225.2725 230/400V 50Hz 3 phase 1.1kW 1.5HP L 335mm rotation direction right FIR		
For models:	MS1100, MS1100E, MS1100T, MS900, MS900E, MS900T		
spare parts for	500023		
	GEV No.	510602	Ref. No. 512047100 80002859
	impellor ø 110mm H 34mm rotation direction right thread M8L shaft ø 28mm seat ø 12.2mm blades 6		
	GEV No.	510693	Ref. No. 512011200 80001305 80004115 80004671
	mechanical shaft seal for shaft ø 12mm slide ring ext. ø 24mm slide ring H 15.5mm slide ring int. ø 11mm counter ring mounting ø 24mm height counter ring 8mm counter ring int. ø 13.5mm		
	GEV No.	521513	Ref. No. 512012500
	pump cover FIR inlet ø 63mm outlet ø 47mm turn direction right ID ø 150mm inner height 32mm		
	GEV No.	524416	Ref. No. —
	pump cover gasket thickness 4x4mm Qty 1 pcs		

GEV No.	510693	Ref. No.	512011200 80001305 80004115 80004671
	mechanical shaft seal for shaft ø 12mm slide ring ext. ø 24mm slide ring H 15.5mm slide ring int. ø 11mm counter ring mounting ø 24mm height counter ring 8mm counter ring int. ø 13.5mm		
	GEV No.	521513	Ref. No. 512012500
	pump cover FIR inlet ø 63mm outlet ø 47mm turn direction right ID ø 150mm inner height 32mm		
	GEV No.	524416	Ref. No. —
	pump cover gasket thickness 4x4mm Qty 1 pcs		



1

GEV No.	500325	Ref. No.	512007600 80001297
description	pump inlet ø 63mm outlet ø 47mm type 1293.1603 230V 50Hz 1 phase 0.55kW 0.75HP L 300mm rotation direction right capacitor 12.5µF FIR		
For models:	MS450, MS450E, MS450PS		
spare parts for	500325		
	GEV No.	365014	Ref. No. —
	operating capacitor capacity 12.5µF 450V tolerance 5%Hz ambient temperature max. -25 to +85°C ø 35mm L 70mm M8 plastic connection male faston 6.3mm 45S.C3DS.12.5 protection		
	GEV No.	510601	Ref. No. 512011700 80001307
	impellor ø 103mm H 25mm rotation direction right thread M8L seat ø 12.2mm blades 6		
	GEV No.	510693	Ref. No. 512011200 80001305 80004115 80004671
	mechanical shaft seal for shaft ø 12mm slide ring ext. ø 24mm slide ring H 15.5mm slide ring int. ø 11mm counter ring mounting ø 24mm height counter ring 8mm counter ring int. ø 13.5mm		
	GEV No.	521513	Ref. No. 512012500
	pump cover FIR inlet ø 63mm outlet ø 47mm turn direction right ID ø 150mm inner height 32mm		
	GEV No.	524416	Ref. No. —
	pump cover gasket thickness 4x4mm Qty 1 pcs		

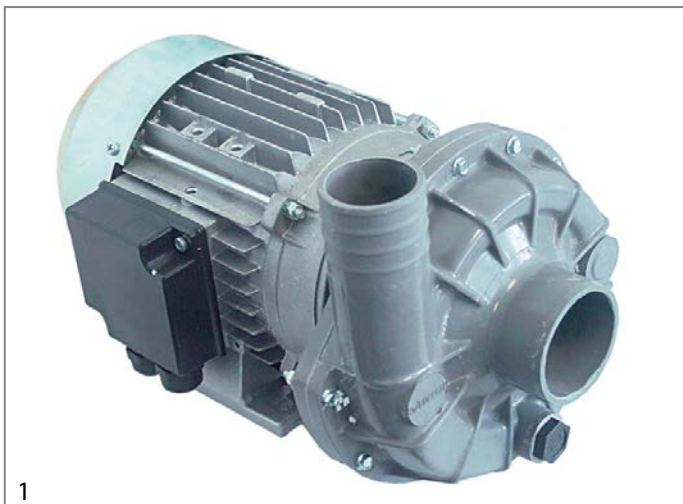

1

GEV No.	500323	Ref. No.	512049800 80004255
description	pump inlet ø 63mm outlet ø 47mm type 1227.2721 230/400V 50Hz 3 phase 2kW 2.7HP L 335mm rotation direction right FIR		
For models:	MB240LI, MLP60, MLP60E		
spare parts for	500323		
	GEV No.	510599	Ref. No. 512052800 80004669
	impellor ø 123mm H 34mm M8L		

electric components





Зип Общепит

vsezip.ru





+7(812)987-08-81



1

GEV No.	500330	Ref. No.	512014400 80004225
description	pump inlet \varnothing 63mm outlet \varnothing 47mm type 1295.1409 230V 50Hz 1 phase 0.88kW 1.2HP L 305mm rotation direction right capacitor 12.5 μ F FIR		
For models:	MS1100, MS1100E, MS1100T, MS900, MS900E, MS900T, MS905		
spare parts for	500330		
	GEV No.	365014	Ref. No. —
	operating capacitor capacity 12.5 μ F 450V tolerance 5%Hz ambient temperature max. -25 to +85°C \varnothing 35mm L 70mm M8 plastic connection male faston 6.3mm 45S.C3DS.12.5 protection		
	GEV No.	510693	Ref. No. 512011200 80001305 80004115 80004671
	mechanical shaft seal for shaft \varnothing 12mm slide ring ext. \varnothing 24mm slide ring H 15.5mm slide ring int. \varnothing 11mm counter ring mounting \varnothing 24mm height counter ring 8mm counter ring int. \varnothing 13.5mm		
	GEV No.	521213	Ref. No. 512011800 80001697
	impellor \varnothing 117mm H 24mm M8L		
	GEV No.	521513	Ref. No. 512012500
	pump cover FIR inlet \varnothing 63mm outlet \varnothing 47mm turn direction right ID \varnothing 150mm inner height 32mm		
	GEV No.	524416	Ref. No. —
	pump cover gasket thickness 4x4mm Qty 1 pcs		

1

GEV No.	500029	Ref. No.	512007700 512024200 51204400 80001685 80002139
description	pump inlet \varnothing 63mm outlet \varnothing 47mm type 1295.2503 230/400V 50Hz 3 phase 0.88kW 1.2HP L 305mm rotation direction right FIR		
For models:	MS1100, MS1100E, MS1100T, MS700, MS700E, MS900, MS900E, MS900T		
spare parts for	500029		
	GEV No.	510693	Ref. No. 512011200 80001305 80004115 80004671
	mechanical shaft seal for shaft \varnothing 12mm slide ring ext. \varnothing 24mm slide ring H 15.5mm slide ring int. \varnothing 11mm counter ring mounting \varnothing 24mm height counter ring 8mm counter ring int. \varnothing 13.5mm		
	GEV No.	521213	Ref. No. 512011800 80001697
	impellor \varnothing 117mm H 24mm M8L		
	GEV No.	521513	Ref. No. 512012500
	pump cover FIR inlet \varnothing 63mm outlet \varnothing 47mm turn direction right ID \varnothing 150mm inner height 32mm		
	GEV No.	524416	Ref. No. —
	pump cover gasket thickness 4x4mm Qty 1 pcs		

Зип Общепит





vsezip.ru

+7(812)987-08-81



GEV No.	500031	Ref. No.	512039800 80003823
description	pump inlet ø 63mm outlet ø 53mm type 1205.2528 230/400V 50Hz 3 phase 2kW 2.7HP L 330mm rotation direction left FIR		
For models:	MLP70, MLP80, MS1100P, MS1300P		
spare parts for	500031		
	GEV No.	510357	Ref. No. 512052700 80004113
	impellor ø 124mm H 34/16mm thread M8R blades 6		
	GEV No.	510523	Ref. No. —
	fan wheel ø 142mm shaft intake ø 15mm blades 12		
	GEV No.	510531	Ref. No. 512013700
	pump cover FIR inlet ø 63mm outlet ø 53mm auxiliary pressure connection M16x1.5mm supporting pressure open turn direction left ø 185mm ID ø 150mm inner hight 37mm		
	GEV No.	510693	Ref. No. 512011200 80001305 80004115 80004671
	mechanical shaft seal for shaft ø 12mm slide ringext. ø 24mm slide ring H 15.5mm slide ring int. ø 11mm counter ring mounting ø 24mm height counter ring 8mm counter ring int. ø 13.5mm		
	GEV No.	524416	Ref. No. —
	pump cover gasket thickness 4x4mm Qty 1 pcs		



GEV No.	500119	Ref. No.	512014500 80004221
description	pump inlet ø 63mm outlet ø 53mm type 1241.1402 230V 50Hz 1 phase 1.1kW 1.5HP L 330mm rotation direction left capacitor 31.5µF FIR		
For models:	MS1300, MS1300E, MS1300T		
spare parts for	500119		
	GEV No.	365016	Ref. No. —
	operating capacitor capacity 31.5µF 400V tolerance 5%Hz ambient temperature max. -25 to +85°C ø 45mm L 95mm M8 plastic connection male faston 6.3mm protection		
	GEV No.	510531	Ref. No. 512013700
	pump cover FIR inlet ø 63mm outlet ø 53mm auxiliary pressure connection M16x1.5mm supporting pressure open turn direction left ø 185mm ID ø 150mm inner hight 37mm		
	GEV No.	510612	Ref. No. 512011900 80001441
	impellor ø 110mm H 34mm M8R		
	GEV No.	510693	Ref. No. 512011200 80001305 80004115 80004671
	mechanical shaft seal for shaft ø 12mm slide ringext. ø 24mm slide ring H 15.5mm slide ring int. ø 11mm counter ring mounting ø 24mm height counter ring 8mm counter ring int. ø 13.5mm		
	GEV No.	524416	Ref. No. —
	pump cover gasket thickness 4x4mm Qty 1 pcs		



Зиг-Общепит



spare parts for 500324			
GEV No.	510531	Ref. No.	512013700
pump cover FIR inlet ø 63mm outlet ø 53mm auxiliary pressure connection M16x1.5mm supporting pressure open turn direction left ø 185mm ID ø 150mm inner height 37mm			
GEV No.	510693	Ref. No.	512011200 80001305 80004115 80004671
mechanical shaft seal for shaft ø 12mm slide ring ext. ø 24mm slide ring H 15.5mm slide ring int. ø 11mm counter ring mounting ø 24mm height counter ring 8mm counter ring int. ø 13.5mm			
GEV No.	524416	Ref. No.	—
pump cover gasket thickness 4x4mm Qty 1 pcs			



1

GEV No.	500111	Ref. No.	512007800 80001423
description pump inlet ø 63mm outlet ø 53mm type 1241.2500 230/400V 50Hz 3 phase 1.1kW 1.5HP L 330mm rotation direction left FIR			
For models: MS1300, MS1300E, MS1300T			
spare parts for 500111			
GEV No.	510531	Ref. No.	512013700
pump cover FIR inlet ø 63mm outlet ø 53mm auxiliary pressure connection M16x1.5mm supporting pressure open turn direction left ø 185mm ID ø 150mm inner height 37mm			
GEV No.	510612	Ref. No.	512011900 80001441
impellor ø 110mm H 34mm M8R			
GEV No.	510693	Ref. No.	512011200 80001305 80004115 80004671
mechanical shaft seal for shaft ø 12mm slide ring ext. ø 24mm slide ring H 15.5mm slide ring int. ø 11mm counter ring mounting ø 24mm height counter ring 8mm counter ring int. ø 13.5mm			
GEV No.	524416	Ref. No.	—
pump cover gasket thickness 4x4mm Qty 1 pcs			

LGB

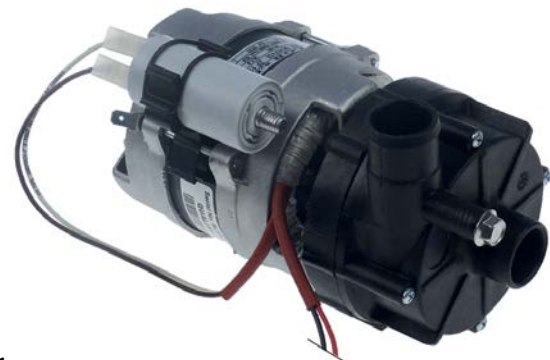

1

GEV No.	499061	Ref. No.	512050800 80004317
description pump inlet ø 28mm outlet ø 26mm type ZF115SX 230V 50Hz 1 phase 0.21kW L 190mm capacitor 5µF LGB			
For models: MB235LI, MB9235, MB9240			
spare parts for 499061			
GEV No.	510122	Ref. No.	—
pump cover LGB inlet ø 28mm outlet ø 26mm auxiliary pressure connection 13mm supporting pressure open ø 98mm ID ø 77mm inner height 31mm			
GEV No.	510703	Ref. No.	512063400
mechanical shaft seal for shaft ø 13mm slide ring H 13mm height counter ring 5.5mm ED ø 26mm			
GEV No.	521221	Ref. No.	—
impellor ø 67mm H 16mm rotation direction right thread M7L shaft ø 13mm shaft length 12mm blades 8			
GEV No.	528800	Ref. No.	—
O-ring EPDM thickness 2.62mm ID ø 75.87mm Qty 1 pcs			
accessories for 499061			
GEV No.	365017	Ref. No.	—
operating capacitor capacity 5µF 450V tolerance 5% 50/60Hz ambient temperature max. -25 to +85°C ø 28mm L 54mm M8 plastic connection male faston 6.3mm 16.10.08 protection			

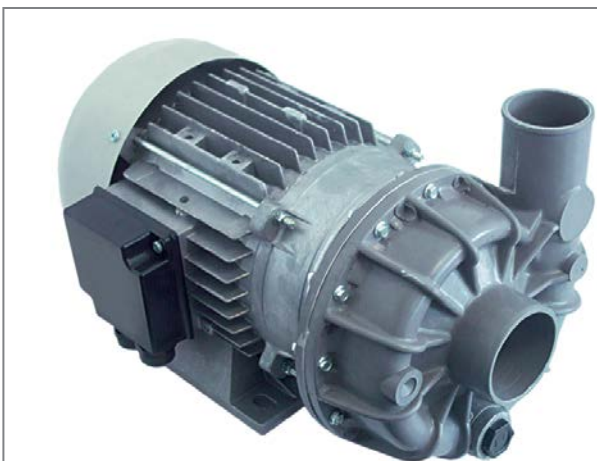

1

GEV No.	500324	Ref. No.	512044700 80004023
description pump inlet ø 63mm outlet ø 53mm type 1243.2591 230/400V 50Hz 3 phase 2.35kW 3.2HP L 365mm rotation direction left FIR			
For models: MLP140, MLP70, MLP80			
spare parts for 500324			
GEV No.	510357	Ref. No.	512052700 80004113
impellor ø 124mm H 34/16mm thread M8R blades 6			

Зип Общежит





drain pumps

ASKOLL
vsezip.ru

+7(812)987-08-81



1

GEV No.	499154	Ref. No.	51205500 80004611
description	pump inlet \varnothing 45mm outlet \varnothing 38mm type ZF320SX 230V 50Hz 1 phase 0.55kW 0.75HP L 205mm rotation direction right capacitor 12.5 μ F LGB		
For models:	MB9500, MB9501, MB9503, MS351, MS353, MS400E, MS451, MS453, MS500E, MS9400, MS9401, MS9403, MS9451, MS9453		
spare parts for	499154		
	GEV No.	365014	Ref. No. —
	operating capacitor capacity 12.5 μ F 450V tolerance 5%Hz ambient temperature max. -25 to +85°C \varnothing 35mm L 70mm M8 plastic connection male faston 6.3mm 45S.C3DS.12.5 protection		
	GEV No.	510702	Ref. No. 512031300 80002321
	mechanical shaft seal height counter ring 5.5mm ID \varnothing 12mm		
	GEV No.	521247	Ref. No. —
	impellor \varnothing 80mm H 27mm rotation direction right thread M8L blades 6		
	GEV No.	521542	Ref. No. 512031600 80002311
	pump cover LGB inlet \varnothing 45mm outlet \varnothing 40mm auxiliary pressure connection 13mm supporting pressure open \varnothing 150mm ID \varnothing 120mm inner high 25mm		
	GEV No.	521714	Ref. No. 512034400 80002313
	pump cover gasket thickness 4x4mm Qty 1 pcs		

booster pumps I



1

GEV No.	500944	Ref. No.	512023600 80004253
description	pump inlet \varnothing 3/8" IT outlet \varnothing 3/8" IT type PS45DX 230V 50Hz 0.3kW 2800rpm \varnothing 100mm L 170mm rotation direction left capacitor 8 μ F LGB		
For models:	MGL500, MLP50, MLP56, MLP60, MLP60E, MS1100P, MS1300P, MS400T, MS500PPB, MS500T, MS800B, MS800T		
accessories for	500944		
	GEV No.	365013	Ref. No. —
	operating capacitor capacity 8 μ F 400V tolerance 5%Hz ambient temperature max. -25 to +85°C \varnothing 31.5mm L 55mm M8 plastic connection male faston 6.3mm protection		



1

GEV No.	499310	Ref. No.	512052100
description	drain pump 40W 220V inlet \varnothing 24mm outlet \varnothing 22mm 50Hz ASKOLL type M231 XP complete		
For models:	MB630PS, MB9235, MB9240, MB930PS, MB9510, MB9510R, MB9920, MB9920R, MGL40, MLP50		

GRE



1

GEV No.	500039	Ref. No.	512006900 80002817
description	pump inlet \varnothing 24mm outlet \varnothing 24mm 190W 230V 50Hz GRE		
For models:	MS350PS, MS450PS		

PLASET



1

GEV No.	500926	Ref. No.	512052200 512055700 80004473 80004617
description	drain pump inlet \varnothing 30mm outlet \varnothing 22mm 230V 34W 50Hz PLASET type 53176		
For models:	MB630, MB630PS, MB930, MB930K, MB930PS, MB930T, MB9500, MB9501, MB9503, MGL500, MLP50, MS1100T, MS1300T, MS400T, MS500PPB, MS500T, MS800T, MS900T, MS9400, MS9401, MS9403, MS9451, MS9453		

booster pumps II

accessories



GEV No.	365015	Ref. No.	512008200 80001509
description	operating capacitor capacity 10µF 400V tolerance 5%Hz ambient temperature max. -25 to +85°C ø 35.5mm L 59mm M8 plastic connection male faston 6.3mm protection		
For models:	GL220, MB510E, MB510ER, MB520, MB520K, MB530, MB530K, MB535, MB630, MB630PS, MB920E, MB920ER, MB930, MB930K, MB930PS, MB930T		

condensators & interference suppression filters

operating capacitors

plastic



GEV No.	365015	Ref. No.	512008200 80001509
description	operating capacitor capacity 10µF 400V tolerance 5%Hz ambient temperature max. -25 to +85°C ø 35.5mm L 59mm M8 plastic connection male faston 6.3mm protection		
For models:	GL220, MB510E, MB510ER, MB520, MB520K, MB530, MB530K, MB535, MB630, MB630PS, MB920E, MB920ER, MB930, MB930K, MB930PS, MB930T		



GEV No.	365009	Ref. No.	512008300
description	operating capacitor capacity 2.5µF 400V tolerance 5% 50Hz ambient temperature max. -25 to +85°C ø 36.5mm L 55mm M8 plastic connection male faston 6.3mm 1.27.65C3 protection		
For models:	MB235LI, MB240LI, MB9510, MB9510R, MB9920, MB9920R		

filters

interference suppression filters



GEV No.	365043	Ref. No.	500011600 80003933
description	interference suppression filter type 790Y2 240V 50/60Hz conductor 2 with E connection cable 100mm L 42mm ø 23.5mm Hmm Wmm plastic Qty 1 pcs		
For models:	MLP140, MLP60, MLP60E, MLP70, MLP80		

Зип Общепит

vsezip.ru

+7(812)987-08-81



GEV No.	365169	Ref. No.	500088000
description	interference suppression filter type FC489001 400V 50/60Hz conductor 4 with E connection cable 200mm L 55mm ø 37.5mm Hmm Wmm plastic Qty 1 pcs		
For models:	MB9500, MB9503, MGL500, MLP50, MLP56, MS1100E, MS1100P, MS1100T, MS1300E, MS1300P, MS1300T, MS351, MS353, MS400B, MS400T, MS451, MS453, MS500B, MS500T, MS800B, MS800E, MS800T, MS900E, MS900T, MS905, MS9400, MS9403, MS9451, MS9453		



GEV No.	365044	Ref. No.	500011400 80002441
description	interference suppression filter type FC701Y2F 250V 50-60Hz conductor 2 with E connection cable 200mm L 42mm ø 23mm Hmm Wmm plastic Qty 1 pcs		
For models:	GL220, GL250, MB235LI, MB240LI, MB510E, MB510ER, MB520, MB520K, MB530, MB530K, MB535, MB630, MB630PS, MB920E, MB920ER, MB9235, MB9240, MB930, MB930K, MB930PS, MB930T, MB9501, MB9510, MB9510R, MB9920, MB9920R, MGL40, MGL500, MLP50, MS1100, MS1100E, MS1100P, MS1100T, MS1300, MS1300E, MS1300P, MS1300T, MS350, MS350PS, MS350TRI, MS351, MS353, MS400B, MS400E, MS400T, MS450, MS450E, MS450PS, MS451, MS453...(Other models you can see in the webshop)		

fuses

fine fuses



GEV No.	358678	Ref. No.	500087200
description	fine fuse size ø5x20mm 8A fast-acting rated 250V Qty 10 pcs		
For models:	MB9500, MB9501, MB9503, MLP50, MLP56, MS9400, MS9401, MS9403, MS9451, MS9453		



GEV No.	358690	Ref. No.	500014700 80002983
description	fine fuse size ø5x20mm 1A medium lag rated 250V Qty 10 pcs		
For models:	MGL40, MGL500, MLP140, MLP60, MLP60E, MLP70, MLP80, MS1100T, MS1300T, MS400T, MS500T, MS800T, MS900T		



Зип Общежит
for dishwashers

vsezip.ru

+7 (812) 987-08-81

 <p>1</p>			
GEV No.	358697	Ref. No.	500014900 80002985
description	fine fuse size ø5x20mm 6.3A medium lag rated 250V Qty 10 pcs		
For models:	MB630, MB630PS, MB9235, MB9240, MB930, MB930K, MB930PS, MB930T, MB9510, MB9510R, MB9920, MB9920R, MGL40, MLP140, MLP60, MLP70, MLP80		

electric accessories

cables

ribbon cables

group 1

 <p>1</p>			
GEV No.	400718	Ref. No.	500032500 80001797
description	ribbon cable 20-pole L 1000mm plug type FC-20P raster size 2.54mm		
For models:	MS1100, MS1100E, MS1300, MS1300E, MS450, MS450E, MS450PS, MS700, MS900, MS900E		

terminals

terminal blocks with fuse holder

 <p>1</p>			
GEV No.	358389	Ref. No.	512044100 80002981
description	lustre terminal 0-pole max. 10A max 250V suitable fuse ø5x20mm cross section 2.5mm ² with fuse holder		
For models:	MB630, MB630PS, MB9235, MB9240, MB930, MB930K, MB930PS, MB930T, MB9500, MB9501, MB9503, MB9510, MB9510R, MB9920, MB9920R, MGL40, MGL500, MLP140, MLP50, MLP56, MLP60, MLP70, MLP80, MS1100T, MS1300T, MS400T, MS500T, MS800T, MS900T, MS9400, MS9401, MS9403, MS9451, MS9453		

non-return valves

complete

 <p>1</p>			
GEV No.	543266	Ref. No.	500046300 80003889
description	non-return valve brass connection 3/8" IT - 3/8" IT total length 55mm DN10 Qty 1 pcs		
For models:	MGL500, MLP50, MLP60, MLP60E, MS800B, MS800T		

drain and intake components

drain /intake bodies

 <p>1</p>			
GEV No.	504135	Ref. No.	500055600 80002941
description	drain valve		
For models:	MGL40		

filters

 <p>1</p>			
GEV No.	504111	Ref. No.	513111200 80002459
description	bar for filter fixing L 44mm		
For models:	MB235LI, MB240LI, MB510E, MB510ER, MB920E, MB920ER		

 <p>1</p>			
GEV No.	504060	Ref. No.	513064900 80001817
description	centre web		
For models:	MS1100P, MS1300, MS1300E, MS1300P, MS1300T		

 <p>1</p>			
GEV No.	504061	Ref. No.	513065000 80001847
description	centre web		
For models:	MS1100, MS1100E, MS1100T, MS900, MS900E, MS900T, MS905		

 <p>1</p>			
GEV No.	504101	Ref. No.	513091300 80002403
description	centre web		
For models:	MS700, MS700E		

Зип Общепит
vsezip.ru
7(812)987-08-81

mechanical components, equipment accessories



1

GEV No.	504130	Ref. No.	511042800 80002923
description	drain filter		
For models:	MGL40		



1

GEV No.	504102	Ref. No.	511027400 80002405
description	flat filter		
For models:	MS700, MS700E		



1

GEV No.	517722	Ref. No.	512074900
description	filter ø 193mm H 84mm SS hole ø 37mm		
For models:	MS9451, MS9453		



1

GEV No.	504149	Ref. No.	511048200 80003851
description	flat filter		
For models:	MLP60, MLP60E		



1

GEV No.	504213	Ref. No.	513122800 80004027
description	filter support		
For models:	MLP140, MLP60, MLP60E, MLP70, MLP80		



1

GEV No.	504150	Ref. No.	511048300 80003853
description	flat filter		
For models:	MLP60, MLP60E		



1

GEV No.	504070	Ref. No.	513072700 80001961
description	filter support L 90mm		
For models:	GL220, MB520, MB520K, MB530, MB530K, MB535		



1

GEV No.	504164	Ref. No.	511039900 80003997
description	flat filter		
For models:	MLP70, MLP80		



1

GEV No.	504039	Ref. No.	513045500 51345500 80001435
description	filter support ø 5mm L 49mm		
For models:	MLP50, MS1100, MS1100E, MS1100P, MS1100T, MS1300, MS1300E, MS1300P, MS1300T, MS350, MS350PS, MS350TRI, MS351, MS353, MS450, MS450E, MS450PS, MS451, MS453, MS700, MS700E, MS900, MS900E, MS900T, MS905		



1

GEV No.	504165	Ref. No.	511040000 80003999
description	flat filter		
For models:	MLP70, MLP80		





Зип Общепит

vsezip.ru

87(812)987-08-81



 <p>1</p>			
GEV No.	504189	Ref. No.	511044400 80004161
description	flat filter		
For models:	MLP140		

 <p>1</p>			
GEV No.	504190	Ref. No.	511044500 80004163
description	flat filter		
For models:	MLP140		

 <p>1</p>			
GEV No.	504211	Ref. No.	511049100 80004419
description	flat filter		
For models:	MS1100P, MS1300, MS1300E, MS1300P, MS1300T		

 <p>1</p>			
GEV No.	504210	Ref. No.	511049000 80004411
description	flat filter H 15mm L 225mm W 215mm		
For models:	MS1100, MS1100E, MS900, MS900E, MS905		

 <p>1</p>			
GEV No.	507368	Ref. No.	51.2.0728.00 511061000 511062400 80004535
description	round filters mounting pos. lower suction		
For models:	MLP50, MS400B, MS400E, MS400T, MS500B, MS500E, MS500T, MS800B, MS800E, MS800T		

 <p>1</p>			
GEV No.	504106	Ref. No.	511033200 80002427
description	round filters outflow		
For models:	MB235LI, MB240LI, MB510E, MB510ER, MB920E, MB920ER		
accessories for	504106		
			
GEV No.	504111	Ref. No.	513111200 80002459
bar for filter fixing L 44mm			

 <p>1</p>			
GEV No.	504126	Ref. No.	511031400 80002833
description	round filters outflow ø 109mm H 50mm		
For models:	MS350PS, MS450PS		

 <p>1</p>			
GEV No.	504005	Ref. No.	511020600 80001051
description	round filters outflow ø 190mm		
For models:	MS1100, MS1100E, MS1100P, MS1100T, MS1300, MS1300E, MS1300P, MS1300T, MS350, MS350PS, MS350TRI, MS351, MS353, MS450, MS450E, MS450PS, MS451, MS453, MS700, MS700E, MS900, MS900E, MS900T, MS905		

<p>overflow pipes</p>			
 <p>1</p>			
GEV No.	510072	Ref. No.	512013100 513013100 80002243
description	O-ring EPDM thickness 3.53mm ID ø 32.93mm Qty 1 pcs		
For models:	GL250, MB510E, MB510ER, MB630, MB920E, MB920ER, MB930, MB930K, MB930T, MGL40		

mechanical components, equipment accessories

Зип-Общепит

boilers

boilers for dishwashers

vsezip.ru

+7(812)987-08-81

			
1			
GEV No.	504064	Ref. No.	511023500 80001233 80001913
description	overflow pipe L 115mm ø 27mm		
For models:	GL220, MB235LI, MB240LI, MB510E, MB510ER, MB520, MB520K, MB530, MB530K, MB535, MB920E, MB920ER, MS350, MS350PS, MS350TRI, MS351, MS353, MS450, MS450E, MS450PS, MS451, MS453		

			
1			
GEV No.	504016	Ref. No.	511000200 80001101
description	boiler		
For models:	MS450, MS450E, MS450PS, MS700, MS700E		

			
1			
GEV No.	504200	Ref. No.	511051100 80004287
description	overflow pipe L 300mm ø 27mm		
For models:	MLP60, MLP60E		

			
1			
GEV No.	504034	Ref. No.	511006300 80001385
description	boiler		
For models:	MS1100P, MS1300, MS1300E, MS1300P		

			
1			
GEV No.	517723	Ref. No.	511099600
description	overflow pipe ø 28mm L 113mm		
For models:	MS9451, MS9453		

			
1			
GEV No.	504067	Ref. No.	511018600 80001935 511018600
description	boiler		
For models:	GL220, MB520, MB520K, MB530, MB530K, MB535		

			
1			
GEV No.	517724	Ref. No.	511099700
description	overflow pipe ø 28mm L 139mm		
For models:	MB630, MB630PS, MB9235, MB9240, MB930, MB930K, MB930PS, MB930T, MB9510, MB9510R, MB9920, MB9920R		

			
1			
GEV No.	504094	Ref. No.	511030400 80002329
description	boiler		
For models:	GL250, MS350, MS350PS, MS350TRI		



Зип Общепит

vsezip.ru

+7(812)987-08-81

1



GEV No.	504137	Ref. No.	511042700 511071800 80002953
description	boiler		
For models:	MGL40		

1



GEV No.	504274	Ref. No.	511052300 80002505
description	boiler ø 130mm L 320mm new edition		
For models:	MB235LI, MB240LI, MB510E, MB510ER		

1



GEV No.	504148	Ref. No.	511047500 80003837
description	boiler		
For models:	MLP60, MLP60E		

1



GEV No.	504087	Ref. No.	511050300 80002235
description	boiler ø 132mm L 375mm inlet ø 12		
For models:	GL250, MB240LI, MB630, MB630PS, MB920E, MB920ER, MB930, MB930K, MB930PS, MB930T		

1



GEV No.	504158	Ref. No.	511046100 80003897
description	boiler		
For models:	MLP70, MLP80		

1







GEV No.	504091	Ref. No.	511031000 80002259
description	boiler with insulation ø 158mm L 580mm connection 1/2" hose ø 12mm		
For models:	MS1100, MS1100E, MS900, MS900E		
accessories for	504091		

1



GEV No.	504195	Ref. No.	511045100 80004257
description	boiler		
For models:	MLP140		

	GEV No.	504050	Ref. No.	513000200 80001647
				nut thread M20x1.5
	GEV No.	504078	Ref. No.	513074700 80002023
				end cap
	GEV No.	504081	Ref. No.	512006500 512045300 80002189
				flat gasket FIBER ED ø 28mm ID ø 20mm thickness 2mm Qty 1 pcs
	GEV No.	504082	Ref. No.	513003400 80002195
				hose connector

1



GEV No.	504215	Ref. No.	511060100 511103100 80004599
description	boiler		
For models:	MS351, MS353, MS400B, MS400E, MS400T, MS451, MS453, MS500B, MS500E, MS500PPB, MS500T		

1



GEV No.	517726	Ref. No.	511080300
description	boiler with insulation ø 160mm L 574mm inlet ø 12		
For models:	MS1100, MS1100E, MS1100T, MS900, MS900E, MS900T, MS905		

mechanical components, equipment accessories

Зип Общепит

housing and covers

accessories

			
1			
GEV No.	504078	Ref. No.	513074700 80002023
description	end cap		
For models:	MS1100, MS1300, MS450, MS450E, MS450PS, MS700, MS700E, MS900		

			
1			
GEV No.	504082	Ref. No.	513003400 80002195
description	hose connector		
For models:	GL220, GL250, MB235LI, MB240LI, MB510E, MB510ER, MB520, MB520K, MB530, MB530K, MB535, MB630, MB920E, MB930, MB930K, MGL40, MLP140, MLP60, MLP60E, MLP70, MLP80, MS1100, MS1300, MS350, MS350PS, MS450, MS450E, MS450PS, MS700, MS700E, MS900		

rotation plates

rotation plates

			
1			
GEV No.	504047	Ref. No.	512001700 80001591
description	rotation plate \varnothing 280mm seat \varnothing 15mm		
For models:	MB520, MB520K, MB530, MB530K, MB630, MB630PS, MB930, MB930K, MB930T		

softener cartridges

softening columns

			
1			
GEV No.	504046	Ref. No.	512008900 80001555
description	softener 4-fold L 380mm W 180mm		
For models:	MB520K, MB530K, MB930K		

fascias

			
1			
GEV No.	504384	Ref. No.	600007100
description	control panel W 650mm H 600mm complete		

hood mechanics for dishwashers

bolts

			
1			
GEV No.	504264	Ref. No.	513233700
description	roller ED \varnothing 25mm L 21mm thread M12x1.75/M6 hood mechanics warewashing		
For models:	MS1100E, MS1100P, MS1100T, MS1300E, MS1300P, MS1300T, MS900E, MS900T, MS905		

			
1			
GEV No.	504056	Ref. No.	513052700 80001711
description	screw bolt for hood joint		
For models:	MS1100, MS1100E, MS1100P, MS1300, MS1300E, MS1300P, MS900, MS900E, MS905		

bushes

			
1			
GEV No.	504271	Ref. No.	513233800
description	bush ED \varnothing 10mm ID \varnothing 6.4mm L 3.6mm SS		
For models:	MS1100E, MS1100P, MS1100T, MS1300E, MS1300P, MS1300T, MS900E, MS900T, MS905		



Зип Общепит
vsezip.ru

51304500 (812)987-08-81
80001359



1

GEV No.	504031	Ref. No.	51304500 80001359
description	bush slotted hood mechanics		
For models:	MS1100, MS1100E, MS1100P, MS1100T, MS1300, MS1300E, MS1300P, MS1300T, MS900, MS900E, MS900T, MS905		

linkage

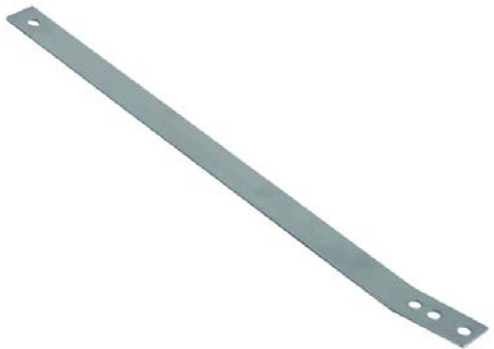

1

GEV No.	504029	Ref. No.	513029400 80001357
description	lace hood mechanics		
For models:	MLP55, MLP80, MS1100, MS1100E, MS1100P, MS1100T, MS1300, MS1300E, MS1300P, MS1300T, MS900, MS900E, MS900T, MS905		

hood handles



1

GEV No.	504452	Ref. No.	511086200
description	hood handle L 900mm W 700mm tube ø 25mm		
For models:	MS1100E, MS1100T, MS900E, MS900T, MS905		

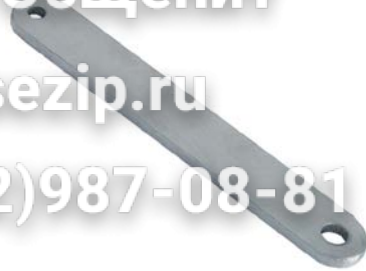

1

GEV No.	504054	Ref. No.	513052500 80001707
description	lever joint hood mechanics		
For models:	MS1100, MS1100E, MS1100P, MS1300, MS1300E, MS1300P, MS900, MS900E, MS905		



1

GEV No.	504267	Ref. No.	513233600
description	lever joint L 185mm W 25mm thickness 3mm hole ø 10mm hood mechanics SS		
For models:	MS1100E, MS1100P, MS1100T, MS1300E, MS1300P, MS1300T, MS900E, MS900T, MS905		

rollers



1

GEV No.	504055	Ref. No.	513052600 80001709
description	roller hood mechanics		
For models:	MS1100, MS1100E, MS1100P, MS1300, MS1300E, MS1300P, MS900, MS900E, MS905		

miscellaneous



1

GEV No.	504032	Ref. No.	513023300 80001371
description	clamp hood mechanics		
For models:	MS1100, MS1100E, MS1100P, MS1100T, MS1300, MS1300E, MS1300P, MS1300T, MS900, MS900E, MS900T, MS905		

mechanical components, equipment accessories

Зип Общепит

vsezip.ru

+7(812)987-08-81



1

GEV No.	504257	Ref. No.	1367 511011400 80001367
description	guide for hood linkage		
For models:	MS1100, MS1100E, MS1100P, MS1100T, MS1300, MS1300E, MS1300P, MS1300T, MS900, MS900E, MS900T, MS905		



1

GEV No.	504268	Ref. No.	513233900
description	plate L 38mm H 9mm W 26mm		
For models:	MS1100E, MS1100P, MS1100T, MS1300E, MS1300P, MS1300T, MS900E, MS900T, MS905		
accessories for	504268		
	GEV No.	Ref. No.	—
	560159		
	blind rivet SS ϕ 3.2mm L 10mm Qty 50 pcs DIN 1700		



1



GEV No.	504385	Ref. No.	511105500
description	plate with bolts D1 ϕ 14mm H 13mm W 25mm hole ϕ 7mm		

air traps

air traps





1

GEV No.	504028	Ref. No.	511007000 80001273
description	air trap		
For models:	MS450, MS450E, MS450PS, MS700		
accessories for	504028		
	GEV No.	Ref. No.	513000400 80001165
	503042		
	nut thread 3/8" H 6mm brass WS 22 Qty 1 pcs		
	GEV No.	Ref. No.	512006700 80001167
	504020		
	flat gasket FIBER ED ϕ 24mm ID ϕ 17mm thickness 2mm Qty 1 pcs		

1

GEV No.	504062	Ref. No.	511007700 511023300 80001885 80002917
description	air trap		
For models:	GL220, MB520, MB520K, MB530, MB530K, MB535, MS700E		
accessories for	504062		
	GEV No.	Ref. No.	513000400 80001165
	503042		
	nut thread 3/8" H 6mm brass WS 22 Qty 1 pcs		
	GEV No.	Ref. No.	512006700 80001167
	504020		
	flat gasket FIBER ED ϕ 24mm ID ϕ 17mm thickness 2mm Qty 1 pcs		

1

GEV No.	504116	Ref. No.	511037400 80002507
description	air trap		
For models:	MB235LI, MB240LI, MB510E, MB510ER, MB920E, MB920ER		
accessories for	504116		
	GEV No.	Ref. No.	513000400 80001165
	503042		
	nut thread 3/8" H 6mm brass WS 22 Qty 1 pcs		
	GEV No.	Ref. No.	512006700 80001167
	504020		
	flat gasket FIBER ED ϕ 24mm ID ϕ 17mm thickness 2mm Qty 1 pcs		

1

GEV No.	504193	Ref. No.	511029900 80004247
description	air trap		
For models:	MS350, MS350PS, MS350TRI		
accessories for	504193		
	GEV No.	Ref. No.	513000400 80001165
	503042		
	nut thread 3/8" H 6mm brass WS 22 Qty 1 pcs		

Table continues overleaf





Зип Общепит

vsezip.ru

+7(812)987-08-81

accessories for 504193			
	GEV No.	504020	Ref. No. 512006700 80001167
flat gasket FIBER ED ø 24mm ID ø 17mm thickness 2mm Qty 1 pcs			

 1			
GEV No.	504207	Ref. No.	511051000 80004343
description air trap			
For models: GL220, MB520, MB520K, MB530, MB530K, MB535, MLP140, MLP60, MLP60E, MLP70, MLP80, MS1100, MS1100E, MS1100P, MS1300, MS1300E, MS1300P, MS900, MS900E, MS905			

accessories for 504207			
	GEV No.	504208	Ref. No. 502004000 80004345
nut thread M10			
	GEV No.	504209	Ref. No. 512015300 80004347
flat gasket FIBER ED ø 18.5mm ID ø 11mm thickness 2mm Qty 1 pcs			

miscellaneous			
 1			
GEV No.	701382	Ref. No.	514217700
description bush plastic H 17mm D1 ø 37.2mm D2 ø 35.4mm for Mach			

door mechanics			
linkage			
 1			
GEV No.	504192	Ref. No.	513144200 80004183
description door pin extension			
For models: MLP140			

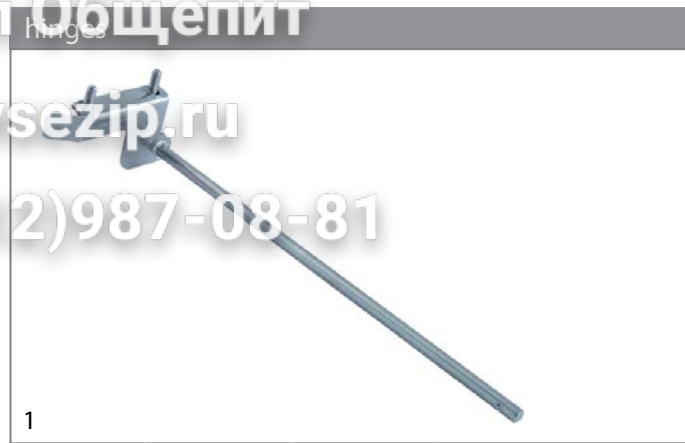

1			
GEV No.	504000	Ref. No.	511000500 80001011 80003911
description door hinge hinge left mounting pos. left			
For models: GL220, GL250, MB235LI, MB240LI, MB510E, MB510ER, MB520, MB520K, MB530, MB530K, MB535, MB630, MB920E, MB920ER, MB930, MB930K, MB930T, MGL40, MLP50, MLP70, MLP80, MS350, MS350PS, MS350TRI, MS351, MS353, MS450, MS450E, MS450PS, MS451, MS453, MS700, MS700E			



1			
GEV No.	504153	Ref. No.	511048500 80003859 8000859
description door hinge hinge left mounting pos. left			
For models: MLP60, MLP60E			

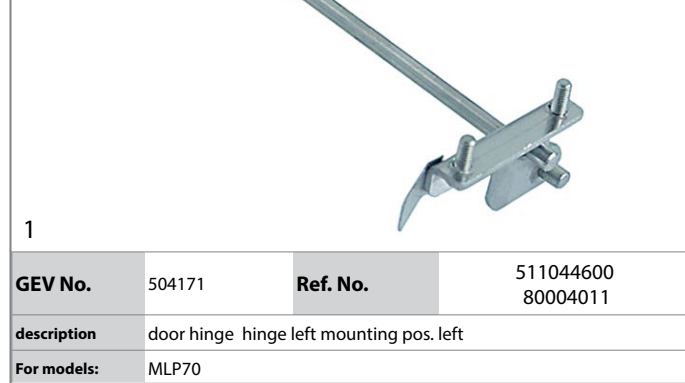

1			
GEV No.	504171	Ref. No.	511044600 80004011
description door hinge hinge left mounting pos. left			
For models: MLP70			

mechanical components, equipment accessories

Зип Общепит

vsezip.ru

+7(812)987-08-81

mechanical components, equipment accessories



1

GEV No.	504191	Ref. No.	511045000 80004165
description	door hinge hinge left mounting pos. left		
For models:	MLP140		



1

GEV No.	504052	Ref. No.	511008100 80001679
description	door hinge hinge right mounting pos. right		
For models:	MLP140, MLP50, MLP70, MLP80, MS450, MS450E, MS450PS, MS451, MS453, MS700, MS700E		



1

GEV No.	504001	Ref. No.	511000400 80001013
description	door hinge hinge right mounting pos. right		
For models:	MB535, MS350, MS350PS, MS350TRI, MS351, MS353		



1

GEV No.	504063	Ref. No.	511019100 80001895 80002499
description	door hinge hinge right mounting pos. right		
For models:	GL220, MB235LI, MB510E, MB510ER, MB520, MB520K, MB530, MB530K, MB535		



1

GEV No.	504038	Ref. No.	511003700 80001475
description	door hinge hinge right mounting pos. right		
For models:	MB240LI, MB630, MB920E, MB920ER, MB930, MB930K, MB930T, MGL40		



1

GEV No.	504154	Ref. No.	511048400 80003861
description	door hinge hinge right mounting pos. right		
For models:	MLP60, MLP60E		



Зип Общепит

vsezip.ru

+7(812)987-08-81

miscellaneous



1			
GEV No.	504004	Ref. No.	513000300 80001019
description	spring compressor		
For models:	GL220, GL250, MB235LI, MB240LI, MB510E, MB510ER, MB520, MB520K, MB530, MB530K, MB535, MB630, MB920E, MB920ER, MB930, MB930K, MB930T, MGL40, MGL500, MLP140, MLP50, MLP60, MLP60E, MLP70, MLP80, MS350, MS350PS, MS350TRI, MS351, MS353, MS400B, MS400E, MS400T, MS450, MS450E, MS450PS, MS451, MS453, MS500B, MS500E, MS500PPB, MS500T, MS700, MS700E, MS800B, MS800E, MS800T		

washing and rinsing systems



1			
GEV No.	504072	Ref. No.	513079500 80002001
description	bush		
For models:	GL220, GL250, MB235LI, MB240LI, MB510E, MB510ER, MB520, MB520K, MB530, MB530K, MB535, MB630, MB630PS, MB920E, MB920ER, MB930, MB930K, MB930PS, MB930T, MGL40, MLP50, MS1100, MS1100E, MS1300, MS1300E, MS350, MS350PS, MS350TRI, MS450, MS450E, MS450PS, MS700, MS700E, MS900, MS900E, MS905		



1			
GEV No.	504177	Ref. No.	513128700 80004073
description	bush		
For models:	MLP140, MLP60, MLP60E, MLP70, MLP80, MS1100P, MS1300P		



1			
GEV No.	504180	Ref. No.	513129000 80004079
description	bush for rinse arm		
For models:	MLP140, MLP60, MLP60E, MLP70, MLP80, MS1100P, MS1300P		



1			
GEV No.	504181	Ref. No.	513129100 80004081
description	bush for rinse arm		
For models:	MLP140, MLP60, MLP60E, MLP70, MLP80, MS1100P, MS1300P		



1			
GEV No.	504787	Ref. No.	513186100 51386100 80004573
description	bush for rinse arm ø 15mm ID ø 7mm H 18.5mm		
For models:	MB235LI, MB240LI, MB630, MB630PS, MB9235, MB9240, MB930, MB930K, MB930PS, MB930T, MB9500, MB9501, MB9503, MB9510, MB9510R, MB9920, MB9920R, MGL500, MLP140, MLP50, MLP56, MLP60, MLP60E, MLP70, MLP80, MS1100E, MS1100P, MS1100T, MS1300E, MS1300P, MS1300T, MS351, MS353, MS400B, MS400E, MS400T, MS451, MS453, MS500B, MS500E, MS500PPB, MS500T, MS800B, MS800E, MS800T, MS900E, MS900T, MS905, MS9400, MS9401...(Other models you can see in the webshop)		



1			
GEV No.	504236	Ref. No.	513219400
description	bush for rinse arm ø 22mm H 34mm		
For models:	MLP140, MLP60, MLP60E, MLP70, MLP80, MS1100P, MS1300P		



1			
GEV No.	517728	Ref. No.	513185900 80004577
description	bush for wash arm ø 45mm H 16mm ID ø 18mm Qty 1 pcs		
For models:	MB630, MB630PS, MB9235, MB9240, MB930, MB930K, MB930PS, MB930T, MB9500, MB9501, MB9503, MB9510, MB9510R, MB9920, MB9920R, MGL500, MLP50, MLP56, MS1100E, MS1100T, MS1300E, MS1300T, MS351, MS353, MS400B, MS400E, MS400T, MS451, MS453, MS500B, MS500E, MS500PPB, MS500T, MS800B, MS800E, MS800T, MS900E, MS900T, MS905, MS9400, MS9401, MS9403, MS9451, MS9453		

mechanical components, equipment accessories

Зип Общепит
vsezip.ru
812 987-08-81



1

GEV No.	504109	Ref. No.	513072300 80002435
description	extension for wash arm		
For models:	GL220, GL250, MB510E, MB530, MB530K, MB535, MB920E, MB930, MB930K		



1

GEV No.	504073	Ref. No.	513080800 80002003
description	flange		
For models:	GL220, GL250, MB235LI, MB240LI, MB510E, MB510ER, MB520, MB520K, MB530, MB530K, MB535, MB630, MB630PS, MB920E, MB920ER, MB930, MB930K, MB930PS, MB930T, MGL40, MLP50, MS1100, MS1100E, MS1300, MS1300E, MS350, MS350PS, MS350TRI, MS450, MS450E, MS450PS, MS700, MS700E, MS900, MS900E, MS905		



1

GEV No.	504179	Ref. No.	513128900 80004077
description	knurled nut		
For models:	MLP140, MLP60, MLP60E, MLP70, MLP80, MS1100P, MS1300P		



1

GEV No.	504231	Ref. No.	513227000
description	manifold		
For models:	MB510E, MB510ER, MB520, MB520K, MB530, MB530K, MB535, MB630, MB630PS, MB920E, MB920ER, MB930, MB930K, MB930PS, MB930T, MB9510, MB9510R, MB9920, MB9920R, MGL40, MGL500, MLP50, MLP60, MLP60E, MS1100E, MS1100P, MS1100T, MS1300E, MS1300P, MS1300T, MS400B, MS400T, MS500B, MS500T, MS800B, MS800T, MS900E, MS900T		



1

GEV No.	504170	Ref. No.	511043100 80004009
description	manifold connection 4-way		
For models:	MLP70, MLP80		



GEV No.

504188

Ref. No.

511043600
80004147

description

manifold connection 6-way

For models:

MLP140



1

GEV No.	504127	Ref. No.	513224800
description	manifold triple \varnothing 13mm		
For models:	MB235LI, MB240LI, MB9235, MB9240, MB9500, MB9501, MB9503, MLP50, MLP56, MS351, MS353, MS400E, MS451, MS453, MS500E, MS800E, MS905, MS9400, MS9401, MS9403, MS9451, MS9453		



1

GEV No.	504007	Ref. No.	513000500 80001069
description	nut		
For models:	MB630, MB630PS, MLP140, MLP60, MLP60E, MLP70, MLP80, MS1100, MS1100E, MS1100P, MS1100T, MS1300, MS1300E, MS1300P, MS1300T, MS350, MS350PS, MS350TRI, MS450, MS450E, MS450PS, MS700, MS700E, MS900, MS900E, MS900T, MS905		



1

GEV No.	504050	Ref. No.	513000200 80001647
description	nut thread M20x1.5		
For models:	MB235LI, MB240LI, MB630, MB630PS, MLP140, MLP60, MLP60E, MLP70, MLP80, MS1100, MS1100E, MS1100P, MS1300, MS1300E, MS1300P, MS450, MS450E, MS450PS, MS700, MS700E, MS900, MS900E		



1

GEV No.	504092	Ref. No.	511029600 513211900 80002267
description	rinse arm support mounting pos. upper		
For models:	MB630, MB630PS, MLP140, MLP60, MLP60E, MLP70, MLP80, MS1100, MS1100E, MS1100P, MS1100T, MS1300, MS1300E, MS1300P, MS1300T, MS900, MS900E, MS900T, MS905		
accessories for	504092		



GEV No.

101248

Ref. No.

502009100
80001071olive for pipe \varnothing 12mm Qty 1 pcs suitable for PEL



Table continues overleaf





Зип Общепит

vsezip.ru

+7(812)987-08-81

accessories for 504092				
	GEV No.	504007	Ref. No.	513000500 80001069
nut				
	GEV No.	504050	Ref. No.	513000200 80001647
nut thread M20x1.5				
	GEV No.	504081	Ref. No.	512006500 512045300 80002189
flat gasket FIBER ED ø 28mm ID ø 20mm thickness 2mm Qty 1 pcs				

	GEV No.	504178	Ref. No.	513128800 80004075
description wash arm bearing				
For models: MLP140, MLP60, MLP60E, MLP70, MLP80, MS1100P, MS1300P				

	GEV No.	504197	Ref. No.	513156700 80004273
description rinse arm support mounting pos. upper				
For models: MB235LI, MB240LI				

	GEV No.	504229	Ref. No.	513149700
description washer ø 20mm H 3.5mm				
For models: MB235LI, MB240LI, MB510E, MB510ER, MB520, MB520K, MB530, MB530K, MB535, MB630, MB630PS, MB920E, MB920ER, MB930, MB930K, MB930PS, MB930T, MGL40, MLP50, MS1100, MS1100E, MS1300, MS1300E, MS900, MS900E, MS905				

	GEV No.	504095	Ref. No.	511030900 80002331
description rinse pipe with manifold connection				
For models: MS350, MS350PS, MS350TRI				

washing and rinsing systems (sorted by producer)

MACH

	GEV No.	517729	Ref. No.	513185600 513856000 80004561
description slide ring for wash arm ED ø 46mm ID ø 36mm thickness 18mm				
For models: MB630, MB630PS, MB9235, MB9240, MB930, MB930K, MB930PS, MB930T, MB9500, MB9501, MB9503, MB9510, MB9510R, MB9920, MB9920R, MGL500, MLP50, MLP56, MS1100E, MS1100T, MS1300E, MS1300T, MS351, MS353, MS400B, MS400E, MS400T, MS451, MS453, MS500B, MS500E, MS500PPB, MS500T, MS800B, MS800E, MS800T, MS900E, MS900T, MS905, MS9400, MS9401, MS9403, MS9451, MS9453				

	GEV No.	504217	Ref. No.	600062600 80004997
description wash and rinse arm wash arm L 340mm rinse arm L 340mm w. jets 5 r. jets 4 mounting ø 12/42mm mounting pos. lower complete				
For models: MB235LI, MB510E, MB510ER, MB520, MB520K, MB530, MB530K, MB535				

	GEV No.	504228	Ref. No.	513149900
description Thumb screw thread M6 thread L 13mm ø 24mm H 4mm SS				
For models: MB235LI, MB240LI, MB510E, MB510ER, MB520, MB520K, MB530, MB530K, MB535, MB630, MB630PS, MB920E, MB920ER, MB930, MB930K, MB930PS, MB930T, MGL40, MLP50, MS1100, MS1100E, MS1300, MS1300E, MS900, MS900E, MS905				

	GEV No.	504219	Ref. No.	600062500 80004951
description wash and rinse arm wash arm L 420mm rinse arm L 420mm w. jets 6 r. jets 5 mounting ø 12/42mm mounting pos. lower 2 wash arms/ 2 rinse arms				
For models: MB240LI, MB630, MB630PS, MB920E, MB920ER, MB930, MB930K, MB930PS, MB930T, MGL40				

mechanical components, equipment accessories

Зип Общепит

vsezip.ru

(812) 980 88 00

			
1			
GEV No.	504216	Ref. No.	511009700 600063900
description	wash and rinse arm wash arm L 515mm rinse arm L 520mm w. jets 11 r. jets 6 mounting ø 12/61mm mounting pos. upper/lower complete		
For models:	MLP50, MS1100, MS1100E, MS1300, MS1300E, MS900, MS900E, MS905		

			
1			
GEV No.	517811	Ref. No.	600061800
description	wash arm L 520mm nozzles 11 mounting ø 18mm		
For models:	MLP50, MLP56, MS1100E, MS1100T, MS1300E, MS1300T, MS900E, MS900T, MS905		

			
1			
GEV No.	517720	Ref. No.	600062900
description	wash arm mounting pos. lower L 480mm nozzles 10		
For models:	MB9500, MB9501, MB9503, MGL500, MS351, MS353, MS400B, MS400E, MS400T, MS451, MS453, MS500B, MS500E, MS500T, MS800B, MS800E, MS800T, MS9400, MS9401, MS9403, MS9451, MS9453		

			
1			
GEV No.	504079	Ref. No.	513002600 80002171
description	bearing		
For models:	GL220, GL250, MB235LI, MB240LI, MB510E, MB510ER, MB520, MB520K, MB530, MB530K, MB535, MB630, MB630PS, MB920E, MB920ER, MB930, MB930K, MGL40, MLP140, MLP60, MLP60E, MLP70, MLP80, MS1100, MS1300, MS350, MS350PS, MS450, MS450E, MS450PS, MS700, MS700E, MS900		



			
1			
GEV No.	504066	Ref. No.	513061800 80001933
description	connector holder		
For models:	GL220, GL250, MB235LI, MB240LI, MB510E, MB510ER, MB520, MB520K, MB530, MB530K, MB535, MB630, MB630PS, MB920E, MB920ER, MB930, MB930K, MB930PS, MB930T, MGL40, MLP50, MS1100, MS1100E, MS1300, MS1300E, MS350, MS350PS, MS350TRI, MS450, MS450E, MS450PS, MS700, MS700E, MS900, MS900E, MS905		

			
1			
GEV No.	504080	Ref. No.	513002700 80002173
description	end cap		
For models:	GL220, GL250, MB235LI, MB240LI, MB510E, MB510ER, MB520, MB520K, MB530, MB530K, MB535, MB630, MB920E, MB920ER, MB930, MB930K, MGL40, MLP140, MLP60, MLP60E, MLP70, MLP80, MS1100, MS1300, MS350, MS350PS, MS450, MS450E, MS450PS, MS700, MS700E, MS900		

			
1			
GEV No.	504203	Ref. No.	513159700 51359700 80004323
description	end cap		
For models:	GL220, GL250, MB235LI, MB240LI, MB510E, MB510ER, MB520, MB520K, MB530, MB530K, MB535, MB630, MB920E, MB920ER, MB930, MB930K, MB930T, MGL40, MGL500, MLP140, MLP50, MLP60, MLP60E, MLP70, MLP80, MS1100, MS1100E, MS1100P, MS1300, MS1300E, MS1300P, MS350, MS350TRI, MS351, MS353, MS400B, MS400E, MS400T, MS450, MS450E, MS451, MS453, MS500B, MS500E, MS500PPB, MS500T, MS700, MS700E, MS800B, MS800T...(Other models you can see in the webshop)		

			
1			
GEV No.	504798	Ref. No.	513202900 80004953
description	end cap H 7mm thread L 2.5mm ø 55mm		
For models:	MB235LI, MB240LI, MB510E, MB510ER, MB520, MB520K, MB530, MB530K, MB535, MB630, MB630PS, MB920E, MB920ER, MB9235, MB9240, MB930, MB930K, MB930PS, MB930T, MB9500, MB9501, MB9503, MB9510, MB9510R, MB9920, MB9920R, MGL40, MGL500, MLP140, MLP50, MLP56, MLP60, MLP60E, MLP70, MLP80, MS1100, MS1100E, MS1100P, MS1100T, MS1300, MS1300E, MS1300P, MS1300T, MS351, MS353, MS400B, MS400E, MS400T, MS451, MS453...(Other models you can see in the webshop)		

			
1			
GEV No.	504204	Ref. No.	513159800 80004325
description	nozzle holder		
For models:	GL220, GL250, MB235LI, MB240LI, MB510E, MB510ER, MB520, MB520K, MB530, MB530K, MB535, MB630, MB920E, MB920ER, MB930, MB930K, MB930T, MGL40, MGL500, MLP140, MLP50, MLP60, MLP60E, MLP70, MLP80, MS1100, MS1100E, MS1100P, MS1300, MS1300E, MS1300P, MS350, MS350TRI, MS351, MS353, MS400B, MS400E, MS400T, MS450, MS450E, MS451, MS453, MS500B, MS500E, MS500PPB, MS500T, MS700, MS700E, MS800B, MS800T...(Other models you can see in the webshop)		

			
1			
GEV No.	504013	Ref. No.	513001300 80001089
description	nozzle holder with O-ring		
For models:	GL220, GL250, MB235LI, MB240LI, MB510E, MB510ER, MB520, MB520K, MB530, MB530K, MB535, MB630, MB920E, MB930, MB930K, MGL40, MLP140, MLP60, MLP60E, MLP70, MLP80, MS1100, MS1300, MS350, MS350PS, MS450, MS450E, MS450PS, MS700, MS700E, MS900		
accessories for	504013		
	GEV No.	528815	Ref. No. —
	 O-ring EPDM thickness 1.78mm ID ø 3.69mm Qty 1 pcs		





Зип Общепит

vsezip.ru

(812)987-08-81

			
1			
GEV No.	504015	Ref. No.	513001200 80001093
description	rinse jet		
For models:	GL220, GL250, MB235LI, MB240LI, MB510E, MB510ER, MB520, MB520K, MB530, MB530K, MB535, MB630, MB920E, MB920ER, MB930, MB930K, MGL40, MGL500, MLP140, MLP50, MLP60, MLP60E, MLP70, MLP80, MS1100, MS1100E, MS1100P, MS1300, MS1300E, MS1300P, MS350, MS350TRI, MS351, MS353, MS400B, MS400E, MS400T, MS450, MS450E, MS451, MS453, MS500B, MS500E, MS500PPB, MS500T, MS700, MS700E, MS800B, MS800T...(Other models you can see in the webshop)		

			
1			
GEV No.	504205	Ref. No.	513159600 51359800 80004327
description	rinse jet		
For models:	GL220, GL250, MB235LI, MB240LI, MB510E, MB510ER, MB520, MB520K, MB530, MB530K, MB535, MB630, MB920E, MB920ER, MB930, MB930K, MB930T, MGL40, MGL500, MLP140, MLP50, MLP60, MLP60E, MLP70, MLP80, MS1100, MS1100E, MS1100P, MS1300, MS1300E, MS1300P, MS350, MS350TRI, MS351, MS353, MS400B, MS400E, MS400T, MS450, MS450E, MS451, MS453, MS500B, MS500E, MS500PPB, MS500T, MS700, MS700E, MS800B, MS800T...(Other models you can see in the webshop)		
accessories for	504205		
			
GEV No.	504204	Ref. No.	513159800 80004325
nozzle holder			

			
1			
GEV No.	504151	Ref. No.	511048700 80003855
description	wash arm L 240mm		
For models:	MLP60, MLP60E		

			
1			
GEV No.	504167	Ref. No.	511040200 80004003
description	wash arm L 270mm		
For models:	MLP140, MLP60, MLP60E, MLP70, MLP80		

			
1			
GEV No.	504145	Ref. No.	511047000 80003825
description	wash arm L 300mm		
For models:	MLP70, MLP80		

			
1			
GEV No.	504166	Ref. No.	511040100 80004001
description	wash arm boss		
For models:	MLP140, MLP60, MLP60E, MLP70, MLP80, MS1100P, MS1300P		

				
1				
GEV No.	504093	Ref. No.	511029500 80002269	
description	rinse arm mounting pos. lower L 220mm nozzles 4 mounting ø 12mm			
For models:	MB630			
accessories for	504093			
	GEV No.	101248	Ref. No.	502009100 80001071
olive for pipe ø 12mm Qty 1 pcs suitable for PEL				
	GEV No.	504007	Ref. No.	513000500 80001069
nut				
	GEV No.	504050	Ref. No.	513000200 80001647
nut thread M20x1.5				
	GEV No.	504081	Ref. No.	512006500 512045300 80002189
flat gasket FIBER ED ø 28mm ID ø 20mm thickness 2mm Qty 1 pcs				
	GEV No.	504092	Ref. No.	511029600 513211900 80002267
rinse arm support mounting pos. upper				
	GEV No.	504204	Ref. No.	513159800 80004325
nozzle holder				
	GEV No.	504205	Ref. No.	513159600 51359800 80004327
rinse jet				

mechanical components, equipment accessories

Зип Общепит

vsezip.ru

+7(812)987-08-81



1

GEV No.	504203	Ref. No.	513159700 51359700 80004323
description	end cap		
For models:	GL220, GL250, MB235LI, MB240LI, MB510E, MB510ER, MB520, MB520K, MB530, MB530K, MB535, MB630, MB920E, MB920ER, MB930, MB930K, MB930T, MGL40, MGL500, MLP140, MLP50, MLP60, MLP60E, MLP70, MLP80, MS1100, MS1100E, MS1100P, MS1300, MS1300E, MS1300P, MS350, MS350TRI, MS351, MS353, MS400B, MS400E, MS400T, MS450, MS450E, MS451, MS453, MS500B, MS500E, MS500PPB, MS500T, MS700, MS700E, MS800B, MS800T...(Other models you can see in the webshop)		



1

GEV No.	504204	Ref. No.	513159800 80004325
description	nozzle holder		
For models:	GL220, GL250, MB235LI, MB240LI, MB510E, MB510ER, MB520, MB520K, MB530, MB530K, MB535, MB630, MB920E, MB920ER, MB930, MB930K, MB930T, MGL40, MGL500, MLP140, MLP50, MLP60, MLP60E, MLP70, MLP80, MS1100, MS1100E, MS1100P, MS1300, MS1300E, MS1300P, MS350, MS350TRI, MS351, MS353, MS400B, MS400E, MS400T, MS450, MS450E, MS451, MS453, MS500B, MS500E, MS500PPB, MS500T, MS700, MS700E, MS800B, MS800T...(Other models you can see in the webshop)		



1

GEV No.	504205	Ref. No.	513159600 51359800 80004327
description	rinse jet		
For models:	GL220, GL250, MB235LI, MB240LI, MB510E, MB510ER, MB520, MB520K, MB530, MB530K, MB535, MB630, MB920E, MB920ER, MB930, MB930K, MB930T, MGL40, MGL500, MLP140, MLP50, MLP60, MLP60E, MLP70, MLP80, MS1100, MS1100E, MS1100P, MS1300, MS1300E, MS1300P, MS350, MS350TRI, MS351, MS353, MS400B, MS400E, MS400T, MS450, MS450E, MS451, MS453, MS500B, MS500E, MS500PPB, MS500T, MS700, MS700E, MS800B, MS800T...(Other models you can see in the webshop)		

accessories for	504205			
	GEV No.	504204	Ref. No.	513159800 80004325
	nozzle holder			





1

GEV No.	504373	Ref. No.	600062700
description	rinse arm L 340mm nozzles 4 mounting ø 15mm mounting pos. upper/lower		
For models:	MB235LI, MB9235, MB930, MB930K, MB930PS, MB930T, MB9510, MB9510R, MB9920, MB9920R		

	GEV No.	504860	Ref. No.	600064400
	description	rinse arm L 557mm nozzles 7 mounting ø 15mm		
	For models:	MLP50, MLP56, MS1100P, MS1300E, MS1300P, MS1300T		

	GEV No.	504233	Ref. No.	600064100
	description	rinse arm L 580mm nozzles 7 mounting ø 15mm mounting pos. upper/lower		
	For models:	MLP60, MLP60E		

	GEV No.	504234	Ref. No.	600064200
	description	rinse arm L 633mm nozzles 8 mounting ø 15mm mounting pos. upper/lower		
	For models:	MLP140, MLP70, MLP80		

	GEV No.	517721	Ref. No.	511060900 511069900 80004555
	description	rinse arm mounting pos. upper/lower L 480mm nozzles 6 mounting ø 11mm		
	For models:	MB9500, MB9501, MB9503, MGL500, MS1100E, MS1100T, MS351, MS353, MS400B, MS400E, MS400T, MS451, MS453, MS500B, MS500E, MS500PPB, MS500T, MS800B, MS800E, MS800T, MS900E, MS900T, MS905, MS9400, MS9401, MS9403, MS9451, MS9453		







Зип Общепит

vsezip.ru



+7(812)987-08-81

			
1			
GEV No.	504374	Ref. No.	511028100
description	rinse arm mounting pos. lower L 235mm nozzles 4 mounting ø 12mm thread 3/8"		
For models:	MB520, MB520K		

			
1			
GEV No.	504203	Ref. No.	513159700 51359700 80004323
description	end cap		
For models:	GL220, GL250, MB235LI, MB240LI, MB510E, MB510ER, MB520, MB520K, MB530, MB530K, MB535, MB630, MB920E, MB920ER, MB930, MB930K, MB930T, MGL40, MGL500, MLP140, MLP50, MLP60, MLP60E, MLP70, MLP80, MS1100, MS1100E, MS1100P, MS1300, MS1300E, MS1300P, MS350, MS350TRI, MS351, MS353, MS400B, MS400E, MS400T, MS450, MS450E, MS451, MS453, MS500B, MS500E, MS500PPB, MS500T, MS700, MS700E, MS800B, MS800T...(Other models you can see in the webshop)		

				
1				
GEV No.	504075	Ref. No.	511028000 80002015	
description	wash arm H 70mm L 200mm nozzles 3 mounting pos. lower			
For models:	MB520, MB520K, MB530K, MB630			
accessories for	504075			
	GEV No.	504018	Ref. No.	512021800 80001159
	description			gasket for wash arm support ø 60/101mm rubber thickness 2mm with 3 screw holes
	GEV No.	504048	Ref. No.	513077800 80001597
	description			wash jet
	GEV No.	504049	Ref. No.	513077700 80001599
	description			swirl

			
1			
GEV No.	504049	Ref. No.	513077700 80001599
description	swirl		
For models:	MB520, MB520K, MB530K, MB630, MB630PS		

				
1				
GEV No.	504048	Ref. No.	513077800 80001597	
description	wash jet			
For models:	MB520, MB520K, MB530K, MB630, MB630PS			
accessories for	504048			
	GEV No.	504049	Ref. No.	513077700 80001599
	description			swirl

			
1			
GEV No.	512481	Ref. No.	513186200 80004571
description	knurled nut for wash arm mounting pos. upper/lower thread M18x1 ø 34mm H 8mm stainless steel		
For models:	MB235LI, MB240LI, MB630, MB630PS, MB9235, MB9240, MB930, MB930K, MB930PS, MB930T, MB9500, MB9501, MB9503, MB9510, MB9510R, MB9920, MB9920R, MGL500, MLP140, MLP50, MLP56, MLP60, MLP60E, MLP70, MLP80, MS1100E, MS1100P, MS1100T, MS1300E, MS1300P, MS1300T, MS351, MS353, MS400B, MS400E, MS400T, MS451, MS453, MS500B, MS500E, MS500PPB, MS500T, MS800B, MS800E, MS800T, MS900E, MS900T, MS905, MS9400, MS9401...(Other models you can see in the webshop)		

			
1			
GEV No.	504859	Ref. No.	513186900 80004565
description	flange wash arm ø 43mm H 3mm		
For models:	MB630, MB630PS, MB930, MB930K, MB930PS, MB930T, MB9500, MB9501, MB9503, MB9510, MB9510R, MB9920, MB9920R, MGL500, MLP50, MLP56, MS1100E, MS1100T, MS1300E, MS1300T, MS351, MS353, MS400B, MS400E, MS400T, MS451, MS453, MS500B, MS500E, MS500PPB, MS500T, MS800B, MS800E, MS800T, MS900E, MS900T, MS905, MS9400, MS9401, MS9403, MS9451, MS9453		

			
1			
GEV No.	504136	Ref. No.	511042500 80002945
description	wash arm support mounting pos. lower		
For models:	MB930, MB930K, MB930T, MGL40		

mechanical components, equipment accessories

Зип Общепит

vsezip.ru

+7(812)987-08-81



1

GEV No.	504143	Ref. No.	511038500 80003321
description	wash arm support mounting pos. lower		
For models:	MLP140, MLP60, MLP60E, MLP70, MLP80		



1

GEV No.	504089	Ref. No.	511027900 80002241
description	wash arm support mounting pos. upper		
For models:	GL250, MB510E, MB510ER, MB630, MB920E, MB920ER, MB930, MB930K, MB930T, MGL40		



1

GEV No.	504142	Ref. No.	511046600 80003819
description	wash arm support mounting pos. upper		
For models:	MLP140, MLP70, MLP80		



1

GEV No.	504035	Ref. No.	511004600 80001395
description	wash arm support mounting pos. upper/lower		
For models:	MS1300, MS1300E		



1

GEV No.	504053	Ref. No.	511011300 80001687
description	wash arm support mounting pos. upper/lower		
For models:	MS700, MS700E		

accessories for 504053



GEV No.	101248	Ref. No.	502009100 80001071
olive for pipe \varnothing 12mm Qty 1 pcs suitable for PEL			



GEV No.	504007	Ref. No.	513000500 80001069
nut			



GEV No.	504009	Ref. No.	513001800 80001075
rinse arm shaft			



GEV No.	504018	Ref. No.	512021800 80001159
gasket for wash arm support \varnothing \varnothing 60/101mm rubber thickness 2mm with 3 screw holes			



1

GEV No.	504050	Ref. No.	511014900 80001761
description	wash arm support mounting pos. upper/lower		
For models:	MS1100, MS1100E, MS900, MS900E, MS905		



1

GEV No.	504096	Ref. No.	511030600 80002333
description	wash arm support mounting pos. upper/lower		
For models:	MS350, MS350PS, MS350TRI		

accessories for 504096



GEV No.	101248	Ref. No.	502009100 80001071
olive for pipe \varnothing 12mm Qty 1 pcs suitable for PEL			



GEV No.	504007	Ref. No.	513000500 80001069
nut			



GEV No.	504009	Ref. No.	513001800 80001075
rinse arm shaft			



GEV No.	504018	Ref. No.	512021800 80001159
gasket for wash arm support \varnothing \varnothing 60/101mm rubber thickness 2mm with 3 screw holes			



GEV No.	504097	Ref. No.	513099600 80002335
screw connection			



GEV No.	504121	Ref. No.	511038000 80002549
rinse arm shaft			



1

GEV No.	504018	Ref. No.	512021800 80001159
----------------	--------	-----------------	-----------------------

description gasket for wash arm support \varnothing \varnothing 60/101mm rubber thickness 2mm with 3 screw holes

For models: MLP140, MLP60, MLP60E, MLP70, MLP80, MS1100, MS1100E, MS1100P, MS1100T, MS1300, MS1300E, MS1300P, MS1300T, MS350, MS350PS, MS350TRI, MS450, MS450E, MS450PS, MS700, MS700E, MS900, MS900E, MS900T, MS905





Зип Общепит
vsezip.ru
+7(812)987-08-81

rinse arm shafts			
			
1			
GEV No.	504009	Ref. No.	513001800 80001075
description	rinse arm shaft		
For models:	GL250, MB235LI, MB240LI, MB510E, MB510ER, MB520, MB520K, MB530, MB530K, MB535, MB630, MB630PS, MB920E, MB920ER, MB930, MB930K, MB930PS, MB930T, MGL40, MS1100, MS1100E, MS1300, MS1300E, MS350, MS350PS, MS350TRI, MS450, MS450E, MS450PS, MS700, MS700E, MS900, MS900E, MS905		

			
1			
GEV No.	504121	Ref. No.	511038000 80002549
description	rinse arm shaft		
For models:	MS350, MS350PS, MS350TRI		

			
1			
GEV No.	504176	Ref. No.	513128600 80004071
description	rinse arm shaft		
For models:	MLP140, MLP60, MLP60E, MLP70, MLP80		

			
1			
GEV No.	504194	Ref. No.	511045700 80004249
description	rinse arm shaft		
For models:	GL220, GL250, MB235LI, MB240LI, MB510E, MB510ER, MB530, MB530K, MB535, MB920E, MB920ER, MB930, MB930K, MB930PS, MB930T, MGL40, MS1100, MS1100E, MS1300, MS1300E, MS900, MS900E, MS905		

			
1			
GEV No.	504235	Ref. No.	513219300
description	rinse arm shaft ø 18mm		
For models:	MLP140, MLP60, MLP60E, MLP70, MLP80		

GEV No.	503185	Ref. No.	513186000 51386000 80004569
description	rinse arm shaft total length 36mm ED ø 18mm		
For models:	MB630, MB630PS, MB9235, MB9240, MB930, MB930K, MB930PS, MB930T, MB9500, MB9501, MB9503, MB9510, MB9510R, MB9920, MB9920R, MGL500, MLP50, MLP56, MS1100E, MS1100T, MS1300E, MS1300T, MS351, MS353, MS400B, MS400E, MS400T, MS451, MS453, MS500B, MS500E, MS500PPB, MS500T, MS800B, MS800E, MS800T, MS900E, MS900T, MS905, MS9400, MS9401, MS9403, MS9451, MS9453		

knobs

producer-specific knobs

MACH			
			
1			
GEV No.	110100	Ref. No.	500000300 80001175
description	knob thermostat t.max. 90°C 0-90°C ø 42mm shaft ø 6x4.6mm shaft flat -135° black		
For models:	GL220, GL250, MB510E, MB520, MB520K, MB530, MB530K, MB535, MB630, MB920E, MB930, MB930K, MLP140, MLP60, MLP60E, MLP70, MLP80, MS1100, MS1300, MS350, MS350PS, MS450, MS450E, MS450PS, MS700, MS700E, MS900		

handles and hand wheels

bracket handles

			
1			
GEV No.	504163	Ref. No.	511039400 80003987
description	pull handle		
For models:	MLP140, MLP60, MLP60E, MLP70, MLP80		

gaskets

O-rings

EPDM

ø1.78mm

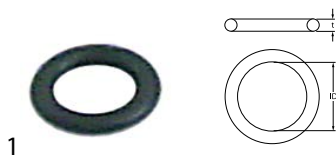

1

GEV No.	505045	Ref. No.	512006600 80002387
description	O-ring EPDM thickness 1.78mm ID ø 5.28mm Qty 1 pcs		
For models:	GL220, GL250, MB235LI, MB240LI, MB510E, MB510ER, MB520, MB520K, MB530, MB530K, MB535, MB630, MB920E, MB930, MB930K, MGL40, MLP140, MLP60, MLP60E, MLP70, MLP80, MS1100, MS1300, MS350, MS350PS, MS450, MS450E, MS450PS, MS700, MS700E, MS900		

ø2.62mm

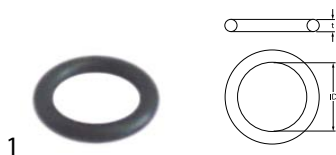

1

GEV No.	528487	Ref. No.	512006400 80002429
description	O-ring EPDM thickness 2.62mm ID ø 9.19mm Qty 1 pcs		
For models:	GL220, GL250, MB235LI, MB240LI, MB510E, MB510ER, MB520, MB520K, MB530, MB530K, MB535, MB630, MB920E, MB930, MB930K, MGL40, MLP140, MLP60, MLP60E, MLP70, MLP80, MS1100, MS1300, MS350, MS350PS, MS450, MS450E, MS450PS, MS700, MS700E, MS900		

ø3.53mm

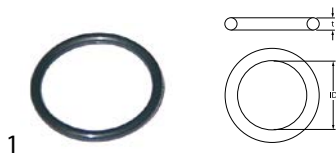

1

GEV No.	510072	Ref. No.	512013100 513013100 80002243
description	O-ring EPDM thickness 3.53mm ID ø 32.93mm Qty 1 pcs		
For models:	GL250, MB510E, MB510ER, MB630, MB920E, MB920ER, MB930, MB930K, MB930T, MGL40		

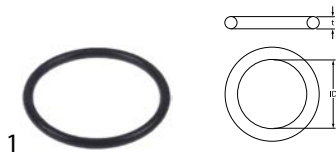

1

GEV No.	519179	Ref. No.	512029500 80002557
description	O-ring EPDM thickness 3.53mm ID ø 41.28mm Qty 1 pcs		
For models:	MLP140, MLP70, MS350, MS350PS, MS350TRI		

Зип-Общепит

ø5.34mm



1

GEV No.	532158	Ref. No.	512006800 80004231
description	O-ring EPDM thickness 5.34mm ID ø 47mm Qty 10 pcs		

sealing washers

fibre gaskets



1

GEV No.	504209	Ref. No.	512015300 80004347
description	flat gasket FIBER ED ø 18.5mm ID ø 11mm thickness 2mm Qty 1 pcs		
For models:	GL220, GL250, MB520, MB520K, MB530, MB530K, MB535, MB630, MB930, MB930K, MB930T, MLP140, MLP50, MLP60, MLP60E, MLP70, MLP80, MS1100, MS1100E, MS1100P, MS1300, MS1300E, MS1300P, MS351, MS353, MS400B, MS400E, MS400T, MS451, MS453, MS500B, MS500E, MS500PPB, MS500T, MS800B, MS800E, MS800T, MS900, MS900E, MS905		



1

GEV No.	504020	Ref. No.	512006700 80001167
description	flat gasket FIBER ED ø 24mm ID ø 17mm thickness 2mm Qty 1 pcs		
For models:	GL220, MB235LI, MB240LI, MB510E, MB510ER, MB520, MB520K, MB530, MB530K, MB535, MB920E, MB920ER, MGL40, MS1100, MS1300, MS350, MS350PS, MS350TRI, MS400T, MS450, MS450E, MS450PS, MS500PPB, MS500T, MS700, MS700E, MS900		



1

GEV No.	504081	Ref. No.	512006500 512045300 80002189
description	flat gasket FIBER ED ø 28mm ID ø 20mm thickness 2mm Qty 1 pcs		
For models:	MB235LI, MB240LI, MB630, MB630PS, MLP140, MLP60, MLP60E, MLP70, MLP80, MS1100, MS1100E, MS1100P, MS1300, MS1300E, MS1300P, MS450, MS450E, MS450PS, MS700, MS700E, MS900, MS900E		



Зип-Общепит

vsezip.ru

+7(812)987-08-81

rubber gaskets



1

GEV No.	504014	Ref. No.	512021600
description	flat gasket rubber ED ø 10mm ID ø 6.5mm thickness 1.5mm Qty 1 pcs		

special gaskets

door seals for dishwashers



GEV No.	518618	Ref. No.	512054900 80004513
----------------	--------	-----------------	-----------------------

description door seal L 600mm for dishwasher suitable for Mach

For models: MB235LI, MB240LI, MB510E, MB510ER, MB520, MB520K, MB530, MB530K, MB630, MB630PS, MB920E, MB920ER, MB9235, MB9240, MB930, MB930K, MB930PS, MB930T, MB9500, MB9501, MB9503, MB9510, MB9510R, MB9920, MB9920R, MGL40, MGL500, MLP50, MLP56, MS351, MS353, MS400B, MS400E, MS400T, MS451, MS453, MS500B, MS500E, MS500PPB, MS500T, MS800B, MS800E, MS800T, MS9400, MS9401, MS9403, MS9451, MS9453

gaskets for wash arm support



1

GEV No.	504041	Ref. No.	512021700 80001485
----------------	--------	-----------------	-----------------------

description gasket D1 ø 50mm D2 ø 80mm thickness 3mm rubber with 3 screw holes equiv. no. 1485 suitable for Mach

For models: GL220, GL250, MB235LI, MB240LI, MB510E, MB510ER, MB520, MB520K, MB530, MB530K, MB535, MB630, MB630PS, MB920E, MB920ER, MB930, MB930K, MGL40

torsion springs



1

GEV No.	504002	Ref. No.	512006200 80001015
----------------	--------	-----------------	-----------------------

description torsion spring

For models: GL220, GL250, MB235LI, MB240LI, MB510E, MB510ER, MB520, MB520K, MB530, MB530K, MB535, MB630, MB630PS, MB920E, MB920ER, MB9235, MB9240, MB930, MB930K, MB930PS, MB930T, MB9500, MB9501, MB9503, MB9510, MB9510R, MB9920, MB9920R, MGL40, MGL500, MLP140, MLP50, MLP56, MLP60, MLP60E, MLP70, MLP80, MS350, MS350PS, MS350TRI, MS351, MS353, MS400B, MS400E, MS400T, MS450, MS450E, MS450PS, MS451, MS453...(Other models you can see in the webshop)

spring compressors



1

GEV No.	504033	Ref. No.	513003200 80001383
----------------	--------	-----------------	-----------------------

description spring compressor

For models: MS1100, MS1100E, MS1100P, MS1100T, MS1300, MS1300E, MS1300P, MS1300T, MS900, MS900E, MS900T, MS905

tension springs



1

GEV No.	504030	Ref. No.	512006300 80001359
----------------	--------	-----------------	-----------------------

description tension spring ø 40mm total length 283mm wire gauge ø 5mm

For models: MS1100, MS1100E, MS1100P, MS1100T, MS1300, MS1300E, MS1300P, MS1300T, MS900, MS900E, MS900T, MS905

mechanical components, equipment accessories

dosing pumps

peristaltic dosing pumps

MICRODOS

built-in version

with frequency control



GEV No.	361803	Ref. No.	512072000
description	dosing pump MICRODOS frequency control 4l/h 230VAC detergent hose ø 4x6mm hose Santoprene suction level 1.5m type MP3-T		
For models:	MGL40, MGL500, MLP140, MLP50, MLP56, MLP60, MLP60E, MLP70, MLP80		
spare parts for	361803		
	GEV No.	Ref. No.	—
	361977		
	pump hose MICRODOS detergent ID ø 6.4mm ED ø 9.6mm hose ø 6mm hose type Santoprene		

with time control



GEV No.	361915	Ref. No.	512072100
description	dosing pump MICRODOS time control 1l/h 230VAC rinse aid hose ø 4x6mm hose silicone suction level 1.5m type MP3-T CODE P09CA0301237 dosing time 1-25s		
For models:	MGL500, MLP50, MLP56, MS800B, MS800T		
spare parts for	361915		
	GEV No.	Ref. No.	—
	362022		
	pump hose MICRODOS with non-return valve hose ø 10mm hose length 110mm hose type silicone		

Зип-Общепит





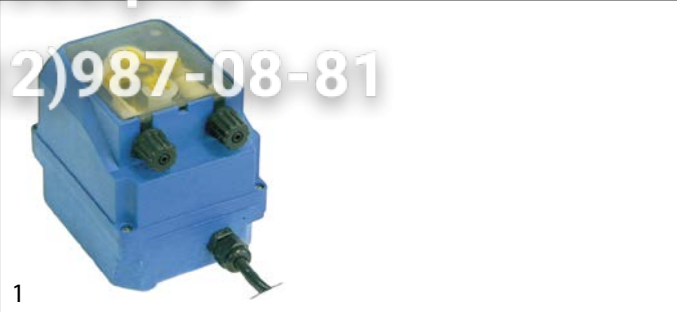

SEKO wall-mounted version

with speed control

vsezip.ru

+7(812)987-08-81



GEV No.	361156 ¹	Ref. No.	512047200 80004167
description	dosing pump SEKO speed control 0.6-4l/h 230VAC detergent hose ø 4x6mm hose type K hose Santoprene suction level 1.5m type PR wall-mounted version dimensions 103x82x92mm		
For models:	MLP140, MS500PPB		
spare parts for	361156		
	GEV No.	Ref. No.	—
	361136		
	roller assembly for dosing pump hole ø 4.8x4mm		
	GEV No.	Ref. No.	—
	361815		
	pump hose detergent hose ø 6x10mm hose ø 4x6mm hose type K hose Santoprene type SEKO		
accessories for	361156		
	GEV No.	Ref. No.	—
	361142		
	mounting set detergent hose type 4x6mm hose length 2m PVC 2x hose/container filter/tank intake transparent		
	GEV No.	Ref. No.	—
	361891		
	mounting set detergent hose type 4x6mm hose length 2m PVC 2x hose/container filter/tank intake transparent		
	GEV No.	Ref. No.	512009100
	520090		
	PVC hose ID ø 4mm ED ø 6mm L 2m thickness 1mm t.max. 60°C transparent		
	GEV No.	Ref. No.	—
	520091		
	nylon hose ID ø 4mm ED ø 6mm L 2m thickness 1mm operating p. 10bar burst p. 50bar t.max. 100°C transparent		

¹with accessories



Зип-Общепит

vsezip.ru





+7(812)987-08-81

built-in version

with frequency control



1

GEV No.	361215	Ref. No.	512060700 80002955 80004021 80004219
description	dosing pump SEKO frequency control 0.3-3.0l/h 230VAC detergent hose \varnothing 4x6mm hose type K hose Santoprene suction level 1.5m type PBR protection IP55 dimensions 100x67x68mm power input 3.5W		
For models:	MGL40, MGL500, MLP50, MLP60, MLP60E, MLP70, MLP80		
spare parts for	361215		
	GEV No.	361136	Ref. No. —
	roller assembly for dosing pump hole \varnothing 4.8x4mm		
	GEV No.	361226	Ref. No. —
	PCB L 59mm W 26mm electronic control		
accessories for	361215		
	GEV No.	361142	Ref. No. —
	mounting set detergent hose type 4x6mm hose length 2m PVC 2x hose/container filter/tank intake transparent		
	GEV No.	520090	Ref. No. 512009100
	PVC hose ID \varnothing 4mm ED \varnothing 6mm L 2m thickness 1mm t.max. 60°C transparent		
	GEV No.	520091	Ref. No. —
	nylon hose ID \varnothing 4mm ED \varnothing 6mm L 2m thickness 1mm operating p. 10bar burst p. 50bar t.max. 100°C transparent		



with time control



1

GEV No.	361250 ¹	Ref. No.	4233 512046900 80004233
description	dosing pump SEKO with single time control 0.7l/h 230VAC rinse aid hose \varnothing 4x6mm hose type B hose Sekobril suction level 1.5m type PBM built-in version dosing time 1-20s		
For models:	MGL500, MS800B, MS800T		
spare parts for	361250		
	GEV No.	361136	Ref. No. —
	roller assembly for dosing pump hole \varnothing 4.8x4mm		

¹with accessories

spare parts for	361250		
	GEV No.	361562	Ref. No. —
	pump cover for dosing pump yellow		
	GEV No.	361882	Ref. No. —
	pump hose SEKO rinse aid hose \varnothing 3x7.4mm hose length 135mm hose \varnothing 6mm hose type B hose Sekobril		

piston pumps

dosing pumps



1

GEV No.	361800	Ref. No.	512025600
description	dosing pump type EKP-R/E 230V detergent inlet 8x12mm outlet 8x12mm 60 strokes/min		
spare parts for	361800		
	GEV No.	361047	Ref. No. —
	pressure/suction valve suitable for EKP-R L 38.7mm 3/8" WS 22		
	GEV No.	361652	Ref. No. —
	union nut suitable for EKP-RT1: 3/8"		
	GEV No.	361653	Ref. No. —
	olive suitable for EKP-R		
	GEV No.	361654	Ref. No. —
	hose tail suitable for EKP-R		
	GEV No.	361655	Ref. No. —
	O-ring suitable for EKP-R		
	GEV No.	361857	Ref. No. —
	pump head type EKP-R for dosing pump plastic		







Зип-Общепит



vsezip.ru

+7(812)987-08-81

with solenoid coil



GEV No.	361013	Ref. No.	512021900 80001965
description	dosing pump inlet 4x6mm outlet 5mm 230V rinse aid duty cycle 25% type EKP-M 50Hz impulse 3imp/s		
For models:	GL220, GL250, MB520, MB520K, MB530, MB530K, MB535, MB630, MB930, MB930K, MGL40, MLP50, MS1100, MS1100E, MS1100P, MS1300, MS1300E, MS1300P, MS350, MS350PS, MS350TRI, MS450, MS450E, MS450PS, MS700, MS700E, MS900, MS900E		
spare parts for	361013		
	GEV No.	361482	Ref. No. —
solenoid coil 230VAC for type EKP-M			
	GEV No.	361811	Ref. No. —
hose connector for dosing pump hose ø 6.3mm T1: M12x1.5 chrome-plated brass			
	GEV No.	371090	Ref. No. —
power socket plug type DIN 43650A screw			
accessories for	361013		
	GEV No.	361366	Ref. No. —
PCB dishwasher 11F suitable for DB2 type DB2/EV1/EKP-M			
	GEV No.	361505	Ref. No. —
screw pipe fitting straight nickel-plated brass thread 3/8" IT hose ø 6x8mm			

spare parts for	361013		
	GEV No.	361188	Ref. No. —
disc type DELTA			
	GEV No.	361319	Ref. No. —
flat gasket rubber ID ø 9mm FD ø 14.5mm thickness 1mm type DELTA			

self-priming

LANG





GEV No.	361817	Ref. No.	512005700 80001839
description	dosing pump type N6 membrane dosing pump rinse aid p min 0.5bar pressure connection ø straight, 4x6mm suction connection ø angled, 6mm LANG		
For models:	GL220, GL250, MB235LI, MB240LI, MB510E, MB510ER, MB520, MB520K, MB530, MB530K, MB535, MB630, MB630PS, MB920E, MB920ER, MB9235, MB9240, MB930, MB930K, MB930PS, MB930T, MB9500, MB9501, MB9503, MB9510, MB9510R, MB9920, MB9920R, MGL40, MGL500, MS1100, MS1100E, MS1100P, MS1100T, MS1300, MS1300E, MS1300P, MS1300T, MS351, MS353, MS400B, MS400E, MS400T, MS451, MS453, MS500B, MS500E, MS500T, MS800E, MS900... (Other models you can see in the webshop)		
spare parts for	361817		
	GEV No.	361886	Ref. No. —
non-return valve inletmm outletmm outlet ø 12.4mm L 12.7mm			

membrane dosing pumps

electric dosing pumps



Delta



GEV No.	361003	Ref. No.	512033500
description	dosing pump 220V rinse aid duty cycle 25% type EL-1 valve lip valve		
spare parts for	361003		
	GEV No.	361122	Ref. No. —
lip valve type DELTA			
	GEV No.	361123	Ref. No. —
membrane type DELTA			
	GEV No.	361169	Ref. No. —
hose connector type DELTA			

various



GEV No.	361015	Ref. No.	80002787
description	dosing pump membrane dosing pump rinse aid inlet 6x8mm outlet 4x6mm pressure connection ø 4x6mm suction connection ø 6x8mm		
For models:	MLP55, MLP80		
spare parts for	361015		
	GEV No.	361132	Ref. No. —
membrane dosing pump			
	GEV No.	510298	Ref. No. 512033600
lip valve dosing pump suitable for DB2/DS5			



self-priming with supporting pressure

SEKO



1





GEV No.	361218	Ref. No.	512032200 80004285
description	dosing pump type DIB3P rinse aid 0-3cm ³ per stroke/h pressure connection ø 4x6mm suction connection ø 4x6mm auxiliary pressure connection 10mm SEKO		
For models:	MB235LI, MB240LI, MB510E, MB510ER, MB520, MB520K, MB530, MB530K, MB535, MB930, MB930K		
spare parts for	361218		
	GEV No.	361301	Ref. No. —
hose connector for type DIB3E/DIB5E			
	GEV No.	361302	Ref. No. —
valve bush for type DIB3E/DIB5E			
	GEV No.	361304	Ref. No. —
O-ring EPDM ID ø 11.11mm thickness 1.78mm Qty 1 pcs for type DIB3E/DIB5E			
	GEV No.	361305	Ref. No. —
valve disc for type DIB3E/DIB5E DIB3P/DIB5P			
	GEV No.	361306	Ref. No. —
membrane for type DIB3E/DIB5E ø 49mm hole ø 5mm			
	GEV No.	361481	Ref. No. —
lip valve for type DIB3P/DIB5P DIB3E/DIB5E			

Зип-Общепит

vsezip.ru

+7(812)987-08-81

accessories for 520090

	GEV No.	361106	Ref. No.	—
container filter with weight and non-return valve SS hose ø 4x6mm ø 21mm L 51mm non return valve lip valve				
	GEV No.	361141	Ref. No.	—
container filter with weight ceramic hose ø 4mm				
	GEV No.	361230	Ref. No.	—
container filter with weight stainless steel hose ø 4x6mm				
	GEV No.	361462	Ref. No.	—
container filter with weight SS hose ø 4x6mm				
	GEV No.	361728	Ref. No.	—
container filter with 4m 4x6 hose SS hose ø 4x6mm hose length 4000mm				

tank inlets



1

GEV No.	504125	Ref. No.	513159100 80002819
description	tank inlet		
For models:	MB930T, MGL40, MGL500, MLP140, MLP50, MLP60, MLP60E, MLP70, MLP80, MS1100T, MS1300T, MS350PS, MS400T, MS450PS, MS500PPB, MS500T, MS900T, MS9400		

hoses
supply hoses

PVC supply hoses



1

GEV No.	520631	Ref. No.	1143 1779 512047500
description	supply hose PVC straight-straight DN13 connections 3/4" L 1500mm operating p. 10bar burst p. 32bar t.max. 90°C approval VDE flat seal		
For models:	MB235LI, MB240LI, MB510E, MB510ER, MB520, MB520K, MB530, MB530K, MB535, MB630, MB630PS, MB920E, MB920ER, MB9235, MB9240, MB930, MB930K, MB930PS, MB930T, MB9500, MB9501, MB9503, MB9510, MB9510R, MB9920, MB9920R, MGL40, MGL500, MLP140, MLP50, MLP56, MLP60, MLP60E, MLP70, MLP80, MS1100, MS1100E, MS1100P, MS1100T, MS1300, MS1300E, MS1300P, MS351, MS353, MS400B, MS400E, MS400T, MS451, MS453...(Other models you can see in the webshop)		



accessories

hoses

PVC hoses



1

GEV No.	520090	Ref. No.	512009100
description	PVC hose ID ø 4mm ED ø 6mm L 2m thickness 1mm t.max. 60°C transparent		
For models:	MB235LI, MB240LI, MB510E, MB510ER, MB520, MB520K, MB530, MB530K, MB535, MB630, MB920E, MB920ER, MB930, MB930K, MB930T, MGL40, MGL500, MLP140, MLP50, MLP56, MLP60, MLP60E, MLP70, MLP80, MS1100, MS1100E, MS1100P, MS1100T, MS1300, MS1300E, MS1300P, MS351, MS353, MS400B, MS400E, MS400T, MS451, MS453, MS500B, MS500E, MS500T, MS800B, MS800E, MS800T, MS900, MS900E, MS900T, MS905		
accessories for	520090		
	GEV No.	361058	Ref. No. —
container filter with non-return valve SS hose ø 4x6mm ø 20mm L 56mm			
	GEV No.	361066	Ref. No. —
container filter straight SS hose ø 4x6mm L 37mm non return valve ball valve			

water and beverage technology

drain hoses

3 Зип-Общепит

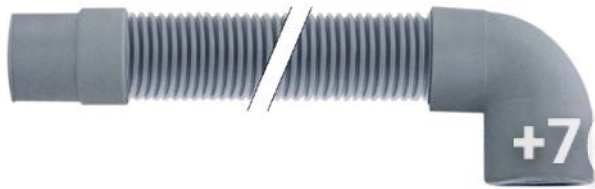

1			
GEV No.	530571	Ref. No.	512035300 80002513
description	drain hose DN24 L 1500mm straight ø inside 24mm straight ext. ø 29mm elbow ø inside 29mm elbow ext. ø 35mm outer hose ø 28mm		
For models:	GL220, GL250, MB235LI, MB240LI, MB510E, MB510ER, MB520, MB520K, MB530, MB530K, MB535, MB630, MB630PS, MB920E, MB920ER, MB9235, MB9240, MB930, MB930K, MB930PS, MB930T, MB9501, MB9503, MB9510, MB9510R, MB9920, MB9920R, MGL40, MLP50, MLP56, MS1100, MS1100E, MS1100P, MS1300, MS1300E, MS1300P, MS1300T, MS351, MS353, MS400B, MS400E, MS451, MS453, MS500B, MS500E, MS800B, MS800E, MS900, MS900E, MS905...(Other models you can see in the webshop)		

accessories for	520090		
GEV No.	361106	Ref. No.	—
description	container filter with weight and non-return valve SS hose ø 4x6mm ø 21mm L 51mm non return valve lip valve		
GEV No.	361141	Ref. No.	—
description	container filter with weight ceramic hose ø 4mm		
GEV No.	361230	Ref. No.	—
description	container filter with weight stainless steel hose ø 4x6mm		
GEV No.	361462	Ref. No.	—
description	container filter with weight SS hose ø 4x6mm		
GEV No.	361728	Ref. No.	—
description	container filter with 4m 4x6 hose SS hose ø 4x6mm hose length 4000mm		

industrial hoses

pressure control hoses



1			
GEV No.	530560	Ref. No.	512009900 80001651
description	pressure control hose ID ø 5mm ED ø 9mm L 5m operating p. 30bar burst p. 90bar temp.-resist. 60°C		
For models:	MB235LI, MB240LI, MB510E, MB510ER, MB520, MB520K, MB530, MB530K, MB535, MB630, MB920E, MB920ER, MB930, MB930K, MB930T, MGL40, MGL500, MLP140, MLP50, MLP60, MLP60E, MLP70, MLP80, MS1100, MS1100E, MS1100P, MS1100T, MS1300, MS1300E, MS1300P, MS1300T, MS351, MS353, MS400B, MS400E, MS400T, MS451, MS453, MS500B, MS500E, MS500T, MS800B, MS800E, MS800T, MS900, MS900E, MS900T, MS905, MS9400, MS9401...(Other models you can see in the webshop)		

formed hoses

straight



1			
GEV No.	504071	Ref. No.	512027300 80001963
description	formed hose L 100mm dishwasher straight hose ext. ø 30mm equiv. no. 1963		
For models:	GL220, GL250, MB235LI, MB240LI, MB520, MB520K, MB530, MB530K, MB535, MB630, MB630PS, MB9235, MB9240, MB930, MB930K, MB930PS, MB930T, MGL40, MGL500, MS350PS, MS400T, MS450PS, MS500PPB, MS500T		



PVC hoses

PVC hoses without fabric



1			
GEV No.	520090	Ref. No.	512009100
description	PVC hose ID ø 4mm ED ø 6mm L 2m thickness 1mm t.max. 60°C transparent		
For models:	MB235LI, MB240LI, MB510E, MB510ER, MB520, MB520K, MB530, MB530K, MB535, MB630, MB920E, MB920ER, MB930, MB930K, MB930T, MGL40, MGL500, MLP140, MLP50, MLP56, MLP60, MLP60E, MLP70, MLP80, MS1100, MS1100E, MS1100P, MS1100T, MS1300, MS1300E, MS1300P, MS351, MS353, MS400B, MS400E, MS400T, MS451, MS453, MS500B, MS500E, MS500T, MS800B, MS800E, MS800T, MS900, MS900E, MS900T, MS905		

1			
GEV No.	504160	Ref. No.	512010600 80003927 80004085
description	formed hose L 100mm dishwasher straight hose ext. ø 60mm equiv. no. 4085, 3927		
For models:	MLP140, MLP70, MLP80		

accessories for	520090		
	GEV No.	361058	Ref. No.
			—
	container filter with non-return valve SS hose ø 4x6mm ø 20mm L 56mm		
	GEV No.	361066	Ref. No.
			—
	container filter straight SS hose ø 4x6mm L 37mm non return valve ball valve		

water and beverage technology



Зип Общепит

vsezip.ru

+7(812)987-08-81



1

GEV No.	504186	Ref. No.	512045800 80004097 80004099
description	formed hose L 155mm dishwasher straight hose int. ø 50mm		
For models:	MLP140, MLP60, MLP60E, MLP70, MLP80		



1

GEV No.	504027	Ref. No.	512027000 80001255
description	formed hose L 40mm dishwasher straight hose ext. ø 45mm equiv. no. 1255		
For models:	MLP50, MS450, MS450E, MS450PS, MS700, MS700E		



1

GEV No.	504042	Ref. No.	512026800 80001487
description	formed hose L 45mm dishwasher straight hose ext. ø 30mm equiv. no. 1487		
For models:	MB235LI, MB240LI, MB510E, MB510ER, MB520, MB520K, MB530, MB530K, MB535, MB630, MB630PS, MB920E, MB920ER, MB930, MB930K, MB930PS, MB930T, MB9510, MB9510R, MB9920, MB9920R, MGL40, MLP50		



1

GEV No.	504012	Ref. No.	512026900 80001085
description	formed hose L 46mm dishwasher straight hose ext. ø 40mm equiv. no.		
For models:	MGL500, MLP50, MS350, MS350PS, MS350TRI, MS351, MS353, MS400B, MS400E, MS400T, MS451, MS453, MS500B, MS500E, MS500PPB, MS500T, MS800B, MS800E, MS800T		



1

GEV No.	504036	Ref. No.	512027100 80001401
description	formed hose L 60mm dishwasher straight hose ext. ø 45mm equiv. no. 1401		
For models:	MLP50, MS1100, MS1100E, MS1100P, MS1100T, MS1300, MS1300E, MS1300P, MS1300T, MS900, MS900E, MS900T, MS905		

form L



1

GEV No.	504037	Ref. No.	512026600 80001405
description	formed hose L 110/145mm warewashing L-shape equiv. no. 1405 ID ø 60mm		
For models:	MLP140, MLP60, MLP60E, MLP70, MLP80, MS1100, MS1100E, MS1100P, MS1100T, MS1300, MS1300E, MS1300P, MS1300T, MS351, MS353, MS450, MS450E, MS450PS, MS451, MS453, MS700, MS700E, MS900, MS900E, MS900T, MS905		



1

GEV No.	504011	Ref. No.	512026700 80001081
description	formed hose warewashing L-shape equiv. no. 1801 ID ø 45mm		
For models:	MLP50, MS350, MS350PS, MS350TRI, MS351, MS353, MS451, MS453, MS9451, MS9453		



1

GEV No.	504068	Ref. No.	512016900 80001937
description	formed hose warewashing L-shape equiv. no. 1937 ID ø 30mm		
For models:	GL220, GL250, MB235LI, MB240LI, MB510E, MB510ER, MB520, MB520K, MB530, MB530K, MB535, MB630, MB630PS, MB920E, MB920ER, MB9235, MB9240, MB930, MB930K, MB930PS, MB930T, MB9510, MB9510R, MB9920, MB9920R, MGL40, MGL500, MS400T, MS500PPB, MS500T		

with branch



1

GEV No.	504237	Ref. No.	512068600
description	formed hose		
For models:	MB9500, MB9501, MB9503, MGL500, MLP50, MLP56, MS351, MS353, MS400B, MS400E, MS400T, MS451, MS453, MS500B, MS500E, MS500T, MS800B, MS800E, MS800T, MS9400, MS9401, MS9403, MS9451, MS9453		

for dishwashers

miscellaneous

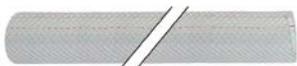

1

GEV No.	504173	Ref. No.	512040500 80004017
description	braided hose ED ø 30mm ID ø 24mm PVC warewashing equiv. no. 4017		
For models:	MLP140, MLP60, MLP60E, MLP70, MLP80		

fittings, hose and pipe connectors

fittings

double nipples



1

GEV No.	520166	Ref. No.	500070900 80003887
description	double nipple nickel-plated brass thread 3/8" - 3/8" Qty 1 pcs		
For models:	MGL500, MLP60, MLP60E, MS800B, MS800T		

Зип-Общепит

hose connectors

producer-specific

vsezip.ru

+7(812)987-08-81



1

GEV No.	504141	Ref. No.	500046400 80003815
description	hose connector thread 3/8" straight hose ø 14mm nickel-plated brass		
For models:	MGL500, MLP50, MLP56, MLP60, MLP60E, MS800B, MS800T		



1

GEV No.	504097	Ref. No.	513099600 80002335
description	screw connection		
For models:	MS350, MS350PS, MS350TRI		

valves and tank inlets

ball valves

universal

ball valves with lever handle



1

GEV No.	504162	Ref. No.	500031100 80003943
description	ball valve connection 1 1/4" IT - 1 1/4" ET DN32 total length 96mm with lever handle handle length 145mm		
For models:	MLP140, MLP60, MLP60E, MLP70, MLP80		

accessories

lever handles



1

GEV No.	504869	Ref. No.	513306800
description	lever handle L 150mm shaft diameter 10x10mm		



connection fittings

screw pipe fittings

			
1			
GEV No.	540056	Ref. No.	500037100 80002021
description	T-piece thread 1/2" tube ø 12mm chrome-plated brass		
For models:	MS1100, MS1300, MS450, MS450E, MS450PS, MS700, MS700E, MS900		

Зип Общепит

vsezip.ru

+7(812)987-08-81

GEV No.	520120	Ref. No.	502000800
description	hose clamp SS W4 ø 12-20mm width 9mm Qty 1 pcs DIN 3017		
For models:	MB235LI, MB240LI, MB510E, MB510ER, MB520, MB520K, MB530, MB530K, MB535, MB630, MB630PS, MB920E, MB920ER, MB9235, MB9240, MB930, MB930K, MB930PS, MB930T, MB9500, MB9501, MB9503, MB9510, MB9510R, MB9920, MB9920R, MGL40, MGL500, MLP140, MLP50, MLP56, MLP60, MLP60E, MLP70, MLP80, MS1100, MS1100E, MS1100P, MS1100T, MS1300, MS1300E, MS1300P, MS1300T, MS351, MS353, MS400B, MS400E, MS400T, MS451, MS453...(Other models you can see in the webshop)		

water cycle components

non-return valves

			
1			
GEV No.	543266	Ref. No.	500046300 80003889
description	non-return valve brass connection 3/8" IT - 3/8" IT total length 55mm DN10 Qty 1 pcs		
For models:	MGL500, MLP50, MLP60, MLP60E, MS800B, MS800T		

miscellaneous

			
1			
GEV No.	504392	Ref. No.	502000400
description	hose clamp stainless steel ø 30-60mm width 9mm Qty 1 pcs		
For models:	MB9500, MB9501, MB9503, MGL500, MLP140, MLP50, MLP56, MLP60, MLP60E, MLP70, MLP80, MS351, MS353, MS400B, MS400E, MS400T, MS451, MS453, MS500B, MS500E, MS500T, MS800B, MS800E, MS800T, MS9400, MS9401, MS9403, MS9451, MS9453		

ancillary products

clamps

hose clamps

DIN 3017 - W2

			
1			
GEV No.	520110	Ref. No.	502000200
description	hose clamp ø 8-12mm width 9mm Qty 10 pcs DIN 3017		
For models:	MB235LI, MB240LI, MB510E, MB510ER, MB520, MB520K, MB530, MB530K, MB535, MB630, MB630PS, MB920E, MB920ER, MB9235, MB9240, MB930, MB930K, MB930PS, MB930T, MB9500, MB9501, MB9503, MB9510, MB9510R, MB9920, MB9920R, MGL40, MGL500, MLP140, MLP50, MLP56, MLP60E, MLP70, MLP80, MS1100, MS1100E, MS1100P, MS1100T, MS1300, MS1300E, MS1300P, MS1300T, MS351, MS353, MS400B, MS400E, MS400T, MS451, MS453, MS500B...(Other models you can see in the webshop)		

pipe clamps

			
1			
GEV No.	504110	Ref. No.	513095500 513109100 80002457 80002909
description	pipe clamp ø 68/66mm SS		
For models:	GL220, GL250, MB510E, MB510ER, MB520, MB520K, MB530, MB530K, MB535, MB630, MB630PS, MB920E, MB920ER, MB930, MB930K, MB930PS, MB930T, MGL40		



measuring equipment

thermometers

built-in thermometers



1

GEV No.	541086	Ref. No.	500002500 80001409
description	thermometer mounting measurements 58x25.5mm 0 up to +120°C capillary pipe 2000mm probe ø 6mm probe L 23mm		
For models:	MLP55, MLP60E, MLP80, MS1100, MS1100E, MS1100P, MS1100T, MS1300, MS1300E, MS1300P, MS1300T, MS900, MS900E, MS900T		

hexagonal nuts

hexagonal nuts metric (without norm)



1

GEV No.	504208	Ref. No.	502004000 80004345
description	nut thread M10		
For models:	GL220, GL250, MB520, MB520K, MB530, MB530K, MB535, MB630, MB930, MB930K, MB930T, MGL500, MLP140, MLP50, MLP60, MLP60E, MLP70, MLP80, MS1100, MS1100E, MS1100P, MS1300, MS1300E, MS1300P, MS351, MS353, MS400B, MS400E, MS400T, MS451, MS453, MS500B, MS500E, MS500PPB, MS500T, MS800B, MS800E, MS800T, MS900, MS900E, MS905		

fastening material

screws

side bolts



1

GEV No.	560289	Ref. No.	502016000
description	side bolts thread M6 L 12mm SS Qty 1 pcs intake Phillips head ø 12.6mm		
For models:	MS1100E, MS1100P, MS1100T, MS1300E, MS1300P, MS1300T, MS900E, MS900T, MS905		

knurled screws



1

GEV No.	504228	Ref. No.	513149900
description	Thumb screw thread M6 thread L 13mm ø 24mm H 4mm SS		
For models:	MB235LI, MB240LI, MB510E, MB510ER, MB520, MB520K, MB530, MB530K, MB535, MB630, MB630PS, MB920E, MB920ER, MB930, MB930K, MB930PS, MB930T, MGL40, MLP50, MS1100, MS1100E, MS1300, MS1300E, MS900, MS900E, MS905		

hexagonal nuts inch thread



1

GEV No.	504134	Ref. No.	513134600 80002939
description	nut thread 1¼"		
For models:	MGL40		



1

GEV No.	503042	Ref. No.	513000400 80001165
description	nut thread 3/8" H 6mm brass WS 22 Qty 1 pcs		
For models:	GL220, MB235LI, MB240LI, MB510E, MB510ER, MB520, MB520K, MB530, MB530K, MB535, MB920E, MB920ER, MGL40, MS1100, MS1300, MS350, MS350PS, MS350TRI, MS400T, MS450, MS450E, MS450PS, MS500PPB, MS500T, MS700, MS700E, MS900		



Зип Общепит

pipe clamps

fasteners

clamps

hose clamps

DIN 3017 - W2



1

GEV No.	520110	Ref. No.	502000200
description	hose clamp ϕ 8-12mm width 9mm Qty 10 pcs DIN 3017		
For models:	MB235LI, MB240LI, MB510E, MB510ER, MB520, MB520K, MB530, MB530K, MB535, MB630, MB630PS, MB920E, MB920ER, MB9235, MB9240, MB930, MB930K, MB930PS, MB930T, MB9500, MB9501, MB9503, MB9510, MB9510R, MB9920, MB9920R, MGL40, MGL500, MLP140, MLP50, MLP60, MLP60E, MLP70, MLP80, MS1100, MS1100E, MS1100P, MS1100T, MS1300, MS1300E, MS1300P, MS1300T, MS351, MS353, MS400B, MS400E, MS400T, MS451, MS453, MS500B...(Other models you can see in the webshop)		

DIN 3017 - W4



1

GEV No.	520120	Ref. No.	502000800
description	hose clamp SS W4 ϕ 12-20mm width 9mm Qty 1 pcs DIN 3017		
For models:	MB235LI, MB240LI, MB510E, MB510ER, MB520, MB520K, MB530, MB530K, MB535, MB630, MB630PS, MB920E, MB920ER, MB9235, MB9240, MB930, MB930K, MB930PS, MB930T, MB9500, MB9501, MB9503, MB9510, MB9510R, MB9920, MB9920R, MGL40, MGL500, MLP140, MLP50, MLP56, MLP60, MLP60E, MLP70, MLP80, MS1100, MS1100E, MS1100P, MS1100T, MS1300, MS1300E, MS1300P, MS1300T, MS351, MS353, MS400B, MS400E, MS400T, MS451, MS453...(Other models you can see in the webshop)		

miscellaneous



1

GEV No.	504392	Ref. No.	502000400
description	hose clamp stainless steel ϕ 30-60mm width 9mm Qty 1 pcs		
For models:	MB9500, MB9501, MB9503, MGL500, MLP140, MLP50, MLP56, MLP60, MLP60E, MLP70, MLP80, MS351, MS353, MS400B, MS400E, MS400T, MS451, MS453, MS500B, MS500E, MS500T, MS800B, MS800E, MS800T, MS9400, MS9401, MS9403, MS9451, MS9453		



+7(812)987-08-81

GEV No.	504110	Ref. No.	513095500 513109100 80002457 80002909
description	pipe clamp ϕ 68/66mm SS		
For models:	GL220, GL250, MB510E, MB510ER, MB520, MB520K, MB530, MB530K, MB535, MB630, MB630PS, MB920E, MB920ER, MB930, MB930K, MB930PS, MB930T, MGL40		

retaining rings

DIN 7993



1

GEV No.	523029	Ref. No.	512053100 80004563
description	retaining ring shaft ϕ 47mm DIN 7993 thickness 3mm		
For models:	MB630, MB630PS, MB9235, MB9240, MB930, MB930K, MB930PS, MB930T, MB9500, MB9501, MB9503, MB9510, MB9510R, MB9920, MB9920R, MGL500, MLP50, MLP56, MS1100E, MS1100T, MS1300E, MS1300T, MS351, MS353, MS400B, MS400E, MS400T, MS451, MS453, MS500B, MS500E, MS500PPB, MS500T, MS800B, MS800E, MS800T, MS900E, MS900T, MS905, MS9400, MS9401, MS9403, MS9451, MS9453		

roll pins



1

GEV No.	691637	Ref. No.	502001800
description	roll pin ϕ 3mm L 20mm		
For models:	MB520, MB520K, MB530, MB530K, MB535, MB630, MB630PS, MB9235, MB9240, MB930, MB930K, MB930PS, MB930T, MB9500, MB9501, MB9503, MB9510, MB9510R, MB9920, MB9920R, MGL40, MGL500, MLP140, MLP50, MLP56, MLP60, MLP60E, MLP70, MLP80, MS351, MS353, MS400B, MS400E, MS400T, MS451, MS453, MS500B, MS500E, MS500T, MS800B, MS800E, MS800T, MS9400, MS9401, MS9403, MS9451, MS9453		

consumables

fuses

fine fuses



1

GEV No.	358678	Ref. No.	500087200
description	fine fuse size ø5x20mm 8A fast-acting rated 250V Qty 10 pcs		
For models:	MB9500, MB9501, MB9503, MLP50, MLP56, MS9400, MS9401, MS9403, MS9451, MS9453		



1

GEV No.	358690	Ref. No.	500014700 80002983
description	fine fuse size ø5x20mm 1A medium lag rated 250V Qty 10 pcs		
For models:	MGL40, MGL500, MLP140, MLP60, MLP60E, MLP70, MLP80, MS1100T, MS1300T, MS400T, MS500T, MS800T, MS900T		

Зип Общепит

vsezip.ru

+7(812)987-08-81



GEV No.	358697	Ref. No.	500014900 80002985
description	fine fuse size ø5x20mm 6.3A medium lag rated 250V Qty 10 pcs		
For models:	MB630, MB630PS, MB9235, MB9240, MB930, MB930K, MB930PS, MB930T, MB9510, MB9510R, MB9920, MB9920R, MGL40, MLP140, MLP60, MLP70, MLP80		

Зип Общепит

K

vsezip.ru

L

+7(812)987-08-81

B			
ball valves	50	knurled screws	52
bi-metal thermostats	4, 4		
booster pumps I	21		
booster pumps II	22	lamps	7
C		M	
cables	23	magnetic switches	6
clamps	51, 53	measuring equipment	52
condensators & interference suppression filters	22	N	
connection fittings	51	non-return valves	51
consumables	54	nuts	52
contactors	8	O	
control thermostats	4, 5	operating capacitors	22
D		O-rings	42
door seals for dishwashers	43	P	
dosing pumps	44	pipe clamps	51, 53
double nipples	50	plunger sockets	5
drain hoses	48	position switches	6
drain pumps	21	pressure control hoses	48
E		pressure switches	13
electric accessories	23	probes	9
electrodes	14	programme timers	7
electronic controllers	9	pumps	14
F		push/momentary push switches	5
fasteners	53	PVC hoses	48
fastening material	52	PVC supply hoses	47
filters	22	R	
fine fuses	54	relays	8
fittings	50	retaining rings	53
flow heaters	4	ribbon cables	23
formed hoses	48	roll pins	53
fuses	22, 54	S	
G		safety thermostats	5
gaskets for wash arm support	43	screw pipe fittings	51
H		screws	52
heating elements	2	sealing washers	42
hexagonal nuts	52	side bolts	52
hose clamps	51, 53	solenoid valves	11
hose connectors	50	supply hoses	47
hoses	47	switches and momentary switches	5
I		T	
immersion heating elements	2	tank inlets	47
indicator lights	7	temperature probes	9
industrial hoses	48	terminals	23
		thermostats	4

timers 7

T-pieces 51

U

universal probes 9

V

valves and tank inlets 50

W

wash and rinse pumps 14

water cycle components 51

Зип Общепит

vsezip.ru

+7(812)987-08-81