



Зип Общепит

vsezip.ru

+7(812)987-08-81



**GAS COMPONENTS**



**ELECTRIC COMPONENTS**



**WATER TECHNOLOGY**



**MECHANICAL COMPONENTS**



**TOOLS**

Spare parts suitable for

**EMMEPI**

Find the complete and up-to-date range of products in our GEV Webshop

Зип Общепит

vsezip.ru

+7(812)987-08-81

# Manufacturer catalogue

The most important spare parts and accessories arranged clearly for every manufacturer



**Complete product range and all appliance data always up to date in the GEV Webshop**







**Alphabetical Index at the end of the catalogue**

## GEV Webshop

[www.gev-online.co.uk](http://www.gev-online.co.uk)

[www.gev-online.com](http://www.gev-online.com)



-  Add to Favourites
-  Sign In with email address and usual password
-  Easy-order – place several items in your basket at the same time
-  Quick Item search – no login needed



# heating elements

## heating elements for ovens

Зип Общепит

vsezip.ru

+7(812)987-08-81

1

|                        |  |                 |                        |
|------------------------|--|-----------------|------------------------|
| <b>GEV No.</b>         | 416074   | <b>Ref. No.</b> | C00215                 |
| <b>description</b>     | heating element 2500W 230V L 523mm W 555mm L1 64mm L2 458mm W1 525mm W2 30mm flange length 70mm flange width 22mm hole distance 56mm hole ø 5mm tube ø 6.3mm heating circuits 1 rectangular flange dry heating element |                 |                        |
| <b>accessories for</b> | 416074   |                 |                        |
|                        | <b>GEV No.</b>   | 510368          | <b>Ref. No.</b> 8C0286 |
|                        | gasket L 70mm W 23.5mm hole ø 5mm hole distance 56mm FIBER thickness 2mm for heating element   |                 |                        |

1

|                        |   |                 |                        |
|------------------------|---|-----------------|------------------------|
| <b>GEV No.</b>         | 416068  | <b>Ref. No.</b> | C00215                 |
| <b>description</b>     | heating element 2500W 230V L 525mm W 500mm L1 60mm L2 460mm W1 524mm W2 31mm flange length 70mm flange width 22mm hole distance 56mm hole ø 5mm tube ø 6.3mm connection M4 heating circuits 1 rectangular flange oven |                 |                        |
| <b>accessories for</b> | 416068  |                 |                        |
|                        | <b>GEV No.</b>  | 510368          | <b>Ref. No.</b> 8C0286 |
|                        | gasket L 70mm W 23.5mm hole ø 5mm hole distance 56mm FIBER thickness 2mm for heating element  |                 |                        |

1

|                    |  |                 |        |
|--------------------|--|-----------------|--------|
| <b>GEV No.</b>     | 419171   | <b>Ref. No.</b> | C10194 |
| <b>description</b> | heating element 2500W 230V L 525mm W 560mm L2 465mm W1 525mm W2 30mm flange length 70mm flange width 23mm hole distance 56mm hole ø 5mm tube ø 6.3mm connection length 41mm heating circuits 1 mounting thread M4 oven heating element |                 |        |

1

|                        |  |                 |                        |
|------------------------|--|-----------------|------------------------|
| <b>GEV No.</b>         | 416061   | <b>Ref. No.</b> | C10193                 |
| <b>description</b>     | heating element 3000W 230V L 715mm W 470mm L1 60mm L2 655mm W1 436mm W2 34mm flange length 70mm flange width 22mm hole distance 56mm hole ø 4mm tube ø 9mm connection length 53mm connection M4 heating circuits 1 rectangular flange dry heating element oven |                 |                        |
| <b>accessories for</b> | 416061   |                 |                        |
|                        | <b>GEV No.</b>   | 510368          | <b>Ref. No.</b> 8C0286 |
|                        | gasket L 70mm W 23.5mm hole ø 5mm hole distance 56mm FIBER thickness 2mm for heating element   |                 |                        |

1

|                        |  |                 |                        |
|------------------------|--|-----------------|------------------------|
| <b>GEV No.</b>         | 416069   | <b>Ref. No.</b> | C10195                 |
| <b>description</b>     | heating element 4000W 230V L 860mm W 500mm L1 60mm L2 800mm W1 466mm W2 34mm flange length 70mm flange width 22mm hole distance 56mm hole ø 5mm tube ø 8.5mm connection length 45mm connection M4 heating circuits 1 rectangular flange dry heating element oven |                 |                        |
| <b>accessories for</b> | 416069   |                 |                        |
|                        | <b>GEV No.</b>   | 510368          | <b>Ref. No.</b> 8C0286 |
|                        | gasket L 70mm W 23.5mm hole ø 5mm hole distance 56mm FIBER thickness 2mm for heating element   |                 |                        |

## heating elements for bain maries

1

|                        |  |                 |                   |
|------------------------|--|-----------------|-------------------|
| <b>GEV No.</b>         | 416067   | <b>Ref. No.</b> | 808174            |
| <b>description</b>     | heating element 1380W 230V heating circuits 1 L 346mm W 190mm connection M5 tube ø 8.5mm 2 hole fixing thread 1/4" immersion heater W1 70mm W2 105mm H 27mm mounting distance 67mm |                 |                   |
| <b>spare parts for</b> | 416067   |                 |                   |
|                        | <b>GEV No.</b>   | 510417          | <b>Ref. No.</b> — |
|                        | flat gasket fibre ED ø 20mm ID ø 14mm thickness 2mm Qty 1 pcs  |                 |                   |
| <b>accessories for</b> | 416067   |                 |                   |
|                        | <b>GEV No.</b>   | 361182          | <b>Ref. No.</b> — |
|                        | nut thread 1/4" H 5mm nickel-plated brass WS 17 Qty 1 pcs  |                 |                   |
|                        | <b>GEV No.</b>   | 520228          | <b>Ref. No.</b> — |
|                        | tooth lock washer ID ø 15.3mm ED ø 24mm steel Qty 1 pcs for thread M14   |                 |                   |
|                        | <b>GEV No.</b>   | 550262          | <b>Ref. No.</b> — |
|                        | flat gasket copper ED ø 20mm ID ø 14mm thickness 2mm   |                 |                   |
|                        | <b>GEV No.</b>   | 560112          | <b>Ref. No.</b> — |
|                        | plain washer ID ø 5.3mm ED ø 10mm thickness 1mm SS Qty 20 pcs DIN 125A for thread M5   |                 |                   |





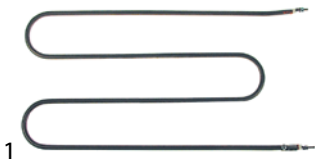

Table continues overleaf

Зип Общежит  
heating elements for fryers

|   |  |        |          |
|---|--|--------|----------|
| <b>accessories for</b>  | 416067   |        |          |
|  | GEV No.  | 560132 | Ref. No. |
|   |  |        | —        |
|   | hexagonal nut thread M5 H 4mm WS 8 SS DIN/ISO DIN 934 / ISO 4032/8673 Qty 20 pcs |        |          |





|   |  |                 |           |
|---|--|-----------------|-----------|
|  | 1  |                 |           |
| <b>GEV No.</b>  | 418335   | <b>Ref. No.</b> | ED1110004 |
| <b>description</b>  | heating element 500W 230V heating circuits 1 L 430mm L1 38mm W 280mm connection M4 connection distance 271mm tube $\phi$ 8.5mm dry heating element L2 392mm H 16mm |                 |           |

## heating elements for chip scuttles





|   |   |                 |          |
|---|---|-----------------|----------|
|    | 1   |                 |          |
| <b>GEV No.</b>  | 416067  | <b>Ref. No.</b> | 808174   |
| <b>description</b>  | heating element 1380W 230V heating circuits 1 L 346mm W 190mm connection M5 tube $\phi$ 8.5mm 2 hole fixing thread 1/4" immersion heater W1 70mm W2 105mm H 27mm mounting distance 67mm |                 |          |
| <b>spare parts for</b>  | 416067  |                 |          |
|   | GEV No.   | 510417          | Ref. No. |
|   |   |                 | —        |
|   | flat gasket fibre ED $\phi$ 20mm ID $\phi$ 14mm thickness 2mm Qty 1 pcs   |                 |          |
| <b>accessories for</b>  | 416067  |                 |          |
|  | GEV No.   | 361182          | Ref. No. |
|   |   |                 | —        |
|   | nut thread 1/4" H 5mm nickel-plated brass WS 17 Qty 1 pcs   |                 |          |
|  | GEV No.   | 520228          | Ref. No. |
|   |   |                 | —        |
|   | tooth lock washer ID $\phi$ 15.3mm ED $\phi$ 24mm steel Qty 1 pcs for thread M14  |                 |          |
|  | GEV No.   | 550262          | Ref. No. |
|   |   |                 | —        |
|   | flat gasket copper ED $\phi$ 20mm ID $\phi$ 14mm thickness 2mm  |                 |          |
|  | GEV No.   | 560112          | Ref. No. |
|   |   |                 | —        |
|   | plain washer ID $\phi$ 5.3mm ED $\phi$ 10mm thickness 1mm SS Qty 20 pcs DIN 125A for thread M5  |                 |          |
|  | GEV No.   | 560132          | Ref. No. |
|   |   |                 | —        |
|   | hexagonal nut thread M5 H 4mm WS 8 SS DIN/ISO DIN 934 / ISO 4032/8673 Qty 20 pcs  |                 |          |

## off-center connection

vsezip.ru

|  |  |                 |          |
|--|--|-----------------|----------|
|  | 1  |                 |          |
| <b>GEV No.</b>   | 416070   | <b>Ref. No.</b> | 808256   |
| <b>description</b>   | heating element 10200W 230/400V heating circuits 3 L 300mm W 180mm H 33mm flange length 19.5mm flange length 1 9.5mm flange length 2 9.8mm flange $\phi$ 1 62mm flange $\phi$ 2 57mm thermostat sleeves $\phi$ 6.5mm sensor screw connection 2x M10x1 thermostat sleeve upper/lower L1 18mm L2 282mm W1 30mm W2 35mm thread M54x1.5 windings 5 tube $\phi$ 8.5mm cable length 450mm rotation flange immersion heater fryer connection length 130mm 2 |                 |          |
| <b>spare parts for</b>   | 416070   |                 |          |
|   | GEV No.  | 510243          | Ref. No. |
|  |  |                 | 808055   |
|  | O-ring Viton thickness 3.53mm ID $\phi$ 55.56mm Qty 1 pcs  |                 |          |
| <b>accessories for</b>   | 416070   |                 |          |
|   | GEV No.  | 510243          | Ref. No. |
|  |  |                 | 808055   |
|  | O-ring Viton thickness 3.53mm ID $\phi$ 55.56mm Qty 1 pcs  |                 |          |
|  | GEV No.  | 550662          | Ref. No. |
|  |  |                 | 808892   |
|  | ring nut thread M54x1.5 H 7mm  |                 |          |

## center connection

|  |  |                 |          |
|--|--|-----------------|----------|
|  | 1  |                 |          |
| <b>GEV No.</b>   | 415297   | <b>Ref. No.</b> | 808689   |
| <b>description</b>   | heating element 6800W 230/400V heating circuits 3 L 299mm W 107mm H 35mm flange length 19.5mm flange length 1 9.5mm flange length 2 9.8mm flange $\phi$ 1 62mm flange $\phi$ 2 57mm thermostat sleeves $\phi$ 8.5mm sensor screw connection 2x M10x1 thermostat sleeve upper/lower L1 16mm L2 283mm W1 30mm W2 77mm thread M54x1.5 tube $\phi$ 8.5mm cable length 450mm rotation flange immersion heater |                 |          |
| <b>accessories for</b>   | 415297   |                 |          |
|   | GEV No.  | 510243          | Ref. No. |
|  |  |                 | 808055   |
|  | O-ring Viton thickness 3.53mm ID $\phi$ 55.56mm Qty 1 pcs  |                 |          |
|   | GEV No.  | 510245          | Ref. No. |
|  |  |                 | 808054   |
|  | O-ring Viton thickness 3.53mm ID $\phi$ 50.8mm Qty 1 pcs   |                 |          |
|   | GEV No.  | 550447          | Ref. No. |
|  |  |                 | 808892   |
|  | ring nut thread M54x1.5  |                 |          |



Зип Общепит

vsezip.ru

+7(812)987-08-81

electric components

2 hole fixing

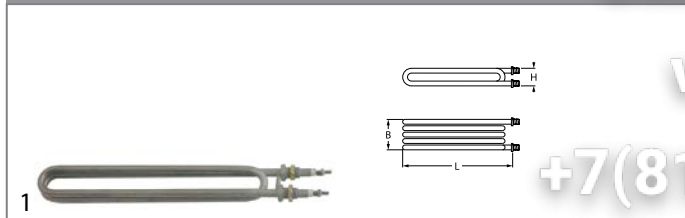

|                        |   |                 |                   |
|------------------------|---|-----------------|-------------------|
| <b>GEV No.</b>         | 416065  | <b>Ref. No.</b> | 808620            |
| <b>description</b>     | heating element 1333W 230V heating circuits 1 L 283mm W 20mm H 40mm thread M12x1 tube ø 8.5mm connection M4 connection length 52mm mounting distance 31mm windings 2 immersion heater 2 hole fixing |                 |                   |
| <b>spare parts for</b> | 416065  |                 |                   |
|                        | <b>GEV No.</b>  | 507313          | <b>Ref. No.</b> — |
|                        | O-ring EPDM thickness 2.62mm ID ø 13.95mm Qty 1 pcs   |                 |                   |
| <b>accessories for</b> | 416065  |                 |                   |
|                        | <b>GEV No.</b>  | 361182          | <b>Ref. No.</b> — |
|                        | nut thread 1/4" H 5mm nickel-plated brass WS 17 Qty 1 pcs   |                 |                   |
|                        | <b>GEV No.</b>  | 510417          | <b>Ref. No.</b> — |
|                        | flat gasket fibre ED ø 20mm ID ø 14mm thickness 2mm Qty 1 pcs   |                 |                   |
|                        | <b>GEV No.</b>  | 520228          | <b>Ref. No.</b> — |
|                        | tooth lock washer ID ø 15.3mm ED ø 24mm steel Qty 1 pcs for thread M14  |                 |                   |
|                        | <b>GEV No.</b>  | 521103          | <b>Ref. No.</b> — |
|                        | nut thread M4 H 3mm WS 7 brass Qty 20 pcs   |                 |                   |
|                        | <b>GEV No.</b>  | 521104          | <b>Ref. No.</b> — |
|                        | washer ID ø 4.3mm ED ø 8mm thickness 0.5mm brass Qty 20 pcs for thread M4   |                 |                   |
|                        | <b>GEV No.</b>  | 550262          | <b>Ref. No.</b> — |
|                        | flat gasket copper ED ø 20mm ID ø 14mm thickness 2mm  |                 |                   |
|                        | <b>GEV No.</b>  | 560111          | <b>Ref. No.</b> — |
|                        | plain washer ID ø 4.3mm ED ø 9mm thickness 0.8mm SS Qty 20 pcs DIN 125A for thread M4   |                 |                   |
|                        | <b>GEV No.</b>  | 560131          | <b>Ref. No.</b> — |
|                        | hexagonal nut thread M4 H 3.2mm WS 7 SS DIN/ISO DIN 934 / ISO 4032/8673 Qty 20 pcs  |                 |                   |

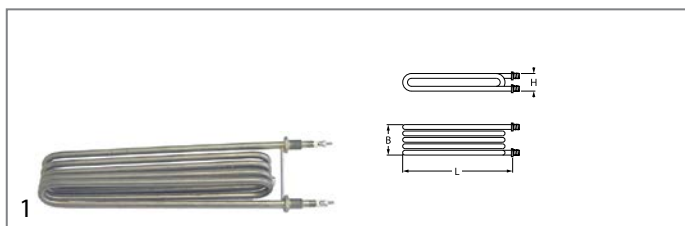

|                        |   |                 |                   |
|------------------------|---|-----------------|-------------------|
| <b>GEV No.</b>         | 416064  | <b>Ref. No.</b> | 809460            |
| <b>description</b>     | heating element 3300W 230V heating circuits 1 L 285mm W 74mm H 42mm thread M12x1 tube ø 8.5mm connection M4 connection length 37mm windings 5 fryer heaters 2 hole fixing |                 |                   |
| <b>accessories for</b> | 416064  |                 |                   |
|                        | <b>GEV No.</b>  | 520229          | <b>Ref. No.</b> — |
|                        | nut thread M12x1 H 4mm WS 16 zinc-coated steel Qty 1 pcs  |                 |                   |
|                        | <b>GEV No.</b>  | 521103          | <b>Ref. No.</b> — |
|                        | nut thread M4 H 3mm WS 7 brass Qty 20 pcs   |                 |                   |

|                |   |                 |   |
|----------------|---|-----------------|---|
| <b>GEV No.</b> | 521104  | <b>Ref. No.</b> | — |
|                | washer ID ø 4.3mm ED ø 8mm thickness 0.5mm brass Qty 20 pcs for thread M4             |                 |   |
| <b>GEV No.</b> | 521110  | <b>Ref. No.</b> | — |
|                | flat gasket fibre ED ø 20mm ID ø 13mm thickness 2mm Qty 1 pcs                         |                 |   |
| <b>GEV No.</b> | 521131  | <b>Ref. No.</b> | — |
|                | nut thread M12x1 H 3.5mm WS 17 SS Qty 1 pcs   |                 |   |
| <b>GEV No.</b> | 528110  | <b>Ref. No.</b> | — |
|                | O-ring EPDM thickness 2.62mm ID ø 12.37mm Qty 1 pcs                                   |                 |   |
| <b>GEV No.</b> | 560111  | <b>Ref. No.</b> | — |
|                | plain washer ID ø 4.3mm ED ø 9mm thickness 0.8mm SS Qty 20 pcs DIN 125A for thread M4 |                 |   |
| <b>GEV No.</b> | 560131  | <b>Ref. No.</b> | — |
|                | hexagonal nut thread M4 H 3.2mm WS 7 SS DIN/ISO DIN 934 / ISO 4032/8673 Qty 20 pcs    |                 |   |

heating elements for griddles



|                    |   |                 |        |
|--------------------|---|-----------------|--------|
| <b>GEV No.</b>     | 416062  | <b>Ref. No.</b> | C10199 |
| <b>description</b> | heating element 1000W 230V heating circuits 1 L 220mm W 103mm H 32mm tube ø 6.3mm L1 42mm L2 178mm W1 28mm W2 45mm connection length 19mm griddle dry heating element |                 |        |



|                    |  |                 |        |
|--------------------|--|-----------------|--------|
| <b>GEV No.</b>     | 416075   | <b>Ref. No.</b> | C00650 |
| <b>description</b> | heating element 1200W 230V heating circuits 1 L 295mm W 105mm H 32mm tube ø 6.5mm L1 40mm L2 252mm W1 35mm W2 35mm connection M4 connection length 23mm tilting bratt pan connection distance 29mm dry heating element |                 |        |

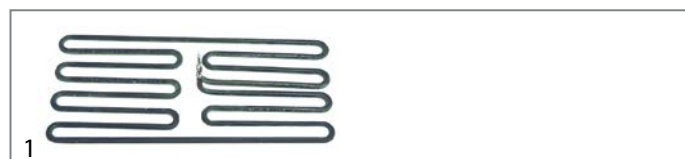

|                    |   |                 |        |
|--------------------|---|-----------------|--------|
| <b>GEV No.</b>     | 416072  | <b>Ref. No.</b> | C00644 |
| <b>description</b> | heating element 1800W 230V L 290mm W 130mm H 30mm tube ø 6.5mm L1 130mm L2 160mm W1 60mm W2 20mm connection M4 connection length 20mm dry heating element |                 |        |

heating elements for pasta cookers











|                        |  |                 |                   |
|------------------------|--|-----------------|-------------------|
| <b>GEV No.</b>         | 416066   | <b>Ref. No.</b> | 808056            |
| <b>description</b>     | heating element 1840W 230V heating circuits 1 L 275mm W 64mm H 42mm 2 hole fixing connection M4 thread 1/4" tube ø 8.5mm |                 |                   |
| <b>accessories for</b> | 416066   |                 |                   |
|                        | <b>GEV No.</b>   | 361182          | <b>Ref. No.</b> — |
|                        | nut thread 1/4" H 5mm nickel-plated brass WS 17 Qty 1 pcs  |                 |                   |

Table continues overleaf







| accessories for   |         | 416066 |            |
|---|---------|--------|------------|
|      | GEV No. | 510417 | Ref. No. — |
| flat gasket fibre ED ø 20mm ID ø 14mm thickness 2mm Qty 1 pcs                         |         |        |            |
|      | GEV No. | 520228 | Ref. No. — |
| tooth lock washer ID ø 15.3mm ED ø 24mm steel Qty 1 pcs for thread M14                |         |        |            |
|      | GEV No. | 521103 | Ref. No. — |
| nut thread M4 H 3mm WS 7 brass Qty 20 pcs   |         |        |            |
|      | GEV No. | 521104 | Ref. No. — |
| washer ID ø 4.3mm ED ø 8mm thickness 0.5mm brass Qty 20 pcs for thread M4             |         |        |            |
|      | GEV No. | 550262 | Ref. No. — |
| flat gasket copper ED ø 20mm ID ø 14mm thickness 2mm                                  |         |        |            |
|      | GEV No. | 560111 | Ref. No. — |
| plain washer ID ø 4.3mm ED ø 9mm thickness 0.8mm SS Qty 20 pcs DIN 125A for thread M4 |         |        |            |
|      | GEV No. | 560131 | Ref. No. — |
| hexagonal nut thread M4 H 3.2mm WS 7 SS DIN/ISO DIN 934 / ISO 4032/8673 Qty 20 pcs    |         |        |            |

|   |   |          |            |
|---|---|----------|------------|
|      |   |          |            |
| 1   |   |          |            |
| GEV No.   | 416077  | Ref. No. | 808756     |
| description   | heating element 2520/3000W 220/240V heating circuits 1 L 445mm W 66mm H mm 2 hole fixing connection M4 thread 1/4" tube ø 8.5mm mounting distance 58mm connection length 34mm pasta cooker immersion heater |          |            |
| accessories for 416077  |   |          |            |
|    | GEV No.   | 361182   | Ref. No. — |
| nut thread 1/4" H 5mm nickel-plated brass WS 17 Qty 1 pcs                             |   |          |            |
|    | GEV No.   | 510417   | Ref. No. — |
| flat gasket fibre ED ø 20mm ID ø 14mm thickness 2mm Qty 1 pcs                         |   |          |            |
|    | GEV No.   | 520228   | Ref. No. — |
| tooth lock washer ID ø 15.3mm ED ø 24mm steel Qty 1 pcs for thread M14                |   |          |            |
|    | GEV No.   | 521103   | Ref. No. — |
| nut thread M4 H 3mm WS 7 brass Qty 20 pcs   |   |          |            |
|    | GEV No.   | 521104   | Ref. No. — |
| washer ID ø 4.3mm ED ø 8mm thickness 0.5mm brass Qty 20 pcs for thread M4             |   |          |            |
|    | GEV No.   | 550262   | Ref. No. — |
| flat gasket copper ED ø 20mm ID ø 14mm thickness 2mm                                  |   |          |            |
|    | GEV No.   | 560111   | Ref. No. — |
| plain washer ID ø 4.3mm ED ø 9mm thickness 0.8mm SS Qty 20 pcs DIN 125A for thread M4 |   |          |            |
|    | GEV No.   | 560131   | Ref. No. — |
| hexagonal nut thread M4 H 3.2mm WS 7 SS DIN/ISO DIN 934 / ISO 4032/8673 Qty 20 pcs    |   |          |            |

Зип Общепит

vsezip.ru

+7(812)987-0881

|  |  |          |            |
|--|--|----------|------------|
|  |  |          |            |
| GEV No.  | 416071   | Ref. No. | 809070     |
| description  | heating element 800W 230V L 350mm W 87mm H 36mm 2 hole fixing connection male faston 6.3mm thread 1/4" tube ø 8.5mm mounting distance 74mm dry heating element |          |            |
| spare parts for 416071   |  |          |            |
|   | GEV No.  | 510417   | Ref. No. — |
| flat gasket fibre ED ø 20mm ID ø 14mm thickness 2mm Qty 1 pcs                      |  |          |            |
| accessories for 416071   |  |          |            |
|   | GEV No.  | 361182   | Ref. No. — |
| nut thread 1/4" H 5mm nickel-plated brass WS 17 Qty 1 pcs                          |  |          |            |
|   | GEV No.  | 520228   | Ref. No. — |
| tooth lock washer ID ø 15.3mm ED ø 24mm steel Qty 1 pcs for thread M14             |  |          |            |
|   | GEV No.  | 550262   | Ref. No. — |
| flat gasket copper ED ø 20mm ID ø 14mm thickness 2mm                               |  |          |            |

## heating elements for pizza ovens

|  |   |          |        |
|--|---|----------|--------|
|  |   |          |        |
| 1  |   |          |        |
| GEV No.  | 415917  | Ref. No. | 808633 |
| description  | heating element 1400W 230V L 572mm W 159mm flange length 220mm flange width 32mm hole distance 199mm connection length 134mm connection M5 L1 30mm L2 27mm L3 515mm W1 25mm W2 110mm tube ø 10.2mm heating circuits 1 rectangular flange hole ø 4mm dry heating element |          |        |

## heating elements for heated cabinets

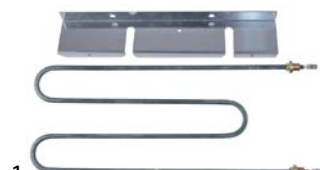
|  |   |          |        |
|--|---|----------|--------|
|  |   |          |        |
| 1  |   |          |        |
| GEV No.  | 419155  | Ref. No. | 8C2213 |
| description  | heating element 1200W 230V heating circuits 1 L 350mm W 150mm connection male faston 6.3mm tube ø 6.3mm thread M12x1.25 mounting distance 145mm |          |        |

## heating cables

|  |   |          |        |
|--|---|----------|--------|
| connection on both sides   |   |          |        |
| with wire end ferrules   |   |          |        |
|  |   |          |        |
| 1  |   |          |        |
| GEV No.  | 420387  | Ref. No. | 8C1890 |
| description  | heating cable 37W 220V L 4900mm for blast chiller |          |        |



heater battery

Зип-Общепит

vsezip.ru

+7(812)987-08-81



|   |   |                 |                   |
|---|---|-----------------|-------------------|
| <b>GEV No.</b>  | 415115  | <b>Ref. No.</b> | 827915            |
| <b>description</b>  | heater battery mounting distance 185mm W 38mm H 40mm 2000W 230V temperature restriction 125°C heating circuits 2 connection male faston 6.3mm L 195mm |                 |                   |
| <b>spare parts for</b>  | 415115  |                 |                   |
|  | <b>GEV No.</b>  | 375095          | <b>Ref. No.</b> — |
| <b>description</b>  | bi-metal thermostat hole distance 18mm switch-off temp. 105°C 1NC 1-pole 16A connection F6.3 2 hole fixing  |                 |                   |



|   |   |        |                 |        |
|---|---|--------|-----------------|--------|
|  | <b>GEV No.</b>  | 415122 | <b>Ref. No.</b> | 827915 |
| <b>description</b>  | heater battery mounting distance 185mm W 40mm H 35mm 2000W 230V temperature restriction 105°C heating circuits 2 connection cable cable length 340mm L 197mm for cross flow fan |        |                 |        |



coil heating elements

|   |   |        |                 |        |
|---|---|--------|-----------------|--------|
|  | <b>GEV No.</b>  | 420345 | <b>Ref. No.</b> | 8C0424 |
| <b>description</b>  | heating element 1400W 230V L 285mm W 135mm ø 19.5mm thread 3/8" connection M5 for drying heating circuits 1 2 hole fixing |        |                 |        |

immersion heating elements

3 hole flange ø47.5mm



|   |  |        |                 |        |
|---|--|--------|-----------------|--------|
|  | <b>GEV No.</b>   | 418136 | <b>Ref. No.</b> | 808674 |
| <b>description</b>  | heating element 4360W 240V mounting ø 47.5mm heating circuits 3 L 310mm W 31mm H 35mm number of thermostat sleeves 1 thermostat sleeves ø 7mm length thermostat sleeves 200mm thermostat sleeve clinging tube ø 6.3mm hole distance 62mm hole ø 8mm connection M4 3 hole flange immersion heater |        |                 |        |
| <b>spare parts for</b>  | 418136   |        |                 |        |
|  | <b>GEV No.</b>   | 510408 | <b>Ref. No.</b> | —      |
| <b>description</b>  | O-ring EPDM thickness 5.34mm ID ø 47mm Qty 1 pcs   |        |                 |        |



|   |  |  |                 |                 |   |
|---|--|--|-----------------|-----------------|---|
| <b>accessories for</b>  | 418136   | <b>GEV No.</b>                                   | 510408          | <b>Ref. No.</b> | — |
|  | <b>description</b>                                   | O-ring EPDM thickness 5.34mm ID ø 47mm Qty 1 pcs |                 |                 |   |
|  | <b>GEV No.</b>                                       | 510562   | <b>Ref. No.</b> | —               |   |
| <b>description</b>  | O-ring silicone thickness 5.34mm ID ø 47mm Qty 1 pcs |  |                 |                 |   |

3 hole flange ø57.5mm

|  |  |        |                 |        |
|--|--|--------|-----------------|--------|
|  | <b>GEV No.</b>   | 418084 | <b>Ref. No.</b> | 807858 |
| <b>description</b>   | heating element 7599W 230V mounting ø 57.5mm heating circuits 3 L 340mm W 36mm H 42mm number of thermostat sleeves 1 thermostat sleeves ø 7mm length thermostat sleeves 270mm thermostat sleeve clinging tube ø 8.5mm hole distance 72mm hole ø 8mm connection M4 3 hole flange immersion heater |        |                 |        |

miscellaneous

|   |  |        |                 |                  |
|---|--|--------|-----------------|------------------|
|   | <b>GEV No.</b>   | 418548 | <b>Ref. No.</b> | 809218<br>8C0728 |
| <b>description</b>  | heating element 5200W 230V heating circuits 3 L 325mm W 47mm H 50mm tube ø 8.5mm hole distance 62mm hole ø 9.3mm connection M4 4 hole flange immersion heater flange width 81mm flange length 96mm with thermal fuse |        |                 |                  |
| <b>spare parts for</b>  | 418548   |        |                 |                  |
|  | <b>GEV No.</b>   | 510401 | <b>Ref. No.</b> | —                |
| <b>description</b>  | gasket rubber L 88mm W 73mm thickness 5mm hole ø 7mm hole distance 65mm for heating element 4 holes ID ø 50mm  |        |                 |                  |

|  |   |        |                 |        |
|--|---|--------|-----------------|--------|
|  | <b>GEV No.</b>  | 415550 | <b>Ref. No.</b> | 809556 |
| <b>description</b>   | heating element 9000W 230V heating circuits 3 L 205mm W 38mm H 70mm number of thermostat sleeves 1 thermostat sleeves ø 2.5mm length thermostat sleeves 120mm thermostat sleeve eccentric, clinging tube ø 6.3mm hole distance 64mm hole ø 8mm connection male faston 6.3mm 4 hole flange immersion heater flange width 82mm flange length 82mm |        |                 |        |
| <b>accessories for</b>   | 415550  |        |                 |        |
|   | <b>GEV No.</b>  | 379078 | <b>Ref. No.</b> | —      |
| <b>description</b>   | temperature probe thermocouple K (NiCr-Ni) cable silicone probe -50 up to 1150°C cable -50 up to +180°C connection 2-wire thread probe ø1.5x100mm cable length 1.8m   |        |                 |        |
|   | <b>GEV No.</b>  | 510565 | <b>Ref. No.</b> | —      |
| <b>description</b>   | gasket rubber L 82mm W 82mm thickness 4mm hole ø 9mm hole distance 64mm for heating element suitable for RATIONAL 4 holes   |        |                 |        |

electric components



Зип Общепит

vsezip.ru

8(12)987-08-81

2"



1

|   |   |                 |                   |
|---|---|-----------------|-------------------|
| <b>GEV No.</b>  | 416073  | <b>Ref. No.</b> | 808525            |
| <b>description</b>  | heating element 6000W 220V heating circuits 3 L 315mm W 43mm H 39mm tube $\varnothing$ 8.5mm thermostat sleeves $\varnothing$ 5mm length thermostat sleeves 280mm number of thermostat sleeves 1 thermostat sleeve eccentric, clinging connection M4 immersion heater flange with thread 2" |                 |                   |
| <b>accessories for</b>  | 416073  |                 |                   |
|  | <b>GEV No.</b>  | 510407          | <b>Ref. No.</b> — |
|   | flat gasket fibre ED $\varnothing$ 78mm ID $\varnothing$ 60mm thickness 2mm for heating element for thread 2" Qty 1 pcs   |                 |                   |



1

|   |   |                 |                   |
|---|---|-----------------|-------------------|
| <b>GEV No.</b>  | 416078  | <b>Ref. No.</b> | 808595            |
| <b>description</b>  | heating element 8000W 230V heating circuits 3 L 305mm W 39mm H 43mm tube $\varnothing$ 8.5mm thermostat sleeves $\varnothing$ 5mm length thermostat sleeves 285mm number of thermostat sleeves 1 thermostat sleeve clinging connection M4 connection length 48mm immersion heater flange with thread 2" |                 |                   |
| <b>accessories for</b>  | 416078  |                 |                   |
|  | <b>GEV No.</b>  | 510407          | <b>Ref. No.</b> — |
|   | flat gasket fibre ED $\varnothing$ 78mm ID $\varnothing$ 60mm thickness 2mm for heating element for thread 2" Qty 1 pcs   |                 |                   |





1

|                    |  |                 |        |
|--------------------|--|-----------------|--------|
| <b>GEV No.</b>     | 416076   | <b>Ref. No.</b> | 808756 |
| <b>description</b> | heating element 2520W 220V L 445mm W 60mm thread 1/4" mounting distance 52mm tube $\varnothing$ 8.5mm 2 hole fixing immersion heater connection M5 |                 |        |

## heating elements for convection





1

|   |   |                 |                   |
|---|---|-----------------|-------------------|
| <b>GEV No.</b>  | 415914  | <b>Ref. No.</b> | 809571            |
| <b>description</b>  | heating element 15000W 230V heating circuits 6 ID $\varnothing$ 505mm ED $\varnothing$ 520mm L 615mm H 180mm L1 50mm W1 156mm H1 35mm H2 145mm flange length 210mm flange width 24mm hole distance 30mm connection male faston 6.3mm connection length 80mm tube $\varnothing$ 6.5mm convection heating element hole $\varnothing$ 8mm mounting pos. inner rectangular flange |                 |                   |
| <b>accessories for</b>  | 415914  |                 |                   |
|  | <b>GEV No.</b>  | 521127          | <b>Ref. No.</b> — |
|   | gasket L 210mm W 24mm thickness 2mm for heating element   |                 |                   |
|  | <b>GEV No.</b>  | 693548          | <b>Ref. No.</b> — |
|   | flange suitable for convection heating element W 23mm mounting pos. outer length 210  |                 |                   |



1

|   |   |                 |                   |
|---|---|-----------------|-------------------|
| <b>GEV No.</b>  | 415915  | <b>Ref. No.</b> | 809570            |
| <b>description</b>  | heating element 15000W 230V heating circuits 6 ID $\varnothing$ 635mm ED $\varnothing$ 650mm L 696mm H 200mm L1 23mm W1 156mm H1 35mm H2 165mm flange length 210mm flange width 24mm hole distance 31mm connection male faston 6.3mm connection length 80mm tube $\varnothing$ 6.3mm convection heating element hole $\varnothing$ 7mm mounting pos. outer rectangular flange |                 |                   |
| <b>accessories for</b>  | 415915  |                 |                   |
|  | <b>GEV No.</b>  | 521127          | <b>Ref. No.</b> — |
|   | gasket L 210mm W 24mm thickness 2mm for heating element   |                 |                   |
|  | <b>GEV No.</b>  | 693548          | <b>Ref. No.</b> — |
|   | flange suitable for convection heating element W 23mm mounting pos. outer length 210  |                 |                   |



1

|   |   |                 |                        |
|---|---|-----------------|------------------------|
| <b>GEV No.</b>  | 415119  | <b>Ref. No.</b> | 132110020              |
| <b>description</b>  | heating element 1600W 230V heating circuits 1 ID $\varnothing$ 179mm ED $\varnothing$ 197mm L 254mm H 30mm L1 51mm W1 31mm H1 9mm H2 21mm flange length 70mm flange width 22mm hole distance 56mm connection male faston 6.3mm connection length 41mm tube $\varnothing$ 6.3mm convection heating element hole $\varnothing$ 4mm rectangular flange |                 |                        |
| <b>accessories for</b>  | 415119  |                 |                        |
|  | <b>GEV No.</b>  | 510368          | <b>Ref. No.</b> 8C0286 |
|   | gasket L 70mm W 23.5mm hole $\varnothing$ 5mm hole distance 56mm FIBER thickness 2mm for heating element  |                 |                        |



1

|                    |   |                 |        |
|--------------------|---|-----------------|--------|
| <b>GEV No.</b>     | 418861  | <b>Ref. No.</b> | 828041 |
| <b>description</b> | heating element 2400W 220V heating circuits 1 ID $\varnothing$ 185mm ED $\varnothing$ 200mm L 210mm H 35mm L1 10mm W1 61mm H1 5mm H2 30mm flange length 100mm flange width 22mm hole distance 86mm connection male faston 6.3mm connection length 36mm tube $\varnothing$ 6.3mm convection heating element hole $\varnothing$ 5mm rectangular flange angled |                 |        |





Зип Общепит

vsezip.ru

+7(812)987-08-81



1

|                    |   |                 |         |
|--------------------|---|-----------------|---------|
| <b>GEV No.</b>     | 418986  | <b>Ref. No.</b> | 9629911 |
| <b>description</b> | heating element 3000W 240V heating circuits 1 ID $\varnothing$ 180mm ED $\varnothing$ 186mm L 210mm H 31mm L1 11mm W1 60mm H1 7mm H2 24.5mm flange length 100mm flange width 22mm hole distance 86mm connection male faston 6.3mm connection length 34.5mm tube $\varnothing$ 6.25mm convection heating element hole $\varnothing$ 5mm rectangular flange |                 |         |



1

|                    |   |                 |        |
|--------------------|---|-----------------|--------|
| <b>GEV No.</b>     | 418858  | <b>Ref. No.</b> | 806187 |
| <b>description</b> | heating element 7350W 230V heating circuits 3 ID $\varnothing$ 215mm ED $\varnothing$ 230mm L 267mm H 85mm L1 38mm W1 102mm H1 5mm H2 80mm flange length 142mm flange width 25mm hole distance 63mm cable length 1000mm convection heating element hole $\varnothing$ 6mm |                 |        |





1

|                    |   |                 |           |
|--------------------|---|-----------------|-----------|
| <b>GEV No.</b>     | 415845  | <b>Ref. No.</b> | 142110001 |
| <b>description</b> | heating element 3150W 230V heating circuits 3 ID $\varnothing$ 201mm ED $\varnothing$ 215mm L 272mm H 35mm L1 57mm W1 60mm H1 8mm H2 27mm flange length 95mm flange width 22mm hole distance 77mm connection male faston 6.3mm connection length 20mm tube $\varnothing$ 6.5mm convection heating element hole $\varnothing$ 6mm rectangular flange |                 |           |



1

|   |  |                 |                 |   |
|---|--|-----------------|-----------------|---|
| <b>GEV No.</b>  | 415912   | <b>Ref. No.</b> | 809555          |   |
| <b>description</b>  | heating element 9000W 230V heating circuits 3 ID $\varnothing$ 445mm ED $\varnothing$ 458mm L 474mm H 130mm W1 156mm H1 33mm H2 97mm flange length 210mm flange width 24mm hole distance 31mm connection male faston 6.3mm connection length 80mm tube $\varnothing$ 6.5mm dry heating element hole $\varnothing$ 7.5mm mounting pos. inner rectangular flange L1 16mm |                 |                 |   |
| <b>accessories for</b>  | 415912   |                 |                 |   |
|  | <b>GEV No.</b>   | 521127          | <b>Ref. No.</b> | — |
|   | gasket L 210mm W 24mm thickness 2mm for heating element  |                 |                 |   |
|  | <b>GEV No.</b>   | 693548          | <b>Ref. No.</b> | — |
|   | flange suitable for convection heating element W 23mm mounting pos. outer length 210   |                 |                 |   |





1

|                    |  |                 |        |
|--------------------|--|-----------------|--------|
| <b>GEV No.</b>     | 418134   | <b>Ref. No.</b> | 808778 |
| <b>description</b> | heating element 3300W 240V heating circuits 1 ID $\varnothing$ 185mm ED $\varnothing$ 200mm L 215mm H 30mm W1 60mm H1 5mm H2 25mm flange length 100mm flange width 22mm hole distance 85mm connection male faston 6.3mm connection length 22mm tube $\varnothing$ 6.5mm convection heating element hole $\varnothing$ 5mm rectangular flange |                 |        |



1

|   |  |                 |                 |   |
|---|--|-----------------|-----------------|---|
| <b>GEV No.</b>  | 415913   | <b>Ref. No.</b> | 809554          |   |
| <b>description</b>  | heating element 9000W 230V heating circuits 3 ID $\varnothing$ 504mm ED $\varnothing$ 516mm L 535mm H 130mm W1 156mm H1 35mm H2 95mm flange length 210mm flange width 25mm hole distance 31mm connection male faston 6.3mm connection length 80mm tube $\varnothing$ 6.5mm dry heating element hole $\varnothing$ 7.5mm mounting pos. outer rectangular flange L1 19mm |                 |                 |   |
| <b>accessories for</b>  | 415913   |                 |                 |   |
|  | <b>GEV No.</b>   | 521127          | <b>Ref. No.</b> | — |
|   | gasket L 210mm W 24mm thickness 2mm for heating element  |                 |                 |   |
|  | <b>GEV No.</b>   | 693548          | <b>Ref. No.</b> | — |
|   | flange suitable for convection heating element W 23mm mounting pos. outer length 210   |                 |                 |   |



1



|                    |  |                 |        |
|--------------------|--|-----------------|--------|
| <b>GEV No.</b>     | 418131   | <b>Ref. No.</b> | 808781 |
| <b>description</b> | heating element 6000W 230V heating circuits 3 ID $\varnothing$ 217mm ED $\varnothing$ 231mm L 271mm H 90mm L1 41mm W1 103mm H1 24mm H2 66mm flange length 140mm flange width 22mm hole distance 63mm tube $\varnothing$ 6.3mm convection heating element hole $\varnothing$ 5mm rectangular flange |                 |        |



Зип Общежит  
radiation heaters

vsezip.ru

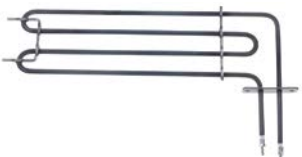

+7(812)987-08-81

|  |   |                 |                   |
|--|---|-----------------|-------------------|
|  <p>1</p> |   |                 |                   |
| <b>GEV No.</b>   | 418135  | <b>Ref. No.</b> | 808779            |
| <b>description</b>   | heating element 920W 230V heating circuits 1 ID ø 200mm ED ø 215mm L 255mm H 40mm thread 1/4" connection male faston 6.3mm 2 hole fixing mounting distance 24mm tube ø 8.5mm convection heating element |                 |                   |
| <b>accessories for</b>   | 418135  |                 |                   |
|           | <b>GEV No.</b>  | 361182          | <b>Ref. No.</b> — |
|  | nut thread 1/4" H 5mm nickel-plated brass WS 17 Qty 1 pcs   |                 |                   |
|           | <b>GEV No.</b>  | 510417          | <b>Ref. No.</b> — |
|  | flat gasket fibre ED ø 20mm ID ø 14mm thickness 2mm Qty 1 pcs   |                 |                   |
|           | <b>GEV No.</b>  | 520228          | <b>Ref. No.</b> — |
|  | tooth lock washer ID ø 15.3mm ED ø 24mm steel Qty 1 pcs for thread M14  |                 |                   |
|           | <b>GEV No.</b>  | 550262          | <b>Ref. No.</b> — |
|  | flat gasket copper ED ø 20mm ID ø 14mm thickness 2mm  |                 |                   |

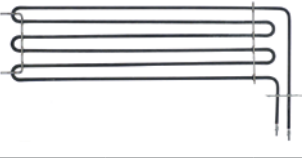
|   |  |                 |                      |
|---|--|-----------------|----------------------|
|  <p>1</p> |  |                 |                      |
| <b>GEV No.</b>  | 419140   | <b>Ref. No.</b> | 8C0256<br>J03RST1B50 |
| <b>description</b>  | heating element 1500W 230V heating circuits 1 L 340mm W 105mm L1 30mm L2 310mm W2 90mm flange length 70mm flange width 22mm hole distance 56mm connection M4 tube ø 6.3mm W1 15mm windings 2 |                 |                      |

|  |  |                 |        |
|--|--|-----------------|--------|
|  <p>1</p> |  |                 |        |
| <b>GEV No.</b>   | 419235   | <b>Ref. No.</b> | 8C0392 |
| <b>description</b>   | heating element 3500W 230V heating circuits 1 L 560mm W 175mm L1 30mm L2 530mm W2 145mm flange length 70mm flange width 22.5mm hole distance 56mm connection M4 tube ø 6.3mm W1 33mm convection heating element combi-steamer windings 3 |                 |        |

|  |   |                 |        |
|--|---|-----------------|--------|
|  <p>1</p> |   |                 |        |
| <b>GEV No.</b>   | 418139  | <b>Ref. No.</b> | 808780 |
| <b>description</b>   | heating element 3500W 240V heating circuits 1 L 620mm W 120mm L1 33mm L2 587mm W2 90mm flange length 70mm flange width 22mm hole distance 56mm connection length 100mm connection M4 tube ø 8.5mm hole ø 6mm W1 30mm rectangular flange convection heating element windings 2 |                 |        |

|   |   |                 |                   |
|---|---|-----------------|-------------------|
|  <p>1</p> |   |                 |                   |
| <b>GEV No.</b>  | 490079  | <b>Ref. No.</b> | 809045            |
| <b>description</b>  | radiation heater octagonal 3400W 230V L 300mm W 300mm heating circuits 2 H 30mm with heating coil energy regulation with temperature signalization connections 4+2 connection type cable AD |                 |                   |
| <b>spare parts for</b>  | 490079  |                 |                   |
|            | <b>GEV No.</b>  | 390931          | <b>Ref. No.</b> — |
|   | safety thermostat for radiation heater  |                 |                   |

|  |   |                 |        |
|--|---|-----------------|--------|
| <p>2-circuit</p>  <p>1</p> |   |                 |        |
| <b>GEV No.</b>   | 490080  | <b>Ref. No.</b> | 809127 |
| <b>description</b>   | radiation heater ø 250mm 2400W heating circuits 2 partial power 1000W |                 |        |

hot plates

square & rectangular

with radiused edge

|   |  |                 |        |
|---|--|-----------------|--------|
|  <p>1</p> |  |                 |        |
| <b>GEV No.</b>  | 490066 <sup>1</sup>  | <b>Ref. No.</b> | C00637 |
| <b>description</b>  | hot plate dimensions 220x220mm 2600W 230V with spill ring connection 4 screw clamps protector yes square |                 |        |

<sup>1</sup>incl. protector



Зип Обществит  
energy regulators

EGO  
1-circuit

+7(812)987-08-81



1

|                    |  |                 |        |
|--------------------|--|-----------------|--------|
| <b>GEV No.</b>     | 490071 <sup>1</sup>  | <b>Ref. No.</b> | C00212 |
| <b>description</b> | hot plate dimensions 300x300mm 4000W 230V with spill ring connection 4 screw clamps protector yes square |                 |        |

<sup>1</sup>incl. protector

round

with radiused edge

for domestic and commercial kitchens





1

|                    |  |                 |        |
|--------------------|--|-----------------|--------|
| <b>GEV No.</b>     | 490016   | <b>Ref. No.</b> | C10000 |
| <b>description</b> | hot plate ø 180mm 2000W 230V connection 4 screw clamps with 8mm spill ring |                 |        |



1

|   |  |                 |        |
|---|--|-----------------|--------|
| <b>GEV No.</b>  | 490020   | <b>Ref. No.</b> | C00208 |
| <b>description</b>  | hot plate ø 220mm 2600W 230V connection 4 screw clamps with 8mm spill ring |                 |        |
| <b>accessories for</b>  | 490020   |                 |        |
|   | <b>GEV No.</b>   | <b>Ref. No.</b> | —      |
|  | 550796   |                 |        |
|   | fixing plate for hot plate ø220mm  |                 |        |



1

|                    |  |                 |        |
|--------------------|--|-----------------|--------|
| <b>GEV No.</b>     | 490062   | <b>Ref. No.</b> | C00210 |
| <b>description</b> | hot plate ø 300mm 3500W 220V connection 4 screw clamps with 8mm spill ring |                 |        |



1

|                    |   |                 |        |
|--------------------|---|-----------------|--------|
| <b>GEV No.</b>     | 380015  | <b>Ref. No.</b> | 809397 |
| <b>description</b> | energy regulator 230V 13A single-circuit turn direction right shaft ø 6x4.6mm shaft L 23mm mounting thread M4 power release 6-100% no. 50.57021.010 |                 |        |



1

|                    |   |                 |        |
|--------------------|---|-----------------|--------|
| <b>GEV No.</b>     | 380019  | <b>Ref. No.</b> | 806287 |
| <b>description</b> | energy regulator 240V 13A single-circuit turn direction right shaft ø 6x4.6mm shaft L 23mm mounting thread M4 power release 6-100% no. 50.57071.010 |                 |        |

2-circuit



1

|                    |  |                 |           |
|--------------------|--|-----------------|-----------|
| <b>GEV No.</b>     | 380024   | <b>Ref. No.</b> | unbekannt |
| <b>description</b> | energy regulator 240V 13A turn direction right shaft ø 6x4.6mm shaft L 36mm mounting thread M4 no. 50.67079.601 with operation switch 1-pole |                 |           |

thermostats

bi-metal thermostats

bi-metal thermostats



1

|                    |  |                 |        |
|--------------------|--|-----------------|--------|
| <b>GEV No.</b>     | 375160   | <b>Ref. No.</b> | 809559 |
| <b>description</b> | bi-metal thermostat hole distancemm switch-off temp. 110°C 1NC 1-pole 16A connection F6.3 M4 |                 |        |



control and safety thermostats

EGO

control thermostats

51.\_ series

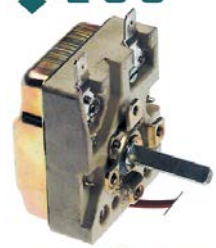

|                    |  |                 |        |
|--------------------|--|-----------------|--------|
| <b>GEV No.</b>     | 375334   | <b>Ref. No.</b> | 808144 |
| <b>description</b> | thermostat t.max. 85°C temperature range 30-85°C 1-pole 1NO 16A probe ø 6mm probe L 130mm capillary pipe 900mm capillary pipe isolated 900mm gland nut shaft ø 6x4.6mm shaft L 23mm shaft position upper rotation 270° |                 |        |

55.10/19\_ series



|                    |  |                 |        |
|--------------------|--|-----------------|--------|
| <b>GEV No.</b>     | 375055   | <b>Ref. No.</b> | 828838 |
| <b>description</b> | thermostat t.max. 110°C temperature range 30-110°C 1-pole 1CO 16A probe ø 6mm probe L 130mm capillary pipe 1500mm capillary pipe isolatedmm gland nut shaft L 23mm shaft position upper rotation 318° 250V |                 |        |



|                    |  |                 |        |
|--------------------|--|-----------------|--------|
| <b>GEV No.</b>     | 375647   | <b>Ref. No.</b> | 809017 |
| <b>description</b> | thermostat t.max. 110°C temperature range 31-110°C 1-pole 1NO 16A probe ø 6mm probe L 133mm capillary pipe 870mm capillary pipe isolatedmm gland nut shaft ø 6x4.6mm shaft L 23mm shaft position upper rotation 318° |                 |        |

Зип Общепит

vsezip.ru

+7(812)987-08-81



|                    |  |                 |        |
|--------------------|--|-----------------|--------|
| <b>GEV No.</b>     | 375341   | <b>Ref. No.</b> | 809036 |
| <b>description</b> | thermostat t.max. 150°C temperature range 60-150°C 1-pole 1NO 16A probe ø 3mm probe L 219mm capillary pipe 900mm capillary pipe isolated 900mm gland nut shaft ø 6x4.6mm shaft L 23mm shaft position upper rotation 270° |                 |        |



|                    |  |                 |        |
|--------------------|--|-----------------|--------|
| <b>GEV No.</b>     | 375718   | <b>Ref. No.</b> | C10379 |
| <b>description</b> | thermostat t.max. 180°C temperature range 70-180°C 1-pole 1NO 16A probe ø 6mm probe L 87mm capillary pipe 1500mm capillary pipe isolatedmm gland nut shaft ø 6x4.6mm shaft L 23mm shaft position upper rotation 270° |                 |        |



|                    |   |                 |        |
|--------------------|---|-----------------|--------|
| <b>GEV No.</b>     | 375336  | <b>Ref. No.</b> | C00545 |
| <b>description</b> | thermostat t.max. 255°C temperature range 45-255°C 1-pole 1CO 16A probe ø 6mm probe L 74mm capillary pipe 900mm capillary pipe isolated 900mm gland nut shaft ø 6x4.6mm shaft L 23mm shaft position upper rotation 270° |                 |        |



Зип Общежит

vsezip.ru

+7(812)987-08-81

→ electric components



|                    |  |                 |        |
|--------------------|--|-----------------|--------|
| <b>GEV No.</b>     | 375216   | <b>Ref. No.</b> | 808672 |
| <b>description</b> | thermostat t.max. 280°C temperature range 50-280°C 1-pole 1NO 16A probe ø 3mm probe L 228mm capillary pipe 1300mm capillary pipe isolated 1150mm gland nut shaft L 23mm shaft position upper rotation 318° |                 |        |



|                    |   |                 |           |
|--------------------|---|-----------------|-----------|
| <b>GEV No.</b>     | 375594  | <b>Ref. No.</b> | 132110015 |
| <b>description</b> | thermostat t.max. 318°C temperature range 60-318°C 1-pole 1NO 16A probe ø 3.03mm probe L 139mm capillary pipe 870mm capillary pipe isolatedmm gland nut shaft ø 6x4.6mm shaft L 23mm shaft position upper rotation 270° |                 |           |



|                    |   |                 |                  |
|--------------------|---|-----------------|------------------|
| <b>GEV No.</b>     | 375860  | <b>Ref. No.</b> | 8C0888<br>8C1605 |
| <b>description</b> | thermostat t.max. 289°C temperature range 57-289°C 1-pole 1NO 16A probe ø 3.1mm probe L 226mm capillary pipe 1780mm capillary pipe isolated 1770mm gland nut shaft ø 6x4.6mm shaft L 23mm shaft position upper° rotation 270° probe material SS |                 |                  |



|                    |  |                 |        |
|--------------------|--|-----------------|--------|
| <b>GEV No.</b>     | 375002   | <b>Ref. No.</b> | C00563 |
| <b>description</b> | thermostat t.max. 320°C temperature range 55-320°C 1-pole 1NO 16A probe ø 3.1mm probe L 226mm capillary pipe 870mm capillary pipe isolated 850mm gland nut shaft L 23mm shaft position upper rotation 270° |                 |        |



|                    |   |                 |           |
|--------------------|---|-----------------|-----------|
| <b>GEV No.</b>     | 375800  | <b>Ref. No.</b> | 132110016 |
| <b>description</b> | thermostat t.max. 308°C temperature range 65-308°C 1-pole 1NO 16A probe ø 3.03mm probe L 120mm capillary pipe 600mm capillary pipe isolatedmm gland nut shaft ø 6x4.6mm shaft L 23mm shaft position upper rotation 270° with 2 probes |                 |           |



|                    |   |                 |        |
|--------------------|---|-----------------|--------|
| <b>GEV No.</b>     | 375232  | <b>Ref. No.</b> | C00563 |
| <b>description</b> | thermostat t.max. 320°C temperature range 55-320°C 1-pole capillary pipe isolatedmm gland nut |                 |        |



|                    |  |                 |        |
|--------------------|--|-----------------|--------|
| <b>GEV No.</b>     | 375253   | <b>Ref. No.</b> | 8C0363 |
| <b>description</b> | thermostat t.max. 455°C temperature range 85-455°C 1-pole 1NO 16A probe ø 3.9mm probe L 228mm capillary pipe 870mm capillary pipe isolated 660mm gland nut shaft ø 6x4.6mm shaft L 23mm shaft position upper rotation 270° |                 |        |

Зип-Общепит

vsezip.ru

+7(812)987-08-81



|                    |  |                 |        |
|--------------------|--|-----------------|--------|
| <b>GEV No.</b>     | 375247   | <b>Ref. No.</b> | 808542 |
| <b>description</b> | thermostat t.max. 500°C temperature range 75-500°C 1-pole 1NO 16A probe ø 4mm probe L 228mm capillary pipe 900mm capillary pipe isolated gland nut shaft ø 6x4.6mm shaft L 23mm shaft position upper rotation 270° |                 |        |



|                    |   |                 |        |
|--------------------|---|-----------------|--------|
| <b>GEV No.</b>     | 375534  | <b>Ref. No.</b> | 809260 |
| <b>description</b> | thermostat t.max. 90°C temperature range 19-90°C 1-pole 1CO 16A probe ø 6mm probe L 129mm capillary pipe 980mm capillary pipe isolated 960mm gland nut shaft Lmm shaft position rotation 180° |                 |        |

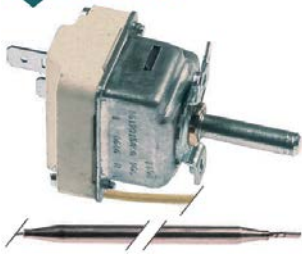

|                    |  |                 |                    |
|--------------------|--|-----------------|--------------------|
| <b>GEV No.</b>     | 375809   | <b>Ref. No.</b> | 809890<br>J0THR090 |
| <b>description</b> | thermostat t.max. 90°C temperature range 30-90°C 1-pole 1NO 16A probe ø 6mm probe L 130mm capillary pipe 1800mm capillary pipe isolated 1800mm gland nut shaft ø 6x4.6mm shaft L 23mm shaft position upper rotation 270° |                 |                    |

55.13\_series

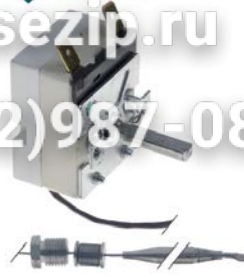

|                    |  |                 |        |
|--------------------|--|-----------------|--------|
| <b>GEV No.</b>     | 375492   | <b>Ref. No.</b> | 808935 |
| <b>description</b> | thermostat t.max. 190°C temperature range 94-190°C 1-pole 1NO 16A probe ø 6mm probe L 94mm capillary pipe 1090mm capillary pipe isolated 960mm gland nut M10x1 shaft ø 6x4.6mm shaft L 23mm shaft position upper rotation 310° probe material SS |                 |        |

55.34\_series

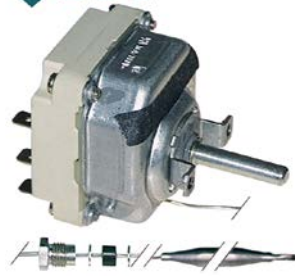

|                    |   |                 |        |
|--------------------|---|-----------------|--------|
| <b>GEV No.</b>     | 375021  | <b>Ref. No.</b> | 808058 |
| <b>description</b> | thermostat t.max. 110°C temperature range 32-110°C 3-pole 3CO 16A probe ø 6mm probe L 138mm capillary pipe 2980mm capillary pipe isolated 2200mm gland nut M9x1 shaft ø 6x4.6mm shaft L 23mm shaft position upper rotation 270° |                 |        |



|                    |  |                 |        |
|--------------------|--|-----------------|--------|
| <b>GEV No.</b>     | 375410   | <b>Ref. No.</b> | 807603 |
| <b>description</b> | thermostat t.max. 180°C temperature range 95-180°C 3-pole 3NO 16A probe ø 6mm probe L 133mm capillary pipe 1780mm capillary pipe isolated 1400mm gland nut M10x1 shaft ø 6x4.6mm shaft L 23mm shaft position upper rotation 270° |                 |        |



Зип Общепит

vsezip.ru

+7(812)987-08-81



|                    |   |                 |        |
|--------------------|---|-----------------|--------|
| <b>GEV No.</b>     | 375929  | <b>Ref. No.</b> | X12076 |
| <b>description</b> | thermostat t.max. 182°C temperature range 101-182°C 3-pole 3NO 16A probe ø 6mm probe L 133mm capillary pipe 1180mm capillary pipe isolated 1040mm gland nut shaft ø 6x4.6mm shaft L 23mm shaft position upper rotation 270° |                 |        |



|                    |  |                 |        |
|--------------------|--|-----------------|--------|
| <b>GEV No.</b>     | 375435   | <b>Ref. No.</b> | 807603 |
| <b>description</b> | thermostat t.max. 190°C temperature range 56-190°C 3-pole 3NO 16A probe ø 6mm probe L 130mm capillary pipe 900mm capillary pipe isolated 670mm gland nut M10x1 shaft ø 6x4.6mm shaft L 23mm shaft position upper rotation 318° probe material SS |                 |        |

55.40\_series



|                    |  |                 |        |
|--------------------|--|-----------------|--------|
| <b>GEV No.</b>     | 375185   | <b>Ref. No.</b> | 806189 |
| <b>description</b> | thermostat t.max. 320°C temperature range 53-320°C 4-pole 4NO 16A probe ø 3.9mm probe L 228mm capillary pipe 880mm capillary pipe isolatedmm gland nut shaft ø 6x4.6mm shaft L 23mm shaft position upper rotation 270° |                 |        |

safety thermostats

55.10/19\_series



|   |   |                 |                 |   |
|---|---|-----------------|-----------------|---|
| <b>GEV No.</b>  | 375250  | <b>Ref. No.</b> | 808671          |   |
| <b>description</b>  | safety thermostat capillary pipe 870mm probe ø 6mm 1-pole probe L 129mm 16A capillary pipe isolatedmm gland nut switch-off temp. 130°C probe SS |                 |                 |   |
| <b>spare parts for</b>  | 375250  |                 |                 |   |
|  | <b>GEV No.</b>  | 551083          | <b>Ref. No.</b> | — |
|   | cap for safety thermostat thread M8x1   |                 |                 |   |



|                    |   |                 |        |
|--------------------|---|-----------------|--------|
| <b>GEV No.</b>     | 375376  | <b>Ref. No.</b> | 808181 |
| <b>description</b> | safety thermostat capillary pipe 870mm probe ø 6mm 1-pole probe L 133mm 0.5A capillary pipe isolatedmm gland nut M10x1 switch-off temp. 224°C probe |                 |        |



|   |   |                 |                 |   |
|---|---|-----------------|-----------------|---|
| <b>GEV No.</b>  | 375339  | <b>Ref. No.</b> | 808181          |   |
| <b>description</b>  | safety thermostat switch-off temp. 225°C 1-pole 0.5A probe ø 6mm probe L 133mm capillary pipe 870mm capillary pipe isolatedmm gland nut M10x1 probe |                 |                 |   |
| <b>accessories for</b>  | 375339  |                 |                 |   |
|  | <b>GEV No.</b>  | 551083          | <b>Ref. No.</b> | — |
|   | cap for safety thermostat thread M8x1   |                 |                 |   |

electric components

Зип Общепит

vsezip.ru

+7(812)987-08-81



|                    |   |                 |        |
|--------------------|---|-----------------|--------|
| <b>GEV No.</b>     | 375337  | <b>Ref. No.</b> | C00546 |
| <b>description</b> | safety thermostat switch-off temp. 300°C 1-pole 16A probe ø 6mm probe L 74mm capillary pipe 900mm capillary pipe isolated 700mm gland nut probe |                 |        |



|                    |   |                 |        |
|--------------------|---|-----------------|--------|
| <b>GEV No.</b>     | 375277  | <b>Ref. No.</b> | 808057 |
| <b>description</b> | safety thermostat switch-off temp. 150°C 3-pole 3NC 20A probe ø 6mm probe L 79mm capillary pipe 900mm capillary pipe isolated 700mm gland nut probe |                 |        |

55.14\_series

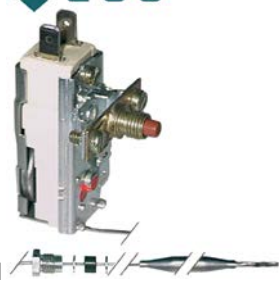

|                    |  |                 |                  |
|--------------------|--|-----------------|------------------|
| <b>GEV No.</b>     | 375260   | <b>Ref. No.</b> | 808430<br>813430 |
| <b>description</b> | safety thermostat switch-off temp. 240°C 1-pole 16A probe ø 6mm probe L 77mm capillary pipe 1280mm capillary pipe isolated 1050mm gland nut M10x1 probe SS |                 |                  |



|                    |  |                 |        |
|--------------------|--|-----------------|--------|
| <b>GEV No.</b>     | 390338                                   | <b>Ref. No.</b> | C00686 |
| <b>description</b> | safety thermostat switch-off temp. 169°C |                 |        |

55.32\_series

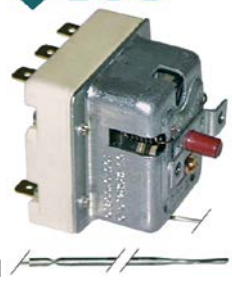

|                    |   |                 |        |
|--------------------|---|-----------------|--------|
| <b>GEV No.</b>     | 375281  | <b>Ref. No.</b> | 808203 |
| <b>description</b> | safety thermostat switch-off temp. 150°C 3-pole 0.5A probe ø 3mm probe L 188mm capillary pipe 1100mm capillary pipe isolated 670mm gland nut probe SS |                 |        |

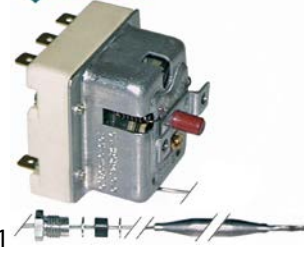

|                    |  |                 |        |
|--------------------|--|-----------------|--------|
| <b>GEV No.</b>     | 375258   | <b>Ref. No.</b> | 807349 |
| <b>description</b> | safety thermostat switch-off temp. 232°C 3-pole 20A probe ø 6mm probe L 94mm capillary pipe 900mm capillary pipe isolated 670mm gland nut M10x1 probe SS |                 |        |



|                    |   |                 |        |
|--------------------|---|-----------------|--------|
| <b>GEV No.</b>     | 375628  | <b>Ref. No.</b> | 808718 |
| <b>description</b> | safety thermostat switch-off temp. 350°C 3-pole 20A probe ø 4mm probe L 120mm capillary pipe 900mm capillary pipe isolated 670mm gland nut M10x1 probe SS |                 |        |





Зип Общепит

vsezip.ru

+7(812)987-08-81



1

|                    |  |                 |                  |
|--------------------|--|-----------------|------------------|
| <b>GEV No.</b>     | 375338   | <b>Ref. No.</b> | C00098<br>C00686 |
| <b>description</b> | safety thermostat switch-off temp. 350°C 3-pole 20A probe ø 6mm probe L 79mm capillary pipe 900mm capillary pipe isolated 700mm gland nut probe SS |                 |                  |



1

|                    |   |                 |        |
|--------------------|---|-----------------|--------|
| <b>GEV No.</b>     | 390797  | <b>Ref. No.</b> | 809505 |
| <b>description</b> | safety thermostat switch-off temp. 157°C 1-pole 16A probe ø 6mm probe L 62mm capillary pipe 1520mm capillary pipe isolated 1380mm gland nut probe |                 |        |



1

|                    |   |                 |           |
|--------------------|---|-----------------|-----------|
| <b>GEV No.</b>     | 390141  | <b>Ref. No.</b> | 513130206 |
| <b>description</b> | safety thermostat switch-off temp. 350°C 3-pole 3NC 20A probe ø 6mm probe L 77mm capillary pipe 1490mm capillary pipe isolated 800mm gland nut probe SS |                 |           |



1

|                    |  |                 |        |
|--------------------|--|-----------------|--------|
| <b>GEV No.</b>     | 390714   | <b>Ref. No.</b> | C00926 |
| <b>description</b> | safety thermostat switch-off temp. 230°C 1-pole 1NC 16A probe ø 6mm probe L 75mm capillary pipe 740mm capillary pipe isolated 200mm gland nut probe SS |                 |        |



1

|                    |  |                 |        |
|--------------------|--|-----------------|--------|
| <b>GEV No.</b>     | 390142   | <b>Ref. No.</b> | 807790 |
| <b>description</b> | safety thermostat switch-off temp. 360°C 3-pole 20A probe ø 3.1mm probe L 188mm capillary pipe 1490mm capillary pipe isolated 800mm gland nut probe SS |                 |        |



1

|                    |  |                 |        |
|--------------------|--|-----------------|--------|
| <b>GEV No.</b>     | 375159   | <b>Ref. No.</b> | 809504 |
| <b>description</b> | safety thermostat switch-off temp. 365°C 1-pole 16A probe ø 4mm probe L 96mm capillary pipe 1160mm capillary pipe isolated 1100mm gland nut probe with special screwing screw connection M14x1 |                 |        |

electric components

Зип Общепит

vsezip.ru

+7(812)987-08-81

control thermostats with operation switch

55.10/19\_ series

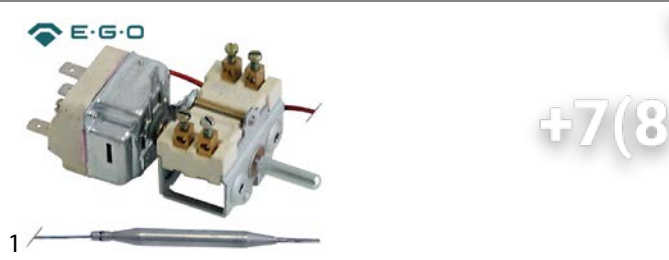

|                        |  |                 |                                  |
|------------------------|--|-----------------|----------------------------------|
| <b>GEV No.</b>         | 375119   | <b>Ref. No.</b> | C98972                           |
| <b>description</b>     | thermostat t.max. 255°C temperature range 45-255°C 1-pole 1CO 16A probe ø 6mm probe L 74mm capillary pipe 900mm capillary pipe isolated 900mm gland nut shaft L 23mm shaft position upper rotation 270° outer switch 2NO |                 |                                  |
| <b>spare parts for</b> | 375119   |                 |                                  |
|                        | <b>GEV No.</b>   | 300091          | <b>Ref. No.</b> 806286<br>C00217 |
|                        | operation switch EGO 2 operating positions 2NO 16A sequence 0-1 shaft ø 6x4.6mm shaft L 23mm connection screw ceramic  |                 |                                  |
|                        | <b>GEV No.</b>   | 375778          | <b>Ref. No.</b> —                |
|                        | thermostat t.max. 255°C temperature range 45-255°C 1-pole 1CO probe ø 6mm probe L 74mm capillary pipe 900mm capillary pipe isolated 900mm gland nut shaft ø 6x4.6mm shaft L 23mm shaft position upper rotation 270°      |                 |                                  |
|                        | <b>GEV No.</b>   | 550060          | <b>Ref. No.</b> C00218           |
|                        | connecting bow long for thermostat Qty 1 pcs   |                 |                                  |

CAEM

control thermostats



|                    |   |                 |        |
|--------------------|---|-----------------|--------|
| <b>GEV No.</b>     | 390082  | <b>Ref. No.</b> | 807256 |
| <b>description</b> | thermostat t.max. 100°C temperature range 30-90°C 1-pole 1CO 16A probe ø 6mm probe L 94mm capillary pipe 1600mm capillary pipe isolatedmm gland nut shaft ø 6x4.6mm shaft L 22mm shaft position upper rotation 270° probe material copper |                 |        |

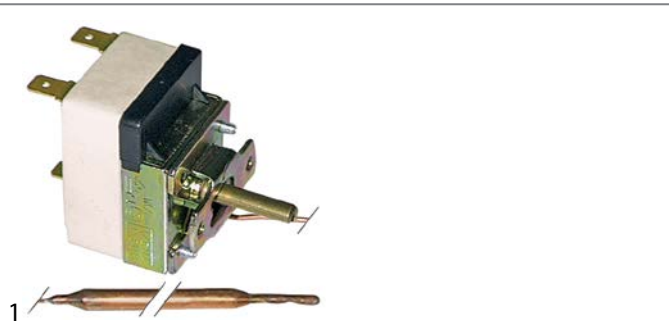

|                    |  |                 |        |
|--------------------|--|-----------------|--------|
| <b>GEV No.</b>     | 375094   | <b>Ref. No.</b> | 828838 |
| <b>description</b> | thermostat t.max. 110°C temperature range 30-110°C 1-pole 1CO 16A probe ø 6mm probe L 75mm capillary pipe 1600mm capillary pipe isolatedmm gland nut shaft ø 6x4.6mm shaft L 22mm shaft position upper rotation 270° probe material copper |                 |        |



|                    |   |                 |        |
|--------------------|---|-----------------|--------|
| <b>GEV No.</b>     | 375545  | <b>Ref. No.</b> | 808809 |
| <b>description</b> | thermostat t.max. 120°C temperature range 30-120°C 1-pole 1CO 16A probe ø 6mm probe L 110mm capillary pipe 1600mm capillary pipe isolated 1550mm gland nut shaft ø 6x4.6mm shaft L 22mm shaft position upper rotation 270° probe material copper 250V |                 |        |

safety thermostats



|                    |  |                 |        |
|--------------------|--|-----------------|--------|
| <b>GEV No.</b>     | 375456   | <b>Ref. No.</b> | 809891 |
| <b>description</b> | safety thermostat switch-off temp. 335°C 2-pole 20A probe ø 3mm probe L 200mm capillary pipe 1050mm capillary pipe isolated 650mm gland nut probe SS at 250V 20A at 400V 10A |                 |        |

refrigeration thermostats

RANCO

K50 series



|                    |  |                 |        |
|--------------------|--|-----------------|--------|
| <b>GEV No.</b>     | 390292   | <b>Ref. No.</b> | 828317 |
| <b>description</b> | thermostat RANCO type K50P1118 probe ømm probe Lmm capillary pipe 1250mm temperature range -3 up to +2.5°C |                 |        |

accessories

capillary tube clips

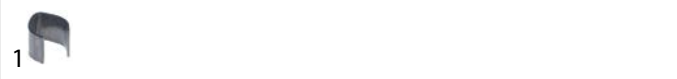

|                    |   |                 |        |
|--------------------|---|-----------------|--------|
| <b>GEV No.</b>     | 550138  | <b>Ref. No.</b> | C10433 |
| <b>description</b> | capillary tube clip for pipe ø 8.5mm for circular tube heating elements |                 |        |



Зип Общепит

vsezip.ru

7 (812) 987-08-81



connecting bows



|   |  |                 |        |
|---|--|-----------------|--------|
|  |  |                 |        |
| 1   |  |                 |        |
| <b>GEV No.</b>  | 550060                                       | <b>Ref. No.</b> | C00218 |
| <b>description</b>  | connecting bow long for thermostat Qty 1 pcs |                 |        |

switches and momentary switches

rocker/momentary rocker switches



30x22mm

|   |   |                 |                     |
|---|---|-----------------|---------------------|
|  |   |                 |                     |
| 1   |   |                 |                     |
| <b>GEV No.</b>  | 301003  | <b>Ref. No.</b> | 712110000<br>818181 |
| <b>description</b>  | rocker switch mounting measurements 30x22mm green 2NO 250V 16A illuminated 0-I connection male faston 6.3mm ambient temperature max. 125/55°C protection IP65 |                 |                     |
| <b>accessories for</b>  | 301003  |                 |                     |
|  | <b>GEV No.</b>  | 301036          | <b>Ref. No.</b> —   |
|   | protective cover internal size 30x22mm for rocker switch mounting measurementsmm  |                 |                     |

|   |   |                 |                   |
|---|---|-----------------|-------------------|
|   |   |                 |                   |
| 1   |   |                 |                   |
| <b>GEV No.</b>  | 301001  | <b>Ref. No.</b> | E61110003         |
| <b>description</b>  | rocker switch mounting measurements 30x22mm red 2NO 250V 16A illuminated 0-I connection male faston 6.3mm ambient temperature max. 125/55°C protection IP65 |                 |                   |
| <b>accessories for</b>  | 301001  |                 |                   |
|  | <b>GEV No.</b>  | 301036          | <b>Ref. No.</b> — |
|   | protective cover internal size 30x22mm for rocker switch mounting measurementsmm  |                 |                   |



|   |  |                 |        |
|---|--|-----------------|--------|
|  |  |                 |        |
| 1   |  |                 |        |
| <b>GEV No.</b>  | 300136   | <b>Ref. No.</b> | C00610 |
| <b>description</b>  | rocker switch mounting measurements 30x22mm green 2NO 24V 16A illuminated connection male faston 6.3mm ambient temperature max. 125/55°C protection IP40 |                 |        |

blank

|   |  |                 |                   |
|---|--|-----------------|-------------------|
|  |  |                 |                   |
| 1   |  |                 |                   |
| <b>GEV No.</b>  | 347675   | <b>Ref. No.</b> | 809832            |
| <b>description</b>  | momentary rocker switch mounting measurements 30x22mm green 2CO 250V 16A illuminated connection male faston 6.3mm ambient temperature max. 125/55°C protection IP65 with cover cap |                 |                   |
| <b>accessories for</b>  | 347675   |                 |                   |
|  | <b>GEV No.</b>   | 301036          | <b>Ref. No.</b> — |
|   | protective cover internal size 30x22mm for rocker switch mounting measurementsmm   |                 |                   |

push/momentary push switches

19x13mm

|   |   |                 |                   |
|---|---|-----------------|-------------------|
|  |   |                 |                   |
| 1   |   |                 |                   |
| <b>GEV No.</b>  | 347605 <sup>1</sup>   | <b>Ref. No.</b> | 809883            |
| <b>description</b>  | push switch mounting measurements 19x13mm yellow 2NO 250V 16A illuminated connection male faston 6.3mm ambient temperature max. 105°C protection IP40 |                 |                   |
| <b>accessories for</b>  | 347605  |                 |                   |
|  | <b>GEV No.</b>  | 346541          | <b>Ref. No.</b> — |
|   | protective cover for rocker switch external size 23.4x17.4mm internal size 19x13mm H 9.5mm mounting measurementsmm                                    |                 |                   |

<sup>1</sup>illuminated

28.5x28.5mm

|   |   |                 |        |
|---|---|-----------------|--------|
|  |   |                 |        |
| 1   |   |                 |        |
| <b>GEV No.</b>  | 347617  | <b>Ref. No.</b> | 809337 |
| <b>description</b>  | momentary push switch mounting measurements 28.5x28.5mm grey 2CO 250V 16A clock connection male faston 6.3mm ambient temperature max. 150°C protection IP40 |                 |        |

|  |   |                 |        |
|--|---|-----------------|--------|
|  |   |                 |        |
| 1  |   |                 |        |
| <b>GEV No.</b>   | 100160  | <b>Ref. No.</b> | C10250 |
| <b>description</b>   | momentary push switch mounting measurements 28.5x28.5mm red 1NO 250V 12A ignition connection male faston 6.3mm ambient temperature max. 85°C protection IP40 mounting ømm |                 |        |

ø16mm

|   |   |                 |        |
|---|---|-----------------|--------|
|  |   |                 |        |
| 1   |   |                 |        |
| <b>GEV No.</b>  | 346287 <sup>1</sup>   | <b>Ref. No.</b> | 809886 |
| <b>description</b>  | momentary push switch mounting ø 16mm red 1NO 250V 3A illuminated connection male faston 2.8mm ambient temperature max. 125/55°C protection IP65 with cover cap |                 |        |

<sup>1</sup>illuminated

|   |  |                 |        |
|---|--|-----------------|--------|
|  |  |                 |        |
| 1   |  |                 |        |
| <b>GEV No.</b>  | 346346   | <b>Ref. No.</b> | 809600 |
| <b>description</b>  | momentary push switch mounting ø 16mm red 1NO/indicator light 250V 3A connection male faston 2.8mm ambient temperature max. 125/55°C protection IP40 |                 |        |





Зип Общежит

microswitches

ø22mm



1

|   |   |                 |                 |
|---|---|-----------------|-----------------|
| <b>GEV No.</b>  | 401357  | <b>Ref. No.</b> | 8C1407          |
| <b>description</b>  | momentary push switch mounting measurements ø22mm 1NO/1NC/indicator light 400V 4A indicator lamp 24V 0-1 connection screw ambient temperature max. 125/55°C protection IP40 |                 |                 |
| <b>spare parts for</b>  | 401357  |                 |                 |
|  | <b>GEV No.</b>  | 346181          | <b>Ref. No.</b> |
|   | push button mounting ø 21mm external size 30x55mm oval  |                 |                 |
| <b>accessories for</b>  | 401357  |                 |                 |
|  | <b>GEV No.</b>  | 401709          | <b>Ref. No.</b> |
|   | protective cover external size 57x32mm internal size 47x22mm matt finish rubber H 27.5mm  |                 |                 |



1

|                    |  |                 |        |
|--------------------|--|-----------------|--------|
| <b>GEV No.</b>     | 699002   | <b>Ref. No.</b> | 809151 |
| <b>description</b> | momentary push switch mounting ø 22mm black/white 1NO/1NC/indicator light 230V 6A 0-1 connection screw ambient temperature max. 70°C protection IP40 |                 |        |

ø25mm



1

|                    |  |                 |        |
|--------------------|--|-----------------|--------|
| <b>GEV No.</b>     | 345162 <sup>1</sup>  | <b>Ref. No.</b> | 8C0427 |
| <b>description</b> | push switch mounting ø 25mm yellow 2NO 250V 16A illuminated connection male faston 6.3mm ambient temperature max. 85°C protection IP40 |                 |        |

<sup>1</sup>illuminated

1

|                    |  |                 |           |
|--------------------|--|-----------------|-----------|
| <b>GEV No.</b>     | 348211   | <b>Ref. No.</b> | 244230001 |
| <b>description</b> | push switch mounting ø 25mm red 1NO/indicator light 250V 16A illuminated connection male faston 6.3mm ambient temperature max. 85°C protection IP65 with cover |                 |           |

universal

vsezip.ru  
CROUZET

7(812)987-08-81



1

|   |  |                 |                 |
|---|--|-----------------|-----------------|
| <b>GEV No.</b>  | 345042   | <b>Ref. No.</b> | 809481          |
| <b>description</b>  | microswitch with plunger 250V 16A 1CO connection male faston 6.3mm L 28mm ambient temperature max. 125°C mounting distance 22mm type EF83161.3 actuating force: 75g blue/black |                 |                 |
| <b>accessories for</b>  | 345042   |                 |                 |
|  | <b>GEV No.</b>   | 345043          | <b>Ref. No.</b> |
|   | lever set 5-piece  |                 |                 |

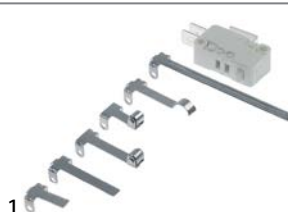

1

|                    |   |                 |           |
|--------------------|---|-----------------|-----------|
| <b>GEV No.</b>     | 348043  | <b>Ref. No.</b> | E61110082 |
| <b>description</b> | microswitch with plunger 250V 16A 1CO connection male faston 6.3mm Lmm L1 27.8mm ambient temperature max. 125°C mounting distance 22mm with lever set type MS1-16 actuating force: 100g white |                 |           |

lever actuated



1

|                    |   |                 |           |
|--------------------|---|-----------------|-----------|
| <b>GEV No.</b>     | 345254  | <b>Ref. No.</b> | E00010041 |
| <b>description</b> | microswitch with lever 250V 16A 1CO connection male faston 6.3mm ambient temperature max. 120°C mounting distance 22mm actuating force: 60g lever length 58mm |                 |           |





1

|                    |  |                 |                  |
|--------------------|--|-----------------|------------------|
| <b>GEV No.</b>     | 300128   | <b>Ref. No.</b> | 807999<br>808053 |
| <b>description</b> | microswitch with lever 250V 16A 1CO connection male faston 6.3mm ambient temperature max. 85°C lever length 63mm |                 |                  |





Зип Общепит  
vsezip.ru  
+7(812)987-08-81

|  |   |                 |           |
|--|---|-----------------|-----------|
|  <p>1</p> |   |                 |           |
| <b>GEV No.</b>   | 346314  | <b>Ref. No.</b> | 132110023 |
| <b>description</b>   | microswitch with lever 250V 16A 1CO connection male faston 6.3mm L 56mm ambient temperature max. 125°C mounting distance 22mm type VRSR01DA1 actuating force: 50g |                 |           |



|  |   |                 |        |
|--|---|-----------------|--------|
|  <p>1</p> |   |                 |        |
| <b>GEV No.</b>   | 345156  | <b>Ref. No.</b> | 809173 |
| <b>description</b>   | microswitch with plunger thread M10x1 thread L 13mm 250V 16A 1CO connection male faston 6.3mm stroke 6mm mounting distance 25mm L 46mm L1 13mm ambient temperature max. 85°C type C4A-ZN3 actuating force: 340g |                 |        |

|  |   |                 |        |
|--|---|-----------------|--------|
|  <p>1</p> |   |                 |        |
| <b>GEV No.</b>   | 345125  | <b>Ref. No.</b> | 809568 |
| <b>description</b>   | microswitch with lever 250V 16A 1CO connection male faston 6.3mm ambient temperature max. 85°C mounting distance 25mm type C9ZP3 actuating force: 25g lever length 63.5mm |                 |        |

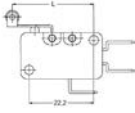
|  |                               |                 |        |
|--|-------------------------------|-----------------|--------|
| <b>accessories</b>   |                               |                 |        |
|  <p>1</p> |                               |                 |        |
| <b>GEV No.</b>   | 698204                        | <b>Ref. No.</b> | 809479 |
| <b>description</b>   | bracket for microswitch C4-C6 |                 |        |

|  |   |                 |           |
|--|---|-----------------|-----------|
| <b>roller-lever actuated</b>   |   |                 |           |
| <b>microswitches</b>   |   |                 |           |
|   <p>1</p> |   |                 |           |
| <b>GEV No.</b>   | 345041  | <b>Ref. No.</b> | E61110082 |
| <b>description</b>   | microswitch with handle with a switch 250V 16A 1CO connection male faston 6.3mm ambient temperature max. 85°C black lever length 20.5mm |                 |           |

|   |   |                 |        |
|---|---|-----------------|--------|
| <b>position switches</b>  |   |                 |        |
| <b>PIZZATO</b>  |   |                 |        |
| <b>FA series</b>  |   |                 |        |
|  <p>1</p> |   |                 |        |
| <b>GEV No.</b>  | 300137  | <b>Ref. No.</b> | C00430 |
| <b>description</b>  | position switch cast aluminum 1NO/1NC 400V 3A L 49mm W 30mm H 16mm protection IP67 actuating force: 1000g screw connection mounting distance 20mm cable length 1800mm |                 |        |

|  |  |                 |                   |
|--|--|-----------------|-------------------|
| <b>pin-plunger actuated</b>  |  |                 |                   |
|   <p>1</p> |  |                 |                   |
| <b>GEV No.</b>   | 345042   | <b>Ref. No.</b> | 809481            |
| <b>description</b>   | microswitch with plunger 250V 16A 1CO connection male faston 6.3mm L 28mm ambient temperature max. 125°C mounting distance 22mm type EF83161.3 actuating force: 75g blue/black |                 |                   |
| <b>accessories for</b>   | 345042   |                 |                   |
|   | <b>GEV No.</b>   | 345043          | <b>Ref. No.</b> — |
| lever set 5-piece  |  |                 |                   |

|  |   |                 |        |
|--|---|-----------------|--------|
| <b>system switches (ROLD)</b>  |   |                 |        |
|  <p>1</p> |   |                 |        |
| <b>GEV No.</b>   | 345131  | <b>Ref. No.</b> | 808948 |
| <b>description</b>   | element holder mounting measurements 28.5x28.5mm grey single element holder |                 |        |

|  |   |                 |                     |
|--|---|-----------------|---------------------|
| <b>M10</b>   |   |                 |                     |
|  <p>1</p> |   |                 |                     |
| <b>GEV No.</b>   | 347216  | <b>Ref. No.</b> | 807351<br>E61110053 |
| <b>description</b>   | microswitch with plunger thread M10x0.75 thread L 14mm 250V 10A 1CO connection male faston 6.3mm stroke 7.5mm mounting distance 22mm L 28mm ambient temperature max. 125°C type NR6K5 actuating force: 260g |                 |                     |

|   |   |                 |        |
|---|---|-----------------|--------|
|  <p>1</p> |   |                 |        |
| <b>GEV No.</b>  | 345606  | <b>Ref. No.</b> | 809021 |
| <b>description</b>  | momentary switch unit 2CO 250V 16A connection male faston 6.3mm |                 |        |

1 electric components



Зип Оффенит

vsezip.ru

+7(812)987-08-81



|   |                    |                                   |                 |        |
|---|--------------------|-----------------------------------|-----------------|--------|
| 1 | <b>GEV No.</b>     | 346211                            | <b>Ref. No.</b> | 808950 |
|   | <b>description</b> | push button ø 23mm grey with lens |                 |        |



|   |                    |                                     |                 |        |
|---|--------------------|-------------------------------------|-----------------|--------|
| 1 | <b>GEV No.</b>     | 346364                              | <b>Ref. No.</b> | 808949 |
|   | <b>description</b> | rotary disc red/white disc ø 20.6mm |                 |        |



|   |                    |  |                 |        |
|---|--------------------|--|-----------------|--------|
| 1 | <b>GEV No.</b>     | 345605   | <b>Ref. No.</b> | 808807 |
|   | <b>description</b> | switch 2CO 250V 16A connection male faston 6.3mm |                 |        |

cam switches

on/off



|   |                    |   |                 |        |
|---|--------------------|---|-----------------|--------|
| 1 | <b>GEV No.</b>     | 300129  | <b>Ref. No.</b> | 808145 |
|   | <b>description</b> | cam switch 2 operating positions 2NO sequence 0-1 16A shaft ø 6x4.6mm shaft L 23mm connection male faston 6.3mm ceramic |                 |        |



|   |                    |   |                 |        |
|---|--------------------|---|-----------------|--------|
| 1 | <b>GEV No.</b>     | 300088  | <b>Ref. No.</b> | C00685 |
|   | <b>description</b> | cam switch 2 operating positions 4NO sequence 0-1 16A shaft ø 6x4.6mm shaft L 23mm connection male faston 6.3mm ceramic |                 |        |



|   |                    |   |                 |        |
|---|--------------------|---|-----------------|--------|
| 1 | <b>GEV No.</b>     | 300074  | <b>Ref. No.</b> | 806286 |
|   | <b>description</b> | cam switch 4 operating positions 2NO sequence 0-1-0-1 16A shaft ø 6x4.6mm shaft L 23mm connection male faston 6.3mm ceramic |                 |        |

7-position



|   |                    |  |                 |        |
|---|--------------------|--|-----------------|--------|
| 1 | <b>GEV No.</b>     | 300025   | <b>Ref. No.</b> | C00213 |
|   | <b>description</b> | cam switch 7 operating positions 1NO/2CO sequence 0-1-2-3-4-5-6 16A shaft ø 6x4.6mm shaft L 23mm connection screw 7-position ceramic |                 |        |

|                        |                |   |                 |   |
|------------------------|----------------|---|-----------------|---|
| <b>accessories for</b> | 300025         |   |                 |   |
|                        | <b>GEV No.</b> | 112172  | <b>Ref. No.</b> | — |
|                        |                | knob universal ø 70mm black without adaptor/dial plate                  |                 |   |
|                        | <b>GEV No.</b> | 112213  | <b>Ref. No.</b> | — |
|                        |                | knob dial plate silver switch 7-position t.max.°C ED ø 63mm ID ø 45.5mm |                 |   |
|                        | <b>GEV No.</b> | 112311  | <b>Ref. No.</b> | — |
|                        |                | knob adapter shaft ø 6x4.6mm L 0mm with spring                          |                 |   |



|   |                    |   |                 |        |
|---|--------------------|---|-----------------|--------|
| 1 | <b>GEV No.</b>     | 300106  | <b>Ref. No.</b> | C00214 |
|   | <b>description</b> | cam switch 7 operating positions 1NO/2CO sequence 0-1-2-3-4-5-6 32A shaft ø 6x4.6mm shaft L 23mm connection screw 7-position shaft flat upper |                 |        |



Зип Общежит

vsezip.ru

+7(812)987-08-81

4 operating positions

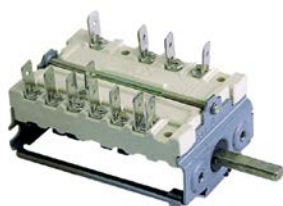

|                    |  |        |                 |        |
|--------------------|--|--------|-----------------|--------|
| 1                  | <b>GEV No.</b>   | 300010 | <b>Ref. No.</b> | 807290 |
| <b>description</b> | cam switch 4 operating positions 2NO/2CO sequence 0-1-2-3 16A shaft $\phi$ 6x4.6mm shaft L 23mm connection male faston 6.3mm ceramic |        |                 |        |



|                    |  |        |                 |                  |
|--------------------|--|--------|-----------------|------------------|
| 1                  | <b>GEV No.</b>   | 300091 | <b>Ref. No.</b> | 806286<br>C00217 |
| <b>description</b> | operation switch EGO 2 operating positions 2NO 16A sequence 0-1 shaft $\phi$ 6x4.6mm shaft L 23mm connection screw ceramic |        |                 |                  |

5 operating positions

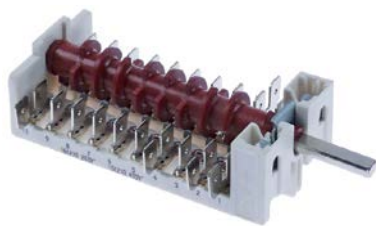

|                    |  |        |                 |        |
|--------------------|--|--------|-----------------|--------|
| 1                  | <b>GEV No.</b>   | 347652 | <b>Ref. No.</b> | 808962 |
| <b>description</b> | cam switch 5 operating positions 5NO/2CO sequence 0-1-2-3-4 16A shaft $\phi$ 6x4.6mm shaft L 23mm connection male faston 6.3mm plastic |        |                 |        |

operation switches



|                    |  |        |                 |                  |
|--------------------|--|--------|-----------------|------------------|
| 1                  | <b>GEV No.</b>   | 300002 | <b>Ref. No.</b> | 808052<br>C00690 |
| <b>description</b> | cam switch 2 operating positions 4NO 16A sequence 0-1 shaft $\phi$ 6x4.6mm shaft L 23mm connection male faston 6.3mm ceramic |        |                 |                  |



|                    |   |        |                 |        |
|--------------------|---|--------|-----------------|--------|
| 1                  | <b>GEV No.</b>  | 300200 | <b>Ref. No.</b> | C00217 |
| <b>description</b> | operation switch 2 operating positions 2NO 16A sequence 0-1 shaft $\phi$ 6x4.6mm shaft L 23mm connection male faston 6.3mm operation switch ceramic |        |                 |        |

magnetic switches

29x19mm



|                    |   |        |                 |        |
|--------------------|---|--------|-----------------|--------|
| 1                  | <b>GEV No.</b>  | 345217 | <b>Ref. No.</b> | 809557 |
| <b>description</b> | magnetic switch L 29mm W 19mm 1NO 125V 0.5A P max. 10W connection cable cable length 2000mm |        |                 |        |

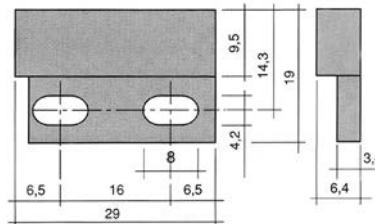

36x13mm



|   |   |        |                 |        |
|---|---|--------|-----------------|--------|
| 1   | <b>GEV No.</b>  | 345335 | <b>Ref. No.</b> | 8C0129 |
| <b>description</b>  | magnetic switch L 36mm W 13mm 1NO 250V 0.04A P max. 10W connection cable cable length 960mm |        |                 |        |
| <b>accessories for</b>  | 345335  |        |                 |        |
|   | <b>GEV No.</b>  | 519049 | <b>Ref. No.</b> | TR0220 |
|  | magnet $\phi$ mm L 63mm H 10.7mm W 18.8mm hole distance 52mm M2 hole $\phi$ 2mm             |        |                 |        |

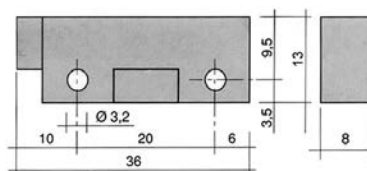

Зип-Общепит

accessories

magnets

vsezip.ru

+7(812)987-08-81

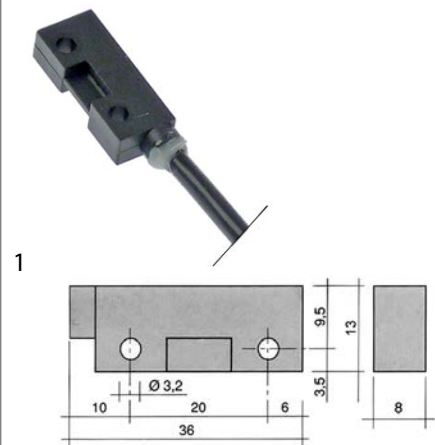

|  |  |                 |                   |
|--|--|-----------------|-------------------|
| <b>GEV No.</b>   | 345118 <sup>1</sup>  | <b>Ref. No.</b> | E61110057         |
| <b>description</b>   | magnetic switch L 36mm W 13mm 1NO 250V 1A P max. 50W connection cable cable length 980mm |                 |                   |
| <b>accessories for</b>   | 345118   |                 |                   |
|  | <b>GEV No.</b>   | 345399          | <b>Ref. No.</b> — |
|  | magnet ø 3.3mm L 40mm H 8mm W 13mm hole distance 30mm M3                                 |                 |                   |

<sup>1</sup>with coded connector

37x16mm

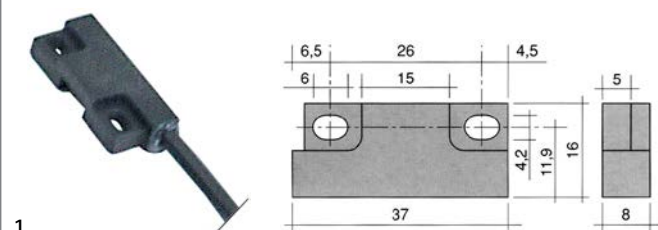

|  |  |                 |                        |
|--|--|-----------------|------------------------|
| <b>GEV No.</b>   | 345600   | <b>Ref. No.</b> | TR0666                 |
| <b>description</b>   | magnetic switch L 37mm W 16mm 1NO 250V 0.2A P max. 50W connection cable cable length 960mm |                 |                        |
| <b>accessories for</b>   | 345600   |                 |                        |
|  | <b>GEV No.</b>   | 519049          | <b>Ref. No.</b> TR0220 |
|  | magnet ømm L 63mm H 10.7mm W 18.8mm hole distance 52mm M2 hole ø 2mm                       |                 |                        |

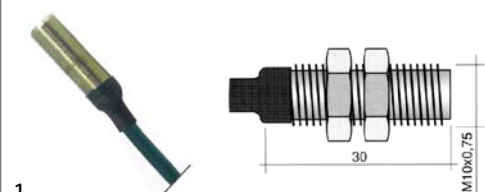

M10x0.75



|  |  |                 |                   |
|--|--|-----------------|-------------------|
| <b>GEV No.</b>   | 345632   | <b>Ref. No.</b> | TR0309            |
| <b>description</b>   | magnetic switch thread M10x0.75 1NO 250V 0.5A P max. 50W connection cable cable length 2000mm type 102 |                 |                   |
| <b>accessories for</b>   | 345632   |                 |                   |
|  | <b>GEV No.</b>   | 100779          | <b>Ref. No.</b> — |
|  | nut thread M10x0.75 H 3mm WS 14 SS Qty 2 pcs   |                 |                   |

|                    |  |                 |        |
|--------------------|--|-----------------|--------|
| <b>GEV No.</b>     | 691178                                   | <b>Ref. No.</b> | 8C2146 |
| <b>description</b> | magnet ø 22mm Lmm H 7mm Wmm ED ø 22mm M5 |                 |        |

|  |   |        |                 |           |
|--|---|--------|-----------------|-----------|
|  | <b>GEV No.</b>  | 345398 | <b>Ref. No.</b> | E00010012 |
| <b>description</b>   | magnet ømm L 36mm H 8mm W 13mm hole distance 20mm M3 hole ø 3mm |        |                 |           |

|  |   |        |                 |        |
|--|---|--------|-----------------|--------|
|  | <b>GEV No.</b>  | 519049 | <b>Ref. No.</b> | TR0220 |
| <b>description</b>   | magnet ømm L 63mm H 10.7mm W 18.8mm hole distance 52mm M2 hole ø 2mm                      |        |                 |        |
| <b>accessories for</b>   | 519049  |        |                 |        |
|   | <b>GEV No.</b>  | 560095 | <b>Ref. No.</b> | —      |
|  | sheet metal screws ø 2.9mm L 9.5mm SS Qty 20 pcs DIN 7981/ISO 7049 head ø 5.6mm oval head |        |                 |        |

control equipment

MOELLER/EATON

switches (complete)

rotary switches



|                    |  |                 |        |
|--------------------|--|-----------------|--------|
| <b>GEV No.</b>     | 300132   | <b>Ref. No.</b> | 808641 |
| <b>description</b> | rotary switch mounting measurements ø22mm green complete |                 |        |



## push/momentary push switches



1

|                    |  |                 |        |
|--------------------|--|-----------------|--------|
| <b>GEV No.</b>     | 300131   | <b>Ref. No.</b> | 800472 |
| <b>description</b> | momentary push switch mounting measurements ø22mm red illuminated, 80-264V 1NO momentary |                 |        |

## ERSCE

## rotary switches



1



|                    |  |                 |        |
|--------------------|--|-----------------|--------|
| <b>GEV No.</b>     | 346691   | <b>Ref. No.</b> | 8C0281 |
| <b>description</b> | rotary selector mounting measurements ø22mm black complete 1 latching / 2 momentary sequence 1-0-2 2NO/1NO 10(4)A max 400V |                 |        |

## GIOVENZANA

## switches (complete)



1

|   |   |                 |                 |   |
|---|---|-----------------|-----------------|---|
| <b>GEV No.</b>  | 401357  | <b>Ref. No.</b> | 8C1437          |   |
| <b>description</b>  | momentary push switch mounting measurements ø22mm 1NO/1NC/indicator light 400V 4A indicator lamp 24V 0-1 connection screw ambient temperature max. 125/55°C protection IP40 |                 |                 |   |
| <b>spare parts for</b>  | 401357  |                 |                 |   |
|  | <b>GEV No.</b>  | 346181          | <b>Ref. No.</b> | — |
|   | push button mounting ø 21mm external size 30x55mm oval  |                 |                 |   |
| <b>accessories for</b>  | 401357  |                 |                 |   |
|  | <b>GEV No.</b>  | 401709          | <b>Ref. No.</b> | — |
|   | protective cover external size 57x32mm internal size 47x22mm matt finish rubber H 27.5mm  |                 |                 |   |

## TELEMECANIQUE (EFA)

## XB2 series

## push buttons



1

|                    |   |                 |                         |
|--------------------|---|-----------------|-------------------------|
| <b>GEV No.</b>     | 300134  | <b>Ref. No.</b> | C00278<br>C00278+C00279 |
| <b>description</b> | push button mounting measurements ø22mm black |                 |                         |



1

|                |        |                 |        |
|----------------|--------|-----------------|--------|
| <b>GEV No.</b> | 345412 | <b>Ref. No.</b> | C00279 |
|----------------|--------|-----------------|--------|

**description** contact block with holder 1NO**spare parts for** 345412

|                |        |                 |   |
|----------------|--------|-----------------|---|
| <b>GEV No.</b> | 345220 | <b>Ref. No.</b> | — |
|----------------|--------|-----------------|---|

contact block EFA ZB2BE101 1NO max 230V 10(6)A black



|                |        |                 |   |
|----------------|--------|-----------------|---|
| <b>GEV No.</b> | 345221 | <b>Ref. No.</b> | — |
|----------------|--------|-----------------|---|

contact block EFA ZB2BE102 1NC max 230V 10(6)A black



|                |        |                 |   |
|----------------|--------|-----------------|---|
| <b>GEV No.</b> | 347526 | <b>Ref. No.</b> | — |
|----------------|--------|-----------------|---|

contact block holder for XB2

## encoders and potentiometers



1

|                |        |                 |           |
|----------------|--------|-----------------|-----------|
| <b>GEV No.</b> | 401953 | <b>Ref. No.</b> | IB5944010 |
|----------------|--------|-----------------|-----------|

**description** PCB hand blenders VORTEX with potentiometer 230V

## lamps

## indicator lights

## indicator lights 2-piece (lens and indicator lamp)

## indicator light lenses

## ø10mm (type SRZ-3)



1

|                    |   |                 |        |
|--------------------|---|-----------------|--------|
| <b>GEV No.</b>     | 359124  | <b>Ref. No.</b> | C00614 |
| <b>description</b> | indicator light housings mounting measurements ø10mm yellow round Qty 1 pcs |                 |        |

**accessories for** 359124

|                |        |                 |        |
|----------------|--------|-----------------|--------|
| <b>GEV No.</b> | 359132 | <b>Ref. No.</b> | 808943 |
|----------------|--------|-----------------|--------|

indicator lamp green 250V connection male faston 6.3mm protection IP54 ambient temperature max. 85°C

## ø13mm (type SFK-3)



1

|                    |  |                 |        |
|--------------------|--|-----------------|--------|
| <b>GEV No.</b>     | 359126   | <b>Ref. No.</b> | 808461 |
| <b>description</b> | indicator light housings mounting measurements ø13mm green Qty 1 pcs |                 |        |

Зип.Общепит

vsezip.ru

+7(812)987-08-81

|   |   |                 |        |
|---|---|-----------------|--------|
|  |   |                 |        |
| 1   |   |                 |        |
| <b>GEV No.</b>  | 359127  | <b>Ref. No.</b> | 809085 |
| <b>description</b>  | indicator light housings mounting measurements ø13mm yellow Qty 1 pcs |                 |        |

|   |  |                 |        |
|---|--|-----------------|--------|
| indicator lamps for socket type SRZ / SDK / SDY / SFK                             |  |                 |        |
|  |  |                 |        |
| 1   |  |                 |        |
| <b>GEV No.</b>  | 359130   | <b>Ref. No.</b> | 809084 |
| <b>description</b>  | indicator lamp 230V clear connection male faston 6.3mm ø 8mm |                 |        |

|   |   |                 |        |
|---|---|-----------------|--------|
|  |   |                 |        |
| 1   |   |                 |        |
| <b>GEV No.</b>  | 359129  | <b>Ref. No.</b> | C00614 |
| <b>description</b>  | indicator lamp 24V clear connection male faston 6.3mm |                 |        |

|   |  |                 |        |
|---|--|-----------------|--------|
|  |  |                 |        |
| 1   |  |                 |        |
| <b>GEV No.</b>  | 359132   | <b>Ref. No.</b> | 808943 |
| <b>description</b>  | indicator lamp green 250V connection male faston 6.3mm protection IP54 ambient temperature max. 85°C |                 |        |

|   |                                  |                 |        |
|---|----------------------------------|-----------------|--------|
| indicator lights (complete)   |                                  |                 |        |
| ø 6mm   |                                  |                 |        |
|  |                                  |                 |        |
| 1   |                                  |                 |        |
| <b>GEV No.</b>  | 359031                           | <b>Ref. No.</b> | 8C0298 |
| <b>description</b>  | indicator light ø 6mm 230V green |                 |        |



|   |  |                 |        |
|---|--|-----------------|--------|
| ø10mm   |  |                 |        |
| with plug-in socket   |  |                 |        |
|  |  |                 |        |
| 1   |  |                 |        |
| <b>GEV No.</b>  | 359138   | <b>Ref. No.</b> | 808969 |
| <b>description</b>  | indicator light ø 10mm red 230V connection male faston 6.3mm Qty 1 pcs |                 |        |

|   |  |                 |        |
|---|--|-----------------|--------|
|  |  |                 |        |
| 1   |  |                 |        |
| <b>GEV No.</b>  | 359334   | <b>Ref. No.</b> | C00614 |
| <b>description</b>  | indicator light ø 10mm yellow 24V connection male faston 6.3mm Qty 1 pcs |                 |        |

|   |  |                 |        |
|---|--|-----------------|--------|
| ø12mm   |  |                 |        |
| with screw socket   |  |                 |        |
|  |  |                 |        |
| 1   |  |                 |        |
| <b>GEV No.</b>  | 359291   | <b>Ref. No.</b> | 809133 |
| <b>description</b>  | indicator light ø 12mm 400V green connection male faston 6.3mm |                 |        |

|   |  |                 |        |
|---|--|-----------------|--------|
| ø13mm   |  |                 |        |
| with plug-in socket   |  |                 |        |
|  |  |                 |        |
| 1   |  |                 |        |
| <b>GEV No.</b>  | 359142   | <b>Ref. No.</b> | 807773 |
| <b>description</b>  | indicator light ø 13mm green 230V connection male faston 6.3mm temp.-resist. 120°C Qty 1 pcs |                 |        |

|   |   |                 |        |
|---|---|-----------------|--------|
|  |   |                 |        |
| 1   |   |                 |        |
| <b>GEV No.</b>  | 359143  | <b>Ref. No.</b> | 806128 |
| <b>description</b>  | indicator light ø 13mm yellow 230V connection male faston 6.3mm temp.-resist. 120°C Qty 1 pcs |                 |        |

|   |   |                 |                 |
|---|---|-----------------|-----------------|
| 30x22mm   |   |                 |                 |
|  |   |                 |                 |
| 1   |   |                 |                 |
| <b>GEV No.</b>  | 359157  | <b>Ref. No.</b> | 806080          |
| <b>description</b>  | indicator light mounting measurements 30x22mm 230V green connection male faston 6.3mm temp.-resist. 125/55°C type RL2 |                 |                 |
| <b>accessories for</b>  | 359157  |                 |                 |
|  | <b>GEV No.</b>  | 301036          | <b>Ref. No.</b> |
|   |   |                 | —               |
|   | protective cover internal size 30x22mm for rocker switch mounting measurementsmm                                      |                 |                 |

|  |                 |                 |        |
|--|-----------------|-----------------|--------|
| miscellaneous  |                 |                 |        |
|  |                 |                 |        |
| Image not available  |                 |                 |        |
| 1  |                 |                 |        |
| <b>GEV No.</b>   | 359335          | <b>Ref. No.</b> | 809133 |
| <b>description</b>   | indicator light |                 |        |



Зип-Общепит

vsezip.ru

+7(812)987-08-81

screw-on/push-on fit

light bulbs

for ovens



1

|                    |   |                 |        |
|--------------------|---|-----------------|--------|
| <b>GEV No.</b>     | 357153  | <b>Ref. No.</b> | 809884 |
| <b>description</b> | light bulb t.max. 300°C socket E14 25W 230V ø 25mm L 55mm lens L 30mm for oven type |                 |        |

hard-glass infrared lamps



1

|                    |   |                 |              |
|--------------------|---|-----------------|--------------|
| <b>GEV No.</b>     | 359463  | <b>Ref. No.</b> | 40XX-XX40999 |
| <b>description</b> | infrared lamp socket E27 240V 250W ø 125mm L 173mm type BR125 red hard glas |                 |              |



oven lamps

universal oven lamps

mounting diameter 35.5mm







1

|   |  |                 |                  |
|---|--|-----------------|------------------|
| <b>GEV No.</b>  | 359718   | <b>Ref. No.</b> | 809935           |
| <b>description</b>  | oven lamp mounting ø 35.5mm 230V 15W socket E14 temp.-resist. 300°C connection male faston 6.3mm hard glas |                 |                  |
| <b>spare parts for</b>  | 359718   |                 |                  |
|  | <b>GEV No.</b>   | 359701          | <b>Ref. No.</b>  |
|   |  |                 | 809715<br>8C0278 |
|   | lamp socket socket E14 220-230V mounting ø 35.5mm connection male faston 6.3mm 15W                         |                 |                  |
|  | <b>GEV No.</b>   | 359740          | <b>Ref. No.</b>  |
|   |  |                 | —                |
|   | light bulb t.max. 300°C socket E14 15W 230V ø 22mm L 48mm lens L 20mm for oven lamp IMPORT                 |                 |                  |



1

|   |  |                 |                  |
|---|--|-----------------|------------------|
| <b>GEV No.</b>  | 359701   | <b>Ref. No.</b> | 809715<br>8C0278 |
| <b>description</b>  | lamp socket socket E14 220-230V mounting ø 35.5mm connection male faston 6.3mm 15W |                 |                  |
| <b>accessories for</b>  | 359701   |                 |                  |
|  | <b>GEV No.</b>   | 359705          | <b>Ref. No.</b>  |
|   |  |                 | —                |
|   | oven lamp glass thr.ø 33.5mm ø 52mm hard glas temp.-resist. 350°C                  |                 |                  |

|   |   |        |                 |
|---|---|--------|-----------------|
| <b>accessories for</b>  | 359701  |        |                 |
|  | <b>GEV No.</b>  | 359709 | <b>Ref. No.</b> |
|   |   |        | —               |
|   | oven lamp glass thr.ø 33.5mm ø 42mm hard glas temp.-resist. 350°C |        |                 |
|  | <b>GEV No.</b>  | 359721 | <b>Ref. No.</b> |
|   |   |        | —               |
|   | gasket silicone ED ø 44mm ID ø 39.5mm thickness 5mm Qty 1 pcs     |        |                 |
|  | <b>GEV No.</b>  | 359942 | <b>Ref. No.</b> |
|   |   |        | —               |
|   | oven lamp glass thr.ø 33.5mm ø 41mm hard glas temp.-resist. 350°C |        |                 |



1

|   |   |                 |                 |
|---|---|-----------------|-----------------|
| <b>GEV No.</b>  | 359661  | <b>Ref. No.</b> | 808808          |
| <b>description</b>  | oven lamp glass thread 32.1 ø 58mm hard glas temp.-resist. 350°C      |                 |                 |
| <b>accessories for</b>  | 359661  |                 |                 |
|  | <b>GEV No.</b>  | 359700          | <b>Ref. No.</b> |
|   |   |                 | —               |
|   | gasket for pizza oven fibre glass ID ø 32.5mm ED ø 55mm thickness 5mm |                 |                 |

mounting diameter 47.8mm

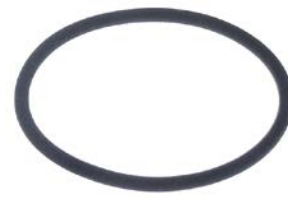

1

|                    |  |                 |        |
|--------------------|--|-----------------|--------|
| <b>GEV No.</b>     | 525313   | <b>Ref. No.</b> | 808709 |
| <b>description</b> | O-ring Viton ID ø 60.33mm thickness 3.53mm Qty 1 pcs |                 |        |



1

|                    |  |                 |        |
|--------------------|--|-----------------|--------|
| <b>GEV No.</b>     | 532649   | <b>Ref. No.</b> | 808710 |
| <b>description</b> | O-ring Viton ID ø 63.17mm thickness 2.62mm Qty 1 pcs |                 |        |



## Зип-Общепит





vsezip.ru

+7(812)987-08-81

mounting diameter 65.5mm



1

|   |   |                 |                        |
|---|---|-----------------|------------------------|
| <b>GEV No.</b>  | 359712  | <b>Ref. No.</b> | 808850                 |
| <b>description</b>  | oven lamp mounting $\phi$ 65.5mm 230V 40W socket E14 temp.-resist. 300°C connection male faston 6.3mm hard glas |                 |                        |
| <b>spare parts for</b>  | 359712  |                 |                        |
|  | <b>GEV No.</b>  | 359022          | <b>Ref. No.</b> —      |
|   | lamp socket socket E14 mounting $\phi$ 65.5mm connection male faston 6.3mm                                      |                 |                        |
|  | <b>GEV No.</b>  | 359611          | <b>Ref. No.</b> —      |
|   | light bulb t.max. 300°C socket E14 40W 230V $\phi$ 45mm L 75mm lens L 50mm for oven lamp IMPORT                 |                 |                        |
|  | <b>GEV No.</b>  | 359722          | <b>Ref. No.</b> —      |
|   | gasket silicone ID $\phi$ 57.5mm ED $\phi$ 68mm thickness 2mm   |                 |                        |
|  | <b>GEV No.</b>  | 359724          | <b>Ref. No.</b> 808851 |
|   | oven lamp glass thread $\phi$ 62mm H 46mm $\phi$ 74mm hard glas temp.-resist. 350°C                             |                 |                        |



1

|                    |   |                 |        |
|--------------------|---|-----------------|--------|
| <b>GEV No.</b>     | 359724  | <b>Ref. No.</b> | 808851 |
| <b>description</b> | oven lamp glass thread $\phi$ 62mm H 46mm $\phi$ 74mm hard glas temp.-resist. 350°C |                 |        |

55x70mm











1

|   |   |                 |                   |
|---|---|-----------------|-------------------|
| <b>GEV No.</b>  | 359297  | <b>Ref. No.</b> | 131110027         |
| <b>description</b>  | frame L 95mm W 81mm mounting distance 68/83mm thickness 6mm |                 |                   |
| <b>accessories for</b>  | 359297  |                 |                   |
|  | <b>GEV No.</b>  | 359299          | <b>Ref. No.</b> — |
|   | gasket L 91mm W 77mm hole $\phi$ 3mm for oven lamp          |                 |                   |

55x70mm



1

|   |   |                 |                        |
|---|---|-----------------|------------------------|
| <b>GEV No.</b>  | 359698  | <b>Ref. No.</b> | 808979                 |
| <b>description</b>  | lamp socket L 100mm W 55mm socket E14 connection male faston 6.3mm                                    |                 |                        |
| <b>spare parts for</b>  | 359698  |                 |                        |
|    | <b>GEV No.</b>  | 358119          | <b>Ref. No.</b> —      |
|   | frame L 118mm W 72mm mounting distance 143mm for bulb socket  |                 |                        |
|    | <b>GEV No.</b>  | 358122          | <b>Ref. No.</b> —      |
|   | gasket L 112mm W 68mm silicone thickness 3mm for bulb socket  |                 |                        |
|    | <b>GEV No.</b>  | 358123          | <b>Ref. No.</b> —      |
|   | lamp glass L 112mm W 68mm   |                 |                        |
|    | <b>GEV No.</b>  | 359612          | <b>Ref. No.</b> —      |
|   | light bulb t.max. 300°C socket E14 25W 230V $\phi$ 25mm L 56mm lens L 30mm for oven lamp type Philips |                 |                        |
|    | <b>GEV No.</b>  | 359714          | <b>Ref. No.</b> 808977 |
|   | gasket for bulb socket  |                 |                        |
|   | <b>GEV No.</b>  | 359715          | <b>Ref. No.</b> 808976 |
|   | lamp glass L 110mm W 65mm thickness 5mm   |                 |                        |
|  | <b>GEV No.</b>  | 359716          | <b>Ref. No.</b> 808975 |
|   | frame for bulb socket   |                 |                        |
| <b>accessories for</b>  | 359698  |                 |                        |
|  | <b>GEV No.</b>  | 359612          | <b>Ref. No.</b> —      |
|   | light bulb t.max. 300°C socket E14 25W 230V $\phi$ 25mm L 56mm lens L 30mm for oven lamp type Philips |                 |                        |
|  | <b>GEV No.</b>  | 359938          | <b>Ref. No.</b> —      |
|   | borosilicate glass L 115mm W 69mm   |                 |                        |





1

|                    |                       |                 |        |
|--------------------|-----------------------|-----------------|--------|
| <b>GEV No.</b>     | 359716                | <b>Ref. No.</b> | 808975 |
| <b>description</b> | frame for bulb socket |                 |        |

Зип Общепит  
vsezip.ru  
+7(812)987-08-81

|   |                        |                 |        |
|---|------------------------|-----------------|--------|
|  |                        |                 |        |
| 1   |                        |                 |        |
| <b>GEV No.</b>  | 359714                 | <b>Ref. No.</b> | 808977 |
| <b>description</b>  | gasket for bulb socket |                 |        |

|   |   |                 |        |
|---|---|-----------------|--------|
|  |   |                 |        |
| 1   |   |                 |        |
| <b>GEV No.</b>  | 359715                                  | <b>Ref. No.</b> | 808976 |
| <b>description</b>  | lamp glass L 110mm W 65mm thickness 5mm |                 |        |

|   |  |                 |        |
|---|--|-----------------|--------|
|  |  |                 |        |
| 1   |  |                 |        |
| <b>GEV No.</b>  | 359698   | <b>Ref. No.</b> | 808979 |
| <b>description</b>  | lamp socket L 100mm W 55mm socket E14 connection male faston 6.3mm |                 |        |

**spare parts for** 359698

|   |  |        |                 |   |
|---|--|--------|-----------------|---|
|  | <b>GEV No.</b>   | 358119 | <b>Ref. No.</b> | — |
|   | frame L 118mm W 72mm mounting distance 143mm for bulb socket |        |                 |   |

|   |  |        |                 |   |
|---|--|--------|-----------------|---|
|  | <b>GEV No.</b>   | 358122 | <b>Ref. No.</b> | — |
|   | gasket L 112mm W 68mm silicone thickness 3mm for bulb socket |        |                 |   |

|   |                           |        |                 |   |
|---|---------------------------|--------|-----------------|---|
|  | <b>GEV No.</b>            | 358123 | <b>Ref. No.</b> | — |
|   | lamp glass L 112mm W 68mm |        |                 |   |

|   |  |        |                 |   |
|---|--|--------|-----------------|---|
|  | <b>GEV No.</b>   | 359612 | <b>Ref. No.</b> | — |
|   | light bulb t.max. 300°C socket E14 25W 230V ø 25mm L 56mm lens L 30mm for oven lamp type Philips |        |                 |   |

|   |                        |        |                 |        |
|---|------------------------|--------|-----------------|--------|
|  | <b>GEV No.</b>         | 359714 | <b>Ref. No.</b> | 808977 |
|   | gasket for bulb socket |        |                 |        |







|   |   |        |                 |        |
|---|---|--------|-----------------|--------|
|  | <b>GEV No.</b>                          | 359715 | <b>Ref. No.</b> | 808976 |
|   | lamp glass L 110mm W 65mm thickness 5mm |        |                 |        |

|   |                       |        |                 |        |
|---|-----------------------|--------|-----------------|--------|
|  | <b>GEV No.</b>        | 359716 | <b>Ref. No.</b> | 808975 |
|   | frame for bulb socket |        |                 |        |

**accessories for** 359698

|   |  |        |                 |   |
|---|--|--------|-----------------|---|
|  | <b>GEV No.</b>   | 359612 | <b>Ref. No.</b> | — |
|   | light bulb t.max. 300°C socket E14 25W 230V ø 25mm L 56mm lens L 30mm for oven lamp type Philips |        |                 |   |

|   |                                   |        |                 |   |
|---|-----------------------------------|--------|-----------------|---|
|  | <b>GEV No.</b>                    | 359938 | <b>Ref. No.</b> | — |
|   | borosilicate glass L 115mm W 69mm |        |                 |   |

|  |  |                 |                 |        |
|--|--|-----------------|-----------------|--------|
|  |  |                 |                 |        |
| <b>GEV No.</b>   | 101372   | <b>Ref. No.</b> | 808569          |        |
| <b>description</b>   | oven lamp complete L 100mm W 55mm 230V 25W socket E14 rectangular temp.-resist. 300°C connection male faston 6.3mm |                 |                 |        |
| <b>spare parts for</b>   | 101372   |                 |                 |        |
|   | <b>GEV No.</b>   | 359612          | <b>Ref. No.</b> | —      |
|  | light bulb t.max. 300°C socket E14 25W 230V ø 25mm L 56mm lens L 30mm for oven lamp type Philips                   |                 |                 |        |
|   | <b>GEV No.</b>   | 359698          | <b>Ref. No.</b> | 808979 |
|  | lamp socket L 100mm W 55mm socket E14 connection male faston 6.3mm   |                 |                 |        |
|   | <b>GEV No.</b>   | 359714          | <b>Ref. No.</b> | 808977 |
|  | gasket for bulb socket   |                 |                 |        |
|   | <b>GEV No.</b>   | 359715          | <b>Ref. No.</b> | 808976 |
|  | lamp glass L 110mm W 65mm thickness 5mm  |                 |                 |        |
|   | <b>GEV No.</b>   | 359716          | <b>Ref. No.</b> | 808975 |
|  | frame for bulb socket  |                 |                 |        |

lamps

light bulbs

|   |   |                 |        |
|---|---|-----------------|--------|
|  |   |                 |        |
| 1   |   |                 |        |
| <b>GEV No.</b>  | 357153  | <b>Ref. No.</b> | 809884 |
| <b>description</b>  | light bulb t.max. 300°C socket E14 25W 230V ø 25mm L 55mm lens L 30mm for oven type |                 |        |

residual heat indicators

|  |                                |                 |        |
|--|--------------------------------|-----------------|--------|
|  |                                |                 |        |
| 1  |                                |                 |        |
| <b>GEV No.</b>   | 359326                         | <b>Ref. No.</b> | 809047 |
| <b>description</b>   | residual heat indicator 4-fold |                 |        |

|  |                                |                 |        |
|--|--------------------------------|-----------------|--------|
|  |                                |                 |        |
| 1  |                                |                 |        |
| <b>GEV No.</b>   | 359327                         | <b>Ref. No.</b> | 809398 |
| <b>description</b>   | residual heat indicator single |                 |        |



## timers

## Зип Общежит

electric timers

## programme timers



1

|   |  |                 |                 |
|---|--|-----------------|-----------------|
| <b>GEV No.</b>  | 360525   | <b>Ref. No.</b> | 809346          |
| <b>description</b>  | timer CDC 11904 engines 1 chambers 4 operation time 10min 230V shaft $\varnothing$ mm shaft Lmm manif. no. 11904F1 / BCR000.0000 motor type M48R ATS                                   |                 |                 |
| <b>spare parts for</b>  | 360525   |                 |                 |
|  | <b>GEV No.</b>   | 360118          | <b>Ref. No.</b> |
|   |  |                 | —               |
|   | motor CDC pinion $\varnothing$ 4.9mm teeth 10 230V voltage AC 50/60Hz turn direction right motor $\varnothing$ 47mm H 19.3mm motor type M48R ATS for timer cable length 260mm 1.9/2.5W |                 |                 |





1

|                    |   |                 |                     |
|--------------------|---|-----------------|---------------------|
| <b>GEV No.</b>     | 360511  | <b>Ref. No.</b> | 8C0289<br>J03CCL001 |
| <b>description</b> | timer FIBER P19 engines 1 chambers 4 operation time 270s 230V shaft $\varnothing$ mm shaft Lmm manif. no. P195JV4H700 motor type M51B-J0R6400 |                 |                     |



1

|   |  |                 |                 |
|---|--|-----------------|-----------------|
| <b>GEV No.</b>  | 360303   | <b>Ref. No.</b> | 809247          |
| <b>description</b>  | timer FIBER P25 engines 2 chambers 5 operation time 72s / 4.8min 230V shaft $\varnothing$ mm shaft Lmm manif. no. P255J05ANM0 motor type M51BJ0R6400 / M51BJ0L6400                               |                 |                 |
| <b>spare parts for</b>  | 360303   |                 |                 |
|  | <b>GEV No.</b>   | 360673          | <b>Ref. No.</b> |
|   |  |                 | —               |
|   | motor kit pinion $\varnothing$ 6.8mm teeth 15 230V voltage AC 50/60Hz turn direction clockwise motor $\varnothing$ 48mm H 18.5mm motor type UDS-40NE1RNZ165 cable length 150mm with holder       |                 |                 |
|  | <b>GEV No.</b>   | 360674          | <b>Ref. No.</b> |
|   |  |                 | —               |
|   | motor kit pinion $\varnothing$ 6.8mm teeth 15 230V voltage AC 50/60Hz turn direction counterclockwise motor $\varnothing$ 48mm H 18.5mm motor type UDS40NE1RNZ165 cable length 150mm with holder |                 |                 |

## with time spread

vsezip.ru

+7(812)987-08-81



1

|                    |   |                 |        |
|--------------------|---|-----------------|--------|
| <b>GEV No.</b>     | 350074  | <b>Ref. No.</b> | 809442 |
| <b>description</b> | timer MS65 operation time 120min time spread 30min 1CO/2NO/1NC at 250V 16A permanent position yes impulse electric shaft $\varnothing$ 6x4.6mm shaft L 22mm mounting distance 28mm connection lateral Invensys 4-pole shaft position lower° |                 |        |





1

|                    |  |                 |        |
|--------------------|--|-----------------|--------|
| <b>GEV No.</b>     | 350073   | <b>Ref. No.</b> | 8C1391 |
| <b>description</b> | timer MS65 with buzzer board operation time 120min time spread 30min 1CO/1NC/2NO at 250V 16A permanent position yes impulse electric shaft $\varnothing$ 6x4.6mm shaft L 20mm with bell mounting distance 28mm connection lateral 3-pole |                 |        |

## mechanical timers



1

|   |  |                 |                 |
|---|--|-----------------|-----------------|
| <b>GEV No.</b>  | 350159   | <b>Ref. No.</b> | 132110014       |
| <b>description</b>  | timer M2 2-pole operation time 120min impulse mechanical 2CO at 250V 16A permanent position yes shaft $\varnothing$ 6x4.6mm shaft 6x4.6mm shaft L 22mm mounting distance 28mm mounting thread M4 connection male faston 6.3mm ambient temperature max. 125°C with buzzer |                 |                 |
| <b>spare parts for</b>  | 350159   |                 |                 |
|  | <b>GEV No.</b>   | 350186          | <b>Ref. No.</b> |
|   |  |                 | —               |
|   | timer M2 2-pole operation time 120min impulse mechanical 2CO at 250V 16A permanent position yes shaft $\varnothing$ 6x4.6mm shaft 6x4.6mm shaft L 23mm mounting distance 28mm  |                 |                 |
|  | <b>GEV No.</b>   | 401062          | <b>Ref. No.</b> |
|   |  |                 | —               |
|   | buzzer board 230VAC L 48mm W 45mm connection Faston 6.3mm  |                 |                 |

Зип Общедит

alarm devices

buzzers

vsezip.ru

+7(812)987-08-81

|  |   |                 |                   |
|--|---|-----------------|-------------------|
|  <p>1</p>   |   |                 |                   |
| <b>GEV No.</b>   | 350030  | <b>Ref. No.</b> | 8C2008            |
| <b>description</b>   | timer M2 2-pole operation time 120min impulse mechanical 2NO at 250V 16A permanent position no shaft ø 6x4.6mm shaft L 23mm mounting distance 28mm connection lateral |                 |                   |
| <b>accessories for</b>   | 350030  |                 |                   |
|             | <b>GEV No.</b>  | 110366          | <b>Ref. No.</b> — |
| knob switch zero mark t.max.°C ø 44mm shaft ø 6x4.6mm shaft flat upper black                 |   |                 |                   |
|             | <b>GEV No.</b>  | 111199          | <b>Ref. No.</b> — |
| dial plate graduation 120min permanent position no rotation 0-330° ø 60mm timers knob ø 45mm |   |                 |                   |

|  |   |                 |                   |
|--|---|-----------------|-------------------|
|  <p>1</p>   |   |                 |                   |
| <b>GEV No.</b>   | 350003  | <b>Ref. No.</b> | 813170            |
| <b>description</b>   | timer M2 with bell 2-pole operation time 120min impulse mechanical 2NO at 250V 16A permanent position no shaft ø 6x4.6mm shaft L 23mm mounting distance 28mm connection lateral |                 |                   |
| <b>accessories for</b>   | 350003  |                 |                   |
|           | <b>GEV No.</b>  | 110366          | <b>Ref. No.</b> — |
| knob switch zero mark t.max.°C ø 44mm shaft ø 6x4.6mm shaft flat upper black                 |   |                 |                   |
|           | <b>GEV No.</b>  | 111199          | <b>Ref. No.</b> — |
| dial plate graduation 120min permanent position no rotation 0-330° ø 60mm timers knob ø 45mm |   |                 |                   |

|  |  |                 |        |
|--|--|-----------------|--------|
|  <p>1</p> |  |                 |        |
| <b>GEV No.</b>   | 350008   | <b>Ref. No.</b> | 809674 |
| <b>description</b>   | timer M2 with bell 2-pole operation time 120min impulse mechanical 2NO at 250V 16A permanent position yes shaft ø 6x4.6mm shaft L 24mm mounting distance 28mm connection lateral |                 |        |

|   |   |                 |        |
|---|---|-----------------|--------|
|  <p>1</p> |   |                 |        |
| <b>GEV No.</b>  | 350136  | <b>Ref. No.</b> | 809553 |
| <b>description</b>  | buzzer 12VAC connection cable 200mm screw mounting 63dB |                 |        |

## contactors

### GENERAL ELECTRIC (AEG)

#### power contactors

|   |  |                 |                  |
|---|--|-----------------|------------------|
|  <p>1</p> |  |                 |                  |
| <b>GEV No.</b>  | 380244   | <b>Ref. No.</b> | 807553<br>8C0148 |
| <b>description</b>  | power contactor resistive load 25A 230VAC (AC3/400V) 9A/4kW main contacts 3NO auxiliary contacts 1NO connection screw connection type AEG LS4K 10A type GE CL00A 310 |                 |                  |

|   |   |                 |        |
|---|---|-----------------|--------|
|  <p>1</p> |   |                 |        |
| <b>GEV No.</b>  | 380261  | <b>Ref. No.</b> | C00571 |
| <b>description</b>  | power contactor resistive load 32A 230VAC (AC3/400V) 17A/7.5kW main contacts 3NO auxiliary contacts 1NO connection screw connection type AEG LS7K 10A type GE CL02A 310 |                 |        |



Зип-Общепит

LOVATO

power contactors



1

|                |        |                 |        |
|----------------|--------|-----------------|--------|
| <b>GEV No.</b> | 380705 | <b>Ref. No.</b> | C00287 |
|----------------|--------|-----------------|--------|

|                    |  |  |  |
|--------------------|--|--|--|
| <b>description</b> | power contactor resistive load 20A 230VAC (AC3/400V) 9A/4kW main contacts 3NO auxiliary contacts 1NO connection screw connection type 11BG0910A230 |  |  |
|--------------------|--|--|--|

|                        |        |  |  |
|------------------------|--------|--|--|
| <b>accessories for</b> | 380705 |  |  |
|------------------------|--------|--|--|



|                    |   |                 |   |
|--------------------|---|-----------------|---|
| <b>GEV No.</b>     | 380057  | <b>Ref. No.</b> | — |
| <b>description</b> | auxiliary contact contacts 1NO/1NC AC1 10A for contactors BG series connection screw type BGX1011 |                 |   |



1

|                |        |                 |        |
|----------------|--------|-----------------|--------|
| <b>GEV No.</b> | 380082 | <b>Ref. No.</b> | C00287 |
|----------------|--------|-----------------|--------|

|                    |   |  |  |
|--------------------|---|--|--|
| <b>description</b> | power contactor resistive load 20A 240VAC (AC3/400V) 9A/4kW main contacts 4NO |  |  |
|--------------------|---|--|--|

SIEMENS

power contactors



1

|                |        |                 |        |
|----------------|--------|-----------------|--------|
| <b>GEV No.</b> | 380645 | <b>Ref. No.</b> | 809820 |
|----------------|--------|-----------------|--------|

|                    |  |  |  |
|--------------------|--|--|--|
| <b>description</b> | power contactor 230VAC with auxiliary contacts |  |  |
|--------------------|--|--|--|

power contactors



1

|                |        |                 |        |
|----------------|--------|-----------------|--------|
| <b>GEV No.</b> | 380882 | <b>Ref. No.</b> | 8C0216 |
|----------------|--------|-----------------|--------|

|                    |   |  |  |
|--------------------|---|--|--|
| <b>description</b> | power contactor resistive load 25A 230VAC AC3 10A main contacts 3NO auxiliary contacts 1NO connection screw connection type J7KN-10D-10 OMRON |  |  |
|--------------------|---|--|--|

solid state relays

CELDUC



1

|                |        |                 |        |
|----------------|--------|-----------------|--------|
| <b>GEV No.</b> | 400105 | <b>Ref. No.</b> | 809558 |
|----------------|--------|-----------------|--------|

|                    |   |  |  |
|--------------------|---|--|--|
| <b>description</b> | solid state relay CELDUC 2 phase 65A 400V 24VDC L 58mm W 45mm plug-in connection screw type 40.00.453 |  |  |
|--------------------|---|--|--|

|                        |        |  |  |
|------------------------|--------|--|--|
| <b>accessories for</b> | 400105 |  |  |
|------------------------|--------|--|--|



|                    |  |                 |   |
|--------------------|--|-----------------|---|
| <b>GEV No.</b>     | 401794   | <b>Ref. No.</b> | — |
| <b>description</b> | connecting cable L 1440mm 4-pole suitable for RATIONAL |                 |   |

relays

power relays

with bracket mounting

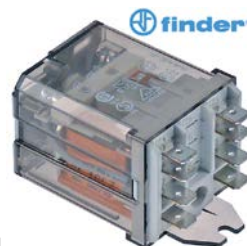

1

|                |        |                 |        |
|----------------|--------|-----------------|--------|
| <b>GEV No.</b> | 380139 | <b>Ref. No.</b> | 809863 |
|----------------|--------|-----------------|--------|

|                    |   |  |  |
|--------------------|---|--|--|
| <b>description</b> | power relays FINDER 230VAC 16A 2CO connection F6.3 bracket mounting dimensions 68x38.2x35.8mm manuf. no. 62.82.8.230.0000 |  |  |
|--------------------|---|--|--|





Зип-Общепит

vsezip.ru

+7(812)987-08-81



1

|                    |   |                 |        |
|--------------------|---|-----------------|--------|
| <b>GEV No.</b>     | 380403  | <b>Ref. No.</b> | 905475 |
| <b>description</b> | power relays FINDER 230VAC 16A 3CO connection F6.3 bracket mounting manuf. no. 62.83.8.230.0500 |                 |        |

with male contacts  
female contact 2.0mm





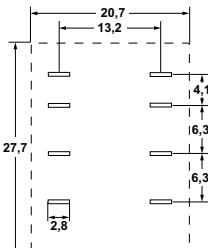

1



|                    |   |                 |        |
|--------------------|---|-----------------|--------|
| <b>GEV No.</b>     | 380129  | <b>Ref. No.</b> | 809015 |
| <b>description</b> | power relays 24VAC 12A 2CO connection F2 plug-in connection 94.92.3 250V connection 2mm |                 |        |

**accessories for** 380129

|   |                    |   |                 |   |
|---|--------------------|---|-----------------|---|
|  | <b>GEV No.</b>     | 380341  | <b>Ref. No.</b> | — |
|   | <b>description</b> | relay socket 4-pole contacts 12 300V voltage AC 6A Italiana Relè manuf. no. ZMD4              |                 |   |
|  | <b>GEV No.</b>     | 380378  | <b>Ref. No.</b> | — |
|   | <b>description</b> | relay socket 2-pole 55/85 dimensions 70.5x30x27mm 250V voltage AC 10A FINDER manuf. no. 94.72 |                 |   |
|  | <b>GEV No.</b>     | 380384  | <b>Ref. No.</b> | — |
|   | <b>description</b> | relay socket 2-pole contacts male faston 2.8mm 250V voltage AC 10A W 23mm for                 |                 |   |
|  | <b>GEV No.</b>     | 380399  | <b>Ref. No.</b> | — |
|   | <b>description</b> | relay socket 4-pole dimensions 76.2x27x86.1mm 250V voltage AC 1A FINDER manuf. no. 94.94.3    |                 |   |

plug-in/print relays



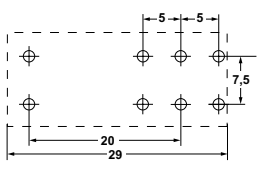

1



|                    |  |                 |           |
|--------------------|--|-----------------|-----------|
| <b>GEV No.</b>     | 380333   | <b>Ref. No.</b> | J03REL001 |
| <b>description</b> | print relay 230VAC 2CO at 250V 8A connection pins raster size 5mm FINDER manuf. no. 40.52.8.230.0000 95.65/95.75 |                 |           |

**accessories for** 380333

|   |                    |  |                 |   |
|---|--------------------|--|-----------------|---|
|  | <b>GEV No.</b>     | 380340   | <b>Ref. No.</b> | — |
|   | <b>description</b> | relay socket dimensions 62x36x15mm 250V voltage AC 10A Italiana Relè manuf. no. ZMEM/5         |                 |   |
|  | <b>GEV No.</b>     | 380505   | <b>Ref. No.</b> | — |
|   | <b>description</b> | relay socket 2CO 40.52 dimensions 81.9x15.5x75mm 250V voltage AC 10A FINDER manuf. no. 95.95.3 |                 |   |

**accessories for** 380333

|                    |   |                 |   |
|--------------------|---|-----------------|---|
| <b>GEV No.</b>     | 381181  | <b>Ref. No.</b> | — |
| <b>description</b> | relay socket 2-pole 40.51/40.52/40.61 connection screw clamp dimensions 15.8x78.6mm 250V voltage AC 10A FINDER manuf. no. 95.75 |                 |   |

relays sockets



1

|                    |  |                 |        |
|--------------------|--|-----------------|--------|
| <b>GEV No.</b>     | 380638   | <b>Ref. No.</b> | 809018 |
| <b>description</b> | relay socket 8-pole dimensions 51x41x23mm 250V 10A FINDER manuf. no. 90.26 |                 |        |

level relays

GICAR



1

|                    |  |                 |        |
|--------------------|--|-----------------|--------|
| <b>GEV No.</b>     | 401173   | <b>Ref. No.</b> | 807853 |
| <b>description</b> | level relay 230V connection F6.3 type RL30/3ES/F |                 |        |

time relays

time relays



1

|                    |   |                 |        |
|--------------------|---|-----------------|--------|
| <b>GEV No.</b>     | 380639  | <b>Ref. No.</b> | 809016 |
| <b>description</b> | time relay TECNOLOGIC RTR12DS065 time range 6s 230VAC 5A mounting measurements 34x34mm 1CO connection plug-in connection round 8-pole |                 |        |

**accessories for** 380639

|   |                    |  |                 |        |
|---|--------------------|--|-----------------|--------|
|  | <b>GEV No.</b>     | 380638   | <b>Ref. No.</b> | 809018 |
|   | <b>description</b> | relay socket 8-pole dimensions 51x41x23mm 250V 10A FINDER manuf. no. 90.26 |                 |        |

Зип Обществит  
electronic controllersDIXELL  
refrigeration controllers

built-in version

+7(812)987-08-81













1

|   |   |                 |                        |
|---|---|-----------------|------------------------|
| <b>GEV No.</b>  | 380640  | <b>Ref. No.</b> | 809019                 |
| <b>description</b>  | time relay TECHNOLOGIC RTR12DS60S time range 60s 230VAC 5A 1CO connection plug-in connection round 8-pole |                 |                        |
| <b>accessories for</b>  | 380640  |                 |                        |
|  | <b>GEV No.</b>  | 380638          | <b>Ref. No.</b> 809018 |
|   | relay socket 8-pole dimensions 51x41x23mm 250V 10A FINDER manuf. no. 90.26                                |                 |                        |



1

|   |  |                 |                           |
|---|--|-----------------|---------------------------|
| <b>GEV No.</b>  | 378384   | <b>Ref. No.</b> | 246430107                 |
| <b>description</b>  | electronic controller DIXELL XR40CX-5NOC1 mounting measurements 71x29mm 230V voltage AC NTC/PTC relay outputs 2 NO-20A(8) CO-8A(3) NTC/PTC NTC/PTC DI -50 up to +150°C display 3½ digits |                 |                           |
| <b>accessories for</b>  | 378384   |                 |                           |
|    | <b>GEV No.</b>   | 378551          | <b>Ref. No.</b> —         |
|   | adapter for reducer mounting measurements 71x29mm  |                 |                           |
|    | <b>GEV No.</b>   | 379053          | <b>Ref. No.</b> —         |
|   | temperature probe PTC 1kOhm cable PVC probe -50 up to +150°C cable -10 up to 100°C probe ø6x30mm cable length 3m without screw connection 2-wire   |                 |                           |
|   | <b>GEV No.</b>   | 379057          | <b>Ref. No.</b> —         |
|   | temperature probe NTC 10kOhm cable PVC probe -20 up to +80°C cable -10 up to 100°C probe ø6x25mm cable length 3m 2-wire  |                 |                           |
|  | <b>GEV No.</b>   | 379064          | <b>Ref. No.</b> —         |
|   | temperature probe PTC 1kOhm cable silicone probe -50 up to +150°C cable -50 up to +180°C probe ø6x40mm cable length 3m without screw connection 2-wire                                   |                 |                           |
|  | <b>GEV No.</b>   | 379142          | <b>Ref. No.</b> E25110070 |
|   | temperature probe PTC 1kOhm cable PVC probe -50 up to +150°C cable -10 up to 100°C probe ø6x30mm cable length 1.5m without screw connection 2-wire                                       |                 |                           |
|  | <b>GEV No.</b>   | 379160          | <b>Ref. No.</b> —         |
|   | temperature probe NTC 10kOhm cable thermoplastic probe -40 up to +110°C cable -40 up to +110°C probe ø6x14mm cable length 1.5m without screw connection 2-wire                           |                 |                           |
|  | <b>GEV No.</b>   | 379161          | <b>Ref. No.</b> —         |
|   | temperature probe NTC 10kOhm cable thermoplastic probe -40 up to +110°C cable -40 up to +110°C probe ø6x14mm cable length 3m without screw connection 2-wire                             |                 |                           |
|  | <b>GEV No.</b>   | 379343          | <b>Ref. No.</b> 825830    |
|   | temperature probe NTC 10kOhm cable silicone probe -40 up to +110°C cable -50 up to +180°C probe ø6x40mm cable length 3m 2-wire   |                 |                           |
|  | <b>GEV No.</b>   | 379749          | <b>Ref. No.</b> —         |
|   | temperature probe NTC 10kOhm cable silicone probe -40 up to +110°C cable -50 up to +180°C probe ø6x30mm cable length 1.5m without screw connection 2-wire                                |                 |                           |
|  | <b>GEV No.</b>   | 379782          | <b>Ref. No.</b> —         |
|   | temperature probe PTC 1kOhm cable thermoplastic probe -50 up to +150°C cable -40 up to +110°C probe ø6x14mm cable length 3m 2-wire resistor 1kOhm  |                 |                           |
|  | <b>GEV No.</b>   | 402818          | <b>Ref. No.</b> —         |
|   | programming key 4K for electronic controller DIXELL  |                 |                           |

## transformers

## open transformers

## with clamp terminal



1

|                    |  |                 |        |
|--------------------|--|-----------------|--------|
| <b>GEV No.</b>     | 401983   | <b>Ref. No.</b> | C00718 |
| <b>description</b> | transformer primary 230V secondary 24V 30VA connection screw 50/60Hz |                 |        |



1

|                    |   |                 |        |
|--------------------|---|-----------------|--------|
| <b>GEV No.</b>     | 400203  | <b>Ref. No.</b> | C00506 |
| <b>description</b> | transformer primary 230V secondary 24V 30VA H 64mm L 75mm W 65mm connection screw 50/60Hz |                 |        |



Зип Общепит

universal controllers

vsezip.ru

built-in version

+7(812)987-08-81



1

|                        |  |                 |           |
|------------------------|--|-----------------|-----------|
| <b>GEV No.</b>         | 378229   | <b>Ref. No.</b> | 246430103 |
| <b>description</b>     | electronic controller DIXELL XW60L-5N0C1 mounting measurements 150x30mm built-in depth 65.5mm 230V voltage AC NTC/PTC relay outputs 4 CO-20A(8) CO-8A(3) NO-8A(3) NO-8A(3) NTC/PTC NTC/PTC DI -50 up to +150°C display 3½ digits |                 |           |
| <b>accessories for</b> | 378229   |                 |           |
|                        | <b>GEV No.</b>   | <b>Ref. No.</b> |           |
|                        | 378194   |                 | —         |
|                        | temperature probe NTC 10kOhm cable PVC probe -20 up to +80°C cable -10 up to 100°C probe ø7x24.5mm cable length 1.5m without screw connection 2-wire   |                 |           |
|                        | <b>GEV No.</b>   | <b>Ref. No.</b> |           |
|                        | 379052   |                 | —         |
|                        | temperature probe PTC 1kOhm cable silicone probe -50 up to +150°C cable -50 up to +180°C probe ø6x40mm cable length 1.5m without screw connection 2-wire   |                 |           |
|                        | <b>GEV No.</b>   | <b>Ref. No.</b> |           |
|                        | 379053   |                 | —         |
|                        | temperature probe PTC 1kOhm cable PVC probe -50 up to +150°C cable -10 up to 100°C probe ø6x30mm cable length 3m without screw connection 2-wire   |                 |           |
|                        | <b>GEV No.</b>   | <b>Ref. No.</b> |           |
|                        | 379057   |                 | —         |
|                        | temperature probe NTC 10kOhm cable PVC probe -20 up to +80°C cable -10 up to 100°C probe ø6x25mm cable length 3m 2-wire  |                 |           |
|                        | <b>GEV No.</b>   | <b>Ref. No.</b> |           |
|                        | 379064   |                 | —         |
|                        | temperature probe PTC 1kOhm cable silicone probe -50 up to +150°C cable -50 up to +180°C probe ø6x40mm cable length 3m without screw connection 2-wire   |                 |           |
|                        | <b>GEV No.</b>   | <b>Ref. No.</b> |           |
|                        | 379160   |                 | —         |
|                        | temperature probe NTC 10kOhm cable thermoplastic probe -40 up to +110°C cable -40 up to +110°C probe ø6x14mm cable length 1.5m without screw connection 2-wire   |                 |           |
|                        | <b>GEV No.</b>   | <b>Ref. No.</b> |           |
|                        | 379161   |                 | —         |
|                        | temperature probe NTC 10kOhm cable thermoplastic probe -40 up to +110°C cable -40 up to +110°C probe ø6x14mm cable length 3m without screw connection 2-wire   |                 |           |
|                        | <b>GEV No.</b>   | <b>Ref. No.</b> |           |
|                        | 379343   |                 | 825830    |
|                        | temperature probe NTC 10kOhm cable silicone probe -40 up to +110°C cable -50 up to +180°C probe ø6x40mm cable length 3m 2-wire   |                 |           |
|                        | <b>GEV No.</b>   | <b>Ref. No.</b> |           |
|                        | 379458   |                 | —         |
|                        | temperature probe NTC 10kOhm cable silicone probe -40 up to +110°C cable -50 up to +180°C probe ø6x40mm cable length 1.5m without screw connection 2-wire  |                 |           |
|                        | <b>GEV No.</b>   | <b>Ref. No.</b> |           |
|                        | 402818   |                 | —         |
|                        | programming key 4K for electronic controller DIXELL  |                 |           |



1

|                        |  |                 |                  |
|------------------------|--|-----------------|------------------|
| <b>GEV No.</b>         | 379605   | <b>Ref. No.</b> | 831131<br>8C0227 |
| <b>description</b>     | electronic controller ELIWELL type ICPlus915 model ICP22J135000 mounting measurements 71x29mm 12V voltage AC/DC Pt100/TC (J,K) relay outputs 2 NO-8A(4) NO-8A(4) Pt100/TC (J,K) cooking front measurements 78x37mm built-in depth 59mm mode of operation cooking protection IPx0 accuracy 1% built-in version defr. funct. no dependend on probe°C display 3½ digits |                 |                  |
| <b>accessories for</b> | 379605   |                 |                  |
|                        | <b>GEV No.</b>   | <b>Ref. No.</b> |                  |
|                        | 379050   |                 | —                |
|                        | temperature probe Pt100 cable Vetrotex probe -200 up to +600°C cable -50 up to +350°C probe ø6x100mm cable length 2.7m without screw connection 3-wire   |                 |                  |
|                        | <b>GEV No.</b>   | <b>Ref. No.</b> |                  |
|                        | 379054   |                 | —                |
|                        | transformer primary 230VAC secondary 12VAC 3VA secondary 0.25A H 40mm L 45mm W 50mm connection screw 50/60Hz type 153/M  |                 |                  |
|                        | <b>GEV No.</b>   | <b>Ref. No.</b> |                  |
|                        | 379785   |                 | —                |
|                        | temperature probe Pt100 cable silicone probe -100 up to 450°C cable -50 up to +180°C probe ø6x100mm cable length 1.5m without screw connection 2-wire resistor 0.1kOhm   |                 |                  |
|                        | <b>GEV No.</b>   | <b>Ref. No.</b> |                  |
|                        | 379786   |                 | —                |
|                        | temperature probe Pt100 cable silicone probe -100 up to 450°C cable -50 up to +180°C probe ø6x100mm cable length 3m without screw connection 2-wire resistor 0.1kOhm   |                 |                  |
|                        | <b>GEV No.</b>   | <b>Ref. No.</b> |                  |
|                        | 379787   |                 | —                |
|                        | temperature probe Pt100 cable Vetrotex probe -200 up to +600°C cable -50 up to +350°C probe ø6x100mm cable length 1.4m without screw connection 2-wire resistor 0.1kOhm  |                 |                  |

refrigeration controllers

built-in version



1

|                        |  |                 |           |
|------------------------|--|-----------------|-----------|
| <b>GEV No.</b>         | 379645   | <b>Ref. No.</b> | 712110005 |
| <b>description</b>     | electronic controller ELIWELL type ID961 mounting measurements 71x29mm 230V voltage AC NTC/PTC relay outputs 1 relay -55 up to +150°C display 3½ digits compressor relay 15A |                 |           |
| <b>accessories for</b> | 379645   |                 |           |
|                        | <b>GEV No.</b>   | <b>Ref. No.</b> |           |
|                        | 379053   |                 | —         |
|                        | temperature probe PTC 1kOhm cable PVC probe -50 up to +150°C cable -10 up to 100°C probe ø6x30mm cable length 3m without screw connection 2-wire                             |                 |           |

Table continues overleaf

electric components

Зип Общепит

vsezip.ru

(812)987-08-81

|                        |  |        |          |   |
|------------------------|--|--------|----------|---|
| <b>accessories for</b> | 379645   |        |          |   |
|                        | GEV No.  | 379064 | Ref. No. | — |
|                        | temperature probe PTC 1kOhm cable silicone probe -50 up to +150°C cable -50 up to +180°C probe ø6x40mm cable length 3m without screw connection 2-wire       |        |          |   |
|                        | GEV No.  | 379161 | Ref. No. | — |
|                        | temperature probe NTC 10kOhm cable thermoplastic probe -40 up to +110°C cable -40 up to +110°C probe ø6x14mm cable length 3m without screw connection 2-wire |        |          |   |
|                        | GEV No.  | 379782 | Ref. No. | — |
|                        | temperature probe PTC 1kOhm cable thermoplastic probe -50 up to +150°C cable -40 up to +110°C probe ø6x14mm cable length 3m 2-wire resistor 1kOhm            |        |          |   |

## EVCO - EVERY CONTROL

### universal controllers

#### built-in version



|                        |   |                 |          |   |
|------------------------|---|-----------------|----------|---|
| <b>GEV No.</b>         | 378169  | <b>Ref. No.</b> | 807302   |   |
| <b>description</b>     | electronic controller EVERY CONTROL EV7401 mounting measurements 66.5x66.5mm built-in depth 90mm 24/230V voltage AC NTC/PTC/Pt100/TC(J,K)/mA relay outputs 1 CO-8A(3) NTC/PTC/Pt100/TC(-J,K)/mA yes protection IP54 dependent on probe°C display 4 digits |                 |          |   |
| <b>accessories for</b> | 378169  |                 |          |   |
|                        | GEV No.   | 379053          | Ref. No. | — |
|                        | temperature probe PTC 1kOhm cable PVC probe -50 up to +150°C cable -10 up to 100°C probe ø6x30mm cable length 3m without screw connection 2-wire  |                 |          |   |
|                        | GEV No.   | 379062          | Ref. No. | — |
|                        | temperature probe thermocouple J (Fe-CuNi) cable Vetrotex probe -50 up to +750°C cable -50 up to +350°C probe ø6x50mm cable length 3m without screw connection 2-wire   |                 |          |   |
|                        | GEV No.   | 379064          | Ref. No. | — |
|                        | temperature probe PTC 1kOhm cable silicone probe -50 up to +150°C cable -50 up to +180°C probe ø6x40mm cable length 3m without screw connection 2-wire  |                 |          |   |
|                        | GEV No.   | 379131          | Ref. No. | — |
|                        | temperature probe Pt100 cable Vetrotex probe -200 up to +600°C cable -50 up to +350°C probe ø6x85mm cable length 3m without screw connection 3-wire resistance at 0°C 100Ohm  |                 |          |   |
|                        | GEV No.   | 379161          | Ref. No. | — |
|                        | temperature probe NTC 10kOhm cable thermoplastic probe -40 up to +110°C cable -40 up to +110°C probe ø6x14mm cable length 3m without screw connection 2-wire  |                 |          |   |

|                    |  |                 |                            |  |
|--------------------|--|-----------------|----------------------------|--|
| <b>GEV No.</b>     | 378151   | <b>Ref. No.</b> | 809889<br>8C0257<br>8C0258 |  |
| <b>description</b> | electronic controller EVERY CONTROL EVK412 mounting measurements 71x29mm built-in depth 59mm 12/24V voltage AC/DC NTC/PTC/Pt100/Pt1000/TC(J,K)/mV/mA relay outputs 2 CO-16A(8) CO-8A(3) NTC/PTC/Pt100/Pt1000/TC(J,K)/mV/mA yes protection IP54 dependent on probe°C display 4 digits |                 |                            |  |

### refrigeration controllers

#### built-in version



|                    |   |                 |                            |  |
|--------------------|---|-----------------|----------------------------|--|
| <b>GEV No.</b>     | 379524  | <b>Ref. No.</b> | 809889<br>8C0257<br>8C0258 |  |
| <b>description</b> | electronic controller EVERY CONTROL type EVK412 mounting measurements 71x29mm 12/24V voltage AC TC/J -100 to +800°C |                 |                            |  |

### timers



|                    |  |                 |        |  |
|--------------------|--|-----------------|--------|--|
| <b>GEV No.</b>     | 379522   | <b>Ref. No.</b> | 809892 |  |
| <b>description</b> | electronic timer EVERY CONTROL type EVK702D2VXS mounting measurements 71x29mm 12V voltage AC/DC time setting range 0.1s.-99h:59min display 4 digits relay outputs 2 8A 8A front measurements 75x33mm |                 |        |  |

### probes

#### universal probes

#### temperature probes



|                    |  |                 |        |  |
|--------------------|--|-----------------|--------|--|
| <b>GEV No.</b>     | 379343   | <b>Ref. No.</b> | 825830 |  |
| <b>description</b> | temperature probe NTC 10kOhm cable silicone probe -40 up to +110°C cable -50 up to +180°C probe ø6x40mm cable length 3m 2-wire |                 |        |  |



Зип Общепит

vsezip.ru

+7(812)987-08-81

|                    |  |                 |           |
|--------------------|--|-----------------|-----------|
|                    |  |                 |           |
| <b>GEV No.</b>     | 379142   | <b>Ref. No.</b> | E25110070 |
| <b>description</b> | temperature probe PTC 1kOhm cable PVC probe -50 up to +150°C cable -10 up to 100°C probe ø6x30mm cable length 1.5m without screw connection 2-wire |                 |           |

|                        |   |                 |                   |
|------------------------|---|-----------------|-------------------|
|                        |   |                 |                   |
| <b>GEV No.</b>         | 379051  | <b>Ref. No.</b> | 8C0221            |
| <b>description</b>     | temperature probe thermocouple J (Fe-CuNi) cable Vetrotex probe -50 up to +750°C cable -50 up to +350°C probe ø6x100mm cable length 3m without screw connection cable colours red/blue 2-wire   |                 |                   |
| <b>accessories for</b> | 379051  |                 |                   |
|                        | <b>GEV No.</b>  | 379877          | <b>Ref. No.</b> — |
| <b>description</b>     | electronic controller HONEYWELL type DC10N-400 mounting measurements 92x92mm 24/230V voltage ACT TC (J) relay outputs 1 CO-10A(6) TC (J) universal built-in depth 55mm protection IP54 accuracy 1% built-in version defr. funct. no 0 up to +400°C display 3 digits |                 |                   |

|                    |   |                 |        |
|--------------------|---|-----------------|--------|
|                    |   |                 |        |
| <b>GEV No.</b>     | 379945  | <b>Ref. No.</b> | 808682 |
| <b>description</b> | core temperature probe Pt100 cable PTFE probe -40 up to +250°C cable -40 up to +250°C connection plug probe ø3.5x100mm thread cable length 0.5m handle ø10mm handle length 80mm |                 |        |

|                    |   |                 |        |
|--------------------|---|-----------------|--------|
|                    |   |                 |        |
| <b>GEV No.</b>     | 379946  | <b>Ref. No.</b> | 8C1187 |
| <b>description</b> | core temperature probe Pt100 cable PTFE probe -40 up to +250°C cable -40 up to +250°C connection plug probe ø3.5x100mm thread cable length 0.7m handle ø10mm handle length 80mm |                 |        |

|                    |  |                 |        |
|--------------------|--|-----------------|--------|
|                    |  |                 |        |
| <b>GEV No.</b>     | 379548   | <b>Ref. No.</b> | 8C1881 |
| <b>description</b> | core temperature probe PTC 1kOhm cable silicone probe -50 up to +150°C cable -50 up to +180°C connection 4-wire probe ø5x70mm thread cable length 1.2m handle ø10mm handle length 120mm L1 150mm L2 80mm |                 |        |

|                    |   |                 |        |
|--------------------|---|-----------------|--------|
|                    |   |                 |        |
| <b>GEV No.</b>     | 381426  | <b>Ref. No.</b> | 809658 |
| <b>description</b> | core temperature probe thermocouple K (NiCr-Ni) cable PTFE probe -40 up to +250°C cable -40 up to +250°C connection 2-wire probe ø3.2x100mm thread M12 cable length 1.9m handle ø10mm handle length 100mm |                 |        |

producer-specific probes

probes

|                    |   |                 |        |
|--------------------|---|-----------------|--------|
|                    |   |                 |        |
| <b>GEV No.</b>     | 378011  | <b>Ref. No.</b> | 809887 |
| <b>description</b> | core temperature probe Pt100 cable silicone probe -40 up to +120°C cable -50 up to +180°C connection 2-wire thread probe ø3x150mm cable length 2m |                 |        |

|                    |   |                 |         |
|--------------------|---|-----------------|---------|
|                    |   |                 |         |
| <b>GEV No.</b>     | 379756  | <b>Ref. No.</b> | 9629931 |
| <b>description</b> | probe Pt100 cable PTFE probe -100 up to 450°C cable -40 up to +250°C connection 3-wire thread M12x1 probe ø4x50mm cable length 1.5m |                 |         |

|                    |  |                 |        |
|--------------------|--|-----------------|--------|
|                    |  |                 |        |
| <b>GEV No.</b>     | 381430   | <b>Ref. No.</b> | 809525 |
| <b>description</b> | temperature probe thermocouple K (NiCr-Ni) cable silicone probe -50 up to 1150°C cable -50 up to +180°C connection 2-wire thread probe ø2x100mm cable length 0.25m |                 |        |

|                    |   |                 |        |
|--------------------|---|-----------------|--------|
|                    |   |                 |        |
| <b>GEV No.</b>     | 379124  | <b>Ref. No.</b> | 809564 |
| <b>description</b> | temperature probe thermocouple K (NiCr-Ni) cable silicone probe -50 up to 1150°C cable -50 up to +180°C connection 2-wire thread probe ø2x100mm cable length 2.2m |                 |        |

electric components



## electronics

## PCBs



1

|                    |   |                 |        |
|--------------------|---|-----------------|--------|
| <b>GEV No.</b>     | 400098  | <b>Ref. No.</b> | 809736 |
| <b>description</b> | control PCB combi-steamer CD 101/CM 101 without EPROM |                 |        |



1

|                    |        |                 |        |
|--------------------|--------|-----------------|--------|
| <b>GEV No.</b>     | 400200 | <b>Ref. No.</b> | 809431 |
| <b>description</b> | PCB    |                 |        |



1

|                    |         |                 |        |
|--------------------|---------|-----------------|--------|
| <b>GEV No.</b>     | 400202  | <b>Ref. No.</b> | C00566 |
| <b>description</b> | PCB 24V |                 |        |



1

|                    |                   |                 |        |
|--------------------|-------------------|-----------------|--------|
| <b>GEV No.</b>     | 401171            | <b>Ref. No.</b> | 809099 |
| <b>description</b> | PCB combi-steamer |                 |        |

Зип Общепит

vsezip.ru

+7(812)987-08-81



|                    |  |                 |           |
|--------------------|--|-----------------|-----------|
| <b>GEV No.</b>     | 401953   | <b>Ref. No.</b> | IB5944010 |
| <b>description</b> | PCB hand blenders VORTEX with potentiometer 230V |                 |           |



1

|                    |                                     |                 |        |
|--------------------|-------------------------------------|-----------------|--------|
| <b>GEV No.</b>     | 697908                              | <b>Ref. No.</b> | 807598 |
| <b>description</b> | PCB L 102mm W 95mm 50/60Hz 230/400V |                 |        |



1

|                    |                                    |                 |        |
|--------------------|------------------------------------|-----------------|--------|
| <b>GEV No.</b>     | 401451                             | <b>Ref. No.</b> | 809432 |
| <b>description</b> | PCB pyroceram range 110/920 series |                 |        |



1

|                    |                     |                 |        |
|--------------------|---------------------|-----------------|--------|
| <b>GEV No.</b>     | 400955              | <b>Ref. No.</b> | 808629 |
| <b>description</b> | PCB slicer 230/400V |                 |        |

**accessories for** 400955

|                |        |                 |        |
|----------------|--------|-----------------|--------|
| <b>GEV No.</b> | 401357 | <b>Ref. No.</b> | 8C1437 |
|----------------|--------|-----------------|--------|

 momentary push switch mounting measurements  $\varnothing 22\text{mm}$   
1NO/1NC/indicator light 400V 4A indicator lamp 24V 0-1 connection  
screw ambient temperature max. 125/55°C protection IP40

|                    |  |                 |   |
|--------------------|--|-----------------|---|
| <b>GEV No.</b>     | 401709   | <b>Ref. No.</b> | — |
| <b>description</b> | protective cover external size 57x32mm internal size 47x22mm matt finish rubber H 27.5mm |                 |   |



1

|                    |                                    |                 |                        |
|--------------------|------------------------------------|-----------------|------------------------|
| <b>GEV No.</b>     | 403575                             | <b>Ref. No.</b> | E61110058<br>E61110059 |
| <b>description</b> | PCB slicer L 128mm W 43mm 230-400V |                 |                        |



Зип Общепит vs.p.ru



+7(812)987-08-81



|   |                                |                 |        |
|---|--------------------------------|-----------------|--------|
|  |                                |                 |        |
| 1   |                                |                 |        |
| <b>GEV No.</b>  | 400954                         | <b>Ref. No.</b> | 808742 |
| <b>description</b>  | PCB slicer/cutter 50/60Hz 230V |                 |        |

|   |  |                 |        |
|---|--|-----------------|--------|
| ROBERTO A. W. INVENZYS  |  |                 |        |
| medium temperature: 90°C 90°C 60°C  |  |                 |        |
| ambient temperature: 60°C 25°C 60°C   |  |                 |        |
| duty cycle: 40% 100% 100%   |  |                 |        |
| with coded terminal   |  |                 |        |
|  |  |                 |        |
| 1   |  |                 |        |
| <b>GEV No.</b>  | 370269   | <b>Ref. No.</b> | 809565 |
| <b>description</b>  | solenoid valve double straight 230VAC inlet 3/4" outlet 11.5mm DN10 EATON (INVENSYS) |                 |        |

keypads



keypad units

|   |  |                 |                 |
|---|--|-----------------|-----------------|
|  |  |                 |                 |
| 1   |  |                 |                 |
| <b>GEV No.</b>  | 401735   | <b>Ref. No.</b> | 8C0477          |
| <b>description</b>  | keypad unit meat mincer TC12 buttons 3 cable length 90mm L 130mm W 41mm cable colours brown/yellow/grey/green/pink/white |                 |                 |
| <b>accessories for</b>  | 401735   |                 |                 |
|  | <b>GEV No.</b>   | 401373          | <b>Ref. No.</b> |
|   |  |                 | —               |
|   | gasket for keypad housing L 135mm W 50mm   |                 |                 |

|   |  |                 |                 |
|---|--|-----------------|-----------------|
|  |  |                 |                 |
| 1   |  |                 |                 |
| <b>GEV No.</b>  | 403002   | <b>Ref. No.</b> | 808612          |
| <b>description</b>  | keypad unit slicer buttons 2 MIRRA/SAN-DANIELE/YORK L 120mm W 48mm |                 |                 |
| <b>accessories for</b>  | 403002   |                 |                 |
|  | <b>GEV No.</b>   | 403004          | <b>Ref. No.</b> |
|   |  |                 | —               |
|   | gasket for keypad housing L 122mm W 52mm                           |                 |                 |

solenoid valves

solenoid valves (water)

|  |  |                 |                 |
|--|--|-----------------|-----------------|
| ELBI   |  |                 |                 |
| straight   |  |                 |                 |
|  |  |                 |                 |
| 1  |  |                 |                 |
| <b>GEV No.</b>   | 373018   | <b>Ref. No.</b> | 809566          |
| <b>description</b>   | solenoid valve single straight 230VAC inlet 3/4" outlet 14mm DN10 ELBI |                 |                 |
| <b>spare parts for</b>   | 373018   |                 |                 |
|                                     | <b>GEV No.</b>   | 370467          | <b>Ref. No.</b> |
|  |  |                 | —               |
|  | solenoid valve filter suitable for ELBI                                |                 |                 |

|   |  |                 |        |
|---|--|-----------------|--------|
| RPE   |  |                 |        |
| reducers  |  |                 |        |
| outlet side   |  |                 |        |
|  |  |                 |        |
| 1   |  |                 |        |
| <b>GEV No.</b>  | 371269                                 | <b>Ref. No.</b> | 8C0117 |
| <b>description</b>  | reducer flow rate 0.07-0.14l/min brown |                 |        |









|  |  |                 |                 |
|--|--|-----------------|-----------------|
| TP   |  |                 |                 |
|  |  |                 |                 |
| 1  |  |                 |                 |
| <b>GEV No.</b>   | 370017   | <b>Ref. No.</b> | 809327          |
| <b>description</b>   | solenoid valve single straight 230VAC inlet 3/4" outlet 11.5mm DN10 TP p max 10bar |                 |                 |
| <b>spare parts for</b>   | 370017   |                 |                 |
|   | <b>GEV No.</b>   | 371013          | <b>Ref. No.</b> |
|  |  |                 | —               |
|  | solenoid coil TP 230VAC 50/60Hz  |                 |                 |
| <b>accessories for</b>   | 370017   |                 |                 |
|   | <b>GEV No.</b>   | 371220          | <b>Ref. No.</b> |
|  |  |                 | —               |
|  | reducer TP flow rate 3l/min red tolerance ±15%                                     |                 |                 |
|   | <b>GEV No.</b>   | 371221          | <b>Ref. No.</b> |
|  |  |                 | —               |
|  | reducer TP flow rate 5.5l/min yellow tolerance ±15%                                |                 |                 |
|   | <b>GEV No.</b>   | 371222          | <b>Ref. No.</b> |
|  |  |                 | —               |
|  | reducer TP flow rate 6l/min grey tolerance ±15%                                    |                 |                 |
|   | <b>GEV No.</b>   | 371223          | <b>Ref. No.</b> |
|  |  |                 | —               |
|  | reducer TP flow rate 10l/min white tolerance ±15%                                  |                 |                 |
|   | <b>GEV No.</b>   | 371224          | <b>Ref. No.</b> |
|  |  |                 | —               |
|  | reducer TP flow rate 12l/min bronze tolerance ±15%                                 |                 |                 |
|   | <b>GEV No.</b>   | 371225          | <b>Ref. No.</b> |
|  |  |                 | —               |
|  | reducer TP flow rate 16l/min light brown tolerance ±15%                            |                 |                 |











Table continues overleaf







Зип-Общепит

vsezip.ru

+7(812)987-08-81

| accessories for   |   | 370017   |   |
|---|---|----------|---|
| GEV No.   | 371226  | Ref. No. | — |
|    | reducer TP flow rate 20l/min red tolerance ±15% |          |   |
|    | 371230  | Ref. No. | — |
| reducer TP flow rate 0.25l/min red tolerance ±25%                                   |   |          |   |
|    | 371231  | Ref. No. | — |
| reducer TP flow rate 0.35l/min violet tolerance ±25%                                |   |          |   |
|    | 371232  | Ref. No. | — |
| reducer TP flow rate 0.5l/min orange tolerance ±25%                                 |   |          |   |
|    | 371233  | Ref. No. | — |
| reducer TP flow rate 0.8l/min white tolerance ±25%                                  |   |          |   |
|    | 371234  | Ref. No. | — |
| reducer TP flow rate 1l/min light blue tolerance ±25%                               |   |          |   |
|    | 371235  | Ref. No. | — |
| reducer TP flow rate 1.2l/min brown tolerance ±25%                                  |   |          |   |
|    | 371236  | Ref. No. | — |
| reducer TP flow rate 1.5l/min light brown tolerance ±25%                            |   |          |   |
|    | 371237  | Ref. No. | — |
| reducer TP flow rate 2.5l/min yellow tolerance ±25%                                 |   |          |   |
|   | 371238  | Ref. No. | — |
| reducer TP flow rate 3.4l/min dark green tolerance ±25%                             |   |          |   |
|  | 371239  | Ref. No. | — |
| reducer TP flow rate 5l/min black tolerance ±25%                                    |   |          |   |
|  | 371240  | Ref. No. | — |
| reducer TP flow rate 8l/min blue tolerance ±20%                                     |   |          |   |

|  |  |          |           |
|---|--|----------|-----------|
| 1   |  |          |           |
| GEV No.   | 370026   | Ref. No. | E00010011 |
| description   | solenoid valve triple straight 230VAC inlet 3/4" outlet 14mm DN10 TP |          |           |
| spare parts for   | 370026   |          |           |
|  | 371013   | Ref. No. | —         |
| solenoid coil TP 230VAC 50/60Hz   |  |          |           |
| accessories for   | 370026   |          |           |
|  | 371220   | Ref. No. | —         |
| reducer TP flow rate 3l/min red tolerance ±15%                                      |  |          |           |
|  | 371221   | Ref. No. | —         |
| reducer TP flow rate 5.5l/min yellow tolerance ±15%                                 |  |          |           |
|  | 371222   | Ref. No. | —         |
| reducer TP flow rate 6l/min grey tolerance ±15%                                     |  |          |           |

| accessories for   |   | 370026   |   |
|---|---|----------|---|
| GEV No.   | 371223  | Ref. No. | — |
|    | reducer TP flow rate 10l/min white tolerance ±15% |          |   |
|    | 371224  | Ref. No. | — |
| reducer TP flow rate 12l/min bronze tolerance ±15%                                  |   |          |   |
|    | 371225  | Ref. No. | — |
| reducer TP flow rate 16l/min light brown tolerance ±15%                             |   |          |   |
|    | 371226  | Ref. No. | — |
| reducer TP flow rate 20l/min red tolerance ±15%                                     |   |          |   |
|    | 371230  | Ref. No. | — |
| reducer TP flow rate 0.25l/min red tolerance ±25%                                   |   |          |   |
|    | 371231  | Ref. No. | — |
| reducer TP flow rate 0.35l/min violet tolerance ±25%                                |   |          |   |
|    | 371232  | Ref. No. | — |
| reducer TP flow rate 0.5l/min orange tolerance ±25%                                 |   |          |   |
|    | 371233  | Ref. No. | — |
| reducer TP flow rate 0.8l/min white tolerance ±25%                                  |   |          |   |
|    | 371234  | Ref. No. | — |
| reducer TP flow rate 1l/min light blue tolerance ±25%                               |   |          |   |
|   | 371235  | Ref. No. | — |
| reducer TP flow rate 1.2l/min brown tolerance ±25%                                  |   |          |   |
|  | 371236  | Ref. No. | — |
| reducer TP flow rate 1.5l/min light brown tolerance ±25%                            |   |          |   |
|  | 371237  | Ref. No. | — |
| reducer TP flow rate 2.5l/min yellow tolerance ±25%                                 |   |          |   |
|  | 371238  | Ref. No. | — |
| reducer TP flow rate 3.4l/min dark green tolerance ±25%                             |   |          |   |
|  | 371239  | Ref. No. | — |
| reducer TP flow rate 5l/min black tolerance ±25%                                    |   |          |   |
|  | 371240  | Ref. No. | — |
| reducer TP flow rate 8l/min blue tolerance ±20%                                     |   |          |   |







Зип-Общепит

vsezip.ru

+7(812)987-08-81

|   |  |                 |                   |
|---|--|-----------------|-------------------|
|    |  |                 |                   |
|    |  |                 |                   |
| 1   |  |                 |                   |
| <b>GEV No.</b>  | 370015   | <b>Ref. No.</b> | 051J00002         |
| <b>description</b>  | solenoid valve single angled 230VAC inlet 3/4" outlet 11.5mm DN10 TP |                 |                   |
| <b>accessories for</b>  | 370015   |                 |                   |
|    | <b>GEV No.</b>   | 371220          | <b>Ref. No.</b> — |
|   | reducer TP flow rate 3l/min red tolerance ±15%                       |                 |                   |
|    | <b>GEV No.</b>   | 371221          | <b>Ref. No.</b> — |
|   | reducer TP flow rate 5.5l/min yellow tolerance ±15%                  |                 |                   |
|    | <b>GEV No.</b>   | 371222          | <b>Ref. No.</b> — |
|   | reducer TP flow rate 6l/min grey tolerance ±15%                      |                 |                   |
|    | <b>GEV No.</b>   | 371223          | <b>Ref. No.</b> — |
|   | reducer TP flow rate 10l/min white tolerance ±15%                    |                 |                   |
|    | <b>GEV No.</b>   | 371224          | <b>Ref. No.</b> — |
|   | reducer TP flow rate 12l/min bronze tolerance ±15%                   |                 |                   |
|  | <b>GEV No.</b>   | 371225          | <b>Ref. No.</b> — |
|   | reducer TP flow rate 16l/min light brown tolerance ±15%              |                 |                   |
|  | <b>GEV No.</b>   | 371226          | <b>Ref. No.</b> — |
|   | reducer TP flow rate 20l/min red tolerance ±15%                      |                 |                   |
|  | <b>GEV No.</b>   | 371230          | <b>Ref. No.</b> — |
|   | reducer TP flow rate 0.25l/min red tolerance ±25%                    |                 |                   |
|  | <b>GEV No.</b>   | 371231          | <b>Ref. No.</b> — |
|   | reducer TP flow rate 0.35l/min violet tolerance ±25%                 |                 |                   |
|  | <b>GEV No.</b>   | 371232          | <b>Ref. No.</b> — |
|   | reducer TP flow rate 0.5l/min orange tolerance ±25%                  |                 |                   |
|  | <b>GEV No.</b>   | 371233          | <b>Ref. No.</b> — |
|   | reducer TP flow rate 0.8l/min white tolerance ±25%                   |                 |                   |
|  | <b>GEV No.</b>   | 371234          | <b>Ref. No.</b> — |
|   | reducer TP flow rate 1l/min light blue tolerance ±25%                |                 |                   |
|  | <b>GEV No.</b>   | 371235          | <b>Ref. No.</b> — |
|   | reducer TP flow rate 1.2l/min brown tolerance ±25%                   |                 |                   |
|  | <b>GEV No.</b>   | 371236          | <b>Ref. No.</b> — |
|   | reducer TP flow rate 1.5l/min light brown tolerance ±25%             |                 |                   |
|  | <b>GEV No.</b>   | 371237          | <b>Ref. No.</b> — |
|   | reducer TP flow rate 2.5l/min yellow tolerance ±25%                  |                 |                   |
|  | <b>GEV No.</b>   | 371238          | <b>Ref. No.</b> — |
|   | reducer TP flow rate 3.4l/min dark green tolerance ±25%              |                 |                   |

|   |  |        |                   |
|---|--|--------|-------------------|
| <b>accessories for</b>  | 370015   |        |                   |
|  | <b>GEV No.</b>                                   | 371239 | <b>Ref. No.</b> — |
|   | reducer TP flow rate 5l/min black tolerance ±25% |        |                   |
|  | <b>GEV No.</b>                                   | 371240 | <b>Ref. No.</b> — |
|   | reducer TP flow rate 8l/min blue tolerance ±20%  |        |                   |

solenoid valves with reducers

|  |  |                 |        |
|--|--|-----------------|--------|
|  |  |                 |        |
| 1  |  |                 |        |
| <b>GEV No.</b>   | 370628   | <b>Ref. No.</b> | 8C0145 |
| <b>description</b>   | solenoid valve double straight 230VAC inlet 3/4" input 16l/min DN10 TP plastic outlet 11.5mm |                 |        |

|  |   |                 |        |
|--|---|-----------------|--------|
|  |   |                 |        |
| 1  |   |                 |        |
| <b>GEV No.</b>   | 370250  | <b>Ref. No.</b> | 902410 |
| <b>description</b>   | solenoid valve triple straight 230VAC inlet 3/4" outlet 11.5mm t.max. 90°C TP plastic output B 0.25l/min flow regulating valve outlet B red |                 |        |

pressure switches for steam control

|   |   |                 |        |
|---|---|-----------------|--------|
|  |   |                 |        |
| 1   |   |                 |        |
| <b>GEV No.</b>  | 541074  | <b>Ref. No.</b> | 8C0444 |
| <b>description</b>  | pressure control ø 45mm triggering pressure 0.5bar reset pressure 0.35bar pressure connection vertical steam control pressure range 0.35/0.51bar connection 1/8" pressure connection 1/8" |                 |        |

|   |  |                 |        |
|---|--|-----------------|--------|
|  |  |                 |        |
| 1   |  |                 |        |
| <b>GEV No.</b>  | 541025   | <b>Ref. No.</b> | 808590 |
| <b>description</b>  | pressure control pressure connection vertical steam control pressure range adjustable 0.2-0.9bar connection male faston 6.3mm pressure connection ø 1/4"mm |                 |        |



for combi-steamers

Зип.Общепит

compressors

ACC/ZEL  
R404a/R507

HMBP monophasе

High/Medium evaporation temperature above -20/-15 °C



|                    |  |                 |        |
|--------------------|--|-----------------|--------|
| <b>GEV No.</b>     | 345218   | <b>Ref. No.</b> | 809509 |
| <b>description</b> | pressure control pressure range 0-3mbar connection 6mm pressure connection 6mm |                 |        |



|                    |  |                 |        |
|--------------------|--|-----------------|--------|
| <b>GEV No.</b>     | 541329   | <b>Ref. No.</b> | 809754 |
| <b>description</b> | pressure control pressure range 350/150mbar connection 8mm pressure connection 8mm |                 |        |



|                    |  |                 |        |
|--------------------|--|-----------------|--------|
| <b>GEV No.</b>     | 605068   | <b>Ref. No.</b> | 8C1859 |
| <b>description</b> | compressor coolant R404a/R507 type ML45TB 220-240V 50Hz HMBP fully hermetic 10kg 1/5HP cylinder capacity 4.5cm <sup>3</sup> CSIR H 175.5mmW 192W 246W 309W 382W 465W 557W 659W 771W test method ASHRAE |                 |        |



|                    |  |                 |        |
|--------------------|--|-----------------|--------|
| <b>GEV No.</b>     | 605014   | <b>Ref. No.</b> | 8C1862 |
| <b>description</b> | compressor coolant R404a/R507 type ML80TB 220-240V 50Hz HMBP fully hermetic 11.4kg 3/8HP cylinder capacity 7.57cm <sup>3</sup> CSIR H 175.5mmW 261W 346W 446W 561W 691W 835W 993W 1167W test method ASHRAE ambient temperature max. 43°C |                 |        |

electrodes



|                    |  |                 |        |
|--------------------|--|-----------------|--------|
| <b>GEV No.</b>     | 400021   | <b>Ref. No.</b> | 809561 |
| <b>description</b> | level electrode PG9 total length 110mm probe L 70/47/24mm insulated probe length 62/38/16mm with 3 probes connection grip connection |                 |        |



|                    |  |                 |        |
|--------------------|--|-----------------|--------|
| <b>GEV No.</b>     | 400022   | <b>Ref. No.</b> | 809569 |
| <b>description</b> | level electrode PG9 total length 135mm probe L 89/59/28mm insulated probe length 80mm with 3 probes connection grip connection |                 |        |

**accessories for** 400022

|                |        |                 |   |
|----------------|--------|-----------------|---|
| <b>GEV No.</b> | 379729 | <b>Ref. No.</b> | — |
|----------------|--------|-----------------|---|

connection cable L 1230mm 4-pole for level electrode plug type coded

|                |        |                 |   |
|----------------|--------|-----------------|---|
| <b>GEV No.</b> | 550574 | <b>Ref. No.</b> | — |
|----------------|--------|-----------------|---|

nut thread PG9 H 3mm WS 28 nickel-plated brass Qty 1 pcs mounting ømm cable ømm

electric components

## CUBIGEL

R404a/R507

LBP monophase

Lower evaporation temperature below -20°C



1

|                    |  |                 |                        |
|--------------------|--|-----------------|------------------------|
| <b>GEV No.</b>     | 605180   | <b>Ref. No.</b> | 772110024<br>772110027 |
| <b>description</b> | compressor coolant R404a/R507 type MX23FB 220-240V 50Hz LBP 17.5kg 1HP power input 7/8W cylinder capacity 23.2cm <sup>3</sup> CSIR H 221mm 749W 982W 1246W 1541W 1868W |                 |                        |

Зип Общепит

HMBP, monophase

High/Medium evaporation temperature above -20/-15 °C

vsezip.ru

+7(812)987-08-81



1

|                    |  |                 |        |
|--------------------|--|-----------------|--------|
| <b>GEV No.</b>     | 605125   | <b>Ref. No.</b> | 8C1300 |
| <b>description</b> | compressor coolant R404a/R507 type NEK6213GK 220-240V 50Hz HMBP 11.6kg 1/2HP cylinder capacity 12.12cm <sup>3</sup> CSIR H 206mmW 695W 884W 1093W 1333W 1600W 1894W 2215W test method ASHRAE |                 |        |

## EMBRACO / ASPERA

R404a/R507

MBP monophase

Medium evaporation temperature above -20°C



1

|                        |  |                 |                        |
|------------------------|--|-----------------|------------------------|
| <b>GEV No.</b>         | 605003   | <b>Ref. No.</b> | 826841                 |
| <b>description</b>     | compressor coolant R404a/R507 type NB6144GK 230V 50Hz MBP fully hermetic 10.3kg cylinder capacity 4.52cm <sup>3</sup> CSIR H 187mm 226W 288W 301W 375W 459W 553W 658W test method ASHRAE |                 |                        |
| <b>spare parts for</b> | 605003   |                 |                        |
|                        | <b>GEV No.</b>   | 601022          | <b>Ref. No.</b> —      |
|                        | fan motor 10W 230V 50-60Hz L1 44mm L2 54mm L3 85mm W 84mm cable length 500mm 1300rpm YZF10-20-18/26 5 mounting options bearing slide bearing   |                 |                        |
|                        | <b>GEV No.</b>   | 601071          | <b>Ref. No.</b> —      |
|                        | fan wheel sucking ø 230mm fan wheel mounting 25.4mm blade angle 25° W 37mm aluminium   |                 |                        |
|                        | <b>GEV No.</b>   | 605003          | <b>Ref. No.</b> 826841 |
|                        | compressor coolant R404a/R507 type NB6144GK 230V 50Hz MBP fully hermetic 10.3kg cylinder capacity 4.52cm <sup>3</sup> CSIR H 187mm 226W 288W 301W 375W 459W 553W 658W test method ASHRAE |                 |                        |

## fans

axial fans

ebm-papst



1

|                        |  |                 |                     |
|------------------------|--|-----------------|---------------------|
| <b>GEV No.</b>         | 601030 <sup>1</sup>  | <b>Ref. No.</b> | 809503<br>831100001 |
| <b>description</b>     | axial fan L 119mm W 119mm H 38mm 230VAC 50Hz 18W bearing ball bearing manuf. no. 4656Z metal connection male faston 2.8mm ebm-papst fan wheel ø 110mm temp.-resist. 75°C |                 |                     |
| <b>accessories for</b> | 601030   |                 |                     |
|                        | <b>GEV No.</b>   | 550898          | <b>Ref. No.</b> —   |
|                        | connecting cable cable length 2000mm connection F 2.8 connection distance 7.9mm for axial flow fan   |                 |                     |
|                        | <b>GEV No.</b>   | 692497          | <b>Ref. No.</b> —   |
|                        | guard ø 105mm mounting distance 150mm for axial fan ebm-papst-mm   |                 |                     |

<sup>1</sup>with ball bearings



import

Зип-Общепит



refrigeration fans

vsezip.ru

+7(812)987-08-81



1

|   |  |                 |                   |
|---|--|-----------------|-------------------|
| <b>GEV No.</b>  | 601080 <sup>1</sup>  | <b>Ref. No.</b> | 827851            |
| <b>description</b>  | axial fan L 119mm W 119mm H 38mm 230VAC 50/60Hz 23/20W bearing ball bearing connection male faston 2.8mm metal ADDA fan wheel ø 110mm temp.-resist. 70°C |                 |                   |
| <b>accessories for</b>  | 601080   |                 |                   |
|  | <b>GEV No.</b>   | 550898          | <b>Ref. No.</b> — |
|   | connecting cable cable length 2000mm connection F 2.8 connection distance 7.9mm for axial flow fan   |                 |                   |
|  | <b>GEV No.</b>   | 692519          | <b>Ref. No.</b> — |
|   | guard L 120mm W 120mm plastic  |                 |                   |

<sup>1</sup>with ball bearings

1

|   |   |                 |                   |
|---|---|-----------------|-------------------|
| <b>GEV No.</b>  | 601081 <sup>1</sup>   | <b>Ref. No.</b> | 827852            |
| <b>description</b>  | axial fan L 80mm W 80mm H 38mm 230VAC 50/60Hz 14/13.5W bearing ball bearing connection male faston 2.8mm metal ADDA fan wheel ø 75mm temp.-resist. 70°C |                 |                   |
| <b>accessories for</b>  | 601081  |                 |                   |
|  | <b>GEV No.</b>  | 691102          | <b>Ref. No.</b> — |
|   | guard ø 75mm mounting distance 71 mm for axial fan 80mm   |                 |                   |

<sup>1</sup>with ball bearings

refrigeration motors universal

ELCO

BT series - capacitor motors



1

|                    |   |                 |        |
|--------------------|---|-----------------|--------|
| <b>GEV No.</b>     | 601420 <sup>1</sup>   | <b>Ref. No.</b> | 8C0807 |
| <b>description</b> | fan motor 45W 230V 50Hz L1 53mm L2 18mm L3 120mm W 103mm cable length 500mm 1300rpm ELCO 3FBT 50-40/15 3 mounting options bearing slide bearing |                 |        |

<sup>1</sup>incl. capacitor

cold air circulating fans (complete)

ebm-papst

A4E series

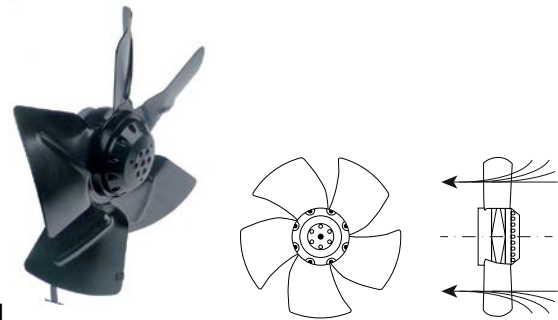

1

|   |   |                 |                   |
|---|---|-----------------|-------------------|
| <b>GEV No.</b>  | 601623  | <b>Ref. No.</b> | 771110007         |
| <b>description</b>  | fan A4E315-AC08-19 fan wheel ø 315mm blades 5 230V 50Hz 95W 1370rpm cable length 450mm ebm-papst sucking suitable capacitor 3µF                               |                 |                   |
| <b>accessories for</b>  | 601623  |                 |                   |
|  | <b>GEV No.</b>  | 365137          | <b>Ref. No.</b> — |
|   | capacitor capacity 3µF 450V tolerance 5% 50/60Hz ambient temperature max. -25 to +85°C ø 25mm L 56mm M8 plastic connection cable 250mm 416.17.77GF protection |                 |                   |

cross flow fans

EMMEVI - FERGAS

with moulded coils



1

|                    |  |                 |        |
|--------------------|--|-----------------|--------|
| <b>GEV No.</b>     | 601110   | <b>Ref. No.</b> | 8C0495 |
| <b>description</b> | cross flow fan TGO 60/1-180/20 roller ø 60mm roller length 180mm laminated core thickness 20mm motor position left 230V/50Hz 28W refrigeration bearing rubber connection male faston 6.3mm -30 up to +100°C 230V cable length 1800mm |                 |        |



Зип Общепит

vsezip.ru

+7(812)987-08-81

COPREL

with standard coil



|                    |   |                 |        |
|--------------------|---|-----------------|--------|
| 1                  |   |                 |        |
| <b>GEV No.</b>     | 602044  | <b>Ref. No.</b> | 8C0496 |
| <b>description</b> | cross flow fan COPREL TFR 180/20-14CSN roller $\phi$ 60mm roller length 180mm laminated core thickness 20mm motor position right 230V/50Hz 27W refrigeration bearing rubber connection male faston 6.3mm t.max. 60°C airflow 144m <sup>3</sup> /h -30 bis +60°C |                 |        |



|                    |   |                 |        |
|--------------------|---|-----------------|--------|
| <b>GEV No.</b>     | 415122  | <b>Ref. No.</b> | 827915 |
| <b>description</b> | heater battery mounting distance 185mm W 40mm H 35mm 2000W 230V temperature restriction 105°C heating circuits 2 connection cable cable length 340mm L 197mm for cross flow fan |                 |        |

hot air motors



|                    |  |                 |        |
|--------------------|--|-----------------|--------|
| 1                  |  |                 |        |
| <b>GEV No.</b>     | 550859   | <b>Ref. No.</b> | 809828 |
| <b>description</b> | counterflange for fan motor ED $\phi$ 60mm int. $\phi$ 1 34mm int. $\phi$ 2 25mm thickness 6mm brass |                 |        |



|                        |   |                 |        |
|------------------------|---|-----------------|--------|
| 1                      |   |                 |        |
| <b>GEV No.</b>         | 601453  | <b>Ref. No.</b> | 827914 |
| <b>description</b>     | cross flow fan TFR 180 roller $\phi$ 60mm roller length 180mm laminated core thickness 16mm motor position right 230V/50-60Hz 17W universal bearing silicone connection male faston 6.3mm airflow 100m <sup>3</sup> /h -30 up to +100°C 230V 50Hz |                 |        |
| <b>accessories for</b> | 601453  |                 |        |
|                        | <b>GEV No.</b>  | <b>Ref. No.</b> | —      |
|                        | 415114  |                 |        |
| <b>description</b>     | heater battery mounting distance 185mm W 40mm H 35mm 2000W 230V temperature restriction 105°C heating circuits 2 connection cable cable length 150mm L 192mm for cross flow fan   |                 |        |



|                    |   |                 |                  |
|--------------------|---|-----------------|------------------|
| 1                  |   |                 |                  |
| <b>GEV No.</b>     | 601046  | <b>Ref. No.</b> | 807314<br>809406 |
| <b>description</b> | fan motor 220/380V 3 phase 50/60Hz 0.75kW 1350/1650rpm speeds 1 L1 185mm L2 42mm L3 47mm D1 $\phi$ 24mm D2 $\phi$ 20mm M12L IT 1.9/3.3A Cos(fi) 0.83 at 50Hz 200-240/346-415V at 60Hz 200-277/346-480V at 50Hz 1350rpm at 60Hz 1650rpm type ST80/4 no. 661512 |                 |                  |

accessories for cross flow fans

heater battery



|                        |   |                 |        |
|------------------------|---|-----------------|--------|
| 1                      |   |                 |        |
| <b>GEV No.</b>         | 415115  | <b>Ref. No.</b> | 827915 |
| <b>description</b>     | heater battery mounting distance 185mm W 38mm H 40mm 2000W 230V temperature restriction 125°C heating circuits 2 connection male faston 6.3mm L 195mm |                 |        |
| <b>spare parts for</b> | 415115  |                 |        |
|                        | <b>GEV No.</b>  | <b>Ref. No.</b> | —      |
|                        | 375095  |                 |        |
| <b>description</b>     | bi-metal thermostat hole distance 18mm switch-off temp. 105°C 1NC 1-pole 16A connection F6.3 2 hole fixing  |                 |        |



|                    |  |                 |        |
|--------------------|--|-----------------|--------|
| 1                  |  |                 |        |
| <b>GEV No.</b>     | 500641   | <b>Ref. No.</b> | 807314 |
| <b>description</b> | fan motor 220/380V 3 phase 50Hz 0.75kW 1420rpm speeds 1 L1 166mm L2 47mm L3 65mm D1 $\phi$ 24mm D2 $\phi$ 20mm M6R IT 1.4/2.4A Cos(fi) 0.83 at 50Hz 220/380V at 60Hz 240/415V type ST80/4 no. 643515 mounting distance 150mm |                 |        |

Зип Общепит

vsezip.ru

+7(812)987-08-81

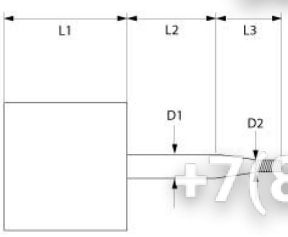

**1**

|                    |  |                 |        |
|--------------------|--|-----------------|--------|
| <b>GEV No.</b>     | 601043   | <b>Ref. No.</b> | 808973 |
| <b>description</b> | fan motor 220-240V 1 phase 50Hz 0.37/0.07kW 0.1/0.5HP 1400/2700rpm speeds 2 L1 123mm L2 107mm L3 15mm D1 ø 15mm D2 ø 12mm M10L ET 2/0.7A suitable capacitor 20µF/250V at 50Hz 1400/2700rpm type 1057 |                 |        |

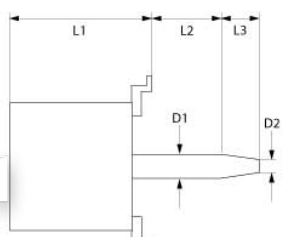



**1**

|                    |   |                 |        |
|--------------------|---|-----------------|--------|
| <b>GEV No.</b>     | 500642  | <b>Ref. No.</b> | 813154 |
| <b>description</b> | fan motor 380-415V 3 phase 50Hz 0.22/0.75kW 700/1400rpm speeds 2 L1 166mm L2 45mm L3 67mm D1 ø 24mm D2 ø 20mm M6R ITA at 50Hz 380-415V at 50Hz 700/1400rpm type FB80 4/8 no. 629764 |                 |        |

**1**

|   |   |                 |                        |
|---|---|-----------------|------------------------|
| <b>GEV No.</b>  | 601166  | <b>Ref. No.</b> | 131110010              |
| <b>description</b>  | fan motor 220-240V 1 phase 50Hz 0.37kW 2700rpm speeds 1 L1 123mm L2 77mm L3 30mm D1 ø 15mm D2 ø 12mm M10L ET 2A suitable capacitor 12.5µF/450V at 50Hz 2700rpm type 1057.2157 |                 |                        |
| <b>spare parts for</b>  | 601166  |                 |                        |
|  | <b>GEV No.</b>  | 365014          | <b>Ref. No.</b> 901740 |
| <b>accessories for</b>  | 601166  |                 |                        |
|  | <b>GEV No.</b>  | 601165          | <b>Ref. No.</b> —      |
| <b>description</b>  | fan wheel D1 ø 160mm H1 60mm blades 15 D2 ø 16mm D3 ø 16mm H2 29mm  |                 |                        |



**1**

|                    |  |                 |        |
|--------------------|--|-----------------|--------|
| <b>GEV No.</b>     | 601067   | <b>Ref. No.</b> | 809000 |
| <b>description</b> | fan wheel D1 ø 150mm H1 38mm blades 36 D2 ø 6mm D3 ø 6mm H2 14mm |                 |        |



**1**

|                    |  |                 |        |
|--------------------|--|-----------------|--------|
| <b>GEV No.</b>     | 601223   | <b>Ref. No.</b> | 809000 |
| <b>description</b> | fan wheel D1 ø 150mm H1 39mm blades 36 D2 ø 6mm D3 ø 6mm H2 13.5mm |                 |        |

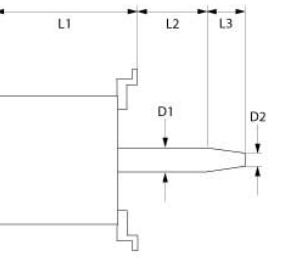
**1**

|                    |  |                 |        |
|--------------------|--|-----------------|--------|
| <b>GEV No.</b>     | 500652   | <b>Ref. No.</b> | 808856 |
| <b>description</b> | fan motor 380-415V 3 phase 50Hz 0.13/0.55kW 700/1350rpm speeds 2 L1 188mm L2 44mm L3 48mm D1 ø 24mm D2 ø 20mm M12L ITA Cos(φ) 0.13/0.55 at 50Hz 700/1350rpm 4P/8P type FB80 4/8 no. 390133 |                 |        |



**1**

|                    |  |                 |        |
|--------------------|--|-----------------|--------|
| <b>GEV No.</b>     | 601060   | <b>Ref. No.</b> | 807604 |
| <b>description</b> | fan wheel D1 ø 180mm H1 60mm blades 16 D2 ø 11mm D3 ø 16mm H2 30mm |                 |        |



Зип Общепит

vsezip.ru

+7(812)987-08-81



1

|                    |   |                 |        |
|--------------------|---|-----------------|--------|
| <b>GEV No.</b>     | 601224  | <b>Ref. No.</b> | 809407 |
| <b>description</b> | fan wheel D1 ø 300mm H1 100mm blades 24 D2 ø 19.5mm D3 ø 23mm H2 46mm |                 |        |



1

|                    |   |                 |        |
|--------------------|---|-----------------|--------|
| <b>GEV No.</b>     | 601063  | <b>Ref. No.</b> | 8C0003 |
| <b>description</b> | fan wheel D1 ø 350mm H1 100mm blades 24 D2 ø 19.5mm D3 ø 23mm H2 46mm |                 |        |



1

|                    |  |                 |        |
|--------------------|--|-----------------|--------|
| <b>GEV No.</b>     | 691810   | <b>Ref. No.</b> | 809827 |
| <b>description</b> | flange for fan motor ED ø 48mm int. ø 1 19.5mm int. ø 2 15mm thickness 3.5mm brass |                 |        |



1

|                    |  |                 |        |
|--------------------|--|-----------------|--------|
| <b>GEV No.</b>     | 511171   | <b>Ref. No.</b> | 809829 |
| <b>description</b> | shaft seal ID ø 14.5mm ED ø 20mm thickness 3mm |                 |        |

hot air fans

miscellaneous

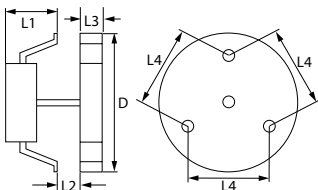



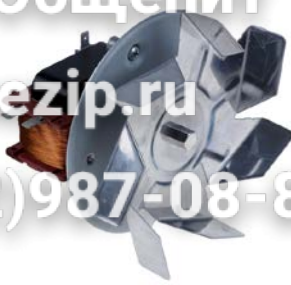

1

|                    |   |                 |        |
|--------------------|---|-----------------|--------|
| <b>GEV No.</b>     | 601273  | <b>Ref. No.</b> | 8C0432 |
| <b>description</b> | hot air fan 220-240V 32W 50/60Hz L1 60mm L2 10mm L3 25mm L4 87mm fan wheel ø 155mm FIME type C20X0E01/15CLH |                 |        |

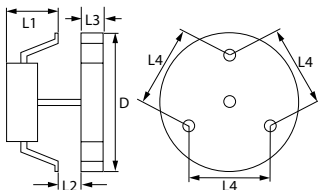

1



|   |  |                 |                 |   |
|---|--|-----------------|-----------------|---|
| <b>GEV No.</b>  | 601011   | <b>Ref. No.</b> | 8C0758          |   |
| <b>description</b>  | hot air fan 220-240V 40W 50/60Hz L1 65mm L2 15mm L3 25mm L4 87mm fan wheel ø 150mm FIME type C25R8023CLH |                 |                 |   |
| <b>accessories for</b>  | 601011   |                 |                 |   |
|   | <b>GEV No.</b>   | 550879          | <b>Ref. No.</b> | — |
|   | insulation ø 130mm thickness 3mm hole ø 20mm for hot air fan   |                 |                 |   |
|  | <b>GEV No.</b>   | 601260          | <b>Ref. No.</b> | — |
|   | nut thread M6L IT for hot air fan  |                 |                 |   |

motors

gear motors

for ice-cube maker

miscellaneous



1

|                    |  |                 |        |
|--------------------|--|-----------------|--------|
| <b>GEV No.</b>     | 500675                                       | <b>Ref. No.</b> | 809160 |
| <b>description</b> | gear motor 220/240V 50Hz for flake ice maker |                 |        |



for ovens

for flues



1

|                    |   |                 |        |
|--------------------|---|-----------------|--------|
| <b>GEV No.</b>     | 601138  | <b>Ref. No.</b> | 809507 |
| <b>description</b> | gear motor CROUZET type G70C10AFTEG 12V voltage DCHz shaft $\varnothing$ 4mm L 66mm W 50mm H 61mm |                 |        |





## pumps

wash and rinse pumps

LGB



1

|   |  |                 |                 |   |
|---|--|-----------------|-----------------|---|
| <b>GEV No.</b>  | 500093   | <b>Ref. No.</b> | 809261          |   |
| <b>description</b>  | pump inlet $\varnothing$ 50mm outlet $\varnothing$ 44mm type W500SX 230V 50Hz 1 phase 0.5kW 0.7HP L 200mm rotation direction right capacitor 16 $\mu$ F LGB  |                 |                 |   |
| <b>spare parts for</b>  | 500093   |                 |                 |   |
|  | <b>GEV No.</b>   | 365021          | <b>Ref. No.</b> | — |
|   | operating capacitor capacity 16 $\mu$ F 425V tolerance 5% 50/60Hz ambient temperature max. -25 to +85°C $\varnothing$ 35mm L 73mm single M8 plastic connection male faston 6.3mm 416.10.99 protection  |                 |                 |   |
|  | <b>GEV No.</b>   | 510607          | <b>Ref. No.</b> | — |
|   | impellor $\varnothing$ 85mm H 29mm shaft intake $\varnothing$ 9x8mm rotation direction right blades 6  |                 |                 |   |
|  | <b>GEV No.</b>   | 510693          | <b>Ref. No.</b> | — |
|   | mechanical shaft seal for shaft $\varnothing$ 12mm slide ring ext. $\varnothing$ 24mm slide ring H 15.5mm slide ring int. $\varnothing$ 11mm counter ring mounting $\varnothing$ 24mm height counter ring 8mm counter ring int. $\varnothing$ 13.5mm |                 |                 |   |
|  | <b>GEV No.</b>   | 521564          | <b>Ref. No.</b> | — |
|   | pump cover   |                 |                 |   |
|  | <b>GEV No.</b>   | 521717          | <b>Ref. No.</b> | — |
|   | O-ring EPDM thickness 1.78mm ID $\varnothing$ 120.37mm Qty 1 pcs   |                 |                 |   |

Зип Общепит

booster pumps

vsezip.ru

+7(812)987-08-81





1

|   |  |                 |                 |   |
|---|--|-----------------|-----------------|---|
| <b>GEV No.</b>  | 500540   | <b>Ref. No.</b> | 8C1367          |   |
| <b>description</b>  | pump inlet $\varnothing$ 1" IT outlet $\varnothing$ 1" IT type PKM60 230V 50Hz 1 phase 0.37kW PEDRELLO 0.5HP   |                 |                 |   |
| <b>accessories for</b>  | 500540   |                 |                 |   |
|  | <b>GEV No.</b>   | 365015          | <b>Ref. No.</b> | — |
|   | operating capacitor capacity 10 $\mu$ F 400V tolerance 5%Hz ambient temperature max. -25 to +85°C $\varnothing$ 35.5mm L 59mm M8 plastic connection male faston 6.3mm protection |                 |                 |   |



1

|   |   |                 |                 |           |
|---|---|-----------------|-----------------|-----------|
| <b>GEV No.</b>  | 500395  | <b>Ref. No.</b> | 8C1339          |           |
| <b>description</b>  | pump inlet $\varnothing$ 3/8" IT outlet $\varnothing$ 3/8" IT type PS45DX 230V 50Hz 0.35kW capacitor 8 $\mu$ F LGB  |                 |                 |           |
| <b>spare parts for</b>  | 500395  |                 |                 |           |
|  | <b>GEV No.</b>  | 365013          | <b>Ref. No.</b> | 132110008 |
|   | operating capacitor capacity 8 $\mu$ F 400V tolerance 5%Hz ambient temperature max. -25 to +85°C $\varnothing$ 31.5mm L 55mm M8 plastic connection male faston 6.3mm protection |                 |                 |           |
|  | <b>GEV No.</b>  | 698400          | <b>Ref. No.</b> | —         |
|   | pump cover gasket pump type PS46 thickness 2mm ID $\varnothing$ 66mm Qty 1 pcs  |                 |                 |           |

drain pumps

ASKOLL



1

|                    |                |                 |        |
|--------------------|----------------|-----------------|--------|
| <b>GEV No.</b>     | 500565         | <b>Ref. No.</b> | 808670 |
| <b>description</b> | drain pump 30W |                 |        |



## HANNING

Зип Общепит

vsezip.ru

+7(812)987-08-81





1

|   |   |                 |                   |
|---|---|-----------------|-------------------|
| <b>GEV No.</b>  | 500042  | <b>Ref. No.</b> | 809563            |
| <b>description</b>  | drain pump inlet $\varnothing$ 24mm outlet $\varnothing$ 24mm 230V 80W 50Hz HANNING type KD22B3-679 |                 |                   |
| <b>spare parts for</b>  | 500042  |                 |                   |
|  | <b>GEV No.</b>  | 510168          | <b>Ref. No.</b> — |
|   | fan wheel shaft intake $\varnothing$ 5mm $\varnothing$ 62mm H 14mm                                  |                 |                   |



1

|   |  |                 |                   |
|---|--|-----------------|-------------------|
| <b>GEV No.</b>  | 500165   | <b>Ref. No.</b> | 808236            |
| <b>description</b>  | pump REBO type 63/35 120W 230V 50/60Hz inlet $\varnothing$ 28mm outlet $\varnothing$ 26mm L 180mm rotation direction right for ice-cube maker capacitor 5 $\mu$ F                            |                 |                   |
| <b>spare parts for</b>  | 500165   |                 |                   |
|  | <b>GEV No.</b>   | 365017          | <b>Ref. No.</b> — |
|   | operating capacitor capacity 5 $\mu$ F 450V tolerance 5% 50/60Hz ambient temperature max. -25 to +85°C $\varnothing$ 28mm L 54mm M8 plastic connection male faston 6.3mm 16.10.08 protection |                 |                   |
|  | <b>GEV No.</b>   | 601412          | <b>Ref. No.</b> — |
|   | fan wheel sucking $\varnothing$ 154mm fan wheel mounting 25.4mm blade angle 28° W 34mm plastic   |                 |                   |
|  | <b>GEV No.</b>   | 601413          | <b>Ref. No.</b> — |
|   | fixing plate suitable for fanwheel ED $\varnothing$ 32mm shaft $\varnothing$ 7 mounting distance 26mm  |                 |                   |

## booster pumps II

## accessories



1

|                    |  |                 |        |
|--------------------|--|-----------------|--------|
| <b>GEV No.</b>     | 365012   | <b>Ref. No.</b> | 8C1588 |
| <b>description</b> | operating capacitor capacity 6.3 $\mu$ F 450V tolerance 5% 50Hz ambient temperature max. -25 to +85°C $\varnothing$ 30mm L 61mm M8 plastic connection male faston 6.3mm protection |                 |        |

## condensators &amp; interference suppression filters

## operating capacitors

## plastic

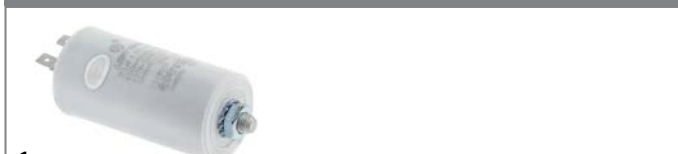



1

|                    |  |                 |        |
|--------------------|--|-----------------|--------|
| <b>GEV No.</b>     | 365014   | <b>Ref. No.</b> | 901740 |
| <b>description</b> | operating capacitor capacity 12.5 $\mu$ F 450V tolerance 5% ambient temperature max. -25 to +85°C $\varnothing$ 35mm L 70mm M8 plastic connection male faston 6.3mm 45S.C3DS.12.5 protection |                 |        |

## pumps for ice machines



1

|   |  |                 |                   |
|---|--|-----------------|-------------------|
| <b>GEV No.</b>  | 500590   | <b>Ref. No.</b> | 8C1356            |
| <b>description</b>  | pump FIR type 4240.2300 120W 230V 50/60Hz inlet $\varnothing$ 22mm outlet $\varnothing$ 22mm L 240mm rotation direction right for ice-cube maker capacitor 5 $\mu$ F |                 |                   |
| <b>spare parts for</b>  | 500590   |                 |                   |
|  | <b>GEV No.</b>   | 601412          | <b>Ref. No.</b> — |
|   | fan wheel sucking $\varnothing$ 154mm fan wheel mounting 25.4mm blade angle 28° W 34mm plastic   |                 |                   |
|  | <b>GEV No.</b>   | 601413          | <b>Ref. No.</b> — |
|   | fixing plate suitable for fanwheel ED $\varnothing$ 32mm shaft $\varnothing$ 7 mounting distance 26mm  |                 |                   |



1

|                    |  |                 |        |
|--------------------|--|-----------------|--------|
| <b>GEV No.</b>     | 365012   | <b>Ref. No.</b> | 8C1588 |
| <b>description</b> | operating capacitor capacity 6.3 $\mu$ F 450V tolerance 5% 50Hz ambient temperature max. -25 to +85°C $\varnothing$ 30mm L 61mm M8 plastic connection male faston 6.3mm protection |                 |        |



electric components

Зип.Общепит

terminals

connection terminals with screw/faston connec-

vsezip.ru

+7(812)987-08-81

1

|                    |  |                 |        |
|--------------------|--|-----------------|--------|
| <b>GEV No.</b>     | 550411   | <b>Ref. No.</b> | C00395 |
| <b>description</b> | power terminal block 6-pole max. 40A max 450V connection $\phi 6\text{mm}^2$ / F6.3 temp.-resist. 150°C cross section 6mm <sup>2</sup> |                 |        |

1

|                    |  |                 |           |
|--------------------|--|-----------------|-----------|
| <b>GEV No.</b>     | 365013   | <b>Ref. No.</b> | 132110008 |
| <b>description</b> | operating capacitor capacity 8 $\mu\text{F}$ 400V tolerance 5%Hz ambient temperature max. -25 to +85°C $\phi$ 31.5mm L 55mm M8 plastic connection male faston 6.3mm protection |                 |           |

## electric accessories

### cables

#### earthing cables

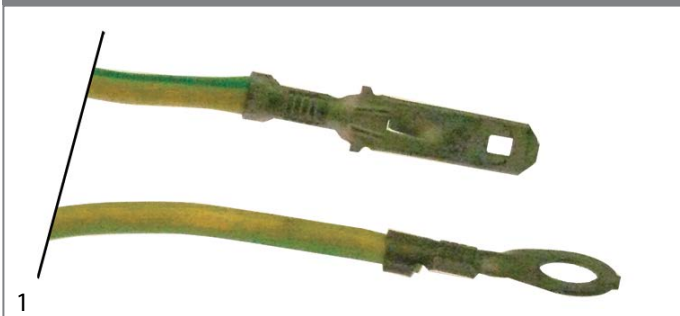

|                    |                |                 |        |
|--------------------|----------------|-----------------|--------|
| <b>GEV No.</b>     | 102149         | <b>Ref. No.</b> | C10362 |
| <b>description</b> | earthing cable |                 |        |

#### accessories

##### cable glands

##### threaded cable glands

##### screw connections



|                    |  |                 |        |
|--------------------|--|-----------------|--------|
| <b>GEV No.</b>     | 550971   | <b>Ref. No.</b> | 809010 |
| <b>description</b> | cable gland thread PG16 cable $\phi$ 14mm mounting $\phi$ 22.5mm Qty 1 pcs plastic WS 27 |                 |        |

## gas taps

### PEL

#### 22S/O series



|                    |   |                 |                               |
|--------------------|---|-----------------|-------------------------------|
| <b>GEV No.</b>     | 101086  | <b>Ref. No.</b> | 512250003<br>808186<br>C00085 |
| <b>description</b> | gas tap PEL type 22S/O gas inlet M20x1.5 (tube $\phi$ 12mm) bypass nozzle $\phi$ 0.35mm gas outlet M20x1.5 (tube $\phi$ 12/10mm) thermocouple connection M9x1 pilot connection M10x1 shaft $\phi$ 10x8mm shaft L 25/17mm shaft flat lower |                 |                               |

|   |  |        |                 |        |
|---|--|--------|-----------------|--------|
| <b>spare parts for</b>  | 101086   |        |                 |        |
|  | <b>GEV No.</b>   | 100259 | <b>Ref. No.</b> | —      |
|   | bypass nozzle type PEL22 bore $\phi$ 0.35mm thread M6x0.5  |        |                 |        |
|  | <b>GEV No.</b>   | 101058 | <b>Ref. No.</b> | —      |
|   | magnet unit L 39mm D1 $\phi$ 15.4mm D2 $\phi$ 13.5mm suitable for PEL22/EGA24197 standard            |        |                 |        |
|  | <b>GEV No.</b>   | 101201 | <b>Ref. No.</b> | —      |
|   | gas tap front part shaft $\phi$ 10x8mm shaft L 25/17mm shaft flat upper/lower suitable for PEL22     |        |                 |        |
|  | <b>GEV No.</b>   | 101231 | <b>Ref. No.</b> | —      |
|   | thermocouple nut T1: M9x1 T2: M18x1  |        |                 |        |
|  | <b>GEV No.</b>   | 101240 | <b>Ref. No.</b> | —      |
|   | gas connection thread M20x1.5 tube $\phi$ 12/10mm for PEL gas taps with gasket and screws horizontal |        |                 |        |
|  | <b>GEV No.</b>   | 101460 | <b>Ref. No.</b> | —      |
|   | O-ring $\phi$ 12.37mm D1 $\phi$ 2.62mm suitable for PEL22  |        |                 |        |
|  | <b>GEV No.</b>   | 101461 | <b>Ref. No.</b> | —      |
|   | screw kit suitable for PEL22 Qty 4 pcs   |        |                 |        |
| <b>accessories for</b>  | 101086   |        |                 |        |
|  | <b>GEV No.</b>   | 100908 | <b>Ref. No.</b> | 806019 |
|   | union screw thread M10x1 for pipe $\phi$ 4mm Qty 1 pcs   |        |                 |        |
|  | <b>GEV No.</b>   | 100909 | <b>Ref. No.</b> | —      |
|   | union screw thread M10x1 for pipe $\phi$ 6mm Qty 1 pcs   |        |                 |        |

Table continues overleaf



Зип-Общепит

vsezip.ru

+7(812)987-08-81

| accessories for 101086 |   | GEV No. | Ref. No. |   |
|------------------------|---|---------|----------|---|
|                        | gas connection thread M20x1.5 tube ø 12/10mm for PEL gas taps vertical    | 101241  | —        | — |
|                        | olive for pipe ø 4mm Qty 1 pcs  | 101246  | —        | — |
|                        | olive for pipe ø 12mm Qty 1 pcs suitable for PEL                          | 101248  | 8C0412   | — |
|                        | olive for pipe ø 10mm Qty 1 pcs   | 101249  | —        | — |
|                        | union nut thread M20x1.5 for pipe ø 10mm                                  | 101250  | —        | — |
|                        | union nut thread M20x1.5 for pipe ø 12mm                                  | 101251  | —        | — |
|                        | olive ID ø 6mm Qty 1 pcs  | 101286  | —        | — |
|                        | knob ø 70mm shaft ø 10x8mm shaft flat universal                           | 110080  | —        | — |
|                        | knob dial plate silver gas tap PEL21/22/23 t.max.°C ED ø 63mm ID ø 45.5mm | 112206  | —        | — |

| accessories for 101341 |   | GEV No. | Ref. No. |   |
|------------------------|---|---------|----------|---|
|                        | union screw thread M10x1 for pipe ø 4mm Qty 1 pcs   | 100908  | 806019   | — |
|                        | union screw thread M10x1 for pipe ø 6mm Qty 1 pcs   | 100909  | —        | — |
|                        | gas connection thread M20x1.5 tube ø 12/10mm for PEL gas taps with gasket and screws horizontal | 101240  | —        | — |
|                        | olive for pipe ø 4mm Qty 1 pcs  | 101246  | —        | — |
|                        | olive for pipe ø 12mm Qty 1 pcs suitable for PEL  | 101248  | 8C0412   | — |
|                        | olive for pipe ø 10mm Qty 1 pcs   | 101249  | —        | — |
|                        | union nut thread M20x1.5 for pipe ø 10mm  | 101250  | —        | — |
|                        | union nut thread M20x1.5 for pipe ø 12mm  | 101251  | —        | — |
|                        | olive ID ø 6mm Qty 1 pcs  | 101286  | —        | — |
|                        | knob ø 70mm shaft ø 10x8mm shaft flat universal   | 110080  | —        | — |
|                        | knob dial plate silver gas tap PEL21/22/23 t.max.°C ED ø 63mm ID ø 45.5mm                       | 112206  | —        | — |

22S/V series

|  |  |                 |          |   |
|--|--|-----------------|----------|---|
|  <p>1</p> |  |                 |          |   |
| <b>GEV No.</b>   | 101341   | <b>Ref. No.</b> | 809469   |   |
| <b>description</b>   | gas tap PEL type 22S/V gas inlet M20x1.5 (tube ø 12mm) bypass nozzle ø 0.35mm gas outlet M20x1.5 (tube ø 12/10mm) thermocouple connection M10x1 pilot connection M10x1 shaft ø 10x8mm shaft L 25/17mm shaft flat lower |                 |          |   |
| <b>spare parts for</b>   | 101341   |                 |          |   |
|  | GEV No.  | 101058          | Ref. No. | — |
|  | magnet unit L 39mm D1 ø 15.4mm D2 ø 13.5mm suitable for PEL22/EGA24197 standard  |                 |          |   |
|  | GEV No.  | 101201          | Ref. No. | — |
|  | gas tap front part shaft ø 10x8mm shaft L 25/17mm shaft flat upper/lower suitable for PEL22  |                 |          |   |
|  | GEV No.  | 101241          | Ref. No. | — |
|  | gas connection thread M20x1.5 tube ø 12/10mm for PEL gas taps vertical   |                 |          |   |
|  | GEV No.  | 101290          | Ref. No. | — |
|  | thermocouple nut T1: M10x1 T2: M18x1 suitable for PEL20/21   |                 |          |   |
|  | GEV No.  | 101460          | Ref. No. | — |
|  | O-ring ø 12.37mm D1 ø 2.62mm suitable for PEL22  |                 |          |   |
|  | GEV No.  | 101461          | Ref. No. | — |
|  | screw kit suitable for PEL22 Qty 4 pcs   |                 |          |   |

|   |   |                 |                  |   |
|---|---|-----------------|------------------|---|
|  <p>1</p> |   |                 |                  |   |
| <b>GEV No.</b>  | 101087  | <b>Ref. No.</b> | 809469<br>C00779 |   |
| <b>description</b>  | gas tap PEL type 22S/V gas inlet M20x1.5 (tube ø 12mm) bypass nozzle ø 0.35mm gas outlet M20x1.5 (tube ø 12/10mm) thermocouple connection M9x1 pilot connection M10x1 shaft ø 10x8mm shaft L 25/17mm shaft flat upper |                 |                  |   |
| <b>spare parts for</b>  | 101087  |                 |                  |   |
|   | GEV No.   | 100259          | Ref. No.         | — |
|   | bypass nozzle type PEL22 bore ø 0.35mm thread M6x0.5  |                 |                  |   |
|   | GEV No.   | 101058          | Ref. No.         | — |
|   | magnet unit L 39mm D1 ø 15.4mm D2 ø 13.5mm suitable for PEL22/EGA24197 standard   |                 |                  |   |
|   | GEV No.   | 101201          | Ref. No.         | — |
|   | gas tap front part shaft ø 10x8mm shaft L 25/17mm shaft flat upper/lower suitable for PEL22   |                 |                  |   |
|   | GEV No.   | 101231          | Ref. No.         | — |
|   | thermocouple nut T1: M9x1 T2: M18x1   |                 |                  |   |

Table continues overleaf



| spare parts for   |         | 101087 |                 |
|---|---------|--------|-----------------|
|                | GEV No. | 101241 | Ref. No. —      |
| gas connection thread M20x1.5 tube ø 12/10mm for PEL gas taps vertical                          |         |        |                 |
|                | GEV No. | 101460 | Ref. No. —      |
| O-ring ø 12.37mm D1 ø 2.62mm suitable for PEL22   |         |        |                 |
|                | GEV No. | 101461 | Ref. No. —      |
| screw kit suitable for PEL22 Qty 4 pcs  |         |        |                 |
| accessories for   |         | 101087 |                 |
|                | GEV No. | 100908 | Ref. No. 806019 |
| union screw thread M10x1 for pipe ø 4mm Qty 1 pcs   |         |        |                 |
|                | GEV No. | 100909 | Ref. No. —      |
| union screw thread M10x1 for pipe ø 6mm Qty 1 pcs   |         |        |                 |
|                | GEV No. | 101240 | Ref. No. —      |
| gas connection thread M20x1.5 tube ø 12/10mm for PEL gas taps with gasket and screws horizontal |         |        |                 |
|                | GEV No. | 101246 | Ref. No. —      |
| olive for pipe ø 4mm Qty 1 pcs  |         |        |                 |
|                | GEV No. | 101248 | Ref. No. 8C0412 |
| olive for pipe ø 12mm Qty 1 pcs suitable for PEL  |         |        |                 |
|               | GEV No. | 101249 | Ref. No. —      |
| olive for pipe ø 10mm Qty 1 pcs   |         |        |                 |
|              | GEV No. | 101250 | Ref. No. —      |
| union nut thread M20x1.5 for pipe ø 10mm  |         |        |                 |
|              | GEV No. | 101251 | Ref. No. —      |
| union nut thread M20x1.5 for pipe ø 12mm  |         |        |                 |
|              | GEV No. | 101286 | Ref. No. —      |
| olive ID ø 6mm Qty 1 pcs  |         |        |                 |
|              | GEV No. | 110080 | Ref. No. —      |
| knob ø 70mm shaft ø 10x8mm shaft flat universal   |         |        |                 |
|              | GEV No. | 112206 | Ref. No. —      |
| knob dial plate silver gas tap PEL21/22/23 t.max.°C ED ø 63mm ID ø 45.5mm                       |         |        |                 |

Зип-Общепит

235/O series

vsezip.ru

+7(812)987-08-81

1















| GEV No.  | 101092  | Ref. No. | 808520          |
|--|---|----------|-----------------|
| <b>description</b>   | gas tap PEL type 235/O gas inlet M28x1.5 (tube ø 20mm) bypass nozzle ø 0.35mm gas outlet M24x1.5 (tube ø 16mm) thermocouple connection M10x1 pilot connection M10x1 shaft ø 10x8mm shaft L 25/17mm shaft flat upper |          |                 |
| spare parts for  |   | 101092   |                 |
|             | GEV No.   | 100455   | Ref. No. —      |
| bypass nozzle type PEL23/24 bore ø 0.35mm thread M8x0.5                                      |   |          |                 |
|             | GEV No.   | 101059   | Ref. No. —      |
| magnet unit T1: M10x1 T2: M22x1 L 46mm ø 18mm suitable for PEL235 M10x1                      |   |          |                 |
|             | GEV No.   | 101204   | Ref. No. —      |
| gas tap front part shaft ø 10x8mm shaft L 25/17mm shaft flat upper/lower suitable for PEL235 |   |          |                 |
|             | GEV No.   | 101244   | Ref. No. —      |
| gas connection thread M24x1.5 tube ø 12/16mm horizontal for PEL gas taps                     |   |          |                 |
|            | GEV No.   | 101463   | Ref. No. —      |
| screw suitable for PEL235 Qty 4 pcs  |   |          |                 |
|           | GEV No.   | 528455   | Ref. No. —      |
| O-ring Viton thickness 2.62mm ID ø 18.72mm Qty 1 pcs   |   |          |                 |
| accessories for  |   | 101092   |                 |
|           | GEV No.   | 100908   | Ref. No. 806019 |
| union screw thread M10x1 for pipe ø 4mm Qty 1 pcs  |   |          |                 |
|           | GEV No.   | 100909   | Ref. No. —      |
| union screw thread M10x1 for pipe ø 6mm Qty 1 pcs  |   |          |                 |
|           | GEV No.   | 101246   | Ref. No. —      |
| olive for pipe ø 4mm Qty 1 pcs   |   |          |                 |
|           | GEV No.   | 101252   | Ref. No. —      |
| union nut thread M24x1.5 for pipe ø 12mm   |   |          |                 |
|           | GEV No.   | 101253   | Ref. No. —      |
| union nut thread M24x1.5 PEL for pipe ø 16mm   |   |          |                 |
|           | GEV No.   | 101254   | Ref. No. —      |
| union nut thread M28x1.5 tube ø 20mm   |   |          |                 |
|           | GEV No.   | 101255   | Ref. No. —      |
| olive for pipe ø 12mm Qty 1 pcs  |   |          |                 |
|           | GEV No.   | 101256   | Ref. No. —      |
| olive for pipe ø 16mm Qty 1 pcs  |   |          |                 |
|           | GEV No.   | 101257   | Ref. No. —      |
| olive for pipe ø 20mm Qty 1 pcs  |   |          |                 |



Table continues overleaf







Зип-Общепит

vsezip.ru

+7(812)987-08-81

|   |   |        |            |
|---|---|--------|------------|
| <b>accessories for</b>  | 101092  |        |            |
|  | GEV No.   | 101286 | Ref. No. — |
|   | olive ID ø 6mm Qty 1 pcs  |        |            |
|  | GEV No.   | 110080 | Ref. No. — |
|   | knob ø 70mm shaft ø 10x8mm shaft flat universal                           |        |            |
|  | GEV No.   | 112206 | Ref. No. — |
|   | knob dial plate silver gas tap PEL21/22/23 t.max.°C ED ø 63mm ID ø 45.5mm |        |            |





|   |  |        |                 |
|---|--|--------|-----------------|
| <b>accessories for</b>  | 101188   |        |                 |
|  | GEV No.  | 100905 | Ref. No. 8C0070 |
|   | locking screw M10x1 for pipe ø 6mm Qty 1 pcs                         |        |                 |
|  | GEV No.  | 101273 | Ref. No. —      |
|   | olive for pipe ø 12mm L 9.5mm brass Qty 1 pcs suitable for universal |        |                 |
|  | GEV No.  | 101276 | Ref. No. —      |
|   | union screw thread 3/8" tube ø 12mm Qty 1 pcs                        |        |                 |
|  | GEV No.  | 101333 | Ref. No. —      |
|   | plug thread 3/8" with O-ring   |        |                 |

SABAF

|   |   |                 |            |
|---|---|-----------------|------------|
|    |   |                 |            |
| <b>1</b>  |   |                 |            |
| <b>GEV No.</b>  | 101458  | <b>Ref. No.</b> | C10107     |
| <b>description</b>  | gas tap SABAF type 11 gas inlet 1/4" (tube ø 6mm) bypass nozzle ø 0mm gas outlet 1/4" (tube ø 8mm) front fixing thermocouple connection plug-in connection shaft ø 8x6.5mm shaft L 40/15mm shaft flat upper |                 |            |
| <b>spare parts for</b>  | 101458  |                 |            |
|   | GEV No.   | 106723          | Ref. No. — |
|   | magnet unit L 29mm D1 ø 12.5mm D2 ø 8.5mm suitable for SABAF  |                 |            |
| <b>accessories for</b>  | 101458  |                 |            |
|  | GEV No.   | 101277          | Ref. No. — |
|   | olive ID ø 8mm Qty 1 pcs  |                 |            |
|  | GEV No.   | 520656          | Ref. No. — |
|   | union nut thread 1/4" tube ø 6/8mm  |                 |            |

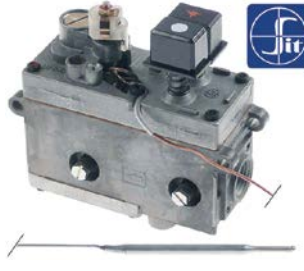
|  |  |                 |           |
|--|--|-----------------|-----------|
|  |  |                 |           |
| <b>1</b>   |  |                 |           |
| <b>GEV No.</b>   | 103076   | <b>Ref. No.</b> | 512250006 |
| <b>description</b>   | gas thermostat type 630 Eurosit series t.max. 190°C 110-190°C gas inlet 3/8" gas outlet 3/8" thermocouple connection M9x1 pilot connection M10x1 probe ø 4mm probe L 202mm capillary pipe 1050mm SIT |                 |           |

710 Minisit series

|  |   |                 |            |
|--|---|-----------------|------------|
|  |   |                 |            |
| <b>1</b>   |   |                 |            |
| <b>GEV No.</b>   | 101135  | <b>Ref. No.</b> | C00897     |
| <b>description</b>   | gas thermostat SIT type MINISIT 710 t.max. 190°C 110-190°C gas inlet 1/2" gas outlet 3/8" thermocouple connection M9x1 pilot connection M10x1 probe ø 6mm probe L 102mm capillary pipe 1050mm probe type type A3 pressure controller no pressure regulator mbar gland nut |                 |            |
| <b>spare parts for</b>   | 101135  |                 |            |
|   | GEV No.   | 101053          | Ref. No. — |
|  | magnet unit T1: M9x1 T2: M24x1 L 45mm ø 17mm suitable for Minisit   |                 |            |
|   | GEV No.   | 102118          | Ref. No. — |
|  | probe 110-190°C probe ø 6mm probe L 102mm capillary pipe 1050mm t.max. 190°C fryer probe type type A3 suitable for MINISIT 710  |                 |            |
| <b>accessories for</b>   | 101135  |                 |            |
|   | GEV No.   | 100809          | Ref. No. — |
|  | O-ring EPDM thickness 2mm ID ø 21mm Qty 1 pcs   |                 |            |
|   | GEV No.   | 100820          | Ref. No. — |
|  | gland duct ET M14x1.5 IT M10x0.75 probe ø max. 6.5mm WS 22  |                 |            |

gas thermostats

SIT

630 Eurosit series



|   |  |                 |               |
|---|--|-----------------|---------------|
|  |  |                 |               |
| <b>1</b>  |  |                 |               |
| <b>GEV No.</b>  | 101188   | <b>Ref. No.</b> | 808934 C00753 |
| <b>description</b>  | gas thermostat type 630 Eurosit series t.max. 190°C 110-190°C gas inlet 3/8" gas outlet 3/8" thermocouple connection M9x1 pilot connection M10x1 probe ø 4mm probe L 202mm capillary pipe 1050mm SIT |                 |               |
| <b>accessories for</b>  | 101188   |                 |               |
|  | GEV No.  | 100904          | Ref. No. —    |
|   | locking screw M10x1 for pipe ø 4mm Qty 1 pcs   |                 |               |

Table continues overleaf

Зип Общепит  
vsezip.ru  
+7(812)987-08-81

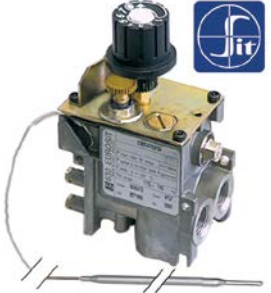

| accessories for |   | 101135   |        |
|-----------------|---|----------|--------|
| GEV No.         | 100904  | Ref. No. | —      |
|                 | locking screw M10x1 for pipe ø 4mm Qty 1 pcs                                      |          |        |
| GEV No.         | 100905  | Ref. No. | 8C0070 |
|                 | locking screw M10x1 for pipe ø 6mm Qty 1 pcs                                      |          |        |
| GEV No.         | 101054  | Ref. No. | —      |
|                 | magnet unit T1: M10x1 T2: M24x1 L 45mm ø 17mm suitable for Minisit                |          |        |
| GEV No.         | 101136  | Ref. No. | 807697 |
|                 | piezoelectric igniter suitable for Minisit with cover cap ømm connection F6.3x0.8 |          |        |
| GEV No.         | 101137  | Ref. No. | —      |
|                 | cover cap without piezoelectric igniter   |          |        |
| GEV No.         | 101267  | Ref. No. | —      |
|                 | reducer IT 3/8" ET 1/2" L 21mm  |          |        |
| GEV No.         | 101268  | Ref. No. | —      |
|                 | gas connection thread 3/8" angled with O-ring MINISIT 710                         |          |        |
| GEV No.         | 101269  | Ref. No. | —      |
|                 | gas connection thread 1/2" angled with O-ring MINISIT 710                         |          |        |
| GEV No.         | 101270  | Ref. No. | —      |
|                 | screw connection IT 3/8" ET 3/8" L 28mm   |          |        |
| GEV No.         | 101272  | Ref. No. | —      |
|                 | screw connection IT 1/2" ET 3/8" L 57mm   |          |        |
| GEV No.         | 101273  | Ref. No. | —      |
|                 | olive for pipe ø 12mm L 9.5mm brass Qty 1 pcs suitable for universal              |          |        |
| GEV No.         | 101274  | Ref. No. | —      |
|                 | olive for pipe ø 16mm Qty 1 pcs   |          |        |
| GEV No.         | 101275  | Ref. No. | —      |
|                 | union screw thread 1/2" for pipe ø 16mm Qty 1 pcs                                 |          |        |
| GEV No.         | 101276  | Ref. No. | —      |
|                 | union screw thread 3/8" tube ø 12mm Qty 1 pcs                                     |          |        |
| GEV No.         | 110068  | Ref. No. | 814979 |
|                 | knob suitable for Minisit ø 37mm  |          |        |

| GEV No.   | 101132   | Ref. No. | 806192          |
|---|--|----------|-----------------|
| <b>description</b>  | gas thermostat SIT type MINISIT 710 t.max. 340°C 100-340°C gas inlet 1/2" gas outlet 3/8" thermocouple connection M9x1 pilot connection M10x1 probe ø 5mm probe L 68mm capillary pipe 1050mm probe type type B1 pressure controller no pressure regulator mbar gland nut ignition gas no |          |                 |
| <b>spare parts for</b>  | 101132   |          |                 |
|   | GEV No.  | 101053   | Ref. No. —      |
| magnet unit T1: M9x1 T2: M24x1 L 45mm ø 17mm suitable for Minisit                 |  |          |                 |
| <b>accessories for</b>  | 101132   |          |                 |
|   | GEV No.  | 100809   | Ref. No. —      |
| O-ring EPDM thickness 2mm ID ø 21mm Qty 1 pcs                                     |  |          |                 |
|   | GEV No.  | 100904   | Ref. No. —      |
| locking screw M10x1 for pipe ø 4mm Qty 1 pcs                                      |  |          |                 |
|   | GEV No.  | 100905   | Ref. No. 8C0070 |
| locking screw M10x1 for pipe ø 6mm Qty 1 pcs                                      |  |          |                 |
|   | GEV No.  | 101054   | Ref. No. —      |
| magnet unit T1: M10x1 T2: M24x1 L 45mm ø 17mm suitable for Minisit                |  |          |                 |
|   | GEV No.  | 101136   | Ref. No. 807697 |
| piezoelectric igniter suitable for Minisit with cover cap ømm connection F6.3x0.8 |  |          |                 |
|   | GEV No.  | 101137   | Ref. No. —      |
| cover cap without piezoelectric igniter   |  |          |                 |
|   | GEV No.  | 101267   | Ref. No. —      |
| reducer IT 3/8" ET 1/2" L 21mm  |  |          |                 |
|   | GEV No.  | 101268   | Ref. No. —      |
| gas connection thread 3/8" angled with O-ring MINISIT 710                         |  |          |                 |
|   | GEV No.  | 101269   | Ref. No. —      |
| gas connection thread 1/2" angled with O-ring MINISIT 710                         |  |          |                 |
|   | GEV No.  | 101270   | Ref. No. —      |
| screw connection IT 3/8" ET 3/8" L 28mm   |  |          |                 |
|   | GEV No.  | 101272   | Ref. No. —      |
| screw connection IT 1/2" ET 3/8" L 57mm   |  |          |                 |
|   | GEV No.  | 101273   | Ref. No. —      |
| olive for pipe ø 12mm L 9.5mm brass Qty 1 pcs suitable for universal              |  |          |                 |
|   | GEV No.  | 101274   | Ref. No. —      |
| olive for pipe ø 16mm Qty 1 pcs   |  |          |                 |
|   | GEV No.  | 101275   | Ref. No. —      |
| union screw thread 1/2" for pipe ø 16mm Qty 1 pcs                                 |  |          |                 |



Table continues overleaf



Зип-Общепит



vsezip.ru

+7(812)987-08-81

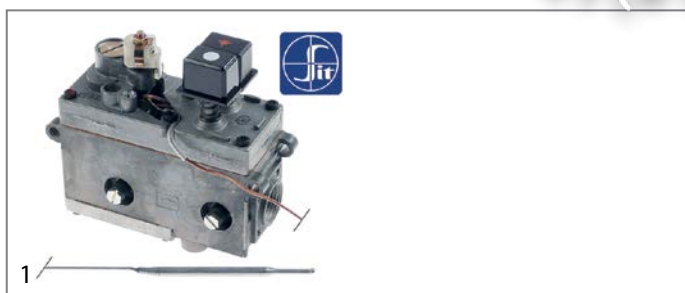
|   |         |        |                 |
|---|---------|--------|-----------------|
| <b>accessories for</b>  | 101132  |        |                 |
|  | GEV No. | 101276 | Ref. No. —      |
| union screw thread 3/8" tube ø 12mm Qty 1 pcs                                     |         |        |                 |
|  | GEV No. | 110068 | Ref. No. 814979 |
| knob suitable for Minisit ø 37mm  |         |        |                 |



|                    |   |                 |        |
|--------------------|---|-----------------|--------|
| <b>GEV No.</b>     | 101131  | <b>Ref. No.</b> | 806267 |
| <b>description</b> | gas thermostat without cap, button and angle SIT type MINISIT 710 t.max. 190°C 50-190°C gas inlet 1/2" gas outlet 3/8" thermocouple connection M9x1 pilot connection M10x1 probe ø 5mm probe L 98mm capillary pipe 1200mm probe type type A2 pressure controller no pressure regulator mbar gland nut |                 |        |

|  |         |        |            |
|--|---------|--------|------------|
| <b>spare parts for</b>   | 101131  |        |            |
|   | GEV No. | 101053 | Ref. No. — |
| magnet unit T1: M9x1 T2: M24x1 L 45mm ø 17mm suitable for Minisit  |         |        |            |
|   | GEV No. | 102103 | Ref. No. — |
| probe 60-200°C probe ø 5mm probe L 98mm capillary pipe 1050mm t.max. 200°C fryer probe type type A2 suitable for MINISIT 710 |         |        |            |

|   |         |        |                 |
|---|---------|--------|-----------------|
| <b>accessories for</b>  | 101131  |        |                 |
|  | GEV No. | 100809 | Ref. No. —      |
| O-ring EPDM thickness 2mm ID ø 21mm Qty 1 pcs                                       |         |        |                 |
|  | GEV No. | 100820 | Ref. No. —      |
| gland duct ET M14x1.5 IT M10x0.75 probe ø max. 6.5mm WS 22                          |         |        |                 |
|  | GEV No. | 100904 | Ref. No. —      |
| locking screw M10x1 for pipe ø 4mm Qty 1 pcs  |         |        |                 |
|  | GEV No. | 100905 | Ref. No. 8C0070 |
| locking screw M10x1 for pipe ø 6mm Qty 1 pcs  |         |        |                 |
|  | GEV No. | 101054 | Ref. No. —      |
| magnet unit T1: M10x1 T2: M24x1 L 45mm ø 17mm suitable for Minisit                  |         |        |                 |
|  | GEV No. | 101136 | Ref. No. 807697 |
| piezoelectric igniter suitable for Minisit with cover cap ømm connection F6.3x0.8   |         |        |                 |
|  | GEV No. | 101137 | Ref. No. —      |
| cover cap without piezoelectric igniter   |         |        |                 |
|  | GEV No. | 101267 | Ref. No. —      |
| reducer IT 3/8" ET 1/2" L 21mm  |         |        |                 |
|  | GEV No. | 101268 | Ref. No. —      |
| gas connection thread 3/8" angled with O-ring MINISIT 710                           |         |        |                 |
|  | GEV No. | 101269 | Ref. No. —      |
| gas connection thread 1/2" angled with O-ring MINISIT 710                           |         |        |                 |



|   |         |        |                 |
|---|---------|--------|-----------------|
| <b>accessories for</b>  | 101131  |        |                 |
|  | GEV No. | 101270 | Ref. No. —      |
| union screw connection IT 3/8" ET 3/8" L 28mm                                     |         |        |                 |
|  | GEV No. | 101272 | Ref. No. —      |
| union screw connection IT 1/2" ET 3/8" L 57mm                                     |         |        |                 |
|  | GEV No. | 101273 | Ref. No. —      |
| olive for pipe ø 12mm L 9.5mm brass Qty 1 pcs suitable for universal              |         |        |                 |
|  | GEV No. | 101274 | Ref. No. —      |
| olive for pipe ø 16mm Qty 1 pcs   |         |        |                 |
|  | GEV No. | 101275 | Ref. No. —      |
| union screw thread 1/2" for pipe ø 16mm Qty 1 pcs                                 |         |        |                 |
|  | GEV No. | 101276 | Ref. No. —      |
| union screw thread 3/8" tube ø 12mm Qty 1 pcs                                     |         |        |                 |
|  | GEV No. | 110068 | Ref. No. 814979 |
| knob suitable for Minisit ø 37mm  |         |        |                 |

PEL

24ST series



|                    |  |                 |        |
|--------------------|--|-----------------|--------|
| <b>GEV No.</b>     | 101078   | <b>Ref. No.</b> | C00417 |
| <b>description</b> | gas thermostat PEL type 24ST 55-110°C gas inlet M20x1.5 (tube ø 12mm) bypass nozzle ø 0.35mm gas outlet M20x1.5 (tube ø 12/10mm) thermocouple connection M9x1 pilot connection M10x1 capillary pipe 1200mm probe ø 6mm probe L 160mm shaft ø 10x8mm shaft L 27/17mm shaft flat upper |                 |        |

|   |         |        |            |
|---|---------|--------|------------|
| <b>spare parts for</b>  | 101078  |        |            |
|  | GEV No. | 100455 | Ref. No. — |
| bypass nozzle type PEL23/24 bore ø 0.35mm thread M8x0.5                             |         |        |            |
|  | GEV No. | 101058 | Ref. No. — |
| magnet unit L 39mm D1 ø 15.4mm D2 ø 13.5mm suitable for PEL22/EGA24197 standard     |         |        |            |
|  | GEV No. | 106200 | Ref. No. — |
| nut thread M9x1 suitable for PEL 24/255   |         |        |            |





|   |         |        |                 |
|---|---------|--------|-----------------|
| <b>accessories for</b>  | 101078  |        |                 |
|  | GEV No. | 100908 | Ref. No. 806019 |
| union screw thread M10x1 for pipe ø 4mm Qty 1 pcs                                   |         |        |                 |
|  | GEV No. | 100909 | Ref. No. —      |
| union screw thread M10x1 for pipe ø 6mm Qty 1 pcs                                   |         |        |                 |
|  | GEV No. | 101246 | Ref. No. —      |
| olive for pipe ø 4mm Qty 1 pcs  |         |        |                 |
|  | GEV No. | 101248 | Ref. No. 8C0412 |
| olive for pipe ø 12mm Qty 1 pcs suitable for PEL                                    |         |        |                 |







Table continues overleaf

1 gas components

Зип-Общепит

vsezip.ru



+7(812)9811111

| accessories for   |         | 101078 |            |
|---|---------|--------|------------|
|  | GEV No. | 101249 | Ref. No. — |
| olive for pipe ø 10mm Qty 1 pcs   |         |        |            |
|  | GEV No. | 101250 | Ref. No. — |
| union nut thread M20x1.5 for pipe ø 10mm  |         |        |            |
|  | GEV No. | 101251 | Ref. No. — |
| union nut thread M20x1.5 for pipe ø 12mm  |         |        |            |
|  | GEV No. | 101286 | Ref. No. — |
| olive ID ø 6mm Qty 1 pcs  |         |        |            |
|  | GEV No. | 110079 | Ref. No. — |
| knob dial plate gas thermostat 1-8 silver   |         |        |            |
|  | GEV No. | 110080 | Ref. No. — |
| knob ø 70mm shaft ø 10x8mm shaft flat universal                                   |         |        |            |







24STS series



| GEV No.            | 101159  | Ref. No. | C00600 |
|--------------------|---|----------|--------|
| <b>description</b> | gas thermostat PEL type 24STS 120-320°C gas inlet flange bypass nozzle ø 0.35mm gas outlet flange thermocouple connection M9x1 pilot connection M10x1 capillary pipe 1200mm probe ø 6mm probe L 100mm shaft ø 10x8mm shaft L 27/17mm shaft flat upper |          |        |

| spare parts for   |         | 101159 |            |
|---|---------|--------|------------|
|  | GEV No. | 100455 | Ref. No. — |
| bypass nozzle type PEL23/24 bore ø 0.35mm thread M8x0.5                             |         |        |            |
|  | GEV No. | 101058 | Ref. No. — |
| magnet unit L 39mm D1 ø 15.4mm D2 ø 13.5mm suitable for PEL22/EGA24197 standard     |         |        |            |
|  | GEV No. | 106200 | Ref. No. — |
| nut thread M9x1 suitable for PEL 24/25S   |         |        |            |

| accessories for   |         | 101159 |                 |
|---|---------|--------|-----------------|
|              | GEV No. | 101235 | Ref. No. —      |
| gas connection thread M20x1.5 tube ø 12/10mm for PEL gas taps horizontal                        |         |        |                 |
|              | GEV No. | 101236 | Ref. No. —      |
| gas connection thread M20x1.5 tube ø 12/10mm for PEL gas taps vertical                          |         |        |                 |
|              | GEV No. | 101240 | Ref. No. —      |
| gas connection thread M20x1.5 tube ø 12/10mm for PEL gas taps with gasket and screws horizontal |         |        |                 |
|              | GEV No. | 101241 | Ref. No. —      |
| gas connection thread M20x1.5 tube ø 12/10mm for PEL gas taps vertical                          |         |        |                 |
|              | GEV No. | 101248 | Ref. No. 8C0412 |
| olive for pipe ø 12mm Qty 1 pcs suitable for PEL  |         |        |                 |
|              | GEV No. | 101249 | Ref. No. —      |
| olive for pipe ø 10mm Qty 1 pcs   |         |        |                 |
|              | GEV No. | 101250 | Ref. No. —      |
| union nut thread M20x1.5 for pipe ø 10mm  |         |        |                 |

| accessories for  |         | 101159 |            |
|--|---------|--------|------------|
|   | GEV No. | 101251 | Ref. No. — |
| union nut thread M20x1.5 for pipe ø 12mm   |         |        |            |
|   | GEV No. | 101356 | Ref. No. — |
| gas tap PEL-type 21S gas inlet M16x1.5 (tube ø 10mm) bypass nozzle ø 0.35mm gas outlet M16x1.5 (tube ø 10/8mm) thermocouple connection M10x1 pilot connection M10x1 shaft ø 8x6.5mm shaft L 22/15mm shaft flat lower |         |        |            |
|   | GEV No. | 101460 | Ref. No. — |
| O-ring ø 12.37mm D1 ø 2.62mm suitable for PEL22  |         |        |            |
|   | GEV No. | 101461 | Ref. No. — |
| screw kit suitable for PEL22 Qty 4 pcs   |         |        |            |
|   | GEV No. | 106165 | Ref. No. — |
| gasket ø 27mm  |         |        |            |
|   | GEV No. | 110079 | Ref. No. — |
| knob dial plate gas thermostat 1-8 silver  |         |        |            |
|   | GEV No. | 110080 | Ref. No. — |
| knob ø 70mm shaft ø 10x8mm shaft flat universal  |         |        |            |



| GEV No.            | 101161  | Ref. No. | C00084 C00600 |
|--------------------|---|----------|---------------|
| <b>description</b> | gas thermostat PEL type 24STS 120-320°C gas inlet M20x1.5 (tube ø 12/10mm) bypass nozzle ø 0.35mm gas outlet M20x1.5 (tube ø 12/10mm) thermocouple connection M9x1 pilot connection M10x1 capillary pipe 1200mm probe ø 6mm probe L 100mm shaft ø 10x8mm shaft L 27/17mm shaft flat upper |          |               |

| spare parts for   |         | 101161 |            |
|---|---------|--------|------------|
|  | GEV No. | 101058 | Ref. No. — |
| magnet unit L 39mm D1 ø 15.4mm D2 ø 13.5mm suitable for PEL22/EGA24197 standard     |         |        |            |







| accessories for   |         | 101161 |                 |
|---|---------|--------|-----------------|
|              | GEV No. | 101235 | Ref. No. —      |
| gas connection thread M20x1.5 tube ø 12/10mm for PEL gas taps horizontal                        |         |        |                 |
|              | GEV No. | 101236 | Ref. No. —      |
| gas connection thread M20x1.5 tube ø 12/10mm for PEL gas taps vertical                          |         |        |                 |
|              | GEV No. | 101240 | Ref. No. —      |
| gas connection thread M20x1.5 tube ø 12/10mm for PEL gas taps with gasket and screws horizontal |         |        |                 |
|              | GEV No. | 101241 | Ref. No. —      |
| gas connection thread M20x1.5 tube ø 12/10mm for PEL gas taps vertical                          |         |        |                 |
|              | GEV No. | 101248 | Ref. No. 8C0412 |
| olive for pipe ø 12mm Qty 1 pcs suitable for PEL  |         |        |                 |
|              | GEV No. | 101249 | Ref. No. —      |
| olive for pipe ø 10mm Qty 1 pcs   |         |        |                 |

Table continues overleaf





Зип-Общепит

vsezip.ru



+7(812)987-08-81

|   |  |
|---|--|
| <b>accessories for</b> 101161   |  |
|  | GEV No. 101250 Ref. No. —<br>union nut thread M20x1.5 for pipe ø 10mm                              |
|  | GEV No. 101251 Ref. No. —<br>union nut thread M20x1.5 for pipe ø 12mm                              |
|  | GEV No. 101365 Ref. No. —<br>gas connection thread M20x1.5 tube ø 12mm for PEL gas taps horizontal |
|  | GEV No. 101460 Ref. No. —<br>O-ring ø 12.37mm D1 ø 2.62mm suitable for PEL22                       |
|  | GEV No. 101461 Ref. No. —<br>screw kit suitable for PEL22 Qty 4 pcs                                |
|  | GEV No. 110079 Ref. No. —<br>knob dial plate gas thermostat 1-8 silver                             |
|  | GEV No. 110080 Ref. No. —<br>knob ø 70mm shaft ø 10x8mm shaft flat universal                       |

## gas valves and ignition boxes

### gas control valves







#### HONEYWELL

|   |   |
|---|---|
|  |   |
| 1   |   |
| <b>GEV No.</b> 101186   | <b>Ref. No.</b> 809510  |
| <b>description</b>  | gas valve type VK4105C 220-240V 50/60Hz gas inlet flange 32x32mm gas outlet flange 32x32mm thermocouple connection pilot connection pressure range 15-60mbar max 60mbar operator type pressure controller type V5360E 1226 1 HONEYWELL flange 32x32mm |
| <b>accessories for</b> 101186   |   |
|  | GEV No. 102845 Ref. No. —<br>gas connection angled 1/2" flange 32x32mm hole distance 24x24mm Tandem   |
|  | GEV No. 102846 Ref. No. —<br>gas connection straight 1/2" flange 32x32mm hole distance 24x24mm suitable for Tandem  |

#### ELETTROSIT



1

|   |   |
|---|---|
| <b>GEV No.</b> 101126   | <b>Ref. No.</b> C00302  |
| <b>description</b>  | gas valve SIT type ELETTROSIT 230V gas inlet 1/2" gas outlet 1/2" thermocouple connection M9x1 pilot connection M10x1 bottom equiv. no. 0.810.136 |
| <b>spare parts for</b> 101126   |   |
|    | GEV No. 101312 Ref. No. C00309<br>microswitch   |
|    | GEV No. 101352 Ref. No. —<br>solenoid coil 230V 50Hz suitable for ELETTROSIT  |
| <b>accessories for</b> 101126   |   |
|   | GEV No. 100006 Ref. No. —<br>piezoelectric igniter suitable for ELETTROSIT body plastic blowing connection ø2.4mm ø 14mm                          |
|  | GEV No. 100904 Ref. No. —<br>locking screw M10x1 for pipe ø 4mm Qty 1 pcs   |
|  | GEV No. 100905 Ref. No. 8C0070<br>locking screw M10x1 for pipe ø 6mm Qty 1 pcs  |
|  | GEV No. 101301 Ref. No. —<br>gas connection thread 1/2" straight ELETTROSIT screw with O-ring   |
|  | GEV No. 101303 Ref. No. —<br>gas connection straight thread 3/4" ELETTROSIT   |
|  | GEV No. 101309 Ref. No. —<br>extension  |



Зип Общепит

vsezip.ru

+7(812)987-08-81

**NOVASIT**

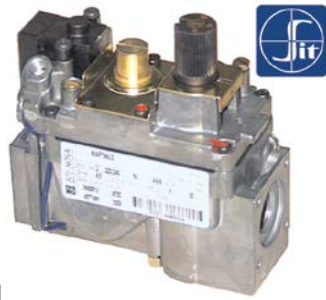

|                        |  |                 |                        |
|------------------------|--|-----------------|------------------------|
| <b>1</b>               |  |                 |                        |
| <b>GEV No.</b>         | 101162   | <b>Ref. No.</b> | 813436                 |
| <b>description</b>     | gas valve SIT series Novasit 820 230V 50Hz gas inlet 1/2" gas outlet 1/2" thermocouple connection M9x1 pilot connection M10x1 ignition pressure 3-5mbar pressure range 3-30mbar pressure regulator connection blind equiv. no. 0.820.010 |                 |                        |
| <b>spare parts for</b> | 101162   |                 |                        |
|                        | <b>GEV No.</b>   | 101065          | <b>Ref. No.</b> —      |
|                        | magnet unit with cable L 44mm D1 ø 30mm D2 ø 20mm suitable for NOVASIT   |                 |                        |
|                        | <b>GEV No.</b>   | 101313          | <b>Ref. No.</b> —      |
|                        | solenoid coil 230V 50Hz  |                 |                        |
| <b>accessories for</b> | 101162   |                 |                        |
|                        | <b>GEV No.</b>   | 100006          | <b>Ref. No.</b> —      |
|                        | piezoelectric igniter suitable for ELETTROSIT body plastic blowing connection ø2.4mm ø 14mm  |                 |                        |
|                        | <b>GEV No.</b>   | 101305          | <b>Ref. No.</b> —      |
|                        | gas connection straight 1/2" flange 45x45mm ELETTROSIT/V4400/4600/4605 suitable for SIT/HONEYWELL hole distance 36x36mm  |                 |                        |
|                        | <b>GEV No.</b>   | 101306          | <b>Ref. No.</b> —      |
|                        | gas connection angled flange 45x45mm hole distance 36x36mm 1/2" ELETTROSIT/V4400/4600/4605 screw with O-ring suitable for SIT/HONEYWELL  |                 |                        |
|                        | <b>GEV No.</b>   | 101307          | <b>Ref. No.</b> —      |
|                        | gas connection straight flange 45x45mm hole distance 36x36mm 3/4" ELETTROSIT/V4400/4600/4605 screw with O-ring suitable for SIT/HONEYWELL  |                 |                        |
|                        | <b>GEV No.</b>   | 101308          | <b>Ref. No.</b> —      |
|                        | gas connection angled flange 45x45mm hole distance 36x36mm 3/4" ELETTROSIT/V4400/4600/4605 screw with O-ring suitable for SIT/HONEYWELL  |                 |                        |
|                        | <b>GEV No.</b>   | 101312          | <b>Ref. No.</b> C00309 |
|                        | microswitch  |                 |                        |
|                        | <b>GEV No.</b>   | 101314          | <b>Ref. No.</b> —      |
|                        | solenoid coil 24V 50Hz   |                 |                        |
|                        | <b>GEV No.</b>   | 101317          | <b>Ref. No.</b> C00974 |
|                        | plug with cable L 1000mm suitable for NOVASIT  |                 |                        |
|                        | <b>GEV No.</b>   | 101318          | <b>Ref. No.</b> —      |
|                        | cover cap for solenoid coil suitable for NOVASIT   |                 |                        |

|                        |  |                 |                        |
|------------------------|--|-----------------|------------------------|
| <b>1</b>               |  |                 |                        |
| <b>GEV No.</b>         | 101956   | <b>Ref. No.</b> | C00946                 |
| <b>description</b>     | gas valve SIT series Novasit 820 230V 50Hz gas inlet 1/2" gas outlet 1/2" thermocouple connection M9x1 pilot connection M10x1 ignition pressure 3-5mbar pressure range 3-30mbar pressure regulator connection blind equiv. no. 0.820.031 |                 |                        |
| <b>spare parts for</b> | 101956   |                 |                        |
|                        | <b>GEV No.</b>   | 101065          | <b>Ref. No.</b> —      |
|                        | magnet unit with cable L 44mm D1 ø 30mm D2 ø 20mm suitable for NOVASIT   |                 |                        |
|                        | <b>GEV No.</b>   | 101313          | <b>Ref. No.</b> —      |
|                        | solenoid coil 230V 50Hz  |                 |                        |
| <b>accessories for</b> | 101956   |                 |                        |
|                        | <b>GEV No.</b>   | 100006          | <b>Ref. No.</b> —      |
|                        | piezoelectric igniter suitable for ELETTROSIT body plastic blowing connection ø2.4mm ø 14mm  |                 |                        |
|                        | <b>GEV No.</b>   | 101305          | <b>Ref. No.</b> —      |
|                        | gas connection straight 1/2" flange 45x45mm ELETTROSIT/V4400/4600/4605 suitable for SIT/HONEYWELL hole distance 36x36mm  |                 |                        |
|                        | <b>GEV No.</b>   | 101306          | <b>Ref. No.</b> —      |
|                        | gas connection angled flange 45x45mm hole distance 36x36mm 1/2" ELETTROSIT/V4400/4600/4605 screw with O-ring suitable for SIT/HONEYWELL  |                 |                        |
|                        | <b>GEV No.</b>   | 101307          | <b>Ref. No.</b> —      |
|                        | gas connection straight flange 45x45mm hole distance 36x36mm 3/4" ELETTROSIT/V4400/4600/4605 screw with O-ring suitable for SIT/HONEYWELL  |                 |                        |
|                        | <b>GEV No.</b>   | 101308          | <b>Ref. No.</b> —      |
|                        | gas connection angled flange 45x45mm hole distance 36x36mm 3/4" ELETTROSIT/V4400/4600/4605 screw with O-ring suitable for SIT/HONEYWELL  |                 |                        |
|                        | <b>GEV No.</b>   | 101312          | <b>Ref. No.</b> C00309 |
|                        | microswitch  |                 |                        |
|                        | <b>GEV No.</b>   | 101314          | <b>Ref. No.</b> —      |
|                        | solenoid coil 24V 50Hz   |                 |                        |
|                        | <b>GEV No.</b>   | 101317          | <b>Ref. No.</b> C00974 |
|                        | plug with cable L 1000mm suitable for NOVASIT  |                 |                        |
|                        | <b>GEV No.</b>   | 101318          | <b>Ref. No.</b> —      |
|                        | cover cap for solenoid coil suitable for NOVASIT   |                 |                        |











Зип-Общепит

vsezip.ru

+7(812)987-08-81









1

|   |   |                 |                   |
|---|---|-----------------|-------------------|
| <b>GEV No.</b>  | 101914  | <b>Ref. No.</b> | 808578            |
| <b>description</b>  | gas valve SIT series Novasit 822 230V 50Hz gas inlet 1/2" gas outlet 1/2" thermocouple connection pilot connection closed ignition pressure range 3-30mbar pressure regulator connection blind equiv. no. 0.822.144 |                 |                   |
| <b>spare parts for</b>  | 101914  |                 |                   |
|    | <b>GEV No.</b>  | 101313          | <b>Ref. No.</b> — |
|   | solenoid coil 230V 50Hz   |                 |                   |
|    | <b>GEV No.</b>  | 101542          | <b>Ref. No.</b> — |
|   | solenoid coil 50Hz NOVA 822/826/827 suitable for NOVASIT 230V   |                 |                   |
| <b>accessories for</b>  | 101914  |                 |                   |
|    | <b>GEV No.</b>  | 101305          | <b>Ref. No.</b> — |
|   | gas connection straight 1/2" flange 45x45mm ELETTROSIT/V4400/4600/4605 suitable for SIT/HONEYWELL hole distance 36x36mm   |                 |                   |
|  | <b>GEV No.</b>  | 101306          | <b>Ref. No.</b> — |
|   | gas connection angled flange 45x45mm hole distance 36x36mm 1/2" ELETTROSIT/V4400/4600/4605 screw with O-ring suitable for SIT/HONEYWELL   |                 |                   |
|  | <b>GEV No.</b>  | 101307          | <b>Ref. No.</b> — |
|   | gas connection straight flange 45x45mm hole distance 36x36mm 3/4" ELETTROSIT/V4400/4600/4605 screw with O-ring suitable for SIT/HONEYWELL   |                 |                   |
|  | <b>GEV No.</b>  | 101308          | <b>Ref. No.</b> — |
|   | gas connection angled flange 45x45mm hole distance 36x36mm 3/4" ELETTROSIT/V4400/4600/4605 screw with O-ring suitable for SIT/HONEYWELL   |                 |                   |
|  | <b>GEV No.</b>  | 101503          | <b>Ref. No.</b> — |
|   | O-ring EPDM thickness 2mm ID ø 32mm Qty 1 pcs   |                 |                   |
|  | <b>GEV No.</b>  | 101924          | <b>Ref. No.</b> — |
|   | plug with cable L 1090mm suitable for NOVA 822/826/827  |                 |                   |



1

|   |  |                 |                   |
|---|--|-----------------|-------------------|
| <b>GEV No.</b>  | 101984   | <b>Ref. No.</b> | 809326            |
| <b>description</b>  | gas valve 230V 50Hz gas inlet 1/2" gas outlet 1/2" pilot connection level slow ignition ignition times pressure range 2-50mbar power supply for modulator 230VAC rectified Tandem equiv. no. 0.836.010 |                 |                   |
| <b>spare parts for</b>  | 101984   |                 |                   |
|    | <b>GEV No.</b>   | 101379          | <b>Ref. No.</b> — |
|   | solenoid coil 230V 50Hz suitable for Tandem  |                 |                   |
| <b>accessories for</b>  | 101984   |                 |                   |
|    | <b>GEV No.</b>   | 101274          | <b>Ref. No.</b> — |
|   | olive for pipe ø 16mm Qty 1 pcs  |                 |                   |
|    | <b>GEV No.</b>   | 101275          | <b>Ref. No.</b> — |
|   | union screw thread 1/2" for pipe ø 16mm Qty 1 pcs  |                 |                   |
|   | <b>GEV No.</b>   | 101925          | <b>Ref. No.</b> — |
|   | plug with O-ring thread M10x1 for pilot burner suitable for NOVASIT  |                 |                   |
|  | <b>GEV No.</b>   | 102845          | <b>Ref. No.</b> — |
|   | gas connection angled 1/2" flange 32x32mm hole distance 24x24mm Tandem   |                 |                   |
|  | <b>GEV No.</b>   | 102846          | <b>Ref. No.</b> — |
|   | gas connection straight 1/2" flange 32x32mm hole distance 24x24mm suitable for Tandem  |                 |                   |
|  | <b>GEV No.</b>   | 102847          | <b>Ref. No.</b> — |
|   | O-ring   |                 |                   |



1

|   |  |                 |                   |
|---|--|-----------------|-------------------|
| <b>GEV No.</b>  | 101684   | <b>Ref. No.</b> | 809595<br>8C0068  |
| <b>description</b>  | gas valve 230V 50Hz gas inlet 1/2" gas outlet 1/2" pilot connection level slow ignition standard ignition time 3-7s pressure range 3-50mbar power supply for modulator type SIT equiv. no. 0.830.034 |                 |                   |
| <b>spare parts for</b>  | 101684   |                 |                   |
|  | <b>GEV No.</b>   | 101379          | <b>Ref. No.</b> — |
|   | solenoid coil 230V 50Hz suitable for Tandem  |                 |                   |

Table continues overleaf





1 gas components



Зип Общепит

vsezip.ru

+7(812)987-08-81

|   |   |        |            |
|---|---|--------|------------|
| <b>accessories for</b>  | 101684  |        |            |
|  | GEV No.   | 101274 | Ref. No. — |
|   | olive for pipe ø 16mm Qty 1 pcs   |        |            |
|  | GEV No.   | 101275 | Ref. No. — |
|   | union screw thread 1/2" for pipe ø 16mm Qty 1 pcs                                     |        |            |
|  | GEV No.   | 102845 | Ref. No. — |
|   | gas connection angled 1/2" flange 32x32mm hole distance 24x24mm Tandem                |        |            |
|  | GEV No.   | 102846 | Ref. No. — |
|   | gas connection straight 1/2" flange 32x32mm hole distance 24x24mm suitable for Tandem |        |            |
|  | GEV No.   | 102847 | Ref. No. — |
|   | O-ring  |        |            |

|  |   |                 |        |
|--|---|-----------------|--------|
|  |   |                 |        |
| <b>GEV No.</b>   | 101166  | <b>Ref. No.</b> | 808611 |
| <b>description</b>   | ignition box HONEYWELL type S4560B 1006 electrodes 1 waiting time 0s safety time 10s 220-240V 10VA 50Hz |                 |        |



### ignition boxes

#### BRAHMA

|   |   |                 |        |
|---|---|-----------------|--------|
|  |   |                 |        |
| <b>GEV No.</b>  | 107471  | <b>Ref. No.</b> | 809878 |
| <b>description</b>  | ignition box BRAHMA type CM11 electrodes 2 waiting time 1.5s safety time 10s 230V 7VA 50-60Hz |                 |        |

|  |   |                 |                  |
|--|---|-----------------|------------------|
| <b>SIT</b>   |   |                 |                  |
|  |   |                 |                  |
| <b>GEV No.</b>   | 101685  | <b>Ref. No.</b> | 809602<br>8C0069 |
| <b>description</b>   | ignition box SIT type 503EFD electrodes 2 waiting time 1.5s safety time 10s 220/240V 10VA 50-60Hz protection IP40 |                 |                  |

#### HONEYWELL

|   |  |                 |            |
|---|--|-----------------|------------|
|  |  |                 |            |
| <b>GEV No.</b>  | 101165   | <b>Ref. No.</b> | 809751     |
| <b>description</b>  | ignition box HONEYWELL type S4560A 1008 equiv. no. S4560A 1008 electrodes 1 waiting time 0s safety time 10s 220-240V 10VA 50Hz |                 |            |
| <b>spare parts for</b>  | 101165   |                 |            |
|  | GEV No.  | 358696          | Ref. No. — |
|   | fine fuse size ø5x20mm 4A medium lag rated 250V Qty 10 pcs   |                 |            |

|  |   |                 |        |
|--|---|-----------------|--------|
|  |   |                 |        |
| <b>GEV No.</b>   | 102309  | <b>Ref. No.</b> | 809752 |
| <b>description</b>   | ignition box SIT type 537ABC electrodes 3 waiting time 1.5s safety time 10s 230V 10VA 50-60Hz protection IP44 |                 |        |



ignition parts

pilot burners

SIT

100 series





1













|   |   |                 |                 |
|---|---|-----------------|-----------------|
| <b>GEV No.</b>  | 107139  | <b>Ref. No.</b> | C00391          |
| <b>description</b>  | pilot burner SIT type 100 series 1 flame nozzle $\varnothing$ 0.2mm gas connection mm |                 |                 |
| <b>spare parts for</b>  | 107139  |                 |                 |
|    | GEV No.   | 100854          | Ref. No. —      |
| pilot burner bracket double   |   |                 |                 |
|    | GEV No.   | 100885          | Ref. No. —      |
| air mixing sleeve for pilot burner Qty 1 pcs  |   |                 |                 |
|    | GEV No.   | 107160          | Ref. No. —      |
| pilot burner cap SIT 1 flame Hmm Lmm Qty 1 pcs                                      |   |                 |                 |
| <b>accessories for</b>  | 107139  |                 |                 |
|  | GEV No.   | 100904          | Ref. No. —      |
| locking screw M10x1 for pipe $\varnothing$ 4mm Qty 1 pcs                            |   |                 |                 |
|  | GEV No.   | 100905          | Ref. No. 8C0070 |
| locking screw M10x1 for pipe $\varnothing$ 6mm Qty 1 pcs                            |   |                 |                 |
|  | GEV No.   | 100998          | Ref. No. —      |
| pilot burner bottom part nozzle $\varnothing$ 0.21mm suitable for 100 series        |   |                 |                 |
|  | GEV No.   | 102110          | Ref. No. —      |
| pilot tube copper pipe $\varnothing$ 4mm thickness 1mm L 3000mm                     |   |                 |                 |
|  | GEV No.   | 102111          | Ref. No. —      |
| pilot tube copper pipe $\varnothing$ 6mm thickness 1mm L 3000mm                     |   |                 |                 |



1

|   |   |                 |                 |
|---|---|-----------------|-----------------|
| <b>GEV No.</b>  | 106906  | <b>Ref. No.</b> | C00711          |
| <b>description</b>  | pilot burner SIT type 100 series 3 flames nozzle $\varnothing$ 0.2mm gas connection 6mm |                 |                 |
| <b>spare parts for</b>  | 106906  |                 |                 |
|  | GEV No.   | 100245          | Ref. No. 8C0030 |
| pilot burner nozzle LPG code 20 bore $\varnothing$ 0.2mm Qty 1 pcs thread M8x0.75   |   |                 |                 |
|  | GEV No.   | 100855          | Ref. No. —      |
| pilot burner bracket triple   |   |                 |                 |

Зип-Общепит

|   |         |        |          |        |
|---|---------|--------|----------|--------|
|    | GEV No. | 100885 | Ref. No. | —      |
| air mixing sleeve for pilot burner Qty 1 pcs  |         |        |          |        |
|    | GEV No. | 100916 | Ref. No. | —      |
| compression spring for pilot burner Qty 1 pcs                                       |         |        |          |        |
|    | GEV No. | 100917 | Ref. No. | —      |
| gasket for pilot burner Qty 1 pcs aluminium   |         |        |          |        |
|    | GEV No. | 100918 | Ref. No. | —      |
| screw for pilot burner  |         |        |          |        |
|    | GEV No. | 107162 | Ref. No. | —      |
| pilot burner cap SIT 3 flames Hmm Lmm Qty 1 pcs                                     |         |        |          |        |
|    | GEV No. | 107701 | Ref. No. | —      |
| pilot burner bottom part SIT 100 series nozzle $\varnothing$ 0.2mm                  |         |        |          |        |
| <b>accessories for</b>  | 106906  |        |          |        |
|    | GEV No. | 100245 | Ref. No. | 8C0030 |
| pilot burner nozzle LPG code 20 bore $\varnothing$ 0.2mm Qty 1 pcs thread M8x0.75   |         |        |          |        |
|    | GEV No. | 100246 | Ref. No. | 8C0031 |
| pilot burner nozzle natural gas bore $\varnothing$ 0.35mm Qty 1 pcs thread M8x0.75  |         |        |          |        |
|   | GEV No. | 100904 | Ref. No. | —      |
| locking screw M10x1 for pipe $\varnothing$ 4mm Qty 1 pcs                            |         |        |          |        |
|  | GEV No. | 100905 | Ref. No. | 8C0070 |
| locking screw M10x1 for pipe $\varnothing$ 6mm Qty 1 pcs                            |         |        |          |        |
|  | GEV No. | 102110 | Ref. No. | —      |
| pilot tube copper pipe $\varnothing$ 4mm thickness 1mm L 3000mm                     |         |        |          |        |
|  | GEV No. | 102111 | Ref. No. | —      |
| pilot tube copper pipe $\varnothing$ 6mm thickness 1mm L 3000mm                     |         |        |          |        |
|  | GEV No. | 107171 | Ref. No. | —      |
| pilot burner nozzle SIT natural/liquid gas bore $\varnothing$ 0.25mm Qty 1 pcs      |         |        |          |        |
|  | GEV No. | 107700 | Ref. No. | —      |
| pilot burner bottom part SIT 100 series nozzle $\varnothing$ 0.25mm                 |         |        |          |        |
|  | GEV No. | 107702 | Ref. No. | —      |
| pilot burner bottom part SIT 100 series nozzle $\varnothing$ 0.35mm                 |         |        |          |        |







1 gas components

Зип Общепит

vsezip.ru

+7(812)987-08-81

|   |   |                        |
|---|---|------------------------|
|    | <b>GEV No.</b> 106907   | <b>Ref. No.</b> C00166 |
| <b>description</b>  | pilot burner SIT type 100 series 3 flames nozzle $\phi$ 0.35mm gas connection 6mm |                        |
| <b>spare parts for</b>  | 106907  |                        |
|    | <b>GEV No.</b> 100246   | <b>Ref. No.</b> 8C0031 |
| <b>description</b>  | pilot burner nozzle natural gas bore $\phi$ 0.35mm Qty 1 pcs thread M8x0.75       |                        |
|    | <b>GEV No.</b> 100855   | <b>Ref. No.</b> —      |
| <b>description</b>  | pilot burner bracket triple   |                        |
|    | <b>GEV No.</b> 100885   | <b>Ref. No.</b> —      |
| <b>description</b>  | air mixing sleeve for pilot burner Qty 1 pcs                                      |                        |
|    | <b>GEV No.</b> 100916   | <b>Ref. No.</b> —      |
| <b>description</b>  | compression spring for pilot burner Qty 1 pcs                                     |                        |
|    | <b>GEV No.</b> 100917   | <b>Ref. No.</b> —      |
| <b>description</b>  | gasket for pilot burner Qty 1 pcs aluminium                                       |                        |
|   | <b>GEV No.</b> 100918   | <b>Ref. No.</b> —      |
| <b>description</b>  | screw for pilot burner  |                        |
|  | <b>GEV No.</b> 107162   | <b>Ref. No.</b> —      |
| <b>description</b>  | pilot burner cap SIT 3 flames Hmm Lmm Qty 1 pcs                                   |                        |
|  | <b>GEV No.</b> 107702   | <b>Ref. No.</b> —      |
| <b>description</b>  | pilot burner bottom part SIT 100 series nozzle $\phi$ 0.35mm                      |                        |
| <b>accessories for</b>  | 106907  |                        |
|  | <b>GEV No.</b> 100245   | <b>Ref. No.</b> 8C0030 |
| <b>description</b>  | pilot burner nozzle LPG code 20 bore $\phi$ 0.2mm Qty 1 pcs thread M8x0.75        |                        |
|  | <b>GEV No.</b> 100904   | <b>Ref. No.</b> —      |
| <b>description</b>  | locking screw M10x1 for pipe $\phi$ 4mm Qty 1 pcs                                 |                        |
|  | <b>GEV No.</b> 100905   | <b>Ref. No.</b> 8C0070 |
| <b>description</b>  | locking screw M10x1 for pipe $\phi$ 6mm Qty 1 pcs                                 |                        |
|  | <b>GEV No.</b> 102110   | <b>Ref. No.</b> —      |
| <b>description</b>  | pilot tube copper pipe $\phi$ 4mm thickness 1mm L 3000mm                          |                        |
|  | <b>GEV No.</b> 102111   | <b>Ref. No.</b> —      |
| <b>description</b>  | pilot tube copper pipe $\phi$ 6mm thickness 1mm L 3000mm                          |                        |
|  | <b>GEV No.</b> 107171   | <b>Ref. No.</b> —      |
| <b>description</b>  | pilot burner nozzle SIT natural/liquid gas bore $\phi$ 0.25mm Qty 1 pcs           |                        |
|  | <b>GEV No.</b> 107700   | <b>Ref. No.</b> —      |
| <b>description</b>  | pilot burner bottom part SIT 100 series nozzle $\phi$ 0.25mm                      |                        |
|  | <b>GEV No.</b> 107701   | <b>Ref. No.</b> —      |
| <b>description</b>  | pilot burner bottom part SIT 100 series nozzle $\phi$ 0.2mm                       |                        |

|  |   |                        |
|--|---|------------------------|
|   | <b>GEV No.</b> 107140   | <b>Ref. No.</b> C00392 |
| <b>description</b>   | pilot burner SIT type 100 series 3 flames nozzle $\phi$ 20mm gas connectionmm |                        |
| <b>spare parts for</b>   | 107140  |                        |
|   | <b>GEV No.</b> 100855   | <b>Ref. No.</b> —      |
| <b>description</b>   | pilot burner bracket triple   |                        |
|   | <b>GEV No.</b> 100885   | <b>Ref. No.</b> —      |
| <b>description</b>   | air mixing sleeve for pilot burner Qty 1 pcs                                  |                        |
|   | <b>GEV No.</b> 100916   | <b>Ref. No.</b> —      |
| <b>description</b>   | compression spring for pilot burner Qty 1 pcs                                 |                        |
|   | <b>GEV No.</b> 107162   | <b>Ref. No.</b> —      |
| <b>description</b>   | pilot burner cap SIT 3 flames Hmm Lmm Qty 1 pcs                               |                        |
| <b>accessories for</b>   | 107140  |                        |
|   | <b>GEV No.</b> 100904   | <b>Ref. No.</b> —      |
| <b>description</b>   | locking screw M10x1 for pipe $\phi$ 4mm Qty 1 pcs                             |                        |
|  | <b>GEV No.</b> 100905   | <b>Ref. No.</b> 8C0070 |
| <b>description</b>   | locking screw M10x1 for pipe $\phi$ 6mm Qty 1 pcs                             |                        |

accessories

pilot burner nozzles

|   |  |                        |
|---|--|------------------------|
|  | <b>GEV No.</b> 100245  | <b>Ref. No.</b> 8C0030 |
| <b>description</b>  | pilot burner nozzle LPG code 20 bore $\phi$ 0.2mm Qty 1 pcs thread M8x0.75 |                        |

|   |   |                        |
|---|---|------------------------|
|  | <b>GEV No.</b> 100246   | <b>Ref. No.</b> 8C0031 |
| <b>description</b>  | pilot burner nozzle natural gas bore $\phi$ 0.35mm Qty 1 pcs thread M8x0.75 |                        |



Зип-Общепит

vsezip.ru

+7(812)987-08-81

ignition electrodes

|                    |  |                 |                     |
|--------------------|--|-----------------|---------------------|
| <b>GEV No.</b>     | 100706                                     | <b>Ref. No.</b> | 051H10002<br>808177 |
| <b>description</b> | ignition electrode connection M4 Qty 1 pcs |                 |                     |

|                    |   |                 |        |
|--------------------|---|-----------------|--------|
| <b>GEV No.</b>     | 100707  | <b>Ref. No.</b> | 807741 |
| <b>description</b> | ignition electrode D1 ø 7mm D2 ø 9mm connection ø2.4mm L1 14mm L2 6mm BL1 18mm BL2 3mm BL3 23mm to clip Qty 1 pcs |                 |        |

140 - 145 -150 series

|                        |  |                 |  |
|------------------------|--|-----------------|--|
| <b>GEV No.</b>         | 107133   | <b>Ref. No.</b> | 808353                                     |
| <b>description</b>     | pilot burner SIT type 140 series 1 flame nozzle ømm gas connectionmm                                 |                 |  |
| <b>accessories for</b> | 107133   |                 |  |
|                        | <b>GEV No.</b>   | 100204          | <b>Ref. No.</b> 8C0955                     |
|                        | pilot burner nozzle SIT LPG code 14 bore ø 0.18/0.20mm Qty 1 pcs suitable for 140 series             |                 |  |
|                        | <b>GEV No.</b>   | 100205          | <b>Ref. No.</b> 809996                     |
|                        | pilot burner nozzle SIT LPG code 19 bore ø 0.23/0.26mm Qty 1 pcs suitable for SIT 150 series         |                 |  |
|                        | <b>GEV No.</b>   | 100206          | <b>Ref. No.</b> 809994                     |
|                        | pilot burner nozzle SIT natural gas code 36 bore ø 0.60/0.55mm Qty 1 pcs suitable for SIT 150 series |                 |  |
|                        | <b>GEV No.</b>   | 100207          | <b>Ref. No.</b> 8C1497                     |
|                        | pilot burner nozzle SIT natural gas code 27 bore ø 0.40/0.38mm suitable for SIT 140 series           |                 |  |
|                        | <b>GEV No.</b>   | 100216          | <b>Ref. No.</b> —                          |
|                        | pilot burner nozzle SIT natural gas code 38 bore ø 0.45mm Qty 1 pcs suitable for SIT 150 series      |                 |  |
|                        | <b>GEV No.</b>   | 100701          | <b>Ref. No.</b> 807905<br>809475<br>C00173 |
|                        | ignition electrode connection M4 Qty 1 pcs   |                 |  |

|  |  |        |                 |        |
|--|--|--------|-----------------|--------|
|  | <b>GEV No.</b>   | 100897 | <b>Ref. No.</b> | —      |
|  | olive for pipe ø4mm Qty 1 pcs for pilot burner                             |        |                 |        |
|  | <b>GEV No.</b>   | 100898 | <b>Ref. No.</b> | —      |
|  | olive for pipe ø6mm Qty 1 pcs for pilot burner                             |        |                 |        |
|  | <b>GEV No.</b>   | 100906 | <b>Ref. No.</b> | —      |
|  | screw connection thread M10x1 for ignition electrode brass Qty 1 pcs WS 10 |        |                 |        |
|  | <b>GEV No.</b>   | 100907 | <b>Ref. No.</b> | —      |
|  | screw connection thread M10x1 Qty 1 pcs type SEF 1 ømm for thermocouple    |        |                 |        |
|  | <b>GEV No.</b>   | 100908 | <b>Ref. No.</b> | 806019 |
|  | union screw thread M10x1 for pipe ø 4mm Qty 1 pcs                          |        |                 |        |
|  | <b>GEV No.</b>   | 100909 | <b>Ref. No.</b> | —      |
|  | union screw thread M10x1 for pipe ø 6mm Qty 1 pcs                          |        |                 |        |
|  | <b>GEV No.</b>   | 102110 | <b>Ref. No.</b> | —      |
|  | pilot tube copper pipe ø 4mm thickness 1mm L 3000mm                        |        |                 |        |
|  | <b>GEV No.</b>   | 102111 | <b>Ref. No.</b> | —      |
|  | pilot tube copper pipe ø 6mm thickness 1mm L 3000mm                        |        |                 |        |

|  |  |   |                 |                            |
|--|--|---|-----------------|----------------------------|
|  | <b>GEV No.</b>   | 107114 <sup>1</sup>   | <b>Ref. No.</b> | 809474                     |
|  | <b>description</b>   | pilot burner SIT type 140 series 2 flames nozzle ømm gas connectionmm |                 |                            |
|  | <b>spare parts for</b>   | 107114  |                 |                            |
|  | <b>GEV No.</b>   | 100907  | <b>Ref. No.</b> | —                          |
|  | screw connection thread M10x1 Qty 1 pcs type SEF 1 ømm for thermocouple                              |   |                 |                            |
|  | <b>accessories for</b>   | 107114  |                 |                            |
|  | <b>GEV No.</b>   | 100204  | <b>Ref. No.</b> | 8C0955                     |
|  | pilot burner nozzle SIT LPG code 14 bore ø 0.18/0.20mm Qty 1 pcs suitable for 140 series             |   |                 |                            |
|  | <b>GEV No.</b>   | 100205  | <b>Ref. No.</b> | 809996                     |
|  | pilot burner nozzle SIT LPG code 19 bore ø 0.23/0.26mm Qty 1 pcs suitable for SIT 150 series         |   |                 |                            |
|  | <b>GEV No.</b>   | 100206  | <b>Ref. No.</b> | 809994                     |
|  | pilot burner nozzle SIT natural gas code 36 bore ø 0.60/0.55mm Qty 1 pcs suitable for SIT 150 series |   |                 |                            |
|  | <b>GEV No.</b>   | 100207  | <b>Ref. No.</b> | 8C1497                     |
|  | pilot burner nozzle SIT natural gas code 27 bore ø 0.40/0.38mm suitable for SIT 140 series           |   |                 |                            |
|  | <b>GEV No.</b>   | 100216  | <b>Ref. No.</b> | —                          |
|  | pilot burner nozzle SIT natural gas code 38 bore ø 0.45mm Qty 1 pcs suitable for SIT 150 series      |   |                 |                            |
|  | <b>GEV No.</b>   | 100701  | <b>Ref. No.</b> | 807905<br>809475<br>C00173 |
|  | ignition electrode connection M4 Qty 1 pcs   |   |                 |                            |
|  | <b>GEV No.</b>   | 100801  | <b>Ref. No.</b> | —                          |
|  | gasket for pilot burner Qty 1 pcs  |   |                 |                            |





<sup>1</sup>incl. thermocouple fitting  
Table continues overleaf

1 gas components

Зип-Общепит









vsezip.ru





+7(812)987-08-81

|   |  |        |          |        |
|---|--|--------|----------|--------|
| <b>accessories for</b>  | 107114   |        |          |        |
|  | GEV No.  | 100897 | Ref. No. | —      |
|   | olive for pipe ø 4mm Qty 1 pcs for pilot burner                            |        |          |        |
|  | GEV No.  | 100898 | Ref. No. | —      |
|   | olive for pipe ø 6mm Qty 1 pcs for pilot burner                            |        |          |        |
|  | GEV No.  | 100906 | Ref. No. | —      |
|   | screw connection thread M10x1 for ignition electrode brass Qty 1 pcs WS 10 |        |          |        |
|  | GEV No.  | 100908 | Ref. No. | 806019 |
|   | union screw thread M10x1 for pipe ø 4mm Qty 1 pcs                          |        |          |        |
|  | GEV No.  | 100909 | Ref. No. | —      |
|   | union screw thread M10x1 for pipe ø 6mm Qty 1 pcs                          |        |          |        |
|  | GEV No.  | 102110 | Ref. No. | —      |
|   | pilot tube copper pipe ø 4mm thickness 1mm L 3000mm                        |        |          |        |
|  | GEV No.  | 102111 | Ref. No. | —      |
|   | pilot tube copper pipe ø 6mm thickness 1mm L 3000mm                        |        |          |        |

160 series



|   |  |                 |          |                            |
|---|--|-----------------|----------|----------------------------|
| <b>GEV No.</b>  | 100052   | <b>Ref. No.</b> | 806153   |                            |
| <b>description</b>  | pilot burner SIT type 160 series 2 flames nozzle ømm gas connectionmm      |                 |          |                            |
| <b>spare parts for</b>  | 100052   |                 |          |                            |
|  | GEV No.  | 100907          | Ref. No. | —                          |
|   | screw connection thread M10x1 Qty 1 pcs type SEF 1 ømm for thermocouple    |                 |          |                            |
| <b>accessories for</b>  | 100052   |                 |          |                            |
|  | GEV No.  | 100202          | Ref. No. | —                          |
|   | pilot burner nozzle natural gas code 41 Qty 1 pcs nozzle ø 0.41mm          |                 |          |                            |
|  | GEV No.  | 100203          | Ref. No. | —                          |
|   | pilot burner nozzle LPG code 25 Qty 1 pcs nozzle ø 0.25mm                  |                 |          |                            |
|  | GEV No.  | 100701          | Ref. No. | 807905<br>809475<br>C00173 |
|   | ignition electrode connection M4 Qty 1 pcs                                 |                 |          |                            |
|  | GEV No.  | 100801          | Ref. No. | —                          |
|   | gasket for pilot burner Qty 1 pcs  |                 |          |                            |
|  | GEV No.  | 100906          | Ref. No. | —                          |
|   | screw connection thread M10x1 for ignition electrode brass Qty 1 pcs WS 10 |                 |          |                            |
|  | GEV No.  | 100908          | Ref. No. | 806019                     |
|   | union screw thread M10x1 for pipe ø 4mm Qty 1 pcs                          |                 |          |                            |
|  | GEV No.  | 100909          | Ref. No. | —                          |
|   | union screw thread M10x1 for pipe ø 6mm Qty 1 pcs                          |                 |          |                            |

|   |   |        |          |        |
|---|---|--------|----------|--------|
| <b>accessories for</b>  | 100052  |        |          |        |
|  | GEV No.   | 101282 | Ref. No. | —      |
|   | olive for pipe ø 4mm L 7.4mm Qty 1 pcs              |        |          |        |
|  | GEV No.   | 101287 | Ref. No. | —      |
|   | olive for pipe ø 6mm Qty 1 pcs                      |        |          |        |
|  | GEV No.   | 102110 | Ref. No. | —      |
|   | pilot tube copper pipe ø 4mm thickness 1mm L 3000mm |        |          |        |
|  | GEV No.   | 102111 | Ref. No. | —      |
|   | pilot tube copper pipe ø 6mm thickness 1mm L 3000mm |        |          |        |
|  | GEV No.   | 107650 | Ref. No. | 808365 |
|   | pilot burner nozzle SIT LPG code 30 Qty 1 pcs       |        |          |        |

POLIDORO

pilot burners











|   |  |                 |                  |                                  |
|---|--|-----------------|------------------|----------------------------------|
| <b>GEV No.</b>  | 100051   | <b>Ref. No.</b> | 808039<br>808197 |                                  |
| <b>description</b>  | pilot burner POLIDORO 3 flames code gas connectionmm                       |                 |                  |                                  |
| <b>spare parts for</b>  | 100051   |                 |                  |                                  |
|  | GEV No.  | 100907          | Ref. No.         | —                                |
|   | screw connection thread M10x1 Qty 1 pcs type SEF 1 ømm for thermocouple    |                 |                  |                                  |
| <b>accessories for</b>  | 100051   |                 |                  |                                  |
|  | GEV No.  | 100000          | Ref. No.         | —                                |
|   | pilot burner nozzle POLIDORO LPG code 22 bore ø 0.22mm Qty 1 pcs           |                 |                  |                                  |
|  | GEV No.  | 100208          | Ref. No.         | 512120005<br>512120010<br>C00170 |
|   | pilot burner nozzle POLIDORO LPG code 20 bore ø 0.2mm Qty 1 pcs            |                 |                  |                                  |
|  | GEV No.  | 100209          | Ref. No.         | —                                |
|   | pilot burner nozzle POLIDORO natural gas code 40 bore ø 0.4mm Qty 1 pcs    |                 |                  |                                  |
|  | GEV No.  | 100701          | Ref. No.         | 807905<br>809475<br>C00173       |
|   | ignition electrode connection M4 Qty 1 pcs                                 |                 |                  |                                  |
|  | GEV No.  | 100906          | Ref. No.         | —                                |
|   | screw connection thread M10x1 for ignition electrode brass Qty 1 pcs WS 10 |                 |                  |                                  |
|  | GEV No.  | 100907          | Ref. No.         | —                                |
|   | screw connection thread M10x1 Qty 1 pcs type SEF 1 ømm for thermocouple    |                 |                  |                                  |
|  | GEV No.  | 100908          | Ref. No.         | 806019                           |
|   | union screw thread M10x1 for pipe ø 4mm Qty 1 pcs                          |                 |                  |                                  |
|  | GEV No.  | 100909          | Ref. No.         | —                                |
|   | union screw thread M10x1 for pipe ø 6mm Qty 1 pcs                          |                 |                  |                                  |

Table continues overleaf

























Зип Общепит

vsezip.ru

+7(812)987-08-81

| accessories for  |         | 100051 |                    |
|--|---------|--------|--------------------|
|     | GEV No. | 102110 | Ref. No. —         |
| pilot tube copper pipe ø 4mm thickness 1mm L 3000mm                                  |         |        |                    |
|     | GEV No. | 102111 | Ref. No. —         |
| pilot tube copper pipe ø 6mm thickness 1mm L 3000mm                                  |         |        |                    |
|     | GEV No. | 102508 | Ref. No. —         |
| union screw thread M10x1 for pipe ø 4mm Qty 5 pcs                                    |         |        |                    |
|     | GEV No. | 102509 | Ref. No. —         |
| union screw thread M10x1 for pipe ø 6mm Qty 5 pcs                                    |         |        |                    |
|     | GEV No. | 102699 | Ref. No. —         |
| pilot burner nozzle POLIDORO natural gas code 25.2 bore ø 2x0.25mm Qty 1 pcs 2 bores |         |        |                    |
|     | GEV No. | 102795 | Ref. No. —         |
| olive for pipe ø 4mm Qty 1 pcs   |         |        |                    |
|     | GEV No. | 102797 | Ref. No. —         |
| olive for pipe ø 6mm Qty 1 pcs   |         |        |                    |
|     | GEV No. | 106703 | Ref. No. 512120007 |
| pilot burner nozzle POLIDORO natural gas code 27.2 bore ø 2x0.27mm Qty 1 pcs         |         |        |                    |
|    | GEV No. | 106704 | Ref. No. —         |
| pilot burner nozzle POLIDORO LPG code 16.2 bore ø 2x0.16mm Qty 1 pcs                 |         |        |                    |
|   | GEV No. | 106763 | Ref. No. —         |
| pilot burner nozzle POLIDORO natural gas code 27.2A bore ø 2x 0.27mm Qty 1 pcs       |         |        |                    |
|   | GEV No. | 106859 | Ref. No. —         |
| pilot burner nozzle POLIDORO LPG code 24 bore ø 0.24mm Qty 1 pcs                     |         |        |                    |

|  |  |                 |   |
|--|--|-----------------|---|
|  <p>1</p> |  |                 |   |
| <b>GEV No.</b>   | 100162   | <b>Ref. No.</b> | 809195                                    |
| <b>description</b>   | pilot burner POLIDORO 3 flames code gas connectionmm |                 |   |
| <b>spare parts for</b>   | 100162   |                 |   |
|           | GEV No.  | 100907          | Ref. No. —                                |
| screw connection thread M10x1 Qty 1 pcs type SEF 1 ømm for thermocouple                      |  |                 |   |
| <b>accessories for</b>   | 100162   |                 |   |
|           | GEV No.  | 100000          | Ref. No. —                                |
| pilot burner nozzle POLIDORO LPG code 22 bore ø 0.22mm Qty 1 pcs                             |  |                 |   |
|           | GEV No.  | 100208          | Ref. No. 512120005<br>512120010<br>C00170 |
| pilot burner nozzle POLIDORO LPG code 20 bore ø 0.2mm Qty 1 pcs                              |  |                 |   |
|           | GEV No.  | 100209          | Ref. No. —                                |
| pilot burner nozzle POLIDORO natural gas code 40 bore ø 0.4mm Qty 1 pcs                      |  |                 |   |
|           | GEV No.  | 100701          | Ref. No. 807905<br>809475<br>C00173       |
| ignition electrode connection M4 Qty 1 pcs   |  |                 |   |

| accessories for  |         | 100162 |                    |
|--|---------|--------|--------------------|
|     | GEV No. | 100906 | Ref. No. —         |
| screw connection thread M10x1 for ignition electrode brass Qty 1 pcs V/S 10          |         |        |                    |
|     | GEV No. | 100907 | Ref. No. —         |
| screw connection thread M10x1 Qty 1 pcs type SEF 1 ømm for thermocouple              |         |        |                    |
|     | GEV No. | 100908 | Ref. No. 806019    |
| union screw thread M10x1 for pipe ø 4mm Qty 1 pcs                                    |         |        |                    |
|     | GEV No. | 100909 | Ref. No. —         |
| union screw thread M10x1 for pipe ø 6mm Qty 1 pcs                                    |         |        |                    |
|     | GEV No. | 102110 | Ref. No. —         |
| pilot tube copper pipe ø 4mm thickness 1mm L 3000mm                                  |         |        |                    |
|     | GEV No. | 102111 | Ref. No. —         |
| pilot tube copper pipe ø 6mm thickness 1mm L 3000mm                                  |         |        |                    |
|     | GEV No. | 102508 | Ref. No. —         |
| union screw thread M10x1 for pipe ø 4mm Qty 5 pcs                                    |         |        |                    |
|     | GEV No. | 102509 | Ref. No. —         |
| union screw thread M10x1 for pipe ø 6mm Qty 5 pcs                                    |         |        |                    |
|    | GEV No. | 102699 | Ref. No. —         |
| pilot burner nozzle POLIDORO natural gas code 25.2 bore ø 2x0.25mm Qty 1 pcs 2 bores |         |        |                    |
|   | GEV No. | 102795 | Ref. No. —         |
| olive for pipe ø 4mm Qty 1 pcs   |         |        |                    |
|   | GEV No. | 102797 | Ref. No. —         |
| olive for pipe ø 6mm Qty 1 pcs   |         |        |                    |
|   | GEV No. | 106703 | Ref. No. 512120007 |
| pilot burner nozzle POLIDORO natural gas code 27.2 bore ø 2x0.27mm Qty 1 pcs         |         |        |                    |
|   | GEV No. | 106704 | Ref. No. —         |
| pilot burner nozzle POLIDORO LPG code 16.2 bore ø 2x0.16mm Qty 1 pcs                 |         |        |                    |
|   | GEV No. | 106763 | Ref. No. —         |
| pilot burner nozzle POLIDORO natural gas code 27.2A bore ø 2x 0.27mm Qty 1 pcs       |         |        |                    |
|   | GEV No. | 106859 | Ref. No. —         |
| pilot burner nozzle POLIDORO LPG code 24 bore ø 0.24mm Qty 1 pcs                     |         |        |                    |





















|   |   |                 |                  |
|---|---|-----------------|------------------|
|  <p>1</p> |   |                 |                  |
| <b>GEV No.</b>  | 100076  | <b>Ref. No.</b> | 806154<br>807835 |
| <b>description</b>  | pilot burner POLIDORO 3 flames natural gas code 29.2 gas connection 6mm |                 |                  |
| <b>spare parts for</b>  | 100076  |                 |                  |
|            | GEV No.   | 100907          | Ref. No. —       |
| screw connection thread M10x1 Qty 1 pcs type SEF 1 ømm for thermocouple                       |   |                 |                  |

Table continues overleaf





1 gas components

| accessories for   |  | 100076 |   |
|---|--|--------|---|
|    | GEV No.  | 100000 | Ref. No. —                                |
|   | pilot burner nozzle POLIDORO LPG code 22 bore $\varnothing$ 0.22mm Qty 1 pcs                     |        |   |
|    | GEV No.  | 100208 | Ref. No. 512120005<br>512120010<br>C00170 |
|   | pilot burner nozzle POLIDORO LPG code 20 bore $\varnothing$ 0.2mm Qty 1 pcs                      |        |   |
|    | GEV No.  | 100209 | Ref. No. —                                |
|   | pilot burner nozzle POLIDORO natural gas code 40 bore $\varnothing$ 0.4mm Qty 1 pcs              |        |   |
|    | GEV No.  | 100701 | Ref. No. 807905<br>809475<br>C00173       |
|   | ignition electrode connection M4 Qty 1 pcs   |        |   |
|    | GEV No.  | 100906 | Ref. No. —                                |
|   | screw connection thread M10x1 for ignition electrode brass Qty 1 pcs WS 10                       |        |   |
|    | GEV No.  | 100907 | Ref. No. —                                |
|   | screw connection thread M10x1 Qty 1 pcs type SEF 1 $\varnothing$ mm for thermocouple             |        |   |
|    | GEV No.  | 100908 | Ref. No. 806019                           |
|   | union screw thread M10x1 for pipe $\varnothing$ 4mm Qty 1 pcs                                    |        |   |
|    | GEV No.  | 100909 | Ref. No. —                                |
|   | union screw thread M10x1 for pipe $\varnothing$ 6mm Qty 1 pcs                                    |        |   |
|   | GEV No.  | 102110 | Ref. No. —                                |
|   | pilot tube copper pipe $\varnothing$ 4mm thickness 1mm L 3000mm                                  |        |   |
|  | GEV No.  | 102111 | Ref. No. —                                |
|   | pilot tube copper pipe $\varnothing$ 6mm thickness 1mm L 3000mm                                  |        |   |
|  | GEV No.  | 102508 | Ref. No. —                                |
|   | union screw thread M10x1 for pipe $\varnothing$ 4mm Qty 5 pcs                                    |        |   |
|  | GEV No.  | 102509 | Ref. No. —                                |
|   | union screw thread M10x1 for pipe $\varnothing$ 6mm Qty 5 pcs                                    |        |   |
|  | GEV No.  | 102699 | Ref. No. —                                |
|   | pilot burner nozzle POLIDORO natural gas code 25.2 bore $\varnothing$ 2x0.25mm Qty 1 pcs 2 bores |        |   |
|  | GEV No.  | 102795 | Ref. No. —                                |
|   | olive for pipe $\varnothing$ 4mm Qty 1 pcs   |        |   |
|  | GEV No.  | 102797 | Ref. No. —                                |
|   | olive for pipe $\varnothing$ 6mm Qty 1 pcs   |        |   |
|  | GEV No.  | 106703 | Ref. No. 512120007                        |
|   | pilot burner nozzle POLIDORO natural gas code 27.2 bore $\varnothing$ 2x0.27mm Qty 1 pcs         |        |   |
|  | GEV No.  | 106704 | Ref. No. —                                |
|   | pilot burner nozzle POLIDORO LPG code 16.2 bore $\varnothing$ 2x0.16mm Qty 1 pcs                 |        |   |
|  | GEV No.  | 106763 | Ref. No. —                                |
|   | pilot burner nozzle POLIDORO natural gas code 27.2A bore $\varnothing$ 2x 0.27mm Qty 1 pcs       |        |   |
|  | GEV No.  | 106859 | Ref. No. —                                |
|   | pilot burner nozzle POLIDORO LPG code 24 bore $\varnothing$ 0.24mm Qty 1 pcs                     |        |   |

Зип Общепит

vsezip.ru

+7(812)987-08-81

| accessories for   |   | 106580 |                                     |
|---|---|--------|-------------------------------------|
|  | GEV No.   | 106580 | Ref. No. C10515                     |
|   | description pilot burner POLIDORO 3 flames natural gas nozzle 27.2 code 27.2 gas connection 6mm |        |                                     |
| spare parts for   |   | 106680 |                                     |
|  | GEV No.   | 106703 | Ref. No. 512120007                  |
|   | pilot burner nozzle POLIDORO natural gas code 27.2 bore $\varnothing$ 2x0.27mm Qty 1 pcs        |        |                                     |
| accessories for   |   | 106680 |                                     |
|  | GEV No.   | 100701 | Ref. No. 807905<br>809475<br>C00173 |
|   | ignition electrode connection M4 Qty 1 pcs  |        |                                     |
|  | GEV No.   | 100908 | Ref. No. 806019                     |
|   | union screw thread M10x1 for pipe $\varnothing$ 4mm Qty 1 pcs                                   |        |                                     |
|  | GEV No.   | 100909 | Ref. No. —                          |
|   | union screw thread M10x1 for pipe $\varnothing$ 6mm Qty 1 pcs                                   |        |                                     |









| accessories for   |  | 100148 |   |
|---|--|--------|---|
|    | GEV No.  | 100148 | Ref. No. 808524                           |
|   | description pilot burner POLIDORO type A 3 flames LPG code 20 gas connectionmm       |        |   |
| accessories for   |  | 100148 |   |
|  | GEV No.  | 100000 | Ref. No. —                                |
|   | pilot burner nozzle POLIDORO LPG code 22 bore $\varnothing$ 0.22mm Qty 1 pcs         |        |   |
|  | GEV No.  | 100208 | Ref. No. 512120005<br>512120010<br>C00170 |
|   | pilot burner nozzle POLIDORO LPG code 20 bore $\varnothing$ 0.2mm Qty 1 pcs          |        |   |
|  | GEV No.  | 100209 | Ref. No. —                                |
|   | pilot burner nozzle POLIDORO natural gas code 40 bore $\varnothing$ 0.4mm Qty 1 pcs  |        |   |
|  | GEV No.  | 100701 | Ref. No. 807905<br>809475<br>C00173       |
|   | ignition electrode connection M4 Qty 1 pcs   |        |   |
|  | GEV No.  | 100906 | Ref. No. —                                |
|   | screw connection thread M10x1 for ignition electrode brass Qty 1 pcs WS 10           |        |   |
|  | GEV No.  | 100907 | Ref. No. —                                |
|   | screw connection thread M10x1 Qty 1 pcs type SEF 1 $\varnothing$ mm for thermocouple |        |   |
|  | GEV No.  | 100908 | Ref. No. 806019                           |
|   | union screw thread M10x1 for pipe $\varnothing$ 4mm Qty 1 pcs                        |        |   |
|  | GEV No.  | 100909 | Ref. No. —                                |
|   | union screw thread M10x1 for pipe $\varnothing$ 6mm Qty 1 pcs                        |        |   |

Table continues overleaf





Зип Общепит

vsezip.ru

+7(812)987-08-81

|  |  |        |                    |
|--|--|--------|--------------------|
| <b>accessories for</b>   | 100148   |        |                    |
|   | GEV No.  | 102110 | Ref. No. —         |
|  | pilot tube copper pipe $\varnothing$ 4mm thickness 1mm L 3000mm                                  |        |                    |
|   | GEV No.  | 102111 | Ref. No. —         |
|  | pilot tube copper pipe $\varnothing$ 6mm thickness 1mm L 3000mm                                  |        |                    |
|   | GEV No.  | 102699 | Ref. No. —         |
|  | pilot burner nozzle POLIDORO natural gas code 25.2 bore $\varnothing$ 2x0.25mm Qty 1 pcs 2 bores |        |                    |
|   | GEV No.  | 102795 | Ref. No. —         |
|  | olive for pipe $\varnothing$ 4mm Qty 1 pcs   |        |                    |
|   | GEV No.  | 102797 | Ref. No. —         |
|  | olive for pipe $\varnothing$ 6mm Qty 1 pcs   |        |                    |
|   | GEV No.  | 106703 | Ref. No. 512120007 |
|  | pilot burner nozzle POLIDORO natural gas code 27.2 bore $\varnothing$ 2x0.27mm Qty 1 pcs         |        |                    |
|   | GEV No.  | 106704 | Ref. No. —         |
|  | pilot burner nozzle POLIDORO LPG code 16.2 bore $\varnothing$ 2x0.16mm Qty 1 pcs                 |        |                    |
|   | GEV No.  | 106763 | Ref. No. —         |
|  | pilot burner nozzle POLIDORO natural gas code 27.2A bore $\varnothing$ 2x 0.27mm Qty 1 pcs       |        |                    |
|  | GEV No.  | 106859 | Ref. No. —         |
|  | pilot burner nozzle POLIDORO LPG code 24 bore $\varnothing$ 0.24mm Qty 1 pcs                     |        |                    |



|   |                    |  |                 |                     |
|---|--------------------|--|-----------------|---------------------|
|  | <b>GEV No.</b>     | 100706                                     | <b>Ref. No.</b> | 051H10002<br>808177 |
|   | <b>description</b> | ignition electrode connection M4 Qty 1 pcs |                 |                     |

|  |                    |  |                 |        |
|--|--------------------|--|-----------------|--------|
|  | <b>GEV No.</b>     | 100753   | <b>Ref. No.</b> | C10085 |
|  | <b>description</b> | ignition electrode D1 $\varnothing$ 6mm cable length 600mm connection F 2.8x0.8mm D2 $\varnothing$ 10mm L1 1mm BL1 15mm BL2 2mm BL3 22mm to clip |                 |        |

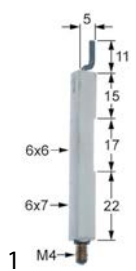
|  |                    |  |                 |        |
|--|--------------------|--|-----------------|--------|
|  | <b>GEV No.</b>     | 100754   | <b>Ref. No.</b> | C10161 |
|  | <b>description</b> | ignition electrode D1 $\varnothing$ 6mm cable length 750mm connection F 2.8x0.8mm D2 $\varnothing$ 10mm L1 4.5mm BL1 14mm BL2 2mm BL3 22mm |                 |        |

|   |                    |  |                 |        |
|---|--------------------|--|-----------------|--------|
|  | <b>GEV No.</b>     | 100708   | <b>Ref. No.</b> | C00172 |
|   | <b>description</b> | ignition electrode D1 $\varnothing$ 6x7mm connection M4 D2 $\varnothing$ 6x6mm L1 11mm L2 5mm BL1 15mm BL2 16mm BL3 23mm |                 |        |

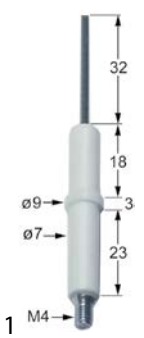
electrodes

|   |  |  |                 |                            |
|---|--|--|-----------------|----------------------------|
|  | <b>GEV No.</b>   | 100701                                     | <b>Ref. No.</b> | 807905<br>809475<br>C00173 |
|   | <b>description</b>   | ignition electrode connection M4 Qty 1 pcs |                 |                            |
| <b>accessories for</b>  | 100701   |  |                 |                            |
|  | GEV No.  | 100906                                     | Ref. No.        | —                          |
|   | screw connection thread M10x1 for ignition electrode brass Qty 1 pcs WS 10 |  |                 |                            |

1 gas components



Зип Общепит

vsezip.ru

+7(812)987-08-81



|                    |   |                 |        |
|--------------------|---|-----------------|--------|
| <b>GEV No.</b>     | 100707  | <b>Ref. No.</b> | 807741 |
| <b>description</b> | ignition electrode D1 ø 7mm D2 ø 9mm connection ø2.4mm L1 14mm L2 6mm BL1 18mm BL2 3mm BL3 23mm to clip Qty 1 pcs |                 |        |



|                    |  |                 |        |
|--------------------|--|-----------------|--------|
| <b>GEV No.</b>     | 100756   | <b>Ref. No.</b> | 808593 |
| <b>description</b> | ignition electrode flange length 24mm flange width 17mm fixing dimensions ø4.5mm with flange |                 |        |

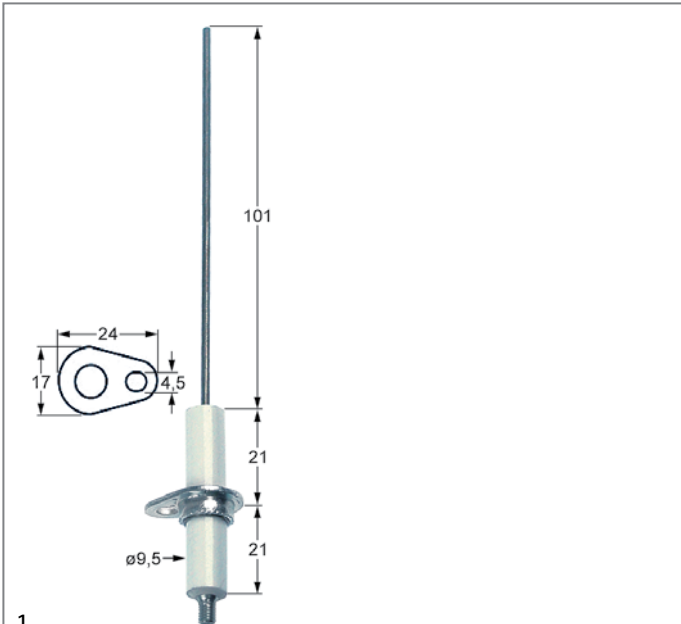

|                    |  |                 |        |
|--------------------|--|-----------------|--------|
| <b>GEV No.</b>     | 102323   | <b>Ref. No.</b> | 808592 |
| <b>description</b> | ignition electrode flange length 24mm flange width 17mm D1 ø 9.5mm L1 101mm BL2 21mm BL3 21mm connection M4 fixing dimensions ø4.5mm with flange |                 |        |



|                    |  |                 |        |
|--------------------|--|-----------------|--------|
| <b>GEV No.</b>     | 100755   | <b>Ref. No.</b> | 808592 |
| <b>description</b> | ignition electrode flange length 38mm flange width 17mm connection M4 fixing dimensions ø4.5mm mounting distance 28mm with flange with earthing contact connection ø 4mm |                 |        |

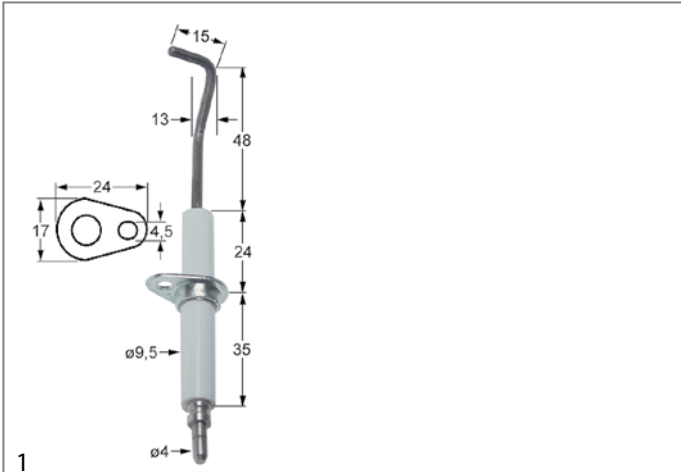

|                    |  |                 |        |
|--------------------|--|-----------------|--------|
| <b>GEV No.</b>     | 102342   | <b>Ref. No.</b> | 809281 |
| <b>description</b> | ignition electrode flange length 24mm flange width 17mm D1 ø 9.5mm L1 48mm L2 13mm L3 15mm BL1 24mm BL2 35mm fixing dimensions ø4.5mm with flange connection ø 4mm |                 |        |

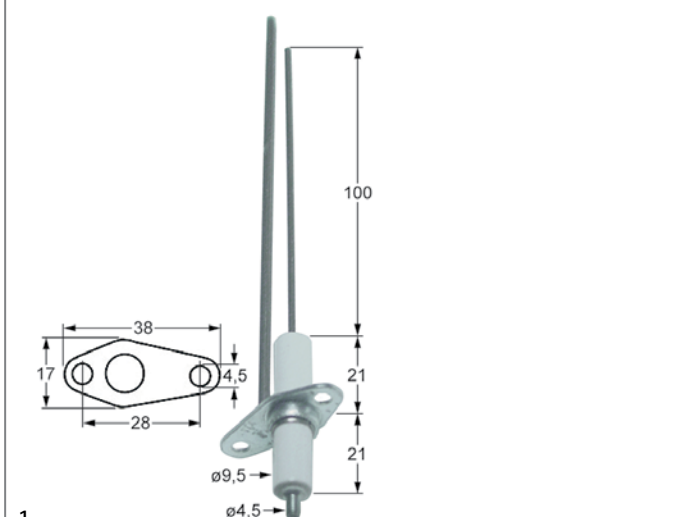

|                    |   |                 |        |
|--------------------|---|-----------------|--------|
| <b>GEV No.</b>     | 102322  | <b>Ref. No.</b> | 808592 |
| <b>description</b> | ignition electrode flange length 38mm flange width 17mm D1 ø 9.5mm L1 100mm BL1 21mm BL2 21mm connection M4 fixing dimensions ø4.5mm mounting distance 28mm with flange with earthing contact |                 |        |



ignition cables

3 in 1 Общепит  
piezoelectric igniters

pre-assembled cables

|                    |   |                 |        |
|--------------------|---|-----------------|--------|
| 1                  |   |                 |        |
| <b>GEV No.</b>     | 100026  | <b>Ref. No.</b> | 809430 |
| <b>description</b> | ignition cable cable length 1000mm connection ø4mm / F6.3mm |                 |        |

|                    |   |                 |        |
|--------------------|---|-----------------|--------|
| 1                  |   |                 |        |
| <b>GEV No.</b>     | 100164  | <b>Ref. No.</b> | C10259 |
| <b>description</b> | ignition cable cable length 1200mm connection ø4mm / F2.8mm |                 |        |

|                    |   |                 |        |
|--------------------|---|-----------------|--------|
| 1                  |   |                 |        |
| <b>GEV No.</b>     | 102163  | <b>Ref. No.</b> | 808276 |
| <b>description</b> | ignition cable cable length 1500mm connection F2.8mm / ø2.4mm |                 |        |

|                    |   |                 |        |
|--------------------|---|-----------------|--------|
| 1                  |   |                 |        |
| <b>GEV No.</b>     | 100147  | <b>Ref. No.</b> | 809468 |
| <b>description</b> | ignition cable cable length 1500mm connection ø2.4mm / ø4mm |                 |        |

|                    |  |                 |        |
|--------------------|--|-----------------|--------|
| 1                  |  |                 |        |
| <b>GEV No.</b>     | 100014   | <b>Ref. No.</b> | C00808 |
| <b>description</b> | ignition cable cable length 300mm connection ø2.4mm / ø2.4mm |                 |        |

|                    |  |                 |           |
|--------------------|--|-----------------|-----------|
| 1                  |  |                 |           |
| <b>GEV No.</b>     | 100197   | <b>Ref. No.</b> | 051E10008 |
| <b>description</b> | ignition cable cable length 600mm connection F2.8mm / ø2.4mm |                 |           |

|                    |  |                 |                  |
|--------------------|--|-----------------|------------------|
| 1                  |  |                 |                  |
| <b>GEV No.</b>     | 100018   | <b>Ref. No.</b> | 808230<br>C00171 |
| <b>description</b> | ignition cable cable length 600mm connection ø2.4mm / ø4mm permanent temperature 200°C |                 |                  |

|                    |  |                 |        |
|--------------------|--|-----------------|--------|
| 1                  |  |                 |        |
| <b>GEV No.</b>     | 100025   | <b>Ref. No.</b> | 809439 |
| <b>description</b> | ignition cable cable length 600mm connection ø4mm / F6.3mm |                 |        |

|                    |  |                 |        |
|--------------------|--|-----------------|--------|
| 1                  |  |                 |        |
| <b>GEV No.</b>     | 100019   | <b>Ref. No.</b> | 809389 |
| <b>description</b> | ignition cable cable length 900mm connection ø2.4mm / ø4mm |                 |        |

mounting diameter 18mm

|                    |  |                 |        |
|--------------------|--|-----------------|--------|
| 1                  |  |                 |        |
| <b>GEV No.</b>     | 100009   | <b>Ref. No.</b> | 809476 |
| <b>description</b> | piezoelectric igniter body plastic blowing mounting ø 18mm connection ø2.4mm front measurements 26mm M18x1.5 |                 |        |

|                        |        |  |  |
|------------------------|--------|--|--|
| <b>accessories for</b> | 100009 |  |  |
|------------------------|--------|--|--|

|                                     |                |        |                 |   |
|-------------------------------------|----------------|--------|-----------------|---|
|                                     | <b>GEV No.</b> | 101339 | <b>Ref. No.</b> | — |
| cover cap for piezoelectric igniter |                |        |                 |   |

|  |                |        |                 |   |
|--|----------------|--------|-----------------|---|
|  | <b>GEV No.</b> | 106869 | <b>Ref. No.</b> | — |
| cover cap for piezoelectric igniter ID ø 22mm ED ø 35mm H 25mm |                |        |                 |   |

|   |                |        |                 |   |
|---|----------------|--------|-----------------|---|
|   | <b>GEV No.</b> | 107931 | <b>Ref. No.</b> | — |
| cover cap for piezoelectric igniter ID ø 21mm ED ø 36mm |                |        |                 |   |

mounting diameter 22mm

|                    |   |                 |        |
|--------------------|---|-----------------|--------|
| 1                  |   |                 |        |
| <b>GEV No.</b>     | 100005  | <b>Ref. No.</b> | C00069 |
| <b>description</b> | piezoelectric igniter body plastic blowing mounting ø 22mm connection ø2.4mm cable lengthmm SIT |                 |        |

miscellaneous

|                    |   |                 |        |
|--------------------|---|-----------------|--------|
| 1                  |   |                 |        |
| <b>GEV No.</b>     | nla <sup>1</sup>  | <b>Ref. No.</b> | 806090 |
| <b>description</b> | piezoelectric igniter body metal connection F6.3x0.8 2 hole fixing ø 22mm |                 |        |

<sup>1</sup>no longer available

|                    |   |                 |        |
|--------------------|---|-----------------|--------|
| 1                  |   |                 |        |
| <b>GEV No.</b>     | nla <sup>1</sup>  | <b>Ref. No.</b> | 807697 |
| <b>description</b> | piezoelectric igniter suitable for Minisit with cover cap ømm connection F6.3x0.8 |                 |        |

|                        |        |  |  |
|------------------------|--------|--|--|
| <b>spare parts for</b> | 101136 |  |  |
|------------------------|--------|--|--|

|  |                |        |                 |   |
|--|----------------|--------|-----------------|---|
|  | <b>GEV No.</b> | 100001 | <b>Ref. No.</b> | — |
| piezoelectric igniter suitable for Minisit connection F6.3x0.8 ømm |                |        |                 |   |

<sup>1</sup>no longer available

ignition units



|                    |                                  |                        |
|--------------------|----------------------------------|------------------------|
| 1                  | <b>GEV No.</b> 101030            | <b>Ref. No.</b> C10167 |
| <b>description</b> | ignition unit outputs 2 1.5 V/DC |                        |



|                    |  |                        |
|--------------------|--|------------------------|
| 1                  | <b>GEV No.</b> 101002  | <b>Ref. No.</b> C00507 |
| <b>description</b> | ignition unit outputs 2 230VAC dimensions 88x23x34mm mounting distance 73mm inlet F6.3x0.8 outlet F2.8x0.8 0.6VA 50/60Hz |                        |



|                    |   |                        |
|--------------------|---|------------------------|
| 1                  | <b>GEV No.</b> 101031   | <b>Ref. No.</b> C10168 |
| <b>description</b> | ignition unit outputs 4 1.5 V/DC dimensions 111x23x34mm mounting distance 100mm inlet F6.3x0.8 outlet F2.8x0.8 mounting ø 100mm |                        |



|                    |   |                        |
|--------------------|---|------------------------|
| 1                  | <b>GEV No.</b> 101032   | <b>Ref. No.</b> C10169 |
| <b>description</b> | ignition unit outputs 6 1.5 V/DC dimensions 135x23x34mm mounting distance 123mm inlet F6.3x0.8 outlet F2.8x0.8 mounting ø 122mm |                        |

ignition switches



|                    |   |                        |
|--------------------|---|------------------------|
| 1                  | <b>GEV No.</b> 100160   | <b>Ref. No.</b> C10250 |
| <b>description</b> | momentary push switch mounting measurements 28.5x28.5mm red 1NO 250V 12A ignition connection male faston 6.3mm ambient temperature max. 85°C protection IP40 mounting ømm |                        |



|                    |  |                        |
|--------------------|--|------------------------|
| 1                  | <b>GEV No.</b> 101036  | <b>Ref. No.</b> C10166 |
| <b>description</b> | battery holder for battery type AA 1.5V mounting ø 22mm connection male faston 2.8mm/6.3mm |                        |

thermocouples

plug-in thermocouples

plug-in thermocouples standard

with barrel socket ø6(6.5)mm

thermocouples SIT

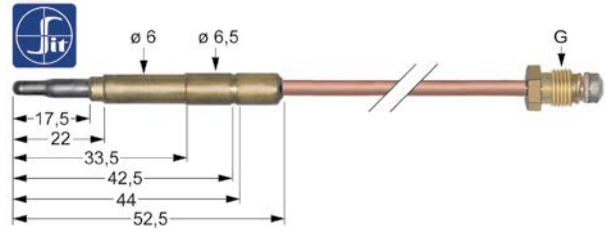

|                       |   |
|-----------------------|---|
| <b>GEV No.</b> 107621 | <b>Ref. No.</b> 808521                                      |
| <b>description</b>    | thermocouple SIT M10x1 L 1500mm plug connection ø6.0(6.5)mm |

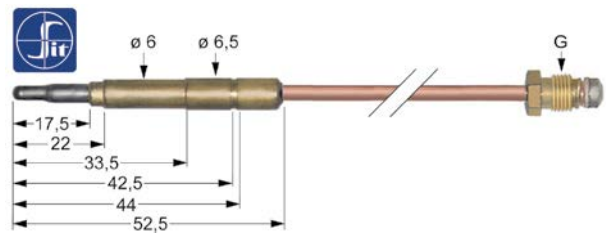

|                       |  |
|-----------------------|--|
| <b>GEV No.</b> 107612 | <b>Ref. No.</b> 806185                                     |
| <b>description</b>    | thermocouple SIT M9x1 L 1000mm plug connection ø6.0(6.5)mm |

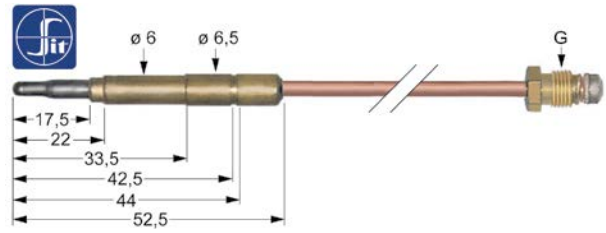

|                       |  |
|-----------------------|--|
| <b>GEV No.</b> 107613 | <b>Ref. No.</b> 8C0639                                     |
| <b>description</b>    | thermocouple SIT M9x1 L 1200mm plug connection ø6.0(6.5)mm |

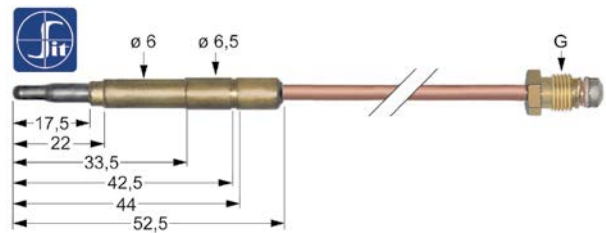

|                       |  |
|-----------------------|--|
| <b>GEV No.</b> 107614 | <b>Ref. No.</b> 814980<br>C10201                           |
| <b>description</b>    | thermocouple SIT M9x1 L 1500mm plug connection ø6.0(6.5)mm |



Зип Общепит

plug thermocouples with interruption

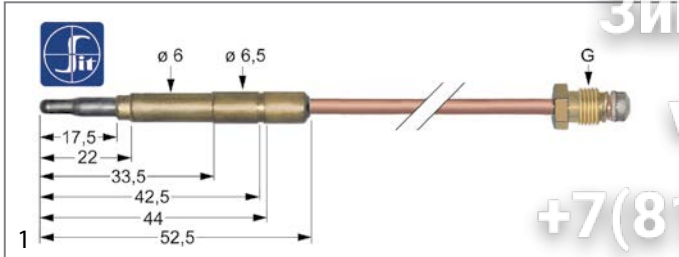

|                    |   |                 |        |
|--------------------|---|-----------------|--------|
| <b>GEV No.</b>     | 107606  | <b>Ref. No.</b> | C00072 |
| <b>description</b> | thermocouple SIT M9x1 L 320mm plug connection $\varnothing 6.0(6.5)$ mm |                 |        |

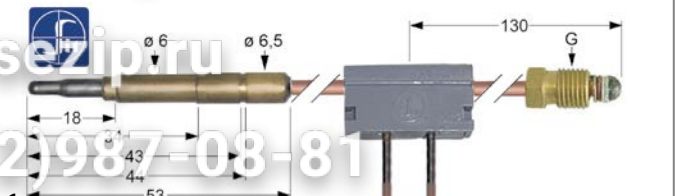

|                    |  |                 |           |
|--------------------|--|-----------------|-----------|
| <b>GEV No.</b>     | 107164   | <b>Ref. No.</b> | 513120001 |
| <b>description</b> | thermocouple SIT with interrupter M9x1 L 1000mm plug connection $\varnothing 6.0(6.5)$ mm soldering connection |                 |           |

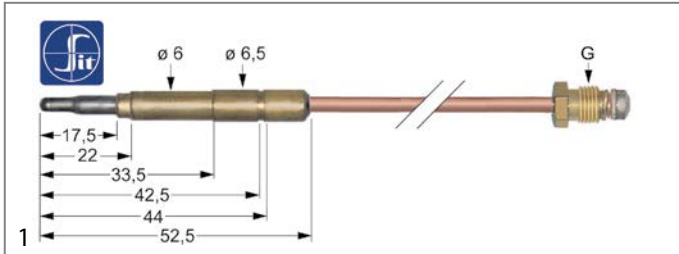

|                    |   |                 |        |
|--------------------|---|-----------------|--------|
| <b>GEV No.</b>     | 107609  | <b>Ref. No.</b> | 806271 |
| <b>description</b> | thermocouple SIT M9x1 L 600mm plug connection $\varnothing 6.0(6.5)$ mm |                 |        |

threaded thermocouples

threaded thermocouples with cable link

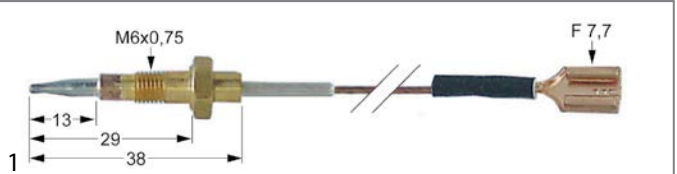

|   |  |                 |                 |   |
|---|--|-----------------|-----------------|---|
| <b>GEV No.</b>  | 102145   | <b>Ref. No.</b> | C10067          |   |
| <b>description</b>  | thermocouple L 600mm connection F 7.7mm M6x0.75            |                 |                 |   |
| <b>accessories for</b>  | 102145   |                 |                 |   |
|  | <b>GEV No.</b>   | 102680          | <b>Ref. No.</b> | — |
|   | nut thread M6x0.75 H 2.6mm WS 8 brass Qty 1 pcs type SEF 2 |                 |                 |   |

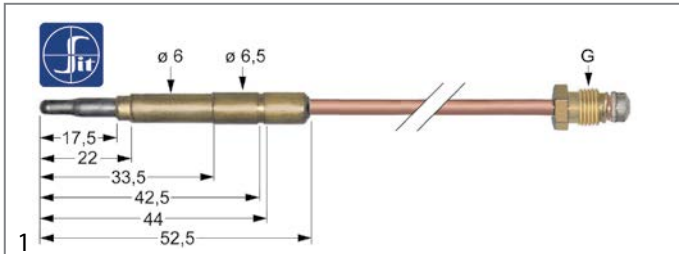

|                    |   |                 |        |
|--------------------|---|-----------------|--------|
| <b>GEV No.</b>     | 107611  | <b>Ref. No.</b> | C00377 |
| <b>description</b> | thermocouple SIT M9x1 L 850mm plug connection $\varnothing 6.0(6.5)$ mm |                 |        |

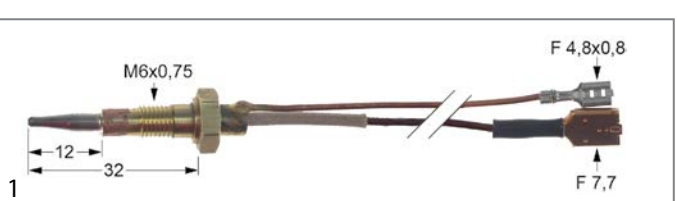
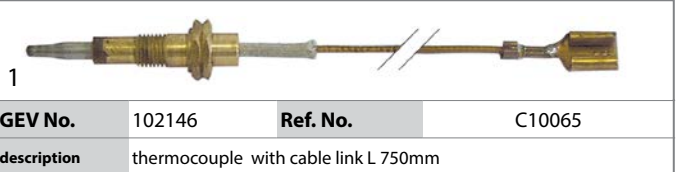

|                    |  |                 |                  |
|--------------------|--|-----------------|------------------|
| <b>GEV No.</b>     | 102147   | <b>Ref. No.</b> | C10065<br>C10334 |
| <b>description</b> | thermocouple L 750mm M6x0.75 F 7.7mm F 4.8x0.8mm |                 |                  |

thermocouples with aluminised tip

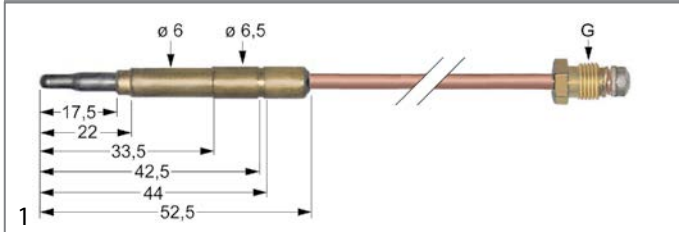

|                    |   |                 |        |
|--------------------|---|-----------------|--------|
| <b>GEV No.</b>     | 102034  | <b>Ref. No.</b> | 808151 |
| <b>description</b> | thermocouple M8x1 L 600mm plug connection $\varnothing 6.0(6.5)$ mm |                 |        |

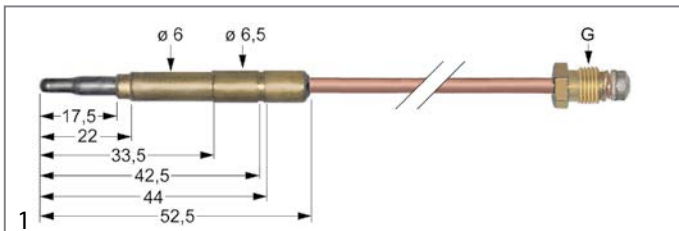

|                    |   |                 |        |
|--------------------|---|-----------------|--------|
| <b>GEV No.</b>     | 102041  | <b>Ref. No.</b> | 806183 |
| <b>description</b> | thermocouple M9x1 L 600mm plug connection $\varnothing 6.0(6.5)$ mm |                 |        |

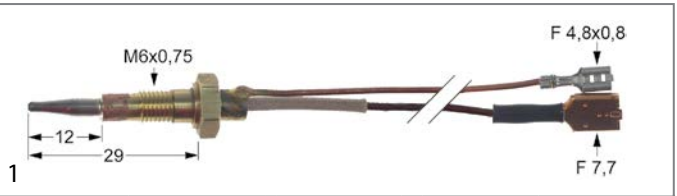

|   |  |                 |                 |   |
|---|--|-----------------|-----------------|---|
| <b>GEV No.</b>  | 102148   | <b>Ref. No.</b> | C10333          |   |
| <b>description</b>  | thermocouple with two-conductors L 600mm M6x0.75 F 7.7mm F 4.8x0.8mm |                 |                 |   |
| <b>accessories for</b>  | 102148   |                 |                 |   |
|  | <b>GEV No.</b>   | 102680          | <b>Ref. No.</b> | — |
|   | nut thread M6x0.75 H 2.6mm WS 8 brass Qty 1 pcs type SEF 2           |                 |                 |   |

1 gas components



Зип Общепит

vsezip.ru

+7(812)987-08-81

accessories

interrupters



1

|                    |                         |                 |        |
|--------------------|-------------------------|-----------------|--------|
| <b>GEV No.</b>     | 101264                  | <b>Ref. No.</b> | 8C1701 |
| <b>description</b> | interrupter thread M8x1 |                 |        |



1

|                    |                         |                 |        |
|--------------------|-------------------------|-----------------|--------|
| <b>GEV No.</b>     | 101265                  | <b>Ref. No.</b> | 807842 |
| <b>description</b> | interrupter thread M9x1 |                 |        |

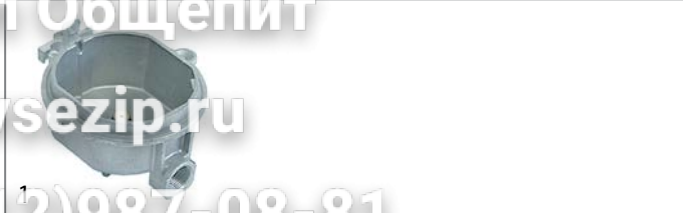

|                |        |                 |        |
|----------------|--------|-----------------|--------|
| <b>GEV No.</b> | 105120 | <b>Ref. no.</b> | C10046 |
|----------------|--------|-----------------|--------|

**description** burner lower part 3kW for igniter ø 7mm for thermocouple ø 6mm with nozzle ø1.15mm for burner cap ø 100mm

**accessories for** 105120

|  |                |        |                 |        |
|--|----------------|--------|-----------------|--------|
|  | <b>GEV No.</b> | 105121 | <b>Ref. No.</b> | C10045 |
| burner head 3kW for igniter ø 7.5mm for burner cap ø 100mm |                |        |                 |        |

|  |                |        |                 |        |
|--|----------------|--------|-----------------|--------|
|  | <b>GEV No.</b> | 105122 | <b>Ref. No.</b> | C10196 |
| burner cap 3kW ø 100mm H 6mm matt finish |                |        |                 |        |

gas burners

hob burners

universal hob burners

SABAF

2 series - standard



1

|                    |  |                 |        |
|--------------------|--|-----------------|--------|
| <b>GEV No.</b>     | 105122                                   | <b>Ref. No.</b> | C10196 |
| <b>description</b> | burner cap 3kW ø 100mm H 6mm matt finish |                 |        |

**accessories for** 105122



|   |        |                 |        |
|---|--------|-----------------|--------|
| <b>GEV No.</b>  | 105120 | <b>Ref. No.</b> | C10046 |
| burner lower part 3kW for igniter ø 7mm for thermocouple ø 6mm with nozzle ø1.15mm for burner cap ø 100mm |        |                 |        |



|  |        |                 |        |
|--|--------|-----------------|--------|
| <b>GEV No.</b>   | 105121 | <b>Ref. No.</b> | C10045 |
| burner head 3kW for igniter ø 7.5mm for burner cap ø 100mm |        |                 |        |

2 series - flat skirt version



1

|                |        |                 |        |
|----------------|--------|-----------------|--------|
| <b>GEV No.</b> | 105120 | <b>Ref. No.</b> | C10046 |
|----------------|--------|-----------------|--------|

**description** burner lower part 3kW for igniter ø 7mm for thermocouple ø 6mm with nozzle ø1.15mm for burner cap ø 100mm

**accessories for** 105120

|  |                |        |                 |        |
|--|----------------|--------|-----------------|--------|
|  | <b>GEV No.</b> | 105121 | <b>Ref. No.</b> | C10045 |
| burner head 3kW for igniter ø 7.5mm for burner cap ø 100mm |                |        |                 |        |

|  |                |        |                 |        |
|--|----------------|--------|-----------------|--------|
|  | <b>GEV No.</b> | 105122 | <b>Ref. No.</b> | C10196 |
| burner cap 3kW ø 100mm H 6mm matt finish |                |        |                 |        |

triple ring burner series - standard version



1

|                |        |                 |        |
|----------------|--------|-----------------|--------|
| <b>GEV No.</b> | 105125 | <b>Ref. No.</b> | C10197 |
|----------------|--------|-----------------|--------|

**description** burner cap 3.6kW ø 131mm H 7mm mounting pos. outer

**accessories for** 105125

|  |                |        |                 |        |
|--|----------------|--------|-----------------|--------|
|  | <b>GEV No.</b> | 105123 | <b>Ref. No.</b> | C10049 |
| burner lower part 3.6kW for igniter ø 7mm for thermocouple ø 6mm with nozzle ø1.35mm ID ø 75mm for burner cap ø 61/131mm |                |        |                 |        |

|   |                |        |                 |        |
|---|----------------|--------|-----------------|--------|
|   | <b>GEV No.</b> | 105124 | <b>Ref. No.</b> | C10048 |
| burner head 3.6kW for burner cap ø 61/131mm |                |        |                 |        |

|   |                |        |                 |        |
|---|----------------|--------|-----------------|--------|
|   | <b>GEV No.</b> | 105126 | <b>Ref. No.</b> | C10198 |
| burner cap 3.6kW ø 61mm H 9mm mounting pos. inner matt finish |                |        |                 |        |



1

|                    |  |                 |        |
|--------------------|--|-----------------|--------|
| <b>GEV No.</b>     | 105121   | <b>Ref. No.</b> | C10045 |
| <b>description</b> | burner head 3kW for igniter ø 7.5mm for burner cap ø 100mm |                 |        |

**accessories for** 105121



|   |        |                 |        |
|---|--------|-----------------|--------|
| <b>GEV No.</b>  | 105120 | <b>Ref. No.</b> | C10046 |
| burner lower part 3kW for igniter ø 7mm for thermocouple ø 6mm with nozzle ø1.15mm for burner cap ø 100mm |        |                 |        |



|  |        |                 |        |
|--|--------|-----------------|--------|
| <b>GEV No.</b>                           | 105122 | <b>Ref. No.</b> | C10196 |
| burner cap 3kW ø 100mm H 6mm matt finish |        |                 |        |













Зип Общежит





the following burner series flat skirt version





vsezip.ru





+7(812)987-08-81





|   |  |                 |                        |
|---|--|-----------------|------------------------|
|  |  |                 |                        |
| <b>GEV No.</b>  | 105126   | <b>Ref. No.</b> | C10198                 |
| <b>description</b>  | burner cap 3.6kW ø 61mm H 9mm mounting pos. inner matt finish  |                 |                        |
| <b>accessories for</b>  | 105126   |                 |                        |
|  | <b>GEV No.</b>   | 105123          | <b>Ref. No.</b> C10049 |
| <b>description</b>  | burner lower part 3.6kW for igniter ø 7mm for thermocouple ø 6mm with nozzle ø1.35mm ID ø 75mm for burner cap ø 61/131mm |                 |                        |
|  | <b>GEV No.</b>   | 105124          | <b>Ref. No.</b> C10048 |
| <b>description</b>  | burner head 3.6kW for burner cap ø 61/131mm  |                 |                        |
|  | <b>GEV No.</b>   | 105125          | <b>Ref. No.</b> C10197 |
| <b>description</b>  | burner cap 3.6kW ø 131mm H 7mm mounting pos. outer   |                 |                        |

|  |  |                 |                        |
|--|--|-----------------|------------------------|
|  |  |                 |                        |
| <b>GEV No.</b>   | 105125   | <b>Ref. No.</b> | C10197                 |
| <b>description</b>   | burner cap 3.6kW ø 131mm H 7mm mounting pos. outer   |                 |                        |
| <b>accessories for</b>   | 105125   |                 |                        |
|   | <b>GEV No.</b>   | 105123          | <b>Ref. No.</b> C10049 |
| <b>description</b>   | burner lower part 3.6kW for igniter ø 7mm for thermocouple ø 6mm with nozzle ø1.35mm ID ø 75mm for burner cap ø 61/131mm |                 |                        |
|   | <b>GEV No.</b>   | 105124          | <b>Ref. No.</b> C10048 |
| <b>description</b>   | burner head 3.6kW for burner cap ø 61/131mm  |                 |                        |
|   | <b>GEV No.</b>   | 105126          | <b>Ref. No.</b> C10198 |
| <b>description</b>   | burner cap 3.6kW ø 61mm H 9mm mounting pos. inner matt finish  |                 |                        |

|   |  |                 |                        |
|---|--|-----------------|------------------------|
|    |  |                 |                        |
| <b>GEV No.</b>  | 105124   | <b>Ref. No.</b> | C10048                 |
| <b>description</b>  | burner head 3.6kW for burner cap ø 61/131mm  |                 |                        |
| <b>accessories for</b>  | 105124   |                 |                        |
|    | <b>GEV No.</b>   | 105123          | <b>Ref. No.</b> C10049 |
| <b>description</b>  | burner lower part 3.6kW for igniter ø 7mm for thermocouple ø 6mm with nozzle ø1.35mm ID ø 75mm for burner cap ø 61/131mm |                 |                        |
|  | <b>GEV No.</b>   | 105125          | <b>Ref. No.</b> C10197 |
| <b>description</b>  | burner cap 3.6kW ø 131mm H 7mm mounting pos. outer   |                 |                        |
|  | <b>GEV No.</b>   | 105126          | <b>Ref. No.</b> C10198 |
| <b>description</b>  | burner cap 3.6kW ø 61mm H 9mm mounting pos. inner matt finish  |                 |                        |

|   |  |                 |                        |
|---|--|-----------------|------------------------|
|    |  |                 |                        |
| <b>GEV No.</b>  | 105126   | <b>Ref. No.</b> | C10198                 |
| <b>description</b>  | burner cap 3.6kW ø 61mm H 9mm mounting pos. inner matt finish  |                 |                        |
| <b>accessories for</b>  | 105126   |                 |                        |
|   | <b>GEV No.</b>   | 105123          | <b>Ref. No.</b> C10049 |
| <b>description</b>  | burner lower part 3.6kW for igniter ø 7mm for thermocouple ø 6mm with nozzle ø1.35mm ID ø 75mm for burner cap ø 61/131mm |                 |                        |
|  | <b>GEV No.</b>   | 105124          | <b>Ref. No.</b> C10048 |
| <b>description</b>  | burner head 3.6kW for burner cap ø 61/131mm  |                 |                        |
|  | <b>GEV No.</b>   | 105125          | <b>Ref. No.</b> C10197 |
| <b>description</b>  | burner cap 3.6kW ø 131mm H 7mm mounting pos. outer   |                 |                        |

|   |  |                 |                        |
|---|--|-----------------|------------------------|
|  |  |                 |                        |
| <b>GEV No.</b>  | 105123   | <b>Ref. No.</b> | C10049                 |
| <b>description</b>  | burner lower part 3.6kW for igniter ø 7mm for thermocouple ø 6mm with nozzle ø1.35mm ID ø 75mm for burner cap ø 61/131mm |                 |                        |
| <b>accessories for</b>  | 105123   |                 |                        |
|  | <b>GEV No.</b>   | 105124          | <b>Ref. No.</b> C10048 |
| <b>description</b>  | burner head 3.6kW for burner cap ø 61/131mm  |                 |                        |
|  | <b>GEV No.</b>   | 105125          | <b>Ref. No.</b> C10197 |
| <b>description</b>  | burner cap 3.6kW ø 131mm H 7mm mounting pos. outer   |                 |                        |
|  | <b>GEV No.</b>   | 105126          | <b>Ref. No.</b> C10198 |
| <b>description</b>  | burner cap 3.6kW ø 61mm H 9mm mounting pos. inner matt finish  |                 |                        |

|  |  |                 |                        |
|--|--|-----------------|------------------------|
|  |  |                 |                        |
| <b>GEV No.</b>   | 105123   | <b>Ref. No.</b> | C10049                 |
| <b>description</b>   | burner lower part 3.6kW for igniter ø 7mm for thermocouple ø 6mm with nozzle ø1.35mm ID ø 75mm for burner cap ø 61/131mm |                 |                        |
| <b>accessories for</b>   | 105123   |                 |                        |
|   | <b>GEV No.</b>   | 105124          | <b>Ref. No.</b> C10048 |
| <b>description</b>   | burner head 3.6kW for burner cap ø 61/131mm  |                 |                        |
|   | <b>GEV No.</b>   | 105125          | <b>Ref. No.</b> C10197 |
| <b>description</b>   | burner cap 3.6kW ø 131mm H 7mm mounting pos. outer   |                 |                        |
|   | <b>GEV No.</b>   | 105126          | <b>Ref. No.</b> C10198 |
| <b>description</b>   | burner cap 3.6kW ø 61mm H 9mm mounting pos. inner matt finish  |                 |                        |

1 gas components



## producer-specific hob burners

EMMEPI

Snack series



1

|                |        |                 |        |
|----------------|--------|-----------------|--------|
| <b>GEV No.</b> | 105125 | <b>Ref. No.</b> | C10197 |
|----------------|--------|-----------------|--------|

|                    |  |  |  |
|--------------------|--|--|--|
| <b>description</b> | burner cap 3.6kW ø 131mm H 7mm mounting pos. outer |  |  |
|--------------------|--|--|--|

|                        |        |  |  |
|------------------------|--------|--|--|
| <b>accessories for</b> | 105125 |  |  |
|------------------------|--------|--|--|



|                |        |                 |        |
|----------------|--------|-----------------|--------|
| <b>GEV No.</b> | 105123 | <b>Ref. No.</b> | C10049 |
|----------------|--------|-----------------|--------|

|                    |   |  |  |
|--------------------|---|--|--|
| <b>description</b> | burner lower part 3.6kW for igniter ø 7mm for thermocouple ø 6mm with nozzle ø 1.35mm ID ø 75mm for burner cap ø 61/131mm |  |  |
|--------------------|---|--|--|



|                |        |                 |        |
|----------------|--------|-----------------|--------|
| <b>GEV No.</b> | 105124 | <b>Ref. No.</b> | C10048 |
|----------------|--------|-----------------|--------|

|                    |   |  |  |
|--------------------|---|--|--|
| <b>description</b> | burner head 3.6kW for burner cap ø 61/131mm |  |  |
|--------------------|---|--|--|



|                |        |                 |        |
|----------------|--------|-----------------|--------|
| <b>GEV No.</b> | 105126 | <b>Ref. No.</b> | C10198 |
|----------------|--------|-----------------|--------|

|                    |   |  |  |
|--------------------|---|--|--|
| <b>description</b> | burner cap 3.6kW ø 61mm H 9mm mounting pos. inner matt finish |  |  |
|--------------------|---|--|--|



1

|                |        |                 |        |
|----------------|--------|-----------------|--------|
| <b>GEV No.</b> | 105126 | <b>Ref. No.</b> | C10198 |
|----------------|--------|-----------------|--------|

|                    |   |  |  |
|--------------------|---|--|--|
| <b>description</b> | burner cap 3.6kW ø 61mm H 9mm mounting pos. inner matt finish |  |  |
|--------------------|---|--|--|

|                        |        |  |  |
|------------------------|--------|--|--|
| <b>accessories for</b> | 105126 |  |  |
|------------------------|--------|--|--|



|                |        |                 |        |
|----------------|--------|-----------------|--------|
| <b>GEV No.</b> | 105123 | <b>Ref. No.</b> | C10049 |
|----------------|--------|-----------------|--------|

|                    |   |  |  |
|--------------------|---|--|--|
| <b>description</b> | burner lower part 3.6kW for igniter ø 7mm for thermocouple ø 6mm with nozzle ø 1.35mm ID ø 75mm for burner cap ø 61/131mm |  |  |
|--------------------|---|--|--|



|                |        |                 |        |
|----------------|--------|-----------------|--------|
| <b>GEV No.</b> | 105124 | <b>Ref. No.</b> | C10048 |
|----------------|--------|-----------------|--------|

|                    |   |  |  |
|--------------------|---|--|--|
| <b>description</b> | burner head 3.6kW for burner cap ø 61/131mm |  |  |
|--------------------|---|--|--|



|                |        |                 |        |
|----------------|--------|-----------------|--------|
| <b>GEV No.</b> | 105125 | <b>Ref. No.</b> | C10197 |
|----------------|--------|-----------------|--------|

|                    |  |  |  |
|--------------------|--|--|--|
| <b>description</b> | burner cap 3.6kW ø 131mm H 7mm mounting pos. outer |  |  |
|--------------------|--|--|--|



1

|                |        |                 |        |
|----------------|--------|-----------------|--------|
| <b>GEV No.</b> | 105122 | <b>Ref. No.</b> | C10196 |
|----------------|--------|-----------------|--------|

|                    |  |  |  |
|--------------------|--|--|--|
| <b>description</b> | burner cap 3kW ø 100mm H 6mm matt finish |  |  |
|--------------------|--|--|--|

|                        |        |  |  |
|------------------------|--------|--|--|
| <b>accessories for</b> | 105122 |  |  |
|------------------------|--------|--|--|



|                |        |                 |        |
|----------------|--------|-----------------|--------|
| <b>GEV No.</b> | 105120 | <b>Ref. No.</b> | C10046 |
|----------------|--------|-----------------|--------|

|                    |  |  |  |
|--------------------|--|--|--|
| <b>description</b> | burner lower part 3kW for igniter ø 7mm for thermocouple ø 6mm with nozzle ø 1.15mm for burner cap ø 100mm |  |  |
|--------------------|--|--|--|



|                |        |                 |        |
|----------------|--------|-----------------|--------|
| <b>GEV No.</b> | 105121 | <b>Ref. No.</b> | C10045 |
|----------------|--------|-----------------|--------|

|                    |  |  |  |
|--------------------|--|--|--|
| <b>description</b> | burner head 3kW for igniter ø 7.5mm for burner cap ø 100mm |  |  |
|--------------------|--|--|--|



1

|                |        |                 |        |
|----------------|--------|-----------------|--------|
| <b>GEV No.</b> | 105124 | <b>Ref. No.</b> | C10048 |
|----------------|--------|-----------------|--------|

|                    |   |  |  |
|--------------------|---|--|--|
| <b>description</b> | burner head 3.6kW for burner cap ø 61/131mm |  |  |
|--------------------|---|--|--|

|                        |        |  |  |
|------------------------|--------|--|--|
| <b>accessories for</b> | 105124 |  |  |
|------------------------|--------|--|--|



|                |        |                 |        |
|----------------|--------|-----------------|--------|
| <b>GEV No.</b> | 105123 | <b>Ref. No.</b> | C10049 |
|----------------|--------|-----------------|--------|

|                    |   |  |  |
|--------------------|---|--|--|
| <b>description</b> | burner lower part 3.6kW for igniter ø 7mm for thermocouple ø 6mm with nozzle ø 1.35mm ID ø 75mm for burner cap ø 61/131mm |  |  |
|--------------------|---|--|--|

Зип-Общепит

vsezip.ru

+7(812)987-08-81

|                        |   |                 |        |
|------------------------|---|-----------------|--------|
| <b>accessories for</b> | 105124  |                 |        |
| <b>GEV No.</b>         | 105125  | <b>Ref. No.</b> | C10197 |
| <b>description</b>     | burner cap 3.6kW ø 131mm H 7mm mounting pos. outer            |                 |        |
| <b>GEV No.</b>         | 105126  | <b>Ref. No.</b> | C10198 |
| <b>description</b>     | burner cap 3.6kW ø 61mm H 9mm mounting pos. inner matt finish |                 |        |

|                        |  |                 |        |
|------------------------|--|-----------------|--------|
| <b>GEV No.</b>         | 105121   | <b>Ref. No.</b> | C10045 |
| <b>description</b>     | burner head 3kW for igniter ø 7.5mm for burner cap ø 100mm   |                 |        |
| <b>accessories for</b> | 105121   |                 |        |
| <b>GEV No.</b>         | 105120   | <b>Ref. No.</b> | C10046 |
| <b>description</b>     | burner lower part 3kW for igniter ø 7mm for thermocouple ø 6mm with nozzle ø 1.15mm for burner cap ø 100mm |                 |        |
| <b>GEV No.</b>         | 105122   | <b>Ref. No.</b> | C10196 |
| <b>description</b>     | burner cap 3kW ø 100mm H 6mm matt finish   |                 |        |

|                        |   |                 |        |
|------------------------|---|-----------------|--------|
| <b>GEV No.</b>         | 105123  | <b>Ref. No.</b> | C10049 |
| <b>description</b>     | burner lower part 3.6kW for igniter ø 7mm for thermocouple ø 6mm with nozzle ø 1.35mm ID ø 75mm for burner cap ø 61/131mm |                 |        |
| <b>accessories for</b> | 105123  |                 |        |
| <b>GEV No.</b>         | 105124  | <b>Ref. No.</b> | C10048 |
| <b>description</b>     | burner head 3.6kW for burner cap ø 61/131mm   |                 |        |
| <b>GEV No.</b>         | 105125  | <b>Ref. No.</b> | C10197 |
| <b>description</b>     | burner cap 3.6kW ø 131mm H 7mm mounting pos. outer  |                 |        |
| <b>GEV No.</b>         | 105126  | <b>Ref. No.</b> | C10198 |
| <b>description</b>     | burner cap 3.6kW ø 61mm H 9mm mounting pos. inner matt finish   |                 |        |

|                        |  |                 |        |
|------------------------|--|-----------------|--------|
| <b>GEV No.</b>         | 105120   | <b>Ref. No.</b> | C10046 |
| <b>description</b>     | burner lower part 3kW for igniter ø 7mm for thermocouple ø 6mm with nozzle ø 1.15mm for burner cap ø 100mm |                 |        |
| <b>accessories for</b> | 105120   |                 |        |
| <b>GEV No.</b>         | 105121   | <b>Ref. No.</b> | C10045 |
| <b>description</b>     | burner head 3kW for igniter ø 7.5mm for burner cap ø 100mm   |                 |        |
| <b>GEV No.</b>         | 105122   | <b>Ref. No.</b> | C10196 |
| <b>description</b>     | burner cap 3kW ø 100mm H 6mm matt finish   |                 |        |



Зип Общепит  
vsezip.ru

+7(812)987-08-81



700 Daga series



1



|   |  |                 |                        |
|---|--|-----------------|------------------------|
| <b>GEV No.</b>  | 105137                                   | <b>Ref. No.</b> | C10285                 |
| <b>description</b>  | burner cap ø 100mm 5kW                   |                 |                        |
| <b>accessories for</b>  | 105137                                   |                 |                        |
|  | <b>GEV No.</b>                           | 105136          | <b>Ref. No.</b> C89437 |
|   | burner head for burner cap ø 100mm 5kW   |                 |                        |
|  | <b>GEV No.</b>                           | 105138          | <b>Ref. No.</b> C10274 |
|   | burner holder for burner cap ø 100mm 5kW |                 |                        |



|   |   |                 |                        |
|---|---|-----------------|------------------------|
| <b>GEV No.</b>  | 105139                                  | <b>Ref. No.</b> | C89438                 |
| <b>description</b>  | burner head for burner cap ø 70mm 3kW   |                 |                        |
| <b>accessories for</b>  | 105139                                  |                 |                        |
|  | <b>GEV No.</b>                          | 105140          | <b>Ref. No.</b> C10284 |
|   | burner cap ø 70mm 3kW                   |                 |                        |
|  | <b>GEV No.</b>                          | 105141          | <b>Ref. No.</b> C10273 |
|   | burner holder for burner cap ø 70mm 3kW |                 |                        |





1

|  |                                       |                 |                        |
|--|---------------------------------------|-----------------|------------------------|
| <b>GEV No.</b>   | 105140                                | <b>Ref. No.</b> | C10284                 |
| <b>description</b>   | burner cap ø 70mm 3kW                 |                 |                        |
| <b>accessories for</b>   | 105140                                |                 |                        |
|   | <b>GEV No.</b>                        | 105139          | <b>Ref. No.</b> C89438 |
|  | burner head for burner cap ø 70mm 3kW |                 |                        |
|  | <b>GEV No.</b>                        | 105140          | <b>Ref. No.</b> C10284 |
|  | burner cap ø 70mm 3kW                 |                 |                        |



1

|   |  |                 |                        |
|---|--|-----------------|------------------------|
| <b>GEV No.</b>  | 105138                                   | <b>Ref. No.</b> | C10274                 |
| <b>description</b>  | burner holder for burner cap ø 100mm 5kW |                 |                        |
| <b>accessories for</b>  | 105138                                   |                 |                        |
|   | <b>GEV No.</b>                           | 105136          | <b>Ref. No.</b> C89437 |
|   | burner head for burner cap ø 100mm 5kW   |                 |                        |
|  | <b>GEV No.</b>                           | 105137          | <b>Ref. No.</b> C10285 |
|   | burner cap ø 100mm 5kW                   |                 |                        |





1

|   |  |                 |                        |
|---|--|-----------------|------------------------|
| <b>GEV No.</b>  | 105136                                   | <b>Ref. No.</b> | C89437                 |
| <b>description</b>  | burner head for burner cap ø 100mm 5kW   |                 |                        |
| <b>accessories for</b>  | 105136                                   |                 |                        |
|  | <b>GEV No.</b>                           | 105137          | <b>Ref. No.</b> C10285 |
|   | burner cap ø 100mm 5kW                   |                 |                        |
|  | <b>GEV No.</b>                           | 105138          | <b>Ref. No.</b> C10274 |
|   | burner holder for burner cap ø 100mm 5kW |                 |                        |



1

|   |   |                 |                        |
|---|---|-----------------|------------------------|
| <b>GEV No.</b>  | 105141                                  | <b>Ref. No.</b> | C10273                 |
| <b>description</b>  | burner holder for burner cap ø 70mm 3kW |                 |                        |
| <b>accessories for</b>  | 105141                                  |                 |                        |
|  | <b>GEV No.</b>                          | 105139          | <b>Ref. No.</b> C89438 |
|   | burner head for burner cap ø 70mm 3kW   |                 |                        |
|  | <b>GEV No.</b>                          | 105140          | <b>Ref. No.</b> C10284 |
|   | burner cap ø 70mm 3kW                   |                 |                        |

700 Professional, 900 Classica series



1

|                    |  |                 |        |
|--------------------|--|-----------------|--------|
| <b>GEV No.</b>     | 107539   | <b>Ref. No.</b> | C00108 |
| <b>description</b> | air mixing tube L 58mm D1 ø 16mm D2 ø 19mm ID ø 14mm aluminium |                 |        |



Зип Общепит



vsezip.ru



+7(812)987-08-81

|   |  |                 |        |
|---|--|-----------------|--------|
|  |  |                 |        |
| 1   |  |                 |        |
| <b>GEV No.</b>  | 107540   | <b>Ref. No.</b> | C00109 |
| <b>description</b>  | air mixing tube L 58mm D1 ø 20mm D2 ø 24.5mm ID ø 17.6mm aluminium |                 |        |





|   |  |                 |        |
|---|--|-----------------|--------|
|  |  |                 |        |
| 1   |  |                 |        |
| <b>GEV No.</b>  | 104649   | <b>Ref. No.</b> | C00110 |
| <b>description</b>  | air mixing tube L 83mm D1 ø 28mm D2 ø 32mm ID ø 24.5mm brass |                 |        |

|   |  |                 |                               |
|---|--|-----------------|-------------------------------|
|  |  |                 |                               |
| 1   |  |                 |                               |
| <b>GEV No.</b>  | 105128                                     | <b>Ref. No.</b> | C00457                        |
| <b>description</b>  | burner cap ø 100mm 5.5kW                   |                 |                               |
| <b>accessories for</b>  | 105128                                     |                 |                               |
|  | <b>GEV No.</b>                             | 105127          | <b>Ref. No.</b> C99637        |
|   | burner head for burner cap ø 100mm 5.5kW   |                 |                               |
|  | <b>GEV No.</b>                             | 105129          | <b>Ref. No.</b> C00011 C00815 |
|   | burner holder for burner cap ø 100mm 5.5kW |                 |                               |

|   |  |                 |   |
|---|--|-----------------|---|
|   |  |                 |   |
| 1   |  |                 |   |
| <b>GEV No.</b>  | 105134                                     | <b>Ref. No.</b> | C00458                                    |
| <b>description</b>  | burner cap ø 120mm 7.5kW with central hole |                 |   |
| <b>accessories for</b>  | 105134                                     |                 |   |
|  | <b>GEV No.</b>                             | 105133          | <b>Ref. No.</b> C99638 C99638 + 511120104 |
|   | burner head for burner cap ø 120mm 7.5kW   |                 |   |
|  | <b>GEV No.</b>                             | 105135          | <b>Ref. No.</b> C00012 C00816             |
|   | burner holder for burner cap ø 120mm 7.5kW |                 |   |

|   |   |                 |                               |
|---|---|-----------------|-------------------------------|
|  |   |                 |                               |
| 1   |   |                 |                               |
| <b>GEV No.</b>  | 105131                                    | <b>Ref. No.</b> | C00456                        |
| <b>description</b>  | burner cap ø 70mm 3.5kW                   |                 |                               |
| <b>accessories for</b>  | 105131                                    |                 |                               |
|  | <b>GEV No.</b>                            | 105130          | <b>Ref. No.</b> C99636        |
|   | burner head for burner cap ø 70mm 3.5kW   |                 |                               |
|  | <b>GEV No.</b>                            | 105132          | <b>Ref. No.</b> C00010 C00814 |
|   | burner holder for burner cap ø 70mm 3.5kW |                 |                               |

|   |  |                 |                               |
|---|--|-----------------|-------------------------------|
|  |  |                 |                               |
| 1   |  |                 |                               |
| <b>GEV No.</b>  | 105127   | <b>Ref. No.</b> | C99637                        |
| <b>description</b>  | burner head for burner cap ø 100mm 5.5kW                           |                 |                               |
| <b>accessories for</b>  | 105127   |                 |                               |
|  | <b>GEV No.</b>   | 105128          | <b>Ref. No.</b> C00457        |
|   | burner cap ø 100mm 5.5kW   |                 |                               |
|  | <b>GEV No.</b>   | 105129          | <b>Ref. No.</b> C00011 C00815 |
|   | burner holder for burner cap ø 100mm 5.5kW                         |                 |                               |
|  | <b>GEV No.</b>   | 107540          | <b>Ref. No.</b> C00109        |
|   | air mixing tube L 58mm D1 ø 20mm D2 ø 24.5mm ID ø 17.6mm aluminium |                 |                               |

|   |   |                 |                               |
|---|---|-----------------|-------------------------------|
|    |   |                 |                               |
| 1   |   |                 |                               |
| <b>GEV No.</b>  | 105133  | <b>Ref. No.</b> | C99638 C99638 + 511120104     |
| <b>description</b>  | burner head for burner cap ø 120mm 7.5kW                              |                 |                               |
| <b>spare parts for</b>  | 105133  |                 |                               |
|  | <b>GEV No.</b>  | 104649          | <b>Ref. No.</b> C00110        |
|   | air mixing tube L 83mm D1 ø 28mm D2 ø 32mm ID ø 24.5mm brass          |                 |                               |
|  | <b>GEV No.</b>  | 560366          | <b>Ref. No.</b> C00513        |
|   | grub screw thread M6 L 20mm SS intake internal hexagon WS 3 Qty 1 pcs |                 |                               |
| <b>accessories for</b>  | 105133  |                 |                               |
|  | <b>GEV No.</b>  | 105134          | <b>Ref. No.</b> C00458        |
|   | burner cap ø 120mm 7.5kW with central hole                            |                 |                               |
|  | <b>GEV No.</b>  | 105135          | <b>Ref. No.</b> C00012 C00816 |
|   | burner holder for burner cap ø 120mm 7.5kW                            |                 |                               |



|   |   |                 |                               |
|---|---|-----------------|-------------------------------|
|  |   |                 |                               |
| 1   |   |                 |                               |
| <b>GEV No.</b>  | 105130                                    | <b>Ref. No.</b> | C99636                        |
| <b>description</b>  | burner head for burner cap ø 70mm 3.5kW   |                 |                               |
| <b>accessories for</b>  | 105130                                    |                 |                               |
|  | <b>GEV No.</b>                            | 105131          | <b>Ref. No.</b> C00456        |
|   | burner cap ø 70mm 3.5kW                   |                 |                               |
|  | <b>GEV No.</b>                            | 105132          | <b>Ref. No.</b> C00010 C00814 |
|   | burner holder for burner cap ø 70mm 3.5kW |                 |                               |

Table continues overleaf





Зип Общепит

vsezip.ru



+7(812)987-08-81

|   |  |        |                        |
|---|--|--------|------------------------|
| <b>accessories for</b>  | 105130   |        |                        |
|  | <b>GEV No.</b>   | 107539 | <b>Ref. No.</b> C00108 |
|   | air mixing tube L 58mm D1 ø 16mm D2 ø 19mm ID ø 14mm aluminium |        |                        |



|   |  |                 |                  |
|---|--|-----------------|------------------|
|  | 1  |                 |                  |
| <b>GEV No.</b>  | 105129                                     | <b>Ref. No.</b> | C00011<br>C00815 |
| <b>description</b>  | burner holder for burner cap ø 100mm 5.5kW |                 |                  |

|   |  |        |                        |
|---|--|--------|------------------------|
| <b>accessories for</b>  | 105129                                   |        |                        |
|  | <b>GEV No.</b>                           | 105127 | <b>Ref. No.</b> C99637 |
|   | burner head for burner cap ø 100mm 5.5kW |        |                        |
|  | <b>GEV No.</b>                           | 105128 | <b>Ref. No.</b> C00457 |
|   | burner cap ø 100mm 5.5kW                 |        |                        |

|   |  |                 |                  |
|---|--|-----------------|------------------|
|  | 1  |                 |                  |
| <b>GEV No.</b>  | 105135                                     | <b>Ref. No.</b> | C00012<br>C00816 |
| <b>description</b>  | burner holder for burner cap ø 120mm 7.5kW |                 |                  |

|   |  |        |   |
|---|--|--------|---|
| <b>accessories for</b>  | 105135                                     |        |   |
|  | <b>GEV No.</b>                             | 105133 | <b>Ref. No.</b> C99638<br>C99638 +<br>511120104 |
|   | burner head for burner cap ø 120mm 7.5kW   |        |   |
|  | <b>GEV No.</b>                             | 105134 | <b>Ref. No.</b> C00458                          |
|   | burner cap ø 120mm 7.5kW with central hole |        |   |

|   |   |                 |                  |
|---|---|-----------------|------------------|
|  | 1   |                 |                  |
| <b>GEV No.</b>  | 105132                                    | <b>Ref. No.</b> | C00010<br>C00814 |
| <b>description</b>  | burner holder for burner cap ø 70mm 3.5kW |                 |                  |

|   |   |        |                        |
|---|---|--------|------------------------|
| <b>accessories for</b>  | 105132                                  |        |                        |
|  | <b>GEV No.</b>                          | 105130 | <b>Ref. No.</b> C99636 |
|   | burner head for burner cap ø 70mm 3.5kW |        |                        |
|  | <b>GEV No.</b>                          | 105131 | <b>Ref. No.</b> C00456 |
|   | burner cap ø 70mm 3.5kW                 |        |                        |

|  |  |                 |        |
|--|--|-----------------|--------|
|  | 1  |                 |        |
| <b>GEV No.</b>   | 210030   | <b>Ref. No.</b> | C00859 |
| <b>description</b>   | pan support W 313mm L 390mm H 47mm suitable for EMMEPI |                 |        |

|  |  |                 |        |
|--|--|-----------------|--------|
| <b>accessories</b>   | pan supports   |                 |        |
|  | 1  |                 |        |
| <b>GEV No.</b>   | 210030   | <b>Ref. No.</b> | C00859 |
| <b>description</b>   | pan support W 313mm L 390mm H 47mm suitable for EMMEPI |                 |        |

|  |                              |                 |        |
|--|------------------------------|-----------------|--------|
| <b>simmering plates</b>  | 1                            |                 |        |
|  | 1                            |                 |        |
| <b>GEV No.</b>   | 109723                       | <b>Ref. No.</b> | 100083 |
| <b>description</b>   | simmer plate L 365mm W 355mm |                 |        |

|  |   |                 |        |
|--|---|-----------------|--------|
| <b>bar burners</b>   | 1   |                 |        |
|  | 1   |                 |        |
| <b>GEV No.</b>   | 105788  | <b>Ref. No.</b> | 809328 |
| <b>description</b>   | bar burner 1-row ø 50mm Wmm Hmm L 483mm flange width 71mm convection oven flange ø 75mm |                 |        |

1 gas components





Зип Общежит

vsezip.ru

+7(812)987-08-81

gas components

|   |   |                 |        |
|---|---|-----------------|--------|
|  |   |                 |        |
| 1   |   |                 |        |
| <b>GEV No.</b>  | 105687  | <b>Ref. No.</b> | 8C2060 |
| <b>description</b>  | bar burner 2 row L 370mm W 220mm ømm H 50mm chargrill |                 |        |

|  |   |                 |                                |
|--|---|-----------------|--------------------------------|
|  |   |                 |                                |
| 1  |   |                 |                                |
| <b>GEV No.</b>   | 105326  | <b>Ref. No.</b> | C00082+C00083+C00290<br>C99716 |
| <b>description</b>   | bar burner 4 row L 440mm W 300mm ømm H 50mm solid top |                 |                                |

|   |   |                 |                                |
|---|---|-----------------|--------------------------------|
|  |   |                 |                                |
| 1   |   |                 |                                |
| <b>GEV No.</b>  | 105323  | <b>Ref. No.</b> | C10074+C10060+C00290<br>C89456 |
| <b>description</b>  | bar burner 2 row L 390mm W 160mm ømm H 50mm solid top |                 |                                |

|  |  |                 |  |
|--|--|-----------------|--|
|  |  |                 |  |
| 1  |  |                 |  |
| <b>GEV No.</b>   | 105312   | <b>Ref. No.</b> | C10076+C10060+C00290<br>C89435<br>C89435+C10060+C00290 |
| <b>description</b>   | bar burner 4 row L 460mm W 545mm ømm H 40mm oven |                 |  |

|   |   |                 |        |
|---|---|-----------------|--------|
|  |   |                 |        |
| 1   |   |                 |        |
| <b>GEV No.</b>  | 105320                                      | <b>Ref. No.</b> | C89458 |
| <b>description</b>  | bar burner 2 row L 950mm W 180mm ømm H 50mm |                 |        |

|   |  |                 |                  |
|---|--|-----------------|------------------|
|  |  |                 |                  |
| 1   |  |                 |                  |
| <b>GEV No.</b>  | 105321   | <b>Ref. No.</b> | C00886<br>C89436 |
| <b>description</b>  | bar burner angled L 524mm W 243mm ømm H 5.8kW oven |                 |                  |

|   |  |                 |        |
|---|--|-----------------|--------|
|  |  |                 |        |
| 1   |  |                 |        |
| <b>GEV No.</b>  | 105311   | <b>Ref. No.</b> | 809388 |
| <b>description</b>  | bar burner 3 row L 370mm W 345mm ømm H 145mm chargrill |                 |        |

|  |  |                 |                  |
|--|--|-----------------|------------------|
|  |  |                 |                  |
| 1  |  |                 |                  |
| <b>GEV No.</b>   | 105325                                       | <b>Ref. No.</b> | C00885<br>C99724 |
| <b>description</b>   | bar burner angled L 625mm W 250mm ømm H oven |                 |                  |

|   |   |                 |                               |
|---|---|-----------------|-------------------------------|
|  |   |                 |                               |
| 1   |   |                 |                               |
| <b>GEV No.</b>  | 105327  | <b>Ref. No.</b> | C0080+C00111+C00290<br>C99717 |
| <b>description</b>  | bar burner 3 row L 490mm W 240mm ømm H 60mm grill |                 |                               |

|  |  |                 |        |
|--|--|-----------------|--------|
|  |  |                 |        |
| 1  |  |                 |        |
| <b>GEV No.</b>   | 105328                                       | <b>Ref. No.</b> | C99711 |
| <b>description</b>   | bar burner ø 25mm Wmm Hmm L 520mm bain marie |                 |        |

|   |  |                 |        |
|---|--|-----------------|--------|
|  |  |                 |        |
| 1   |  |                 |        |
| <b>GEV No.</b>  | 105319   | <b>Ref. No.</b> | 809467 |
| <b>description</b>  | bar burner 4 row L 390mm W 270mm ømm H 60mm kettle |                 |        |

|   |   |                 |        |
|---|---|-----------------|--------|
|  |   |                 |        |
| 1   |   |                 |        |
| <b>GEV No.</b>  | 105718  | <b>Ref. No.</b> | 8C1040 |
| <b>description</b>  | bar burner ø 40mm Wmm Hmm L 395mm flange ø 61mm tilting bratt pan |                 |        |

|   |   |                 |                                |
|---|---|-----------------|--------------------------------|
|  |   |                 |                                |
| 1   |   |                 |                                |
| <b>GEV No.</b>  | 105324  | <b>Ref. No.</b> | C10077+C10060+C00290<br>C89457 |
| <b>description</b>  | bar burner 4 row L 425mm W 470mm ømm H 50mm 9kW grill |                 |                                |





Зип Общепит

vsezip.ru

+7(812)987-08-81

|  |   |                 |        |
|--|---|-----------------|--------|
|  <p>1</p> |   |                 |        |
| <b>GEV No.</b>   | 105330  | <b>Ref. No.</b> | 808738 |
| <b>description</b>   | bar burner ø 40mm Wmm Hmm L 500mm mounting thread with bolt M5x12 flange width 43mm flange length 43mm bain marie |                 |        |

|   |  |                 |        |
|---|--|-----------------|--------|
|  <p>1</p> |  |                 |        |
| <b>GEV No.</b>  | 105314   | <b>Ref. No.</b> | 808417 |
| <b>description</b>  | tubular burner L 295mm W 55mm H 70mm 4.7kW mounting pos. centre oval |                 |        |

|  |   |                 |                  |
|--|---|-----------------|------------------|
|  <p>1</p> |   |                 |                  |
| <b>GEV No.</b>   | 105310  | <b>Ref. No.</b> | 808726<br>809434 |
| <b>description</b>   | bar burner ø 60mm Wmm Hmm L 260mm flange width 67mm flange length 67mm pasta cooker |                 |                  |

|   |  |                 |        |
|---|--|-----------------|--------|
|  <p>1</p> |  |                 |        |
| <b>GEV No.</b>  | 105313   | <b>Ref. No.</b> | 808419 |
| <b>description</b>  | tubular burner L 295mm W 55mm H 70mm 4.7kW mounting pos. left oval |                 |        |

|  |  |                 |        |
|--|--|-----------------|--------|
|  <p>1</p> |  |                 |        |
| <b>GEV No.</b>   | 105317   | <b>Ref. No.</b> | 808434 |
| <b>description</b>   | bar burner ø 60mm Wmm Hmm L 388mm flange width 67mm flange length 67mm |                 |        |

|  |   |                 |        |
|--|---|-----------------|--------|
|  <p>1</p> |   |                 |        |
| <b>GEV No.</b>   | 105329  | <b>Ref. No.</b> | 808418 |
| <b>description</b>   | tubular burner L 295mm W 55mm H 70mm 4.7kW mounting pos. right oval |                 |        |

tube burners

|  |  |                 |        |
|--|--|-----------------|--------|
|  <p>1</p> |  |                 |        |
| <b>GEV No.</b>   | 105315   | <b>Ref. No.</b> | 809428 |
| <b>description</b>   | tubular burner L 170mm W 55mm H 70mm 3.8kW mounting pos. left oval |                 |        |

gas nozzles

main nozzles

gas nozzles M10x1

|   |   |                 |        |
|---|---|-----------------|--------|
|  <p>1</p> |   |                 |        |
| <b>GEV No.</b>  | 106466  | <b>Ref. No.</b> | 809960 |
| <b>description</b>  | gas injector thread M10x1 WS 12 bore ø 1.15mm |                 |        |

|  |   |                 |        |
|--|---|-----------------|--------|
|  <p>1</p> |   |                 |        |
| <b>GEV No.</b>   | 105316  | <b>Ref. No.</b> | 809429 |
| <b>description</b>   | tubular burner L 170mm W 55mm H 70mm 3.8kW mounting pos. right oval |                 |        |

gas nozzles M12x1

|   |   |                 |        |
|---|---|-----------------|--------|
|  <p>1</p> |   |                 |        |
| <b>GEV No.</b>  | 106266  | <b>Ref. No.</b> | C00112 |
| <b>description</b>  | gas injector thread M12x1 WS 13 bore ø 0.81mm |                 |        |



Зип Общепит  
vsezip.ru  
+7(812)987-08-81



|                    |   |                 |        |
|--------------------|---|-----------------|--------|
| <b>GEV No.</b>     | 106674  | <b>Ref. No.</b> | C00113 |
| <b>description</b> | gas injector thread M12x1 WS 13 bore ø 0.95mm |                 |        |



|                    |   |                 |        |
|--------------------|---|-----------------|--------|
| <b>GEV No.</b>     | 106267  | <b>Ref. No.</b> | C00114 |
| <b>description</b> | gas injector thread M12x1 WS 13 bore ø 1.05mm |                 |        |



|                    |   |                 |        |
|--------------------|---|-----------------|--------|
| <b>GEV No.</b>     | 107791  | <b>Ref. No.</b> | C00525 |
| <b>description</b> | gas injector thread M12x1 WS 13 bore ø 1.15mm |                 |        |



|                    |   |                 |        |
|--------------------|---|-----------------|--------|
| <b>GEV No.</b>     | 106423  | <b>Ref. No.</b> | C00116 |
| <b>description</b> | gas injector thread M12x1 WS 13 bore ø 1.25mm |                 |        |



|                    |  |                 |        |
|--------------------|--|-----------------|--------|
| <b>GEV No.</b>     | 106268                                       | <b>Ref. No.</b> | C00115 |
| <b>description</b> | gas injector thread M12x1 WS 13 bore ø 1.2mm |                 |        |



|                    |   |                 |        |
|--------------------|---|-----------------|--------|
| <b>GEV No.</b>     | 107785  | <b>Ref. No.</b> | C00117 |
| <b>description</b> | gas injector thread M12x1 WS 13 bore ø 1.35mm |                 |        |



|                    |  |                 |        |
|--------------------|--|-----------------|--------|
| <b>GEV No.</b>     | 106857                                       | <b>Ref. No.</b> | C00804 |
| <b>description</b> | gas injector thread M12x1 WS 13 bore ø 1.3mm |                 |        |



|                    |  |                 |        |
|--------------------|--|-----------------|--------|
| <b>GEV No.</b>     | 106856                                       | <b>Ref. No.</b> | C00536 |
| <b>description</b> | gas injector thread M12x1 WS 13 bore ø 1.7mm |                 |        |



|                    |   |                 |        |
|--------------------|---|-----------------|--------|
| <b>GEV No.</b>     | 100282  | <b>Ref. No.</b> | C00113 |
| <b>description</b> | gas injector thread M12x1 WS 14 bore ø 0.95mm |                 |        |

### pilot burner nozzles

#### pilot burner nozzles POLIDORO

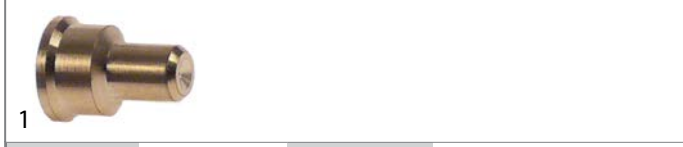

|                    |   |                 |                                  |
|--------------------|---|-----------------|----------------------------------|
| <b>GEV No.</b>     | 100208  | <b>Ref. No.</b> | 512120005<br>512120010<br>C00170 |
| <b>description</b> | pilot burner nozzle POLIDORO LPG code 20 bore ø 0.2mm Qty 1 pcs |                 |                                  |



|                    |  |                 |           |
|--------------------|--|-----------------|-----------|
| <b>GEV No.</b>     | 106703   | <b>Ref. No.</b> | 512120007 |
| <b>description</b> | pilot burner nozzle POLIDORO natural gas code 27.2 bore ø 2x0.27mm Qty 1 pcs |                 |           |

#### pilot burner nozzles SIT

##### 100 series



|                    |   |                 |        |
|--------------------|---|-----------------|--------|
| <b>GEV No.</b>     | 100245  | <b>Ref. No.</b> | 8C0030 |
| <b>description</b> | pilot burner nozzle LPG code 20 bore ø 0.2mm Qty 1 pcs thread M8x0.75 |                 |        |







Зип Общепит

vsezip.ru

+7(812)987-08-81

|                    |   |
|--------------------|---|
| 1                  |  |
| <b>GEV No.</b>     | 100246  |
| <b>Ref. No.</b>    | 8C0031  |
| <b>description</b> | pilot burner nozzle natural gas bore ø 0.35mm Qty 1 pcs thread M8x0.75            |

|                    |   |
|--------------------|---|
| 1                  |  |
| <b>GEV No.</b>     | 107170  |
| <b>Ref. No.</b>    | 8C0031  |
| <b>description</b> | pilot burner nozzle SIT natural gas bore ø 0.35mm Qty 1 pcs                       |

140/150 series

|                    |  |
|--------------------|--|
| 1                  |         |
| <b>GEV No.</b>     | 100204   |
| <b>Ref. No.</b>    | 8C0955   |
| <b>description</b> | pilot burner nozzle SIT LPG code 14 bore ø 0.18/0.20mm Qty 1 pcs suitable for 140 series |

|                    |  |
|--------------------|--|
| 1                  |             |
| <b>GEV No.</b>     | 100205   |
| <b>Ref. No.</b>    | 809996   |
| <b>description</b> | pilot burner nozzle SIT LPG code 19 bore ø 0.23/0.26mm Qty 1 pcs suitable for SIT 150 series |

|                    |  |
|--------------------|--|
| 1                  |          |
| <b>GEV No.</b>     | 100207   |
| <b>Ref. No.</b>    | 8C1497   |
| <b>description</b> | pilot burner nozzle SIT natural gas code 27 bore ø 0.40/0.38mm suitable for SIT 140 series |

|                    |  |
|--------------------|--|
| 1                  |                   |
| <b>GEV No.</b>     | 100206   |
| <b>Ref. No.</b>    | 809994   |
| <b>description</b> | pilot burner nozzle SIT natural gas code 36 bore ø 0.60/0.55mm Qty 1 pcs suitable for SIT 150 series |

160 series

|                    |   |
|--------------------|---|
| 1                  |  |
| <b>GEV No.</b>     | 107650  |
| <b>Ref. No.</b>    | 808365  |
| <b>description</b> | pilot burner nozzle SIT LPG code 30 Qty 1 pcs                                       |

|                    |  |
|--------------------|--|
| 1                  |  |
| <b>GEV No.</b>     | 107175   |
| <b>Ref. No.</b>    | 808364   |
| <b>description</b> | pilot burner nozzle SIT natural gas code 51 Qty 1 pcs suitable for 160 series      |

auxiliary gas parts

screw connections

olives

|                    |   |
|--------------------|---|
| 1                  |  |
| <b>GEV No.</b>     | 101248  |
| <b>Ref. No.</b>    | 8C0412  |
| <b>description</b> | olive for pipe ø 12mm Qty 1 pcs suitable for PEL                                  |

|   |  |
|---|--|
| <b>accessories for</b>  | 101248                                   |
|  | <b>GEV No.</b> 101251 <b>Ref. No.</b> —  |
|   | union nut thread M20x1.5 for pipe ø 12mm |

|                    |  |
|--------------------|--|
| 1                  |  |
| <b>GEV No.</b>     | 100870   |
| <b>Ref. No.</b>    | 830885   |
| <b>description</b> | olive for pipe ø 4mm Qty 1 pcs suitable for 160 series for pilot burner            |

union screws

|                    |   |
|--------------------|---|
| 1                  |  |
| <b>GEV No.</b>     | 100905  |
| <b>Ref. No.</b>    | 8C0070  |
| <b>description</b> | locking screw M10x1 for pipe ø 6mm Qty 1 pcs  |

|                    |   |
|--------------------|---|
| 1                  |  |
| <b>GEV No.</b>     | 100908  |
| <b>Ref. No.</b>    | 806019  |
| <b>description</b> | union screw thread M10x1 for pipe ø 4mm Qty 1 pcs                                   |

|   |   |
|---|---|
| <b>accessories for</b>  | 100908  |
|  | <b>GEV No.</b> 100897 <b>Ref. No.</b> —         |
|   | olive for pipe ø 4mm Qty 1 pcs for pilot burner |

|   |   |
|---|---|
|  | <b>GEV No.</b> 101246 <b>Ref. No.</b> — |
|   | olive for pipe ø 4mm Qty 1 pcs          |

|   |   |
|---|---|
|  | <b>GEV No.</b> 101280 <b>Ref. No.</b> — |
|   | olive for pipe ø 4mm Qty 1 pcs          |



|   |   |
|---|---|
|  | <b>GEV No.</b> 101280 <b>Ref. No.</b> — |
|   | olive for pipe ø 4mm Qty 1 pcs          |

Table continues overleaf

|   |         |        |          |
|---|---------|--------|----------|
| accessories for   | 100908  |        |          |
|  | GEV No. | 101282 | Ref. No. |
|   |         |        | —        |
| olive for pipe ø 4mm L 7.4mm Qty 1 pcs  |         |        |          |

## equipment-specific units

### for slicers

#### hand guard



1

|             |  |          |        |
|-------------|--|----------|--------|
| GEV No.     | 698196   | Ref. No. | 808991 |
| description | hand protection for carriage 275-300 H 220mm W 150mm thickness 4mm hole ø 6mm mounting distance 88mm |          |        |

#### food holders

##### handles



1

|             |   |          |        |
|-------------|---|----------|--------|
| GEV No.     | 111123  | Ref. No. | 808764 |
| description | handle thread M10 IT ø 30mm L 110mm D1 ø 65mm |          |        |

### for bandsaws

#### saw blades

##### width 20mm



1

|             |   |          |        |
|-------------|---|----------|--------|
| GEV No.     | 699083  | Ref. No. | 807993 |
| description | saw blade L 1800mm W 20mm thickness 0.5mm tooth spacing 6mm |          |        |

### for meat mincers

#### gear wheels



1

|             |  |          |        |
|-------------|--|----------|--------|
| GEV No.     | 698286   | Ref. No. | 808554 |
| description | gear wheel ø 64mm shaft intake ø 16mm teeth 40 splitting tooth width 13mm DIN/ISO groove width 0mm |          |        |

drive shafts

for blades



1

|             |   |          |        |
|-------------|---|----------|--------|
| GEV No.     | 698292  | Ref. No. | 808559 |
| description | drive shaft ENTERPRISE model 12 ø 9.5mm L 67mm thread M12x1.75 D1 ø 18mm thread L 698mm |          |        |

#### blades

##### ENTERPRISE



1

|             |  |          |                  |
|-------------|--|----------|------------------|
| GEV No.     | 696023   | Ref. No. | 809654<br>8C1342 |
| description | knife type ENTERPRISE size 22 ø 73mm internal size 13x13mm stainless steel |          |                  |

#### augers

##### complete



1

|             |   |          |        |
|-------------|---|----------|--------|
| GEV No.     | 698282  | Ref. No. | 808651 |
| description | auger model 12 ø 54mm L 150mm stainless steel with spindle ENTERPRISE |          |        |

### for vegetable slicers

#### ejector discs

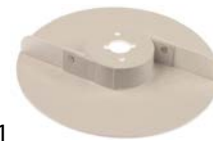

1

|             |   |          |        |
|-------------|---|----------|--------|
| GEV No.     | 699016  | Ref. No. | 808636 |
| description | ejector disc high H 25mm ø 200mm seat ø 21mm hole distance 40mm |          |        |

## for potato peelers

## abrasive side elements

## grinding discs



1

|                    |   |                 |        |
|--------------------|---|-----------------|--------|
| <b>GEV No.</b>     | 696201  | <b>Ref. No.</b> | 809309 |
| <b>description</b> | grating disc ø 280mm potato peeler PP4-PP8 Expo |                 |        |



1

|                    |   |                 |                  |
|--------------------|---|-----------------|------------------|
| <b>GEV No.</b>     | 696377  | <b>Ref. No.</b> | 809399<br>8C0950 |
| <b>description</b> | grating disc ø 350mm for potato peeler device |                 |                  |

## for ice-cube maker

## floats

## float containers



1

|                    |  |                 |        |
|--------------------|--|-----------------|--------|
| <b>GEV No.</b>     | 695072   | <b>Ref. No.</b> | 8C0072 |
| <b>description</b> | float container for ice maker with microswitch plastic |                 |        |

## for deep fryers

## door magnets



1

|                    |  |                 |                  |
|--------------------|--|-----------------|------------------|
| <b>GEV No.</b>     | 690524   | <b>Ref. No.</b> | 808161<br>C00247 |
| <b>description</b> | door magnet L 87mm W 18mm H 15mm mounting distance 73mm for folding door hinge |                 |                  |

3ип Общежит

miscellaneous



1

|                    |                             |                 |        |
|--------------------|-----------------------------|-----------------|--------|
| <b>GEV No.</b>     | 550449                      | <b>Ref. No.</b> | 808893 |
| <b>description</b> | special wrench for ring nut |                 |        |



1

|                    |  |                 |        |
|--------------------|--|-----------------|--------|
| <b>GEV No.</b>     | 550448   | <b>Ref. No.</b> | 808894 |
| <b>description</b> | tubular box wrench special for fryer L 280mm WS 10 |                 |        |

## for convection ovens/combi-steamers

## glass panels



1

|                    |                                   |                 |        |
|--------------------|-----------------------------------|-----------------|--------|
| <b>GEV No.</b>     | 694847                            | <b>Ref. No.</b> | 8C1724 |
| <b>description</b> | glass panel L 673mm W 510mm H 5mm |                 |        |

## air filters



1

|                    |   |                 |        |
|--------------------|---|-----------------|--------|
| <b>GEV No.</b>     | 692695                                  | <b>Ref. No.</b> | 809502 |
| <b>description</b> | filter insert L 213mm W 60mm ømm H 90mm |                 |        |

## miscellaneous



1

|                    |   |                 |        |
|--------------------|---|-----------------|--------|
| <b>GEV No.</b>     | 512184  | <b>Ref. No.</b> | 809567 |
| <b>description</b> | hose connector plastic thread 3/4" Qty 1 pcs connection distance 60mm T-shape |                 |        |

## for tilting bratt pans

## miscellaneous



1

|                    |  |                 |           |
|--------------------|--|-----------------|-----------|
| <b>GEV No.</b>     | 523510   | <b>Ref. No.</b> | EC1110002 |
| <b>description</b> | deep-groove ball bearing type 6202-2RS shaft $\varnothing$ 15mm ED $\varnothing$ 35mm W 11mm with sealing discs deep-groove ball bearing DIN 625-1 |                 |           |

## for boiling pans

## level glasses

## complete



1

|                    |   |                 |        |
|--------------------|---|-----------------|--------|
| <b>GEV No.</b>     | 540706  | <b>Ref. No.</b> | 808704 |
| <b>description</b> | level glass hole distance 76mm mounting thread M10 L 107mm W 28mm plastic/SS for kettle model ELESA HCX-76-BW-SST |                 |        |

## for pizza ovens

## glass panels



1

|                    |   |                 |        |
|--------------------|---|-----------------|--------|
| <b>GEV No.</b>     | 700205  | <b>Ref. No.</b> | 808440 |
| <b>description</b> | glass panel L 320mm W 100mm thickness 5mm rectangular |                 |        |

## for dishwashers

## boilers

## boilers for dishwashers



1

|                    |                                    |                 |        |
|--------------------|------------------------------------|-----------------|--------|
| <b>GEV No.</b>     | 519022                             | <b>Ref. No.</b> | 900353 |
| <b>description</b> | boiler $\varnothing$ 150mm L 400mm |                 |        |

## backflow preventers

## backflow preventers



1

|                    |                    |                 |        |
|--------------------|--------------------|-----------------|--------|
| <b>GEV No.</b>     | 504140             | <b>Ref. No.</b> | 907460 |
| <b>description</b> | backflow preventer |                 |        |

## miscellaneous



1

|                    |  |                 |        |
|--------------------|--|-----------------|--------|
| <b>GEV No.</b>     | 506160   | <b>Ref. No.</b> | 8C0647 |
| <b>description</b> | plain washer ID $\varnothing$ 8.6mm ED $\varnothing$ 16mm thickness 1.5mm SS Qty 1 pcs |                 |        |

## door mechanics

## rollers



1

|                    |   |                 |        |
|--------------------|---|-----------------|--------|
| <b>GEV No.</b>     | 501431  | <b>Ref. No.</b> | 8C1472 |
| <b>description</b> | roller ED $\varnothing$ 9mm for door mechanism shaft diameter 3.5mm W 5mm |                 |        |

+7(812)987-08-81



Зип-Общепит

vsezip.ru

+7(812)987-08-81

locks





1

|                    |                        |                 |        |
|--------------------|------------------------|-----------------|--------|
| <b>GEV No.</b>     | 511083                 | <b>Ref. No.</b> | 809676 |
| <b>description</b> | counterpart door catch |                 |        |



1

|   |                           |                 |                 |        |
|---|---------------------------|-----------------|-----------------|--------|
| <b>GEV No.</b>  | 511082                    | <b>Ref. No.</b> | 809675          |        |
| <b>description</b>  | door catch complete catch |                 |                 |        |
| <b>accessories for</b>  | 511082                    |                 |                 |        |
|  | <b>GEV No.</b>            | 511083          | <b>Ref. No.</b> | 809676 |
|   | counterpart door catch    |                 |                 |        |



1

|   |  |                 |                 |   |
|---|--|-----------------|-----------------|---|
| <b>GEV No.</b>  | 519247   | <b>Ref. No.</b> | 906113          |   |
| <b>description</b>  | door catch door locking catch                              |                 |                 |   |
| <b>accessories for</b>  | 519247   |                 |                 |   |
|  | <b>GEV No.</b>   | 519050          | <b>Ref. No.</b> | — |
|   | nut thread M12x1.75 H 4mm WS 16 SS Qty 1 pcs for snap lock |                 |                 |   |

miscellaneous



1

|                    |  |                 |        |
|--------------------|--|-----------------|--------|
| <b>GEV No.</b>     | 524047   | <b>Ref. No.</b> | 8C1197 |
| <b>description</b> | hauling cable for door mechanism ø 1.5mm L 475mm |                 |        |

curtains



1

|                    |   |                 |        |
|--------------------|---|-----------------|--------|
| <b>GEV No.</b>     | 533016  | <b>Ref. No.</b> | TR0460 |
| <b>description</b> | curtain W 640mm H 410mm plastic thickness 1.5mm warewashing |                 |        |

universal knobs



1

|                    |  |                 |        |
|--------------------|--|-----------------|--------|
| <b>GEV No.</b>     | 110811   | <b>Ref. No.</b> | C99683 |
| <b>description</b> | knob gas tap with ignition flame ø 70mm shaft ø 10x8mm shaft flat universal black/silver |                 |        |



1

|                    |   |                 |        |
|--------------------|---|-----------------|--------|
| <b>GEV No.</b>     | 110817  | <b>Ref. No.</b> | C98971 |
| <b>description</b> | knob switch 7-position ø 70mm shaft ø 6x4.6mm shaft flat universal black/silver |                 |        |



1

|                    |  |                 |        |
|--------------------|--|-----------------|--------|
| <b>GEV No.</b>     | 110816   | <b>Ref. No.</b> | C99704 |
| <b>description</b> | knob thermostat t.max. 90°C 30-90°C ø 70mm shaft ø 6x4.6mm shaft flat universal black/silver rotation 270° |                 |        |

producer-specific knobs

EMMEPI



1

|                    |   |                 |                  |
|--------------------|---|-----------------|------------------|
| <b>GEV No.</b>     | 110810  | <b>Ref. No.</b> | C89433<br>C89459 |
| <b>description</b> | knob gas tap without ignition flame ø 75mm shaft ø 8x6.5mm shaft flat upper black |                 |                  |

Зип Общепит

vsezip.ru

+7(812)987-08-81

|   |  |                 |        |
|---|--|-----------------|--------|
|  |  |                 |        |
| 1   |  |                 |        |
| <b>GEV No.</b>  | 110812   | <b>Ref. No.</b> | C99698 |
| <b>description</b>  | knob gas thermostat 1-8 ø 75mm shaft ø 10x8mm shaft flat lower |                 |        |

|   |   |                 |        |
|---|---|-----------------|--------|
|  |   |                 |        |
| 1   |   |                 |        |
| <b>GEV No.</b>  | 110813  | <b>Ref. No.</b> | C99707 |
| <b>description</b>  | knob switch 0-1 ø 75mm shaft ø 6x4.6mm shaft flat upper black |                 |        |

|   |  |                 |        |
|---|--|-----------------|--------|
|  |  |                 |        |
| 1   |  |                 |        |
| <b>GEV No.</b>  | 110818   | <b>Ref. No.</b> | C99695 |
| <b>description</b>  | knob switch 7-position ø 75mm shaft ø 6x4.6mm shaft flat upper black |                 |        |

|   |   |                 |        |
|---|---|-----------------|--------|
|  |   |                 |        |
| 1   |   |                 |        |
| <b>GEV No.</b>  | 110819  | <b>Ref. No.</b> | C99692 |
| <b>description</b>  | knob thermostat t.max. 110°C ø 75mm shaft ø 6x4.6mm shaft flat upper black temperature range 30-110°C rotation 270° |                 |        |

|   |  |                 |        |
|---|--|-----------------|--------|
|  |  |                 |        |
| 1   |  |                 |        |
| <b>GEV No.</b>  | 110815   | <b>Ref. No.</b> | C99686 |
| <b>description</b>  | knob thermostat t.max. 200°C 150-200°C ø 76mm shaft ø 6x4.6mm shaft flat upper black temperature range 150-200°C |                 |        |

|  |  |                 |        |
|--|--|-----------------|--------|
|  |  |                 |        |
| 1  |  |                 |        |
| <b>GEV No.</b>   | 110814   | <b>Ref. No.</b> | C99639 |
| <b>description</b>   | knob thermostat t.max. 250°C 100-250°C ø 75mm shaft ø 6x4.6mm shaft flat upper black rotation 270° |                 |        |

### accessories

#### button springs

|   |                                  |                 |        |
|---|----------------------------------|-----------------|--------|
|  |                                  |                 |        |
| 1   |                                  |                 |        |
| <b>GEV No.</b>  | 550132                           | <b>Ref. No.</b> | C00196 |
| <b>description</b>  | knob spring ø 6x4.6mm Qty 10 pcs |                 |        |

### handles and hand wheels

#### hand wheels

##### hand wheels

|   |                                |                 |        |
|---|--------------------------------|-----------------|--------|
|  |                                |                 |        |
| 1   |                                |                 |        |
| <b>GEV No.</b>  | 540715                         | <b>Ref. No.</b> | C00248 |
| <b>description</b>  | hand wheel ø 200mm bore ø 16mm |                 |        |

|  |  |                 |                 |
|--|--|-----------------|-----------------|
|  |  |                 |                 |
| 1  |  |                 |                 |
| <b>GEV No.</b>   | 690609   | <b>Ref. No.</b> | C00248          |
| <b>description</b>   | hand wheel ø 200mm D1 ø 50mm bore ø 16mm thread groove width-mm L1 28mm L2 55mm handle length 85mm with folding handle |                 |                 |
| <b>spare parts for</b>   | 690609   |                 |                 |
|  | <b>GEV No.</b>   | 514255          | <b>Ref. No.</b> |
|  |                                     |                 |                 |
|  | folding handle ø 26mm total length 85mm seat ø 20mm shaft ø 6mm thread M6 with pin L 85mm                              |                 |                 |

cylindrical handles

fixed



1

**GEV No.** 540713 **Ref. No.** 809039

**description** cylindrical handle thread M8 ø 17mm L 38mm

levers

without handle



1

**GEV No.** 540712 **Ref. No.** 809038

**description** lever

locks

edgmount latches

handle latches

CAFF/FERMOD

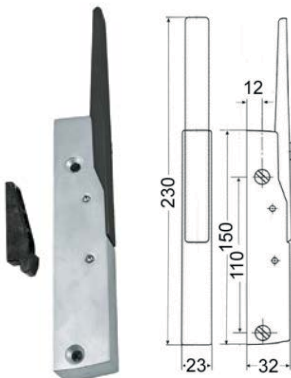

1

**GEV No.** 690454 **Ref. No.** 8C2082

**description** handle latch L 150mm mounting distance 110mm matt chrome-plated/Rilsan non lockable heated units 560 black complete with door catch

**spare parts for** 690454

**GEV No.** 690429 **Ref. No.** —

**description** door catch CT 25.5mm

**accessories for** 690454

**GEV No.** 690428 **Ref. No.** —

**description** door catch H 51mm W 13.9mm mounting distance 30mm plastic CT 16.5mm

**GEV No.** 690445 **Ref. No.** —

**description** base plate H 2mm

Зип Общепит

vsezip.ru

+7(812)987-08-81

|   |                       |                   |
|---|-----------------------|-------------------|
| <b>accessories for</b> 690454                     | <b>GEV No.</b> 690446 | <b>Ref. No.</b> — |
| <b>description</b> base plate H 5mm L 56mm W 18mm |                       |                   |

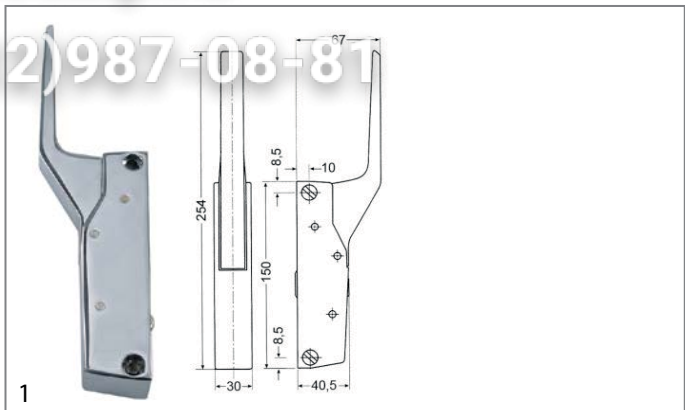

1

**GEV No.** 700060 **Ref. No.** 9629921

**description** handle latch L 150mm mounting distance 133mm non lockable heated units G 791

**accessories for** 700060

**GEV No.** 700061 **Ref. No.** 8C0315

**description** door catch L 58mm W 20mm H 35mm mounting distance 42mm chrome-plated brass for headed units

**GEV No.** 700062 **Ref. No.** —

**description** handle protection heated units

door catches



1

**GEV No.** 700061 **Ref. No.** 8C0315

**description** door catch L 58mm W 20mm H 35mm mounting distance 42mm chrome-plated brass for headed units

**accessories for** 700061

**GEV No.** 690414 **Ref. No.** —

**description** handle latch L 150mm mounting distance 133mm non lockable refrigeration units G 791



1

**GEV No.** 700435 **Ref. No.** 809875 8C0315

**description** door catch L 58mm W 20mm H 35mm mounting distance 42mm zamak for refrigeration units

snap locks

universal



|                    |  |                 |           |
|--------------------|--|-----------------|-----------|
| <b>GEV No.</b>     | 690596   | <b>Ref. No.</b> | 131110006 |
| <b>description</b> | snap lock L 60mm W 15mm H 36mm mounting distance 48/28mm spring thickness 1.5mm complete with door catch zamak |                 |           |

miscellaneous



|                    |                                    |                 |        |
|--------------------|------------------------------------|-----------------|--------|
| <b>GEV No.</b>     | 511482                             | <b>Ref. No.</b> | 809708 |
| <b>description</b> | pressure pin L 52mm thread M10x1.5 |                 |        |

hinges

oven hinges



|                    |                  |                 |        |
|--------------------|------------------|-----------------|--------|
| <b>GEV No.</b>     | 690535           | <b>Ref. No.</b> | C00132 |
| <b>description</b> | opposite support |                 |        |

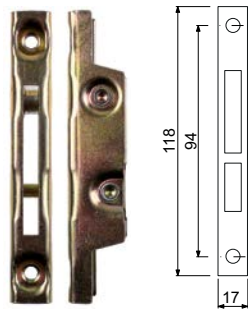

|                    |  |                 |        |
|--------------------|--|-----------------|--------|
| <b>GEV No.</b>     | 700001   | <b>Ref. No.</b> | C00132 |
| <b>description</b> | opposite support L 118mm W 17mm mounting distance 94mm |                 |        |

Зип Общепит

vsezip.ru

+7(812)987-08-81

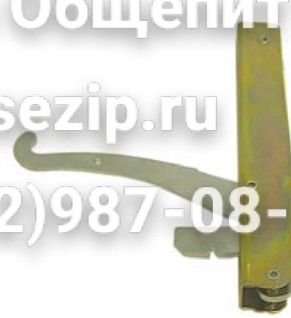

|                    |                 |                 |        |
|--------------------|-----------------|-----------------|--------|
| <b>GEV No.</b>     | 690532          | <b>Ref. No.</b> | C00131 |
| <b>description</b> | oven hinge left |                 |        |

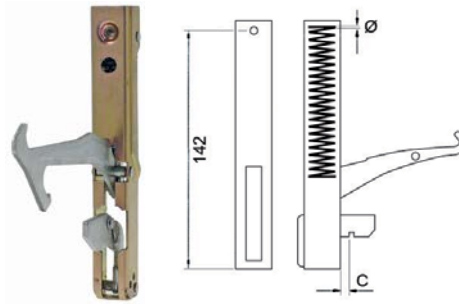

|                    |  |                 |           |
|--------------------|--|-----------------|-----------|
| <b>GEV No.</b>     | 700433   | <b>Ref. No.</b> | 132110006 |
| <b>description</b> | oven hinge mounting distance 142mm mounting distance 2mm lug mountingmm lever length 100mm groove distance 14mm spring thickness 4mm mounting ear position spring length 55mm L 155mm mounting pos. left/right |                 |           |

|                        |                             |        |                 |   |
|------------------------|-----------------------------|--------|-----------------|---|
| <b>accessories for</b> | 700433                      |        |                 |   |
|                        | <b>GEV No.</b>              | 700434 | <b>Ref. No.</b> | — |
|                        | opposite support oven hinge |        |                 |   |



|                    |   |                 |        |
|--------------------|---|-----------------|--------|
| <b>GEV No.</b>     | 700006  | <b>Ref. No.</b> | C00130 |
| <b>description</b> | oven hinge mounting distance 173mm mounting distance 2 105mm lug mounting 14mm lever length 120mm groove distance 11mm spring thickness 3.5mm mounting ear position left spring length 112mm W 25mm |                 |        |

|                        |  |        |                 |        |
|------------------------|--|--------|-----------------|--------|
| <b>accessories for</b> | 700006   |        |                 |        |
|                        | <b>GEV No.</b>   | 700001 | <b>Ref. No.</b> | C00132 |
|                        | opposite support L 118mm W 17mm mounting distance 94mm |        |                 |        |

|  |  |        |                 |        |
|--|--|--------|-----------------|--------|
|  | <b>GEV No.</b>   | 700007 | <b>Ref. No.</b> | C00131 |
|  | oven hinge mounting distance 173mm mounting distance 2 105mm lug mounting 14mm lever length 120mm groove distance 11mm spring thickness 3.5mm mounting ear position right spring length 112mm W 25mm |        |                 |        |



Зип Общепит

vsezip.ru

+7(812)987-08-81

1

|                        |  |                 |        |
|------------------------|--|-----------------|--------|
| <b>GEV No.</b>         | 700007   | <b>Ref. No.</b> | C00131 |
| <b>description</b>     | oven hinge mounting distance 173mm mounting distance 2 105mm lug mounting 14mm lever length 120mm groove distance 11mm spring thickness 3.5mm mounting ear position right spring length 112mm W 25mm |                 |        |
| <b>accessories for</b> | 700007   |                 |        |
|                        | <b>GEV No.</b>   | <b>Ref. No.</b> | C00132 |
|                        | opposite support L 118mm W 17mm mounting distance 94mm   |                 |        |

1

|                    |   |                 |        |
|--------------------|---|-----------------|--------|
| <b>GEV No.</b>     | 690533  | <b>Ref. No.</b> | C10079 |
| <b>description</b> | oven hinge mounting distance 173mm mounting distance 2 105mm lug mounting 14mm lever length 120mm groove distance 11mm spring thickness 4mm mounting ear position left spring length 112mm L 206mm W 25mm |                 |        |

1

|                    |  |                 |        |
|--------------------|--|-----------------|--------|
| <b>GEV No.</b>     | 690534   | <b>Ref. No.</b> | C10080 |
| <b>description</b> | oven hinge mounting distance 173mm mounting distance 2 105mm lug mounting 14mm lever length 120mm groove distance 11mm spring thickness 4mm mounting ear position right spring length 112mm L 206mm W 25mm |                 |        |

door bearing

1

|                    |   |                 |        |
|--------------------|---|-----------------|--------|
| <b>GEV No.</b>     | 690523  | <b>Ref. No.</b> | C98973 |
| <b>description</b> | hinge bearing mounting pos. bottom left with bolt |                 |        |

1

|                    |   |                 |        |
|--------------------|---|-----------------|--------|
| <b>GEV No.</b>     | 690526  | <b>Ref. No.</b> | 809412 |
| <b>description</b> | hinge bearing mounting pos. bottom left/upper right with bolt |                 |        |

1

|                    |  |                 |        |
|--------------------|--|-----------------|--------|
| <b>GEV No.</b>     | 690527   | <b>Ref. No.</b> | 809400 |
| <b>description</b> | hinge bearing mounting pos. bottom right with bolt |                 |        |

1

|                    |  |                 |        |
|--------------------|--|-----------------|--------|
| <b>GEV No.</b>     | 690522   | <b>Ref. No.</b> | C98974 |
| <b>description</b> | hinge bearing mounting pos. upper left with bolt |                 |        |

1

|                    |  |                 |        |
|--------------------|--|-----------------|--------|
| <b>GEV No.</b>     | 690530   | <b>Ref. No.</b> | 809403 |
| <b>description</b> | hinge bearing mounting pos. upper left with bolt |                 |        |

1

|                    |   |                 |        |
|--------------------|---|-----------------|--------|
| <b>GEV No.</b>     | 514309  | <b>Ref. No.</b> | 8C1386 |
| <b>description</b> | hinge bearing mounting pos. upper left without bolt |                 |        |

1

|                    |   |                 |        |
|--------------------|---|-----------------|--------|
| <b>GEV No.</b>     | 690525  | <b>Ref. No.</b> | 809411 |
| <b>description</b> | hinge bearing mounting pos. upper left/bottom right with bolt |                 |        |

Зип Общепит

vsezip.ru

+7(812)987-08-81

|   |   |                 |        |
|---|---|-----------------|--------|
|  |   |                 |        |
| 1   |   |                 |        |
| <b>GEV No.</b>  | 690521  | <b>Ref. No.</b> | C98975 |
| <b>description</b>  | hinge bearing mounting pos. upper right with bolt |                 |        |



|   |   |                 |        |
|---|---|-----------------|--------|
|  |   |                 |        |
| 1   |   |                 |        |
| <b>GEV No.</b>  | 690528  | <b>Ref. No.</b> | 809401 |
| <b>description</b>  | hinge bearing mounting pos. upper right with bolt |                 |        |

## fittings for catering equipment

### outlet taps

#### producer-specific

#### EMMEPI

|   |   |                 |                         |
|---|---|-----------------|-------------------------|
|  |   |                 |                         |
| 1   |   |                 |                         |
| <b>GEV No.</b>  | 540700  | <b>Ref. No.</b> | 808037<br>808037+808432 |
| <b>description</b>  | ball valve straight thread 1/2" IT - 1/2" IT connection 1/2" mounting pos. total length 64mm shaft intake ø 9x7.5mm 1/2" rosette thread G2 3/8" total length 64mm |                 |                         |
| <b>spare parts for</b>  | 540700  |                 |                         |
|   | <b>GEV No.</b>  | 540701          | <b>Ref. No.</b> 808432  |
|   | lever handle plastic L 65mm H 40mm thread connection 9x7.5  |                 |                         |

|   |  |                 |        |
|---|--|-----------------|--------|
|  |  |                 |        |
| 1   |  |                 |        |
| <b>GEV No.</b>  | 540701   | <b>Ref. No.</b> | 808432 |
| <b>description</b>  | lever handle plastic L 65mm H 40mm thread connection 9x7.5 |                 |        |

|   |  |                 |                        |
|---|--|-----------------|------------------------|
|  |  |                 |                        |
| <b>GEV No.</b>  | 540776   | <b>Ref. No.</b> | 809040                 |
| <b>description</b>  | outlet tap L 83mm without handle thread 3/4" IT shaft L 9mm shaft ø 10x7.3mm handle M6 |                 |                        |
| <b>spare parts for</b>  | 540776   |                 |                        |
|    | <b>GEV No.</b>   | 532453          | <b>Ref. No.</b> —      |
|   | O-ring EPDM thickness 2.62mm ID ø 21.89mm Qty 1 pcs                                    |                 |                        |
| <b>accessories for</b>  | 540776   |                 |                        |
|    | <b>GEV No.</b>   | 514006          | <b>Ref. No.</b> 808931 |
|   | drain pipe L 200mm thread ø 22mm   |                 |                        |
|    | <b>GEV No.</b>   | 514217          | <b>Ref. No.</b> —      |
|   | handle for outlet tap  |                 |                        |
|    | <b>GEV No.</b>   | 540651          | <b>Ref. No.</b> —      |
|   | drain pipe total length 210mm shaft ø 22mm   |                 |                        |
|    | <b>GEV No.</b>   | 540734          | <b>Ref. No.</b> —      |
|   | drain pipe thread  |                 |                        |
|    | <b>GEV No.</b>   | 693082          | <b>Ref. No.</b> —      |
|   | lever handle thread  |                 |                        |

### aerators and air bleeders

|  |  |                 |        |
|--|--|-----------------|--------|
|  |  |                 |        |
| 1  |  |                 |        |
| <b>GEV No.</b>   | 540827   | <b>Ref. No.</b> | 809385 |
| <b>description</b>   | aerator and air bleeder thread 3/4" ET chrome-plated L 45mm ø 36mm |                 |        |



## inlet taps

1



|   |  |                 |                  |
|---|--|-----------------|------------------|
| <b>GEV No.</b>  | 514048   | <b>Ref. No.</b> | C10510+224110004 |
| <b>description</b>  | ball valve connection 1/2" complete total length 55mm mounting pos. any brass H 30mm L 55mm rosette ø 70mm rosette thread G2 M22x1 |                 |                  |
| <b>spare parts for</b>  | 514048   |                 |                  |
|  | <b>GEV No.</b>   | 540871          | <b>Ref. No.</b>  |
|   |  |                 | —                |
|   | lever handle cold water suitable for intake tap  |                 |                  |

## drain taps

## brass

## drain taps

1



|   |   |                 |                 |
|---|---|-----------------|-----------------|
| <b>GEV No.</b>  | 540131                                  | <b>Ref. No.</b> | 808350          |
| <b>description</b>  | drain tap 1 1/4" IT chrome-plated brass |                 |                 |
| <b>spare parts for</b>  | 540131                                  |                 |                 |
|  | <b>GEV No.</b>                          | 540213          | <b>Ref. No.</b> |
|   |   |                 | —               |
|   | handle ID ø 5mm L 117mm                 |                 |                 |
|  | <b>GEV No.</b>                          | 540461          | <b>Ref. No.</b> |
|   |   |                 | —               |
|   | shim for drain tap                      |                 |                 |
|  | <b>GEV No.</b>                          | 540464          | <b>Ref. No.</b> |
|   |   |                 | —               |
|   | nut for drain tap thread 1 1/2"         |                 |                 |



Зип Общепит

vsezip.ru

+7(812)987-08-81

1



|   |  |                 |                 |
|---|--|-----------------|-----------------|
| <b>GEV No.</b>  | 540134   | <b>Ref. No.</b> | 806172          |
| <b>description</b>  | drain tap 2" IT fixed A 115mm B1 90mm B2 165mm chrome-plated brass |                 |                 |
| <b>spare parts for</b>  | 540134   |                 |                 |
|  | <b>GEV No.</b>   | 540214          | <b>Ref. No.</b> |
|   |  |                 | —               |
|   | handle ID ø 6mm L 145mm  |                 |                 |
|  | <b>GEV No.</b>   | 540462          | <b>Ref. No.</b> |
|   |  |                 | —               |
|   | ring for drain tap   |                 |                 |
|  | <b>GEV No.</b>   | 540465          | <b>Ref. No.</b> |
|   |  |                 | —               |
|   | nut for drain tap thread 2 3/4"                                    |                 |                 |
| <b>accessories for</b>  | 540134   |                 |                 |
|  | <b>GEV No.</b>   | 529484          | <b>Ref. No.</b> |
|   |  |                 | —               |
|   | flat gasket fibre ED ø 58mm ID ø 50mm thickness 2mm Qty 1 pcs      |                 |                 |

## safety valves

1



|                    |              |                 |        |
|--------------------|--------------|-----------------|--------|
| <b>GEV No.</b>     | 540708       | <b>Ref. No.</b> | 809470 |
| <b>description</b> | safety valve |                 |        |

## equipment feet and end caps

## bullet feet

## zamak/SS

1



|                    |   |                 |        |
|--------------------|---|-----------------|--------|
| <b>GEV No.</b>     | 700112  | <b>Ref. No.</b> | 819841 |
| <b>description</b> | equipment foot pipe type 40x40 thickness 1mm H 33-60mm Zamak/SS Qty 1 pcs |                 |        |

## screw-in feet



1

|                |        |                 |          |
|----------------|--------|-----------------|----------|
| <b>GEV No.</b> | 802136 | <b>Ref. No.</b> | E6111092 |
|----------------|--------|-----------------|----------|

|                    |  |  |  |
|--------------------|--|--|--|
| <b>description</b> | equipment foot thread M8 thread L 15mm ø 47mm H 40mm |  |  |
|--------------------|--|--|--|

## baskets

## fryer baskets

## EMMEPI



1

|                |        |                 |        |
|----------------|--------|-----------------|--------|
| <b>GEV No.</b> | 970577 | <b>Ref. No.</b> | 808182 |
|----------------|--------|-----------------|--------|

|                    |   |  |  |
|--------------------|---|--|--|
| <b>description</b> | fryer basket L1 270mm W1 185mm H1 120mm chrome-plated steel |  |  |
|--------------------|---|--|--|



1

|                |        |                 |        |
|----------------|--------|-----------------|--------|
| <b>GEV No.</b> | 970240 | <b>Ref. No.</b> | 205011 |
|----------------|--------|-----------------|--------|

|                    |   |  |  |
|--------------------|---|--|--|
| <b>description</b> | fryer basket L1 285mm W1 230mm H1 105mm |  |  |
|--------------------|---|--|--|



1

|                |        |                 |        |
|----------------|--------|-----------------|--------|
| <b>GEV No.</b> | 970244 | <b>Ref. No.</b> | 299939 |
|----------------|--------|-----------------|--------|

|                    |   |  |  |
|--------------------|---|--|--|
| <b>description</b> | fryer basket L1 290mm W1 115mm H1 120mm |  |  |
|--------------------|---|--|--|



1

|                |        |                 |           |
|----------------|--------|-----------------|-----------|
| <b>GEV No.</b> | 970355 | <b>Ref. No.</b> | CFR142812 |
|----------------|--------|-----------------|-----------|

|                    |  |  |  |
|--------------------|--|--|--|
| <b>description</b> | fryer basket L1 290mm W1 115mm H1 120mm L2 50mm H2 180mm H3 220mm chrome-plated steel L3 160mm |  |  |
|--------------------|--|--|--|



1

|                |        |                 |                          |
|----------------|--------|-----------------|--------------------------|
| <b>GEV No.</b> | 970243 | <b>Ref. No.</b> | CF518120017<br>CFR232910 |
|----------------|--------|-----------------|--------------------------|

|                    |  |  |  |
|--------------------|--|--|--|
| <b>description</b> | fryer basket L1 290mm W1 230mm H1 105mm L2 470mm H2 175mm H3 220mm chrome-plated steel |  |  |
|--------------------|--|--|--|

Зип Общепит

vsezip.ru

+7(812)987-08-81



1

|                |        |                 |        |
|----------------|--------|-----------------|--------|
| <b>GEV No.</b> | 970242 | <b>Ref. No.</b> | 299938 |
|----------------|--------|-----------------|--------|

|                    |   |  |  |
|--------------------|---|--|--|
| <b>description</b> | fryer basket L1 290mm W1 230mm H1 120mm |  |  |
|--------------------|---|--|--|



1

|                |        |                 |                     |
|----------------|--------|-----------------|---------------------|
| <b>GEV No.</b> | 970356 | <b>Ref. No.</b> | 299938<br>CFR242812 |
|----------------|--------|-----------------|---------------------|

|                    |   |  |  |
|--------------------|---|--|--|
| <b>description</b> | fryer basket L1 290mm W1 230mm H1 120mm chrome-plated steel |  |  |
|--------------------|---|--|--|



1

|                |        |                 |                     |
|----------------|--------|-----------------|---------------------|
| <b>GEV No.</b> | 970249 | <b>Ref. No.</b> | 299935<br>CFR303112 |
|----------------|--------|-----------------|---------------------|

|                    |   |  |  |
|--------------------|---|--|--|
| <b>description</b> | fryer basket L1 290mm W1 330mm H1 120mm |  |  |
|--------------------|---|--|--|



1

|                |        |                 |                  |
|----------------|--------|-----------------|------------------|
| <b>GEV No.</b> | 540714 | <b>Ref. No.</b> | 808735<br>8C1875 |
|----------------|--------|-----------------|------------------|

|                    |   |  |  |
|--------------------|---|--|--|
| <b>description</b> | handle for fryer basket complete L 140mm H 22.5mm W 40mm hole ø 5.5mm |  |  |
|--------------------|---|--|--|

## pasta baskets

## EMMEPI



1

|                |        |                 |       |
|----------------|--------|-----------------|-------|
| <b>GEV No.</b> | 970746 | <b>Ref. No.</b> | CP2-3 |
|----------------|--------|-----------------|-------|

|                    |   |  |  |
|--------------------|---|--|--|
| <b>description</b> | pasta basket H1 217mm W1 290mm L1 290mm |  |  |
|--------------------|---|--|--|



Зип Общепит

vsezip.ru

+7(812)987-08-81



1

|                    |  |                 |        |
|--------------------|--|-----------------|--------|
| <b>GEV No.</b>     | 970253   | <b>Ref. No.</b> | 205070 |
| <b>description</b> | pasta basket L1 335mm W1 300mm H1 225mm H3 337mm stainless steel |                 |        |



1

|                    |  |                 |        |
|--------------------|--|-----------------|--------|
| <b>GEV No.</b>     | 970252   | <b>Ref. No.</b> | 299977 |
| <b>description</b> | pasta basket L1 335mm W1 300mm H1 225mm H3 365mm stainless steel |                 |        |

## shelves and shelf rails

### grates

#### producer-specific



1

|                    |  |                 |        |
|--------------------|--|-----------------|--------|
| <b>GEV No.</b>     | 970491                                     | <b>Ref. No.</b> | 834385 |
| <b>description</b> | grate W 518mm D 408mm plastic-coated steel |                 |        |

### shelf rails and supports

#### producer-specific



1

|                    |   |                 |           |
|--------------------|---|-----------------|-----------|
| <b>GEV No.</b>     | 691841  | <b>Ref. No.</b> | A73310008 |
| <b>description</b> | guide U-shape L 430mm W 13mm mounting pos. left inner height 21mm |                 |           |



1

|                    |  |                 |           |
|--------------------|--|-----------------|-----------|
| <b>GEV No.</b>     | 691925   | <b>Ref. No.</b> | A73310007 |
| <b>description</b> | guide U-shape L 430mm W 13mm mounting pos. right inner height 21mm |                 |           |

## gaskets

### refrigeration gaskets

#### plug-in gaskets

#### profile 9048

We offer custom-made gaskets for this profile

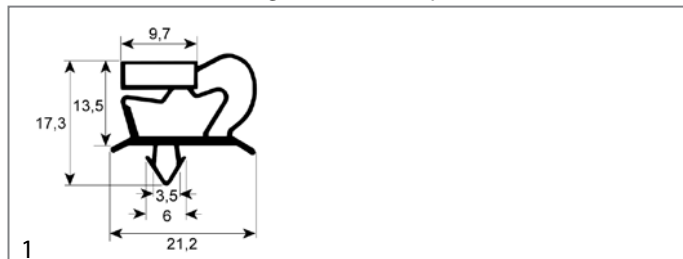

1

|                    |   |                 |        |
|--------------------|---|-----------------|--------|
| <b>GEV No.</b>     | 900359  | <b>Ref. No.</b> | 827880 |
| <b>description</b> | refrigeration gasket profile 9048 W 296mm L 405mm plug size drawer size 1/2 |                 |        |

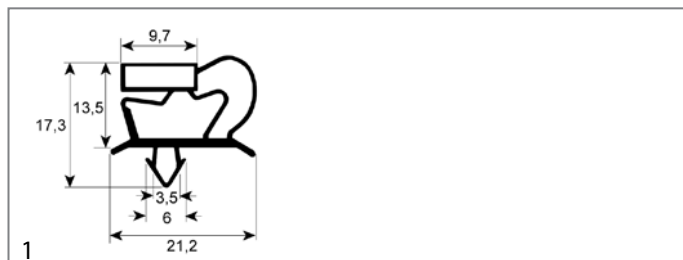

1

|                    |   |                 |        |
|--------------------|---|-----------------|--------|
| <b>GEV No.</b>     | 901250  | <b>Ref. No.</b> | 827705 |
| <b>description</b> | refrigeration gasket profile 9048 W 403mm L 400mm plug size |                 |        |

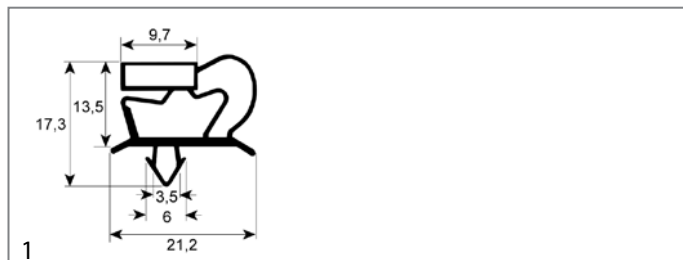

1

|                    |   |                 |        |
|--------------------|---|-----------------|--------|
| <b>GEV No.</b>     | 901238  | <b>Ref. No.</b> | 827881 |
| <b>description</b> | refrigeration gasket profile 9048 W 407mm L 184mm plug size |                 |        |

Зип Общепит

vsezip.ru

+7(812)987-08-81

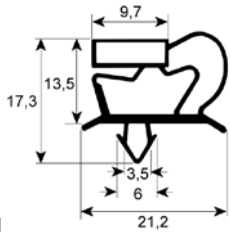

1

|                    |   |                 |        |
|--------------------|---|-----------------|--------|
| <b>GEV No.</b>     | 901240  | <b>Ref. No.</b> | 827879 |
| <b>description</b> | refrigeration gasket profile 9048 W 407mm L 620mm plug size |                 |        |

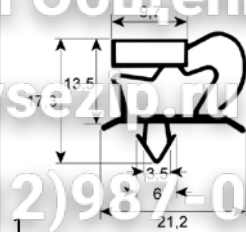

1

|                    |   |                 |        |
|--------------------|---|-----------------|--------|
| <b>GEV No.</b>     | 901258  | <b>Ref. No.</b> | 827785 |
| <b>description</b> | refrigeration gasket profile 9048 W 457mm L 500mm plug size |                 |        |

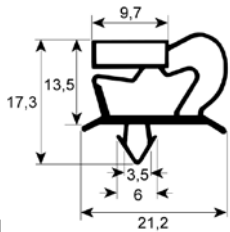

1

|                    |   |                 |        |
|--------------------|---|-----------------|--------|
| <b>GEV No.</b>     | 901222  | <b>Ref. No.</b> | 8C1879 |
| <b>description</b> | refrigeration gasket profile 9048 W 415mm L 709mm plug size for blast chiller |                 |        |

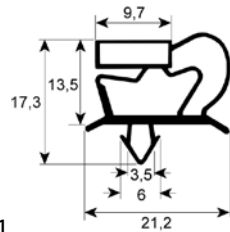

1

|                    |   |                 |        |
|--------------------|---|-----------------|--------|
| <b>GEV No.</b>     | 901256  | <b>Ref. No.</b> | 827786 |
| <b>description</b> | refrigeration gasket profile 9048 W 488mm L 233mm plug size |                 |        |

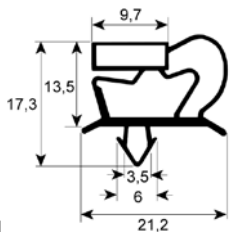

1

|                    |   |                 |        |
|--------------------|---|-----------------|--------|
| <b>GEV No.</b>     | 901262  | <b>Ref. No.</b> | 808421 |
| <b>description</b> | refrigeration gasket profile 9048 W 445mm L 288mm plug size |                 |        |

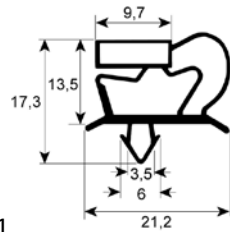

1

|                    |   |                 |        |
|--------------------|---|-----------------|--------|
| <b>GEV No.</b>     | 901257  | <b>Ref. No.</b> | 827787 |
| <b>description</b> | refrigeration gasket profile 9048 W 488mm L 500mm plug size |                 |        |

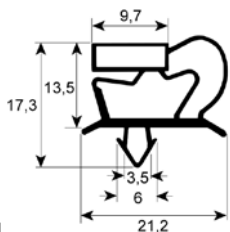

1

|                    |   |                 |        |
|--------------------|---|-----------------|--------|
| <b>GEV No.</b>     | 901261  | <b>Ref. No.</b> | 807584 |
| <b>description</b> | refrigeration gasket profile 9048 W 445mm L 620mm plug size |                 |        |

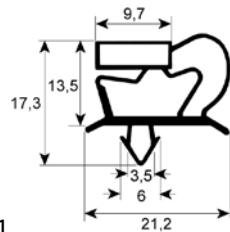

1

|                    |   |                 |        |
|--------------------|---|-----------------|--------|
| <b>GEV No.</b>     | 901251  | <b>Ref. No.</b> | 827875 |
| <b>description</b> | refrigeration gasket profile 9048 W 496mm L 184mm plug size |                 |        |

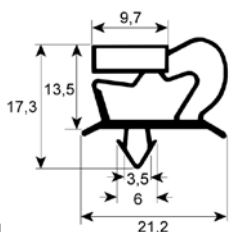

1

|                    |   |                 |        |
|--------------------|---|-----------------|--------|
| <b>GEV No.</b>     | 901255  | <b>Ref. No.</b> | 827784 |
| <b>description</b> | refrigeration gasket profile 9048 W 457mm L 233mm plug size |                 |        |

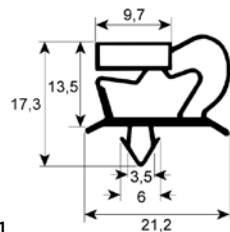

1

|                    |   |                 |        |
|--------------------|---|-----------------|--------|
| <b>GEV No.</b>     | 901252  | <b>Ref. No.</b> | 827874 |
| <b>description</b> | refrigeration gasket profile 9048 W 496mm L 293mm plug size |                 |        |



Зип Общепит

vsezip.ru

+7(812)987-08-81

|                    |   |                 |        |
|--------------------|---|-----------------|--------|
| <b>GEV No.</b>     | 901253  | <b>Ref. No.</b> | 827666 |
| <b>description</b> | refrigeration gasket profile 9048 W 496mm L 402mm plug size |                 |        |

|                    |  |                 |        |
|--------------------|--|-----------------|--------|
| <b>GEV No.</b>     | 900350   | <b>Ref. No.</b> | 807997 |
| <b>description</b> | refrigeration gasket profile 9048 W 670mm L 760mm plug size 1/2 door |                 |        |

|                    |   |                 |        |
|--------------------|---|-----------------|--------|
| <b>GEV No.</b>     | 901254  | <b>Ref. No.</b> | 827873 |
| <b>description</b> | refrigeration gasket profile 9048 W 496mm L 620mm plug size |                 |        |

|                    |   |                 |        |
|--------------------|---|-----------------|--------|
| <b>GEV No.</b>     | 900351  | <b>Ref. No.</b> | 807996 |
| <b>description</b> | refrigeration gasket profile 9048 W 672mm L 1587mm plug size door |                 |        |

|                    |   |                 |        |
|--------------------|---|-----------------|--------|
| <b>GEV No.</b>     | 901062  | <b>Ref. No.</b> | 827873 |
| <b>description</b> | refrigeration gasket profile 9048 W 510mm L 633mm plug size |                 |        |

|                    |  |                 |        |
|--------------------|--|-----------------|--------|
| <b>GEV No.</b>     | 901244   | <b>Ref. No.</b> | 807160 |
| <b>description</b> | refrigeration gasket profile 9048 W 690mm L 1510mm plug size |                 |        |

|                    |  |                 |        |
|--------------------|--|-----------------|--------|
| <b>GEV No.</b>     | 901127   | <b>Ref. No.</b> | 827632 |
| <b>description</b> | refrigeration gasket profile 9048 W 560mm L 1420mm plug size |                 |        |

|                    |   |                 |        |
|--------------------|---|-----------------|--------|
| <b>GEV No.</b>     | 901243  | <b>Ref. No.</b> | 814600 |
| <b>description</b> | refrigeration gasket profile 9048 W 690mm L 735mm plug size |                 |        |

|                    |  |                 |        |
|--------------------|--|-----------------|--------|
| <b>GEV No.</b>     | 900710   | <b>Ref. No.</b> | 8C1563 |
| <b>description</b> | refrigeration gasket profile 9048 W 655mm L 1500mm plug size |                 |        |

|                    |   |                 |        |
|--------------------|---|-----------------|--------|
| <b>GEV No.</b>     | 901220  | <b>Ref. No.</b> | 8C1888 |
| <b>description</b> | refrigeration gasket profile 9048 W 721mm L 929mm plug size for blast chiller |                 |        |

## profile 9046

We offer custom-made gaskets for this profile

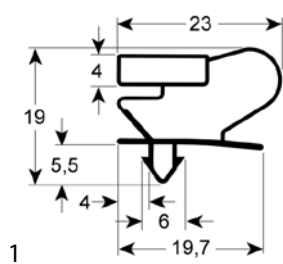

|                    |  |                 |     |
|--------------------|--|-----------------|-----|
| <b>GEV No.</b>     | 902257   | <b>Ref. No.</b> | N/A |
| <b>description</b> | refrigeration gasket profile 9046 Wmm L 2500mm |                 |     |

## profile 9773

We offer custom-made gaskets for this profile

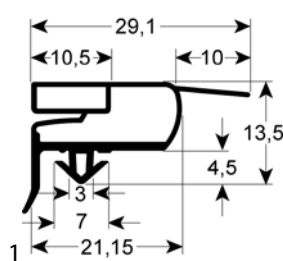

|                    |   |                 |        |
|--------------------|---|-----------------|--------|
| <b>GEV No.</b>     | 901089  | <b>Ref. No.</b> | 8C2123 |
| <b>description</b> | refrigeration gasket profile 9773 W 640mm L 1540mm external size W1 627mm L1 1527mm plug size |                 |        |

## profile 9703

We offer custom-made gaskets for this profile

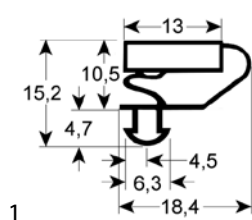

|                    |   |                 |        |
|--------------------|---|-----------------|--------|
| <b>GEV No.</b>     | 901189  | <b>Ref. No.</b> | 818998 |
| <b>description</b> | refrigeration gasket profile 9703 W 387mm L 603mm plug size |                 |        |

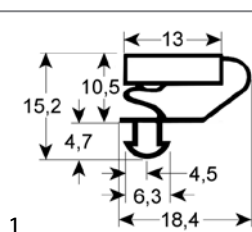

|                    |   |                 |        |
|--------------------|---|-----------------|--------|
| <b>GEV No.</b>     | 901190  | <b>Ref. No.</b> | 828532 |
| <b>description</b> | refrigeration gasket profile 9703 W 390mm L 310mm plug size |                 |        |

Зип Общепит

vsezip.ru

+7(812)987-08-81

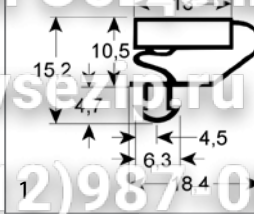

|                    |   |                 |        |
|--------------------|---|-----------------|--------|
| <b>GEV No.</b>     | 901191  | <b>Ref. No.</b> | 828533 |
| <b>description</b> | refrigeration gasket profile 9703 W 390mm L 663mm plug size |                 |        |

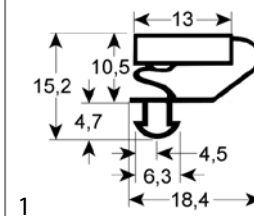

|                    |   |                 |        |
|--------------------|---|-----------------|--------|
| <b>GEV No.</b>     | 901266  | <b>Ref. No.</b> | 819854 |
| <b>description</b> | refrigeration gasket profile 9703 W 452mm L 259mm plug size |                 |        |

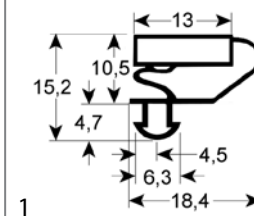

|                    |   |                 |        |
|--------------------|---|-----------------|--------|
| <b>GEV No.</b>     | 901271  | <b>Ref. No.</b> | 819853 |
| <b>description</b> | refrigeration gasket profile 9703 W 452mm L 603mm plug size |                 |        |

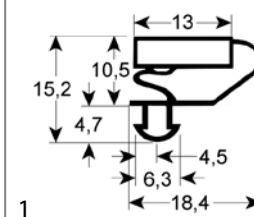

|                    |   |                 |        |
|--------------------|---|-----------------|--------|
| <b>GEV No.</b>     | 901192  | <b>Ref. No.</b> | 828138 |
| <b>description</b> | refrigeration gasket profile 9703 W 460mm L 505mm plug size |                 |        |

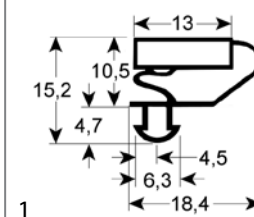

|                    |   |                 |        |
|--------------------|---|-----------------|--------|
| <b>GEV No.</b>     | 901265  | <b>Ref. No.</b> | 828289 |
| <b>description</b> | refrigeration gasket profile 9703 W 462mm L 194mm plug size |                 |        |





Зип Общепит

vsezip.ru

+7(812)987-08-81

|                    |   |                 |        |
|--------------------|---|-----------------|--------|
| <b>GEV No.</b>     | 901270  | <b>Ref. No.</b> | 828288 |
| <b>description</b> | refrigeration gasket profile 9703 W 462mm L 309mm plug size |                 |        |

|                    |  |                 |     |
|--------------------|--|-----------------|-----|
| <b>GEV No.</b>     | 902265   | <b>Ref. No.</b> | N/A |
| <b>description</b> | refrigeration gasket profile 9151 Wmm L 2500mm |                 |     |

|                    |   |                 |        |
|--------------------|---|-----------------|--------|
| <b>GEV No.</b>     | 901269  | <b>Ref. No.</b> | 828431 |
| <b>description</b> | refrigeration gasket profile 9703 W 462mm L 418mm plug size |                 |        |

**profile 9010**

We offer custom-made gaskets for this profile

|                    |   |                 |        |
|--------------------|---|-----------------|--------|
| <b>GEV No.</b>     | 901249  | <b>Ref. No.</b> | 807832 |
| <b>description</b> | gasket profile 9010 W 650mm L 745mm plug size |                 |        |

|                    |   |                 |        |
|--------------------|---|-----------------|--------|
| <b>GEV No.</b>     | 901268  | <b>Ref. No.</b> | 828392 |
| <b>description</b> | refrigeration gasket profile 9703 W 462mm L 659mm plug size |                 |        |

|                    |  |                 |        |
|--------------------|--|-----------------|--------|
| <b>GEV No.</b>     | 900598   | <b>Ref. No.</b> | 807830 |
| <b>description</b> | refrigeration gasket profile 9010 W 655mm L 1550mm plug size |                 |        |

**profile 9151**

We offer custom-made gaskets for this profile

|                    |  |                 |           |
|--------------------|--|-----------------|-----------|
| <b>GEV No.</b>     | 901168   | <b>Ref. No.</b> | 715210005 |
| <b>description</b> | refrigeration gasket profile 9151 W 737mm L 1699mm plug size |                 |           |

|                    |  |                 |     |
|--------------------|--|-----------------|-----|
| <b>GEV No.</b>     | 902251   | <b>Ref. No.</b> | N/A |
| <b>description</b> | refrigeration gasket profile 9010 Wmm L 2500mm |                 |     |

|                    |   |                 |           |
|--------------------|---|-----------------|-----------|
| <b>GEV No.</b>     | 901092  | <b>Ref. No.</b> | 714410002 |
| <b>description</b> | refrigeration gasket profile 9151 W 755mm L 1705mm plug size L1 1695mm W1 745mm external size |                 |           |

**profile 9012**

We offer custom-made gaskets for this profile

|                    |   |                 |        |
|--------------------|---|-----------------|--------|
| <b>GEV No.</b>     | 900353  | <b>Ref. No.</b> | 818997 |
| <b>description</b> | refrigeration gasket profile 9012 W 242mm L 367mm plug size drawer size 1/2 |                 |        |

Зип Общежит

vsezip.ru

+7(812)987-08-81

|                    |   |                 |        |
|--------------------|---|-----------------|--------|
| <b>GEV No.</b>     | 901186  | <b>Ref. No.</b> | 808451 |
| <b>description</b> | refrigeration gasket profile 9012 W 375mm L 243mm plug size |                 |        |

|                    |   |                 |        |
|--------------------|---|-----------------|--------|
| <b>GEV No.</b>     | 901196  | <b>Ref. No.</b> | 806370 |
| <b>description</b> | refrigeration gasket profile 9140 W 390mm L 640mm external size |                 |        |

|                    |   |                 |        |
|--------------------|---|-----------------|--------|
| <b>GEV No.</b>     | 901263  | <b>Ref. No.</b> | 808450 |
| <b>description</b> | refrigeration gasket profile 9012 W 435mm L 243mm plug size |                 |        |

|                    |   |                 |        |
|--------------------|---|-----------------|--------|
| <b>GEV No.</b>     | 901267  | <b>Ref. No.</b> | 808428 |
| <b>description</b> | refrigeration gasket profile 9140 W 465mm L 315mm external size |                 |        |

|                    |  |                 |     |
|--------------------|--|-----------------|-----|
| <b>GEV No.</b>     | 902252   | <b>Ref. No.</b> | N/A |
| <b>description</b> | refrigeration gasket profile 9012 Wmm L 2500mm |                 |     |

|                    |  |                 |        |
|--------------------|--|-----------------|--------|
| <b>GEV No.</b>     | 901198   | <b>Ref. No.</b> | 806335 |
| <b>description</b> | refrigeration gasket profile 9140 W 670mm L 1575mm external size |                 |        |

screw-in gaskets  
profile 9140

We offer custom-made gaskets for this profile

|                    |   |                 |        |
|--------------------|---|-----------------|--------|
| <b>GEV No.</b>     | 901194  | <b>Ref. No.</b> | 818396 |
| <b>description</b> | refrigeration gasket profile 9140 W 370mm L 620mm external size |                 |        |

|                    |   |                 |        |
|--------------------|---|-----------------|--------|
| <b>GEV No.</b>     | 901197  | <b>Ref. No.</b> | 813377 |
| <b>description</b> | refrigeration gasket profile 9140 W 670mm L 770mm external size |                 |        |

|                    |   |                 |        |
|--------------------|---|-----------------|--------|
| <b>GEV No.</b>     | 901195  | <b>Ref. No.</b> | 813417 |
| <b>description</b> | refrigeration gasket profile 9140 W 390mm L 310mm external size |                 |        |

gaskets for heated units

window seals

|                    |   |                 |        |
|--------------------|---|-----------------|--------|
| <b>GEV No.</b>     | 900472                                    | <b>Ref. No.</b> | 807587 |
| <b>description</b> | window gasket profile 1650 L 1700mm Qty 1 |                 |        |

Зип Общепит

vsezip.ru

+7(812)987-08-81

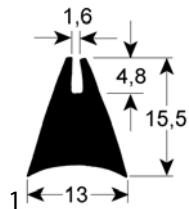

|                    |  |                 |        |
|--------------------|--|-----------------|--------|
| <b>GEV No.</b>     | 900881   | <b>Ref. No.</b> | 809024 |
| <b>description</b> | window gasket profile 1650 Qty supplied by meter |                 |        |

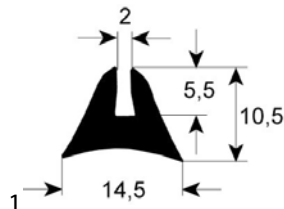

|                    |  |                 |        |
|--------------------|--|-----------------|--------|
| <b>GEV No.</b>     | 900601   | <b>Ref. No.</b> | 809882 |
| <b>description</b> | window gasket profile 1660 Qty supplied by meter |                 |        |

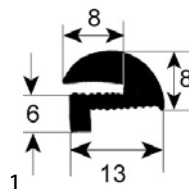

|                    |  |                 |         |
|--------------------|--|-----------------|---------|
| <b>GEV No.</b>     | 900782   | <b>Ref. No.</b> | 9629920 |
| <b>description</b> | window gasket profile 1889 Qty supplied by meter |                 |         |

door seals

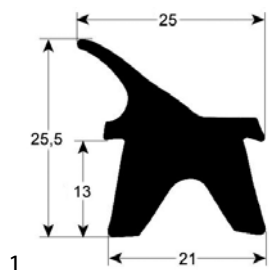

|                    |  |                 |        |
|--------------------|--|-----------------|--------|
| <b>GEV No.</b>     | 900348                                       | <b>Ref. No.</b> | 8C1193 |
| <b>description</b> | door seal profile 2402 Qty supplied by meter |                 |        |

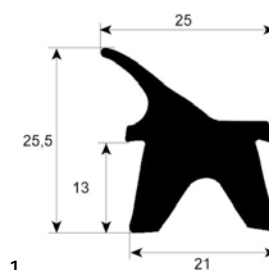

|                    |  |                 |        |
|--------------------|--|-----------------|--------|
| <b>GEV No.</b>     | 901351   | <b>Ref. No.</b> | 809796 |
| <b>description</b> | door seal profile 2402 W 490mm L 635mm external size |                 |        |

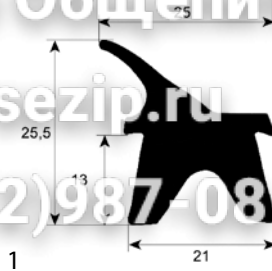

|                    |  |                 |        |
|--------------------|--|-----------------|--------|
| <b>GEV No.</b>     | 901158                                 | <b>Ref. No.</b> | 8C0029 |
| <b>description</b> | door seal profile 2402 W 640mm L 740mm |                 |        |

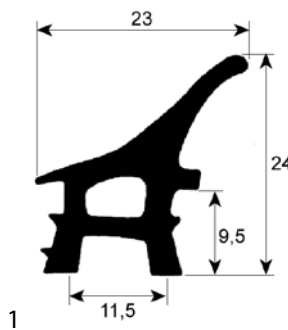

|                    |  |                 |         |
|--------------------|--|-----------------|---------|
| <b>GEV No.</b>     | 900781                                       | <b>Ref. No.</b> | 9629918 |
| <b>description</b> | door seal profile 2403 Qty supplied by meter |                 |         |

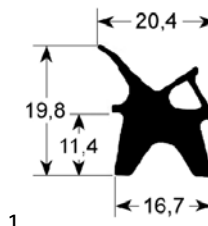

|                    |  |                 |                            |
|--------------------|--|-----------------|----------------------------|
| <b>GEV No.</b>     | 900059                                       | <b>Ref. No.</b> | 807582<br>807583<br>808226 |
| <b>description</b> | door seal profile 2410 Qty supplied by meter |                 |                            |

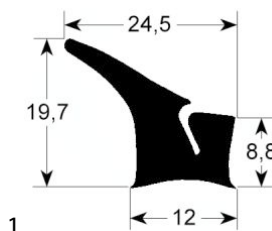

|                    |  |                 |        |
|--------------------|--|-----------------|--------|
| <b>GEV No.</b>     | 900602                                       | <b>Ref. No.</b> | 809881 |
| <b>description</b> | door seal profile 2430 Qty supplied by meter |                 |        |

Зип Общепит

vsezip.ru

+7(812)987-08-81

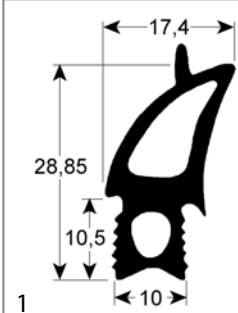

|                    |  |                 |        |
|--------------------|--|-----------------|--------|
| <b>GEV No.</b>     | 902219   | <b>Ref. No.</b> | 902219 |
| <b>description</b> | door seal profile 2730 W 465mm L 520mm external size Qty 1 |                 |        |

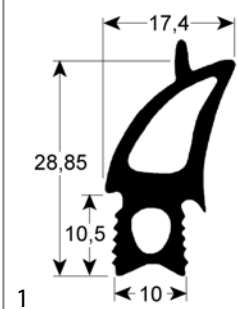

|                    |  |                 |        |
|--------------------|--|-----------------|--------|
| <b>GEV No.</b>     | 902247   | <b>Ref. No.</b> | 809562 |
| <b>description</b> | door seal profile 2730 W 470mm L 785mm suitable for RATIONAL for model CPC 101 outer plug size Qty 1 |                 |        |

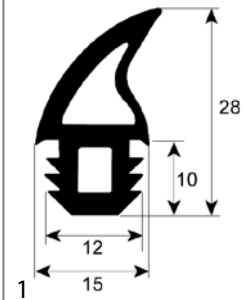

|                    |  |                 |        |
|--------------------|--|-----------------|--------|
| <b>GEV No.</b>     | 901331                                       | <b>Ref. No.</b> | 8C0917 |
| <b>description</b> | door seal profile 2756 Qty supplied by meter |                 |        |

door seals with fixing hook



|                    |   |                 |        |
|--------------------|---|-----------------|--------|
| <b>GEV No.</b>     | 900224  | <b>Ref. No.</b> | C10088 |
| <b>description</b> | door seal W 480mm long side open with mounting clip H 400mm |                 |        |



|                    |  |                 |        |
|--------------------|--|-----------------|--------|
| <b>GEV No.</b>     | 900225                                   | <b>Ref. No.</b> | C00165 |
| <b>description</b> | door seal W 510mm long side open H 300mm |                 |        |



|                    |   |                 |        |
|--------------------|---|-----------------|--------|
| <b>GEV No.</b>     | 900227  | <b>Ref. No.</b> | C10090 |
| <b>description</b> | door seal W 560mm long side open with mounting clip H 360mm |                 |        |



|                    |   |                 |        |
|--------------------|---|-----------------|--------|
| <b>GEV No.</b>     | 900228  | <b>Ref. No.</b> | C10091 |
| <b>description</b> | door seal W 840mm long side open with mounting clip H 370mm |                 |        |



|                    |   |                 |           |
|--------------------|---|-----------------|-----------|
| <b>GEV No.</b>     | 900394  | <b>Ref. No.</b> | 132110003 |
| <b>description</b> | oven gasket L 370mm W 640mm 6 hooks external size |                 |           |

gaskets for tray rack trolleys

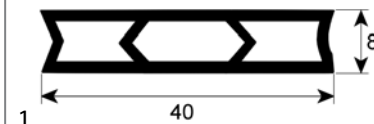

|                    |  |                 |           |
|--------------------|--|-----------------|-----------|
| <b>GEV No.</b>     | 901330   | <b>Ref. No.</b> | 141110016 |
| <b>description</b> | tray rack trolley gasket profile 4065 silicone Qty supplied by meter |                 |           |

O-rings

EPDM

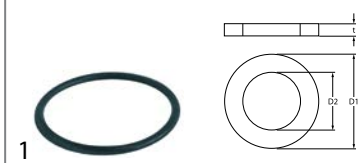

|                    |  |                 |                  |
|--------------------|--|-----------------|------------------|
| <b>GEV No.</b>     | 532118   | <b>Ref. No.</b> | 808043<br>808055 |
| <b>description</b> | O-ring EPDM thickness 3.53mm ID ø 55.56mm Qty 10 pcs |                 |                  |

Viton

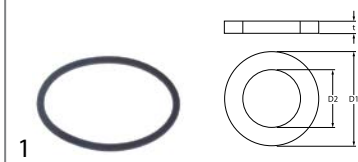

|                    |  |                 |        |
|--------------------|--|-----------------|--------|
| <b>GEV No.</b>     | 525313   | <b>Ref. No.</b> | 808709 |
| <b>description</b> | O-ring Viton ID ø 60.33mm thickness 3.53mm Qty 1 pcs |                 |        |



Зип.Общепит  
transmission technology and ball bearings  
vsezip.ru  
drive bits

+7(812)987-08-81

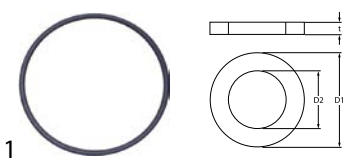

|                    |  |                 |        |
|--------------------|--|-----------------|--------|
| <b>GEV No.</b>     | 532649   | <b>Ref. No.</b> | 808710 |
| <b>description</b> | O-ring Viton ID $\varnothing$ 63.17mm thickness 2.62mm Qty 1 pcs |                 |        |



|                    |   |                 |        |
|--------------------|---|-----------------|--------|
| <b>GEV No.</b>     | 510245  | <b>Ref. No.</b> | 808054 |
| <b>description</b> | O-ring Viton thickness 3.53mm ID $\varnothing$ 50.8mm Qty 1 pcs |                 |        |



|                    |  |                 |        |
|--------------------|--|-----------------|--------|
| <b>GEV No.</b>     | 510243   | <b>Ref. No.</b> | 808055 |
| <b>description</b> | O-ring Viton thickness 3.53mm ID $\varnothing$ 55.56mm Qty 1 pcs |                 |        |

sealing washers

fibre gaskets



|                    |   |                 |        |
|--------------------|---|-----------------|--------|
| <b>GEV No.</b>     | 510405  | <b>Ref. No.</b> | 903300 |
| <b>description</b> | flat gasket fibre ED 56mm ID $\varnothing$ 42mm thickness 2mm for thread 1/4" Qty 1 pcs |                 |        |

shaft gaskets

shaft gaskets



|                    |  |                 |        |
|--------------------|--|-----------------|--------|
| <b>GEV No.</b>     | 511171   | <b>Ref. No.</b> | 809829 |
| <b>description</b> | shaft seal ID $\varnothing$ 14.5mm ED $\varnothing$ 20mm thickness 3mm |                 |        |

poly-v belts

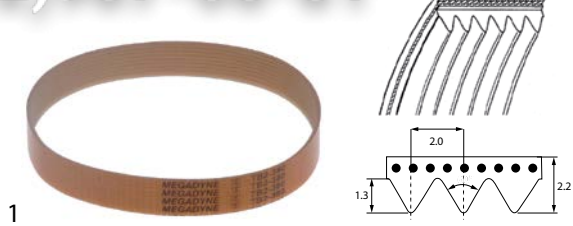

|                    |  |                 |        |
|--------------------|--|-----------------|--------|
| <b>GEV No.</b>     | 693939   | <b>Ref. No.</b> | 8C0949 |
| <b>description</b> | poly-v belt grooves 6 W 12mm L 630mm profile TB2 |                 |        |

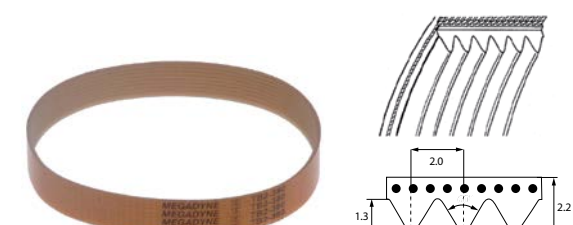

|                    |  |                 |        |
|--------------------|--|-----------------|--------|
| <b>GEV No.</b>     | 697367   | <b>Ref. No.</b> | 808759 |
| <b>description</b> | poly-v belt grooves 8 W 16mm L 330mm profile TB2 |                 |        |

springs

torsion springs





|                        |  |                 |        |
|------------------------|--|-----------------|--------|
| <b>GEV No.</b>         | 690081   | <b>Ref. No.</b> | 808873 |
| <b>description</b>     | torsion spring $\varnothing$ 19.4mm L2 36mm wire gauge $\varnothing$ 3.3mm mounting pos. left L1 42mm L3 36mm Qty 1 pcs  |                 |        |
| <b>accessories for</b> | 690081   |                 |        |
| <b>GEV No.</b>         | 690080   | <b>Ref. No.</b> | 808874 |
| <b>description</b>     | torsion spring $\varnothing$ 19.4mm L2 37mm wire gauge $\varnothing$ 3.4mm mounting pos. right L1 42mm L3 37mm Qty 1 pcs |                 |        |

Зип-Общепит



vsezip.ru

+7(812)987-08-81

|   |  |                 |                        |
|---|--|-----------------|------------------------|
|  |  |                 |                        |
| 1   |  |                 |                        |
| <b>GEV No.</b>  | 690080   | <b>Ref. No.</b> | 808874                 |
| <b>description</b>  | torsion spring ø 19.4mm L2 37mm wire gauge ø 3.4mm mounting pos. right L1 42mm L3 37mm Qty 1 pcs |                 |                        |
| <b>accessories for</b>  | 690080   |                 |                        |
|  | <b>GEV No.</b>   | 690081          | <b>Ref. No.</b> 808873 |
| <b>description</b>  | torsion spring ø 19.4mm L2 36mm wire gauge ø 3.3mm mounting pos. left L1 42mm L3 36mm Qty 1 pcs  |                 |                        |

|   |   |                 |        |
|---|---|-----------------|--------|
|  |   |                 |        |
| 1   |   |                 |        |
| <b>GEV No.</b>  | 700171  | <b>Ref. No.</b> | 8C0361 |
| <b>description</b>  | torsion spring ø 21.4mm L2 40mm wire gauge ø 3.3mm L1 100mm L3 34mm |                 |        |

### manometers

|   |   |                 |                   |
|---|---|-----------------|-------------------|
|   |   |                 |                   |
| 1   |   |                 |                   |
| <b>GEV No.</b>  | 541062  | <b>Ref. No.</b> | 808347            |
| <b>description</b>  | manometer ø 63mm pressure range 0 up to 1bar connection marking adjustable kettle thread 1/4" |                 |                   |
| <b>spare parts for</b>  | 541062  |                 |                   |
|  | <b>GEV No.</b>  | 541130          | <b>Ref. No.</b> — |
| <b>description</b>  | glass panel ø 58mm thickness 2mm  |                 |                   |

### hose reels and spray guns







#### cleaning guns

|   |  |                 |                   |
|---|--|-----------------|-------------------|
|  |  |                 |                   |
| 1   |  |                 |                   |
| <b>GEV No.</b>  | 541473   | <b>Ref. No.</b> | 8C2178            |
| <b>description</b>  | cleaning spray gun connection with snap-on connection DN13 brass |                 |                   |
| <b>spare parts for</b>  | 541473   |                 |                   |
|  | <b>GEV No.</b>   | 540516          | <b>Ref. No.</b> — |
| <b>description</b>  | coupling bush type DN13 chrome-plated brass connection 1/2" IT   |                 |                   |

|                        |   |                 |   |
|------------------------|---|-----------------|---|
| <b>spare parts for</b> | 541473  |                 |   |
| <b>GEV No.</b>         | 540535  | <b>Ref. No.</b> | — |
| <b>description</b>     | nozzle connection snap-on connection short SS                       |                 |   |
| <b>accessories for</b> | 541473  |                 |   |
| <b>GEV No.</b>         | 540536  | <b>Ref. No.</b> | — |
| <b>description</b>     | foam lance connection snap-on connection plastic total length 182mm |                 |   |
| <b>GEV No.</b>         | 541870  | <b>Ref. No.</b> | — |
| <b>description</b>     | foam lance connection snap-on connection aluminium L 450mm          |                 |   |

### dosing pumps

#### peristaltic dosing pumps

|   |   |                 |                   |
|---|---|-----------------|-------------------|
| <b>SEKO</b>   |   |                 |                   |
| built-in version  |   |                 |                   |
| with frequency control  |   |                 |                   |
|  |   |                 |                   |
| 1   |   |                 |                   |
| <b>GEV No.</b>  | 361215  | <b>Ref. No.</b> | 8C0900            |
| <b>description</b>  | dosing pump SEKO frequency control 0.3-3.0l/h 230VAC detergent hose ø 4x6mm hose type K hose Santoprene suction level 1.5m type PBR protection IP55 dimensions 100x67x68mm power input 3.5W |                 |                   |
| <b>spare parts for</b>  | 361215  |                 |                   |
|  | <b>GEV No.</b>  | 361136          | <b>Ref. No.</b> — |
| <b>description</b>  | roller assembly for dosing pump hole ø 4.8x4mm  |                 |                   |
|  | <b>GEV No.</b>  | 361226          | <b>Ref. No.</b> — |
| <b>description</b>  | PCB L 59mm W 26mm electronic control  |                 |                   |
|  | <b>GEV No.</b>  | 361815          | <b>Ref. No.</b> — |
| <b>description</b>  | pump hose detergent hose ø 6x10mm hose ø 4x6mm hose type K hose Santoprene type SEKO  |                 |                   |
| <b>accessories for</b>  | 361215  |                 |                   |
|  | <b>GEV No.</b>  | 361142          | <b>Ref. No.</b> — |
| <b>description</b>  | mounting set detergent hose type 4x6mm hose length 2m PVC 2x hose/container filter/tank intake transparent  |                 |                   |
|  | <b>GEV No.</b>  | 520090          | <b>Ref. No.</b> — |
| <b>description</b>  | PVC hose ID ø 4mm ED ø 6mm L 2m thickness 1mm t.max. 60°C transparent   |                 |                   |
|  | <b>GEV No.</b>  | 520091          | <b>Ref. No.</b> — |
| <b>description</b>  | nylon hose ID ø 4mm ED ø 6mm L 2m thickness 1mm operating p. 10bar burst p. 50bar t.max. 100°C transparent  |                 |                   |

## accessories

## non-return valves



1

|                    |   |                 |                  |
|--------------------|---|-----------------|------------------|
| <b>GEV No.</b>     | 361821  | <b>Ref. No.</b> | 809742<br>8C0192 |
| <b>description</b> | non-return valve inlet 4x6mm outlet 1/4" L 45mm |                 |                  |

## hoses

## drain hoses



1

|                    |  |                 |        |
|--------------------|--|-----------------|--------|
| <b>GEV No.</b>     | 513718   | <b>Ref. No.</b> | 8C0154 |
| <b>description</b> | drain hose DN19 L 1500mm straight ø inside 24mm straight ext. ø 28mm outer hose ø 23mm |                 |        |

## for dishwashers

## miscellaneous



1

|                    |                        |                 |        |
|--------------------|------------------------|-----------------|--------|
| <b>GEV No.</b>     | 511467                 | <b>Ref. No.</b> | 907295 |
| <b>description</b> | pressure hose L 1000mm |                 |        |

## valves and tank inlets

## ball valves

## universal

## ball valves with lever handle



1

|                    |  |                 |        |
|--------------------|--|-----------------|--------|
| <b>GEV No.</b>     | 514325   | <b>Ref. No.</b> | C00913 |
| <b>description</b> | ball valve connection 1" IT - 1" IT DN25 total length 83mm with lever handle |                 |        |

Зип Общепит

vsezip.ru

+7(812)987-08-81



1

|                    |   |                 |        |
|--------------------|---|-----------------|--------|
| <b>GEV No.</b>     | 520280  | <b>Ref. No.</b> | 827969 |
| <b>description</b> | ball valve connection 1/2" IT - 1/2" IT DN15 total length 50mm with lever handle handle length 85mm |                 |        |



1

|                    |   |                 |        |
|--------------------|---|-----------------|--------|
| <b>GEV No.</b>     | 540730  | <b>Ref. No.</b> | 808433 |
| <b>description</b> | ball valve connection 3/4" IT - 3/4" IT DN20 total length 70mm with lever handle handle length 95mm |                 |        |

## inlet taps



1

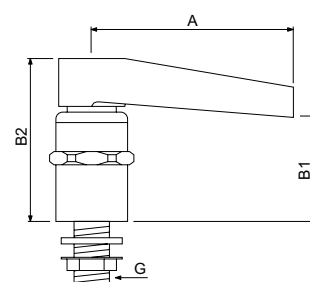

|                    |   |                 |        |
|--------------------|---|-----------------|--------|
| <b>GEV No.</b>     | 540705  | <b>Ref. No.</b> | 809314 |
| <b>description</b> | inlet tap connection 1/2" ET tube ø 40mm projection 120mm overall height 95mm spout height 60mm rotation 360° |                 |        |



1





|                    |             |                 |        |
|--------------------|-------------|-----------------|--------|
| <b>GEV No.</b>     | 540704      | <b>Ref. No.</b> | 808420 |
| <b>description</b> | inlet spout |                 |        |

drain systems and wash basins ancillary products

drain fittings

universal







|   |   |                 |                   |
|---|---|-----------------|-------------------|
| <b>GEV No.</b>  | 515041  | <b>Ref. No.</b> | 825827            |
| <b>description</b>  | drain fitting size 3/4" usable heightmm overall height 30mm ED ø 38mm chrome-plated brass             |                 |                   |
| <b>accessories for</b>  | 515041  |                 |                   |
|  | <b>GEV No.</b>  | 515047          | <b>Ref. No.</b> — |
|   | standpipe size 3/4" usable height 28mm overall height 54mm ED ø 20mm chrome-plated brass with O-ring  |                 |                   |
|  | <b>GEV No.</b>  | 515048          | <b>Ref. No.</b> — |
|   | standpipe size 3/4" usable height 48mm overall height 74mm ED ø 20mm chrome-plated brass with O-ring  |                 |                   |
|  | <b>GEV No.</b>  | 515049          | <b>Ref. No.</b> — |
|   | standpipe size 3/4" usable height 68mm overall height 94mm ED ø 20mm chrome-plated brass with O-ring  |                 |                   |
|  | <b>GEV No.</b>  | 515050          | <b>Ref. No.</b> — |
|   | standpipe size 3/4" usable height 98mm overall height 124mm ED ø 20mm chrome-plated brass with O-ring |                 |                   |

standpipes

3/4"



|   |   |                 |                   |
|---|---|-----------------|-------------------|
| <b>GEV No.</b>  | 515041  | <b>Ref. No.</b> | 825827            |
| <b>description</b>  | drain fitting size 3/4" usable heightmm overall height 30mm ED ø 38mm chrome-plated brass             |                 |                   |
| <b>accessories for</b>  | 515041  |                 |                   |
|  | <b>GEV No.</b>  | 515047          | <b>Ref. No.</b> — |
|   | standpipe size 3/4" usable height 28mm overall height 54mm ED ø 20mm chrome-plated brass with O-ring  |                 |                   |
|  | <b>GEV No.</b>  | 515048          | <b>Ref. No.</b> — |
|   | standpipe size 3/4" usable height 48mm overall height 74mm ED ø 20mm chrome-plated brass with O-ring  |                 |                   |
|  | <b>GEV No.</b>  | 515049          | <b>Ref. No.</b> — |
|   | standpipe size 3/4" usable height 68mm overall height 94mm ED ø 20mm chrome-plated brass with O-ring  |                 |                   |
|  | <b>GEV No.</b>  | 515050          | <b>Ref. No.</b> — |
|   | standpipe size 3/4" usable height 98mm overall height 124mm ED ø 20mm chrome-plated brass with O-ring |                 |                   |

clamps

hose clamps

DIN 3017 - W2



|                    |  |                 |        |
|--------------------|--|-----------------|--------|
| <b>GEV No.</b>     | 520112   | <b>Ref. No.</b> | 902440 |
| <b>description</b> | hose clamp ø 12-20mm width 9mm Qty 10 pcs DIN 3017 |                 |        |



|                    |   |                 |        |
|--------------------|---|-----------------|--------|
| <b>GEV No.</b>     | 520119  | <b>Ref. No.</b> | 902490 |
| <b>description</b> | hose clamp ø 60-80mm width 9mm Qty 5 pcs DIN 3017 |                 |        |



|                    |   |                 |           |
|--------------------|---|-----------------|-----------|
| <b>GEV No.</b>     | 520454  | <b>Ref. No.</b> | E23110007 |
| <b>description</b> | hose clamp ø 70-90mm width 9mm Qty 5 pcs DIN 3017 |                 |           |

tools

hand tools

wrenches

miscellaneous



|                    |                             |                 |        |
|--------------------|-----------------------------|-----------------|--------|
| <b>GEV No.</b>     | 550449                      | <b>Ref. No.</b> | 808893 |
| <b>description</b> | special wrench for ring nut |                 |        |





## socket wrenches

## tubular box wrenches



1

|                    |  |                 |        |
|--------------------|--|-----------------|--------|
| <b>GEV No.</b>     | 550448   | <b>Ref. No.</b> | 808894 |
| <b>description</b> | tubular box wrench special for fryer L 280mm WS 10 |                 |        |

## measuring equipment

## thermometers

## built-in thermometers

ø52mm



1

|                    |  |                 |        |
|--------------------|--|-----------------|--------|
| <b>GEV No.</b>     | 541077   | <b>Ref. No.</b> | 808667 |
| <b>description</b> | thermometer mounting ø 52mm t.max. 350°C +50 up to +350°C probe ø 6mm probe L 30mm capillary pipe 1000mm built-in depth 28mm |                 |        |

ø60mm



1

|                    |   |                 |        |
|--------------------|---|-----------------|--------|
| <b>GEV No.</b>     | 541863  | <b>Ref. No.</b> | 809747 |
| <b>description</b> | thermometer mounting ø 60mm 50-350°C probe ø 6mm probe L 19mm capillary pipe 1600mm |                 |        |

## fastening material

## screws

## grub screws

DIN 916/ISO 4029

+7(812)987-08-81



1

|                    |   |                 |        |
|--------------------|---|-----------------|--------|
| <b>GEV No.</b>     | 560366  | <b>Ref. No.</b> | C00513 |
| <b>description</b> | grub screw thread M6 L 20mm SS intake internal hexagon WS 3 Qty 1 pcs |                 |        |

## nuts

## cap nuts



1

|                    |   |                 |        |
|--------------------|---|-----------------|--------|
| <b>GEV No.</b>     | 560137  | <b>Ref. No.</b> | 808998 |
| <b>description</b> | cap nuts thread M6 WS 10 SS Qty 20 pcs DIN/ISO DIN 1587 |                 |        |

## washers

## washers

DIN 125A



1

|                    |   |                 |        |
|--------------------|---|-----------------|--------|
| <b>GEV No.</b>     | 560312  | <b>Ref. No.</b> | 8C0631 |
| <b>description</b> | plain washer ID ø 10.5mm ED ø 20mm thickness 2mm SS Qty 1 pcs DIN 125A for thread M10 |                 |        |

## miscellaneous



1

|                    |  |                 |           |
|--------------------|--|-----------------|-----------|
| <b>GEV No.</b>     | 524117   | <b>Ref. No.</b> | E25110025 |
| <b>description</b> | plain washer ID ø 6.4mm ED ø 12mm thickness 1.6mm SS Qty 1 pcs |                 |           |



1

|                    |  |                 |        |
|--------------------|--|-----------------|--------|
| <b>GEV No.</b>     | 506160   | <b>Ref. No.</b> | 8C0647 |
| <b>description</b> | plain washer ID ø 8.6mm ED ø 16mm thickness 1.5mm SS Qty 1 pcs |                 |        |

Зип-Общепит

roll pins

vsezip.ru

+7(812)987-08-81

## fasteners

## clamps

## hose clamps

DIN 3017 - W2



1

|                |        |                 |        |
|----------------|--------|-----------------|--------|
| <b>GEV No.</b> | 520112 | <b>Ref. No.</b> | 902440 |
|----------------|--------|-----------------|--------|

|                    |  |  |  |
|--------------------|--|--|--|
| <b>description</b> | hose clamp ø 12-20mm width 9mm Qty 10 pcs DIN 3017 |  |  |
|--------------------|--|--|--|



1

|                |        |                 |        |
|----------------|--------|-----------------|--------|
| <b>GEV No.</b> | 520119 | <b>Ref. No.</b> | 902490 |
|----------------|--------|-----------------|--------|

|                    |   |  |  |
|--------------------|---|--|--|
| <b>description</b> | hose clamp ø 60-80mm width 9mm Qty 5 pcs DIN 3017 |  |  |
|--------------------|---|--|--|



1

|                |        |                 |           |
|----------------|--------|-----------------|-----------|
| <b>GEV No.</b> | 520454 | <b>Ref. No.</b> | E23110007 |
|----------------|--------|-----------------|-----------|

|                    |   |  |  |
|--------------------|---|--|--|
| <b>description</b> | hose clamp ø 70-90mm width 9mm Qty 5 pcs DIN 3017 |  |  |
|--------------------|---|--|--|

## consumables

## containers

## bags



1

|                |        |                 |                |
|----------------|--------|-----------------|----------------|
| <b>GEV No.</b> | 960027 | <b>Ref. No.</b> | 825873<br>TA-G |
|----------------|--------|-----------------|----------------|

|                    |                                   |  |  |
|--------------------|-----------------------------------|--|--|
| <b>description</b> | bag polypropylene L 475mm ø 130mm |  |  |
|--------------------|-----------------------------------|--|--|

Зип Общепит

fastening material

105

vsezip.ru

+7(812)987-08-81

|   |          |                                      |          |
|---|----------|--------------------------------------|----------|
| <b>A</b>  |          |                                      |          |
| alarm devices                                   | 31       |                                      |          |
| axial fans                                      | 43       | gas burners                          | 72       |
| <b>B</b>  |          | gas control valves                   | 57       |
| ball valves                                     | 103      | gas nozzles                          | 79       |
| bar burners                                     | 77       | gas taps                             | 50       |
| bi-metal thermostats                            | 11, 11   | gas thermostats                      | 53       |
| booster pumps I                                 | 48       | gaskets for heated units             | 98       |
| booster pumps II                                | 49       | gaskets for tray rack trolleys       | 100      |
| <b>C</b>  |          | grates                               | 93       |
| cable glands                                    | 50       | grub screws                          | 105      |
| cables  | 50       | <b>H</b>                             |          |
| cam switches                                    | 22       | hand tools                           | 104      |
| cap nuts  | 105      | handle latches                       | 87       |
| capillary tube clips                            | 18       | heater battery                       | 7        |
| clamps  | 104, 106 | heating cables                       | 6        |
| cleaning guns                                   | 102, 102 | heating elements                     | 3        |
| coil heating elements                           | 7        | heating elements for bain maries     | 3        |
| cold air circulating fans (complete)            | 44       | heating elements for chip scuttles   | 4        |
| compressors                                     | 42       | heating elements for convection      | 8        |
| condensators & interference suppression filters | 49       | heating elements for fryers          | 4        |
| consumables                                     | 106      | heating elements for griddles        | 5        |
| contactors                                      | 31       | heating elements for heated cabinets | 6        |
| containers                                      | 106      | heating elements for ovens           | 3        |
| control equipment                               | 24       | heating elements for pasta cookers   | 5        |
| control thermostats                             | 12       | heating elements for pizza ovens     | 6        |
| cross flow fans                                 | 44       | hob burners                          | 72       |
| <b>D</b>  |          | hose clamps                          | 104, 106 |
| door catches                                    | 87       | hoses                                | 103      |
| door seals                                      | 99       | hot air fans                         | 47       |
| door seals with fixing hook                     | 100      | hot air motors                       | 45       |
| dosing pumps                                    | 102      | hot plates                           | 10       |
| drain fittings                                  | 104      | <b>I</b>                             |          |
| drain hoses                                     | 103      | ignition boxes                       | 60       |
| drain pumps                                     | 48       | ignition cables                      | 69       |
| drain systems and wash basins                   | 104      | ignition switches                    | 70       |
| <b>E</b>  |          | ignition units                       | 70       |
| earthing cables                                 | 50       | immersion heating elements           | 7        |
| edgemount latches                               | 87       | indicator lights                     | 25       |
| electric accessories                            | 50       | indicator lights (complete)          | 26       |
| electric timers                                 | 30       | inlet spouts                         | 103      |
| electrodes                                      | 42       | inlet taps                           | 103      |
| electronic controllers                          | 34       | <b>L</b>                             |          |
| energy regulators                               | 11       | lamps                                | 25       |
| <b>F</b>  |          | light bulbs                          | 27       |
| fans  | 43       | <b>M</b>                             |          |
| fasteners                                       | 106      | magnetic switches                    | 23       |
|   |          | measuring equipment                  | 105      |

Зип Общепит

T

vsezip.ru

+7(812)987-08-81

|                                  |     |                        |     |
|----------------------------------|-----|------------------------|-----|
| mechanical timers                | 30  | temperature probes     | 36  |
| microswitches                    | 20  | terminals              | 50  |
| motors                           | 47  | thermocouples          | 70  |
| <b>N</b>                         |     | thermostats            | 11  |
| non-return valves                | 103 | threaded cable glands  | 50  |
| nuts                             | 105 | time relays            | 33  |
| <b>O</b>                         |     | timers                 | 30  |
| operating capacitors             | 49  | tools                  | 104 |
| O-rings                          | 100 | transformers           | 34  |
| oven hinges                      | 88  | tube burners           | 79  |
| oven lamps                       | 27  | tubular box wrenches   | 105 |
| <b>P</b>                         |     | <b>U</b>               |     |
| piezoelectric igniters           | 69  | universal probes       | 36  |
| pilot burners                    | 61  | <b>V</b>               |     |
| plug-in gaskets                  | 93  | valves and tank inlets | 103 |
| position switches                | 21  | <b>W</b>               |     |
| pressure switches                | 41  | wash and rinse pumps   | 48  |
| probes                           | 36  | washers                | 105 |
| programme timers                 | 30  | window seals           | 98  |
| pumps                            | 48  | wrenches               | 104 |
| pumps for ice machines           | 49  |                        |     |
| push/momentary push switches     | 19  |                        |     |
| <b>R</b>                         |     |                        |     |
| radiation heaters                | 10  |                        |     |
| refrigeration fans               | 44  |                        |     |
| refrigeration gaskets            | 93  |                        |     |
| refrigeration motors universal   | 44  |                        |     |
| refrigeration thermostats        | 18  |                        |     |
| relays                           | 32  |                        |     |
| residual heat indicators         | 29  |                        |     |
| rocker/momentary rocker switches | 19  |                        |     |
| roll pins                        | 106 |                        |     |
| <b>S</b>                         |     |                        |     |
| safety thermostats               | 15  |                        |     |
| screw-in gaskets                 | 98  |                        |     |
| screws                           | 105 |                        |     |
| sealing washers                  | 101 |                        |     |
| shaft gaskets                    | 101 |                        |     |
| shelves and shelf rails          | 93  |                        |     |
| snap locks                       | 88  |                        |     |
| socket wrenches                  | 105 |                        |     |
| solenoid valves                  | 39  |                        |     |
| solid state relays               | 32  |                        |     |
| standpipes                       | 104 |                        |     |
| switches and momentary switches  | 19  |                        |     |
| system switches (ROLD)           | 21  |                        |     |