



Зип Ощепит

vsezip.ru

Spare Parts for

+7(812)987-08781 **Combi Ovens**



Spare parts suitable for

**ALTOSHAAM**

2017

Find the complete and up-to-date range of products in our GEV Webshop



## heating elements

## heating cables

## miscellaneous



<b>GEV No.</b>	580139	<b>Ref. No.</b>	4878
<b>description</b>	heating cable kit		



<b>GEV No.</b>	420280	<b>Ref. No.</b>	4881 CB-3045
<b>description</b>	heating cable kit L 210Ft~64008mm for heated cabinet		



<b>GEV No.</b>	580006	<b>Ref. No.</b>	4880
<b>description</b>	heating cable L 134Ft~40843mm		

## heating cartridges



<b>GEV No.</b>	419035	<b>Ref. No.</b>	CB-3538
<b>description</b>	heating cartridge 230W 240V ø 12.5mm L 112mm thread 5/8"-18UNF cable length 150mm		

## Зип-Общепит

accessories

## washers

vsezip.ru

+7(812)987-08-81

<b>GEV No.</b>	560112	<b>Ref. No.</b>	WS-22295
<b>description</b>	plain washer ID ø 5.3mm ED ø 10mm thickness 1mm SS Qty 20 pcs DIN 125A for thread M5		



<b>GEV No.</b>	560113	<b>Ref. No.</b>	WS-22297
<b>description</b>	plain washer ID ø 6.4mm ED ø 12mm thickness 1.6mm SS Qty 20 pcs DIN 125A for thread M6		

## thermostats

## bi-metal thermostats

## safety bi-metal thermostats



<b>GEV No.</b>	390991	<b>Ref. No.</b>	TT-3859
<b>description</b>	bi-metal safety thermostat hole distance 23.5mm switch-off temp. 150°C 1CO 1-pole 16A 250V connection F6.3 screw		

## control and safety thermostats

## EGO

## safety thermostats

## 55.32\_ series



<b>GEV No.</b>	375474	<b>Ref. No.</b>	TT-33325
<b>description</b>	safety thermostat t.max. 340°C switch-off temp. 340°C 2-pole 1NC/1CO 1x20/1x0.5A probe ø 4mm probe L 120mm capillary pipe 1300mm capillary pipe isolated 900mm gland nut probe		



Зип Общепит

vsezip.ru

+7(812)987-08-81

INVENSYS / ROBERTSHAW

control thermostats



<b>GEV No.</b>	390992	<b>Ref. No.</b>	TT-3978
<b>description</b>	thermostat t.max. 121.111°C temperature range 15.55-121.11°C 1-pole 1NO 16A probe ø 5mm probe L 400mm capillary pipe 850mm capillary pipe isolatedmm gland nut shaft ø 6x4.6mm shaft L 21mm shaft position lower rotation 315° 60-250°F		



<b>GEV No.</b>	390875	<b>Ref. No.</b>	TT-3498
<b>description</b>	thermostat t.max. 232.2°C temperature range 37.77-232.22°C 1-pole 1NO 30A probe ø 5mm probe L 280mm capillary pipe 900mm capillary pipe isolatedmm gland nut shaft L 24mm rotation 315° 100-450°F t.max. 450°F		



<b>GEV No.</b>	580075	<b>Ref. No.</b>	TT3057 TT3058
<b>description</b>	thermostat t.max. 93°C temperature range 15-93°C 1-pole 1NO 15A probe ø 5mm probe L 400mm capillary pipe 1000mm capillary pipe isolatedmm gland nut shaft ø 6x4.6mm shaft L 22mm operating temperature range 60-200°F		



<b>GEV No.</b>	390993	<b>Ref. No.</b>	TT-33432
<b>description</b>	thermostat t.max. 93°C temperature range 15-93°C 1-pole 1NO 15A probe ø 5mm probe L 400mm capillary pipe 2100mm capillary pipe isolatedmm gland nut shaft ø 6x4.6mm shaft L 22mm operating temperature range 60-200°F		

various

control thermostats

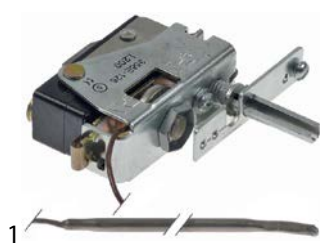

<b>GEV No.</b>	390994	<b>Ref. No.</b>	TT-33626
<b>description</b>	thermostat t.max. 121.11°C temperature range adjustable°C 1-pole 1NO 16A probe ø 4mm probe L 250mm capillary pipe 2140mm capillary pipe isolatedmm gland nut shaft ø 6x4.6mm shaft L 21mm shaft position° shaft position right rotation°		
<b>For models:</b>	750-S-HD		

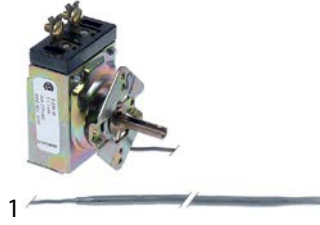

<b>GEV No.</b>	580008	<b>Ref. No.</b>	TT3329
<b>description</b>	thermostat temperature range 37.77-162.78°C probe ø 5mm probe L 300mm capillary pipe 950mm shaft ø 6x4.6mm shaft L 23mm operating temperature range 100-325°F		

switches and momentary switches

rocker/momentary rocker switches

28x13.5mm



<b>GEV No.</b>	348099	<b>Ref. No.</b>	SW-3409
<b>description</b>	rocker switch mounting measurements 27.4x12.4mm black 1CO 250V 10A with neutral position connection male faston 6.3mm ambient temperature max. 85°C protection IP40		



Зип Общепит

vsezip.ru

+7(812)987-08-81

lamps

30x22mm



1

<b>GEV No.</b>	301004	<b>Ref. No.</b>	SW-3387
<b>description</b>	rocker switch mounting measurements 30x22mm black 2CO 230V 16A connection male faston 6.3mm ambient temperature max. 125/55°C protection IP40		
<b>accessories for</b>	301004		
	<b>GEV No.</b>	301036	<b>Ref. No.</b>
	protective cover internal size 30x22mm for rocker switch mounting measurementsmm		



1

<b>GEV No.</b>	346377	<b>Ref. No.</b>	SW-34788
<b>description</b>	rocker switch mounting measurements 30x22mm black 2CO 230V 16A 0-1 connection male faston 6.3mm ambient temperature max. 125/55°C protection IP40		
<b>accessories for</b>	346377		
	<b>GEV No.</b>	301036	<b>Ref. No.</b>
	protective cover internal size 30x22mm for rocker switch mounting measurementsmm		

37x21mm



1

<b>GEV No.</b>	347969	<b>Ref. No.</b>	SW-34769
<b>description</b>	rocker switch mounting measurements 37x21mm black 2NO 250V 10A 0-1 connection male faston 6.3mm ambient temperature max. 85°C protection IP44		



1

<b>GEV No.</b>	348153 <sup>1</sup>	<b>Ref. No.</b>	5010847
<b>description</b>	rocker switch mounting measurements 37x21mm black 2NO 250V 10A 0-1 connection male faston 6.3mm ambient temperature max. 85°C protection IP44 mounting frame inclusive		

<sup>1</sup>with accessories

## toggle switches

M12x0.75



1

<b>GEV No.</b>	348151	<b>Ref. No.</b>	SW-3040
<b>description</b>	toggle switch 2NO 250V screw		



<b>GEV No.</b>	348154	<b>Ref. No.</b>	SW-3041
<b>description</b>	toggle switch thread M10x0.75 1NO 120-240V 12/20A ON-OFF screw		

## indicator lights

## indicator lights (complete)

ø12mm

with plug-in socket



1

<b>GEV No.</b>	580014	<b>Ref. No.</b>	LI3025 LI3027
<b>description</b>	indicator light ø 12mm 230V red		

30x13mm



1

<b>GEV No.</b>	346547	<b>Ref. No.</b>	LI-3516
<b>description</b>	indicator light mounting measurements 27.4x12.4mm 230V red connection male faston 6.3mm temp.-resist. 120°C		

## screw-on/push-on fit

## halogen lamp

for socket G4 / G6.35 / G9



1

<b>GEV No.</b>	357193	<b>Ref. No.</b>	LP-34213
<b>description</b>	halogen lamp socket G4 12V 20W temp.-resist. 300°C OSRAM HALOSTAR OVEN		



Зип Общежит

vsezip.ru

+7(812)987-08-81

oven lamps

universal oven lamps

55x70mm



1

<b>GEV No.</b>	359297	<b>Ref. No.</b>	CV-26607
----------------	--------	-----------------	----------

**description** frame L 95mm W 81mm mounting distance 68/83mm thickness 6mm

**accessories for** 359297

<b>GEV No.</b>	359299	<b>Ref. No.</b>	GS-26609
----------------	--------	-----------------	----------

**description** gasket L 91mm W 77mm hole ø 3mm for oven lamp



1

<b>GEV No.</b>	359299	<b>Ref. No.</b>	GS-26609
----------------	--------	-----------------	----------

**description** gasket L 91mm W 77mm hole ø 3mm for oven lamp

lamps

halogen lamps

for socket G4 / G6.35 / G9



1

<b>GEV No.</b>	357193	<b>Ref. No.</b>	LP-34213
----------------	--------	-----------------	----------

**description** halogen lamp socket G4 12V 20W temp.-resist. 300°C OSRAM HALOSTAR OVEN

timers

electric timers



1

<b>GEV No.</b>	580007	<b>Ref. No.</b>	TR3318
----------------	--------	-----------------	--------

**description** timer 240V operation time 12h

HARTLAND

power contactors



1

<b>GEV No.</b>	381284	<b>Ref. No.</b>	CN-3062
----------------	--------	-----------------	---------

**description** power contactor resistive load 40A 208/240VAC 30A/10HP (AC3/240V) 30A/7.46kW main contacts 3NO auxiliary contacts connection screw clamp/male faston 6.3mm type HCCY3XU02CY

SPRECHER+SCHUH

power contactors



1

<b>GEV No.</b>	381396	<b>Ref. No.</b>	CN-3654
----------------	--------	-----------------	---------

**description** power contactor resistive load 32A 220VAC (AC3/400V) 20A/11kW main contacts 3NO auxiliary contacts 1NC connection screw type CA7-23-01

solid state relays

CRYDOM



1

<b>GEV No.</b>	403662	<b>Ref. No.</b>	RL-3736
----------------	--------	-----------------	---------

**description** solid state relay CRYDOM 1 phase 25A 240V 90-280VAC L 57mm W 44.6mm screw connection type A2425



miscellaneous



1	<b>GEV No.</b>	403789	<b>Ref. No.</b>	RL-3583
<b>description</b> solid state relay TELEDYNE 25A 12-280V 4-30VDC L 58mm W 44mm screw type S24D25				

probes

producer-specific probes

probes



1	<b>GEV No.</b>	379800	<b>Ref. No.</b>	5002100
<b>description</b> temperature probe thermocouple K (NiCr-Ni) cable silicone probe -50 up to 1150°C cable -50 up to +180°C connection 2-wire thread M5 probe ø4x20mm cable length 3m				
<b>accessories for</b> 379800				
	<b>GEV No.</b>	521012	<b>Ref. No.</b>	—
gasket graphite ED ø 15mm ID ø 5mm thickness 1.2mm Qty 1 pcs				



1	<b>GEV No.</b>	378507	<b>Ref. No.</b>	PR-33751
<b>description</b> temperature probe thread M5 cable length 3m				

solenoid valves

solenoid valves (water)

ROBERTSHAW/INVENSYS

medium temperature: 90°C 90°C 60°C  
 ambient temperature: 60°C 25°C 60°C  
 duty cycle: 40% 100% 100%





1	<b>GEV No.</b>	372022	<b>Ref. No.</b>	VA-34045
<b>description</b> solenoid valve double straight 230VAC inlet 3/4" outlet 14mm DN10 EATON (INVENSYS)				

Зип Общепит

vsezip.ru

+7(812)987-08-81





1	<b>GEV No.</b>	372018	<b>Ref. No.</b>	VA-34300
<b>description</b> solenoid valve single straight 230VAC inlet 3/4" outlet 14mm DN10 EATON (INVENSYS) flow regulating valve outlet flow regulating valve inlet white				
<b>spare parts for</b> 372018				
	<b>GEV No.</b>	371122	<b>Ref. No.</b>	—
solenoid valve filter ø 19mm H 10mm suitable for MÜLLER				
	<b>GEV No.</b>	371131	<b>Ref. No.</b>	—
solenoid coil 230VAC				

fans

axial fans

import



1	<b>GEV No.</b>	601080 <sup>1</sup>	<b>Ref. No.</b>	FA-3568
<b>description</b> axial fan L 119mm W 119mm H 38mm 230VAC 50/60Hz 23/20W bearing ball bearing connection male faston 2.8mm metal ADDA fan wheel ø 110mm temp.-resist. 70°C				
<b>accessories for</b> 601080				
	<b>GEV No.</b>	550898	<b>Ref. No.</b>	—
connecting cable cable length 2000mm connection F 2.8 connection distance 7.9mm for axial flow fan				
	<b>GEV No.</b>	692519	<b>Ref. No.</b>	—
guard L 120mm W 120mm plastic				

<sup>1</sup>with ball bearings



ignition parts

pilot burners

HONEYWELL

pilot burners



1

**GEV No.** 102490 **Ref. No.** BN-33371

**description** pilot burner 1 flame

spare parts and accessories



Image not available

1

**GEV No.** 580002 **Ref. No.** HD2575

**description** counterpart

knobs

universal knobs



1

**GEV No.** 110124 **Ref. No.** KN3468

**description** knob thermostat t.max. 350°C t.max.°F 100-350°C°F ø 50mm shaft ø 6x4.6mm shaft flat upper black temperature range 100-350°C rotation 270°

**accessories for** 110124



**GEV No.** 110135 **Ref. No.** —

rosette knob up to ø 52mm

Зип-Общепит  
producer specific knobs

ALTO-SHAAM  
vsezip.ru



1

**GEV No.** 110124 **Ref. No.** KN3468

**description** knob thermostat t.max. 350°C t.max.°F 100-350°C°F ø 50mm shaft ø 6x4.6mm shaft flat upper black temperature range 100-350°C rotation 270°

**accessories for** 110124



**GEV No.** 110135 **Ref. No.** —  
rosette knob up to ø 52mm



1

**GEV No.** 111491 **Ref. No.** KN-3474

**description** knob thermostat t.max. 90°C t.max.°F 15-90°C°F ø 48mm shaft ø 6x4.6mm shaft flat lower

**For models:** 750-S-HD



1

**GEV No.** 580011 **Ref. No.** KN3469

**description** knob thermostat t.max.°C t.max. 200°F°C 60-200°F ø 49mm shaft ø 6x4.6mm shaft flat lower

**For models:** 750-S-HD

gas components

locks

edgmount latches

magnetic locks

CHG

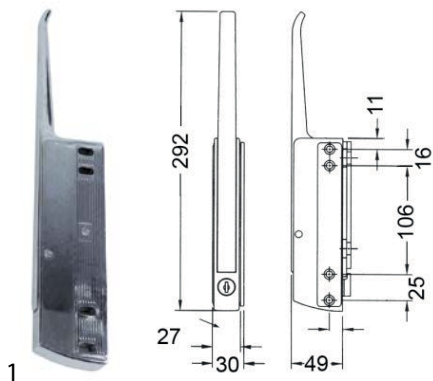

<b>GEV No.</b>	690208	<b>Ref. No.</b>	HD2007
<b>description</b>	magnetic lock L 168mm mounting distance 105/147mm non lockable refrigeration units R25		

hinges

edgmount hinges

CHG

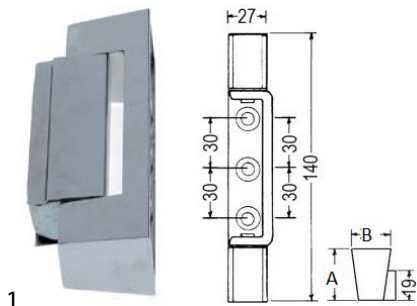

<b>GEV No.</b>	690294	<b>Ref. No.</b>	HG-2014
<b>description</b>	edgmount hinge L 140mm mounting distance 30/30mm hinging left/right without lift L1 33mm L2 30mm series R42		
<b>spare parts for</b>	690294		
	<b>GEV No.</b>	<b>Ref. No.</b>	—
	690292		
	spring for R42 (140mm)		

miscellaneous



<b>GEV No.</b>	710031	<b>Ref. No.</b>	CS-25675
<b>description</b>	swivel castor with swivel brake ø 90mm square pipes housing chrome-plated sheet steel capacitykg spigot hight 56mm spigot-ø 35x35mm bearing slide bearing wheel body tread H 190mm wheel width 32mm Qty 1 pcs		

gaskets for heated units

door seals

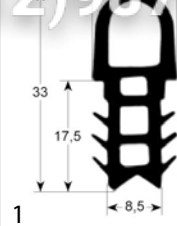

<b>GEV No.</b>	901675	<b>Ref. No.</b>	GS-25550
<b>description</b>	door seal profile 2060 W 420mm L 475mm external size Qty 1		

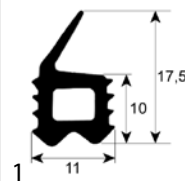

<b>GEV No.</b>	901312	<b>Ref. No.</b>	GS-23790
<b>description</b>	door seal profile 2708 W 385mm L 545mm external size		

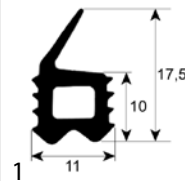

<b>GEV No.</b>	901313	<b>Ref. No.</b>	GS-23794
<b>description</b>	door seal profile 2708 W 500mm L 730mm external size		

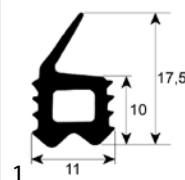

<b>GEV No.</b>	901132	<b>Ref. No.</b>	GS22903 GS-23778
<b>description</b>	door seal profile 2708 W 545mm L 590mm external size		
<b>For models:</b>	750-S-HD		

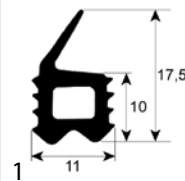

<b>GEV No.</b>	901314	<b>Ref. No.</b>	GS-23796
<b>description</b>	door seal profile 2708 W 560mm L 780mm external size		

mechanical components, equipment accessories





Зип-Общепит  
fastening material

vsezip.ru

+7(812)987-08-81

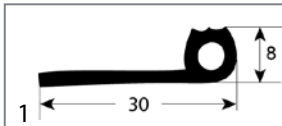

<b>GEV No.</b>	580013	<b>Ref. No.</b>	GS2398
<b>description</b>	door seal profile 2949 L 3000mm Qty 1		

## fittings, hose and pipe connectors

### hose connectors

#### nickel-plated brass



<b>GEV No.</b>	512440	<b>Ref. No.</b>	PB-26512
<b>description</b>	T-piece with probe connection nickel-plated brass thread 3/4" hose $\varnothing$ 16mm		

## measuring equipment

### thermometers

#### built-in thermometers

$\varnothing$ 41mm



<b>GEV No.</b>	541894	<b>Ref. No.</b>	TH-33713
<b>description</b>	thermometer mounting $\varnothing$ 41mm t.max. 105°C 0-105°C probe $\varnothing$ 9.5mm probe L 65mm capillary pipe 900mm		

$\varnothing$ 52mm



<b>GEV No.</b>	580016	<b>Ref. No.</b>	GU-33384
<b>description</b>	thermometer mounting $\varnothing$ 52mm t.max. 175°C +40 up to +175°C probe $\varnothing$ 11mm probe L 67mm capillary pipe 1800mm		

### screws

#### hexagonal screws



<b>GEV No.</b>	560084	<b>Ref. No.</b>	SC-26060
<b>description</b>	hexagonal screw thread M5 thread L 16mm SS WS 8 Qty 20 pcs DIN 933 / ISO 4017		



<b>GEV No.</b>	560088	<b>Ref. No.</b>	SC-22924
<b>description</b>	hexagonal screw thread M6 thread L 20mm SS WS 10 Qty 20 pcs DIN 933 / ISO 4017		

### nuts

#### hexagonal nuts

DIN 934 / ISO 4032/8673



<b>GEV No.</b>	511212	<b>Ref. No.</b>	NU-22291
<b>description</b>	hexagonal nut thread M6 H 5mm WS 10 SS DIN/ISO DIN 934 / ISO 4032/8673 Qty 1 pcs		

### washers

#### spring rings



<b>GEV No.</b>	560122	<b>Ref. No.</b>	WS-22301
<b>description</b>	lock washer ID $\varnothing$ 5.2mm ED $\varnothing$ 9mm SS DIN127 Qty 20 pcs for thread M5		



<b>GEV No.</b>	560123	<b>Ref. No.</b>	WS-22302
<b>description</b>	lock washer ID $\varnothing$ 6.3mm ED $\varnothing$ 11mm SS DIN127 Qty 20 pcs for thread M6		



washers

DIN 125A



1

<b>GEV No.</b>	560112	<b>Ref. No.</b>	WS-22295
<b>description</b>	plain washer ID ø 5.3mm ED ø 10mm thickness 1mm SS Qty 20 pcs DIN 125A for thread M5		

Зип Общепит



vsezip.ru

+7(812)987-08-91

<b>GEV No.</b>	560113	<b>Ref. No.</b>	WS-22297
<b>description</b>	plain washer ID ø 6.1mm ED ø 12mm thickness 1.6mm SS Qty 20 pcs DIN 125A for thread M6		

Зип Общепит

vsezip.ru

+7(812)987-08-81

<b>A</b>			
axial fans	6		
<b>B</b>			
bi-metal thermostats	2		
<b>C</b>			
castors and bumper angles	8		
contactors	5		
<b>D</b>			
door seals	8		
<b>E</b>			
edgemount hinges	8		
edgemount latches	8		
electric timers	5		
<b>F</b>			
fans	6		
fastening material	9		
<b>G</b>			
gaskets for heated units	8		
<b>H</b>			
halogen lamp	4		
heating cables	2		
heating cartridges	2		
heating elements	2		
hexagonal nuts	9		
hexagonal screws	9		
hose connectors	9		
<b>I</b>			
indicator lights	4		
indicator lights (complete)	4		
<b>L</b>			
lamps	4		
<b>M</b>			
magnetic locks	8		
measuring equipment	9		
<b>N</b>			
nuts	9		
<b>O</b>			
oven lamps	5		
		<b>P</b>	
		pilot burners	7
		probes	6
		rocker/momentary rocker switches	3
		<b>S</b>	
		safety bi-metal thermostats	2
		safety thermostats	2
		screws	9
		solenoid valves	6
		solid state relays	5
		spring rings	9
		switches and momentary switches	3
		<b>T</b>	
		thermostats	2
		timers	5
		toggle switches	4
		<b>W</b>	
		washers	10