



Зип Ощепит

vsezip.ru

Spare Parts for

+7(812)987-08781 **Combi Ovens**



Spare parts suitable for

**BONNET**

2017

Find the complete and up-to-date range of products in our GEV Webshop



## heating elements

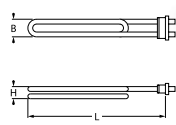

## immersion heating elements

with compression flange 50 x 26mm





|                    |                                                                                                                                                               |                 |        |
|--------------------|---------------------------------------------------------------------------------------------------------------------------------------------------------------|-----------------|--------|
| <b>GEV No.</b>     | 418932                                                                                                                                                        | <b>Ref. No.</b> | 71244E |
| <b>description</b> | heating element 2000W 240V heating circuits 1 flange 50x26mm L 350mm W 30mm Hmm compression flange connection male faston 6.3mm tube ø 6.3mm immersion heater |                 |        |

## heating elements for convection

|                                                                                     |                                                                                                                                                                                                                                                                                 |                 |                      |
|-------------------------------------------------------------------------------------|---------------------------------------------------------------------------------------------------------------------------------------------------------------------------------------------------------------------------------------------------------------------------------|-----------------|----------------------|
| <b>GEV No.</b>                                                                      | 418925                                                                                                                                                                                                                                                                          | <b>Ref. No.</b> | 71844E<br>BAAN309621 |
| <b>description</b>                                                                  | heating element 1500W 230V heating circuits 1 L 293mm W 106mm L1 32mm L2 261mm W2 83mm flange length 50mm flange width 26mm connection length 63mm connection male faston 6.3mm tube ø 8.5mm hole ø 6.2mm W1 23mm convection heating element convection oven INCOLOY windings 2 |                 |                      |
| <b>accessories for</b>                                                              | 418925                                                                                                                                                                                                                                                                          |                 |                      |
|  | <b>GEV No.</b>                                                                                                                                                                                                                                                                  | 520588          | <b>Ref. No.</b> —    |
|                                                                                     | gasket L 46mm W 22mm hole distance 24.5mm silicone for heating element                                                                                                                                                                                                          |                 |                      |

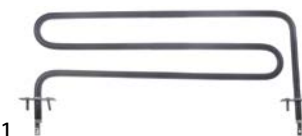

|                    |                                                                                                                                                                                                                                              |                 |        |
|--------------------|----------------------------------------------------------------------------------------------------------------------------------------------------------------------------------------------------------------------------------------------|-----------------|--------|
| <b>GEV No.</b>     | 418933                                                                                                                                                                                                                                       | <b>Ref. No.</b> | 71240E |
| <b>description</b> | heating element 2000W 240V heating circuits 1 L 390mm W 134mm W2 100mm flange length 50mm flange width 20mm connection length 50mm connection M4 tube ø 10mm thread M4 W1 34mm rectangular flange convection heating element convection oven |                 |        |



|                    |                                                                                                                                                                                                                                                                  |                 |                                |
|--------------------|------------------------------------------------------------------------------------------------------------------------------------------------------------------------------------------------------------------------------------------------------------------|-----------------|--------------------------------|
| <b>GEV No.</b>     | 418917                                                                                                                                                                                                                                                           | <b>Ref. No.</b> | 309252<br>71241E<br>BAAN71241E |
| <b>description</b> | heating element 3000W 240V heating circuits 3 L 570mm W 140mm W2 110mm flange length 110mm flange width 20mm hole distance 40mm connection length 55mm connection M4 tube ø 10mm thread M4 W1 30mm rectangular flange convection heating element convection oven |                 |                                |

Зип Общепит

vsezip.ru

+7(812)987-08-81

|                    |                                                                                                                                                                                                                                                                  |                 |                      |
|--------------------|------------------------------------------------------------------------------------------------------------------------------------------------------------------------------------------------------------------------------------------------------------------|-----------------|----------------------|
| <b>GEV No.</b>     | 418918                                                                                                                                                                                                                                                           | <b>Ref. No.</b> | 71242E<br>BAAN309253 |
| <b>description</b> | heating element 2000W 240V heating circuits 3 L 570mm W 140mm W2 110mm flange length 110mm flange width 20mm hole distance 40mm connection length 55mm connection M4 tube ø 10mm thread M4 W1 30mm rectangular flange convection heating element convection oven |                 |                      |

## accessories

## sealing washers

## O-rings

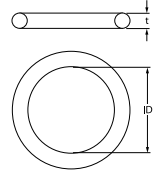
|                    |                                                  |                 |          |
|--------------------|--------------------------------------------------|-----------------|----------|
| <b>GEV No.</b>     | 510408                                           | <b>Ref. No.</b> | 2001827H |
| <b>description</b> | O-ring EPDM thickness 5.34mm ID ø 47mm Qty 1 pcs |                 |          |



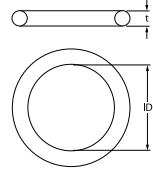

|                    |                                                     |                 |                                                         |
|--------------------|-----------------------------------------------------|-----------------|---------------------------------------------------------|
| <b>GEV No.</b>     | 510409                                              | <b>Ref. No.</b> | 318044<br>905588<br>966001<br>BAAN1323306<br>BAAN311999 |
| <b>description</b> | O-ring EPDM thickness 5.34mm ID ø 56.52mm Qty 1 pcs |                 |                                                         |

## energy regulators

## EGO

## 1-circuit



|                    |                                                                                                                                                     |                 |                                                                   |
|--------------------|-----------------------------------------------------------------------------------------------------------------------------------------------------|-----------------|-------------------------------------------------------------------|
| <b>GEV No.</b>     | 380015                                                                                                                                              | <b>Ref. No.</b> | 1800602<br>301200<br>70486E<br>72113E<br>BAAN167036<br>BAAN304497 |
| <b>description</b> | energy regulator 230V 13A single-circuit turn direction right shaft ø 6x4.6mm shaft L 23mm mounting thread M4 power release 6-100% no. 50.57021.010 |                 |                                                                   |



## thermostats

### bi-metal thermostats

#### bi-metal thermostats



|                    |                                                                                        |                 |        |
|--------------------|----------------------------------------------------------------------------------------|-----------------|--------|
| <b>GEV No.</b>     | 375927                                                                                 | <b>Ref. No.</b> | 301045 |
| <b>description</b> | bi-metal thermostat hole distance 23.5mm switch-off temp. 50°C 1NO 10A connection F6.3 |                 |        |

### control and safety thermostats

#### EGO

#### control thermostats

#### 55.10/19\_series



|                    |                                                                                                                                                                                                            |                 |                                      |
|--------------------|------------------------------------------------------------------------------------------------------------------------------------------------------------------------------------------------------------|-----------------|--------------------------------------|
| <b>GEV No.</b>     | 375002                                                                                                                                                                                                     | <b>Ref. No.</b> | 7471032<br>BAAN1209939<br>BAAN310615 |
| <b>description</b> | thermostat t.max. 320°C temperature range 55-320°C 1-pole 1NO 16A probe ø 3.1mm probe L 226mm capillary pipe 870mm capillary pipe isolated 850mm gland nut shaft L 23mm shaft position upper rotation 270° |                 |                                      |

#### safety thermostats

#### 55.13\_series



|                    |                                                                                                                                                        |                 |                  |
|--------------------|--------------------------------------------------------------------------------------------------------------------------------------------------------|-----------------|------------------|
| <b>GEV No.</b>     | 375830                                                                                                                                                 | <b>Ref. No.</b> | 905866<br>905886 |
| <b>description</b> | safety thermostat switch-off temp. 365°C 1-pole 1NC 16A probe ø 3mm probe L 160mm capillary pipe 1730mm capillary pipe isolated 1710mm gland nut probe |                 |                  |

Зип Общежит

vsezip.ru

+7(812)987-08-81



|                    |                                                                                                                                                                    |                 |        |
|--------------------|--------------------------------------------------------------------------------------------------------------------------------------------------------------------|-----------------|--------|
| <b>GEV No.</b>     | 390801                                                                                                                                                             | <b>Ref. No.</b> | 71280E |
| <b>description</b> | thermostat switch-off temp. 140°C 1-pole 16A probe ø 6mm probe L 78mm capillary pipe 1500mm capillary pipe isolatedmm gland nut probe connection male faston 6.3mm |                 |        |

#### 55.32\_series



|                    |                                                                                                                                                              |                 |                                    |
|--------------------|--------------------------------------------------------------------------------------------------------------------------------------------------------------|-----------------|------------------------------------|
| <b>GEV No.</b>     | 375984                                                                                                                                                       | <b>Ref. No.</b> | 301061<br>BAAN171095<br>BAAN304480 |
| <b>description</b> | safety thermostat switch-off temp. 225°C 3-pole 3NC 20A probe ø 6mm probe L 94mm capillary pipe 900mm capillary pipe isolated 670mm gland nut M10x1 probe SS |                 |                                    |



|                    |                                                                                                                                                        |                 |                                    |
|--------------------|--------------------------------------------------------------------------------------------------------------------------------------------------------|-----------------|------------------------------------|
| <b>GEV No.</b>     | 375706                                                                                                                                                 | <b>Ref. No.</b> | 301049<br>BAAN169338<br>BAAN304476 |
| <b>description</b> | safety thermostat switch-off temp. 400°C 3-pole 3NC 20A probe ø 3.9mm probe L 228mm capillary pipe 1190mm capillary pipe isolatedmm gland nut probe SS |                 |                                    |



56.\_ series

E-G-O

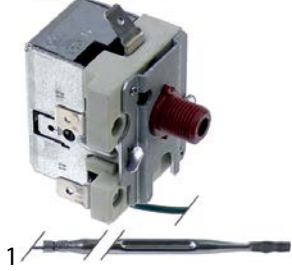

1

|                                                                                   |                                                                                                                                                          |                 |                                              |
|-----------------------------------------------------------------------------------|----------------------------------------------------------------------------------------------------------------------------------------------------------|-----------------|----------------------------------------------|
| <b>GEV No.</b>                                                                    | 375442                                                                                                                                                   | <b>Ref. No.</b> | 301039<br>301066<br>BAAN172196<br>BAAN304485 |
| <b>description</b>                                                                | safety thermostat capillary pipe 1760mm probe ø 4mm 1-pole probe L 100mm 16A capillary pipe isolated 1600mm gland nut switch-off temp. 320°C probe M10x1 |                 |                                              |
| <b>accessories for</b>                                                            | 375442                                                                                                                                                   |                 |                                              |
|  | <b>GEV No.</b>                                                                                                                                           | 101860          | <b>Ref. No.</b> —                            |
|                                                                                   | nut thread M10x1 H 4mm WS 14 chrome-plated brass Qty 1 pcs                                                                                               |                 |                                              |

## control thermostats with operation switch

55.34\_ series

E-G-O

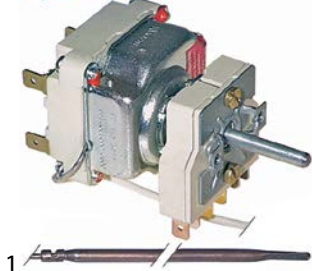

1

|                    |                                                                                                                                                                                                                                                                       |                 |        |
|--------------------|-----------------------------------------------------------------------------------------------------------------------------------------------------------------------------------------------------------------------------------------------------------------------|-----------------|--------|
| <b>GEV No.</b>     | 375246                                                                                                                                                                                                                                                                | <b>Ref. No.</b> | 301034 |
| <b>description</b> | thermostat t.max. 645°C temperature range 100-615/645°C 2-pole 2NO 16A probe ø 4mm probe L 230mm capillary pipe 1100mm capillary pipe isolated 600mm gland nut shaft ø 6x4.6mm shaft L 25mm shaft position lower rotation 270° outer switch 2NO probe material copper |                 |        |

## accessories

## gland nut accessories

ducts



1

|                    |                                                                  |                 |                                       |
|--------------------|------------------------------------------------------------------|-----------------|---------------------------------------|
| <b>GEV No.</b>     | 550148                                                           | <b>Ref. No.</b> | 91373062<br>BAAN1323396<br>BAAN312763 |
| <b>description</b> | gland duct ET M12x0.75 IT M9x1 probe ø max. 6.5mm WS 17 silicone |                 |                                       |

Зип-Общепит

connecting bows

vsezip.ru

+7(812)987-08-81

1

|                    |                                              |                 |        |
|--------------------|----------------------------------------------|-----------------|--------|
| <b>GEV No.</b>     | 550060                                       | <b>Ref. No.</b> | 300177 |
| <b>description</b> | connecting bow long for thermostat Qty 1 pcs |                 |        |

## switches and momentary switches

## rocker/momentary rocker switches

30x22mm



1

|                    |                                                                                                                                                                      |                 |        |
|--------------------|----------------------------------------------------------------------------------------------------------------------------------------------------------------------|-----------------|--------|
| <b>GEV No.</b>     | 301202 <sup>1</sup>                                                                                                                                                  | <b>Ref. No.</b> | 905913 |
| <b>description</b> | rocker switch mounting measurements 30x22mm black 2NO 230V 20A 0-1 connection male faston 6.3mm ambient temperature max. 125/55°C protection IP65 with rubber collar |                 |        |

<sup>1</sup>non-illuminated

## microswitches

## lever actuated



1

|                    |                                                                                                                                                                                 |                 |                               |
|--------------------|---------------------------------------------------------------------------------------------------------------------------------------------------------------------------------|-----------------|-------------------------------|
| <b>GEV No.</b>     | 345257                                                                                                                                                                          | <b>Ref. No.</b> | 300688<br>3755E<br>BAAN305693 |
| <b>description</b> | microswitch with lever 250V 16A 1CO connection male faston 6.3mm L 29mm L1 33mm ambient temperature max. 120°C mounting distance 22mm actuating force: 130g lever length 31.5mm |                 |                               |

## pin-plunger actuated

M10



1



|                    |                                                                                                                                                                                                         |                 |        |
|--------------------|---------------------------------------------------------------------------------------------------------------------------------------------------------------------------------------------------------|-----------------|--------|
| <b>GEV No.</b>     | 345032                                                                                                                                                                                                  | <b>Ref. No.</b> | 303621 |
| <b>description</b> | microswitch with plunger thread M10x1 thread L 12mm 250V 16A 1CO connection male faston 6.3mm stroke 7mm mounting distance 22mm L 28mm ambient temperature max. 125°C type SP9603 actuating force: 180g |                 |        |



Зип Общежит

vsezip.ru

+7(812)987-08-81

|                                                                                   |                                                                                                                                                                                                       |                 |                                      |
|-----------------------------------------------------------------------------------|-------------------------------------------------------------------------------------------------------------------------------------------------------------------------------------------------------|-----------------|--------------------------------------|
| M12                                                                               |                                                                                                                                                                                                       |                 |                                      |
|  |                                                                                                                                                                                                       |                 |                                      |
| 1                                                                                 |                                                                                                                                                                                                       |                 |                                      |
| <b>GEV No.</b>                                                                    | 345350                                                                                                                                                                                                | <b>Ref. No.</b> | 1700340<br>BAAN1320656<br>BAAN302929 |
| <b>description</b>                                                                | microswitch with plunger mounting distance 22mm thread M12x0.75 thread L 16mm 250V 16A 1CO connection male faston 6.3mm stroke 4mm ambient temperature max. 125°C type EF83161.3 actuating force: 66g |                 |                                      |
| <b>accessories for</b>                                                            | 345350                                                                                                                                                                                                |                 |                                      |
|                                                                                   |                                                                                                                      | <b>GEV No.</b>  | 345351 <b>Ref. No.</b> —             |
| <b>description</b>                                                                | nut thread M12x0.75 H 1.6mm WS 14 chrome-plated brass Qty 1 pcs                                                                                                                                       |                 |                                      |

|                                                                                    |                                                                                                                                               |                 |                                    |
|------------------------------------------------------------------------------------|-----------------------------------------------------------------------------------------------------------------------------------------------|-----------------|------------------------------------|
| 7-position<br>cam switches                                                         |                                                                                                                                               |                 |                                    |
|  |                                                                                                                                               |                 |                                    |
| 1                                                                                  |                                                                                                                                               |                 |                                    |
| <b>GEV No.</b>                                                                     | 300106                                                                                                                                        | <b>Ref. No.</b> | 300010<br>BAAN166926<br>BAAN304345 |
| <b>description</b>                                                                 | cam switch 7 operating positions 1NO/2CO sequence 0-1-2-3-4-5-6 32A shaft ø 6x4.6mm shaft L 23mm connection screw 7-position shaft flat upper |                 |                                    |

system switches (ROLD)

|                                                                                   |                                           |                 |        |
|-----------------------------------------------------------------------------------|-------------------------------------------|-----------------|--------|
|  |                                           |                 |        |
| 1                                                                                 |                                           |                 |        |
| <b>GEV No.</b>                                                                    | 345536                                    | <b>Ref. No.</b> | 900162 |
| <b>description</b>                                                                | element holder mounting ø 16mm flat black |                 |        |

|                                                                                     |                                                                 |                 |          |
|-------------------------------------------------------------------------------------|-----------------------------------------------------------------|-----------------|----------|
|  |                                                                 |                 |          |
| 1                                                                                   |                                                                 |                 |          |
| <b>GEV No.</b>                                                                      | 345606                                                          | <b>Ref. No.</b> | 2001544H |
| <b>description</b>                                                                  | momentary switch unit 2CO 250V 16A connection male faston 6.3mm |                 |          |

|                                                                                     |                            |                 |        |
|-------------------------------------------------------------------------------------|----------------------------|-----------------|--------|
|  |                            |                 |        |
| 1                                                                                   |                            |                 |        |
| <b>GEV No.</b>                                                                      | 345538                     | <b>Ref. No.</b> | 900163 |
| <b>description</b>                                                                  | push button ø 11.9mm black |                 |        |

|                                                                                     |                                                  |                 |                                     |
|-------------------------------------------------------------------------------------|--------------------------------------------------|-----------------|-------------------------------------|
|  |                                                  |                 |                                     |
| 1                                                                                   |                                                  |                 |                                     |
| <b>GEV No.</b>                                                                      | 345651                                           | <b>Ref. No.</b> | 900053<br>BAAN1323148<br>BAAN311603 |
| <b>description</b>                                                                  | switch 2CO 250V 16A connection male faston 6.3mm |                 |                                     |

magnetic switches

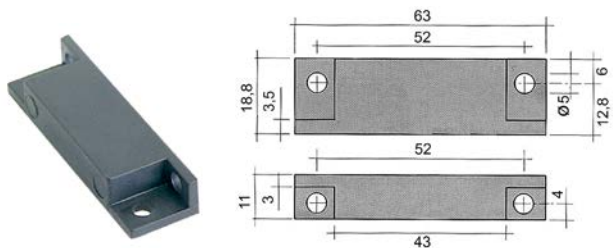
|                                                                                     |                                                             |                 |                                       |
|-------------------------------------------------------------------------------------|-------------------------------------------------------------|-----------------|---------------------------------------|
| accessories                                                                         |                                                             |                 |                                       |
| magnets                                                                             |                                                             |                 |                                       |
|  |                                                             |                 |                                       |
| 1                                                                                   |                                                             |                 |                                       |
| <b>GEV No.</b>                                                                      | 345336                                                      | <b>Ref. No.</b> | 2001868H<br>BAAN1321497<br>BAAN307903 |
| <b>description</b>                                                                  | magnet ø 4.8mm L 63mm H 11mm W 18.8mm hole distance 51mm M4 |                 |                                       |

encoders and potentiometers

|                                                                                      |               |                 |                                    |
|--------------------------------------------------------------------------------------|---------------|-----------------|------------------------------------|
|  |               |                 |                                    |
| 1                                                                                    |               |                 |                                    |
| <b>GEV No.</b>                                                                       | 300265        | <b>Ref. No.</b> | 309411<br>BAAN172230<br>BAAN701367 |
| <b>description</b>                                                                   | potentiometer |                 |                                    |



## lamps

## indicator lights



## indicator lights 3-piece (housing, lens and bulb)

## lamps

## neon light bulbs



1

|                                                                                   |                                                                       |                 |                 |
|-----------------------------------------------------------------------------------|-----------------------------------------------------------------------|-----------------|-----------------|
| <b>GEV No.</b>                                                                    | 359585                                                                | <b>Ref. No.</b> | 74540008        |
| <b>description</b>                                                                | neon light bulb socket E10 230V green ø 10mm L 28mm                   |                 |                 |
| <b>accessories for</b>                                                            | 359585                                                                |                 |                 |
|  | <b>GEV No.</b>                                                        | 359060          | <b>Ref. No.</b> |
|                                                                                   |                                                                       |                 | —               |
| <b>description</b>                                                                | lamp socket mounting measurements ø16.2mm socket E10 connection screw |                 |                 |
|  | <b>GEV No.</b>                                                        | 359685          | <b>Ref. No.</b> |
|                                                                                   |                                                                       |                 | —               |
| <b>description</b>                                                                | lamp socket mounting measurements ø16.2mm socket E10                  |                 |                 |

## indicator lights (complete)

## ø 6mm



1

|                    |                                                      |                 |          |
|--------------------|------------------------------------------------------|-----------------|----------|
| <b>GEV No.</b>     | 359005                                               | <b>Ref. No.</b> | 2002147H |
| <b>description</b> | indicator light ø 6mm 230V yellow cable length 400mm |                 |          |

## ø12mm

## with plug-in socket



1

|                    |                                                                                            |                 |                                    |
|--------------------|--------------------------------------------------------------------------------------------|-----------------|------------------------------------|
| <b>GEV No.</b>     | 359925                                                                                     | <b>Ref. No.</b> | 308334<br>BAAN167305<br>BAAN304818 |
| <b>description</b> | indicator light ø 12mm 400V green connection 2-wire cable length 700mm temp.-resist. 150°C |                 |                                    |

## ø13mm

## with plug-in socket



1

|                    |                                                                                               |                 |                                               |
|--------------------|-----------------------------------------------------------------------------------------------|-----------------|-----------------------------------------------|
| <b>GEV No.</b>     | 359143                                                                                        | <b>Ref. No.</b> | 904300<br>904360<br>BAAN1323249<br>BAAN311747 |
| <b>description</b> | indicator light ø 13mm yellow 230V connection male faston 6.3mm temp.-resist. 120°C Qty 1 pcs |                 |                                               |

Зип-Общепит

30x22mm



1



|                    |                                                                                                                        |                 |         |
|--------------------|------------------------------------------------------------------------------------------------------------------------|-----------------|---------|
| <b>GEV No.</b>     | 359156                                                                                                                 | <b>Ref. No.</b> | S175P15 |
| <b>description</b> | indicator light mounting measurements 30x22mm 230V yellow connection male faston 6.3mm temp.-resist. 125/55°C type RL2 |                 |         |

## screw-on/push-on fit

## neon light bulbs



1

|                                                                                   |                                                                       |                 |                 |
|-----------------------------------------------------------------------------------|-----------------------------------------------------------------------|-----------------|-----------------|
| <b>GEV No.</b>                                                                    | 359585                                                                | <b>Ref. No.</b> | 74540008        |
| <b>description</b>                                                                | neon light bulb socket E10 230V green ø 10mm L 28mm                   |                 |                 |
| <b>accessories for</b>                                                            | 359585                                                                |                 |                 |
|  | <b>GEV No.</b>                                                        | 359060          | <b>Ref. No.</b> |
|                                                                                   |                                                                       |                 | —               |
| <b>description</b>                                                                | lamp socket mounting measurements ø16.2mm socket E10 connection screw |                 |                 |
|  | <b>GEV No.</b>                                                        | 359685          | <b>Ref. No.</b> |
|                                                                                   |                                                                       |                 | —               |
| <b>description</b>                                                                | lamp socket mounting measurements ø16.2mm socket E10                  |                 |                 |

## light bulbs

## for ovens



1

|                    |                                                                                                  |                 |        |
|--------------------|--------------------------------------------------------------------------------------------------|-----------------|--------|
| <b>GEV No.</b>     | 359610                                                                                           | <b>Ref. No.</b> | 70597E |
| <b>description</b> | light bulb t.max. 300°C socket E14 15W 230V ø 22mm L 47mm lens L 20mm for oven lamp type Philips |                 |        |



1

|                    |                                                                                     |                 |        |
|--------------------|-------------------------------------------------------------------------------------|-----------------|--------|
| <b>GEV No.</b>     | 357153                                                                              | <b>Ref. No.</b> | 70598E |
| <b>description</b> | light bulb t.max. 300°C socket E14 25W 230V ø 25mm L 55mm lens L 30mm for oven type |                 |        |



1

|                    |                                                                                 |                 |        |
|--------------------|---------------------------------------------------------------------------------|-----------------|--------|
| <b>GEV No.</b>     | 359614                                                                          | <b>Ref. No.</b> | 308463 |
| <b>description</b> | light bulb t.max. 300°C socket E27 230V 40W ø 45mm L 71mm lens L 44mm Qty 1 pcs |                 |        |



Зип Общежит

vsezip.ru

+7(812)987-08-81

|                                                                                   |                                                    |                 |                                    |
|-----------------------------------------------------------------------------------|----------------------------------------------------|-----------------|------------------------------------|
| halogen lamp                                                                      |                                                    |                 |                                    |
| for socket G4 / G6.35 / G9                                                        |                                                    |                 |                                    |
|  |                                                    |                 |                                    |
| 1 <b>500°C</b>                                                                    |                                                    |                 |                                    |
| <b>GEV No.</b>                                                                    | 359599                                             | <b>Ref. No.</b> | 308477<br>BAAN172222<br>BAAN304831 |
| <b>description</b>                                                                | halogen lamp socket G4 12V 20W temp.-resist. 500°C |                 |                                    |

|                                                                                    |                                                    |                 |                                    |
|------------------------------------------------------------------------------------|----------------------------------------------------|-----------------|------------------------------------|
| halogen lamps                                                                      |                                                    |                 |                                    |
| for socket G4 / G6.35 / G9                                                         |                                                    |                 |                                    |
|  |                                                    |                 |                                    |
| 1 <b>500°C</b>                                                                     |                                                    |                 |                                    |
| <b>GEV No.</b>                                                                     | 359599                                             | <b>Ref. No.</b> | 308477<br>BAAN172222<br>BAAN304831 |
| <b>description</b>                                                                 | halogen lamp socket G4 12V 20W temp.-resist. 500°C |                 |                                    |

fluorescent lamps

|                                                                                   |                                              |                 |                                              |
|-----------------------------------------------------------------------------------|----------------------------------------------|-----------------|----------------------------------------------|
| fluorescent lamps                                                                 |                                              |                 |                                              |
| G23                                                                               |                                              |                 |                                              |
|  |                                              |                 |                                              |
| 1                                                                                 |                                              |                 |                                              |
| <b>GEV No.</b>                                                                    | 359933                                       | <b>Ref. No.</b> | 309597<br>71819E<br>BAAN309597<br>BAAN71819E |
| <b>description</b>                                                                | fluorescent lamp socket G23 L 237mm 11W 230V |                 |                                              |

sockets

|                                                                                   |                                                                                                                                                         |                 |        |
|-----------------------------------------------------------------------------------|---------------------------------------------------------------------------------------------------------------------------------------------------------|-----------------|--------|
| G4 / G5,3 / G6,35                                                                 |                                                                                                                                                         |                 |        |
|  |                                                                                                                                                         |                 |        |
| 1                                                                                 |                                                                                                                                                         |                 |        |
| <b>GEV No.</b>                                                                    | 359646                                                                                                                                                  | <b>Ref. No.</b> | 147328 |
| <b>description</b>                                                                | lamp socket socket G4/G5.3/G6.35 24V ø 17mm H 15mm connection cable 130mm mounting distance 26mm for halogen lamp holder length 31mm cable length 130mm |                 |        |

oven lamps

|                                                                                     |                                                                                                  |                 |        |
|-------------------------------------------------------------------------------------|--------------------------------------------------------------------------------------------------|-----------------|--------|
| lamps                                                                               |                                                                                                  |                 |        |
| light bulbs                                                                         |                                                                                                  |                 |        |
|  |                                                                                                  |                 |        |
| 1                                                                                   |                                                                                                  |                 |        |
| <b>GEV No.</b>                                                                      | 359610                                                                                           | <b>Ref. No.</b> | 70597E |
| <b>description</b>                                                                  | light bulb t.max. 300°C socket E14 15W 230V ø 22mm L 47mm lens L 20mm for oven lamp type Philips |                 |        |

alarm devices

|                                                                                     |                                                                          |                 |        |
|-------------------------------------------------------------------------------------|--------------------------------------------------------------------------|-----------------|--------|
| buzzers                                                                             |                                                                          |                 |        |
|  |                                                                          |                 |        |
| 1                                                                                   |                                                                          |                 |        |
| <b>GEV No.</b>                                                                      | 350050                                                                   | <b>Ref. No.</b> | 305106 |
| <b>description</b>                                                                  | buzzer 230VAC connection male faston 6.3mm screw mounting thread M4 60dB |                 |        |

|                                                                                     |                                                                                     |                 |        |
|-------------------------------------------------------------------------------------|-------------------------------------------------------------------------------------|-----------------|--------|
|  |                                                                                     |                 |        |
| 1                                                                                   |                                                                                     |                 |        |
| <b>GEV No.</b>                                                                      | 357153                                                                              | <b>Ref. No.</b> | 70598E |
| <b>description</b>                                                                  | light bulb t.max. 300°C socket E14 25W 230V ø 25mm L 55mm lens L 30mm for oven type |                 |        |

contactors

SIEMENS

power contactors

|                                                                                      |                                                                                                                                                                |                 |          |
|--------------------------------------------------------------------------------------|----------------------------------------------------------------------------------------------------------------------------------------------------------------|-----------------|----------|
|  |                                                                                                                                                                |                 |          |
| 1                                                                                    |                                                                                                                                                                |                 |          |
| <b>GEV No.</b>                                                                       | 380957                                                                                                                                                         | <b>Ref. No.</b> | 2001138H |
| <b>description</b>                                                                   | power contactor resistive load 22A 24VAC (AC3/400V) 12A/5.5kW main contacts 3NO auxiliary contacts 1NO connection screw connection type 3RT10-17-1AB01 50/60Hz |                 |          |

|                                                                                     |                                                                                 |                 |        |
|-------------------------------------------------------------------------------------|---------------------------------------------------------------------------------|-----------------|--------|
|  |                                                                                 |                 |        |
| 1                                                                                   |                                                                                 |                 |        |
| <b>GEV No.</b>                                                                      | 359614                                                                          | <b>Ref. No.</b> | 308463 |
| <b>description</b>                                                                  | light bulb t.max. 300°C socket E27 230V 40W ø 45mm L 71mm lens L 44mm Qty 1 pcs |                 |        |



## TELEMECANIQUE (Schneider Electric)

Зип Общепит

## power contactors



1

|                    |                                                                                                                                                   |                 |         |
|--------------------|---------------------------------------------------------------------------------------------------------------------------------------------------|-----------------|---------|
| <b>GEV No.</b>     | 380617                                                                                                                                            | <b>Ref. No.</b> | 1700468 |
| <b>description</b> | power contactor resistive load 25A 24VAC (AC3/400V) 9A/4kW main contacts 3NO auxiliary contacts 1NO/1NC connection screw connection type LC1D09B7 |                 |         |



1

|                    |                                                                                                                                         |                 |                   |
|--------------------|-----------------------------------------------------------------------------------------------------------------------------------------|-----------------|-------------------|
| <b>GEV No.</b>     | 380976                                                                                                                                  | <b>Ref. No.</b> | 1700732<br>300698 |
| <b>description</b> | power contactor resistive load 32A 230VAC (AC3/400V) 18A/7.5kW main contacts 3NO auxiliary contacts 1NO/1NC connection screw connection |                 |                   |



1

|                    |                                                                                                                                                      |                 |                                                                                                                                                           |
|--------------------|------------------------------------------------------------------------------------------------------------------------------------------------------|-----------------|-----------------------------------------------------------------------------------------------------------------------------------------------------------|
| <b>GEV No.</b>     | 380979                                                                                                                                               | <b>Ref. No.</b> | 300697<br>300699<br>300760<br>5875E<br>900130<br>905239<br>905241<br>905686<br>906759<br>910566<br>BAAN1322995<br>BAAN169330<br>BAAN304436<br>BAANS084P20 |
| <b>description</b> | power contactor resistive load 40A 230VAC (AC3/400V) 25A/11kW main contacts 3NO auxiliary contacts 1NO/1NC connection screw connection type LC1D25P7 |                 |                                                                                                                                                           |



1

|                    |                                                                                                                                                      |                 |        |
|--------------------|------------------------------------------------------------------------------------------------------------------------------------------------------|-----------------|--------|
| <b>GEV No.</b>     | 380980                                                                                                                                               | <b>Ref. No.</b> | 300700 |
| <b>description</b> | power contactor resistive load 50A 230VAC (AC3/400V) 32A/15kW main contacts 3NO auxiliary contacts 1NO/1NC connection screw connection type LC1D32P7 |                 |        |

## relays

## power relays

## with bracket mounting



1

|                    |                                                                                                                                        |                 |                      |
|--------------------|----------------------------------------------------------------------------------------------------------------------------------------|-----------------|----------------------|
| <b>GEV No.</b>     | 380312                                                                                                                                 | <b>Ref. No.</b> | 2001867H<br>2001887H |
| <b>description</b> | power relays FINDER 230VAC 10A 3CO connection male faston 4.8mm bracket mounting dimensions 52x32.2x36.5mm manuf. no. 60.63.8.230.0000 |                 |                      |

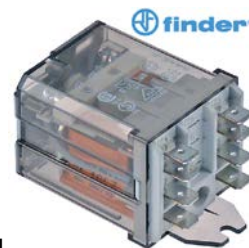

1

|                    |                                                                                                                           |                 |          |
|--------------------|---------------------------------------------------------------------------------------------------------------------------|-----------------|----------|
| <b>GEV No.</b>     | 380139                                                                                                                    | <b>Ref. No.</b> | 2001873H |
| <b>description</b> | power relays FINDER 230VAC 16A 2CO connection F6.3 bracket mounting dimensions 68x38.2x35.8mm manuf. no. 62.82.8.230.0000 |                 |          |







Зип.Общепит  
transformers

open transformers  
with plug connection

+7(812)987-08-81

|                                                                                   |                                                                                                 |                 |                                                             |
|-----------------------------------------------------------------------------------|-------------------------------------------------------------------------------------------------|-----------------|-------------------------------------------------------------|
|  |                                                                                                 |                 |                                                             |
| 1                                                                                 |                                                                                                 |                 |                                                             |
| <b>GEV No.</b>                                                                    | 380403                                                                                          | <b>Ref. No.</b> | 2001258H<br>2001873H<br>900073<br>BAAN1323154<br>BAAN311608 |
| <b>description</b>                                                                | power relays FINDER 230VAC 16A 3CO connection F6.3 bracket mounting manuf. no. 62.83.8.230.0500 |                 |                                                             |

|                                                                                    |                                                                                                                                                                 |                 |        |
|------------------------------------------------------------------------------------|-----------------------------------------------------------------------------------------------------------------------------------------------------------------|-----------------|--------|
|  |                                                                                                                                                                 |                 |        |
| 1                                                                                  |                                                                                                                                                                 |                 |        |
| <b>GEV No.</b>                                                                     | 400956                                                                                                                                                          | <b>Ref. No.</b> | 308479 |
| <b>description</b>                                                                 | transformer primary 230VAC secondary 12VAC 20VA connection male faston 6.3mm 50/60Hz type T602012/E temperature restriction 150°C ambient temperature max. 80°C |                 |        |

|                                                                                   |                                                                                                                               |                 |          |
|-----------------------------------------------------------------------------------|-------------------------------------------------------------------------------------------------------------------------------|-----------------|----------|
|  |                                                                                                                               |                 |          |
| 2                                                                                 |                                                                                                                               |                 |          |
| <b>GEV No.</b>                                                                    | 380702                                                                                                                        | <b>Ref. No.</b> | 2002044H |
| <b>description</b>                                                                | power relays FINDER 230VAC 16A 3NO connection male faston 6.3mm flange dimensions 36x38x68mm manuf. no. 62.83.8.230.0300 230V |                 |          |





electronic controllers

EVCO - EVERY CONTROL



universal controllers

built-in version

|                                                                                     |                                                                                                                                |                 |                                                               |
|-------------------------------------------------------------------------------------|--------------------------------------------------------------------------------------------------------------------------------|-----------------|---------------------------------------------------------------|
|  |                                                                                                                                |                 |                                                               |
| 1                                                                                   |                                                                                                                                |                 |                                                               |
| <b>GEV No.</b>                                                                      | 380185                                                                                                                         | <b>Ref. No.</b> | 2001929h<br>300283<br>BAAN1027526<br>BAAN171090<br>BAAN304383 |
| <b>description</b>                                                                  | power relays Italiana Relè 230VAC 30A 1NO connection F6.3 bracket mounting dimensions 36.5x32.2x51.8mm manuf. no. A10-230AC-FA |                 |                                                               |

|                                                                                     |                                                                                                                                                                                                                                          |                 |                   |
|-------------------------------------------------------------------------------------|------------------------------------------------------------------------------------------------------------------------------------------------------------------------------------------------------------------------------------------|-----------------|-------------------|
|  |                                                                                                                                                                                                                                          |                 |                   |
| 1                                                                                   |                                                                                                                                                                                                                                          |                 |                   |
| <b>GEV No.</b>                                                                      | 378131                                                                                                                                                                                                                                   | <b>Ref. No.</b> | 651225<br>S225P20 |
| <b>description</b>                                                                  | electronic controller EVERY CONTROL EVK411M mounting measurements 71x29mm 12V voltage AC/DC NTC/PTC/Pt100/Pt1000 relay outputs 1 CO-16A(8) NTC/PTC/Pt100/Pt1000/TC(J,K)/mV/mA yes protection IP65 dependent on probe°C display 3½ digits |                 |                   |
| <b>accessories for</b>                                                              | 378131                                                                                                                                                                                                                                   |                 |                   |
|  | <b>GEV No.</b>                                                                                                                                                                                                                           | 379050          | <b>Ref. No.</b> — |
|                                                                                     | temperature probe Pt100 cable Vetrotex probe -200 up to +600°C cable -50 up to +350°C probe ø6x100mm cable length 2.7m without screw connection 3-wire                                                                                   |                 |                   |
|  | <b>GEV No.</b>                                                                                                                                                                                                                           | 379160          | <b>Ref. No.</b> — |
|                                                                                     | temperature probe NTC 10kOhm cable thermoplastic probe -40 up to +110°C cable -40 up to +110°C probe ø6x14mm cable length 1.5m without screw connection 2-wire                                                                           |                 |                   |
|  | <b>GEV No.</b>                                                                                                                                                                                                                           | 379781          | <b>Ref. No.</b> — |
|                                                                                     | temperature probe PTC 1kOhm cable thermoplastic probe -50 up to +150°C cable -40 up to +110°C probe ø6x14mm cable length 1.5m without screw connection 2-wire                                                                            |                 |                   |
|  | <b>GEV No.</b>                                                                                                                                                                                                                           | 379944          | <b>Ref. No.</b> — |
|                                                                                     | temperature probe Pt1000 cable Vetrotex probe -70 up to +500°C cable -50 up to +350°C connection 2-wire thread probe ø6x180mm cable length 1.7m                                                                                          |                 |                   |

relay sockets

|                                                                                     |                                                                                                                                        |                 |                   |
|-------------------------------------------------------------------------------------|----------------------------------------------------------------------------------------------------------------------------------------|-----------------|-------------------|
|  |                                                                                                                                        |                 |                   |
| 1                                                                                   |                                                                                                                                        |                 |                   |
| <b>GEV No.</b>                                                                      | 380137                                                                                                                                 | <b>Ref. No.</b> | 5937E             |
| <b>description</b>                                                                  | relay socket 8-pole connection plug-in connection round 8-pole dimensions 65x28x40mm 380V voltage AC 10A Italiana Relè manuf. no. ZVE8 |                 |                   |
| <b>accessories for</b>                                                              | 380137                                                                                                                                 |                 |                   |
|  | <b>GEV No.</b>                                                                                                                         | 380805          | <b>Ref. No.</b> — |
|                                                                                     | support bracket                                                                                                                        |                 |                   |



## solenoid valves

## solenoid valves (water)

## ELBI



1

|                    |                                                                                                                                                  |                 |        |
|--------------------|--------------------------------------------------------------------------------------------------------------------------------------------------|-----------------|--------|
| <b>GEV No.</b>     | 373020                                                                                                                                           | <b>Ref. No.</b> | 241447 |
| <b>description</b> | solenoid valve double angled 230VAC inlet 3/4" outlet 14mm input 10l/min DN10 t.max. 90°C duty cycle 100% ELBI flow regulating valve inlet white |                 |        |

## ROBERTSHAW/INVENSYS

medium temperature: 90°C 90°C 60°C  
 ambient temperature: 60°C 25°C 60°C  
 duty cycle: 40% 100% 100%



1

|                    |                                                                                      |                 |                                    |
|--------------------|--------------------------------------------------------------------------------------|-----------------|------------------------------------|
| <b>GEV No.</b>     | 372017                                                                               | <b>Ref. No.</b> | 144937<br>BAAN171061<br>BAAN302233 |
| <b>description</b> | solenoid valve single straight 230VAC inlet 3/4" outlet 11.5mm DN10 EATON (INVENSYS) |                 |                                    |

## TP



1

|                    |                                                                                                          |                 |                                               |
|--------------------|----------------------------------------------------------------------------------------------------------|-----------------|-----------------------------------------------|
| <b>GEV No.</b>     | 370021                                                                                                   | <b>Ref. No.</b> | 1700434<br>3697E<br>BAAN1320666<br>BAAN302969 |
| <b>description</b> | solenoid valve double straight 230VAC inlet 3/4" outlet 11.5mm DN10 TP flow regulating valve inlet white |                 |                                               |

## spare parts for 370021

|                                 |                |        |                 |   |
|---------------------------------|----------------|--------|-----------------|---|
|                                 | <b>GEV No.</b> | 371013 | <b>Ref. No.</b> | — |
| solenoid coil TP 230VAC 50/60Hz |                |        |                 |   |

## accessories for 370021

|                                                     |                |        |                 |   |
|-----------------------------------------------------|----------------|--------|-----------------|---|
|                                                     | <b>GEV No.</b> | 371220 | <b>Ref. No.</b> | — |
| reducer TP flow rate 3l/min red tolerance ±15%      |                |        |                 |   |
|                                                     | <b>GEV No.</b> | 371221 | <b>Ref. No.</b> | — |
| reducer TP flow rate 5.5l/min yellow tolerance ±15% |                |        |                 |   |
|                                                     | <b>GEV No.</b> | 371222 | <b>Ref. No.</b> | — |
| reducer TP flow rate 6l/min grey tolerance ±15%     |                |        |                 |   |

Зип-Общепит

|                                                          |                |        |                 |   |
|----------------------------------------------------------|----------------|--------|-----------------|---|
|                                                          | <b>GEV No.</b> | 371223 | <b>Ref. No.</b> | — |
| reducer TP flow rate 10l/min white tolerance ±15%        |                |        |                 |   |
|                                                          | <b>GEV No.</b> | 371224 | <b>Ref. No.</b> | — |
| reducer TP flow rate 12l/min bronze tolerance ±15%       |                |        |                 |   |
|                                                          | <b>GEV No.</b> | 371225 | <b>Ref. No.</b> | — |
| reducer TP flow rate 16l/min light brown tolerance ±15%  |                |        |                 |   |
|                                                          | <b>GEV No.</b> | 371226 | <b>Ref. No.</b> | — |
| reducer TP flow rate 20l/min red tolerance ±15%          |                |        |                 |   |
|                                                          | <b>GEV No.</b> | 371230 | <b>Ref. No.</b> | — |
| reducer TP flow rate 0.25l/min red tolerance ±25%        |                |        |                 |   |
|                                                          | <b>GEV No.</b> | 371231 | <b>Ref. No.</b> | — |
| reducer TP flow rate 0.35l/min violet tolerance ±25%     |                |        |                 |   |
|                                                          | <b>GEV No.</b> | 371232 | <b>Ref. No.</b> | — |
| reducer TP flow rate 0.5l/min orange tolerance ±25%      |                |        |                 |   |
|                                                          | <b>GEV No.</b> | 371233 | <b>Ref. No.</b> | — |
| reducer TP flow rate 0.8l/min white tolerance ±25%       |                |        |                 |   |
|                                                          | <b>GEV No.</b> | 371234 | <b>Ref. No.</b> | — |
| reducer TP flow rate 1l/min light blue tolerance ±25%    |                |        |                 |   |
|                                                          | <b>GEV No.</b> | 371235 | <b>Ref. No.</b> | — |
| reducer TP flow rate 1.2l/min brown tolerance ±25%       |                |        |                 |   |
|                                                          | <b>GEV No.</b> | 371236 | <b>Ref. No.</b> | — |
| reducer TP flow rate 1.5l/min light brown tolerance ±25% |                |        |                 |   |
|                                                          | <b>GEV No.</b> | 371237 | <b>Ref. No.</b> | — |
| reducer TP flow rate 2.5l/min yellow tolerance ±25%      |                |        |                 |   |
|                                                          | <b>GEV No.</b> | 371238 | <b>Ref. No.</b> | — |
| reducer TP flow rate 3.4l/min dark green tolerance ±25%  |                |        |                 |   |
|                                                          | <b>GEV No.</b> | 371239 | <b>Ref. No.</b> | — |
| reducer TP flow rate 5l/min black tolerance ±25%         |                |        |                 |   |
|                                                          | <b>GEV No.</b> | 371240 | <b>Ref. No.</b> | — |
| reducer TP flow rate 8l/min blue tolerance ±20%          |                |        |                 |   |

|                                 |                                                                                    |        |                 |        |
|---------------------------------|------------------------------------------------------------------------------------|--------|-----------------|--------|
|                                 | <b>GEV No.</b>                                                                     | 370017 | <b>Ref. No.</b> | 634084 |
| <b>description</b>              | solenoid valve single straight 230VAC inlet 3/4" outlet 11.5mm DN10 TP p max 10bar |        |                 |        |
| <b>spare parts for</b>          | 370017                                                                             |        |                 |        |
|                                 | <b>GEV No.</b>                                                                     | 371013 | <b>Ref. No.</b> | —      |
| solenoid coil TP 230VAC 50/60Hz |                                                                                    |        |                 |        |

Table continues overleaf



Зип-Общепит

vsezip.ru

+7(812)987-08-81

| accessories for 370017                                                              |                                                          | GEV No. | Ref. No. |   |
|-------------------------------------------------------------------------------------|----------------------------------------------------------|---------|----------|---|
|    | reducer TP flow rate 3l/min red tolerance ±15%           | 371220  |          | — |
|    | reducer TP flow rate 5.5l/min yellow tolerance ±15%      | 371221  |          | — |
|    | reducer TP flow rate 6l/min grey tolerance ±15%          | 371222  |          | — |
|    | reducer TP flow rate 10l/min white tolerance ±15%        | 371223  |          | — |
|    | reducer TP flow rate 12l/min bronze tolerance ±15%       | 371224  |          | — |
|    | reducer TP flow rate 16l/min light brown tolerance ±15%  | 371225  |          | — |
|    | reducer TP flow rate 20l/min red tolerance ±15%          | 371226  |          | — |
|    | reducer TP flow rate 0.25l/min red tolerance ±25%        | 371230  |          | — |
|    | reducer TP flow rate 0.35l/min violet tolerance ±25%     | 371231  |          | — |
|   | reducer TP flow rate 0.5l/min orange tolerance ±25%      | 371232  |          | — |
|  | reducer TP flow rate 0.8l/min white tolerance ±25%       | 371233  |          | — |
|  | reducer TP flow rate 1l/min light blue tolerance ±25%    | 371234  |          | — |
|  | reducer TP flow rate 1.2l/min brown tolerance ±25%       | 371235  |          | — |
|  | reducer TP flow rate 1.5l/min light brown tolerance ±25% | 371236  |          | — |
|  | reducer TP flow rate 2.5l/min yellow tolerance ±25%      | 371237  |          | — |
|  | reducer TP flow rate 3.4l/min dark green tolerance ±25%  | 371238  |          | — |
|  | reducer TP flow rate 5l/min black tolerance ±25%         | 371239  |          | — |
|  | reducer TP flow rate 8l/min blue tolerance ±20%          | 371240  |          | — |



| GEV No.                                                                                 | Ref. No.       |            |
|-----------------------------------------------------------------------------------------|----------------|------------|
| 370018                                                                                  | 904693         |            |
| <b>description</b> solenoid valve single straight 230VAC inlet 3/4" outlet 14mm DN10 TP |                |            |
| <b>spare parts for</b> 370018                                                           |                |            |
|        | GEV No. 371013 | Ref. No. — |
| solenoid coil TP 230VAC 50/60Hz                                                         |                |            |
| <b>accessories for</b> 370018                                                           |                |            |
|        | GEV No. 371220 | Ref. No. — |
| reducer TP flow rate 3l/min red tolerance ±15%                                          |                |            |
|        | GEV No. 371221 | Ref. No. — |
| reducer TP flow rate 5.5l/min yellow tolerance ±15%                                     |                |            |
|        | GEV No. 371222 | Ref. No. — |
| reducer TP flow rate 6l/min grey tolerance ±15%                                         |                |            |
|        | GEV No. 371223 | Ref. No. — |
| reducer TP flow rate 10l/min white tolerance ±15%                                       |                |            |
|       | GEV No. 371224 | Ref. No. — |
| reducer TP flow rate 12l/min bronze tolerance ±15%                                      |                |            |
|      | GEV No. 371225 | Ref. No. — |
| reducer TP flow rate 16l/min light brown tolerance ±15%                                 |                |            |
|      | GEV No. 371226 | Ref. No. — |
| reducer TP flow rate 20l/min red tolerance ±15%                                         |                |            |
|      | GEV No. 371230 | Ref. No. — |
| reducer TP flow rate 0.25l/min red tolerance ±25%                                       |                |            |
|      | GEV No. 371231 | Ref. No. — |
| reducer TP flow rate 0.35l/min violet tolerance ±25%                                    |                |            |
|      | GEV No. 371232 | Ref. No. — |
| reducer TP flow rate 0.5l/min orange tolerance ±25%                                     |                |            |
|      | GEV No. 371233 | Ref. No. — |
| reducer TP flow rate 0.8l/min white tolerance ±25%                                      |                |            |
|      | GEV No. 371234 | Ref. No. — |
| reducer TP flow rate 1l/min light blue tolerance ±25%                                   |                |            |
|      | GEV No. 371235 | Ref. No. — |
| reducer TP flow rate 1.2l/min brown tolerance ±25%                                      |                |            |
|      | GEV No. 371236 | Ref. No. — |
| reducer TP flow rate 1.5l/min light brown tolerance ±25%                                |                |            |
|      | GEV No. 371237 | Ref. No. — |
| reducer TP flow rate 2.5l/min yellow tolerance ±25%                                     |                |            |

Table continues overleaf



electric components



Зип-Общепит

vsezip.ru

+7(812)987-08-81

| accessories for                                                                   |          | 370018 |  |   |
|-----------------------------------------------------------------------------------|----------|--------|--|---|
| GEV No.                                                                           | Ref. No. |        |  |   |
|  | 371238   |        |  | — |
| reducer TP flow rate 3.4l/min dark green tolerance ±25%                           |          |        |  |   |
|  | 371239   |        |  | — |
| reducer TP flow rate 5l/min black tolerance ±25%                                  |          |        |  |   |
|  | 371240   |        |  | — |
| reducer TP flow rate 8l/min blue tolerance ±20%                                   |          |        |  |   |



| GEV No. | 370025 | Ref. No. | 314345<br>3664E<br>BAAN305607 |
|---------|--------|----------|-------------------------------|
|---------|--------|----------|-------------------------------|

description solenoid valve triple straight 230VAC inlet 3/4" outlet 11.5mm DN10 TP

| spare parts for                                                                   |          | 370025 |  |   |
|-----------------------------------------------------------------------------------|----------|--------|--|---|
| GEV No.                                                                           | Ref. No. |        |  |   |
|  | 371013   |        |  | — |
| solenoid coil TP 230VAC 50/60Hz                                                   |          |        |  |   |

| accessories for                                                                     |          | 370025 |  |   |
|-------------------------------------------------------------------------------------|----------|--------|--|---|
| GEV No.                                                                             | Ref. No. |        |  |   |
|  | 371220   |        |  | — |
| reducer TP flow rate 3l/min red tolerance ±15%                                      |          |        |  |   |
|  | 371221   |        |  | — |
| reducer TP flow rate 5.5l/min yellow tolerance ±15%                                 |          |        |  |   |
|  | 371222   |        |  | — |
| reducer TP flow rate 6l/min grey tolerance ±15%                                     |          |        |  |   |
|  | 371223   |        |  | — |
| reducer TP flow rate 10l/min white tolerance ±15%                                   |          |        |  |   |
|  | 371224   |        |  | — |
| reducer TP flow rate 12l/min bronze tolerance ±15%                                  |          |        |  |   |
|  | 371225   |        |  | — |
| reducer TP flow rate 16l/min light brown tolerance ±15%                             |          |        |  |   |
|  | 371226   |        |  | — |
| reducer TP flow rate 20l/min red tolerance ±15%                                     |          |        |  |   |
|  | 371230   |        |  | — |
| reducer TP flow rate 0.25l/min red tolerance ±25%                                   |          |        |  |   |
|  | 371231   |        |  | — |
| reducer TP flow rate 0.35l/min violet tolerance ±25%                                |          |        |  |   |
|  | 371232   |        |  | — |
| reducer TP flow rate 0.5l/min orange tolerance ±25%                                 |          |        |  |   |
|  | 371233   |        |  | — |
| reducer TP flow rate 0.8l/min white tolerance ±25%                                  |          |        |  |   |

| accessories for                                                                   |          | 370025 |  |   |
|-----------------------------------------------------------------------------------|----------|--------|--|---|
| GEV No.                                                                           | Ref. No. |        |  |   |
|  | 371234   |        |  | — |
| reducer TP flow rate 1l/min light blue tolerance ±25%                             |          |        |  |   |
|  | 371235   |        |  | — |
| reducer TP flow rate 1.2l/min brown tolerance ±25%                                |          |        |  |   |
|  | 371236   |        |  | — |
| reducer TP flow rate 1.5l/min light brown tolerance ±25%                          |          |        |  |   |
|  | 371237   |        |  | — |
| reducer TP flow rate 2.5l/min yellow tolerance ±25%                               |          |        |  |   |
|  | 371238   |        |  | — |
| reducer TP flow rate 3.4l/min dark green tolerance ±25%                           |          |        |  |   |
|  | 371239   |        |  | — |
| reducer TP flow rate 5l/min black tolerance ±25%                                  |          |        |  |   |
|  | 371240   |        |  | — |
| reducer TP flow rate 8l/min blue tolerance ±20%                                   |          |        |  |   |



| GEV No. | 370020 | Ref. No. | 914123 |
|---------|--------|----------|--------|
|---------|--------|----------|--------|

description solenoid valve double angled 230VAC inlet 3/4" outlet 14mm DN10 TP

| spare parts for                                                                     |          | 370020 |  |   |
|-------------------------------------------------------------------------------------|----------|--------|--|---|
| GEV No.                                                                             | Ref. No. |        |  |   |
|  | 371013   |        |  | — |
| solenoid coil TP 230VAC 50/60Hz                                                     |          |        |  |   |

| accessories for                                                                     |          | 370020 |  |   |
|-------------------------------------------------------------------------------------|----------|--------|--|---|
| GEV No.                                                                             | Ref. No. |        |  |   |
|  | 371220   |        |  | — |
| reducer TP flow rate 3l/min red tolerance ±15%                                      |          |        |  |   |
|  | 371221   |        |  | — |
| reducer TP flow rate 5.5l/min yellow tolerance ±15%                                 |          |        |  |   |
|  | 371222   |        |  | — |
| reducer TP flow rate 6l/min grey tolerance ±15%                                     |          |        |  |   |
|  | 371223   |        |  | — |
| reducer TP flow rate 10l/min white tolerance ±15%                                   |          |        |  |   |
|  | 371224   |        |  | — |
| reducer TP flow rate 12l/min bronze tolerance ±15%                                  |          |        |  |   |
|  | 371225   |        |  | — |
| reducer TP flow rate 16l/min light brown tolerance ±15%                             |          |        |  |   |
|  | 371226   |        |  | — |
| reducer TP flow rate 20l/min red tolerance ±15%                                     |          |        |  |   |











Table continues overleaf



















Зип-Общепит

vsezip.ru

+7(812)987-08-81

| accessories for                                                                     |          | 370020  |          |
|-------------------------------------------------------------------------------------|----------|---------|----------|
| GEV No.                                                                             | Ref. No. | GEV No. | Ref. No. |
|    | 371230   | —       | —        |
| reducer TP flow rate 0.25l/min red tolerance ±25%                                   |          |         |          |
|    | 371231   | —       | —        |
| reducer TP flow rate 0.35l/min violet tolerance ±25%                                |          |         |          |
|    | 371232   | —       | —        |
| reducer TP flow rate 0.5l/min orange tolerance ±25%                                 |          |         |          |
|    | 371233   | —       | —        |
| reducer TP flow rate 0.8l/min white tolerance ±25%                                  |          |         |          |
|    | 371234   | —       | —        |
| reducer TP flow rate 1l/min light blue tolerance ±25%                               |          |         |          |
|    | 371235   | —       | —        |
| reducer TP flow rate 1.2l/min brown tolerance ±25%                                  |          |         |          |
|    | 371236   | —       | —        |
| reducer TP flow rate 1.5l/min light brown tolerance ±25%                            |          |         |          |
|    | 371237   | —       | —        |
| reducer TP flow rate 2.5l/min yellow tolerance ±25%                                 |          |         |          |
|    | 371238   | —       | —        |
| reducer TP flow rate 3.4l/min dark green tolerance ±25%                             |          |         |          |
|   | 371239   | —       | —        |
| reducer TP flow rate 5l/min black tolerance ±25%                                    |          |         |          |
|  | 371240   | —       | —        |
| reducer TP flow rate 8l/min blue tolerance ±20%                                     |          |         |          |

| accessories for                                                                     |          | 370015  |          |
|-------------------------------------------------------------------------------------|----------|---------|----------|
| GEV No.                                                                             | Ref. No. | GEV No. | Ref. No. |
|    | 371225   | —       | —        |
| reducer TP flow rate 16l/min light brown tolerance ±15%                             |          |         |          |
|    | 371226   | —       | —        |
| reducer TP flow rate 2l/min red tolerance ±15%                                      |          |         |          |
|    | 371230   | —       | —        |
| reducer TP flow rate 0.25l/min red tolerance ±25%                                   |          |         |          |
|    | 371231   | —       | —        |
| reducer TP flow rate 0.35l/min violet tolerance ±25%                                |          |         |          |
|    | 371232   | —       | —        |
| reducer TP flow rate 0.5l/min orange tolerance ±25%                                 |          |         |          |
|    | 371233   | —       | —        |
| reducer TP flow rate 0.8l/min white tolerance ±25%                                  |          |         |          |
|    | 371234   | —       | —        |
| reducer TP flow rate 1l/min light blue tolerance ±25%                               |          |         |          |
|    | 371235   | —       | —        |
| reducer TP flow rate 1.2l/min brown tolerance ±25%                                  |          |         |          |
|    | 371236   | —       | —        |
| reducer TP flow rate 1.5l/min light brown tolerance ±25%                            |          |         |          |
|   | 371237   | —       | —        |
| reducer TP flow rate 2.5l/min yellow tolerance ±25%                                 |          |         |          |
|  | 371238   | —       | —        |
| reducer TP flow rate 3.4l/min dark green tolerance ±25%                             |          |         |          |
|  | 371239   | —       | —        |
| reducer TP flow rate 5l/min black tolerance ±25%                                    |          |         |          |
|  | 371240   | —       | —        |
| reducer TP flow rate 8l/min blue tolerance ±20%                                     |          |         |          |

|   |                                                                      |          |        |
|-------------------------------------------------------------------------------------------------------------------------------------------------------------------------|----------------------------------------------------------------------|----------|--------|
| 1                                                                                                                                                                       |                                                                      |          |        |
| GEV No.                                                                                                                                                                 | 370015                                                               | Ref. No. | 634085 |
| description                                                                                                                                                             | solenoid valve single angled 230VAC inlet 3/4" outlet 11.5mm DN10 TP |          |        |
| accessories for                                                                                                                                                         | 370015                                                               |          |        |
|                                                                                      | GEV No. 371220                                                       | Ref. No. | —      |
| reducer TP flow rate 3l/min red tolerance ±15%                                                                                                                          |                                                                      |          |        |
|                                                                                      | GEV No. 371221                                                       | Ref. No. | —      |
| reducer TP flow rate 5.5l/min yellow tolerance ±15%                                                                                                                     |                                                                      |          |        |
|                                                                                      | GEV No. 371222                                                       | Ref. No. | —      |
| reducer TP flow rate 6l/min grey tolerance ±15%                                                                                                                         |                                                                      |          |        |
|                                                                                      | GEV No. 371223                                                       | Ref. No. | —      |
| reducer TP flow rate 10l/min white tolerance ±15%                                                                                                                       |                                                                      |          |        |
|                                                                                      | GEV No. 371224                                                       | Ref. No. | —      |
| reducer TP flow rate 12l/min bronze tolerance ±15%                                                                                                                      |                                                                      |          |        |





|   |                                                                    |          |                                    |
|-------------------------------------------------------------------------------------------------------------------------------------------------------------------------|--------------------------------------------------------------------|----------|------------------------------------|
| 1                                                                                                                                                                       |                                                                    |          |                                    |
| GEV No.                                                                                                                                                                 | 370016                                                             | Ref. No. | 23458<br>BAAN1322350<br>BAAN303848 |
| description                                                                                                                                                             | solenoid valve single angled 230VAC inlet 3/4" outlet 14mm DN10 TP |          |                                    |
| spare parts for                                                                                                                                                         | 370016                                                             |          |                                    |
|                                                                                      | GEV No. 371013                                                     | Ref. No. | —                                  |
| solenoid coil TP 230VAC 50/60Hz                                                                                                                                         |                                                                    |          |                                    |
| accessories for                                                                                                                                                         | 370016                                                             |          |                                    |
|                                                                                      | GEV No. 371220                                                     | Ref. No. | —                                  |
| reducer TP flow rate 3l/min red tolerance ±15%                                                                                                                          |                                                                    |          |                                    |

Table continues overleaf

1 electric components



Зип-Общепит

vsezip.ru

+7(812)987-08-81



| accessories for |                                                          | 370016   |   |
|-----------------|----------------------------------------------------------|----------|---|
| GEV No.         | 371221                                                   | Ref. No. | — |
|                 | reducer TP flow rate 5.5l/min yellow tolerance ±15%      |          |   |
|                 | reducer TP flow rate 6l/min grey tolerance ±15%          |          |   |
|                 | reducer TP flow rate 10l/min white tolerance ±15%        |          |   |
|                 | reducer TP flow rate 12l/min bronze tolerance ±15%       |          |   |
|                 | reducer TP flow rate 16l/min light brown tolerance ±15%  |          |   |
|                 | reducer TP flow rate 20l/min red tolerance ±15%          |          |   |
|                 | reducer TP flow rate 20l/min red tolerance ±15%          |          |   |
|                 | reducer TP flow rate 20l/min red tolerance ±15%          |          |   |
|                 | reducer TP flow rate 0.25l/min red tolerance ±25%        |          |   |
|                 | reducer TP flow rate 0.35l/min violet tolerance ±25%     |          |   |
|                 | reducer TP flow rate 0.5l/min orange tolerance ±25%      |          |   |
|                 | reducer TP flow rate 0.8l/min white tolerance ±25%       |          |   |
|                 | reducer TP flow rate 1l/min light blue tolerance ±25%    |          |   |
|                 | reducer TP flow rate 1.2l/min brown tolerance ±25%       |          |   |
|                 | reducer TP flow rate 1.5l/min light brown tolerance ±25% |          |   |
|                 | reducer TP flow rate 2.5l/min yellow tolerance ±25%      |          |   |
|                 | reducer TP flow rate 3.4l/min dark green tolerance ±25%  |          |   |
|                 | reducer TP flow rate 5l/min black tolerance ±25%         |          |   |
|                 | reducer TP flow rate 8l/min blue tolerance ±20%          |          |   |
|                 | solenoid valve filter ø 19.5mm H 16mm                    |          |   |

| GEV No.                | 370024                                                             | Ref. No. | 634089   |
|------------------------|--------------------------------------------------------------------|----------|----------|
| <b>description</b>     | solenoid valve triple angled 230VAC inlet 3/4" outlet 14mm DN10 TP |          |          |
| <b>spare parts for</b> | 370024                                                             |          |          |
|                        | GEV No.                                                            | 371013   | Ref. No. |
|                        | solenoid coil TP 230VAC 50/60Hz                                    |          |          |
| <b>accessories for</b> | 370024                                                             |          |          |
|                        | GEV No.                                                            | 371220   | Ref. No. |
|                        | reducer TP flow rate 3l/min red tolerance ±15%                     |          |          |
|                        | GEV No.                                                            | 371221   | Ref. No. |
|                        | reducer TP flow rate 5.5l/min yellow tolerance ±15%                |          |          |
|                        | GEV No.                                                            | 371222   | Ref. No. |
|                        | reducer TP flow rate 6l/min grey tolerance ±15%                    |          |          |
|                        | GEV No.                                                            | 371223   | Ref. No. |
|                        | reducer TP flow rate 10l/min white tolerance ±15%                  |          |          |
|                        | GEV No.                                                            | 371224   | Ref. No. |
|                        | reducer TP flow rate 12l/min bronze tolerance ±15%                 |          |          |
|                        | GEV No.                                                            | 371225   | Ref. No. |
|                        | reducer TP flow rate 16l/min light brown tolerance ±15%            |          |          |
|                        | GEV No.                                                            | 371226   | Ref. No. |
|                        | reducer TP flow rate 20l/min red tolerance ±15%                    |          |          |
|                        | GEV No.                                                            | 371230   | Ref. No. |
|                        | reducer TP flow rate 0.25l/min red tolerance ±25%                  |          |          |
|                        | GEV No.                                                            | 371231   | Ref. No. |
|                        | reducer TP flow rate 0.35l/min violet tolerance ±25%               |          |          |
|                        | GEV No.                                                            | 371232   | Ref. No. |
|                        | reducer TP flow rate 0.5l/min orange tolerance ±25%                |          |          |
|                        | GEV No.                                                            | 371233   | Ref. No. |
|                        | reducer TP flow rate 0.8l/min white tolerance ±25%                 |          |          |
|                        | GEV No.                                                            | 371234   | Ref. No. |
|                        | reducer TP flow rate 1l/min light blue tolerance ±25%              |          |          |
|                        | GEV No.                                                            | 371235   | Ref. No. |
|                        | reducer TP flow rate 1.2l/min brown tolerance ±25%                 |          |          |
|                        | GEV No.                                                            | 371236   | Ref. No. |
|                        | reducer TP flow rate 1.5l/min light brown tolerance ±25%           |          |          |
|                        | GEV No.                                                            | 371237   | Ref. No. |
|                        | reducer TP flow rate 2.5l/min yellow tolerance ±25%                |          |          |

Table continues overleaf





Зип-Общепит

vsezip.ru

ebm-papst

+7(812)987-08-81

| accessories for                                                                   |                                                         | 370024   |   |
|-----------------------------------------------------------------------------------|---------------------------------------------------------|----------|---|
| GEV No.                                                                           | 371238                                                  | Ref. No. | — |
|  | reducer TP flow rate 3.4l/min dark green tolerance ±25% |          |   |
| GEV No.                                                                           | 371239                                                  | Ref. No. | — |
|  | reducer TP flow rate 5l/min black tolerance ±25%        |          |   |
| GEV No.                                                                           | 371240                                                  | Ref. No. | — |
|  | reducer TP flow rate 8l/min blue tolerance ±20%         |          |   |

solenoid valves with reducers

|  |                                                                      |          |        |
|-----------------------------------------------------------------------------------|----------------------------------------------------------------------|----------|--------|
| 1                                                                                 |                                                                      |          |        |
| GEV No.                                                                           | 370255                                                               | Ref. No. | 914135 |
| description                                                                       | solenoid valve triple angled 230VAC inlet 3/4" outlet 11.5mm plastic |          |        |

|  |                                                                                                                                             |          |        |
|------------------------------------------------------------------------------------|---------------------------------------------------------------------------------------------------------------------------------------------|----------|--------|
| 1                                                                                  |                                                                                                                                             |          |        |
| GEV No.                                                                            | 370250                                                                                                                                      | Ref. No. | 147723 |
| description                                                                        | solenoid valve triple straight 230VAC inlet 3/4" outlet 11.5mm t.max. 90°C TP plastic output B 0.25l/min flow regulating valve outlet B red |          |        |



ball valves electric

|  |                                                                                                                                                           |          |        |
|-------------------------------------------------------------------------------------|-----------------------------------------------------------------------------------------------------------------------------------------------------------|----------|--------|
| 1                                                                                   |                                                                                                                                                           |          |        |
| GEV No.                                                                             | 401190                                                                                                                                                    | Ref. No. | 314359 |
| description                                                                         | ball valve inlet 3/4" IT outlet 3/4" IT IP42 230V L 68mm 50/60Hz closed off-current mode of operation electric connection cable 300mm 3.5W duty cycle 50% |          |        |

axial fans

ebm-papst





| 1                                                                                 |                                                                                                                                                                          |          |           |
|-----------------------------------------------------------------------------------|--------------------------------------------------------------------------------------------------------------------------------------------------------------------------|----------|-----------|
| GEV No.                                                                           | 601030 <sup>1</sup>                                                                                                                                                      | Ref. No. | 780002656 |
| description                                                                       | axial fan L 119mm W 119mm H 38mm 230VAC 50Hz 18W bearing ball bearing manuf. no. 4656Z metal connection male faston 2.8mm ebm-papst fan wheel ø 110mm temp.-resist. 75°C |          |           |
| accessories for                                                                   | 601030                                                                                                                                                                   |          |           |
| GEV No.                                                                           | 550898                                                                                                                                                                   | Ref. No. | —         |
|  | connecting cable cable length 2000mm connection F 2.8 connection distance 7.9mm for axial flow fan                                                                       |          |           |
| GEV No.                                                                           | 692497                                                                                                                                                                   | Ref. No. | —         |
|  | guard ø 105mm mounting distance 150mm for axial fan ebm-papst-mm                                                                                                         |          |           |

<sup>1</sup>with ball bearings

import



| 1                                                                                   |                                                                                                                                                          |          |                                                           |
|-------------------------------------------------------------------------------------|----------------------------------------------------------------------------------------------------------------------------------------------------------|----------|-----------------------------------------------------------|
| GEV No.                                                                             | 601080 <sup>1</sup>                                                                                                                                      | Ref. No. | 304194<br>780002656<br>906107<br>BAAN167195<br>BAAN312100 |
| description                                                                         | axial fan L 119mm W 119mm H 38mm 230VAC 50/60Hz 23/20W bearing ball bearing connection male faston 2.8mm metal ADDA fan wheel ø 110mm temp.-resist. 70°C |          |                                                           |
| accessories for                                                                     | 601080                                                                                                                                                   |          |                                                           |
| GEV No.                                                                             | 550898                                                                                                                                                   | Ref. No. | —                                                         |
|  | connecting cable cable length 2000mm connection F 2.8 connection distance 7.9mm for axial flow fan                                                       |          |                                                           |
| GEV No.                                                                             | 692519                                                                                                                                                   | Ref. No. | —                                                         |
|  | guard L 120mm W 120mm plastic                                                                                                                            |          |                                                           |

<sup>1</sup>with ball bearings

electric components



## cross flow fans

## COPREL

with standard coil



1

|                    |                                                                                                                                                                                                                                                  |                 |        |
|--------------------|--------------------------------------------------------------------------------------------------------------------------------------------------------------------------------------------------------------------------------------------------|-----------------|--------|
| <b>GEV No.</b>     | 602060                                                                                                                                                                                                                                           | <b>Ref. No.</b> | 304229 |
| <b>description</b> | cross flow fan COPREL FFR roller $\varnothing$ 60mm roller length 240mm laminated core thickness 20mm motor position right 230V/50-60Hz 33W universal bearing silicone connection male faston 6.3mm airflow 149m <sup>3</sup> /h -10 up to +60°C |                 |        |

## hot air motors



1

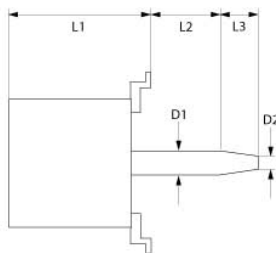

|                    |                                                                                                               |                 |        |
|--------------------|---------------------------------------------------------------------------------------------------------------|-----------------|--------|
| <b>GEV No.</b>     | 500812                                                                                                        | <b>Ref. No.</b> | 71251E |
| <b>description</b> | fan motor 220-240/380-415V 3 phase 50Hz 0.26kW 1440rpm speeds 1 D1 $\varnothing$ 17mm D2 $\varnothing$ 13.5mm |                 |        |



1

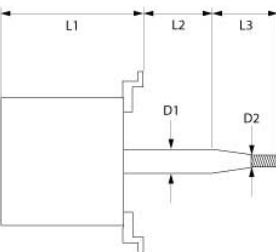

|                    |                                                                                                                                                                                                              |                 |                                      |
|--------------------|--------------------------------------------------------------------------------------------------------------------------------------------------------------------------------------------------------------|-----------------|--------------------------------------|
| <b>GEV No.</b>     | 499206                                                                                                                                                                                                       | <b>Ref. No.</b> | 304267<br>BAAN1050261<br>BAAN1051644 |
| <b>description</b> | fan motor 230/400V 3 phase 50/60Hz 0.12kW 1400/1700rpm speeds 2 L1 145mm L2 30mm L3 25mm D1 $\varnothing$ 17mm D2 $\varnothing$ 14mm M6 1.2/0.7A suitable capacitor 16 $\mu$ F/450V Cos(fi) 0.53 type 1079TH |                 |                                      |

Зип.Общепит

## wash and rinse pumps

vsezip.ru



HANNING

pumps

+7(812)987-08-81



1

|                                                                                     |                                                                                                                                                                                              |                 |                                   |
|-------------------------------------------------------------------------------------|----------------------------------------------------------------------------------------------------------------------------------------------------------------------------------------------|-----------------|-----------------------------------|
| <b>GEV No.</b>                                                                      | 499284                                                                                                                                                                                       | <b>Ref. No.</b> | 314361                            |
| <b>description</b>                                                                  | pump inlet $\varnothing$ 28mm outlet $\varnothing$ 26mm type UP60-321 Ru. 220-240V 50Hz 1 phase 0.27kW L 190mm rotation direction right capacitor 5 $\mu$ F HANNING                          |                 |                                   |
| <b>spare parts for</b>                                                              | 499284                                                                                                                                                                                       |                 |                                   |
|    | <b>GEV No.</b>                                                                                                                                                                               | 365017          | <b>Ref. No.</b> 2000001<br>304269 |
|                                                                                     | operating capacitor capacity 5 $\mu$ F 450V tolerance 5% 50/60Hz ambient temperature max. -25 to +85°C $\varnothing$ 28mm L 54mm M8 plastic connection male faston 6.3mm 16.10.08 protection |                 |                                   |
|  | <b>GEV No.</b>                                                                                                                                                                               | 507558          | <b>Ref. No.</b> —                 |
|                                                                                     | mechanical shaft seal for shaft $\varnothing$ 7mm height counter ring 5mm ID $\varnothing$ 6.75mm ED $\varnothing$ 20mm mounting $\varnothing$ counter ring 18.5/slide ring 20mm             |                 |                                   |
|  | <b>GEV No.</b>                                                                                                                                                                               | 532644          | <b>Ref. No.</b> —                 |
|                                                                                     | O-ring EPDM thickness 3mm ID $\varnothing$ 78mm Qty 1 pcs                                                                                                                                    |                 |                                   |

## drain pumps

## ASKOLL



1

|                    |                                                                                                             |                 |          |
|--------------------|-------------------------------------------------------------------------------------------------------------|-----------------|----------|
| <b>GEV No.</b>     | 500346                                                                                                      | <b>Ref. No.</b> | 2001518H |
| <b>description</b> | drain pump inlet $\varnothing$ 30mm outlet $\varnothing$ 22mm 230V 40W 50Hz ASKOLL type M231 XP with holder |                 |          |





booster pumps II

Зип Общепит

vsezip.ru

+7(812)987-08-81

accessories



1

|                    |                                                                                                                                                                            |                 |                   |
|--------------------|----------------------------------------------------------------------------------------------------------------------------------------------------------------------------|-----------------|-------------------|
| <b>GEV No.</b>     | 365017                                                                                                                                                                     | <b>Ref. No.</b> | 2000001<br>304269 |
| <b>description</b> | operating capacitor capacity 5µF 450V tolerance 5% 50/60Hz ambient temperature max. -25 to +85°C ø 28mm L 54mm M8 plastic connection male faston 6.3mm 16.10.08 protection |                 |                   |



1

|                    |                                                                                                                                                                  |                 |         |
|--------------------|------------------------------------------------------------------------------------------------------------------------------------------------------------------|-----------------|---------|
| <b>GEV No.</b>     | 365012                                                                                                                                                           | <b>Ref. No.</b> | 2000059 |
| <b>description</b> | operating capacitor capacity 6.3µF 450V tolerance 5% 50Hz ambient temperature max. -25 to +85°C ø 30mm L 61mm M8 plastic connection male faston 6.3mm protection |                 |         |

condensators & interference suppression filters

operating capacitors

plastic



1

|                    |                                                                                                                                                                                     |                 |                    |
|--------------------|-------------------------------------------------------------------------------------------------------------------------------------------------------------------------------------|-----------------|--------------------|
| <b>GEV No.</b>     | 365021                                                                                                                                                                              | <b>Ref. No.</b> | 2001118H<br>304259 |
| <b>description</b> | operating capacitor capacity 16µF 425V tolerance 5% 50/60Hz ambient temperature max. -25 to +85°C ø 35mm L 73mm single M8 plastic connection male faston 6.3mm 416.10.99 protection |                 |                    |



1

|                    |                                                                                                                                                                                |                 |          |
|--------------------|--------------------------------------------------------------------------------------------------------------------------------------------------------------------------------|-----------------|----------|
| <b>GEV No.</b>     | 365019                                                                                                                                                                         | <b>Ref. No.</b> | 2001119H |
| <b>description</b> | operating capacitor capacity 20µF 400V tolerance 5% 50/60Hz ambient temperature max. -25 to +85°C ø 39.5mm L 70mm M8 plastic connection male faston 6.3mm 16.10.25. protection |                 |          |



|                    |                                                                                                                                                                            |                 |                   |
|--------------------|----------------------------------------------------------------------------------------------------------------------------------------------------------------------------|-----------------|-------------------|
| <b>GEV No.</b>     | 365017                                                                                                                                                                     | <b>Ref. No.</b> | 2000001<br>304269 |
| <b>description</b> | operating capacitor capacity 5µF 450V tolerance 5% 50/60Hz ambient temperature max. -25 to +85°C ø 28mm L 54mm M8 plastic connection male faston 6.3mm 16.10.08 protection |                 |                   |



1

|                    |                                                                                                                                                                  |                 |         |
|--------------------|------------------------------------------------------------------------------------------------------------------------------------------------------------------|-----------------|---------|
| <b>GEV No.</b>     | 365012                                                                                                                                                           | <b>Ref. No.</b> | 2000059 |
| <b>description</b> | operating capacitor capacity 6.3µF 450V tolerance 5% 50Hz ambient temperature max. -25 to +85°C ø 30mm L 61mm M8 plastic connection male faston 6.3mm protection |                 |         |



1

|                    |                                                                                                                                                                  |                 |       |
|--------------------|------------------------------------------------------------------------------------------------------------------------------------------------------------------|-----------------|-------|
| <b>GEV No.</b>     | 365013                                                                                                                                                           | <b>Ref. No.</b> | 3709E |
| <b>description</b> | operating capacitor capacity 8µF 400V tolerance 5% 50Hz ambient temperature max. -25 to +85°C ø 31.5mm L 55mm M8 plastic connection male faston 6.3mm protection |                 |       |

metal



1

|                    |                                                                                                                                                                                    |                 |       |
|--------------------|------------------------------------------------------------------------------------------------------------------------------------------------------------------------------------|-----------------|-------|
| <b>GEV No.</b>     | 365139                                                                                                                                                                             | <b>Ref. No.</b> | 5843E |
| <b>description</b> | operating capacitor capacity 10µF 450V tolerance 5% 60Hz ambient temperature max. -25 up to +70°C ø 40mm L 83mm M8 aluminium connection male faston 6.3mm C.87.8BF2 MKP protection |                 |       |

Зип Общепит  
gas thermostats

PEL  
2551 series

+7(812)987-08-81

fuses

fine fuses



|                                                                                    |                |        |                 |        |
|------------------------------------------------------------------------------------|----------------|--------|-----------------|--------|
| 1                                                                                  | <b>GEV No.</b> | 358666 | <b>Ref. No.</b> | 309316 |
| <b>description</b> fine fuse size ø5x20mm 0.315A fast-acting rated 250V Qty 10 pcs |                |        |                 |        |



|                                                                                  |                |        |                 |          |
|----------------------------------------------------------------------------------|----------------|--------|-----------------|----------|
| 1                                                                                | <b>GEV No.</b> | 358530 | <b>Ref. No.</b> | 2001921H |
| <b>description</b> fine fuse size ø5x20mm 0.8A fast-acting rated 250V Qty 10 pcs |                |        |                 |          |



|                                                                                |                |        |                 |                      |
|--------------------------------------------------------------------------------|----------------|--------|-----------------|----------------------|
| 1                                                                              | <b>GEV No.</b> | 358677 | <b>Ref. No.</b> | 2001981H<br>2002146H |
| <b>description</b> fine fuse size ø5x20mm 4A fast-acting rated 250V Qty 10 pcs |                |        |                 |                      |



|                                                                                   |                |        |                 |         |
|-----------------------------------------------------------------------------------|----------------|--------|-----------------|---------|
| 1                                                                                 | <b>GEV No.</b> | 358752 | <b>Ref. No.</b> | 3090506 |
| <b>description</b> fine fuse size ø6.3x32mm 10A fast-acting rated 500V Qty 10 pcs |                |        |                 |         |

electric accessories

terminals

connection terminals with screw/faston connections



|                                                                                                                                                         |                |        |                 |                                                 |
|---------------------------------------------------------------------------------------------------------------------------------------------------------|----------------|--------|-----------------|-------------------------------------------------|
| 1                                                                                                                                                       | <b>GEV No.</b> | 550411 | <b>Ref. No.</b> | 2001039H<br>306090<br>306157<br>5876E<br>906154 |
| <b>description</b> power terminal block 6-pole max. 40A max 450V connection ø6mm <sup>2</sup> / F6.3 temp.-resist. 150°C cross section 6mm <sup>2</sup> |                |        |                 |                                                 |

|                                                                                                                                                                                                                                                                                                          |                |        |                 |        |
|----------------------------------------------------------------------------------------------------------------------------------------------------------------------------------------------------------------------------------------------------------------------------------------------------------|----------------|--------|-----------------|--------|
| 1                                                                                                                                                                                                                                                                                                        | <b>GEV No.</b> | 101172 | <b>Ref. No.</b> | 310137 |
| <b>description</b> gas thermostat PEL type 255T 100-300°C gas inlet M16x1.5 (tube ø 10mm) bypass nozzle ø 0.35mm gas outlet M16x1.5 (tube ø 10/8mm) thermocouple connection M9x1 pilot connection M10x1 capillary pipe 1200mm probe ø 6mm probe L 100mm shaft ø 8x6.5mm shaft L 21/15mm shaft flat upper |                |        |                 |        |

|                                                                                   |                |        |                 |   |
|-----------------------------------------------------------------------------------|----------------|--------|-----------------|---|
| <b>spare parts for</b> 101172                                                     |                |        |                 |   |
|  | <b>GEV No.</b> | 100259 | <b>Ref. No.</b> | — |

bypass nozzle type PEL22 bore ø 0.35mm thread M6x0.5

|                                                                                   |                |        |                 |                       |
|-----------------------------------------------------------------------------------|----------------|--------|-----------------|-----------------------|
|  | <b>GEV No.</b> | 101060 | <b>Ref. No.</b> | 7473048<br>BAAN310651 |
|-----------------------------------------------------------------------------------|----------------|--------|-----------------|-----------------------|

magnet unit standard L 39mm D1 ø 15.4mm D2 ø 11mm suitable for PEL20-21/JUNKERS/EGA

|                                                                                   |                |        |                 |   |
|-----------------------------------------------------------------------------------|----------------|--------|-----------------|---|
|  | <b>GEV No.</b> | 106200 | <b>Ref. No.</b> | — |
|-----------------------------------------------------------------------------------|----------------|--------|-----------------|---|

nut thread M9x1 suitable for PEL 24/255

|                               |  |  |  |  |
|-------------------------------|--|--|--|--|
| <b>accessories for</b> 101172 |  |  |  |  |
|-------------------------------|--|--|--|--|

|                                                                                    |                |        |                 |   |
|------------------------------------------------------------------------------------|----------------|--------|-----------------|---|
|  | <b>GEV No.</b> | 100908 | <b>Ref. No.</b> | — |
|------------------------------------------------------------------------------------|----------------|--------|-----------------|---|

union screw thread M10x1 for pipe ø 4mm Qty 1 pcs

|                                                                                     |                |        |                 |   |
|-------------------------------------------------------------------------------------|----------------|--------|-----------------|---|
|  | <b>GEV No.</b> | 100909 | <b>Ref. No.</b> | — |
|-------------------------------------------------------------------------------------|----------------|--------|-----------------|---|

union screw thread M10x1 for pipe ø 6mm Qty 1 pcs

|                                                                                     |                |        |                 |   |
|-------------------------------------------------------------------------------------|----------------|--------|-----------------|---|
|  | <b>GEV No.</b> | 101246 | <b>Ref. No.</b> | — |
|-------------------------------------------------------------------------------------|----------------|--------|-----------------|---|

olive for pipe ø 4mm Qty 1 pcs

|                                                                                     |                |        |                 |   |
|-------------------------------------------------------------------------------------|----------------|--------|-----------------|---|
|  | <b>GEV No.</b> | 101278 | <b>Ref. No.</b> | — |
|-------------------------------------------------------------------------------------|----------------|--------|-----------------|---|

olive for pipe ø 10mm Qty 1 pcs

|                                                                                     |                |        |                 |   |
|-------------------------------------------------------------------------------------|----------------|--------|-----------------|---|
|  | <b>GEV No.</b> | 101286 | <b>Ref. No.</b> | — |
|-------------------------------------------------------------------------------------|----------------|--------|-----------------|---|

olive ID ø 6mm Qty 1 pcs

|                                                                                     |                |        |                 |   |
|-------------------------------------------------------------------------------------|----------------|--------|-----------------|---|
|  | <b>GEV No.</b> | 101300 | <b>Ref. No.</b> | — |
|-------------------------------------------------------------------------------------|----------------|--------|-----------------|---|

union nut thread M16x1.5 tube ø 10mm

|                                                                                     |                |        |                 |   |
|-------------------------------------------------------------------------------------|----------------|--------|-----------------|---|
|  | <b>GEV No.</b> | 101450 | <b>Ref. No.</b> | — |
|-------------------------------------------------------------------------------------|----------------|--------|-----------------|---|

olive for pipe ø 8mm L 12.7mm Qty 1 pcs ED ø 10mm

|                                                                                     |                |        |                 |   |
|-------------------------------------------------------------------------------------|----------------|--------|-----------------|---|
|  | <b>GEV No.</b> | 101451 | <b>Ref. No.</b> | — |
|-------------------------------------------------------------------------------------|----------------|--------|-----------------|---|

union nut thread M16x1.5 tube ø 8mm

|                                                                                     |                |        |                 |   |
|-------------------------------------------------------------------------------------|----------------|--------|-----------------|---|
|  | <b>GEV No.</b> | 110079 | <b>Ref. No.</b> | — |
|-------------------------------------------------------------------------------------|----------------|--------|-----------------|---|

knob dial plate gas thermostat 1-8 silver

|                                                                                     |                |        |                 |        |
|-------------------------------------------------------------------------------------|----------------|--------|-----------------|--------|
|  | <b>GEV No.</b> | 110081 | <b>Ref. No.</b> | 171475 |
|-------------------------------------------------------------------------------------|----------------|--------|-----------------|--------|

knob ø 70mm shaft ø 8x6.5mm shaft flat universal



gas valves and ignition boxes

Зип-Общепит









gas control valves

SIT

ELETTROSIT



1

|                                                                                     |                                                                                                                                                    |                 |                                      |
|-------------------------------------------------------------------------------------|----------------------------------------------------------------------------------------------------------------------------------------------------|-----------------|--------------------------------------|
| <b>GEV No.</b>                                                                      | 101127                                                                                                                                             | <b>Ref. No.</b> | 7472025<br>BAAN1209942<br>BAAN310630 |
| <b>description</b>                                                                  | gas valve SIT type ELETTROSIT 230V gas inlet 3/4" gas outlet 3/4" thermocouple connection M9x1 pilot connection M10x1 lateral equiv. no. 0.810.175 |                 |                                      |
| <b>spare parts for</b>                                                              | 101127                                                                                                                                             |                 |                                      |
|    | <b>GEV No.</b>                                                                                                                                     | 101312          | <b>Ref. No.</b> —                    |
|                                                                                     | microswitch                                                                                                                                        |                 |                                      |
|  | <b>GEV No.</b>                                                                                                                                     | 101352          | <b>Ref. No.</b> —                    |
|                                                                                     | solenoid coil 230V 50Hz suitable for ELETTROSIT                                                                                                    |                 |                                      |
| <b>accessories for</b>                                                              | 101127                                                                                                                                             |                 |                                      |
|  | <b>GEV No.</b>                                                                                                                                     | 100006          | <b>Ref. No.</b> —                    |
|                                                                                     | piezoelectric igniter suitable for ELETTROSIT body plastic blowing connection $\varnothing 2.4\text{mm}$ $\varnothing 14\text{mm}$                 |                 |                                      |
|  | <b>GEV No.</b>                                                                                                                                     | 100904          | <b>Ref. No.</b> —                    |
|                                                                                     | locking screw M10x1 for pipe $\varnothing 4\text{mm}$ Qty 1 pcs                                                                                    |                 |                                      |
|  | <b>GEV No.</b>                                                                                                                                     | 100905          | <b>Ref. No.</b> —                    |
|                                                                                     | locking screw M10x1 for pipe $\varnothing 6\text{mm}$ Qty 1 pcs                                                                                    |                 |                                      |
|  | <b>GEV No.</b>                                                                                                                                     | 101301          | <b>Ref. No.</b> —                    |
|                                                                                     | gas connection thread 1/2" straight ELETTROSIT screw with O-ring                                                                                   |                 |                                      |
|  | <b>GEV No.</b>                                                                                                                                     | 101303          | <b>Ref. No.</b> —                    |
|                                                                                     | gas connection straight thread 3/4" ELETTROSIT                                                                                                     |                 |                                      |
|  | <b>GEV No.</b>                                                                                                                                     | 101309          | <b>Ref. No.</b> —                    |
|                                                                                     | extension                                                                                                                                          |                 |                                      |

accessories



1

|                                                                                   |                                      |                 |                   |
|-----------------------------------------------------------------------------------|--------------------------------------|-----------------|-------------------|
| <b>GEV No.</b>                                                                    | 101313                               | <b>Ref. No.</b> | 2020037           |
| <b>description</b>                                                                | solenoid coil 230V 50Hz              |                 |                   |
| <b>accessories for</b>                                                            | 101313                               |                 |                   |
|  | <b>GEV No.</b>                       | 550896          | <b>Ref. No.</b> — |
|                                                                                   | gasket with screw gas valves NOVASIT |                 |                   |

TANDEM

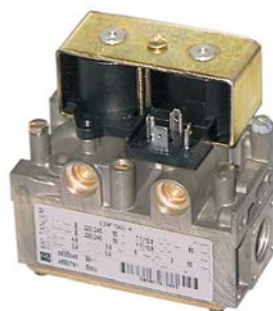

1









|                                                                                     |                                                                                                                                                                                                          |                 |                                    |
|-------------------------------------------------------------------------------------|----------------------------------------------------------------------------------------------------------------------------------------------------------------------------------------------------------|-----------------|------------------------------------|
| <b>GEV No.</b>                                                                      | 101189                                                                                                                                                                                                   | <b>Ref. No.</b> | 310305<br>BAAN829205<br>BAAN847641 |
| <b>description</b>                                                                  | gas valve 230V 50Hz gas inlet 1/2" gas outlet 1/2" pilot connection M10x1 level slow ignition ignition times pressure range 3-50mbar power supply for modulator equiv. no. 0.830.040 suitable for Tandem |                 |                                    |
| <b>spare parts for</b>                                                              | 101189                                                                                                                                                                                                   |                 |                                    |
|  | <b>GEV No.</b>                                                                                                                                                                                           | 101379          | <b>Ref. No.</b> —                  |
|                                                                                     | solenoid coil 230V 50Hz suitable for Tandem                                                                                                                                                              |                 |                                    |
| <b>accessories for</b>                                                              | 101189                                                                                                                                                                                                   |                 |                                    |
|  | <b>GEV No.</b>                                                                                                                                                                                           | 100904          | <b>Ref. No.</b> —                  |
|                                                                                     | locking screw M10x1 for pipe $\varnothing 4\text{mm}$ Qty 1 pcs                                                                                                                                          |                 |                                    |
|  | <b>GEV No.</b>                                                                                                                                                                                           | 100905          | <b>Ref. No.</b> —                  |
|                                                                                     | locking screw M10x1 for pipe $\varnothing 6\text{mm}$ Qty 1 pcs                                                                                                                                          |                 |                                    |
|  | <b>GEV No.</b>                                                                                                                                                                                           | 101274          | <b>Ref. No.</b> —                  |
|                                                                                     | olive for pipe $\varnothing 16\text{mm}$ Qty 1 pcs                                                                                                                                                       |                 |                                    |
|  | <b>GEV No.</b>                                                                                                                                                                                           | 101275          | <b>Ref. No.</b> —                  |
|                                                                                     | union screw thread 1/2" for pipe $\varnothing 16\text{mm}$ Qty 1 pcs                                                                                                                                     |                 |                                    |
|  | <b>GEV No.</b>                                                                                                                                                                                           | 101925          | <b>Ref. No.</b> —                  |
|                                                                                     | plug with O-ring thread M10x1 for pilot burner suitable for NOVASIT                                                                                                                                      |                 |                                    |
|  | <b>GEV No.</b>                                                                                                                                                                                           | 102845          | <b>Ref. No.</b> —                  |
|                                                                                     | gas connection angled 1/2" flange 32x32mm hole distance 24x24mm Tandem                                                                                                                                   |                 |                                    |
|  | <b>GEV No.</b>                                                                                                                                                                                           | 102846          | <b>Ref. No.</b> —                  |
|                                                                                     | gas connection straight 1/2" flange 32x32mm hole distance 24x24mm suitable for Tandem                                                                                                                    |                 |                                    |

Table continues overleaf

gas components

Зип-Общепит  
vsezip.ru  
+7(812)987-08-81

|                                                                                   |                |        |                   |
|-----------------------------------------------------------------------------------|----------------|--------|-------------------|
| <b>accessories for</b>                                                            | 101189         |        |                   |
|  | <b>GEV No.</b> | 102847 | <b>Ref. No.</b> — |
|                                                                                   | O-ring         |        |                   |





|                    |                                                                                                                                            |                 |        |
|--------------------|--------------------------------------------------------------------------------------------------------------------------------------------|-----------------|--------|
| <b>GEV No.</b>     | 107831                                                                                                                                     | <b>Ref. No.</b> | 310196 |
| <b>description</b> | gas valve 230V 50Hz gas inlet 1/2" gas outlet 1/2" pilot connection M10x1 pressure range 3-50mbar type Tandem 830 SIT equiv. no. 0.830.030 |                 |        |

|                                                                                   |                                             |        |                   |
|-----------------------------------------------------------------------------------|---------------------------------------------|--------|-------------------|
| <b>spare parts for</b>                                                            | 107831                                      |        |                   |
|  | <b>GEV No.</b>                              | 101379 | <b>Ref. No.</b> — |
|                                                                                   | solenoid coil 230V 50Hz suitable for Tandem |        |                   |

|                                                                                   |                                              |        |                   |
|-----------------------------------------------------------------------------------|----------------------------------------------|--------|-------------------|
| <b>accessories for</b>                                                            | 107831                                       |        |                   |
|  | <b>GEV No.</b>                               | 100904 | <b>Ref. No.</b> — |
|                                                                                   | locking screw M10x1 for pipe ø 4mm Qty 1 pcs |        |                   |

|                                                                                     |                                              |        |                   |
|-------------------------------------------------------------------------------------|----------------------------------------------|--------|-------------------|
|  | <b>GEV No.</b>                               | 100905 | <b>Ref. No.</b> — |
|                                                                                     | locking screw M10x1 for pipe ø 6mm Qty 1 pcs |        |                   |

|                                                                                     |                                 |        |                   |
|-------------------------------------------------------------------------------------|---------------------------------|--------|-------------------|
|  | <b>GEV No.</b>                  | 101274 | <b>Ref. No.</b> — |
|                                                                                     | olive for pipe ø 16mm Qty 1 pcs |        |                   |

|                                                                                     |                                                   |        |                   |
|-------------------------------------------------------------------------------------|---------------------------------------------------|--------|-------------------|
|  | <b>GEV No.</b>                                    | 101275 | <b>Ref. No.</b> — |
|                                                                                     | union screw thread 1/2" for pipe ø 16mm Qty 1 pcs |        |                   |

|                                                                                     |                                                                     |        |                   |
|-------------------------------------------------------------------------------------|---------------------------------------------------------------------|--------|-------------------|
|  | <b>GEV No.</b>                                                      | 101925 | <b>Ref. No.</b> — |
|                                                                                     | plug with O-ring thread M10x1 for pilot burner suitable for NOVASIT |        |                   |

|                                                                                     |                                                                        |        |                   |
|-------------------------------------------------------------------------------------|------------------------------------------------------------------------|--------|-------------------|
|  | <b>GEV No.</b>                                                         | 102845 | <b>Ref. No.</b> — |
|                                                                                     | gas connection angled 1/2" flange 32x32mm hole distance 24x24mm Tandem |        |                   |

|                                                                                     |                                                                                       |        |                   |
|-------------------------------------------------------------------------------------|---------------------------------------------------------------------------------------|--------|-------------------|
|  | <b>GEV No.</b>                                                                        | 102846 | <b>Ref. No.</b> — |
|                                                                                     | gas connection straight 1/2" flange 32x32mm hole distance 24x24mm suitable for Tandem |        |                   |

|                                                                                     |                |        |                   |
|-------------------------------------------------------------------------------------|----------------|--------|-------------------|
|  | <b>GEV No.</b> | 102847 | <b>Ref. No.</b> — |
|                                                                                     | O-ring         |        |                   |

|                                                                                    |                                                                                                |        |                                                      |
|------------------------------------------------------------------------------------|------------------------------------------------------------------------------------------------|--------|------------------------------------------------------|
| <b>SIT</b>                                                                         |                                                                                                |        |                                                      |
| <b>100 series</b>                                                                  |                                                                                                |        |                                                      |
|  | <b>GEV No.</b>                                                                                 | 107519 | <b>Ref. No.</b> 310324<br>BAAN1064197<br>BAAN1067290 |
| <b>description</b>                                                                 | ignition box SIT type 579DBC electrodes 2 waiting time 3s safety time 5s 220/240V 12VA 50/60Hz |        |                                                      |

ignition parts









|                                                                                     |                                                                             |        |                                    |
|-------------------------------------------------------------------------------------|-----------------------------------------------------------------------------|--------|------------------------------------|
| <b>pilot burners</b>                                                                |                                                                             |        |                                    |
| <b>SIT</b>                                                                          |                                                                             |        |                                    |
| <b>100 series</b>                                                                   |                                                                             |        |                                    |
|  | <b>GEV No.</b>                                                              | 106906 | <b>Ref. No.</b> 2020124<br>7434003 |
| <b>description</b>                                                                  | pilot burner SIT type 100 series 3 flames nozzle ø 0.2mm gas connection 6mm |        |                                    |
| <b>spare parts for</b>                                                              | 106906                                                                      |        |                                    |
|  | <b>GEV No.</b>                                                              | 100245 | <b>Ref. No.</b> —                  |
|                                                                                     | pilot burner nozzle LPG code 20 bore ø 0.2mm Qty 1 pcs thread M8x0.75       |        |                                    |
|  | <b>GEV No.</b>                                                              | 100855 | <b>Ref. No.</b> —                  |
|                                                                                     | pilot burner bracket triple                                                 |        |                                    |
|  | <b>GEV No.</b>                                                              | 100885 | <b>Ref. No.</b> —                  |
|                                                                                     | air mixing sleeve for pilot burner Qty 1 pcs                                |        |                                    |
|  | <b>GEV No.</b>                                                              | 100916 | <b>Ref. No.</b> —                  |
|                                                                                     | compression spring for pilot burner Qty 1 pcs                               |        |                                    |
|  | <b>GEV No.</b>                                                              | 100917 | <b>Ref. No.</b> —                  |
|                                                                                     | gasket for pilot burner Qty 1 pcs aluminium                                 |        |                                    |
|  | <b>GEV No.</b>                                                              | 100918 | <b>Ref. No.</b> —                  |
|                                                                                     | screw for pilot burner                                                      |        |                                    |
|  | <b>GEV No.</b>                                                              | 107162 | <b>Ref. No.</b> —                  |
|                                                                                     | pilot burner cap SIT 3 flames Hmm Lmm Qty 1 pcs                             |        |                                    |
|  | <b>GEV No.</b>                                                              | 107701 | <b>Ref. No.</b> —                  |
|                                                                                     | pilot burner bottom part SIT 100 series nozzle ø 0.2mm                      |        |                                    |

Table continues overleaf



Зип Общежит

electrodes

vsezip.ru

+7(812)987-08-81

| accessories for                                                                    |                                                                                    | 106906 |            |
|------------------------------------------------------------------------------------|------------------------------------------------------------------------------------|--------|------------|
|   | GEV No.                                                                            | 100245 | Ref. No. — |
|                                                                                    | pilot burner nozzle LPG code 20 bore $\varnothing$ 0.2mm Qty 1 pcs thread M8x0.75  |        |            |
|   | GEV No.                                                                            | 100246 | Ref. No. — |
|                                                                                    | pilot burner nozzle natural gas bore $\varnothing$ 0.35mm Qty 1 pcs thread M8x0.75 |        |            |
|   | GEV No.                                                                            | 100904 | Ref. No. — |
|                                                                                    | locking screw M10x1 for pipe $\varnothing$ 4mm Qty 1 pcs                           |        |            |
|   | GEV No.                                                                            | 100905 | Ref. No. — |
|                                                                                    | locking screw M10x1 for pipe $\varnothing$ 6mm Qty 1 pcs                           |        |            |
|   | GEV No.                                                                            | 102110 | Ref. No. — |
|                                                                                    | pilot tube copper pipe $\varnothing$ 4mm thickness 1mm L 3000mm                    |        |            |
|   | GEV No.                                                                            | 102111 | Ref. No. — |
|                                                                                    | pilot tube copper pipe $\varnothing$ 6mm thickness 1mm L 3000mm                    |        |            |
|   | GEV No.                                                                            | 107171 | Ref. No. — |
|                                                                                    | pilot burner nozzle SIT natural/liquid gas bore $\varnothing$ 0.25mm Qty 1 pcs     |        |            |
|   | GEV No.                                                                            | 107700 | Ref. No. — |
|                                                                                    | pilot burner bottom part SIT 100 series nozzle $\varnothing$ 0.25mm                |        |            |
|  | GEV No.                                                                            | 107702 | Ref. No. — |
|                                                                                    | pilot burner bottom part SIT 100 series nozzle $\varnothing$ 0.35mm                |        |            |

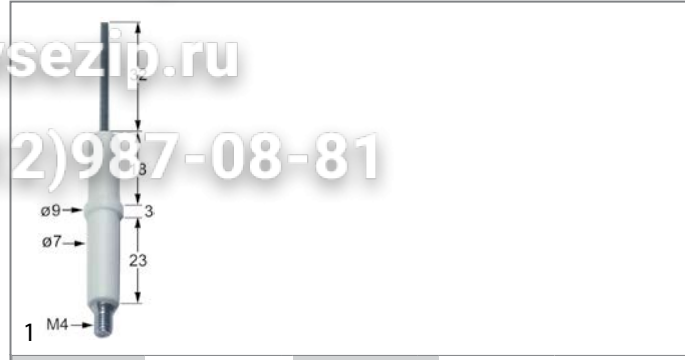

|                                                                                   |                                                                            |                 |                                             |
|-----------------------------------------------------------------------------------|----------------------------------------------------------------------------|-----------------|---------------------------------------------|
| <b>GEV No.</b>                                                                    | 100701                                                                     | <b>Ref. No.</b> | 308480<br>BAAN824045<br>BAAN838031          |
| <b>description</b>                                                                | ignition electrode connection M4 Qty 1 pcs                                 |                 |                                             |
| <b>accessories for</b>                                                            | 100701                                                                     |                 |                                             |
|  | GEV No.                                                                    | 100906          | Ref. No. 317980<br>BAAN829766<br>BAAN838033 |
|                                                                                   | screw connection thread M10x1 for ignition electrode brass Qty 1 pcs WS 10 |                 |                                             |

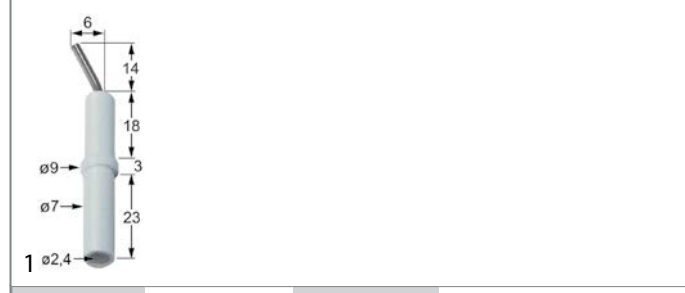

|                    |                                                                                                                                                        |                 |         |
|--------------------|--------------------------------------------------------------------------------------------------------------------------------------------------------|-----------------|---------|
| <b>GEV No.</b>     | 100707                                                                                                                                                 | <b>Ref. No.</b> | 7455048 |
| <b>description</b> | ignition electrode D1 $\varnothing$ 7mm D2 $\varnothing$ 9mm connection $\varnothing$ 2.4mm L1 14mm L2 6mm BL1 18mm BL2 3mm BL3 23mm to clip Qty 1 pcs |                 |         |

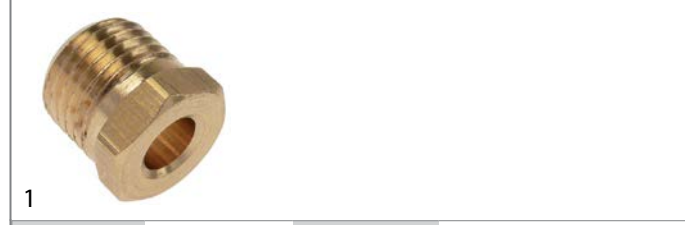

|                    |                                                                            |                 |                                    |
|--------------------|----------------------------------------------------------------------------|-----------------|------------------------------------|
| <b>GEV No.</b>     | 100906                                                                     | <b>Ref. No.</b> | 317980<br>BAAN829766<br>BAAN838033 |
| <b>description</b> | screw connection thread M10x1 for ignition electrode brass Qty 1 pcs WS 10 |                 |                                    |

accessories  
ignition electrodes

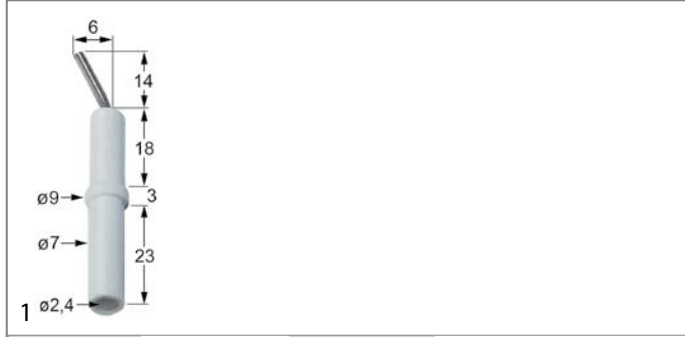

|                    |                                                                                                                                                        |                 |         |
|--------------------|--------------------------------------------------------------------------------------------------------------------------------------------------------|-----------------|---------|
| <b>GEV No.</b>     | 100707                                                                                                                                                 | <b>Ref. No.</b> | 7455048 |
| <b>description</b> | ignition electrode D1 $\varnothing$ 7mm D2 $\varnothing$ 9mm connection $\varnothing$ 2.4mm L1 14mm L2 6mm BL1 18mm BL2 3mm BL3 23mm to clip Qty 1 pcs |                 |         |

ignition cables

pre-assembled cables

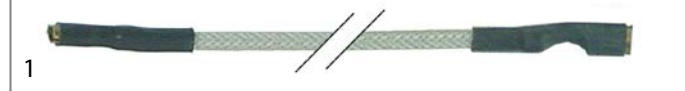

|                    |                                                                                                                   |                 |        |
|--------------------|-------------------------------------------------------------------------------------------------------------------|-----------------|--------|
| <b>GEV No.</b>     | 100176                                                                                                            | <b>Ref. No.</b> | 307997 |
| <b>description</b> | ignition cable cable length 1000mm connection $\varnothing$ 2.4mm / $\varnothing$ 4mm permanent temperature 200°C |                 |        |

2 gas components

ignition units



|                    |                                                                                                                                        |                 |                                |
|--------------------|----------------------------------------------------------------------------------------------------------------------------------------|-----------------|--------------------------------|
| <b>GEV No.</b>     | 102388                                                                                                                                 | <b>Ref. No.</b> | 308466<br>680782<br>BAAN308466 |
| <b>description</b> | ignition unit outputs 4 230VAC dimensions 111x23x34mm mounting distance 100mm inlet F6.3x0.8 outlet F2.8x0.8 type WAC-T4 0.6VA 50/60Hz |                 |                                |

thermocouples

thermocouple sets universal

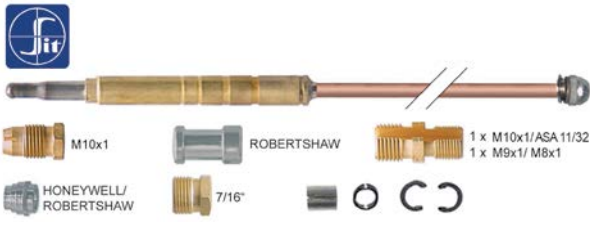

|                    |                                        |                 |         |
|--------------------|----------------------------------------|-----------------|---------|
| <b>GEV No.</b>     | 107648                                 | <b>Ref. No.</b> | 7473055 |
| <b>description</b> | thermocouple set SIT 11-piece L 1200mm |                 |         |

|                    |                                           |                 |        |
|--------------------|-------------------------------------------|-----------------|--------|
| <b>GEV No.</b>     | 102286                                    | <b>Ref. No.</b> | 634321 |
| <b>description</b> | thermocouple set 8-piece L 900mm flexible |                 |        |

plug-in thermocouples

plug-in thermocouples standard

with barrel socket  $\phi 6(6.5)$ mm

thermocouples SIT

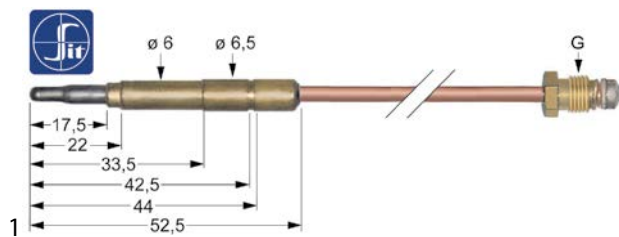

|                    |                                                                                 |                 |                                               |
|--------------------|---------------------------------------------------------------------------------|-----------------|-----------------------------------------------|
| <b>GEV No.</b>     | 102682                                                                          | <b>Ref. No.</b> | 310276<br>7473056<br>BAAN310657<br>BAAN840079 |
| <b>description</b> | thermocouple SIT aluminized tip M9x1 L 850mm plug connection $\phi 6.0(6.5)$ mm |                 |                                               |

Зип Общепит

vsezip.ru

+7(812)987-08-81

|                    |                                                                   |                 |                                               |
|--------------------|-------------------------------------------------------------------|-----------------|-----------------------------------------------|
| <b>GEV No.</b>     | 107613                                                            | <b>Ref. No.</b> | 310277<br>7473029<br>BAAN310646<br>BAAN838026 |
| <b>description</b> | thermocouple SIT M9x1 L 1200mm plug connection $\phi 6.0(6.5)$ mm |                 |                                               |

|                    |                                                                   |                 |         |
|--------------------|-------------------------------------------------------------------|-----------------|---------|
| <b>GEV No.</b>     | 107614                                                            | <b>Ref. No.</b> | 7473034 |
| <b>description</b> | thermocouple SIT M9x1 L 1500mm plug connection $\phi 6.0(6.5)$ mm |                 |         |

threaded thermocouples

threaded thermocouples standard

with socket with thread M8x1

SIT

|                                                                                     |                                                  |                 |                   |
|-------------------------------------------------------------------------------------|--------------------------------------------------|-----------------|-------------------|
| <b>GEV No.</b>                                                                      | 107634                                           | <b>Ref. No.</b> | 310193            |
| <b>description</b>                                                                  | thermocouple SIT M8x1 L 1500mm M8x1              |                 |                   |
| <b>accessories for</b>                                                              | 107634                                           |                 |                   |
|  | <b>GEV No.</b>                                   | 102067          | <b>Ref. No.</b> — |
|                                                                                     | nut thread M8x1 H 3mm brass Qty 1 pcs type SEF 1 |                 |                   |

extensions

|                    |                                                   |                 |         |
|--------------------|---------------------------------------------------|-----------------|---------|
| <b>GEV No.</b>     | 102811                                            | <b>Ref. No.</b> | 7492000 |
| <b>description</b> | thermocouple extension thread M9x1 - M9x1 L 600mm |                 |         |



Зип Общежит  
vsezip.ru  
+7(812)987-08-81

accessories

interrupters

|                                                                                            |                         |                 |                  |
|--------------------------------------------------------------------------------------------|-------------------------|-----------------|------------------|
|  <p>1</p> |                         |                 |                  |
| <b>GEV No.</b>                                                                             | 101265                  | <b>Ref. No.</b> | 605680<br>905680 |
| <b>description</b>                                                                         | interrupter thread M9x1 |                 |                  |

gas nozzles

pilot burner nozzles

pilot burner nozzles SIT

100 series

|                                                                                            |                                                         |                 |         |
|--------------------------------------------------------------------------------------------|---------------------------------------------------------|-----------------|---------|
|  <p>1</p> |                                                         |                 |         |
| <b>GEV No.</b>                                                                             | 102973                                                  | <b>Ref. No.</b> | 7433158 |
| <b>description</b>                                                                         | pilot burner nozzle natural gas bore ø 0.45mm Qty 1 pcs |                 |         |

160 series

|                                                                                             |                                               |                 |                                    |
|---------------------------------------------------------------------------------------------|-----------------------------------------------|-----------------|------------------------------------|
|  <p>1</p> |                                               |                 |                                    |
| <b>GEV No.</b>                                                                              | 107172                                        | <b>Ref. No.</b> | 310274<br>BAAN834138<br>BAAN838035 |
| <b>description</b>                                                                          | pilot burner nozzle SIT LPG code 25 Qty 1 pcs |                 |                                    |

|                                                                                              |                                               |                 |        |
|----------------------------------------------------------------------------------------------|-----------------------------------------------|-----------------|--------|
|  <p>1</p> |                                               |                 |        |
| <b>GEV No.</b>                                                                               | 107650                                        | <b>Ref. No.</b> | 311171 |
| <b>description</b>                                                                           | pilot burner nozzle SIT LPG code 30 Qty 1 pcs |                 |        |

|                                                                                              |                                                       |                 |                                    |
|----------------------------------------------------------------------------------------------|-------------------------------------------------------|-----------------|------------------------------------|
|  <p>1</p> |                                                       |                 |                                    |
| <b>GEV No.</b>                                                                               | 107174                                                | <b>Ref. No.</b> | 310273<br>BAAN829765<br>BAAN838038 |
| <b>description</b>                                                                           | pilot burner nozzle SIT natural gas code 41 Qty 1 pcs |                 |                                    |

screw connections

union screws

|                                                                                            |                                                                            |                 |                                    |
|--------------------------------------------------------------------------------------------|----------------------------------------------------------------------------|-----------------|------------------------------------|
|  <p>1</p> |                                                                            |                 |                                    |
| <b>GEV No.</b>                                                                             | 100906                                                                     | <b>Ref. No.</b> | 317980<br>BAAN829766<br>BAAN838033 |
| <b>description</b>                                                                         | screw connection thread M10x1 for ignition electrode brass Qty 1 pcs WS 10 |                 |                                    |

|                                                                                            |                                                                         |                 |                                    |
|--------------------------------------------------------------------------------------------|-------------------------------------------------------------------------|-----------------|------------------------------------|
|  <p>1</p> |                                                                         |                 |                                    |
| <b>GEV No.</b>                                                                             | 100907                                                                  | <b>Ref. No.</b> | 317979<br>BAAN829767<br>BAAN838027 |
| <b>description</b>                                                                         | screw connection thread M10x1 Qty 1 pcs type SEF 1 ømm for thermocouple |                 |                                    |

for ice-cube maker

hoses

formed hoses

straight

silicone hoses

|                                                                                               |                                                                 |                 |        |
|-----------------------------------------------------------------------------------------------|-----------------------------------------------------------------|-----------------|--------|
|  <p>1</p> |                                                                 |                 |        |
| <b>GEV No.</b>                                                                                | 530063                                                          | <b>Ref. No.</b> | 71289E |
| <b>description</b>                                                                            | silicone hose ID ø 18mm ED ø 25mm L 1m t.max. 200°C transparent |                 |        |

brewing units

filter holder gaskets

O-rings

|                                                                                              |                                                     |                 |                                                         |
|----------------------------------------------------------------------------------------------|-----------------------------------------------------|-----------------|---------------------------------------------------------|
|  <p>1</p> |                                                     |                 |                                                         |
| <b>GEV No.</b>                                                                               | 510409                                              | <b>Ref. No.</b> | 318044<br>905588<br>966001<br>BAAN1323306<br>BAAN311999 |
| <b>description</b>                                                                           | O-ring EPDM thickness 5.34mm ID ø 56.52mm Qty 1 pcs |                 |                                                         |

2 gas components

Зип.Общепит

door catches

vsezip.ru

+7(812)987-08-81

knobs

producer-specific knobs

BONNET



|                    |                                                  |                 |        |
|--------------------|--------------------------------------------------|-----------------|--------|
| <b>GEV No.</b>     | 110081                                           | <b>Ref. No.</b> | 171475 |
| <b>description</b> | knob ø 70mm shaft ø 8x6.5mm shaft flat universal |                 |        |

locks

edgemoat latches

handle latches

CAFF/FERMOD

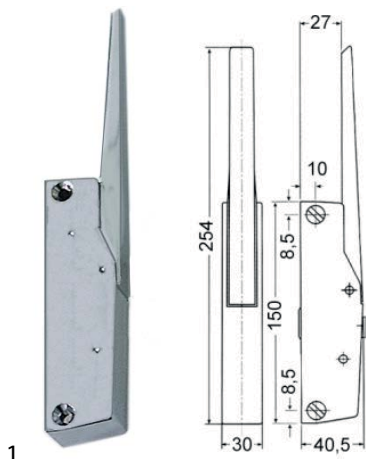

|                    |                                                                                                        |                 |                                               |
|--------------------|--------------------------------------------------------------------------------------------------------|-----------------|-----------------------------------------------|
| <b>GEV No.</b>     | 690412                                                                                                 | <b>Ref. No.</b> | 21433E<br>384634<br>BAAN1322230<br>BAAN303576 |
| <b>description</b> | handle latch L 150mm mounting distance 133mm non lockable G 790 total length 254mm handle length 105mm |                 |                                               |

|                        |                                                                                                  |        |                 |   |
|------------------------|--------------------------------------------------------------------------------------------------|--------|-----------------|---|
| <b>accessories for</b> | 690412                                                                                           |        |                 |   |
|                        | <b>GEV No.</b>                                                                                   | 690418 | <b>Ref. No.</b> | — |
|                        | door catch L 36mm W 19mm H 29mm mounting distance 12mm zinc-coated steel for refrigeration units |        |                 |   |
|                        | <b>GEV No.</b>                                                                                   | 690419 | <b>Ref. No.</b> | — |
|                        | door catch L 52mm W 20mm H 30mm mounting distance 26-37mm zamak for refrigeration units          |        |                 |   |
|                        | <b>GEV No.</b>                                                                                   | 700061 | <b>Ref. No.</b> | — |
|                        | door catch L 58mm W 20mm H 35mm mounting distance 42mm chrome-plated brass for headed units      |        |                 |   |
|                        | <b>GEV No.</b>                                                                                   | 700435 | <b>Ref. No.</b> | — |
|                        | door catch L 58mm W 20mm H 35mm mounting distance 42mm zamak for refrigeration units             |        |                 |   |

shelves and shelf rails

grates

universal

without upstand

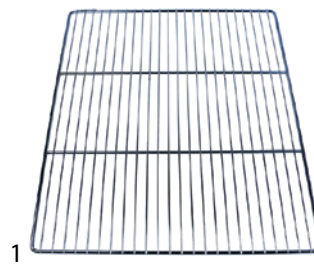

|                        |                                                                                                                                             |                 |                 |   |
|------------------------|---------------------------------------------------------------------------------------------------------------------------------------------|-----------------|-----------------|---|
| <b>GEV No.</b>         | 970123                                                                                                                                      | <b>Ref. No.</b> | 635022          |   |
| <b>description</b>     | grate W 650mm D 530mm GN 2/1 stainless steel wire gauge frame 7.8mm lengthwise wires gauge 3.8mm crossing wires 2 suitable for refrigerator |                 |                 |   |
| <b>accessories for</b> | 970123                                                                                                                                      |                 |                 |   |
|                        | <b>GEV No.</b>                                                                                                                              | 690330          | <b>Ref. No.</b> | — |
|                        | rack L 1000mm W 22mm H 4mm aperture 3x8mm hole distance 12.5mm stainless steel                                                              |                 |                 |   |
|                        | <b>GEV No.</b>                                                                                                                              | 694700          | <b>Ref. No.</b> | — |
|                        | shelf support L 31/28mm W 22mm H 18mm SS Qty 12 pcs                                                                                         |                 |                 |   |
|                        | <b>GEV No.</b>                                                                                                                              | 694701          | <b>Ref. No.</b> | — |
|                        | shelf support L 31/28mm W 22mm H 17mm SS with hook Qty 12 pcs                                                                               |                 |                 |   |

gaskets

gaskets for heated units

window seals

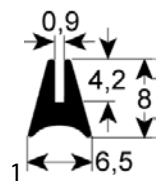

|                    |                                                  |                 |        |
|--------------------|--------------------------------------------------|-----------------|--------|
| <b>GEV No.</b>     | 901306                                           | <b>Ref. No.</b> | 366122 |
| <b>description</b> | window gasket profile 1515 Qty supplied by meter |                 |        |

mechanical components, equipment accessories





Зип Общепит

vsezip.ru

+7(812)987-08-81

|                    |                                                                         |                 |        |
|--------------------|-------------------------------------------------------------------------|-----------------|--------|
| <b>GEV No.</b>     | 901513                                                                  | <b>Ref. No.</b> | 71209E |
| <b>description</b> | window gasket profile 1615 suitable for BOURGEOIS Qty supplied by meter |                 |        |

|                    |                                               |                 |        |
|--------------------|-----------------------------------------------|-----------------|--------|
| <b>GEV No.</b>     | 532000                                        | <b>Ref. No.</b> | 366185 |
| <b>description</b> | O-ring EPDM thickness 7mm ID ø 57mm Qty 1 pcs |                 |        |

**door seals**

|                    |                                       |                 |                                              |
|--------------------|---------------------------------------|-----------------|----------------------------------------------|
| <b>GEV No.</b>     | 901424                                | <b>Ref. No.</b> | 71204E<br>71206E<br>BAAN309220<br>BAAN309222 |
| <b>description</b> | door seal profile 2711 L 2600mm Qty 1 |                 |                                              |

**special gaskets**

**miscellaneous**

|                    |                  |                 |        |
|--------------------|------------------|-----------------|--------|
| <b>GEV No.</b>     | 511600           | <b>Ref. No.</b> | 71860E |
| <b>description</b> | gasket ED ø 80mm |                 |        |

|                    |                                 |                 |        |
|--------------------|---------------------------------|-----------------|--------|
| <b>GEV No.</b>     | 518126                          | <b>Ref. No.</b> | 71876E |
| <b>description</b> | door seal profile 2980 L 2820mm |                 |        |

**transmission technology and ball bearings**

**ball bearings**

**deep-groove ball bearings 2RS**

|                    |                                                                                                                            |                 |          |
|--------------------|----------------------------------------------------------------------------------------------------------------------------|-----------------|----------|
| <b>GEV No.</b>     | 523522                                                                                                                     | <b>Ref. No.</b> | 21090500 |
| <b>description</b> | deep-groove ball bearing type 6004-2RS shaft ø 20mm ED ø 42mm W 12mm with sealing discs deep-groove ball bearing DIN 625-1 |                 |          |

**O-rings**

**EPDM**

**ø5.34mm**

|                    |                                                  |                 |          |
|--------------------|--------------------------------------------------|-----------------|----------|
| <b>GEV No.</b>     | 510408                                           | <b>Ref. No.</b> | 2001827H |
| <b>description</b> | O-ring EPDM thickness 5.34mm ID ø 47mm Qty 1 pcs |                 |          |

**dosing pumps**

**accessories**

**container filters with non-return valve**

|                    |                                                                      |                 |         |
|--------------------|----------------------------------------------------------------------|-----------------|---------|
| <b>GEV No.</b>     | 361058                                                               | <b>Ref. No.</b> | 2000034 |
| <b>description</b> | container filter with non-return valve SS hose ø 4x6mm ø 20mm L 56mm |                 |         |

|                    |                                                     |                 |                                                         |
|--------------------|-----------------------------------------------------|-----------------|---------------------------------------------------------|
| <b>GEV No.</b>     | 510409                                              | <b>Ref. No.</b> | 318044<br>905588<br>966001<br>BAAN1323306<br>BAAN311999 |
| <b>description</b> | O-ring EPDM thickness 5.34mm ID ø 56.52mm Qty 1 pcs |                 |                                                         |

mechanical components, equipment accessories



hoses

supply hoses

PVC supply hoses



1

|                                                                                   |                                                                                                                                          |                 |                   |
|-----------------------------------------------------------------------------------|------------------------------------------------------------------------------------------------------------------------------------------|-----------------|-------------------|
| <b>GEV No.</b>                                                                    | 520010                                                                                                                                   | <b>Ref. No.</b> | 2001753H<br>42551 |
| <b>description</b>                                                                | supply hose PVC straight-curved DN13 connections 3/4" L 1500mm operating p. 10bar burst p. 32bar t.max. 90°C blue approval VDE flat seal |                 |                   |
| <b>accessories for</b>                                                            | 520010                                                                                                                                   |                 |                   |
|  | <b>GEV No.</b>                                                                                                                           | 520053          | <b>Ref. No.</b> — |
|                                                                                   | screen connection 3/4" D1 ø 26mm D2 ø 15mm Qty 10 pcs rubber thickness 8mm                                                               |                 |                   |
|  | <b>GEV No.</b>                                                                                                                           | 520054          | <b>Ref. No.</b> — |
|                                                                                   | flat gasket rubber ED ø 23.5mm ID ø 14mm thickness 2.3mm Qty 10 pcs                                                                      |                 |                   |



1

|                    |                                                                                                                                     |                 |          |
|--------------------|-------------------------------------------------------------------------------------------------------------------------------------|-----------------|----------|
| <b>GEV No.</b>     | 520011                                                                                                                              | <b>Ref. No.</b> | 2001738H |
| <b>description</b> | supply hose PVC straight-curved DN13 connections 3/4" L 2000mm operating p. 10bar burst p. 32bar t.max. 90°C approval VDE flat seal |                 |          |

industrial hoses

Niplaflex hoses



1

|                    |                                                                                                       |                 |          |
|--------------------|-------------------------------------------------------------------------------------------------------|-----------------|----------|
| <b>GEV No.</b>     | 530561                                                                                                | <b>Ref. No.</b> | 2001726H |
| <b>description</b> | pressure hose ID ø 10mm ED ø 17mm L 5m thickness 3.5mm operating p. 10bar burst p. 30bar t.max. 110°C |                 |          |

PVC hoses

PVC hoses without fabric



1

|                    |                                                                          |                 |          |
|--------------------|--------------------------------------------------------------------------|-----------------|----------|
| <b>GEV No.</b>     | 520029                                                                   | <b>Ref. No.</b> | 2001747H |
| <b>description</b> | PVC hose ID ø 6mm ED ø 9mm L 10m thickness 1.5mm t.max. 60°C transparent |                 |          |

Зип-Общепит

silicone hoses

without fabric



1

|                    |                                                                 |                 |        |
|--------------------|-----------------------------------------------------------------|-----------------|--------|
| <b>GEV No.</b>     | 530063                                                          | <b>Ref. No.</b> | 71289E |
| <b>description</b> | silicone hose ID ø 18mm ED ø 25mm L 1m t.max. 200°C transparent |                 |        |

with fabric

with monofilament braid



1

|                    |                                                                                                                                                                                                |                 |        |
|--------------------|------------------------------------------------------------------------------------------------------------------------------------------------------------------------------------------------|-----------------|--------|
| <b>GEV No.</b>     | 530542                                                                                                                                                                                         | <b>Ref. No.</b> | 71265E |
| <b>description</b> | silicone hose with monofilament braid ID ø 10mm ED ø 17mm L 5m thickness 3.5mm operating p. 4bar burst pressure at 95°C non definedbar burst pressure 130°C non definedbar t.max. 200°C Qty 5m |                 |        |

valves and tank inlets

ball valves

ball valves electric



1

|                    |                                                                                                                                                           |                 |        |
|--------------------|-----------------------------------------------------------------------------------------------------------------------------------------------------------|-----------------|--------|
| <b>GEV No.</b>     | 401190                                                                                                                                                    | <b>Ref. No.</b> | 314359 |
| <b>description</b> | ball valve inlet 3/4" IT outlet 3/4" IT IP42 230V L 68mm 50/60Hz closed off-current mode of operation electric connection cable 300mm 3.5W duty cycle 50% |                 |        |

water cycle components

supply filters



1

|                    |                                                                                       |                 |          |
|--------------------|---------------------------------------------------------------------------------------|-----------------|----------|
| <b>GEV No.</b>     | 520261                                                                                | <b>Ref. No.</b> | 91297387 |
| <b>description</b> | supply filter thread 1/2" IT - 1/2" IT total length 58mm red brass mesh opening 0.4mm |                 |          |



## ancillary products

Зип-Общепит consumables

vsezip.ru

+7(812)987-08-81

### clamps

#### hose clamps

DIN 3017 - W2



1

|                    |                                                    |                 |        |
|--------------------|----------------------------------------------------|-----------------|--------|
| <b>GEV No.</b>     | 520114                                             | <b>Ref. No.</b> | 917110 |
| <b>description</b> | hose clamp ø 20-32mm width 9mm Qty 10 pcs DIN 3017 |                 |        |

## fastening material

### nuts

#### hexagonal nuts

DIN 985



1

|                    |                                                                                 |                 |                       |
|--------------------|---------------------------------------------------------------------------------|-----------------|-----------------------|
| <b>GEV No.</b>     | 560141                                                                          | <b>Ref. No.</b> | 389540<br>BAAN1050326 |
| <b>description</b> | hexagonal nut thread M5 H 5.4mm SS WS 8 Qty 20 pcs DIN/ISO DIN 985 self-locking |                 |                       |

### fasteners

#### clamps

#### hose clamps

DIN 3017 - W2



1

|                    |                                                    |                 |        |
|--------------------|----------------------------------------------------|-----------------|--------|
| <b>GEV No.</b>     | 520114                                             | <b>Ref. No.</b> | 917110 |
| <b>description</b> | hose clamp ø 20-32mm width 9mm Qty 10 pcs DIN 3017 |                 |        |

### fuses

#### fine fuses



1

|                    |                                                                 |                 |        |
|--------------------|-----------------------------------------------------------------|-----------------|--------|
| <b>GEV No.</b>     | 358666                                                          | <b>Ref. No.</b> | 309316 |
| <b>description</b> | fine fuse size ø5x20mm 0.315A fast-acting rated 250V Qty 10 pcs |                 |        |



1

|                    |                                                               |                 |          |
|--------------------|---------------------------------------------------------------|-----------------|----------|
| <b>GEV No.</b>     | 358530                                                        | <b>Ref. No.</b> | 2001921H |
| <b>description</b> | fine fuse size ø5x20mm 0.8A fast-acting rated 250V Qty 10 pcs |                 |          |



1

|                    |                                                             |                 |                      |
|--------------------|-------------------------------------------------------------|-----------------|----------------------|
| <b>GEV No.</b>     | 358677                                                      | <b>Ref. No.</b> | 2001981H<br>2002146H |
| <b>description</b> | fine fuse size ø5x20mm 4A fast-acting rated 250V Qty 10 pcs |                 |                      |

#### ø6.3x32mm 500V

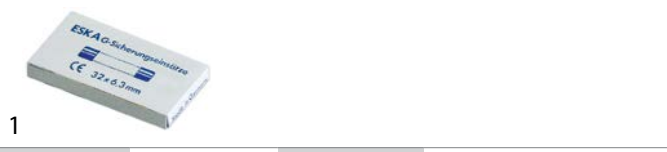

1

|                    |                                                                |                 |         |
|--------------------|----------------------------------------------------------------|-----------------|---------|
| <b>GEV No.</b>     | 358752                                                         | <b>Ref. No.</b> | 3090506 |
| <b>description</b> | fine fuse size ø6.3x32mm 10A fast-acting rated 500V Qty 10 pcs |                 |         |

**Зип Общепит**

**vsezip.ru**

**+7(812)987-08-81**

Зип Общепит

vsezip.ru

+7(812)987-08-81

|                                                 |        |                                  |        |
|-------------------------------------------------|--------|----------------------------------|--------|
| <b>A</b>                                        |        |                                  |        |
| alarm devices                                   | 7      | hexagonal nuts                   | 27     |
| axial fans                                      | 15     | hose clamps                      | 27, 27 |
|                                                 |        | hoses                            | 26     |
|                                                 |        | hot air motors                   | 16     |
| <b>B</b>                                        |        |                                  |        |
| ball valves                                     | 26     | ignition boxes                   | 20     |
| ball valves electric                            | 15, 26 | ignition cables                  | 21     |
| bi-metal thermostats                            | 3, 3   | ignition units                   | 22     |
| booster pumps II                                | 17     | immersion heating elements       | 2      |
|                                                 |        | indicator lights                 | 6      |
|                                                 |        | indicator lights (complete)      | 6      |
|                                                 |        | industrial hoses                 | 26     |
| <b>C</b>                                        |        | <b>L</b>                         |        |
| cam switches                                    | 5      | lamps                            | 6      |
| clamps                                          | 27, 27 | light bulbs                      | 6      |
| condensators & interference suppression filters | 17     |                                  |        |
| consumables                                     | 27     | <b>M</b>                         |        |
| contactors                                      | 7      | magnetic switches                | 5      |
| container filters                               | 25     | microswitches                    | 4      |
| control thermostats                             | 3      |                                  |        |
| cross flow fans                                 | 16     | <b>N</b>                         |        |
|                                                 |        | neon light bulbs                 | 6, 6   |
| <b>D</b>                                        |        | Niplaflex hoses                  | 26     |
| door catches                                    | 24     | nuts                             | 27     |
| door seals                                      | 25     |                                  |        |
| dosing pumps                                    | 25     | <b>O</b>                         |        |
| drain pumps                                     | 16     | operating capacitors             | 17     |
|                                                 |        | O-rings                          | 25     |
|                                                 |        | oven lamps                       | 7      |
| <b>E</b>                                        |        | <b>P</b>                         |        |
| edgemount latches                               | 24     | pilot burners                    | 20     |
| electric accessories                            | 18     | pumps                            | 16     |
| electronic controllers                          | 9      | PVC hoses                        | 26     |
| energy regulators                               | 2      | PVC supply hoses                 | 26     |
|                                                 |        | <b>R</b>                         |        |
| <b>F</b>                                        |        | relays                           | 8      |
| fans                                            | 15     | rocker/momentary rocker switches | 4      |
| fasteners                                       | 27     |                                  |        |
| fastening material                              | 27     | <b>S</b>                         |        |
| fine fuses                                      | 27     | safety thermostats               | 3      |
| fluorescent lamps                               | 7, 7   | shelves and shelf rails          | 24     |
| fuses                                           | 18, 27 | silicone hoses                   | 26     |
|                                                 |        | solenoid valves                  | 10     |
| <b>G</b>                                        |        | supply filters                   | 26, 26 |
| gas control valves                              | 19     | supply hoses                     | 26     |
| gas nozzles                                     | 23     | switches and momentary switches  | 4      |
| gas thermostats                                 | 18     | system switches (ROLD)           | 5      |
| gaskets for heated units                        | 24     |                                  |        |
| grates                                          | 24     |                                  |        |
|                                                 |        |                                  |        |
| <b>H</b>                                        |        |                                  |        |
| halogen lamp                                    | 7      |                                  |        |
| handle latches                                  | 24     |                                  |        |
| heating elements                                | 2      |                                  |        |
| heating elements for convection                 | 2      |                                  |        |

**Зип Общепит****vsezip.ru****+7(812)987-08-81****T**

|               |    |
|---------------|----|
| terminals     | 18 |
| thermocouples | 22 |
| thermostats   | 23 |
| transformers  | 29 |

**V**

|                        |    |
|------------------------|----|
| valves and tank inlets | 26 |
|------------------------|----|

**W**

|                        |    |
|------------------------|----|
| wash and rinse pumps   | 16 |
| water cycle components | 26 |
| window seals           | 24 |