

1937400 (4kW - 400V)
1937300 (4kW - 230V) (2)
(300 x 300 mm)

812)987-08-81

Mod. 400V 3N

- NC94E CR0590190
- NC98E CR0590210
- NC9FE8E CR0590230

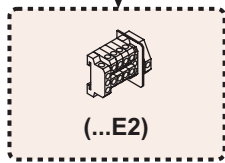
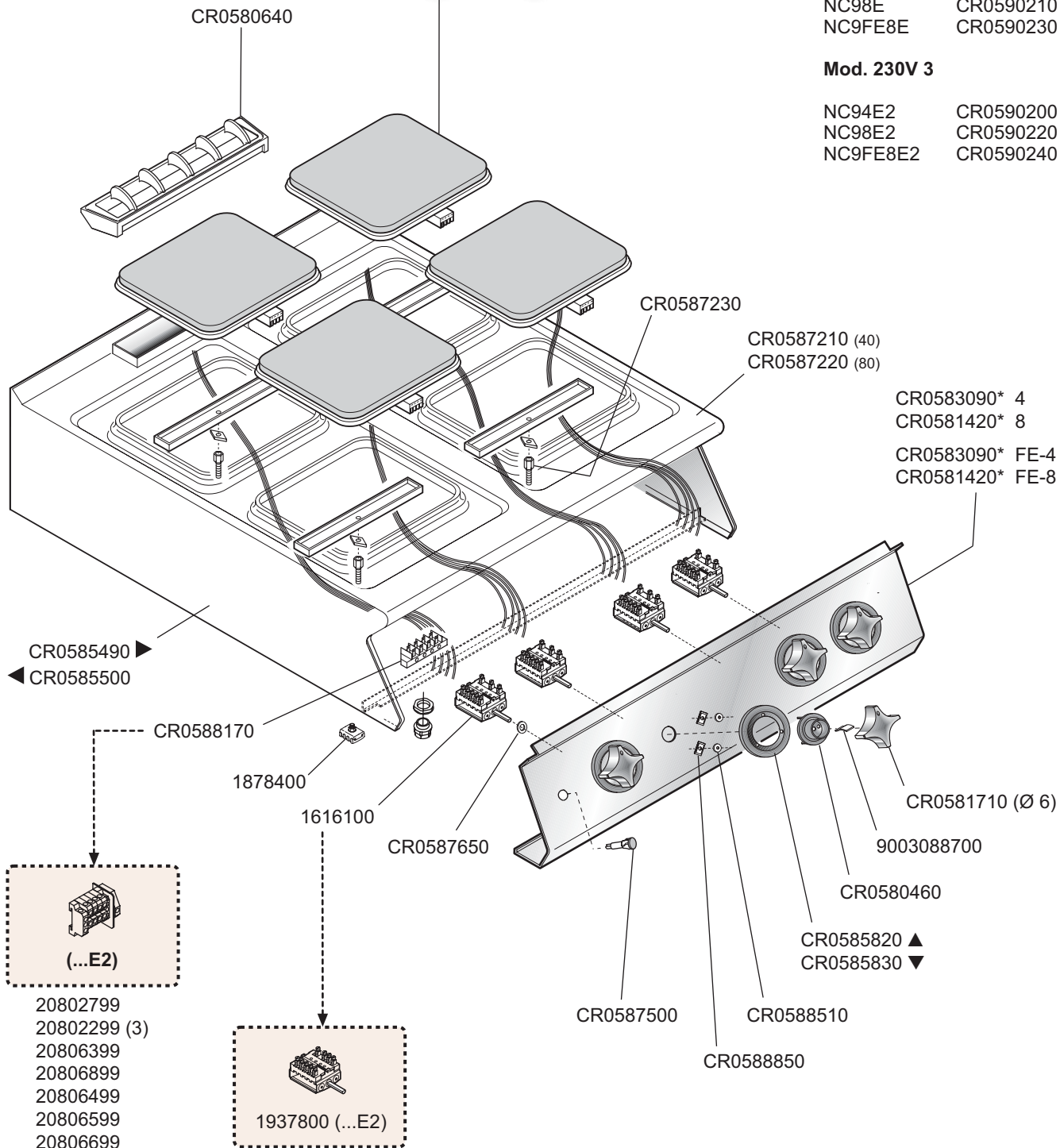

Mod. 230V 3

- NC94E2 CR0590200
- NC98E2 CR0590220
- NC9FE8E2 CR0590240



- 20802799
- 20802299 (3)
- 20806399
- 20806899
- 20806499
- 20806599
- 20806699



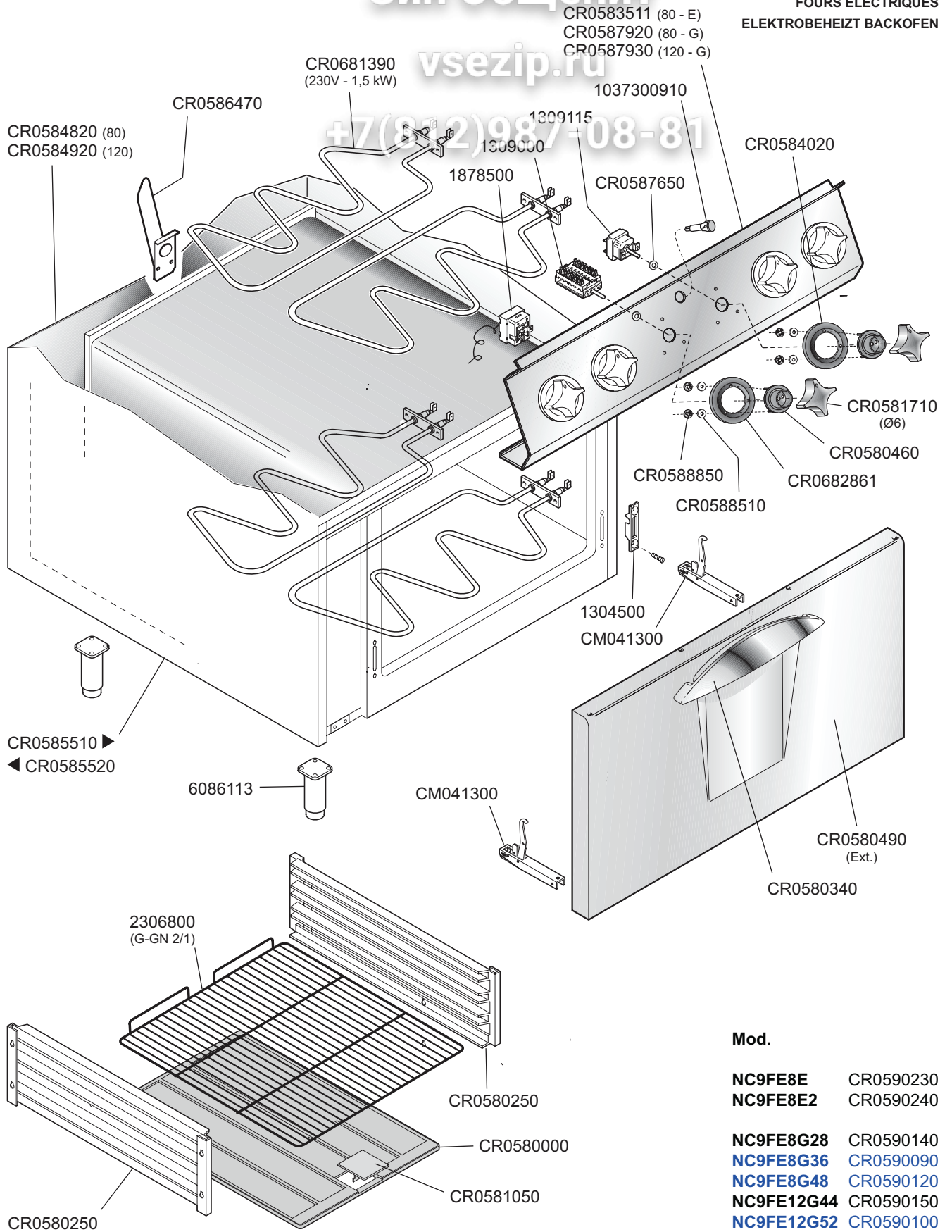

 MARENO INDUSTRIE ALI spa Mareno di Piave (TV)	ELABORATO:	APPROVATO:	GRUPPO:	DENOMINAZIONE:		
			Serie NP90	Impianto elettrico e mobile		
	DATA:	DATA:	PARTICOLARE:	REV. N.	DEL	DISEGNO N.
	11 Set. 2007	11 Set. 2007	Disegno esploso per ricambi	▼ Z00	▼ 0907	▼ 3.P.90.06
SOST. DIS.						



Mod.

NC9FE8E CR0590230
NC9FE8E2 CR0590240

NC9FE8G28 CR0590140
NC9FE8G36 CR0590090
NC9FE8G48 CR0590120
NC9FE12G44 CR0590150
NC9FE12G52 CR0590100

 MARENO INDUSTRIE ALI spa Mareno di Piave (TV)	ELABORATO:	APPROVATO:	GRUPPO:	DENOMINAZIONE:		
			Serie NP90	Impianto elettrico e mobile		
	DATA:	DATA:	PARTICOLARE:	REV. N.	DEL	DISEGNO N.
	11 Set. 2007	11 Set. 2007	Disegno esplosivo per ricambi	Z00	0810	3.P90.03
SOST. DIS.						