



Зип Общепит

vsezip.ru

+7(812)987-08-81



GAS COMPONENTS



ELECTRIC COMPONENTS



WATER TECHNOLOGY



MECHANICAL COMPONENTS



TOOLS

Spare parts suitable for

OMNIWASH

Find the complete and up-to-date range of products in our GEV Webshop

Зип Общепит

vsezip.ru

+7(812)987-08-82

Manufacturer catalogue

The most important spare parts and accessories arranged clearly for every manufacturer



Complete product range and all appliance data always up to date in the GEV Webshop



Alphabetical Index at the end of the catalogue

GEV Webshop

www.gev-online.co.uk

www.gev-online.com



Add to Favourites



Sign In with email address and usual password



Easy-order – place several items in your basket at the same time



Quick Item search – no login needed



heating elements

immersion heating elements

Зип Общежит

3 hole flange ø35.0mm

vsezip.ru

+7(812)987-08481

3 hole flange ø35.0mm

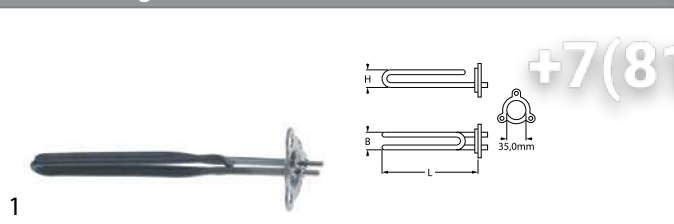

GEV No.	416210	Ref. No.	CERB22
description	heating element 2200W 230V heating circuits 1 mounting ø 35mm L 253mm W 25mm H 25mm tube ø 6.5mm hole distance 44mm hole ø 10mm connection M5 immersion heater 3 hole flange connection length 16mm		
For models:	JOLLY AQ, JOLLY AT, JOLLY Q, JOLLY T		
accessories for	416210		
	GEV No.	507048	Ref. No. G42303S
	gasket ID ø 30mm silicone thickness 3mm hole ø 10mm hole distance 41mm for heating element warewashing		

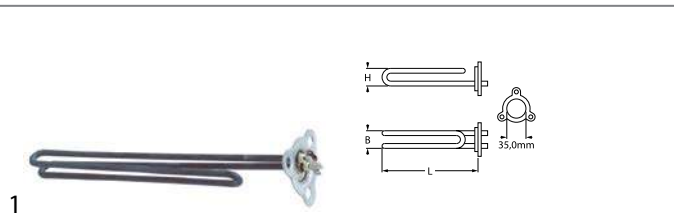

GEV No.	416211	Ref. No.	CERB2712 CERB27R
description	heating element 2700W 230V heating circuits 1 mounting ø 35mm L 300mm W 25mm H 24mm tube ø 6.3mm hole distance 44mm hole ø 10mm connection male faston 6.3mm immersion heater 3 hole flange connection length 15mm		
For models:	DUE ACLQ, DUE ACSQ, DUE AQ, UNO AQ, UNO CLQ, UNO CSQ, UNO Q		
accessories for	416211		
	GEV No.	507048	Ref. No. G42303S
	gasket ID ø 30mm silicone thickness 3mm hole ø 10mm hole distance 41mm for heating element warewashing		

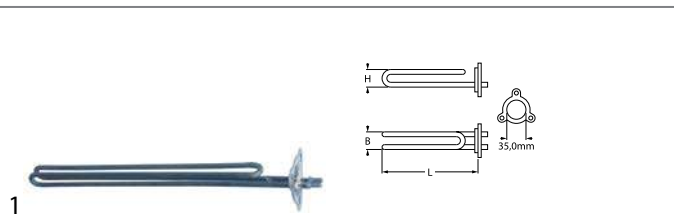



GEV No.	416212	Ref. No.	CERB30
description	heating element 3000W 230V heating circuits 1 mounting ø 35mm L 330mm W 28.5mm H 25mm tube ø 6.25mm hole distance 44mm hole ø 10mm connection M5 immersion heater 3 hole flange connection length 15mm		
For models:	QUATTRO Q/82, QUATTRO T/82		
accessories for	416212		
	GEV No.	507048	Ref. No. G42303S
	gasket ID ø 30mm silicone thickness 3mm hole ø 10mm hole distance 41mm for heating element warewashing		

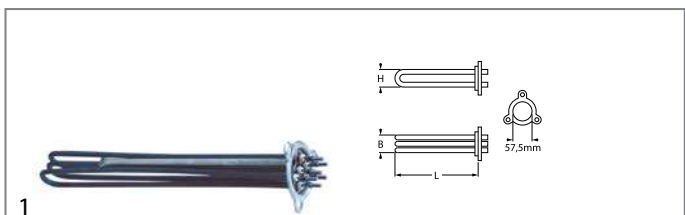

GEV No.	416213	Ref. No.	CERB453F
description	heating element 4500W 230V mounting ø 57.5mm heating circuits 3 L 383mm W 50mm H 38mm number of thermostat sleeves 1 thermostat sleeves ø 8mm length thermostat sleeves 290mm thermostat sleeve eccentric, non clinging tube ø 8mm hole distance 70mm hole ø 8mm connection M5 3 hole flange immersion heater		
For models:	QUATTRO Q/82, QUATTRO T/82, SEI 1P, SEI 2P, SEI 2P/S		
accessories for	416213		
	GEV No.	550002	Ref. No. —
	tension strap H 10mm L 21mm W 10mm hole ø 6.5mm for heating element		



GEV No.	416214	Ref. No.	CERB603F
description	heating element 6000W 230V mounting ø 57.5mm heating circuits 3 L 410mm W 32mm H 50mm thermostat sleeves ø 8.5mm length thermostat sleeves 270mm thermostat sleeve upper centre not clinging tube ø 8.5mm hole distance 70mm hole ø 10mm connection length 30mm connection M5 3 hole flange immersion heater		
For models:	QUATTRO Q/82, QUATTRO T/82, SEI 1P, SEI 2P, SEI 2P/S		
spare parts for	416214		
	GEV No.	510409	Ref. No. GUREBOT ORRB3F
	O-ring EPDM thickness 5.34mm ID ø 56.52mm Qty 1 pcs		
accessories for	416214		
	GEV No.	510409	Ref. No. GUREBOT ORRB3F
	O-ring EPDM thickness 5.34mm ID ø 56.52mm Qty 1 pcs		
	GEV No.	520332	Ref. No. GB083F GB083FV0
	protection cap for heating element		

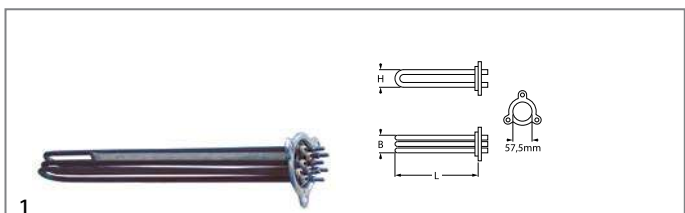

GEV No.	416215	Ref. No.	CERB903F
description	heating element 9000W 230V mounting ø 57.5mm heating circuits 3 L 410mm W 35mm H 52mm number of thermostat sleeves 1 thermostat sleeves ø 7.5mm length thermostat sleeves 290mm thermostat sleeve eccentric, non clinging tube ø 8mm hole distance 70mm hole ø 8mm connection M5 3 hole flange immersion heater		
For models:	SEI 1P, SEI 2P, SEI 2P/S		

1 electric components





Зип-Общепит

vsezip.ru



+7(812)987-08-81

1¼"







GEV No.	416218	Ref. No.	CERV453F
description	heating element 4500W 230V heating circuits 3 thread 1¼" L 275mm W 95mm H 45mm L1 40mm L2 25mm L3 210mm W1 32mm W2 29mm H1 23mm H2 22mm connection male faston 6.3mm immersion heater flange with thread		
For models:	SEI 1P, SEI 2P/S		
spare parts for	416218		
	GEV No.	510405	Ref. No. —
	flat gasket fibre ED ø 56mm ID ø 42mm thickness 2mm for thread 1¼" Qty 1 pcs		
accessories for	416218		
	GEV No.	507333	Ref. No. G50403GT
	flat gasket rubber ED ø 52mm ID ø 41.5mm thickness 3mm Qty 1 pcs equiv. no. G50403GT suitable for IME/Omniwash		
	GEV No.	528021	Ref. No. —
	flat gasket PTFE ED ø 53mm ID ø 42.5mm thickness 3mm Qty 1 pcs equiv. no. 12001/02286 suitable for Astoria/Aurora/Brasilia/Wega		



GEV No.	416216	Ref. No.	CERV18
description	heating element 1800W 230V heating circuits 1 L 330mm W 48mm H 32mm thread M12x1 mounting distance 40mm tube ø 8.5mm connection male faston 6.3mm 2 hole fixing immersion heater		
For models:	DUE ACLQ, DUE ACSQ, DUE AQ, UNO AQ, UNO CLQ, UNO CSQ, UNO Q		
accessories for	416216		
	GEV No.	507332	Ref. No. G18122GT
	flat gasket fibre ED ø 18mm ID ø 12mm thickness 2mm Qty 1 pcs		
	GEV No.	511923	Ref. No. CEPRV0 CEPRV0GR
	protection cap for heating element thread M12		
	GEV No.	550681	Ref. No. —
	nut thread M12x1.25 H 5mm WS 17 brass Qty 1 pcs		





GEV No.	418603	Ref. No.	CERV22
description	heating element 2200W 230V heating circuits 1 L 405mm W 160mm H 35mm thread M12x1 mounting distance 42mm tube ø 8.5mm 2 hole fixing connection male faston 6.3mm immersion heater L1 208mm L2 197mm W1 110mm W2 50mm		
spare parts for	418603		
	GEV No.	528110	Ref. No. —
	O-ring EPDM thickness 2.62mm ID ø 12.37mm Qty 1 pcs		
accessories for	418603		
	GEV No.	520229	Ref. No. —
	nut thread M12x1 H 4mm WS 16 zinc-coated steel Qty 1 pcs		

GEV No.	521110	Ref. No.	—
	flat gasket fibre ED ø 20mm ID ø 13mm thickness 2mm Qty 1 pcs		
GEV No.	521131	Ref. No.	—
	nut thread M12x1 H 3.5mm WS 17 SS Qty 1 pcs		



GEV No.	416217	Ref. No.	CERV25
description	heating element 2500W 230V heating circuits 1 L 410mm W 147mm H 27mm thread M12x1 mounting distance 35mm tube ø 8.3mm connection male faston 6.3mm 2 hole fixing immersion heater L1 195mm L2 215mm W1 96mm W2 43mm		
For models:	QUATTRO Q/82, QUATTROT/82		
accessories for	416217		
	GEV No.	507332	Ref. No. G18122GT
	flat gasket fibre ED ø 18mm ID ø 12mm thickness 2mm Qty 1 pcs		



GEV No.	416219	Ref. No.	CERV8
description	heating element 800W 230V heating circuits 1 L 317mm W 55mm H 32mm thread M12x1 mounting distance 46.5mm tube ø 8.5mm connection male faston 6.3mm 2 hole fixing immersion heater		
For models:	JOLLY AQ, JOLLY AT, JOLLY Q, JOLLY T		
accessories for	416219		
	GEV No.	507332	Ref. No. G18122GT
	flat gasket fibre ED ø 18mm ID ø 12mm thickness 2mm Qty 1 pcs		
	GEV No.	520229	Ref. No. —
	nut thread M12x1 H 4mm WS 16 zinc-coated steel Qty 1 pcs		

thermostats

bi-metal thermostats

safety bi-metal thermostats





GEV No.	390455	Ref. No.	CESB454
description	bi-metal safety thermostat hole distance 40mm switch-off temp. 100°C 2NC 2-pole 16A connection F6.3 2 hole fixing		
For models:	DUE ACLQ, DUE ACSQ, DUE AQ, JOLLY AQ, JOLLY AT, JOLLY Q, JOLLY T, QUATTRO Q/82, QUATTROT/82, SEI 1P, SEI 2P, SEI 2P/S, UNO AQ, UNO CLQ, UNO CSQ, UNO Q		



Зип Общепит
vsezip.ru
+7(812)9800000

			
1			
GEV No.	390456	Ref. No.	CESV001
description	bi-metal safety thermostat hole distance 40mm switch-off temp. 85°C 2NC 2-pole 16A connection F6.3 2 hole fixing		
For models:	SEI 1P, SEI 2P, SEI 2P/S		



			
1			
GEV No.	301018	Ref. No.	CEPUASL
description	momentary rocker switch mounting measurements 30x22mm orange 2NO 230V 16A illuminated 0-I connection male faston 6.3mm ambient temperature max. 125/55°C protection IP65		
For models:	DUE AQ, DUE AT, QUATTRO Q/82, QUATTRO T/82, UNO AQ, UNO AT, UNO Q, UNO T		
accessories for	301018		
	GEV No.	301036	Ref. No. —
	protective cover internal size 30x22mm for rocker switch mounting measurementsmm		

control and safety thermostats

IMIT / TEMPOMATIC / ARTHERMO

control thermostats

			
1			
GEV No.	390186	Ref. No.	CETV55 CETV55CAM
description	thermostat t.max. 52°C temperature range fixed 52°C 1-pole 1CO 16A probe ø 6.5mm probe L 95mm capillary pipe 1000mm capillary pipe isolated 1000mm gland nut shaft Lmm contacts 1CO		
For models:	DUE ACLQ, DUE ACSQ, DUE AQ, JOLLY AQ, JOLLY AT, JOLLY Q, JOLLY T, QUATTRO Q/82, QUATTRO T/82, UNO AQ, UNO CLQ, UNO CSQ, UNO Q		

			
1			
GEV No.	301145	Ref. No.	CEDV6364
description	momentary rocker switch mounting measurements 30x22mm green 2CO 250V 16A illuminated connection male faston 6.3mm ambient temperature max. 85°C protection IP40		
accessories for	301145		
	GEV No.	301036	Ref. No. —
	protective cover internal size 30x22mm for rocker switch mounting measurementsmm		

			
1			
GEV No.	390457	Ref. No.	CETB85 CETB85CAM
description	thermostat t.max. 85°C temperature range 0-90°C 1-pole 1CO 16A probe ø 6.5mm probe L 110mm capillary pipe 1000mm capillary pipe isolated 950mm gland nut shaft ø 6x4.6mm shaft L 19mm shaft position upper shaft position +135° rotation 270° probe material copper		
For models:	DUE ACLQ, DUE ACSQ, DUE AQ, JOLLY AQ, JOLLY AT, JOLLY Q, JOLLY T, QUATTRO Q/82, QUATTRO T/82, SEI 1P, SEI 2P, SEI 2P/S, UNO AQ, UNO CLQ, UNO CSQ, UNO Q		



			
1			
GEV No.	301278	Ref. No.	CEDV6364 CEDVRT
description	rocker switch mounting measurements 30x22mm green 2CO 24V 6A illuminated connection male faston 6.3mm ambient temperature max. 85°C protection IP40		
For models:	SEI 2P		

switches and momentary switches

rocker/momentary rocker switches

30x22mm

			
1			
GEV No.	301135	Ref. No.	CEPU6374
description	momentary rocker switch mounting measurements 30x22mm orange 2NO 24V 16A illuminated connection male faston 6.3mm ambient temperature max. 100/55°C protection IP40		

			
1			
GEV No.	301017	Ref. No.	CEDV01VSL
description	rocker switch mounting measurements 30x22mm green 2CO 250V 16A illuminated connection male faston 6.3mm ambient temperature max. 125/55°C protection IP40		
For models:	DUE AQ, DUE AT, QUATTRO Q/82, QUATTRO T/82, UNO AQ, UNO AT, UNO Q, UNO T		
accessories for	301017		
	GEV No.	301036	Ref. No. —
	protective cover internal size 30x22mm for rocker switch mounting measurementsmm		

electric components



Зип Общепит

vsezip.ru

(812) 982-1150



1

GEV No.	301140	Ref. No.	CEDVC2
description	rocker switch mounting measurements 30x22mm black 2CO 250V 16A I-II connection male faston 6.3mm ambient temperature max. 125/55°C protection IP40		
For models:	QUATTRO Q/82, QUATTRO T/82		
accessories for	301140		
	GEV No.	301036	Ref. No.
			—
	protective cover internal size 30x22mm for rocker switch mounting measurementsmm		



1

GEV No.	301288	Ref. No.	CEPU6374
description	momentary rocker switch mounting measurements 30x22mm orange 2NO 250V 16A illuminated connection male faston 6.3mm ambient temperature max. 100/55°C protection IP40		
For models:	SEI 2P		



1

GEV No.	301136	Ref. No.	CEPUC2
description	momentary rocker switch mounting measurements 30x22mm orange 2NO/indicator light 250V 16A connection male faston 6.3mm ambient temperature max. 100/55°C protection IP40		
For models:	QUATTRO Q/82, QUATTRO T/82		



1

GEV No.	301132	Ref. No.	CEPUVSL
description	momentary rocker switch mounting measurements 30x22mm green 2NO 250V 16A illuminated rinsing warm/cold connection male faston 6.3mm ambient temperature max. 85°C protection IP40		
For models:	DUE AQ, DUE AT, QUATTRO Q/82, QUATTRO T/82, UNO AQ, UNO AT, UNO Q, UNO T		



1

GEV No.	301134	Ref. No.	CEPUPS
description	momentary rocker switch mounting measurements 30x22mm orange 2NO 250V 16A illuminated outflow connection male faston 6.3mm ambient temperature max. 100/55°C protection IP40		
For models:	DUE AQ, DUE AT, QUATTRO Q/82, QUATTRO T/82, UNO AQ, UNO AT, UNO Q, UNO T		



1

GEV No.	301133	Ref. No.	CEPURIG
description	momentary rocker switch mounting measurements 30x22mm orange 2NO 250V 16A illuminated regeneration connection male faston 6.3mm ambient temperature max. 85/125°C protection IP40		
For models:	DUE AQ, DUE AT, QUATTRO Q/82, QUATTRO T/82, UNO AQ, UNO AT, UNO Q, UNO T		

34.2x12.6mm



1

GEV No.	301131	Ref. No.	CEPUR3012
description	momentary rocker switch mounting measurements 34.2x12.6mm orange 2NO 250V 16A illuminated rinsing warm/cold connection male faston 6.3mm		
For models:	DUE ACLQ, DUE ACLT, JOLLY AQ, JOLLY AT, JOLLY Q, JOLLY T, UNO CLQ, UNO CLT		



1

GEV No.	301130	Ref. No.	CEPUC3012
description	momentary rocker switch mounting measurements 34.2x12.6mm orange 2NO 250V 16A illuminated ventilation connection male faston 6.3mm		
For models:	DUE ACLQ, DUE ACLT, JOLLY AQ, JOLLY AT, JOLLY Q, JOLLY T, UNO CLQ, UNO CLT		

accessories

element holders



1

GEV No.	346938	Ref. No.	CETP2230
description	element holder dimensions 30x22mm		
accessories for	346938		



GEV No.	346950	Ref. No.	CETRP2230V
	push button L 25mm W 19.5mm green		



microswitches

Зип Общепит

vsezip.ru

+7(812)98708781

lever actuated



1

GEV No.	345515	Ref. No.	CEMP12CL
description	microswitch 250V 16A 1CO connection male faston 6.3mm ambient temperature max. 125°C with plunger type EF83161.1		



1

GEV No.	346946	Ref. No.	CEMP12CLC
description	microswitch with lever 230V 4A 1NO connection male faston 6.3mm ambient temperature max. 85°C lever length 48/42mm		

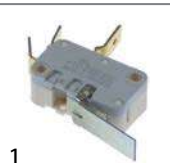

1

GEV No.	347725	Ref. No.	CEMP62PS306
description	microswitch with lever 250V 16A 1CO connection male faston 6.3mm L 35mm ambient temperature max. 125°C mounting distance 22mm type VRSR01DA1 actuating force: 70g lever length 22mm		



1

GEV No.	346237	Ref. No.	CEMP12CSC
description	microswitch with lever 250V 16A 1NO connection male faston 6.3mm L 46.5mm ambient temperature max. 125°C mounting distance 22.5mm with plunger type U83161.1 actuating force: 80g lever length 48/42mm		



1

GEV No.	345529	Ref. No.	CEMP12CS
description	microswitch with lever connection male faston		
For models:	DUE AQ, DUE AT, JOLLY AQ, JOLLY AT, JOLLY Q, JOLLY T, QUATTRO Q/82, QUATTRO T/82, UNO AQ, UNO AT, UNO Q, UNO T		

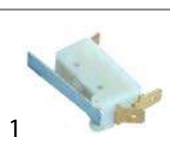

1

GEV No.	345561	Ref. No.	CEMP62PS3
description	microswitch		
For models:	SEI 1P, SEI 2P, SEI 2P/S		



GEV No.	345560	Ref. No.	CEMP62PS
description	microswitch with lever connection male faston		
For models:	SEI 1P, SEI 2P, SEI 2P/S		

pin-plunger actuated



1

GEV No.	345528	Ref. No.	CEMP12
description	microswitch 250V 4A 1CO connection male faston 6.3mm ambient temperature max. 125°C mounting distance 22mm with plunger white		
For models:	QUATTRO Q/82, QUATTRO T/82		



1

GEV No.	347847	Ref. No.	CEMP12SM
description	microswitch with plunger 250V 4A 1CO connection male faston 6.3mm ambient temperature max. 125°C mounting distance 22.2mm type U83161.1 actuating force: 240g white		

non-standard



1

GEV No.	346888	Ref. No.	CESMP61SC
description	microswitch with push button mounting distance 97mm 250V 16A 3CO connection male faston 6.3mm L 32mm ambient temperature max. 125°C type VRSR01DA1 actuating force: 1000g		

accessories for 346888

	GEV No.	346939	Ref. No.	CETAM62PS
		push button for microswitch		

	GEV No.	346940	Ref. No.	18010943 CEMMP6S
		compression spring ø 9mm L 19mm wire gauge ø 0.7mm for micro-switch		

	GEV No.	346941	Ref. No.	CEMP6S
		bolt for microswitch thread M5x0.75 L 60mm ø 6mm		

	GEV No.	346943	Ref. No.	CEAZM62PS
		pressure plate for microswitch		



Зип Общепит





veszip.ru

7(812)987-08-81

accessories



1

GEV No.	507402	Ref. No.	CEMP1823 CEMP1823B CEMP1823BGR
description	actuator for microswitch thread 3/8" L 105mm complete ID ø 12mm ED ø 32mm		
spare parts for	507402		
	GEV No.	507038	Ref. No. CEMP20
description	compression spring ø 8.8mm L 31mm wire gauge ø 0.7mm		
	GEV No.	507039	Ref. No. CEMP21
description	door shaft		
	GEV No.	507040	Ref. No. CEMP22
description	retaining ring E D1 ø 4mm D2 ø 9mm SS DIN 6799 thickness 0.7mm		
accessories for	507402		
	GEV No.	347533	Ref. No. —
description	microswitch with lever 250V 16A 1NO connection male faston 6.3mm ambient temperature max. 125°C for door lever length 74mm		



1

GEV No.	507037	Ref. No.	CEMP18 CEMP18B CEMP18BGR
description	back part for microswitch		
For models:	QUATTRO Q/82, QUATTRO T/82		



1

GEV No.	346941	Ref. No.	CEMP6S
description	bolt for microswitch thread M5x0.75 L 60mm ø 6mm		



1

GEV No.	507041	Ref. No.	CEMP23 CEMP23B
description	front part for microswitch		
For models:	QUATTRO Q/82, QUATTRO T/82		



1

GEV No.	551057	Ref. No.	CESMP6SC
description	housing with microswitch suitable for IME/Omniwash		



1

GEV No.	507032	Ref. No.	CECSM62P
description	lid microswitch box		



1

GEV No.	346943	Ref. No.	CEAZM62PS
description	pressure plate for microswitch		



1

GEV No.	346939	Ref. No.	CETAM62PS
description	push button for microswitch		



1

GEV No.	346944	Ref. No.	CEMPPI
description	screw cap		

system switches (ROLD)



1

GEV No.	345721	Ref. No.	CETP25SF
description	blank cap holder		



1

GEV No.	345546	Ref. No.	CEPUD08
description	momentary switch unit 1CO 250V 16A connection male faston 6.3mm		



1

GEV No.	345606	Ref. No.	CEBP6FD
description	momentary switch unit 2CO 250V 16A connection male faston 6.3mm		



Зип Общепит

vsezip.ru

+7(812)987-08-81



1

GEV No.	347843	Ref. No.	CEBPFDCOMP
description	momentary switch unit 2NO 250V 16A 2-pole		
accessories for	347843		
	GEV No.	347844	Ref. No.
			CETRP2230GR
	push button L 25mm W 19.5mm grey		



1

GEV No.	346951	Ref. No.	CET2230APS CETRP2230A
description	push button L 25mm W 19.5mm orange		



1

GEV No.	347147	Ref. No.	CETRP2230AR
description	push button L 19.5mm W 25mm regeneration orange		



1

GEV No.	347135	Ref. No.	CETRP2230APS
description	push button L 25mm W 19.5mm orange drain pump		



1

GEV No.	347134	Ref. No.	CETRP2230ALV
description	push button L 19.5mm W 25mm short/long orange		



1

GEV No.	347136	Ref. No.	CETP25B
description	push button ø 23mm blue		



1

GEV No.	346952	Ref. No.	CETRP2230N
description	push button L 25mm W 19.5mm black		



1

GEV No.	347137	Ref. No.	CETP25BR
description	push button ø 23mm blue heating		



1

GEV No.	346950	Ref. No.	CETRP2230V
description	push button L 25mm W 19.5mm green		





1

GEV No.	347145	Ref. No.	CETSTBCL
description	push button ø 23mm blue programme		



1

GEV No.	347844	Ref. No.	CETRP2230GR
description	push button L 25mm W 19.5mm grey		
accessories for	347844		
	GEV No.	347843	Ref. No.
			CEBPFDCOMP
	momentary switch unit 2NO 250V 16A 2-pole		



1

GEV No.	346949	Ref. No.	CETP25V01
description	push button ø 23mm green ON-OFF		



Зип Общепит

vsezip.ru

+7(812)987-08-81



1

GEV No.	347133	Ref. No.	CETP25VRF
description	push button ø 23mm green rinsing warm/cold		



1

GEV No.	345523	Ref. No.	CETSTGCL
description	push button ø 23mm grey programme		
For models:	SEI 1P, SEI 2P/S		



1

GEV No.	347141	Ref. No.	CETP25GR
description	push button ø 23mm grey		



1

GEV No.	347148	Ref. No.	CETP25GLV
description	push button ø 23mm grey programme		



1

GEV No.	347139	Ref. No.	CETP25GPC
description	push button ø 23mm grey cycle		



1

GEV No.	347143	Ref. No.	CETP25GRR
description	push button ø 23mm grey regeneration		



1

GEV No.	347144	Ref. No.	CETP25GPS
description	push button ø 23mm grey drain pump		



1

GEV No.	347140	Ref. No.	CETP25GRF
description	push button ø 23mm grey rinsing warm/cold		



1

GEV No.	347142	Ref. No.	CETP25GRRS
description	push button ø 23mm grey heating		



1

GEV No.	346947	Ref. No.	CETP25APC
description	push button ø 23mm orange cycle		



1

GEV No.	347138	Ref. No.	CETP25G01
description	push button ø 23mm grey ON-OFF		



1

GEV No.	346948	Ref. No.	CETP25APS
description	push button ø 23mm orange drain pump		



Зип Общепит
vsezip.ru
+7(812)987-08-81



1

GEV No.	347845	Ref. No.	CETP25ALV/USA
description	push button ø 23mm orange NORMAL/HEAVY		



1

GEV No.	347146	Ref. No.	CETP25ALV
description	push button ø 23mm orange programme		



1

GEV No.	347132	Ref. No.	CETP25AR
description	push button ø 23mm orange regeneration		



1

GEV No.	345524	Ref. No.	CETSTR01
description	push button ø 23mm red ON-OFF		
For models:	SEI 1P, SEI 2P/S		



1

GEV No.	348197	Ref. No.	CETPED16G01
description	push button size 17x13mm grey 0-1 white		



1

GEV No.	348198	Ref. No.	CETPED16GRF
description	push button size 17x13mm grey cold rinsing white		



1

GEV No.	347846	Ref. No.	CETPED16GPC
description	push button size 17x13mm grey START white		





1

GEV No.	345719	Ref. No.	CEDPU08
description	switch 1CO 250V 16A connection male faston 6.3mm		



1

GEV No.	347467	Ref. No.	CEDPPFD CEDPPFDCOMP	
description	switch 2CO 250V 16A 2-pole			
spare parts for	347467			
	GEV No.	347098	Ref. No.	—
	switch 2CO 250V 16A connection male faston 6.3mm			
accessories for	347467			
	GEV No.	346950	Ref. No.	CETRP2230V
	push button L 25mm W 19.5mm green			



1

GEV No.	345651	Ref. No.	CEDP62PS
description	switch 2CO 250V 16A connection male faston 6.3mm		
For models:	SEI 1P, SEI 2P/S		

system switches

OMNIWASH

push buttons



1

GEV No.	347983	Ref. No.	CETPCBSIM
description	push button blue L 24.2mm W 19.2mm H 16.6mm		



1

GEV No.	347726	Ref. No.	CETPCSIM
description	push button grey L 24.2mm W 19.2mm H 16.4mm		





magnetic switches

65x20mm

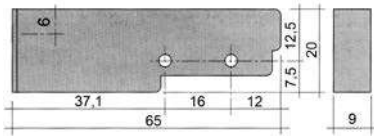

1



GEV No.	345116	Ref. No.	CERD6434
description	magnetic switch L 65mm W 20mm 1NO 250V 0.4A P max. 100W connection cable cable length 3000mm		
accessories for	345116		
	GEV No.	345399	Ref. No. —
	magnet ø 3.3mm L 40mm H 8mm W 13mm hole distance 30mm M3		

accessories

magnets

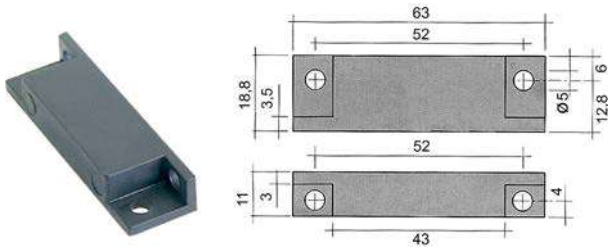

1

GEV No.	345336	Ref. No.	CERM6444
description	magnet ø 4.8mm L 63mm H 11mm W 18.8mm hole distance 51mm M4		

control equipment

SIEMENS

3SB series ø22mm old

rotary switches



1

GEV No.	345526	Ref. No.	CEIN623A4NT
description	rotary selector mounting measurements ø22mm sequence 0-1 latching black		

Зип Общепит

vsezip.ru

+7(812)987 08 81



1

GEV No.	345527	Ref. No.	CESC6284 CESC6284NT
description	rotary selector mounting measurements ø22mm sequence 1-0-2 latching black		
For models:	SEI 2P		

3SB series ø22mm new



1

GEV No.	346630	Ref. No.	CECNO6244NT
description	contact block SIEMENS 3SB3400-0B 1NO max 400V 10A black		
accessories for	346630		
	GEV No.	347520	Ref. No. —
	push button mounting measurements ø22mm non-illuminated black		



1

GEV No.	346631	Ref. No.	CECNC6294 (from 03/2005)
description	contact block SIEMENS 3SB3400-0C 1NC max 400V 10A black		

rotary switches



1





GEV No.	346601	Ref. No.	CEIN623A4
description	rotary selector mounting measurements ø22mm black latching sequence 0-1		
For models:	SEI 2P		
accessories for	346601		
	GEV No.	346602	Ref. No. —
	contact block SIEMENS 3SB3400-0D 2NO max 400V 10A black		
	GEV No.	346603	Ref. No. —
	contact block SIEMENS 3SB3400-0E 2NC max 400V 10A black		
	GEV No.	346630	Ref. No. CECNO6244NT
	contact block SIEMENS 3SB3400-0B 1NO max 400V 10A black		
	GEV No.	346631	Ref. No. CECNC6294 (from 03/2005)
	contact block SIEMENS 3SB3400-0C 1NC max 400V 10A black		

Table continues overleaf



Зип Общепит

vsezip.ru

+7(812)987-08-81

accessories for	346601			
	GEV No.	346632	Ref. No.	—
contact block SIEMENS 3SB3400-0D 1NC/1NO max 400V 10A black				

lamps

indicator lights

indicator lights 2-piece (lens and indicator lamp)

indicator light lenses

ø 6mm (type SQ-20)



GEV No.	359803	Ref. No.	CEGV6
description	indicator light lens green Qty 1 pcs ø 6mm		



GEV No.	359805	Ref. No.	CEGA6
description	indicator light lens red Qty 1 pcs ø 6mm		

ø10mm (type SRZ-2)



GEV No.	359359	Ref. No.	CESP6224
description	indicator light housings mounting measurements ø10mm green square		
For models:	SEI 2P		



GEV No.	359358	Ref. No.	CESP6274
description	indicator light housings mounting measurements ø10mm orange square		
For models:	SEI 2P		

ø10mm (type SRZ-3)



GEV No.	359123	Ref. No.	CESPE31
description	indicator light housings mounting measurements ø10mm green round Qty 1 pcs		
For models:	DUE ACLQ, DUE ACLT, JOLLY AQ, JOLLY AT, JOLLY Q, JOLLY T, SEI 1P, SEI 2P/S, UNO CLQ, UNO CLT		

accessories for	359123			
	GEV No.	359132	Ref. No.	CESP27V
indicator lamp green 250V connection male faston 6.3mm protection IP54 ambient temperature max. 85°C				

GEV No.	359124	Ref. No.	CESPE32
description	indicator light housings mounting measurements ø10mm yellow round Qty 1 pcs		
For models:	DUE ACLQ, DUE ACLT, JOLLY AQ, JOLLY AT, JOLLY Q, JOLLY T, SEI 1P, SEI 2P/S, UNO CLQ, UNO CLT		

accessories for	359124			
	GEV No.	359132	Ref. No.	CESP27V
indicator lamp green 250V connection male faston 6.3mm protection IP54 ambient temperature max. 85°C				

indicator lamps for socket type SQ



GEV No.	359109	Ref. No.	CESPV6
description	indicator lamp 230V green connection male faston 6.3mm no lens ø 6mm		

accessories for	359109			
	GEV No.	359806	Ref. No.	—
indicator light lens clear Qty 1 pcs ø 6mm				



GEV No.	359110	Ref. No.	CESPA6
description	indicator lamp 230V white connection male faston 6.3mm no lens ø 6mm		

indicator lamps for socket type SRZ / SDK / SDY / SFK



GEV No.	359130	Ref. No.	CESP27
description	indicator lamp 230V clear connection male faston 6.3mm ø 8mm		
For models:	DUE ACLQ, DUE ACLT, JOLLY AQ, JOLLY AT, JOLLY Q, JOLLY T, SEI 1P, SEI 2P/S, UNO CLQ, UNO CLT		



GEV No.	359129	Ref. No.	CESP6394
description	indicator lamp 24V clear connection male faston 6.3mm		
For models:	SEI 2P		



GEV No.	359132	Ref. No.	CESP27V
description	indicator lamp green 250V connection male faston 6.3mm protection IP54 ambient temperature max. 85°C		

1 electric components



indicator lights (complete)

30x22mm



1

GEV No.	301138	Ref. No.	CESDAV CESPDAV
description	indicator light mounting measurements 30x22mm 230V red/green connection male faston 6.3mm temp.-resist. 125/55°C type RL2		
For models:	DUE AQ, DUE AT, QUATTRO Q/82, QUATTRO T/82, UNO AQ, UNO AT, UNO Q, UNO T		

blank elements



1

GEV No.	359784	Ref. No.	CESB6334
description	bezel		
For models:	SEI 2P		



1

GEV No.	359787	Ref. No.	CESB6384
description	bezel		
For models:	SEI 2P		



1

GEV No.	359778	Ref. No.	CESB6194
description	bezel boiler		
For models:	SEI 2P		



1

GEV No.	359781	Ref. No.	CESB6304
description	bezel cycle 1-short		
For models:	SEI 2P		



1

GEV No.	359783	Ref. No.	CESB6324
description	bezel cycle 2-medium		
For models:	SEI 2P		

Зип Общепит

vsezip.ru

+7(812)987-08-81

GEV No.	359782	Ref. No.	CESB6314
description	bezel cycle 1-long		
For models:	SEI 2P		



1

GEV No.	359777	Ref. No.	CESB6184
description	bezel O		
For models:	SEI 2P		



1

GEV No.	359776	Ref. No.	CEGV2329
description	bezel ø 10mm cycle		
For models:	SEI 1P, SEI 2P/S		



1

GEV No.	359773	Ref. No.	CEGA2328
description	bezel ø 10mm ON-OFF		
For models:	SEI 1P, SEI 2P/S		



1

GEV No.	359774	Ref. No.	CEGV2307
description	bezel ø 10mm tank		
For models:	SEI 2P/S		



1

GEV No.	359775	Ref. No.	CEGV2320
description	bezel ø 13mm boiler mounting ø 10mm		
For models:	SEI 1P, SEI 2P/S		



1

GEV No.	359780	Ref. No.	CESB6264
description	bezel on		
For models:	SEI 2P		





Зип Общепит

vsezip.ru

+7(812)987-08-81

 <p>1</p>			
GEV No.	359785	Ref. No.	CESB6344
description	bezel rinsing		
For models:	SEI 2P		

 <p>1</p>			
GEV No.	359779	Ref. No.	CESB6204
description	bezel tank		
For models:	SEI 2P		

 <p>1</p>			
GEV No.	359786	Ref. No.	CESB6354
description	bezel washing		
For models:	SEI 2P		

 <p>1</p>			
GEV No.	360560	Ref. No.	CEPRI150
description	timer CDC 7804F engines 1 chambers 4 operation time 12min 230V 50Hz shaft ømm shaft Lmm manif. no. 7804 motor type M37RN voltage AC		



 <p>1</p>			
GEV No.	360689	Ref. No.	CETD1224BGB
description	timer CDC 7805DV engines 2 chambers 5 operation time 40s/4min 230V 50Hz shaft ømm shaft Lmm		

timers

programme timers

 <p>Image not available</p> <p>1</p>			
GEV No.	360226	Ref. No.	CETR24
description	timer		

 <p>1</p>			
GEV No.	360220	Ref. No.	CETF150J
description	timer CDC 11803 engines 1 chambers 3 operation time 150s		



 <p>1</p>				
GEV No.	360216	Ref. No.	CET2C6S	
description	timer CDC 7805DV engines 2 chambers 5 operation time 6s / 135s 230V shaft ømm shaft Lmm manif. no. 7805DV / CET2C6S motor type M37RN/M37LN			
For models:	SEI 2P/S			
spare parts for	360216			
	GEV No.	360119	Ref. No.	—
motor CDC pinion ø 5.4mm teeth 12 230V turn direction right motor ø 37mm motor type M37RN for timer				
	GEV No.	360131	Ref. No.	—
motor CDC pinion ø 5.4mm teeth 12 230V turn direction left motor ø 37mm motor type M37LN for timer				



Зип Общепит

vsezip.ru

+7(812)987-08-81



			
1			
GEV No.	360215	Ref. No.	CET2C61P
description	timer CDC 7805DV engines 2 chambers 5 operation time 6s / 3min 230V shaft ømm shaft Lmm motor type M37RN/M37LN		
For models:	SEI 1P		
spare parts for	360215		
	GEV No.	360119	Ref. No. —
	motor CDC pinion ø 5.4mm teeth 12 230V turn direction right motor ø 37mm motor type M37RN for timer		
	GEV No.	360131	Ref. No. —
	motor CDC pinion ø 5.4mm teeth 12 230V turn direction left motor ø 37mm motor type M37LN for timer		

			
1			
GEV No.	360217	Ref. No.	CET3C4SC CET3C6 CET3C6NT
description	timer CDC 7807DV engines 2 chambers 7 operation time 6s / 3min 24V manuf. no. 7807DV motor type M37RN/M37LN		
For models:	SEI 2P		
spare parts for	360217		
	GEV No.	360324	Ref. No. —
	motor CDC pinion ø 5.4mm teeth 12 24V voltage AC turn direction right motor ø 37mm motor type M37RN		
	GEV No.	360325	Ref. No. —
	motor CDC pinion ø 5.4mm teeth 12 24V voltage AC turn direction left motor ø 37mm motor type M37LN		

			
1			
GEV No.	360451	Ref. No.	CET2C6SGB
description	timer CDC 7806DV engines 2 chambers 6 230V 50Hz manuf. no. 7806DV / CET2C6SGB motor type M37RN/M37LN run-time 6/135s		

			
1			
GEV No.	360692	Ref. No.	CEPSTFB
description	timer CDC CEPSTFB engines 1 chambers 2 operation time 180s 230V shaft ømm shaft Lmm manuf. no. 7802F10AEE000.0000 motor type M37R		
For models:	QUATTRO Q/82, QUATTRO T/82		

			
1			
GEV No.	360561	Ref. No.	CET2C6S08
description	timer CDC 7806DV engines 2 chambers 6 operation time 6s / 2min 230V 50Hz shaft ømm shaft Lmm manuf. no. 7806DV motor type M37R/M37L voltage AC		

			
1			
GEV No.	360219	Ref. No.	CETF12
description	timer FIBER P25 engines 1 chambers 3 operation time 120s 230V shaft ømm shaft Lmm manuf. no. P255J03H3C1 motor type M51B-J0R6400		
spare parts for	360219		
	GEV No.	360673	Ref. No. —
	motor kit pinion ø 6.8mm teeth 15 230V voltage AC 50/60Hz turn direction clockwise motor ø 48mm H 18.5mm motor type UDS-40NE1RNZ165 cable length 150mm with holder		

			
1			
GEV No.	360452	Ref. No.	CET2C61PGB
description	timer CDC 7806DV engines 2 chambers 6 operation time 6s / 3min 230V 50Hz shaft ømm shaft Lmm manuf. no. 7806DV / CET2C61PGB motor type M37RN/M37LN		

Зип Общепит

vsezip.ru

+7(812)987-08-81



1

GEV No.	360249	Ref. No.	CETF150J CETF150J05
description	timer FIBER P25 engines 1 chambers 3 operation time 150s 230V shaft ømm shaft Lmm manif. no. P255J03H4U7 motor type M51B-J0R6400 / 230V		
For models:	JOLLY AQ, JOLLY AT, JOLLY Q, JOLLY T		
spare parts for	360249		
	GEV No.	360673	Ref. No. —
	motor kit pinion ø 6.8mm teeth 15 230V voltage AC 50/60Hz turn direction clockwise motor ø 48mm H 18.5mm motor type UDS-40NE1RNZ165 cable length 150mm with holder		





1

GEV No.	360221	Ref. No.	CETF20 CETR20B
description	timer FIBER P26 engines 1 chambers 3 operation time 20min 230V shaft ømm shaft Lmm manif. no. P265J03L147 motor type M61B40R6400		



1

GEV No.	360548	Ref. No.	CETF24
description	timer FIBER P25 engines 1 chambers 3 operation time 4min 230V shaft ømm shaft Lmm manif. no. P255J03H6Y3		
spare parts for	360548		
	GEV No.	360673	Ref. No. —
	motor kit pinion ø 6.8mm teeth 15 230V voltage AC 50/60Hz turn direction clockwise motor ø 48mm H 18.5mm motor type UDS-40NE1RNZ165 cable length 150mm with holder		



1

GEV No.	360559	Ref. No.	CETF12B
description	timer FIBER P26 engines 1 chambers 3 operation time 2min 230V shaft ømm shaft Lmm motor type M61B40R0000 type P265J03H346		



1

GEV No.	360227	Ref. No.	CETR24B
description	timer FIBER P26 engines 1 chambers 3 operation time 4min 230V shaft ø 6x4.6mm shaft L 19mm manif. no. P265J03H650 motor type M61B40L6400		
For models:	QUATTRO Q/82, QUATTRO T/82		



1

GEV No.	360228	Ref. No.	CEPSTF
description	timer FIBER P26 engines 1 chambers 2 operation time 180s 230V shaft ømm shaft Lmm manif. no. P265J02H545 motor type M61B40R6400		



1

GEV No.	360222	Ref. No.	CETF24B
description	timer FIBER P26 engines 1 chambers 3 operation time 4min 230V shaft ømm shaft Lmm manif. no. P265J03H649 motor type M61B40R6400		
For models:	QUATTRO Q/82, QUATTRO T/82		



spare parts and accessories

miscellaneous



1			
GEV No.	360229	Ref. No.	CETF60 CETF60S
description	plug		
For models:	SEI 2P		

contactors

ISKRA (FANAL)

power contactors



1			
GEV No.	380415	Ref. No.	TEBOFA
description	power contactor resistive load 16A 230VAC (AC3/400V) 8.5A/5.5kW main contacts 3NO auxiliary contacts 1NC connection male faston 6.3mm type Fanal DSL7 01 type ISKRA K07MF 01		



1			
GEV No.	380212	Ref. No.	CECT
description	power contactor resistive load 20A 230VAC (AC3/400V) 8.5A/5.5kW main contacts 3NO auxiliary contacts 1NC connection screw connection type Fanal K07M 01 type ISKRA DSL7 01		



1			
GEV No.	380411	Ref. No.	CECT24P
description	power contactor resistive load 20A 24VAC (AC3/400V) 8.5A/5.5kW main contacts 3NO auxiliary contacts 1NC connection screw connection type Fanal DSL7 10 type ISKRA K07M 01		
For models:	SEI 2P		

Зип Общепит

vsezip.ru

+7(812)987-08-81



1			
GEV No.	380204	Ref. No.	CECT24G
description	power contactor resistive load 25A 230VAC (AC3/400V) 9A/4kW main contacts 3NO auxiliary contacts 1NO connection screw connection type Fanal DSL9 10 type ISKRA KNL9 10		
For models:	SEI 2P		



1			
GEV No.	380420	Ref. No.	CER16A2NO
description	power contactor resistive load 25A 24VAC (AC3/400V) 9A/4kW main contacts 3NO auxiliary contacts 1NO connection screw connection type Fanal DSL9 10 type ISKRA KNL9 10		

SIEMENS

power contactors



1			
GEV No.	380529	Ref. No.	CECTF CER16A2NO
description	power contactor resistive load 16A 230VAC (AC3/400V) 8.4A/4kW main contacts 3NO auxiliary contacts 1NC connection male faston 6.3mm type 3TG10-01-1A2L2		
For models:	DUE AQ, DUE AT, JOLLY AQ, JOLLY AT, JOLLY Q, JOLLY T, QUATTRO Q/82, QUATTRO T/82, SEI 1P, SEI 2P/S, UNO AQ, UNO AT, UNO Q, UNO T		



relays

relay sockets

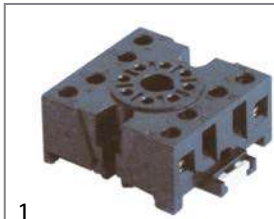

1

GEV No.	360230	Ref. No.	CETF60A
description	base		
For models:	SEI 2P, SEI 2P/S		

transformers

open transformers

with clamp terminal



1

GEV No.	400134	Ref. No.	CETRS24 CETRS24E
description	transformer primary 230/400VAC secondary 24VAC 100VA secondary 5A H 95mm L 85mm W 85mm connection screw 50/60Hz type USE10BB		
For models:	SEI 2P		

electronic controllers



ELIWELL

refrigeration controllers

built-in version 2-piece



1

GEV No.	379398	Ref. No.	TKS0312	
description	keypad unit ELIWELL type IS972LX model IS23DI0XCD000 mounting measurements 71x29mm 230V voltage AC relay outputs DI built-in depth 30mm °C display 3½ digits			
accessories for	379398			
	GEV No.	379533	Ref. No.	—
	load module ELIWELL type EWEM233 model DS34000DC700 mounting measurements 70x85mm 230V voltage AC NTC/PTC relay outputs 3 NO-15A(12) CO-10A(7) NO-16A(8) NTC/PTC NTC/PTC front measurements 70mm built-in depth 61mm protection IPx0 yes -55 up to +150°C display			
	GEV No.	379534	Ref. No.	—
	connection cable type EC0000110 connection RJ45 L 1000mm for ELIWELL/universal			

Зип.Общепит

probes

vsezip.ru

+7(812)987-08-81

producer-specific probes



GEV No.	379823	Ref. No.	CESTVBJ CESTM
description	temperature probe PTC 2kOhm cable PTFE probe -50 up to +150°C cable -40 up to +250°C connection plug thread probe ø6.5x25mm cable length 1.5m		

electronics

PCBs

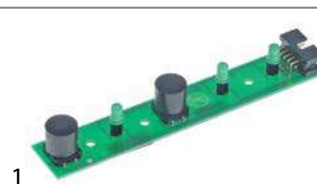

1

GEV No.	403121	Ref. No.	CEMTEM2BT CEMTEM2BT
description	keypad PCB dishwasher L 126mm W 22mm buttons 3		



1

GEV No.	403772	Ref. No.	CESEMM3500ST
description	main PCB dishwasher 3500ST L 122mm W 100mm		

keypads

front foils



1

GEV No.	519538	Ref. No.	CETSHILTA4 TAORHIS42
description	front foil grey/black suitable for IME L 585mm W 55mm		

control panel



1

GEV No.	502253	Ref. No.	CEPC6214P1 CEPC6214P105
description	control panel warewashing L 310mm W 133mm H 7mm black		

electric components



Зип Общепит

vsezip.ru

+7(812)987-08-81

electric components



1

GEV No.	511639	Ref. No.	CEPC62145
description	switch panel dishwasher L 312mm W 132mm blue suitable for IME/Omniwash		



1

GEV No.	512435	Ref. No.	CEPC6214505
description	switch panel dishwasher L 312mm W 132mm grey suitable for IME/Omniwash		



1

GEV No.	511686	Ref. No.	CEPC621405
description	switch panel for dishwasher L 312mm W 132mm suitable for IME/Omniwash grey		

accessories



1

GEV No.	347147	Ref. No.	CETRP2230AR
description	push button L 19.5mm W 25mm regeneration orange		



1

GEV No.	347134	Ref. No.	CETRP2230ALV
description	push button L 19.5mm W 25mm short/long orange		



1

GEV No.	347844	Ref. No.	CETRP2230GR
description	push button L 25mm W 19.5mm grey		
accessories for	347844		
	GEV No.	347843	Ref. No.
			CEPBPFDCOMP
	momentary switch unit 2NO 250V 16A 2-pole		



1

GEV No.	347135	Ref. No.	CETRP2230APS
description	push button L 25mm W 19.5mm orange drain pump		

solenoid valves

solenoid valves (water)

RPE



1

GEV No.	374054	Ref. No.	CEEV124
description	solenoid valve single straight 24V inlet 3/4" outlet 11.5mm DN10		
For models:	SEI 2P		

solenoid valves with reducers

3-fold



1















GEV No.	370240	Ref. No.	CEEV3
description	solenoid valve triple straight 230VAC inlet 3/4" outlet 11.5mm t.max. 90°C RPE plastic output B 0.32-0.42l/min flow regulating valve outlet B green		
For models:	DUE AQ, QUATTRO Q/82, QUATTRO T/82, UNO AQ, UNO Q		







Зип Общепит

vsezip.ru

+7(812)987-08-81

TP			
			
1			
GEV No.	370021	Ref. No.	CEEV2
description	solenoid valve double straight 230VAC inlet 3/4" outlet 11.5mm DN10 TP flow regulating valve inlet white		
For models:	DUE ACLQ, DUE ACSQ, DUE AQ, JOLLY AQ, JOLLY AT, JOLLY Q, JOLLY T, QUATTRO Q/82, QUATTRO T/82, UNO AQ, UNO CLQ, UNO CSQ, UNO Q		
spare parts for	370021		
	GEV No.	371013	Ref. No. —
	solenoid coil TP 230VAC 50/60Hz		
accessories for	370021		
	GEV No.	371220	Ref. No. —
	reducer TP flow rate 3l/min red tolerance ±15%		
	GEV No.	371221	Ref. No. —
	reducer TP flow rate 5.5l/min yellow tolerance ±15%		
	GEV No.	371222	Ref. No. —
	reducer TP flow rate 6l/min grey tolerance ±15%		
	GEV No.	371223	Ref. No. —
	reducer TP flow rate 10l/min white tolerance ±15%		
	GEV No.	371224	Ref. No. —
	reducer TP flow rate 12l/min bronze tolerance ±15%		
	GEV No.	371225	Ref. No. —
	reducer TP flow rate 16l/min light brown tolerance ±15%		
	GEV No.	371226	Ref. No. —
	reducer TP flow rate 20l/min red tolerance ±15%		
	GEV No.	371230	Ref. No. —
	reducer TP flow rate 0.25l/min red tolerance ±25%		
	GEV No.	371231	Ref. No. —
	reducer TP flow rate 0.35l/min violet tolerance ±25%		
	GEV No.	371232	Ref. No. —
	reducer TP flow rate 0.5l/min orange tolerance ±25%		
	GEV No.	371233	Ref. No. —
	reducer TP flow rate 0.8l/min white tolerance ±25%		
	GEV No.	371234	Ref. No. —
	reducer TP flow rate 1l/min light blue tolerance ±25%		
	GEV No.	371235	Ref. No. —
	reducer TP flow rate 1.2l/min brown tolerance ±25%		
	GEV No.	371236	Ref. No. —
	reducer TP flow rate 1.5l/min light brown tolerance ±25%		

accessories for 370021			
	GEV No.	371237	Ref. No. —
	reducer TP flow rate 2.5l/min yellow tolerance ±25%		
	GEV No.	371238	Ref. No. —
	reducer TP flow rate 3.4l/min dark green tolerance ±25%		
	GEV No.	371239	Ref. No. —
	reducer TP flow rate 5l/min black tolerance ±25%		
	GEV No.	371240	Ref. No. —
	reducer TP flow rate 8l/min blue tolerance ±20%		

TP			
			
1			
GEV No.	370017	Ref. No.	CEEV1
description	solenoid valve single straight 230VAC inlet 3/4" outlet 11.5mm DN10 TP p max 10bar		
For models:	QUATTRO Q/82, QUATTRO T/82, SEI 1P, SEI 2P/S		
spare parts for	370017		
	GEV No.	371013	Ref. No. —
	solenoid coil TP 230VAC 50/60Hz		
accessories for	370017		
	GEV No.	371220	Ref. No. —
	reducer TP flow rate 3l/min red tolerance ±15%		
	GEV No.	371221	Ref. No. —
	reducer TP flow rate 5.5l/min yellow tolerance ±15%		
	GEV No.	371222	Ref. No. —
	reducer TP flow rate 6l/min grey tolerance ±15%		
	GEV No.	371223	Ref. No. —
	reducer TP flow rate 10l/min white tolerance ±15%		
	GEV No.	371224	Ref. No. —
	reducer TP flow rate 12l/min bronze tolerance ±15%		
	GEV No.	371225	Ref. No. —
	reducer TP flow rate 16l/min light brown tolerance ±15%		
	GEV No.	371226	Ref. No. —
	reducer TP flow rate 20l/min red tolerance ±15%		
	GEV No.	371230	Ref. No. —
	reducer TP flow rate 0.25l/min red tolerance ±25%		
	GEV No.	371231	Ref. No. —
	reducer TP flow rate 0.35l/min violet tolerance ±25%		
	GEV No.	371232	Ref. No. —
	reducer TP flow rate 0.5l/min orange tolerance ±25%		

Table continues overleaf



Зип-Общепит

vsezip.ru

+7(812)987-08-81

accessories for		370017	
	GEV No.	371233	Ref. No. —
	reducer TP flow rate 0.8l/min white tolerance ±25%		
	GEV No.	371234	Ref. No. —
	reducer TP flow rate 1l/min light blue tolerance ±25%		
	GEV No.	371235	Ref. No. —
	reducer TP flow rate 1.2l/min brown tolerance ±25%		
	GEV No.	371236	Ref. No. —
	reducer TP flow rate 1.5l/min light brown tolerance ±25%		
	GEV No.	371237	Ref. No. —
	reducer TP flow rate 2.5l/min yellow tolerance ±25%		
	GEV No.	371238	Ref. No. —
	reducer TP flow rate 3.4l/min dark green tolerance ±25%		
	GEV No.	371239	Ref. No. —
	reducer TP flow rate 5l/min black tolerance ±25%		
	GEV No.	371240	Ref. No. —
	reducer TP flow rate 8l/min blue tolerance ±20%		

accessories for		370029	
	GEV No.	371230	Ref. No. —
	reducer TP flow rate 0.25l/min red tolerance ±25%		
	GEV No.	371231	Ref. No. —
	reducer TP flow rate 0.3l/min violet tolerance ±25%		
	GEV No.	371232	Ref. No. —
	reducer TP flow rate 0.5l/min orange tolerance ±25%		
	GEV No.	371233	Ref. No. —
	reducer TP flow rate 0.8l/min white tolerance ±25%		
	GEV No.	371234	Ref. No. —
	reducer TP flow rate 1l/min light blue tolerance ±25%		
	GEV No.	371235	Ref. No. —
	reducer TP flow rate 1.2l/min brown tolerance ±25%		
	GEV No.	371236	Ref. No. —
	reducer TP flow rate 1.5l/min light brown tolerance ±25%		
	GEV No.	371237	Ref. No. —
	reducer TP flow rate 2.5l/min yellow tolerance ±25%		
	GEV No.	371238	Ref. No. —
	reducer TP flow rate 3.4l/min dark green tolerance ±25%		
	GEV No.	371239	Ref. No. —
	reducer TP flow rate 5l/min black tolerance ±25%		
	GEV No.	371240	Ref. No. —
	reducer TP flow rate 8l/min blue tolerance ±20%		



1	GEV No.	370029	Ref. No.	CEEV124
description	solenoid valve single straight 24VAC inlet 3/4" outlet 11.5mm DN10 TP flow regulating valve inlet white			
spare parts for	370029			
	GEV No.	371035	Ref. No.	—
	solenoid coil 24VAC			
accessories for	370029			
	GEV No.	371220	Ref. No.	—
	reducer TP flow rate 3l/min red tolerance ±15%			
	GEV No.	371221	Ref. No.	—
	reducer TP flow rate 5.5l/min yellow tolerance ±15%			
	GEV No.	371222	Ref. No.	—
	reducer TP flow rate 6l/min grey tolerance ±15%			
	GEV No.	371223	Ref. No.	—
	reducer TP flow rate 10l/min white tolerance ±15%			
	GEV No.	371224	Ref. No.	—
	reducer TP flow rate 12l/min bronze tolerance ±15%			
	GEV No.	371225	Ref. No.	—
	reducer TP flow rate 16l/min light brown tolerance ±15%			
	GEV No.	371226	Ref. No.	—
	reducer TP flow rate 20l/min red tolerance ±15%			

pressure switches

for warewashing

ø51 mm with coded plug



1	GEV No.	541784	Ref. No.	CECBCMPR CEPR PRL110
description	pressure control pressure range 50/20mbar ø 51mm pressure connection horizontal warewashing pressure connection ø 5.5mm at 250V 10A			



Зип Общепит

vsezip.ru

+7(812)987-08-81

ø 58mm with male faston 6.3mm
with connection horizontal



1

GEV No.	541889	Ref. No.	CEPR
description	pressure control pressure range 50/20mbar connection 6mm ø 58mm		
For models:	DUE AQ, DUE AT, JOLLY AQ, JOLLY AT, JOLLY Q, JOLLY T, QUATTRO Q/82, QUATTRO T/82, UNO AQ, UNO AT, UNO Q, UNO T		

ø 84mm with coded plug



1

GEV No.	541645	Ref. No.	CEPRE2LUL
description	pressure control 2 pressure ranges pressure range 45/20 65/47mbar connection 6mm ø 84mm pressure connection ø 6mm		



1

GEV No.	541165	Ref. No.	CEPRE
description	pressure control pressure range 60/30mbar connection 6mm ø 58mm pressure connection horizontal warewashing pressure connection ø 6mm		
For models:	QUATTRO Q/82, QUATTRO T/82		



1

GEV No.	541959	Ref. No.	CEPR62P
description	pressure control pressure range 90/30mbar connection 6mm ø 58mm pressure connection horizontal warewashing pressure connection ø 6mm		

ø 79mm with coded plug



1

GEV No.	541874	Ref. No.	CEPR2LE
description	pressure control 2 pressure ranges pressure range 27/12 41/26mbar connection 6mm ø 79mm warewashing pressure connection ø 6mm		

pumps
wash and rinse pumps

ALBA (C&A)
pumps



1

GEV No.	500938	Ref. No.	EP25CPG EP30
description	pump inlet ø 30mm outlet ø 30mm type IM1629030 230V 50Hz 1 phase 0.22kW 0.3HP L 175mm rotation direction right capacitor 10µF auxiliary pressure connection 10mm supporting pressure open ALBA PUMPS (C&A)		
For models:	JOLLY AQ, JOLLY AT, JOLLY Q, JOLLY T, UNO AQ, UNO AT, UNO Q, UNO T		
spare parts for	500938		
	GEV No.	507065	Ref. No. EP251TP
	pump cover		
	GEV No.	509018	Ref. No. —
	O-ring EPDM thickness 3.53mm ID ø 107.5mm Qty 1 pcs		
	GEV No.	509028	Ref. No. —
	impellor ø 87mm H 21mm rotation direction right thread M7L shaft ø 12mm		
	GEV No.	510693	Ref. No. —
	mechanical shaft seal for shaft ø 12mm slide ring ext. ø 24mm slide ring H 15.5mm slide ring int. ø 11mm counter ring mounting ø 24mm height counter ring 8mm counter ring int. ø 13.5mm		

Table continues overleaf



ЗипОбщепит

pumps



vsezip.ru

+7(812)987-08-81







accessories for 500938

GEV No.	365014	Ref. No.	CECN12
	operating capacitor capacity 12.5µF 450V tolerance 5%Hz ambient temperature max. -25 to +85°C ø 35mm L 70mm M8 plastic connection male faston 6.3mm 45S.C3DS.12.5 protection		



GEV No.	500941	Ref. No.	EP50CPG EP60
description	pump inlet ø 30mm outlet ø 30mm type IM32591 230V 50Hz 1 phase 0.45kW 0.6HP L 200mm rotation direction right capacitor 12.5µF auxiliary pressure connection 11mm supporting pressure open ALBA PUMPS (C&A)		
For models:	DUE AQ, DUE AT		
spare parts for	500941		
	GEV No.	365014	Ref. No. CECN12
	operating capacitor capacity 12.5µF 450V tolerance 5%Hz ambient temperature max. -25 to +85°C ø 35mm L 70mm M8 plastic connection male faston 6.3mm 45S.C3DS.12.5 protection		
	GEV No.	509018	Ref. No. —
	O-ring EPDM thickness 3.53mm ID ø 107.5mm Qty 1 pcs		
	GEV No.	510692	Ref. No. —
	mechanical shaft seal for shaft ø 11mm slide ring ext. ø 24mm slide ring H 13mm counter ring mounting ø 26mm height counter ring 8mm counter ring int. ø 14mm		

1

GEV No.	499137	Ref. No.	ABPRF5213
description	pump inlet ø 30mm outlet ø 26mm type 5213E2452 220/240V 50Hz 1 phase 0.07kW 0.1HP L 195mm rotation direction left capacitor 5µF FIR		
spare parts for	499137		
	GEV No.	365017	Ref. No. —
	operating capacitor capacity 5µF 450V tolerance 5% 50/60Hz ambient temperature max. -25 to +85°C ø 28mm L 54mm M8 plastic connection male faston 6.3mm 16.10.08 protection		
	GEV No.	502250	Ref. No. —
	O-ring EPDM thickness 4mm ID ø 74mm Qty 1 pcs		
	GEV No.	502265	Ref. No. —
	pump cover inlet ø 30mm outlet ø 26mm ID ø 89mm inner height 35mm		
	GEV No.	510695	Ref. No. —
	mechanical shaft seal height counter ring 5.5mm ID ø 11mm		
	GEV No.	521203	Ref. No. —
	impeller ø 72mm H 18mm thread M7 shaft ø 11mm shaft length 32mm blades 3		
	GEV No.	532718	Ref. No. —
	O-ring EPDM thickness 4mm ID ø 80mm Qty 1 pcs		
	GEV No.	699372	Ref. No. —
	flange for pump with cover type 5213 L 103mm W 103mm H 69mm		

drain pumps

ASKOLL



GEV No.	500347	Ref. No.	CEPS031482
description	drain pump 230V 34W		
For models:	QUATTRO Q/82, QUATTROT/82		



Зип Обществит

vsezip.ru

+7(812)987-08-81



1

GEV No.	499340	Ref. No.	CEPS51
description	drain pump 40W 220-240V inlet ø 30mm outlet ø 22mm 50Hz ASKOLL type M332		



1

GEV No.	500346	Ref. No.	CEPS031
description	drain pump inlet ø 30mm outlet ø 22mm 230V 40W 50Hz ASKOLL type M231 XP with holder		

booster pumps II

accessories



1

GEV No.	365015	Ref. No.	CECN10
description	operating capacitor capacity 10µF 400V tolerance 5%Hz ambient temperature max. -25 to +85°C ø 35.5mm L 59mm M8 plastic connection male faston 6.3mm protection		
For models:	JOLLY AQ, JOLLY AT, JOLLY Q, JOLLY T, UNO AQ, UNO AT, UNO Q, UNO T		

condensators & interference suppression filters

plastic



1

GEV No.	365015	Ref. No.	CECN10
description	operating capacitor capacity 10µF 400V tolerance 5%Hz ambient temperature max. -25 to +85°C ø 35.5mm L 59mm M8 plastic connection male faston 6.3mm protection		
For models:	JOLLY AQ, JOLLY AT, JOLLY Q, JOLLY T, UNO AQ, UNO AT, UNO Q, UNO T		



1

GEV No.	365014	Ref. No.	CECN12
description	operating capacitor capacity 12.5µF 450V tolerance 5%Hz ambient temperature max. -25 to +85°C ø 35mm L 70mm M8 plastic connection male faston 6.3mm 45S.C3DS.12.5 protection		
For models:	DUE AQ, DUE AT, QUATTRO Q/82, QUATTRO T/82, SEI 1P, SEI 2P, SEI 2P/S		

filters

interference suppression filters



1

GEV No.	365046	Ref. No.	CEFA
description	interference suppression filter type 10S7E-G1474253105-Q 115/250V 50/60Hz conductor 2 with E connection male faston 6.3mm L 40mm ø 40mm Hmm Wmm M8 plastic Qty 1 pcs		
For models:	DUE AQ, DUE AT, JOLLY AQ, JOLLY AT, JOLLY Q, JOLLY T, QUATTRO Q/82, QUATTRO T/82, SEI 1P, SEI 2P, SEI 2P/S, UNO AQ, UNO AT, UNO Q, UNO T		

fuses

fine fuses



1

GEV No.	358074	Ref. No.	CEFU5205A
description	fine fuse size ø5x20mm 5A fast-acting rated 250V Qty 10 pcs		

1 electric components

fine fuse holders

			
1			
GEV No.	358512	Ref. No.	CEMI-STR
description	fuse holder		
For models:	SEI 1P, SEI 2P, SEI 2P/S		

brewing units with solenoid valve

gaskets			
			
1			
GEV No.	532554	Ref. No.	OR102
description	O-ring silicone unfillers 15mm ID ø 4.1mm Qty 1 pcs		

electric accessories

terminals

connection terminals with screw/faston connections

			
1			
GEV No.	550278	Ref. No.	CEMOS
description	power terminal block 3-pole max. 40A max 400V connection ø6mm ² / F6.3 temp.-resist. 150°C cross section 6mm ²		

			
1			
GEV No.	550411	Ref. No.	CEMOS3F
description	power terminal block 6-pole max. 40A max 450V connection ø6mm ² / F6.3 temp.-resist. 150°C cross section 6mm ²		
For models:	QUATTRO Q/82, QUATTRO T/82, SEI 1P, SEI 2P, SEI 2P/S		

equipment-specific units

for espresso machines

brewing units

filter holder gaskets

O-rings

			
1			
GEV No.	510409	Ref. No.	GUREBOT ORRB3F
description	O-ring EPDM thickness 5.34mm ID ø 56.52mm Qty 1 pcs		

steam/water taps

steam/water pipes

accessories

gaskets

			
1			
GEV No.	510893	Ref. No.	OR112
description	O-ring EPDM thickness 2.62mm ID ø 9.92mm Qty 1 pcs		
For models:	JOLLY AQ, JOLLY AT, JOLLY Q, JOLLY T, UNO AQ, UNO AT, UNO Q, UNO T		

for tilting bratt pans

spindles

			
1			
GEV No.	507405	Ref. No.	CEPAMP6S
description	threaded rod thread M6 L 43mm ø 6mm		

for dishwashers

drain and intake components

OMNIWASH

drain /intake bodies

			
Image not available			
1			
GEV No.	507234	Ref. No.	LI426F
description	drain fitting		
For models:	QUATTRO Q/82		



			
1			
GEV No.	524838	Ref. No.	GAPS1299B GAPS1299BGR
description	drain fitting straight ø 50mm H 68mm thread 1"		





Зип Общепит
vsezip.ru
7(812)987-08-81

			
1			
GEV No.	507204	Ref. No.	GS117 GS117B
description	drain fitting thread 1" ID ø 25mm		

			
1			
GEV No.	507086	Ref. No.	GA111 GA111B
description	intake body thread 1¼" ID ø 30mm		

			
1			
GEV No.	507209	Ref. No.	GS317 GS317B GS317BGR
description	drain fitting thread 1¼" ID ø 33mm		
For models:	QUATTRO Q/82, QUATTRO T/82		
accessories for	507209		
	GEV No.	507058	Ref. No.
			DP114 DP114GR
	screw connection thread 1¼" H 14mm WS 55		
	GEV No.	507315	Ref. No.
			OR3168
	O-ring EPDM thickness 2.62mm ID ø 42.52mm		



			
1			
GEV No.	507059	Ref. No.	DP14
description	nut		



			
1			
GEV No.	507056	Ref. No.	DP1 DP1GR
description	nut thread 1" H 14mm WS 46 ø 52mm		
For models:	DUE ACLQ, DUE ACLT, DUE ACSQ, DUE ACST, DUE AQ, DUE AT, JOLLY AQ, JOLLY AT, JOLLY Q, JOLLY T, UNO ACSQ, UNO ACST, UNO AQ, UNO AT, UNO CLQ, UNO CLT, UNO CSQ, UNO CST, UNO Q, UNO T		

			
1			
GEV No.	507046	Ref. No.	GA311B
description	drain fitting thread 1½" ED ø 38mm		

			
1			
GEV No.	507057	Ref. No.	DP112 DP112GR
description	nut thread 1½" H 14mm WS 60 ø 65mm		
For models:	QUATTRO Q/82, QUATTRO T/82, SEI 1P, SEI 2P, SEI 2P/S		

			
1			
GEV No.	507092	Ref. No.	GA311
description	intake body		
For models:	QUATTRO Q/82		

			
1			
GEV No.	507314	Ref. No.	OR3131
description	O-ring EPDM thickness 2.62mm ID ø 32.99mm		
For models:	DUE ACLQ, DUE ACLT, DUE ACSQ, DUE ACST, DUE AQ, DUE AT, JOLLY AQ, JOLLY AT, JOLLY Q, JOLLY T, UNO ACSQ, UNO ACST, UNO AQ, UNO AT, UNO CLQ, UNO CLT, UNO CSQ, UNO CST, UNO Q, UNO T		
accessories for	507314		
	GEV No.	507314	Ref. No.
			OR3131
	O-ring EPDM thickness 2.62mm ID ø 32.99mm		

			
1			
GEV No.	507087 ¹	Ref. No.	GA111T GA111TB
description	intake body thread 1¼" ED ø 55mm H 30mm		
For models:	QUATTRO Q/82, QUATTRO T/82		
accessories for	507087		
	GEV No.	507057	Ref. No.
			DP112 DP112GR
	nut thread 1½" H 14mm WS 60 ø 65mm		
	GEV No.	540222	Ref. No.
			OR3187
	O-ring EPDM thickness 2.62mm ID ø 47.3mm Qty 1 pcs		

			
1			
GEV No.	507315	Ref. No.	OR3168
description	O-ring EPDM thickness 2.62mm ID ø 42.52mm		
For models:	DUE AQ, DUE AT, JOLLY AQ, JOLLY AT, JOLLY Q, JOLLY T, QUATTRO Q/82, QUATTRO T/82, SEI 1P, SEI 2P, SEI 2P/S, UNO AQ, UNO AT, UNO Q, UNO T		

¹for drain pump

Зип Общепит

vsezip.ru
+7(812)987-08-81

Image not available

GEV No.	507247	Ref. No.	LIF4V4TP LIF4V4TPC
description	filter		



GEV No.	507338	Ref. No.	GA115SCOMP
description	filter		

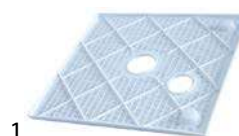

GEV No.	507243	Ref. No.	LIF12V1P LIF12V1PV0
description	flat filter		
For models:	UNO ACSQ, UNO ACST, UNO AQ, UNO CLQ, UNO CLT, UNO CSQ, UNO CST, UNO Q		

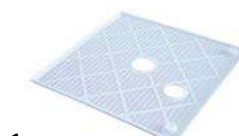

GEV No.	507244	Ref. No.	LIF22V1P
description	flat filter		
For models:	DUE ACLQ, DUE ACLT, DUE ACSQ, DUE ACST, DUE AQ		



GEV No.	524919	Ref. No.	LIF4V2PSX04GR REFO40
description	flat filter for dishwasher H 15mm L 540mm W 288mm with hole plastic mounting pos. right		



GEV No.	540222	Ref. No.	OR3187
description	O-ring EPDM thickness 2.62mm ID ø 47.3mm Qty 1 pcs		
For models:	QUATTRO Q/82, QUATTRO T/82, SEI 1P, SEI 2P, SEI 2P/S		



GEV No.	507058	Ref. No.	DP114 DP114GR
description	screw connection thread 1¼" H 14mm WS 55		
For models:	DUE AQ, DUE AT, JOLLY AQ, JOLLY AT, JOLLY Q, JOLLY T, QUATTRO Q/82, QUATTRO T/82, SEI 1P, SEI 2P, SEI 2P/S, UNO AQ, UNO AT, UNO Q, UNO T		



GEV No.	507237	Ref. No.	LI430FC
description	wash arm support wash arm support		
For models:	QUATTRO Q/82		

filters



GEV No.	507084	Ref. No.	GA012C
description	bar for filter		



GEV No.	507396	Ref. No.	GASA12C
description	bar for filter L 140mm thread M6		



GEV No.	507082	Ref. No.	GA012A GA012B GAGS1299
description	bar for filter L 52mm thread M6		
For models:	QUATTRO Q/82, QUATTRO T/82		



GEV No.	507096	Ref. No.	GA512 GA5120T
description	bar for filter L 74mm thread M6		
For models:	QUATTRO Q/82		





GEV No.	507098	Ref. No.	GA6122 GA61220T
description	bar for filter L 86mm thread M6		
For models:	QUATTRO Q/82, QUATTRO T/82, SEI 1P, SEI 2P, SEI 2P/S		



Зип Общепит
vsezip.ru
+7(812)987-08-81

			
1			
GEV No.	524918	Ref. No.	LIF4V2PCSX04
description	flat filter for dishwasher H 15mm L 540mm W 288mm without hole plastic mounting pos. left		

			
1			
GEV No.	507246	Ref. No.	LIF4V4P LIF4V4PL LIF4V4PV0 LIF4V4PV0GR REFI40
description	flat filter H 15mm L 230mm W 200mm		
For models:	QUATTRO Q/82, SEI 1P, SEI 2P/S		

			
1			
GEV No.	507248	Ref. No.	LIF4V4TPP LIF4V4TPPGR
description	flat filter H 15mm L 230mm W 200mm with hole		
For models:	QUATTRO Q/82		

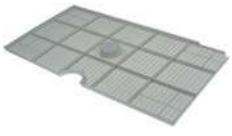

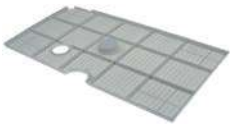
			
1			
GEV No.	519489	Ref. No.	LIF4V2PDX04
description	flat filter H 15mm L 535mm W 285mm mounting pos. right		



			
1			
GEV No.	519488	Ref. No.	LIF4V2PSX04
description	flat filter H 15mm L 535mm W 285mm with hole mounting pos. left		

			
1			
GEV No.	507089	Ref. No.	GA115RA GA115RAB GA115RABV0 GA115RABV0GR
description	flat filter H 27mm L 140mm W 95mm		
For models:	QUATTRO Q/82, QUATTRO T/82		

			
1			
GEV No.	507094	Ref. No.	GA315RA GA315RAV0 GA315RAV0GR GA315RCA
description	flat filter H 36mm L 170mm W 135mm		
For models:	QUATTRO Q/82, QUATTRO T/82, SEI 1P, SEI 2P, SEI 2P/S		

			
1			
GEV No.	507245	Ref. No.	LIF4V4 LIF4V4C
description	flat filter L 230mm W 200mm		
For models:	SEI 2P, SEI 2P/S		

				
1				
GEV No.	524916	Ref. No.	GA115RCBV0 GA115RCBV0GR	
description	intake filter for dishwasher H 50mm L 140mm W 95mm complete			
spare parts for	524916			
	GEV No.	507088	Ref. No.	GA115R GA115RV0 GA115RV0GR
rectangular filter H 50mm L 137mm W 92mm				
	GEV No.	507515	Ref. No.	GA115RAV0 GA115RAV0GR
lid for filter H 10mm L 140mm W 95mm				

				
1				
GEV No.	507515	Ref. No.	GA115RAV0 GA115RAV0GR	
description	lid for filter H 10mm L 140mm W 95mm			
accessories for	507515			
	GEV No.	507088	Ref. No.	GA115R GA115RV0 GA115RV0GR
rectangular filter H 50mm L 137mm W 92mm				

Зип Общепит

vsezip.ru

+7(812)987-08-81



1 

GEV No.	507085	Ref. No.	GA013 GA013B GA013GR
description	nut for filter ED ø 32mm H 10mm thread M6		
For models:	QUATTRO Q/82, QUATTRO T/82		

2 

GEV No.	507100	Ref. No.	GAPS335
description	rectangular filter		

1 

GEV No.	507362	Ref. No.	GA315RAV0GR+GA315RVOGR GA315RCB GA315RCBV0 GA315RCBV0GR	
description	rectangular filter H 100mm L 170mm W 130mm			
For models:	QUATTRO Q/82, QUATTRO T/82			
spare parts for	507362			
	GEV No.	507093	Ref. No.	GA315R GA315RV0
	rectangular filter H 62mm L 168mm W 126mm			
	GEV No.	507094	Ref. No.	GA315RA GA315RAV0 GA315RAV0GR GA315RCA
	flat filter H 36mm L 170mm W 135mm			

1 

GEV No.	507088	Ref. No.	GA115R GA115RV0 GA115RV0GR	
description	rectangular filter H 50mm L 137mm W 92mm			
For models:	DUE AQ, DUE AT, JOLLY AQ, JOLLY AT, JOLLY Q, JOLLY T, QUATTRO Q/82, QUATTRO T/82, UNO AQ, UNO AT, UNO Q, UNO T			
accessories for	507088			
	GEV No.	507515	Ref. No.	GA115RAV0 GA115RAV0GR
	lid for filter H 10mm L 140mm W 95mm			

1 

GEV No.	507093	Ref. No.	GA315R GA315RV0
description	rectangular filter H 62mm L 168mm W 126mm		
For models:	QUATTRO Q/82, QUATTRO T/82, SEI 1P, SEI 2P, SEI 2P/S		

1 

GEV No.	507091	Ref. No.	GA214AT
description	round filters H 52mm ø 62mm		
For models:	QUATTRO Q/82, QUATTRO T/82		

overflow pipes

1 

GEV No.	507217	Ref. No.	GSSA16
description	overflow pipe		

1 

GEV No.	507203	Ref. No.	GS116CCA GS116CC GS116CCAB GS116CCABGR
description	overflow pipe L 100mm ø 26mm		

1 



GEV No.	507212	Ref. No.	GS416CC
description	overflow pipe L 167mm ø 35mm		
For models:	QUATTRO Q/82, QUATTRO T/82		





Зип Общепит

vsezip.ru

+7(812)987-08-81

 <p>1</p>			
GEV No.	507410	Ref. No.	GS416CCAB
description	overflow pipe L 167mm ø 35mm		
accessories for	507410		
			
GEV No.	507209	Ref. No.	GS317 GS317B GS317BGR
description	drain fitting thread 1¼" ID ø 33mm		

 <p>1</p>			
GEV No.	524836	Ref. No.	GS416CCABGR
description	overflow pipe L 170mm ø 34mm		

 <p>1</p>			
GEV No.	507214	Ref. No.	GS6013 GS6013B GS6013BGR
description	overflow pipe L 190mm ø 33mm		

 <p>1</p>			
GEV No.	507408	Ref. No.	GSSA16PLB
description	overflow pipe L 205mm ø 33mm		

containers

container lids



 <p>1</p>			
GEV No.	507020	Ref. No.	AM030
description	container lid suitable for rinse aid container		
For models:	DUE AQ, DUE AT, QUATTRO Q/82, QUATTRO T/82, UNO AQ, UNO AT, UNO Q, UNO T		

			
GEV No.	507050	Ref. No.	CER150NT
description	lid for salt tank		
For models:	DUE AQ, DUE AT, QUATTRO Q/82, QUATTRO T/82, UNO AQ, UNO AT, UNO Q, UNO T		

dosing containers

 <p>1</p>			
GEV No.	507016	Ref. No.	AM027
description	rinse aid container		
For models:	DUE AQ, DUE AT, QUATTRO Q/82, QUATTRO T/82, UNO AQ, UNO AT, UNO Q, UNO T		
spare parts for	507016		
			
GEV No.	507020	Ref. No.	AM030
description	container lid suitable for rinse aid container		

salt tanks

 <p>1</p>			
GEV No.	524177	Ref. No.	CER146
description	lid ø 69mm H 20mm for salt tank ID ø 50mm		
For models:	DUE AQ, DUE AT, QUATTRO Q/82, QUATTRO T/82, UNO AQ, UNO AT, UNO Q, UNO T		
accessories for	524177		
			
GEV No.	524148	Ref. No.	—
description	O-ring EPDM thickness 3.53mm ID ø 40.86mm Qty 1 pcs		

Зип-Общепит

boilers

boilers for dishwashers

vsezip.ru

+7(812)987-08-81









1

GEV No.	510018	Ref. No.	CERI45
description	nut \varnothing 92mm H 10.5mm for salt tank ID \varnothing 64mm		
For models:	DUE AQ, DUE AT, QUATTRO Q/82, QUATTRO T/82, UNO AQ, UNO AT, UNO Q, UNO T		



1

GEV No.	510929	Ref. No.	CERI43
description	salt tank \varnothing 120mm H 117mm hose \varnothing 10mm mounting \varnothing 70mm overall height 157mm		
For models:	DUE AQ, DUE AT, QUATTRO Q/82, QUATTRO T/82, UNO AQ, UNO AT, UNO Q, UNO T		
spare parts for	510929		
	GEV No.	506015	Ref. No. CERI46A
	O-ring EPDM thickness 3.53mm ID \varnothing 39.69mm Qty 1 pcs		
	GEV No.	510018	Ref. No. CERI45
	nut \varnothing 92mm H 10.5mm for salt tank ID \varnothing 64mm		
	GEV No.	524177	Ref. No. CERI46
	lid \varnothing 69mm H 20mm for salt tank ID \varnothing 50mm		
accessories for	510929		
	GEV No.	510071	Ref. No. —
	flat gasket rubber ED \varnothing 81mm ID \varnothing 68mm thickness 3mm for salt tank Qty 1 pcs		
	GEV No.	510654	Ref. No. —
	gasket H 6mm D1 \varnothing 82mm D2 \varnothing 68mm		
	GEV No.	510883	Ref. No. —
	gasket rubber ED \varnothing 86mm ID \varnothing 66mm thickness 2mm for salt tank Qty 1 pcs		



1

GEV No.	507106	Ref. No.	GB11
description	boiler		



1

GEV No.	507107	Ref. No.	GB11NT
description	boiler		
For models:	JOLLY AQ, JOLLY AT, JOLLY Q, JOLLY T, UNO AQ, UNO CLQ, UNO CSQ, UNO Q		



1

GEV No.	507108	Ref. No.	GB21
description	boiler		



1

GEV No.	507110	Ref. No.	GB4133F
description	boiler		



1

GEV No.	507111	Ref. No.	GB4821F
description	boiler		
For models:	QUATTRO Q/82, QUATTRO T/82		



1

GEV No.	507508	Ref. No.	GB21NTPR5
description	boiler \varnothing 140mm L 365mm		



Зип Общежит
rotation plates

vsezip.ru
+7(812)987-08-81



1

GEV No.	507112	Ref. No.	GB4823F
description	boiler ø 150mm L 425mm		
For models:	QUATTRO Q/82, QUATTRO T/82		



1

GEV No.	507047	Ref. No.	GB413FNT05
description	boiler ø 160mm L 440mm		



1

GEV No.	507109	Ref. No.	GB413F GB413FNT
description	boiler ø 160mm L 440mm hose ø 10mm		

accessories



1

GEV No.	507406	Ref. No.	GBPBSA
description	insulating mat for boiler L 330mm W 330mm thickness 10mm		



1

GEV No.	507126	Ref. No.	GG3TA
description	rotation plate		
For models:	QUATTRO T/82		



1

GEV No.	507321	Ref. No.	GG1T1 GG1T1B GG1T1CGR
description	rotation plate ø 292mm		
For models:	DUE AT, JOLLY AT, JOLLY T, UNO AT, UNO T		



1

GEV No.	507117	Ref. No.	GG1TA GG1TAB
description	rotation plate ø 293mm plastic seat ø 15mm		

rotation plate bearings



1

GEV No.	507115	Ref. No.	GG1T2
description	bearing rotation plate		
For models:	DUE AT, JOLLY AT, JOLLY T, UNO AT, UNO T		

accessories



1

GEV No.	507124	Ref. No.	GG3T2
description	bushing		
For models:	QUATTRO T/82		



1

GEV No.	507132	Ref. No.	GG4TFEG
description	spindle with ball		
For models:	QUATTRO T/82		



1

GEV No.	507123	Ref. No.	GG1TH GG1THBGR
description	union screw for rotation plate \varnothing 19mm		
For models:	JOLLY AT, JOLLY T		

softener cartridges

softening columns



1

GEV No.	530000	Ref. No.	CERI47
description	softener 4-fold L 380mm W 180mm		
For models:	DUE AQ, DUE AT, QUATTRO Q/82, QUATTRO T/82, UNO AQ, UNO AT, UNO Q, UNO T		

housing and bezels

fascias



1

GEV No.	699271	Ref. No.	CEPC6214S05C CEPC6214S08C CEPC6214SGR12C
description	control panel for dishwasher assembled L 312mm W 132mm H 85mm		



1

GEV No.	502188	Ref. No.	CEPC6214
description	control panel LTM1600 L 400mm W 50mm H 159mm black		



1

GEV No.	502253	Ref. No.	CEPC6214P1 CEPC6214P105
description	control panel warewashing L 310mm W 133mm H 7mm black		

miscellaneous



1

GEV No.	507055	Ref. No.	DOT14P
description	end cap		



1

GEV No.	507569	Ref. No.	DOT38PBGR
description	screw connection thread 3/8"		

Зип Общепит

vsezip.ru

+7(812)987-08-81



Зип Общежит
hood handles supports

vsezip.ru
+7(812)987-08-81

hood mechanics for dishwashers

bolts



1	GEV No.	507166	Ref. No.	GMMN6171
	description	bolt for hood joint		
	For models:	SEI 2P, SEI 2P/S		

bushes



1	GEV No.	507167	Ref. No.	GMMN6191
	description	bush for hood joint		
	For models:	SEI 1P, SEI 2P, SEI 2P/S		

spring holders



1	GEV No.	507156	Ref. No.	GMMML6251
	description	spring holder hood mechanics		
	For models:	SEI 2P, SEI 2P/S		

linkage



1	GEV No.	507158	Ref. No.	GMMML6271
	description	tie bar for hood spring		
	For models:	SEI 1P, SEI 2P, SEI 2P/S		

hood handles



1	GEV No.	507159	Ref. No.	GMMN6151
	description	hood handle		
	For models:	SEI 1P, SEI 2P, SEI 2P/S		

1	GEV No.	507163	Ref. No.	GMMN6171
	description	handle holder hood mechanics		

1	GEV No.	507168	Ref. No.	GMMN630
	description	handle holder hood mechanics		

1	GEV No.	507169	Ref. No.	GMMN6301 GMMN6301GR GMMN6301P1
	description	handle holder hood mechanics		

1	GEV No.	507170	Ref. No.	GMMN6301S
	description	handle holder hood mechanics		
	For models:	SEI 1P, SEI 2P, SEI 2P/S		

1	GEV No.	507164	Ref. No.	GMMN6171P1
	description	handle holder hood mechanics mounting pos. lower		

1	GEV No.	507165	Ref. No.	GMMN6171S
	description	handle holder hood mechanics mounting pos. lower		
	For models:	SEI 1P, SEI 2P, SEI 2P/S		

Зип Общепит

vsezip.ru

+7(812)987-08-81

			
1			
GEV No.	507160	Ref. No.	GMMN6161
description	handle holder hood mechanics mounting pos. upper		

 Image not available			
1			
GEV No.	507161	Ref. No.	GMMN6161P1
description	handle holder hood mechanics mounting pos. upper		

			
1			
GEV No.	507162	Ref. No.	GMMN6161S
description	handle holder hood mechanics mounting pos. upper		
For models:	SEI 1P, SEI 2P, SEI 2P/S		

basket guides
guide bars

			
1			
GEV No.	971141	Ref. No.	GMGC6461
description	basket guide		

			
1			
GEV No.	971142	Ref. No.	LISFA6
description	basket guide		

			
1			
GEV No.	517322	Ref. No.	GMGC55XI GMGC55XINT
description	basket guide mounting pos. left		

			
1			
GEV No.	517323	Ref. No.	GMGC5DXI
description	basket guide mounting pos. right		

basket holders

			
1			
GEV No.	971140	Ref. No.	GMGC6401 GMGC6401FC
description	basket support L 500m W 500mm		



Зип Общепит

vsezip.ru

+7(812)987-08-81

air traps			
 <p>1</p>			
GEV No.	507171	Ref. No.	GP025 GP025B GP025BGR
description	air trap		
For models:	QUATTRO Q/82, QUATTRO T/82		
accessories for	507171		
	GEV No.	507052	Ref. No. D034
hexagonal nut thread 3/4" Qty 1 pcs			
	GEV No.	507078	Ref. No. G15253G G251525G
flat gasket rubber ED ø 25mm ID ø 14.5mm thickness 2.5mm Qty 1 pcs			
	GEV No.	507080	Ref. No. G382615G
flat gasket rubber ED ø 39mm ID ø 25mm thickness 1.5mm Qty 1 pcs			
	GEV No.	507172	Ref. No. GP026A GP026AB GP026ABGR
connection angle for air trap			
	GEV No.	507173	Ref. No. GP026B GP026BB GP026BBGR
nut for connection angle for air trap			

 <p>1</p>			
GEV No.	507516	Ref. No.	GP025BCOMP GP025BGRCOMP
description	air trap complete L 80mm W 30mm H 50mm hose ø 5mm plastic		
spare parts for	507516		
	GEV No.	507052	Ref. No. D034
hexagonal nut thread 3/4" Qty 1 pcs			
	GEV No.	507078	Ref. No. G15253G G251525G
flat gasket rubber ED ø 25mm ID ø 14.5mm thickness 2.5mm Qty 1 pcs			
	GEV No.	507080	Ref. No. G382615G
flat gasket rubber ED ø 39mm ID ø 25mm thickness 1.5mm Qty 1 pcs			
	GEV No.	507171	Ref. No. GP025 GP025B GP025BGR
air trap			
	GEV No.	507172	Ref. No. GP026A GP026AB GP026ABGR
connection angle for air trap			
	GEV No.	524463	Ref. No. GP026BB GP026BBGR
union nut thread 3/4" H 13mm WS 32 plastic Qty 1 pcs for air trap			

 <p>1</p>			
GEV No.	524917	Ref. No.	GP02562PB GP02562PBGR SE12PCQ
description	air trap ø 60.5mm H 110mm thread 3/4" hose ø 6mm plastic		

air trap accessories			
 <p>1</p>			
GEV No.	507172	Ref. No.	GP026A GP026AB GP026ABGR
description	connection angle for air trap		
For models:	DUE AQ, DUE AT, QUATTRO Q/82, QUATTRO T/82, UNO AQ, UNO AT, UNO Q, UNOT		

 <p>1</p>			
GEV No.	507173	Ref. No.	GP026B GP026BB GP026BBGR
description	nut for connection angle for air trap		
For models:	DUE AQ, DUE AT, QUATTRO Q/82, QUATTRO T/82, UNO AQ, UNO AT, UNO Q, UNOT		

miscellaneous			
 <p>1</p>			
GEV No.	506249	Ref. No.	CETP6GR
description	blind plug D1 ø 6mm for control panel		

 <p>1</p>			
GEV No.	507219	Ref. No.	LI027A
description	reducer		

Зип.Общепит

vsezip.ru

+7(812)987-08-81

door mechanics

doors



GEV No.	507400	Ref. No.	GMP02A
description	door complete IME/Omniwash DUE AT suitable for dishwasher		



GEV No.	507401	Ref. No.	GMP05
description	door IME/Omniwash Quattro Q 4/82 suitable for dishwasher		



GEV No.	694275	Ref. No.	GMP05MPR5
description	door W 555mm H 410mm thickness 22mm		

door bumpers

GEV No.	507490	Ref. No.	AMPCP
description	door bumper H 10mm silicone L 33mm W 15mm		

door shafts

GEV No.	507023	Ref. No.	AM112NTM
description	door shaft		
For models:	JOLLY AQ, JOLLY AT, JOLLY Q, JOLLY T, UNO ACSQ, UNO ACST, UNO AT, UNO CLQ, UNO CLT, UNO CSQ, UNO CST, UNO T		

GEV No.	507039	Ref. No.	CEMP21
description	door shaft		
For models:	DUE AQ, DUE AT, QUATTRO Q/82, QUATTRO T/82, UNO AQ, UNO AT, UNO Q, UNO T		
accessories for	507039		
GEV No.	507040	Ref. No.	CEMP22
description	retaining ring E D1 ø 4mm D2 ø 9mm SS DIN 6799 thickness 0.7mm		

GEV No.	507024	Ref. No.	AM212NT
description	door shaft L 120mm		
For models:	DUE AQ		
accessories for	507024		
GEV No.	507015	Ref. No.	AM013NT
description	retaining ring E D1 ø 7mm D2 ø 14mm SS DIN 6799 thickness 0.9mm for shaft ø 8-11mm		

GEV No.	507025	Ref. No.	AM412 AM412NTM
description	door shaft L 170mm		
For models:	QUATTRO Q/82, QUATTRO T/82		

GEV No.	507026	Ref. No.	AM512
description	door shaft L 175mm		
For models:	QUATTRO Q/82, QUATTRO T/82		
accessories for	507026		
GEV No.	507015	Ref. No.	AM013NT
description	retaining ring E D1 ø 7mm D2 ø 14mm SS DIN 6799 thickness 0.9mm for shaft ø 8-11mm		

Зип Общепит

vsezip.ru

+7(812)987-08-81

 <p>1</p>			
GEV No.	507022	Ref. No.	AM112NT
description	door shaft \varnothing 8mm L 90mm		
For models:	UNO AQ, UNO Q		
accessories for	507022		
 <p>retaining ring E D1 \varnothing 7mm D2 \varnothing 14mm SS DIN 6799 thickness 0.9mm for shaft \varnothing 8-11mm</p>			
GEV No.	507015	Ref. No.	AM013NT

 <p>1</p>			
GEV No.	507035	Ref. No.	CEMP13CL
description	fastening angle for microswitch		

locks			
 <p>1</p>			
GEV No.	507011	Ref. No.	AM011 AM011A+AM011C+AM011D+AM011E AM011R
description	door catch complete door locking catch		
For models:	DUE ACLQ, DUE ACLT, DUE ACSQ, DUE ACST, DUE AQ, DUE AT, JOLLY AQ, JOLLY AT, JOLLY Q, JOLLY T, QUATTRO Q/82, QUATTRO T/82, UNO ACSQ, UNO ACST, UNO AQ, UNO AT, UNO CLQ, UNO CLT, UNO CSQ, UNO CST, UNO Q, UNO T		

 <p>1</p>			
GEV No.	507036	Ref. No.	CEMP13CS
description	fastening angle for microswitch		
For models:	DUE AQ, DUE AT, JOLLY AQ, JOLLY AT, JOLLY Q, JOLLY T, QUATTRO Q/82, QUATTRO T/82, UNO AQ, UNO AT, UNO Q, UNO T		

 <p>1</p>			
GEV No.	518231	Ref. No.	AM011NT AM011NT+011CNT+011ENT+011D
description	snap lock thread 1/4" SS		

 <p>1</p>			
GEV No.	507031	Ref. No.	AM0PFPPM
description	fixing plate for door		
For models:	DUE ACLQ, DUE ACLT, DUE ACSQ, DUE ACST, DUE AQ, DUE AT, JOLLY AQ, JOLLY AT, JOLLY Q, JOLLY T, QUATTRO Q/82, QUATTRO T/82, UNO ACSQ, UNO ACST, UNO AQ, UNO AT, UNO CLQ, UNO CLT, UNO CSQ, UNO CST, UNO Q, UNO T		

miscellaneous			
 <p>1</p>			
GEV No.	346945	Ref. No.	AM014
description	angle piece		

 <p>1</p>			
GEV No.	507053	Ref. No.	D038
description	nut nut 3/8"		

 <p>1</p>			
GEV No.	507034	Ref. No.	CEMP13
description	fastening angle for microswitch		
For models:	QUATTRO Q/82, QUATTRO T/82		

 <p>1</p>			
GEV No.	507012	Ref. No.	AM012
description	spacer ring bush		
For models:	QUATTRO Q/82, QUATTRO T/82		

 <p>1</p>			
GEV No.	507013	Ref. No.	AM012M
description	spacer ring bush		
For models:	DUE ACLQ, DUE ACLT, DUE ACSQ, DUE ACST, DUE AQ, DUE AT, JOLLY AQ, JOLLY AT, JOLLY Q, JOLLY T, QUATTRO Q/82, QUATTRO T/82, UNO ACSQ, UNO ACST, UNO AQ, UNO AT, UNO CLQ, UNO CLT, UNO CSQ, UNO CST, UNO Q, UNO T		

screw connections



1

GEV No.	507059	Ref. No.	DP14
description	nut		



1

GEV No.	507056	Ref. No.	DP1 DP1GR
description	nut thread 1" H 14mm WS 46 ø 52mm		
For models:	DUE ACLQ, DUE ACLT, DUE ACSQ, DUE ACST, DUE AQ, DUE AT, JOLLY AQ, JOLLY AT, JOLLY Q, JOLLY T, UNO ACSQ, UNO ACST, UNO AQ, UNO AT, UNO CLQ, UNO CLT, UNO CSQ, UNO CST, UNO Q, UNO T		



1

GEV No.	507057	Ref. No.	DP112 DP112GR
description	nut thread 1½" H 14mm WS 60 ø 65mm		
For models:	QUATTRO Q/82, QUATTRO T/82, SEI 1P, SEI 2P, SEI 2P/S		



1

GEV No.	507058	Ref. No.	DP114 DP114GR
description	screw connection thread 1¼" H 14mm WS 55		
For models:	DUE AQ, DUE AT, JOLLY AQ, JOLLY AT, JOLLY Q, JOLLY T, QUATTRO Q/82, QUATTRO T/82, SEI 1P, SEI 2P, SEI 2P/S, UNO AQ, UNO AT, UNO Q, UNO T		

Зип Общепит

vsezip.ru

+7(812)987-08-81

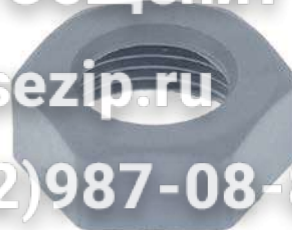

1

GEV No.	524463	Ref. No.	GP026BB GP026BBGR
description	union nut thread 3/4" H 13mm WS 32 plastic Qty 1 pcs for air trap		

washing and rinsing systems



1

GEV No.	507251	Ref. No.	LISA26F
description	connecting fitting		



1

GEV No.	507233	Ref. No.	LI335
description	counterpart wash arm support		
For models:	QUATTRO Q/82		



1

GEV No.	507226	Ref. No.	LI128
description	extension for wash arm support		



1

GEV No.	507230	Ref. No.	LI228
description	extension for wash arm support		



1

GEV No.	507236	Ref. No.	LI428F
description	extension for wash arm support		





Зип Общепит

vsezip.ru

+7(812)987-08-81

			
1			
GEV No.	507250	Ref. No.	LISA26A
description	extension for wash arm support		

			
1			
GEV No.	507177	Ref. No.	GR016PNT
description	hose connector brass straight		
For models:	DUE AT, JOLLY AT, JOLLY T, QUATTRO T/82, UNO AT, UNO T		

			
1			
GEV No.	507054	Ref. No.	D038 D038A
description	nut thread 3/8" H 10mm brass WS 20 Qty 1 pcs		
For models:	DUE ACLQ, DUE ACSQ, DUE AQ, DUE AT, JOLLY AT, JOLLY T, QUATTRO Q/82, QUATTRO T/82, SEI 1P, SEI 2P, SEI 2P/S, UNO AQ, UNO AT, UNO CLQ, UNO CSQ, UNO Q, UNO T		

			
1			
GEV No.	507178	Ref. No.	GR019A
description	rinse arm support mounting pos. lower		
For models:	QUATTRO T/82		

			
1			
GEV No.	517414	Ref. No.	LI133FOT
description	rinse arm support ø20mm H 44mm thread 1/4"/M10x1 WS 23		
For models:	DUE ACLQ, DUE ACLT, DUE ACSQ, DUE ACST, DUE AQ, JOLLY AQ, JOLLY Q, UNO ACSQ, UNO ACST, UNO AQ, UNO CLQ, UNO CLT, UNO CSQ, UNO CST, UNO Q		

			
GEV No.	507175	Ref. No.	GR016A
description	screw connection for rinse arm		
For models:	QUATTRO T/82		

			
1			
GEV No.	507224	Ref. No.	LI034P LI034PV0 LI034PV0GR
description	slide ring		
For models:	DUE ACLQ, DUE ACLT, DUE ACSQ, DUE ACST, DUE AQ, JOLLY AQ, JOLLY Q, QUATTRO Q/82, SEI 1P, SEI 2P, SEI 2P/S, UNO ACSQ, UNO ACST, UNO AQ, UNO CLQ, UNO CLT, UNO CSQ, UNO CST, UNO Q		

			
1			
GEV No.	507235	Ref. No.	LI428
description	wash pipe		
For models:	QUATTRO Q/82		

			
1			
GEV No.	507227	Ref. No.	LI12830
description	wash pipe L 160mm		
For models:	JOLLY AQ, JOLLY Q, UNO ACSQ, UNO ACST, UNO AQ, UNO CLQ, UNO CLT, UNO CSQ, UNO CST, UNO Q		

			
1			
GEV No.	507231	Ref. No.	LI22830
description	wash pipe L 195mm		
For models:	DUE ACLQ, DUE ACLT, DUE ACSQ, DUE ACST, DUE AQ		

Зип Общепит

vsezip.ru

+7(812)987-08-81

			
1			
GEV No.	507407	Ref. No.	LS6372
description	wash pipe mounting pos. upper		

washing and rinsing systems (sorted by producer)

OMNIWASH

			
1			
GEV No.	507284	Ref. No.	LSI16CSL
description	wash and rinse arm 2 wash arms/ 2 rinse arms		

			
1			
GEV No.	507276	Ref. No.	LSI16 LSI16BBB LSI16BBBGR
description	wash and rinse arm wash arm L 315mm rinse arm L 320mm w. jets 5 r. jets 6 mounting ø 12/45mm mounting pos. upper/lower 2 wash arms/ 2 rinse arms		

			
1			
GEV No.	507309	Ref. No.	OR122
description	O-ring EPDM thickness 2.62mm ID ø 17.13mm Qty 1 pcs		
For models:	DUE ACLQ, DUE ACSQ, DUE AQ, DUE AT, JOLLY AQ, JOLLY AT, JOLLY Q, JOLLY T, QUATTRO Q/82, QUATTRO T/82, SEI 1P, SEI 2P, SEI 2P/S, UNO AQ, UNO AT, UNO CLQ, UNO CSQ, UNO Q, UNO T		

			
1			
GEV No.	504590	Ref. No.	OR124
description	O-ring EPDM thickness 2.62mm ID ø 18.72mm Qty 1 pcs		
For models:	DUE ACLQ, DUE ACLT, DUE ACSQ, DUE ACST, DUE AQ, JOLLY AQ, JOLLY Q, QUATTRO Q/82, SEI 1P, SEI 2P, SEI 2P/S, UNO ACSQ, UNO ACST, UNO AQ, UNO CLQ, UNO CLT, UNO CSQ, UNO CST, UNO Q		

			
1			
GEV No.	507280	Ref. No.	LSI16C
description	rinse arm		

			
1			
GEV No.	507282	Ref. No.	LSI16CDSB LSI16CDSBGR
description	rinse arm L 132mm nozzles 3 thread 1/2" mounting pos. lower grey		

			
1			
GEV No.	524837	Ref. No.	LSI16CB
description	rinse arm L 132mm nozzles 3 thread 1/2" mounting pos. lower grey		

			
1			
GEV No.	507355	Ref. No.	LSI020B LSI020BGR
description	rinse jet grey		
For models:	SEI 1P		

			
1			
GEV No.	507267	Ref. No.	LSI017
description	union nut		
For models:	QUATTRO Q/82		

			
1			
GEV No.	507350	Ref. No.	GHGELA LSI017B LSI017BGR
description	union nut		
For models:	SEI 1P		

			
1			
GEV No.	507354	Ref. No.	LSI021B LSI021BGR
description	union nut		
For models:	SEI 1P		





Зип Общепит

vsezip.ru

+7(812)987-08-81

			
1			
GEV No.	507270	Ref. No.	LSI021
description	union nut for rinse jet		
For models:	QUATTRO Q/82		

			
1			
GEV No.	507277	Ref. No.	LSI16B
description	wash arm		
For models:	UNO AQ, UNO Q		

			
1			
GEV No.	507278	Ref. No.	LSI16BD
description	wash arm		

			
1			
GEV No.	507279	Ref. No.	LSI16BS
description	wash arm		

			
1			
GEV No.	507272	Ref. No.	LSI0607A LSI0607AN
description	wash arm boss		
For models:	QUATTRO Q/82		

			
1			
GEV No.	507274	Ref. No.	LSI06A LSI06AN
description	wash arm boss		

			
1			
GEV No.	507341	Ref. No.	LSI0607ABGR LSI0607ANT
description	wash arm boss L 83mm W 80mm H 54mm		

			
1			
GEV No.	507265	Ref. No.	LSI015
description	wash jet		
For models:	QUATTRO Q/82		

			
1			
GEV No.	507266	Ref. No.	LSI016
description	wash jet		
For models:	QUATTRO Q/82		

			
1			
GEV No.	507352	Ref. No.	LSI015B
description	wash jet mounting pos. inner white		
For models:	SEI 1P		

			
1			
GEV No.	507351	Ref. No.	LSI016B LSI016BGR
description	wash jet mounting pos. left grey H 16mm ø 13mm		
For models:	SEI 1P		

			
1			
GEV No.	507285	Ref. No.	LSI26
description	wash and rinse arm 2 wash arms/ 2 rinse arms		

			
1			
GEV No.	507290	Ref. No.	LSI26BBB LSI26BBBGR LSI26CSL
description	wash and rinse arm wash arm L 365mm rinse arm L 370mm w. jets 6 r. jets 6 mounting ø 12/45mm mounting pos. lower 2 wash arms/ 2 rinse arms		

			
1			
GEV No.	507268	Ref. No.	LSI018
description	blank nozzle		
For models:	QUATTRO Q/82		

Зип Общепит

vsezip.ru

+7(812)987-08-81

			
1			
GEV No.	507353	Ref. No.	LSI018B LSI018BGR
description	blank nozzle		
For models:	SEI 1P		

			
1			
GEV No.	507356	Ref. No.	LSI022B LSI022BGR
description	blank nozzle for rinse arm white		
For models:	SEI 1P		

			
1			
GEV No.	504590	Ref. No.	OR124
description	O-ring EPDM thickness 2.62mm ID ø 18.72mm Qty 1 pcs		
For models:	DUE ACLQ, DUE ACLT, DUE ACSQ, DUE ACST, DUE AQ, JOLLY AQ, JOLLY Q, QUATTRO Q/82, SEI 1P, SEI 2P, SEI 2P/S, UNO ACSQ, UNO ACST, UNO AQ, UNO CLQ, UNO CLT, UNO CSQ, UNO CST, UNO Q		

			
1			
GEV No.	507281	Ref. No.	LSI26CD
description	rinse arm		

			
1			
GEV No.	507289	Ref. No.	LSI26C
description	rinse arm		

			
1			
GEV No.	507044	Ref. No.	LSI26CSB
description	rinse arm L 160mm nozzles 3		

			
1			
GEV No.	507283	Ref. No.	LSI26CS
description	rinse arm L 160mm nozzles 3		

			
1			
GEV No.	507415	Ref. No.	LSI26CDB
description	rinse arm with nozzles		

			
1			
GEV No.	507416	Ref. No.	LSI26CB
description	rinse arm without nozzles		

			
1			
GEV No.	507355	Ref. No.	LSI020B LSI020BGR
description	rinse jet grey		
For models:	SEI 1P		

			
1			
GEV No.	507350	Ref. No.	GHGELA LSI017B LSI017BGR
description	union nut		
For models:	SEI 1P		

			
1			
GEV No.	507354	Ref. No.	LSI021B LSI021BGR
description	union nut		
For models:	SEI 1P		

			
1			
GEV No.	507286	Ref. No.	LSI26B
description	wash arm		
For models:	DUE AQ		

			
1			
GEV No.	507287	Ref. No.	LSI26BD
description	wash arm		





Зип Общепит
vsezip.ru

+7(812)987-08-81

			
1			
GEV No.	507288	Ref. No.	LSI26BS
description	wash arm		

			
1			
GEV No.	507399	Ref. No.	LSI26BSB
description	wash arm mounting pos. left complete with nozzles		

			
1			
GEV No.	507398	Ref. No.	LSI26BDB
description	wash arm mounting pos. right L 155mm nozzles 3		

			
1			
GEV No.	507337	Ref. No.	LSI0607AB
description	wash arm boss		
For models:	SEI 1P		

			
1			
GEV No.	507352	Ref. No.	LSI015B
description	wash jet mounting pos. inner white		
For models:	SEI 1P		

			
1			
GEV No.	507351	Ref. No.	LSI016B LSI016BGR
description	wash jet mounting pos. left grey H 16mm ø 13mm		
For models:	SEI 1P		

			
1			
GEV No.	507342	Ref. No.	LSI46 LSI46BBB LSI46BBBGR LSI66BBB LSI66BBBGR
description	wash and rinse arm wash arm L 500mm rinse arm L 500mm w. jets 8 r. jets 6 mounting ø 12/45mm mounting pos. upper/lower 2 wash arms/ 2 rinse arms		
For models:	QUATTRO Q/82, SEI 1P		
spare parts for	507342		
	GEV No.	504590	Ref. No. OR124
	O-ring EPDM thickness 2.62mm ID ø 18.72mm Qty 1 pcs		
	GEV No.	507309	Ref. No. OR122
	O-ring EPDM thickness 2.62mm ID ø 17.13mm Qty 1 pcs		
	GEV No.	507337	Ref. No. LSI0607AB
	wash arm boss		
	GEV No.	507343	Ref. No. LSI46CDB
	rinse arm mounting pos. right complete		
	GEV No.	507344	Ref. No. LSI46CSB
	rinse arm L 220mm nozzles 3 thread 1/2" mounting pos. left white		
	GEV No.	507346	Ref. No. LSI66BSB
	wash arm		
	GEV No.	507347	Ref. No. LSI66BDB
	wash arm		
	GEV No.	507349	Ref. No. LS09PB LS09PBGR
	Thumb screw		
	GEV No.	507350	Ref. No. GHGELA LSI017B LSI017BGR
	union nut		
	GEV No.	507351	Ref. No. LSI016B LSI016BGR
	wash jet mounting pos. left grey H 16mm ø 13mm		
	GEV No.	507352	Ref. No. LSI015B
	wash jet mounting pos. inner white		
	GEV No.	507353	Ref. No. LSI018B LSI018BGR
	blank nozzle		
	GEV No.	507354	Ref. No. LSI021B LSI021BGR
	union nut		
	GEV No.	507355	Ref. No. LSI020B LSI020BGR
	rinse jet grey		

Зип Общепит

vsezip.ru

+7(812)987-08-81

	GEV No. 507271	Ref. No.	LSI022
description	blank nozzle		
For models:	QUATTRO Q/82		

	GEV No. 507356	Ref. No.	LSI022B LSI022BGR
description	blank nozzle for rinse arm white		
For models:	SEI 1P		

	GEV No. 507309	Ref. No.	OR122
description	O-ring EPDM thickness 2.62mm ID ø 17.13mm Qty 1 pcs		
For models:	DUE ACLQ, DUE ACSQ, DUE AQ, DUE AT, JOLLY AQ, JOLLY AT, JOLLY Q, JOLLY T, QUATTRO Q/82, QUATTRO T/82, SEI 1P, SEI 2P, SEI 2P/S, UNO AQ, UNO AT, UNO CLQ, UNO CSQ, UNO Q, UNO T		

	GEV No. 504590	Ref. No.	OR124
description	O-ring EPDM thickness 2.62mm ID ø 18.72mm Qty 1 pcs		
For models:	DUE ACLQ, DUE ACLT, DUE ACSQ, DUE ACST, DUE AQ, JOLLY AQ, JOLLY Q, QUATTRO Q/82, SEI 1P, SEI 2P, SEI 2P/S, UNO ACSQ, UNO ACST, UNO AQ, UNO CLQ, UNO CLT, UNO CSQ, UNO CST, UNO Q		

	GEV No. 507295	Ref. No.	LSI46C LSI46CB
description	rinse arm		
For models:	SEI 1P		

	GEV No. 507297	Ref. No.	LSI46CS LSI46CSBGR
description	rinse arm L 220mm nozzles 3 thread 1/2" mounting pos. left grey		
For models:	QUATTRO Q/82		

	GEV No. 507344	Ref. No.	LSI46CSB
description	rinse arm L 220mm nozzles 3 thread 1/2" mounting pos. left white		
For models:	SEI 1P		

spare parts for	507344		
GEV No.	507309	Ref. No.	OR122

	O-ring EPDM thickness 2.62mm ID ø 17.13mm Qty 1 pcs		
---	---	--	--

	GEV No. 507354	Ref. No.	LSI021B LSI021BGR
description	union nut		

	GEV No. 507355	Ref. No.	LSI020B LSI020BGR
description	rinse jet grey		

	GEV No. 507356	Ref. No.	LSI022B LSI022BGR
description	blank nozzle for rinse arm white		

	GEV No. 507296	Ref. No.	LSI46CD LSI46CDBGR
description	rinse arm L 220mm nozzles 3 thread 1/2" mounting pos. right grey		
For models:	QUATTRO Q/82		

GEV No.	507309	Ref. No.	OR122
description	O-ring EPDM thickness 2.62mm ID ø 17.13mm Qty 1 pcs		

	GEV No. 507343	Ref. No.	LSI46CDB
description	rinse arm mounting pos. right complete		
For models:	SEI 1P		

spare parts for	507343		
GEV No.	507309	Ref. No.	OR122

	O-ring EPDM thickness 2.62mm ID ø 17.13mm Qty 1 pcs		
---	---	--	--

	GEV No. 507354	Ref. No.	LSI021B LSI021BGR
description	union nut		

	GEV No. 507355	Ref. No.	LSI020B LSI020BGR
description	rinse jet grey		

	GEV No. 507356	Ref. No.	LSI022B LSI022BGR
description	blank nozzle for rinse arm white		



Зип Общепит

vsezip.ru

+7(812)987-08-81





			
1			
GEV No.	507355	Ref. No.	LSI020B LSI020BGR
description	rinse jet grey		
For models:	SEI 1P		

			
1			
GEV No.	507293	Ref. No.	LSI46BD
description	wash arm		
For models:	QUATTRO Q/8z		

			
1			
GEV No.	507261	Ref. No.	LS09P LS09PB LS09PBGR
description	Thumb screw		
For models:	QUATTRO Q/82		







			
1			
GEV No.	507346	Ref. No.	LSI66BSB
description	wash arm		
For models:	SEI 1P		

			
1			
GEV No.	507349	Ref. No.	LS09PB LS09PBGR
description	Thumb screw		
For models:	SEI 1P		

spare parts for 507346			
	GEV No.	504590	Ref. No. OR124
O-ring EPDM thickness 2.62mm ID ø 18.72mm Qty 1 pcs			
	GEV No.	507350	Ref. No. GHGELA LSI017B LSI017BGR
union nut			
	GEV No.	507351	Ref. No. LSI016B LSI016BGR
wash jet mounting pos. left grey H 16mm ø 13mm			
	GEV No.	507352	Ref. No. LSI015B
wash jet mounting pos. inner white			
	GEV No.	507353	Ref. No. LSI018B LSI018BGR
blank nozzle			

			
1			
GEV No.	507350	Ref. No.	GHGELA LSI017B LSI017BGR
description	union nut		
For models:	SEI 1P		

			
1			
GEV No.	507354	Ref. No.	LSI021B LSI021BGR
description	union nut		
For models:	SEI 1P		

			
1			
GEV No.	507347	Ref. No.	LSI66BDB
description	wash arm		
For models:	SEI 1P		
spare parts for 507347			
	GEV No.	504590	Ref. No. OR124
O-ring EPDM thickness 2.62mm ID ø 18.72mm Qty 1 pcs			
	GEV No.	507350	Ref. No. GHGELA LSI017B LSI017BGR
union nut			
	GEV No.	507351	Ref. No. LSI016B LSI016BGR
wash jet mounting pos. left grey H 16mm ø 13mm			
	GEV No.	507352	Ref. No. LSI015B
wash jet mounting pos. inner white			
	GEV No.	507353	Ref. No. LSI018B LSI018BGR
blank nozzle			





			
1			
GEV No.	507292	Ref. No.	LSI46B
description	wash arm		





Зип Общепит

vsezip.ru

+7(812)987-08-81

			
1			
GEV No.	524835	Ref. No.	LSI46BDB LSI46EDBGR
description	wash arm L 220mm nozzles 4 thread 3/4" mounting pos. lower grey		

			
1			
GEV No.	507294	Ref. No.	LSI46BS LSI46BSB
description	wash arm mounting pos. left		
For models:	QUATTRO Q/82		
spare parts for	507294		
	GEV No.	507350	Ref. No.
union nut			GHGELA LSI017B LSI017BGR
	GEV No.	507351	Ref. No.
wash jet mounting pos. left grey H 16mm ø 13mm			LSI016B LSI016BGR
	GEV No.	507353	Ref. No.
blank nozzle			LSI018B LSI018BGR

			
1			
GEV No.	507348	Ref. No.	LSI66BB
description	wash arm mounting pos. left/right without nozzles white		
For models:	SEI 1P		
accessories for	507348		
	GEV No.	504590	Ref. No.
O-ring EPDM thickness 2.62mm ID ø 18.72mm Qty 1 pcs			OR124
	GEV No.	507350	Ref. No.
union nut			GHGELA LSI017B LSI017BGR
	GEV No.	507351	Ref. No.
wash jet mounting pos. left grey H 16mm ø 13mm			LSI016B LSI016BGR
	GEV No.	507352	Ref. No.
wash jet mounting pos. inner white			LSI015B
	GEV No.	507353	Ref. No.
blank nozzle			LSI018B LSI018BGR

			
1			
GEV No.	507337	Ref. No.	LSI0607AB
description	wash arm boss		
For models:	SEI 1P		

			
1			
GEV No.	507352	Ref. No.	LSI015B
description	wash jet mounting pos. inner white		
For models:	SEI 1P		

			
1			
GEV No.	507351	Ref. No.	LSI016B LSI016BGR
description	wash jet mounting pos. left grey H 16mm ø 13mm		
For models:	SEI 1P		

			
1			
GEV No.	507300	Ref. No.	LSISA6
description	wash and rinse arm 2 wash arms/ 2 rinse arms		





			
1			
GEV No.	507301	Ref. No.	09GILR60 LSISA6B LSISA6BGR
description	wash and rinse arm wash arm L 500mm rinse arm L 500mm w. jets 10 r. jets 6 mounting ø 12/45mm mounting pos. upper/lower 2 wash arms/ 2 rinse arms		
For models:	SEI 2P, SEI 2P/S		
spare parts for	507301		
	GEV No.	507298	Ref. No.
wash jet			LSISA15 LSISA15B LSISA15BGR
	GEV No.	507299	Ref. No.
wash jet			LSISA16 LSISA16B LSISA16BGR
	GEV No.	507341	Ref. No.
wash arm boss L 83mm W 80mm H 54mm			LSI0607ABGR LSI0607ANT
	GEV No.	507350	Ref. No.
union nut			GHGELA LSI017B LSI017BGR



Table continues overleaf





Зип Общепит

vsezip.ru

+7(812)987-08-81

spare parts for 507301			
	GEV No. 507354	Ref. No.	LSI021B LSI021BGR
union nut			
	GEV No. 507355	Ref. No.	LSI020B LSI020BGR
rinse jet grey			
	GEV No. 507356	Ref. No.	LSI022B LSI022BGR
blank nozzle for rinse arm white			

	GEV No. 507356	Ref. No.	LSI022B LSI022BGR
description blank nozzle for rinse arm white			
For models: SEI 1P			





	GEV No. 507309	Ref. No.	OR122
description O-ring EPDM thickness 2.62mm ID ø 17.13mm Qty 1 pcs			
For models: DUE ACLQ, DUE ACSQ, DUE AQ, DUE AT, JOLLY AQ, JOLLY AT, JOLLY Q, JOLLY T, QUATTRO Q/82, QUATTRO T/82, SEI 1P, SEI 2P, SEI 2P/S, UNO AQ, UNO AT, UNO CLQ, UNO CSQ, UNO Q, UNO T			

	GEV No. 504590	Ref. No.	OR124
description O-ring EPDM thickness 2.62mm ID ø 18.72mm Qty 1 pcs			
For models: DUE ACLQ, DUE ACLT, DUE ACSQ, DUE ACST, DUE AQ, JOLLY AQ, JOLLY Q, QUATTRO Q/82, SEI 1P, SEI 2P, SEI 2P/S, UNO ACSQ, UNO ACST, UNO AQ, UNO CLQ, UNO CLT, UNO CSQ, UNO CST, UNO Q			





	GEV No. 507295	Ref. No.	LSI46C LSI46CB
description rinse arm			
For models: SEI 1P			





	GEV No. 507297	Ref. No.	LSI46CS LSI46CSBGR
description rinse arm L 220mm nozzles 3 thread 1/2" mounting pos. left grey			
For models: QUATTRO Q/82			

	GEV No. 507344	Ref. No.	LSI46CSB
description rinse arm L 220mm nozzles 3 thread 1/2" mounting pos. left white			
For models: SEI 1P			

spare parts for 507344			
	GEV No. 507309	Ref. No.	OR122
O-ring EPDM thickness 2.62mm ID ø 17.13mm Qty 1 pcs			
	GEV No. 507354	Ref. No.	LSI021B LSI021BGR
union nut			
	GEV No. 507355	Ref. No.	LSI020B LSI020BGR
rinse jet grey			
	GEV No. 507356	Ref. No.	LSI022B LSI022BGR
blank nozzle for rinse arm white			

	GEV No. 507296	Ref. No.	LSI46CD LSI46CDBGR
description rinse arm L 220mm nozzles 3 thread 1/2" mounting pos. right grey			
For models: QUATTRO Q/82			

	GEV No. 507343	Ref. No.	LSI46CDB
description rinse arm mounting pos. right complete			
For models: SEI 1P			
spare parts for 507343			
	GEV No. 507309	Ref. No.	OR122
O-ring EPDM thickness 2.62mm ID ø 17.13mm Qty 1 pcs			
	GEV No. 507354	Ref. No.	LSI021B LSI021BGR
union nut			
	GEV No. 507355	Ref. No.	LSI020B LSI020BGR
rinse jet grey			
	GEV No. 507356	Ref. No.	LSI022B LSI022BGR
blank nozzle for rinse arm white			

	GEV No. 507309	Ref. No.	OR122
O-ring EPDM thickness 2.62mm ID ø 17.13mm Qty 1 pcs			
	GEV No. 507354	Ref. No.	LSI021B LSI021BGR
union nut			
	GEV No. 507355	Ref. No.	LSI020B LSI020BGR
rinse jet grey			
	GEV No. 507356	Ref. No.	LSI022B LSI022BGR
blank nozzle for rinse arm white			

Зип-Общепит

vsezip.ru

+7(812)987-08-81

			
1			
GEV No.	507355	Ref. No.	LSI020B LSI020BGR
description	rinse jet grey		
For models:	SEI 1P		



			
1			
GEV No.	507350	Ref. No.	GHGELA LSI017B LSI017BGR
description	union nut		
For models:	SEI 1P		



			
1			
GEV No.	507354	Ref. No.	LSI021B LSI021BGR
description	union nut		
For models:	SEI 1P		

			
1			
GEV No.	507303	Ref. No.	LSISA6BS
description	wash arm		

			
1			
GEV No.	507302	Ref. No.	LSISA6BSBGR
description	wash arm L 223mm nozzles 1 left - 4 right thread 3/4" mounting pos. left grey		

			
1			
GEV No.	507409	Ref. No.	LSISA6BDBGR
description	wash arm L 223mm nozzles 1 right - 4 left thread 3/4" mounting pos. right grey		

			
1			
GEV No.	507348	Ref. No.	LSI66BB
description	wash arm mounting pos. left/right without nozzles white		
For models:	SEI 1P		
accessories for	507348		
	GEV No.	504590	Ref. No.
			OR124

			
GEV No.	507350	Ref. No.	GHGELA LSI017B LSI017BGR
description	wash jet mounting pos. left grey H 16mm ø 13mm		
			
GEV No.	507351	Ref. No.	LSI016B LSI016BGR
description	wash jet mounting pos. inner white		
			
GEV No.	507352	Ref. No.	LSI015B
description	blank nozzle		

			
1			
GEV No.	507337	Ref. No.	LSI0607AB
description	wash arm boss		
For models:	SEI 1P		

			
1			
GEV No.	507298	Ref. No.	LSISA15 LSISA15B LSISA15BGR
description	wash jet		

			
1			
GEV No.	507299	Ref. No.	LSISA16 LSISA16B LSISA16BGR
description	wash jet		

			
1			
GEV No.	507185	Ref. No.	GR119C
description	rinse arm H 323mm L 273mm nozzles 5 mounting pos. left		
For models:	JOLLY T, UNO T		

			
1			
GEV No.	507186	Ref. No.	GR119IN
description	rinse arm H 323mm L 273mm nozzles 5 mounting pos. left complete with nozzle		
For models:	JOLLY T		



Зип Общепит

vsezip.ru

+7(812)987-08-81

			
1			
GEV No.	507187	Ref. No.	GR1A19C
description	rinse arm H 385mm L 270mm nozzles 5 mounting pos. left		
For models:	JOLLY AT, UNO AT		

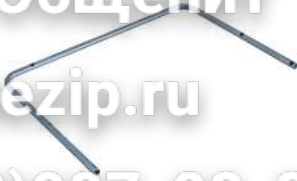
			
1			
GEV No.	507201	Ref. No.	GRS2Q
description	rinse arm H 430mm L 320mm nozzles 6 mounting pos. right without nozzles		
For models:	DUE ACLQ, DUE ACLT, DUE ACSQ, DUE ACST		

			
1			
GEV No.	507188	Ref. No.	GR1A19IN
description	rinse arm H 385mm L 275mm nozzles 5 mounting pos. lower complete		
For models:	JOLLY AT		

			
1			
GEV No.	507202	Ref. No.	GRS2QBCM GRS2QCM
description	rinse arm H 430mm L 320mm nozzles 6 mounting pos. upper complete		

			
1			
GEV No.	507568	Ref. No.	GR119INGR
description	rinse arm H 390mm L 280mm nozzles 5 suitable for JOLLY		

			
1			
GEV No.	507190	Ref. No.	GR2A19IN
description	rinse arm H 435mm L 300mm nozzles 5 mounting pos. left complete with nozzle		

			
1			
GEV No.	507200	Ref. No.	GRS1QBCM GRS1QCM
description	rinse arm H 395mm L 275mm nozzles 6 mounting pos. left complete		
For models:	JOLLY AQ, JOLLY Q, UNO ACSQ, UNO ACST, UNO CLQ, UNO CLT, UNO CSQ, UNO CST		

			
1			
GEV No.	507189	Ref. No.	GR2A19C
description	rinse arm H 435mm L 300mm nozzles 5 mounting pos. left without nozzles		
For models:	DUE AT		

			
1			
GEV No.	507199	Ref. No.	GRS1Q
description	rinse arm H 395mm L 275mm nozzles 6 mounting pos. left without nozzles		
For models:	JOLLY AQ, JOLLY Q, UNO ACSQ, UNO ACST, UNO CLQ, UNO CLT, UNO CSQ, UNO CST		

			
1			
GEV No.	507191	Ref. No.	GR419C
description	rinse arm H 475mm L 375mm nozzles 6 mounting pos. left		
For models:	QUATTRO T/82		

Зип Общепит

vsezip.ru

+7(812)987-08-81

 <p>1</p>			
GEV No.	507192	Ref. No.	GR419IN
description	rinse arm H 475mm L 380mm nozzles 6 mounting pos. left suitable for IME/Omniwash type QUATTRO T-82 complete		
For models:	QUATTRO T/82		
spare parts for	507192		
 <p>GEV No. 507178 Ref. No. GR019A</p> <p>rinse arm support mounting pos. lower</p>			
 <p>GEV No. 507180 Ref. No. GR019B GR019BBGR</p> <p>rinse jet holder</p>			
 <p>GEV No. 507181 Ref. No. GR019D GR019DB</p> <p>opposite support for rinse jet</p>			
 <p>GEV No. 507182 Ref. No. GR019G GR019GB GR019GBGR</p> <p>end cap for rinse arm</p>			
 <p>GEV No. 507183 Ref. No. GR020 GR020B GR020BGR</p> <p>rinse jet</p>			
 <p>GEV No. 507184 Ref. No. GR021 GR021B GR021BGR</p> <p>swirl H 15mm ø 10mm 1.5mm H1 5mm</p>			
 <p>GEV No. 507191 Ref. No. GR419C</p> <p>rinse arm H 475mm L 375mm nozzles 6 mounting pos. left</p>			
 <p>GEV No. 510303 Ref. No. OR106</p> <p>O-ring EPDM thickness 1.78mm ID ø 6.75mm Qty 1 pcs</p>			
 <p>GEV No. 560062 Ref. No. —</p> <p>flat-headed bolt thread M4 thread L 10mm SS DIN 7985/ISO 7045 Qty 20 pcs intake Phillips head ø 8mm head thickness 2mm</p>			

 <p>1</p>			
GEV No.	507182	Ref. No.	GR019G GR019GB GR019GBGR
description	end cap for rinse arm		
For models:	QUATTRO T/82		

 <p>1</p>			
GEV No.	507181	Ref. No.	GR019D GR019DB
description	opposite support for rinse jet		
For models:	JOLLY AQ, JOLLY Q, QUATTRO T/82		

 <p>1</p>			
GEV No.	507196	Ref. No.	GRS04 GRS04BGR
description	opposite support for rinse jet		

 <p>1</p>			
GEV No.	510303	Ref. No.	OR106
description	O-ring EPDM thickness 1.78mm ID ø 6.75mm Qty 1 pcs		
For models:	DUE ACLQ, DUE ACLT, DUE ACSQ, DUE ACST, DUE AQ, DUE AT, JOLLY AQ, JOLLY AT, JOLLY Q, JOLLY T, QUATTRO Q/82, QUATTRO T/82, UNO ACSQ, UNO ACST, UNO AQ, UNO AT, UNO CLQ, UNO CLT, UNO CSQ, UNO CST, UNO Q, UNO T		

 <p>1</p>			
GEV No.	505073	Ref. No.	OR128
description	O-ring EPDM thickness 2.62mm ID ø 20.63mm Qty 1 pcs		
For models:	DUE ACLQ, DUE ACLT, DUE ACSQ, DUE ACST, DUE AT, JOLLY AQ, JOLLY AT, JOLLY Q, JOLLY T, QUATTRO T/82, UNO ACSQ, UNO ACST, UNO AQ, UNO AT, UNO CLQ, UNO CLT, UNO CSQ, UNO CST, UNO T		

 <p>1</p>			
GEV No.	507179	Ref. No.	GR019ANT
description	rinse arm support mounting pos. upper		

 <p>1</p>			
GEV No.	507195	Ref. No.	GRS03 GRS03B GRS03BGR
description	rinse arm support mounting pos. upper		

 <p>1</p>			
GEV No.	507197	Ref. No.	GRS05 GRS05B GRS05BGR
description	rinse arm support mounting pos. upper		

 <p>1</p>			
GEV No.	507198	Ref. No.	GRS06 GRS06B GRS06BGR
description	rinse arm support mounting pos. upper		





Зип Общепит

vsezip.ru

+7(812)987-08-81

 <p>1</p>			
GEV No.	507183	Ref. No.	GR020 GR020B GR020BGR
description	rinse jet		
For models:	QUATTRO T/82		

 <p>1</p>			
GEV No.	507180	Ref. No.	GR019B GR019BBGR
description	rinse jet holder		
For models:	QUATTRO T/82		

 <p>1</p>			
GEV No.	507184	Ref. No.	GR021 GR021B GR021BGR
description	swirl H 15mm ø 10mm 1.5mm H1 5mm		
For models:	QUATTRO T/82		

 <p>1</p>			
GEV No.	507142	Ref. No.	GL1T32 GL1T32B
description	end piece for wash pipe mounting pos. upper		

 <p>1</p>			
GEV No.	507147	Ref. No.	GL2T32 GL2T3BGR
description	end piece for wash pipe mounting pos. upper		

 <p>1</p>			
GEV No.	507151	Ref. No.	GL4T28I
description	wash arm		
For models:	QUATTRO T/82		

 <p>1</p>			
GEV No.	507152	Ref. No.	GL4T29I
description	wash arm		
For models:	QUATTRO T/82		
spare parts for	507152		
 <p>GEV No. 507133 Ref. No. GL030 GL030B GL30BGR</p> <p>wash jet</p>			
 <p>GEV No. 507134 Ref. No. GL031 GL031B GL031BGR</p> <p>swirl H 5mm ø 14.5mm 5.5mm</p>			
 <p>GEV No. 507135 Ref. No. GL032 GL032B GL032BGR</p> <p>rinse jet holder</p>			
 <p>GEV No. 507136 Ref. No. GL033 GL033B GL033BGR</p> <p>opposite support</p>			
 <p>GEV No. 507137 Ref. No. GL034A GL034AB</p> <p>end cap</p>			
 <p>GEV No. 507148 Ref. No. GL34T27A</p> <p>union nut wash jet</p>			
 <p>GEV No. 510302 Ref. No. OR2050</p> <p>O-ring EPDM ID ø 12.42mm thickness 1.78mm Qty 1 pcs</p>			
 <p>GEV No. 560340 Ref. No. VD4I</p> <p>hexagonal nut thread M4 H 3.2mm WS 7 SS DIN/ISO DIN 934 / ISO 4032/8673 Qty 1 pcs</p>			

 <p>1</p>			
GEV No.	507140	Ref. No.	GL1T28CM
description	wash arm complete		

 <p>1</p>			
GEV No.	507143	Ref. No.	GL2AT28BCMI GL2AT28CMI
description	wash arm complete		

Зип Общепит

vsezip.ru

+7(812)987-08-81



1

GEV No.	507145	Ref. No.	GL2T28CM
description	wash arm complete		



1

GEV No.	507141	Ref. No.	GL1T28P GL1T28PBGR
description	wash arm L 202mm nozzles 4		



1

GEV No.	507146	Ref. No.	GL2T28P GL2T28PBGR
description	wash arm L 220mm nozzles 4		



1

GEV No.	507397	Ref. No.	GL1T28BCM GL2T28BPGR
description	wash arm mounting pos. upper/lower L 220mm nozzles 4		



1

GEV No.	507324	Ref. No.	GL2T28BCM
description	wash arm nozzles 4		



1

GEV No.	507139	Ref. No.	GL1T27 GL1T27BGR	
description	wash pipe mounting pos. upper/lower			
accessories for	507139			
	GEV No.	505073	Ref. No.	OR128
	 O-ring EPDM thickness 2.62mm ID ø 20.63mm Qty 1 pcs			



1

GEV No.	507150	Ref. No.	GL4T27
description	wash pipe mounting pos. upper/lower		
For models:	QUATTRO T/82		



1

GEV No.	507137	Ref. No.	GL034A GL034AB
description	end cap		
For models:	QUATTRO T/82		





Зип Общепит

vsezip.ru



+7(812)987-08-81

			
1			
GEV No.	507056	Ref. No.	DP1 DF1GR
description	nut thread 1" H 14mm WS 46 ø 52mm		
For models:	DUE ACLQ, DUE ACLT, DUE ACSQ, DUE ACST, DUE AQ, DUE AT, JOLLY AQ, JOLLY AT, JOLLY Q, JOLLY T, UNO ACSQ, UNO ACST, UNO AQ, UNO AT, UNO CLQ, UNO CLT, UNO CSQ, UNO CST, UNO Q, UNO T		

			
2			
GEV No.	507136	Ref. No.	GL033 GL033B GL033BGR
description	opposite support		
For models:	QUATTRO T/82		

			
1			
GEV No.	510302	Ref. No.	OR2050
description	O-ring EPDM ID ø 12.42mm thickness 1.78mm Qty 1 pcs		
For models:	DUE ACLQ, DUE ACLT, DUE ACSQ, DUE ACST, DUE AQ, DUE AT, JOLLY AQ, JOLLY AT, JOLLY Q, JOLLY T, QUATTRO Q/82, QUATTRO T/82, UNO ACSQ, UNO ACST, UNO AQ, UNO AT, UNO CLQ, UNO CLT, UNO CSQ, UNO CST, UNO Q, UNO T		

			
1			
GEV No.	505073	Ref. No.	OR128
description	O-ring EPDM thickness 2.62mm ID ø 20.63mm Qty 1 pcs		
For models:	DUE ACLQ, DUE ACLT, DUE ACSQ, DUE ACST, DUE AQ, DUE AT, JOLLY AQ, JOLLY AT, JOLLY Q, JOLLY T, QUATTRO T/82, UNO ACSQ, UNO ACST, UNO AT, UNO CLQ, UNO CLT, UNO CSQ, UNO CST, UNO T		

			
1			
GEV No.	507314	Ref. No.	OR3131
description	O-ring EPDM thickness 2.62mm ID ø 32.99mm		
For models:	DUE ACLQ, DUE ACLT, DUE ACSQ, DUE ACST, DUE AQ, DUE AT, JOLLY AQ, JOLLY AT, JOLLY Q, JOLLY T, UNO ACSQ, UNO ACST, UNO AQ, UNO AT, UNO CLQ, UNO CLT, UNO CSQ, UNO CST, UNO Q, UNO T		
accessories for	507314		
	GEV No.	507314	Ref. No. OR3131
	 O-ring EPDM thickness 2.62mm ID ø 32.99mm		

			
1			
GEV No.	507135	Ref. No.	GL032 GL032B GL032BGR
description	rinse jet holder		
For models:	QUATTRO T/82		

			
1			
GEV No.	507134	Ref. No.	GL031 GL031B GL031BGR
description	swirl H 5mm ø 14.5mm 15.5mm		
For models:	QUATTRO T/82		

			
1			
GEV No.	507148	Ref. No.	GL34T27A
description	union nut wash jet		
For models:	QUATTRO T/82		

			
1			
GEV No.	507133	Ref. No.	GL030 GL030B GL30BGR
description	wash jet		
For models:	QUATTRO T/82		

miscellaneous

			
Image not available			
1			

GEV No.	519533	Ref. No.	LS146CSBGR
description	rinse arm mounting pos. left with nozzles		

			
Image not available			
1			

GEV No.	519534	Ref. No.	LS146CDBGR
description	rinse arm mounting pos. right with nozzles		

			
1			
GEV No.	507517	Ref. No.	LSI020VABS
description	rinse jet ø 12mm H 12mm plastic		

			
1			
GEV No.	507554	Ref. No.	GR0190BBGR
description	rinse jet ø 3mm H 17.5mm		



1

GEV No.	519535	Ref. No.	LS166BSBGR
description	wash arm mounting pos. left with nozzles		



1

GEV No.	519536	Ref. No.	LS166BDBGR
description	wash arm mounting pos. right with nozzles		



1

GEV No.	507259	Ref. No.	LS06 LS06ACBNT
description	wash arm boss		



1

GEV No.	519433	Ref. No.	LS015
description	wash jet mounting pos. left		



1

GEV No.	507510	Ref. No.	GELASD LSI015BGR
description	wash jet mounting pos. right H 16mm ø 13mm		

wash arm supports



1

GEV No.	507395	Ref. No.	LI430FCB LI430FCBGR
description	angle piece wash pipe		



1

GEV No.	507249	Ref. No.	GLICQ1BCOMP LIGC1CSL
description	wash arm support complete mounting pos. lower		



1

GEV No.	507220	Ref. No.	LI029
description	wash arm support mounting pos. lower		
For models:	QUATTRO Q/82		



1

GEV No.	507221	Ref. No.	LI029CA
description	wash arm support mounting pos. lower		
For models:	QUATTRO Q/82		



1

GEV No.	507222	Ref. No.	LI029CB LI135D
description	wash arm support mounting pos. lower		



1

GEV No.	507225	Ref. No.	LI126FC LI126FCB LI126FCBGR
description	wash arm support mounting pos. lower		
accessories for	507225		



GEV No.	507056	Ref. No.	DP1 DP1GR
description	nut thread 1" H 14mm WS 46 ø 52mm		



GEV No.	507314	Ref. No.	OR3131
description	O-ring EPDM thickness 2.62mm ID ø 32.99mm		



1

GEV No.	507323	Ref. No.	LI135
description	wash arm support mounting pos. lower		

Зип Общепит

vse707u

+7(812)987-08-81





Зип Общепит
vsezip.ru
(812)987-08-81

			
1			
GEV No.	507358	Ref. No.	LI029CAB SULRI20
description	wash arm support mounting pos. lower		
For models:	SEI 1P		



			
1			
GEV No.	507359	Ref. No.	LI029CBB
description	wash arm support mounting pos. lower		

			
Image not available			
1			
GEV No.	507240	Ref. No.	LI6012
description	wash arm support mounting pos. upper		

			
1			
GEV No.	507254	Ref. No.	LS01
description	wash arm support mounting pos. upper		

			
1			
GEV No.	507263	Ref. No.	LS5 LS5B LS5BGR
description	wash arm support mounting pos. upper		
For models:	QUATTRO Q/82		
accessories for	507263		
	GEV No.	507255	Ref. No.
			LS02
	gasket D1 ø 45mm D2 ø 85mm thickness 2mm cork with 4 screw holes wash arm support equiv. no. LS02		

			
1			
GEV No.	507264	Ref. No.	LS6012
description	wash arm support mounting pos. upper		

			
1			
GEV No.	507357	Ref. No.	LS6012B LS6012BGR
description	wash arm support mounting pos. upper		
For models:	SEI 1P		
spare parts for	507357		
	GEV No.	507229	Ref. No.
			LI18F
	rinse arm shaft		

			
1			
GEV No.	507257	Ref. No.	LS03
description	disc for wash arm support		

			
1			
GEV No.	507258	Ref. No.	LS03P LS03PGR
description	flange for wash arm support		
For models:	DUE AQ, QUATTRO Q/82, UNO AQ, UNO Q		

rinse arm shafts			
			
1			
GEV No.	507228	Ref. No.	LI130
description	rinse arm shaft		
For models:	DUE ACLQ, DUE ACLT, DUE ACSQ, DUE ACST, DUE AQ, JOLLY AQ, JOLLY Q, UNO ACSQ, UNO ACST, UNO AQ, UNO CLQ, UNO CLT, UNO CSQ, UNO CST, UNO Q		

			
1			
GEV No.	507229	Ref. No.	LI18F
description	rinse arm shaft		
For models:	DUE ACLQ, DUE ACLT, DUE ACSQ, DUE ACST, DUE AQ, JOLLY AQ, JOLLY Q, SEI 1P, SEI 2P, SEI 2P/S, UNO ACSQ, UNO ACST, UNO AQ, UNO CLQ, UNO CLT, UNO CSQ, UNO CST, UNO Q		

			
1			
GEV No.	507232	Ref. No.	LI330
description	rinse arm shaft		
For models:	QUATTRO Q/82, SEI 1P, SEI 2P, SEI 2P/S		



1

GEV No.	507239	Ref. No.	LI533F LI533FOT
description	rinse arm shaft		
For models:	QUATTRO Q/82		



1

GEV No.	507242	Ref. No.	LI6333
description	rinse arm shaft		
For models:	SEI 1P, SEI 2P, SEI 2P/S		



1

GEV No.	507252	Ref. No.	LISA33F
description	rinse arm shaft		



1

GEV No.	507260	Ref. No.	LS08
description	rinse arm shaft		
For models:	DUE AQ, QUATTRO Q/82, SEI 1P, SEI 2P, SEI 2P/S, UNO AQ, UNO Q		

knobs

producer-specific knobs

OMNIWASH



1

GEV No.	507043	Ref. No.	CEMTR
description	knob timer ø 43mm shaft ø 6x4.6mm shaft flat lower		
For models:	QUATTRO Q/82, QUATTRO T/82		

handles and hand wheels

handle rails

handle rails



1

GEV No.	507005	Ref. No.	AM010F
description	handle rail		
For models:	DUE ACLQ, DUE ACLT, DUE ACSQ, DUE ACST, DUE AQ, DUE AT, QUATTRO Q/82, QUATTRO T/82, UNO ACSQ, UNO ACST, UNO AQ, UNO AT, UNO CLQ, UNO CLT, UNO CSQ, UNO CST, UNO Q, UNO T		

Зип Общепит



vseGEV.ru

Image not available

+7(812)987-08-81

GEV No.	507006	Ref. No.	AM010N
description	handle rail		



Image not available

GEV No.	507007	Ref. No.	AM010P
description	handle rail		
For models:	DUE ACLQ, DUE ACLT, DUE ACSQ, DUE ACST, DUE AQ, DUE AT, QUATTRO Q/82, QUATTRO T/82, UNO ACSQ, UNO ACST, UNO AQ, UNO AT, UNO CLQ, UNO CLT, UNO CSQ, UNO CST, UNO Q, UNO T		

GEV No.	507010	Ref. No.	AM010R
description	handle rail		
For models:	QUATTRO Q/82, QUATTRO T/82		

GEV No.	510664	Ref. No.	AM010MD25
description	handle rail L 250mm W 50mm H 50mm blue hole distance 120mm Qty 1 pcs		

bracket handles

GEV No.	507008	Ref. No.	AM010PA AM010SW
description	pull handle mounting distance 120mm		
For models:	DUE ACLQ, DUE ACLT, DUE ACSQ, DUE ACST, DUE AQ, DUE AT, JOLLY AQ, JOLLY AT, JOLLY Q, JOLLY T, QUATTRO Q/82, QUATTRO T/82, UNO ACSQ, UNO ACST, UNO AQ, UNO AT, UNO CLQ, UNO CLT, UNO CSQ, UNO CST, UNO Q, UNO T		



3ип Общежит
equipment feet and end caps

recessed handles



1

GEV No.	507009	Ref. No.	AM010MPC AM010PC
description	recessed handle		
For models:	DUE ACLQ, DUE ACLT, DUE ACSQ, DUE ACST, DUE AQ, DUE AT, QUATTRO Q/82, QUATTRO T/82, UNO ACSQ, UNO ACST, UNO AQ, UNO AT, UNO CLQ, UNO CLT, UNO CSQ, UNO CST, UNO Q, UNO T		

screw-in feet



1

GEV No.	701168	Ref. No.	AM016C
description	equipment feet kit thread M10x1.5 thread L 25mm ø 38mm H 38mm		

miscellaneous



1

GEV No.	507440	Ref. No.	AM010CD25
description	plate L 269mm W 80mm hole distance 120mm plastic for door handle		

baskets

warewashing baskets

plastic baskets round



1

GEV No.	970812	Ref. No.	CT3617L CT3617PL2
description	mix basket ED ø 367mm H 173mm seat ø 280mm mesh type wide-meshed/plastic		



1

GEV No.	970827	Ref. No.	CT4117L
description	mix basket ED ø 410mm H 170mm seat ø 375mm mesh type straight		

locks

snap locks

producer-specific

OMNIWASH



1

GEV No.	518231	Ref. No.	AM011NT AM011NT+011CNT+011ENT+011D
description	snap lock thread 1/4" SS		

steel wire baskets square

plate baskets



Image not available

1

GEV No.	971088	Ref. No.	CQ5018P
description	plate basket L 500mm W 500mm plates 18		

fittings for catering equipment

drain taps

accessories



1

GEV No.	540222	Ref. No.	OR3187
description	O-ring EPDM thickness 2.62mm ID ø 47.3mm Qty 1 pcs		
For models:	QUATTRO Q/82, QUATTRO T/82, SEI 1P, SEI 2P, SEI 2P/S		

plastic baskets square

mix baskets



1

GEV No.	971058	Ref. No.	CQ3516LPL
description	mix basket L 350mm W 350mm H 150mm		

Зип Общепит

vsezip.ru

+7(812)987-08-81

			
GEV No.	971078	Ref. No.	CQ4016LP
description	mix basket L 400mm W 400mm H 150mm		

accessories

cutlery inserts

			
GEV No.	970349	Ref. No.	IP2PP
description	cutlery insert L 130mm W 57mm ømm H 110mm		

section inserts for glasses



			
GEV No.	971080	Ref. No.	CQIB403FSP
description	section insert for glasses L 365mm W 365mm H 145mm number of rows 3		

plate inserts

			
GEV No.	971079	Ref. No.	CQIP408P
description	plate insert L 365mm W 365mm		

gaskets

O-rings

EPDM

			
GEV No.	510302	Ref. No.	OR2050
description	O-ring EPDM ID ø 12.42mm thickness 1.78mm Qty 1 pcs		
For models:	DUE ACLQ, DUE ACLT, DUE ACSQ, DUE ACST, DUE AQ, DUE AT, JOLLY AQ, JOLLY AT, JOLLY Q, JOLLY T, QUATTRO Q/82, QUATTRO T/82, UNO ACSQ, UNO ACST, UNO AQ, UNO AT, UNO CLQ, UNO CLT, UNO CSQ, UNO CST, UNO Q, UNO T		

			
GEV No.	517035	Ref. No.	OR103
description	O-ring EPDM thickness 1.78mm ID ø 4.48mm Qty 1 pcs		

			
GEV No.	510303	Ref. No.	OR106
description	O-ring EPDM thickness 1.78mm ID ø 6.75mm Qty 1 pcs		
For models:	DUE ACLQ, DUE ACLT, DUE ACSQ, DUE ACST, DUE AQ, DUE AT, JOLLY AQ, JOLLY AT, JOLLY Q, JOLLY T, QUATTRO Q/82, QUATTRO T/82, UNO ACSQ, UNO ACST, UNO AQ, UNO AT, UNO CLQ, UNO CLT, UNO CSQ, UNO CST, UNO Q, UNO T		

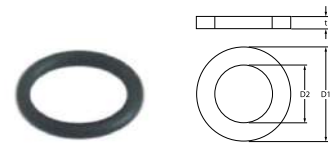
			
GEV No.	528333	Ref. No.	OR117
description	O-ring EPDM thickness 2.62mm ID ø 13.1mm Qty 1 pcs		
For models:	DUE ACLQ, DUE ACLT, DUE ACSQ, DUE ACST, DUE AQ, JOLLY AQ, JOLLY AT, JOLLY Q, JOLLY T, UNO ACSQ, UNO ACST, UNO AQ, UNO CLQ, UNO CLT, UNO CSQ, UNO CST, UNO Q		

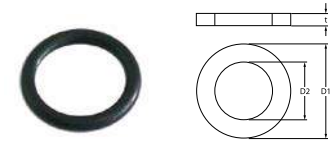
			
GEV No.	507313	Ref. No.	OR3056
description	O-ring EPDM thickness 2.62mm ID ø 13.95mm Qty 1 pcs		

			
GEV No.	508008	Ref. No.	OR121
description	O-ring EPDM thickness 2.62mm ID ø 15.88mm Qty 1 pcs		

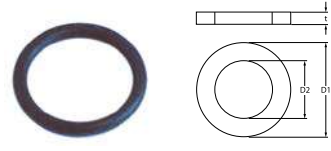
			
GEV No.	507309	Ref. No.	OR122
description	O-ring EPDM thickness 2.62mm ID ø 17.13mm Qty 1 pcs		
For models:	DUE ACLQ, DUE ACSQ, DUE AQ, DUE AT, JOLLY AQ, JOLLY AT, JOLLY Q, JOLLY T, QUATTRO Q/82, QUATTRO T/82, SEI 1P, SEI 2P, SEI 2P/S, UNO AQ, UNO AT, UNO CLQ, UNO CSQ, UNO Q, UNO T		



Зип Общепит
vsezip.ru
+7(812)987-08-81



GEV No.	504590	Ref. No.	OF124
description	O-ring EPDM thickness 2.62mm ID ø 18.72mm Qty 1 pcs		
For models:	DUE ACLQ, DUE ACLT, DUE ACSQ, DUE ACST, DUE AQ, JOLLY AQ, JOLLY Q, QUATTRO Q/82, SEI 1P, SEI 2P, SEI 2P/S, UNO ACSQ, UNO ACST, UNO AQ, UNO CLQ, UNO CLT, UNO CSQ, UNO CST, UNO Q		



GEV No.	540222	Ref. No.	OR3187
description	O-ring EPDM thickness 2.62mm ID ø 47.3mm Qty 1 pcs		
For models:	QUATTRO Q/82, QUATTRO T/82, SEI 1P, SEI 2P, SEI 2P/S		

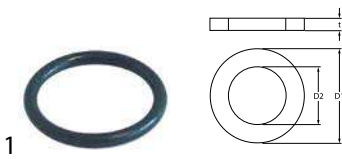

GEV No.	505073	Ref. No.	OR128
description	O-ring EPDM thickness 2.62mm ID ø 20.63mm Qty 1 pcs		
For models:	DUE ACLQ, DUE ACLT, DUE ACSQ, DUE ACST, DUE AT, JOLLY AQ, JOLLY AT, JOLLY Q, JOLLY T, QUATTRO T/82, UNO ACSQ, UNO ACST, UNO AT, UNO CLQ, UNO CLT, UNO CSQ, UNO CST, UNO T		

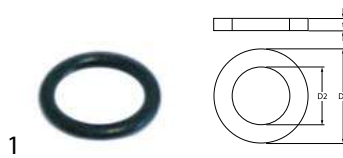

GEV No.	510893	Ref. No.	OR112
description	O-ring EPDM thickness 2.62mm ID ø 9.92mm Qty 1 pcs		
For models:	JOLLY AQ, JOLLY AT, JOLLY Q, JOLLY T, UNO AQ, UNO AT, UNO Q, UNO T		

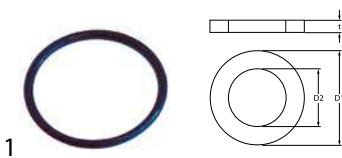

GEV No.	507314	Ref. No.	OR3131
description	O-ring EPDM thickness 2.62mm ID ø 32.99mm		
For models:	DUE ACLQ, DUE ACLT, DUE ACSQ, DUE ACST, DUE AQ, DUE AT, JOLLY AQ, JOLLY AT, JOLLY Q, JOLLY T, UNO ACSQ, UNO ACST, UNO AQ, UNO AT, UNO CLQ, UNO CLT, UNO CSQ, UNO CST, UNO Q, UNO T		
accessories for	507314		
	GEV No.	Ref. No.	OR3131
	O-ring EPDM thickness 2.62mm ID ø 32.99mm		

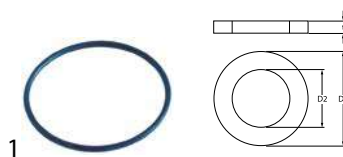

GEV No.	361345	Ref. No.	OR422
description	O-ring EPDM thickness 2mm ID ø 42.5mm Qty 1 pcs		



GEV No.	506015	Ref. No.	CERI46A
description	O-ring EPDM thickness 3.53mm ID ø 39.69mm Qty 1 pcs		
For models:	DUE AQ, DUE AT, QUATTRO Q/82, QUATTRO T/82, UNO AQ, UNO AT, UNO Q, UNO T		

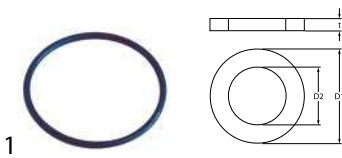

GEV No.	507315	Ref. No.	OR3168
description	O-ring EPDM thickness 2.62mm ID ø 42.52mm		
For models:	DUE AQ, DUE AT, JOLLY AQ, JOLLY AT, JOLLY Q, JOLLY T, QUATTRO Q/82, QUATTRO T/82, SEI 1P, SEI 2P, SEI 2P/S, UNO AQ, UNO AT, UNO Q, UNO T		

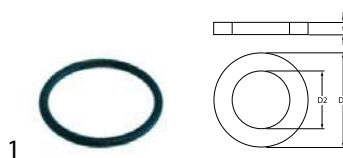

GEV No.	510409	Ref. No.	GUREBOT ORRB3F
description	O-ring EPDM thickness 5.34mm ID ø 56.52mm Qty 1 pcs		

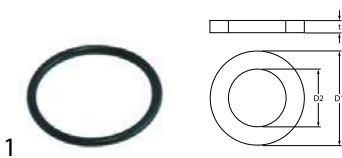

GEV No.	512111	Ref. No.	OR3181
description	O-ring EPDM thickness 2.62mm ID ø 45.69mm Qty 1 pcs		
For models:	QUATTRO Q/82, QUATTRO T/82		

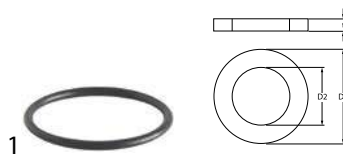

GEV No.	508109	Ref. No.	OR6275
description	O-ring EPDM thickness 5.34mm ID ø 69.22mm Qty 1 pcs		
For models:	DUE AQ, DUE AT, QUATTRO Q/82, QUATTRO T/82, UNO AQ, UNO AT, UNO Q, UNO T		

silicone

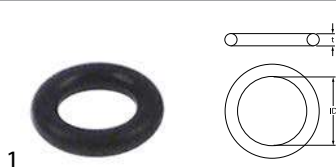

GEV No.	532554	Ref. No.	OR102
description	O-ring silicone thickness 1.5mm ID \varnothing 4.1mm Qty 1 pcs		

sealing washers

fibre gaskets



GEV No.	507332	Ref. No.	G18122GT
description	flat gasket fibre ED \varnothing 18mm ID \varnothing 12mm thickness 2mm Qty 1 pcs		
For models:	DUE ACLQ, DUE ACSQ, DUE AQ, JOLLY AQ, JOLLY AT, JOLLY Q, JOLLY T, QUATTRO Q/82, QUATTRO T/82, UNO AQ, UNO CLQ, UNO CSQ, UNO Q		

rubber gaskets



GEV No.	507075	Ref. No.	G15101G G1510G G16101G
description	flat gasket rubber ED \varnothing 15mm ID \varnothing 10mm thickness 2mm Qty 1 pcs		
For models:	DUE AQ, DUE AT, JOLLY AQ, JOLLY AT, JOLLY Q, JOLLY T, QUATTRO Q/82, QUATTRO T/82, SEI 1P, SEI 2P, SEI 2P/S, UNO AQ, UNO AT, UNO Q, UNO T		



GEV No.	512376	Ref. No.	G18102G GDSDET62P
description	flat gasket rubber ED \varnothing 18mm ID \varnothing 10mm thickness 2mm Qty 1 pcs		
For models:	SEI 1P, SEI 2P, SEI 2P/S		



GEV No.	507113	Ref. No.	G18102G GDSDET62P
description	flat gasket rubber ED \varnothing 24mm ID \varnothing 11mm thickness 2.5mm Qty 1 pcs		

Зип Общепит

vsezip.ru

+7(812)987-08-81

GEV No.	507078	Ref. No.	G15253G G251525G
description	flat gasket rubber ED \varnothing 25mm ID \varnothing 14.5mm thickness 2.5mm Qty 1 pcs		
For models:	DUE AQ, DUE AT, JOLLY AQ, JOLLY AT, JOLLY Q, JOLLY T, QUATTRO Q/82, QUATTRO T/82, SEI 1P, SEI 2P, SEI 2P/S, UNO AQ, UNO AT, UNO Q, UNO T		



GEV No.	507080	Ref. No.	G382615G
description	flat gasket rubber ED \varnothing 39mm ID \varnothing 25mm thickness 1.5mm Qty 1 pcs		
For models:	DUE AQ, DUE AT, JOLLY AQ, JOLLY AT, JOLLY Q, JOLLY T, QUATTRO Q/82, QUATTRO T/82, UNO AQ, UNO AT, UNO Q, UNO T		



GEV No.	507333	Ref. No.	G50403GT
description	flat gasket rubber ED \varnothing 52mm ID \varnothing 41.5mm thickness 3mm Qty 1 pcs equiv. no. G50403GT suitable for IME/Omniwash		
For models:	SEI 1P, SEI 2P, SEI 2P/S		



GEV No.	507045	Ref. No.	CERI44 CERI44GS
description	flat gasket rubber ED \varnothing 78mm ID \varnothing 68mm thickness 3mm Qty 1 pcs		
For models:	DUE AQ, DUE AT, QUATTRO Q/82, QUATTRO T/82, UNO AQ, UNO AT, UNO Q, UNO T		



GEV No.	507404	Ref. No.	G1282G
description	gasket rubber ED \varnothing 12mm ID \varnothing 8mm thickness 3mm Qty 1 pcs		



special gaskets

gaskets for wash arm support



GEV No.	507255	Ref. No.	LS02
description	gasket D1 ø 45mm D2 ø 85mm thickness 2mm cork with 4 screw holes wash arm support equiv. no. LS02		
For models:	DUE AQ, QUATTRO Q/82, UNO AQ, UNO Q		



GEV No.	507256	Ref. No.	GUSUW13 LS026
description	gasket D2 ø 31mm thickness 3mm with 4 screw holes wash arm support equiv. no. LS026 suitable for IME/Omnivash L 70mm W 58mm hole ø 31mm		
For models:	SEI 1P, SEI 2P, SEI 2P/S		

springs

torsion springs

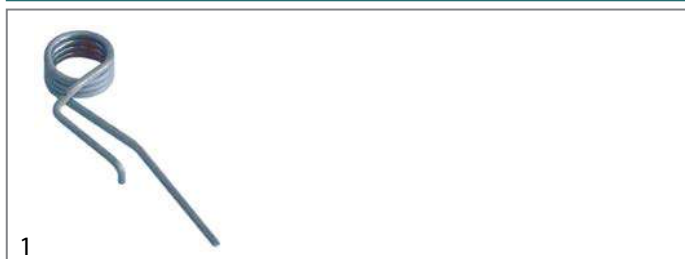

GEV No.	507030	Ref. No.	AMMP1SX
description	torsion spring mounting pos. left for door		
For models:	JOLLY Q, JOLLY T, UNO AT, UNO CLQ, UNO CLT, UNO CSQ, UNO CST, UNO Q, UNO T		



GEV No.	507029	Ref. No.	AMMP1DX
description	torsion spring mounting pos. right for door		
For models:	JOLLY Q, JOLLY T, UNO CLQ, UNO CLT, UNO CSQ, UNO CST, UNO Q, UNO T		

3ип Общепит

vsezip.ru

+7(812)987-0988

GEV No.	507027	Ref. No.	AMMP1A2DX AMMP24DX
description	torsion spring ø 17mm L2 38mm wire gauge ø 2mm mounting pos. right L1 10mm L3 70mm Qty. 1 pcs for door		
For models:	DUE ACLQ, DUE ACLT, DUE ACSQ, DUE ACST, DUE AQ, DUE AT, JOLLY AQ, JOLLY AT, UNO ACSQ, UNO ACST, UNO AQ, UNO AT		

GEV No.	507028	Ref. No.	AMMP1A2SX AMMP24SX
description	torsion spring ø 17mm L2 70mm wire gauge ø 2mm mounting pos. left L1 10mm L3 38mm for door		
For models:	DUE ACLQ, DUE ACLT, DUE ACSQ, DUE ACST, DUE AQ, DUE AT, JOLLY AQ, JOLLY AT, UNO ACSQ, UNO ACST, UNO AQ, UNO AT		

compression springs

GEV No.	507038	Ref. No.	CEMP20
description	compression spring ø 8.8mm L 31mm wire gauge ø 0.7mm		
For models:	DUE AQ, DUE AT, JOLLY AQ, JOLLY AT, JOLLY Q, JOLLY T, QUATTRO Q/82, QUATTRO T/82, UNO AQ, UNO AT, UNO Q, UNO T		

GEV No.	346940	Ref. No.	18010943 CEMMP6S
description	compression spring ø 9mm L 19mm wire gauge ø 0.7mm for micro-switch		

tension springs

GEV No.	507157	Ref. No.	GMML6261
description	tension spring ø 37mm total length 875mm wire gauge ø 4.5mm L1 305mm L2 570mm for hood		
For models:	SEI 1P, SEI 2P, SEI 2P/S		

dosing pumps

peristaltic dosing pumps

SEKO

built-in version

with frequency control



1

GEV No.	361765	Ref. No.	DOSDETETLE
description	dosing pump frequency control 3l/h 230VAC detergent		



1

GEV No.	361923	Ref. No.	DOSDETETLE
description	dosing pump SEKO frequency control 0.1-3l/h 230VAC detergent hose ø 6mm hose type I hose Santoprene suction level 1.5m type PBR		
spare parts for	361923		
	GEV No.	361238	Ref. No. DOSTSANSKC
	pump hose SEKO detergent hose ø 6x10mm hose length 135mm hose ø 6mm hose type I hose Santoprene		

with time control



1

GEV No.	361887	Ref. No.	DOSBRIETLE
description	dosing pump SEKO with single time control 0.7l/h 230VAC rinse aid hose ø 6mm hose type C hose Sekobril suction level 1.5m type PBM built-in version dosing time 1-20s		
spare parts for	361887		
	GEV No.	361890	Ref. No. —
	pump hose SEKO rinse aid hose ø 3x8mm hose length 128mm hose ø 6mm hose type C hose Sekobril		

Зип-Общепит

spare parts

vsezip.ru

+7(812)987-08-81

1

GEV No.	361136	Ref. No.	DOSPRRSKC
description	roller assembly for dosing pump hole ø 4.8x4mm		

seko



1

GEV No.	361238	Ref. No.	DOSTSANSKC
description	pump hose SEKO detergent hose ø 6x10mm hose length 135mm hose ø 6mm hose type I hose Santoprene		

spare parts for	361238		
	GEV No.	361639	Ref. No. —
	pump hose ED ø 10mm ID ø 6mm Shore 64° Santoprene dosing Qty 5m		

various

wall-mounted version

without control



1

GEV No.	361766	Ref. No.	DOSDET72
description	dosing pump detergent 230V hose ø 4x6mm peristaltic pump		



3m Общепит
accessories

membrane dosing pumps

self-priming with supporting pressure

OMNIWASH



1

GEV No.	361054	Ref. No.	DSAM3NT DSAM3NTGR DSAM3NTSPL
---------	--------	----------	------------------------------------

description dosing pump rinse aid pressure connection ø 6mm suction connection ø 6mm auxiliary pressure connection 10mm

For models: DUE ACLQ, DUE ACSQ, DUE AQ, JOLLY AQ, JOLLY AT, JOLLY Q, JOLLY T, QUATTRO Q/82, QUATTRO T/82, SEI 1P, SEI 2P, SEI 2P/S, UNO AQ, UNO CLQ, UNO CSQ, UNO Q

spare parts for 361054

	GEV No.	361308	Ref. No.	DS06M3
membrane rinse aid pressure connection ømm suction connection ømm auxiliary pressure connectionmm				

	GEV No.	361348	Ref. No.	DS085 DS85
lip valve rinse aid pressure connection ømm suction connection ømm auxiliary pressure connectionmm				

accessories for 361054

	GEV No.	520252	Ref. No.	—
nylon hose ID ø 6mm ED ø 8mm L 5m thickness 1mm operating p. 10bar burst p. 50bar t.max. 100°C white				

	GEV No.	520278	Ref. No.	—
PVC hose ID ø 6mm ED ø 8mm L 2m thickness 1mm t.max. 60°C transparent				



1

GEV No.	361348	Ref. No.	DS085 DS85
---------	--------	----------	---------------

description lip valve rinse aid pressure connection ømm suction connection ømm auxiliary pressure connectionmm



1

GEV No.	361308	Ref. No.	DS06M3
---------	--------	----------	--------

description membrane rinse aid pressure connection ømm suction connection ømm auxiliary pressure connectionmm

hose couplings

vsezip.ru

+7(812)987-08-81



1

GEV No.	361182	Ref. No.	VDRV
description nut thread 1/4" H 5mm nickel-plated brass WS 17 Qty 1 pcs			
For models: DUE ACLQ, DUE ACSQ, DUE AQ, JOLLY AQ, JOLLY AT, JOLLY Q, JOLLY T, QUATTRO Q/82, QUATTRO T/82, UNO AQ, UNO CLQ, UNO CSQ, UNO Q			

tank inlets



1

GEV No.	361858	Ref. No.	DSD040BC
description tank inlet plastic M10 hose ø 5.5mm			



1

GEV No.	361859	Ref. No.	GSD06M3
description tank inlet SS M10 hose ø 6mm			



1

GEV No.	361270	Ref. No.	DSD04M3
description tank inlet SS M12 hose ø 4mm			

hoses

supply hoses

stainless steel flexi hoses

universal hoses



1

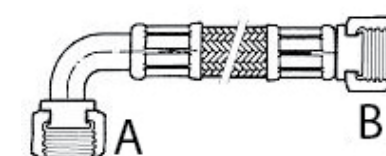

GEV No.	520576	Ref. No.	GR6223FLEX
---------	--------	----------	------------

description flex hose SS braid straight-curved DN6 connection 1: 3/8" connection 2: 3/8" L 290mm approval DVGW operating p. 10bar burst p. 95bar



PVC supply hoses



GEV No.	520011	Ref. No.	TC34
description	supply hose PVC straight-curved DN13 connections 3/4" L 2000mm operating p. 10bar burst p. 32bar t.max. 90°C approval VDE flat seal		

plastic/rubber hoses



GEV No.	520746	Ref. No.	TC3/415
description	supply hose DN DN10mm L 1500mm operating p. 10bar burst p. 32bar straight-curved connections 3/4"		

drain hoses



GEV No.	507329	Ref. No.	CEPS032
description	drain hose DN19 L 1500mm A int. ø 19mm A ext. ø 24mm B int. ø 21mm B ext. ø 28mm outer hose ø 24mm		
For models:	DUE AQ, DUE AT, QUATTRO Q/82, QUATTRO T/82, UNO AQ, UNO AT, UNO Q, UNO T		



GEV No.	507207	Ref. No.	GS130
description	drain hose DN24 L 1500mm A int. ø 24mm A ext. ø 28mm B int. ø 24mm B ext. ø 28mm outer hose ø 28mm		
For models:	DUE ACLQ, DUE ACSQ, DUE AQ, JOLLY AQ, JOLLY AT, JOLLY Q, JOLLY T, UNO AQ, UNO CLQ, UNO CSQ, UNO Q		



GEV No.	507211	Ref. No.	GS330
description	drain hose DN26 L 1500mm A int. ø 33mm A ext. ø 40mm B int. ø 32mm B ext. ø 40mm outer hose ø 35mm		
For models:	QUATTRO Q/82, QUATTRO T/82, SEI 1P, SEI 2P, SEI 2P/S		

Зип Общепит

vsezip.ru

+7(812)987-08-81



GEV No.	530789	Ref. No.	GSTS820PS
description	drain hose DN19 L 820mm straight ø inside 21mm straight ext. ø 27mm elbow ø inside 21mm elbow ext. ø 28mm outer hose ø 24mm		

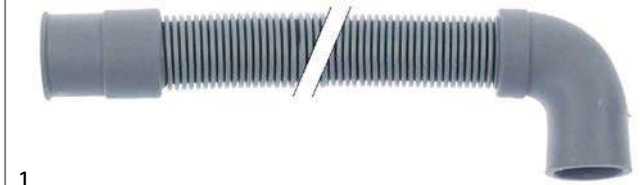

GEV No.	530382	Ref. No.	GSTS2500PS
description	drain hose DN21 L 2575mm straight ø inside 20.5mm straight ext. ø 28mm elbow ø inside 20.5mm elbow ext. ø 26.5mm outer hose ø 24mm		

industrial hoses

nylon hoses



GEV No.	520091	Ref. No.	TN64
description	nylon hose ID ø 4mm ED ø 6mm L 2m thickness 1mm operating p. 10bar burst p. 50bar t.max. 100°C transparent		

pressure control hoses



GEV No.	530560	Ref. No.	TG510DS TG512FDA
description	pressure control hose ID ø 5mm ED ø 9mm L 5m operating p. 30bar burst p. 90bar temp.-resist. 60°C		

PVC hoses

PVC hoses without fabric



GEV No.	570026	Ref. No.	TC46
description	PVC hose ID ø 4mm ED ø 6mm L 100m thickness 1mm t.max. 60°C transparent		

accessories for	570026			
	GEV No.	361058	Ref. No.	—
	container filter with non-return valve SS hose ø 4x6mm ø 20mm L 56mm			
	GEV No.	361066	Ref. No.	—
	container filter straight SS hose ø 4x6mm L 37mm non return valve ball valve			

Table continues overleaf



3zip Общепит

formed hoses

form L
vsezip.ru

+7(812)987-08-81

accessories for		570026	
	GEV No.	361106	Ref. No. —
container filter with weight and non-return valve SS hose ø 4x6mm ø 21mm L 51mm non return valve lip valve			
	GEV No.	361141	Ref. No. —
container filter with weight ceramic hose ø 4mm			
	GEV No.	361230	Ref. No. —
container filter with weight stainless steel hose ø 4x6mm			
	GEV No.	361462	Ref. No. —
container filter with weight SS hose ø 4x6mm			
	GEV No.	361728	Ref. No. —
container filter with 4m 4x6 hose SS hose ø 4x6mm hose length 4000mm			

1	GEV No.	694923	Ref. No. GA18P55USA
description formed hose end piece A ext. ø 40mm end piece A int. ø 30mm AD2 ø 44mm end piece B 36mm L 90mm Qty 1 warewashing			

1	GEV No.	507102	Ref. No. GASA6
description formed hose warewashing			

1	GEV No.	520026	Ref. No. TC46
description PVC hose ID ø 4mm ED ø 6mm L 10m thickness 1mm t.max. 60°C transparent			
accessories for		520026	
	GEV No.	361058	Ref. No. —
container filter with non-return valve SS hose ø 4x6mm ø 20mm L 56mm			
	GEV No.	361066	Ref. No. —
container filter straight SS hose ø 4x6mm L 37mm non return valve ball valve			
	GEV No.	361106	Ref. No. —
container filter with weight and non-return valve SS hose ø 4x6mm ø 21mm L 51mm non return valve lip valve			
	GEV No.	361141	Ref. No. —
container filter with weight ceramic hose ø 4mm			
	GEV No.	361230	Ref. No. —
container filter with weight stainless steel hose ø 4x6mm			
	GEV No.	361462	Ref. No. —
container filter with weight SS hose ø 4x6mm			
	GEV No.	361728	Ref. No. —
container filter with 4m 4x6 hose SS hose ø 4x6mm hose length 4000mm			

1	GEV No.	507414	Ref. No. GS120SPEC
description formed hose warewashing L			

1	GEV No.	507090	Ref. No. GA18
description formed hose warewashing L-shape equiv. no. GA18			
For models: DUE AQ, DUE AT, JOLLY AQ, JOLLY AT, JOLLY Q, JOLLY T, UNO AQ, UNO AT, UNO Q, UNO T			

1	GEV No.	520545	Ref. No. TC58
description PVC hose ID ø 5mm ED ø 8mm L 10m thickness 1.5mm t.max. 60°C transparent warewashing			

1	GEV No.	507095	Ref. No. GA38
description formed hose warewashing L-shape equiv. no. GA38			
For models: SEI 1P, SEI 2P, SEI 2P/S			



Зип Общепит

vsezip.ru

+7(812)987-08-81



1

GEV No.	507097	Ref. No.	GA538
description	formed hose warewashing L-shape equiv. no. GA538		
For models:	QUATTRO Q/82, QUATTRO T/82		



1

GEV No.	507213	Ref. No.	GS520
description	formed hose warewashing L-shape equiv. no. GS520		
For models:	QUATTRO Q/82, QUATTRO T/82		



1

GEV No.	507103	Ref. No.	GASA8
description	formed hose warewashing L-shape equiv. no. GASA8		
For models:	SEI 2P, SEI 2P/S		



1

GEV No.	507328	Ref. No.	GSMAPS
description	formed hose warewashing L-shape equiv. no. GSMAPS		
For models:	DUE AQ, DUE AT, UNO AQ, UNO AT, UNO Q, UNO T		



1

GEV No.	507216	Ref. No.	GSMPS5
description	formed hose warewashing L-shape equiv. no. GSMPS5		
For models:	QUATTRO Q/82, QUATTRO T/82		



1

GEV No.	507205	Ref. No.	GS120
description	formed hose warewashing L-shape equiv. no. GS120 hose int. ø 25mm		
For models:	JOLLY AQ, JOLLY AT, JOLLY Q, JOLLY T, UNO AQ, UNO CLQ, UNO CSQ, UNO Q		



1

GEV No.	507304	Ref. No.	LSSA13A
description	formed hose warewashing L-shape equiv. no. LSSA13A		



1

GEV No.	507208	Ref. No.	GS220
description	formed hose warewashing L-shape equiv. no. GS220		
For models:	DUE ACLQ, DUE ACSQ, DUE AQ		

with branch



1

GEV No.	507153	Ref. No.	GLMSI61P
description	formed hose warewashing equiv. no. GLMSI61P with piggyback		
For models:	SEI 1P		



Зип Общепит

vsezip.ru

+7(812)987-08-81



1

GEV No.	507325	Ref. No.	GLMSIC1 GLMSIC104
description	formed hose warewashing equiv. no. GLMSIC1 with piggyback		
For models:	UNO Q		



1

GEV No.	507326	Ref. No.	GLMSIC2A GLMSIC2A04
description	formed hose warewashing equiv. no. GLMSIC2A with piggyback		
For models:	DUE AQ		



1

GEV No.	507327	Ref. No.	GLMSIC4 GLMSIC404
description	formed hose warewashing equiv. no. GLMSIC4 with piggyback		
For models:	QUATTRO Q/82		

form S



1

GEV No.	507253	Ref. No.	LISA392
description	formed hose for pump S-shape warewashing equiv. no. LISA392 mounting pos. upper		



1

GEV No.	507241	Ref. No.	LI6312
description	formed hose S-shape warewashing		
For models:	SEI 2P, SEI 2P/S		



1

GEV No.	530818	Ref. No.	DS327
description	formed hose S-shape warewashing		



Зип.Общепит
fittings, hose and pipe connectors

hose connectors

without screw connection

+7(812)987-08-81



1	
GEV No. 507138	Ref. No. GL1T22
description	formed hose S-shape warewashing equiv. no. GL1T22
For models:	JOLLY AQ, JOLLY AT, JOLLY Q, JOLLY T, UNO ACSQ, UNO ACST, UNO AT, UNO CLQ, UNO CLT, UNO CSQ, UNO CST, UNO T



1	
GEV No. 507193	Ref. No. GR6183
description	Y-piece
For models:	SEI 1P, SEI 2P, SEI 2P/S



1	
GEV No. 507144	Ref. No. GL2T22
description	formed hose S-shape warewashing equiv. no. GL2T22
For models:	DUE ACLQ, DUE ACLT, DUE ACSQ, DUE ACST, DUE AT



1	
GEV No. 507174	Ref. No. GP RTP
description	T-piece plastic hose ø 4-4mm 3-way
For models:	QUATTRO Q/82, QUATTRO T/82

form U



1	
GEV No. 507394	Ref. No. LISA39206
description	formed hose warewashing U-shape

miscellaneous



1	
GEV No. 507149	Ref. No. GL4T22
description	formed hose warewashing equiv. no. GL4T22
For models:	QUATTRO T/82

hose connectors

producer-specific



1	
GEV No. 507061	Ref. No. DSD ET040
description	elbow connection
For models:	QUATTRO Q/82, QUATTRO T/82
accessories for	507061



GEV No. 507075	Ref. No. G15101G G1510G G16101G
description	flat gasket rubber ED ø 15mm ID ø 10mm thickness 2mm Qty 1 pcs



GEV No. 507330	Ref. No. VD101P1
description	nut thread M10x1 H 7mm WS 13 stainless steel Qty 1 pcs

for dishwashers

miscellaneous





1	
GEV No. 507262	Ref. No. LS313B
description	hose







Зип Общепит
vsezip.ru
+7(812)987-08-81

			
1			
GEV No.	507063	Ref. No.	DSDET62P
description	elbow connection		
For models:	SEI 1P, SEI 2P, SEI 2P/S		





			
1			
GEV No.	507194	Ref. No.	GR193GR GR6193
description	hose connector thread 1/8" angled L 23mm		
For models:	SEI 1P, SEI 2P, SEI 2P/S		

			
1			
GEV No.	507176	Ref. No.	GR016P
description	hose connector		
For models:	QUATTRO T/82		

			
1			
GEV No.	520581	Ref. No.	DSDET040BGR
description	hose connector thread M10x1 for hose ID 5mm		
accessories for	520581		
	GEV No.	507062	Ref. No. DSDET043
	cap		
	GEV No.	507075	Ref. No. G15101G G1510G G16101G
	flat gasket rubber ED ø 15mm ID ø 10mm thickness 2mm Qty 1 pcs		
	GEV No.	507330	Ref. No. VD10IP1
	nut thread M10x1 H 7mm WS 13 stainless steel Qty 1 pcs		

			
1			
GEV No.	507206	Ref. No.	GS121
description	hose connector		
For models:	DUE ACLQ, DUE ACSQ, DUE AQ, JOLLY AQ, JOLLY AT, JOLLY Q, JOLLY T, UNO AQ, UNO CLQ, UNO CSQ, UNO Q		

			
1			
GEV No.	507210	Ref. No.	GS321
description	hose connector		
For models:	QUATTRO Q/82, QUATTRO T/82		

			
1			
GEV No.	521184	Ref. No.	siehe Bemerkung
description	hose connector thread M10x1 for hose ID 5mm		
spare parts for	521184		
	GEV No.	507062	Ref. No. DSDET043
	cap		
	GEV No.	507075	Ref. No. G15101G G1510G G16101G
	flat gasket rubber ED ø 15mm ID ø 10mm thickness 2mm Qty 1 pcs		
	GEV No.	507330	Ref. No. VD10IP1
	nut thread M10x1 H 7mm WS 13 stainless steel Qty 1 pcs		

			
1			
GEV No.	507340	Ref. No.	DSDETOT040
description	hose connector connection 1/8"		

			
1			
GEV No.	507004	Ref. No.	ABPRIRS14
description	hose connector thread 1/4"		

			
1			
GEV No.	507105	Ref. No.	GB055
description	manifold 4-way hose ø 13-13-13-13mm plastic		
For models:	DUE ACLQ, DUE ACSQ, DUE AQ, JOLLY AQ, JOLLY Q, QUATTRO Q/82, QUATTRO T/82, UNO AQ, UNO CLQ, UNO CSQ, UNO Q		

Зип Общепит

vsezip.ru

+7(812)987-08-81

1			
GEV No.	507001	Ref. No.	ABPRIRA54
description	screw connection T1: 3/4" T2: 1/4"		

1			
GEV No.	560341	Ref. No.	FAM46 FAM57 FAM58
description	hose clamp ø 7-9mm wire gauge ø 1mm Qty 1 pcs		

1			
GEV No.	507104	Ref. No.	GB017
description	T-piece 3-way hose ø 13-13-13mm plastic		

1			
GEV No.	560503	Ref. No.	FAM710
description	hose clamp ø 8-10mm wire gauge ø 1mm Qty 1 pcs		

ancillary products

clamps

hose clamps

DIN 3017 - W2

1			
GEV No.	520115	Ref. No.	FA3040
description	hose clamp ø 25-40mm width 9mm Qty 10 pcs DIN 3017		

DIN 3017 - W4

1			
GEV No.	520120	Ref. No.	FA1220
description	hose clamp SS W4 ø 12-20mm width 9mm Qty 1 pcs DIN 3017		

double wire clamps

1			
GEV No.	520788	Ref. No.	FAM4050
description	hose clamp ø 43-50mm wire gauge ø 3.5mm Qty 1 pcs		

measuring equipment

thermometers

built-in thermometers

1			
GEV No.	541095	Ref. No.	CETEM
description	thermometer mounting measurements 58x25.5mm 0 up to +120°C capillary pipe 3000mm probe ø 6.5mm probe L 20mm		
For models:	SEI 2P		

fastening material

screws

sheet metal screws

1			
GEV No.	560500	Ref. No.	VATE4232Z
description	hexagonal screw ø 4mm L 35mm WS 7 zinc-plated Qty 1 pcs		

countersunk screws

1			
GEV No.	560044	Ref. No.	VVTSEI616I
description	countersunk screw thread M6 L 16mm WS 4 SS DIN 7991/ISO 10642 Qty 20 pcs intake hexagonal		





Зип Общепит

vsezip.ru

77(812)987-08-81

			
1			
GEV No.	560337	Ref. No.	VVTSEI625I
description	countersunk screw thread M6 L 20mm WS 4 SS DIN 9131/ISO 10342 Qty 1 pcs intake hexagonal		

flat-headed bolts			
			
1			
GEV No.	507320	Ref. No.	VVTC410I
description	screw		
For models:	DUE ACLQ, DUE ACLT, DUE ACSQ, DUE ACST, DUE AT, JOLLY AQ, JOLLY AT, JOLLY Q, JOLLY T, QUATTRO T/82, UNO ACSQ, UNO ACST, UNO AT, UNO CLQ, UNO CLT, UNO CSQ, UNO CST, UNO T		

hexagonal screws			
			
1			
GEV No.	560339	Ref. No.	VVTE810I
description	hexagonal screw thread M8 thread L 10mm SS WS 13 Qty 1 pcs DIN 933 / ISO 4017		

cylinder head bolts			
DIN 912/ISO 4762			
			
1			
GEV No.	560025	Ref. No.	N/A
description	cylinder head bolt thread M4 thread L 10mm WS 3 SS Qty 20 pcs DIN 912/ISO 4762		

			
1			
GEV No.	560335	Ref. No.	VVEI520I
description	cylinder head bolt thread M5 thread L 20mm WS 4 SS Qty 1 pcs DIN 912/ISO 4762		

			
1			
GEV No.	560338	Ref. No.	VVEI655I
description	cylinder head bolt thread M6 L 55mm thread L 25mm WS 4 intake hexagonal SS Qty 1 pcs DIN 912/ISO 4762		

nuts			
hexagonal nuts			
DIN 934 / ISO 4032/8673			

			
1			
GEV No.	560340	Ref. No.	VD4I
description	hexagonal nut thread M4 H 3.2mm WS 7 SS DIN/ISO DIN 934 / ISO 4032/8673 Qty 1 pcs		

			
1			
GEV No.	560341	Ref. No.	VD5I
description	hexagonal nut thread M5 H 3.5mm WS 8 SS DIN/ISO DIN 934 / ISO 4032/8673 Qty 1 pcs		

			
1			
GEV No.	511212	Ref. No.	VD6I
description	hexagonal nut thread M6 H 5mm WS 10 SS DIN/ISO DIN 934 / ISO 4032/8673 Qty 1 pcs		

			
1			
GEV No.	507331	Ref. No.	VVDET62P
description	nut thread M12 H 10mm WS 19 SS DIN/ISO DIN 934 / ISO 4032/8673 Qty 1 pcs		

hexagonal nuts metric (without norm)			
			
1			
GEV No.	507330	Ref. No.	VD10IP1
description	nut thread M10x1 H 7mm WS 13 stainless steel Qty 1 pcs		
For models:	DUE AQ, DUE AT, JOLLY AQ, JOLLY AT, JOLLY Q, JOLLY T, QUATTRO Q/82, QUATTRO T/82, UNO AQ, UNO AT, UNO Q, UNO T		

Зип-Общепит

vsezip.ru

+7(812)987-08-81

hexagonal nuts inch thread



1

GEV No.	507052	Ref. No.	D034
description	hexagonal nut thread 3/4" Qty 1 pcs		



1

GEV No.	361182	Ref. No.	VDRV
description	nut thread 1/4" H 5mm nickel-plated brass WS 17 Qty 1 pcs		
For models:	DUE ACLQ, DUE ACSQ, DUE AQ, JOLLY AQ, JOLLY AT, JOLLY Q, JOLLY T, QUATTRO Q/82, QUATTRO T/82, UNO AQ, UNO CLQ, UNO CSQ, UNO Q		



1

GEV No.	507051	Ref. No.	D014
description	nut thread 1/4" H 7.5mm brass WS 17 Qty 1 pcs		



1

GEV No.	507054	Ref. No.	D038 D038A
description	nut thread 3/8" H 10mm brass WS 20 Qty 1 pcs		
For models:	DUE ACLQ, DUE ACSQ, DUE AQ, DUE AT, JOLLY AT, JOLLY T, QUATTRO Q/82, QUATTRO T/82, SEI 1P, SEI 2P, SEI 2P/S, UNO AQ, UNO AT, UNO CLQ, UNO CSQ, UNO Q, UNO T		

washers

spring rings



1

GEV No.	560336	Ref. No.	VRG4I
description	lock washer ID \varnothing 4.2mm ED \varnothing 8mm SS DIN127 Qty 1 pcs for thread M4		

washers

DIN 125A



1

GEV No.	560334	Ref. No.	VRP18I
description	plain washer ID \varnothing 19mm ED \varnothing 34mm for thread M18		



1

GEV No.	560333	Ref. No.	VRP6I
description	plain washer ID \varnothing 6.4mm ED \varnothing 12mm thickness 1.6mm SS Qty 1 pcs DIN 125A for thread M6		

miscellaneous



1

GEV No.	507114	Ref. No.	GG0T4 VRP16I
description	disc D1 \varnothing 30mm D2 \varnothing 17mm thickness 3mm		
For models:	DUE AT, JOLLY AT, JOLLY T, QUATTRO T/82, UNO AT, UNO T		

tooth lock washers

DIN 6798A



1

GEV No.	560342	Ref. No.	VR6I
description	tooth lock washer ID \varnothing 6.5mm ED \varnothing 11mm SS Qty 1 pcs for thread M6		

fasteners

clamps

hose clamps

DIN 3017 - W2



1

GEV No.	520115	Ref. No.	FA3040
description	hose clamp \varnothing 25-40mm width 9mm Qty 10 pcs DIN 3017		



Зип Ообщепит

vsezip.ru

+7(812)987-08-81

DIN 3017 - W4



1

GEV No.	520120	Ref. No.	FA1220
description	hose clamp SS W4 ø 12-20mm width 9mm Qty 1 pcs DIN 3017		

double wire clamps



1

GEV No.	520788	Ref. No.	FAM4050
description	hose clamp ø 43-50mm wire gauge ø 3.5mm Qty 1 pcs		



1

GEV No.	560344	Ref. No.	FAM46 FAM57 FAM58
description	hose clamp ø 7-9mm wire gauge ø 1mm Qty 1 pcs		



1

GEV No.	560503	Ref. No.	FAM710
description	hose clamp ø 8-10mm wire gauge ø 1mm Qty 1 pcs		

retaining rings

DIN 471



1

GEV No.	507130	Ref. No.	GG3TE
description	retaining ring shaft ø 12mm DIN 471		
For models:	QUATTRO T/82		



1

GEV No.	507121	Ref. No.	GG1TE
description	retaining ring shaft ø 9mm DIN 471		
For models:	DUE AT, JOLLY AT, JOLLY T, UNO AT, UNO T		

DIN 6799



1

GEV No.	507040	Ref. No.	CEMP22
description	retaining ring E D1 ø 4mm D2 ø 9mm SS DIN 6799 thickness 0.7mm		
For models:	DUE AQ, DUE AT, JOLLY AQ, JOLLY AT, JOLLY Q, JOLLY T, QUATTRO Q/82, QUATTRO T/82, SEI 1P, SEI 2P, SEI 2P/S, UNO AQ, UNO AT, UNO Q, UNO T		



1

GEV No.	507014	Ref. No.	AM013
description	retaining ring E D1 ø 7mm D2 ø 14mm SS DIN 6799 thickness 0.9mm		



1

GEV No.	507015	Ref. No.	AM013NT
description	retaining ring E D1 ø 7mm D2 ø 14mm SS DIN 6799 thickness 0.9mm for shaft ø 8-11mm		
For models:	QUATTRO Q/82, QUATTRO T/82		

consumables

fuses

fine fuses



1

GEV No.	358074	Ref. No.	CEFU5205A
description	fine fuse size ø5x20mm 5A fast-acting rated 250V Qty 10 pcs		

fine fuse holders



1

GEV No.	358512	Ref. No.	CEMFSTR
description	fuse holder		
For models:	SEI 1P, SEI 2P, SEI 2P/S		

Зип Общепит

vsezip.ru

+7(812)987-08-81

Зип Общепит

vsezip.ru

+7(812)987-08-81

B					
bi-metal thermostats	4				
booster pumps II	25				
C					
clamps	72, 74				
condensators & interference suppression filters	25				
consumables	75				
contactors	18				
control equipment	12				
control thermostats	5				
countersunk screws	72				
cylinder head bolts	73				
D					
dosing pumps	64				
double wire clamps	72, 75				
drain hoses	66				
drain pumps	24				
E					
electric accessories	26				
electronic controllers	19				
F					
fasteners	74				
fastening material	72				
filters	25				
fine fuses	75				
flat-headed bolts	73				
formed hoses	67				
fuses	25, 75				
G					
gaskets for wash arm support	63				
H					
heating elements	3				
hexagonal nuts	73				
hexagonal screws	73				
hose clamps	72, 74				
hose connectors	70, 70				
hose couplings	65				
hoses	65				
I					
immersion heating elements	3				
indicator lights	13				
indicator lights (complete)	14				
industrial hoses	66				
L					
lamps	13				
M					
magnetic switches	12				
measuring equipment	72				
microswitches	7				
N					
nuts	73				
nylon hoses	66				
O					
operating capacitors	25				
O-rings	60				
P					
plastic/rubber hoses	66				
pressure control hoses	66				
pressure switches	22				
probes	19				
programme timers	15				
pumps	23				
PVC hoses	66				
PVC supply hoses	66				
R					
relays	19				
retaining rings	75				
rocker/momentary rocker switches	5				
S					
safety bi-metal thermostats	4				
screws	72				
sealing washers	62				
sheet metal screws	72				
snap locks	59				
solenoid valves	20				
spring rings	74				
stainless steel flexi hoses	65				
supply hoses	65				
switches and momentary switches	5				
system switches	11				
system switches (ROLD)	8				
T					
tank inlets	65				
terminals	26				
thermostats	4				
timers	15				
tooth lock washers	74				
transformers	19				

Зип Общепит**U**

universal hoses

65

vsezip.ru**W**

wash and rinse pumps

23

washers

74

+7(812)987-08-81