



Зип Общепит

vsezip.ru

+7(812)987-08-81



**GAS COMPONENTS**



**ELECTRIC COMPONENTS**



**WATER TECHNOLOGY**



**MECHANICAL COMPONENTS**



**TOOLS**

Spare parts suitable for

**ANGELO-PO**

Find the complete and up-to-date range of products in our GEV Webshop

Зип Общепит

vsezip.ru

+7(812)987-08-82

# Manufacturer catalogue

The most important spare parts and accessories arranged clearly for every manufacturer



**Complete product range and all appliance data always up to date in the GEV Webshop**



**Alphabetical Index at the end of the catalogue**







## GEV Webshop

[www.gev-online.co.uk](http://www.gev-online.co.uk)

[www.gev-online.com](http://www.gev-online.com)



-  Add to Favourites
-  Sign In with email address and usual password
-  Easy-order – place several items in your basket at the same time
-  Quick Item search – no login needed



heating elements

heating elements for ovens

Зип Общепит

vsezip.ru

+7(812)987-08-81

electric components

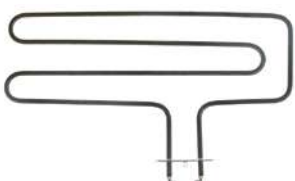

1

|                    |  |                 |                    |
|--------------------|--|-----------------|--------------------|
| <b>GEV No.</b>     | 418596   | <b>Ref. No.</b> | 32G1590<br>32G1591 |
| <b>description</b> | heating element 2600W 230V L 265mm W 510mm L1 93mm W2 62mm flange length 100mm flange width 22mm hole distance 86mm hole ø 5mm |                 |                    |
| <b>For models:</b> | 1G1FA0E, 1G1FA0EV, 1G1PE1E, 1G1PE1EV, 1G1PE2E, 1G1PE2EV, 2G1PE1E, 2G1PE1EV, 2G1PE2E, 2G1PE2EV, 31GE, 31TCE, 32TCE              |                 |                    |



1

|                    |   |                 |                               |
|--------------------|---|-----------------|-------------------------------|
| <b>GEV No.</b>     | 415169  | <b>Ref. No.</b> | 32G0950<br>32G0951<br>32G1601 |
| <b>description</b> | heating element 2700W 380V L 450mm W 590mm L1 115mm L2 335mm W1 370mm W2 60mm flange length 100mm flange width 22mm hole distance 86mm hole ø 5mm tube ø 6.5mm connection male faston 6.3mm heating circuits 1 rectangular flange dry heating element |                 |                               |
| <b>For models:</b> | 08WFA4E, 08WFAAE, 10WTPGE, 12WFA6E, 12WFAAE, 191FAAE, 191FAE, 191FAG, 191PE4E, 1A1PE4E, 1A1PEFTE, 1A1FBE, 1D1PE4E, 1D1FBE, 6043590, 71E, 71GE, 71GEGG, FS30E  |                 |                               |

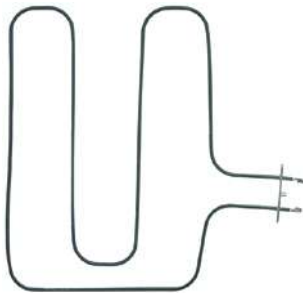

1

|                    |  |                 |                               |
|--------------------|--|-----------------|-------------------------------|
| <b>GEV No.</b>     | 416677   | <b>Ref. No.</b> | 32G0151<br>32G1350<br>32G1351 |
| <b>description</b> | heating element 2600W 400V L 460mm W 505mm L1 115mm L2 340mm W1 150mm W2 60mm flange length 100mm flange width 22mm hole distance 86mm hole ø 5mm tube ø 6.3mm connection male faston 6.3mm heating circuits 1 rectangular flange oven |                 |                               |
| <b>For models:</b> | 31GE, 31TCE, 32TCE   |                 |                               |

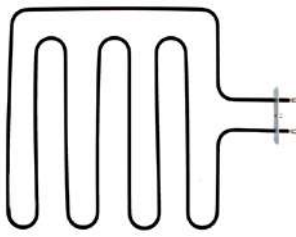

1

|                    |  |                 |         |
|--------------------|--|-----------------|---------|
| <b>GEV No.</b>     | 418641   | <b>Ref. No.</b> | 32G3250 |
| <b>description</b> | heating element 2700W 400V heating circuits 1 L 465mm W 385mm L1 100mm L2 365mm W1 162mm W2 61mm flange length 100mm flange width 22mm hole distance 86mm hole ø 5mm tube ø 6.5mm connection male faston 6.3mm connection length 45mm mounting pos. upper rectangular flange dry heating element |                 |         |
| <b>For models:</b> | 1G1FA0E, 1G1FA0EV, 1G1PE1E, 1G1PE1EV, 1G1PE2E, 1G1PE2EV, 2G1FA0E, 2G1PE1E, 2G1PE1EV, 2G1PE2E, 2G1PE2EV   |                 |         |

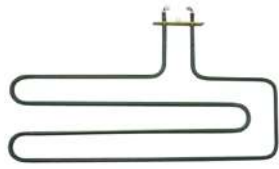

1

|                    |  |                 |                    |
|--------------------|--|-----------------|--------------------|
| <b>GEV No.</b>     | 415673   | <b>Ref. No.</b> | 32G1621<br>32G1630 |
| <b>description</b> | heating element 2600W 415V L 251mm W 510mm L1 89mm L2 162mm W1 287mm W2 63mm flange length 100mm flange width 22mm hole distance 86mm hole ø 5mm tube ø 8.7mm connection length 31mm connection male faston 6.3mm heating circuits 1 rectangular flange dry heating element oven |                 |                    |
| <b>For models:</b> | 1G1FA0E, 1G1FA0EV, 1G1PE1E, 1G1PE1EV, 1G1PE2E, 1G1PE2EV, 2G1FA0E, 2G1PE1E, 2G1PE1EV, 2G1PE2E, 2G1PE2EV, 31GE, 31TCE, 32TCE   |                 |                    |

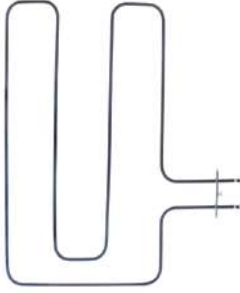



1

|                    |   |                 |         |
|--------------------|---|-----------------|---------|
| <b>GEV No.</b>     | 418837  | <b>Ref. No.</b> | 32G1220 |
| <b>description</b> | heating element 2940W 230V L 455mm W 590mm L1 115mm L2 340mm W1 370mm W2 60mm flange length 100mm flange width 22mm hole distance 86mm hole ø 5mm tube ø 6.3mm connection length 55mm heating circuits 1 oven |                 |         |
| <b>For models:</b> | 71E, FS30E  |                 |         |





Зип Общепит  
vsezip.ru  
8(2)987-08-81

|   |   |                 |         |
|---|---|-----------------|---------|
|  |   |                 |         |
| <b>GEV No.</b>  | 416676  | <b>Ref. No.</b> | 32G0160 |
| <b>description</b>  | heating element 800W 230V heating circuits 1 L 405mm W 122mm H 16mm L1 42mm L2 363mm W1 30mm W2 62mm flange length 100mm flange width 22mm hole distance 86mm hole ø 4mm tube ø 8.5mm connection male faston 6.3mm rectangular flange dry heating element |                 |         |

|   |   |                 |         |
|---|---|-----------------|---------|
|  |   |                 |         |
| <b>GEV No.</b>  | 415171  | <b>Ref. No.</b> | 32G0080 |
| <b>description</b>  | heating element 900W 230V heating circuits 1 L 430mm W 122mm H 28mm L1 55mm L2 375mm W1 30mm W2 62mm flange length 100mm flange width 22mm hole distance 86mm hole ø 4mm tube ø 6.3mm connection male faston 6.3mm rectangular flange dry heating element |                 |         |





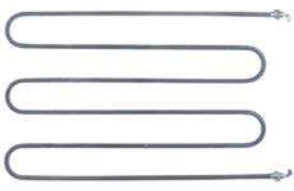

### heating elements for bain maries

|   |  |                 |         |
|---|--|-----------------|---------|
|  |  |                 |         |
| <b>GEV No.</b>  | 416683   | <b>Ref. No.</b> | 32G2220 |
| <b>description</b>  | heating element 1000W 230V heating circuits 1 L 480mm W 35mm flange length 70mm flange width 22mm hole distance 56mm connection length 28mm connection M4 tube ø 8.5mm rectangular flange hole ø 5.5mm dry heating element |                 |         |
| <b>For models:</b>  | 04WBMEV, 090BM1E, 0A0BME, 0B0BME, 0D0BME, 190BM2E, 1A0BME, 1D0BME, 6040110, 6042680  |                 |         |

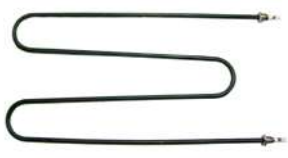
|   |   |                 |         |
|---|---|-----------------|---------|
|  |   |                 |         |
| <b>GEV No.</b>  | 416682  | <b>Ref. No.</b> | 32G0280 |
| <b>description</b>  | heating element 1450W 230V L 378mm W 252mm connection male faston 6.3mm tube ø 8.5mm 2 hole fixing thread 1/4" dry heating element water bath mounting distance 245mm |                 |         |
| <b>For models:</b>  | 030EBM, 031EBM, 0G0BME, 1G0BME  |                 |         |

|   |   |                 |         |
|---|---|-----------------|---------|
|  |   |                 |         |
| <b>GEV No.</b>  | 418688  | <b>Ref. No.</b> | 32G1730 |
| <b>description</b>  | heating element 1500W 230V L 470mm W 305mm tube ø 8.5mm thread 1/4" bain marie mounting distance 297mm                        |                 |         |
| <b>For models:</b>  | ACBM, ACBM218, ANBM, ANBM218, ANBM75, SE14VB, SE21VB, SI14VB, SI21VB, SL14CVB, SL14NVB, SL21CVB, SL21NVB, SL7NVB, TBM, TBM218 |                 |         |

|  |   |                 |                    |
|--|---|-----------------|--------------------|
|  |   |                 |                    |
| <b>GEV No.</b>   | 415173  | <b>Ref. No.</b> | 32G0070<br>32G0071 |
| <b>description</b>   | heating element 1600W 230V L 585mm W 200mm connection M6 tube ø 8.5mm 2 hole fixing thread M14x1.5 immersion heater mounting distance 184mm |                 |                    |
| <b>For models:</b>   | 070BME, 071BME, 090BME, 091BME  |                 |                    |
| <b>accessories for</b>   | 415173  |                 |                    |
|   | <b>GEV No.</b>  | 510417          | <b>Ref. No.</b> —  |
|  | flat gasket fibre ED ø 20mm ID ø 14mm thickness 2mm Qty 1 pcs   |                 |                    |
|   | <b>GEV No.</b>  | 520228          | <b>Ref. No.</b> —  |
|  | tooth lock washer ID ø 15.3mm ED ø 24mm steel Qty 1 pcs for thread M14  |                 |                    |
|   | <b>GEV No.</b>  | 520230          | <b>Ref. No.</b> —  |
|  | nut thread M14x1.5 H 5mm WS 19 zinc-coated steel Qty 1 pcs  |                 |                    |
|   | <b>GEV No.</b>  | 521101          | <b>Ref. No.</b> —  |
|  | nut thread M14x1.5 H 5mm WS 19 SS Qty 1 pcs   |                 |                    |
|   | <b>GEV No.</b>  | 550262          | <b>Ref. No.</b> —  |
|  | flat gasket copper ED ø 20mm ID ø 14mm thickness 2mm  |                 |                    |

|  |   |                 |                   |
|--|---|-----------------|-------------------|
|  |   |                 |                   |
| <b>GEV No.</b>   | 415181  | <b>Ref. No.</b> | 32G1250           |
| <b>description</b>   | heating element 2000W 230V heating circuits 1 L 458mm W 208mm connection male faston 6.3mm tube ø 8.5mm 2 hole fixing thread M14x1 immersion heater mounting distance 200mm |                 |                   |
| <b>For models:</b>   | 030BME, 031BME  |                 |                   |
| <b>accessories for</b>   | 415181  |                 |                   |
|   | <b>GEV No.</b>  | 510417          | <b>Ref. No.</b> — |
|  | flat gasket fibre ED ø 20mm ID ø 14mm thickness 2mm Qty 1 pcs   |                 |                   |
|   | <b>GEV No.</b>  | 520228          | <b>Ref. No.</b> — |
|  | tooth lock washer ID ø 15.3mm ED ø 24mm steel Qty 1 pcs for thread M14  |                 |                   |
|   | <b>GEV No.</b>  | 521133          | <b>Ref. No.</b> — |
|  | nut thread M14x1.5 H 6mm WS 19 zinc-coated steel Qty 1 pcs  |                 |                   |
|   | <b>GEV No.</b>  | 550261          | <b>Ref. No.</b> — |
|  | nut thread M14x1 H 4mm WS 19 SS Qty 1 pcs   |                 |                   |
|   | <b>GEV No.</b>  | 550262          | <b>Ref. No.</b> — |
|  | flat gasket copper ED ø 20mm ID ø 14mm thickness 2mm  |                 |                   |









Зип Общепит  
heating elements for fryers

vsezip.ru  
miscellaneous

+7(812)987-08-81







1

|   |  |                 |                     |
|---|--|-----------------|---------------------|
| <b>GEV No.</b>  | 415175   | <b>Ref. No.</b> | 32G0650             |
| <b>description</b>  | heating element 4800W 220V heating circuits 3 L 410mm W 417mm connection M3 tube ø 8.5mm flange with thread thread 1¼" immersion heater H1 10mm H 19mm |                 |                     |
| <b>accessories for</b>  | 415175   |                 |                     |
|    | <b>GEV No.</b>   | 510405          | <b>Ref. No.</b> N/A |
|   | flat gasket fibre ED ø 56mm ID ø 42mm thickness 2mm for thread 1¼" Qty 1 pcs   |                 |                     |
|    | <b>GEV No.</b>   | 520232          | <b>Ref. No.</b> —   |
|   | nut thread 1¼" H 5mm nickel-plated brass WS 47 Qty 1 pcs   |                 |                     |
|    | <b>GEV No.</b>   | 527169          | <b>Ref. No.</b> —   |
|   | hexagonal nut thread M3 H 2.8mm WS 5.5 brass Qty 1 pcs   |                 |                     |
|    | <b>GEV No.</b>   | 528021          | <b>Ref. No.</b> —   |
|   | flat gasket PTFE ED ø 53mm ID ø 42.5mm thickness 3mm Qty 1 pcs equiv. no. 12001/02286 suitable for Astoria/Aurora/Brasilia/Wega                        |                 |                     |
|   | <b>GEV No.</b>   | 560110          | <b>Ref. No.</b> —   |
|   | plain washer ID ø 3.2mm ED ø 7mm thickness 0.5mm SS Qty 20 pcs DIN 125A for thread M3  |                 |                     |
|  | <b>GEV No.</b>   | 560130          | <b>Ref. No.</b> —   |
|   | hexagonal nut thread M3 H 2.4mm WS 5.5 SS DIN/ISO DIN 934 / ISO 4032/8673 Qty 20 pcs   |                 |                     |





1

|   |  |                 |                   |
|---|--|-----------------|-------------------|
| <b>GEV No.</b>  | 415172   | <b>Ref. No.</b> | 32G0090           |
| <b>description</b>  | heating element 800W 230V L 405mm W 50mm connection male faston 6.3mm tube ø 8.5mm 2 hole fixing thread M12x1 dry heating element mounting distance 42mm |                 |                   |
| <b>For models:</b>  | 0G0BME-VERS.032008, 1G0BME-VERS.032008   |                 |                   |
| <b>spare parts for</b>  | 415172   |                 |                   |
|  | <b>GEV No.</b>   | 510417          | <b>Ref. No.</b> — |
|   | flat gasket fibre ED ø 20mm ID ø 14mm thickness 2mm Qty 1 pcs  |                 |                   |
| <b>accessories for</b>  | 415172   |                 |                   |
|  | <b>GEV No.</b>   | 520229          | <b>Ref. No.</b> — |
|   | nut thread M12x1 H 4mm WS 16 zinc-coated steel Qty 1 pcs   |                 |                   |
|  | <b>GEV No.</b>   | 521110          | <b>Ref. No.</b> — |
|   | flat gasket fibre ED ø 20mm ID ø 13mm thickness 2mm Qty 1 pcs  |                 |                   |



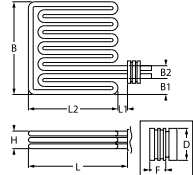

1

|   |  |                 |                         |
|---|--|-----------------|-------------------------|
| <b>GEV No.</b>  | 419049   | <b>Ref. No.</b> | 32G2610                 |
| <b>description</b>  | heating element 7200W 230V L 300mm W 155mm   |                 |                         |
| <b>For models:</b>  | 04WFR3ED, 08WFR4ED, 091FR3E, 091FR3ED, 0A1FR3E, 0A1FR3ED, 0D1FR3E, 0D1FR3ED, 0G0FR3E, 0G0FR3ED, 191FR4E, 191FR4ED, 1A1FR4E, 1A1FR4ED, 1D1FR4E, 1D1FR4ED, 1G0FR4E, 6043840, 6043970 |                 |                         |
| <b>accessories for</b>  | 419049   |                 |                         |
|  | <b>GEV No.</b>   | 510219          | <b>Ref. No.</b> 60A0980 |
|   | O-ring set Qty 2 pcs   |                 |                         |

1

|   |   |                 |                                    |
|---|---|-----------------|------------------------------------|
| <b>GEV No.</b>  | 416589  | <b>Ref. No.</b> | 32G2400                            |
| <b>description</b>  | heating element 18000W 400V heating circuits 3 mounting pos. left L 395mm W 270mm H 32mm flange length 20mm flange ø 53.5mm thermostat sleeves ø 7mm length thermostat sleeves 315mm number of thermostat sleeves 1 thermostat sleeve clinging L1 15mm L2 380mm W1 34mm W2 41mm tube ø 8.5mm cable length 2000mm rotation flange immersion heater fryer connection length 110mm |                 |                                    |
| <b>For models:</b>  | 091FR1E, 091FR1EA, 091FR1ED, 0A1FR1E, 0A1FR1ED, 0D1FR1E, 0D1FR1ED, 191FR2E, 191FR2ED, 1A1FR2E, 1A1FR2ED, 1D1FR2ED   |                 |                                    |
| <b>accessories for</b>  | 416589  |                 |                                    |
|  | <b>GEV No.</b>  | 510219          | <b>Ref. No.</b> 60A0980            |
|   | O-ring set Qty 2 pcs  |                 |                                    |
|  | <b>GEV No.</b>  | 550494          | <b>Ref. No.</b> 3152150<br>3152151 |
|   | O-ring Viton thickness 3.53mm ID ø 47.22mm Qty 1 pcs  |                 |                                    |



Зип-Общепит

vsezip.ru

+7(812)987-08-81

2 hole fixing

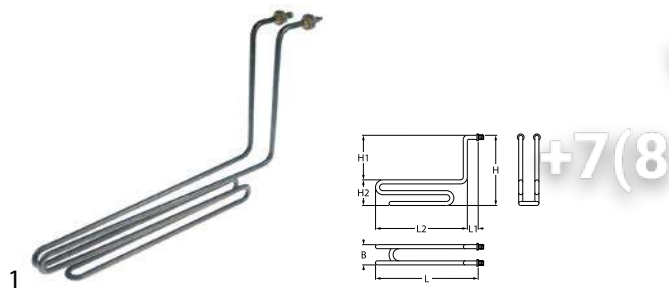

|                    |  |                 |         |
|--------------------|--|-----------------|---------|
| <b>GEV No.</b>     | 418597   | <b>Ref. No.</b> | 32G0060 |
| <b>description</b> | heating element 2500W 230V heating circuits 1 L 460mm W 33mm H 275mm L1 45mm L2 415mm H1 220mm H2 55mm thread 1/4" tube ø 8.5mm windings 3 |                 |         |

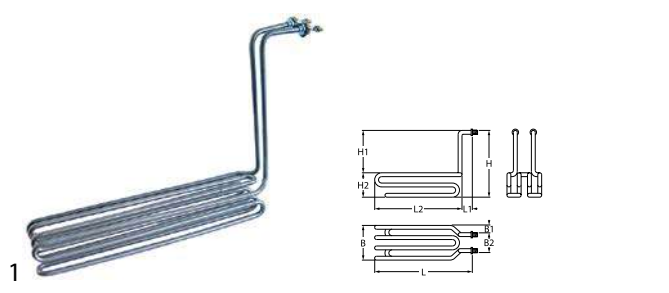

|                    |   |                 |                    |
|--------------------|---|-----------------|--------------------|
| <b>GEV No.</b>     | 416588  | <b>Ref. No.</b> | 32G0100<br>32G1181 |
| <b>description</b> | heating element 4700W 400V heating circuits 1 L 480mm W 90mm H 230mm L1 60mm L2 420mm W1 40mm W2 25mm H1 415mm H2 65mm thread 1/4" mounting distance 35mm tube ø 8.5mm 2 hole fixing connection M6 fryer windings 6 |                 |                    |

|                        |  |        |                         |
|------------------------|--|--------|-------------------------|
| <b>For models:</b>     | 70FE, 70FE1, 70FE1B, 71FE, 71FE2, 71FE2B   |        |                         |
| <b>accessories for</b> | 416588   |        |                         |
|                        | <b>GEV No.</b>   | 560113 | <b>Ref. No.</b> 3121480 |
|                        | plain washer ID ø 6.4mm ED ø 12mm thickness 1.6mm SS Qty 20 pcs DIN 125A for thread M6 |        |                         |
|                        | <b>GEV No.</b>   | 560133 | <b>Ref. No.</b> —       |
|                        | hexagonal nut thread M6 H 5mm WS 10 SS DIN/ISO DIN 934 / ISO 4032/8673 Qty 20 pcs      |        |                         |

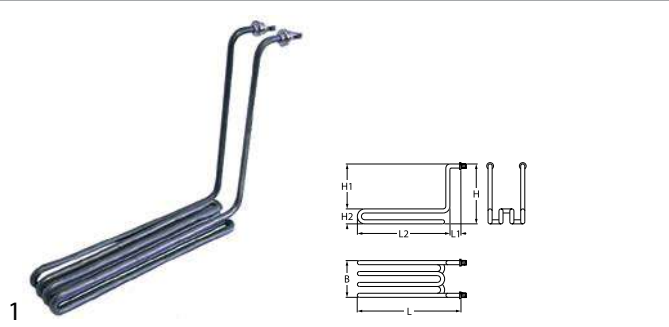

|                    |  |                 |         |
|--------------------|--|-----------------|---------|
| <b>GEV No.</b>     | 415180   | <b>Ref. No.</b> | 32G1241 |
| <b>description</b> | heating element 2050W 230V heating circuits 1 L 305mm W 53mm H 245mm L1 30mm L2 275mm H1 210mm H2 35mm thread 1/4" mounting distance 22mm tube ø 8.5mm 2 hole fixing connection male faston 6.3mm fryer heaters windings 4 |                 |         |
| <b>For models:</b> | 030FE1, 030FE1B, 091FE28, 091FE28B, 30FES2, 30FES2B, 70FES2, 70FES2B   |                 |         |

|                        |   |        |                         |
|------------------------|---|--------|-------------------------|
| <b>accessories for</b> | 415180  |        |                         |
|                        | <b>GEV No.</b>  | 361182 | <b>Ref. No.</b> 3117580 |
|                        | nut thread 1/4" H 5mm nickel-plated brass WS 17 Qty 1 pcs     |        |                         |
|                        | <b>GEV No.</b>  | 510417 | <b>Ref. No.</b> —       |
|                        | flat gasket fibre ED ø 20mm ID ø 14mm thickness 2mm Qty 1 pcs |        |                         |

|                |   |                 |   |
|----------------|---|-----------------|---|
| <b>GEV No.</b> | 520228  | <b>Ref. No.</b> | — |
|                | tooth lock washer ID ø 15.3mm ED ø 24mm steel Qty 1 pcs for thread M 14 |                 |   |
| <b>GEV No.</b> | 550262  | <b>Ref. No.</b> | — |
|                | flat gasket copper ED ø 20mm ID ø 14mm thickness 2mm                    |                 |   |

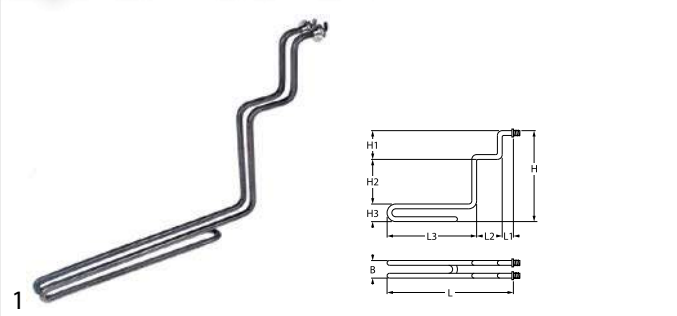

|                    |  |                 |         |
|--------------------|--|-----------------|---------|
| <b>GEV No.</b>     | 418760   | <b>Ref. No.</b> | 32G0130 |
| <b>description</b> | heating element 1750W 230V L 415mm W 35mm H 260mm 2 hole fixing connection 6.3x0.8 heating circuits 1 L1 30mm L2 70mm L3 315mm H1 30mm H2 135mm H3 24mm tube ø 8.5mm thread M13 mounting distance 23mm connection length 7.5mm |                 |         |

heating elements for griddles



|                    |   |                 |         |
|--------------------|---|-----------------|---------|
| <b>GEV No.</b>     | 416678  | <b>Ref. No.</b> | 32G1040 |
| <b>description</b> | heating element 1700W 400V heating circuits 1 L 445mm W 75mm H 83mm tube ø 8.8mm connection male faston 6.3mm connection length 23mm griddle connection distance 66mm dry heating element |                 |         |
| <b>For models:</b> | 031FTE04, 031FTE06  |                 |         |



|                    |   |                 |                    |
|--------------------|---|-----------------|--------------------|
| <b>GEV No.</b>     | 415179  | <b>Ref. No.</b> | 32G1260<br>32G1262 |
| <b>description</b> | heating element 1750W 230V heating circuits 1 L 445mm W 82mm H 50mm tube ø 8.5mm connection M4 griddle connection distance 80mm dry heating element |                 |                    |
| <b>For models:</b> | 030FTE, 030FTEB, 031FTE, 031FTEB, 031FTEB   |                 |                    |



|                    |   |                 |         |
|--------------------|---|-----------------|---------|
| <b>GEV No.</b>     | 418481  | <b>Ref. No.</b> | 32G2371 |
| <b>description</b> | heating element 2200W 230V heating circuits 1 L 615mm W 83.5mm H 89mm tube ø 8.5mm connection male faston 6.3mm connection length 21mm connection distance 75mm dry heating element   |                 |         |
| <b>For models:</b> | 090FT1E, 090FT2E, 090FT4E, 090FT5E, 090FT7E, 091FT1E, 091FT2E, 091FT4E, 091FT5E, 091FT7E, 0A0FT1E, 0A0FT2E, 0A0FT4E, 0A0FT5E, 0D0FT1E, 0D0FT2E, 0D0FT4E, 0D0FT5E, 190FT15E, 190FT1E, 190FT2E, 190FT3E, 190FT42E, 190FT4E, 190FT5E, 190FT6E, 190FT72E, 190FT7E, 191FT1E, 191FT2E, 191FT3E, 191FT4E, 191FT6E, 191FT7E, 1A0FT1E, 1A0FT2E, 1A0FT3E, 1A0FT4E, 1A0FT6E, 1A1PEFTE, 1D0FT1E, 1D0FT2E, 1D0FT3E, 1D0FT4E, 1D0FT6E |                 |         |



Зип Общежит

heating elements for tilting bratt pan

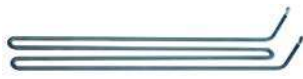

|                    |  |                 |         |
|--------------------|--|-----------------|---------|
| <b>GEV No.</b>     | 416680   | <b>Ref. No.</b> | 32G2370 |
| <b>description</b> | heating element 2200W 230V heating circuits 1 L 615mm W 86mm H 92mm tube ø 8.5mm connection male faston 6.3mm griddle connection distance 84mm dry heating element |                 |         |
| <b>For models:</b> | 0A0FT1E, 0A0FT2E, 0A0FT4E, 0A0FT5E, 0D0FT1E, 0D0FT2E, 0D0FT4E, 0D0FT5E, 1A0FT1E, 1A0FT2E, 1A0FT3E, 1A0FT4E, 1A0FT6E, 1D0FT1E, 1D0FT2E, 1D0FT3E, 1D0FT4E, 1D0FT6E   |                 |         |



|                    |   |                 |                    |
|--------------------|---|-----------------|--------------------|
| <b>GEV No.</b>     | 416525  | <b>Ref. No.</b> | 32G1920<br>32G1921 |
| <b>description</b> | heating element 1500W 230V L 415mm W 82mm H 50mm connection M4 dry heating element heating circuits 1 tube ø 8.5mm connection distance 65mm |                 |                    |
| <b>For models:</b> | 31RE  |                 |                    |



|                    |  |                 |         |
|--------------------|--|-----------------|---------|
| <b>GEV No.</b>     | 416679   | <b>Ref. No.</b> | 32G1870 |
| <b>description</b> | heating element 2200W 400V heating circuits 1 L 572mm W 81mm H 85mm tube ø 8.5mm connection male faston 6.3mm griddle connection distance 75mm dry heating element |                 |         |
| <b>For models:</b> | 070FTE04, 070FTE05, 071FTE04, 071FTE06, 090FTE04, 090FTE05, 091FTE04, 091FTE06   |                 |         |



|                    |   |                 |         |
|--------------------|---|-----------------|---------|
| <b>GEV No.</b>     | 416596  | <b>Ref. No.</b> | 32G0251 |
| <b>description</b> | heating element 1750W 230V L 500mm W 81mm H 50mm connection M4 dry heating element heating circuits 1 tube ø 8.5mm L1 18mm W1 10mm W2 47mm connection distance 73mm |                 |         |
| <b>For models:</b> | 71ARE, 91ARE  |                 |         |

heating elements for refrigeration

heating elements for defrosting

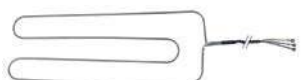

|                    |   |                 |         |
|--------------------|---|-----------------|---------|
| <b>GEV No.</b>     | 418600  | <b>Ref. No.</b> | 32G1021 |
| <b>description</b> | heating element 160W 220V L 540mm W 170mm tube ø 4.5mm defrosting |                 |         |
| <b>For models:</b> | K16APGPZ, K16XPZAP, SA16AGB, SA16GB                               |                 |         |



|                    |  |                 |         |
|--------------------|--|-----------------|---------|
| <b>GEV No.</b>     | 416597   | <b>Ref. No.</b> | 32G2481 |
| <b>description</b> | heating element 2000W 230V L 530mm W 93mm H 70mm connection M4 dry heating element heating circuits 1 tube ø 8.5mm connection distance 83mm                            |                 |         |
| <b>For models:</b> | 191BR1E, 191BR2E, 191BR2EA, 1A1BR1E, 1A1BR2E, 1A1BR2EA, 1D1BR1E, 1D1BR2E, 1D1BR2EA, 291BR1E, 291BR2E, 291BR2EA, 2A1BR1E, 2A1BR2E, 2A1BR2EA, 2D1BR1E, 2D1BR2E, 2D1BR2EA |                 |         |



|                    |   |                 |         |
|--------------------|---|-----------------|---------|
| <b>GEV No.</b>     | 418609  | <b>Ref. No.</b> | 32G0350 |
| <b>description</b> | heating element 2x110W 2x115V L 620mm cable length 2000mm tube ø 8.5mm defrosting   |                 |         |
| <b>For models:</b> | 65NB, 6BEABA, 6BEABB, 6BEABM, 6BEABZ, 6BEBBA, 6BEBBB, 6BEBBM, 6BEBBZ, 6BECBA, 6BECBB, 6BECBM, 6BECBZ, 6BMABA, 6BMABB, 6BMABM, 6BMABZ, 6MBBBA, 6MBBBB, 6MBBBM, 6MBBBZ, 6BMCBA, 6BMCBB, 6BMCBM, 6BMCBZ, 6RA, 6RA2, 6RA2A, 6RA2M, 6RA2Z, 6RA4, 6RA4A, 6RA4M, 6RA4Z, 6RAA, 6RAM, 6RAZ, 6RB, 6RB11, 6RB11A, 6RB11M, 6RB11Z, 6RB2, 6RB2A, 6RB2M, 6RB2Z, 6RB4, 6RB4A, 6RB4M, 6RB4Z...(Other models you can see in the webshop) |                 |         |

heating elements for pasta cookers



|                    |  |                 |                    |
|--------------------|--|-----------------|--------------------|
| <b>GEV No.</b>     | 415020   | <b>Ref. No.</b> | 32G0230<br>32G0380 |
| <b>description</b> | heating element 4500W 230V mounting ø 57.5mm heating circuits 3 L 355mm W 35mm H 47mm number of thermostat sleeves 1 thermostat sleeves ø 7mm length thermostat sleeves 295mm thermostat sleeve upper tube ø 8.5mm hole distance 70mm hole ø 10mm connection length 25mm connection male faston 6.3mm 3 hole flange immersion heater |                 |                    |
| <b>For models:</b> | 0G1CP1EC, F60P, F60PR, F60T, L100, L40S, L60, L80  |                 |                    |



|                    |  |                 |         |
|--------------------|--|-----------------|---------|
| <b>GEV No.</b>     | 418594   | <b>Ref. No.</b> | 32G1970 |
| <b>description</b> | heating element 400W 220V L 480mm W 140mm H 80mm cable length 1000mm tube ø 8.5mm defrosting |                 |         |
| <b>For models:</b> | S60B, S60B-2, S60BE, S60BX, S60BX-2  |                 |         |



|   |  |                 |                               |
|---|--|-----------------|-------------------------------|
| <b>GEV No.</b>  | 418602   | <b>Ref. No.</b> | 32G3270                       |
| <b>description</b>  | heating element 4500W 400V heating circuits 3 L 315mm W 36mm H 48mm thermostat sleeves ø 7.5mm length thermostat sleeves 285mm hole distance 72mm mounting ø 57.5mm number of thermostat sleeves 1 thermostat sleeve eccentric, non clinging |                 |                               |
| <b>For models:</b>  | 0G1CP1E, 0G1CP1EC, 0G1CP1E-VERS.2004, 1G1PI1E, 6043850, 6043980  |                 |                               |
| <b>accessories for</b>  | 418602   |                 |                               |
|  | <b>GEV No.</b>   | 510409          | <b>Ref. No.</b>               |
|   |  |                 | 3150430<br>3151960<br>37Q5260 |
|   | O-ring EPDM thickness 5.34mm ID ø 56.52mm Qty 1 pcs  |                 |                               |



Зип-Общепит

accessories for 415182

|  |        |          |   |
|--|--------|----------|---|
| GEV No.  | 510417 | Ref. No. | — |
| flat gasket fibre ED ø 20mm ID ø 14mm thickness 2mm Qty 1 pcs          |        |          |   |
| GEV No.  | 520228 | Ref. No. | — |
| tooth lock washer ID ø 15.3mm ED ø 24mm steel Qty 1 pcs for thread M17 |        |          |   |
| GEV No.  | 550262 | Ref. No. | — |
| flat gasket copper ED ø 20mm ID ø 14mm thickness 2mm                   |        |          |   |



|  |        |          |                               |
|--|--------|----------|-------------------------------|
| GEV No.  | 415182 | Ref. No. | 32G1300<br>32G1301<br>32G1930 |
| description heating element 4540W 230V heating circuits 3 L 325mm V 30mm H 48mm round flange connection M4 tube ø 8.5mm thermostat sleeves ø 7.5mm length thermostat sleeves 300mm mounting ø 57.5mm number of thermostat sleeves 1 thermostat sleeve eccentric, clinging pasta cooker |        |          |                               |
| For models: 30CPSE, 70CPE, 90CPE   |        |          |                               |

|   |         |        |                               |
|---|---------|--------|-------------------------------|
| spare parts for 415182                              |         |        |                               |
|   | GEV No. | 510409 | Ref. No.                      |
|   |         |        | 3150430<br>3151960<br>37Q5260 |
| O-ring EPDM thickness 5.34mm ID ø 56.52mm Qty 1 pcs |         |        |                               |

|                        |  |  |  |
|------------------------|--|--|--|
| accessories for 415182 |  |  |  |
|------------------------|--|--|--|

|   |         |        |          |     |
|---|---------|--------|----------|-----|
|   | GEV No. | 521103 | Ref. No. | N/A |
| nut thread M4 H 3mm WS 7 brass Qty 20 pcs |         |        |          |     |

|   |         |        |          |   |
|---|---------|--------|----------|---|
|   | GEV No. | 521104 | Ref. No. | — |
| washer ID ø 4.3mm ED ø 8mm thickness 0.5mm brass Qty 20 pcs for thread M4 |         |        |          |   |

|   |         |        |          |         |
|---|---------|--------|----------|---------|
|   | GEV No. | 550002 | Ref. No. | 3113780 |
| tension strap H 10mm L 21mm W 10mm hole ø 6.5mm for heating element |         |        |          |         |

|   |         |        |          |   |
|---|---------|--------|----------|---|
|   | GEV No. | 560111 | Ref. No. | — |
| plain washer ID ø 4.3mm ED ø 9mm thickness 0.8mm SS Qty 20 pcs DIN 125A for thread M4 |         |        |          |   |

|  |         |        |          |   |
|--|---------|--------|----------|---|
|  | GEV No. | 560131 | Ref. No. | — |
| hexagonal nut thread M4 H 3.2mm WS 7 SS DIN/ISO DIN 934 / ISO 4032/8673 Qty 20 pcs |         |        |          |   |



|   |        |          |         |
|---|--------|----------|---------|
| GEV No.   | 416681 | Ref. No. | 32G2310 |
| description heating element 6000W 400V heating circuits 3 L 485mm W 37mm H 40mm 3 hole flange connection M4 tube ø 8.5mm thermostat sleeves ø 7mm length thermostat sleeves 445mm hole distance 70mm mounting ø 57.5mm hole ø 10mm number of thermostat sleeves 1 connection length 30mm thermostat sleeve upper pasta cooker |        |          |         |
| For models: 04WCP1EM, 091CP1E, 0A1CP1E, 0D1CP1E, 6040090, 6040310   |        |          |         |

|   |         |        |                               |
|---|---------|--------|-------------------------------|
| spare parts for 416681                              |         |        |                               |
|   | GEV No. | 510409 | Ref. No.                      |
|   |         |        | 3150430<br>3151960<br>37Q5260 |
| O-ring EPDM thickness 5.34mm ID ø 56.52mm Qty 1 pcs |         |        |                               |

## heating elements for chargrills



|  |        |          |         |
|--|--------|----------|---------|
| GEV No.  | 415148 | Ref. No. | 32G0140 |
| description heating element 750W 230V L 519mm W 35mm H 105mm 2 hole fixing mounting distance 26mm connection male faston 6.3mm L1 30mm L2 489mm tube ø 8.5mm dry heating element thread 1/4" |        |          |         |

|   |         |        |          |         |
|---|---------|--------|----------|---------|
| accessories for 415148                                    |         |        |          |         |
|   | GEV No. | 361182 | Ref. No. | 3117580 |
| nut thread 1/4" H 5mm nickel-plated brass WS 17 Qty 1 pcs |         |        |          |         |

## heating elements for salamanders/toast-



|   |        |          |                    |
|---|--------|----------|--------------------|
| GEV No.   | 415758 | Ref. No. | 32G1441<br>32G1580 |
| description heating element 1300W 230V heating circuits 1 L 238mm W 132mm H 72mm connection distance 124mm tube ø 8.5mm cable length 900mm dry heating element connection length 20mm |        |          |                    |
| For models: 60SME   |        |          |                    |

## heating elements for heating bridges



|   |        |          |         |
|---|--------|----------|---------|
| GEV No.   | 418202 | Ref. No. | 3003800 |
| description heating element 500W 220V heating circuits 1 L 485mm Wmm lug length 40mm lug width 18mm connection M5 tube ø 6.3mm rectangular flange hole ø M4mm dry heating element |        |          |         |

## heating cables

## connection on both sides

## with male fastons



|  |        |          |         |
|--|--------|----------|---------|
| GEV No.  | 418761 | Ref. No. | 32G2420 |
| description heating cable 25W 230V L 5000mm ø 4mm  |        |          |         |
| For models: 40CP-OPR01, 40CPX-OPR01, AF1B, AF1B-OPR01, AF1N, AF1N-OPR01, AF2B, AF2B-OPR01, AF2N, AF2N-OPR01, CX120, CX120B, CX120NN, CX130B, CX140, CX140B, CX140BN, CX140BR, CX140CP, CX140NN, CX140PV, CX140R, CX150B, CX150BN, CX150BR, CX150CP, CX150R, CX55, CX55B, CX60B, CX65, CX652, CX65B, CX65BR, CX65NB, CX65NCP, CX65NN, CX65PV, CX65R, CX70B, CX70BR, CX70NB, CX70NN, CX70R, FG2B, FSD1B, FSD1N, FSD2B, FSD2N, FSD2N2...(Other models you can see in the webshop) |        |          |         |



|   |        |          |         |
|---|--------|----------|---------|
| GEV No.   | 420382 | Ref. No. | 32G3290 |
| description heating cable 31W 230V L 5000mm for blast chiller connection male faston  |        |          |         |
| For models: DS31, DS31A, DS31C, DS31M, DS51, DS51A, DS51C, DS51M, IS51, IS51A, IS51AR, IS51C, IS51CR, IS51M, IS51MR, IS51R, IS51W, IS51WA, IS51WC, IS51WM, SM03LT7, SM03LT7A, SM03LT7M, SM1L7, SM1L7A, SM1L7FCV, SM1L7M, SM1LT7, SM1LT7A, SM1LT7M |        |          |         |





Зип Общепит heating cartridges

vsezip.ru

+7(812)987-0871

|                    |  |                 |         |
|--------------------|--|-----------------|---------|
|                    |  |                 |         |
| <b>GEV No.</b>     | 420383   | <b>Ref. No.</b> | 32G2280 |
| <b>description</b> | heating cable 45W 230V L 6000mm for blast chiller connection male faston                   |                 |         |
| <b>For models:</b> | IS101L, IS101LR, IS101LW, IS101S, IS101SR, IS101SW, SM2L, SM2LR, SM2LW, SM2S, SM2SR, SM2SW |                 |         |

|                    |  |                 |         |
|--------------------|--|-----------------|---------|
|                    |  |                 |         |
| <b>GEV No.</b>     | 420384   | <b>Ref. No.</b> | 32G3500 |
| <b>description</b> | heating cable 53W 230V L 6800mm for blast chiller connection male faston |                 |         |
| <b>For models:</b> | IS102S, IS102SR, IS102SR-0NR01, IS102SW, IS72S, IS72SR, IS72SW           |                 |         |

|                    |  |                 |         |
|--------------------|--|-----------------|---------|
|                    |  |                 |         |
| <b>GEV No.</b>     | 418755   | <b>Ref. No.</b> | 32G1820 |
| <b>description</b> | heating cable 80W 220V $\phi$ 3mm connection male faston 6.3mm cable length 5250mm   |                 |         |
| <b>For models:</b> | 135BN, 135BNX, 135CPX, 135NN, 135NNX, 40CP, 40CPX, 55B, 65, 65B, 65BA, 65BX, 65BX-2, 65BXE, 65BXR, 65NB, 65NBX, 65PVX, 65X, 65X-2, 65XR, SP120BN, SP120NN, SP135BN, SP135CP, SP135NN, SP55, SP55B, SP65, SP65B, SP65NB |                 |         |

connection on both sides (metal braided)

|                    |  |                 |         |
|--------------------|--|-----------------|---------|
|                    |  |                 |         |
| <b>GEV No.</b>     | 419170   | <b>Ref. No.</b> | 32G0240 |
| <b>description</b> | heating cable 100W 230V L1 (unheated) 600mm L2 (heated) 6600mm $\phi$ 4mm Qty 1  |                 |         |
| <b>For models:</b> | 6BEA11A, 6BEA11B, 6BEA11M, 6BEA11Z, 6BEA2A, 6BEA2B, 6BEA2M, 6BEA2Z, 6BEA3A, 6BEA3B, 6BEA3M, 6BEA3Z, 6BEA4A, 6BEA4B, 6BEA4M, 6BEA4Z, 6BEA5A, 6BEA5B, 6BEA5M, 6BEA5Z, 6BEA6A, 6BEA6B, 6BEA6M, 6BEA6Z, 6BEA7A, 6BEA7B, 6BEA7M, 6BEA7Z, 6BEA8A, 6BEA8B, 6BEA8M, 6BEA8Z, 6BEA9A, 6BEA9B, 6BEA9M, 6BEA9Z, 6BEA10A, 6BEA10B, 6BEA10M, 6BEA10Z, 6BEB11A, 6BEB11B, 6BEB11M, 6BEB11Z, 6BEB22A, 6BEB22B, 6BEB22M, 6BEB22Z, 6BEB23A, 6BEB23B, 6BEB23M, 6BEB23Z, 6BEB24A, 6BEB24B, 6BEB24M, 6BEB24Z, 6BEB33A, 6BEB33B, 6BEB33M, 6BEB33Z, 6BEB34A, 6BEB34B, 6BEB34M, 6BEB34Z, 6BEB44A, 6BEB44B, 6BEB44M, 6BEB44Z, 6BEB55A, 6BEB55B, 6BEB55M, 6BEB55Z, 6BEB66A, 6BEB66B, 6BEB66M, 6BEB66Z, 6BEB77A, 6BEB77B, 6BEB77M, 6BEB77Z, 6BEB88A, 6BEB88B, 6BEB88M, 6BEB88Z, 6BEB99A, 6BEB99B, 6BEB99M, 6BEB99Z, 6BEC11A, 6BEC11B...(Other models you can see in the webshop) |                 |         |

|                    |  |                 |         |
|--------------------|--|-----------------|---------|
|                    |  |                 |         |
| <b>GEV No.</b>     | 419109   | <b>Ref. No.</b> | 32G1810 |
| <b>description</b> | heating cable 150W 220V L1 (unheated) 2x1000mm L2 (heated) 5000mm $\phi$ 3.5mm L 7000mm connection male faston 6.3mm                               |                 |         |
| <b>For models:</b> | 120B, 135, 135-4, 135B, 135BA, 135BX, 135BXE, 135BXR, 135PVX, 135X, 135X-3, 135X-4, 135XR, ISP202R, ISR201R, ISR202R, SP120, SP120B, SP135, SP135B |                 |         |

|                        |  |   |         |
|------------------------|--|---|---------|
|                        |  |   |         |
| <b>GEV No.</b>         | 418892   | <b>Ref. No.</b>   | 32G3310 |
| <b>description</b>     | heating cartridge 190W 230V $\phi$ 12mm L 240mm thread 3/8" cable length 2000mm immersion heater   |   |         |
| <b>For models:</b>     | AF1N, AF1N-0PR01, AF2N, AF2N-0PR01, CX120, CX120NN, CX130, CX130NN, CX140, CX140BN, CX140BR, CX140CP, CX140NN, CX140PV, CX140R, CX150, CX150BN, CX150BR, CX150CP, CX150NN, CX150PV, CX150R, CX55, CX60, CX65, CX652, CX65BR, CX65NB, CX65NCP, CX65NN, CX65PV, CX65R, CX70, CX702, CX70BR, CX70NB, CX70NN, CX70PV, CX70R, FSD1N, FSD2N, FSD2N2, FSDR1B-0PR01, FSDR1N-0PR01, FSDR2B-0PR01, FSDR2B2-0PR01, FSDR2N, FSDR2N-0PR01, FSDR2N2-0PR01, FSE2N...(Other models you can see in the webshop) |   |         |
| <b>accessories for</b> | 418892   |   |         |
|                        |  | <b>GEV No.</b>  | 511472  |
|                        |  | <b>Ref. No.</b>   | —       |
|                        |  | nut thread 3/8" H 4mm brass WS 21 Qty 1 pcs                             |         |
|                        |  | <b>GEV No.</b>  | 518393  |
|                        |  | <b>Ref. No.</b>   | —       |
|                        |  | flat gasket FIBER ED $\phi$ 24mm ID $\phi$ 17mm thickness 2mm Qty 1 pcs |         |

|                    |   |                 |         |
|--------------------|---|-----------------|---------|
|                    |   |                 |         |
| <b>GEV No.</b>     | 417747  | <b>Ref. No.</b> | 3134541 |
| <b>description</b> | heating cartridge 150W 230V $\phi$ 10mm L 165mm connection female faston 6.3mm cable length 520mm |                 |         |

heater battery

|                    |   |                 |         |
|--------------------|---|-----------------|---------|
|                    |   |                 |         |
| <b>GEV No.</b>     | 415122  | <b>Ref. No.</b> | 32G1990 |
| <b>description</b> | heater battery mounting distance 185mm W 40mm H 35mm 2000W 230V temperature restriction 105°C heating circuits 2 connection cable cable length 340mm L 197mm for cross flow fan |                 |         |

coil heating elements

|                    |  |                 |         |
|--------------------|--|-----------------|---------|
|                    |  |                 |         |
| <b>GEV No.</b>     | 419164   | <b>Ref. No.</b> | 32G2200 |
| <b>description</b> | heating element 1500W 230V L 345mm W 95mm thread 3/8" connection M6 connection length 46mm dishwasher dry heating element heating circuits 1 2 hole fixing |                 |         |
| <b>For models:</b> | TA9C, TA9C-VERS.2006   |                 |         |

electric components



immersion heating elements

Зип Общепит

vsezip.ru

+7(812)987-08-81

3 hole flange ø38.5mm

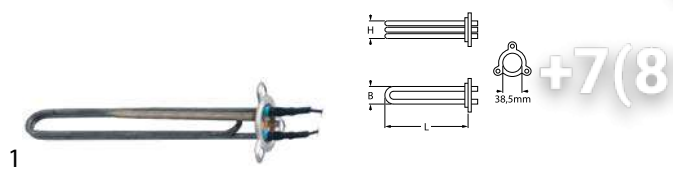

|                |        |                 |         |
|----------------|--------|-----------------|---------|
| <b>GEV No.</b> | 416277 | <b>Ref. No.</b> | 3030200 |
|----------------|--------|-----------------|---------|

**description** heating element 2800W 230V mounting ø 38.5mm heating circuits 1 L 302mm W 37mm H 28mm number of thermostat sleeves 1 thermostat sleeves ø 7mm length thermostat sleeves 199mm thermostat sleeve not clinging tube ø 6.4mm hole distance 57mm hole ø 10mm cable length 114mm 3 hole flange connection 26 immersion heater

**accessories for** 416277

|                |        |                 |   |
|----------------|--------|-----------------|---|
| <b>GEV No.</b> | 532577 | <b>Ref. No.</b> | — |
|----------------|--------|-----------------|---|

 O-ring EPDM thickness 5.34mm ID ø 40.65mm Qty 1 pcs

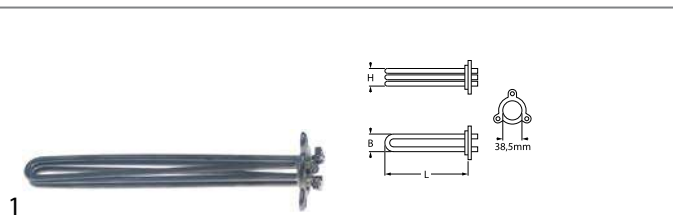

|                |        |                 |         |
|----------------|--------|-----------------|---------|
| <b>GEV No.</b> | 420037 | <b>Ref. No.</b> | 3104990 |
|----------------|--------|-----------------|---------|

**description** heating element 4000W 230V mounting ø 38.5mm heating circuits 3 L 300mm W 33mm H 27mm tube ø 6.4mm hole distance 57mm hole ø 10mm connection male faston 6.3mm vertical

**For models:** KD40, KD40PS, KD40-VERS.112009

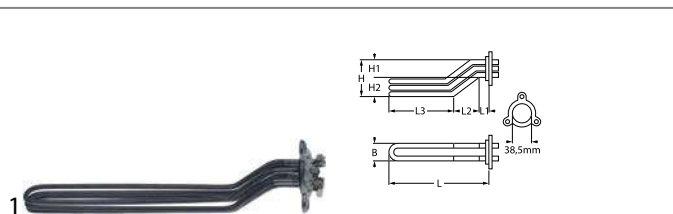

|                |        |                 |         |
|----------------|--------|-----------------|---------|
| <b>GEV No.</b> | 420061 | <b>Ref. No.</b> | 3075840 |
|----------------|--------|-----------------|---------|

**description** heating element 3500W 230V heating circuits 3 L 366mm W 35mm H 60mm L1 30mm L2 56mm L3 280mm H1 36mm H2 24mm hole distance 57mm hole ø 10mm tube ø 6.2mm connection male faston 6.3mm

**For models:** LF50EM

**accessories for** 420061

|                |        |                 |   |
|----------------|--------|-----------------|---|
| <b>GEV No.</b> | 532577 | <b>Ref. No.</b> | — |
|----------------|--------|-----------------|---|

 O-ring EPDM thickness 5.34mm ID ø 40.65mm Qty 1 pcs

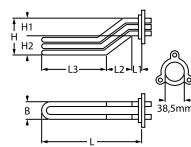

|                |        |                 |         |
|----------------|--------|-----------------|---------|
| <b>GEV No.</b> | 416267 | <b>Ref. No.</b> | 32G2140 |
|----------------|--------|-----------------|---------|

**description** heating element 4500W 230V mounting ø 38.5mm heating circuits 3 L 358mm W 32mm H 58mm L1 36mm L2 72mm L3 250mm H1 28mm H2 30mm hole distance 57mm hole ø 10mm tube ø 6.3mm connection male faston 6.3mm immersion heater 3 hole flange

**For models:** CS243D, CS243D-VERS.2006, CS243S, CS243VD, CS243VS, CS370AD, CS370AD-VERS.2006, CS370AS, CS370AS-VERS.2006, CS370AVD, CS370AVS, CS370D, CS370D-VERS.2006, CS370S, CS370S-VERS.2006, CS370VD, CS370VS, CS466AD, CS466AD-VERS.2006, CS466AS, CS466AS-VERS.2006, CS466AVD, CS466AVS, CS466D, CS466D-VERS.2006, CS466S, CS466S-VERS.2006, CS466VD, CS466VS, LF50E, LF50EMPS, LF50EM-VERS.122012, LF50E-VERS.122012, LF50E-VERS.2007, N303D, N303S, N303VD, N303VS, N354D, N354S, N354VD, N354VS, N506D, N506S, N506VD, N506VS, N607D, N607S, N607VD, N607VS

**accessories for** 416267

|                |        |                 |   |
|----------------|--------|-----------------|---|
| <b>GEV No.</b> | 532577 | <b>Ref. No.</b> | — |
|----------------|--------|-----------------|---|

 O-ring EPDM thickness 5.34mm ID ø 40.65mm Qty 1 pcs

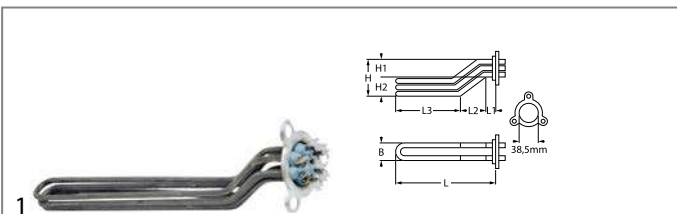

|                |        |                 |         |
|----------------|--------|-----------------|---------|
| <b>GEV No.</b> | 416268 | <b>Ref. No.</b> | 32G2180 |
|----------------|--------|-----------------|---------|

**description** heating element 6000W 230V mounting ø 38.5mm heating circuits 3 L 360mm W 34mm H 55mm L1 35mm L2 70mm L3 255mm H1 27mm H2 28mm hole distance 57mm hole ø 10mm tube ø 6.3mm connection male faston 6.3mm immersion heater 3 hole flange

**spare parts for** 416268

|                |        |                 |   |
|----------------|--------|-----------------|---|
| <b>GEV No.</b> | 532577 | <b>Ref. No.</b> | — |
|----------------|--------|-----------------|---|

 O-ring EPDM thickness 5.34mm ID ø 40.65mm Qty 1 pcs



Зип Общежит

vsezip.ru

+7(812)987-08-31

3 hole flange  $\varnothing 38.5\text{mm}$

|                        |   |                 |                   |
|------------------------|---|-----------------|-------------------|
| <b>GEV No.</b>         | 416269  | <b>Ref. No.</b> | 32G2170           |
| <b>description</b>     | heating element 8000W 230V mounting $\varnothing 38.5\text{mm}$ heating circuits 3 L 545mm W 32mm H 60mm L1 38mm L2 55mm L3 447mm H1 27mm H2 33mm hole distance 57mm hole $\varnothing 10\text{mm}$ tube $\varnothing 6.3\text{mm}$ connection male faston 6.3mm immersion heater 3 hole flange   |                 |                   |
| <b>For models:</b>     | C165D, C165S, C165VD, C165VS, C207D, C207D-VERS.2006, C207S, C207S-VERS.2006, C207VD, C207VS, C304AD, C304AD-VERS.2006, C304AS, C304AS-VERS.2006, C304AVD, C304AVS, C304D, C304D-VERS.2006, C304S, C304S-VERS.2006, C304VD, C304VS, C92D-VERS.2006, C92S-VERS.2006, CS243D, CS243D-VERS.2006, CS243S, CS243S-VERS.2006, CS243VD, CS243VS, CS370AD, CS370AD-VERS.2006, CS370AS, CS370AS-VERS.2006, CS370AVD, CS370AVS, CS370D, CS370D-VERS.2006, CS370S, CS370S-VERS.2006, CS370VD, CS370VS, CS466AD, CS466AD-VERS.2006, CS466AS, CS466AS-VERS.2006, CS466AVD, CS466AVS, CS466D, CS466D-VERS.2006... (Other models you can see in the webshop) |                 |                   |
| <b>accessories for</b> | 416269  |                 |                   |
|                        | <b>GEV No.</b>  | <b>532577</b>   | <b>Ref. No.</b> — |
|                        | O-ring EPDM thickness 5.34mm ID $\varnothing 40.65\text{mm}$ Qty 1 pcs  |                 |                   |

3 hole flange  $\varnothing 47.5\text{mm}$

|                        |  |                 |                         |
|------------------------|--|-----------------|-------------------------|
| <b>GEV No.</b>         | 415013   | <b>Ref. No.</b> | 32G0390<br>32G0790      |
| <b>description</b>     | heating element 2400W 230V mounting $\varnothing 47.5\text{mm}$ heating circuits 1 L 215mm W 40mm H 35mm number of thermostat sleeves 1 thermostat sleeves $\varnothing 6.5\text{mm}$ length thermostat sleeves 190mm thermostat sleeve eccentric, non clinging tube $\varnothing 6.5\text{mm}$ hole distance 64mm hole $\varnothing 8 \times 10\text{mm}$ connection male faston 6.3mm 3 hole flange immersion heater |                 |                         |
| <b>For models:</b>     | L40, L45   |                 |                         |
| <b>accessories for</b> | 415013   |                 |                         |
|                        | <b>GEV No.</b>   | <b>510408</b>   | <b>Ref. No.</b> 3152650 |
|                        | O-ring EPDM thickness 5.34mm ID $\varnothing 47\text{mm}$ Qty 1 pcs  |                 |                         |
|                        | <b>GEV No.</b>   | <b>510562</b>   | <b>Ref. No.</b> —       |
|                        | O-ring silicone thickness 5.34mm ID $\varnothing 47\text{mm}$ Qty 1 pcs  |                 |                         |

3 hole flange  $\varnothing 57.5\text{mm}$

|                    |   |                 |         |
|--------------------|---|-----------------|---------|
| <b>GEV No.</b>     | 418249  | <b>Ref. No.</b> | 32G2150 |
| <b>description</b> | heating element 10000W 230V mounting $\varnothing 57.5\text{mm}$ heating circuits 3 L 512mm W 50mm H 33mm number of thermostat sleeves 1 thermostat sleeves $\varnothing 8.5\text{mm}$ length thermostat sleeves 458mm thermostat sleeve eccentric, clinging tube $\varnothing 6.3\text{mm}$ hole distance 70mm hole $\varnothing 9\text{mm}$ connection length 30mm connection M4 3 hole flange immersion heater   |                 |         |
| <b>For models:</b> | C304AD, C304AD-VERS.2006, C304AS, C304AS-VERS.2006, C304D, C304D-VERS.2006, C304S, C304S-VERS.2006, CS243D, CS243S, CS243VD, CS243VS, CS370AD, CS370AD-VERS.2006, CS370AS, CS370AS-VERS.2006, CS370AVD, CS370AVS, CS370D, CS370D-VERS.2006, CS370S, CS370S-VERS.2006, CS370VD, CS370VS, CS466AD, CS466AD-VERS.2006, CS466AS, CS466AS-VERS.2006, CS466AVD, CS466AVS, CS466D, CS466D-VERS.2006, CS466S, CS466S-VERS.2006, CS466VD, CS466VS, LC130-VERS.2001 |                 |         |

3 hole flange  $\varnothing 57.5\text{mm}$

|                        |  |                 |   |
|------------------------|--|-----------------|---|
| <b>GEV No.</b>         | 415023   | <b>Ref. No.</b> | 32G0840                                       |
| <b>description</b>     | heating element 12500W 230V mounting $\varnothing 57.5\text{mm}$ heating circuits 3 L 630mm W 36mm H 48mm number of thermostat sleeves 1 thermostat sleeves $\varnothing 7\text{mm}$ length thermostat sleeves 295mm thermostat sleeve eccentric, non clinging tube $\varnothing 8.5\text{mm}$ hole distance 76mm hole $\varnothing 8 \times 10\text{mm}$ connection M5 3 hole flange immersion heater |                 |   |
| <b>spare parts for</b> | 415023   |                 |   |
|                        | <b>GEV No.</b>   | <b>510409</b>   | <b>Ref. No.</b> 3150430<br>3151960<br>37Q5260 |
|                        | O-ring EPDM thickness 5.34mm ID $\varnothing 56.52\text{mm}$ Qty 1 pcs   |                 |   |

3 hole flange  $\varnothing 57.5\text{mm}$

|                        |  |                 |   |
|------------------------|--|-----------------|---|
| <b>GEV No.</b>         | 419138   | <b>Ref. No.</b> | 32G2000<br>32G2340<br>32G2840                 |
| <b>description</b>     | heating element 14000W 230V mounting $\varnothing 57.5\text{mm}$ heating circuits 3 L 515mm W 37mm H 50mm number of thermostat sleeves 1 thermostat sleeves $\varnothing 7.5\text{mm}$ length thermostat sleeves 450mm thermostat sleeve upper tube $\varnothing 10\text{mm}$ hole distance 72mm hole $\varnothing 8 \times 10\text{mm}$ connection length 30mm connection M5 3 hole flange immersion heater |                 |   |
| <b>For models:</b>     | C165D, C165S, C207D, C207D-VERS.2006, C207S, C207S-VERS.2006, C92D-VERS.2006, C92S-VERS.2006, CS243D-VERS.2006, CS243S-VERS.2006, LP124, LP124S-VERS.052006, LP124-VERS.052006   |                 |   |
| <b>accessories for</b> | 419138   |                 |   |
|                        | <b>GEV No.</b>   | <b>510409</b>   | <b>Ref. No.</b> 3150430<br>3151960<br>37Q5260 |
|                        | O-ring EPDM thickness 5.34mm ID $\varnothing 56.52\text{mm}$ Qty 1 pcs   |                 |   |

electric components







Зип Общепит

vsezip.ru



+7(812)987-08-81

|   |  |                 |                    |
|---|--|-----------------|--------------------|
|  |  |                 |                    |
| <b>GEV No.</b>  | 415020   | <b>Ref. No.</b> | 32G0230<br>32G0380 |
| <b>description</b>  | heating element 4500W 230V mounting $\varnothing$ 57.5mm heating circuits 3 L 355mm W 35mm H 47mm number of thermostat sleeves 1 thermostat sleeves $\varnothing$ 7mm length thermostat sleeves 295mm thermostat sleeve upper tube $\varnothing$ 8.5mm hole distance 70mm hole $\varnothing$ 10mm connection length 25mm connection male faston 6.3mm 3 hole flange immersion heater |                 |                    |
| <b>For models:</b>  | OG1CP1EC, F60P, F60PR, F60T, L100, L40S, L60, L80  |                 |                    |

|  |  |                 |                               |                               |
|--|--|-----------------|-------------------------------|-------------------------------|
|  |  |                 |                               |                               |
| <b>GEV No.</b>   | 415022   | <b>Ref. No.</b> | 32G0850<br>32G2100<br>32G2720 |                               |
| <b>description</b>   | heating element 9000W 230/400V mounting $\varnothing$ 57.5mm heating circuits 3 L 475mm W 36mm H 43mm number of thermostat sleeves 1 thermostat sleeves $\varnothing$ 7mm length thermostat sleeves 300mm thermostat sleeve eccentric, non clinging tube $\varnothing$ 10mm hole distance 73mm hole $\varnothing$ 10mm connection length 30mm connection M5 3 hole flange immersion heater |                 |                               |                               |
| <b>spare parts for</b>   | 415022   |                 |                               |                               |
|   | <b>GEV No.</b>   | 510409          | <b>Ref. No.</b>               | 3150430<br>3151960<br>37Q5260 |
| O-ring EPDM thickness 5.34mm ID $\varnothing$ 56.52mm Qty 1 pcs                    |  |                 |                               |                               |

|   |   |                 |  |                               |
|---|---|-----------------|--|-------------------------------|
|    |   |                 |  |                               |
| <b>GEV No.</b>  | 415021  | <b>Ref. No.</b> | 32G0400<br>32G0420<br>32G0520<br>32G0920 |                               |
| <b>description</b>  | heating element 6000W 230V mounting $\varnothing$ 57.5mm heating circuits 3 L 343mm W 37mm H 50mm number of thermostat sleeves 1 thermostat sleeves $\varnothing$ 7mm length thermostat sleeves 294mm thermostat sleeve not clinging tube $\varnothing$ 8.5mm hole distance 72mm hole $\varnothing$ 8mm connection M5 3 hole flange |                 |  |                               |
| <b>For models:</b>  | F60P, F60PR, F60T, F80P, F80PR, L100, L45, L60, L80   |                 |  |                               |
| <b>spare parts for</b>  | 415021  |                 |  |                               |
|  | <b>GEV No.</b>  | 510409          | <b>Ref. No.</b>                          | 3150430<br>3151960<br>37Q5260 |
| O-ring EPDM thickness 5.34mm ID $\varnothing$ 56.52mm Qty 1 pcs                     |   |                 |  |                               |
| <b>accessories for</b>  | 415021  |                 |  |                               |
|  | <b>GEV No.</b>  | 550002          | <b>Ref. No.</b>                          | 3113780                       |
| tension strap H 10mm L 21mm W 10mm hole $\varnothing$ 6.5mm for heating element     |   |                 |  |                               |

|  |   |                 |         |
|--|---|-----------------|---------|
|  |   |                 |         |
| <b>GEV No.</b>   | 418586  | <b>Ref. No.</b> | 32G2720 |
| <b>description</b>   | heating element 9000W 230V mounting $\varnothing$ 57.5mm heating circuits 3 L 515mm W 37mm H 46mm number of thermostat sleeves 1 thermostat sleeves $\varnothing$ 7mm length thermostat sleeves 440mm thermostat sleeve eccentric, clinging hole distance 73mm                    |                 |         |
| <b>For models:</b>   | CS370AD-VERS.2006, CS370AS-VERS.2006, CS370D-VERS.2006, CS370S-VERS.2006, CS466AD-VERS.2006, CS466AS-VERS.2006, CS466D-VERS.2006, CS466S-VERS.2006, LC130, LP84, LP84S-VERS.052006, LP84-VERS.052006, N303D, N303S, N354D, N354S, N506S, N607D, N607S, N760D, N760S, N886D, N886S |                 |         |

|  |  |                 |                 |   |
|--|--|-----------------|-----------------|---|
| <b>with compression flange 50 x 26mm</b>   |  |                 |                 |   |
|  |  |                 |                 |   |
| <b>GEV No.</b>   | 416209   | <b>Ref. No.</b> | 32G2070         |   |
| <b>description</b>   | heating element 2000W 230V heating circuits 1 compression flange flange 50x26mm L 180mm W 90mm H 24mm L1 55mm L2 125mm W1 28mm W2 35mm connection male faston 6.3mm tube $\varnothing$ 8.5mm connection length 28mm immersion heater |                 |                 |   |
| <b>For models:</b>   | LF50EM, LF50EMPS, LF50EMPS-VERS.122012, LF50EM-VERS.122012, LF50E-VERS.122012, LF50E-VERS.2007, LP70   |                 |                 |   |
| <b>accessories for</b>   | 416209   |                 |                 |   |
|   | <b>GEV No.</b>   | 510387          | <b>Ref. No.</b> | — |
| gasket L 46mm W 22mm $\varnothing$ mm EPDM for heating element for flange 50x26mm    |  |                 |                 |   |

|   |   |                 |         |
|---|---|-----------------|---------|
|  |   |                 |         |
| <b>GEV No.</b>  | 418585  | <b>Ref. No.</b> | 32G2580 |
| <b>description</b>  | heating element 6000W 400V mounting $\varnothing$ 57.5mm heating circuits 3 L 324mm W 42mm H 30mm number of thermostat sleeves 1 thermostat sleeves $\varnothing$ 7mm length thermostat sleeves 280mm thermostat sleeve eccentric, clinging tube $\varnothing$ 8.5mm hole distance 74mm hole $\varnothing$ 8/10mm connection length 10mm connection M4 3 hole flange immersion heater |                 |         |
| <b>For models:</b>  | LC100, LC100-VERS.2001, LC80, LF50, LP84S-VERS.052006, LP84-VERS.052006   |                 |         |



Зип Общежит

vsezip.ru

+7(812)987-08-81

with compression flange 62 x 26mm



|                    |   |                 |         |
|--------------------|---|-----------------|---------|
| <b>GEV No.</b>     | 415268  | <b>Ref. No.</b> | 3030180 |
| <b>description</b> | heating element 1850-2020W 230-240V heating circuits 1 expansion flange flange 62x26mm L 245mm W 40mm H 25mm tube ø 6.5mm connection male faston 6.3mm immersion heater |                 |         |



|                    |  |                 |         |
|--------------------|--|-----------------|---------|
| <b>GEV No.</b>     | 415270   | <b>Ref. No.</b> | 32g3360 |
| <b>description</b> | heating element 2700W 230V heating circuits 1 compression flange flange 62x26mm L 335mm W 43mm H 25mm tube ø 6.3mm connection male faston 6.3mm immersion heater   |                 |         |
| <b>For models:</b> | KD100, KD100A, KD100PSD, KD60, KD60E, KD60EAT, KD60M, KD60MA, KD60ME, KD60MPS, KD60MPSA, KD60PS, KD60PSD, KD6E-ATSD, KD85, KD85A, KD85E, KD85EA, KD85EAT, KD85EATS, KD85EPS, KD85EPSA, KD85PS, KD85PSA, KN1100, KN1100SD, KN11PSDD, KN50, KN50M, KN50MPS, KN50PS, KN50PSD, KN50PSDD, KN80, KN800, KN800PSD, KN80PS, LP70 |                 |         |

with expansion flange 70 x 18mm









|                    |  |                 |         |
|--------------------|--|-----------------|---------|
| <b>GEV No.</b>     | 418588   | <b>Ref. No.</b> | 32G0120 |
| <b>description</b> | heating element 1000W 220V heating circuits 1 flange 70x18mm L 175mm W 83mm H 55mm connection male faston 6.3mm tube ø 8.3mm |                 |         |



|                    |   |                 |         |
|--------------------|---|-----------------|---------|
| <b>GEV No.</b>     | 418598  | <b>Ref. No.</b> | 32G0190 |
| <b>description</b> | heating element 1500W 220V heating circuits 1 flange 70x18mm L 175mm W 83mm H 55mm connection male faston 6.3mm immersion heater tube ø 8.5mm |                 |         |

with round flange ø 47.5mm



|   |   |                 |                 |         |
|---|---|-----------------|-----------------|---------|
| <b>GEV No.</b>  | 415249  | <b>Ref. No.</b> | 32G0480         |         |
| <b>description</b>  | heating element 1500W 220V heating circuits 1 mounting ø 47.5mm L 220mm W 36mm H 49mm round flange connection male faston 6.3mm immersion heater tube ø 6.5mm connection length 18mm thermostat sleeves ø 7.5mm number of thermostat sleeves 1 length thermostat sleeves 181mm thermostat sleeve not clinging |                 |                 |         |
| <b>spare parts for</b>  | 415249  |                 |                 |         |
|    | <b>GEV No.</b>  | 510408          | <b>Ref. No.</b> | 3152650 |
|   | O-ring EPDM thickness 5.34mm ID ø 47mm Qty 1 pcs  |                 |                 |         |
| <b>accessories for</b>  | 415249  |                 |                 |         |
|    | <b>GEV No.</b>  | 510562          | <b>Ref. No.</b> | —       |
|   | O-ring silicone thickness 5.34mm ID ø 47mm Qty 1 pcs  |                 |                 |         |
|    | <b>GEV No.</b>  | 520235          | <b>Ref. No.</b> | —       |
|   | 3 hole flange hole distance 70.5mm perforation ø 6.5mm ID ø 53.5mm  |                 |                 |         |
|    | <b>GEV No.</b>  | 520236          | <b>Ref. No.</b> | —       |
|   | flange for heating element ID ø 50mm ED ø 90mm hole ø 6.5mm 3 holes   |                 |                 |         |
|    | <b>GEV No.</b>  | 550002          | <b>Ref. No.</b> | 3113780 |
|   | tension strap H 10mm L 21mm W 10mm hole ø 6.5mm for heating element   |                 |                 |         |
|  | <b>GEV No.</b>  | 550362          | <b>Ref. No.</b> | —       |
|   | blind flange ø 64mm mounting ø 47.5mm   |                 |                 |         |









|   |  |                 |                 |         |
|---|--|-----------------|-----------------|---------|
| <b>GEV No.</b>  | 415043   | <b>Ref. No.</b> | 32g0540         |         |
| <b>description</b>  | heating element 2500W 230V heating circuits 1 mounting ø 47.5mm L 225mm W 41mm H 36mm round flange connection male faston 6.3mm immersion heater tube ø 6.5mm connection length 17mm thermostat sleeves ø 7mm number of thermostat sleeves 1 length thermostat sleeves 210mm thermostat sleeve eccentric, non clinging |                 |                 |         |
| <b>For models:</b>  | LT10R, LT20F, LT25F  |                 |                 |         |
| <b>spare parts for</b>  | 415043   |                 |                 |         |
|  | <b>GEV No.</b>   | 510408          | <b>Ref. No.</b> | 3152650 |
|   | O-ring EPDM thickness 5.34mm ID ø 47mm Qty 1 pcs   |                 |                 |         |
| <b>accessories for</b>  | 415043   |                 |                 |         |
|  | <b>GEV No.</b>   | 510408          | <b>Ref. No.</b> | 3152650 |
|   | O-ring EPDM thickness 5.34mm ID ø 47mm Qty 1 pcs   |                 |                 |         |
|  | <b>GEV No.</b>   | 510562          | <b>Ref. No.</b> | —       |
|   | O-ring silicone thickness 5.34mm ID ø 47mm Qty 1 pcs   |                 |                 |         |
|  | <b>GEV No.</b>   | 520235          | <b>Ref. No.</b> | —       |
|   | 3 hole flange hole distance 70.5mm perforation ø 6.5mm ID ø 53.5mm   |                 |                 |         |
|  | <b>GEV No.</b>   | 520236          | <b>Ref. No.</b> | —       |
|   | flange for heating element ID ø 50mm ED ø 90mm hole ø 6.5mm 3 holes  |                 |                 |         |
|  | <b>GEV No.</b>   | 550002          | <b>Ref. No.</b> | 3113780 |
|   | tension strap H 10mm L 21mm W 10mm hole ø 6.5mm for heating element  |                 |                 |         |

Table continues overleaf

electric components









Зип Общепит

vsezip.ru



+7(812)987-08-81



|   |   |        |          |   |
|---|---|--------|----------|---|
| <b>accessories for</b>  | 415043  |        |          |   |
|  | GEV No.   | 550362 | Ref. No. | — |
|   | blind flange $\varnothing$ 64mm mounting $\varnothing$ 47.5mm |        |          |   |

|                    |  |                 |         |
|--------------------|--|-----------------|---------|
| <b>1</b>           |   |                 |         |
| <b>GEV No.</b>     | 415269   | <b>Ref. No.</b> | 32G3400 |
| <b>description</b> | heating element 2700W 230V heating circuits 3 mounting $\varnothing$ 47.5mm L 257mm W 28mm H 45mm round flange connection male faston 6.3mm immersion heater tube $\varnothing$ 6.3mm H1 11mm H2 34mm connection length 28mm |                 |         |
| <b>For models:</b> | KD100, KD100A, KD100PSD, KD130, KD130A, KD130E, KD130EAT, LP151  |                 |         |

|   |   |        |          |         |
|---|---|--------|----------|---------|
| <b>accessories for</b>  | 415269  |        |          |         |
|    | GEV No.   | 510408 | Ref. No. | 3152650 |
|   | O-ring EPDM thickness 5.34mm ID $\varnothing$ 47mm Qty 1 pcs  |        |          |         |
|    | GEV No.   | 510562 | Ref. No. | —       |
|   | O-ring silicone thickness 5.34mm ID $\varnothing$ 47mm Qty 1 pcs  |        |          |         |
|    | GEV No.   | 520235 | Ref. No. | —       |
|   | 3 hole flange hole distance 70.5mm perforation $\varnothing$ 6.5mm ID $\varnothing$ 53.5mm              |        |          |         |
|    | GEV No.   | 520236 | Ref. No. | —       |
|   | flange for heating element ID $\varnothing$ 50mm ED $\varnothing$ 90mm hole $\varnothing$ 6.5mm 3 holes |        |          |         |
|  | GEV No.   | 550002 | Ref. No. | 3113780 |
|   | tension strap H 10mm L 21mm W 10mm hole $\varnothing$ 6.5mm for heating element                         |        |          |         |
|  | GEV No.   | 550362 | Ref. No. | —       |
|   | blind flange $\varnothing$ 64mm mounting $\varnothing$ 47.5mm   |        |          |         |

|   |  |                 |          |         |
|---|--|-----------------|----------|---------|
| <b>1</b>  |   |                 |          |         |
| <b>GEV No.</b>  | 415263   | <b>Ref. No.</b> | 32G3390  |         |
| <b>description</b>  | heating element 4500W 230V heating circuits 3 mounting $\varnothing$ 47.5mm L 375mm W 38mm H 46mm round flange connection male faston 6.3mm immersion heater tube $\varnothing$ 6.3mm thermostat sleeves $\varnothing$ 7mm number of thermostat sleeves 1 length thermostat sleeves 240mm thermostat sleeve not clinging |                 |          |         |
| <b>accessories for</b>  | 415263   |                 |          |         |
|  | GEV No.  | 510408          | Ref. No. | 3152650 |
|   | O-ring EPDM thickness 5.34mm ID $\varnothing$ 47mm Qty 1 pcs   |                 |          |         |
|  | GEV No.  | 520235          | Ref. No. | —       |
|   | 3 hole flange hole distance 70.5mm perforation $\varnothing$ 6.5mm ID $\varnothing$ 53.5mm   |                 |          |         |
|  | GEV No.  | 520236          | Ref. No. | —       |
|   | flange for heating element ID $\varnothing$ 50mm ED $\varnothing$ 90mm hole $\varnothing$ 6.5mm 3 holes  |                 |          |         |
|  | GEV No.  | 521012          | Ref. No. | —       |
|   | gasket graphite ED $\varnothing$ 15mm ID $\varnothing$ 5mm thickness 1.2mm Qty 1 pcs   |                 |          |         |
|  | GEV No.  | 550002          | Ref. No. | 3113780 |
|   | tension strap H 10mm L 21mm W 10mm hole $\varnothing$ 6.5mm for heating element  |                 |          |         |
|  | GEV No.  | 550362          | Ref. No. | —       |
|   | blind flange $\varnothing$ 64mm mounting $\varnothing$ 47.5mm  |                 |          |         |







|   |   |                 |          |         |
|---|---|-----------------|----------|---------|
| <b>1</b>  |   |                 |          |         |
| <b>GEV No.</b>  | 415019  | <b>Ref. No.</b> | 32G0220  |         |
| <b>description</b>  | heating element 3000W 230V heating circuits 3 mounting $\varnothing$ 57.5mm L 338mm W 37mm H 41mm round flange connection male faston 6.3mm immersion heater tube $\varnothing$ 8.5mm connection length 27mm thermostat sleeves $\varnothing$ 7mm number of thermostat sleeves 1 length thermostat sleeves 300mm thermostat sleeve not clinging with 3 hole flange & O-ring |                 |          |         |
| <b>accessories for</b>  | 415019  |                 |          |         |
|  | GEV No.   | 550002          | Ref. No. | 3113780 |
|   | tension strap H 10mm L 21mm W 10mm hole $\varnothing$ 6.5mm for heating element   |                 |          |         |



|  |  |                 |          |         |
|--|--|-----------------|----------|---------|
| <b>1</b>   |    |                 |          |         |
| <b>GEV No.</b>   | 416598   | <b>Ref. No.</b> | 32G1931  |         |
| <b>description</b>   | heating element 4540W 400V heating circuits 3 L 312mm W 55mm H 48mm tube $\varnothing$ 8.5mm thermostat sleeves $\varnothing$ 7mm length thermostat sleeves 290mm number of thermostat sleeves 1 connection M4 immersion heater round flange mounting $\varnothing$ 57.5mm |                 |          |         |
| <b>For models:</b>   | 31PIE6   |                 |          |         |
| <b>accessories for</b>   | 416598   |                 |          |         |
|  | GEV No.  | 550002          | Ref. No. | 3113780 |
|  | tension strap H 10mm L 21mm W 10mm hole $\varnothing$ 6.5mm for heating element  |                 |          |         |



|   |   |                 |          |                               |
|---|---|-----------------|----------|-------------------------------|
| <b>1</b>  |   |                 |          |                               |
| <b>GEV No.</b>  | 415264  | <b>Ref. No.</b> | 3037760  |                               |
| <b>description</b>  | heating element 6000W 230V heating circuits 3 mounting $\varnothing$ 57.5mm L 480mm W 33mm H 42mm round flange connection M5 immersion heater tube $\varnothing$ 8.5mm connection length 19mm thermostat sleeves $\varnothing$ 7.5mm number of thermostat sleeves 1 length thermostat sleeves 268mm thermostat sleeve not clinging                |                 |          |                               |
| <b>For models:</b>  | KD85, KD85A, KD85E, KD85EA, KD85EAT, KD85EATS, KD85EPS, KD85EPSA, KD85PS, KD85PSA, KN1100, KN1100SD, KN11PSDD, KN800, KN800PSD, LP151, LP202, LP202HC, LP302, LP302HC, N100D, N100S, N100VD, N100VS, N38D, N38S, N42D, N42S, N42VD, N42VS, N50D, N50S, N50VD, N50VS, N66D, N66S, N66VD, N66VS, N70D, N70S, N70VD, N70VS, N85D, N85S, N85VD, N85VS |                 |          |                               |
| <b>spare parts for</b>  | 415264  |                 |          |                               |
|  | GEV No.   | 510409          | Ref. No. | 3150430<br>3151960<br>37Q5260 |
|   | O-ring EPDM thickness 5.34mm ID $\varnothing$ 56.52mm Qty 1 pcs   |                 |          |                               |
| <b>accessories for</b>  | 415264  |                 |          |                               |
|  | GEV No.   | 550002          | Ref. No. | 3113780                       |
|   | tension strap H 10mm L 21mm W 10mm hole $\varnothing$ 6.5mm for heating element   |                 |          |                               |









Зип Общепит  
vsezip.ru  
(812)9818888



|   |  |                 |                         |
|---|--|-----------------|-------------------------|
|  |  |                 |                         |
| <b>GEV No.</b>  | 415183   | <b>Ref. No.</b> | 32G0770                 |
| <b>description</b>  | heating element 7000W 220V heating circuits 3 L 415mm W 41mm H 70mm tube ø 8.5mm connection M4 immersion heater round flange L1 265mm L2 150mm H1 25mm H2 55mm mounting ø 57.5mm |                 |                         |
| <b>accessories for</b>  | 415183   |                 |                         |
|  | <b>GEV No.</b>   | 521103          | <b>Ref. No.</b> N/A     |
|   | nut thread M4 H 3mm WS 7 brass Qty 20 pcs  |                 |                         |
|  | <b>GEV No.</b>   | 521104          | <b>Ref. No.</b> —       |
|   | washer ID ø 4.3mm ED ø 8mm thickness 0.5mm brass Qty 20 pcs for thread M4  |                 |                         |
|  | <b>GEV No.</b>   | 550002          | <b>Ref. No.</b> 3113780 |
|   | tension strap H 10mm L 21mm W 10mm hole ø 6.5mm for heating element  |                 |                         |
|  | <b>GEV No.</b>   | 560111          | <b>Ref. No.</b> —       |
|   | plain washer ID ø 4.3mm ED ø 9mm thickness 0.8mm SS Qty 20 pcs DIN 125A for thread M4  |                 |                         |
|  | <b>GEV No.</b>   | 560131          | <b>Ref. No.</b> —       |
|   | hexagonal nut thread M4 H 3.2mm WS 7 SS DIN/ISO DIN 934 / ISO 4032/8673 Qty 20 pcs   |                 |                         |

|   |   |                 |                         |
|---|---|-----------------|-------------------------|
|    |   |                 |                         |
| <b>GEV No.</b>  | 416599  | <b>Ref. No.</b> | 32G1031<br>32G1160      |
| <b>description</b>  | heating element 7000W 240V heating circuits 3 L 405mm W 42mm H 70mm tube ø 8.5mm thermostat sleeves ø 7mm length thermostat sleeves 51mm number of thermostat sleeves 1 thermostat sleeve eccentric sensor screw connection M9x1 connection M4 immersion heater round flange kettle L1 250mm L2 155mm H1 30mm H2 40mm mounting ø 57.5mm |                 |                         |
| <b>For models:</b>  | 71PIE15, 71PIE15A, 91PIE15, 91PIE15A  |                 |                         |
| <b>accessories for</b>  | 416599  |                 |                         |
|  | <b>GEV No.</b>  | 550002          | <b>Ref. No.</b> 3113780 |
|   | tension strap H 10mm L 21mm W 10mm hole ø 6.5mm for heating element   |                 |                         |

|   |  |                 |                         |
|---|--|-----------------|-------------------------|
|  |  |                 |                         |
| <b>GEV No.</b>  | 416600   | <b>Ref. No.</b> | 32G2330                 |
| <b>description</b>  | heating element 7000W 400V heating circuits 3 L 415mm W 41mm H 84mm tube ø 8.5mm thermostat sleeves ø 6.5mm length thermostat sleeves 51mm number of thermostat sleeves 1 thermostat sleeve not clinging connection M4 connection length 12mm immersion heater round flange kettle L1 265mm L2 150mm H1 32mm H2 52mm mounting ø 57.5mm |                 |                         |
| <b>For models:</b>  | 191PI2E, 191PI2EA, 1A1PI2E, 1A1PI2EA, 1D1PI2E, 1D1PI2EA  |                 |                         |
| <b>accessories for</b>  | 416600   |                 |                         |
|  | <b>GEV No.</b>   | 550002          | <b>Ref. No.</b> 3113780 |
|   | tension strap H 10mm L 21mm W 10mm hole ø 6.5mm for heating element  |                 |                         |

|  |  |                 |   |
|--|--|-----------------|---|
|  |  |                 |   |
| <b>GEV No.</b>   | 415265   | <b>Ref. No.</b> | 32G3410                                       |
| <b>description</b>   | heating element 9000W 230V heating circuits 3 mounting ø 57.5mm L 470mm W 35mm H 41mm round flange connection M5 immersion heater tube ø 8.5mm connection length upper centre not clinging number of thermostat sleeves ø 7.5mm number of thermostat sleeves 1 length thermostat sleeves 29.5mm      |                 |   |
| <b>For models:</b>   | KD100, KD100A, KD100PSD, KD130, KD130A, KD130E, KD130EAT, LP202, LP202HC, LP302, LP302HC, LP402, LP402HC, LP402V, LPG300, N100D, N100S, N100VD, N100VS, N38D, N38S, N42D, N42S, N42VD, N42VS, N50D, N50S, N50VD, N50VS, N66D, N66S, N66VD, N66VS, N70D, N70S, N70VD, N70VS, N85D, N85S, N85VD, N85VS |                 |   |
| <b>spare parts for</b>   | 415265   |                 |   |
|   | <b>GEV No.</b>   | 510409          | <b>Ref. No.</b> 3150430<br>3151960<br>37Q5260 |
|  | O-ring EPDM thickness 5.34mm ID ø 56.52mm Qty 1 pcs  |                 |   |
| <b>accessories for</b>   | 415265   |                 |   |
|   | <b>GEV No.</b>   | 550002          | <b>Ref. No.</b> 3113780                       |
|  | tension strap H 10mm L 21mm W 10mm hole ø 6.5mm for heating element  |                 |   |

|   |  |                 |                     |
|---|--|-----------------|---------------------|
|   |  |                 |                     |
| <b>GEV No.</b>  | 415011   | <b>Ref. No.</b> | 32g0500             |
| <b>description</b>  | heating element 3000W 230V heating circuits 1 thread 1¼" L 285mm W 24mm H 20mm tube ø 6.5mm connection M4 immersion heater connection length 26mm flange with thread WS 54 |                 |                     |
| <b>accessories for</b>  | 415011   |                 |                     |
|  | <b>GEV No.</b>   | 510405          | <b>Ref. No.</b> N/A |
|   | flat gasket fibre ED ø 56mm ID ø 42mm thickness 2mm for thread 1¼" Qty 1 pcs   |                 |                     |
|  | <b>GEV No.</b>   | 520232          | <b>Ref. No.</b> —   |
|   | nut thread 1¼" H 5mm nickel-plated brass WS 47 Qty 1 pcs   |                 |                     |
|  | <b>GEV No.</b>   | 528021          | <b>Ref. No.</b> —   |
|   | flat gasket PTFE ED ø 53mm ID ø 42.5mm thickness 3mm Qty 1 pcs equiv. no. 12001/02286 suitable for Astoria/Aurora/Brasilia/Wega  |                 |                     |

|  |  |                 |                   |
|--|--|-----------------|-------------------|
|  |  |                 |                   |
| <b>GEV No.</b>   | 417167   | <b>Ref. No.</b> | 32G0170           |
| <b>description</b>   | heating element 4500W 230V heating circuits 3 thread 2" L 300mm W 37mm H 37mm tube ø 8.5mm connection M4 immersion heater connection length 65mm |                 |                   |
| <b>spare parts for</b>   | 417167   |                 |                   |
|   | <b>GEV No.</b>   | 510407          | <b>Ref. No.</b> — |
|  | flat gasket fibre ED ø 78mm ID ø 60mm thickness 2mm for heating element for thread 2" Qty 1 pcs  |                 |                   |

electric components



Зип Общепит



vsezip.ru

812)987-08-81

|   |  |                 |                   |
|---|--|-----------------|-------------------|
|  |  |                 |                   |
| <b>GEV No.</b>  | 416261   | <b>Ref. No.</b> | 32G2590           |
| <b>description</b>  | heating element 3000W 230V heating circuits 1 L 358mm W 32mm H 34mm H2 37mm thread M10x1 mounting distance 25mm tube ø 6.5mm connection male faston 6.3mm 2 hole fixing immersion heater |                 |                   |
| <b>For models:</b>  | LC100, LC100-VERS.2001, LC130, LC130-VERS.2001, LC80, LF50, LF50E  |                 |                   |
| <b>accessories for</b>  | 416261   |                 |                   |
|  | <b>GEV No.</b>   | 510416          | <b>Ref. No.</b> — |
|   | flat gasket fibre ED ø 19mm ID ø 10.5mm thickness 1.5mm for thread M10 Qty 1 pcs   |                 |                   |
|  | <b>GEV No.</b>   | 510893          | <b>Ref. No.</b> — |
|   | O-ring EPDM thickness 2.62mm ID ø 9.92mm Qty 1 pcs   |                 |                   |
|  | <b>GEV No.</b>   | 520231          | <b>Ref. No.</b> — |
|   | nut thread M10x1 H 6mm WS 14 zinc-coated steel Qty 1 pcs   |                 |                   |
|  | <b>GEV No.</b>   | 521129          | <b>Ref. No.</b> — |
|   | nut thread M10 H 6mm SS WS 17 Qty 1 pcs DIN/ISO DIN 439  |                 |                   |

|  |  |                 |                         |
|--|--|-----------------|-------------------------|
|  |  |                 |                         |
| <b>GEV No.</b>   | 418103   | <b>Ref. No.</b> | 32G1711                 |
| <b>description</b>   | heating element 24000W 400V heating circuits 3 ID ø 518mm ED ø 535mm L 590mm H 143mm L1 38mm W1 104mm H1 120mm H2 23mm flange length 142mm flange width 25mm hole distance 125mm connection M6 tube ø 8.5mm convection heating element hole ø 6mm rectangular flange |                 |                         |
| <b>For models:</b>   | FC1221E, FC241E, FCV241E, FCV241EDM, FCV241EDS, FCV401EDM, FM1221E1, FM1221E1-VERS.2006, FM1221E2, FM1221E2-VERS.2006, FM1221E3, FM1221E3-VERS.2006, FM2021E1, FM2021E2, FM2021E2-VERS.2006, FM2021E3, FM2021E3-VERS.2006  |                 |                         |
| <b>accessories for</b>   | 418103   |                 |                         |
|   | <b>GEV No.</b>   | 699165          | <b>Ref. No.</b> 3332550 |
|  | gasket L 142mm W 25mm D1 ø 6.5mm D2 ø 12mm hole distance 17mm 9 holes graphite thickness 2mm   |                 |                         |

## heating elements for convection

|   |  |                 |                         |
|---|--|-----------------|-------------------------|
|   |  |                 |                         |
| <b>GEV No.</b>  | 418102   | <b>Ref. No.</b> | 32G1701                 |
| <b>description</b>  | heating element 16400W 230V heating circuits 3 ID ø 441mm ED ø 458mm L 492mm H 143mm L1 34mm W1 104mm H1 128mm H2 115mm flange length 142mm flange width 25mm hole distance 63mm connection M6x1 tube ø 8.5mm convection heating element hole ø 6mm rectangular flange   |                 |                         |
| <b>For models:</b>  | BX101E, BX101E-VERS.122013, FC101E, FC101E, FCV101E, FCV101EDM, FCV101EDM-UL, FCV101EDS, FCV101EDS-UL, FCV101E-UL, FCV141E, FCV141EDM, FCV141EDS, FCV72EDM-UL, FCV72EDS-UL, FCV72E-UL, FM1011E1, FM1011E1-VERS.2006, FM1011E2, FM1011E2-VERS.2006, FM1011E3, FM1011E3-VERS.2006, FM2011E2-VERS.2006, FM2011E3-VERS.2006, FM721E1, FM721E1-VERS.2006, FM721E2, FM721E2-VERS.2006, FM721E3, FM721E3-VERS.2006, FX101E1, FX101E1R, FX101E2, FX101E2C, FX101E2R, FX101E3, FX101E3C, FX101E3R, FX10E2CR, FX10E3CR, FX201E2, FX201E2P, FX201E3, FX201E3P |                 |                         |
| <b>accessories for</b>  | 418102   |                 |                         |
|  | <b>GEV No.</b>   | 699165          | <b>Ref. No.</b> 3332550 |
|   | gasket L 142mm W 25mm D1 ø 6.5mm D2 ø 12mm hole distance 17mm 9 holes graphite thickness 2mm   |                 |                         |

|   |  |                 |         |
|---|--|-----------------|---------|
|  |  |                 |         |
| <b>GEV No.</b>  | 419175   | <b>Ref. No.</b> | 32G1550 |
| <b>description</b>  | heating element 2400W 230V heating circuits 1 ID ø 190mm ED ø 210mm 2 hole fixing connection M4 tube ø 8.5mm thread 1/4" heated cabinet  |                 |         |
| <b>For models:</b>  | A12A1E, A12B1E, A12B2E, A12M1E, A12Z1E, A12Z2E, A14A1E, A14B1E, A14B2E, A14M1E, A14Z1E, A14Z2E, A16A1E, A16B1E, A16B2E, A16M1E, A16Z1E, A16Z2E, A18A1E, A18B1E, A18B2E, A18M1E, A18Z1E, A18Z2E, A20A1E, A20B1E, A20B2E, A20M1E, A20Z1E, A20Z2E, ACBM, ACBM218, ACPN, ACPN218, AJ12AE, AJ12ME, AJ14AE, AJ14ME, AJ16AE, AJ16ME, SL14CPN, SL14CVB, SL21CPN, SL21CVB |                 |         |

|  |   |                 |         |
|--|---|-----------------|---------|
|  |   |                 |         |
| <b>GEV No.</b>   | 418099  | <b>Ref. No.</b> | 32G0430 |
| <b>description</b>   | heating element 2800W 230V heating circuits 1 ID ø 217mm ED ø 230mm L 249mm H 72mm L1 11mm W1 68mm H1 11mm H2 41mm flange length 142mm flange width 25mm hole distance 63mm connection male faston 6.3mm connection length 73mm tube ø 6.3mm convection heating element hole ø 6mm rectangular flange |                 |         |
| <b>For models:</b>   | FCV3EM  |                 |         |





Зип Общепит

vsezip.ru

+7(812)987-08-28



1

|                    |  |                 |         |
|--------------------|--|-----------------|---------|
| <b>GEV No.</b>     | 418100   | <b>Ref. No.</b> | 32G1940 |
| <b>description</b> | heating element 4150W 230V heating circuits 3 ID $\varnothing$ 214mm ED $\varnothing$ 226mm L 248mm H 70mm L1 15mm W1 103mm H1 5mm H2 65mm flange length 142mm flange width 25mm hole distance 62mm connection male faston 6.3mm tube $\varnothing$ 6.3mm convection heating element hole $\varnothing$ 6mm rectangular flange |                 |         |
| <b>For models:</b> | FCV4E, FCV4EDS, FCV4EM, FM423E1, FM423E2   |                 |         |



|                    |  |                 |         |
|--------------------|--|-----------------|---------|
| <b>GEV No.</b>     | 415737   | <b>Ref. No.</b> | 32G1280 |
| <b>description</b> | heating element 2500W 250V heating circuits 1 L 655mm W 120mm L1 30mm L2 625mm W2 200mm flange length 70mm flange width 22mm hole distance 56mm connection length 100mm connection M4 tube $\varnothing$ 6.3mm hole $\varnothing$ 5.5mm W1 30mm rectangular flange convection heating element windings 2 |                 |         |



1

|   |  |                 |                         |
|---|--|-----------------|-------------------------|
| <b>GEV No.</b>  | 418101   | <b>Ref. No.</b> | 32G1691                 |
| <b>description</b>  | heating element 8700W 230V heating circuits 3 ID $\varnothing$ 317mm ED $\varnothing$ 333mm L 375mm H 100mm L1 42mm W1 105mm H1 82mm H2 18mm flange length 142mm flange width 25mm hole distance 63mm connection M6 connection length 26mm tube $\varnothing$ 8.5mm convection heating element hole $\varnothing$ 6mm rectangular flange |                 |                         |
| <b>For models:</b>  | FC611E, FC61E, FCV61E, FCV61EDM, FCV61EDM-UL, FCV61EDS, FCV61EDS-UL, FCV61E-UL, FM611E1, FM611E1-VERS.2006, FM611E2, FM611E2-VERS.2006, FM611E3, FM611E3-VERS.2006   |                 |                         |
| <b>accessories for</b>  | 418101   |                 |                         |
|  | <b>GEV No.</b>   | 699165          | <b>Ref. No.</b> 3332550 |
|   | gasket L 142mm W 25mm D1 $\varnothing$ 6.5mm D2 $\varnothing$ 12mm hole distance 17mm 9 holes graphite thickness 2mm   |                 |                         |



1

|                    |   |                 |         |
|--------------------|---|-----------------|---------|
| <b>GEV No.</b>     | 419222  | <b>Ref. No.</b> | 3115001 |
| <b>description</b> | heating element 27000/29000W 400/415V L 590mm W 545mm H 140mm heating circuits 3 cable lengthmm   |                 |         |
| <b>For models:</b> | BX122E, BX122E-VERS.122013, FX122E1, FX122E2, FX122E2C, FX122E2T, FX122E2T-VERS.032014, FX122E3, FX122E3C, FX122E3T, FX122E3T-VERS.022014, FX12E3CT, FX12E3CT-VERS.022014, FX202E2, FX202E2-VERS.032014, FX202E3, FX202E3-VERS.022014 |                 |         |



1

|                    |  |                 |         |
|--------------------|--|-----------------|---------|
| <b>GEV No.</b>     | 415736   | <b>Ref. No.</b> | 32G1360 |
| <b>description</b> | heating element 3500W 230V heating circuits 1 L 655mm W 125mm L1 30mm L2 625mm W2 88mm flange length 70mm flange width 22mm hole distance 56mm connection length 97mm connection M4 tube $\varnothing$ 6.25mm hole $\varnothing$ 5mm W1 30mm rectangular flange convection heating element windings 2 mounting distance 58mm |                 |         |



1

|                    |  |                 |         |
|--------------------|--|-----------------|---------|
| <b>GEV No.</b>     | 419261   | <b>Ref. No.</b> | 3116030 |
| <b>description</b> | heating element 9500/10400W 230/240V heating circuits 3 ID $\varnothing$ 320mm ED $\varnothing$ 337mm L 380mm H 148mm L1 40mm W1 105mm H1 20mm H2 120mm flange length 142mm flange width 25mm hole distance 18mm connection M6x1 connection length 85mm tube $\varnothing$ 8.5mm convection heating element flange combi-steamer |                 |         |
| <b>For models:</b> | BX61E, BX61E-VERS.122013, FX61E1, FX61E1R, FX61E2, FX61E2C, FX61E2CR, FX61E2CR-VERS.032014, FX61E2C-VERS.032014, FX61E2R, FX61E2R-VERS.032014, FX61E2-VERS.032014, FX61E3, FX61E3C, FX61E3CR, FX61E3CR-VERS.022014, FX61E3C-VERS.022014, FX61E3R, FX61E3R-VERS.022014, FX61E3-VERS.022014  |                 |         |

radiation heaters

1-circuit



1

|                    |   |                 |         |
|--------------------|---|-----------------|---------|
| <b>GEV No.</b>     | 490025  | <b>Ref. No.</b> | 3080080 |
| <b>description</b> | radiation heater $\varnothing$ 200mm 1700W 230V heating circuits 1 energy regulation with temperature signalization with heating coil connections 2+2 connection type male faston 6.3mm EGO |                 |         |
| <b>For models:</b> | OG0PEVTR, 1G0PEVTR, 6VTR, 6VTR2   |                 |         |



Зип Общепит

vsezip.ru

+7(812)987-08-81

## 2-circuit



|                    |  |        |                 |         |
|--------------------|--|--------|-----------------|---------|
| 1                  | <b>GEV No.</b>   | 490139 | <b>Ref. No.</b> | 3080070 |
| <b>description</b> | radiation heater ø 250mm 2500W 230V heating circuits 2 energy regulation with temperature signalization partial power 1000W with ribbon heater connections 3+2 connection type male faston 6.3mm EGO |        |                 |         |



|                    |  |                     |                 |                    |
|--------------------|--|---------------------|-----------------|--------------------|
| 1                  | <b>GEV No.</b>   | 490071 <sup>1</sup> | <b>Ref. No.</b> | 32G1210<br>32G1211 |
| <b>description</b> | hot plate dimensions 300x300mm 4000W 230V with spill ring connection 4 screw clamps protector yes square |                     |                 |                    |
| <b>For models:</b> | 070E, 071E, 08WPE4V, 090E, 090PE4, 091E, 190PE4, 71E   |                     |                 |                    |

<sup>1</sup>incl. protector

## hot plates

## square &amp; rectangular

## with radiused edge



|                    |  |                     |                 |         |
|--------------------|--|---------------------|-----------------|---------|
| 1                  | <b>GEV No.</b>   | 490068 <sup>1</sup> | <b>Ref. No.</b> | 32G2860 |
| <b>description</b> | hot plate dimensions 220x220mm 2600W 400V with spill ring connection 4 screw clamps protector yes square |                     |                 |         |
| <b>For models:</b> | 0G0PE2, 0G1PE2, 1G0PE2, 1G1PE2, 1G1PE2E, 1G1PE2EV, 2G0PE2, 2G1PE2E, 2G1PE2EV                             |                     |                 |         |

<sup>1</sup>incl. protector

|                    |  |                     |                 |                    |
|--------------------|--|---------------------|-----------------|--------------------|
| 1                  | <b>GEV No.</b>   | 490074 <sup>1</sup> | <b>Ref. No.</b> | 32G0940<br>32G1080 |
| <b>description</b> | hot plate dimensions 300x300mm 4000W 400V with spill ring connection 4 screw clamps protector yes square                           |                     |                 |                    |
| <b>For models:</b> | 04WPE4V, 070E, 071E, 08WPE4V, 090E, 090PE4, 091E, 0A0PE4, 0D0PE4, 190PE4, 191PE4E, 1A0PE4, 1A1PE4E, 1A1PEFTE, 1D0PE4, 1D1PE4E, 71E |                     |                 |                    |

<sup>1</sup>incl. protector

|                    |  |                     |                 |         |
|--------------------|--|---------------------|-----------------|---------|
| 1                  | <b>GEV No.</b>   | 490056 <sup>1</sup> | <b>Ref. No.</b> | 32G1201 |
| <b>description</b> | hot plate dimensions 300x300mm 3000W 230V with spill ring connection 4 screw clamps protector yes square |                     |                 |         |
| <b>For models:</b> | 070E, 071E, 090E, 091E, 71E  |                     |                 |         |

<sup>1</sup>incl. protector

## round

## with radiused edge

## for domestic and commercial kitchens



|                    |  |        |                 |         |
|--------------------|--|--------|-----------------|---------|
| 1                  | <b>GEV No.</b>   | 490016 | <b>Ref. No.</b> | 32G0030 |
| <b>description</b> | hot plate ø 180mm 2000W 230V connection 4 screw clamps with 8mm spill ring             |        |                 |         |
| <b>For models:</b> | 030E, 031E, 0G0PE1, 1G0PE1, 1G1PE1E, 1G1PE1EV, 2G0PE1, 2G1PE1E, 2G1PE1EV, 31TCE, 32TCE |        |                 |         |



|                    |   |        |                 |                    |
|--------------------|---|--------|-----------------|--------------------|
| 1                  | <b>GEV No.</b>  | 490073 | <b>Ref. No.</b> | 32G0930<br>32G1090 |
| <b>description</b> | hot plate dimensions 300x300mm 3000W 400V with spill ring connection 4 screw clamps protector no square |        |                 |                    |
| <b>For models:</b> | 070E, 071E, 090E, 091E, 71E   |        |                 |                    |





|                    |  |        |                 |                    |
|--------------------|--|--------|-----------------|--------------------|
| 1                  | <b>GEV No.</b>   | 490017 | <b>Ref. No.</b> | 32G0290<br>32G1320 |
| <b>description</b> | hot plate ø 180mm 2000W 400V connection 4 screw clamps with 8mm spill ring             |        |                 |                    |
| <b>For models:</b> | 030E, 031E, 0G0PE1, 1G0PE1, 1G1PE1E, 1G1PE1EV, 2G0PE1, 2G1PE1E, 2G1PE1EV, 31TCE, 32TCE |        |                 |                    |



Зип Общепит  
accessories

knobs  
vsezip.ru

87(812)987-08-81

|   |  |                 |                   |
|---|--|-----------------|-------------------|
|  |  |                 |                   |
| 1   |  |                 |                   |
| <b>GEV No.</b>  | 490020   | <b>Ref. No.</b> | 32G0020           |
| <b>description</b>  | hot plate ø 220mm 2600W 230V connection 4 screw clamps with 8mm spill ring             |                 |                   |
| <b>For models:</b>  | 030E, 031E, 0G0PE1, 1G0PE1, 1G1PE1E, 1G1PE1EV, 2G0PE1, 2G1PE1E, 2G1PE1EV, 31TCE, 32TCE |                 |                   |
| <b>accessories for</b>  | 490020   |                 |                   |
|  | <b>GEV No.</b>   | 550796          | <b>Ref. No.</b> — |
|   | fixing plate for hot plate ø220mm  |                 |                   |

|   |  |                 |                    |
|---|--|-----------------|--------------------|
|  |  |                 |                    |
| 1   |  |                 |                    |
| <b>GEV No.</b>  | 490021   | <b>Ref. No.</b> | 32G0300<br>32G1330 |
| <b>description</b>  | hot plate ø 220mm 2600W 400V connection 4 screw clamps with 8mm spill ring             |                 |                    |
| <b>For models:</b>  | 030E, 031E, 0G0PE1, 1G0PE1, 1G1PE1E, 1G1PE1EV, 2G0PE1, 2G1PE1E, 2G1PE1EV, 31TCE, 32TCE |                 |                    |

## energy regulators



### EGO

#### 1-circuit

|   |   |                 |                    |
|---|---|-----------------|--------------------|
|  |   |                 |                    |
| 1   |   |                 |                    |
| <b>GEV No.</b>  | 380015  | <b>Ref. No.</b> | 32Z0170<br>32Z0171 |
| <b>description</b>  | energy regulator 230V 13A single-circuit turn direction right shaft ø 6x4.6mm shaft L 23mm mounting thread M4 power release 6-100% no. 50.57021.010   |                 |                    |
| <b>For models:</b>  | 06WBR3E, 08WGREV, 090SPE, 0G0SPE, 0G1BR3E, 190GRE, 191BR1E, 191BR2E, 191BR2EA, 1A1BR1E, 1A1BR2E, 1A1BR2EA, 1D1BR1E, 1D1BR2E, 1D1BR2EA, 1G0GRE, 1G1BR3E, 291BR1E, 291BR2E, 291BR2EA, 291PI3E, 2A1BR1E, 2A1BR2E, 2A1BR2EA, 2A1PI3E, 2D1BR1E, 2D1BR2E, 2D1BR2EA, FC1011E, FC1011G, FC1221E, FC1221G, FC611E, FC611G, FMS, FMSX |                 |                    |

#### 2-circuit

|   |  |                 |         |
|---|--|-----------------|---------|
|  |  |                 |         |
| 1   |  |                 |         |
| <b>GEV No.</b>  | 380027   | <b>Ref. No.</b> | 3008300 |
| <b>description</b>  | energy regulator EGO 230V 13A dual circuit turn direction right shaft ø 6x4.6mm shaft L 23mm mounting thread M4 power release 6-70% no. 50.55021.100 |                 |         |
| <b>For models:</b>  | 04WVT3RV, 090VTR, 0G0PEVTR, 190VTR, 1G0PEVTR, 6042520, 6042530, 6043590, 6VTR2   |                 |         |



|  |  |                 |                   |
|--|--|-----------------|-------------------|
|  |  |                 |                   |
| 1  |  |                 |                   |
| <b>GEV No.</b>   | 110117   | <b>Ref. No.</b> | 36M0750           |
| <b>description</b>   | knob energy regulator 1-3 t.max.°C ø 60mm shaft ø 6x4.6mm shaft flat upper black |                 |                   |
| <b>spare parts for</b>   | 110117   |                 |                   |
|   | <b>GEV No.</b>   | 112495          | <b>Ref. No.</b> — |
|  | knob spring L 10.5mm W 8.5mm Qty 1 pcs   |                 |                   |

## thermostats

### bi-metal thermostats

#### safety bi-metal thermostats

|   |   |                 |         |
|---|---|-----------------|---------|
|  |   |                 |         |
| 1   |   |                 |         |
| <b>GEV No.</b>  | 390480  | <b>Ref. No.</b> | 32V7250 |
| <b>description</b>  | bi-metal safety thermostat hole distance 23.8mm switch-off temp. 105°C 1NC 1-pole 16A connection F6.3 2 hole fixing |                 |         |

|   |  |                 |                    |
|---|--|-----------------|--------------------|
|  |  |                 |                    |
| 1   |  |                 |                    |
| <b>GEV No.</b>  | 390233   | <b>Ref. No.</b> | 32V7250<br>32Z8270 |
| <b>description</b>  | bi-metal safety thermostat hole distance 24mm switch-off temp. 110°C 1NC 1-pole 16A connection F6.3 2 hole fixing without holder |                 |                    |
| <b>accessories for</b>  | 390233   |                 |                    |
|  | <b>GEV No.</b>   | 504736          | <b>Ref. No.</b> —  |
|   | bracket for contact thermostat   |                 |                    |
|  | <b>GEV No.</b>   | 550388          | <b>Ref. No.</b> —  |
|   | bracket for contact thermostat mounting distance 24.5mm mounting ø 3.8   |                 |                    |

### bi-metal thermostats

|   |   |                 |         |
|---|---|-----------------|---------|
|  |   |                 |         |
| 1   |   |                 |         |
| <b>GEV No.</b>  | 375927  | <b>Ref. No.</b> | 3093940 |
| <b>description</b>  | bi-metal thermostat hole distance 23.5mm switch-off temp. 50°C 1NO 10A connection F6.3  |                 |         |
| <b>For models:</b>  | 04WPEBV, 08WPEBV, 08WTPEV, 090PEB, 091FR7G, 091PEB, 190PEB, 190TPE, 191PEB, 191TPE, 6BM, 6BR, 6CP, 6FR, 6FTL, 6FTR, 6PC, 6VTR |                 |         |



Зип Общепит

vsezip.ru

+7(812)987-08-81

|   |   |                 |         |
|---|---|-----------------|---------|
|  |   |                 |         |
| 1   |   |                 |         |
| <b>GEV No.</b>  | 390439  | <b>Ref. No.</b> | 3008880 |
| <b>description</b>  | bi-metal thermostat hole distance 23.5mm switch-off temp. 70°C 1NC 10A 250V connection F6.3                               |                 |         |
| <b>For models:</b>  | 04WPE4V, 08WPE4V, 090PE4, 091FR1I, 091FR7G, 190PE4, 191FR2I, 191FR4ED, 191PE4E, 6BM, 6BR, 6CP, 6FR, 6FTL, 6FTR, 6PC, 6VTR |                 |         |



|                    |   |                 |         |
|--------------------|---|-----------------|---------|
| 1                  |   |                 |         |
| <b>GEV No.</b>     | 375844  | <b>Ref. No.</b> | 32Z2940 |
| <b>description</b> | thermostat t.max. 182°C temperature range 100-180°C 1-pole 1NO 16A probe ø 11mm probe L 28mm capillary pipe 850mm capillary pipe isolated 800mm gland nut shaft ø 6x4.6mm shaft L 23mm shaft position upper rotation 270° screw-in probe probe thread M14x1 |                 |         |

## control and safety thermostats

## EGO

## control thermostats

## 51.\_ series

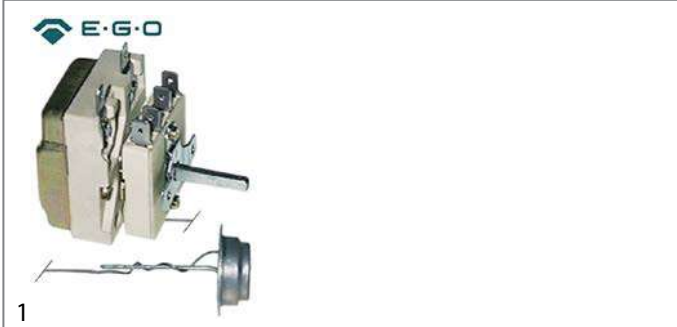

|   |  |                 |                                    |
|---|--|-----------------|------------------------------------|
| 1   |  |                 |                                    |
| <b>GEV No.</b>  | 390033   | <b>Ref. No.</b> | 32Z0410                            |
| <b>description</b>  | thermostat t.max. 93°C temperature range 30-93°C 1-pole 1NO 15A probe ø 20/23.5mm probe L 11mm capillary pipe 900mm capillary pipe isolated 800mm gland nut shaft ø 6x4.6mm shaft L 25mm shaft position upper rotation 270° outer switch 2NO probe material SS with knob probe   |                 |                                    |
| <b>For models:</b>  | 030BME, 030EBM, 031BME, 031EBM, 0G0BME, 1G0BME, A12A1E, A12B1E, A12B2E, A12M1E, A12Z1E, A12Z2E, A14A1E, A14B1E, A14B2E, A14M1E, A14Z1E, A14Z2E, A16A1E, A16B1E, A16B2E, A16M1E, A16Z1E, A16Z2E, A18A1E, A18B1E, A18B2E, A18M1E, A18Z1E, A18Z2E, A20A1E, A20B1E, A20B2E, A20M1E, A20Z1E, A20Z2E, ACBM, ACBM218, ACPN, ACPN218, AJ12AE, AJ12ME, AJ14AE, AJ14ME, AJ16AE, AJ16ME, AJ18AE, AJ18ME, AJ20AE, AJ20ME...(Other models you can see in the webshop) |                 |                                    |
| <b>accessories for</b>  | 390033   |                 |                                    |
|  | <b>GEV No.</b>   | 510167          | <b>Ref. No.</b> 3150270<br>315Q270 |
|   | gasket for thermostat ED ø 41mm ID ø 18mm Qty ANGELO PO/ ZANUSSI pcs equiv. no. 3150270/66717  |                 |                                    |



|                    |  |                 |         |
|--------------------|--|-----------------|---------|
| 1                  |  |                 |         |
| <b>GEV No.</b>     | 375395   | <b>Ref. No.</b> | 32V4540 |
| <b>description</b> | thermostat t.max. 182°C temperature range 95-180°C 1-pole 1NO 16A probe ø 6mm probe L 133mm capillary pipe 870mm capillary pipe isolated 520mm gland nut M9x1 shaft ø 6x4.6mm shaft L 13mm shaft position upper rotation 270° 250V |                 |         |
| <b>For models:</b> | 0M0FR1E, 1M0FR2E   |                 |         |



|                    |   |                 |         |
|--------------------|---|-----------------|---------|
| 1                  |   |                 |         |
| <b>GEV No.</b>     | 375922  | <b>Ref. No.</b> | 3168460 |
| <b>description</b> | thermostat t.max. 185°C temperature range 101-185°C 1-pole 1NO 16A probe ø 6mm probe L 133mm capillary pipe 870mm capillary pipe isolated 520mm gland nut M10x1 shaft ø 6x4.6mm shaft L 23mm shaft position upper |                 |         |
| <b>For models:</b> | 091FR1I, 091FR1I-VERS.032012, 191FR2I, 191FR2I-VERS.032012  |                 |         |

## 55.10/19\_ series



|                    |   |                 |         |
|--------------------|---|-----------------|---------|
| 1                  |   |                 |         |
| <b>GEV No.</b>     | 375345  | <b>Ref. No.</b> | 32Z9380 |
| <b>description</b> | thermostat t.max. 150°C temperature range fixed 150°C 1-pole 1NO 16A probe ø 6mm probe L 74mm capillary pipe 900mm capillary pipe isolated 900mm gland nut shaft Lmm shaft position° shaft position |                 |         |
| <b>For models:</b> | 04WBMEV, 090BM1E, 0A0BME, 0B0BME, 0D0BME, 6040110, 6042680  |                 |         |



Зип Общепит

vsezip.ru

+7(812)987-08-81



|                    |  |                 |         |
|--------------------|--|-----------------|---------|
| <b>GEV No.</b>     | 375631   | <b>Ref. No.</b> | 32Z5820 |
| <b>description</b> | thermostat t.max. 249°C temperature range 55-249°C 1-pole 1NO 16A probe ø 3.1mm probe L 226mm capillary pipe 1270mm capillary pipe isolated 850mm gland nut 3/8"-M8x1 shaft ø 6x4.6mm shaft L 23mm shaft position upper rotation 318°  |                 |         |
| <b>For models:</b> | FC101, FC1011E, FC1011G, FC101E, FC1221E, FC1221G, FC241, FC241E, FC241G, FC61, FC611E, FC611G, FC61E, FCV101, FCV101-CSA, FCV101E, FCV101E-UL, FCV141, FCV141-CSA, FCV141E, FCV241, FCV241E, FCV241E-UL, FCV241G, FCV241G-CSA, FCV3EM, FCV4EM, FCV61, FCV61-CSA, FCV61E, FCV61E-UL, FCV72E-UL |                 |         |



|                    |   |                 |         |
|--------------------|---|-----------------|---------|
| <b>GEV No.</b>     | 375643  | <b>Ref. No.</b> | 32Z2371 |
| <b>description</b> | thermostat t.max. 330°C temperature range fixed 330°C 1-pole 1NC 16A probe ø 3mm probe L 219mm capillary pipe 900mm capillary pipe isolated 900mm gland nut |                 |         |
| <b>For models:</b> | 030EBM, 031EBM, 0G0BME, 0G0BME-VERS.032008, 1G0BME, 1G0BME-VERS.032008  |                 |         |



|                    |   |                 |         |
|--------------------|---|-----------------|---------|
| <b>GEV No.</b>     | 390068  | <b>Ref. No.</b> | 32Z0610 |
| <b>description</b> | thermostat t.max. 269°C temperature range 55-269°C 1-pole 1CO 16A probe ø 3.1mm probe L 219mm capillary pipe 1280mm capillary pipe isolated 1270mm gland nut shaft ø 6x4.6mm shaft L 23mm shaft position upper° rotation 318° |                 |         |



|                    |  |                 |         |
|--------------------|--|-----------------|---------|
| <b>GEV No.</b>     | 390037   | <b>Ref. No.</b> | 32Z0180 |
| <b>description</b> | thermostat t.max. 54°C temperature range fixed 54°C 1-pole 1NC 16A probe ø 20/23.5mm probe L 11mm capillary pipe 900mm capillary pipe isolated 850mm gland nut |                 |         |



|                    |   |                 |         |
|--------------------|---|-----------------|---------|
| <b>GEV No.</b>     | 375437  | <b>Ref. No.</b> | 32Z0210 |
| <b>description</b> | thermostat t.max. 324°C temperature range 66-324°C 1-pole 1NO 16A probe ø 4mm probe L 124mm capillary pipe 1470mm capillary pipe isolatedmm gland nut shaft ø 6x4.6mm shaft L 23mm shaft position upper rotation 270° |                 |         |



|                    |  |                 |         |
|--------------------|--|-----------------|---------|
| <b>GEV No.</b>     | 375845   | <b>Ref. No.</b> | 32Z2160 |
| <b>description</b> | thermostat t.max. 54°C temperature range fixed 54°C 1-pole CO probe ø 20/23.5mm probe L 11mm capillary pipe 1600mm capillary pipe isolatedmm gland nut with knob probe |                 |         |

Зип Общепит

vsezip.ru

+7(812)987-08-81



|                    |  |                 |         |
|--------------------|--|-----------------|---------|
| <b>GEV No.</b>     | 375215   | <b>Ref. No.</b> | 32Z2430 |
| <b>description</b> | thermostat t.max. 65°C temperature range fixed 65°C 1-pole 1CO 16A probe ø 6mm probe L 130mm capillary pipe 900mm capillary pipe isolated 900mm gland nut shaft Lmm shaft position |                 |         |
| <b>For models:</b> | F60PR, F60T, F80P, F80PR, L100, L40, L40S, L60, L80  |                 |         |



|                    |   |                 |         |
|--------------------|---|-----------------|---------|
| <b>GEV No.</b>     | 390040  | <b>Ref. No.</b> | 32V0200 |
| <b>description</b> | thermostat t.max. 90°C temperature range 30-90°C 1-pole 1CO 16A probe ø 6mm probe L 130mm capillary pipe 2040mm capillary pipe isolated 1940mm gland nut shaft ø ø6x4.6mm shaft L 23mm shaft position upper rotation 270° probe material SS |                 |         |
| <b>For models:</b> | F60P, F60PR, F60T, F80P, F80PR, L45   |                 |         |



|   |  |                 |                   |
|---|--|-----------------|-------------------|
| <b>GEV No.</b>  | 390003   | <b>Ref. No.</b> | 32Z0450           |
| <b>description</b>  | thermostat t.max. 90°C temperature range 30-90°C 1-pole 1CO 16A probe ø 15mm probe L 22.5mm capillary pipe 1700mm capillary pipe isolatedmm gland nut shaft ø ø6x4.6mm shaft L 16mm shaft position upper° shaft position rotation 270° with knob probe |                 |                   |
| <b>accessories for</b>  | 390003   |                 |                   |
|  | <b>GEV No.</b>   | 510165          | <b>Ref. No.</b> — |
| gasket for thermostat ED ø 27mm ID ø 11mm thickness 8.5mm                           |  |                 |                   |



|                    |   |                 |                    |
|--------------------|---|-----------------|--------------------|
| <b>GEV No.</b>     | 390032  | <b>Ref. No.</b> | 32Z0160<br>32Z5880 |
| <b>description</b> | thermostat t.max. 90°C temperature range 30-90°C 1-pole 1CO 16A probe ø 6mm probe L 130mm capillary pipe 2500mm capillary pipe isolatedmm gland nut M10x1 shaft ø ø6x4.6mm shaft L 23mm shaft position upper rotation 270° probe material SS  |                 |                    |
| <b>For models:</b> | FC101, FC1011E, FC1011G, FC101E, FC1221E, FC1221G, FC241, FC241E, FC241G, FC61, FC611E, FC611G, FC61E, FCV101, FCV101-CSA, FCV101E, FCV101E-UL, FCV141, FCV141-CSA, FCV141E, FCV241, FCV241E, FCV241E-UL, FCV241G, FCV3EM, FCV401DM, FCV401EDM, FCV401EDM-UL, FCV4EM, FCV61, FCV61-CSA, FCV61E, FCV61E-UL, FCV72E-UL, L100, L40, L40S, L60, L80 |                 |                    |



|                    |  |                 |         |
|--------------------|--|-----------------|---------|
| <b>GEV No.</b>     | 375632   | <b>Ref. No.</b> | 32Z5880 |
| <b>description</b> | thermostat t.max. 90°C temperature range 30-90°C 1-pole 1CO 16A probe ø 6mm probe L 130mm capillary pipe 1300mm capillary pipe isolated 850mm gland nut M10x1 shaft ø ø6x4.6mm shaft L 23mm shaft position upper rotation 270° |                 |         |

55.34\_ series



|                    |  |                 |         |
|--------------------|--|-----------------|---------|
| <b>GEV No.</b>     | 375343   | <b>Ref. No.</b> | 32Z9210 |
| <b>description</b> | thermostat t.max. 160°C temperature range fixed 160°C 3-pole 3NC 16A probe ø 6mm probe L 74mm capillary pipe 900mm capillary pipe isolated 900mm gland nut |                 |         |
| <b>For models:</b> | 190BM2E, 1A0BME, 1D0BME  |                 |         |



Зип Общепит

vsezip.ru

+7(812)987-08-81



|   |  |                 |                   |
|---|--|-----------------|-------------------|
| <b>GEV No.</b>  | 375038   | <b>Ref. No.</b> | 32Z2560           |
| <b>description</b>  | thermostat t.max. 300°C temperature range 50-300°C 3-pole 3NO 16A probe ø 6mm probe L 79mm capillary pipe 1740mm capillary pipe isolated 800mm gland nut shaft ø 6x4.6mm shaft L 23mm shaft position upper rotation 270° |                 |                   |
| <b>For models:</b>  | 191FAAE, 191FAE, 191PE4E, 1A1PE4E, 1A1PEFTE, 1A1FBE, 1D1PE4E, 1D1FBE, 71E, 71GE, 71GEGG, FS30E   |                 |                   |
| <b>accessories for</b>  | 375038   |                 |                   |
|  | <b>GEV No.</b>   | 110123          | <b>Ref. No.</b> — |
|   | knob thermostat t.max. 300°C ø 50mm shaft ø 6x4.6mm shaft flat upper black temperature range 50-300°C rotation 270°  |                 |                   |



|                    |   |                 |         |
|--------------------|---|-----------------|---------|
| <b>GEV No.</b>     | 375836  | <b>Ref. No.</b> | 3001550 |
| <b>description</b> | thermostat t.max. 95°C temperature range fixed 95°C 3-pole 1CO/2NC 16A probe ø 3.1mm probe L 226mm capillary pipe 880mm capillary pipe isolated 880mm gland nut |                 |         |
| <b>For models:</b> | 08WGREV, 190GRE, 1G0GRE, 1G1PE1E, 1G1PE1EV, 1G1PE2E, 1G1PE2EV, 2G1PE1E, 2G1PE1EV, 2G1PE2E, 2G1PE2EV   |                 |         |





|                    |  |                 |         |
|--------------------|--|-----------------|---------|
| <b>GEV No.</b>     | 375991   | <b>Ref. No.</b> | 3110640 |
| <b>description</b> | thermostat t.max. 560°C temperature range fixed 560°C 3-pole 3NC 16A probe ø 3.9mm probe L 225mm capillary pipe 1150mm capillary pipe isolated 600mm gland nut |                 |         |
| <b>For models:</b> | 04WPBEV, 08WPBEV, 08WTPBEV, 090PEB, 091PEB, 190PEB, 190TPE, 191PEB, 191TPE, 6042610, 6042630, 6044340, 6044350   |                 |         |

safety thermostats

55.10/19\_ series



|   |   |                 |                               |
|---|---|-----------------|-------------------------------|
| <b>GEV No.</b>  | 375166  | <b>Ref. No.</b> | 31Z7990<br>32Z3340<br>32Z8000 |
| <b>description</b>  | safety thermostat switch-off temp. 230°C 1-pole 0.5A probe ø 11mm probe L 16.5mm capillary pipe 850mm capillary pipe isolated 850mm gland nut probe screw-in probe probe thread M14x1 |                 |                               |
| <b>For models:</b>  | 30F, 30FS, 70F, 71F   |                 |                               |
| <b>accessories for</b>  | 375166  |                 |                               |
|  | <b>GEV No.</b>  | 521133          | <b>Ref. No.</b> —             |
|   | nut thread M14x1.5 H 6mm WS 19 zinc-coated steel Qty 1 pcs  |                 |                               |
|  | <b>GEV No.</b>  | 532520          | <b>Ref. No.</b> 3150390       |
|   | O-ring silicone thickness 2.62mm ID ø 15.08mm Qty 1 pcs   |                 |                               |
|  | <b>GEV No.</b>  | 550261          | <b>Ref. No.</b> —             |
|   | nut thread M14x1 H 4mm WS 19 SS Qty 1 pcs   |                 |                               |



|                    |  |                 |         |
|--------------------|--|-----------------|---------|
| <b>GEV No.</b>     | 375411   | <b>Ref. No.</b> | 32z0130 |
| <b>description</b> | thermostat t.max. 93°C temperature range 30-93°C 3-pole 3NO 16A probe ø 6mm probe L 129mm capillary pipe 1480mm capillary pipe isolated 1100mm gland nut M10x1 shaft ø 6x4.6mm shaft L 23mm shaft position upper rotation 270° |                 |         |



Зип Общепит

vsezip.ru

+7(812)987-08-81

55.32\_series



1

|                    |  |                 |                    |
|--------------------|--|-----------------|--------------------|
| <b>GEV No.</b>     | 375308   | <b>Ref. No.</b> | 32Z9620<br>32Z9621 |
| <b>description</b> | safety thermostat switch-off temp. 135°C 3-pole 0.5A probe ø 11mm probe L 27.5mm capillary pipe 1000mm capillary pipe isolated 960mm gland nut probe screw-in probe probe thread M14x1 |                 |                    |
| <b>For models:</b> | 191PI1G, 191PI1GA, 191PI2G, 191PI2GA, 1A1PI1G, 1A1PI1GA, 1D1PI1G, 1D1PI1GA, 1G1PI1G, 291PD3G, 291PI3G, 31PI6, 71PI10, 71PI10A, 91PI10, 91PI10A   |                 |                    |



1

|                    |  |                 |        |
|--------------------|--|-----------------|--------|
| <b>GEV No.</b>     | 375208   | <b>Ref. No.</b> | 32V398 |
| <b>description</b> | safety thermostat switch-off temp. 139°C 3-pole 2x20/1x0.5A probe ø 6mm probe L 77mm capillary pipe 890mm capillary pipe isolated-mm gland nut M9x1 probe SS |                 |        |



1

|                    |   |                 |                    |
|--------------------|---|-----------------|--------------------|
| <b>GEV No.</b>     | 375209  | <b>Ref. No.</b> | 32V3980<br>32Z2011 |
| <b>description</b> | safety thermostat switch-off temp. 140°C 3-pole 20A probe ø 6mm probe L 89mm capillary pipe 900mm capillary pipe isolated 900mm gland nut probe SS                              |                 |                    |
| <b>For models:</b> | 191CP1GA, 1A1CP1GA, 1A1PI2G, 1A1PI2GA, 1D1CP1GA, 1D1PI2G, 1D1PI2GA, 291PD3G, 291PI3G, 2A1PD3G, 2A1PI3G, 2D1PI3G, F60P, F60PR, F60T, F80P, F80PR, L100, L40, L40S, L45, L60, L80 |                 |                    |



1

|                    |   |                 |         |
|--------------------|---|-----------------|---------|
| <b>GEV No.</b>     | 375622  | <b>Ref. No.</b> | 32V0320 |
| <b>description</b> | safety thermostat switch-off temp. 147°C 1-pole 20A probe ø 6mm probe L 89mm capillary pipe 900mm capillary pipe isolated 800mm gland nut probe |                 |         |
| <b>For models:</b> | 291PI3E, 2A1PI3E, MCF20E, MCF40E  |                 |         |



1

|                    |   |                 |         |
|--------------------|---|-----------------|---------|
| <b>GEV No.</b>     | 390166  | <b>Ref. No.</b> | 32Z2710 |
| <b>description</b> | safety thermostat switch-off temp. 150°C 3-pole 20A probe ø 6mm probe L 87mm capillary pipe 1490mm capillary pipe isolated 1250mm gland nut M9x1 probe SS                 |                 |         |
| <b>For models:</b> | 04WCP1EM, 0A1CP1E, 0D1CP1E, 0G1CP1E, 191PI2E, 191PI2EA, 1A1PI2E, 1A1PI2EA, 1D1PI2E, 1D1PI2EA, 1G1PI1E, 30CPSE, 31PIE6, 70CPE, 71PIE15, 71PIE15A, 90CPE, 91PIE15, 91PIE15A |                 |         |



1

|                    |   |                 |         |
|--------------------|---|-----------------|---------|
| <b>GEV No.</b>     | 375528  | <b>Ref. No.</b> | 32V0460 |
| <b>description</b> | safety thermostat switch-off temp. 200°C 1-pole 0.5A probe ø 6mm probe L 79mm capillary pipe 900mm capillary pipe isolated 900mm gland nut probe SS |                 |         |
| <b>For models:</b> | 090BM1G, 0A0BMG, 0D0BMG, 190BM2G, 1A0BMG, 1D0BMG  |                 |         |





Зип Общепит

vsezip.ru

+7(812)987-08-81



|                    |  |                 |         |
|--------------------|--|-----------------|---------|
| <b>GEV No.</b>     | 375290   | <b>Ref. No.</b> | 32Z3631 |
| <b>description</b> | safety thermostat switch-off temp. 240°C 3-pole 20A probe ø 6mm probe L 87mm capillary pipe 2000mm capillary pipe isolated 1800mm gland nut probe SS |                 |         |
| <b>For models:</b> | 030FE, 030FE1, 030FE1B, 091FE28, 091FE28B, 30FES, 30FES2, 30FES2B, 70FE, 70FE1, 70FE1B, 70FES, 70FES2, 70FES2B, 71FE, 71FE2, 71FE2B                  |                 |         |



|                    |   |                 |         |
|--------------------|---|-----------------|---------|
| <b>GEV No.</b>     | 391040  | <b>Ref. No.</b> | 32V6561 |
| <b>description</b> | safety thermostat switch-off temp. 270°C 3-pole 3NC 16A probe ø 6mm probe L 79mm capillary pipe 2050mm capillary pipe isolated 1700mm probe no to be sold in France probe material SS   |                 |         |
| <b>For models:</b> | 04WFR3ED, 08WFR4ED, 091FR1E, 091FR1EA, 091FR1ED, 091FR1EX, 091FR3E, 091FR3ED, 091FR7G, 091FR7GS, 091FR7G-VERS.052012, 091FR7GX, 0A1FR1E, 0A1FR1ED, 0A1FR3E, 0A1FR3ED, 0D1FR1E, 0D1FR1ED, 0D1FR3E, 0D1FR3ED, 0G0FR3E, 0G0FR3ED, 191FR2E, 191FR2ED, 191FR4E, 1A1FR2E, 1A1FR2ED, 1A1FR4E, 1A1FR4ED, 1D1FR2ED, 1D1FR4E, 1D1FR4ED, 1G0FR4E, 6043840, 6043970 |                 |         |



|                    |   |                 |                               |
|--------------------|---|-----------------|-------------------------------|
| <b>GEV No.</b>     | 375841  | <b>Ref. No.</b> | 32V4630<br>32Z0200<br>32Z7980 |
| <b>description</b> | safety thermostat switch-off temp. 248°C 3-pole probe ø 6mm probe L 87mm capillary pipe 1500mm capillary pipe isolatedmm gland nut probe SS |                 |                               |
| <b>For models:</b> | 0M0FR1E, 1M0FR2E  |                 |                               |



|                    |   |                 |         |
|--------------------|---|-----------------|---------|
| <b>GEV No.</b>     | 375840  | <b>Ref. No.</b> | 32V6560 |
| <b>description</b> | safety thermostat switch-off temp. 270°C 3-pole 3NC 20A probe ø 6mm probe L 79mm capillary pipe 2000mm capillary pipe isolatedmm gland nut probe SS   |                 |         |
| <b>For models:</b> | 04WFR3ED, 08WFR4ED, 091FR1E, 091FR1ED, 091FR3E, 091FR3ED, 0A1FR1E, 0A1FR1ED, 0A1FR3E, 0A1FR3ED, 0D1FR1E, 0D1FR1ED, 0D1FR3E, 0D1FR3ED, 0G0FR3E, 0G0FR3ED, 191FR2E, 191FR2ED, 191FR4E, 191FR4ED, 1A1FR2E, 1A1FR2ED, 1A1FR4E, 1A1FR4ED, 1D1FR2ED, 1D1FR4E, 1D1FR4ED, 1G0FR4E |                 |         |



|                    |   |                 |         |
|--------------------|---|-----------------|---------|
| <b>GEV No.</b>     | 375292  | <b>Ref. No.</b> | 32V0970 |
| <b>description</b> | safety thermostat switch-off temp. 253°C 3-pole 20A probe ø 6mm probe L 79mm capillary pipe 2000mm capillary pipe isolated 1800mm gland nut probe |                 |         |
| <b>For models:</b> | 0A1FR1E, 0A1FR1ED, 0D1FR1E, 0D1FR1ED, 1A1FR2E, 1A1FR2ED, 1D1FR2ED   |                 |         |



|                    |  |                 |                    |
|--------------------|--|-----------------|--------------------|
| <b>GEV No.</b>     | 375286   | <b>Ref. No.</b> | 32Z5381<br>32Z5610 |
| <b>description</b> | safety thermostat switch-off temp. 285°C 1-pole 0.5A probe ø 4mm probe L 120mm capillary pipe 1500mm capillary pipe isolated 1500mm gland nut probe  |                 |                    |
| <b>For models:</b> | 06WFR3GD, 091FR1G, 091FR1GD, 091FR3G, 091FR3GD, 0A1FR1G, 0A1FR1GD, 0A1FR1GD-VERS.2004, 0A1FR1G-VERS.2004, 0A1FR3G, 0A1FR3GD, 0B1FR1G, 0B1FR1GD, 0D1FR1G, 0D1FR1GD, 0D1FR1GD-VERS.2004, 0D1FR1G-VERS.2004, 0D1FR3G, 0D1FR3GD, 0G1FR3G, 0G1FR3GD, 10WFR4GD, 191FR2G, 191FR2GD, 191FR4G, 191FR4GD, 1A1FR2G, 1A1FR2GD, 1A1FR2GD-VERS.2004, 1A1FR2G-VERS.2004, 1A1FR4G, 1A1FR4GD, 1D1FR2G, 1D1FR2GD, 1D1FR2GD-VERS.2004, 1D1FR2G-VERS.2004, 1D1FR4G, 1D1FR4GD, 1G1FR4G, 1G1FR4GD, 30F1, 30F1B, 30FS2, 30FS2B, 70F1, 70F1B, 71F2, 71F2B, 90F110B, 91F210...(Other models you can see in the webshop) |                 |                    |

Зип Общепит

vsezip.ru

+7(812)987-08-81



|                    |   |                 |         |
|--------------------|---|-----------------|---------|
| <b>GEV No.</b>     | 375943  | <b>Ref. No.</b> | 32Z5612 |
| <b>description</b> | safety thermostat switch-off temp. 299°C 1-pole 20A probe ø 4mm probe L 123mm capillary pipe 1500mm capillary pipe isolated 1400mm gland nut probe  |                 |         |
| <b>For models:</b> | 06WFR3GD, 091FR1G, 091FR1GD, 091FR1I, 091FR1IA, 091FR1ID, 091FR1ID-VERS.052012, 091FR1I-VERS.032012, 091FR3G, 091FR3GD, 0A1FR1G, 0A1FR1GD, 0A1FR1GD-VERS.2004, 0A1FR1G-VERS.2004, 0A1FR3G, 0A1FR3GD, 0B1FR1G, 0B1FR1GD, 0D1FR1G, 0D1FR1GD, 0D1FR1GD-VERS.2004, 0D1FR1G-VERS.2004, 0D1FR3G, 0D1FR3GD, 0G1FR3G, 0G1FR3GD, 10WFR4GD, 191FR2G, 191FR2GD, 191FR2I, 191FR2ID, 191FR2ID-VERS.092012, 191FR2I-VERS.032012, 191FR4G, 191FR4GD, 1A1FR2G, 1A1FR2GD, 1A1FR2GD-VERS.2004, 1A1FR2G-VERS.2004, 1A1FR4G, 1A1FR4GD, 1D1FR2G, 1D1FR2GD, 1D1FR2GD-VERS.2004, 1D1FR2G-VERS.2004, 1D1FR4G, 1D1FR4GD, 1G1FR4G, 1G1FR4GD, 30F1...(Other models you can see in the webshop) |                 |         |



|                    |  |                 |                    |
|--------------------|--|-----------------|--------------------|
| <b>GEV No.</b>     | 375307   | <b>Ref. No.</b> | 32Z9201<br>32Z9202 |
| <b>description</b> | safety thermostat switch-off temp. 365°C 3-pole 20A probe ø 4mm probe L 120mm capillary pipe 1300mm capillary pipe isolated 1250mm gland nut probe SS  |                 |                    |
| <b>For models:</b> | 031FTE04, 031FTE06, 06WBR3E, 06WFT1EV, 06WFT2EV, 06WFT3EV, 06WFT4EV, 06WFT6EV, 06WFT7EV, 070FTE04, 070FTE05, 071FTE04, 071FTE06, 08WFA4E, 08WFAAE, 08WFT1EV, 08WFT2EV, 08WFT3EV, 08WFT4EV, 08WFT6EV, 08WFT7EV, 090FT1E, 090FT2E, 090FT4E, 090FT5E, 090FT7E, 090FTE04, 090FTE05, 091FT1E, 091FT2E, 091FT4E, 091FT5E, 091FT7E, 091FTE04, 091FTE06, 0A0FT1E, 0A0FT2E, 0A0FT4E, 0A0FT5E, 0D0FT1E, 0D0FT2E, 0D0FT4E, 0D0FT5E, 0G0FT1E, 0G0FT2E, 0G0FT4E, 0G0FT5E, 0G0FT7E, 0G1BR3E, 0G1FT2E...(Other models you can see in the webshop) |                 |                    |



|                    |  |                 |         |
|--------------------|--|-----------------|---------|
| <b>GEV No.</b>     | 375220   | <b>Ref. No.</b> | 32Z6790 |
| <b>description</b> | safety thermostat switch-off temp. 330°C 3-pole 20A probe ø 11mm probe L 18.5mm capillary pipe 900mm capillary pipe isolated 900mm gland nut probe screw-in probe probe thread M14x1 |                 |         |
| <b>For models:</b> | FCV4E, FCV4EDS   |                 |         |



|                    |  |                 |                    |
|--------------------|--|-----------------|--------------------|
| <b>GEV No.</b>     | 375474   | <b>Ref. No.</b> | 3111950<br>32Z5511 |
| <b>description</b> | safety thermostat t.max. 340°C switch-off temp. 340°C 2-pole 1NC/1CO 1x20/1x0.5A probe ø 4mm probe L 120mm capillary pipe 1300mm capillary pipe isolated 900mm gland nut probe   |                 |                    |
| <b>For models:</b> | FC101, FC1011E, FC1011G, FC101E, FC1221E, FC1221G, FC241, FC241E, FC241G, FC61, FC611E, FC611G, FC61E, FCV101, FCV101DM, FCV101DS, FCV101E, FCV101EDM, FCV101EDS, FCV141, FCV141DM, FCV141DS, FCV141E, FCV141EDM, FCV141EDS, FCV241, FCV241DM, FCV241DS, FCV241E, FCV241EDM, FCV241EDS, FCV241G, FCV241G-CSA, FCV241GDM, FCV241GDS, FCV3EM, FCV401DM, FCV401EDM, FCV4EM, FCV61, FCV61DM, FCV61DS, FCV61E, FCV61EDM, FCV61EDS, FM1011E1, FM1011E1-VERS.2006, FM1011E2, FM1011E2-VERS.2006, FM1011E3...(Other models you can see in the webshop) |                 |                    |



|                    |   |                 |         |
|--------------------|---|-----------------|---------|
| <b>GEV No.</b>     | 375344  | <b>Ref. No.</b> | 32Z1400 |
| <b>description</b> | safety thermostat switch-off temp. 360°C 1-pole 0.5A probe ø 4mm probe L 120mm capillary pipe 1500mm capillary pipe isolated 1500mm gland nut probe   |                 |         |
| <b>For models:</b> | 031FT04, 031FT06, 070FT04, 070FT05, 071FT04, 071FT06, 08WFT-4GV, 08WFT6GV, 090FT04, 090FT05, 090FT4G, 090FT5G, 091FT04, 091FT06, 0A0FT1G, 0A0FT2G, 0A0FT4G, 0A0FT5G, 0B0FT1G, 0B0FT2G, 0B0FT4G, 0B0FT5G, 0D0FT1G, 0D0FT2G, 0D0FT4G, 0D0FT5G, 0G0FT4G, 0G0FT4G-VERS.032008, 0G0FT5G, 0G0FT5G-VERS.032008, 0G1BR3G, 190FT15G, 190FT42G, 190FT4G, 190FT6G, 1A0FT1G, 1A0FT2G, 1A0FT3G, 1A0FT4G, 1A0FT6G, 1B0FT4G, 1B0FT6G, 1D0FT1G, 1D0FT2G, 1D0FT3G, 1D0FT4G, 1D0FT6G, 1G0FT4G, 1G0FT4G-VERS.032008, 1G0FT6G...(Other models you can see in the webshop) |                 |         |



Зип Общепит

vsezip.ru

+7(812)987-08-81



|                    |  |                 |                    |
|--------------------|--|-----------------|--------------------|
| <b>GEV No.</b>     | 375438   | <b>Ref. No.</b> | 3014260<br>3014261 |
| <b>description</b> | thermostat switch-off temp. 156°C 3-pole 20A probe ø 6mm probe L 87mm capillary pipe 1490mm capillary pipe isolated 1350mm gland nut shaft ø 6x4.6mm probe                     |                 |                    |
| <b>For models:</b> | 04WCP1EM, 091CP1E, 0A1CP1E, 0D1CP1E, 0G1CP1E, 0G1CP1EC, 0G1CP1E-VERS.2004, 10CP1EA, 12CP1EA, 18CP2EA, 6040090, 6040310, 6043250, 6043470, 6043850, 6043980, PIER06HD, PIER15HD |                 |                    |



|                    |  |                 |         |
|--------------------|--|-----------------|---------|
| <b>GEV No.</b>     | 375288   | <b>Ref. No.</b> | 32Z6630 |
| <b>description</b> | thermostat capillary pipe isolatedmm gland nut shaft ø 6x4.6mm screw-in probe  |                 |         |
| <b>For models:</b> | 030FE1B, 091FE28B, 091FR1G, 091FR3G, 0A1FR1G, 0A1FR1G-VERS.2004, 0A1FR3G, 0A1FR3GD, 0B1FR1G, 0D1FR1G, 0D1FR1G-VERS.2004, 0D1FR3G, 0D1FR3GD, 0G1FR3G, 191FR2G, 191FR4G, 1A1FR2G, 1A1FR2G-VERS.2004, 1A1FR4G, 1A1FR4GD, 1D1FR2G, 1D1FR2G-VERS.2004, 1D1FR4G, 1D1FR4GD, 1G1FR4G, 30F1B, 30FES2B, 30FS2B, 70F1B, 70FE1B, 70FES2, 70FES2B, 71F2B, 71FE2B, 90F110B, 91F210B, 91F223B |                 |         |





control thermostats with operation switch

51.\_series



|                    |   |                 |         |
|--------------------|---|-----------------|---------|
| <b>GEV No.</b>     | 375346  | <b>Ref. No.</b> | 32Z9270 |
| <b>description</b> | thermostat t.max. 110°C temperature range 30-110°C 1-pole 1NO 15A probe ø 6mm probe L 130mm capillary pipe 900mm capillary pipe isolated 900mm shaft ø 6x4.6mm shaft L 23mm shaft position upper rotation 318° outer switch 2NO |                 |         |



|   |   |                 |                         |
|---|---|-----------------|-------------------------|
| <b>GEV No.</b>  | 375289  | <b>Ref. No.</b> | 32Z2480                 |
| <b>description</b>  | thermostat t.max. 180°C temperature range 100-180°C 1-pole 1NO 16A probe ø 11mm probe L 10mm capillary pipe 850mm capillary pipe isolated 850mm gland nut outer switch 2NO probe thread M14x1 |                 |                         |
| <b>For models:</b>  | 030FE, 30FES, 70FE, 70FES, 71FE   |                 |                         |
| <b>spare parts for</b>  | 375289  |                 |                         |
|  | <b>GEV No.</b>  | 300200          | <b>Ref. No.</b> —       |
|   | operation switch 2 operating positions 2NO 16A sequence 0-1 shaft ø 6x4.6mm shaft L 23mm connection male faston 6.3mm operation switch ceramic  |                 |                         |
|  | <b>GEV No.</b>  | 550060          | <b>Ref. No.</b> —       |
|   | connecting bow long for thermostat Qty 1 pcs  |                 |                         |
| <b>accessories for</b>  | 375289  |                 |                         |
|  | <b>GEV No.</b>  | 361182          | <b>Ref. No.</b> 3117580 |
|   | nut thread 1/4" H 5mm nickel-plated brass WS 17 Qty 1 pcs   |                 |                         |
|  | <b>GEV No.</b>  | 532520          | <b>Ref. No.</b> 3150390 |
|   | O-ring silicone thickness 2.62mm ID ø 15.08mm Qty 1 pcs   |                 |                         |



|                    |   |                 |         |
|--------------------|---|-----------------|---------|
| <b>GEV No.</b>     | 390069  | <b>Ref. No.</b> | 32Z0500 |
| <b>description</b> | thermostat t.max. 265°C temperature range 45-265°C 1-pole 1NO 15A probe ø 3mm probe L 219mm capillary pipe 900mm capillary pipe isolatedmm shaft ø 6x4.6mm shaft L 23mm shaft position upper rotation 270° outer switch 2NO |                 |         |

Зип-Общепит

vsezip.ru

+7(812)987-08-81



|                    |   |                 |                    |
|--------------------|---|-----------------|--------------------|
| <b>GEV No.</b>     | 390600  | <b>Ref. No.</b> | 32V0240<br>6300752 |
| <b>description</b> | thermostat t.max. 185°C temperature range 105-185°C 1-pole 1NO 16A probe Ø6mm probe L 130mm capillary pipe 900mm capillary pipe isolated 700mm gland nut M10x1 shaft Ø6x4.6mm shaft L 23mm shaft position lower rotation 270° probe material SS |                 |                    |
| <b>For models:</b> | 091FR1E, 091FR3E, 0A1FR1E, 0A1FR3E, 0A1FR3ED, 0D1FR1E, 0D1FR3E, 0D1FR3ED, 0G0FR3E, 191FR2E, 191FR4E, 1A1FR2E, 1A1FR4E, 1A1FR4ED, 1D1FR4E, 1D1FR4ED, 1G0FR4E   |                 |                    |

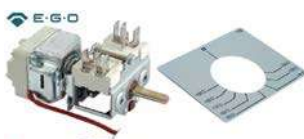

|                    |  |                 |         |
|--------------------|--|-----------------|---------|
| <b>GEV No.</b>     | 375293   | <b>Ref. No.</b> | 6005040 |
| <b>description</b> | thermostat t.max. 185°C temperature range 106-185°C 1-pole 1NO probe Ø8mm probe L 50mm capillary pipe 850mm capillary pipe isolated 850mm gland nut shaft position lower rotation 270° probe thread 1/2" |                 |         |



|                    |  |                 |                    |
|--------------------|--|-----------------|--------------------|
| <b>GEV No.</b>     | 375768   | <b>Ref. No.</b> | 32V6510<br>32Z2670 |
| <b>description</b> | thermostat t.max. 310°C temperature range 50-310°C 1-pole 1NO 16A probe Ø4mm probe L 128mm capillary pipe 1500mm capillary pipe isolated 1500mm gland nut shaft Ø6x4.6mm shaft L 23mm shaft position upper rotation 270° |                 |                    |
| <b>For models:</b> | 06WBR3E, 070FTE, 070FTE, 071FTE, 071FTE, 071FTE, 090FTE, 090FTE, 091FTE, 091FTE, 091FTE, 091FTE, 0G1BR3E, 1G1BR1E, 1G1BR3E, 31RE, 71AR, 71ARE, 71AR, 91AR, 91ARE, 91RA   |                 |                    |



|                    |   |                 |         |
|--------------------|---|-----------------|---------|
| <b>GEV No.</b>     | 375900  | <b>Ref. No.</b> | 32Z9271 |
| <b>description</b> | thermostat t.max. 112°C temperature range 28-112°C 1-pole 1NO 15A probe Ø6mm probe L 115mm capillary pipe 900mm capillary pipe isolated 810mm gland nut shaft Ø6x4.6mm shaft L 23mm shaft position upper rotation 315° outer switch yes probe material SS |                 |         |
| <b>For models:</b> | 04WBMEV, 090BM1E, 0A0BME, 0B0BME, 0D0BME, 0G0BME-VERS.032008, 1G0BME-VERS.032008, 6040110, 6042680  |                 |         |

55.34\_ series



|                    |   |                 |         |
|--------------------|---|-----------------|---------|
| <b>GEV No.</b>     | 375342  | <b>Ref. No.</b> | 32V0060 |
| <b>description</b> | thermostat t.max. 110°C temperature range 30-110°C 3-pole 3NO 16A probe Ø6mm probe L 130mm capillary pipe 1200mm capillary pipe isolated 1200mm gland nut shaft Ø6x4.6mm shaft L 23mm shaft position lower rotation 318° outer switch 2NO |                 |         |
| <b>For models:</b> | 12WFAAA, 190BM2E, 1A0BME, 1D0BME, 6043250, 6043470  |                 |         |

|                               |  |  |  |
|-------------------------------|--|--|--|
| <b>spare parts for</b> 375342 |  |  |  |
|-------------------------------|--|--|--|

|  |                |        |                 |   |
|--|----------------|--------|-----------------|---|
|  | <b>GEV No.</b> | 300200 | <b>Ref. No.</b> | — |
| operation switch 2 operating positions 2NO 16A sequence 0-1 shaft Ø6x4.6mm shaft L 23mm connection male faston 6.3mm operation switch ceramic  |                |        |                 |   |
|  | <b>GEV No.</b> | 375814 | <b>Ref. No.</b> | — |
| thermostat t.max. 110°C temperature range 30-110°C 3-pole 3NO 16A probe Ø6mm probe L 130mm capillary pipe 1200mm capillary pipe isolated 1200mm gland nut shaft Ø6x4.6mm shaft L 23mm shaft position upper rotation 318° |                |        |                 |   |
|  | <b>GEV No.</b> | 550060 | <b>Ref. No.</b> | — |
| connecting bow long for thermostat Qty 1 pcs   |                |        |                 |   |



Зип Общепит

vsezip.ru

+7(812)987-08-81





|                    |   |                 |         |
|--------------------|---|-----------------|---------|
| <b>GEV No.</b>     | 390765  | <b>Ref. No.</b> | 32Z5970 |
| <b>description</b> | thermostat t.max. 110°C temperature range 30-110°C 3-pole 3NO 16A probe ø 6mm probe L 131mm capillary pipe 1160mm gland nut shaft ø 6x4.6mm shaft L 23mm shaft position upper rotation 310° |                 |         |
| <b>For models:</b> | ACBM, ACBM218, ANBM, ANBM218, ANBM75, SE14VB, SE21VB, SI14VB, SI21VB, SL14CVB, SL14NVB, SL21CVB, SL21NVB, SL7NVB, TBM, TBM218   |                 |         |



|   |   |                 |                   |
|---|---|-----------------|-------------------|
| <b>GEV No.</b>  | 375269  | <b>Ref. No.</b> | 32Z3790           |
| <b>description</b>  | thermostat t.max. 300°C temperature range 100-300°C 3-pole 3NO 16A probe ø 6mm probe L 75mm capillary pipe 1150mm capillary pipe isolated 1150mm gland nut shaft L 23mm rotation 270° outer switch 4NO  |                 |                   |
| <b>For models:</b>  | 030FTE, 030FTE06, 031FTE, 031FTE06, 031FTE08, 031FTE12, 031FTE16, 031FTE20, 031FTE24, 031FTE28, 031FTE32, 031FTE36, 031FTE40, 031FTE44, 031FTE48, 031FTE52, 031FTE56, 031FTE60, 031FTE64, 031FTE68, 031FTE72, 031FTE76, 031FTE80, 031FTE84, 031FTE88, 031FTE92, 031FTE96, 031FTE100, 031FTE104, 031FTE108, 031FTE112, 031FTE116, 031FTE120, 031FTE124, 031FTE128, 031FTE132, 031FTE136, 031FTE140, 031FTE144, 031FTE148, 031FTE152, 031FTE156, 031FTE160, 031FTE164, 031FTE168, 031FTE172, 031FTE176, 031FTE180, 031FTE184, 031FTE188, 031FTE192, 031FTE196, 031FTE200, 031FTE204, 031FTE208, 031FTE212, 031FTE216, 031FTE220, 031FTE224, 031FTE228, 031FTE232, 031FTE236, 031FTE240, 031FTE244, 031FTE248, 031FTE252, 031FTE256, 031FTE260, 031FTE264, 031FTE268, 031FTE272, 031FTE276, 031FTE280, 031FTE284, 031FTE288, 031FTE292, 031FTE296, 031FTE300 |                 |                   |
| <b>spare parts for</b>  | 375269  |                 |                   |
|  | <b>GEV No.</b>  | 300080          | <b>Ref. No.</b> — |
|   | cam switch 2 operating positions 4NO 16A sequence 0-1 shaft ø 6x4.6mm shaft L 23mm connection screw operation switch ceramic ambient temperature max. 150°C   |                 |                   |
|  | <b>GEV No.</b>  | 375453          | <b>Ref. No.</b> — |
|   | thermostat t.max. 308°C temperature range 100-300°C 3-pole 3NO 16A probe ø 6mm probe L 75mm capillary pipe 1150mm capillary pipe isolated 1150mm gland nut shaft ø 6x4.6mm shaft L 23mm rotation 270° probe material SS   |                 |                   |



|   |   |                 |                   |
|---|---|-----------------|-------------------|
| <b>GEV No.</b>  | 375274  | <b>Ref. No.</b> | 32Z7400           |
| <b>description</b>  | thermostat t.max. 260°C temperature range 100-260°C 3-pole 3NO 16A probe ø 6mm probe L 75mm capillary pipe 1150mm capillary pipe isolated 1150mm gland nut rotation 270°  |                 |                   |
| <b>For models:</b>  | 031FTE04, 031FTE06, 06WFT1EV, 06WFT2EV, 06WFT3EV, 06WFT4EV, 06WFT6EV, 06WFT7EV, 070FTE04, 070FTE05, 071FTE04, 071FTE06, 08WFT1EV, 08WFT2EV, 08WFT3EV, 08WFT4EV, 08WFT6EV, 08WFT7EV, 090FT1E, 090FT2E, 090FT4E, 090FT5E, 090FT7E, 090FTE04, 090FTE05, 091FT1E, 091FT2E, 091FT4E, 091FT5E, 091FT7E, 091FTE04, 091FTE06, 0A0FT1E, 0A0FT2E, 0A0FT4E, 0A0FT5E, 0D0FT1E, 0D0FT2E, 0D0FT4E, 0D0FT5E, 0G0FT1E, 0G0FT2E, 0G0FT4E, 0G0FT5E, 0G0FT7E, 0G1FT2E, 0G1FT4E, 0G1FT5E, 0G1FT7E, 190FT15E...(Other models you can see in the webshop) |                 |                   |
| <b>spare parts for</b>  | 375274  |                 |                   |
|  | <b>GEV No.</b>  | 300200          | <b>Ref. No.</b> — |
|   | operation switch 2 operating positions 2NO 16A sequence 0-1 shaft ø 6x4.6mm shaft L 23mm connection male faston 6.3mm operation switch ceramic  |                 |                   |
|  | <b>GEV No.</b>  | 375813          | <b>Ref. No.</b> — |
|   | thermostat t.max. 260°C temperature range 100-260°C 3-pole 3NO 16A probe ø 6mm probe L 75mm capillary pipe 1150mm capillary pipe isolated 1150mm gland nut shaft ø 6x4.6mm shaft L 23mm shaft position upper rotation 270°  |                 |                   |
|  | <b>GEV No.</b>  | 550060          | <b>Ref. No.</b> — |
|   | connecting bow long for thermostat Qty 1 pcs  |                 |                   |



|   |  |                 |                    |
|---|--|-----------------|--------------------|
| <b>GEV No.</b>  | 375299   | <b>Ref. No.</b> | 32V0660<br>32V0661 |
| <b>description</b>  | thermostat t.max. 330°C temperature range 60-330°C 2-pole 2NO 16A probe ø 4mm probe L 128mm capillary pipe 1500mm capillary pipe isolated 1450mm gland nut shaft ø 6x4.6mm shaft L 23mm shaft position upper rotation 270° outer switch 2NO  |                 |                    |
| <b>For models:</b>  | 191BR1E, 191BR1G, 191BR1GA, 191BR2E, 191BR2EA, 191BR2G, 191BR2GA, 1A1BR1E, 1A1BR1G, 1A1BR1GA, 1A1BR2E, 1A1BR2EA, 1A1BR2G, 1A1BR2GA, 1D1BR1E, 1D1BR1G, 1D1BR1GA, 1D1BR2E, 1D1BR2EA, 1D1BR2G, 1D1BR2GA, 291BR1E, 291BR1G, 291BR1GA, 291BR2E, 291BR2EA, 291BR2G, 291BR2GA, 2A1BR1E, 2A1BR1G, 2A1BR1GA, 2A1BR2E, 2A1BR2EA, 2A1BR2G, 2A1BR2GA, 2D1BR1E, 2D1BR1G, 2D1BR1GA, 2D1BR2E, 2D1BR2EA, 2D1BR2G, 2D1BR2GA |                 |                    |
| <b>spare parts for</b>  | 375299   |                 |                    |
|  | <b>GEV No.</b>   | 300200          | <b>Ref. No.</b> —  |
|   | operation switch 2 operating positions 2NO 16A sequence 0-1 shaft ø 6x4.6mm shaft L 23mm connection male faston 6.3mm operation switch ceramic   |                 |                    |
|  | <b>GEV No.</b>   | 550060          | <b>Ref. No.</b> —  |
|   | connecting bow long for thermostat Qty 1 pcs   |                 |                    |

electric components



IMIT / TEMPOMATIC / ARTHERMO

control thermostats



|                    |   |                 |         |
|--------------------|---|-----------------|---------|
| <b>GEV No.</b>     | 390193  | <b>Ref. No.</b> | 32V1920 |
| <b>description</b> | thermostat t.max. 56°C temperature range 0-90°C 1-pole 1CO 16A probe ø 6.5mm probe L 95mm capillary pipe 1500mm capillary pipe isolated 1500mm gland nut shaft ømm shaft Lmm shaft position rotation 270° probe material copper |                 |         |
| <b>For models:</b> | LC100, LC100-VERS.2001, LC130, LC130-VERS.2001, LC80  |                 |         |



|                    |   |                 |         |
|--------------------|---|-----------------|---------|
| <b>GEV No.</b>     | 390421  | <b>Ref. No.</b> | 32Z7200 |
| <b>description</b> | thermostat t.max. 85°C temperature range 0-90°C 1-pole 1CO 16A probe ø 6.5mm probe L 95mm capillary pipe 1500mm capillary pipe isolated 1450mm gland nut shaft ømm shaft Lmm shaft position rotation 270° probe material copper |                 |         |
| <b>For models:</b> | LT10R, LT20F, LT25F   |                 |         |

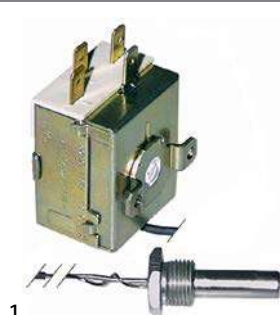

|                    |  |                 |         |
|--------------------|--|-----------------|---------|
| <b>GEV No.</b>     | 390310   | <b>Ref. No.</b> | 32V2630 |
| <b>description</b> | thermostat t.max. 85°C temperature range fixed 55°C 1-pole 1CO 16A probe ø 9.5mm probe L 37mm capillary pipe 600mm capillary pipe isolated 540mm gland nut shaft ømm shaft Lmm shaft position rotation° screw-in probe probe thread 3/8" probe material SS |                 |         |
| <b>For models:</b> | LF50, LF50E, LF50EM, LF50EMPS, LF50E-VERS.2007   |                 |         |

|                        |   |        |                 |   |
|------------------------|---|--------|-----------------|---|
| <b>accessories for</b> | 390310  |        |                 |   |
|                        | <b>GEV No.</b>  | 506024 | <b>Ref. No.</b> | — |
|                        | nut thread 3/8" H 6mm SS WS 22 Qty 1 pcs  |        |                 |   |
|                        | <b>GEV No.</b>  | 529349 | <b>Ref. No.</b> | — |
|                        | flat gasket FIBER ED ø 22mm ID ø 16.5mm thickness 2mm for thread 3/8" Qty 1 pcs |        |                 |   |

Зип Общепит

vsezip.ru

+7(812)987-08-81



|                    |  |                 |                    |
|--------------------|--|-----------------|--------------------|
| <b>GEV No.</b>     | 390006   | <b>Ref. No.</b> | 32V1910<br>32Z8840 |
| <b>description</b> | thermostat t.max. 86°C temperature range 0-86°C 1-pole 1CO 16A probe ø 6.5mm probe L 95mm capillary pipe 1500mm capillary pipe isolatedmm gland nut shaft ø 6x4.6mm shaft L 19mm rotation 270°   |                 |                    |
| <b>For models:</b> | C207D-VERS.2006, C207S-VERS.2006, C207VD-VERS.2006, C207VS-VERS.2006, C304AD-VERS.2006, C304AS-VERS.2006, C304AVD-VERS.2006, C304AVS-VERS.2006, C304D-VERS.2006, C304S-VERS.2006, C304VD-VERS.2006, C304VS-VERS.2006, C92D-VERS.2006, C92S-VERS.2006, C92VD-VERS.2006, C92VS-VERS.2006, CS243D-VERS.2006, CS243S-VERS.2006, CS243VD-VERS.2006, CS243VS-VERS.2006, CS370AD-VERS.2006, CS370AS-VERS.2006, CS370AVD-VERS.2006, CS370AVS-VERS.2006, CS370D-VERS.2006, CS370S-VERS.2006, CS370VD-VERS.2006, CS370VS-VERS.2006, CS466AD-VERS.2006, CS466AS-VERS.2006, CS466AVD-VERS.2006, CS466AVS-VERS.2006, CS466D-VERS.2006, CS466S-VERS.2006, CS466VD-VERS.2006, CS466VS-VERS.2006, LC100, LC100-VERS.2001, LC130, LC130-VERS.2001, LC80, LF50 |                 |                    |

|                        |  |        |                 |         |
|------------------------|--|--------|-----------------|---------|
| <b>accessories for</b> | 390006   |        |                 |         |
|                        | <b>GEV No.</b>   | 110100 | <b>Ref. No.</b> | 36M2830 |
|                        | knob thermostat t.max. 90°C 0-90°C ø 42mm shaft ø 6x4.6mm shaft flat -135° black |        |                 |         |
|                        | <b>GEV No.</b>   | 110105 | <b>Ref. No.</b> | —       |
|                        | rosette knob ø 42mm ø 56mm zero mark   |        |                 |         |



|                    |  |                 |         |
|--------------------|--|-----------------|---------|
| <b>GEV No.</b>     | 390704   | <b>Ref. No.</b> | 32Z8840 |
| <b>description</b> | thermostat t.max. 86°C temperature range 0-86°C 1-pole 1CO 16A probe ø 6.5mm probe L 98mm capillary pipe 1020mm capillary pipe isolated 950mm gland nut shaft ø 6x4.6mm shaft L 19mm shaft position +135° rotation 270° probe material copper 250V   |                 |         |
| <b>For models:</b> | C165D, C165S, C165VD, C165VS, C207D, C207S, C207VD, C207VS, C304AD, C304AD-VERS.2006, C304AS, C304AS-VERS.2006, C304AVD, C304AVD-VERS.2006, C304AVS, C304AVS-VERS.2006, C304D, C304D-VERS.2006, C304S, C304S-VERS.2006, C304VD, C304VD-VERS.2006, C304VS, C304VS-VERS.2006, CS243D, CS243D-VERS.2006, CS243S, CS243S-VERS.2006, CS243VD, CS243VD-VERS.2006, CS243VS, CS243VS-VERS.2006, CS370AD, CS370AD-VERS.2006, CS370AS, CS370AS-VERS.2006, CS370AVD, CS370AVD-VERS.2006, CS370AVS, CS370AVS-VERS.2006, CS370D, CS370D-VERS.2006, CS370S, CS370S-VERS.2006, CS370VD, CS370VD-VERS.2006, CS370VS, CS370VS-VERS.2006, CS466AD, CS466AD-VERS.2006...(Other models you can see in the webshop) |                 |         |



Зип Общепит

vsezip.ru

+7(812)987-08-81



|                    |  |                 |         |
|--------------------|--|-----------------|---------|
| <b>GEV No.</b>     | 390460   | <b>Ref. No.</b> | 32V7240 |
| <b>description</b> | thermostat t.max. 90°C temperature range 30-90°C 1-pole 1CO 16A probe ø 6.5mm probe L 95mm capillary pipe 2000mm capillary pipe isolated 1950mm gland nut shaft ømm shaft Lmm shaft position rotation 270° probe material copper |                 |         |

safety thermostats

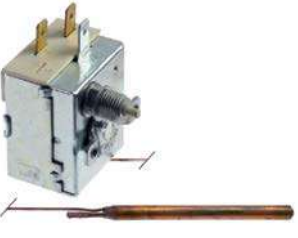

|                    |   |                 |                    |
|--------------------|---|-----------------|--------------------|
| <b>GEV No.</b>     | 390023  | <b>Ref. No.</b> | 32Z8530<br>32Z8830 |
| <b>description</b> | safety thermostat switch-off temp. 90-110°C 1-pole 16A probe ø 6.5mm probe L 90mm capillary pipe 1000mm capillary pipe isolated mm gland nut probe  |                 |                    |
| <b>For models:</b> | C165D, C165S, C207D, C207D-VERS.2006, C207S, C207S-VERS.2006, C207VD-VERS.2006, C207VS-VERS.2006, C304AD, C304AD-VERS.2006, C304AS, C304AS-VERS.2006, C304AVD-VERS.2006, C304A-VS-VERS.2006, C304D, C304D-VERS.2006, C304S, C304S-VERS.2006, C304VD-VERS.2006, C304VS-VERS.2006, C92D-VERS.2006, C92S-VERS.2006, C92VD-VERS.2006, C92VS-VERS.2006, CS243D, CS243S, CS243VD, CS243VS, CS370AD, CS370AS, CS370AVD, CS370AVS, CS370D, CS370S, CS370VD, CS370VS, CS466AD, CS466AS, CS466AVD, CS466AVS, CS466D, CS466S, CS466VD, CS466VS, LC100, LC100-VERS.2001, LC130, LC130-VERS.2001, LC80, LF50...(Other models you can see in the webshop) |                 |                    |

PRODIGY / FIRT

control thermostats



|                        |  |                 |         |
|------------------------|--|-----------------|---------|
| <b>GEV No.</b>         | 390723   | <b>Ref. No.</b> | 32Z0190 |
| <b>description</b>     | thermostat PRODIGY temperature range -35 up to +35°C probe ø 6mm probe L 110mm capillary pipe 1500mm type TR/711-N           |                 |         |
| <b>accessories for</b> | 390723   |                 |         |
|                        |   | <b>GEV No.</b>  | 110305  |
|                        |  | <b>Ref. No.</b> | —       |
|                        | knob thermostat t.max. 35°C temperature range -35 up to +35°C ø 45mm shaft ø 6x4.6mm shaft flat inclined rotation 270° white |                 |         |

safety thermostats



|                    |  |                 |         |
|--------------------|--|-----------------|---------|
| <b>GEV No.</b>     | 375832   | <b>Ref. No.</b> | 3040550 |
| <b>description</b> | safety thermostat t.max. 70°C temperature range 0-70°C 1-pole 1NO 16A probe ø 8mm probe L 60mm capillary pipe 870mm capillary pipe isolatedmm gland nut shaft ømm shaft Lmm shaft position rotation° probe material copper switch-off temp. 70°C |                 |         |
| <b>For models:</b> | PG22C, PG23C, PG23CW, PG24CW, PG30C, PG31CW, PG42C, PG43CW, PG60C, PG61CW, PG80C, PG80C-VERS.200911, PG81CW, PG81CW-VERS.200911, PGC132, PGC134W, PGC210, PGC212W  |                 |         |

various



control thermostats



|                    |   |                 |         |
|--------------------|---|-----------------|---------|
| <b>GEV No.</b>     | 375287  | <b>Ref. No.</b> | 6300359 |
| <b>description</b> | thermostat t.max. 190°C temperature range 160-190°C probe ø 16mm probe L 93mm probe thread 1/2" |                 |         |
| <b>For models:</b> | 030FE1, 30F1, 30FES2, 30FS2, 70F1, 70FE1, 70FES2, 71F2, 71FE2, 91F210                           |                 |         |

control thermostats with operation switch



|                        |  |                 |         |
|------------------------|--|-----------------|---------|
| <b>GEV No.</b>         | 375951   | <b>Ref. No.</b> | 6300738 |
| <b>description</b>     | thermostat t.max. 187°C 1-pole 1NO probe ø 6mm probe L 132mm capillary pipe 900mm capillary pipe isolated 480mm shaft ø 4.5x6mm shaft L 23mm outer switch 42.02900.000 with thermowell   |                 |         |
| <b>For models:</b>     | 030FE1B, 091FE28B, 091FR1G, 091FR3G, 0A1FR1G, 0A1FR1G-VERS.2004, 0A1FR3G, 0A1FR3GD, 0B1FR1G, 0D1FR1G, 0D1FR1G-VERS.2004, 0D1FR3G, 0D1FR3GD, 0G1FR3G, 191FR2G, 191FR4G, 1A1FR2G, 1A1FR2G-VERS.2004, 1A1FR4G, 1A1FR4GD, 1D1FR2G, 1D1FR2G-VERS.2004, 1D1FR4G, 1D1FR4GD, 1G1FR4G, 30F1B, 30FES2B, 30FS2B, 70F1B, 70FE1B, 70FES2, 70FES2B, 71F2B, 71FE2B, 90F110B, 91F210B, 91F223B |                 |         |
| <b>spare parts for</b> | 375951   |                 |         |
|                        |   | <b>GEV No.</b>  | 301115  |
|                        |  | <b>Ref. No.</b> | 3168540 |
|                        | cam switch 2 operating positions 2NO sequence 0-1 16A shaft ø 6x4.6mm shaft L 23mm connection male faston 6.3mm  |                 |         |
|                        |   | <b>GEV No.</b>  | 375922  |
|                        |  | <b>Ref. No.</b> | 3168460 |
|                        | thermostat t.max. 185°C temperature range 101-185°C 1-pole 1NO 16A probe ø 6mm probe L 133mm capillary pipe 870mm capillary pipe isolated 520mm gland nut M10x1 shaft ø 6x4.6mm shaft L 23mm shaft position upper  |                 |         |

Зип Общепит  
refrigeration thermostats

universal without housing  
vsezip.ru

+7(812)987-08-81



|                    |   |                 |                    |
|--------------------|---|-----------------|--------------------|
| <b>GEV No.</b>     | 375267  | <b>Ref. No.</b> | 32Z3550<br>32Z3551 |
| <b>description</b> | thermostat t.max. 290°C temperature range 50-290°C 3-pole 3NO probe ø 3mm probe L 219mm capillary pipe 1200mm capillary pipe isolated 1200mm shaft position lower rotation 270° |                 |                    |
| <b>For models:</b> | 1G1FA0E, 1G1FA0EV, 1G1PE1E, 1G1PE1EV, 1G1PE2E, 1G1PE2EV, 2G1FA0E, 2G1PE1E, 2G1PE1EV, 2G1PE2E, 2G1PE2EV, 31GE, 31TCE, 32TCE  |                 |                    |



|                    |  |                 |         |
|--------------------|--|-----------------|---------|
| <b>GEV No.</b>     | 375265   | <b>Ref. No.</b> | 32W0030 |
| <b>description</b> | thermostat t.max. 300°C temperature range 50-300°C 3-pole 3NO 16A probe ø 6mm probe L 79mm capillary pipe 1740mm capillary pipe isolated 800mm shaft ø 6x4.6mm rotation 270° |                 |         |

|                        |  |        |                 |         |
|------------------------|--|--------|-----------------|---------|
| <b>spare parts for</b> | 375265   |        |                 |         |
|                        | <b>GEV No.</b>   | 375038 | <b>Ref. No.</b> | 32Z2560 |
|                        | thermostat t.max. 300°C temperature range 50-300°C 3-pole 3NO 16A probe ø 6mm probe L 79mm capillary pipe 1740mm capillary pipe isolated 800mm gland nut shaft ø 6x4.6mm shaft L 23mm shaft position upper rotation 270° |        |                 |         |
|                        | <b>GEV No.</b>   | 550059 | <b>Ref. No.</b> | —       |
|                        | connecting bow short for switch Qty 1 pcs  |        |                 |         |

safety thermostats

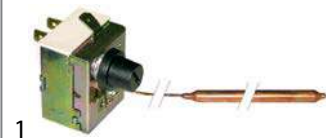

|                    |  |                 |         |
|--------------------|--|-----------------|---------|
| <b>GEV No.</b>     | 390194   | <b>Ref. No.</b> | 32V7260 |
| <b>description</b> | safety thermostat switch-off temp. 90-110°C 1-pole 16A probe ø 6.5mm probe L 87mm capillary pipe 1500mm capillary pipe isolated 1497mm connection male faston 6.3mm adjustable |                 |         |



|                |        |                 |  |
|----------------|--------|-----------------|--|
| <b>GEV No.</b> | 390534 | <b>Ref. No.</b> | 32Z1090<br>32Z2590<br>32Z6310<br>32Z7110 |
|----------------|--------|-----------------|--|

|                    |   |  |  |
|--------------------|---|--|--|
| <b>description</b> | thermostat temperature range -35 up to +35°C probe ø6x110mm capillary pipe 1800mm PRODIGY   |  |  |
| <b>For models:</b> | 120, 120B, 120NN, 120PV, 135, 135-4, 135B, 135BA, 135BN, 135BNX, 135BX, 135BXE, 135BXR, 135CPX, 135NN, 135NNX, 135PVX, 135X, 135X-3, 135X-4, 135XR, 40CP, 40CPX, 55, 55B, 55PV, 65, 65B, 65BA, 65BX, 65BX-2, 65BXE, 65BXR, 65NB, 65NBX, 65NN, 65NNX, 65PVX, 65X, 65X-2, 65XR, 6BMA11A, 6BMA11B, 6BMA11M, 6BMA2A, 6BMA2B, 6BMA2M, 6BMA3A, 6BMA3B, 6BMA3M...(Other models you can see in the webshop) |  |  |

|                        |  |        |                 |   |
|------------------------|--|--------|-----------------|---|
| <b>accessories for</b> | 390534   |        |                 |   |
|                        | <b>GEV No.</b>   | 110305 | <b>Ref. No.</b> | — |
|                        | knob thermostat t.max. 35°C temperature range -35 up to +35°C ø 45mm shaft ø 6x4.6mm shaft flat inclined rotation 270° white |        |                 |   |

RANCO

K22 series



|                    |   |                 |         |
|--------------------|---|-----------------|---------|
| <b>GEV No.</b>     | 390202  | <b>Ref. No.</b> | 32Z7450 |
| <b>description</b> | thermostat RANCO type K22L2025 probe ømm probe Lmm capillary pipe 1500mm temperature range +1°C up to +11°C |                 |         |
| <b>For models:</b> | PGA20, PGA30, PGA40, PGA60, PGA80, PGW20, PGW30, PGW40, PGW60, PGW80  |                 |         |



|                    |   |                 |         |
|--------------------|---|-----------------|---------|
| <b>GEV No.</b>     | 390207  | <b>Ref. No.</b> | 32Z3890 |
| <b>description</b> | thermostat RANCO type K22L2030 probe ø 2mm probe Lmm capillary pipe 2000mm temperature range -13 up to -4°C |                 |         |
| <b>For models:</b> | PGA20, PGA30, PGA40, PGA60, PGA80, PGW20, PGW30, PGW40, PGW60, PGW80  |                 |         |





Зип Общепит

vsezip.ru

+7(812)987-08-81

|   |  |                 |                    |
|---|--|-----------------|--------------------|
|  |  |                 |                    |
| <b>GEV No.</b>  | 390209   | <b>Ref. No.</b> | 32V2280<br>32V4360 |
| <b>description</b>  | thermostat RANCO type K22L1020 probe ø 9mm probe L 40mm capillary pipe 2000mm temperature range -20.5 up to -1.5°C |                 |                    |
| <b>For models:</b>  | PG22C, PG23C, PG23CW, PG24CW, PG30C, PG31CW  |                 |                    |

|   |   |                 |         |
|---|---|-----------------|---------|
|  |   |                 |         |
| <b>GEV No.</b>  | 390254  | <b>Ref. No.</b> | 32V4270 |
| <b>description</b>  | thermostat RANCO type K50P1135 probe ømm probe Lmm capillary pipe 2500mm T cold 1.5°C |                 |         |

|   |  |                 |         |
|---|--|-----------------|---------|
|  |  |                 |         |
| <b>GEV No.</b>  | 390737   | <b>Ref. No.</b> | 32V4400 |
| <b>description</b>  | thermostat RANCO type K22-L1074 probe ø 9mm probe L 42mm capillary pipe 1450mm temperature range -19 up to -1°C  |                 |         |
| <b>For models:</b>  | PG42C, PG43CW, PG60C, PG61CW, PG80C, PG80C-VERS.200911, PG81CW, PG81CW-VERS.200911, PGC132, PGC132-VERS.200911, PGC134W, PGC134W-VERS.200911, PGC210, PGC210-VERS.200911, PGC212W, PGC212W-VERS.200911 |                 |         |

|   |   |                 |         |
|---|---|-----------------|---------|
|  |   |                 |         |
| <b>GEV No.</b>  | 390581  | <b>Ref. No.</b> | 3111590 |
| <b>description</b>  | thermostat RANCO type K50-S3595 probe ø 2mm probe Lmm capillary pipe 2000mm |                 |         |
| <b>For models:</b>  | PG23C, PG24CW, PG30C, PG31CW  |                 |         |

|   |   |                 |         |
|---|---|-----------------|---------|
| <h3>K50 series</h3>   |   |                 |         |
|  |   |                 |         |
| <b>GEV No.</b>  | 390208  | <b>Ref. No.</b> | 3034730 |
| <b>description</b>  | thermostat RANCO type K50L3006 probe ømm probe Lmm capillary pipe 2000mm temperature range +1.5 up to +4°C  |                 |         |
| <b>For models:</b>  | PG22C, PG23C, PG23CW, PG24CW, PG30C, PG31CW, PG42C, PG43CW, PG60C, PG61CW, PG80C, PG80C-VERS.200911, PG81CW, PG81CW-VERS.200911, PGC132, PGC132-VERS.200911, PGC134W, PGC134W-VERS.200911, PGC210, PGC210-VERS.200911, PGC212W, PGC212W-VERS.200911 |                 |         |

|   |  |                 |         |
|---|--|-----------------|---------|
| <h3>K52 series</h3>   |  |                 |         |
|  |  |                 |         |
| <b>GEV No.</b>  | 390214   | <b>Ref. No.</b> | 32Z0920 |
| <b>description</b>  | thermostat RANCO type K52L4512 probe ø 11mm probe L 30mm capillary pipe 2100mm temperature range -6.4 up to +3.2°C |                 |         |
| <b>For models:</b>  | 40, 40EV, 40EVP, 40PL, 40PV, 40X, 40XPV  |                 |         |

|   |  |                 |         |
|---|--|-----------------|---------|
|  |  |                 |         |
| <b>GEV No.</b>  | 390278   | <b>Ref. No.</b> | 32Z6360 |
| <b>description</b>  | thermostat RANCO type K50L3207 probe ømm probe Lmm capillary pipe 1500mm temperature range -10 up to -2°C          |                 |         |
| <b>For models:</b>  | BRPR, BRPR218, BRPR21C, BRPRV, BRVR, BRVR218, BRVR21C, BRVRV, TPR, TPR218, TPR21C, TPRV, TVR, TVR218, TVR21C, TVRV |                 |         |

|   |   |                 |         |
|---|---|-----------------|---------|
| <h3>K55 series</h3>   |   |                 |         |
|  |   |                 |         |
| <b>GEV No.</b>  | 390252  | <b>Ref. No.</b> | 32Z7580 |
| <b>description</b>  | thermostat RANCO type K55L5070 capillary pipe 2500mm temperature range -22 up to -7°C |                 |         |
| <b>For models:</b>  | 40B, S125B, S125B-4, S125BX, S125BX-4, S60B, S60B-2, S60BX, S60BX-2                   |                 |         |



Зип.Общепит

vsezip.ru

+7(812)987-08-81

K60 series

RANCO



|                    |   |                 |         |
|--------------------|---|-----------------|---------|
| <b>GEV No.</b>     | 390598  | <b>Ref. No.</b> | 32Z4730 |
| <b>description</b> | thermostat RANCO type K60-L2045 probe ø 2mm probe Lmm capillary pipe 2000mm |                 |         |

accessories

probe clips

clamps

for thermostat



|                    |  |                 |         |
|--------------------|--|-----------------|---------|
| <b>GEV No.</b>     | 691171   | <b>Ref. No.</b> | 35T3540 |
| <b>description</b> | probe clip for probe ø 9mm Qty 1 pcs L 30mm W 20mm   |                 |         |
| <b>For models:</b> | 030FE, 030FE1, 030FE1B, 031FT04, 031FT06, 031FTE04, 031FTE06, 06WBR3E, 06WFT1EV, 06WFT2EV, 06WFT3EV, 06WFT4EV, 06WFT6EV, 06WFT7EV, 070FTE04, 070FTE05, 071FTE04, 071FTE06, 090FT1G, 090FT2G, 090FT4G, 090FT5G, 090FT7G, 090FTE04, 090FTE05, 091FE28, 091FE28B, 091FTE04, 091FTE06, 0A0FT1E, 0A0FT1G, 0A0FT2E, 0A0FT2G, 0A0FT4E, 0A0FT4G, 0A0FT5E, 0A0FT5G, 0B0FT1G, 0B0FT2G, 0B0FT4G, 0B0FT5G, 0D0FT1E, 0D0FT1G, 0D0FT2E, 0D0FT2G, 0D0FT4E, 0D0FT4G, 0D0FT5E, 0D0FT5G, 0G0FT1E...(Other models you can see in the webshop) |                 |         |



|                    |   |                 |         |
|--------------------|---|-----------------|---------|
| <b>GEV No.</b>     | 691170  | <b>Ref. No.</b> | 35S0540 |
| <b>description</b> | probe clip for probe ø 9mm Qty 1 pcs L 38mm W 20mm                                    |                 |         |
| <b>For models:</b> | 030FE, 030FE1, 030FE1B, 091FE28, 091FE28B, 0G1BR3E, 1G1BR3E, 30FES, 70FE, 70FES, 71FE |                 |         |

miscellaneous



|                    |  |                 |         |
|--------------------|--|-----------------|---------|
| <b>GEV No.</b>     | 691175   | <b>Ref. No.</b> | 35S5040 |
| <b>description</b> | probe clip for probe ø 4mm for pipe ø 9mm                            |                 |         |
| <b>For models:</b> | 030FE1, 030FE1B, 091FE28, 091FE28B, 30FES2, 30FES2B, 70FES2, 70FES2B |                 |         |

gland ducts



|                    |  |                 |         |
|--------------------|--|-----------------|---------|
| <b>GEV No.</b>     | 560623   | <b>Ref. No.</b> | 3003400 |
| <b>description</b> | gland duct ET M16 IT M10x1 WS 19 L 18mm  |                 |         |
| <b>For models:</b> | FM1011E2-VERS.2006, FM1011E3, FM1011E3-VERS.2006, FM1011G2-VERS.2006, FM1011G3, FM1011G3-VERS.2006, FM1221E2-VERS.2006, FM1221E3, FM1221E3-VERS.2006, FM1221G2-VERS.2006, FM1221G3, FM1221G3-VERS.2006, FM2011E2-VERS.2006, FM2011E3-VERS.2006, FM2011G2-VERS.2006, FM2011G3-VERS.2006, FM2021E2-VERS.2006, FM2021E3, FM2021E3-VERS.2006, FM2021G2-VERS.2006, FM2021G3, FM2021G3-VERS.2006, FM423E2, FM611E2-VERS.2006, FM611E3, FM611E3-VERS.2006, FM611G2-VERS.2006, FM611G3, FM611G3-VERS.2006, FM721E2-VERS.2006, FM721E3, FM721E3-VERS.2006, FM721G2-VERS.2006, FM721G3, FM721G3-VERS.2006, FX101E2, FX101E2C, FX101E2C-VERS.032014, FX101E2R, FX101E2R-VERS.032014, FX101E2-VERS.032014, FX101E3, FX101E3C, FX101E3C-VERS.022014, FX101E3R, FX101E3R-VERS.022014, FX101E3-VERS.022014, FX101G2, FX101G2C, FX101G2C-VERS.032014...(Other models you can see in the webshop) |                 |         |

miscellaneous



|                    |                                 |                 |         |
|--------------------|---------------------------------|-----------------|---------|
| <b>GEV No.</b>     | 691191                          | <b>Ref. No.</b> | 36D6970 |
| <b>description</b> | connecting piece for thermostat |                 |         |
| <b>For models:</b> | 030FE1, 30F1, 30FES2, 30FS2     |                 |         |



|                    |   |                 |         |
|--------------------|---|-----------------|---------|
| <b>GEV No.</b>     | 691154  | <b>Ref. No.</b> | 37Q3270 |
| <b>description</b> | cover cap temperature limiter   |                 |         |
| <b>For models:</b> | 04WCP1EM, 04WFR3ED, 06WFR3GD, 08WFA4E, 08WFAAE, 08WFR4ED, 08WFT1EV, 08WFT2EV, 08WFT3EV, 08WFT4EV, 08WFT6EV, 08WFT7EV, 091CP1E, 091FR1E, 091FR1EA, 091FR1ED, 091FR1G, 091FR1GD, 091FR3E, 091FR3ED, 091FR3G, 091FR3GD, 091FT1E, 091FT2E, 091FT4E, 091FT5E, 091FT7E, 0A1CP1E, 0A1FR1E, 0A1FR1ED, 0A1FR1G, 0A1FR1GD, 0A1FR1GD-VERS.2004, 0A1FR1G-VERS.2004, 0A1FR3G, 0A1FR3GD, 0B1FR1G, 0B1FR1GD, 0D1CP1E, 0D1FR1E, 0D1FR1ED, 0D1FR1G, 0D1FR1GD, 0D1FR1GD-VERS.2004, 0D1FR1G-VERS.2004, 0D1FR3G, 0D1FR3GD, 0G1BR3E, 0G1CP1E, 0G1CP1EC...(Other models you can see in the webshop) |                 |         |



switches and momentary switches

rocker/momentary rocker switches

25.5x25mm



|                    |   |                 |         |
|--------------------|---|-----------------|---------|
| <b>GEV No.</b>     | 345280 <sup>1</sup>   | <b>Ref. No.</b> | 32W6010 |
| <b>description</b> | rocker switch mounting measurements 25.5x25mm green 2CO 250V 16A illuminated connection male faston 6.3mm ambient temperature max. 85°C protection IP40 |                 |         |

<sup>1</sup>illuminated



|                    |   |                 |                    |
|--------------------|---|-----------------|--------------------|
| <b>GEV No.</b>     | 345278 <sup>1</sup>   | <b>Ref. No.</b> | 32W0990<br>32W3970 |
| <b>description</b> | rocker switch mounting measurements 25.5x25mm green 2NO 250V 16A illuminated 0-I connection male faston 6.3mm protection IP40   |                 |                    |
| <b>For models:</b> | 3G6SA, 3G6SA2, 3G6SA4, 40-OPR01, 40B-OPR01, 40BX-OPR01, 40CP-OPR01, 40CPX-OPR01, 40EV-OPR01, 40PV-OPR01, 40X-OPR01, 4G6SB, 4G6SB2, 4G6SB4, 4G6SB6, 6BR15V, 6BR15VC, 6BR19V, 6BR19VC, 6ERA-OPR01, 6ERA2-OPR01, 6ERA2A-OPR01, 6ERA2M-OPR01, 6ERAA-OPR01, 6ERAB-OPR01, 6ERABA-OPR01, 6ERABM-OPR01, 6ERAM-OPR01, 6ERB-OPR01, 6ERB2-OPR01, 6ERB2A-OPR01, 6ERB2M-OPR01, 6ERB4-OPR01, 6ERB4A-OPR01, 6ERB4M-OPR01, 6ERBA-OPR01, 6ERBB-OPR01, 6ERBBA-OPR01, 6ERBBM-OPR01, 6ERBM-OPR01, 6ERC-OPR01, 6ERC2-OPR01, 6ERC2A-OPR01, 6ERC2M-OPR01, 6ERC4-OPR01, 6ERC4A-OPR01, 6ERC4M-OPR01, 6ERCA-OPR01, 6ERCB-OPR01, 6ERCBM-OPR01... (Other models you can see in the webshop) |                 |                    |

<sup>1</sup>illuminated

30x22mm

labelled



|                    |  |                 |                               |
|--------------------|--|-----------------|-------------------------------|
| <b>GEV No.</b>     | 300125   | <b>Ref. No.</b> | 32W0860<br>32W2331<br>32W2990 |
| <b>description</b> | rocker switch mounting measurements 30x22mm green 2NO 230V 16A 0-I connection male faston 6.3mm ambient temperature max. 125/55°C protection IP65 with cover cap   |                 |                               |
| <b>For models:</b> | 120, 120B, 120NN, 120PV, 135, 135-4, 135A, 135B, 135BA, 135BN, 135BNX, 135BX, 135BXE, 135BXR, 135CPX, 135NN, 135NNX, 135PVX, 135X, 135X-3, 135X-4, 135XE, 135XR, 40, 40B, 40CP, 40CPX, 40EV, 40EVP, 40PL, 40PV, 40X, 40XPV, 55, 55B, 55PV, 65, 65A, 65B, 65BA, 65BX, 65BX-2, 65BXE, 65BXR, 65NB, 65NBX, 65NN, 65NNX, 65PVX, 65X... (Other models you can see in the webshop) |                 |                               |

**accessories for**



|  |        |                 |   |
|--|--------|-----------------|---|
| <b>GEV No.</b>   | 301036 | <b>Ref. No.</b> | — |
| protective cover internal size 30x22mm for rocker switch mounting measurementsmm |        |                 |   |



|                    |  |                 |         |
|--------------------|--|-----------------|---------|
| <b>GEV No.</b>     | 301164   | <b>Ref. No.</b> | 32W0631 |
| <b>description</b> | rocker switch mounting measurements 30x22mm green 2NO 250V 16A illuminated connection male faston 6.3mm ambient temperature max. 85°C protection IP65 with cover cap   |                 |         |
| <b>For models:</b> | 1G1FA0EV, 1G1FA0GV, 1G1PE1EV, 1G1PE2EV, 2091SCP, 2G1FA0GV, 2G1PE1EV, 2G1PE2EV, 31GE, 31TC, 31TCE, 32TC, 32TCE, FX101E1, FX101E1R, FX101E2, FX101E2C, FX101E2R, FX101E3, FX101E3C, FX101E3C-VERS.022014, FX101E3R, FX101G1, FX101G1R, FX101G2, FX101G2C, FX101G2R, FX101G3, FX101G3C, FX101G3C-VERS.022014, FX101G3R, FX10E2CR, FX10E3CR, FX10E3CR-VERS.022014, FX10G2CR, FX10G3CR, FX10G3CR-VERS.022014, FX122E1, FX122E2, FX122E2C, FX122E3, FX122E3C, FX122G1, FX122G2, FX122G2C, FX122G3, FX122G3C, FX12E3CT, FX12E3CT-VERS.022014, FX12G3CT... (Other models you can see in the webshop) |                 |         |

**accessories for**



|  |        |                 |   |
|--|--------|-----------------|---|
| <b>GEV No.</b>   | 301036 | <b>Ref. No.</b> | — |
| protective cover internal size 30x22mm for rocker switch mounting measurementsmm |        |                 |   |



|                    |  |                 |         |
|--------------------|--|-----------------|---------|
| <b>GEV No.</b>     | 345275   | <b>Ref. No.</b> | 32W3190 |
| <b>description</b> | rocker switch mounting measurements 30x22mm white 1CO/indicator light 230V 16A 1-2 connection male faston 6.3mm ambient temperature max. 125/55°C protection IP65 with cover cap   |                 |         |
| <b>For models:</b> | 120, 120NN, 120PV, 135, 135-4, 135BN, 135BNX, 135CPX, 135NN, 135NNX, 135PVX, 135X, 135X-3, 135X-4, 135XR, 55, 55PV, 65, 65NB, 65NBX, 65NN, 65NNX, 65PVX, 65X, 65X-2, 65XR, 6BMA11A, 6BMA11B, 6BMA11M, 6BMA11Z, 6BMA2A, 6BMA2B, 6BMA2M, 6BMA2Z, 6BMA3A, 6BMA3B, 6BMA3M, 6BMA3Z, 6BMAA, 6BMAB, 6BMAM, 6BMAZ, 6BMB11A, 6BMB11B, 6BMB11M, 6BMB11Z, 6BMB22A, 6BMB22B, 6BMB22M, 6BMB22Z... (Other models you can see in the webshop) |                 |         |

push/momentary push switches

19x13mm





|                    |   |                 |         |
|--------------------|---|-----------------|---------|
| <b>GEV No.</b>     | 347431  | <b>Ref. No.</b> | 3126050 |
| <b>description</b> | momentary push switch mounting measurements 19x13mm red 1NO 250V 16A connection male faston 6.3mm ambient temperature max. 105/55°C protection IP40 |                 |         |
| <b>For models:</b> | 090FAA, 091FR11, 091FR11-VERS.032012, 091FR7G, 091FR7G-VERS.052012, 10CP1GA, 12CP1GA, 18CP2GA, 190FAA, 191FR21, 191FR21-VERS.032012                 |                 |         |

electric components





Зип Общепит  
vsezip.ru  
7(812)9804800

|   |   |                 |                    |
|---|---|-----------------|--------------------|
|  |   |                 |                    |
| 1   |   |                 |                    |
| <b>GEV No.</b>  | 301054  | <b>Ref. No.</b> | 3062550<br>6300676 |
| <b>description</b>  | momentary push switch mounting measurements 19x13mm red 1NO 250V 16A connection male faston 6.3mm ambient temperature max. 105/55°C protection IP65 with cover cap  |                 |                    |
| <b>For models:</b>  | 090BM1G, 090FAVA, 090FT1G, 090FT2G, 090FT4G, 090FT5G, 090FT7G, 090GRG, 091CP1G, 190BM2G, 190FAB, 190FT15G, 190FT1G, 190FT2G, 190FT3G, 190FT42G, 190FT4G, 190FT6G, 190FT72G, 190FT7G, 190GRG, 190TP0, 191CP1G, 191CP1GA, 191CP2G, 191FAAG, 191FABG, 191FADG, 191FAG, 191PD1G, 191PD2G, 191PI1G, 191PI1GA, 191PI2G, 191PI2GA, 191TPG, 291FAG, 291FAGF, 291PD3G, 291PI3G, 291TPCG, 391FAG, G1FAGS, G1FAGST |                 |                    |

|   |   |                 |         |
|---|---|-----------------|---------|
|  |   |                 |         |
| 2   |   |                 |         |
| <b>GEV No.</b>  | 301713  | <b>Ref. No.</b> | 6300674 |
| <b>description</b>  | push switch mounting measurements 19x13mm blue 1NO 250V 16A connection male faston 6.3mm ambient temperature max. 85°C protection IP65 with cover cap |                 |         |
| <b>For models:</b>  | 191BR1E, 191BR1G, 191BR1GA, 191BR2E, 191BR2EA, 191BR2G, 191BR2GA, 291BR1E, 291BR1G, 291BR1GA, 291BR2E, 291BR2EA, 291BR2G, 291BR2GA                    |                 |         |

### 28.5x28.5mm

|   |  |                 |         |
|---|--|-----------------|---------|
|  |  |                 |         |
| 1   |  |                 |         |
| <b>GEV No.</b>  | 346916   | <b>Ref. No.</b> | 32V2050 |
| <b>description</b>  | momentary push switch mounting measurements 28.5x28.5mm grey 1NO 250V 16A connection male faston 6.3mm ambient temperature max. 125/55°C protection IP40 |                 |         |
| <b>For models:</b>  | LF50, LF50E, LF50EM, LF50E-VERS.2007   |                 |         |

|   |  |                 |         |
|---|--|-----------------|---------|
|  |  |                 |         |
| 1   |  |                 |         |
| <b>GEV No.</b>  | 346915   | <b>Ref. No.</b> | 32V2030 |
| <b>description</b>  | push switch mounting measurements 28.5x28.5mm grey 1CO 250V 16A connection male faston 6.3mm ambient temperature max. 125/55°C protection IP40 |                 |         |
| <b>For models:</b>  | LF50, LF50E, LF50EM, LF50E-VERS.2007   |                 |         |

|   |   |                 |         |
|---|---|-----------------|---------|
|  |   |                 |         |
| 1   |   |                 |         |
| <b>GEV No.</b>  | 346914  | <b>Ref. No.</b> | 32V2040 |
| <b>description</b>  | push switch mounting measurements 28.5x28.5mm weak 2CO 250V 16A connection male faston 6.3mm ambient temperature max. 150°C protection IP40 |                 |         |
| <b>For models:</b>  | LF50, LF50E, LF50EM, LF50E-VERS.2007  |                 |         |

|   |   |                 |         |
|---|---|-----------------|---------|
|  |   |                 |         |
| 1   |   |                 |         |
| <b>GEV No.</b>  | 345587  | <b>Ref. No.</b> | 32V2050 |
| <b>description</b>  | momentary push switch mounting measurements 28.5x28.5mm yellow 1NO 250V 16A connection male faston 6.3mm ambient temperature max. 125°C protection IP40 |                 |         |

|   |  |                 |                    |
|---|--|-----------------|--------------------|
|  |  |                 |                    |
| 1   |  |                 |                    |
| <b>GEV No.</b>  | 345589   | <b>Ref. No.</b> | 32V2030<br>32V2070 |
| <b>description</b>  | push switch mounting measurements 28.5x28.5mm yellow 2CO 250V 16A connection male faston 6.3mm ambient temperature max. 85/125°C protection IP40 |                 |                    |

### ø22mm

|   |  |                 |         |
|---|--|-----------------|---------|
|  |  |                 |         |
| 1   |  |                 |         |
| <b>GEV No.</b>  | 699002   | <b>Ref. No.</b> | 32W2030 |
| <b>description</b>  | momentary push switch mounting ø 22mm black/white 1NO/1NC/indicator light 230V 6A 0-1 connection screw ambient temperature max. 70°C protection IP40 |                 |         |
| <b>For models:</b>  | TG12, TG12X, TG12XE  |                 |         |

### ø25mm

|   |   |                 |         |
|---|---|-----------------|---------|
|  |   |                 |         |
| 1   |   |                 |         |
| <b>GEV No.</b>  | 301322  | <b>Ref. No.</b> | 3203760 |
| <b>description</b>  | push switch mounting ø 25mm silver 1NO/1NC 250V 5A stainless steel connection male faston 2.8mm   |                 |         |
| <b>For models:</b>  | B151H, B151M, FX201E2, FX201E2P, FX201E2P-VERS.032014, FX201E2-VERS.032014, FX201E3, FX201E3P, FX201E3P-VERS.022014, FX201E3-VERS.022014, FX201G2, FX201G2P, FX201G2P-VERS.032014, FX201G2-VERS.032014, FX201G3P, FX201G3-VERS.022014, FX202E2, FX202E2-VERS.032014, FX202E3, FX202E3-230V-3-50Hz-60Hz, FX202E3-230V-3-50Hz-60Hz-VERS.022014, FX202E3-VERS.022014, FX202G2, FX202G2-VERS.032014, FX202G3, FX202G3-VERS.022014 |                 |         |

### 2 hole fixing

|  |                                |                 |         |
|--|--------------------------------|-----------------|---------|
|  |                                |                 |         |
| 1  |                                |                 |         |
| <b>GEV No.</b>   | 346906                         | <b>Ref. No.</b> | 32W0280 |
| <b>description</b>   | switch combination 2CO/2CO/2NO |                 |         |



Зип Общепит  
vsezip.ru  
+7(812)987-0885

|   |   |                 |         |
|---|---|-----------------|---------|
|  |   |                 |         |
| 1   |   |                 |         |
| <b>GEV No.</b>  | 346905  | <b>Ref. No.</b> | 32W0830 |
| <b>description</b>  | switch combination 2CO/2CO/2NO 250V 16A connection male faston 6.3mm ambient temperature max. 85°C protection IP 40 |                 |         |

|   |   |                 |         |
|---|---|-----------------|---------|
| <b>miscellaneous</b>  |   |                 |         |
|  |   |                 |         |
| 1   |   |                 |         |
| <b>GEV No.</b>  | 346910  | <b>Ref. No.</b> | 32W0410 |
| <b>description</b>  | momentary push switch green 1NO/1NC/indicator light 600V 10A connection screw ambient temperature max. 85°C protection IP40 |                 |         |

|   |  |                 |         |
|---|--|-----------------|---------|
|  |  |                 |         |
| 1   |  |                 |         |
| <b>GEV No.</b>  | 346911   | <b>Ref. No.</b> | 32W1430 |
| <b>description</b>  | momentary push switch green 2NO 300V 3A connection screw ambient temperature max. 125/55°C protection IP40 |                 |         |

|  |  |                 |         |
|--|--|-----------------|---------|
|  |  |                 |         |
| 1  |  |                 |         |
| <b>GEV No.</b>   | 348228   | <b>Ref. No.</b> | 32W4140 |
| <b>description</b>   | push switch mounting ø 12mm black 2NO/1NC 250V 16A connection male faston 6.3mm  |                 |         |
| <b>For models:</b>   | KD100, KD100A, KD100PSD, KD85, KD85A, KD85PS, KD85PSA, KN1100, KN1100SD, KN11PSDD, KN35, KN37, KN37PS, KN800, KN800PSD |                 |         |

**accessories**

|   |                   |                 |         |
|---|-------------------|-----------------|---------|
| <b>push buttons</b>   |                   |                 |         |
|  |                   |                 |         |
| 1   |                   |                 |         |
| <b>GEV No.</b>  | 346912            | <b>Ref. No.</b> | 32W1420 |
| <b>description</b>  | push button black |                 |         |

**microswitches**

|   |   |                 |         |
|---|---|-----------------|---------|
| <b>lever actuated</b>   |   |                 |         |
|  |   |                 |         |
| 1   |   |                 |         |
| <b>GEV No.</b>  | 345254  | <b>Ref. No.</b> | 32W1320 |
| <b>description</b>  | microswitch with lever 250V 16A 1CO connection male faston 6.3mm ambient temperature max. 120°C mounting distance 22mm actuating force: 60g lever length 58mm |                 |         |

|   |   |                 |         |
|---|---|-----------------|---------|
|  |   |                 |         |
| 1   |   |                 |         |
| <b>GEV No.</b>  | 345257  | <b>Ref. No.</b> | 32W4240 |
| <b>description</b>  | microswitch with lever 250V 16A 1CO connection male faston 6.3mm L 29mm L1 33mm ambient temperature max. 120°C mounting distance 22mm actuating force: 130g lever length 31.5mm |                 |         |

|   |   |                 |         |
|---|---|-----------------|---------|
|  |   |                 |         |
| 1   |   |                 |         |
| <b>GEV No.</b>  | 345255  | <b>Ref. No.</b> | 32W1320 |
| <b>description</b>  | microswitch with lever 250V 16A 1CO connection male faston 6.3mm L 35mm L1 28mm ambient temperature max. 125°C mounting distance 22mm actuating force: 136g lever length 27mm   |                 |         |
| <b>For models:</b>  | 120, 120B, 120NN, 120PV, 135, 135-4, 135A, 135B, 135BA, 135BN, 135BNX, 135BX, 135BXE, 135BXR, 135CPX, 135NN, 135NNX, 135PVX, 135X, 135X-3, 135X-4, 135XE, 135XR, 40, 40CP, 40CPX, 40PV, 40X, 40XPV, 55, 55B, 55PV, 65, 65A, 65B, 65BA, 65BX, 65BX-2, 65BXE, 65BXR, 65NB, 65NBX, 65NN, 65NNX, 65PVX, 65X, 65X-2, 65XE, 65XR, S125... (Other models you can see in the webshop) |                 |         |

|   |   |                 |         |
|---|---|-----------------|---------|
|  |   |                 |         |
| 1   |   |                 |         |
| <b>GEV No.</b>  | 345459  | <b>Ref. No.</b> | 32W1180 |
| <b>description</b>  | microswitch with lever 250V 15A 1NC connection male faston 6.3mm ambient temperature max. 85°C mounting distance 15-25mm ROLD lever length 66mm series RM |                 |         |

|   |  |                 |         |
|---|--|-----------------|---------|
|  |  |                 |         |
| 1   |  |                 |         |
| <b>GEV No.</b>  | 346909   | <b>Ref. No.</b> | 32W0010 |
| <b>description</b>  | microswitch with lever 250V 16A 1CO connection male faston 6.3mm ambient temperature max. 125°C mounting distance 13mm lever length 50mm |                 |         |

|   |  |                 |         |
|---|--|-----------------|---------|
|  |  |                 |         |
| 1   |  |                 |         |
| <b>GEV No.</b>  | 346907   | <b>Ref. No.</b> | 32W0020 |
| <b>description</b>  | microswitch with lever 250V 16A 1CO connection male faston ambient temperature max. 85°C |                 |         |

|   |   |                 |         |
|---|---|-----------------|---------|
|  |   |                 |         |
| 1   |   |                 |         |
| <b>GEV No.</b>  | 346904  | <b>Ref. No.</b> | 32W3700 |
| <b>description</b>  | microswitch with lever 250V 16A 1NO connection male faston ambient temperature max. male faston 6.3mm°C |                 |         |
| <b>For models:</b>  | 0M0FR1E, 1M0FR2E  |                 |         |



Зип Общепит

vsezip.ru

+7(812)987-08-81

## pin-plunger actuated

M10



1

|                    |   |                 |                    |
|--------------------|---|-----------------|--------------------|
| <b>GEV No.</b>     | 347216  | <b>Ref. No.</b> | 32W1660<br>32W3340 |
| <b>description</b> | microswitch with plunger thread M10x0.75 thread L 14mm 250V 10A 1CO connection male faston 6.3mm stroke 7.5mm mounting distance 22mm L 28mm ambient temperature max. 125°C type NR6K5 actuating force: 260g   |                 |                    |
| <b>For models:</b> | 030FE, 030FE1, 030FE1B, 04WFR3ED, 08WFR4ED, 091FE28, 091FE28B, 091FR3E, 091FR3ED, 0A1FR3E, 0A1FR3ED, 0D1FR3E, 0D1FR3ED, 0G0FR3E, 0G0FR3ED, 10CP1EA, 10CP1GA, 10CP1IA, 12CP1EA, 12CP1GA, 12CP1IA, 18CP2EA, 18CP2GA, 18CP2IA, 191BR1E, 191BR1G, 191BR2E, 191BR2G, 191FR4E, 191FR4ED, 1A1FR4E, 1A1FR4ED, 1D1FR4E, 1D1FR4ED, 1G0FR4E, 291BR1E, 291BR1G, 291BR2E, 291BR2G, 30FES, 30FES2, 30FES2B, 6043840, 6043970, 70FE, 70FE1, 70FE1B, 70FES, 70FES2, 70FES2B...(Other models you can see in the webshop) |                 |                    |

M12



1

|   |   |                 |                   |
|---|---|-----------------|-------------------|
| <b>GEV No.</b>  | 345350  | <b>Ref. No.</b> | 32W3020           |
| <b>description</b>  | microswitch with plunger mounting distance 22mm thread M12x0.75 thread L 16mm 250V 16A 1CO connection male faston 6.3mm stroke 4mm ambient temperature max. 125°C type EF83161.3 actuating force: 66g   |                 |                   |
| <b>For models:</b>  | FC101, FC101E, FC241, FC241E, FC241G, FC61, FC61E, FCV101, FCV101DM, FCV101DS, FCV101E, FCV101EDM, FCV101EDS, FCV141, FCV141DM, FCV141DS, FCV141E, FCV141EDM, FCV141EDS, FCV241, FCV241DM, FCV241DS, FCV241E, FCV241EDM, FCV241EDS, FCV241G, FCV241GDM, FCV241GDS, FCV401DM, FCV401EDM, FCV61, FCV61DM, FCV61DS, FCV61E, FCV61EDM, FCV61EDS |                 |                   |
| <b>accessories for</b>  | 345350  |                 |                   |
|  | <b>GEV No.</b>  | 345351          | <b>Ref. No.</b> — |
|   | nut thread M12x0.75 H 1.6mm WS 14 chrome-plated brass Qty 1 pcs   |                 |                   |



1

|                    |  |                 |         |
|--------------------|--|-----------------|---------|
| <b>GEV No.</b>     | 345360   | <b>Ref. No.</b> | 32W1410 |
| <b>description</b> | microswitch with plunger mounting distance 25.4mm thread M12x1 thread L 15mm 250V 10A 1CO connection screw stroke 5mm ambient temperature max. 125°C type Highly D5000 actuating force: 200g |                 |         |
| <b>For models:</b> | 65NN, SP65NN   |                 |         |



1

|                    |  |                 |         |
|--------------------|--|-----------------|---------|
| <b>GEV No.</b>     | 345679   | <b>Ref. No.</b> | 32W0960 |
| <b>description</b> | microswitch with plunger mounting distance 25mm thread M12x1 thread L 9mm 250V 5A 1CO connection male faston 6.3mm stroke 5mm ambient temperature max. 125°C type MF12 actuating force: 680g |                 |         |
| <b>For models:</b> | 31RE, 71AR   |                 |         |

## with push button

## switches with snap-fit



1

|                    |   |                 |         |
|--------------------|---|-----------------|---------|
| <b>GEV No.</b>     | 347027  | <b>Ref. No.</b> | 32W3770 |
| <b>description</b> | microswitch with push button 250V 1A 1CO connection male faston 2.8mm L 26x12mm ambient temperature max. 85°C type XKA-304B1AAJ11 actuating force: 50g  |                 |         |
| <b>For models:</b> | CX120, CX120B, CX120NN, CX130, CX130B, CX130NN, CX140, CX140B, CX140BN, CX140BR, CX140CP, CX140NN, CX140PV, CX140R, CX150, CX150B, CX150BN, CX150BR, CX150CP, CX150NN, CX150PV, CX150R, CX55, CX55B, CX60, CX60B, CX65, CX652, CX65B, CX65BR, CX65NB, CX65NCP, CX65NN, CX65PV, CX65R, CX70, CX702, CX70B, CX70BR, CX70NB, CX70NN, CX70PV, CX70R, FG2B, FSD1B, FSD1N, FSD2B, FSD2N, FSD2N2, FSDR2B...(Other models you can see in the webshop) |                 |         |



1

|                    |   |                 |         |
|--------------------|---|-----------------|---------|
| <b>GEV No.</b>     | 348008  | <b>Ref. No.</b> | 3096020 |
| <b>description</b> | microswitch with push button 250V 2.5A 1NO/1NC connection male faston 2.8mm/6.3mm L 27mm L1 22mm ambient temperature max. 104°C actuating force: 180g |                 |         |

## roller actuated

## roller 0°



1

|                    |  |                 |         |
|--------------------|--|-----------------|---------|
| <b>GEV No.</b>     | 345639   | <b>Ref. No.</b> | 32W1040 |
| <b>description</b> | microswitch with roller plunger 230V 16A 1CO connection solder/screw connection L1 49mm ambient temperature max. 125°C thread L 14mm thread M10 mounting distance 25mm actuating force: 300g type MS15-1 |                 |         |



Зип Общепит

vsezip.ru

+7(812)9870881

roller 90°



|                    |  |                 |         |
|--------------------|--|-----------------|---------|
| <b>GEV No.</b>     | 347096   | <b>Ref. No.</b> | 32W4150 |
| <b>description</b> | microswitch with roller plunger 250V 20A 1CO connection screw L1 49mm ambient temperature max. 125°C thread L 14.5mm thread M12x1 mounting distance 25mm actuating force: 370g type Z15G1318 |                 |         |
| <b>For models:</b> | KD100, KD100A, KD100PSD, KD130, KD130A, KD130E, KD130EAT, KN1100, KN1100SD, KN11PSDD, KN800, KN800PSD  |                 |         |

non-standard



|                    |   |                 |                    |
|--------------------|---|-----------------|--------------------|
| <b>GEV No.</b>     | 346183  | <b>Ref. No.</b> | 33Q5620<br>6300496 |
| <b>description</b> | microswitch connection male faston  |                 |                    |
| <b>For models:</b> | FC101, FC101E, FC241, FC241E, FC241G, FC61, FC61E, FCV101, FCV101DM, FCV101DS, FCV101E, FCV101EDM, FCV101EDS, FCV141, FCV141DM, FCV141DM-CSA, FCV141DS, FCV141E, FCV141EDM, FCV141EDS, FCV241, FCV241DM, FCV241DS, FCV241E, FCV241EDM, FCV241EDS, FCV241G, FCV241GDM, FCV241GDS, FCV401DM, FCV401EDM, FCV61, FCV61DM, FCV61DS, FCV61E, FCV61EDM, FCV61EDS |                 |                    |

accessories



|                    |   |                 |         |
|--------------------|---|-----------------|---------|
| <b>GEV No.</b>     | 691143  | <b>Ref. No.</b> | 36D8360 |
| <b>description</b> | bolt for microswitch  |                 |         |
| <b>For models:</b> | FC101, FC101E, FC241, FC61, FC61E, FCV101, FCV101-CSA, FCV101DM, FCV101DM-CSA, FCV101DS, FCV101DS-CSA, FCV101E, FCV101EDM, FCV101EDM-CSA, FCV101EDS, FCV101EDS-CSA, FCV101E-UL, FCV141, FCV141-CSA, FCV141DM, FCV141DM-CSA, FCV141DS, FCV141DS-CSA, FCV141E, FCV141EDM, FCV141EDS, FCV241, FCV241DM, FCV241DS, FCV401DM, FCV401DM-CSA, FCV401EDM, FCV401EDM-CSA, FCV61, FCV61-CSA, FCV61DM, FCV61DM-CSA, FCV61DS, FCV61DS-CSA, FCV61E, FCV61EDM, FCV61EDM-CSA, FCV61EDS, FCV61EDS-CSA, FCV61E-UL, FCV72EDM-UL, FCV72EDS-UL, FCV72E-UL |                 |         |



|                    |   |                 |         |
|--------------------|---|-----------------|---------|
| <b>GEV No.</b>     | 691140  | <b>Ref. No.</b> | 33Q5610 |
| <b>description</b> | bush for microswitch thread M16x1.5   |                 |         |
| <b>For models:</b> | FC101, FC101E, FC241, FC241E, FC241G, FC61, FC61E, FCV101, FCV101-CSA, FCV101DM, FCV101DM-CSA, FCV101DS, FCV101DS-CSA, FCV101E, FCV101EDM, FCV101EDM-CSA, FCV101EDS, FCV101EDS-CSA, FCV101E-UL, FCV141, FCV141-CSA, FCV141DM, FCV141DM-CSA, FCV141DS, FCV141DS-CSA, FCV141E, FCV141EDM, FCV141EDS, FCV241, FCV241DM, FCV241DS, FCV241E, FCV241EDM, FCV241EDM-CSA, FCV241EDS, FCV241EDS-CSA, FCV241E-UL, FCV241G, FCV241G-CSA, FCV241GDM, FCV241GDM-CSA, FCV241GDS, FCV241GDS-CSA, FCV401DM, FCV401DM-CSA, FCV401EDM, FCV401EDM-CSA, FCV61, FCV61-CSA, FCV61DM...(Other models you can see in the webshop) |                 |         |



|                    |   |                 |                    |
|--------------------|---|-----------------|--------------------|
| <b>GEV No.</b>     | 691139  | <b>Ref. No.</b> | 33Q4120<br>33Q5610 |
| <b>description</b> | connecting plate for microswitch  |                 |                    |
| <b>For models:</b> | FC101, FC101E, FC241E, FC241G, FC61, FC61E, FCV101, FCV101-CSA, FCV101DM, FCV101DM-CSA, FCV101DS, FCV101DS-CSA, FCV101E, FCV101EDM, FCV101EDM-CSA, FCV101EDS, FCV101EDS-CSA, FCV101E-UL, FCV141, FCV141-CSA, FCV141DM, FCV141DS, FCV141DS-CSA, FCV141E, FCV141EDM, FCV141EDS, FCV241E, FCV241EDM, FCV241EDM-CSA, FCV241EDS, FCV241EDS-CSA, FCV241E-UL, FCV241G, FCV241G-CSA, FCV241GDM, FCV241GDM-CSA, FCV241GDS, FCV241GDS-CSA, FCV401DM, FCV401DM-CSA, FCV401EDM, FCV401EDM-CSA, FCV61, FCV61-CSA, FCV61DM, FCV61DM-CSA, FCV61DS, FCV61DS-CSA, FCV61E, FCV61EDM...(Other models you can see in the webshop) |                 |                    |



|                    |                                |                 |         |
|--------------------|--------------------------------|-----------------|---------|
| <b>GEV No.</b>     | 516249                         | <b>Ref. No.</b> | 36G1720 |
| <b>description</b> | hexagonal screw thread M5 WS 8 |                 |         |
| <b>For models:</b> | LT10R, LT20F, LT25F            |                 |         |



|                    |   |                 |         |
|--------------------|---|-----------------|---------|
| <b>GEV No.</b>     | 691138  | <b>Ref. No.</b> | 35Q2360 |
| <b>description</b> | housing for microswitch   |                 |         |
| <b>For models:</b> | FC101, FC101E, FC241, FC241E, FC241G, FC61, FC61E, FCV101, FCV101-CSA, FCV101DM, FCV101DM-CSA, FCV101DS, FCV101DS-CSA, FCV101E, FCV101EDM, FCV101EDM-CSA, FCV101EDS, FCV101EDS-CSA, FCV101E-UL, FCV141, FCV141-CSA, FCV141DM, FCV141DM-CSA, FCV141DS, FCV141DS-CSA, FCV141E, FCV141EDM, FCV141EDS, FCV241, FCV241DM, FCV241DS, FCV241E, FCV241EDM, FCV241EDM-CSA, FCV241EDS, FCV241EDS-CSA, FCV241E-UL, FCV241G, FCV241GDM, FCV241GDM-CSA, FCV241GDS, FCV241GDS-CSA, FCV401DM, FCV401DM-CSA, FCV401EDM, FCV401EDM-CSA, FCV61, FCV61-CSA, FCV61DM, FCV61DM-CSA...(Other models you can see in the webshop) |                 |         |



|                    |   |                 |                    |
|--------------------|---|-----------------|--------------------|
| <b>GEV No.</b>     | 691142  | <b>Ref. No.</b> | 36G6040<br>36G6041 |
| <b>description</b> | pin for microswitch   |                 |                    |
| <b>For models:</b> | FC101, FC101E, FC241, FC241E, FC241G, FC61, FC61E, FCV101, FCV101-CSA, FCV101DM, FCV101DM-CSA, FCV101DS, FCV101DS-CSA, FCV101E, FCV101EDM, FCV101EDM-CSA, FCV101EDS, FCV101EDS-CSA, FCV101E-UL, FCV141, FCV141-CSA, FCV141DM, FCV141DM-CSA, FCV141DS, FCV141DS-CSA, FCV141E, FCV141EDM, FCV141EDS, FCV241, FCV241DM, FCV241DS, FCV241E, FCV241EDM, FCV241EDM-CSA, FCV241EDS, FCV241EDS-CSA, FCV241E-UL, FCV241G, FCV241G-CSA, FCV241GDM, FCV241GDM-CSA, FCV241GDS, FCV241GDS-CSA, FCV401DM, FCV401DM-CSA, FCV401EDM, FCV401EDM-CSA, FCV61, FCV61-CSA, FCV61DM...(Other models you can see in the webshop) |                 |                    |



Зип Общепит

vsezip.ru

812)987-0881

|  |   |                 |         |
|--|---|-----------------|---------|
|  |   |                 |         |
| <b>GEV No.</b>   | 691141  | <b>Ref. No.</b> | 36G7140 |
| <b>description</b>   | spring for microswitch  |                 |         |
| <b>For models:</b>   | 1A1BR1E, 1A1BR1G, 1A1BR1GA, 1A1BR2E, 1A1BR2EA, 1A1BR2G, 1A1BR2GA, 1D1BR1E, 1D1BR1G, 1D1BR1GA, 1D1BR2E, 1D1BR2EA, 1D1BR2G, 1D1BR2GA, 2A1BR1G, 2A1BR1GA, 2A1BR2G, 2A1BR2GA, 2D1BR1G, 2D1BR1GA, 2D1BR2G, 2D1BR2GA, FC101, FC101E, FC241, FC241E, FC241G, FC61, FC61E, FCV101, FCV101-CSA, FCV101DM, FCV101DM-CSA, FCV101DS, FCV101DS-CSA, FCV101E, FCV101EDM, FCV101EDM-UL, FCV101EDS, FCV101EDS-UL, FCV101E-UL, FCV141, FCV141-CSA, FCV141DM, FCV141DM-CSA, FCV141DS, FCV141DS-CSA, FCV141E, FCV141EDM, FCV141EDS...(Other models you can see in the webshop) |                 |         |



|   |                          |                 |         |
|---|--------------------------|-----------------|---------|
|  |                          |                 |         |
| <b>GEV No.</b>  | 346317                   | <b>Ref. No.</b> | 32W1630 |
| <b>description</b>  | push button ø 23mm white |                 |         |
| <b>For models:</b>  | LT25F                    |                 |         |

## position switches

|  |   |                 |         |
|--|---|-----------------|---------|
| <b>PIZZATO</b>   |   |                 |         |
| <b>FR series</b>   |   |                 |         |
|  |   |                 |         |
| <b>GEV No.</b>   | 345337  | <b>Ref. No.</b> | 32W3251 |
| <b>description</b>   | position switch plastic 1NO/1NC 400V 3A L 83mm W 31mm H 31mm protection IP67 actuating force: 900g screw connection PG11 mounting distance 20mm   |                 |         |
| <b>For models:</b>   | 091FR1E, 091FR1EA, 091FR1ED, 091FR1EX, 0A1FR1E, 0A1FR1ED, 0D1FR1E, 0D1FR1ED, 191BR1GA, 191BR2EA, 191BR2GA, 191FR2E, 191FR2ED, 1A1BR1E, 1A1BR1G, 1A1BR1GA, 1A1BR2E, 1A1BR2EA, 1A1BR2G, 1A1BR2GA, 1A1FR2E, 1A1FR2ED, 1D1BR1E, 1D1BR1G, 1D1BR1GA, 1D1BR2E, 1D1BR2EA, 1D1BR2G, 1D1BR2GA, 1D1FR2ED, 1G1BR1E, 291BR1GA, 291BR2EA, 291BR2GA, 2A1BR1E, 2A1BR1G, 2A1BR1GA, 2A1BR2E, 2A1BR2EA, 2A1BR2G, 2A1BR2GA, 2D1BR1E, 2D1BR1G, 2D1BR1GA, 2D1BR2E, 2D1BR2EA, 2D1BR2G, 2D1BR2GA, 71ARE, 71RA...(Other models you can see in the webshop) |                 |         |

|   |   |                 |         |
|---|---|-----------------|---------|
|  |   |                 |         |
| <b>GEV No.</b>  | 346221  | <b>Ref. No.</b> | 32W4260 |
| <b>description</b>  | push button size 23x23mm green ON-OFF with lens   |                 |         |
| <b>For models:</b>  | KD100, KD100A, KD100PSD, KD130, KD130A, KD37, KD37PS, KD37-VERS.112009, KD40, KD40LUX, KD40PS, KD40-VERS.112009, KD60, KD60M, KD60MA, KD60MPS, KD60MPSA, KD60PS, KD60PSD, KD85, KD85A, KD85PS, KD85PSA, KN1100, KN1100SD, KN11PSDD, KN35, KN37, KN37PS, KN40, KN40PS, KN40PSD, KN50, KN50M, KN50MPS, KN50PS, KN50PSD, KN50PSDD, KN80, KN800, KN800PSD, KN80PS, N100D, N100S, N100VD, N100VS, N38D, N38S, N38VD, N38VS...(Other models you can see in the webshop) |                 |         |

## system switches (ROLD)

|  |   |                 |         |
|--|---|-----------------|---------|
|  |   |                 |         |
| <b>GEV No.</b>   | 345130  | <b>Ref. No.</b> | 3040850 |
| <b>description</b>   | momentary switch unit 1NO 250V 16A connection male faston 6.3mm |                 |         |
|  |   |                 |         |
| <b>GEV No.</b>   | 347193  | <b>Ref. No.</b> | 3040850 |
| <b>description</b>   | momentary switch unit 1NO 250V 16A connection male faston 6.3mm |                 |         |

|  |   |                 |         |
|--|---|-----------------|---------|
|  |   |                 |         |
| <b>GEV No.</b>   | 346222  | <b>Ref. No.</b> | 3063320 |
| <b>description</b>   | push button size 23x23mm green START  |                 |         |
| <b>For models:</b>   | KD37, KD37PS, KD37-VERS.112009, KD40, KD40LUX, KD40PS, KD40-VERS.112009, KD60, KD60M, KD60MA, KD60MPS, KD60MPSA, KD60PS, KD60PSD, KD85, KD85A, KN35, KN37, KN37PS, KN40, KN40PS, KN40PSD, KN50, KN50M, KN50MPS, KN50PS, KN50PSD, KN50PSDD, KN80, KN80PS |                 |         |

|   |   |                 |         |
|---|---|-----------------|---------|
|  |   |                 |         |
| <b>GEV No.</b>  | 346251  | <b>Ref. No.</b> | 33Q6440 |
| <b>description</b>  | rotary disc orange/green disc ø 20.6mm  |                 |         |
| <b>For models:</b>  | KD100, KD100A, KD100PSD, KD130, KD130A, KD37, KD37PS, KD37-VERS.112009, KD40, KD40LUX, KD40PS, KD40-VERS.112009, KD60, KD60M, KD60MA, KD60MPS, KD60MPSA, KD60PS, KD60PSD, KD85, KD85A, KD85PS, KD85PSA, KN1100, KN1100SD, KN11PSDD, KN35, KN37, KN37PS, KN40, KN40PS, KN40PSD, KN50, KN50M, KN50MPS, KN50PS, KN50PSD, KN50PSDD, KN80, KN800, KN800PSD, KN80PS, N100D, N100S, N100VD, N100VS, N38D, N38S, N38VD, N38VS...(Other models you can see in the webshop) |                 |         |





Зип Общепит  
vsezip.ru  
+7(812)987-08-81



1

|                    |   |                 |         |
|--------------------|---|-----------------|---------|
| <b>GEV No.</b>     | 345720  | <b>Ref. No.</b> | 32W4150 |
| <b>description</b> | switch 2NO 250V 16A connection male faston 6.3mm  |                 |         |
| <b>For models:</b> | KD100, KD100A, KD100PSD, KD130, KD130A, KD37, KD37PS, KD37-VERS.112009, KD40, KD40LUX, KD40PS, KD40-VERS.112009, KD60, KD60M, KD60MA, KD60MPS, KD60MPSA, KD60PS, KD60PSD, KD85, KD85A, KD85PS, KD85PSA, KN1100, KN1100SD, KN11PSDD, KN35, KN37, KN37PS, KN40, KN40PS, KN40PSD, KN50, KN50M, KN50MPS, KN50PS, KN50PSD, KN50PSDD, KN80, KN800, KN800PSD, KN80PS, N100D, N100S, N100VD, N100VS, N38D, N38S, N38VD, N38VS...(Other models you can see in the webshop) |                 |         |



1

|                    |   |                 |         |
|--------------------|---|-----------------|---------|
| <b>GEV No.</b>     | 300088  | <b>Ref. No.</b> | 32W3830 |
| <b>description</b> | cam switch 2 operating positions 4NO sequence 0-1 16A shaft ø 6x4.6mm shaft L 23mm connection male faston 6.3mm ceramic   |                 |         |
| <b>For models:</b> | 0M0BR1E, 0M0FR1E, 0M0FT1E, 0M0FT2E, 0M0FT4E, 0M0FT5E, 0M0GR1E, 0M0GR2E, 1M0FR2E, 1M0FT1E, 1M0FT2E, 1M0FT3E, 1M0FT4E, 1M0FT5E, 1M0FT6E, 2M0FT1E, 2M0FT2E, 2M0FT3E, 2M0FT4E, 2M0FT5E, 2M0FT6E |                 |         |

float switches



1

|                    |  |                 |         |
|--------------------|--|-----------------|---------|
| <b>GEV No.</b>     | 403292   | <b>Ref. No.</b> | 6300787 |
| <b>description</b> | float switch 1NO ø 12mm mounting ø 8mm 24V 0.2A plug cable length 880mm 1-pole   |                 |         |
| <b>For models:</b> | FX101E3, FX101E3C, FX101E3C-VERS.022014, FX101E3R, FX101E3R-VERS.022014, FX101E3-VERS.022014, FX101G3, FX101G3C, FX101G3C-VERS.022014, FX101G3R, FX101G3R-VERS.022014, FX101G3-VERS.022014, FX10E3CR, FX10E3CR-VERS.022014, FX10G3CR, FX10G3CR-VERS.022014, FX122E3, FX122E3C, FX122E3T, FX122E3T-VERS.022014, FX122G3, FX122G3C, FX122G3T, FX122G3T-VERS.022014, FX12E3CT, FX12E3CT-VERS.022014, FX12G3CT, FX12G3CT-VERS.022014, FX201E3, FX201E3P, FX201E3P-VERS.022014, FX201E3-VERS.022014, FX201G3P, FX201G3-VERS.022014, FX202E3, FX202E3-230V-3-50Hz-60Hz, FX202E3-230V-3-50Hz-60Hz-VERS.022014, FX202E3-VERS.022014, FX202G3, FX202G3-VERS.022014, FX61E3, FX61E3C, FX61E3CR, FX61E3CR-VERS.022014, FX61E3C-VERS.022014, FX61E3R, FX61E3R-VERS.022014, FX61E3-VERS.022014, FX61G3, FX61G3C...(Other models you can see in the webshop) |                 |         |



1

|                        |   |                 |  |
|------------------------|---|-----------------|--|
| <b>GEV No.</b>         | 300020  | <b>Ref. No.</b> | 32W0490<br>32W3610   |
| <b>description</b>     | cam switch 4 operating positions 2NO sequence 0-1-0-1 16A shaft ø 6x4.6mm shaft L 23mm connection screw ceramic   |                 |  |
| <b>For models:</b>     | 04WFR3ED, 06WFR3GD, 08WFR4ED, 091FR1ED, 091FR1GD, 091FR3ED, 091FR3GD, 0A1FR1ED, 0A1FR1GD, 0A1FR1GD-VERS.2004, 0B1FR1GD, 0D1FR1ED, 0D1FR1GD, 0D1FR1GD-VERS.2004, 0G0FR3ED, 0G1FR3GD, 10WFR4GD, 191FR2ED, 191FR2GD, 191FR4ED, 191FR4GD, 1A1FR2ED, 1A1FR2GD, 1A1FR2GD-VERS.2004, 1A1PI2G, 1A1PI2GA, 1D1FR2ED, 1D1FR2GD, 1D1FR2GD-VERS.2004, 1D1PI2G, 1D1PI2GA, 1G1FR4GD, 291PI3G, 2A1PI3G, 2D1PI3G, FC101, FC101E, FC241, FC241E, FC241G, FC61, FC61E, L100, L80 |                 |  |
| <b>accessories for</b> | 300020  |                 |  |
|                        |    | <b>GEV No.</b>  | 110135 <b>Ref. No.</b> —   |
|                        |   |                 | rosette knob up to ø 52mm  |
|                        |    | <b>GEV No.</b>  | 110231 <b>Ref. No.</b> —   |
|                        |   |                 | knob switch 0-1-0-1 t.max.°C ø 50mm shaft ø 6x4.6mm shaft flat upper black |

cam switches

on/off



1

|                    |   |                 |         |
|--------------------|---|-----------------|---------|
| <b>GEV No.</b>     | 301115  | <b>Ref. No.</b> | 3168540 |
| <b>description</b> | cam switch 2 operating positions 2NO sequence 0-1 16A shaft ø 6x4.6mm shaft L 23mm connection male faston 6.3mm |                 |         |
| <b>For models:</b> | 091FR1I, 091FR1I-VERS.032012, 191FR2I, 191FR2I-VERS.032012, 6043840, 6043970                                    |                 |         |

5-position



1

|                    |  |                 |         |
|--------------------|--|-----------------|---------|
| <b>GEV No.</b>     | 300147   | <b>Ref. No.</b> | 32W0510 |
| <b>description</b> | cam switch 5 operating positions 1NO/2CO sequence 0-1-2-3-4 16A shaft ø 6x4.6mm shaft L 23mm connection screw 5-position |                 |         |

Зип-Общепит

vsezip.ru

+7(812)987-08-81



|                    |  |                 |         |
|--------------------|--|-----------------|---------|
| <b>GEV No.</b>     | 300149   | <b>Ref. No.</b> | 32W1050 |
| <b>description</b> | cam switch 5 operating positions 2NO/2CO sequence 0-1-2-3-4 32A shaft $\varnothing$ 6x4.6mm shaft L 23mm connection screw 5-position ceramic   |                 |         |
| <b>For models:</b> | 04WPE4V, 070E, 071E, 08WPE4V, 090E, 090PE4, 091E, 0A0PE4, 0D0PE4, 190PE4, 191PE4E, 1A0PE4, 1A1PE4E, 1A1PEFTE, 1D0PE4, 1D1PE4E, 30CPSE, 70CPE, 71E, 71PIE15, 71PIE15A, 90CPE, 91PIE15, 91PIE15A |                 |         |

|  |        |                 |   |
|--|--------|-----------------|---|
| accessories for 300025   |        |                 |   |
| <b>GEV No.</b>   | 112213 | <b>Ref. No.</b> | — |
| knob dial plate silver switch 7-position t.max.°C ED $\varnothing$ 63mm ID $\varnothing$ 4.5mm |        |                 |   |
| <b>GEV No.</b>   | 112311 | <b>Ref. No.</b> | — |
| knob adapter shaft $\varnothing$ 6.40mm L 0mm with spring                                      |        |                 |   |



|                    |  |                 |         |
|--------------------|--|-----------------|---------|
| <b>GEV No.</b>     | 300105   | <b>Ref. No.</b> | 32W3260 |
| <b>description</b> | cam switch 5 operating positions 3NO/1CO sequence 0-1-2-3-4 32A shaft $\varnothing$ 6x4.6mm shaft L 23mm connection screw 5-position ceramic |                 |         |
| <b>For models:</b> | 0A1CP1E, 0D1CP1E, 0G1CP1E, 0G1CP1E-VERS.2004, 191PI2E, 191PI2EA, 1A1PI2E, 1A1PI2EA, 1D1PI2E, 1D1PI2EA, 1G1PI1E, 31PIE6                       |                 |         |

|                        |   |                 |         |
|------------------------|---|-----------------|---------|
| accessories for 300149 |   |                 |         |
| <b>GEV No.</b>         | 300106  | <b>Ref. No.</b> | 32W2920 |
| <b>description</b>     | cam switch 7 operating positions 1NO/2CO sequence 0-1-2-3-4-5-6 32A shaft $\varnothing$ 6x4.6mm shaft L 23mm connection screw 7-position shaft flat upper |                 |         |
| <b>For models:</b>     | 60SME   |                 |         |



|                    |  |                 |         |
|--------------------|--|-----------------|---------|
| <b>GEV No.</b>     | 300133   | <b>Ref. No.</b> | 32w0520 |
| <b>description</b> | cam switch 5-position sequence 0-1-2-3-4 shaft $\varnothing$ 6x4.6mm connection screw clamp 3-pole |                 |         |

3 operating positions



|                        |   |                 |         |
|------------------------|---|-----------------|---------|
| <b>GEV No.</b>         | 345171  | <b>Ref. No.</b> | 3041660 |
| <b>description</b>     | cam switch 3 operating positions 3NO sequence 0-1-2 16A shaft $\varnothing$ 6x4.6mm shaft L 26mm connection male faston 6.3mm ceramic |                 |         |
| <b>For models:</b>     | FC1011E, FC1011G, FC1221E, FC1221G, FC611E, FC611G  |                 |         |
| <b>accessories for</b> | 345171  |                 |         |

7-position



|   |  |                 |                    |
|---|--|-----------------|--------------------|
| <b>GEV No.</b>  | 300025   | <b>Ref. No.</b> | 32W0760<br>32W1840 |
| <b>description</b>  | cam switch 7 operating positions 1NO/2CO sequence 0-1-2-3-4-5-6 16A shaft $\varnothing$ 6x4.6mm shaft L 23mm connection screw 7-position ceramic                     |                 |                    |
| <b>For models:</b>  | 030E, 031E, 0G0PE1, 0G0PE2, 0G1PE2, 1G0PE1, 1G0PE2, 1G1PE1E, 1G1PE1EV, 1G1PE2, 1G1PE2E, 1G1PE2EV, 2G0PE1, 2G0PE2, 2G1PE1E, 2G1PE1EV, 2G1PE2E, 2G1PE2EV, 31TCE, 32TCE |                 |                    |
| <b>accessories for</b>  | 300025   |                 |                    |
|  | <b>GEV No.</b>   | 112172          | <b>Ref. No.</b> —  |
| knob universal $\varnothing$ 70mm black without adaptor/dial plate                  |  |                 |                    |

|   |                |        |                   |
|---|----------------|--------|-------------------|
|                                      | <b>GEV No.</b> | 112340 | <b>Ref. No.</b> — |
| knob switch zero mark t.max.°C temperature range°C $\varnothing$ 40mm shaft $\varnothing$ 6x4.6mm shaft flat left black |                |        |                   |

4 operating positions



|                    |  |                 |         |
|--------------------|--|-----------------|---------|
| <b>GEV No.</b>     | 345996   | <b>Ref. No.</b> | 32W1440 |
| <b>description</b> | cam switch   |                 |         |
| <b>For models:</b> | 191FAAE, 191FAE, 191PE4E, 1A1PE4E, 1A1PEFTE, 1A1FBE, 1D1PE4E, 1D1FBE, 71E, 71GE, 71GEGG, FS30E |                 |         |



Зип Общепит

vsezip.ru

+7(812)987-08-81



1

|                    |   |                 |         |
|--------------------|---|-----------------|---------|
| <b>GEV No.</b>     | 300010  | <b>Ref. No.</b> | 32Z0540 |
| <b>description</b> | cam switch 4 operating positions 2NO/2CO sequence 0-1-2-3 16A shaft ø 6x4.6mm shaft L 23mm connection male faston 6.3mm ceramic |                 |         |



1

|                    |   |                 |         |
|--------------------|---|-----------------|---------|
| <b>GEV No.</b>     | 300122  | <b>Ref. No.</b> | 32W0980 |
| <b>description</b> | operation switch sequence 0-1-2-3 shaft ø 6x4.6mm connection male faston 2-pole |                 |         |
| <b>For models:</b> | F60P, F60PR, F60T, F80P, F80PR, L100, L40, L40S, L45, L60, L80                  |                 |         |



1

|                    |  |                 |         |
|--------------------|--|-----------------|---------|
| <b>GEV No.</b>     | 301144   | <b>Ref. No.</b> | 3162280 |
| <b>description</b> | cam switch 4 operating positions 6NO sequence 0-1-2-3 16A shaft ø 6x4.6mm shaft L 23mm connection male faston 6.3mm plastic  |                 |         |
| <b>For models:</b> | 04WCP1EM, 06WCP1GM, 091CP1E, 091CP1G, 0G1CP1EC, 0G1CP1E-VERS.2004, 0G1CP1G-VERS.2004, 191CP1G, 191CP2G, 1G1CP1G-VERS.2004, 1G1CP2G-VERS.2004, 6040090, 6040310, 6043850, 6043980 |                 |         |

rotary switches

BRETER

rotary switches



1

|                    |   |                 |         |
|--------------------|---|-----------------|---------|
| <b>GEV No.</b>     | 346917  | <b>Ref. No.</b> | 32W2420 |
| <b>description</b> | rotary switch 2 0-1 sets of contacts 4 400V 20A shaft ø 5x5mm shaft square with knob connection screw |                 |         |

operation switches



1

|                    |   |                 |         |
|--------------------|---|-----------------|---------|
| <b>GEV No.</b>     | 301153  | <b>Ref. No.</b> | 32W2550 |
| <b>description</b> | cam switch 2 operating positions 2NO 16A sequence 0-1 shaft ø 6x4.6mm shaft L 23mm connection male faston 6.3mm ceramic |                 |         |
| <b>For models:</b> | 030FE1, 091FE28, 30F1, 30FES2, 30FS2, 70F1, 70FE, 70FE1, 70FES2, 71F2, 71FE2, 91F210                                    |                 |         |

LOVATO



1

|                    |   |                 |         |
|--------------------|---|-----------------|---------|
| <b>GEV No.</b>     | 346178  | <b>Ref. No.</b> | 32W1200 |
| <b>description</b> | rotary switch 2 0-1 sets of contacts 2 type GN209479U 690V 20A shaft ø 6x6mm shaft L 23.5mm shaft square connection screw |                 |         |



1

|                    |   |                 |         |
|--------------------|---|-----------------|---------|
| <b>GEV No.</b>     | 300215  | <b>Ref. No.</b> | 32W0080 |
| <b>description</b> | cam switch 2 operating positions sequence 0-1 3-pole ambient temperature max. 318°C |                 |         |



Зип-Общепит

65x20mm

vsezip.ru

+7(812)987-08-81

## magnetic switches

37x16mm

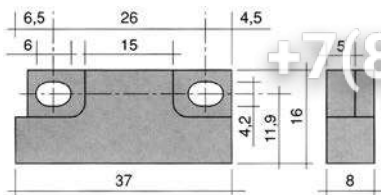

1

|   |  |                 |  |
|---|--|-----------------|--|
| <b>GEV No.</b>  | 345600   | <b>Ref. No.</b> | 32V5740<br>32W2160                               |
| <b>description</b>  | magnetic switch L 37mm W 16mm 1NO 250V 0.2A P max. 50W connection cable cable length 960mm   |                 |  |
| <b>For models:</b>  | BX101E, BX101E-VERS.122013, BX101G, BX101G-VERS.122013, BX122E, BX122E-VERS.122013, BX122G, BX122G-VERS.122013, BX61E, BX61E-VERS.122013, BX61G, BX61G-VERS.122013, BX82E, BX82E-VERS.122013, BX82G, BX82G-VERS.122013, FM1011E1, FM1011E1-VERS.2006, FM1011E2, FM1011E2-VERS.2006, FM1011E3, FM1011E3-VERS.2006, FM1011G1, FM1011G1-VERS.2006, FM1011G2, FM1011G2-VERS.2006, FM1011G3, FM1011G3-VERS.2006, FM1221E1, FM1221E1-VERS.2006, FM1221E2, FM1221E2-VERS.2006, FM1221E3, FM1221E3-VERS.2006, FM1221G1, FM1221G1-VERS.2006, FM1221G2, FM1221G2-VERS.2006, FM1221G3, FM1221G3-VERS.2006, FM2011E2-VERS.2006, FM2011E3-VERS.2006, FM2011G2-VERS.2006, FM2011G3-VERS.2006, FM2021E1, FM2021E2, FM2021E2-VERS.2006, FM2021E3, FM2021E3-VERS.2006, FM2021G1...(Other models you can see in the webshop) |                 |  |
| <b>accessories for</b>  | 345600   |                 |  |
|  | <b>GEV No.</b>   | 519049          | <b>Ref. No.</b><br>3023650<br>32W0870<br>32W1680 |
|   | magnet ømm L 63mm H 10.7mm W 18.8mm hole distance 52mm M2 hole ø 2mm   |                 |  |

51x16mm



1

|                    |   |                 |         |
|--------------------|---|-----------------|---------|
| <b>GEV No.</b>     | 348168  | <b>Ref. No.</b> | 3022950 |
| <b>description</b> | magnetic switch L 51mm W 16mm 1NO 240V 2A P max. 12W cable length 350mm |                 |         |
| <b>For models:</b> | DK112, DK351M, DK352, DK552, DP10, DP25                                 |                 |         |

1

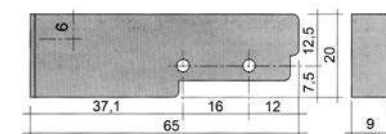

|   |  |                 |                      |
|---|--|-----------------|----------------------|
| <b>GEV No.</b>  | 345116   | <b>Ref. No.</b> | 32W1210              |
| <b>description</b>  | magnetic switch L 65mm W 20mm 1NO 250V 0.4A P max. 100W connection cable cable length 3000mm |                 |                      |
| <b>accessories for</b>  | 345116   |                 |                      |
|  | <b>GEV No.</b>   | 345399          | <b>Ref. No.</b><br>— |
|   | magnet ø 3.3mm L 40mm H 8mm W 13mm hole distance 30mm M3                                     |                 |                      |

M10x0.75



1

|                    |  |                 |                    |
|--------------------|--|-----------------|--------------------|
| <b>GEV No.</b>     | 348024   | <b>Ref. No.</b> | 32W1890<br>32W3460 |
| <b>description</b> | magnetic switch 1NO 250V 1A P max. 10W connection Faston 6.3mm cable length 2000mm |                 |                    |



1

|   |  |                 |                               |
|---|--|-----------------|-------------------------------|
| <b>GEV No.</b>  | 345632   | <b>Ref. No.</b> | 32W3200<br>32W3240<br>32Z8650 |
| <b>description</b>  | magnetic switch thread M10x0.75 1NO 250V 0.5A P max. 50W connection cable cable length 2000mm type 102   |                 |                               |
| <b>For models:</b>  | C165D, C165S, C165VD, C165VS, C207D, C207D-VERS.2006, C207S, C207S-VERS.2006, C207VD, C207VD-VERS.2006, C207VS, C207VS-VERS.2006, C304AD, C304AD-VERS.2006, C304AS, C304AS-VERS.2006, C304AVD, C304AVD-VERS.2006, C304AVS, C304AVS-VERS.2006, C304D, C304D-VERS.2006, C304S, C304S-VERS.2006, C304VD, C304VD-VERS.2006, C304VS, C304VS-VERS.2006, C92D-VERS.2006, C92S-VERS.2006, C92VD-VERS.2006, C92VS-VERS.2006, CS243D, CS243D-VERS.2006, CS243S, CS243S-VERS.2006, CS243VD, CS243VD-VERS.2006, CS243VS, CS243VS-VERS.2006, CS370AD, CS370AD-VERS.2006, CS370AS, CS370AS-VERS.2006, CS370AVD, CS370AVD-VERS.2006, CS370AVS, CS370AVS-VERS.2006, CS370D, CS370D-VERS.2006...(Other models you can see in the webshop) |                 |                               |
| <b>accessories for</b>  | 345632   |                 |                               |
|  | <b>GEV No.</b>   | 100779          | <b>Ref. No.</b><br>—          |
|   | nut thread M10x0.75 H 3mm WS 14 SS Qty 2 pcs   |                 |                               |



Зип Общепит

vsezip.ru

+7(812)987-08-81

accessories

magnets



|                    |   |                 |                    |
|--------------------|---|-----------------|--------------------|
| <b>GEV No.</b>     | 691178  | <b>Ref. No.</b> | 3008810<br>3112370 |
| <b>description</b> | magnet $\varnothing$ 22mm Lmm H 7mm Wmm ED $\varnothing$ 22mm M5  |                 |                    |
| <b>For models:</b> | FC1011E, FC1011G, FC1221E, FC1221G, FC611E, FC611G, FM1011E1, FM1011E1-VERS.2006, FM1011E2, FM1011E2-VERS.2006, FM1011E3, FM1011E3-VERS.2006, FM1011G1, FM1011G1-VERS.2006, FM1011G2, FM1011G2-VERS.2006, FM1011G3, FM1011G3-VERS.2006, FM1221E1, FM1221E1-VERS.2006, FM1221E2, FM1221E2-VERS.2006, FM1221E3, FM1221E3-VERS.2006, FM1221G1, FM1221G1-VERS.2006, FM1221G2, FM1221G2-VERS.2006, FM1221G3, FM1221G3-VERS.2006, FM2011E2-VERS.2006, FM2011E3-VERS.2006, FM2011G2-VERS.2006, FM2011G3-VERS.2006, FM2021E1, FM2021E2, FM2021E2-VERS.2006, FM2021E3, FM2021E3-VERS.2006, FM2021G1, FM2021G2, FM2021G2-VERS.2006, FM2021G3, FM2021G3-VERS.2006, FM611E1, FM611E1-VERS.2006, FM611E2, FM611E2-VERS.2006, FM611E3, FM611E3-VERS.2006... (Other models you can see in the webshop) |                 |                    |

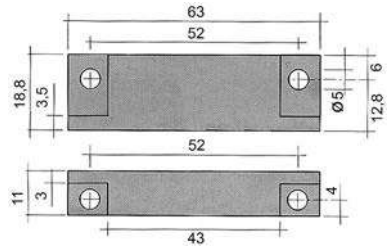

|                    |   |                 |         |
|--------------------|---|-----------------|---------|
| <b>GEV No.</b>     | 345336  | <b>Ref. No.</b> | 3210010 |
| <b>description</b> | magnet $\varnothing$ 4.8mm L 63mm H 11mm W 18.8mm hole distance 51mm M4 |                 |         |
| <b>For models:</b> | LP151, LP202, LP202HC, LP302, LP302HC, LP402, LP402HC, LP402V, LPG300   |                 |         |

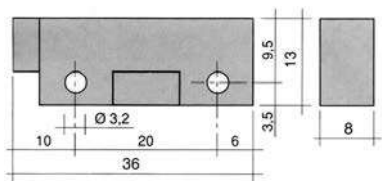

|                    |  |                 |         |
|--------------------|--|-----------------|---------|
| <b>GEV No.</b>     | 345398   | <b>Ref. No.</b> | 32V0080 |
| <b>description</b> | magnet $\varnothing$ mm L 36mm H 8mm W 13mm hole distance 20mm M3 hole $\varnothing$ 3mm |                 |         |

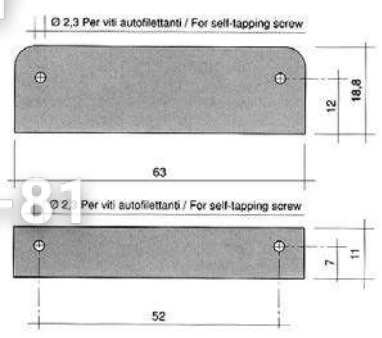

|                        |   |                 |                               |
|------------------------|---|-----------------|-------------------------------|
| <b>GEV No.</b>         | 519049  | <b>Ref. No.</b> | 3023650<br>32W0870<br>32W1680 |
| <b>description</b>     | magnet $\varnothing$ mm L 63mm H 10.7mm W 18.8mm hole distance 52mm M2 hole $\varnothing$ 2mm   |                 |                               |
| <b>For models:</b>     | C165D, C165S, C165VD, C165VS, C207D, C207D-VERS.2006, C207S, C207S-VERS.2006, C207VD, C207VD-VERS.2006, C207VS, C207VS-VERS.2006, C304AD, C304AD-VERS.2006, C304AS, C304AS-VERS.2006, C304AVD, C304AVD-VERS.2006, C304AVS, C304AVS-VERS.2006, C304D, C304D-VERS.2006, C304S, C304S-VERS.2006, C304VD, C304VD-VERS.2006, C304VS, C304VS-VERS.2006, C92D-VERS.2006, C92S-VERS.2006, C92VD-VERS.2006, C92VS-VERS.2006, CS243D, CS243D-VERS.2006, CS243S, CS243S-VERS.2006, CS243VD, CS243VD-VERS.2006, CS243VS, CS243VS-VERS.2006, CS370AD, CS370AD-VERS.2006, CS370AS, CS370AS-VERS.2006, CS370AVD, CS370AVD-VERS.2006, CS370AVS, CS370AVS-VERS.2006, CS370D, CS370D-VERS.2006... (Other models you can see in the webshop) |                 |                               |
| <b>accessories for</b> | 519049  |                 |                               |
|                        | <b>GEV No.</b>  | 560095          | <b>Ref. No.</b> —             |
|                        | sheet metal screws $\varnothing$ 2.9mm L 9.5mm SS Qty 20 pcs DIN 7981/ISO 7049 head $\varnothing$ 5.6mm oval head   |                 |                               |

control equipment

BRETER

switches (complete)



|                    |                                      |                 |         |
|--------------------|--------------------------------------|-----------------|---------|
| <b>GEV No.</b>     | 345718                               | <b>Ref. No.</b> | 32W1640 |
| <b>description</b> | momentary push switch black 1NC/1NO  |                 |         |
| <b>For models:</b> | 71AR, 71ARE, 71RA, 91AR, 91ARE, 91RA |                 |         |



|                    |                                      |                 |         |
|--------------------|--------------------------------------|-----------------|---------|
| <b>GEV No.</b>     | 345717                               | <b>Ref. No.</b> | 32W1650 |
| <b>description</b> | momentary push switch green 1NC/1NO  |                 |         |
| <b>For models:</b> | 71AR, 71ARE, 71RA, 91AR, 91ARE, 91RA |                 |         |



## ELFIN

## switches (complete)



1

|                    |  |                 |         |
|--------------------|--|-----------------|---------|
| <b>GEV No.</b>     | 347947   | <b>Ref. No.</b> | 32Z8470 |
| <b>description</b> | rotary selector mounting measurements ø22mm 2NO/2NC sequence 0-1-2 black   |                 |         |
| <b>For models:</b> | C207D, C207S, C207VD, C207VS, C304AD, C304AS, C304AVD, C304AVS, C304D, C304S, C304VD, C304VS, CS243D, CS243S, CS243VD, CS243VS, CS370AD, CS370AS, CS370AVD, CS370AVS, CS370D, CS370S, CS370VD, CS370VS, CS466AD, CS466AS, CS466AVD, CS466AVS, CS466D, CS466S, CS466VD, CS466VS, N303D, N303S, N303VD, N303VS, N354D, N354S, N354VD, N354VS, N506D, N506S, N506VD, N506VS, N607D, N607S, N607VD, N607VS, N760D, N760S...(Other models you can see in the webshop) |                 |         |

## LOVATO



1

|                    |  |                 |         |
|--------------------|--|-----------------|---------|
| <b>GEV No.</b>     | 301171   | <b>Ref. No.</b> | 32W3330 |
| <b>description</b> | contact block LAVATO 8 LM2T-C10 1NC max 690V 10A   |                 |         |
| <b>For models:</b> | 10CP1EA, 10CP1GA, 10CP1IA, 12CP1EA, 12CP1GA, 12CP1IA, 18CP2EA, 18CP2GA, 18CP2IA, 191BR1GA, 191BR2EA, 191BR2GA, 1A1BR1GA, 1A1BR2EA, 1A1BR2GA, 1D1BR1GA, 1D1BR2EA, 1D1BR2GA, 2091SCP, 291BR1GA, 291BR2EA, 291BR2GA, 2A1BR1GA, 2A1BR2EA, 2A1BR2GA, 2D1BR1GA, 2D1BR2EA, 2D1BR2GA, BRE21HD, BRE31HD, PIER06HD, PIER10HD, PIER15HD |                 |         |



1

|                    |   |                 |         |
|--------------------|---|-----------------|---------|
| <b>GEV No.</b>     | 301170  | <b>Ref. No.</b> | 32W3320 |
| <b>description</b> | contact block LAVATO 8 LM2T-C10 1NO max 690V 10A  |                 |         |
| <b>For models:</b> | 10CP1EA, 10CP1GA, 10CP1IA, 12CP1EA, 12CP1GA, 12CP1IA, 18CP2EA, 18CP2GA, 18CP2IA, 191BR1GA, 191BR2EA, 191BR2GA, 1A1BR1GA, 1A1BR2EA, 1A1BR2GA, 1D1BR1GA, 1D1BR2EA, 1D1BR2GA, 291BR1GA, 291BR2EA, 291BR2GA, 2A1BR1GA, 2A1BR2EA, 2A1BR2GA, 2D1BR1GA, 2D1BR2EA, 2D1BR2GA, BRE21HD, BRE31HD, PIER06HD, PIER10HD, PIER15HD |                 |         |

## Зип, Общепит

plastic series

## switch block brackets



1

|                    |   |                 |         |
|--------------------|---|-----------------|---------|
| <b>GEV No.</b>     | 301169  | <b>Ref. No.</b> | 32W3310 |
| <b>description</b> | contact block holder  |                 |         |
| <b>For models:</b> | 10CP1EA, 10CP1GA, 10CP1IA, 12CP1EA, 12CP1GA, 12CP1IA, 18CP2EA, 18CP2GA, 18CP2IA, 191BR1GA, 191BR2EA, 191BR2GA, 1A1BR1GA, 1A1BR2EA, 1A1BR2GA, 1D1BR1GA, 1D1BR2EA, 1D1BR2GA, 291BR1GA, 291BR2EA, 291BR2GA, 2A1BR1GA, 2A1BR2EA, 2A1BR2GA, 2D1BR1GA, 2D1BR2EA, 2D1BR2GA, BRE21HD, BRE31HD, PIER06HD, PIER10HD, PIER15HD |                 |         |

## metal series

## push buttons



1

|                    |   |                 |                    |
|--------------------|---|-----------------|--------------------|
| <b>GEV No.</b>     | 301197  | <b>Ref. No.</b> | 37Q4030<br>37Q7600 |
| <b>description</b> | protective cover transparent ED ø 34mm H 16mm for push-button   |                 |                    |
| <b>For models:</b> | 10CP1EA, 10CP1GA, 10CP1IA, 12CP1EA, 12CP1GA, 12CP1IA, 18CP2EA, 18CP2GA, 18CP2IA, 191BR1GA, 191BR2EA, 191BR2GA, 1A1BR1GA, 1A1BR2EA, 1A1BR2GA, 1D1BR1GA, 1D1BR2EA, 1D1BR2GA, 291BR1GA, 291BR2EA, 291BR2GA, 2A1BR1GA, 2A1BR2EA, 2A1BR2GA, 2D1BR1GA, 2D1BR2EA, 2D1BR2GA, 71AR, 71ARE, 71RA, 91AR, 91ARE, 91RA, BRE21HD, BRE31HD, PIER06HD, PIER10HD, PIER15HD |                 |                    |



1

|                    |   |                 |         |
|--------------------|---|-----------------|---------|
| <b>GEV No.</b>     | 301196  | <b>Ref. No.</b> | 32W3300 |
| <b>description</b> | push button mounting measurements ø22mm black arrow   |                 |         |
| <b>For models:</b> | 10CP1EA, 10CP1GA, 10CP1IA, 12CP1EA, 12CP1GA, 12CP1IA, 18CP2EA, 18CP2GA, 18CP2IA, 191BR1GA, 191BR2EA, 191BR2GA, 1A1BR1GA, 1A1BR2EA, 1A1BR2GA, 1D1BR1GA, 1D1BR2EA, 1D1BR2GA, 291BR1GA, 291BR2EA, 291BR2GA, 2A1BR1GA, 2A1BR2EA, 2A1BR2GA, 2D1BR1GA, 2D1BR2EA, 2D1BR2GA, BRE21HD, BRE31HD, PIER06HD, PIER10HD, PIER15HD |                 |         |



TELEMECANIQUE (EFA)

3ип Общежит encoders and potentiometers

vsezip.ru

+7(812)987-08-81

XA2 series

switches (complete)



1

|                    |   |                 |         |
|--------------------|---|-----------------|---------|
| <b>GEV No.</b>     | 345592  | <b>Ref. No.</b> | 32W2150 |
| <b>description</b> | rotary selector mounting measurements ø22mm 1NC/1NO complete sequence 0-1-2 |                 |         |
| <b>For models:</b> | LC100, LC100-VERS.2001, LC130, LC130-VERS.2001, LC80                        |                 |         |



1

|                    |  |                 |         |
|--------------------|--|-----------------|---------|
| <b>GEV No.</b>     | 345591   | <b>Ref. No.</b> | 32Z8670 |
| <b>description</b> | rotary selector mounting measurements ø22mm complete   |                 |         |
| <b>For models:</b> | C165D, C165S, C165VD, C165VS, C207D, C207S, C207VD, C207VS, C304AD, C304AS, C304AVD, C304AVS, C304D, C304S, C304VD, C304VS, CS243D, CS243S, CS243VD, CS243VS, CS370AD, CS370AS, CS370AVD, CS370AVS, CS370D, CS370S, CS370VD, CS370VS, CS466AD, CS466AS, CS466AVD, CS466AVS, CS466D, CS466S, CS466VD, CS466VS, LC100, LC100-VERS.2001, LC130, LC130-VERS.2001, LC80, LP124, LP124S-VERS.052006, LP124V, LP124V-VERS.052006, LP124VS-VERS.052006, LP124V-VERS.052006, LP84, LP84S-VERS.052006, LP84V...(Other models you can see in the webshop) |                 |         |

miscellaneous



1

|                    |  |                 |         |
|--------------------|--|-----------------|---------|
| <b>GEV No.</b>     | 349001   | <b>Ref. No.</b> | 32W1700 |
| <b>description</b> | indicator lamp mounting measurements ø22mm yellow  |                 |         |
| <b>For models:</b> | C165D, C165S, C165VD, C165VS, C207D, C207S, C207VD, C207VS, C304AD, C304AS, C304AVD, C304AVS, C304D, C304S, C304VD, C304VS, CS243D, CS243S, CS243VD, CS243VS, CS370AD, CS370AS, CS370AVD, CS370AVS, CS370D, CS370S, CS370VD, CS370VS, CS466AD, CS466AS, CS466AVD, CS466AVS, CS466D, CS466S, CS466VD, CS466VS, LP124, LP124V, LP84, LP84V |                 |         |



1

|                    |  |                 |         |
|--------------------|--|-----------------|---------|
| <b>GEV No.</b>     | 402322   | <b>Ref. No.</b> | 3051070 |
| <b>description</b> | encoder  |                 |         |
| <b>For models:</b> | BX101E, BX101G, BX122E, BX122G, BX61E, BX61G, BX82E, BX82G, FM1011E1-VERS.2006, FM1011E2-VERS.2006, FM1011E3-VERS.2006, FM1011G1-VERS.2006, FM1011G2-VERS.2006, FM1011G3-VERS.2006, FM1221E1-VERS.2006, FM1221E2-VERS.2006, FM1221E3-VERS.2006, FM1221G1-VERS.2006, FM1221G2-VERS.2006, FM1221G3-VERS.2006, FM2011E2-VERS.2006, FM2011E3-VERS.2006, FM2011G2-VERS.2006, FM2011G3-VERS.2006, FM2021E2-VERS.2006, FM2021E3-VERS.2006, FM2021G2-VERS.2006, FM2021G3-VERS.2006, FM423E1, FM423E2, FM611E1-VERS.2006, FM611E2-VERS.2006, FM611E3-VERS.2006, FM611G1-VERS.2006, FM611G2-VERS.2006, FM611G3-VERS.2006, FM721E1-VERS.2006, FM721E2-VERS.2006, FM721E3-VERS.2006, FM721G1-VERS.2006, FM721G2-VERS.2006, FM721G3-VERS.2006 |                 |         |



1

|                    |   |                 |                    |
|--------------------|---|-----------------|--------------------|
| <b>GEV No.</b>     | 300272  | <b>Ref. No.</b> | 3104220<br>6300966 |
| <b>description</b> | encoder shaft ø 6x4.6mm for combi-steamer   |                 |                    |
| <b>For models:</b> | BX101E-VERS.122013, BX101G-VERS.122013, BX122E-VERS.122013, BX122G-VERS.122013, BX61E-VERS.122013, BX61G-VERS.122013, BX82E-VERS.122013, BX82G-VERS.122013, FX101E1, FX101E1R, FX101E2, FX101E2C, FX101E2C-VERS.032014, FX101E2R, FX101E2R-VERS.032014, FX101E2-VERS.032014, FX101E3, FX101E3C, FX101E3C-VERS.022014, FX101E3R, FX101E3R-VERS.022014, FX101E3-VERS.022014, FX101G1, FX101G1R, FX101G2, FX101G2C, FX101G2C-VERS.032014, FX101G2R, FX101G2R-VERS.032014, FX101G2-VERS.032014, FX101G3, FX101G3C, FX101G3C-VERS.022014, FX101G3R, FX101G3R-VERS.022014, FX101G3-VERS.022014, FX10E2CR, FX10E2CR-VERS.032014, FX10E3CR, FX10E3CR-VERS.022014, FX10G2CR, FX10G2CR-VERS.032014, FX10G3CR, FX10G3CR-VERS.022014, FX122E1, FX122E2, FX122E2C, FX122E2T, FX122E2T-VERS.032014, FX122E3...(Other models you can see in the webshop) |                 |                    |



1

|                    |   |                 |         |
|--------------------|---|-----------------|---------|
| <b>GEV No.</b>     | 300230  | <b>Ref. No.</b> | 32V5580 |
| <b>description</b> | potentiometer   |                 |         |
| <b>For models:</b> | FM1011E1, FM1011E2, FM1011E3, FM1011G1, FM1011G2, FM1011G3, FM1221E1, FM1221E2, FM1221E3, FM1221G1, FM1221G2, FM1221G3, FM2021E1, FM2021E2, FM2021E3, FM2021G1, FM2021G2, FM2021G3, FM611E1, FM611E2, FM611E3, FM611G1, FM611G2, FM611G3, FM721E1, FM721E2, FM721E3, FM721G1, FM721G2, FM721G3, FS611 |                 |         |

electric components



## lamps

## indicator lights

## indicator lights 2-piece (lens and indicator lamp)

indicator lamps for socket type SRZ / SDK / SDY / SEK



|                    |   |                 |         |
|--------------------|---|-----------------|---------|
| <b>GEV No.</b>     | 359130  | <b>Ref. No.</b> | 32W4220 |
| <b>description</b> | indicator lamp 230V clear connection male faston 6.3mm ø 8mm  |                 |         |
| <b>For models:</b> | KD100, KD100A, KD100PSD, KD37, KD37PS, KD37-VERS.112009, KD40, KD40LUX, KD40PS, KD40-VERS.112009, KD60, KD60M, KD60MA, KD60MPS, KD60MPSA, KD60PS, KD60PSD, KD85, KD85A, KD85PS, KD85PSA, KN1100, KN1100SD, KN1100SDD, KN35, KN37, KN37PS, KN40, KN40PS, KN40PSD, KN50, KN50M, KN50MPS, KN50PS, KN50PSD, KN50PSDD, KN80, KN800, KN800PSD, KN80PS |                 |         |

## indicator lights (complete)

ø 6mm



|                    |  |                 |         |
|--------------------|--|-----------------|---------|
| <b>GEV No.</b>     | 359004   | <b>Ref. No.</b> | 32W0101 |
| <b>description</b> | indicator light ø 6mm 230V green cable length 400mm temp.-resist. 106°C  |                 |         |
| <b>For models:</b> | FC101, FC1011E, FC1011G, FC101E, FC1221E, FC1221G, FC241, FC241E, FC241G, FC61, FC611E, FC611G, FC61E, FMS, FMSX |                 |         |



|                    |   |                 |         |
|--------------------|---|-----------------|---------|
| <b>GEV No.</b>     | 359009  | <b>Ref. No.</b> | 32W0450 |
| <b>description</b> | indicator light ø 6mm 230V red cable length 400mm with series resistor                                |                 |         |
| <b>For models:</b> | FC101, FC1011E, FC1011G, FC101E, FC1221E, FC1221G, FC241, FC241E, FC241G, FC61, FC611E, FC611G, FC61E |                 |         |



|                    |  |                 |         |
|--------------------|--|-----------------|---------|
| <b>GEV No.</b>     | 359005   | <b>Ref. No.</b> | 32W2250 |
| <b>description</b> | indicator light ø 6mm 230V yellow cable length 400mm   |                 |         |
| <b>For models:</b> | FC101, FC1011E, FC1011G, FC101E, FC1221E, FC1221G, FC241, FC241E, FC241G, FC61, FC611E, FC611G, FC61E, FMS, FMSX |                 |         |

ø 9mm



|                    |  |                 |         |
|--------------------|--|-----------------|---------|
| <b>GEV No.</b>     | 345597   | <b>Ref. No.</b> | 32W2140 |
| <b>description</b> | indicator light ø 9mm 400V green connection male faston 6.3mm temp.-resist. 85°C                     |                 |         |
| <b>For models:</b> | LC100, LC100-VERS.2001, LC130, LC130-VERS.2001, LC80, LF50, LF50E, LF50EM, LF50EMPS, LF50E-VERS.2007 |                 |         |

Зип-Общепит

|                    |  |                 |         |
|--------------------|--|-----------------|---------|
| <b>GEV No.</b>     | 345598   | <b>Ref. No.</b> | 32W2130 |
| <b>description</b> | indicator light ø 9mm 400V yellow connection male faston 6.3mm temp.-resist. 85°C                    |                 |         |
| <b>For models:</b> | LC100, LC100-VERS.2001, LC130, LC130-VERS.2001, LC80, LF50, LF50E, LF50EM, LF50EMPS, LF50E-VERS.2007 |                 |         |

ø10mm

with screw socket



|                    |  |                 |         |
|--------------------|--|-----------------|---------|
| <b>GEV No.</b>     | 359995   | <b>Ref. No.</b> | 32W3280 |
| <b>description</b> | indicator light ø 10mm 230V clear connection male faston 6.3mm |                 |         |
| <b>For models:</b> | P5   |                 |         |



|                    |   |                 |                               |
|--------------------|---|-----------------|-------------------------------|
| <b>GEV No.</b>     | 359378  | <b>Ref. No.</b> | 3106710<br>32W1330<br>32W1331 |
| <b>description</b> | indicator light ø 10mm 230V green connection male faston 6.3mm socket screw base  |                 |                               |
| <b>For models:</b> | 030BME, 030E, 030EBM, 030FE, 030FE1, 030FE1B, 030FTE, 030FTER, 031BME, 031E, 031EBM, 031FTE, 031FTER, 031FTERL, 04WB-MEV, 04WCP1EM, 04WFR3ED, 04WPE4V, 04WVT3RV, 06WBR3E, 06WCP1GM, 06WFR3GD, 06WFT1EV, 06WFT2EV, 06WFT3EV, 06WFT4EV, 06WFT6EV, 06WFT7EV, 070BME, 070E, 070FTE, 070FTER, 071BME, 071E, 071FTE, 071FTER, 071FTERL, 08WCP1GM, 08WFA4E, 08WFAAE, 08WFR4ED, 08WFT1EV, 08WFT2EV, 08WFT3EV, 08WFT4EV, 08WFT6EV, 08WFT7EV, 08WGREV, 08WPE4V, 090BM1E...(Other models you can see in the webshop) |                 |                               |



|                    |  |                 |         |
|--------------------|--|-----------------|---------|
| <b>GEV No.</b>     | 359380   | <b>Ref. No.</b> | 32W1340 |
| <b>description</b> | indicator light ø 10mm 230V red connection male faston 6.3mm socket screw base |                 |         |



|                    |  |                 |                               |
|--------------------|--|-----------------|-------------------------------|
| <b>GEV No.</b>     | 359379   | <b>Ref. No.</b> | 3106730<br>32W0790<br>32W0791 |
| <b>description</b> | indicator light ø 10mm 230V yellow connection male faston 6.3mm socket screw base  |                 |                               |
| <b>For models:</b> | 030BME, 030EBM, 030FE, 030FE1, 030FE1B, 030FTE, 030FTER, 031BME, 031EBM, 031FTE, 031FTER, 031FTERL, 04WBMEV, 04WCP1EM, 04WFR3ED, 06WBR3E, 06WFR3GD, 06WFT1EV, 06WFT2EV, 06WFT3EV, 06WFT4EV, 06WFT6EV, 06WFT7EV, 070BME, 070FTE, 070FTER, 071BME, 071FTE, 071FTER, 071FTERL, 08WFA4E, 08WFAAE, 08WFR4ED, 08WFT1EV, 08WFT2EV, 08WFT3EV, 08WFT4EV, 08WFT6EV, 08WFT7EV, 090BM1E, 090BME, 090FT1E, 090FT2E, 090FT4E, 090FT5E, 090FT7E, 090FTE, 090FTER, 091BME, 091CP1E...(Other models you can see in the webshop) |                 |                               |







Зип Общепит

vsezip.ru

+7(812)987-08-81

|   |  |                 |         |
|---|--|-----------------|---------|
|  |  |                 |         |
| 1   |  |                 |         |
| <b>GEV No.</b>  | 359527   | <b>Ref. No.</b> | 32W1562 |
| <b>description</b>  | indicator light ø 10mm 400V green connection male faston 6.3mm socket screw base   |                 |         |
| <b>For models:</b>  | 031FTE04, 031FTE06, 070E, 070FTE04, 070FTE05, 071E, 071FTE04, 071FTE06, 08WFAAE, 090E, 090FTE04, 090FTE05, 091E, 091FTE04, 091FTE06, 0A0FT1E, 0A0FT2E, 0A0FT4E, 0A0FT5E, 0A0PE4, 0A1CP1E, 0D0FT1E, 0D0FT2E, 0D0FT4E, 0D0FT5E, 0D0PE4, 0D1CP1E, 0G0FT1E, 0G0FT2E, 0G0FT4E, 0G0FT5E, 0G0PE1, 0G0PE2, 0G1CP1E, 10WTPGE, 12WFAAA, 12WFAAE, 190BM2E, 191PI2E, 191PI2EA, 1A0BME, 1A0FT1E, 1A0FT2E, 1A0FT3E, 1A0FT4E, 1A0FT6E, 1A0PE4, 1A1PE4E, 1A1PEFTE, 1A1PI2E...(Other models you can see in the webshop) |                 |         |

|   |   |                 |         |
|---|---|-----------------|---------|
|  |   |                 |         |
| 1   |   |                 |         |
| <b>GEV No.</b>  | 360483  | <b>Ref. No.</b> | 6300652 |
| <b>description</b>  | indicator light ø 10mm 230V green connection male faston 6.3mm cable length 90mm with series resistor for 230V ordinary operation socket screw base   |                 |         |
| <b>For models:</b>  | 031FTE04, 031FTE06, 070E, 070FTE04, 070FTE05, 071E, 071FTE04, 071FTE06, 090E, 090FTE04, 090FTE05, 091E, 091FTE04, 091FTE06, 0A0FT1E, 0A0FT2E, 0A0FT4E, 0A0FT5E, 0A0PE4, 0A1CP1E, 0D0FT1E, 0D0FT2E, 0D0FT4E, 0D0FT5E, 0D0PE4, 0D1CP1E, 0G0FT1E, 0G0FT2E, 0G0FT4E, 0G0FT5E, 0G0FT7E, 0G0PE1, 0G0PE2, 0G1CP1E, 0G1PE2, 10WTPGE, 12WFAAA, 190BM2E, 191PI2E, 191PI2EA, 1A0BME, 1A0FT1E, 1A0FT2E, 1A0FT3E, 1A0FT4E, 1A0FT6E, 1A0PE4, 1A1PE4E, 1A1PEFTE, 1A1PI2E...(Other models you can see in the webshop) |                 |         |

|  |  |                 |                               |
|--|--|-----------------|-------------------------------|
|  |  |                 |                               |
| 1  |  |                 |                               |
| <b>GEV No.</b>   | 346881   | <b>Ref. No.</b> | 3106720<br>32W1341<br>6300653 |
| <b>description</b>   | indicator light ø 10mm 230V red connection male faston 6.3mm |                 |                               |

|   |  |                 |                               |
|---|--|-----------------|-------------------------------|
|  |  |                 |                               |
| 1   |  |                 |                               |
| <b>GEV No.</b>  | 346883   | <b>Ref. No.</b> | 3106730<br>32W1551<br>6300651 |
| <b>description</b>  | indicator light ø 10mm 230V yellow connection male faston 6.3mm  |                 |                               |
| <b>For models:</b>  | 031FTE04, 031FTE06, 070FTE04, 070FTE05, 071FTE04, 071FTE06, 090FTE04, 090FTE05, 091FTE04, 091FTE06, 0A0FT1E, 0A0FT2E, 0A0FT4E, 0A0FT5E, 0D0FT1E, 0D0FT2E, 0D0FT4E, 0D0FT5E, 0G0FT1E, 0G0FT2E, 0G0FT4E, 0G0FT5E, 0G0FT7E, 10WTPGE, 12WFAAA, 190BM2E, 1A0BME, 1A0FT1E, 1A0FT2E, 1A0FT3E, 1A0FT4E, 1A0FT6E, 1A1PE4E, 1A1PEFTE, 1A1FBE, 1D0BME, 1D0FT1E, 1D0FT2E, 1D0FT3E, 1D0FT4E, 1D0FT6E, 1D1PE4E, 1D1FBE, 1G0FT1E, 1G0FT2E, 1G0FT3E, 1G0FT4E, 1G0FT7E, 1G1FA0E, 1G1FA0EV...(Other models you can see in the webshop) |                 |                               |

|   |   |                 |         |
|---|---|-----------------|---------|
|  |   |                 |         |
| 1   |   |                 |         |
| <b>GEV No.</b>  | 359889  | <b>Ref. No.</b> | 32W2080 |
| <b>description</b>  | indicator light ø 10mm 230V red connection cable  |                 |         |
| <b>For models:</b>  | AFC30MS, AFC30S, AFC35, AFT30MS, AFT30S, AFT30VMS, AFT30VS, AFT33MS, AFT33S, AFT35, AFT35VS |                 |         |

|   |  |                 |                    |
|---|--|-----------------|--------------------|
|  |  |                 |                    |
| 1   |  |                 |                    |
| <b>GEV No.</b>  | 359019   | <b>Ref. No.</b> | 32W1560<br>32W1561 |
| <b>description</b>  | indicator light ø 10mm green 400V connection male faston 6.3mm Qty 1 pcs   |                 |                    |
| <b>For models:</b>  | 031FTE04, 031FTE06, 070E, 070FTE04, 070FTE05, 071E, 071FTE04, 071FTE06, 08WFAAE, 090E, 090FTE04, 090FTE05, 091E, 091FTE04, 091FTE06, 0A0FT1E, 0A0FT2E, 0A0FT4E, 0A0FT5E, 0A0PE4, 0A1CP1E, 0D0FT1E, 0D0FT2E, 0D0FT4E, 0D0FT5E, 0D0PE4, 0D1CP1E, 0G0FT1E, 0G0FT2E, 0G0FT4E, 0G0FT5E, 0G0PE1, 0G0PE2, 0G1CP1E, 10WTPGE, 12WFAAA, 12WFAAE, 1A0BME, 1A0FT1E, 1A0FT2E, 1A0FT3E, 1A0FT4E, 1A0FT6E, 1A0PE4, 1A1PE4E, 1A1PEFTE, 1A1PI2E, 1A1PI2EA, 1A1FBE, 1D0BME...(Other models you can see in the webshop) |                 |                    |

|   |   |                 |                    |
|---|---|-----------------|--------------------|
|  |   |                 |                    |
| 1   |   |                 |                    |
| <b>GEV No.</b>  | 359020  | <b>Ref. No.</b> | 32W1550<br>32W1551 |
| <b>description</b>  | indicator light ø 10mm red 400V connection male faston 6.3mm Qty 1 pcs                      |                 |                    |
| <b>For models:</b>  | 0A1CP1E, 0D1CP1E, 0G1CP1E, 191PI2E, 191PI2EA, 1A1PI2E, 1A1PI2EA, 1D1PI2E, 1D1PI2EA, 1G1PI1E |                 |                    |

|   |   |                 |         |
|---|---|-----------------|---------|
|  |   |                 |         |
| 1   |   |                 |         |
| <b>GEV No.</b>  | 359140  | <b>Ref. No.</b> | 32W0790 |
| <b>description</b>  | indicator light ø 10mm yellow 230V connection male faston 6.3mm Qty 1 pcs |                 |         |

|   |  |                 |         |
|---|--|-----------------|---------|
|  |  |                 |         |
| 1   |  |                 |         |
| <b>GEV No.</b>  | 359334   | <b>Ref. No.</b> | 32W2440 |
| <b>description</b>  | indicator light ø 10mm yellow 24V connection male faston 6.3mm Qty 1 pcs |                 |         |

|   |  |                 |                    |
|---|--|-----------------|--------------------|
|  |  |                 |                    |
| 1   |  |                 |                    |
| <b>GEV No.</b>  | 359034   | <b>Ref. No.</b> | 32W2240<br>32W2241 |
| <b>description</b>  | indicator light ø 10mm yellow 400V connection male faston 6.3mm Qty 1 pcs  |                 |                    |
| <b>For models:</b>  | 031FTE04, 031FTE06, 070FTE04, 070FTE05, 071FTE04, 071FTE06, 08WFAAE, 090FTE04, 090FTE05, 091FTE04, 091FTE06, 0A0FT1E, 0A0FT2E, 0A0FT4E, 0A0FT5E, 0D0FT1E, 0D0FT2E, 0D0FT4E, 0D0FT5E, 0G0FT1E, 0G0FT2E, 0G0FT4E, 0G0FT5E, 10WTPGE, 12WFAAA, 12WFAAE, 190BM2E, 1A0BME, 1A0FT1E, 1A0FT2E, 1A0FT3E, 1A0FT4E, 1A0FT6E, 1A1PE4E, 1A1PEFTE, 1A1FBE, 1D0BME, 1D0FT1E, 1D0FT2E, 1D0FT3E, 1D0FT4E, 1D0FT6E, 1D1PE4E, 1D1FBE, 1G0FT1E, 1G0FT2E, 1G0FT3E, 1G0FT4E, 1G1FA0E, 1G1FA0EV...(Other models you can see in the webshop) |                 |                    |

electric components



Зип-Общепит

vsezip.ru

+7(812)987-08-81

electric components

ø12mm

with screw socket



1

|                    |   |                 |         |
|--------------------|---|-----------------|---------|
| <b>GEV No.</b>     | 359023  | <b>Ref. No.</b> | 32W1380 |
| <b>description</b> | indicator light ø 12mm 24V green connection male faston 6.3mm |                 |         |

28.5x28.5mm

lamps (complete)



1

|                    |   |                 |         |
|--------------------|---|-----------------|---------|
| <b>GEV No.</b>     | 359355  | <b>Ref. No.</b> | 32W1250 |
| <b>description</b> | indicator light mounting measurements 28.5x28.5mm 230V blue |                 |         |



1

|                    |  |                 |         |
|--------------------|--|-----------------|---------|
| <b>GEV No.</b>     | 359352   | <b>Ref. No.</b> | 32W1220 |
| <b>description</b> | indicator light mounting measurements 28.5x28.5mm 230V clear |                 |         |



1

|                    |  |                 |         |
|--------------------|--|-----------------|---------|
| <b>GEV No.</b>     | 359353   | <b>Ref. No.</b> | 32W1230 |
| <b>description</b> | indicator light mounting measurements 28.5x28.5mm 230V green |                 |         |



1

|                    |  |                 |     |
|--------------------|--|-----------------|-----|
| <b>GEV No.</b>     | 359356   | <b>Ref. No.</b> | N/A |
| <b>description</b> | indicator light mounting measurements 28.5x28.5mm 230V red |                 |     |

30x11mm



1

|                    |   |                 |         |
|--------------------|---|-----------------|---------|
| <b>GEV No.</b>     | 359158  | <b>Ref. No.</b> | 32W0550 |
| <b>description</b> | indicator light mounting measurements 30x11mm 230V red connection male faston 6.3mm temp.-resist. 125°C |                 |         |

30x22mm



1

|                    |  |                 |         |
|--------------------|--|-----------------|---------|
| <b>GEV No.</b>     | 359155   | <b>Ref. No.</b> | 32W0680 |
| <b>description</b> | indicator light mounting measurements 30x22mm 230V red connection male faston 6.3mm temp.-resist. 125°C type RL2 |                 |         |



1

|                    |  |                 |                    |
|--------------------|--|-----------------|--------------------|
| <b>GEV No.</b>     | 359156   | <b>Ref. No.</b> | 32W0270<br>32W0640 |
| <b>description</b> | indicator light mounting measurements 30x22mm 230V yellow connection male faston 6.3mm temp.-resist. 125/55°C type RL2 |                 |                    |

33x10mm



1

|                    |  |                 |         |
|--------------------|--|-----------------|---------|
| <b>GEV No.</b>     | 359451   | <b>Ref. No.</b> | 32W0720 |
| <b>description</b> | indicator light mounting measurements 33.1x10.3mm 400V yellow connection male faston 6.3mm |                 |         |

34x10mm



1

|                    |   |                 |         |
|--------------------|---|-----------------|---------|
| <b>GEV No.</b>     | 359899  | <b>Ref. No.</b> | 32W0650 |
| <b>description</b> | indicator light mounting measurements 34x10mm 380V red connection male faston 6.3mm temp.-resist. 120°C |                 |         |

screw-on/push-on fit

light bulbs

for ovens



1

|                    |  |                 |         |
|--------------------|--|-----------------|---------|
| <b>GEV No.</b>     | 359610   | <b>Ref. No.</b> | 32W0780 |
| <b>description</b> | light bulb t.max. 300°C socket E14 15W 230V ø 22mm L 47mm lens L 20mm for oven lamp type Philips |                 |         |





Зип Общепит

vsezip.ru

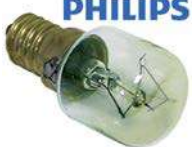
47(812)987-08-81

|   |  |                 |         |
|---|--|-----------------|---------|
|  <p><b>PHILIPS</b></p> |  |                 |         |
| 1   |  |                 |         |
| <b>GEV No.</b>  | 359612   | <b>Ref. No.</b> | 32W0210 |
| <b>description</b>  | light bulb t.max. 300°C socket E14 25W 230V ø 25mm L 56mm. lens L 30mm for oven lamp type Philips  |                 |         |
| <b>For models:</b>  | FC101, FC1011E, FC1011G, FC101E, FC1221E, FC1221G, FC241, FC241E, FC241G, FC61, FC611E, FC611G, FC61E, FCV101, FCV101-CSA, FCV101DM, FCV101DM-CSA, FCV101DS, FCV101DS-CSA, FCV101E, FCV101EDM, FCV101EDM-UL, FCV101EDS, FCV101EDS-UL, FCV101E-UL, FCV141, FCV141-CSA, FCV141DM, FCV141DM-CSA, FCV141DS, FCV141DS-CSA, FCV141E, FCV141EDM, FCV141EDS, FCV241, FCV241DM, FCV241DS, FCV241E, FCV241EDM, FCV241EDM-UL, FCV241EDS, FCV241EDS-UL, FCV241E-UL, FCV241G, FCV241G-CSA, FCV241GDM, FCV241GDM-CSA, FCV241GDS, FCV241GDS-CSA, FCV3EM...(Other models you can see in the webshop) |                 |         |

|  |   |                 |         |
|--|---|-----------------|---------|
|  <p><b>PHILIPS</b></p> |   |                 |         |
| 1  |   |                 |         |
| <b>GEV No.</b>   | 359595  | <b>Ref. No.</b> | 32W3790 |
| <b>description</b>   | light bulb socket E14 15W 230-240V ø 25mm L 56mm lens L 30mm Qty 1 pcs  |                 |         |
| <b>For models:</b>   | AF1B, AF1B-OPR01, AF1N, AF1N-OPR01, AF2B, AF2B-OPR01, AF2N, AF2N-OPR01, AGL6B, CX120, CX120B, CX120NN, CX130, CX130B, CX130NN, CX140, CX140B, CX140BN, CX140BR, CX140CP, CX140NN, CX140R, CX150, CX150B, CX150BN, CX150BR, CX150CP, CX150NN, CX150R, CX55, CX55B, CX60, CX60B, CX65, CX652, CX65B, CX65BR, CX65NB, CX65NCP, CX65NN, CX65R, CX70, CX702, CX70B, CX70BR, CX70NB, CX70NN, CX70R, FG2B, FSD1B...(Other models you can see in the webshop) |                 |         |

|   |   |                 |         |
|---|---|-----------------|---------|
|  |   |                 |         |
| 1   |   |                 |         |
| <b>GEV No.</b>  | 359614  | <b>Ref. No.</b> | 32W2350 |
| <b>description</b>  | light bulb t.max. 300°C socket E27 230V 40W ø 45mm L 71mm lens L 44mm Qty 1 pcs |                 |         |





oven lamps

universal oven lamps





mounting diameter 35.5mm

halogen lamp  
for socket G4 / G6.35 / G9

|   |   |                 |         |
|---|---|-----------------|---------|
|  <p><b>OSRAM</b></p> |   |                 |         |
| 1   |   |                 |         |
| <b>GEV No.</b>  | 357193  | <b>Ref. No.</b> | 3030661 |
| <b>description</b>  | halogen lamp socket G4 12V 20W temp.-resist. 300°C OSRAM HALOSTAR OVEN  |                 |         |
| <b>For models:</b>  | BX101E, BX101E-VERS.122013, BX101G, BX101G-VERS.122013, BX122E, BX122E-VERS.122013, BX122G, BX122G-VERS.122013, BX61E, BX61E-VERS.122013, BX61G, BX61G-VERS.122013, BX82E, BX82E-VERS.122013, BX82G, BX82G-VERS.122013, FM1011E1, FM1011E2, FM1011E3, FM1011G1, FM1011G2, FM1011G3, FM1221E1, FM1221E2, FM1221E3, FM1221G1, FM1221G2, FM1221G3, FM611E2, FM611E3, FM611G1, FM611G2, FM611G3, FM721E1, FM721E2, FM721E3, FM721G1, FM721G2, FM721G3, FX101E1, FX101E1R, FX101E2, FX101E2C, FX101E2C-VERS.032014, FX101E2R, FX101E2R-VERS.032014, FX101E2-VERS.032014, FX101E3, FX101E3C, FX101E3C-VERS.022014...(Other models you can see in the webshop) |                 |         |

|   |  |                 |                    |
|---|--|-----------------|--------------------|
|   |  |                 |                    |
| 1   |  |                 |                    |
| <b>GEV No.</b>  | 357162   | <b>Ref. No.</b> | 3008760            |
| <b>description</b>  | oven lamp mounting ø 35.5mm 12V 20W socket G4 temp.-resist. 300°C connection cable 450mm hard glas |                 |                    |
| <b>spare parts for</b>  | 357162   |                 |                    |
|  | <b>GEV No.</b>   | 359599          | <b>Ref. No.</b>    |
|   |  |                 | 3019710<br>3030660 |
|   | halogen lamp socket G4 12V 20W temp.-resist. 500°C   |                 |                    |
|  | <b>GEV No.</b>   | 359762          | <b>Ref. No.</b>    |
|   |  |                 | —                  |
|   | lamp socket socket G4 mounting ø 35.5mm connection cable 450mm                                     |                 |                    |
|  | <b>GEV No.</b>   | 359942          | <b>Ref. No.</b>    |
|   |  |                 | —                  |
|   | oven lamp glass thr.ø 33.5mm ø 41mm hard glas temp.-resist. 350°C                                  |                 |                    |

|   |   |                 |                    |
|---|---|-----------------|--------------------|
|  <p><b>500°C</b></p> |   |                 |                    |
| 1   |   |                 |                    |
| <b>GEV No.</b>  | 359599  | <b>Ref. No.</b> | 3019710<br>3030660 |
| <b>description</b>  | halogen lamp socket G4 12V 20W temp.-resist. 500°C  |                 |                    |
| <b>For models:</b>  | BX101E, BX101E-VERS.122013, BX101G, BX101G-VERS.122013, BX122E, BX122E-VERS.122013, BX122G, BX122G-VERS.122013, BX61E, BX61E-VERS.122013, BX61G, BX61G-VERS.122013, BX82E, BX82E-VERS.122013, BX82G, BX82G-VERS.122013, FM1011E1, FM1011E2, FM1011E3, FM1011G1, FM1011G2, FM1011G3, FM1221E1, FM1221E2, FM1221E3, FM1221G1, FM1221G2, FM1221G3, FM611E2, FM611E3, FM611G1, FM611G2, FM611G3, FM721E1, FM721E2, FM721E3, FM721G1, FM721G2, FM721G3, FPZ14E, FPZ16E, FPZ24E, FPZ2635E, FPZ26E, FPZ4G, FPZ6G, FX101E1, FX101E1R, FX101E2, FX101E2C...(Other models you can see in the webshop) |                 |                    |

|  |  |                 |                 |
|--|--|-----------------|-----------------|
|  |  |                 |                 |
| 1  |  |                 |                 |
| <b>GEV No.</b>   | 360759   | <b>Ref. No.</b> | 3019720         |
| <b>description</b>   | oven lamp mounting ø 35.5mm 12V 20W socket G4 temp.-resist. 350°C connection cable 450mm hard glas |                 |                 |
| <b>For models:</b>   | FPZ14E, FPZ16E, FPZ24E, FPZ2635E, FPZ26E, FPZ4G, FPZ6G   |                 |                 |
| <b>spare parts for</b>   | 360759   |                 |                 |
|   | <b>GEV No.</b>   | 357192          | <b>Ref. No.</b> |
|  |  |                 | —               |
|  | halogen lamp socket G4 12V 20W temp.-resist. °C OSRAM HALOSTAR STARLITE                            |                 |                 |
|   | <b>GEV No.</b>   | 357264          | <b>Ref. No.</b> |
|  |  |                 | —               |
|  | lamp socket socket G4 mounting ø 35.5mm connection cable 450mm                                     |                 |                 |
|   | <b>GEV No.</b>   | 359033          | <b>Ref. No.</b> |
|  |  |                 | 3019730         |
|  | oven lamp glass thr.ø 33.5mm H 36mm ø 41mm hard glas temp.-resist. 350°C                           |                 |                 |



electric components









Зип Общепит

vsezip.ru



77(812)987-08-81

|   |  |                 |                                    |
|---|--|-----------------|------------------------------------|
|  |  |                 |                                    |
| <b>GEV No.</b>  | 359718   | <b>Ref. No.</b> | 32W0740                            |
| <b>description</b>  | oven lamp mounting ø 35.5mm 230V 15W socket E14 temp.-resist. 300°C connection male faston 6.3mm hard glas |                 |                                    |
| <b>spare parts for</b>  | 359718   |                 |                                    |
|  | <b>GEV No.</b>   | 359701          | <b>Ref. No.</b> 32W0746<br>32W2561 |
|   | lamp socket socket E14 220-230V mounting ø 35.5mm connection male faston 6.3mm 15W                         |                 |                                    |
|  | <b>GEV No.</b>   | 359740          | <b>Ref. No.</b> —                  |
|   | light bulb t.max. 300°C socket E14 15W 230V ø 22mm L 48mm lens L 20mm for oven lamp IMPORT                 |                 |                                    |

|   |   |                 |                         |
|---|---|-----------------|-------------------------|
|    |   |                 |                         |
| <b>GEV No.</b>  | 359701  | <b>Ref. No.</b> | 32W0746<br>32W2561      |
| <b>description</b>  | lamp socket socket E14 220-230V mounting ø 35.5mm connection male faston 6.3mm 15W  |                 |                         |
| <b>For models:</b>  | FC101, FC101E, FC241, FC241E, FC241G, FC61, FC61E, FCV101, FCV101-CSA, FCV101DM, FCV101DM-CSA, FCV101DS, FCV101DS-CSA, FCV101E, FCV101EDM, FCV101EDM-UL, FCV101EDS, FCV101EDS-UL, FCV101E-UL, FCV141, FCV141-CSA, FCV141DM, FCV141DM-CSA, FCV141DS, FCV141DS-CSA, FCV141E, FCV141EDM, FCV141EDS, FCV241, FCV241DM, FCV241DS, FCV241E, FCV241EDM, FCV241EDM-UL, FCV241EDS, FCV241E-UL, FCV241G, FCV241GDM, FCV241GDM-CSA, FCV241GDS, FCV241GDS-CSA, FCV401DM, FCV401DM-CSA, FCV401EDM, FCV401EDM-UL, FCV61, FCV61-CSA, FCV61DM, FCV61DM-CSA, FCV61DS...(Other models you can see in the webshop) |                 |                         |
| <b>accessories for</b>  | 359701  |                 |                         |
|  | <b>GEV No.</b>  | 359705          | <b>Ref. No.</b> 32W3080 |
|   | oven lamp glass thr.ø 33.5mm ø 52mm hard glas temp.-resist. 350°C   |                 |                         |
|  | <b>GEV No.</b>  | 359709          | <b>Ref. No.</b> —       |
|   | oven lamp glass thr.ø 33.5mm ø 42mm hard glas temp.-resist. 350°C   |                 |                         |
|  | <b>GEV No.</b>  | 359721          | <b>Ref. No.</b> —       |
|   | gasket silicone ED ø 48mm ID ø 39.5mm thickness 5mm Qty 1 pcs   |                 |                         |
|  | <b>GEV No.</b>  | 359942          | <b>Ref. No.</b> —       |
|   | oven lamp glass thr.ø 33.5mm ø 41mm hard glas temp.-resist. 350°C   |                 |                         |

|   |  |                 |         |
|---|--|-----------------|---------|
|  |  |                 |         |
| <b>GEV No.</b>  | 359033   | <b>Ref. No.</b> | 3019730 |
| <b>description</b>  | oven lamp glass thr.ø 33.5mm H 36mm ø 41mm hard glas temp.-resist. 350°C |                 |         |
| <b>For models:</b>  | FPZ14E, FPZ16E, FPZ24E, FPZ2635E, FPZ26E, FPZ4G, FPZ6G                   |                 |         |

|   |  |                 |                         |
|---|--|-----------------|-------------------------|
|  |  |                 |                         |
| <b>GEV No.</b>  | 359705   | <b>Ref. No.</b> | 32W3080                 |
| <b>description</b>  | oven lamp glass thr.ø 33.5mm ø 52mm hard glas temp.-resist. 350°C                                |                 |                         |
| <b>accessories for</b>  | 359705   |                 |                         |
|  | <b>GEV No.</b>   | 359610          | <b>Ref. No.</b> 32W0780 |
|   | light bulb t.max. 300°C socket E14 15W 230V ø 22mm L 47mm lens L 20mm for oven lamp type Philips |                 |                         |
|  | <b>GEV No.</b>   | 359700          | <b>Ref. No.</b> —       |
|   | gasket for pizza oven fibre glass ID ø 32.5mm ED ø 55mm thickness 5mm                            |                 |                         |
|  | <b>GEV No.</b>   | 359721          | <b>Ref. No.</b> —       |
|   | gasket silicone ED ø 48mm ID ø 39.5mm thickness 5mm Qty 1 pcs                                    |                 |                         |
|  | <b>GEV No.</b>   | 359837          | <b>Ref. No.</b> —       |
|   | gasket ID ø 33mm ED ø 46mm thickness 1mm graphite  |                 |                         |
|  | <b>GEV No.</b>   | 359838          | <b>Ref. No.</b> —       |
|   | gasket ID ø 33mm ED ø 45mm   |                 |                         |

|   |   |                 |                   |
|---|---|-----------------|-------------------|
|   |   |                 |                   |
| <b>GEV No.</b>  | 359661  | <b>Ref. No.</b> | 32X3080           |
| <b>description</b>  | oven lamp glass thread 32.1 ø 58mm hard glas temp.-resist. 350°C      |                 |                   |
| <b>accessories for</b>  | 359661  |                 |                   |
|  | <b>GEV No.</b>  | 359700          | <b>Ref. No.</b> — |
|   | gasket for pizza oven fibre glass ID ø 32.5mm ED ø 55mm thickness 5mm |                 |                   |

55x70mm

|  |   |                 |         |
|--|---|-----------------|---------|
|  |   |                 |         |
| <b>GEV No.</b>   | 358147  | <b>Ref. No.</b> | 3036970 |
| <b>description</b>   | gasket L 75mm W 65mm thickness 1mm for oven lamp  |                 |         |
| <b>For models:</b>   | FC1011E, FC1011G, FC1221E, FC1221G, FC611E, FC611G, FCV3EM, FCV4E, FCV4EDS, FCV4EM, FM1011E1, FM1011E1-VERS.2006, FM1011E2, FM1011E2-VERS.2006, FM1011E3, FM1011E3-VERS.2006, FM1011G1, FM1011G1-VERS.2006, FM1011G2, FM1011G2-VERS.2006, FM1011G3, FM1011G3-VERS.2006, FM1221E1, FM1221E1-VERS.2006, FM1221E2, FM1221E2-VERS.2006, FM1221E3, FM1221E3-VERS.2006, FM1221G1, FM1221G1-VERS.2006, FM1221G2, FM1221G2-VERS.2006, FM1221G3, FM1221G3-VERS.2006, FM2011E2-VERS.2006, FM2011E3-VERS.2006, FM2011G2-VERS.2006, FM2011G3-VERS.2006, FM2021E1, FM2021E2, FM2021E2-VERS.2006, FM2021E3-VERS.2006, FM2021G1, FM2021G2, FM2021G2-VERS.2006, FM2021G3, FM2021G3-VERS.2006, FM423E1, FM423E2, FM611E1...(Other models you can see in the webshop) |                 |         |



Зип Общепит

vsezip.ru

(812)987-08-81

|   |   |                 |                    |
|---|---|-----------------|--------------------|
|  |   |                 |                    |
| 1   |   |                 |                    |
| <b>GEV No.</b>  | 359299  | <b>Ref. No.</b> | 37Q4107<br>37Q4106 |
| <b>description</b>  | gasket L 91mm W 77mm hole ø 3mm for oven lamp |                 |                    |
| <b>For models:</b>  | FCV3EM, FCV4E, FCV4EDS, FCV4EM                |                 |                    |





|   |  |                 |                    |
|---|--|-----------------|--------------------|
|  |  |                 |                    |
| 1   |  |                 |                    |
| <b>GEV No.</b>  | 359296                                 | <b>Ref. No.</b> | 37M9910<br>37M9911 |
| <b>description</b>  | lamp glass L 74mm W 58mm thickness 3mm |                 |                    |
| <b>For models:</b>  | FCV3EM, FCV4E, FCV4EDS, FCV4EM         |                 |                    |

producer-specific oven lamps

ANGELO PO

|  |  |                 |         |
|--|--|-----------------|---------|
|  |  |                 |         |
| 1  |  |                 |         |
| <b>GEV No.</b>   | 359339   | <b>Ref. No.</b> | 37Q7840 |
| <b>description</b>   | gasket ID ø 65mm ED ø 80mm thickness 1mm   |                 |         |
| <b>For models:</b>   | FC101, FC101E, FC241, FC241E, FC241G, FC61, FC61E, FCV101, FCV101-CSA, FCV101DM, FCV101DM-CSA, FCV101DS, FCV101DS-CSA, FCV101E, FCV101EDM, FCV101EDM-UL, FCV101EDS, FCV101EDS-UL, FCV101E-UL, FCV141, FCV141-CSA, FCV141DM, FCV141DM-CSA, FCV141DS, FCV141DS-CSA, FCV141E, FCV141EDM, FCV141EDS, FCV241, FCV241DM, FCV241DS, FCV241E, FCV241EDM, FCV241EDM-UL, FCV241EDS, FCV241EDS-UL, FCV241E-UL, FCV241G, FCV241G-CSA, FCV241GDM, FCV241GDM-CSA, FCV241GDS, FCV241GDS-CSA, FCV401DM, FCV401DM-CSA, FCV401EDM, FCV401EDM-UL, FCV4E, FCV4EDS, FCV61...(Other models you can see in the webshop) |                 |         |

|   |  |                 |                    |
|---|--|-----------------|--------------------|
|  |  |                 |                    |
| 1   |  |                 |                    |
| <b>GEV No.</b>  | 359340   | <b>Ref. No.</b> | 3036650<br>37M6210 |
| <b>description</b>  | glass panel round ø 78mm thickness 3mm   |                 |                    |
| <b>For models:</b>  | 031FT04, 031FT06, 070FT04, 070FT05, 071FT04, 071FT06, 090FT04, 090FT05, 091FT04, 091FT06, 0A0FT1G, 0A0FT2G, 0A0FT4G, 0A0FT5G, 0D0FT1G, 0D0FT2G, 0D0FT4G, 0D0FT5G, 1A0FT1G, 1A0FT2G, 1A0FT3G, 1A0FT4G, 1A0FT6G, 1D0FT1G, 1D0FT2G, 1D0FT3G, 1D0FT4G, 1D0FT6G, FC101, FC101E, FC241, FC241E, FC241G, FC61, FC61E, FCV101, FCV101-CSA, FCV101DM, FCV101DM-CSA, FCV101DS, FCV101DS-CSA, FCV101E, FCV101EDM, FCV101EDM-UL, FCV101EDS, FCV101EDS-UL, FCV101E-UL, FCV141, FCV141-CSA, FCV141DM...(Other models you can see in the webshop) |                 |                    |

|   |   |                 |                         |
|---|---|-----------------|-------------------------|
|   |   |                 |                         |
| 1   |   |                 |                         |
| <b>GEV No.</b>  | 359701  | <b>Ref. No.</b> | 32W0746<br>32W2561      |
| <b>description</b>  | lamp socket socket E14 220-230V mounting ø 35.5mm connection male faston 6.3mm 15W  |                 |                         |
| <b>For models:</b>  | FC101, FC101E, FC241, FC241E, FC241G, FC61, FC61E, FCV101, FCV101-CSA, FCV101DM, FCV101DM-CSA, FCV101DS, FCV101DS-CSA, FCV101E, FCV101EDM, FCV101EDM-UL, FCV101EDS, FCV101EDS-UL, FCV101E-UL, FCV141, FCV141-CSA, FCV141DM, FCV141DM-CSA, FCV141DS, FCV141DS-CSA, FCV141E, FCV141EDM, FCV141EDS, FCV241, FCV241DM, FCV241DS, FCV241E, FCV241EDM, FCV241EDM-UL, FCV241EDS, FCV241E-UL, FCV241G, FCV241GDM, FCV241GDM-CSA, FCV241GDS, FCV241GDS-CSA, FCV401DM, FCV401DM-CSA, FCV401EDM, FCV401EDM-UL, FCV61, FCV61-CSA, FCV61DM, FCV61DM-CSA, FCV61DS...(Other models you can see in the webshop) |                 |                         |
| <b>accessories for</b>  | 359701  |                 |                         |
|    | <b>GEV No.</b>  | 359705          | <b>Ref. No.</b> 32W3080 |
|    | <b>GEV No.</b>  | 359709          | <b>Ref. No.</b> —       |
|   | <b>GEV No.</b>  | 359721          | <b>Ref. No.</b> —       |
|  | <b>GEV No.</b>  | 359942          | <b>Ref. No.</b> —       |

|  |  |                 |                               |
|--|--|-----------------|-------------------------------|
|  |  |                 |                               |
| 1  |  |                 |                               |
| <b>GEV No.</b>   | 357179   | <b>Ref. No.</b> | 3159800<br>3278370<br>35E3360 |
| <b>description</b>   | frame for oven lamp L 97mm W 97mm thickness 6mm mounting distance 78mm ø 55mm  |                 |                               |
| <b>For models:</b>   | BX101E, BX101E-VERS.122013, BX101G, BX101G-VERS.122013, BX122E, BX122E-VERS.122013, BX122G, BX122G-VERS.122013, BX61E, BX61E-VERS.122013, BX61G, BX61G-VERS.122013, BX82E, BX82E-VERS.122013, BX82G, BX82G-VERS.122013, FC101E, FC101G, FC1221E, FC1221G, FC61E, FC61G, FCV3EM, FCV4E, FCV4EDS, FCV4EM, FM1011E1, FM1011E1-VERS.2006, FM1011E2, FM1011E2-VERS.2006, FM1011E3, FM1011E3-VERS.2006, FM1011G1, FM1011G1-VERS.2006, FM1011G2, FM1011G2-VERS.2006, FM1011G3, FM1011G3-VERS.2006, FM1221E1, FM1221E1-VERS.2006, FM1221E2, FM1221E2-VERS.2006, FM1221E3, FM1221E3-VERS.2006, FM1221G1, FM1221G1-VERS.2006, FM1221G2, FM1221G2-VERS.2006, FM1221G3, FM1221G3-VERS.2006...(Other models you can see in the webshop) |                 |                               |

electric components



Зип-Общепит

|   |        |          |         |
|---|--------|----------|---------|
| accessories for 359295                        |        |          |         |
| GEV No.                                       | 551336 | Ref. No. | 36E3170 |
| gasket for lamp L 92mm W 92mm thickness 2.3mm |        |          |         |



|             |  |          |         |
|-------------|--|----------|---------|
| GEV No.     | 551336   | Ref. No. | 36E3170 |
| description | gasket for lamp L 92mm W 92mm thickness 2.3mm  |          |         |
| For models: | BX101E, BX101E-VERS.122013, BX101G, BX101G-VERS.122013, BX122E, BX122E-VERS.122013, BX122G, BX122G-VERS.122013, BX61E, BX61E-VERS.122013, BX61G, BX61G-VERS.122013, BX82E, BX82E-VERS.122013, BX82G, BX82G-VERS.122013, FC1011E, FC1011G, FC1221E, FC1221G, FC611E, FC611G, FCV3EM, FCV4E, FCV4EDS, FCV4EM, FM1011E1, FM1011E1-VERS.2006, FM1011E2, FM1011E2-VERS.2006, FM1011E3, FM1011E3-VERS.2006, FM1011G1, FM1011G1-VERS.2006, FM1011G2, FM1011G2-VERS.2006, FM1011G3, FM1011G3-VERS.2006, FM1221E1, FM1221E1-VERS.2006, FM1221E2, FM1221E2-VERS.2006, FM1221E3, FM1221E3-VERS.2006, FM1221G1, FM1221G1-VERS.2006, FM1221G2, FM1221G2-VERS.2006, FM1221G3, FM1221G3-VERS.2006...(Other models you can see in the webshop) |          |         |



|                 |  |          |         |
|-----------------|--|----------|---------|
| GEV No.         | 357262   | Ref. No. | 3097180 |
| description     | lamp socket socket E14 mounting measurements 55x70mm connection male faston 6.3mm Qty 1 pcs          |          |         |
| For models:     | FC1011E, FC1011G, FC1221E, FC1221G, FC611E, FC611G, FCV3EM, FCV4E, FCV4EDS, FCV4EM, FM423E1, FM423E2 |          |         |
| accessories for | 357262   |          |         |



|             |  |          |  |
|-------------|--|----------|--|
| GEV No.     | 357180   | Ref. No. | 3036960<br>3036961<br>3036962<br>3036963 |
| description | lamp glass L 73.6mm W 64mm thickness 4mm   |          |  |
| For models: | BX101E, BX101E-VERS.122013, BX101G, BX101G-VERS.122013, BX122E, BX122E-VERS.122013, BX122G, BX122G-VERS.122013, BX61E, BX61E-VERS.122013, BX61G, BX61G-VERS.122013, BX82E, BX82E-VERS.122013, BX82G, BX82G-VERS.122013, FC1011E, FC1011G, FC1221E, FC1221G, FC611E, FC611G, FCV3EM, FCV4E, FCV4EDS, FCV4EM, FM1011E1, FM1011E1-VERS.2006, FM1011E2, FM1011E2-VERS.2006, FM1011E3, FM1011E3-VERS.2006, FM1011G1, FM1011G1-VERS.2006, FM1011G2, FM1011G2-VERS.2006, FM1011G3, FM1011G3-VERS.2006, FM1221E1, FM1221E1-VERS.2006, FM1221E2, FM1221E2-VERS.2006, FM1221E3, FM1221E3-VERS.2006, FM1221G1, FM1221G1-VERS.2006, FM1221G2, FM1221G2-VERS.2006, FM1221G3, FM1221G3-VERS.2006...(Other models you can see in the webshop) |          |  |



|   |        |          |                               |
|---|--------|----------|-------------------------------|
| GEV No.   | 357179 | Ref. No. | 3159800<br>3278370<br>35E3360 |
| frame for oven lamp L 97mm W 97mm thickness 6mm mounting distance 78mm ø 55mm |        |          |                               |



|  |        |          |  |
|--|--------|----------|--|
| GEV No.                                  | 357180 | Ref. No. | 3036960<br>3036961<br>3036962<br>3036963 |
| lamp glass L 73.6mm W 64mm thickness 4mm |        |          |  |



|  |        |          |         |
|--|--------|----------|---------|
| GEV No.  | 358147 | Ref. No. | 3036970 |
| gasket L 75mm W 65mm thickness 1mm for oven lamp |        |          |         |



|   |        |          |         |
|---|--------|----------|---------|
| GEV No.                                       | 551336 | Ref. No. | 36E3170 |
| gasket for lamp L 92mm W 92mm thickness 2.3mm |        |          |         |

## lamps

## light bulbs

PHILIPS





|             |  |          |         |
|-------------|--|----------|---------|
| GEV No.     | 359610   | Ref. No. | 32W0780 |
| description | light bulb t.max. 300°C socket E14 15W 230V ø 22mm L 47mm lens L 20mm for oven lamp type Philips |          |         |

PHILIPS



|             |   |          |         |
|-------------|---|----------|---------|
| GEV No.     | 359612  | Ref. No. | 32W0210 |
| description | light bulb t.max. 300°C socket E14 25W 230V ø 25mm L 56mm lens L 30mm for oven lamp type Philips  |          |         |
| For models: | FC101, FC101E, FC101G, FC101E, FC1221E, FC1221G, FC241, FC241E, FC241G, FC61, FC61E, FC61G, FC61E, FC61E, FCV101, FCV101-CSA, FCV101DM, FCV101DM-CSA, FCV101DS, FCV101DS-CSA, FCV101E, FCV101EDM, FCV101EDM-UL, FCV101EDS, FCV101EDS-UL, FCV101E-UL, FCV141, FCV141-CSA, FCV141DM, FCV141DM-CSA, FCV141DS, FCV141DS-CSA, FCV141E, FCV141EDM, FCV141EDS, FCV241, FCV241DM, FCV241DS, FCV241E, FCV241EDM, FCV241EDM-UL, FCV241EDS, FCV241EDS-UL, FCV241E-UL, FCV241G, FCV241G-CSA, FCV241GDM, FCV241GDM-CSA, FCV241GDS, FCV241GDS-CSA, FCV3EM...(Other models you can see in the webshop) |          |         |



|  |  |          |                    |
|--|--|----------|--------------------|
| GEV No.  | 359295   | Ref. No. | 32V5570            |
| description  | lamp socket for halogen lamp 12V 20W socket G4 mounting measurements 55 x 70mm cable length 135mm  |          |                    |
| For models:  | BX101E, BX101E-VERS.122013, BX101G, BX101G-VERS.122013, BX122E, BX122E-VERS.122013, BX122G, BX122G-VERS.122013, BX61E, BX61E-VERS.122013, BX61G, BX61G-VERS.122013, BX82E, BX82E-VERS.122013, BX82G, BX82G-VERS.122013, FM1011E1, FM1011E1-VERS.2006, FM1011E2, FM1011E2-VERS.2006, FM1011E3, FM1011E3-VERS.2006, FM1011G1, FM1011G1-VERS.2006, FM1011G2, FM1011G2-VERS.2006, FM1011G3, FM1011G3-VERS.2006, FM1221E1, FM1221E1-VERS.2006, FM1221E2, FM1221E2-VERS.2006, FM1221E3, FM1221E3-VERS.2006, FM1221G1, FM1221G1-VERS.2006, FM1221G2, FM1221G2-VERS.2006, FM1221G3, FM1221G3-VERS.2006, FM2011E2-VERS.2006, FM2011E3-VERS.2006, FM2011G2-VERS.2006, FM2011G3-VERS.2006, FM2021E1, FM2021E2, FM2021E2-VERS.2006, FM2021E3, FM2021E3-VERS.2006, FM2021G1...(Other models you can see in the webshop) |          |                    |
| spare parts for  | 359295   |          |                    |
|  | GEV No.  | 359599   | Ref. No.           |
| halogen lamp socket G4 12V 20W temp.-resist. 500°C                                 |  |          | 3019710<br>3030660 |
| accessories for  | 359295   |          |                    |
|  | GEV No.  | 359296   | Ref. No.           |
| lamp glass L 74mm W 58mm thickness 3mm   |  |          | 37M9910<br>37M9911 |

Зип.Общепит  
timers

programme timers  
vsezip.ru

77(812)987-08-81

|   |   |                 |         |
|---|---|-----------------|---------|
|  |   |                 |         |
| 1   |   |                 |         |
| <b>GEV No.</b>  | 359614  | <b>Ref. No.</b> | 32W2350 |
| <b>description</b>  | light bulb t.max. 300°C socket E27 230V 40W ø 45mm L 71mm lens L 44mm Qty 1 pcs |                 |         |

halogen lamps

for socket G4 / G6.35 / G9

|   |   |                 |         |
|---|---|-----------------|---------|
|  |   |                 |         |
| 1   |   |                 |         |
| <b>GEV No.</b>  | 357193  | <b>Ref. No.</b> | 3030661 |
| <b>description</b>  | halogen lamp socket G4 12V 20W temp.-resist. 300°C OSRAM HALOSTAR OVEN  |                 |         |
| <b>For models:</b>  | BX101E, BX101E-VERS.122013, BX101G, BX101G-VERS.122013, BX122E, BX122E-VERS.122013, BX122G, BX122G-VERS.122013, BX61E, BX61E-VERS.122013, BX61G, BX61G-VERS.122013, BX82E, BX82E-VERS.122013, BX82G, BX82G-VERS.122013, FM1011E1, FM1011E2, FM1011E3, FM1011G1, FM1011G2, FM1011G3, FM1221E1, FM1221E2, FM1221E3, FM1221G1, FM1221G2, FM1221G3, FM611E2, FM611E3, FM611G1, FM611G2, FM611G3, FM721E1, FM721E2, FM721E3, FM721G1, FM721G2, FM721G3, FX101E1, FX101E1R, FX101E2, FX101E2C, FX101E2C-VERS.032014, FX101E2R, FX101E2R-VERS.032014, FX101E2-VERS.032014, FX101E3, FX101E3C, FX101E3C-VERS.022014...(Other models you can see in the webshop) |                 |         |

|  |   |                 |                    |
|--|---|-----------------|--------------------|
|  |   |                 |                    |
| 1  |   |                 |                    |
| <b>GEV No.</b>   | 359599  | <b>Ref. No.</b> | 3019710<br>3030660 |
| <b>description</b>   | halogen lamp socket G4 12V 20W temp.-resist. 500°C  |                 |                    |
| <b>For models:</b>   | BX101E, BX101E-VERS.122013, BX101G, BX101G-VERS.122013, BX122E, BX122E-VERS.122013, BX122G, BX122G-VERS.122013, BX61E, BX61E-VERS.122013, BX61G, BX61G-VERS.122013, BX82E, BX82E-VERS.122013, BX82G, BX82G-VERS.122013, FM1011E1, FM1011E2, FM1011E3, FM1011G1, FM1011G2, FM1011G3, FM1221E1, FM1221E2, FM1221E3, FM1221G1, FM1221G2, FM1221G3, FM611E2, FM611E3, FM611G1, FM611G2, FM611G3, FM721E1, FM721E2, FM721E3, FM721G1, FM721G2, FM721G3, FPZ14E, FPZ16E, FPZ24E, FPZ2635E, FPZ26E, FPZ4G, FPZ6G, FX101E1, FX101E1R, FX101E2, FX101E2C...(Other models you can see in the webshop) |                 |                    |

lamp accessories

gaskets

|   |   |                 |         |
|---|---|-----------------|---------|
|  |   |                 |         |
| 1   |   |                 |         |
| <b>GEV No.</b>  | 511436  | <b>Ref. No.</b> | 37Q7370 |
| <b>description</b>  | gasket for lamp   |                 |         |
| <b>For models:</b>  | 135, 135-4, 135B, 135BN, 135BNX, 135BX, 135BXR, 135CPX, 135NN, 135NNX, 135X, 135X-3, 135X-4, 135XR, 65, 65B, 65BX, 65BX-2, 65BXR, 65NB, 65NBX, 65NN, 65NNX, 65X, 65X-2, 65XR, SP120, SP120B, SP120BN, SP120NN, SP135, SP135B, SP135BN, SP135CP, SP135NN, SP55, SP55B, SP65, SP65B, SP65NB, SP65NN |                 |         |

|  |  |                 |         |
|--|--|-----------------|---------|
|  |  |                 |         |
| 1  |  |                 |         |
| <b>GEV No.</b>   | 360380   | <b>Ref. No.</b> | 32Z0391 |
| <b>description</b>   | timer BIGATTI engines 1 chambers 1 operation time 3s 230V shaft ø 6x4.6mm shaft L 18mm manuf. no. 4023/3s. / 32Z0391 motor type 82354039 |                 |         |

|  |  |                 |         |
|--|--|-----------------|---------|
|  |  |                 |         |
| 1  |  |                 |         |
| <b>GEV No.</b>   | 360382   | <b>Ref. No.</b> | 32Z5730 |
| <b>description</b>   | timer BIGATTI engines 1 chambers 1 operation time 6h 230V manuf. no. SA001 / 32Z5730 motor type 82394530 |                 |         |

|  |  |                 |         |
|--|--|-----------------|---------|
|  |  |                 |         |
| 1  |  |                 |         |
| <b>GEV No.</b>   | 360645   | <b>Ref. No.</b> | 3289260 |
| <b>description</b>   | timer CDC 11901F engines 1 chambers 1 operation time 20S 230V 50/60Hz shaft ø 6x4mm shaft L 25mm manuf. no. 11901F1CEE000.0000 |                 |         |
| <b>For models:</b>   | FX201G3P, FX201G3-VERS.022014  |                 |         |

electric components

Зип Общепит

vsezip.ru

+7(812)987-08-81





1

|   |  |                 |                   |
|---|--|-----------------|-------------------|
| <b>GEV No.</b>  | 360389   | <b>Ref. No.</b> | 32V7290           |
| <b>description</b>  | timer CDC 4904F engines 1 chambers 4 operation time 5min 230V shaft ømm shaft Lmm manif. no. 4904F3 / 10300122 motor type M48L ATS |                 |                   |
| <b>For models:</b>  | KD100, KD100A, KD100PSD, KD130, KD130A   |                 |                   |
| <b>spare parts for</b>  | 360389   |                 |                   |
|  | <b>GEV No.</b>   | 360083          | <b>Ref. No.</b> — |
|   | motor CDC pinion ø 4.9mm teeth 10 230V turn direction left motor ø 47mm H 19.3mm motor type M48L ATS for timer                     |                 |                   |



1

|   |  |                 |                   |
|---|--|-----------------|-------------------|
| <b>GEV No.</b>  | 360379   | <b>Ref. No.</b> | 32Z4760           |
| <b>description</b>  | timer CDC 9003F engines 1 chambers 3 operation time 240s 230V shaft ø 6x4.6mm shaft L 20mm manif. no. 9003F1 / 32Z4760 motor type M48R ATS                     |                 |                   |
| <b>spare parts for</b>  | 360379   |                 |                   |
|  | <b>GEV No.</b>   | 360118          | <b>Ref. No.</b> — |
|   | motor CDC pinion ø 4.9mm teeth 10 230V voltage AC 50/60Hz turn direction right motor ø 47mm H 19.3mm motor type M48R ATS for timer cable length 260mm 1.9/2.5W |                 |                   |



1

|                    |  |                 |         |
|--------------------|--|-----------------|---------|
| <b>GEV No.</b>     | 360196   | <b>Ref. No.</b> | 32Z0780 |
| <b>description</b> | timer CDC 4904F engines 1 chambers 4 operation time 60s 230V manif. no. 4904F3 / 3322060 motor type M48L BTN |                 |         |





1

|                    |  |                 |         |
|--------------------|--|-----------------|---------|
| <b>GEV No.</b>     | 360381   | <b>Ref. No.</b> | 32Z5840 |
| <b>description</b> | timer CDC engines 1 chambers 2 operation time 2h 230V shaft ø 6x4.6mm shaft L 19mm manif. no. 4900/32Z5840 |                 |         |



1

|   |  |                 |                   |
|---|--|-----------------|-------------------|
| <b>GEV No.</b>  | 360215   | <b>Ref. No.</b> | 32V1940           |
| <b>description</b>  | timer CDC 7805DV engines 2 chambers 5 operation time 6s / 3min 230V shaft ømm shaft Lmm motor type M37RN/M37LN |                 |                   |
| <b>For models:</b>  | LC130, LC130-VERS.2001   |                 |                   |
| <b>spare parts for</b>  | 360215   |                 |                   |
|  | <b>GEV No.</b>   | 360119          | <b>Ref. No.</b> — |
|   | motor CDC pinion ø 5.4mm teeth 12 230V turn direction right motor ø 37mm motor type M37RN for timer            |                 |                   |
|  | <b>GEV No.</b>   | 360131          | <b>Ref. No.</b> — |
|   | motor CDC pinion ø 5.4mm teeth 12 230V turn direction left motor ø 37mm motor type M37LN for timer             |                 |                   |



1

|                    |   |                 |         |
|--------------------|---|-----------------|---------|
| <b>GEV No.</b>     | 360386  | <b>Ref. No.</b> | 32Z0310 |
| <b>description</b> | timer CRONEL engines 1 chambers 2 operation time 180s 230V shaft ø 6x4.6mm shaft L 18mm manif. no. D9404 motor type 82340 |                 |         |



1

|                    |  |                 |         |
|--------------------|--|-----------------|---------|
| <b>GEV No.</b>     | 360077   | <b>Ref. No.</b> | 3030290 |
| <b>description</b> | timer CROUZET engines 1 chambers 2 operation time 120s 230V shaft ømm shaft Lmm manif. no. 627/5261 motor type 82340 |                 |         |





Зип Общепит

vsezip.ru

+7(812)987-08-81





1

|                    |  |                 |         |
|--------------------|--|-----------------|---------|
| <b>GEV No.</b>     | 360289   | <b>Ref. No.</b> | 3030290 |
| <b>description</b> | timer CROUZET engines 1 chambers 2 operation time 120s 230V shaft ømm shaft Lmm manuf. no. 627/5309 motor type 600 |                 |         |
| <b>For models:</b> | KD37, KD40   |                 |         |



1

|   |  |                 |                   |
|---|--|-----------------|-------------------|
| <b>GEV No.</b>  | 360334   | <b>Ref. No.</b> | 32Z9630           |
| <b>description</b>  | timer FIBER P04 engines 1 chambers 2 operation time 120min 230V shaft ø 6x4.6mm shaft L 20mm manuf. no. P045J02W401 motor type M51BJ0R6400 impulse electric        |                 |                   |
| <b>For models:</b>  | FCV3EM, FCV4EM   |                 |                   |
| <b>spare parts for</b>  | 360334   |                 |                   |
|  | <b>GEV No.</b>   | 360673          | <b>Ref. No.</b> — |
|   | motor kit pinion ø 6.8mm teeth 15 230V voltage AC 50/60Hz turn direction clockwise motor ø 48mm H 18.5mm motor type UDS-40NE1RNZ165 cable length 150mm with holder |                 |                   |





1

|                    |  |                 |         |
|--------------------|--|-----------------|---------|
| <b>GEV No.</b>     | 360436   | <b>Ref. No.</b> | 32V5780 |
| <b>description</b> | timer FIBER P24 engines 1 chambers 1 operation time 20s 230V shaft ø 4x6.4mm shaft L 25mm manuf. no. P245J01C118 motor type M51BJ0R0000  |                 |         |
| <b>For models:</b> | BX101E, BX101E-VERS.122013, BX101G, BX101G-VERS.122013, BX122E, BX122E-VERS.122013, BX122G, BX122G-VERS.122013, BX61E, BX61E-VERS.122013, BX61G, BX61G-VERS.122013, BX82E, BX82E-VERS.122013, BX82G, BX82G-VERS.122013, FM1011E1, FM1011E1-VERS.2006, FM1011E2, FM1011E2-VERS.2006, FM1011E3, FM1011E3-VERS.2006, FM1011G1, FM1011G1-VERS.2006, FM1011G2, FM1011G2-VERS.2006, FM1011G3, FM1011G3-VERS.2006, FM1221E1, FM1221E1-VERS.2006, FM1221E2, FM1221E2-VERS.2006, FM1221E3, FM1221E3-VERS.2006, FM1221G1, FM1221G1-VERS.2006, FM1221G2, FM1221G2-VERS.2006, FM1221G3, FM1221G3-VERS.2006, FM2011E2-VERS.2006, FM2011E3-VERS.2006, FM2011G2-VERS.2006, FM2011G3-VERS.2006, FM2021E1, FM2021E2, FM2021E2-VERS.2006, FM2021E3, FM2021E3-VERS.2006, FM2021G1...(Other models you can see in the webshop) |                 |         |





1

|   |  |                 |                   |
|---|--|-----------------|-------------------|
| <b>GEV No.</b>  | 360435   | <b>Ref. No.</b> | 32V7300           |
| <b>description</b>  | timer FIBER P25 engines 1 chambers 4 operation time 6min 230V 50Hz shaft ømm shaft Lmm motor type M51BJ0L6400  |                 |                   |
| <b>spare parts for</b>  | 360435   |                 |                   |
|  | <b>GEV No.</b>   | 360674          | <b>Ref. No.</b> — |
|   | motor kit pinion ø 6.8mm teeth 15 230V voltage AC 50/60Hz turn direction counterclockwise motor ø 48mm H 18.5mm motor type UDS40NE1RNZ165 cable length 150mm with holder |                 |                   |





1

|   |  |                 |                   |
|---|--|-----------------|-------------------|
| <b>GEV No.</b>  | 360234   | <b>Ref. No.</b> | 32V2060           |
| <b>description</b>  | timer FIBER P25 engines 2 chambers 4 operation time 6s / 3min 230V shaft ømm shaft Lmm manuf. no. P255J04JBC7 motor type M51B-J0R6400 / M51BJ0L6400                      |                 |                   |
| <b>For models:</b>  | LF50, LF50E, LF50EM  |                 |                   |
| <b>spare parts for</b>  | 360234   |                 |                   |
|  | <b>GEV No.</b>   | 360673          | <b>Ref. No.</b> — |
|   | motor kit pinion ø 6.8mm teeth 15 230V voltage AC 50/60Hz turn direction clockwise motor ø 48mm H 18.5mm motor type UDS-40NE1RNZ165 cable length 150mm with holder       |                 |                   |
|  | <b>GEV No.</b>   | 360674          | <b>Ref. No.</b> — |
|   | motor kit pinion ø 6.8mm teeth 15 230V voltage AC 50/60Hz turn direction counterclockwise motor ø 48mm H 18.5mm motor type UDS40NE1RNZ165 cable length 150mm with holder |                 |                   |



1

|   |  |                 |                   |
|---|--|-----------------|-------------------|
| <b>GEV No.</b>  | 360245   | <b>Ref. No.</b> | 32Z2020           |
| <b>description</b>  | timer FIBER P25 engines 2 chambers 5 operation time 180s / 6min 230V shaft ømm shaft Lmm manuf. no. P255J05JZE6 motor type M51BJ0R6400 / M51BJ0L6400                     |                 |                   |
| <b>For models:</b>  | L40, L40S, L45, L60  |                 |                   |
| <b>spare parts for</b>  | 360245   |                 |                   |
|  | <b>GEV No.</b>   | 360673          | <b>Ref. No.</b> — |
|   | motor kit pinion ø 6.8mm teeth 15 230V voltage AC 50/60Hz turn direction clockwise motor ø 48mm H 18.5mm motor type UDS-40NE1RNZ165 cable length 150mm with holder       |                 |                   |
|  | <b>GEV No.</b>   | 360674          | <b>Ref. No.</b> — |
|   | motor kit pinion ø 6.8mm teeth 15 230V voltage AC 50/60Hz turn direction counterclockwise motor ø 48mm H 18.5mm motor type UDS40NE1RNZ165 cable length 150mm with holder |                 |                   |

Зип Общепит

vsezip.ru

+7(812)987-08-81





1

|                    |   |                 |         |
|--------------------|---|-----------------|---------|
| <b>GEV No.</b>     | 360392  | <b>Ref. No.</b> | 3175700 |
| <b>description</b> | timer FIBER P25 engines 2 chambers 5 operation time 60s / 3min 230V shaft ømm shaft Lmm |                 |         |



1

|   |   |                 |                   |
|---|---|-----------------|-------------------|
| <b>GEV No.</b>  | 360232  | <b>Ref. No.</b> | 32V0530           |
| <b>description</b>  | timer FIBER P25 engines 2 chambers 5 operation time 6s / 9min 24V shaft ømm shaft Lmm manuf. no. P255205KEF0 motor type M51B20R6400 / M51B20L6400 voltage AC            |                 |                   |
| <b>spare parts for</b>  | 360232  |                 |                   |
|    | <b>GEV No.</b>  | 360675          | <b>Ref. No.</b> — |
|   | motor kit pinion ø 6.8mm teeth 15 24V voltage AC 50/60Hz turn direction clockwise motor ø 48mm H 18.5mm motor type UDS-40NE1RNZ165 cable length 150mm with holder       |                 |                   |
|  | <b>GEV No.</b>  | 360676          | <b>Ref. No.</b> — |
|   | motor kit pinion ø 6.8mm teeth 15 24V voltage AC 50/60Hz turn direction counterclockwise motor ø 48mm H 18.5mm motor type UDS40NE1RNZ165 cable length 150mm with holder |                 |                   |



1

|   |  |                 |                   |
|---|--|-----------------|-------------------|
| <b>GEV No.</b>  | 360246   | <b>Ref. No.</b> | 32Z8110           |
| <b>description</b>  | timer FIBER P25 engines 2 chambers 5 operation time 80s / 5min 230V shaft ømm shaft Lmm manuf. no. P255J05KRH3 motor type M51BJ0R6400 / M51BJ0L6400 run-time 80/300s     |                 |                   |
| <b>For models:</b>  | F80P, F80PR, L80   |                 |                   |
| <b>spare parts for</b>  | 360246   |                 |                   |
|  | <b>GEV No.</b>   | 360673          | <b>Ref. No.</b> — |
|   | motor kit pinion ø 6.8mm teeth 15 230V voltage AC 50/60Hz turn direction clockwise motor ø 48mm H 18.5mm motor type UDS-40NE1RNZ165 cable length 150mm with holder       |                 |                   |
|  | <b>GEV No.</b>   | 360674          | <b>Ref. No.</b> — |
|   | motor kit pinion ø 6.8mm teeth 15 230V voltage AC 50/60Hz turn direction counterclockwise motor ø 48mm H 18.5mm motor type UDS40NE1RNZ165 cable length 150mm with holder |                 |                   |



1

|   |  |                 |                   |
|---|--|-----------------|-------------------|
| <b>GEV No.</b>  | 360051   | <b>Ref. No.</b> | 32Z3840           |
| <b>description</b>  | timer FIBER P36 engines 1 chambers 2 operation time 15min 230V shaft ømm shaft Lmm manuf. no. P365JR2J717 motor type M51B-J0R6400                                  |                 |                   |
| <b>For models:</b>  | PGA20, PGA30, PGA40, PGA60, PGA80, PGW20, PGW30, PGW40, PGW60, PGW80   |                 |                   |
| <b>spare parts for</b>  | 360051   |                 |                   |
|  | <b>GEV No.</b>   | 360673          | <b>Ref. No.</b> — |
|   | motor kit pinion ø 6.8mm teeth 15 230V voltage AC 50/60Hz turn direction clockwise motor ø 48mm H 18.5mm motor type UDS-40NE1RNZ165 cable length 150mm with holder |                 |                   |

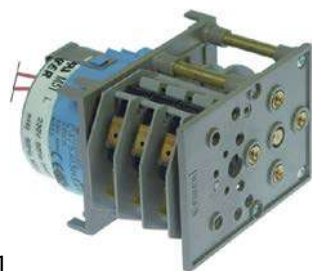

1

|   |  |                 |                   |
|---|--|-----------------|-------------------|
| <b>GEV No.</b>  | 360369   | <b>Ref. No.</b> | 32Z5720           |
| <b>description</b>  | timer FIBER P37 engines 1 chambers 3 operation time 120s 230V shaft ømm shaft Lmm manuf. no. P375J03H340 motor type M51B-J0L***  |                 |                   |
| <b>For models:</b>  | LT10R, LT20F, LT25F  |                 |                   |
| <b>spare parts for</b>  | 360369   |                 |                   |
|  | <b>GEV No.</b>   | 360674          | <b>Ref. No.</b> — |
|   | motor kit pinion ø 6.8mm teeth 15 230V voltage AC 50/60Hz turn direction counterclockwise motor ø 48mm H 18.5mm motor type UDS40NE1RNZ165 cable length 150mm with holder |                 |                   |

mechanical timers



1

|   |   |                 |                    |
|---|---|-----------------|--------------------|
| <b>GEV No.</b>  | 350003  | <b>Ref. No.</b> | 32Z0420<br>32Z2200 |
| <b>description</b>  | timer M2 with bell 2-pole operation time 120min impulse mechanical 2NO at 250V 16A permanent position no shaft ø 6x4.6mm shaft 6x4.6mm shaft L 23mm mounting distance 28mm connection lateral |                 |                    |
| <b>For models:</b>  | FC101, FC1011E, FC1011G, FC101E, FC1221E, FC1221G, FC241, FC241E, FC241G, FC61, FC611E, FC611G, FC61E   |                 |                    |
| <b>accessories for</b>  | 350003  |                 |                    |
|  | <b>GEV No.</b>  | 110366          | <b>Ref. No.</b> —  |
|   | knob switch zero mark t.max. °C°C ø 44mm shaft ø 6x4.6mm shaft flat upper black   |                 |                    |

Table continues overleaf



Зип Общепит

vsezip.ru

+7(812)987-08-81

|   |   |        |          |
|---|---|--------|----------|
| accessories for   | 350003  |        |          |
|  | GEV No.   | 111199 | Ref. No. |
|   |   |        | —        |
|   | dial plate graduation 120min permanent position no rotation 0-330°<br>ø 60mm timers knob ø 45mm |        |          |

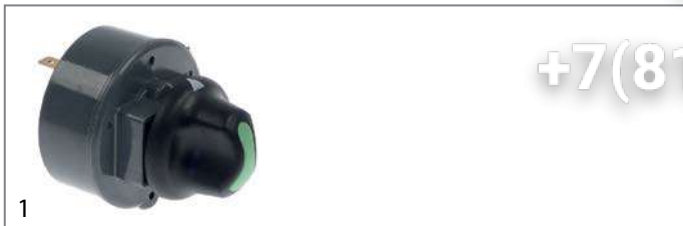

|             |   |          |         |
|-------------|---|----------|---------|
| GEV No.     | 360447  | Ref. No. | 32Z5540 |
| description | timer T203 1-pole operation time 5min impulse mechanical 1NO at 250V 16(3)A permanent position no shaft ø 4x4.6mm shaft 6x4.6mm shaft L 16mm mounting distance 30mm connection rear ambient temperature max. 55°C |          |         |



|             |   |          |         |
|-------------|---|----------|---------|
| GEV No.     | 360384  | Ref. No. | 32Z5731 |
| description | defrost timer CDC type 11901F defrosting interval 4x per 24h fan delaymin 230V                    |          |         |
| For models: | 135A, 135XE, 65A, 65XE, S125, S125-4, S125E, S125X, S125X-4, S60, S60-2, S60E, S60X, S60X-2, SA87 |          |         |

defrost timers

BIGATTI

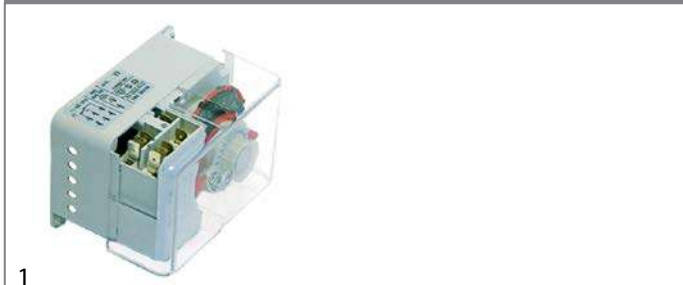

|             |   |          |         |
|-------------|---|----------|---------|
| GEV No.     | 360058  | Ref. No. | 32Z7100 |
| description | defrost timer type SB3.82 defrosting interval 1-12x in 24h defrosting time 2-54min fan delay 0-15min 230V defr. funct. 1-12x per 24h  |          |         |
| For models: | 40CP, 40CPX, 65NN, 65NNX, 6BMA11A, 6BMA11B, 6BMA11M, 6BMA2A, 6BMA2B, 6BMA2M, 6BMA3A, 6BMA3B, 6BMA3M, 6BMAA, 6BMAB, 6BMAM, 6BMB11A, 6BMB11B, 6BMB11M, 6BMB22A, 6BMB22B, 6BMB22M, 6BMB2A, 6BMB2B, 6BMB2M, 6BMB3A, 6BMB3B, 6BMB3M, 6BMB4A, 6BMB4B, 6BMB4M, 6BMBA, 6BMBA, 6BMBB, 6BMBM, 6BMC11A, 6BMC11B, 6BMC11M, 6BMC22A, 6BMC22B, 6BMC22M, 6BMC2A, 6BMC2B, 6BMC2M, 6BMC33A, 6BMC33B, 6BMC33M, 6BMC3A, 6BMC3B, 6BMC3M, 6BMC4A...(Other models you can see in the webshop) |          |         |

miscellaneous



|             |               |          |         |
|-------------|---------------|----------|---------|
| GEV No.     | 360383        | Ref. No. | 32Z2452 |
| description | defrost timer |          |         |

alarm devices

alarm units

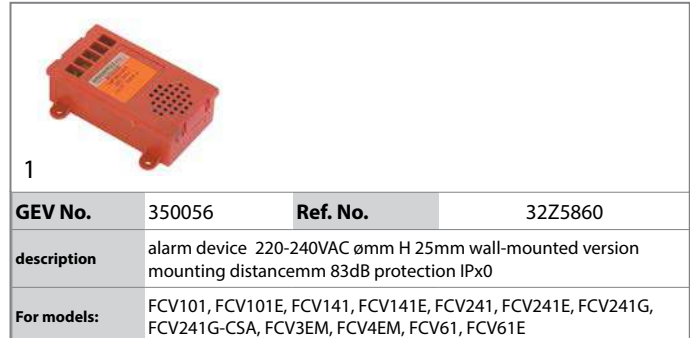

|             |  |          |         |
|-------------|--|----------|---------|
| GEV No.     | 350056   | Ref. No. | 32Z5860 |
| description | alarm device 220-240VAC ømm H 25mm wall-mounted version mounting distancemm 83dB protection IPx0       |          |         |
| For models: | FCV101, FCV101E, FCV141, FCV141E, FCV241, FCV241E, FCV241G, FCV241G-CSA, FCV3EM, FCV4EM, FCV61, FCV61E |          |         |

CDC



|             |   |          |                    |
|-------------|---|----------|--------------------|
| GEV No.     | 360521  | Ref. No. | 32Z2420<br>32Z2421 |
| description | defrost timer CDC type 11901F defrosting interval 4x per 24h defrosting time 12min fan delaymin 230V 50-60Hz defr. funct. every 6h                      |          |                    |
| For models: | 120, 120NN, 120PV, 135, 135-4, 135BN, 135BNX, 135CPX, 135NN, 135NNX, 135PVX, 135X, 135X-3, 135X-4, 55, 55PV, 65, 65NN, 65NNX, 65PVX, 65X, 65X-2, SP65NN |          |                    |

electric components



## contactors

## GENERAL ELECTRIC (AEG)

## power contactors



1

|                    |  |                 |  |
|--------------------|--|-----------------|--|
| <b>GEV No.</b>     | 380262   | <b>Ref. No.</b> | 3100910<br>32V7170<br>32Z2080<br>32Z2083 |
| <b>description</b> | power contactor resistive load 32A 230VAC (AC3/400V) 17A/7.5kW main contacts 3NO auxiliary contacts 1NC connection screw connection type AEG LS7K01A type GE CL02A 301 H 85mm  |                 |  |
| <b>For models:</b> | 030FE, 030FE1, 030FE1B, 04WFR3ED, 08WFR4ED, 091FE28, 091FE28B, 091FR3E, 091FR3ED, 0A1FR3E, 0A1FR3ED, 0D1FR3E, 0D1FR3ED, 0G0FR3E, 0G0FR3ED, 191FR4E, 191FR4ED, 1A1FR4E, 1A1FR4ED, 1D1FR4E, 1D1FR4ED, 1G0FR4E, 1G1BR1E, 30FES, 30FES2, 30FES2B, 31RE, 6043840, 6043970, 70FES, 70FES2, 70FES2B, 71AR, 71ARE, 91AR, FC101, FC101E, FC241E, FC241G, FC61, FC611E, FC61E, FCV101, FCV101DM, FCV101DS, FCV101E, FCV101EDM, FCV101EDS, FCV141, FCV141DM...(Other models you can see in the webshop) |                 |  |



2

|                    |  |                 |         |
|--------------------|--|-----------------|---------|
| <b>GEV No.</b>     | 380265   | <b>Ref. No.</b> | 32Z2091 |
| <b>description</b> | power contactor resistive load 60A 230VAC (AC3/400V) 32A/16kW main contacts 3NO auxiliary contacts 1NO connection screw connection type AEG LS15K 00A type GE CL04A 310 H 98mm L 87mm W 55mm   |                 |         |
| <b>For models:</b> | 04WCP1EM, 091CP1E, 091FR1E, 091FR1ED, 0A1FR1E, 0A1FR1ED, 0D1FR1E, 0D1FR1ED, 0G1BR3E, 191BR1E, 191BR2E, 191BR2EA, 191FR2E, 191FR2ED, 1A1BR1E, 1A1BR2E, 1A1BR2EA, 1A1FR2E, 1A1FR2ED, 1D1BR1E, 1D1BR2E, 1D1BR2EA, 1D1FR2ED, 1G1BR3E, 291BR1E, 291BR2E, 291BR2EA, 2A1BR1E, 2A1BR2E, 2A1BR2EA, 2D1BR1E, 2D1BR2E, 2D1BR2EA, 70FE1, 70FE1B, 71ARE, 71FE2, 71FE2B, 91ARE |                 |         |

## Зип-Общепит

ISKRA (PANEL)

## power contactors

vsezip.ru

+7(812)987-08-81



1

|                    |  |                 |         |
|--------------------|--|-----------------|---------|
| <b>GEV No.</b>     | 380415   | <b>Ref. No.</b> | 32Z4471 |
| <b>description</b> | power contactor resistive load 16A 230VAC (AC3/400V) 8.5A/5.5kW main contacts 3NO auxiliary contacts 1NC connection male faston 6.3mm type Fanal DSL7 01 type ISKRA K07MF 01 |                 |         |



1

|                    |  |                 |         |
|--------------------|--|-----------------|---------|
| <b>GEV No.</b>     | 380212   | <b>Ref. No.</b> | 32V0980 |
| <b>description</b> | power contactor resistive load 20A 230VAC (AC3/400V) 8.5A/5.5kW main contacts 3NO auxiliary contacts 1NC connection screw connection type Fanal K07M 01 type ISKRA DSL7 01 |                 |         |

## LOVATO

## power contactors



1

|                    |  |                 |                    |
|--------------------|--|-----------------|--------------------|
| <b>GEV No.</b>     | 380711   | <b>Ref. No.</b> | 32Z3512<br>32Z4471 |
| <b>description</b> | power contactor resistive load 20A 230VAC (AC3/400V) 9A/4kW main contacts 3NO auxiliary contacts 1NC connection male faston type 11BGF0901A230   |                 |                    |
| <b>For models:</b> | 070FTE, 070FTE, 071BME, 071FTE, 071FTE, 071FTE, 071FTE, 090FTE, 090FTE, 091BME, 091FTE, 091FTE, 091FTE, 71ARE, 91ARE, FC1011E, FC1221E, FC241E, FCV141E, FCV141EDM, FCV141EDS, FCV241E, FCV241EDM, FCV241EDS, FCV401EDM, FCV61E, FM1011E1, FM1011E1-VERS.2006, FM1011E2, FM1011E2-VERS.2006, FM1011E3, FM1011E3-VERS.2006, FM1221E1, FM1221E1-VERS.2006, FM1221E2, FM1221E2-VERS.2006, FM1221E3, FM1221E3-VERS.2006, FM2011E2-VERS.2006, FM2011E3-VERS.2006, FM2021E1, FM2021E2, FM2021E2-VERS.2006, FM2021E3, FM2021E3-VERS.2006, FM611E3, FM721E1, FM721E1-VERS.2006, FM721E2, FM721E2-VERS.2006, FM721E3... |                 |                    |



Зип Общепит

vsezip.ru

+7(812)987-08-81



1

|                    |  |                 |         |
|--------------------|--|-----------------|---------|
| <b>GEV No.</b>     | 380704   | <b>Ref. No.</b> | 32V6550 |
| <b>description</b> | power contactor resistive load 20A 230VAC (AC3/400V) 9A/4kW main contacts 3NO auxiliary contacts 1NC connection screw connection type 11BG0901A230   |                 |         |
| <b>For models:</b> | 08WGREV, 190GRE, 191BR2EA, 1A1BR2EA, 1D1BR2EA, 1G0GRE, 291BR1GA, 291BR2EA, 291BR2GA, 2A1BR1GA, 2A1BR2EA, 2A1BR2GA, 2D1BR1GA, 2D1BR2GA, FC1011E, FC1011G, FC1221E, FC1221G, FC611E, FC611G, FCV3EM, FM1011E3, FM1011E3-VERS.2006, FM1011G3, FM1011G3-VERS.2006, FM1221E3, FM1221E3-VERS.2006, FM1221G3, FM1221G3-VERS.2006, FM2021E3, FM2021G3, FM423E1, FM423E2, FM611E3, FM611E3-VERS.2006, FM611G3, FM611G3-VERS.2006, FM721E3, FM721E3-VERS.2006, FM721G3, FM721G3-VERS.2006, FX101E3, FX101E3C, FX101E3C-VERS.022014, FX101E3R, FX101E3R-VERS.022014, FX101E3-VERS.022014, FX101G3, FX101G3C, FX101G3C-VERS.022014...(Other models you can see in the webshop) |                 |         |



1

|                    |   |                 |         |
|--------------------|---|-----------------|---------|
| <b>GEV No.</b>     | 380782  | <b>Ref. No.</b> | 32Z2090 |
| <b>description</b> | power contactor resistive load 40A 230VAC (AC3/400V) 12.5kW main contacts 3NO connection screw connection |                 |         |



1

|   |  |                 |         |
|---|--|-----------------|---------|
| <b>GEV No.</b>  | 380705   | <b>Ref. No.</b> | 32V1880 |
| <b>description</b>  | power contactor resistive load 20A 230VAC (AC3/400V) 9A/4kW main contacts 3NO auxiliary contacts 1NO connection screw connection type 11BG0910A230 |                 |         |
| <b>accessories for</b>  | 380705   |                 |         |
|   | <b>GEV No.</b>   | <b>Ref. No.</b> | —       |
|  | 380057   |                 |         |
|   | auxiliary contact contacts 1NO/1NC AC1 10A for contactors BG series connection screw type BGX1011  |                 |         |

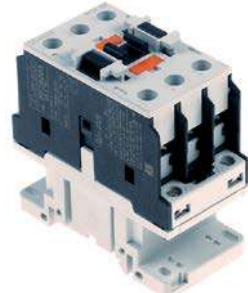

1

|                    |   |                 |         |
|--------------------|---|-----------------|---------|
| <b>GEV No.</b>     | 380721  | <b>Ref. No.</b> | 3110890 |
| <b>description</b> | power contactor resistive load 45A 230VAC (AC3/400V) 26A/13kW main contacts 3NO auxiliary contacts connection screw connection type BF2600A230  |                 |         |
| <b>For models:</b> | 091CP1E, 091FR1E, 091FR1EA, 091FR1ED, 091FR1EX, 0A1FR1E, 0A1FR1ED, 0D1FR1E, 0D1FR1ED, 191BR1E, 191BR2E, 191BR2EA, 191FR2E, 191FR2ED, 1A1FR2E, 1A1FR2ED, 1D1FR2ED, 291BR1E, 291BR2E, 291BR2EA, FX122E3, FX122E3C, FX122E3T, FX122E3T-VERS.022014, FX12E3CT, FX12E3CT-VERS.022014, FX201E3, FX201E3P, FX201E3P-VERS.022014, FX201E3-VERS.022014, FX202E3, FX202E3-VERS.022014 |                 |         |



1

|                    |   |                 |                    |
|--------------------|---|-----------------|--------------------|
| <b>GEV No.</b>     | 380083  | <b>Ref. No.</b> | 3100940<br>32V5290 |
| <b>description</b> | power contactor resistive load 25A 230VAC (AC3/400V) 9A/4.2kW main contacts 3NO auxiliary contacts 1NC connection screw connection type BF0901A230  |                 |                    |
| <b>For models:</b> | 04WBMEV, 06WFT1EV, 06WFT2EV, 06WFT3EV, 06WFT4EV, 06WFT6EV, 06WFT7EV, 08WFT1EV, 08WFT2EV, 08WFT3EV, 08WFT4EV, 08WFT6EV, 08WFT7EV, 091FT1E, 091FT2E, 091FT4E, 091FT5E, 091FT7E, 0G1CP1EC, 0G1FT2E, 0G1FT4E, 0G1FT5E, 0G1FT7E, 191FT1E, 191FT2E, 191FT3E, 191FT4E, 191FT6E, 191FT7E, 1G1FT2E, 1G1FT4E, 1G1FT5E, 1G1FT6E, 1G1FT7E, BX101E, BX101E-VERS.122013, BX101G, BX101G-VERS.122013, BX122E, BX122E-VERS.122013, BX122G, BX122G-VERS.122013, BX61E, BX61E-VERS.122013, BX61G, BX61G-VERS.122013, BX82E, BX82E-VERS.122013, BX82G, BX82G-VERS.122013...(Other models you can see in the webshop) |                 |                    |

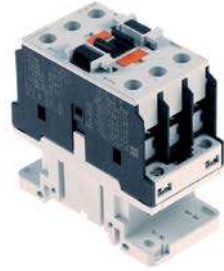

1

|                    |   |                 |                    |
|--------------------|---|-----------------|--------------------|
| <b>GEV No.</b>     | 380722  | <b>Ref. No.</b> | 3100930<br>32Z3511 |
| <b>description</b> | power contactor resistive load 56A 230VAC (AC3/400V) 32A/16kW main contacts 3NO auxiliary contacts connection screw connection type BF3200A230  |                 |                    |
| <b>For models:</b> | 091FR1ED, 10CP1EA, 12CP1EA, 18CP2EA, BRE21HD, BRE31HD, BX101E, BX101E-VERS.122013, BX122E, BX122E-VERS.122013, BX61E, BX61E-VERS.122013, BX82E, BX82E-VERS.122013, FC1011E, FC101E, FC1221E, FC241E, FCV101E, FCV101EDM, FCV101EDS, FCV141E, FCV141EDM, FCV141EDS, FCV241E, FCV241EDM, FCV241EDS, FCV401EDM, FCV61E, FM1011E1, FM1011E1-VERS.2006, FM1011E2, FM1011E2-VERS.2006, FM1011E3, FM1011E3-VERS.2006, FM1221E1, FM1221E1-VERS.2006, FM1221E2, FM1221E2-VERS.2006, FM1221E3, FM1221E3-VERS.2006, FM2011E2-VERS.2006, FM2011E3-VERS.2006, FM2021E1, FM2021E2, FM2021E2-VERS.2006, FM2021E3, FM2021E3-VERS.2006, FM611E3, FM721E1...(Other models you can see in the webshop) |                 |                    |



## MOELLER/EATON

## power contactors



1

|                    |  |                 |         |
|--------------------|--|-----------------|---------|
| <b>GEV No.</b>     | 380171   | <b>Ref. No.</b> | 32Z4840 |
| <b>description</b> | power contactor resistive load 20A 230VAC (AC3/400V) 9A/4kW main contacts 3NO auxiliary contacts 1NO connection screw connection type DILEM 10 |                 |         |
| <b>For models:</b> | LCV, P10, P102, P10M, P20, P202, P5, Q3, Q3M, Q5, Q52, Q5M, Q8, Q82, TV1, TV1M, TV2L   |                 |         |

## SIEMENS

## power contactors



1

|                    |  |                 |         |
|--------------------|--|-----------------|---------|
| <b>GEV No.</b>     | 380646   | <b>Ref. No.</b> | 32Z9250 |
| <b>description</b> | power contactor resistive load 40A 230VAC (AC3/400V) 17A/7.5kW main contacts 3NO auxiliary contacts connection screw connection type 3RT10-25-1AL20  |                 |         |
| <b>For models:</b> | ART1L7, ART1L7A, ART1L7M, ART1LD, ART1LD7, ART1LD7A, ART1LD7M, ART1LDA, ART2LD, ART2SD, ART3SD, B1101S, B151H, B151M, BF101L, BF101S, BF51H, BF51M, D12Q1M, D12Q2, D12Q2M, DS51, DS51A, DS51C, DS51M, FS611, GR135BT, GR140TN4, GR65BT, GR65TN4, IA101L, IA101S, IA51, IA51A, IA51C, IA51M, IA72S, IS101L, IS101LW, IS101S, IS101SR, IS101SW, IS102S, IS102SR-0NR01, IS102SW, IS51, IS51A, IS51AR, IS51C, IS51CR...(Other models you can see in the webshop) |                 |         |

## power contactors



1

|                    |  |                 |         |
|--------------------|--|-----------------|---------|
| <b>GEV No.</b>     | 380617   | <b>Ref. No.</b> | 32Z8680 |
| <b>description</b> | power contactor resistive load 25A 24VAC (AC3/400V) 9A/4kW main contacts 3NO auxiliary contacts 1NO/1NC connection screw connection type LC1D09B7  |                 |         |
| <b>For models:</b> | C165D, C165S, C165VD, C165VS, C207D, C207S, C207VD, C207VS, C304AD, C304AS, C304AVD, C304AVS, C304D, C304S, C304VD, C304VS, CS243D, CS243S, CS243VD, CS243VS, CS370AD, CS370AS, CS370AVD, CS370AVS, CS370D, CS370S, CS370VD, CS370VS, CS466AD, CS466AS, CS466AVD, CS466AVS, CS466D, CS466S, CS466VD, CS466VS, N303D, N303S, N303VD, N303VS, N354D, N354S, N354VD, N354VS, N506D, N506S, N506VD, N506VS, N607D, N607S...(Other models you can see in the webshop) |                 |         |

## relays

## power relays

## with flange mounting



1

|                    |   |                 |         |
|--------------------|---|-----------------|---------|
| <b>GEV No.</b>     | 380817  | <b>Ref. No.</b> | 32Z7930 |
| <b>description</b> | power relays Italiana Relè 230VAC 16A 2NO connection male faston 6.3mm screw mounting manuf. no. B1-2-230AC |                 |         |
| <b>For models:</b> | LT25F   |                 |         |

## with bracket mounting



1

|                    |   |                 |         |
|--------------------|---|-----------------|---------|
| <b>GEV No.</b>     | 380815  | <b>Ref. No.</b> | 32V0540 |
| <b>description</b> | power relays 230VAC 16A 2NO connection male faston 6.3mm flange dimensions 36x38x68mm |                 |         |
| <b>For models:</b> | LC100, LC100-VERS.2001, LC130, LC130-VERS.2001, LC80, LF50, LF50E                     |                 |         |



Зип Общепит  
plug in/print relays

vsezip.ru

+7(812)987-08-81



1

|                    |  |                 |                               |
|--------------------|--|-----------------|-------------------------------|
| <b>GEV No.</b>     | 380139   | <b>Ref. No.</b> | 32V2950<br>32V7100<br>32Z2000 |
| <b>description</b> | power relays FINDER 230VAC 16A 2CO connection F6.3 bracket mounting dimensions 68x38.2x35.8mm manuf. no. 62.82.8.230.0000  |                 |                               |
| <b>For models:</b> | F60P, F60PR, F60T, F80P, F80PR, KD100, KD100A, KD100PSD, KD37, KD40, KD85, KD85A, KD85PS, KD85PSA, KN35, KN37, KN37PS, KN40, KN40PS, KN40PSD, KN50, KN50M, KN50MPS, KN50PS, KN50PSD, KN50PSDD, KN80, KN80PS, L100, L40, L40S, L45, L60, L80, LC100, LC100-VERS.2001, LC130, LC130-VERS.2001, LC80, LP151 |                 |                               |



1

|                    |   |                 |         |
|--------------------|---|-----------------|---------|
| <b>GEV No.</b>     | 380403  | <b>Ref. No.</b> | 32V2940 |
| <b>description</b> | power relays FINDER 230VAC 16A 3CO connection F6.3 bracket mounting manuf. no. 62.83.8.230.0500 |                 |         |
| <b>For models:</b> | LF50EM, LP124, LP124V, LP84V  |                 |         |







1

|                    |  |                 |         |
|--------------------|--|-----------------|---------|
| <b>GEV No.</b>     | 380185   | <b>Ref. No.</b> | 32V3720 |
| <b>description</b> | power relays Italiana Relè 230VAC 30A 1NO connection F6.3 bracket mounting dimensions 36.5x32.2x51.8mm manuf. no. A10-230AC-FA |                 |         |

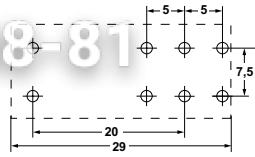

1



|   |  |                 |                 |   |
|---|--|-----------------|-----------------|---|
| <b>GEV No.</b>  | 380333   | <b>Ref. No.</b> | 32V6630         |   |
| <b>description</b>  | print relay 230VAC 2CO at 250V 8A connection pins raster size 5mm FINDER manuf. no. 40.52.8.230.0000 95.65/95.75                                     |                 |                 |   |
| <b>For models:</b>  | 191BR2EA, FM1221G1, FM1221G2, FM1221G3, FM2011G2-VERS.2006, FM2011G3-VERS.2006, FM2021G1, FM2021G2, FM2021G2-VERS.2006, FM2021G3, FM2021G3-VERS.2006 |                 |                 |   |
| <b>accessories for</b>  | 380333   |                 |                 |   |
|  | <b>GEV No.</b>   | 380340          | <b>Ref. No.</b> | — |
|   | relay socket dimensions 62x36x15mm 250V voltage AC 10A Italiana Relè manuf. no. ZMEM/5   |                 |                 |   |
|  | <b>GEV No.</b>   | 380505          | <b>Ref. No.</b> | — |
|   | relay socket 2CO 40.52 dimensions 81.9x15.5x75mm 250V voltage AC 10A FINDER manuf. no. 95.95.3   |                 |                 |   |
|  | <b>GEV No.</b>   | 381181          | <b>Ref. No.</b> | — |
|   | relay socket 2-pole 40.51/40.52/40.61 connection screw clamp dimensions 15.8x78.6mm 250V voltage AC 10A FINDER manuf. no. 95.75                      |                 |                 |   |

transformers

open transformers

with clamp terminal



1

|                    |   |                 |         |
|--------------------|---|-----------------|---------|
| <b>GEV No.</b>     | 403905  | <b>Ref. No.</b> | 3117170 |
| <b>description</b> | transformer primary 230V/50-60Hz secondary 12V 50VA connection screw connection type T1ULF  |                 |         |
| <b>For models:</b> | 10CP1EA, 10CP1GA, 10CP1IA, 12CP1EA, 12CP1GA, 12CP1IA, 18CP2EA, 18CP2GA, 18CP2IA, FX101E1, FX101E1R, FX101E2, FX101E2C, FX101E2C-VERS.032014, FX101E2R, FX101E2R-VERS.032014, FX101E2-VERS.032014, FX101E3, FX101E3C, FX101E3C-VERS.022014, FX101E3R, FX101E3R-VERS.022014, FX101E3-VERS.022014, FX101G1, FX101G1R, FX101G2, FX101G2C, FX101G2C-VERS.032014, FX101G2R, FX101G2R-VERS.032014, FX101G2-VERS.032014, FX101G3, FX101G3C, FX101G3C-VERS.022014, FX101G3R, FX101G3R-VERS.022014, FX101G3-VERS.022014, FX10E2CR, FX10E2CR-VERS.032014, FX10E3CR, FX10E3CR-VERS.022014, FX10G2CR, FX10G2CR-VERS.032014, FX10G3CR, FX10G3CR-VERS.022014, FX122E1, FX122E2, FX122E2C, FX122E2T, FX122E2T-VERS.032014...(Other models you can see in the webshop) |                 |         |

1 electric components



electric components

Зип Обществит  
electronic controllers

ELIWELL  
refrigeration controllers

built-in version

+7(812)987-08-81

with plug connection



|                    |   |                 |         |
|--------------------|---|-----------------|---------|
| <b>GEV No.</b>     | 400956  | <b>Ref. No.</b> | 32V5770 |
| <b>description</b> | transformer primary 230VAC secondary 12VAC 20VA connection male faston 6.3mm 50/60Hz type T602012/E temperature restriction 150°C ambient temperature max. 80°C   |                 |         |
| <b>For models:</b> | B1101S, B151H, B151M, BF101L, BF101S, BF51H, BF51M, BX101E, BX101E-VERS.122013, BX101G, BX101G-VERS.122013, BX61E, BX61E-VERS.122013, BX61G, BX61G-VERS.122013, BX82E, BX82E-VERS.122013, BX82G, BX82G-VERS.122013, FM1011E1, FM1011E1-VERS.2006, FM1011E2, FM1011E2-VERS.2006, FM1011E3, FM1011E3-VERS.2006, FM1011G1, FM1011G1-VERS.2006, FM1011G2, FM1011G2-VERS.2006, FM1011G3, FM1011G3-VERS.2006, FM611E1, FM611E1-VERS.2006, FM611E2, FM611E2-VERS.2006, FM611E3, FM611E3-VERS.2006, FM611G1, FM611G1-VERS.2006, FM611G2, FM611G2-VERS.2006, FM611G3, FM611G3-VERS.2006, FM721E1, FM721E1-VERS.2006, FM721E2, FM721E2-VERS.2006, FM721E3, FM721E3-VERS.2006, FM721G1...(Other models you can see in the webshop) |                 |         |

encapsulated transformers

PMA



|                    |   |                 |         |
|--------------------|---|-----------------|---------|
| <b>GEV No.</b>     | 379054  | <b>Ref. No.</b> | 32Z3470 |
| <b>description</b> | transformer primary 230VAC secondary 12VAC 3VA secondary 0.25A H 40mm L 45mm W 50mm connection screw 50/60Hz type 153/M   |                 |         |
| <b>For models:</b> | 120, 120B, 120PV, 135, 135-4, 135B, 135BA, 135BN, 135BNX, 135BX, 135BXE, 135BXR, 135CPX, 135PVX, 135X, 135X-3, 135X-4, 135XR, 40CP, 40CPX, 55, 55B, 55PV, 65, 65B, 65BA, 65BX, 65BX-2, 65BXE, 65BXR, 65NB, 65NBX, 65PVX, 65X, 65X-2, 65XR, 6BMA11A, 6BMA11B, 6BMA11M, 6BMA11Z, 6BMA2A, 6BMA2B, 6BMA2M, 6BMA2Z, 6BMA3A, 6BMA3B, 6BMA3M, 6BMA3Z, 6BMAA, 6BMAB...(Other models you can see in the webshop) |                 |         |



|                    |  |                 |         |
|--------------------|--|-----------------|---------|
| <b>GEV No.</b>     | 379114   | <b>Ref. No.</b> | 32Z3460 |
| <b>description</b> | electronic controller ELIWELL type EWPC961 mounting measurements 71x29mm |                 |         |



|                    |   |                 |         |
|--------------------|---|-----------------|---------|
| <b>GEV No.</b>     | 379102  | <b>Ref. No.</b> | 32Z3660 |
| <b>description</b> | electronic controller ELIWELL type EWPC970 mounting measurements 71x29mm 12V relay outputs 8A |                 |         |



|                        |  |                 |         |
|------------------------|--|-----------------|---------|
| <b>GEV No.</b>         | 379614   | <b>Ref. No.</b> | 32V7580 |
| <b>description</b>     | electronic controller ELIWELL type ID961 mounting measurements 71x29mm 230V voltage AC NTC/PTC front measurements 33x75mm protection IP65 1x NTC probe inclusive -50 up to +150°C display 3½ digit LCD 1999 Digits |                 |         |
| <b>For models:</b>     | MX120, MX130, MX130NN, MX140, MX150, MX150NN, MX60, MX70   |                 |         |
| <b>accessories for</b> | 379614   |                 |         |

|                    |  |                 |         |
|--------------------|--|-----------------|---------|
| <b>GEV No.</b>     | 378194   | <b>Ref. No.</b> | 32V6000 |
| <b>description</b> | temperature probe NTC 10kOhm cable PVC probe -20 up to +80°C cable -10 up to 100°C probe ø7x24.5mm cable length 1.5m without screw connection 2-wire     |                 |         |
| <b>GEV No.</b>     | 379052   | <b>Ref. No.</b> | —       |
| <b>description</b> | temperature probe PTC 1kOhm cable silicone probe -50 up to +150°C cable -50 up to +180°C probe ø6x40mm cable length 1.5m without screw connection 2-wire |                 |         |
| <b>GEV No.</b>     | 379053   | <b>Ref. No.</b> | —       |
| <b>description</b> | temperature probe PTC 1kOhm cable PVC probe -50 up to +150°C cable -10 up to 100°C probe ø6x30mm cable length 3m without screw connection 2-wire         |                 |         |
| <b>GEV No.</b>     | 379057   | <b>Ref. No.</b> | —       |
| <b>description</b> | temperature probe NTC 10kOhm cable PVC probe -20 up to +80°C cable -10 up to 100°C probe ø6x25mm cable length 3m 2-wire                                  |                 |         |
| <b>GEV No.</b>     | 379064   | <b>Ref. No.</b> | 8223470 |
| <b>description</b> | temperature probe PTC 1kOhm cable silicone probe -50 up to +150°C cable -50 up to +180°C probe ø6x40mm cable length 3m without screw connection 2-wire   |                 |         |

Table continues overleaf





Зип-Общепит  
refrigerator controllers

| accessories for |  | 379614   |         |
|-----------------|--|----------|---------|
| GEV No.         | 379142   | Ref. No. | —       |
|                 | temperature probe PTC 1kOhm cable PVC probe -50 up to +150°C cable -10 up to 100°C probe ø6x30mm cable length 1.5m without screw connection 2-wire             |          |         |
|                 | temperature probe NTC 10kOhm cable thermoplastic probe -40 up to +110°C cable -40 up to +110°C probe ø6x14mm cable length 1.5m without screw connection 2-wire |          |         |
|                 | temperature probe NTC 10kOhm cable thermoplastic probe -40 up to +110°C cable -40 up to +110°C probe ø6x14mm cable length 3m without screw connection 2-wire   |          | 32V6010 |
|                 | temperature probe NTC 10kOhm cable silicone probe -40 up to +110°C cable -50 up to +180°C probe ø6x40mm cable length 3m 2-wire                                 |          | 32V3730 |
|                 | temperature probe NTC 10kOhm cable silicone probe -40 up to +110°C cable -50 up to +180°C probe ø6x40mm cable length 1.5m without screw connection 2-wire      |          | —       |
|                 | temperature probe PTC 1kOhm cable thermoplastic probe -50 up to +150°C cable -40 up to +110°C probe ø6x14mm cable length 1.5m without screw connection 2-wire  |          | —       |
|                 | temperature probe PTC 1kOhm cable thermoplastic probe -50 up to +150°C cable -40 up to +110°C probe ø6x14mm cable length 3m 2-wire resistor 1kOhm              |          | —       |

built-in version



1

| GEV No.     | 379232                | Ref. No. | 32V6500 |
|-------------|-----------------------|----------|---------|
| description | electronic controller |          |         |
| For models: | CX70R                 |          |         |

EVCO - EVERY CONTROL

universal controllers

built-in version



1

| GEV No.     | 379632   | Ref. No. | 32V0421 |
|-------------|--|----------|---------|
| description | electronic controller EVERY CONTROL mounting measurements 135x66mm built-in depth 67mm 230V voltage AC with accessories -50 up to +100°C type ECS805P220D306 front measurements 142x70mm |          |         |
| For models: | ART2LD, ART2SD, ART3SD   |          |         |



1

| GEV No.     | 381388   | Ref. No. | 32V2090 |
|-------------|--|----------|---------|
| description | electronic controller ANGELO PO conversion kit mounting measurements 71x29mm 230V voltage AC NTC front measurements 33x75mm protection IP65 1x NTC probe inclusive -40 up to +99°C   |          |         |
| For models: | 6SMA, 6SMA2, 6SMA2A, 6SMA2B, 6SMA2M, 6SMA2Z, 6SMA4Z, 6SMAA, 6SMAB, 6SMAM, 6SMAZ, 6SMB, 6SMB2, 6SMB2A, 6SMB2B, 6SMB2M, 6SMB2Z, 6SMB4, 6SMB4A, 6SMB4B, 6SMB4M, 6SMB4Z, 6SMB6Z, 6SMB6A, 6SMB6B, 6SMB6M, 6SMBZ, 6SMC, 6SMC2, 6SMC2A, 6SMC2B, 6SMC2M, 6SMC2Z, 6SMC4, 6SMC4A, 6SMC4B, 6SMC4M, 6SMC4Z, 6SMC6, 6SMC6A, 6SMC6B, 6SMC6M, 6SMC6Z, 6SMC8Z, 6SMCA, 6SMCB, 6SMCM, 6SMCZ, PE1633, PE1633V...(Other models you can see in the webshop) |          |         |



1

| GEV No.     | 379616   | Ref. No. | 32V5020 |
|-------------|--|----------|---------|
| description | electronic controller EVERY CONTROL mounting measurements 71x29mm 12V voltage AC TC-K protection IP65 0-999°C type FK400A front measurements 33x75mm |          |         |
| For models: | FPZ4G, FPZ6G   |          |         |



1

| GEV No.     | 379613   | Ref. No. | 32V2980 |
|-------------|--|----------|---------|
| description | electronic controller ANGELO PO mounting measurements 71x29mm 12V voltage AC NTC front measurements 33x75mm protection IP65 2xNTC probe inclusive -40 up to +110°C |          |         |
| For models: | 135B, 135BN, 135BNX, 135BX, 135BXR, 65B, 65BX, 65BX-2, 65BXR, 65NB, 65NBX, SP65NB  |          |         |

electric components



Зип Общепит

vsezip.ru

+7(812)987-08-81



|                    |  |                 |         |
|--------------------|--|-----------------|---------|
| 1                  |  |                 |         |
| <b>GEV No.</b>     | 379609   | <b>Ref. No.</b> | 32V6060 |
| <b>description</b> | electronic controller ANGELO PO mounting measurements 71x29mm 12V voltage AC NTC relay outputs 1 relay front measurements 33x75mm protection IP65 2xNTC probe inclusive -40 up to +99°C compressor relay 16A |                 |         |
| <b>For models:</b> | CX130B, CX60B, FX150B, FX70B, MX120B, MX140B, MX55B, MX65B, S1200B, S1200B4, S1200BE, S600B, S600B2, S600BE  |                 |         |



|                    |   |                 |         |
|--------------------|---|-----------------|---------|
| <b>GEV No.</b>     | 378192  | <b>Ref. No.</b> | 32V6900 |
| <b>description</b> | electronic controller EVERY CONTROL type EVK201 mounting measurements 71x29mm 230V voltage AC NTC relay outputs 1 CO NTC defr. funct. no -50 up to +150°C display 3½ digits compressor relay 10A  |                 |         |
| <b>For models:</b> | 6SMA, 6SMA2, 6SMA2A, 6SMA2B, 6SMA2M, 6SMA2Z, 6SMA4Z, 6SMAA, 6SMAB, 6SMAM, 6SMAZ, 6SMB, 6SMB2, 6SMB2A, 6SMB2B, 6SMB2M, 6SMB2Z, 6SMB4, 6SMB4A, 6SMB4B, 6SMB4M, 6SMB4Z, 6SMB6Z, 6SMBA, 6SMBB, 6SMBM, 6SMBZ, 6SMC, 6SMC2, 6SMC2A, 6SMC2B, 6SMC2M, 6SMC2Z, 6SMC4, 6SMC4A, 6SMC4B, 6SMC4M, 6SMC4Z, 6SMC6, 6SMC6A, 6SMC6B, 6SMC6M, 6SMC6Z, 6SMC8Z, 6SMCA, 6SMCB, 6SMCM, 6SMCZ, PE1633, PE1633V...(Other models you can see in the webshop) |                 |         |



|                    |  |                 |         |
|--------------------|--|-----------------|---------|
| 1                  |  |                 |         |
| <b>GEV No.</b>     | 379608   | <b>Ref. No.</b> | 32V6080 |
| <b>description</b> | electronic controller EVERY CONTROL mounting measurements 71x29mm 12V voltage AC NTC relay outputs 1 relay front measurements 33x75mm protection IP65 2xNTC probe inclusive -40 up to +99°C compressor relay 16A |                 |         |
| <b>For models:</b> | CX130B, CX150B, CX150BN, CX150BR, CX60B, CX70B, CX70BR   |                 |         |



|                |        |                 |   |
|----------------|--------|-----------------|---|
| 1              |        |                 |   |
| <b>GEV No.</b> | 378126 | <b>Ref. No.</b> | 3087950<br>3107290<br>3120900<br>32V6920<br>32V7490<br>32V7820<br>32V8590 |

|                    |   |  |  |
|--------------------|---|--|--|
| <b>description</b> | electronic controller EVERY CONTROL type EVK201N7 mounting measurements 71x29mm 230V voltage AC NTC/PTC relay outputs 1 CO-16A(5) NTC/PTC front measurements 33x75mm built-in depth 59mm protection IP65 -40 up to +105°C display 3½ digits   |  |  |
| <b>For models:</b> | 3G6SA, 3G6SA2, 3G6SA4, 4G6SB, 4G6SB2, 4G6SB4, 4G6SB6, 6BR15V, 6BR15VC, 6BR19V, 6BR19VC, 6MA, 6MA2, 6MA2A, 6MA2M, 6MAA, 6MAM, 6MB, 6MB11, 6MB11A, 6MB11M, 6MB2, 6MB2A, 6MB2M, 6MB4, 6MB4A, 6MB4M, 6MBA, 6MBM, 6MC, 6MC11, 6MC11A, 6MC11M, 6MC2, 6MC2A, 6MC2M, 6MC4, 6MC4A, 6MC4M, 6MCA, 6MCM, 6MJA, 6MJA2, 6MJA2A, 6MJA2M, 6MJAA, 6MJAM, 6MJB, 6MJB2, 6MJB2A...(Other models you can see in the webshop) |  |  |



|                    |   |                 |         |
|--------------------|---|-----------------|---------|
| 1                  |   |                 |         |
| <b>GEV No.</b>     | 378187  | <b>Ref. No.</b> | 32V6050 |
| <b>description</b> | electronic controller EVERY CONTROL mounting measurements 71x29mm 230V voltage AC NTC/PTC relay outputs 1 CO -50 up to +150°C display 3½ digits |                 |         |
| <b>For models:</b> | CX130, CX130NN, CX60, FX150, FX150NN, FX70  |                 |         |

|                        |        |                |  |                 |         |
|------------------------|--------|----------------|--|-----------------|---------|
| <b>accessories for</b> | 378126 | <b>GEV No.</b> | 379053   | <b>Ref. No.</b> | —       |
|                        |        |                | temperature probe PTC 1kOhm cable PVC probe -50 up to +150°C cable -10 up to 100°C probe ø6x30mm cable length 3m without screw connection 2-wire             |                 |         |
|                        |        | <b>GEV No.</b> | 379064   | <b>Ref. No.</b> | 8223470 |
|                        |        |                | temperature probe PTC 1kOhm cable silicone probe -50 up to +150°C cable -50 up to +180°C probe ø6x40mm cable length 3m without screw connection 2-wire       |                 |         |
|                        |        | <b>GEV No.</b> | 379161   | <b>Ref. No.</b> | 32V6010 |
|                        |        |                | temperature probe NTC 10kOhm cable thermoplastic probe -40 up to +110°C cable -40 up to +110°C probe ø6x14mm cable length 3m without screw connection 2-wire |                 |         |
|                        |        | <b>GEV No.</b> | 379782   | <b>Ref. No.</b> | —       |
|                        |        |                | temperature probe PTC 1kOhm cable thermoplastic probe -50 up to +150°C cable -40 up to +110°C probe ø6x14mm cable length 3m 2-wire resistor 1kOhm            |                 |         |



Зип Общепит

vsezip.ru

+7(812)987-08-81



71 x 29mm



1

|                        |  |                 |   |
|------------------------|--|-----------------|---|
| <b>GEV No.</b>         | 378154   | <b>Ref. No.</b> | 3048060<br>3096600<br>3106300<br>3107300<br>3119780 |
| <b>description</b>     | electronic controller EVERY CONTROL type EVK203N7VXBS mounting measurements 71x29mm 230V voltage AC NTC/PTC relay outputs 3 NO-16A(5) CO-8A(4) NO-8A(4) NTC/PTC NTC/PTC DI front measurementsmm built-in depth 59mm protection IP65 yes -50 up to +150°C display 3½ digits   |                 |   |
| <b>For models:</b>     | 6ERA-OPR01, 6ERA2-OPR01, 6ERA2A-OPR01, 6ERA2M-OPR01, 6ERAA-OPR01, 6ERAM-OPR01, 6ERB-OPR01, 6ERB2-OPR01, 6ERB2A-OPR01, 6ERB2M-OPR01, 6ERB4-OPR01, 6ERB4A-OPR01, 6ERB4M-OPR01, 6ERBA-OPR01, 6ERBM-OPR01, 6ERC-OPR01, 6ERC2-OPR01, 6ERC2A-OPR01, 6ERC2M-OPR01, 6ERC4-OPR01, 6ERC4A-OPR01, 6ERC4M-OPR01, 6ERCA-OPR01, 6ERCM-OPR01, BS11, BS11A, BS11M, BS16, BS16A, BS16M, BS21, BS21A, BS21M, BSR11, BSR11A, BSR11M, BSR16, BSR16A, BSR16M, BSR21, BSR21A, BSR21M, MD130, MD130BN, MD130NN, MD150, MD150A, MD150BN, MD150NCP, MD150NN...(Other models you can see in the webshop) |                 |   |
| <b>accessories for</b> | 378154   |                 |   |
|                        | <b>GEV No.</b>   | 379053          | <b>Ref. No.</b> —                                   |
|                        | temperature probe PTC 1kOhm cable PVC probe -50 up to +150°C cable -10 up to 100°C probe ø6x30mm cable length 3m without screw connection 2-wire   |                 |   |
|                        | <b>GEV No.</b>   | 379064          | <b>Ref. No.</b> 8223470                             |
|                        | temperature probe PTC 1kOhm cable silicone probe -50 up to +150°C cable -50 up to +180°C probe ø6x40mm cable length 3m without screw connection 2-wire   |                 |   |
|                        | <b>GEV No.</b>   | 379161          | <b>Ref. No.</b> 32V6010                             |
|                        | temperature probe NTC 10kOhm cable thermoplastic probe -40 up to +110°C cable -40 up to +110°C probe ø6x14mm cable length 3m without screw connection 2-wire   |                 |   |
|                        | <b>GEV No.</b>   | 379782          | <b>Ref. No.</b> —                                   |
|                        | temperature probe PTC 1kOhm cable thermoplastic probe -50 up to +150°C cable -40 up to +110°C probe ø6x14mm cable length 3m 2-wire resistor 1kOhm  |                 |   |



|                    |   |                 |                    |
|--------------------|---|-----------------|--------------------|
| <b>GEV No.</b>     | 378188  | <b>Ref. No.</b> | 32V6070<br>32V6270 |
| <b>description</b> | electronic controller EVERY CONTROL type FK203B mounting measurements 71x29mm 12V voltage AC/DC NTC relay outputs 3 relays -40 up to +99°C DEF Relay 8A fan relay 8A compressor relay 10A |                 |                    |
| <b>For models:</b> | CX130, CX130NN, CX150, CX150BN, CX150CP, CX150NN, CX150PV, CX150R, CX60, CX70, CX702, CX70PV  |                 |                    |



1

|                    |   |                 |         |
|--------------------|---|-----------------|---------|
| <b>GEV No.</b>     | 378190  | <b>Ref. No.</b> | 32V6280 |
| <b>description</b> | electronic controller EVERY CONTROL type FK203B mounting measurements 71x29mm 12V voltage AC/DC NTC relay outputs 3 relays -40 up to +99°C DEF Relay 8A fan relay 8A compressor relay 10A |                 |         |
| <b>For models:</b> | CX70NB, CX70NN  |                 |         |



1

|                    |   |                 |         |
|--------------------|---|-----------------|---------|
| <b>GEV No.</b>     | 378191  | <b>Ref. No.</b> | 32V6260 |
| <b>description</b> | electronic controller EVERY CONTROL type FK203B mounting measurements 71x29mm 12V voltage AC/DC NTC relay outputs 3 relays -40 up to +99°C DEF Relay 8A fan relay 8A compressor relay 10A |                 |         |



1

|                    |   |                 |         |
|--------------------|---|-----------------|---------|
| <b>GEV No.</b>     | 378193  | <b>Ref. No.</b> | 32V2920 |
| <b>description</b> | electronic controller EVERY CONTROL type FK206A mounting measurements 71x29mm 12V voltage AC/DC NTC -40 up to +99°C |                 |         |
| <b>For models:</b> | 6JA, 6JA2, 6JA2A, 6JA2M, 6JAA, 6JAM, 6JB, 6JB2, 6JB2A, 6JB2M, 6JB4A, 6JB4M, 6JBA, 6JBM                              |                 |         |



1

|                    |  |                 |                    |
|--------------------|--|-----------------|--------------------|
| <b>GEV No.</b>     | 378189   | <b>Ref. No.</b> | 32V6290<br>32V6300 |
| <b>description</b> | electronic controller EVERY CONTROL type EVK213 mounting measurements 71x29mm 12V voltage AC/DC NTC/PTC relay outputs 3 relays -40 up to +105°C display 3½ digits DEF Relay 8A fan relay 8A compressor relay 16A |                 |                    |
| <b>For models:</b> | CX150CP, CX70NB  |                 |                    |

Зип-Общепит

vsezip.ru

+7(812)987-08-81



|                    |  |                 |         |
|--------------------|--|-----------------|---------|
| 1                  |  |                 |         |
| <b>GEV No.</b>     | 379615   | <b>Ref. No.</b> | 32V7490 |
| <b>description</b> | electronic controller mounting measurements 71x29mm 230V voltage AC NTC relay outputs 1 relay front measurements 33x75mm protection IP65 1x NTC probe inclusive -40 up to +99°C compressor relay 16A |                 |         |
| <b>For models:</b> | 40, 40-OPR01, 40PV, 40PV-OPR01, 40X, 40X-OPR01, 40XPV  |                 |         |



|                    |  |                 |         |
|--------------------|--|-----------------|---------|
| 1                  |  |                 |         |
| <b>GEV No.</b>     | 378197   | <b>Ref. No.</b> | 32V7460 |
| <b>description</b> | printer EVERY CONTROL PM100AX9S201 mounting measurements 90x90mm |                 |         |
| <b>For models:</b> | ISP202R, ISR201R, ISR202R, SM14SR, SM7SR                         |                 |         |

electronic thermometers

built-in version



|                    |  |                 |         |
|--------------------|--|-----------------|---------|
| 1                  |  |                 |         |
| <b>GEV No.</b>     | 379900   | <b>Ref. No.</b> | 32Z8250 |
| <b>description</b> | thermometer EVERY CONTROL type TM103T N4 mounting measurements 58x25.5mm 24V voltage AC -40 up to +110°C measuring input NTC display 2½ digit front measurements 31x64mm protection IP54 accuracy 1%   |                 |         |
| <b>For models:</b> | C165D, C165S, C165VD, C165VS, C207D, C207D-VERS.2006, C207S, C207S-VERS.2006, C207VD, C207VD-VERS.2006, C207VS, C207VS-VERS.2006, C304AD, C304AD-VERS.2006, C304AS, C304AS-VERS.2006, C304AVD, C304AVD-VERS.2006, C304AVS, C304AVS-VERS.2006, C304D, C304D-VERS.2006, C304S, C304S-VERS.2006, C304VD, C304VD-VERS.2006, C304VS, C304VS-VERS.2006, C92D-VERS.2006, C92S-VERS.2006, C92VD-VERS.2006, C92VS-VERS.2006, CS243D, CS243D-VERS.2006, CS243S, CS243S-VERS.2006, CS243VD, CS243VD-VERS.2006, CS243VS, CS243VS-VERS.2006, CS370AD, CS370AD-VERS.2006, CS370AS, CS370AS-VERS.2006, CS370AVD, CS370AVD-VERS.2006, CS370AVS, CS370AVS-VERS.2006, CS370D, CS370D-VERS.2006...(Other models you can see in the webshop) |                 |         |

SHANGFANG

accessories



|                    |   |                 |         |
|--------------------|---|-----------------|---------|
| 1                  |   |                 |         |
| <b>GEV No.</b>     | 379054  | <b>Ref. No.</b> | 32Z3470 |
| <b>description</b> | transformer primary 230VAC secondary 12VAC 3VA secondary 0.25A H 40mm L 45mm W 50mm connection screw 50/60Hz type 153/M   |                 |         |
| <b>For models:</b> | 120, 120B, 120PV, 135, 135-4, 135B, 135BA, 135BN, 135BNX, 135BX, 135BXE, 135BXR, 135CPX, 135PVX, 135X, 135X-3, 135X-4, 135XR, 40CP, 40CPX, 55, 55B, 55PV, 65, 65B, 65BA, 65BX, 65BX-2, 65BXE, 65BXR, 65NB, 65NBX, 65PVX, 65X, 65X-2, 65XR, 6BMA11A, 6BMA11B, 6BMA11M, 6BMA11Z, 6BMA2A, 6BMA2B, 6BMA2M, 6BMA2Z, 6BMA3A, 6BMA3B, 6BMA3M, 6BMA3Z, 6BMAA, 6BMAB...(Other models you can see in the webshop) |                 |         |

probes

universal probes

temperature probes



|                    |   |                 |         |
|--------------------|---|-----------------|---------|
| 1                  |   |                 |         |
| <b>GEV No.</b>     | 378194  | <b>Ref. No.</b> | 32V6000 |
| <b>description</b> | temperature probe NTC 10kOhm cable PVC probe -20 up to +80°C cable -10 up to 100°C probe ø7x24.5mm cable length 1.5m without screw connection 2-wire  |                 |         |
| <b>For models:</b> | 6MA, 6MA2, 6MA2A, 6MA2M, 6MAA, 6MAM, 6MB, 6MB11, 6MB11A, 6MB11M, 6MB2, 6MB2A, 6MB2M, 6MB4, 6MB4A, 6MB4M, 6MBA, 6MBM, 6MC, 6MC11, 6MC11A, 6MC11M, 6MC2, 6MC2A, 6MC2M, 6MC4, 6MC4A, 6MC4M, 6MCA, 6MCM, 6MJA, 6MJA2, 6MJA2A, 6MJA2M, 6MJAA, 6MJAM, 6MJB, 6MJB2, 6MJB2A, 6MJB2M, 6MJB4, 6MJB4A, 6MJB4M, 6MJB4, 6MJBM, BP41P, BP41X, BP53G, BP53V, BP53X...(Other models you can see in the webshop) |                 |         |





Зип Общепит



vsezip.ru

(812)9877093

|   |   |                 |         |
|---|---|-----------------|---------|
|  |   |                 |         |
| <b>GEV No.</b>  | 379343  | <b>Ref. No.</b> | 32V3730 |
| <b>description</b>  | temperature probe NTC 10kOhm cable silicone probe -40 up to +110°C cable -50 up to +180°C probe ø6x40mm cable length 3m 2-wire  |                 |         |
| <b>For models:</b>  | 6EA, 6EA11, 6EA11A, 6EA11M, 6EA13, 6EA13A, 6EA13M, 6EA2, 6EA2A, 6EA2M, 6EAA, 6EAB, 6EABA, 6EABM, 6EAM, 6EB, 6EB11, 6EB11A, 6EB11M, 6EB13, 6EB13A, 6EB13M, 6EB2, 6EB22, 6EB22A, 6EB22M, 6EB2A, 6EB2M, 6EB4, 6EB4A, 6EB4M, 6EBA, 6EBB, 6EBBA, 6EBBM, 6EBM, 6EC, 6EC11, 6EC11A, 6EC11M, 6EC13, 6EC13A, 6EC13M, 6EC2, 6EC22, 6EC22A, 6EC22M, 6EC2A, 6EC2M, 6EC4...(Other models you can see in the webshop) |                 |         |

|   |   |                 |         |
|---|---|-----------------|---------|
|  |   |                 |         |
| <b>GEV No.</b>  | 379161  | <b>Ref. No.</b> | 32V6010 |
| <b>description</b>  | temperature probe NTC 10kOhm cable thermoplastic probe -40 up to +110°C cable -40 up to +110°C probe ø6x14mm cable length 3m without screw connection 2-wire  |                 |         |
| <b>For models:</b>  | 3G6SA, 3G6SA2, 3G6SA4, 40-OPR01, 40B-OPR01, 40BX-OPR01, 40CP, 40CP-OPR01, 40CPX, 40CPX-OPR01, 40EV-OPR01, 40PV-OPR01, 40X-OPR01, 4G6SB, 4G6SB2, 4G6SB4, 4G6SB6, 6BR15V, 6BR15VC, 6BR19V, 6BR19VC, 6EA, 6EA11, 6EA11A, 6EA11M, 6EA13, 6EA13A, 6EA13M, 6EA2, 6EA2A, 6EA2M, 6EAA, 6EAB, 6EABA, 6EABM, 6EAM, 6EB, 6EB11, 6EB11A, 6EB11M, 6EB13, 6EB13A, 6EB13M, 6EB2, 6EB22, 6EB22A, 6EB22M, 6EB2A, 6EB2M, 6EB4...(Other models you can see in the webshop) |                 |         |



|   |  |                 |         |
|---|--|-----------------|---------|
|  |  |                 |         |
| <b>GEV No.</b>  | 379064   | <b>Ref. No.</b> | 8223470 |
| <b>description</b>  | temperature probe PTC 1kOhm cable silicone probe -50 up to +150°C cable -50 up to +180°C probe ø6x40mm cable length 3m without screw connection 2-wire |                 |         |

|  |  |                 |         |
|--|--|-----------------|---------|
| <br> |  |                 |         |
| <b>GEV No.</b>   | 379487   | <b>Ref. No.</b> | 32V0150 |
| <b>description</b>   | temperature probe PTC cable silicone probe -50 up to +150°C cable -50 up to +180°C probe ø6x30mm cable length 2.5m without screw connection 2-wire   |                 |         |
| <b>For models:</b>   | 6BEA11A, 6BEA11B, 6BEA11M, 6BEA2A, 6BEA2B, 6BEA2M, 6BEA3A, 6BEA3B, 6BEA3M, 6BEAA, 6BEAB, 6BEABA, 6BEABB, 6BEABM, 6BEAM, 6BEB11A, 6BEB11B, 6BEB11M, 6BEB22A, 6BEB22B, 6BEB22M, 6BEB2A, 6BEB2B, 6BEB2M, 6BEB3A, 6BEB3B, 6BEB3M, 6BEB4A, 6BEB4B, 6BEB4M, 6BEBA, 6BEBB, 6BEBBA, 6BEBBB, 6BEBBM, 6BEBM, 6BEC11A, 6BEC11B, 6BEC11M, 6BEC22A, 6BEC22B, 6BEC22M, 6BEC2A, 6BEC2B, 6BEC2M, 6BEC33A, 6BEC33B, 6BEC33M, 6BEC3A, 6BEC3B...(Other models you can see in the webshop) |                 |         |

|  |   |                 |         |
|--|---|-----------------|---------|
|  |   |                 |         |
| <b>GEV No.</b>   | 379932  | <b>Ref. No.</b> | 32Z6041 |
| <b>description</b>   | temperature probe Pt100 cable silicone probe -100 up to 450°C cable -50 up to +180°C connection 3-wire thread M10x1 probe ø3x130mm cable length 1.5m  |                 |         |
| <b>For models:</b>   | FCV101DM, FCV101DM-CSA, FCV101DS, FCV101DS-CSA, FCV101EDM, FCV101EDM-UL, FCV101EDS, FCV101EDS-UL, FCV141DM, FCV141DM-CSA, FCV141DS, FCV141DS-CSA, FCV141EDM, FCV141EDS, FCV241DM, FCV241DS, FCV241EDM, FCV241EDM-UL, FCV241EDS, FCV241EDS-UL, FCV241GDM, FCV241GDM-CSA, FCV241GDS, FCV241GDS-CSA, FCV401DM, FCV401DM-CSA, FCV401EDM, FCV401EDM-UL, FCV61DM, FCV61DM-CSA, FCV61DS, FCV61DS-CSA, FCV61EDM, FCV61EDM-UL, FCV61EDS, FCV61EDS-UL, FCV72EDM-UL, FCV72EDS-UL |                 |         |

|  |  |                 |         |
|--|--|-----------------|---------|
|  |  |                 |         |
| <b>GEV No.</b>   | 379934   | <b>Ref. No.</b> | 32Z6191 |
| <b>description</b>   | temperature probe Pt100 cable silicone probe -100 up to 450°C cable -50 up to +180°C connection 3-wire thread M10x1 probe ø3x65mm cable length 0.65m   |                 |         |
| <b>For models:</b>   | FCV101, FCV101-CSA, FCV101DM, FCV101DM-CSA, FCV101DS, FCV101DS-CSA, FCV101E, FCV101EDM, FCV101EDM-UL, FCV101EDS, FCV101EDS-UL, FCV101E-UL, FCV141, FCV141-CSA, FCV141DM, FCV141DM-CSA, FCV141DS, FCV141DS-CSA, FCV141E, FCV141EDM, FCV141EDS, FCV241, FCV241DM, FCV241DS, FCV241E, FCV241EDM, FCV241EDM-UL, FCV241EDS, FCV241EDS-UL, FCV241E-UL, FCV241G, FCV241G-CSA, FCV241GDM, FCV241GDM-CSA, FCV241GDS, FCV241GDS-CSA, FCV3EM, FCV401DM, FCV401DM-CSA, FCV401EDM, FCV401EDM-UL, FCV4E, FCV4EDS, FCV4EM, FCV61, FCV61-CSA, FCV61DM, FCV61DM-CSA, FCV61DS, FCV61DS-CSA...(Other models you can see in the webshop) |                 |         |

|  |  |                 |         |
|--|--|-----------------|---------|
|  |  |                 |         |
| <b>GEV No.</b>   | 379892   | <b>Ref. No.</b> | 32Z7410 |
| <b>description</b>   | temperature probe Pt100 cable Vetrotex probe -200 up to +600°C cable -50 up to +350°C connection 2-wire thread probe ø6x80mm cable length 1.5m |                 |         |

|  |  |                 |         |
|--|--|-----------------|---------|
| <br> |  |                 |         |
| <b>GEV No.</b>   | 379931   | <b>Ref. No.</b> | 32Z6780 |
| <b>description</b>   | temperature probe Pt100 cable Vetrotex probe -200 up to +600°C cable -50 up to +350°C connection 3-wire thread M10x1 probe ø4x85mm cable length 0.8m |                 |         |
| <b>For models:</b>   | FCV4E, FCV4EDS   |                 |         |

producer-specific probes

|   |  |                 |         |
|---|--|-----------------|---------|
|  |  |                 |         |
| <b>GEV No.</b>  | 379652   | <b>Ref. No.</b> | 32Z3310 |
| <b>description</b>  | temperature probe Pt100 cable glass fibre probe -200 up to +600°C cable -50 up to +350°C connection 2-wire thread 1/4" probe ø6x40mm cable length 1.4m |                 |         |



# Зип-Общепит

core probes

vsezip.ru

+7(812)987-08-81



|                    |   |                 |         |
|--------------------|---|-----------------|---------|
| <b>GEV No.</b>     | 379331  | <b>Ref. No.</b> | 32V5750 |
| <b>description</b> | temperature probe Pt1000 cable PTFE probe -70 up to +500°C cable -40 up to +250°C connection 2-wire thread M10x1 probe ø3x60mm cable length 0.7m  |                 |         |
| <b>For models:</b> | 091FR1EX, 091FR1IA, 091FR1ID, 091FR1ID-VERS.052012, 10CP1EA, 10CP1GA, 10CP1IA, 12CP1EA, 12CP1GA, 12CP1IA, 18CP2EA, 18CP2GA, 18CP2IA, 191FR2ED, 191FR2ID, 191FR2ID-VERS.092012, BX101E, BX101E-VERS.122013, BX101G, BX101G-VERS.122013, BX122E, BX122E-VERS.122013, BX122G, BX122G-VERS.122013, BX61E, BX61E-VERS.122013, BX61G, BX61G-VERS.122013, BX82E, BX82E-VERS.122013, BX82G, BX82G-VERS.122013, FM1011E1, FM1011E1-VERS.2006, FM1011E2, FM1011E2-VERS.2006, FM1011E3, FM1011E3-VERS.2006, FM1011G1, FM1011G1-VERS.2006, FM1011G2, FM1011G2-VERS.2006, FM1011G3, FM1011G3-VERS.2006, FM1221E1, FM1221E1-VERS.2006, FM1221E2, FM1221E2-VERS.2006, FM1221E3, FM1221E3-VERS.2006...(Other models you can see in the webshop) |                 |         |



|                    |   |                 |         |
|--------------------|---|-----------------|---------|
| <b>GEV No.</b>     | 378647  | <b>Ref. No.</b> | 32V5760 |
| <b>description</b> | temperature probe Pt1000 cable Vetrotex probe -70 up to +500°C cable -50 up to +350°C connection 2-wire thread M10x1 probe ø3x100mm cable length 1m   |                 |         |
| <b>For models:</b> | 091FR1EA, 091FR1ED, 091FR7GS, 091FR7GX, 191FR2ED, FM1011E1, FM1011E1-VERS.2006, FM1011E2, FM1011E2-VERS.2006, FM1011E3, FM1011E3-VERS.2006, FM1011G1, FM1011G1-VERS.2006, FM1011G2, FM1011G2-VERS.2006, FM1011G3, FM1011G3-VERS.2006, FM1221E1, FM1221E1-VERS.2006, FM1221E2, FM1221E2-VERS.2006, FM1221E3, FM1221E3-VERS.2006, FM1221G1, FM1221G1-VERS.2006, FM1221G2, FM1221G2-VERS.2006, FM1221G3, FM1221G3-VERS.2006, FM2011E2-VERS.2006, FM2011E3-VERS.2006, FM2011G2-VERS.2006, FM2011G3-VERS.2006, FM2021E1, FM2021E2, FM2021E2-VERS.2006, FM2021E3, FM2021E3-VERS.2006, FM2021G1, FM2021G2, FM2021G2-VERS.2006, FM2021G3, FM2021G3-VERS.2006, FM611E1, FM611E1-VERS.2006, FM611E2, FM611E2-VERS.2006, FM611E3, FM611E3-VERS.2006, FM611G1...(Other models you can see in the webshop) |                 |         |



|                    |  |                 |         |
|--------------------|--|-----------------|---------|
| <b>GEV No.</b>     | 379789   | <b>Ref. No.</b> | 3104950 |
| <b>description</b> | temperature probe thermocouple J (Fe-CuNi) cable glass fibre probe -50 up to +750°C cable -50 up to +350°C connection male faston 2.8mm thread probe ø4x40mm cable length 1m |                 |         |
| <b>For models:</b> | 04WPBEV, 08WPBEV, 08WTPEV, 090PEB, 091PEB, 190PEB, 190TPE, 191PEB, 191TPE  |                 |         |

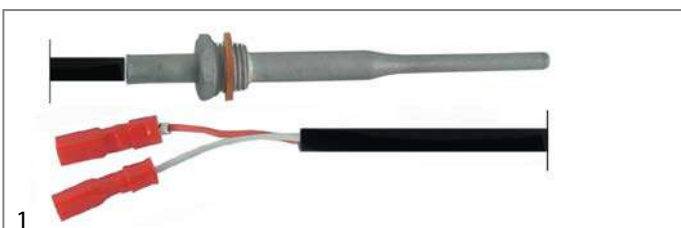

|                    |  |                 |         |
|--------------------|--|-----------------|---------|
| <b>GEV No.</b>     | 379910   | <b>Ref. No.</b> | 32V0030 |
| <b>description</b> | temperature probe thermocouple J (Fe-CuNi) cable silicone probe -50 up to 1150°C cable -50 up to +180°C connection male faston 2.8mm thread M10x1 probe ø4/6x72mm cable length 0.6m  |                 |         |
| <b>For models:</b> | 04WFR3ED, 06WFR3GD, 091FR1ED, 091FR1GD, 091FR3ED, 091FR3GD, 0A1FR1ED, 0A1FR1GD, 0A1FR1GD-VERS.2004, 0A1FR3ED, 0A1FR3GD, 0B1FR1GD, 0D1FR1ED, 0D1FR1GD, 0D1FR1GD-VERS.2004, 0D1FR3ED, 0D1FR3GD, 0G0FR3ED, 0G1FR3GD, 10WFR4GD, 191FR2ED, 191FR2G, 191FR2GD, 191FR4ED, 191FR4GD, 1A1FR2ED, 1A1FR2GD, 1A1FR2GD-VERS.2004, 1A1FR4ED, 1A1FR4GD, 1D1FR2ED, 1D1FR2GD, 1D1FR2GD-VERS.2004, 1D1FR4ED, 1D1FR4GD, 1G1FR4GD, 6FR |                 |         |



|                    |  |                 |         |
|--------------------|--|-----------------|---------|
| <b>GEV No.</b>     | 378550   | <b>Ref. No.</b> | 32V8360 |
| <b>description</b> | core temperature probe NTC 10kOhm cable silicone probe -40 up to +120°C cable -50 up to +180°C connection 2-wire probe ø4.5x100mm thread cable length 3.8m handle ø 16mm handle length 120mm |                 |         |
| <b>For models:</b> | DS31, DS31A, DS31C, DS31M, DS315H, DS51, DS51A, DS51C, DS51M   |                 |         |



|                    |   |                 |                    |
|--------------------|---|-----------------|--------------------|
| <b>GEV No.</b>     | 379933  | <b>Ref. No.</b> | 32Z1982<br>32Z1983 |
| <b>description</b> | core temperature probe Pt100 cable PTFE probe -40 up to +250°C cable -40 up to +250°C connection 3-wire probe ø2.5x100mm thread cable length 2.75m handle ø 15mm handle length 90mm   |                 |                    |
| <b>For models:</b> | FCV101DM, FCV101DM-CSA, FCV101DS, FCV101DS-CSA, FCV101EDM, FCV101EDM-UL, FCV101EDS, FCV101EDS-UL, FCV141DM, FCV141DM-CSA, FCV141DS, FCV141DS-CSA, FCV141EDM, FCV141EDS, FCV241DM, FCV241DS, FCV241EDM, FCV241EDM-UL, FCV241EDS, FCV241EDS-UL, FCV241GDM, FCV241GDS, FCV241GDS-CSA, FCV401DM, FCV401DM-CSA, FCV401EDM, FCV401EDM-UL, FCV4EDS, FCV61DM, FCV61DM-CSA, FCV61DS, FCV61DS-CSA, FCV61EDM, FCV61EDM-UL, FCV61EDS, FCV61EDS-UL, FCV72EDM-UL, FCV72EDS-UL |                 |                    |



|                    |  |                 |         |
|--------------------|--|-----------------|---------|
| <b>GEV No.</b>     | 379891   | <b>Ref. No.</b> | 32Z6830 |
| <b>description</b> | core temperature probe Pt100 cable silicone probe -40 up to +120°C cable -50 up to +180°C connection 3-wire probe ø3.5-5.5x100mm thread cable length 1.85m handle ø 12mm handle length 100mm |                 |         |

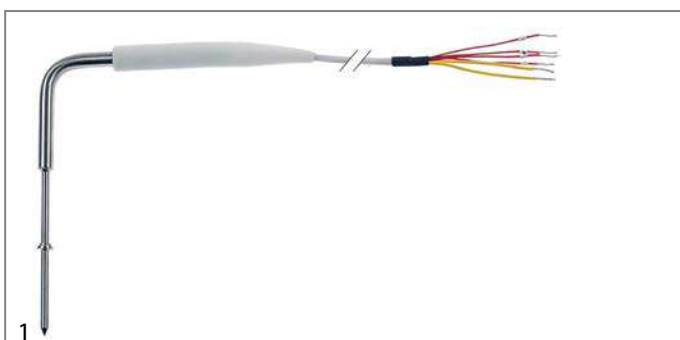

|                    |  |                 |         |
|--------------------|--|-----------------|---------|
| <b>GEV No.</b>     | 378402 <sup>1</sup>  | <b>Ref. No.</b> | 32V7960 |
| <b>description</b> | core temperature probe Pt100 cable silicone probe -40 up to +120°C cable -50 up to +180°C connection 5-wire probe ø5x175mm thread cable length 3.5m handle ø 16mm handle length 125mm  |                 |         |
| <b>For models:</b> | FS611, IA101L, IA101S, IA51, IA51A, IA51C, IA51M, IA72S, IS101L, IS101LR, IS101LW, IS101S, IS101SR, IS101SW, IS102S, IS102SR, IS102SR-ONR01, IS102SW, IS51, IS51A, IS51AR, IS51C, IS51CR, IS51H, IS51HW, IS51M, IS51MR, IS51R, IS51W, IS51WA, IS51WC, IS51WM, IS72S, IS72SR, IS72SW, ISFEB, ISFEB-OPR01, ISFEN, ISFEN-OPR01, ISP202R, ISR201R, ISR202R |                 |         |

<sup>1</sup>multipoint probe



Зип Общепит

vsezip.ru

+7(812)987-08-81

electric components



|                    |  |                 |         |
|--------------------|--|-----------------|---------|
| <b>GEV No.</b>     | 379890   | <b>Ref. No.</b> | 32Z6010 |
| <b>description</b> | core temperature probe Pt100 cable SS corrugated hose probe -40 up to +250°C cable -40 up to +250°C connection 2-wire probe ø4x100mm thread M16x1.5 cable length 1.6m handle ø 8.5mm handle length 100mm |                 |         |



|                    |  |                 |         |
|--------------------|--|-----------------|---------|
| <b>GEV No.</b>     | 403452   | <b>Ref. No.</b> | 6300643 |
| <b>description</b> | core temperature probe Pt1000 cable PTFE probe -40 up to +250°C cable -40 up to +250°C connection 2-wire probe ø3x100mm thread cable length 3.2m handle ø 13mm handle length 60mm                  |                 |         |
| <b>For models:</b> | FM1011E2-VERS.2006, FM1011G2-VERS.2006, FM1221E2-VERS.2006, FM1221G2-VERS.2006, FM2011E2-VERS.2006, FM2011G2-VERS.2006, FM611E2-VERS.2006, FM611G2-VERS.2006, FM721E2-VERS.2006, FM721G2-VERS.2006 |                 |         |



|                    |  |                 |         |
|--------------------|--|-----------------|---------|
| <b>GEV No.</b>     | 401966   | <b>Ref. No.</b> | 6300644 |
| <b>description</b> | core temperature probe Pt1000 cable PTFE probe -40 up to +250°C cable -40 up to +250°C connection 3-wire probe ø3x100mm thread cable length 1.5m handle ø 13mm handle length 75mm  |                 |         |
| <b>For models:</b> | FM1011E3-VERS.2006, FM1011G3-VERS.2006, FM1221E3-VERS.2006, FM1221G3-VERS.2006, FM2011E3-VERS.2006, FM2011G3-VERS.2006, FM2021E3-VERS.2006, FM2021G3-VERS.2006, FM611E3-VERS.2006, FM611G3-VERS.2006, FM721E3-VERS.2006, FM721G3-VERS.2006 |                 |         |



|                    |   |                 |                               |
|--------------------|---|-----------------|-------------------------------|
| <b>GEV No.</b>     | 378264  | <b>Ref. No.</b> | 3159510<br>3159511<br>3200361 |
| <b>description</b> | core temperature probe Pt1000 cable PTFE probe -40 up to +250°C cable -40 up to +250°C connection 5-wire probe ø3x100mm thread cable length 2.7m handle ø 13mm handle length 75mm |                 |                               |
| <b>For models:</b> | FM1011E3, FM1011G3, FM1221E3, FM1221G3, FM2021E3, FM2021G3, FM611E3, FM611G3, FM721E3, FM721G3  |                 |                               |



|                    |  |                 |                    |
|--------------------|--|-----------------|--------------------|
| <b>GEV No.</b>     | 379588   | <b>Ref. No.</b> | 3139610<br>32V5940 |
| <b>description</b> | core temperature probe Pt1000 cable thermoplastic probe -40 up to +250°C cable -40 up to +110°C connection 2-wire probe ø3x110mm thread cable length 3.1m handle ø 13mm handle length 70mm   |                 |                    |
| <b>For models:</b> | FM1011E2, FM1011G2, FM1221E2, FM1221G2, FM2021E2, FM2021G2, FM423E2, FM611E2, FM611G2, FM721E2, FM721G2, FX101E2, FX101E2C, FX101E2C-VERS.032014, FX101E2R, FX101E2R-VERS.032014, FX101E2-VERS.032014, FX101G2, FX101G2C, FX101G2C-VERS.032014, FX101G2R, FX101G2R-VERS.032014, FX101G2-VERS.032014, FX10E2CR, FX10E2CR-VERS.032014, FX10G2CR, FX10G2CR-VERS.032014, FX122E2, FX122E2C, FX122E2T, FX122E2T-VERS.032014, FX122G2, FX122G2C, FX122G2T, FX122G2T-VERS.032014, FX201E2, FX201E2P, FX201E2P-VERS.032014, FX201E2-VERS.032014, FX201G2, FX201G2P, FX201G2P-VERS.032014, FX201G2-VERS.032014, FX202E2, FX202E2-VERS.032014, FX202G2, FX202G2-VERS.032014, FX61E2, FX61E2C, FX61E2CR...(Other models you can see in the webshop) |                 |                    |



|                    |   |                 |       |
|--------------------|---|-----------------|-------|
| <b>GEV No.</b>     | 381511  | <b>Ref. No.</b> | 72378 |
| <b>description</b> | core temperature probe Pt1000 connection 6-wire probe ø3.2x100mm cable length 3.1m handle ø 13mm handle length 70mm combi-steamer |                 |       |



|                    |  |                 |                               |
|--------------------|--|-----------------|-------------------------------|
| <b>GEV No.</b>     | 378186   | <b>Ref. No.</b> | 32V0010<br>32V0441<br>32V8600 |
| <b>description</b> | core temperature probe PTC 1kOhm cable silicone probe -40 up to +120°C cable -50 up to +180°C connection 2-wire probe ø4x90mm thread cable length 3.8m handle ø 15mm handle length 120mm L1 175mm L2 190mm   |                 |                               |
| <b>For models:</b> | ART1LD, ART1LD7, ART1LD7A, ART1LD7M, ART1LDA, ART2LD, ART2SD, ART3SD, SM14SR, SM1L, SM1L7, SM1L7A, SM1L7FCV, SM1L7M, SM1LA, SM1LAR, SM1LAT, SM1LAW, SM1LR, SM1LT, SM1LT7, SM1LT7A, SM1LT7M, SM1LW, SM2L, SM2LR, SM2LW, SM2S, SM2SR, SM2SW, SM3S, SM3SR, SM4SR, SM7SR |                 |                               |

accessories

screw connections



|                    |   |                 |         |
|--------------------|---|-----------------|---------|
| <b>GEV No.</b>     | 401967  | <b>Ref. No.</b> | 3004870 |
| <b>description</b> | screw connection for core temperature probe   |                 |         |
| <b>For models:</b> | FM1011E2, FM1011E2-VERS.2006, FM1011E3, FM1011E3-VERS.2006, FM1011G2, FM1011G2-VERS.2006, FM1011G3, FM1011G3-VERS.2006, FM1221E2, FM1221E2-VERS.2006, FM1221E3, FM1221E3-VERS.2006, FM1221G2, FM1221G2-VERS.2006, FM1221G3, FM1221G3-VERS.2006, FM2011E2-VERS.2006, FM2011E3-VERS.2006, FM2011G2-VERS.2006, FM2011G3-VERS.2006, FM2021E2, FM2021E2-VERS.2006, FM2021E3, FM2021E3-VERS.2006, FM2021G2, FM2021G2-VERS.2006, FM2021G3, FM2021G3-VERS.2006, FM611E2, FM611E2-VERS.2006, FM611E3, FM611E3-VERS.2006, FM611G2, FM611G2-VERS.2006, FM611G3, FM611G3-VERS.2006, FM721E2, FM721E2-VERS.2006, FM721E3, FM721E3-VERS.2006, FM721G2, FM721G2-VERS.2006, FM721G3, FM721G3-VERS.2006, FX101E2, FX101E2C, FX101E3, FX101E3C, FX101E3R, FX101G2...(Other models you can see in the webshop) |                 |         |

miscellaneous



|                    |  |                 |         |
|--------------------|--|-----------------|---------|
| <b>GEV No.</b>     | 519385   | <b>Ref. No.</b> | 3150220 |
| <b>description</b> | gasket for core temperature probe ED ø 8mm ID ø 4mm thickness 5mm  |                 |         |
| <b>For models:</b> | FCV101DM, FCV101DM-CSA, FCV101DS, FCV101DS-CSA, FCV101EDM, FCV101EDM-UL, FCV101EDS, FCV101EDS-UL, FCV141DM, FCV141DM-CSA, FCV141DS, FCV141DS-CSA, FCV141EDM, FCV141EDS, FCV241DM, FCV241DS, FCV241EDM, FCV241EDM-UL, FCV241EDS, FCV241EDS-UL, FCV241GDM, FCV241GDM-CSA, FCV241GDS, FCV241GDS-CSA, FCV401DM, FCV401DM-CSA, FCV401EDM, FCV401EDM-UL, FCV4EDS, FCV61DM, FCV61DM-CSA, FCV61DS, FCV61DS-CSA, FCV61EDM, FCV61EDM-UL, FCV61EDS, FCV61EDS-UL, FCV72EDM-UL, FCV72EDS-UL, FM1011E2, FM1011E3, FM1011G2, FM1011G3, FM1221E2, FM1221E3, FM1221G2, FM1221G3, FM2021E2, FM2021E3, FM2021G2...(Other models you can see in the webshop) |                 |         |

Зип Общепит

vsezip.ru

+7(812)98708-81



|                    |  |                 |         |
|--------------------|--|-----------------|---------|
| <b>GEV No.</b>     | 691159   | <b>Ref. No.</b> | 35Q6360 |
| <b>description</b> | protective plate for probe   |                 |         |
| <b>For models:</b> | FC101, FC101E, FC241, FC241E, FC241G, FC61, FC61E, FCV101, FCV101-CSA, FCV101DM, FCV101DM-CSA, FCV101DS, FCV101DS-CSA, FCV101E, FCV101EDM, FCV101EDM-UL, FCV101EDS, FCV101EDS-UL, FCV101E-UL, FCV141, FCV141-CSA, FCV141DM, FCV141DM-CSA, FCV141DS, FCV141DS-CSA, FCV141E, FCV141EDM, FCV141EDS, FCV241, FCV241DM, FCV241DS, FCV241E, FCV241EDM, FCV241EDM-UL, FCV241EDS, FCV241EDS-UL, FCV241E-UL, FCV241G, FCV241G-CSA, FCV241GDM, FCV241GDM-CSA, FCV241GDS, FCV241GDS-CSA, FCV401DM, FCV401DM-CSA, FCV401EDM, FCV401EDM-UL, FCV4E, FCV4EDS, FCV61...(Other models you can see in the webshop) |                 |         |



|                    |  |                 |                    |
|--------------------|--|-----------------|--------------------|
| <b>GEV No.</b>     | 403687   | <b>Ref. No.</b> | 3034260<br>32V4350 |
| <b>description</b> | electronic timer for ice maker Simag mounting measurements 90x70mm 230   |                 |                    |
| <b>For models:</b> | PG22C, PG23C, PG23CW, PG24CW, PG30C, PG31CW, PG42C, PG43CW, PG60C, PG61CW, PG80C, PG81CW, PGC132, PGC134W, PGC210, PGC212W |                 |                    |

## electronics

### PCBs

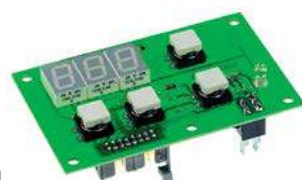

|                    |  |                 |         |
|--------------------|--|-----------------|---------|
| <b>GEV No.</b>     | 400677   | <b>Ref. No.</b> | 32V0780 |
| <b>description</b> | control PCB fryer 091FR1 ED  |                 |         |
| <b>For models:</b> | 04WFR3ED, 06WFR3GD, 08WFR4ED, 091FR1ED, 091FR1GD, 091FR3ED, 091FR3GD, 0A1FR1ED, 0A1FR1GD, 0A1FR1GD-VERS.2004, 0A1FR3ED, 0A1FR3GD, 0B1FR1GD, 0D1FR1ED, 0D1FR1GD, 0D1FR1GD-VERS.2004, 0D1FR3ED, 0D1FR3GD, 0G0FR3ED, 0G1FR3GD, 10WFR4GD, 191FR2ED, 191FR2GD, 191FR4ED, 191FR4GD, 1A1FR2ED, 1A1FR2GD, 1A1FR2GD-VERS.2004, 1A1FR4ED, 1A1FR4GD, 1D1FR2ED, 1D1FR2GD, 1D1FR2GD-VERS.2004, 1D1FR4ED, 1D1FR4GD, 1G1FR4GD |                 |         |

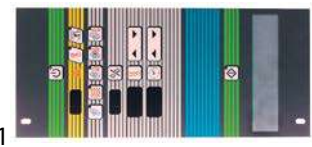

|                    |            |                 |                    |
|--------------------|------------|-----------------|--------------------|
| <b>GEV No.</b>     | 401183     | <b>Ref. No.</b> | 32Z6621<br>32V6622 |
| <b>description</b> | keypad PCB |                 |                    |
| <b>For models:</b> | FCV4E      |                 |                    |



|                    |            |                 |                    |
|--------------------|------------|-----------------|--------------------|
| <b>GEV No.</b>     | 401184     | <b>Ref. No.</b> | 32Z1081<br>32Z1082 |
| <b>description</b> | keypad PCB |                 |                    |
| <b>For models:</b> | FCV4EDS    |                 |                    |

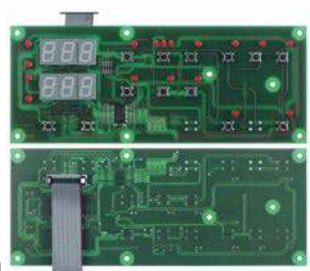

|                    |   |                 |         |
|--------------------|---|-----------------|---------|
| <b>GEV No.</b>     | 403729  | <b>Ref. No.</b> | 32V3060 |
| <b>description</b> | control PCB L 203mm W 80mm  |                 |         |
| <b>For models:</b> | SM2L, SM2LR, SM2LW, SM2S, SM2SR, SM2SW, SM3S, SM3SR, SM4SR, SM7SR |                 |         |



|                    |   |                 |         |
|--------------------|---|-----------------|---------|
| <b>GEV No.</b>     | 401748  | <b>Ref. No.</b> | 3049200 |
| <b>description</b> | keypad PCB  |                 |         |
| <b>For models:</b> | IS101LR, IS101SR, IS102SR, IS102SR-ONR01, IS51AR, IS51CR, IS51MR, IS51R, IS72SR |                 |         |





Зип Общепит

vsezip.ru

+7(812)987-08-81



1

|                    |  |                 |         |
|--------------------|--|-----------------|---------|
| <b>GEV No.</b>     | 401750   | <b>Ref. No.</b> | 32Z8940 |
| <b>description</b> | keypad PCB   |                 |         |
| <b>For models:</b> | SM2L, SM2LR, SM2LW, SM2S, SM2SR, SM2SW, SM3S, SM3SR, SM4SR |                 |         |



1

|                    |   |                 |         |
|--------------------|---|-----------------|---------|
| <b>GEV No.</b>     | 401749  | <b>Ref. No.</b> | 32Z9640 |
| <b>description</b> | PCB   |                 |         |
| <b>For models:</b> | SM1L, SM1LA, SM1LAR, SM1LAW, SM1LR, SM1LW, SM2L, SM2LR, SM2LW, SM2S, SM2SR, SM2SW, SM3S, SM3SR, SM4SR |                 |         |



1

|                    |   |                 |         |
|--------------------|---|-----------------|---------|
| <b>GEV No.</b>     | 401751                                    | <b>Ref. No.</b> | 32Z8240 |
| <b>description</b> | keypad PCB                                |                 |         |
| <b>For models:</b> | SM1L, SM1LA, SM1LAR, SM1LAW, SM1LR, SM1LW |                 |         |



1

|                    |  |                 |                    |
|--------------------|--|-----------------|--------------------|
| <b>GEV No.</b>     | 402866   | <b>Ref. No.</b> | 32V5360<br>32V5361 |
| <b>description</b> | PCB combi-steamer FM1011 suitable for ANGELO PO  |                 |                    |
| <b>For models:</b> | FM1011E1, FM1011E1-VERS.2006, FM1011E2, FM1011E2-VERS.2006, FM1011E3, FM1011G1, FM1011G1-VERS.2006, FM1011G2, FM1011G2-VERS.2006, FM1011G3, FM1221E1, FM1221E1-VERS.2006, FM1221E2, FM1221E2-VERS.2006, FM1221E3, FM1221G1, FM1221G1-VERS.2006, FM1221G2, FM1221G2-VERS.2006, FM1221G3, FM2011E2-VERS.2006, FM2011G2-VERS.2006, FM2021E1, FM2021E2, FM2021E2-VERS.2006, FM2021G1, FM2021G2, FM2021G2-VERS.2006, FM611E1, FM611E1-VERS.2006, FM611E2, FM611E2-VERS.2006, FM611E3, FM611G1, FM611G1-VERS.2006, FM611G2, FM611G2-VERS.2006, FM611G3, FM721E1, FM721E1-VERS.2006, FM721E2, FM721E2-VERS.2006, FM721G1, FM721G1-VERS.2006, FM721G2, FM721G2-VERS.2006 |                 |                    |





1

|                    |  |                 |                    |
|--------------------|--|-----------------|--------------------|
| <b>GEV No.</b>     | 402867   | <b>Ref. No.</b> | 3018770<br>3018771 |
| <b>description</b> | keypad PCB combi-steamer FM1011 L 275mm W 100mm suitable for ANGELO PO buttons 12  |                 |                    |
| <b>For models:</b> | FM1011E1, FM1011E2, FM1011E3, FM1011G1, FM1011G2, FM1011G3, FM1221E1, FM1221E2, FM1221E3, FM1221G1, FM1221G2, FM1221G3, FM2021E1, FM2021E2, FM2021E3, FM2021G1, FM2021G2, FM2021G3, FM611E1, FM611E2, FM611E3, FM611G1, FM611G2, FM611G3, FM721E1, FM721E2, FM721E3, FM721G1, FM721G2, FM721G3 |                 |                    |



1

|   |   |                 |                         |
|---|---|-----------------|-------------------------|
| <b>GEV No.</b>  | 402675  | <b>Ref. No.</b> | 3104130                 |
| <b>description</b>  | PCB dishwasher KD60 L 185mm W 30mm buttons 4  |                 |                         |
| <b>For models:</b>  | KD40EPSD, KD40LEPS, KD40LUXE, KD60E, KD60EAT, KD60ME, KD85E, KD85EA, KD85EAT, KD85EPS, KD85EPSA, LP70 |                 |                         |
| <b>accessories for</b>  | 402675  |                 |                         |
|  | <b>GEV No.</b>  | 400066          | <b>Ref. No.</b> 3099170 |
|   | ribbon cable 10-pole L 1000mm plug type FC-10P raster size 2.54mm                                     |                 |                         |



1

|                    |   |                 |                    |
|--------------------|---|-----------------|--------------------|
| <b>GEV No.</b>     | 401218  | <b>Ref. No.</b> | 32Z6210<br>32Z6211 |
| <b>description</b> | PCB   |                 |                    |
| <b>For models:</b> | FCV101, FCV101E, FCV141, FCV141E, FCV241, FCV241E, FCV241G, FCV3EM, FCV4EM, FCV61, FCV61E |                 |                    |



Зип Общепит

vsezip.ru

+7(812)987-08-81



1

|                    |   |                 |                    |
|--------------------|---|-----------------|--------------------|
| <b>GEV No.</b>     | 401029  | <b>Ref. No.</b> | 3026600<br>3114850 |
| <b>description</b> | PCB dishwasher LF 50 L 122mm W 80mm Qty 1 pcs |                 |                    |
| <b>For models:</b> | LF50EM, LF50EMPS, LF50E-VERS.2007             |                 |                    |

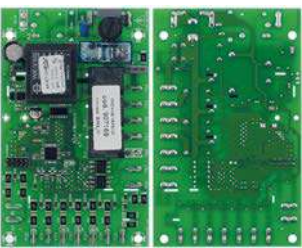

1

|                    |  |                 |         |
|--------------------|--|-----------------|---------|
| <b>GEV No.</b>     | 403255   | <b>Ref. No.</b> | 3207870 |
| <b>description</b> | PCB dishwasher N700/NE1300/S026/S030 L 135mm W 82mm  |                 |         |
| <b>For models:</b> | LF50EM, LF50EMPS, LF50EMPS-VERS.122012, LF50EM-VERS.122012, LF50E-VERS.122012, LF50E-VERS.2007 |                 |         |

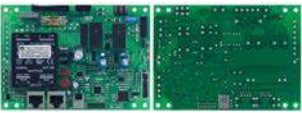

1

|                    |  |                 |         |
|--------------------|--|-----------------|---------|
| <b>GEV No.</b>     | 404028   | <b>Ref. No.</b> | 6300751 |
| <b>description</b> | PCB for combi-steamer ANGELO PO L 140mm W 100mm  |                 |         |
| <b>For models:</b> | BX101G, BX101G-VERS.122013, BX122G, BX122G-VERS.122013, BX61G, BX61G-VERS.122013, BX82G, BX82G-VERS.122013, FX101G1, FX101G1R, FX101G2, FX101G2C, FX101G2C-VERS.032014, FX101G2R, FX101G2R-VERS.032014, FX101G2-VERS.032014, FX101G3, FX101G3C, FX101G3C-VERS.022014, FX101G3R, FX101G3R-VERS.022014, FX101G3-VERS.022014, FX10G2CR, FX10G2CR-VERS.032014, FX10G3CR, FX10G3CR-VERS.022014, FX122G1, FX122G2, FX122G2C, FX122G2T, FX122G2T-VERS.032014, FX122G3, FX122G3C, FX122G3T, FX122G3T-VERS.022014, FX12G3CT, FX12G3CT-VERS.022014, FX201G2, FX201G2P, FX201G2P-VERS.032014, FX201G2-VERS.032014, FX201G3P, FX201G3-VERS.022014, FX202G2, FX202G2-VERS.032014, FX202G3, FX202G3-VERS.022014, FX61G1, FX61G1R, FX61G2...(Other models you can see in the webshop) |                 |         |



1

|                    |  |                 |         |
|--------------------|--|-----------------|---------|
| <b>GEV No.</b>     | 400678   | <b>Ref. No.</b> | 32Z9090 |
| <b>description</b> | PCB fryer 091FR1 ED 230V   |                 |         |
| <b>For models:</b> | 04WFR3ED, 06WFR3GD, 08WFR4ED, 091FR1ED, 091FR1GD, 091FR3ED, 091FR3GD, 0A1FR1ED, 0A1FR1GD, 0A1FR1GD-VERS.2004, 0A1FR3ED, 0A1FR3GD, 0B1FR1GD, 0D1FR1ED, 0D1FR1GD, 0D1FR1GD-VERS.2004, 0D1FR3ED, 0D1FR3GD, 0G0FR3ED, 0G1FR3GD, 10WFR4GD, 191FR2ED, 191FR2GD, 191FR4ED, 191FR4GD, 1A1FR2ED, 1A1FR2GD, 1A1FR2GD-VERS.2004, 1A1FR4ED, 1A1FR4GD, 1D1FR2ED, 1D1FR2GD, 1D1FR2GD-VERS.2004, 1D1FR4ED, 1D1FR4GD, 1G1FR4GD |                 |         |





1

|                    |   |                 |         |
|--------------------|---|-----------------|---------|
| <b>GEV No.</b>     | 402978  | <b>Ref. No.</b> | 3184480 |
| <b>description</b> | PCB L 73mm W 73mm timer   |                 |         |
| <b>For models:</b> | PG22C, PG23C, PG23CW, PG24CW, PG30C, PG31CW, PG42C, PG43CW, PG60C, PG61CW |                 |         |



1

|   |   |                 |                 |   |
|---|---|-----------------|-----------------|---|
| <b>GEV No.</b>  | 400955  | <b>Ref. No.</b> | 3019810         |   |
| <b>description</b>  | PCB slicer 230/400V   |                 |                 |   |
| <b>For models:</b>  | STV   |                 |                 |   |
| <b>accessories for</b>  | 400955  |                 |                 |   |
|    | <b>GEV No.</b>  | 401357          | <b>Ref. No.</b> | — |
|   | momentary push switch mounting measurements ø22mm 1NO/1NC/indicator light 400V 4A indicator lamp 24V 0-1 connection screw ambient temperature max. 125/55°C protection IP40 |                 |                 |   |
|  | <b>GEV No.</b>  | 401709          | <b>Ref. No.</b> | — |
|   | protective cover external size 57x32mm internal size 47x22mm matt finish rubber H 27.5mm  |                 |                 |   |



1

|                    |   |                 |         |
|--------------------|---|-----------------|---------|
| <b>GEV No.</b>     | 403575  | <b>Ref. No.</b> | 32Z7090 |
| <b>description</b> | PCB slicer L 128mm W 43mm 230-400V  |                 |         |
| <b>For models:</b> | AFC30MS, AFC30S, AFC35, AFT30S, AFT30VMS, AFT30VS, AFT33S, AFT35, AFT35VS |                 |         |



1

|                    |                                |                 |         |
|--------------------|--------------------------------|-----------------|---------|
| <b>GEV No.</b>     | 400954                         | <b>Ref. No.</b> | 3069870 |
| <b>description</b> | PCB slicer/cutter 50/60Hz 230V |                 |         |
| <b>For models:</b> | SC9VV, STV                     |                 |         |



Зип Общепит  
vsezip.ru  
+7(812)987-08-81



1

|                    |   |                 |         |
|--------------------|---|-----------------|---------|
| <b>GEV No.</b>     | 401747  | <b>Ref. No.</b> | 32V8030 |
| <b>description</b> | power PCB for blast chiller SERIE IM suitable for SAGI  |                 |         |
| <b>For models:</b> | FS611, IS101L, IS101LW, IS101S, IS101SW, IS102S, IS102SR, IS102SW, IS51, IS51A, IS51C, IS51H, IS51HW, IS51M, IS51W, IS51WA, IS51WC, IS51WM, IS72S, IS72SW, ISFEB, ISFEB-OPR01, ISFEN, ISFEN-OPR01 |                 |         |



1

|                    |   |                 |         |
|--------------------|---|-----------------|---------|
| <b>GEV No.</b>     | 378403  | <b>Ref. No.</b> | 37N0480 |
| <b>description</b> | front foil blast freezer 70 GL                                    |                 |         |
| <b>For models:</b> | SM2L, SM2LR, SM2LW, SM2S, SM2SR, SM2SW, SM3S, SM3SR, SM4SR, SM7SR |                 |         |

## keypads

### front foils



1

|                    |   |                 |         |
|--------------------|---|-----------------|---------|
| <b>GEV No.</b>     | 401180  | <b>Ref. No.</b> | 37M4201 |
| <b>description</b> | front foil  |                 |         |
| <b>For models:</b> | FC101, FC101E, FC241, FC241E, FC241G, FC61, FC61E |                 |         |

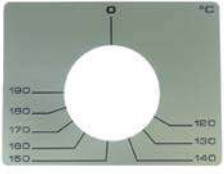

1

|                    |                           |                 |         |
|--------------------|---------------------------|-----------------|---------|
| <b>GEV No.</b>     | 401639                    | <b>Ref. No.</b> | 37M5670 |
| <b>description</b> | front foil L 115mm W 87mm |                 |         |

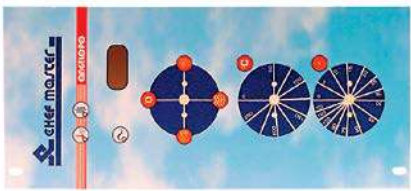

1

|                    |                |                 |         |
|--------------------|----------------|-----------------|---------|
| <b>GEV No.</b>     | 401181         | <b>Ref. No.</b> | 37M9220 |
| <b>description</b> | front foil     |                 |         |
| <b>For models:</b> | FCV3EM, FCV4EM |                 |         |

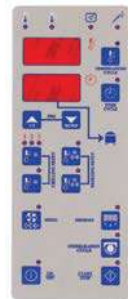

1

|                    |  |                 |         |
|--------------------|--|-----------------|---------|
| <b>GEV No.</b>     | 401956   | <b>Ref. No.</b> | 37N0470 |
| <b>description</b> | keypad foil  |                 |         |
| <b>For models:</b> | SM14SR, SM1L, SM1L7, SM1L7A, SM1L7FCV, SM1L7M, SM1LA, SM1LAR, SM1LAW, SM1LR, SM1LW |                 |         |



1

|                    |   |                 |         |
|--------------------|---|-----------------|---------|
| <b>GEV No.</b>     | 401182  | <b>Ref. No.</b> | 37M5641 |
| <b>description</b> | front foil  |                 |         |
| <b>For models:</b> | FCV101, FCV101E, FCV141, FCV141E, FCV241, FCV241E, FCV241G, FCV61, FCV61E |                 |         |



1

|                    |  |                 |         |
|--------------------|--|-----------------|---------|
| <b>GEV No.</b>     | 400676   | <b>Ref. No.</b> | 37M8560 |
| <b>description</b> | keypad foil for fryer L 97mm W 60mm  |                 |         |
| <b>For models:</b> | 04WFR3ED, 06WFR3GD, 08WFR4ED, 091FR1ED, 091FR1GD, 091FR3ED, 091FR3GD, 0A1FR1ED, 0A1FR1GD, 0A1FR1GD-VERS.2004, 0A1FR3ED, 0A1FR3GD, 0B1FR1GD, 0D1FR1ED, 0D1FR1GD, 0D1FR1GD-VERS.2004, 0D1FR3ED, 0D1FR3GD, 0G0FR3ED, 0G1FR3GD, 10WFR4GD, 191FR2ED, 191FR2GD, 191FR4ED, 191FR4GD, 1A1FR2ED, 1A1FR2GD, 1A1FR2GD-VERS.2004, 1A1FR4ED, 1A1FR4GD, 1D1FR2ED, 1D1FR2GD, 1D1FR2GD-VERS.2004, 1D1FR4ED, 1D1FR4GD, 1G1FR4GD |                 |         |



1

|                    |  |                 |         |
|--------------------|--|-----------------|---------|
| <b>GEV No.</b>     | 511927   | <b>Ref. No.</b> | 37M1610 |
| <b>description</b> | keypad foil for potato peeler device silver L 175mm W 61mm buttons 3 |                 |         |
| <b>For models:</b> | P10, P10M, P20   |                 |         |



Зип.Общепит  
solenoid valves

vsezip.ru  
straight

+7(812)987-08-81



|                    |  |                 |         |
|--------------------|--|-----------------|---------|
| <b>GEV No.</b>     | 401752   | <b>Ref. No.</b> | 37M7330 |
| <b>description</b> | keypad foil SAGI suitable for for ice maker L 200mm W 60mm buttons 8 |                 |         |
| <b>For models:</b> | SM1L, SM1LA, SM1LAR, SM1LAW, SM1LR, SM1LW                            |                 |         |



|                    |  |                 |         |
|--------------------|--|-----------------|---------|
| <b>GEV No.</b>     | 403029   | <b>Ref. No.</b> | 37N5560 |
| <b>description</b> | keypad foil suitable for ANGELO PO L 210mm buttons 6   |                 |         |
| <b>For models:</b> | DS31, DS31A, DS31C, DS31M, DS51, DS51A, DS51C, DS51M, IA101L, IA101S, IA51, IA51A, IA51C, IA51M, IA72S, IS101L, IS101LR, IS101LW, IS101S, IS101SR, IS101SW, IS102S, IS102SR, IS102SW, IS51, IS51A, IS51AR, IS51C, IS51CR, IS51H, IS51HW, IS51M, IS51MR, IS51R, IS51W, IS51WA, IS51WC, IS51WM, IS72S, IS72SR, IS72SW, ISP202R, ISR201R, ISR202R |                 |         |

membrane keypads



|                    |  |                 |         |
|--------------------|--|-----------------|---------|
| <b>GEV No.</b>     | 402027   | <b>Ref. No.</b> | 37M7340 |
| <b>description</b> | membrane keypad for blast freezer buttons 8 suitable for SAGI L 200mm W 60mm |                 |         |
| <b>For models:</b> | SM2L, SM2LR, SM2LW, SM2S, SM2SR, SM2SW, SM3S, SM3SR, SM4SR                   |                 |         |

keypad units



|  |  |                 |                 |   |
|--|--|-----------------|-----------------|---|
| <b>GEV No.</b>                           | 403002   | <b>Ref. No.</b> | 3018180         |   |
| <b>description</b>                       | keypad unit slicer buttons 2 MIRRA/SAN-DANIELE/YORK L 120mm W 48mm |                 |                 |   |
| <b>For models:</b>                       | SC4, SC6, SC9VV, STV   |                 |                 |   |
| <b>accessories for</b>                   | 403002   |                 |                 |   |
|  | <b>GEV No.</b>   | 403004          | <b>Ref. No.</b> | — |
| gasket for keypad housing L 122mm W 52mm |  |                 |                 |   |

solenoid valves (water)

LLBI

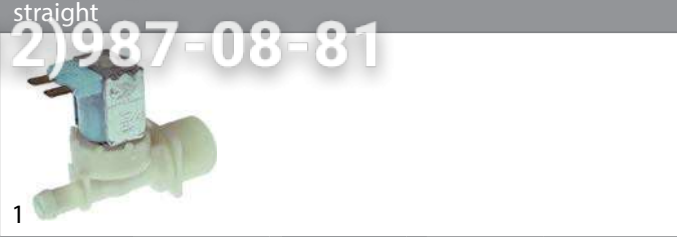

|                        |  |                 |         |
|------------------------|--|-----------------|---------|
| <b>GEV No.</b>         | 374053   | <b>Ref. No.</b> | 3032680 |
| <b>description</b>     | solenoid valve single straight 230VAC inlet 3/4" outlet 11.5mm t.max. 60°C ELBI plastic flow regulating valve outlet orange  |                 |         |
| <b>For models:</b>     | BX101E, BX101E-VERS.122013, BX101G, BX101G-VERS.122013, BX122E, BX122E-VERS.122013, BX122G, BX122G-VERS.122013, BX61E, BX61E-VERS.122013, BX61G, BX61G-VERS.122013, BX82E, BX82E-VERS.122013, BX82G, BX82G-VERS.122013, FM1011E1, FM1011E1-VERS.2006, FM1011E2, FM1011E2-VERS.2006, FM1011E3, FM1011E3-VERS.2006, FM1011G1, FM1011G1-VERS.2006, FM1011G2, FM1011G2-VERS.2006, FM1011G3, FM1011G3-VERS.2006, FM1221E1, FM1221E1-VERS.2006, FM1221E2, FM1221E2-VERS.2006, FM1221E3, FM1221E3-VERS.2006, FM1221G1, FM1221G1-VERS.2006, FM1221G2, FM1221G2-VERS.2006, FM1221G3, FM1221G3-VERS.2006, FM2021E1, FM2021E2, FM2021G1, FM2021G2, FM423E2, FM611E1, FM611E1-VERS.2006, FM611E2, FM611E2-VERS.2006, FM611E3...(Other models you can see in the webshop) |                 |         |
| <b>spare parts for</b> | 374053   |                 |         |

|   |                |        |                 |     |
|---|----------------|--------|-----------------|-----|
|   | <b>GEV No.</b> | 370467 | <b>Ref. No.</b> | N/A |
| solenoid valve filter suitable for ELBI |                |        |                 |     |



|                    |  |                 |         |
|--------------------|--|-----------------|---------|
| <b>GEV No.</b>     | 370431   | <b>Ref. No.</b> | 33D2780 |
| <b>description</b> | solenoid valve single straight 230VAC inlet 3/4" outlet 11.5mm input/min output 2l/min DN10 t.max. 90°C ELBI plastic |                 |         |
| <b>For models:</b> | PGC132, PGC132-VERS.200911, PGC134W, PGC134W-VERS.200911, PGC210, PGC210-VERS.200911, PGC212W, PGC212W-VERS.200911   |                 |         |









Зип Общепит











vsezip.ru

+7(812)987-08-81

MÜLLER

medium temperature: 90°C  
duty cycle: 100%

|  |  |                 |                    |
|--|--|-----------------|--------------------|
|  <p>1</p> |  |                 |                    |
| <b>GEV No.</b>   | 370158   | <b>Ref. No.</b> | 33D1710<br>33D2410 |
| <b>description</b>   | solenoid valve double straight 230VAC inlet 3/4" outlet 11.5mm DN10 t.max. 90°C duty cycle 100% MÜLLER   |                 |                    |
| <b>For models:</b>   | FC101, FC101E, FC241E, FC241G, FC61, FC61E, FCV101, FCV101-CSA, FCV101DM, FCV101DM-CSA, FCV101DS, FCV101DS-CSA, FCV101E, FCV101EDM, FCV101EDM-UL, FCV101EDS, FCV101EDS-UL, FCV101E-UL, FCV141, FCV141-CSA, FCV141DM, FCV141DM-CSA, FCV141DS, FCV141DS-CSA, FCV141E, FCV141EDM, FCV141EDS, FCV241E, FCV241EDM, FCV241EDM-UL, FCV241EDS, FCV241EDS-UL, FCV241E-UL, FCV241G, FCV241G-CSA, FCV241GDM, FCV241GDM-CSA, FCV241GDS, FCV241GDS-CSA, FCV401DM, FCV401DM-CSA, FCV401EDM, FCV401EDM-UL, FCV61, FCV61-CSA, FCV61DM, FCV61DM-CSA, FCV61DS, FCV61DS-CSA, FCV61E...(Other models you can see in the webshop) |                 |                    |
| <b>spare parts for</b>   | 370158   |                 |                    |
|           | <b>GEV No.</b>   | 370195          | <b>Ref. No.</b> —  |
|  | solenoid valve body double straight inlet 3/4" outlet 11.5mm DN10 t.max. 90°C duty cycle 100% MÜLLER 230V  |                 |                    |
|          | <b>GEV No.</b>   | 371002          | <b>Ref. No.</b> —  |
|  | solenoid valve holder MÜLLER flange support  |                 |                    |
|         | <b>GEV No.</b>   | 371009          | <b>Ref. No.</b> —  |
|  | compression spring for solenoid coil   |                 |                    |
|         | <b>GEV No.</b>   | 371011          | <b>Ref. No.</b> —  |
|  | spare parts kit membrane with long star star hight 8mm MÜLLER  |                 |                    |
|         | <b>GEV No.</b>   | 371017          | <b>Ref. No.</b> —  |
|  | solenoid coil MÜLLER 230VAC connection male faston 6.3mm   |                 |                    |
|         | <b>GEV No.</b>   | 371122          | <b>Ref. No.</b> —  |
|  | solenoid valve filter ø 19mm H 10mm suitable for MÜLLER  |                 |                    |
| <b>accessories for</b>   | 370158   |                 |                    |
|         | <b>GEV No.</b>   | 371010          | <b>Ref. No.</b> —  |
|  | solenoid coil 230VAC connection with cable cable length 2000mm   |                 |                    |
|         | <b>GEV No.</b>   | 371037          | <b>Ref. No.</b> —  |
|  | solenoid coil 24VAC 50/60Hz connection male faston 6.3mm   |                 |                    |
|         | <b>GEV No.</b>   | 371038          | <b>Ref. No.</b> —  |
|  | solenoid coil 230VAC connection appliance plug   |                 |                    |

|   |  |                 |                   |
|---|--|-----------------|-------------------|
| <b>GEV No.</b>  | 370117   | <b>Ref. No.</b> | 33D2460           |
| <b>description</b>  | solenoid valve single straight 230VAC inlet 3/4" outlet 11.5mm DN10 t.max. 90°C duty cycle 100% MÜLLER   |                 |                   |
| <b>For models:</b>  | FM1011E3, FM1011G3, FM1221E1, FM1221E2, FM1221E3, FM1221G1, FM1221G2, FM1221G3, FM611E3, FM611G3, FM721E1, FM721E2, FM721E3, FM721G1, FM721G2, FM721G3 |                 |                   |
| <b>spare parts for</b>  | 370117   |                 |                   |
|    | <b>GEV No.</b>   | 370133          | <b>Ref. No.</b> — |
|   | solenoid valve body single straight inlet 3/4" outlet 11.5mm DN10 t.max. 90°C duty cycle 100% MÜLLER 230V  |                 |                   |
|    | <b>GEV No.</b>   | 371002          | <b>Ref. No.</b> — |
|   | solenoid valve holder MÜLLER flange support  |                 |                   |
|    | <b>GEV No.</b>   | 371009          | <b>Ref. No.</b> — |
|   | compression spring for solenoid coil   |                 |                   |
|    | <b>GEV No.</b>   | 371011          | <b>Ref. No.</b> — |
|   | spare parts kit membrane with long star star hight 8mm MÜLLER  |                 |                   |
|  | <b>GEV No.</b>   | 371017          | <b>Ref. No.</b> — |
|   | solenoid coil MÜLLER 230VAC connection male faston 6.3mm   |                 |                   |
|  | <b>GEV No.</b>   | 371122          | <b>Ref. No.</b> — |
|   | solenoid valve filter ø 19mm H 10mm suitable for MÜLLER  |                 |                   |
|  | <b>GEV No.</b>   | 501161          | <b>Ref. No.</b> — |
|   | tap head for solenoid valve holder for solenoid coils  |                 |                   |
| <b>accessories for</b>  | 370117   |                 |                   |
|  | <b>GEV No.</b>   | 371010          | <b>Ref. No.</b> — |
|   | solenoid coil 230VAC connection with cable cable length 2000mm   |                 |                   |
|  | <b>GEV No.</b>   | 371037          | <b>Ref. No.</b> — |
|   | solenoid coil 24VAC 50/60Hz connection male faston 6.3mm   |                 |                   |
|  | <b>GEV No.</b>   | 371038          | <b>Ref. No.</b> — |
|   | solenoid coil 230VAC connection appliance plug   |                 |                   |

1 electric components



Зип-Общепит

vsezip.ru

+7(812)987-08-81

## ROBERTSHAW/INVENSYS

medium temperature: 90°C 90°C 60°C  
 ambient temperature: 60°C 25°C 60°C  
 duty cycle: 40% 100% 100%

## spare parts and accessories

## reducers

## outlet side



1

| GEV No.     | 371255  | Ref. No. | N/A |
|-------------|---|----------|-----|
| description | reducer type EATON (INVENSYS) flow rate 5l/min pressure range 0 up to 10bar tolerance ±15/25% black |          |     |

## RPE



1

| GEV No.     | 374017  | Ref. No. | 33D2310<br>33D3260 |
|-------------|---|----------|--------------------|
| description | solenoid valve single straight 230VAC inlet 3/4" outlet 10mm input 6l/min DN10 RPE polyamide flow regulating valve inlet white membranes NBR pressure range 0.2-10bar |          |                    |



1

| GEV No.     | 374015   | Ref. No. | 33D3280 |
|-------------|--|----------|---------|
| description | solenoid valve single angled 230VAC inlet 3/4" outlet 10mm input 10-12l/min DN10 RPE flow regulating valve inlet white                     |          |         |
| For models: | KD100, KD100A, KD100PSD, KD130, KD130A, KD130E, KD130EAT, KD85, KD85A, KD85PS, KD85PSA, KN1100, KN1100SD, KN11PSDD, KN800, KN800PSD, LP151 |          |         |

| GEV No.   | 370021  | Ref. No. | 33D1640<br>33D1641<br>33D3250 |   |
|---|---|----------|-------------------------------|---|
| description   | solenoid valve double straight 230VAC inlet 3/4" outlet 11.5mm DN10 TP flow regulating valve inlet white  |          |                               |   |
| For models:   | FC101, FC101E, FC241, FC241E, FC241G, FC61, FC61E, FCV101, FCV101DM, FCV101DS, FCV101E, FCV101EDM, FCV101EDS, FCV141, FCV141DM, FCV141DS, FCV141E, FCV141EDM, FCV141EDS, FCV241, FCV241DM, FCV241DS, FCV241E, FCV241EDM, FCV241EDS, FCV241G, FCV241GDM, FCV241GDS, FCV3EM, FCV401DM, FCV401EDM, FCV4E, FCV4EDS, FCV4EM, FCV61, FCV61DM, FCV61DS, FCV61E, FCV61EDM, FCV61EDS, FM423E1, KD37, KD37PS, KD37-VERS.112009, KD40, KD40EPSD, KD40LEPS, KD40LSPS, KD40LUX, KD40LUXE...(Other models you can see in the webshop) |          |                               |   |
| accessories for   | 370021  |          |                               |   |
|   | GEV No.   | 371220   | Ref. No.                      | — |
| reducer TP flow rate 3l/min red tolerance ±15%          |   |          |                               |   |
|   | GEV No.   | 371221   | Ref. No.                      | — |
| reducer TP flow rate 5.5l/min yellow tolerance ±15%     |   |          |                               |   |
|   | GEV No.   | 371222   | Ref. No.                      | — |
| reducer TP flow rate 6l/min grey tolerance ±15%         |   |          |                               |   |
|   | GEV No.   | 371223   | Ref. No.                      | — |
| reducer TP flow rate 10l/min white tolerance ±15%       |   |          |                               |   |
|   | GEV No.   | 371224   | Ref. No.                      | — |
| reducer TP flow rate 12l/min bronze tolerance ±15%      |   |          |                               |   |
|   | GEV No.   | 371225   | Ref. No.                      | — |
| reducer TP flow rate 16l/min light brown tolerance ±15% |   |          |                               |   |
|   | GEV No.   | 371226   | Ref. No.                      | — |
| reducer TP flow rate 20l/min red tolerance ±15%         |   |          |                               |   |
|   | GEV No.   | 371230   | Ref. No.                      | — |
| reducer TP flow rate 0.25l/min red tolerance ±25%       |   |          |                               |   |
|   | GEV No.   | 371231   | Ref. No.                      | — |
| reducer TP flow rate 0.35l/min violet tolerance ±25%    |   |          |                               |   |
|   | GEV No.   | 371232   | Ref. No.                      | — |
| reducer TP flow rate 0.5l/min orange tolerance ±25%     |   |          |                               |   |
|   | GEV No.   | 371233   | Ref. No.                      | — |
| reducer TP flow rate 0.8l/min white tolerance ±25%      |   |          |                               |   |
|   | GEV No.   | 371234   | Ref. No.                      | — |
| reducer TP flow rate 1l/min light blue tolerance ±25%   |   |          |                               |   |
|   | GEV No.   | 371235   | Ref. No.                      | — |
| reducer TP flow rate 1.2l/min brown tolerance ±25%      |   |          |                               |   |

Table continues overleaf



Зип-Общепит

vsezip.ru

+7(812)987-08-81

| accessories for |          | 370021  |          |
|-----------------|----------|---------|----------|
| GEV No.         | Ref. No. | GEV No. | Ref. No. |
|                 | 371236   | —       | —        |
|                 | 371237   | —       | —        |
|                 | 371238   | —       | —        |
|                 | 371239   | —       | —        |
|                 | 371240   | —       | —        |

| accessories for |          | 370017  |          |
|-----------------|----------|---------|----------|
| GEV No.         | Ref. No. | GEV No. | Ref. No. |
|                 | 371232   | —       | —        |
|                 | 371233   | —       | —        |
|                 | 371234   | —       | —        |
|                 | 371235   | —       | —        |
|                 | 371236   | —       | —        |
|                 | 371237   | —       | —        |
|                 | 371238   | —       | —        |
|                 | 371239   | —       | —        |
|                 | 371240   | —       | —        |

|                               |  |                 |                    |
|-------------------------------|--|-----------------|--------------------|
|                               |  |                 |                    |
|                               |  |                 |                    |
| <b>GEV No.</b>                | 370017   | <b>Ref. No.</b> | 33D1370<br>33D2310 |
| <b>description</b>            | solenoid valve single straight 230VAC inlet 3/4" outlet 11.5mm DN10 TP p max 10bar |                 |                    |
| <b>spare parts for</b>        |  | 370017          |                    |
|                               | GEV No.  | 371013          | Ref. No. —         |
| <b>accessories for</b> 370017 |  |                 |                    |
|                               | GEV No.  | 371220          | Ref. No. —         |
|                               | GEV No.  | 371221          | Ref. No. —         |
|                               | GEV No.  | 371222          | Ref. No. —         |
|                               | GEV No.  | 371223          | Ref. No. —         |
|                               | GEV No.  | 371224          | Ref. No. —         |
|                               | GEV No.  | 371225          | Ref. No. —         |
|                               | GEV No.  | 371226          | Ref. No. —         |
|                               | GEV No.  | 371230          | Ref. No. —         |
|                               | GEV No.  | 371231          | Ref. No. —         |

|                               |  |                 |            |
|-------------------------------|--|-----------------|------------|
|                               |  |                 |            |
|                               |  |                 |            |
| <b>GEV No.</b>                | 370019   | <b>Ref. No.</b> | 33D0290    |
| <b>description</b>            | solenoid valve double angled 230VAC inlet 3/4" outlet 11.5mm DN10 TP plastic |                 |            |
| <b>spare parts for</b>        |  | 370019          |            |
|                               | GEV No.  | 371013          | Ref. No. — |
| <b>accessories for</b> 370019 |  |                 |            |
|                               | GEV No.  | 371220          | Ref. No. — |
|                               | GEV No.  | 371221          | Ref. No. — |
|                               | GEV No.  | 371222          | Ref. No. — |
|                               | GEV No.  | 371223          | Ref. No. — |
|                               | GEV No.  | 371224          | Ref. No. — |

Table continues overleaf



Зип-Общепит  
vsezip.ru

+7(812)987-08-81

| accessories for  |          | 370019   |          |          |
|--|----------|----------|----------|----------|
| GEV No.  | Ref. No. | Ref. No. | Ref. No. | Ref. No. |
|  | 371225   |          |          | —        |
| reducer TP flow rate 16l/min light brown tolerance ±15%  |          |          |          |          |
|  | 371226   |          |          | —        |
| reducer TP flow rate 20l/min red tolerance ±15%          |          |          |          |          |
|  | 371230   |          |          | —        |
| reducer TP flow rate 0.25l/min red tolerance ±25%        |          |          |          |          |
|  | 371231   |          |          | —        |
| reducer TP flow rate 0.35l/min violet tolerance ±25%     |          |          |          |          |
|  | 371232   |          |          | —        |
| reducer TP flow rate 0.5l/min orange tolerance ±25%      |          |          |          |          |
|  | 371233   |          |          | —        |
| reducer TP flow rate 0.8l/min white tolerance ±25%       |          |          |          |          |
|  | 371234   |          |          | —        |
| reducer TP flow rate 1l/min light blue tolerance ±25%    |          |          |          |          |
|  | 371235   |          |          | —        |
| reducer TP flow rate 1.2l/min brown tolerance ±25%       |          |          |          |          |
|  | 371236   |          |          | —        |
| reducer TP flow rate 1.5l/min light brown tolerance ±25% |          |          |          |          |
|  | 371237   |          |          | —        |
| reducer TP flow rate 2.5l/min yellow tolerance ±25%      |          |          |          |          |
|  | 371238   |          |          | —        |
| reducer TP flow rate 3.4l/min dark green tolerance ±25%  |          |          |          |          |
|  | 371239   |          |          | —        |
| reducer TP flow rate 5l/min black tolerance ±25%         |          |          |          |          |
|  | 371240   |          |          | —        |
| reducer TP flow rate 8l/min blue tolerance ±20%          |          |          |          |          |

| accessories for  |          | 370015   |          |          |
|--|----------|----------|----------|----------|
| GEV No.  | Ref. No. | Ref. No. | Ref. No. | Ref. No. |
|  | 371223   |          |          | —        |
| reducer TP flow rate 10l/min white tolerance ±15%        |          |          |          |          |
|  | 371224   |          |          | —        |
| reducer TP flow rate 12l/min bronze tolerance ±15%       |          |          |          |          |
|  | 371225   |          |          | —        |
| reducer TP flow rate 16l/min light brown tolerance ±15%  |          |          |          |          |
|  | 371226   |          |          | —        |
| reducer TP flow rate 20l/min red tolerance ±15%          |          |          |          |          |
|  | 371230   |          |          | —        |
| reducer TP flow rate 0.25l/min red tolerance ±25%        |          |          |          |          |
|  | 371231   |          |          | —        |
| reducer TP flow rate 0.35l/min violet tolerance ±25%     |          |          |          |          |
|  | 371232   |          |          | —        |
| reducer TP flow rate 0.5l/min orange tolerance ±25%      |          |          |          |          |
|  | 371233   |          |          | —        |
| reducer TP flow rate 0.8l/min white tolerance ±25%       |          |          |          |          |
|  | 371234   |          |          | —        |
| reducer TP flow rate 1l/min light blue tolerance ±25%    |          |          |          |          |
|  | 371235   |          |          | —        |
| reducer TP flow rate 1.2l/min brown tolerance ±25%       |          |          |          |          |
|  | 371236   |          |          | —        |
| reducer TP flow rate 1.5l/min light brown tolerance ±25% |          |          |          |          |
|  | 371237   |          |          | —        |
| reducer TP flow rate 2.5l/min yellow tolerance ±25%      |          |          |          |          |
|  | 371238   |          |          | —        |
| reducer TP flow rate 3.4l/min dark green tolerance ±25%  |          |          |          |          |
|  | 371239   |          |          | —        |
| reducer TP flow rate 5l/min black tolerance ±25%         |          |          |          |          |
|  | 371240   |          |          | —        |
| reducer TP flow rate 8l/min blue tolerance ±20%          |          |          |          |          |

|   |  |                 |                    |   |
|---|--|-----------------|--------------------|---|
| <br>1   |  |                 |                    |   |
| <b>GEV No.</b>                                      | 370015   | <b>Ref. No.</b> | 33D1370<br>33D1371 |   |
| <b>description</b>                                  | solenoid valve single angled 230VAC inlet 3/4" outlet 11.5mm DN10 TP |                 |                    |   |
| <b>accessories for</b>                              | 370015   |                 |                    |   |
|   | GEV No.  | 371220          | Ref. No.           | — |
| reducer TP flow rate 3l/min red tolerance ±15%      |  |                 |                    |   |
|   | GEV No.  | 371221          | Ref. No.           | — |
| reducer TP flow rate 5.5l/min yellow tolerance ±15% |  |                 |                    |   |
|   | GEV No.  | 371222          | Ref. No.           | — |
| reducer TP flow rate 6l/min grey tolerance ±15%     |  |                 |                    |   |

|                        |   |                 |          |   |
|------------------------|---|-----------------|----------|---|
| <br>1                  |   |                 |          |   |
| <b>GEV No.</b>         | 370031  | <b>Ref. No.</b> | N/A      |   |
| <b>description</b>     | solenoid valve single angled 24VAC inlet 3/4" outlet 14mm DN10 TP |                 |          |   |
| <b>spare parts for</b> | 370031  |                 |          |   |
|                        | GEV No.   | 371035          | Ref. No. | — |
| solenoid coil 24VAC    |   |                 |          |   |

Table continues overleaf





Зип Общепит

vsezip.ru

+7(812)987-08-81

| accessories for 370031  |  | GEV No. | 371220 | Ref. No. | — |
|---|--|---------|--------|----------|---|
|    | reducer TP flow rate 3l/min red tolerance ±15%           | GEV No. | 371221 | Ref. No. | — |
|    | reducer TP flow rate 5.5l/min yellow tolerance ±15%      | GEV No. | 371222 | Ref. No. | — |
|    | reducer TP flow rate 6l/min grey tolerance ±15%          | GEV No. | 371223 | Ref. No. | — |
|    | reducer TP flow rate 10l/min white tolerance ±15%        | GEV No. | 371224 | Ref. No. | — |
|    | reducer TP flow rate 12l/min bronze tolerance ±15%       | GEV No. | 371225 | Ref. No. | — |
|    | reducer TP flow rate 16l/min light brown tolerance ±15%  | GEV No. | 371226 | Ref. No. | — |
|    | reducer TP flow rate 20l/min red tolerance ±15%          | GEV No. | 371230 | Ref. No. | — |
|    | reducer TP flow rate 0.25l/min red tolerance ±25%        | GEV No. | 371231 | Ref. No. | — |
|   | reducer TP flow rate 0.35l/min violet tolerance ±25%     | GEV No. | 371232 | Ref. No. | — |
|  | reducer TP flow rate 0.5l/min orange tolerance ±25%      | GEV No. | 371233 | Ref. No. | — |
|  | reducer TP flow rate 0.8l/min white tolerance ±25%       | GEV No. | 371234 | Ref. No. | — |
|  | reducer TP flow rate 1l/min light blue tolerance ±25%    | GEV No. | 371235 | Ref. No. | — |
|  | reducer TP flow rate 1.2l/min brown tolerance ±25%       | GEV No. | 371236 | Ref. No. | — |
|  | reducer TP flow rate 1.5l/min light brown tolerance ±25% | GEV No. | 371237 | Ref. No. | — |
|  | reducer TP flow rate 2.5l/min yellow tolerance ±25%      | GEV No. | 371238 | Ref. No. | — |
|  | reducer TP flow rate 3.4l/min dark green tolerance ±25%  | GEV No. | 371239 | Ref. No. | — |
|  | reducer TP flow rate 5l/min black tolerance ±25%         | GEV No. | 371240 | Ref. No. | — |
|  | reducer TP flow rate 8l/min blue tolerance ±20%          |         |        |          |   |

| solenoid valves with reducers  |  |        |                  |
|--|--|--------|------------------|
|  |  |        |                  |
| 1  | GEV No.  | 370648 | Ref. No. 3032670 |
| description  | solenoid valve double straight 220-240VAC inlet 3/4" input 10l/min DN10 TP outlet 11.5mm output A 3.4l/min flow regulating valve outlet A green  |        |                  |
| For models:  | 10CP1EA, 10CP1GA, 10CP1IA, 12CP1EA, 12CP1GA, 12CP1IA, 18CP2EA, 18CP2GA, 18CP2IA, FC1011E, FC1011G, FC1221E, FC1221G, FC611E, FC611G, FM1011E2-VERS.2006, FM1011E3, FM1011E3-VERS.2006, FM1011G2-VERS.2006, FM1011G3, FM1011G3-VERS.2006, FM1221E2-VERS.2006, FM1221E3, FM1221E3-VERS.2006, FM1221G2-VERS.2006, FM1221G3, FM1221G3-VERS.2006, FM2011E2-VERS.2006, FM2011E3-VERS.2006, FM2011G2-VERS.2006, FM2011G3-VERS.2006, FM2021E1, FM2021E2, FM2021E2-VERS.2006, FM2021E3, FM2021E3-VERS.2006, FM2021G1, FM2021G2, FM2021G2-VERS.2006, FM2021G3, FM2021G3-VERS.2006, FM423E2, FM611E2-VERS.2006, FM611E3, FM611E3-VERS.2006, FM611G2-VERS.2006, FM611G3, FM611G3-VERS.2006, FM721E1-VERS.2006, FM721E2-VERS.2006...(Other models you can see in the webshop) |        |                  |



| metal   |   |        |                  |
|---|---|--------|------------------|
| ASCO  |   |        |                  |
| spare parts and accessories   |   |        |                  |
| power sockets   |   |        |                  |
|  |   |        |                  |
| 1   | GEV No.   | 371093 | Ref. No. 32A2330 |
| description   | power socket plug type compact cable length 1100mm small  |        |                  |
| For models:   | 0A1FR1G, 0A1FR1GD, 0A1FR1GD-VERS.2004, 0A1FR1G-VERS.2004, 0B1FR1G, 0B1FR1GD, 0D1FR1G, 0D1FR1GD, 0D1FR1GD-VERS.2004, 0D1FR1G-VERS.2004, 1A1BR1G, 1A1BR1GA, 1A1BR2G, 1A1BR2GA, 1A1FR2G, 1A1FR2GD, 1A1FR2GD-VERS.2004, 1A1FR2G-VERS.2004, 1D1BR1G, 1D1BR1GA, 1D1BR2G, 1D1BR2GA, 1D1FR2G, 1D1FR2GD, 1D1FR2GD-VERS.2004, 1D1FR2G-VERS.2004, 2A1BR1G, 2A1BR1GA, 2A1BR2G, 2A1BR2GA, 2D1BR1G, 2D1BR1GA, 2D1BR2G, 2D1BR2GA |        |                  |





Зип Общепит

vsezip.ru

+7(812)987-08-81

|   |  |                 |                     |
|---|--|-----------------|---------------------|
| SIRAI   |  |                 |                     |
| 2-way   |  |                 |                     |
| L140-B series   |  |                 |                     |
|    |  |                 |                     |
| 1   |  |                 |                     |
| <b>GEV No.</b>  | 370320   | <b>Ref. No.</b> | 33D1060             |
| <b>description</b>  | solenoid valve brass 2-ways 24VAC inlet 1/2" outlet 1/2" connection 1/2" L 41mm DN 10mm slide-on receptacle compact -10 up to +90°C SIRAI type series L140-B coil type Z610A membranes NBR (water) p max 12bar p min 0.35bar   |                 |                     |
| <b>For models:</b>  | C165D, C165S, C207D, C207D-VERS.2006, C207S, C207S-VERS.2006, C207VD, C207VD-VERS.2006, C207VS, C207VS-VERS.2006, C304AD, C304AD-VERS.2006, C304AS, C304AS-VERS.2006, C304AVD, C304AVD-VERS.2006, C304AVS, C304AVS-VERS.2006, C304D, C304D-VERS.2006, C304S, C304S-VERS.2006, C304VD, C304VD-VERS.2006, C304VS, C304VS-VERS.2006, C92D-VERS.2006, C92S-VERS.2006, C92VD-VERS.2006, C92VS-VERS.2006, CS243D, CS243D-VERS.2006, CS243S, CS243S-VERS.2006, CS243VD, CS243VD-VERS.2006, CS243VS, CS243VS-VERS.2006, CS370AD, CS370AD-VERS.2006, CS370AS, CS370AS-VERS.2006, CS370AVD, CS370AVD-VERS.2006, CS370AVS, CS370AVS-VERS.2006, CS370D, CS370D-VERS.2006, CS370S, CS370S-VERS.2006...(Other models you can see in the webshop) |                 |                     |
| <b>spare parts for</b>  | 370320   |                 |                     |
|   | <b>GEV No.</b>   | 371070          | <b>Ref. No.</b> N/A |
|   | solenoid coil 24VAC 10VA SIRAI coil type Z610A seat ø 10mm   |                 |                     |
| <b>accessories for</b>  | 370320   |                 |                     |
|  | <b>GEV No.</b>   | 371091          | <b>Ref. No.</b> N/A |
|   | power socket plug type DIN 43650B cable lengthmm small   |                 |                     |

|   |  |                 |                     |
|---|--|-----------------|---------------------|
| L180-B series   |  |                 |                     |
|  |  |                 |                     |
| 1   |  |                 |                     |
| <b>GEV No.</b>  | 370391   | <b>Ref. No.</b> | 33D1050             |
| <b>description</b>  | solenoid valve 2-ways 24VAC connection 3/4" L 79mm DN 18mm -10 up to +90°C coil type Z610A membranes NBR (water) p max 12bar p min 0.35bar   |                 |                     |
| <b>For models:</b>  | C165D, C165S, C207D, C207D-VERS.2006, C207S, C207S-VERS.2006, C207VD-VERS.2006, C207VS-VERS.2006, C304AD, C304AD-VERS.2006, C304AS, C304AS-VERS.2006, C304AVD-VERS.2006, C304AVS-VERS.2006, C304D, C304D-VERS.2006, C304S, C304S-VERS.2006, C304VD-VERS.2006, C304VS-VERS.2006, C92D-VERS.2006, C92S-VERS.2006, C92VD-VERS.2006, C92VS-VERS.2006, CS243D, CS243D-VERS.2006, CS243S, CS243S-VERS.2006, CS243VD, CS243VD-VERS.2006, CS243VS, CS243VS-VERS.2006, CS370AD, CS370AD-VERS.2006, CS370AS, CS370AS-VERS.2006, CS370AVD, CS370AVD-VERS.2006, CS370AVS, CS370AVS-VERS.2006, CS370D, CS370D-VERS.2006, CS370S, CS370S-VERS.2006, CS370VD, CS370VD-VERS.2006, CS370VS, CS370VS-VERS.2006, CS466AD, CS466AD-VERS.2006...(Other models you can see in the webshop) |                 |                     |
| <b>accessories for</b>  | 370391   |                 |                     |
|  | <b>GEV No.</b>   | 371091          | <b>Ref. No.</b> N/A |
|   | power socket plug type DIN 43650B cable lengthmm small   |                 |                     |

|   |  |                 |                     |
|---|--|-----------------|---------------------|
|  |  |                 |                     |
| 1   |  |                 |                     |
| <b>GEV No.</b>  | 370329   | <b>Ref. No.</b> | N/A                 |
| <b>description</b>  | solenoid valve 2-ways 24VAC inlet 1/2" outlet 1/2" connection 1/2" L 66mm DN 13.5mm slide-on receptacle compact -10 up to +90°C SIRAI type series L180-B coil type Z610A membranes NBR (water) p max 12bar p min 0.35bar |                 |                     |
| <b>spare parts for</b>  | 370329   |                 |                     |
|  | <b>GEV No.</b>   | 371070          | <b>Ref. No.</b> N/A |
|   | solenoid coil 24VAC 10VA SIRAI coil type Z610A seat ø 10mm   |                 |                     |
|  | <b>GEV No.</b>   | 371171          | <b>Ref. No.</b> N/A |
|   | membrane series L180-B membrane type NBR (water)   |                 |                     |
| <b>accessories for</b>  | 370329   |                 |                     |
|  | <b>GEV No.</b>   | 371091          | <b>Ref. No.</b> N/A |
|   | power socket plug type DIN 43650B cable lengthmm small   |                 |                     |





|   |   |                 |                     |
|---|---|-----------------|---------------------|
|   |   |                 |                     |
| 1   |   |                 |                     |
| <b>GEV No.</b>  | 370047  | <b>Ref. No.</b> | 33D0070<br>33D1460  |
| <b>description</b>  | solenoid valve brass 2-ways 230VAC inlet 1/2" outlet 1/2" connection 1/2" L 66mm DN 13.5mm slide-on receptacle compact -10 up to +90°C SIRAI type series L180-B coil type Z610A membranes NBR (water) p max 12bar p min 0.35bar 50/60Hz |                 |                     |
| <b>spare parts for</b>  | 370047  |                 |                     |
|  | <b>GEV No.</b>  | 371085          | <b>Ref. No.</b> —   |
|   | solenoid coil 230VAC 4VA SIRAI coil type ZB10A seat ø 10mm 50/60Hz  |                 |                     |
|  | <b>GEV No.</b>  | 371171          | <b>Ref. No.</b> N/A |
|   | membrane series L180-B membrane type NBR (water)  |                 |                     |
| <b>accessories for</b>  | 370047  |                 |                     |
|  | <b>GEV No.</b>  | 371091          | <b>Ref. No.</b> N/A |
|   | power socket plug type DIN 43650B cable lengthmm small  |                 |                     |





Зип Общепит



vsezip.ru

+7(812)987-08-81

|  |  |                 |                     |
|--|--|-----------------|---------------------|
| solenoid valves steam (water)  |  |                 |                     |
| 2-way  |  |                 |                     |
| L145-R series  |  |                 |                     |
|  <p>1</p> |  |                 |                     |
| <b>GEV No.</b>   | 370085   | <b>Ref. No.</b> | 33D1420             |
| <b>description</b>   | solenoid valve 230VAC connection 1" L 105mm DN 18.5mm slide-on receptacle DIN -60 up to +170°C SIRAI type series L145-R coil type Z534A membranes PTFE (steam) p max 8bar p min 0.4bar |                 |                     |
| <b>spare parts for</b>   | 370085   |                 |                     |
|           | <b>GEV No.</b>   | 371067          | <b>Ref. No.</b> N/A |
| solenoid coil 230VAC 14VA SIRAI coil type Z534A seat ø 12mm                                |  |                 |                     |
|           | <b>GEV No.</b>   | 371166          | <b>Ref. No.</b> —   |
| membrane connection 1" series L145-R membrane type PTFE                                    |  |                 |                     |
| <b>accessories for</b>   | 370085   |                 |                     |
|           | <b>GEV No.</b>   | 371090          | <b>Ref. No.</b> N/A |
| power socket plug type DIN 43650A screw  |  |                 |                     |

|   |  |                 |                     |
|---|--|-----------------|---------------------|
|  <p>1</p> |  |                 |                     |
| <b>GEV No.</b>  | 370318   | <b>Ref. No.</b> | 33D0570             |
| <b>description</b>  | solenoid valve 2-ways 24VAC inlet 1/2" outlet 1/2" connection 1/2" L 66mm DN 10mm slide-on receptacle compact -60 up to +170°C SIRAI type series L145-R coil type Z614A membranes PTFE (steam) p max 8bar p min 0.4bar |                 |                     |
| <b>spare parts for</b>  | 370318   |                 |                     |
|          | <b>GEV No.</b>   | 371158          | <b>Ref. No.</b> N/A |
| solenoid coil 24VAC 10VA SIRAI coil type Z614A seat ø 10mm                                  |  |                 |                     |
|          | <b>GEV No.</b>   | 371164          | <b>Ref. No.</b> N/A |
| membrane connection 3/8"-1/2" series L145-R membrane type PTFE                              |  |                 |                     |
| <b>accessories for</b>  | 370318   |                 |                     |
|          | <b>GEV No.</b>   | 371091          | <b>Ref. No.</b> N/A |
| power socket plug type DIN 43650B cable lengthmm small                                      |  |                 |                     |

|  |  |                 |                     |
|--|--|-----------------|---------------------|
|  <p>1</p> |  |                 |                     |
| <b>GEV No.</b>   | 370326   | <b>Ref. No.</b> | 33D0560             |
| <b>description</b>   | solenoid valve 2-ways 230VAC connection 1" L 105mm DN 22mm slide-on receptacle DIN -10 up to 140°C SIRAI type series L153-D coil type Z914A membranes EPDM (steam/water) p max 8bar p min 0.1bar |                 |                     |
| <b>spare parts for</b>   | 370326   |                 |                     |
|           | <b>GEV No.</b>   | 371161          | <b>Ref. No.</b> N/A |
| solenoid coil 230VAC 27VA SIRAI coil type Z923A seat ø 16mm 50Hz                           |  |                 |                     |

|  |  |                 |                     |
|--|--|-----------------|---------------------|
| spare parts and accessories  |  |                 |                     |
| solenoid coils   |  |                 |                     |
|  <p>1</p> |  |                 |                     |
| <b>GEV No.</b>   | 371071   | <b>Ref. No.</b> | 32Z5470             |
| <b>description</b>   | solenoid coil 230VAC 10VA SIRAI coil type Z610A seat ø 10mm H 33mm L 33mm W 25mm 50/60Hz |                 |                     |
| <b>accessories for</b>   | 371071   |                 |                     |
|         | <b>GEV No.</b>   | 371091          | <b>Ref. No.</b> N/A |
| power socket plug type DIN 43650B cable lengthmm small                                     |  |                 |                     |

|  |   |                 |     |
|--|---|-----------------|-----|
|  <p>1</p> |   |                 |     |
| <b>GEV No.</b>   | 371067  | <b>Ref. No.</b> | N/A |
| <b>description</b>   | solenoid coil 230VAC 14VA SIRAI coil type Z534A seat ø 12mm |                 |     |

|  |  |                 |     |
|--|--|-----------------|-----|
|  <p>1</p> |  |                 |     |
| <b>GEV No.</b>   | 371161   | <b>Ref. No.</b> | N/A |
| <b>description</b>   | solenoid coil 230VAC 27VA SIRAI coil type Z923A seat ø 16mm 50Hz |                 |     |



Зип Общепит  
vsezip.ru  
7(812)987-08-81



|                        |  |                 |                 |     |
|------------------------|--|-----------------|-----------------|-----|
| <b>GEV No.</b>         | 371070   | <b>Ref. No.</b> | N/A             |     |
| <b>description</b>     | solenoid coil 24VAC 10VA SIRAI coil type Z610A seat ø 10mm |                 |                 |     |
| <b>accessories for</b> | 371070   |                 |                 |     |
|                        | <b>GEV No.</b>   | 371091          | <b>Ref. No.</b> | N/A |
|                        | power socket plug type DIN 43650B cable lengthmm small     |                 |                 |     |



|                        |  |                 |                 |     |
|------------------------|--|-----------------|-----------------|-----|
| <b>GEV No.</b>         | 371158   | <b>Ref. No.</b> | N/A             |     |
| <b>description</b>     | solenoid coil 24VAC 10VA SIRAI coil type Z614A seat ø 10mm |                 |                 |     |
| <b>accessories for</b> | 371158   |                 |                 |     |
|                        | <b>GEV No.</b>   | 371091          | <b>Ref. No.</b> | N/A |
|                        | power socket plug type DIN 43650B cable lengthmm small     |                 |                 |     |



|                        |   |                 |                 |     |
|------------------------|---|-----------------|-----------------|-----|
| <b>GEV No.</b>         | 371099  | <b>Ref. No.</b> | N/A             |     |
| <b>description</b>     | solenoid coil 24VDC 5.5VA SIRAI coil type ZB10A seat ø 10mm |                 |                 |     |
| <b>accessories for</b> | 371099  |                 |                 |     |
|                        | <b>GEV No.</b>  | 371091          | <b>Ref. No.</b> | N/A |
|                        | power socket plug type DIN 43650B cable lengthmm small      |                 |                 |     |

membranes



|                    |  |                 |     |
|--------------------|--|-----------------|-----|
| <b>GEV No.</b>     | 371163   | <b>Ref. No.</b> | N/A |
| <b>description</b> | membrane connection 1/2" series L140-B membrane type NBR (water) |                 |     |



|                    |  |                 |     |
|--------------------|--|-----------------|-----|
| <b>GEV No.</b>     | 371172   | <b>Ref. No.</b> | N/A |
| <b>description</b> | membrane connection 3/4" series L180-B membrane type NBR (water) |                 |     |



|                    |  |                 |     |
|--------------------|--|-----------------|-----|
| <b>GEV No.</b>     | 371164   | <b>Ref. No.</b> | N/A |
| <b>description</b> | membrane connection 3/8"-1/2" series L145-R membrane type PTFE |                 |     |



|                    |  |                 |     |
|--------------------|--|-----------------|-----|
| <b>GEV No.</b>     | 371170   | <b>Ref. No.</b> | N/A |
| <b>description</b> | membrane series L180-B membrane type NBR (water) |                 |     |



|                    |  |                 |     |
|--------------------|--|-----------------|-----|
| <b>GEV No.</b>     | 371171   | <b>Ref. No.</b> | N/A |
| <b>description</b> | membrane series L180-B membrane type NBR (water) |                 |     |

solenoid valves (gas)

BRAHMA

solenoid valves



|                        |   |                 |                 |   |
|------------------------|---|-----------------|-----------------|---|
| <b>GEV No.</b>         | 101948 <sup>1</sup>   | <b>Ref. No.</b> | 33A1650         |   |
| <b>description</b>     | solenoid valve 230VAC DN 15mm connection 1/2" L 72mm BRAHMA coil type 18811003 p max 0.5bar reg. no. 63AQ0626 |                 |                 |   |
| <b>For models:</b>     | 1A1PI2G, 1A1PI2GA, 1D1PI2G, 1D1PI2GA, 291PI3G, 2A1PI3G, 2D1PI3G   |                 |                 |   |
| <b>spare parts for</b> | 101948  |                 |                 |   |
|                        | <b>GEV No.</b>  | 101968          | <b>Ref. No.</b> | — |
|                        | solenoid valve 230VAC 20VA seat ø 17mm coil type 13902001 BRAHMA  |                 |                 |   |

<sup>1</sup>aluminium housing

spare parts and accessories

solenoid coils



|                    |   |                 |         |
|--------------------|---|-----------------|---------|
| <b>GEV No.</b>     | 106242  | <b>Ref. No.</b> | 32V3640 |
| <b>description</b> | solenoid coil 230VAC 20VA seat ø 17mm                           |                 |         |
| <b>For models:</b> | 1A1PI2G, 1A1PI2GA, 1D1PI2G, 1D1PI2GA, 291PI3G, 2A1PI3G, 2D1PI3G |                 |         |



solenoid valves (refrigeration)

Зип.Общепит pressure switches

vsezip.ru

+7(812)987-08-81

CASTEL

spare parts and accessories



|                    |   |                 |     |
|--------------------|---|-----------------|-----|
| <b>GEV No.</b>     | 371090                                  | <b>Ref. No.</b> | N/A |
| <b>description</b> | power socket plug type DIN 43650A screw |                 |     |

PARKER

valves



|                    |  |                 |         |
|--------------------|--|-----------------|---------|
| <b>GEV No.</b>     | 370611   | <b>Ref. No.</b> | 33A0510 |
| <b>description</b> | solenoid valve 2-way 230V 1.9 tube $\phi$ 6mm coil type ZB09 50/60Hz   |                 |         |
| <b>For models:</b> | 120, 120NN, 120PV, 135, 135-4, 135BN, 135BNX, 135CPX, 135NN, 135NNX, 135PVX, 135X, 135X-3, 135X-4, 40CP, 40CPX, 55, 55PV, 65, 65NB, 65NBX, 65NN, 65NNX, 65PVX, 65X, 65X-2, 6BEA11A, 6BEA11B, 6BEA11M, 6BEA11Z, 6BEA2A, 6BEA2B, 6BEA2M, 6BEA2Z, 6BEA3A, 6BEA3B, 6BEA3M, 6BEA3Z, 6BEA4, 6BEA4B, 6BEA4M, 6BEA4Z, 6BEB11A, 6BEB11B, 6BEB11M, 6BEB11Z, 6BEB22A, 6BEB22B, 6BEB22M, 6BEB22Z...(Other models you can see in the webshop) |                 |         |

Solenoid valve - accessories

filters



|                    |   |                 |     |
|--------------------|---|-----------------|-----|
| <b>GEV No.</b>     | 370467                                  | <b>Ref. No.</b> | N/A |
| <b>description</b> | solenoid valve filter suitable for ELBI |                 |     |



|                    |  |                 |     |
|--------------------|--|-----------------|-----|
| <b>GEV No.</b>     | 371091   | <b>Ref. No.</b> | N/A |
| <b>description</b> | power socket plug type DIN 43650B cable lengthmm small |                 |     |

for warewashing

$\phi$  58mm with male faston 6.3mm

with connection horizontal



|                    |                     |                 |         |
|--------------------|---------------------|-----------------|---------|
| <b>GEV No.</b>     | 541192              | <b>Ref. No.</b> | 32Z7190 |
| <b>description</b> | pressure control    |                 |         |
| <b>For models:</b> | LT10R, LT20F, LT25F |                 |         |



|                    |  |                 |         |
|--------------------|--|-----------------|---------|
| <b>GEV No.</b>     | 541011   | <b>Ref. No.</b> | 32Z4690 |
| <b>description</b> | pressure control pressure range 110/70mbar connection 6mm $\phi$ 58mm pressure connection horizontal warewashing |                 |         |



|                    |  |                 |         |
|--------------------|--|-----------------|---------|
| <b>GEV No.</b>     | 541331   | <b>Ref. No.</b> | 32Z0860 |
| <b>description</b> | pressure control pressure range 225/70mbar connection 6mm $\phi$ 58mm pressure connection horizontal warewashing |                 |         |
| <b>For models:</b> | L100, L80, LCV   |                 |         |



|                    |  |                 |         |
|--------------------|--|-----------------|---------|
| <b>GEV No.</b>     | 541314   | <b>Ref. No.</b> | 32V7060 |
| <b>description</b> | pressure control pressure range 46/26mbar connection 6mm $\phi$ 58mm pressure connection horizontal warewashing pressure connection $\phi$ 6mm   |                 |         |
| <b>For models:</b> | KD100, KD100A, KD100PSD, KD130A, KD130E, KD130EAT, KD37, KD37PS, KD37-VERS.112009, KD40, KD40EPSD, KD40LEPS, KD40LSPS, KD40LUX, KD40LUXE, KD40PS, KD40-VERS.112009, KD60, KD60E, KD60EAT, KD60M, KD60MA, KD60ME, KD60MPS, KD60MPSA, KD60PS, KD60PSD, KD6EATSD, KD85A, KD85EA, KD85EAT, KD85EATS, KD85EPSA, KD85PSA, KN1100, KN1100SD, KN11PSDD, KN35, KN37, KN37PS, KN40, KN40PS, KN40PSD, KN50, KN50M, KN50MPS, KN50PS, KN50PSD, KN50PSDD, KN80...(Other models you can see in the webshop) |                 |         |

electric components





Зип Общепит

vsezip.ru

7(812)987 08 81

|   |  |                 |         |
|---|--|-----------------|---------|
|  |  |                 |         |
| 1   |  |                 |         |
| <b>GEV No.</b>  | 541010   | <b>Ref. No.</b> | 32Z1700 |
| <b>description</b>  | pressure control pressure range 50/30mbar connection 6mm ø 58mm pressure connection horizontal warewashing |                 |         |

|   |  |                 |         |
|---|--|-----------------|---------|
|  |  |                 |         |
| 1   |  |                 |         |
| <b>GEV No.</b>  | 541194   | <b>Ref. No.</b> | 32Z2170 |
| <b>description</b>  | pressure control pressure range 50/32mbar connection male faston 6.3mm ø 58mm pressure connection horizontal warewashing pressure connection ø 6mm |                 |         |

|   |  |                 |                    |
|---|--|-----------------|--------------------|
|  |  |                 |                    |
| 1   |  |                 |                    |
| <b>GEV No.</b>  | 541140   | <b>Ref. No.</b> | 32V7060<br>32Z2170 |
| <b>description</b>  | pressure control pressure range 55/30mbar connection 6mm ø 58mm pressure connection horizontal warewashing |                 |                    |

|   |  |                 |         |
|---|--|-----------------|---------|
|  |  |                 |         |
| 1   |  |                 |         |
| <b>GEV No.</b>  | 541012   | <b>Ref. No.</b> | 32Z0280 |
| <b>description</b>  | pressure control pressure range 68/40mbar connection 6mm ø 58mm pressure connection horizontal warewashing pressure connection ø 6mm |                 |         |

|   |  |                 |                    |
|---|--|-----------------|--------------------|
|  |  |                 |                    |
| 1   |  |                 |                    |
| <b>GEV No.</b>  | 541330   | <b>Ref. No.</b> | 32Z4740<br>32Z4741 |
| <b>description</b>  | pressure control pressure range 70/30mbar connection 6mm ø 58mm pressure connection horizontal warewashing pressure connection ø 6mm |                 |                    |
| <b>For models:</b>  | F60P, F60PR, F60T, F80P, F80PR, L40, L40S, L45, L60, LCV   |                 |                    |

|  |  |                 |         |
|--|--|-----------------|---------|
|  |  |                 |         |
| 1  |  |                 |         |
| <b>GEV No.</b>   | 541311   | <b>Ref. No.</b> | 32Z0070 |
| <b>description</b>   | pressure control pressure range 76/38mbar connection 6mm ø 58mm pressure connection horizontal warewashing pressure connection ø 6mm |                 |         |

|  |  |                 |         |
|--|--|-----------------|---------|
|  |  |                 |         |
| 1  |  |                 |         |
| <b>GEV No.</b>   | 541312   | <b>Ref. No.</b> | 32V7080 |
| <b>description</b>   | pressure control pressure range 86/59mbar connection 6mm ø 58mm pressure connection horizontal warewashing pressure connection ø 6mm |                 |         |
| <b>For models:</b>   | KD100, KD100A, KD100PSD, KD40EPSD, KD40LEPS, KD40LUXE, LP151   |                 |         |

|   |  |                 |                    |
|---|--|-----------------|--------------------|
|  |  |                 |                    |
| 1   |  |                 |                    |
| <b>GEV No.</b>  | 541168   | <b>Ref. No.</b> | 32V1870<br>32Z8880 |
| <b>description</b>  | pressure control pressure range 90/35mbar connection 6mm ø 58mm pressure connection horizontal warewashing pressure connection ø 6mm   |                 |                    |
| <b>For models:</b>  | C165D, C165S, C165VD, C165VS, C207D, C207S, C207VD, C207VD-VERS.2006, C207VS, C207VS-VERS.2006, C304AD, C304AS, C304AVD, C304AVD-VERS.2006, C304AVS, C304AVS-VERS.2006, C304D, C304S, C304VD, C304VD-VERS.2006, C304VS, C304VS-VERS.2006, C92VD-VERS.2006, C92VS-VERS.2006, LC100, LC100-VERS.2001, LC130, LC130-VERS.2001, LC80, N303S, N303VD, N303VS, N354D, N354VD, N354VS, N506D, N506VD, N506VS, N607D, N607VD, N607VS, N760S, N760VD, N760VS, N886D, N886VD, N886VS |                 |                    |

|  |   |                 |         |
|--|---|-----------------|---------|
|  |   |                 |         |
| 1  |   |                 |         |
| <b>GEV No.</b>   | 541017  | <b>Ref. No.</b> | 32Z8930 |
| <b>description</b>   | pressure control with mounting strap pressure range 40/20mbar connection 6mm ø 58mm pressure connection horizontal warewashing  |                 |         |
| <b>For models:</b>   | CS243S, CS243VS, CS370AS, CS370AVS, CS370S, CS370VS, CS466AS, CS466AVS, CS466VS, LF50, LF50E, LF50EM, LF50E-VERS.2007, N303D, N303S, N303VD, N303VS, N354D, N354S, N354VD, N354VS, N506D, N506S, N506VD, N506VS, N607D, N607S, N607VD, N607VS, N760D, N760S, N760VD, N760VS, N886D, N886S, N886VD, N886VS |                 |         |



Зип Общепит

vsezip.ru

+7(812)987-08-81



1

|                    |  |                 |         |
|--------------------|--|-----------------|---------|
| <b>GEV No.</b>     | 541199   | <b>Ref. No.</b> | 6300569 |
| <b>description</b> | pressure control pressure range 0.2-3.0mbar ø 74mm pressure connection ø 6.3mm   |                 |         |
| <b>For models:</b> | FC1011G, FC1221G, FC611G, FM1011G1, FM1011G1-VERS.2006, FM1011G2, FM1011G2-VERS.2006, FM1011G3, FM1011G3-VERS.2006, FM1221G1, FM1221G1-VERS.2006, FM1221G2, FM1221G2-VERS.2006, FM1221G3, FM1221G3-VERS.2006, FM2011G2-VERS.2006, FM2011G3-VERS.2006, FM2021G1, FM2021G2, FM2021G2-VERS.2006, FM2021G3, FM2021G3-VERS.2006, FM611G1, FM611G1-VERS.2006, FM611G2, FM611G2-VERS.2006, FM611G3, FM611G3-VERS.2006, FM721G1, FM721G1-VERS.2006, FM721G2, FM721G2-VERS.2006, FM721G3, FM721G3-VERS.2006 |                 |         |



1

|                    |  |                 |                    |
|--------------------|--|-----------------|--------------------|
| <b>GEV No.</b>     | 541575   | <b>Ref. No.</b> | 3004460<br>3004461 |
| <b>description</b> | pressure control ø 45.5mm pressure range 400/200mbar 1CO pressure connection vertical convection oven connection male faston 6.3mm suitable for ANGELO PO 250V p max 1bar 6A pressure connection 1/8"  |                 |                    |
| <b>For models:</b> | FM1011E3, FM1011E3-VERS.2006, FM1011G3, FM1011G3-VERS.2006, FM1221E3, FM1221E3-VERS.2006, FM1221G3, FM1221G3-VERS.2006, FM2011E3-VERS.2006, FM2011G3-VERS.2006, FM2021E3, FM2021E3-VERS.2006, FM2021G3, FM2021G3-VERS.2006, FM611E3, FM611E3-VERS.2006, FM611G3, FM611G3-VERS.2006, FM721E3, FM721E3-VERS.2006, FM721G3, FM721G3-VERS.2006 |                 |                    |

ø 79mm with coded plug



1

|                    |   |                 |         |
|--------------------|---|-----------------|---------|
| <b>GEV No.</b>     | 541332  | <b>Ref. No.</b> | 32Z2840 |
| <b>description</b> | pressure control 2 pressure ranges pressure range 70/40 90/70mbar connection coded plug ø 78mm pressure connection horizontal warewashing pressure connection ø 6mm at 250V 16A |                 |         |
| <b>For models:</b> | F60PR, F60T, F80P, F80PR  |                 |         |

for pasta cookers



1

|                    |   |                 |         |
|--------------------|---|-----------------|---------|
| <b>GEV No.</b>     | 541980  | <b>Ref. No.</b> | 6300988 |
| <b>description</b> | conversion kit for drain pump pressure range 300/245 385/300bar 0G1CP1G |                 |         |

for combi-steamers



1

|   |   |                 |  |
|---|---|-----------------|--|
| <b>GEV No.</b>  | 541806  | <b>Ref. No.</b> | 3041830<br>32Z5870<br>32Z5871<br>32Z5872 |
| <b>description</b>  | pressure control ø 38mm pressure range 0.2-3.0bar connection 1/8" 250V 10A GP600 pressure connection 1/8"   |                 |  |
| <b>For models:</b>  | BX101E, BX101E-VERS.122013, BX101G, BX101G-VERS.122013, BX122E, BX122E-VERS.122013, BX122G, BX122G-VERS.122013, BX61E, BX61E-VERS.122013, BX61G, BX61G-VERS.122013, BX82E, BX82E-VERS.122013, BX82G, BX82G-VERS.122013, FCV101, FCV101-CSA, FCV101DM, FCV101DM-CSA, FCV101DS, FCV101DS-CSA, FCV101E, FCV101EDM, FCV101EDM-UL, FCV101EDS, FCV101EDS-UL, FCV101E-UL, FCV141, FCV141-CSA, FCV141DM, FCV141DM-CSA, FCV141DS, FCV141DS-CSA, FCV141E, FCV141EDM, FCV141EDS, FCV241, FCV241DM, FCV241DS, FCV241E, FCV241EDM, FCV241EDM-UL, FCV241EDS, FCV241EDS-UL, FCV241E-UL, FCV241G, FCV241G-CSA, FCV241GDM, FCV241GDM-CSA...(Other models you can see in the webshop) |                 |  |
| <b>accessories for</b>  | 541806  |                 |  |
|  | <b>GEV No.</b>  | 541814          | <b>Ref. No.</b> —                        |
|   | protection cap for pressure switch EPDM XP600   |                 |  |



1

|                    |   |                 |                    |
|--------------------|---|-----------------|--------------------|
| <b>GEV No.</b>     | 542229  | <b>Ref. No.</b> | 3160100<br>3253760 |
| <b>description</b> | pressure control pressure range 350/265mbar connection 5.5  |                 |                    |
| <b>For models:</b> | 04WCP1EM, 06WCP1GM, 08WCP1GM, 091CP1E, 091CP1G, 191CP1G, 191CP2G, 1G1CP1G-VERS.2004, 6040090, 6040310 |                 |                    |



1

|                    |  |                 |         |
|--------------------|--|-----------------|---------|
| <b>GEV No.</b>     | 541482   | <b>Ref. No.</b> | 3017600 |
| <b>description</b> | pressure control pressure range 385/325mbar connection 6mm   |                 |         |
| <b>For models:</b> | 04WCP1EM, 06WCP1GM, 08WCP1GM, 091CP1E, 091CP1G, 0G1CP1EC, 0G1CP1E-VERS.2004, 0G1CP1G-VERS.2004, 191CP1G, 191CP2G, 1G1CP1G-VERS.2004, 1G1CP2G-VERS.2004 |                 |         |



for boiling pans



1

|                    |   |                 |         |
|--------------------|---|-----------------|---------|
| <b>GEV No.</b>     | 541510  | <b>Ref. No.</b> | 32V1790 |
| <b>description</b> | pressure control EGO  |                 |         |
| <b>For models:</b> | 1A1PI2G, 1A1PI2GA, 1D1PI2G, 1D1PI2GA, 291PI3E, 291PI3G, 2A1PI3E, 2A1PI3G, 2D1PI3G, MCF20E, MCF20V, MCF40E, MCF40V |                 |         |

for refrigeration

RANCO

G60 series



1

|                    |   |                 |         |
|--------------------|---|-----------------|---------|
| <b>GEV No.</b>     | 541195  | <b>Ref. No.</b> | 32Z6350 |
| <b>description</b> | pressure control RANCO G60H1129401              |                 |         |
| <b>For models:</b> | 120NN, 65NB, 65NBX, 65NN, 65NNX, SP65NB, SP65NN |                 |         |

compressors

ACC/ZEL

R134A

HMBP monophase

*High/Medium evaporation temperature above -20/-15 °C*

1

|                    |   |                 |         |
|--------------------|---|-----------------|---------|
| <b>GEV No.</b>     | 605007  | <b>Ref. No.</b> | 34D6390 |
| <b>description</b> | compressor coolant R134a type GL60TB 220-240V 50Hz HMBP fully hermetic 9.5kg 1/5HP power input 437W cylinder capacity 5.7cm <sup>3</sup> CSIR H 175.5mm 95W 128W 170W 222W 284W 355W 437W 528W test method ASHRAE ambient temperature max. 43°C   |                 |         |
| <b>For models:</b> | 40CP, 40CPX, 65A, 65XE, 6FMA11A, 6FMA11B, 6FMA11M, 6FMA11Z, 6FMA2A, 6FMA2B, 6FMA2M, 6FMA2Z, 6FMA4A, 6FMA4B, 6FMA4M, 6FMA4Z, 6FMAA, 6FMAB, 6FMAM, 6FMAZ, 6TRA, 6TRA2, 6TRA2A, 6TRA2M, 6TRA2Z, 6TRA4, 6TRA4A, 6TRA4M, 6TRA4Z, 6TRAA, 6TRAM, 6TRAZ, CX140CP, CX150CP, CX65NB, CX65NCP, CX65NN, CX70NB, CX70NN, FM1A, FM1A-11, FM1A-2, FM1A-4, S60, S60-2, S60E, S60X, S60X-2, SA87 |                 |         |

Зип Общепит

vsezip.ru

+7(812)987-08-81



1

|                    |   |                 |         |
|--------------------|---|-----------------|---------|
| <b>GEV No.</b>     | 605008  | <b>Ref. No.</b> | 34D6500 |
| <b>description</b> | compressor coolant R134a type GL80TB 220-240V 50Hz HMBP fully hermetic 9.5kg 1/5HP power input 554W cylinder capacity 7.6cm <sup>3</sup> CSIR H 175.5mm 165W 215W 290W 390W 500W 615W 727W 840W test method ASHRAE ambient temperature max. 43°C  |                 |         |
| <b>For models:</b> | 55, 55PV, 6JB, 6JB2, 6JB2A, 6JB2M, 6JB4A, 6JB4M, 6JBA, 6JBM, 6SMB, 6SMB2, 6SMB2A, 6SMB2B, 6SMB2M, 6SMB2Z, 6SMB4, 6SMB4A, 6SMB4B, 6SMB4M, 6SMB4Z, 6SMB6Z, 6SMB6A, 6SMB6B, 6SMB6M, 6SMBZ, PE1633, PE1633V, PZ20, PZ2033A, PZ2033B, PZ2037A, PZ2037B |                 |         |



1

|                    |   |                 |         |
|--------------------|---|-----------------|---------|
| <b>GEV No.</b>     | 605009  | <b>Ref. No.</b> | 34D6510 |
| <b>description</b> | compressor coolant R134a type GL90TB 220-240V 50Hz HMBP fully hermetic 10.8kg 1/4HP power input 293W cylinder capacity 8.8cm <sup>3</sup> CSIR H 175.5mm 143W 194W 259W 339W 432W 539W 661W 796W test method ASHRAE   |                 |         |
| <b>For models:</b> | 6FMB11A, 6FMB11B, 6FMB11M, 6FMB11Z, 6FMB2A, 6FMB2B, 6FMB2M, 6FMB2Z, 6FMB4A, 6FMB4B, 6FMB4M, 6FMB4Z, 6FMB6A, 6FMB6B, 6FMB6M, 6FMB6Z, 6FMC11A, 6FMC11B, 6FMC11M, 6FMC11Z, 6FMC2A, 6FMC2B, 6FMC2M, 6FMC2Z, 6FMC4A, 6FMC4B, 6FMC4M, 6FMC4Z, 6FMC6A, 6FMC6B, 6FMC6M, 6FMC6Z, 6TRB, 6TRB11, 6TRB11A, 6TRB11M, 6TRB11Z, 6TRB2, 6TRB2A, 6TRB2M, 6TRB2Z, 6TRB4, 6TRB4A, 6TRB4M, 6TRB4Z, 6TRB6, 6TRB6A, 6TRB6M, 6TRB6Z, 6TRBA...(Other models you can see in the webshop) |                 |         |





Зип Общепит

EMBRACE / ASTERA

vsezip.ru

R134A  
1HP multiphase

High evaporation temperature above -15°C

+7(812)987-08-81



1

|                    |   |                 |                    |
|--------------------|---|-----------------|--------------------|
| <b>GEV No.</b>     | 605010  | <b>Ref. No.</b> | 34D6520<br>34D6760 |
| <b>description</b> | compressor coolant R134a type GP12TB 220-240V 50Hz HMBP fully hermetic 11.2kg 3/8HP power input 661W cylinder capacity 12cm <sup>3</sup> CSIR H 203.6mmW 143W 194W 259W 339W 432W 539W 661W 796W test method ASHRAE ambient temperature max. 43°C   |                 |                    |
| <b>For models:</b> | 120, 120NN, 120PV, 135, 135-4, 135A, 135NN, 135NNX, 135PVX, 135X, 135X-3, 135X-4, 135XE, 65NN, 65NNX, 65PVX, 6SMC, 6SMC2, 6SMC2A, 6SMC2B, 6SMC2M, 6SMC2Z, 6SMC4, 6SMC4A, 6SMC4B, 6SMC4M, 6SMC4Z, 6SMC6, 6SMC6A, 6SMC6B, 6SMC6M, 6SMC6Z, 6SMC8Z, 6SMCA, 6SMCB, 6SMCM, 6SMCZ, 6TRC, 6TRC11, 6TRC11A, 6TRC11M, 6TRC11Z, 6TRC2, 6TRC2A, 6TRC2M, 6TRC2Z, 6TRC4, 6TRC4A, 6TRC4M, 6TRC4Z...(Other models you can see in the webshop) |                 |                    |



1

|                    |  |                 |         |
|--------------------|--|-----------------|---------|
| <b>GEV No.</b>     | 605209   | <b>Ref. No.</b> | 34D5490 |
| <b>description</b> | compressor coolant R134a type NEK6187Z-A 220-240V 50Hz HBP 11kg 1/3HP cylinder capacity 10cm <sup>3</sup> CSIR H 200mmWWW 365W 482W 624W 791W 983W 1201W test method EN 12900 ambient temperature max. 55°C  |                 |         |
| <b>For models:</b> | 6BEC11A, 6BEC11B, 6BEC11M, 6BEC11Z, 6BEC22A, 6BEC22B, 6BEC22M, 6BEC22Z, 6BEC2A, 6BEC2B, 6BEC2M, 6BEC2Z, 6BEC33A, 6BEC33B, 6BEC33M, 6BEC33Z, 6BEC3A, 6BEC3B, 6BEC3M, 6BEC3Z, 6BEC4A, 6BEC4B, 6BEC4M, 6BEC4Z, 6BEC6A, 6BEC6B, 6BEC6M, 6BEC6Z, 6BECA, 6BECB, 6BECM, 6BECZ, 6BMB11A, 6BMB11B, 6BMB11M, 6BMB11Z, 6BMB22A, 6BMB22B, 6BMB22M, 6BMB22Z, 6BMB2A, 6BMB2B, 6BMB2M, 6BMB2Z, 6BMB3A, 6BMB3B, 6BMB3M, 6BMB3Z, 6BMB4A, 6BMB4B...(Other models you can see in the webshop) |                 |         |

CUBIGEL

accessories



1

|                    |  |                 |         |
|--------------------|--|-----------------|---------|
| <b>GEV No.</b>     | 380091   | <b>Ref. No.</b> | 32Z6920 |
| <b>description</b> | start relay MTRP0027 120/240V voltage AC 8A 1NO  |                 |         |
| <b>For models:</b> | 135CPX, 55, 55PV, 6BEA11A, 6BEA11B, 6BEA11M, 6BEA2A, 6BEA2B, 6BEA2M, 6BEA3A, 6BEA3B, 6BEA3M, 6BEA4, 6BEA5, 6BEAM, 6BEB11A, 6BEB11B, 6BEB11M, 6BEB22A, 6BEB22B, 6BEB22M, 6BEB2A, 6BEB2B, 6BEB2M, 6BEB3A, 6BEB3B, 6BEB3M, 6BEB4A, 6BEB4B, 6BEB4M, 6BEBA, 6BEBB, 6BEBM, 6BMA11A, 6BMA11B, 6BMA11M, 6BMA2A, 6BMA2B, 6BMA2M, 6BMA3A, 6BMA3B, 6BMA3M, 6BMAA, 6BMAB, 6BMAM, 6FMA11A, 6FMA11B, 6FMA11M, 6FMA2A, 6FMA2B...(Other models you can see in the webshop) |                 |         |

accessories

starting relays

klixons



1

|                    |   |                 |         |
|--------------------|---|-----------------|---------|
| <b>GEV No.</b>     | 380094  | <b>Ref. No.</b> | 32Z1050 |
| <b>description</b> | start relay 120/240V voltage AC 8A 1NO 1NO 1-pole |                 |         |

overload protector (klixon)



1

|                    |   |                 |         |
|--------------------|---|-----------------|---------|
| <b>GEV No.</b>     | 390597  | <b>Ref. No.</b> | 32Z1030 |
| <b>description</b> | overload protector for engine protective circuit breaker MRP77A-MN_3001 with cable t.max. 150°C reset automatic |                 |         |

electric components



electric components

Зип.Общепит

axial fans  
vsezip.ru  
ebm-papst

+7(812)987-08-81

|   |  |                 |         |
|---|--|-----------------|---------|
|  |  |                 |         |
| 1   |  |                 |         |
| <b>GEV No.</b>  | 390599   | <b>Ref. No.</b> | 32Z6930 |
| <b>description</b>  | overload protector for engine protective curcuit breaker T0318/22 with cable t.max. 150°C reset automatic  |                 |         |
| <b>For models:</b>  | 135CPX, 55, 55PV, 6BEA11A, 6BEA11B, 6BEA11M, 6BEA2A, 6BEA2B, 6BEA2M, 6BEA3A, 6BEA3B, 6BEA3M, 6BEAA, 6BEAB, 6BEAM, 6BEB11A, 6BEB11B, 6BEB11M, 6BEB22A, 6BEB22B, 6BEB22M, 6BEB2A, 6BEB2B, 6BEB2M, 6BEB3A, 6BEB3B, 6BEB3M, 6BEB4A, 6BEB4B, 6BEB4M, 6BEBA, 6BEBB, 6BEBM, 6BMA11A, 6BMA11B, 6BMA11M, 6BMA2A, 6BMA2B, 6BMA2M, 6BMA3A, 6BMA3B, 6BMA3M, 6BMAA, 6BMAB, 6BMAM, 6FMA11A, 6FMA11B, 6FMA11M, 6FMA2A, 6FMA2B...(Other models you can see in the webshop) |                 |         |

|  |   |                 |                   |
|--|---|-----------------|-------------------|
|  |   |                 |                   |
| 1  |   |                 |                   |
| <b>GEV No.</b>   | 601082 <sup>1</sup>   | <b>Ref. No.</b> | 3076620           |
| <b>description</b>   | axial fan L 92mm W 92mm H 25mm 230VAC 50/60Hz 9/11W bearing ball bearing manuf. no. 3956 metal connection male faston 2.8mm ebm-papst fan wheel ø 85mm temp.-resist. 80°C |                 |                   |
| <b>For models:</b>   | 04WPEBV, 08WPEBV, 08WTPEV, 090PEB, 091FR1EX, 091FR1IA, 091FR7G, 091FR7GS, 091FR7GX, 190PEB, 190TPE, 6BM, 6BR, 6CP, 6FR, 6FTL, 6FTR, 6PC, 6VTR, 6VTR2                      |                 |                   |
| <b>accessories for</b>   | 601082  |                 |                   |
|   | <b>GEV No.</b>  | 691103          | <b>Ref. No.</b> — |
|  | guard ø 90mm mounting distance 83mm for axial fan 92mm  |                 |                   |

<sup>1</sup>with ball bearings

|  |   |                 |                    |
|--|---|-----------------|--------------------|
| import   |   |                 |                    |
|  |   |                 |                    |
| 1  |   |                 |                    |
| <b>GEV No.</b>   | 601604 <sup>1</sup>   | <b>Ref. No.</b> | 32M7130<br>32V5790 |
| <b>description</b>   | axial fan L 119mm W 119mm H 38mm 230VAC 50/60Hz 17/15W bearing slide bearing manuf. no. AA1282HS-AT connection cable 300mm fan wheel ø 110mm temp.-resist. 70°C input current 0.1A airflow 130m <sup>3</sup> /h 2600rpm |                 |                    |



<sup>1</sup>with slide bearings

## evaporation and condensing trays

### condensing trays heated

universal

heating cartridges

|   |  |                 |                   |
|---|--|-----------------|-------------------|
|    |  |                 |                   |
| 1   |  |                 |                   |
| <b>GEV No.</b>  | 418892   | <b>Ref. No.</b> | 32G3310           |
| <b>description</b>  | heating cartridge 300W 230V ø 12mm L 240mm thread 3/8" cable length 2000mm immersion heater  |                 |                   |
| <b>For models:</b>  | AF1N, AF1N-0PR01, AF2N, AF2N-0PR01, CX120, CX120NN, CX130, CX130NN, CX140, CX140BN, CX140BR, CX140CP, CX140NN, CX140PV, CX140R, CX150, CX150BN, CX150BR, CX150CP, CX150NN, CX150PV, CX150R, CX55, CX60, CX65, CX652, CX65BR, CX65NB, CX65NCP, CX65NN, CX65PV, CX65R, CX70, CX702, CX70BR, CX70NB, CX70NN, CX70PV, CX70R, FSD1N, FSD2N, FSD2N2, FSDR1B-0PR01, FSDR1N-0PR01, FSDR2B-0PR01, FSDR2B2-0PR01, FSDR2N, FSDR2N-0PR01, FSDR2N2-0PR01, FSE2N...(Other models you can see in the webshop) |                 |                   |
| <b>accessories for</b>  | 418892   |                 |                   |
|  | <b>GEV No.</b>   | 511472          | <b>Ref. No.</b> — |
|   | nut thread 3/8" H 4mm brass WS 21 Qty 1 pcs  |                 |                   |
|  | <b>GEV No.</b>   | 518393          | <b>Ref. No.</b> — |
|   | flat gasket FIBER ED ø 24mm ID ø 17mm thickness 2mm Qty 1 pcs  |                 |                   |



Зип-Общепит

vsezip.ru

+7(812)9870881



1

|                        |   |                 |                    |
|------------------------|---|-----------------|--------------------|
| <b>GEV No.</b>         | 601055 <sup>1</sup>   | <b>Ref. No.</b> | 3113740<br>3205930 |
| <b>description</b>     | axial fan L 92mm W 92mm H 25mm 230VAC 50/60Hz 14.5/14W bearing ball bearing connection male faston 2.8mm metal ADDA fan wheel ø 85mm temp.-resist. 70°C   |                 |                    |
| <b>For models:</b>     | 08WPBEV, 08WTPEV, 090PEB, 091FR11, 091FR11D, 091PEB, 10CP1EA, 10CP1IA, 12CP1EA, 12CP1IA, 18CP2EA, 18CP2IA, 190PEB, 190TPE, 191FR2I, 191FR2ID, 191PEB, 191TPE, 2091SCP, FX101E1, FX101E1R, FX101E2, FX101E2C, FX101E2C-VERS.032014, FX101E2R, FX101E2R-VERS.032014, FX101E2-VERS.032014, FX101E3, FX101E3C, FX101E3C-VERS.022014, FX101E3R, FX101E3R-VERS.022014, FX101E3-VERS.022014, FX101G1, FX101G1R, FX101G2, FX101G2C, FX101G2C-VERS.032014, FX101G2R, FX101G2R-VERS.032014, FX101G2-VERS.032014, FX101G3, FX101G3C, FX101G3C-VERS.022014, FX101G3R, FX101G3R-VERS.022014, FX101G3-VERS.022014, FX10E2CR, FX10E2CR-VERS.032014, FX10E3CR...(Other models you can see in the webshop) |                 |                    |
| <b>accessories for</b> | 601055  |                 |                    |
|                        | <b>GEV No.</b>  | 550898          | <b>Ref. No.</b> —  |
|                        | connecting cable cable length 2000mm connection F 2.8 connection distance 7.9mm for axial flow fan  |                 |                    |
|                        | <b>GEV No.</b>  | 691103          | <b>Ref. No.</b> —  |
|                        | guard ø 90mm mounting distance 83mm for axial fan 92mm  |                 |                    |

<sup>1</sup>with ball bearings

refrigeration fans

refrigeration motors universal

ELCO

N series - multi fit



1

|                        |  |                 |                    |
|------------------------|--|-----------------|--------------------|
| <b>GEV No.</b>         | 601427   | <b>Ref. No.</b> | 32M4041<br>32M6870 |
| <b>description</b>     | fan motor ELCO 10W 230V 50/60Hz bearing slide bearing L1 49mm L2 59mm L3 86.5mm W 83mm connection cable 500mm 1300/1550rpm 5 mounting options VNT10-20/028   |                 |                    |
| <b>For models:</b>     | 120, 120B, 120NN, 120PV, 135, 135-4, 135A, 135B, 135BA, 135BN, 135BNX, 135BX, 135BXE, 135BXR, 135CPX, 135NN, 135NNX, 135PVX, 135X, 135X-3, 135X-4, 135XE, 135XR, 3G6SA, 3G6SA2, 3G6SA4, 40B, 40CP, 40CPX, 4G6SB, 4G6SB2, 4G6SB4, 4G6SB6, 55, 55B, 55PV, 65, 65A, 65B, 65BA, 65BX, 65BX-2, 65BXE, 65BXR, 65NB, 65NBX, 65NN, 65NNX, 65PVX, 65X...(Other models you can see in the webshop) |                 |                    |
| <b>spare parts for</b> | 601427   |                 |                    |
|                        | <b>GEV No.</b>   | 560140          | <b>Ref. No.</b> —  |
|                        | hexagonal nut thread M4 H 4.8mm SS WS 7 Qty 20 pcs DIN/ISO DIN 985 self-locking  |                 |                    |

|                        |   |        |                   |
|------------------------|---|--------|-------------------|
| <b>spare parts for</b> | 601427  |        |                   |
|                        | <b>GEV No.</b>  | 560332 | <b>Ref. No.</b> — |
|                        | plain washer ID ø 4.3mm ED ø 9mm thickness 0.8mm SS Qty 1 pcs                     |        |                   |
|                        | <b>GEV No.</b>  | 560340 | <b>Ref. No.</b> — |
|                        | hexagonal nut thread M4 H 3.2mm WS 7 SS DIN/ISO DIN 934 / ISO 4032/8673 Qty 1 pcs |        |                   |
|                        | <b>GEV No.</b>  | 601413 | <b>Ref. No.</b> — |
|                        | fixing plate suitable for fanwheel ED ø 32mm shaft ø 7 mounting distance 26mm     |        |                   |

|                        |  |        |                 |         |
|------------------------|--|--------|-----------------|---------|
|                        | <b>GEV No.</b>   | 601430 | <b>Ref. No.</b> | 32M4351 |
| <b>description</b>     | fan motor ELCO 5W 230V 50/60Hz bearing slide bearing L1 48mm L2 52mm L3 79.5mm W 83mm connection cable 500mm 1300/1550rpm 5 mounting options VNT5-13/027 |        |                 |         |
| <b>spare parts for</b> | 601430   |        |                 |         |
|                        | <b>GEV No.</b>   | 560140 | <b>Ref. No.</b> | —       |
|                        | hexagonal nut thread M4 H 4.8mm SS WS 7 Qty 20 pcs DIN/ISO DIN 985 self-locking  |        |                 |         |
|                        | <b>GEV No.</b>   | 560332 | <b>Ref. No.</b> | —       |
|                        | plain washer ID ø 4.3mm ED ø 9mm thickness 0.8mm SS Qty 1 pcs  |        |                 |         |
|                        | <b>GEV No.</b>   | 560340 | <b>Ref. No.</b> | —       |
|                        | hexagonal nut thread M4 H 3.2mm WS 7 SS DIN/ISO DIN 934 / ISO 4032/8673 Qty 1 pcs  |        |                 |         |
|                        | <b>GEV No.</b>   | 601413 | <b>Ref. No.</b> | —       |
|                        | fixing plate suitable for fanwheel ED ø 32mm shaft ø 7 mounting distance 26mm  |        |                 |         |

electric components





# Зип-Общепит

vsezip.ru

+7(812)987-08-81

## N series - standard



|   |   |                 |                   |
|---|---|-----------------|-------------------|
| <b>GEV No.</b>  | 601708 <sup>1</sup>   | <b>Ref. No.</b> | 32M7020           |
| <b>description</b>  | fan motor ELCO 10W 230V 50/60Hz bearing slide bearing L3 82.5mm W 66mm connection Plug In cable lengthmm 1300/1550rpm VN10-20/1124  |                 |                   |
| <b>For models:</b>  | 3G6SA, 3G6SA2, 3G6SA4, 40B, 40B-OPR01, 40BX-OPR01, 40CP-OPR01, 40CPX-OPR01, 4G6SB, 4G6SB2, 4G6SB4, 4G6SB6, 6BR15V, 6BR15VC, 6BR19V, 6BR19VC, 6EA, 6EA11, 6EA11A, 6EA11M, 6EA13, 6EA13A, 6EA13M, 6EA2, 6EA2A, 6EA2M, 6EAA, 6EAB, 6EABA, 6EABM, 6EAM, 6EB, 6EB11, 6EB11A, 6EB11M, 6EB13, 6EB13A, 6EB13M, 6EB2, 6EB22, 6EB22A, 6EB22M, 6EB2A, 6EB2M, 6EB4, 6EB4A, 6EB4M, 6EBA, 6EBM, 6EC...(Other models you can see in the webshop) |                 |                   |
| <b>spare parts for</b>  | 601708  |                 |                   |
|  | <b>GEV No.</b>  | 601413          | <b>Ref. No.</b> — |
|   | fixing plate suitable for fanwheel ED ø 32mm shaft ø 7 mounting distance 26mm   |                 |                   |
| <b>accessories for</b>  | 601708  |                 |                   |
|  | <b>GEV No.</b>  | 601892          | <b>Ref. No.</b> — |
|   | connector cable ELCO cable length 1500mm 0.75mm <sup>2</sup> protection IP42 for Plug-In  |                 |                   |

<sup>1</sup>with coded connector

## RE series



|                    |   |                 |         |
|--------------------|---|-----------------|---------|
| <b>GEV No.</b>     | 602051  | <b>Ref. No.</b> | 32M7240 |
| <b>description</b> | fan motor 18/62W 230V 50/60Hz 2600rpm   |                 |         |
| <b>For models:</b> | AGL6B, B151H, BF51H, FSD2B-OPR01, FSD2B2-OPR01, FSDR2B-OPR01, FSDR2B2-OPR01, FSE2B-OPR01, FSE2B2-OPR01, FSER2B-OPR01, FSER2B2-OPR01, IS51H, XS51H |                 |         |

## BT series - capacitor motors



|                    |   |                 |         |
|--------------------|---|-----------------|---------|
| <b>GEV No.</b>     | 601820 <sup>1</sup>   | <b>Ref. No.</b> | 32M4701 |
| <b>description</b> | fan motor 35W 230V 50/60Hz L2 89mm L3 110mm W 82mm cable length 2150mm 1300/1550rpm ELCO incl. capacitor capacitor 2.5µF  |                 |         |
| <b>For models:</b> | ART2LD, ART2SD, DS51, DS51A, DS51C, DS51M, GR135BT, GR1A, GR2A, IA101L, IA101S, IS101L, IS101S, IS51, IS51A, IS51C, IS51M, ISFEB, ISFEB-OPR01, ISFEN, ISFEN-OPR01, SM1L, SM1L7, SM1L7A, SM1L7FCV, SM1L7M, SM1LA, SM1LAM, SM1LAT, SM1LM, SM1LT, SM1LT7, SM1LT7A, SM1LT7M, SM2L, SM2S, SM3S |                 |         |

<sup>1</sup>incl. capacitor

## multi fit fan motors



|                    |   |                 |                               |
|--------------------|---|-----------------|-------------------------------|
| <b>GEV No.</b>     | 601022  | <b>Ref. No.</b> | 32M0220<br>32M1060<br>32M4371 |
| <b>description</b> | fan motor 10W 230V 50-60Hz L1 44mm L2 54mm L3 85mm W 84mm cable length 500mm 1300rpm YZF10-20-18/26 5 mounting options bearing slide bearing  |                 |                               |
| <b>For models:</b> | 120, 120B, 120NN, 120PV, 135, 135BN, 135NN, 55, 55B, 55PV, 65, 65B, 65NB, 65NN, 6BEABA, 6BEABB, 6BEABM, 6BEABZ, BRPR, BRPR218, BRVR, BRVR218, PGA20, PGA30, PGA40, PGA60, PGA80, PGW20, PGW30, PGW40, PGW60, PGW80, S125X, S60B, S60BX, S60X, SA87, SP120, SP120B, SP120BN, SP120NN, SP135, SP135BN, SP135CP, SP135NN, SP55, SP55B, SP65, SP65B, SP65NB...(Other models you can see in the webshop) |                 |                               |



|                    |   |                 |         |
|--------------------|---|-----------------|---------|
| <b>GEV No.</b>     | 601020  | <b>Ref. No.</b> | 32M4350 |
| <b>description</b> | fan motor 5W 230V 50-60Hz L1 44mm L2 48mm L3 79mm W 84mm cable length 500mm 1300rpm YZF5-13-18/26 5 mounting options bearing slide bearing                  |                 |         |
| <b>For models:</b> | 135BN, 135NN, 40CP, 40CPX, 65, 65NB, 65NN, S125B, S125BX, S125X, S60B, S60X, SP120BN, SP120NN, SP135BN, SP135CP, SP135NN, SP55, SP55B, SP65, SP65NB, SP65NN |                 |         |

Зип Общепит

vsezip.ru

+7(812)987-08-81

accessories

fan wheels

aluminium

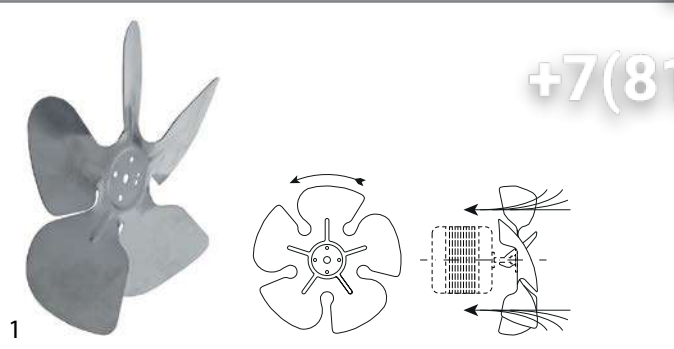

|                    |  |                 |         |
|--------------------|--|-----------------|---------|
| <b>GEV No.</b>     | 601070   | <b>Ref. No.</b> | 32M3280 |
| <b>description</b> | fan wheel sucking $\varnothing$ 200mm fan wheel mounting 25.4mm blade angle 28° W 38mm aluminium   |                 |         |
| <b>For models:</b> | 135BN, 135BNX, 135CPX, 135NN, 135NNX, 3G6SA, 3G6SA2, 3G6SA4, 40B-OPR01, 40BX-OPR01, 40CP, 40CP-OPR01, 40CPX, 40CPX-OPR01, 4G6SB, 4G6SB2, 4G6SB4, 4G6SB6, 55B, 65, 65A, 65NB, 65NBX, 65NN, 65NNX, 65PVX, 65X, 65X-2, 65XE, 65XR, 6BR15V, 6BR15VC, 6BR19V, 6BR19VC, 6EA, 6EA11, 6EA11A, 6EA11M, 6EA13, 6EA13A, 6EA13M, 6EA2, 6EA2A, 6EA2M, 6EAA, 6EAM, 6JA, 6JA2, 6JA2A, 6JA2M...(Other models you can see in the webshop) |                 |         |

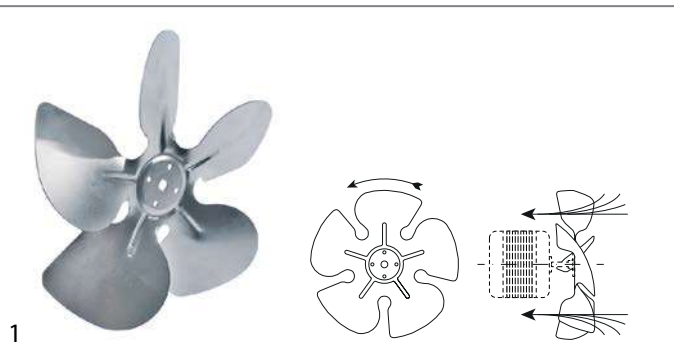

|                    |   |                 |         |
|--------------------|---|-----------------|---------|
| <b>GEV No.</b>     | 601282  | <b>Ref. No.</b> | 32M1550 |
| <b>description</b> | fan wheel sucking $\varnothing$ 200mm fan wheel mounting 25.4mm blade angle 34° W 44mm aluminium  |                 |         |
| <b>For models:</b> | 135BN, 135BNX, 65B, 65BA, 65BX, 65BX-2, 65BXE, 65BXR, ART1L, ART1L7, ART1L7A, ART1L7M, ART1LA, CX120B, CX130, CX130B, CX130NN, CX60, CX60B, DA51, DA51A, DA51M, FX150, FX150B, FX150NN, FX70, FX70B, GD150B, ISFEB-OPR01, ISFEN-OPR01, MD130, MD130B, MD130BN, MD130NN, MD150, MD1504, MD150B, MD150B4, MD150BB, MD150BN, MD150BPV, MD150BR, MD150NCP, MD150NN, MD150PV, MD150R, MD60, MD60B, MD70, MD702...(Other models you can see in the webshop) |                 |         |

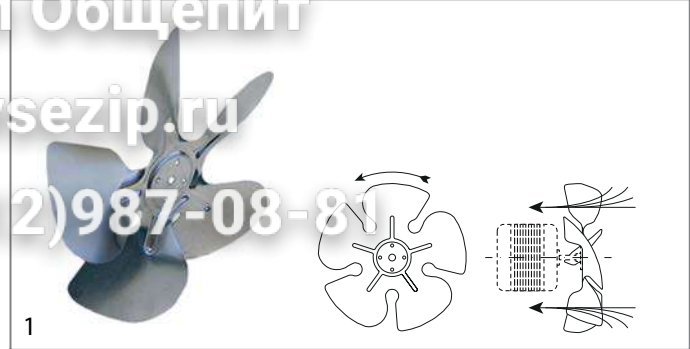

|                    |  |                 |         |
|--------------------|--|-----------------|---------|
| <b>GEV No.</b>     | 601072   | <b>Ref. No.</b> | 32M1080 |
| <b>description</b> | fan wheel sucking $\varnothing$ 250mm fan wheel mounting 25.4mm blade angle 25° W 50mm aluminium   |                 |         |
| <b>For models:</b> | 120, 120B, 120NN, 120PV, 135, 135-4, 135A, 135B, 135BA, 135BN, 135BNX, 135BX, 135BXE, 135BXR, 135NN, 135NNX, 135PVX, 135X, 135X-3, 135X-4, 135XE, 135XR, 65B, 65BX, 65BX-2, 65NB, 65NBX, 65NN, 65NNX, 65PVX, AF1N, AF1N-OPR01, CX120, CX120NN, CX130, CX130B, CX140, CX140BN, CX140CP, CX140NN, CX140PV, CX150, CX150BN, CX150CP, CX150PV, CX55, CX55B, CX60B, CX65, CX652...(Other models you can see in the webshop) |                 |         |

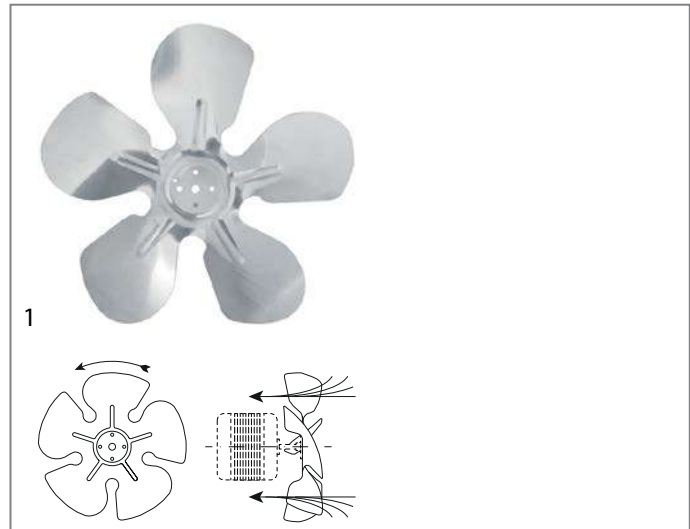

|                    |  |                 |         |
|--------------------|--|-----------------|---------|
| <b>GEV No.</b>     | 601387   | <b>Ref. No.</b> | 32M2260 |
| <b>description</b> | fan wheel sucking $\varnothing$ 254mm fan wheel mounting 25.4mm blade angle 34° W 50mm aluminium   |                 |         |
| <b>For models:</b> | 135B, 135BX, AF2B, AF2B-OPR01, ART1LD, ART1LDA, BRPR, BRPR218, BRPR21C, BRPRV, BRVR, BRVR218, BRVR21C, BRVRV, CX120B, CX130B, CX140B, CX150B, D12Q1M, D12Q2, D12Q2M, FG2B, FSD2B, FSE2B, FSE2B2, GD150B, ISFEB, ISFEB-OPR01, ISFEN, ISFEN-OPR01, MD130B, MD150B, MD150B4, MD150BPV, MDE150B, MX120B, MX140B, PD130B, PD150B, PDG150B, S125B, S125B-4, S125BX, S125BX-4, SE14PRV, SE14PRW, SE14VRV, SE14VRW, SI14PRV, SI14PRW...(Other models you can see in the webshop) |                 |         |

electric components



Зип-Общепит

vsezip.ru

+7(812)987-08-81

cold air circulating fans (complete)

ebm-papst

A2E series

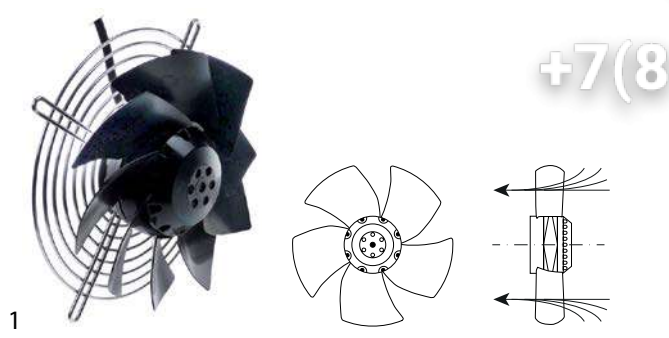

|                        |   |                 |                   |
|------------------------|---|-----------------|-------------------|
| <b>GEV No.</b>         | 601663 <sup>1</sup>   | <b>Ref. No.</b> | 32M6610           |
| <b>description</b>     | fan A2E200-AI38-10 fan wheel ø 200mm blades 9 230V 50/60Hz 64W 2600rpm cable length 450mm ebm-papst sucking suitable capacitor 1.5µF with protective grid |                 |                   |
| <b>For models:</b>     | ART1L, ART1L7, ART1L7A, ART1L7M, ART1LA, ART2LD, ART2SD, ART3SD, DA51, DA51A, DA51M, DS31, DS31A, DS31C, DS31M, DS351H, SM03LT7, SM03LT7A, SM03LT7M       |                 |                   |
| <b>spare parts for</b> | 601663  |                 |                   |
|                        | <b>GEV No.</b>  | 365171          | <b>Ref. No.</b> — |
|                        | capacitor capacity 1.5µF 400V tolerance 5% 50/60Hz ambient temperature max. -40 up to +85°C ø 25mm L 50mm M8 plastic connection cable 250mm MLR25PRL      |                 |                   |
|                        | <b>GEV No.</b>  | 601958          | <b>Ref. No.</b> — |
|                        | guard ø 210mm for fan hole distance 258mm   |                 |                   |

<sup>1</sup>incl. capacitor and guard

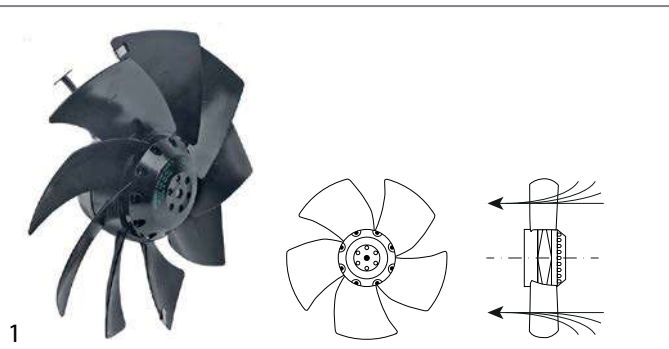

|                        |  |                 |                    |
|------------------------|--|-----------------|--------------------|
| <b>GEV No.</b>         | 601964   | <b>Ref. No.</b> | 32M4720<br>32M6850 |
| <b>description</b>     | fan A2E250AM06-12 fan wheel ø 250mm blades 9 230V 50/60Hz 115/150W ø 250mm 2450rpm cable length 1400mm sucking suitable capacitor 3µF  |                 |                    |
| <b>For models:</b>     | ART1LD, ART1LD7, ART1LD7A, ART1LD7M, ART1LDA, DS51, DS51A, DS51C, DS51M, IA101L, IA101S, IA51, IA51A, IA51C, IA51M, IA72S, IS101L, IS101LR, IS101LW, IS101S, IS101SR, IS101SW, IS51, IS51A, IS51AR, IS51C, IS51CR, IS51H, IS51HW, IS51M, IS51MR, IS51R, IS51W, IS51WA, IS51WC, IS51WM, IS72S, IS72SR, IS72SW, ISFEB, ISFEB-0PR01, ISFEN, ISFEN-0PR01, SM1LAM, SM1LAT, SM1LM, SM1LT, SM1LT7, SM1LT7A, SM1LT7M...(Other models you can see in the webshop) |                 |                    |
| <b>spare parts for</b> | 601964   |                 |                    |
|                        | <b>GEV No.</b>   | 365137          | <b>Ref. No.</b> —  |
|                        | capacitor capacity 3µF 450V tolerance 5% 50/60Hz ambient temperature max. -25 to +85°C ø 25mm L 56mm M8 plastic connection cable 250mm 416.17.77GF protection  |                 |                    |



|                    |   |                 |         |
|--------------------|---|-----------------|---------|
| <b>GEV No.</b>     | 601810  | <b>Ref. No.</b> | 32M6220 |
| <b>description</b> | fan 230V 50Hz ø 278mm suitable capacitor 4µF ECOFIT type 2VRE35 H 90mm fan wheel ø 250mm cable length 2000mm                    |                 |         |
| <b>For models:</b> | SM1L, SM1L7, SM1L7A, SM1L7FCV, SM1L7M, SM1LA, SM1LAR, SM1LAW, SM1LR, SM1LW, SM2L, SM2LR, SM2LW, SM2S, SM2SR, SM2SW, SM3S, SM3SR |                 |         |

cross flow fans

COPREL

with standard coil



|                    |  |                 |         |
|--------------------|--|-----------------|---------|
| <b>GEV No.</b>     | 601032   | <b>Ref. No.</b> | 32M2090 |
| <b>description</b> | cross flow fan COPREL TFL(FN) roller ø 60mm roller length 180mm laminated core thickness 15mm motor position left 230V/50Hz 19W bearing rubber connection male faston 6.3mm coil type airflow 107m <sup>3</sup> /h -10 up to +60°C refrigeration |                 |         |



|                    |  |                 |                               |
|--------------------|--|-----------------|-------------------------------|
| <b>GEV No.</b>     | 601452   | <b>Ref. No.</b> | 32M0050<br>32M0521<br>32M5920 |
| <b>description</b> | cross flow fan TFL 180 roller ø 60mm roller length 180mm laminated core thickness 20mm motor position left 230V/50Hz 19W universal bearing silicone connection male faston 6.3mm airflow 100m <sup>3</sup> /h -30 up to +100°C 230V 50Hz   |                 |                               |
| <b>For models:</b> | 120, 120NN, 120PV, 135CPX, 3G65A, 3G65A2, 3G65A4, 40, 40-0PR01, 40PL, 40PV, 40PV-0PR01, 40X, 40X-0PR01, 40XPV, 4G65B, 4G65B2, 4G65B4, 4G65B6, 55, 55PV, 6BEA11A, 6BEA11B, 6BEA11M, 6BEA11Z, 6BEA2A, 6BEA2B, 6BEA2M, 6BEA2Z, 6BEA3A, 6BEA3B, 6BEA3M, 6BEA3Z, 6BEAA, 6BEAB, 6BEAM, 6BEAZ, 6BEB11A, 6BEB11B, 6BEB11M, 6BEB11Z, 6BEB22A, 6BEB22B, 6BEB22M, 6BEB22Z, 6BEB2A, 6BEB2B, 6BEB2M, 6BEB2Z, 6BEB3A...(Other models you can see in the webshop) |                 |                               |



Зип Общепит

vsezip.ru

+7(812)987-08-81

double fans



|                    |   |                 |                    |
|--------------------|---|-----------------|--------------------|
| <b>GEV No.</b>     | 601026  | <b>Ref. No.</b> | 32M1220<br>32M2210 |
| <b>description</b> | cross flow fan COPREL TFD(FD) roller ø 60mm roller length 2x180mm laminated core thickness 35mm motor position centre 230V/50-60Hz 42W refrigeration bearing rubber connection male faston 6.3mm coil type airflow 255m <sup>3</sup> /h -10 up to +60°C |                 |                    |

accessories for cross flow fans

heater battery



|                    |   |                 |         |
|--------------------|---|-----------------|---------|
| <b>GEV No.</b>     | 415122  | <b>Ref. No.</b> | 32G1990 |
| <b>description</b> | heater battery mounting distance 185mm W 40mm H 35mm 2000W 230V temperature restriction 105°C heating circuits 2 connection cable cable length 340mm L 197mm for cross flow fan |                 |         |

hot air motors



|                    |  |                 |                    |
|--------------------|--|-----------------|--------------------|
| <b>GEV No.</b>     | 550688   | <b>Ref. No.</b> | 31S1490<br>31S1490 |
| <b>description</b> | bushing for fan motor  |                 |                    |
| <b>For models:</b> | FC101, FC101E, FC241, FC241E, FC241G, FC61, FC61E, FCV101, FCV101-CSA, FCV101DM, FCV101DM-CSA, FCV101DS, FCV101DS-CSA, FCV101E, FCV101EDM, FCV101EDM-UL, FCV101EDS, FCV101EDS-UL, FCV101E-UL, FCV141, FCV141-CSA, FCV141DM, FCV141DM-CSA, FCV141DS, FCV141DS-CSA, FCV141E, FCV141EDM, FCV141EDS, FCV241, FCV241DM, FCV241DS, FCV241E, FCV241EDM, FCV241EDM-UL, FCV241EDS, FCV241EDS-UL, FCV241E-UL, FCV241G, FCV241G-CSA, FCV241GDM, FCV241GDM-CSA, FCV241GDS, FCV241GDS-CSA, FCV401DM, FCV401DM-CSA, FCV401EDM, FCV401EDM-UL, FCV61, FCV61-CSA, FCV61DM...(Other models you can see in the webshop) |                 |                    |

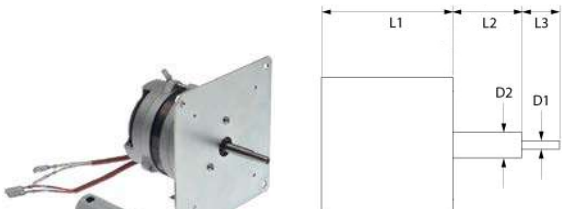

|                    |   |                 |         |
|--------------------|---|-----------------|---------|
| <b>GEV No.</b>     | 601104  | <b>Ref. No.</b> | 32M4301 |
| <b>description</b> | fan motor 220-240V 1 phase 50/60Hz 0.045/0.0765kW 2800/3400rpm speeds 1 L1 97mm L2 41mm L3 19mm D1 ø 8mm D2 ø 10mm 0.35A suitable capacitor 2µF/400V power input 45W at 50Hz 2800/3400rpm |                 |         |
| <b>For models:</b> | 1G1FA0EV, 1G1FA0GV, 1G1PE1EV, 1G1PE2EV, 2G1FA0GV, 2G1PE1EV, 2G1PE2EV, 31GE, 31TC, 31TCE, 32TC, 32TCE  |                 |         |



|                    |   |                 |         |
|--------------------|---|-----------------|---------|
| <b>GEV No.</b>     | 601210  | <b>Ref. No.</b> | 32M4260 |
| <b>description</b> | fan motor 220-240V 1 phase 50Hz 0.075kW 2800rpm speeds 1 L1 120mm L2 38mm L3 36mm D1 ø 12mm D2 ø 8mm M5R IT 0.55A suitable capacitor 2.5µF/400V at 50Hz 2800rpm type 1074 |                 |         |
| <b>For models:</b> | FCV3EM, FCV4E, FCV4EDS, FCV4EM, FM423E1, FM423E2  |                 |         |

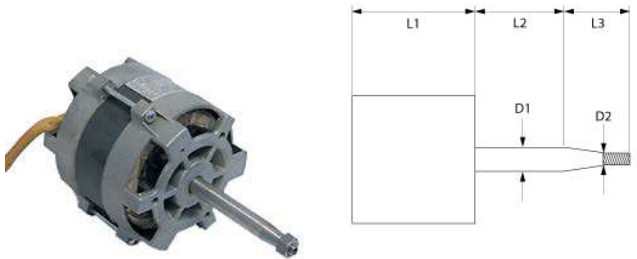

|                        |  |                 |         |
|------------------------|--|-----------------|---------|
| <b>GEV No.</b>         | 601043   | <b>Ref. No.</b> | 32M1500 |
| <b>description</b>     | fan motor 220-240V 1 phase 50Hz 0.37/0.07kW 0.1/0.5HP 1400/2700rpm speeds 2 L1 123mm L2 107mm L3 15mm D1 ø 15mm D2 ø 12mm M10L ET 2/0.7A suitable capacitor 20µF/250V at 50Hz 1400/2700rpm type 1057 |                 |         |
| <b>accessories for</b> | 601043   |                 |         |
| <b>GEV No.</b>         | 365019   | <b>Ref. No.</b> | —       |
| <b>description</b>     | operating capacitor capacity 20µF 400V tolerance 5% 50/60Hz ambient temperature max. -25 to +85°C ø 39.5mm L 70mm M8 plastic connection male faston 6.3mm 16.10.25. protection                       |                 |         |

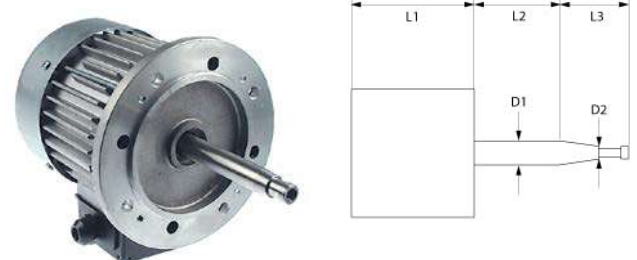

|                        |   |                 |         |
|------------------------|---|-----------------|---------|
| <b>GEV No.</b>         | 601211  | <b>Ref. No.</b> | 32M3820 |
| <b>description</b>     | fan motor 230/400-415V 3 phase 50/60Hz 0.25kW 1400/1600rpm speeds 1 L1 175mm L2 70mm L3 27mm D1 ø 17mm D2 ø 12mm M8R IT 1.4/0.8A at 50Hz 1400rpm at 60Hz 1600rpm type 1046.4530   |                 |         |
| <b>For models:</b>     | FC101, FC101E, FC241, FC241E, FC241G, FC61, FC61E, FCV101, FCV101DS, FCV101E, FCV101EDS, FCV141, FCV141DS, FCV141E, FCV141EDS, FCV241, FCV241DS, FCV241E, FCV241EDS, FCV241G, FCV241GDS, FCV61, FCV61DS, FCV61E, FCV61EDS |                 |         |
| <b>accessories for</b> | 601211  |                 |         |
| <b>GEV No.</b>         | 550690  | <b>Ref. No.</b> | 31S0900 |
| <b>description</b>     | shaft sealing for fan motor   |                 |         |



Зип Общепит

vsezip.ru

+7(812)987-08-81

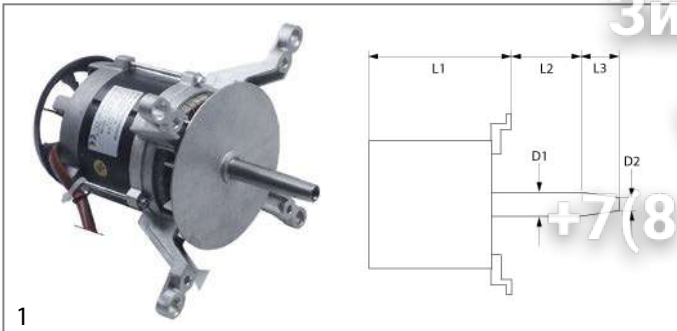

|                    |   |                 |         |
|--------------------|---|-----------------|---------|
| <b>GEV No.</b>     | 601713  | <b>Ref. No.</b> | 32M6722 |
| <b>description</b> | fan motor 230/400V 1 phase 50/60Hz 0.55kW 0.75HP 1400rpm speeds 1 L1 200mm L2 53mm L3 32mm D1 ø 18mm D2 ø 15mm M10x1 suitable capacitor 31.5µF Cos(φ) 0.72 at 50Hz 1400rpm at 60Hz 1700rpm type 3065A4051   |                 |         |
| <b>For models:</b> | FC1011E, FC1011G, FC1221E, FC1221G, FC611E, FC611G, FM1011E1, FM1011E1-VERS.2006, FM1011E2, FM1011E2-VERS.2006, FM1011E3, FM1011G1, FM1011G1-VERS.2006, FM1011G2, FM1011G2-VERS.2006, FM1011G3, FM1221E1, FM1221E1-VERS.2006, FM1221E2, FM1221E2-VERS.2006, FM1221E3, FM1221G1, FM1221G2, FM1221G3, FM2011E2-VERS.2006, FM2011G2-VERS.2006, FM2021E1, FM2021E2, FM2021E2-VERS.2006, FM2021E3, FM2021G1, FM2021G2, FM2021G3, FM611E1, FM611E1-VERS.2006, FM611E2, FM611E2-VERS.2006, FM611E3, FM611G1, FM611G1-VERS.2006, FM611G2, FM611G2-VERS.2006, FM611G3, FM721E1, FM721E1-VERS.2006, FM721E2, FM721E2-VERS.2006, FM721E3, FM721G1, FM721G1-VERS.2006...(Other models you can see in the webshop) |                 |         |

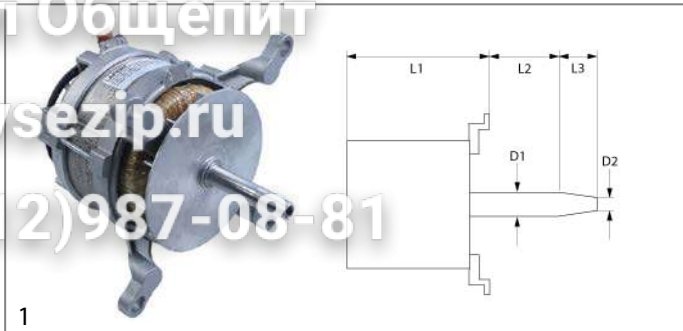

|                    |   |                 |         |
|--------------------|---|-----------------|---------|
| <b>GEV No.</b>     | 601598  | <b>Ref. No.</b> | 3001182 |
| <b>description</b> | fan motor 230V 1 phase 50Hz 0.22/0.55kW 960/1430rpm speeds 2 L1 175mm L2 52mm L3 32mm D1 ø 15mm D2 ø 18mm M10R IT 1.7/3.7A suitable capacitor 36/25 Cos(φ) 0.96 at 50Hz 960/1430rpm type LM/FB 100L |                 |         |
| <b>For models:</b> | FM1011G1, FM1011G2, FM1011G3, FM1011G3-VERS.2006, FM2011G3-VERS.2006, FM611G1, FM611G2, FM611G3, FM611G3-VERS.2006, FM721G1, FM721G2, FM721G3, FM721G3-VERS.2006                                    |                 |         |



|                    |  |                 |         |
|--------------------|--|-----------------|---------|
| <b>GEV No.</b>     | 602175   | <b>Ref. No.</b> | 3103750 |
| <b>description</b> | fan motor 230/400V 3 phase 50/60Hz 0.7kW 1400/1700rpm L1 150mm L2 80mm L3 32mm D1 ø 18mm D2 ø 15mm M8 suitable capacitor 3µF400V type 3042P4050  |                 |         |
| <b>For models:</b> | BX101E, BX101E-VERS.122013, BX101G, BX101G-VERS.122013, BX61E, BX61E-VERS.122013, BX61G, BX61G-VERS.122013, BX82E, BX82E-VERS.122013, BX82G, BX82G-VERS.122013, FX101E1, FX101E1R, FX101E2, FX101E2C, FX101E2C-VERS.032014, FX101E2R, FX101E2R-VERS.032014, FX101E2-VERS.032014, FX101E3, FX101E3C, FX101E3C-VERS.022014, FX101E3R, FX101E3R-VERS.022014, FX101E3-VERS.022014, FX101G3, FX101G3C, FX101G3C-VERS.022014, FX101G3R, FX101G3R-VERS.022014, FX101G3-VERS.022014, FX10E2CR, FX10E2CR-VERS.032014, FX10E3CR, FX10E3CR-VERS.022014, FX10G3CR, FX10G3CR-VERS.022014, FX201E2, FX201E2P, FX201E2P-VERS.032014, FX201E2-VERS.032014, FX201E3, FX201E3P, FX201E3P-VERS.022014, FX201E3-VERS.022014, FX201G2P, FX201G2P-VERS.032014, FX201G3P, FX201G3-VERS.022014...(Other models you can see in the webshop) |                 |         |

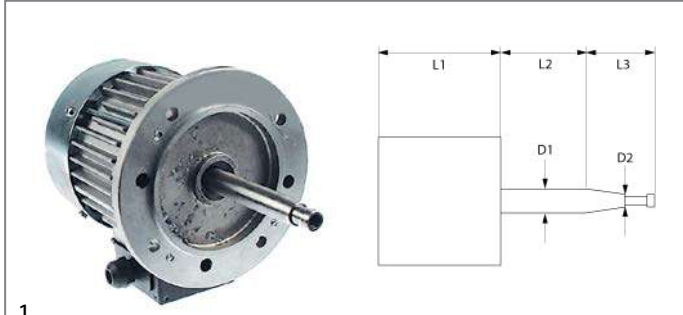

|                    |   |                 |         |
|--------------------|---|-----------------|---------|
| <b>GEV No.</b>     | 601212  | <b>Ref. No.</b> | 32M3880 |
| <b>description</b> | fan motor 380-400-415V 3 phase 50Hz 0.04/0.33HP 700/1400rpm speeds 2 L1 180mm L2 70mm L3 27mm D1 ø 17mm D2 ø 12mm M8R IT 0.4/0.9A at 50Hz 700/1400rpm type 1046/4-8 |                 |         |
| <b>For models:</b> | FCV101DM, FCV101EDM, FCV141DM, FCV141EDM, FCV241DM, FCV241EDM, FCV241GDM, FCV401EDM, FCV61DM, FCV61EDM  |                 |         |



|                    |  |                 |                    |
|--------------------|--|-----------------|--------------------|
| <b>GEV No.</b>     | 602173   | <b>Ref. No.</b> | 32M6760<br>32M6761 |
| <b>description</b> | fan wheel blades 12 D1 ø 365mm D2 ø 14mm D3 ø 18mm H1 140mm H2 23mm  |                 |                    |
| <b>For models:</b> | FC1221E, FC1221G, FM1221E1, FM1221E1-VERS.2006, FM1221E2, FM1221E2-VERS.2006, FM1221E3, FM1221E3-VERS.2006, FM1221G1, FM1221G1-VERS.2006, FM1221G2, FM1221G2-VERS.2006, FM1221G3, FM1221G3-VERS.2006, FM2021E1, FM2021E2, FM2021E2-VERS.2006, FM2021E3, FM2021E3-VERS.2006, FM2021G1, FM2021G2, FM2021G2-VERS.2006, FM2021G3, FM2021G3-VERS.2006 |                 |                    |



Зип Общепит

vsezip.ru

+7(812)987-08-81

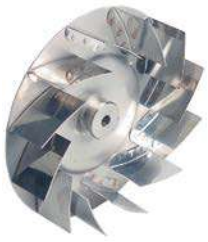

1

|                    |  |                 |         |
|--------------------|--|-----------------|---------|
| <b>GEV No.</b>     | 601109   | <b>Ref. No.</b> | 32M0370 |
| <b>description</b> | fan wheel D1 ø 160mm H1 35mm blades 12 D2 ø 8mm D3 ø 8mm H2 15mm                                     |                 |         |
| <b>For models:</b> | 1G1FA0EV, 1G1FA0GV, 1G1PE1EV, 1G1PE2EV, 2G1FA0GV, 2G1PE1EV, 2G1PE2EV, 31GE, 31TC, 31TCE, 32TC, 32TCE |                 |         |



1

|                    |  |                 |         |
|--------------------|--|-----------------|---------|
| <b>GEV No.</b>     | 514449   | <b>Ref. No.</b> | 32M6741 |
| <b>description</b> | fan wheel D1 ø 283mm H1 140mm blades 8 D2 ø 15mm D3 ø 18mm   |                 |         |
| <b>For models:</b> | FC611E, FC611G, FM611E1, FM611E1-VERS.2006, FM611E2, FM611E2-VERS.2006, FM611E3, FM611E3-VERS.2006, FM611G1, FM611G1-VERS.2006, FM611G2, FM611G2-VERS.2006, FM611G3, FM611G3-VERS.2006 |                 |         |



1

|                    |   |                 |                    |
|--------------------|---|-----------------|--------------------|
| <b>GEV No.</b>     | 601221  | <b>Ref. No.</b> | 32M4270<br>32M4271 |
| <b>description</b> | fan wheel D1 ø 180mm H1 60mm blades 12 D2 ø 9mm D3 ø 12.5mm H2 35mm |                 |                    |
| <b>For models:</b> | FCV3EM, FCV4E, FCV4EDS, FCV4EM, FM423E1, FM423E2                    |                 |                    |



1

|                    |  |                 |         |
|--------------------|--|-----------------|---------|
| <b>GEV No.</b>     | 601208   | <b>Ref. No.</b> | 32M2561 |
| <b>description</b> | fan wheel D1 ø 335mm H1 135mm blades 12 D2 ø 12mm D3 ø 18mm H2 56mm  |                 |         |
| <b>For models:</b> | FC101, FC101E, FCV101, FCV101-CSA, FCV101DM, FCV101DM-CSA, FCV101DS, FCV101DS-CSA, FCV101E, FCV101EDM, FCV101EDM-UL, FCV101EDS, FCV101EDS-UL, FCV101E-UL, FCV141, FCV141-CSA, FCV141DM, FCV141DM-CSA, FCV141DS, FCV141DS-CSA, FCV141E, FCV141EDM, FCV141EDS, FCV72EDM-UL, FCV72EDS-UL, FCV72E-UL |                 |         |



1

|                    |  |                 |         |
|--------------------|--|-----------------|---------|
| <b>GEV No.</b>     | 601060   | <b>Ref. No.</b> | 32M1570 |
| <b>description</b> | fan wheel D1 ø 180mm H1 60mm blades 16 D2 ø 11mm D3 ø 16mm H2 30mm |                 |         |



1

|                    |  |                 |         |
|--------------------|--|-----------------|---------|
| <b>GEV No.</b>     | 601209   | <b>Ref. No.</b> | 32M3992 |
| <b>description</b> | fan wheel D1 ø 400mm H1 135mm blades 20 D2 ø 12mm D3 ø 18mm H2 54mm  |                 |         |
| <b>For models:</b> | FC241E, FC241G, FCV241E, FCV241EDM, FCV241EDM-UL, FCV241EDS, FCV241EDS-UL, FCV241E-UL, FCV241G, FCV241G-CSA, FCV241GDM, FCV241GDM-CSA, FCV241GDS, FCV241GDS-CSA, FCV401EDM, FCV401EDM-UL |                 |         |



1

|                    |  |                 |                    |
|--------------------|--|-----------------|--------------------|
| <b>GEV No.</b>     | 601207   | <b>Ref. No.</b> | 32M3811<br>32M3812 |
| <b>description</b> | fan wheel D1 ø 280mm H1 135mm blades 12 D2 ø 12mm D3 ø 18mm H2 55mm  |                 |                    |
| <b>For models:</b> | FC61, FC61E, FCV61, FCV61-CSA, FCV61DM, FCV61DM-CSA, FCV61DS, FCV61DS-CSA, FCV61E, FCV61EDM, FCV61EDM-UL, FCV61EDS, FCV61EDS-UL, FCV61E-UL |                 |                    |



Зип Общепит  
vsezip.ru  
+7(812)987-08-81

|   |                                |                         |
|---|--------------------------------|-------------------------|
|  | <b>GEV No.</b> 550687          | <b>Ref. No.</b> 33Q6320 |
| <b>description</b>  | flange for fan motor           |                         |
| <b>For models:</b>  | FCV3EM, FCV4E, FCV4EDS, FCV4EM |                         |

|   |  |                         |
|---|--|-------------------------|
|  | <b>GEV No.</b> 552005  | <b>Ref. No.</b> 36E3160 |
| <b>description</b>  | flange for fan motor ED ø 56mm int. ø 1 38mm int. ø 2 20mm thickness 8mm brass   |                         |
| <b>For models:</b>  | BX101E, BX101E-VERS.122013, BX101G, BX101G-VERS.122013, BX122E, BX122E-VERS.122013, BX122G, BX122G-VERS.122013, BX61E, BX61E-VERS.122013, BX61G, BX61G-VERS.122013, BX82E, BX82E-VERS.122013, BX82G, BX82G-VERS.122013, FC1011E, FC1011G, FC1221E, FC1221G, FC611E, FC611G, FM1011E1, FM1011E1-VERS.2006, FM1011E2, FM1011E2-VERS.2006, FM1011E3, FM1011E3-VERS.2006, FM1011G1, FM1011G1-VERS.2006, FM1011G2, FM1011G2-VERS.2006, FM1011G3, FM1011G3-VERS.2006, FM1221E1, FM1221E1-VERS.2006, FM1221E2, FM1221E2-VERS.2006, FM1221E3, FM1221E3-VERS.2006, FM1221G1, FM1221G1-VERS.2006, FM1221G2, FM1221G2-VERS.2006, FM1221G3, FM1221G3-VERS.2006, FM2011E2-VERS.2006, FM2011E3-VERS.2006, FM2011G2-VERS.2006, FM2011G3-VERS.2006...(Other models you can see in the webshop) |                         |

|  |  |                         |
|--|--|-------------------------|
|  | <b>GEV No.</b> 552006  | <b>Ref. No.</b> 33Q5381 |
| <b>description</b>   | flange for fan motor ED ø 57.5mm int. ø 1 35mm int. ø 2 23mm thickness 2mm   |                         |
| <b>For models:</b>   | FC101, FC101E, FC241, FC241E, FC241G, FC61, FC61E, FCV101, FCV101-CSA, FCV101DM, FCV101DM-CSA, FCV101DS, FCV101DS-CSA, FCV101E, FCV101EDM, FCV101EDM-UL, FCV101EDS, FCV101EDS-UL, FCV101E-UL, FCV141, FCV141-CSA, FCV141DM, FCV141DM-CSA, FCV141DS, FCV141DS-CSA, FCV141E, FCV141EDM, FCV141EDS, FCV241, FCV241DM, FCV241DS, FCV241E, FCV241EDM, FCV241EDM-UL, FCV241EDS, FCV241EDS-UL, FCV241E-UL, FCV241G, FCV241G-CSA, FCV241GDM, FCV241GDM-CSA, FCV241GDS, FCV241GDS-CSA, FCV401DM, FCV401DM-CSA, FCV401EDM, FCV401EDM-UL, FCV61, FCV61-CSA, FCV61DM...(Other models you can see in the webshop) |                         |

|   |  |                         |
|---|--|-------------------------|
|  | <b>GEV No.</b> 697866  | <b>Ref. No.</b> 33Q5690 |
| <b>description</b>  | flange for fan motor ED ø 58mm int. ø 1 38.8mm int. ø 2 19/23mm brass  |                         |
| <b>For models:</b>  | FC101, FC101E, FC241, FC241E, FC241G, FC61, FC61E, FCV101, FCV101-CSA, FCV101DM, FCV101DM-CSA, FCV101DS, FCV101DS-CSA, FCV101E, FCV101EDM, FCV101EDM-UL, FCV101EDS, FCV101EDS-UL, FCV101E-UL, FCV141, FCV141-CSA, FCV141DM, FCV141DM-CSA, FCV141DS, FCV141DS-CSA, FCV141E, FCV141EDM, FCV141EDS, FCV241, FCV241DM, FCV241DS, FCV241E, FCV241EDM, FCV241EDM-UL, FCV241EDS, FCV241EDS-UL, FCV241E-UL, FCV241G, FCV241G-CSA, FCV241GDM, FCV241GDM-CSA, FCV241GDS, FCV241GDS-CSA, FCV401DM, FCV401DM-CSA, FCV401EDM, FCV401EDM-UL, FCV61, FCV61-CSA, FCV61DM...(Other models you can see in the webshop) |                         |

|   |  |                         |
|---|--|-------------------------|
|  | <b>GEV No.</b> 550686  | <b>Ref. No.</b> 37Q0250 |
| <b>description</b>  | gasket for fan motor ID ø 22mm ED ø 58mm thickness 1mm with 3 screw holes  |                         |
| <b>For models:</b>  | BX101E, BX101E-VERS.122013, BX101G, BX101G-VERS.122013, BX122E, BX122E-VERS.122013, BX122G, BX122G-VERS.122013, BX61E, BX61E-VERS.122013, BX61G, BX61G-VERS.122013, BX82E, BX82E-VERS.122013, BX82G, BX82G-VERS.122013, FC1011E, FC1011G, FC1221E, FC1221G, FC611E, FC611G, FCV3EM, FCV4E, FCV4EDS, FCV4EM, FM1011E1, FM1011E1-VERS.2006, FM1011E2, FM1011E2-VERS.2006, FM1011E3, FM1011E3-VERS.2006, FM1011G1, FM1011G1-VERS.2006, FM1011G2, FM1011G2-VERS.2006, FM1011G3, FM1011G3-VERS.2006, FM1221E1, FM1221E1-VERS.2006, FM1221E2, FM1221E2-VERS.2006, FM1221E3, FM1221E3-VERS.2006, FM1221G1, FM1221G1-VERS.2006, FM1221G2, FM1221G2-VERS.2006, FM1221G3, FM1221G3-VERS.2006...(Other models you can see in the webshop) |                         |

|   |   |                         |
|---|---|-------------------------|
|  | <b>GEV No.</b> 550689   | <b>Ref. No.</b> 37Q3011 |
| <b>description</b>  | gasket for fan motor ID ø 40mm ED ø 58mm thickness 1mm with 3 screw holes   |                         |
| <b>For models:</b>  | FC101, FC101E, FC241, FC241E, FC241G, FC61, FC61E, FCV101, FCV101-CSA, FCV101DM, FCV101DM-CSA, FCV101DS, FCV101DS-CSA, FCV101E, FCV101EDM, FCV101EDM-UL, FCV101EDS, FCV101EDS-UL, FCV101E-UL, FCV141, FCV141-CSA, FCV141DM, FCV141DM-CSA, FCV141DS, FCV141DS-CSA, FCV141E, FCV141EDM, FCV141EDS, FCV241, FCV241DM, FCV241DS, FCV241E, FCV241EDM, FCV241EDM-UL, FCV241EDS, FCV241EDS-UL, FCV241E-UL, FCV241G, FCV241G-CSA, FCV241GDM, FCV241GDM-CSA, FCV241GDS, FCV241GDS-CSA, FCV3EM, FCV401DM, FCV401DM-CSA, FCV401EDM, FCV401EDM-UL, FCV4E, FCV4EDS...(Other models you can see in the webshop) |                         |

|   |  |                         |
|---|--|-------------------------|
|  | <b>GEV No.</b> 550690  | <b>Ref. No.</b> 3150900 |
| <b>description</b>  | shaft sealing for fan motor  |                         |
| <b>For models:</b>  | FC101, FC101E, FC241, FC241E, FC241G, FC61, FC61E, FCV101, FCV101-CSA, FCV101DM, FCV101DM-CSA, FCV101DS, FCV101DS-CSA, FCV101E, FCV101EDM, FCV101EDM-UL, FCV101EDS, FCV101EDS-UL, FCV101E-UL, FCV141, FCV141-CSA, FCV141DM, FCV141DM-CSA, FCV141DS, FCV141DS-CSA, FCV141E, FCV141EDM, FCV141EDS, FCV241, FCV241DM, FCV241DS, FCV241E, FCV241EDM, FCV241EDM-UL, FCV241EDS, FCV241EDS-UL, FCV241E-UL, FCV241G, FCV241G-CSA, FCV241GDM, FCV241GDM-CSA, FCV241GDS, FCV241GDS-CSA, FCV401DM, FCV401DM-CSA, FCV401EDM, FCV401EDM-UL, FCV61, FCV61-CSA, FCV61DM...(Other models you can see in the webshop) |                         |



hot air fans



3 in 1 zip Общепит

miscellaneous

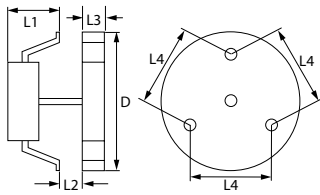

1



|   |  |                 |  |
|---|--|-----------------|--|
| <b>GEV No.</b>  | 601011   | <b>Ref. No.</b> | 32M0360<br>32M2320<br>32M2420<br>32M5690 |
| <b>description</b>  | hot air fan 220-240V 40W 50/60Hz L1 65mm L2 15mm L3 25mm L4 87mm fan wheel ø 150mm FIME type C25R8023CLH   |                 |  |
| <b>For models:</b>  | A12A1E, A12B1E, A12B2E, A12M1E, A12Z1E, A12Z2E, A14A1E, A14B1E, A14B2E, A14M1E, A14Z1E, A14Z2E, A16A1E, A16B1E, A16B2E, A16M1E, A16Z1E, A16Z2E, A18A1E, A18B1E, A18B2E, A18M1E, A18Z1E, A18Z2E, A20A1E, A20B1E, A20B2E, A20M1E, A20Z1E, A20Z2E, ACBM, ACBM218, ACPN, ACPN218, AJ12AE, AJ12ME, AJ14AE, AJ14ME, AJ16AE, AJ16ME, AJ18AE, AJ18ME, AJ20AE, AJ20ME, SL14CPN, SL14CVB, SL21CPN, SL21CVB |                 |  |
| <b>accessories for</b>  | 601011   |                 |  |
|  | <b>GEV No.</b>   | 550879          | <b>Ref. No.</b> —                        |
|   | insulation ø 130mm thickness 3mm hole ø 20mm for hot air fan   |                 |  |
|  | <b>GEV No.</b>   | 601260          | <b>Ref. No.</b> —                        |
|   | nut thread M6L IT for hot air fan  |                 |  |

accessories

fan wheels for hot air fans



1

|                    |   |                 |         |
|--------------------|---|-----------------|---------|
| <b>GEV No.</b>     | 601710  | <b>Ref. No.</b> | 32M2510 |
| <b>description</b> | fan wheel ø 225mm shaft intake ø 7mm aluminium blades 5   |                 |         |
| <b>For models:</b> | 120, 120NN, 135A, 135BN, 135BNX, 135CPX, 135XE, 40B, 40CP, 40CPX, 55B, 65, 65A, 65BA, 65BXE, 65NB, 65NBX, 65NN, 65NNX, 65PVX, 65X, 65X-2, 65XE, 6BEA11A, 6BEA11B, 6BEA11M, 6BEA11Z, 6BEA2A, 6BEA2B, 6BEA2M, 6BEA2Z, 6BEA3A, 6BEA3B, 6BEA3M, 6BEA3Z, 6BEAA, 6BEAB, 6BEABA, 6BEABB, 6BEABM, 6BEABZ, 6BEAM, 6BEAZ, 6BEB11A, 6BEB11B, 6BEB11M, 6BEB11Z, 6BEB22A, 6BEB22B, 6BEB22M...(Other models you can see in the webshop) |                 |         |



1

|                    |   |                 |         |
|--------------------|---|-----------------|---------|
| <b>GEV No.</b>     | 601870  | <b>Ref. No.</b> | 32V6840 |
| <b>description</b> | radial fan 230/240V voltage AC 50/60Hz H1 180mm L1 175mm D1 ø 75mm W1 80mm W2 50mm H2 50mm W3 83mm H3 83mm  |                 |         |
| <b>For models:</b> | FC1221G, FM1221G1, FM1221G1-VERS.2006, FM1221G2, FM1221G2-VERS.2006, FM1221G3, FM1221G3-VERS.2006, FM2021G1, FM2021G2, FM2021G2-VERS.2006, FM2021G3, FM2021G3-VERS.2006 |                 |         |



1

|                    |   |                 |         |
|--------------------|---|-----------------|---------|
| <b>GEV No.</b>     | 601599  | <b>Ref. No.</b> | 32V5830 |
| <b>description</b> | radial fan 230V voltage AC 50Hz 60W H1 175mm L1 205mm D1 ø 109mm W1 135mm W2 58mm H2 58mm convection oven   |                 |         |
| <b>For models:</b> | FC1011G, FC611G, FM1011G1, FM1011G1-VERS.2006, FM1011G2, FM1011G2-VERS.2006, FM1011G3, FM1011G3-VERS.2006, FM2011G2-VERS.2006, FM2011G3-VERS.2006, FM611G1, FM611G1-VERS.2006, FM611G2, FM611G2-VERS.2006, FM611G3, FM611G3-VERS.2006, FM721G1, FM721G1-VERS.2006, FM721G2, FM721G2-VERS.2006, FM721G3, FM721G3-VERS.2006 |                 |         |

accessories universal



1

|   |  |                 |                         |
|---|--|-----------------|-------------------------|
| <b>GEV No.</b>  | 801197   | <b>Ref. No.</b> | 3018670<br>6003060      |
| <b>description</b>  | puller for fan wheel seat ø 27-33mm thread M16x1.5 WS 17   |                 |                         |
| <b>For models:</b>  | FM1011E1, FM1011E2, FM1011E3, FM1011G1, FM1011G2, FM1011G3, FM1221E1, FM1221E2, FM1221E3, FM1221G1, FM1221G2, FM1221G3, FM611E1, FM611E2, FM611E3, FM611G1, FM611G2, FM611G3 |                 |                         |
| <b>spare parts for</b>  | 801197   |                 |                         |
|  | <b>GEV No.</b>   | 801198          | <b>Ref. No.</b> 3019160 |
|   | screw for puller thread M16x1.5 L 63mm WS 17   |                 |                         |



# pumps

## wash and rinse pumps

ALBA (C&A)

pumps

electric components

Зип Общепит

vsezip.ru





+7(812)987-08-81







1



1

|   |  |                 |                                    |
|---|--|-----------------|------------------------------------|
| <b>GEV No.</b>  | 500181   | <b>Ref. No.</b> | 32M2940                            |
| <b>description</b>  | pump inlet $\varnothing$ 45mm outlet $\varnothing$ 40mm type C7675 230V 50Hz 1 phase 0.29kW 0.4HP L 175mm rotation direction right capacitor 10 $\mu$ F ALBA PUMPS (C&A)   |                 |                                    |
| <b>For models:</b>  | LT20F, LT25F   |                 |                                    |
| <b>spare parts for</b>  | 500181   |                 |                                    |
|    | <b>GEV No.</b>   | 365015          | <b>Ref. No.</b> —                  |
|   | operating capacitor capacity 10 $\mu$ F 400V tolerance 5%Hz ambient temperature max. -25 to +85°C $\varnothing$ 35.5mm L 59mm M8 plastic connection male faston 6.3mm protection   |                 |                                    |
|    | <b>GEV No.</b>   | 509018          | <b>Ref. No.</b> —                  |
|   | O-ring EPDM thickness 3.53mm ID $\varnothing$ 107.5mm Qty 1 pcs  |                 |                                    |
|   | <b>GEV No.</b>   | 509028          | <b>Ref. No.</b> —                  |
|   | impellor $\varnothing$ 87mm H 21mm rotation direction right thread M7L shaft $\varnothing$ 12mm  |                 |                                    |
|  | <b>GEV No.</b>   | 510693          | <b>Ref. No.</b> 3036790<br>3152080 |
|   | mechanical shaft seal for shaft $\varnothing$ 12mm slide ring ext. $\varnothing$ 24mm slide ring H 15.5mm slide ring int. $\varnothing$ 11mm counter ring mounting $\varnothing$ 24mm height counter ring 8mm counter ring int. $\varnothing$ 13.5mm |                 |                                    |
|  | <b>GEV No.</b>   | 521528          | <b>Ref. No.</b> 36G8080            |
|   | pump cover ALBA PUMPS (C&A) inlet $\varnothing$ 45mm outlet $\varnothing$ 40mm turn direction right $\varnothing$ 129mm ID $\varnothing$ 105mm inner height 19mm   |                 |                                    |

|   |   |                 |                   |
|---|---|-----------------|-------------------|
| <b>GEV No.</b>  | 500180  | <b>Ref. No.</b> | 32M2950           |
| <b>description</b>  | pump inlet $\varnothing$ 28mm outlet $\varnothing$ 28mm type C7670 230V 50Hz 1 phase 0.11kW 0.15HP L 190mm rotation direction right capacitor 6.3 $\mu$ F ALBA PUMPS (C&A)                                    |                 |                   |
| <b>For models:</b>  | LT10R   |                 |                   |
| <b>spare parts for</b>  | 500180  |                 |                   |
|  | <b>GEV No.</b>  | 365012          | <b>Ref. No.</b> — |
|   | operating capacitor capacity 6.3 $\mu$ F 450V tolerance 5% 50Hz ambient temperature max. -25 to +85°C $\varnothing$ 30mm L 61mm M8 plastic connection male faston 6.3mm protection                            |                 |                   |
|  | <b>GEV No.</b>  | 510692          | <b>Ref. No.</b> — |
|   | mechanical shaft seal for shaft $\varnothing$ 11mm slide ring ext. $\varnothing$ 24mm slide ring H 13mm counter ring mounting $\varnothing$ 26mm height counter ring 8mm counter ring int. $\varnothing$ 14mm |                 |                   |
|  | <b>GEV No.</b>  | 521222          | <b>Ref. No.</b> — |
|   | impellor $\varnothing$ 72mm H 19mm thread M7L shaft $\varnothing$ 11mm shaft length 29mm blades 3   |                 |                   |
|  | <b>GEV No.</b>  | 521518          | <b>Ref. No.</b> — |
|   | pump cover ALBA PUMPS (C&A) inlet $\varnothing$ 28mm outlet $\varnothing$ 28mm turn direction right $\varnothing$ 93mm ID $\varnothing$ 76mm inner height 31mm  |                 |                   |
|  | <b>GEV No.</b>  | 532490          | <b>Ref. No.</b> — |
|   | O-ring EPDM thickness 2.62mm ID $\varnothing$ 72.69mm Qty 1 pcs   |                 |                   |

Зип Общепит

vsezip.ru

+7(812)987-08-81

FIR

pumps







1

|   |  |                 |                         |
|---|--|-----------------|-------------------------|
| <b>GEV No.</b>  | 500010   | <b>Ref. No.</b> | 32M2140                 |
| <b>description</b>  | pump inlet ø 45mm outlet ø 40mm type 2292.1506 230V 50Hz 1 phase 0.55kW 0.75HP L 238mm rotation direction right capacitor 12.5µF FIR   |                 |                         |
| <b>For models:</b>  | L40, L40S  |                 |                         |
| <b>spare parts for</b>  | 500010   |                 |                         |
|    | <b>GEV No.</b>   | 365014          | <b>Ref. No.</b> 32Z1310 |
|   | operating capacitor capacity 12.5µF 450V tolerance 5%Hz ambient temperature max. -25 to +85°C ø 35mm L 70mm M8 plastic connection male faston 6.3mm 45S.C3DS.12.5 protection |                 |                         |
|  | <b>GEV No.</b>   | 510600          | <b>Ref. No.</b> 32G0260 |
|   | impellor ø 102mm H 29mm shaft intake ø 9/8mm rotation direction right blades 6   |                 |                         |
|  | <b>GEV No.</b>   | 510692          | <b>Ref. No.</b> —       |
|   | mechanical shaft seal for shaft ø 11mm slide ring ext. ø 24mm slide ring H 13mm counter ring mounting ø 26mm height counter ring 8mm counter ring int. ø 14mm                |                 |                         |
|  | <b>GEV No.</b>   | 521023          | <b>Ref. No.</b> —       |
|   | fanwheel cover ED ø 150mm H 70mm for wash pump   |                 |                         |
|  | <b>GEV No.</b>   | 521506          | <b>Ref. No.</b> —       |
|   | pump cover FIR inlet ø 45mm outlet ø 40mm turn direction right ø 160mm ID ø 125mm inner height 25mm  |                 |                         |
|  | <b>GEV No.</b>   | 521702          | <b>Ref. No.</b> —       |
|   | pump cover gasket thickness 3.5x4.5mm Qty 1 pcs  |                 |                         |



1

|   |  |                 |                                    |
|---|--|-----------------|------------------------------------|
| <b>GEV No.</b>  | 500023   | <b>Ref. No.</b> | 32M3660                            |
| <b>description</b>  | pump inlet ø 63mm outlet ø 47mm type 1225.2725 230/400V 50Hz 3 phase 1.1kW 1.5HP L 335mm rotation direction right FIR  |                 |                                    |
| <b>spare parts for</b>  | 500023   |                 |                                    |
|    | <b>GEV No.</b>   | 510602          | <b>Ref. No.</b> —                  |
|   | impellor ø 110mm H 34mm rotation direction right thread M8L shaft ø 28mm seat ø 12.2mm blades 6  |                 |                                    |
|    | <b>GEV No.</b>   | 510693          | <b>Ref. No.</b> 3036790<br>3152080 |
|   | mechanical shaft seal for shaft ø 12mm slide ring ext. ø 24mm slide ring H 15.5mm slide ring int. ø 11mm counter ring mounting ø 24mm height counter ring 8mm counter ring int. ø 13.5mm |                 |                                    |
|  | <b>GEV No.</b>   | 521513          | <b>Ref. No.</b> 36D8510            |
|   | pump cover FIR inlet ø 63mm outlet ø 47mm turn direction right ID ø 150mm inner height 32mm  |                 |                                    |
|  | <b>GEV No.</b>   | 524416          | <b>Ref. No.</b> —                  |
|   | pump cover gasket thickness 4x4mm Qty 1 pcs  |                 |                                    |



1

|                    |  |                 |         |
|--------------------|--|-----------------|---------|
| <b>GEV No.</b>     | 500742   | <b>Ref. No.</b> | 32M1590 |
| <b>description</b> | pump inlet ø 63mm outlet ø 47mm type 1226.2602 230/400V 50Hz 3 phase 1.5kW 2HP L 333mm rotation direction left FIR |                 |         |
| <b>For models:</b> | L80  |                 |         |

Зиг-Общепит

vsezip

+7(812)987-08-81



|   |  |                 |                                 |
|---|--|-----------------|---------------------------------|
| <b>1</b>  |  |                 |                                 |
| <b>GEV No.</b>  | 500323   | <b>Ref. No.</b> | 32M1480                         |
| <b>description</b>  | pump inlet ø 63mm outlet ø 47mm type 1227.2721 230/400V 50Hz 3 phase 2kW 2.7HP L 335mm rotation direction right FIR  |                 |                                 |
| <b>For models:</b>  | L100   |                 |                                 |
| <b>spare parts for</b>  | 500323   |                 |                                 |
|    | <b>GEV No.</b>   | 510599          | <b>Ref. No.</b> —               |
|   | impellor ø 123mm H 34mm M8L  |                 |                                 |
|    | <b>GEV No.</b>   | 510693          | <b>Ref. No.</b> 3036790 3152080 |
|   | mechanical shaft seal for shaft ø 12mm slide ring ext. ø 24mm slide ring H 15.5mm slide ring int. ø 11mm counter ring mounting ø 24mm height counter ring 8mm counter ring int. ø 13.5mm |                 |                                 |
|  | <b>GEV No.</b>   | 521513          | <b>Ref. No.</b> 36D8510         |
|   | pump cover FIR inlet ø 63mm outlet ø 47mm turn direction right ID ø 150mm inner height 32mm  |                 |                                 |
|  | <b>GEV No.</b>   | 524416          | <b>Ref. No.</b> —               |
|   | pump cover gasket thickness 4x4mm Qty 1 pcs  |                 |                                 |



|   |  |                 |                   |
|---|--|-----------------|-------------------|
| <b>1</b>  |  |                 |                   |
| <b>GEV No.</b>  | 500117   | <b>Ref. No.</b> | 32M0020           |
| <b>description</b>  | pump inlet ø 63mm outlet ø 47mm type 4225.22725 230/400V 50Hz 3 phase 1.4kW 2HP L 280mm rotation direction right FIR |                 |                   |
| <b>For models:</b>  | L80  |                 |                   |
| <b>spare parts for</b>  | 500117   |                 |                   |
|  | <b>GEV No.</b>   | 510602          | <b>Ref. No.</b> — |
|   | impellor ø 110mm H 34mm rotation direction right thread M8L shaft ø 28mm seat ø 12.2mm blades 6                      |                 |                   |

|   |  |                 |                   |
|---|--|-----------------|-------------------|
| <b>spare parts for</b>  | 500117   |                 |                   |
| <b>GEV No.</b>  | 510693   | <b>Ref. No.</b> | 3036790 3152080   |
|   | mechanical shaft seal for shaft ø 12mm slide ring ext. ø 24mm slide ring H 15.5mm slide ring int. ø 11mm counter ring mounting ø 24mm height counter ring 8mm counter ring int. ø 13.5mm |                 |                   |
| <b>GEV No.</b>  | 521513   | <b>Ref. No.</b> | 36D8510           |
|   | pump cover FIR inlet ø 63mm outlet ø 47mm turn direction right ID ø 150mm inner height 32mm  |                 |                   |
|  | <b>GEV No.</b>   | 524416          | <b>Ref. No.</b> — |
|   | pump cover gasket thickness 4x4mm Qty 1 pcs  |                 |                   |



|   |  |                 |                                 |
|---|--|-----------------|---------------------------------|
| <b>1</b>  |  |                 |                                 |
| <b>GEV No.</b>  | 500111   | <b>Ref. No.</b> | 32M4820                         |
| <b>description</b>  | pump inlet ø 63mm outlet ø 53mm type 1241.2500 230/400V 50Hz 3 phase 1.1kW 1.5HP L 330mm rotation direction left FIR   |                 |                                 |
| <b>For models:</b>  | C304AD, C304AD-VERS.2006, C304AS, C304AS-VERS.2006, C304AVD, C304AVD-VERS.2006, C304AVS, C304AVS-VERS.2006, C304D, C304D-VERS.2006, C304S, C304S-VERS.2006, C304VD, C304VD-VERS.2006, C304VS, C304VS-VERS.2006, CS243S-VERS.2006, CS370AD, CS370AD-VERS.2006, CS370AS, CS370AS-VERS.2006, CS370AVD, CS370AVD-VERS.2006, CS370AVS, CS370AVS-VERS.2006, CS370D, CS370D-VERS.2006, CS370S, CS370S-VERS.2006, CS370VD, CS370VD-VERS.2006, CS370VS, CS370VS-VERS.2006, CS466AD, CS466AD-VERS.2006, CS466AS, CS466AS-VERS.2006, CS466AVD, CS466AVD-VERS.2006, CS466AVS, CS466AVS-VERS.2006, CS466D, CS466D-VERS.2006, CS466S, CS466S-VERS.2006, CS466VD, CS466VD-VERS.2006, CS466VS, CS466VS-VERS.2006 |                 |                                 |
| <b>spare parts for</b>  | 500111   |                 |                                 |
|  | <b>GEV No.</b>   | 510531          | <b>Ref. No.</b> —               |
|   | pump cover FIR inlet ø 63mm outlet ø 53mm auxiliary pressure connection M16x1.5mm supporting pressure open turn direction left ø 185mm ID ø 150mm inner height 37mm  |                 |                                 |
|  | <b>GEV No.</b>   | 510612          | <b>Ref. No.</b> —               |
|   | impellor ø 110mm H 34mm M8R  |                 |                                 |
|  | <b>GEV No.</b>   | 510693          | <b>Ref. No.</b> 3036790 3152080 |
|   | mechanical shaft seal for shaft ø 12mm slide ring ext. ø 24mm slide ring H 15.5mm slide ring int. ø 11mm counter ring mounting ø 24mm height counter ring 8mm counter ring int. ø 13.5mm   |                 |                                 |
|  | <b>GEV No.</b>   | 524416          | <b>Ref. No.</b> —               |
|   | pump cover gasket thickness 4x4mm Qty 1 pcs  |                 |                                 |

Зип Общепит



vsezip.ru

+7(812)987-08-81

LGB





1



|   |  |                 |                   |
|---|--|-----------------|-------------------|
| <b>GEV No.</b>  | 500094   | <b>Ref. No.</b> | 32M2920           |
| <b>description</b>  | pump inlet ø 28mm outlet ø 26mm type ZF131SX 230V 50Hz 1 phase 0.2kW 0.15HP L 195mm rotation direction left capacitor 6.3µF LGB                                  |                 |                   |
| <b>For models:</b>  | F60PR, F60T, F80P, F80PR   |                 |                   |
| <b>spare parts for</b>  | 500094   |                 |                   |
|    | <b>GEV No.</b>   | 365012          | <b>Ref. No.</b> — |
|   | operating capacitor capacity 6.3µF 450V tolerance 5% 50Hz ambient temperature max. -25 to +85°C ø 30mm L 61mm M8 plastic connection male faston 6.3mm protection |                 |                   |
|    | <b>GEV No.</b>   | 502266          | <b>Ref. No.</b> — |
|   | pump cover inlet ø 28mm outlet ø 26mm  |                 |                   |
|  | <b>GEV No.</b>   | 510703          | <b>Ref. No.</b> — |
|   | mechanical shaft seal for shaft ø 13mm slide ring H 13mm height counter ring 5.5mm ED ø 26mm   |                 |                   |
|  | <b>GEV No.</b>   | 521085          | <b>Ref. No.</b> — |
|   | impellor ø 72mm H 17mm thread M7L shaft ø 13mm shaft length 12mm blades 3  |                 |                   |
|  | <b>GEV No.</b>   | 528800          | <b>Ref. No.</b> — |
|   | O-ring EPDM thickness 2.62mm ID ø 75.87mm Qty 1 pcs  |                 |                   |

1



|   |  |                 |                         |
|---|--|-----------------|-------------------------|
| <b>GEV No.</b>  | 500508   | <b>Ref. No.</b> | 32M2910<br>32M4760      |
| <b>description</b>  | pump inlet ø 45mm outlet ø 38mm type ZF320VSX 230V 50Hz 1 phase 0.75kW 1HP L 230mm rotation direction right capacitor 12.5µF LGB   |                 |                         |
| <b>For models:</b>  | F60P, F60PR, F60T, F80P, F80PR, L45  |                 |                         |
| <b>spare parts for</b>  | 500508   |                 |                         |
|    | <b>GEV No.</b>   | 365014          | <b>Ref. No.</b> 32Z1310 |
|   | operating capacitor capacity 12.5µF 450V tolerance 5%Hz ambient temperature max. -25 to +85°C ø 35mm L 70mm M8 plastic connection male faston 6.3mm 45S.C3DS.12.5 protection |                 |                         |
|   | <b>GEV No.</b>   | 510702          | <b>Ref. No.</b> 3152680 |
|   | mechanical shaft seal height counter ring 5.5mm ID ø 12mm  |                 |                         |
|  | <b>GEV No.</b>   | 521247          | <b>Ref. No.</b> —       |
|   | impellor ø 90mm H 27mm rotation direction right thread M8L blades 6  |                 |                         |
|  | <b>GEV No.</b>   | 521542          | <b>Ref. No.</b> —       |
|   | pump cover LGB inlet ø 45mm outlet ø 40mm auxiliary pressure connection 13mm supporting pressure open ø 150mm ID ø 120mm inner high 25mm                                     |                 |                         |
|  | <b>GEV No.</b>   | 521714          | <b>Ref. No.</b> —       |
|   | pump cover gasket thickness 4x4mm Qty 1 pcs  |                 |                         |

1



|                    |   |                 |         |
|--------------------|---|-----------------|---------|
| <b>GEV No.</b>     | 500984  | <b>Ref. No.</b> | 32M5770 |
| <b>description</b> | pump inlet ø 45mm outlet ø 39mm type ZF270VSX 230V 50Hz 1 phase 0.4kW L 209mm rotation direction right capacitor 10µF LGB |                 |         |
| <b>For models:</b> | LF50, LF50E, LF50EM, LF50EMPS, LF50EMPS-VERS.122012, LF50EM-VERS.122012, LF50E-VERS.122012, LF50E-VERS.2007, LP70         |                 |         |



Зип Общепит

vsezip.ru

+7(812)987-08-81







1

|   |  |                 |                         |
|---|--|-----------------|-------------------------|
| <b>GEV No.</b>  | 500377   | <b>Ref. No.</b> | 32M4830                 |
| <b>description</b>  | pump inlet ø 61mm outlet ø 52mm type ZF800DX 230/400V 50Hz 3 phase 2kW 2.72HP L 330mm rotation direction left LGB  |                 |                         |
| <b>For models:</b>  | C165D, C165S, C165VD, C165VS, C207D, C207D-VERS.2006, C207S, C207S-VERS.2006, C207VD, C207VD-VERS.2006, C207VS, C207VS-VERS.2006, C304AD, C304AD-VERS.2006, C304AS, C304AS-VERS.2006, C304AVD, C304AVD-VERS.2006, C304AVS, C304AVS-VERS.2006, C304D, C304D-VERS.2006, C304S, C304S-VERS.2006, C304VD, C304VD-VERS.2006, C304VS, C304VS-VERS.2006, C92D-VERS.2006, C92S-VERS.2006, C92VD-VERS.2006, C92VS-VERS.2006, CS243D, CS243D-VERS.2006, CS243S, CS243S-VERS.2006, CS243VD, CS243VD-VERS.2006, CS243VS, CS243VS-VERS.2006, CS370AD, CS370AD-VERS.2006, CS370AS, CS370AS-VERS.2006, CS370AVD, CS370AVD-VERS.2006, CS370AVS, CS370AVS-VERS.2006, CS370D, CS370D-VERS.2006...(Other models you can see in the webshop) |                 |                         |
| <b>spare parts for</b>  | 500377   |                 |                         |
|  | <b>GEV No.</b>   | 510551          | <b>Ref. No.</b> 3FL1123 |
|   | pump cover gasket ID ø 158.3mm pump type 1214/1293/1225/2243/1226/1204/3473/1241 thickness 3.53mm EPDM Qty 1 pcs   |                 |                         |
|  | <b>GEV No.</b>   | 510694          | <b>Ref. No.</b> —       |
|   | mechanical shaft seal for shaft ø 13mm height counter ring 8mm ID ø 11.5mm H 16mm mounting ø 24/26mm int. ø 1 14mm   |                 |                         |
|  | <b>GEV No.</b>   | 521276          | <b>Ref. No.</b> —       |
|   | impellor ø 120mm H 39mm pump type ZF800DX shaft intake ø 12mm rotation direction left thread M8R pump for ZF800DX blades 6   |                 |                         |
|  | <b>GEV No.</b>   | 521516          | <b>Ref. No.</b> —       |
|   | pump cover LGB inlet ø 62mm outlet ø 52mm auxiliary pressure connection 12mm supporting pressure closed turn direction left ø 190mm ID ø 150mm inner height 40mm   |                 |                         |



1

|   |   |                 |                         |
|---|---|-----------------|-------------------------|
| <b>GEV No.</b>  | 500376  | <b>Ref. No.</b> | 32M6180                 |
| <b>description</b>  | pump inlet ø 62mm outlet ø 50mm type AM5225SX 230V 50Hz 1 phase 0.9kW 1.2HP L 300mm rotation direction right capacitor 16µF LGB   |                 |                         |
| <b>For models:</b>  | LC80  |                 |                         |
| <b>spare parts for</b>  | 500376  |                 |                         |
|    | <b>GEV No.</b>  | 365021          | <b>Ref. No.</b> 32Z6080 |
|   | operating capacitor capacity 16µF 425V tolerance 5% 50/60Hz ambient temperature max. -25 to +85°C ø 35mm L 73mm single M8 plastic connection male faston 6.3mm 416.10.99 protection |                 |                         |
|    | <b>GEV No.</b>  | 510551          | <b>Ref. No.</b> 3FL1123 |
|   | pump cover gasket ID ø 158.3mm pump type 1214/1293/1225/2243/1226/1204/3473/1241 thickness 3.53mm EPDM Qty 1 pcs  |                 |                         |
|  | <b>GEV No.</b>  | 510694          | <b>Ref. No.</b> —       |
|   | mechanical shaft seal for shaft ø 13mm height counter ring 8mm ID ø 11.5mm H 16mm mounting ø 24/26mm int. ø 1 14mm  |                 |                         |
|  | <b>GEV No.</b>  | 512029          | <b>Ref. No.</b> —       |
|   | impellor ø 103mm H 26mm thread M8L shaft ø 19mm shaft length 15mm seat ø 8.2mm  |                 |                         |
|  | <b>GEV No.</b>  | 521536          | <b>Ref. No.</b> —       |
|   | pump cover ALBA / LGB inlet ø 62mm outlet ø 50mm auxiliary pressure connection 12mm supporting pressure closed turn direction right ø 180mm ID ø 150mm inner height 38mm            |                 |                         |





Зип Общепит

vsezip.ru

+7(812)9810888



|                        |  |                 |                  |
|------------------------|--|-----------------|------------------|
| <b>GEV No.</b>         | 500379   | <b>Ref. No.</b> | 32M5740          |
| <b>description</b>     | pump inlet ø 62mm outlet ø 50mm type ZF650SX 230/400V 50Hz 3 phase 1.35kW 1.8HP L 335mm rotation direction right LGB   |                 |                  |
| <b>For models:</b>     | LC100, N354D, N354S, N354VD, N354VS, N506D, N506S, N506VD, N506VS, N607D, N607S, N607VD, N607VS, N760D, N760S, N760VD, N760VS, N886D, N886S, N886VD, N886VS              |                 |                  |
| <b>spare parts for</b> | 500379   |                 |                  |
|                        | GEV No.  | 510551          | Ref. No. 3FL1123 |
|                        | pump cover gasket ID ø 158.3mm pump type 1214/1293/1225/2243/1226/1204/3473/1241 thickness 3.53mm EPDM Qty 1 pcs   |                 |                  |
|                        | GEV No.  | 510694          | Ref. No. —       |
|                        | mechanical shaft seal for shaft ø 13mm height counter ring 8mm ID ø 11.5mm H 16mm mounting ø 24/26mm int. ø 1 14mm   |                 |                  |
|                        | GEV No.  | 521240          | Ref. No. —       |
|                        | impellor ø 110mm H 32mm rotation direction left thread M8L shaft ø 20mm shaft length 10mm seat ø 8.2mm blades 6  |                 |                  |
|                        | GEV No.  | 521536          | Ref. No. —       |
|                        | pump cover ALBA / LGB inlet ø 62mm outlet ø 50mm auxiliary pressure connection 12mm supporting pressure closed turn direction right ø 180mm ID ø 150mm inner height 38mm |                 |                  |

|                |  |                 |                    |
|----------------|--|-----------------|--------------------|
| <b>GEV No.</b> | 509007   | <b>Ref. No.</b> | —                  |
|                | impellor ø 85mm H 20mm rotation direction left thread M10R shaft ø 2mm shaft length 7.5mm blades 12  |                 |                    |
| <b>GEV No.</b> | 510693   | <b>Ref. No.</b> | 3036790<br>3152080 |
|                | mechanical shaft seal for shaft ø 12mm slide ring ext. ø 24mm slide ring H 15.5mm slide ring int. ø 11mm counter ring mounting ø 24mm height counter ring 8mm counter ring int. ø 13.5mm |                 |                    |
| <b>GEV No.</b> | 521167   | <b>Ref. No.</b> | 3101190            |
|                | pump cover OLYMPIA inlet ø 1"mm outlet ø 30/30mm ID ø 94mm   |                 |                    |
| <b>GEV No.</b> | 521723   | <b>Ref. No.</b> | 3116490            |
|                | pump cover gasket EPDM thickness 2mm ID ø 90mm Qty 1 pcs   |                 |                    |



|                        |  |                 |                             |
|------------------------|--|-----------------|-----------------------------|
| <b>GEV No.</b>         | 500958   | <b>Ref. No.</b> | 3034630                     |
| <b>description</b>     | pump inlet ø 33mm outlet ø 30/28mm type T45 230V 50Hz 1 phase 0.33kW 0.45HP L 215mm rotation direction left capacitor 8µF OLYMPIA  |                 |                             |
| <b>For models:</b>     | KD40, KD40LSPS, KD40LUX  |                 |                             |
| <b>spare parts for</b> | 500958   |                 |                             |
|                        | GEV No.  | 365013          | Ref. No. 3222490            |
|                        | operating capacitor capacity 8µF 400V tolerance 5%Hz ambient temperature max. -25 to +85°C ø 31.5mm L 55mm M8 plastic connection male faston 6.3mm protection                            |                 |                             |
|                        | GEV No.  | 510693          | Ref. No. 3036790<br>3152080 |
|                        | mechanical shaft seal for shaft ø 12mm slide ring ext. ø 24mm slide ring H 15.5mm slide ring int. ø 11mm counter ring mounting ø 24mm height counter ring 8mm counter ring int. ø 13.5mm |                 |                             |
|                        | GEV No.  | 521257          | Ref. No. —                  |
|                        | impellor ø 80mm H 12mm rotation direction left thread M10R shaft ø 12mm shaft length 7.5mm blades 6  |                 |                             |
|                        | GEV No.  | 521551          | Ref. No. —                  |
|                        | pump cover OLYMPIA inlet ø 33mm outlet ø 30mm outlet 2 ø 28 turn direction left ø 103mm ID ø 93mm inner height 30mm  |                 |                             |
| <b>GEV No.</b>         | 521723   | <b>Ref. No.</b> | 3116490                     |
|                        | pump cover gasket EPDM thickness 2mm ID ø 90mm Qty 1 pcs   |                 |                             |

OLYMPIA

pumps



|                        |   |                 |                  |
|------------------------|---|-----------------|------------------|
| <b>GEV No.</b>         | 499257  | <b>Ref. No.</b> | 3037780          |
| <b>description</b>     | pump inlet ø 1" IT outlet ø 30mm type L63.T45F_2V 230V 50Hz 1 phase 0.33kW L 230mm rotation direction left capacitor 8µF OLYMPIA                              |                 |                  |
| <b>For models:</b>     | KD40  |                 |                  |
| <b>spare parts for</b> | 499257  |                 |                  |
|                        | GEV No.   | 365013          | Ref. No. 3222490 |
|                        | operating capacitor capacity 8µF 400V tolerance 5%Hz ambient temperature max. -25 to +85°C ø 31.5mm L 55mm M8 plastic connection male faston 6.3mm protection |                 |                  |

electric components

Зип Общепит  
booster pumps

vsezip.ru

+7(812)987-08-81



1

|   |  |                 |                                    |
|---|--|-----------------|------------------------------------|
| <b>GEV No.</b>  | 500529   | <b>Ref. No.</b> | 3234970                            |
| <b>description</b>  | pump inlet $\varnothing$ 60mm outlet $\varnothing$ 48mm type T12 230V 50Hz 1 phase 0.88kW 1.2HP L 270mm rotation direction right capacitor 16 $\mu$ F auxiliary pressure connection 10mm supporting pressure open OLYMPIA                            |                 |                                    |
| <b>For models:</b>  | KN80, KN800, KN800PSD, KN80PS  |                 |                                    |
| <b>spare parts for</b>  | 500529   |                 |                                    |
|    | <b>GEV No.</b>   | 365021          | <b>Ref. No.</b> 32Z6080            |
|   | operating capacitor capacity 16 $\mu$ F 425V tolerance 5% 50/60Hz ambient temperature max. -25 to +85°C $\varnothing$ 35mm L 73mm single M8 plastic connection male faston 6.3mm 416.10.99 protection  |                 |                                    |
|  | <b>GEV No.</b>   | 510693          | <b>Ref. No.</b> 3036790<br>3152080 |
|   | mechanical shaft seal for shaft $\varnothing$ 12mm slide ring ext. $\varnothing$ 24mm slide ring H 15.5mm slide ring int. $\varnothing$ 11mm counter ring mounting $\varnothing$ 24mm height counter ring 8mm counter ring int. $\varnothing$ 13.5mm |                 |                                    |
|  | <b>GEV No.</b>   | 521010          | <b>Ref. No.</b> —                  |
|   | impeller $\varnothing$ 98mm H 12mm M10L blades 8   |                 |                                    |
|  | <b>GEV No.</b>   | 521559          | <b>Ref. No.</b> —                  |
|   | pump cover OLYMPIA inlet $\varnothing$ 60mm outlet $\varnothing$ 48mm outlet 2 $\varnothing$ 31 auxiliary pressure connection 10mm supporting pressure open turn direction right $\varnothing$ 170mm ID $\varnothing$ 150mm inner height 22mm        |                 |                                    |
|  | <b>GEV No.</b>   | 521727          | <b>Ref. No.</b> —                  |
|   | pump cover gasket EPDM thickness 1.78mm ID $\varnothing$ 145mm Qty 1 pcs   |                 |                                    |



1

|   |  |                 |                   |
|---|--|-----------------|-------------------|
| <b>GEV No.</b>  | 500358   | <b>Ref. No.</b> | 3057760           |
| <b>description</b>  | pump inlet $\varnothing$ 3/8" outlet $\varnothing$ 3/8" type PS46 230V 50Hz 0.45kW $\varnothing$ 100mm L 200mm capacitor 10 $\mu$ F LGB  |                 |                   |
| <b>For models:</b>  | KD100A, KD130A, KD60MA, KD60MPSA, KD85A, KD85PSA, LP151, LP70  |                 |                   |
| <b>spare parts for</b>  | 500358   |                 |                   |
|    | <b>GEV No.</b>   | 510713          | <b>Ref. No.</b> — |
|   | slide ring for shaft $\varnothing$ 12mm ED $\varnothing$ 24mm H 16mm   |                 |                   |
|    | <b>GEV No.</b>   | 510723          | <b>Ref. No.</b> — |
|   | counter ring H 8mm ED $\varnothing$ 26mm ID $\varnothing$ 13.5mm for mechanical shaft seal   |                 |                   |
|    | <b>GEV No.</b>   | 698400          | <b>Ref. No.</b> — |
|   | pump cover gasket pump type PS46 thickness 2mm ID $\varnothing$ 66mm Qty 1 pcs   |                 |                   |
| <b>accessories for</b>  | 500358   |                 |                   |
|  | <b>GEV No.</b>   | 365015          | <b>Ref. No.</b> — |
|   | operating capacitor capacity 10 $\mu$ F 400V tolerance 5% ambient temperature max. -25 to +85°C $\varnothing$ 35.5mm L 59mm M8 plastic connection male faston 6.3mm protection |                 |                   |
|  | <b>GEV No.</b>   | 511279          | <b>Ref. No.</b> — |
|   | hose connector brass straight thread 3/8" hose $\varnothing$ 12mm Qty 1 pcs  |                 |                   |
|  | <b>GEV No.</b>   | 520202          | <b>Ref. No.</b> — |
|   | hose connector nickel-plated brass straight thread 3/8" hose $\varnothing$ 12mm Qty 1 pcs  |                 |                   |
|  | <b>GEV No.</b>   | 520677          | <b>Ref. No.</b> — |
|   | hose connector brass straight thread 3/8" hose $\varnothing$ 13mm Qty 1 pcs  |                 |                   |

drain pumps

GRE



1

|                    |   |                 |         |
|--------------------|---|-----------------|---------|
| <b>GEV No.</b>     | 500051  | <b>Ref. No.</b> | 32M4430 |
| <b>description</b> | drain pump inlet $\varnothing$ 22/30mm outlet $\varnothing$ 22mm 100W 230V 50Hz GRE |                 |         |
| <b>For models:</b> | PGA20, PGA30, PGA40, PGA60, PGA80, PGW20, PGW30, PGW40, PGW60, PGW80                |                 |         |



Зип Общепит pumps for ice machines

vsezip.ru

+7(812)987-08-81



1

|                    |  |                 |         |
|--------------------|--|-----------------|---------|
| <b>GEV No.</b>     | 500980   | <b>Ref. No.</b> | 32M5220 |
| <b>description</b> | drain pump inlet ø 30mm outlet ø 21mm 100W 230V 50Hz GRE |                 |         |
| <b>For models:</b> | F60T, F80P   |                 |         |

miscellaneous



1

|                    |   |                 |     |
|--------------------|---|-----------------|-----|
| <b>GEV No.</b>     | 500201  | <b>Ref. No.</b> | N/A |
| <b>description</b> | drain pump inlet ø 24mm outlet ø 22mm 230V 100W |                 |     |

vibration pumps



1

|                    |   |                 |         |
|--------------------|---|-----------------|---------|
| <b>GEV No.</b>     | 520159  | <b>Ref. No.</b> | 3007950 |
| <b>description</b> | hose connector nickel-plated brass straight thread 1/8" hose ø 6mm Qty 1 pcs WS 12 total length 32mm thread L 7.5mm grommet ø 6mm grommet length 19.5mm |                 |         |
| <b>For models:</b> | FM1011E3, FM1011G3, FM1221E3, FM1221G3, FM2021E3, FM2021G3, FM423E2, FM611E3, FM611G3, FM721E3, FM721G3   |                 |         |





1

|                    |  |                 |                    |
|--------------------|--|-----------------|--------------------|
| <b>GEV No.</b>     | 500972   | <b>Ref. No.</b> | 32M7000<br>32M7001 |
| <b>description</b> | vibration pump 230V 47W 50Hz inlet ø 7 outlet ø 1/8" IT CEME type E507   |                 |                    |
| <b>For models:</b> | FM1011E3, FM1011E3-VERS.2006, FM1011G3, FM1011G3-VERS.2006, FM1221E3, FM1221E3-VERS.2006, FM1221G3-VERS.2006, FM2011E3-VERS.2006, FM2011G3-VERS.2006, FM2021E3, FM2021E3-VERS.2006, FM2021G3, FM2021G3-VERS.2006, FM611E3, FM611E3-VERS.2006, FM611G3, FM611G3-VERS.2006, FM721E3, FM721E3-VERS.2006, FM721G3, FM721G3-VERS.2006 |                 |                    |



1

|   |   |                 |                 |   |
|---|---|-----------------|-----------------|---|
| <b>GEV No.</b>  | 501420  | <b>Ref. No.</b> | 32M6430         |   |
| <b>description</b>  | pump GRE 100W 230V 50Hz inlet ø 25mm outlet ø 22mm L 150mm total length 230mm for ice-cube maker                                  |                 |                 |   |
| <b>For models:</b>  | PG80C, PG81CW, PGC132, PGC132-VERS.200911, PGC134W, PGC134W-VERS.200911, PGC210, PGC210-VERS.200911, PGC212W, PGC212W-VERS.200911 |                 |                 |   |
| <b>spare parts for</b>  | 501420  |                 |                 |   |
|  | <b>GEV No.</b>  | 695417          | <b>Ref. No.</b> | — |
|   | insulation for pump   |                 |                 |   |



1

|                    |   |                 |         |
|--------------------|---|-----------------|---------|
| <b>GEV No.</b>     | 500047  | <b>Ref. No.</b> | 32M6310 |
| <b>description</b> | pump REBO type MH30F1 30W 230V 50Hz outlet ø 12.7mm L 135mm rotation direction left |                 |         |
| <b>For models:</b> | PG22C, PG23C, PG23CW, PG24CW, PG30C, PG31CW, PG42C, PG43CW, PG60C, PG61CW           |                 |         |

## condensators & interference suppression filters

### starting capacitors

starting capacitors



1

|                    |  |                 |         |
|--------------------|--|-----------------|---------|
| <b>GEV No.</b>     | 365095   | <b>Ref. No.</b> | 32V1490 |
| <b>description</b> | starting capacitor 43µF 330V 50/60Hz duty cycle 3 60A1D-330043NXET ø 36mm L 80mm M8 plastic connection cable 350mm 04P.5523CM  |                 |         |
| <b>For models:</b> | 120, 120NN, 120PV, 135A, 135XE, 40, 40CP, 40CPX, 40EV, 40EVP, 40PV, 40X, 40XPV, 55, 55PV, 65A, 65XE, 6FMA11A, 6FMA11B, 6FMA11M, 6FMA11Z, 6FMA2A, 6FMA2B, 6FMA2M, 6FMA2Z, 6FMA4A, 6FMA4B, 6FMA4M, 6FMA4Z, 6FMAA, 6FMAB, 6FMAM, 6FMAZ, 6FMB11A, 6FMB11B, 6FMB11M, 6FMB11Z, 6FMB2A, 6FMB2B, 6FMB2M, 6FMB2Z, 6FMB4A, 6FMB4B, 6FMB4M, 6FMB4Z, 6FMBA, 6FMBB, 6FMBM, 6FMBZ, 6FMC11A...(Other models you can see in the webshop) |                 |         |

## operating capacitors

## plastic



1

|                    |  |                 |         |
|--------------------|--|-----------------|---------|
| <b>GEV No.</b>     | 365014   | <b>Ref. No.</b> | 32Z1310 |
| <b>description</b> | operating capacitor capacity 12.5μF 450V tolerance 5%Hz ambient temperature max. -25 to +85°C ø 35mm L 70mm M8 plastic connection male faston 6.3mm 45S.C3DS.12.5 protection |                 |         |
| <b>For models:</b> | L40, L40S  |                 |         |



1

|                    |   |                 |         |
|--------------------|---|-----------------|---------|
| <b>GEV No.</b>     | 365021  | <b>Ref. No.</b> | 32Z6080 |
| <b>description</b> | operating capacitor capacity 16μF 425V tolerance 5% 50/60Hz ambient temperature max. -25 to +85°C ø 35mm L 73mm single M8 plastic connection male faston 6.3mm 416.10.99 protection |                 |         |
| <b>For models:</b> | FC101, FC241, FC61, FCV101, FCV101DS, FCV141, FCV141DS, FCV141DS-CSA, FCV241, FCV241DS, FCV61, FCV61DS  |                 |         |



1

|                    |   |                 |         |
|--------------------|---|-----------------|---------|
| <b>GEV No.</b>     | 365224  | <b>Ref. No.</b> | 32V6440 |
| <b>description</b> | operating capacitor capacity 25μF 420V tolerance 5% 50/60Hz ø 45mm L 75mm M8 plastic connection male faston 6.3mm   |                 |         |
| <b>For models:</b> | FM1011G3, FM1011G3-VERS.2006, FM2011G3-VERS.2006, FM611G3, FM611G3-VERS.2006, FM721G3, FM721G3-VERS.2006, FX61G1, FX61G1R, FX61G2, FX61G2C, FX61G2CR, FX61G2R |                 |         |



1

|                    |   |                 |         |
|--------------------|---|-----------------|---------|
| <b>GEV No.</b>     | 365225  | <b>Ref. No.</b> | 32V5980 |
| <b>description</b> | operating capacitor capacity 35μF 420V tolerance 5% 50/60Hz ambient temperature max. -25 to +85°C ø 45mm L 95mm M8 plastic connection male faston 6.3mm protection  |                 |         |
| <b>For models:</b> | FC1011G, FC611G, FM1011G1-VERS.2006, FM1011G2-VERS.2006, FM1011G3-VERS.2006, FM1221G1, FM1221G1-VERS.2006, FM1221G2, FM1221G2-VERS.2006, FM1221G3-VERS.2006, FM2011G2-VERS.2006, FM2011G3-VERS.2006, FM2021G2-VERS.2006, FM2021G3-VERS.2006, FM611G1-VERS.2006, FM611G2-VERS.2006, FM611G3-VERS.2006, FX101G1, FX101G1R, FX101G2, FX101G2C, FX101G2R, FX10G2CR, FX82G1, FX82G2, FX82G2C |                 |         |

Зип Общепит

vsezip.ru

+7(812)987-08-81

|                    |   |                 |         |
|--------------------|---|-----------------|---------|
| <b>GEV No.</b>     | 365022  | <b>Ref. No.</b> | 32V6540 |
| <b>description</b> | operating capacitor capacity 40μF 400V tolerance 5%Hz ambient temperature max. -25 to +85°C ø 45mm L 95mm M8 plastic connection male faston 6.3mm protection  |                 |         |
| <b>For models:</b> | BX101G, BX101G-VERS.122013, BX82G, BX82G-VERS.122013, FM1011G1, FM1011G2, FM1011G3, FM611G1, FM611G2, FM611G3, FM721G1, FM721G1-VERS.2006, FM721G2, FM721G2-VERS.2006, FM721G3, FM721G3-VERS.2006, FX101G1, FX101G1R, FX101G2, FX101G2C, FX101G2C-VERS.032014, FX101G2R, FX101G2R-VERS.032014, FX101G2-VERS.032014, FX10G2CR, FX10G2CR-VERS.032014, FX201G2, FX201G2P, FX201G2P-VERS.032014, FX201G2-VERS.032014, FX202G2, FX202G2-VERS.032014, FX82G1, FX82G2, FX82G2C, FX82G2T, FX82G2T-VERS.032014 |                 |         |



1

|                    |   |                 |         |
|--------------------|---|-----------------|---------|
| <b>GEV No.</b>     | 365013  | <b>Ref. No.</b> | 32Z2490 |
| <b>description</b> | operating capacitor capacity 8μF 400V tolerance 5%Hz ambient temperature max. -25 to +85°C ø 31.5mm L 55mm M8 plastic connection male faston 6.3mm protection |                 |         |
| <b>For models:</b> | 71AR  |                 |         |

## filters

## interference suppression filters



1

|                    |   |                 |         |
|--------------------|---|-----------------|---------|
| <b>GEV No.</b>     | 365065  | <b>Ref. No.</b> | 32Z6100 |
| <b>description</b> | interference suppression filter 1000Ohm capacity 1μF  |                 |         |
| <b>For models:</b> | FCV101DM, FCV101DS, FCV101EDM, FCV101EDS, FCV141DM, FCV141DS, FCV141EDM, FCV141EDS, FCV241DM, FCV241DS, FCV241EDM, FCV241EDS, FCV241GDM, FCV241GDS, FCV401DM, FCV401EDM, FCV4E, FCV4EDS, FCV61DM, FCV61DM-CSA, FCV61DS, FCV61EDM, FCV61EDM-UL, FCV61EDS |                 |         |



Зип Общепит electric accessories

fuses

fine fuses

1



|                    |   |                 |         |
|--------------------|---|-----------------|---------|
| <b>GEV No.</b>     | 358668  | <b>Ref. No.</b> | 3201540 |
| <b>description</b> | fine fuse size ø5x20mm 0.5A fast-acting rated 250V Qty 10 pcs   |                 |         |
| <b>For models:</b> | 04WFR3ED, 08WFR4ED, 08WGREV, 091FR3ED, 0A1FR1ED, 0A1FR3ED, 0D1FR1ED, 0D1FR3ED, 0G0FR3ED, 10CP1EA, 10CP1GA, 10CP1IA, 12CP1EA, 12CP1GA, 12CP1IA, 18CP2EA, 18CP2GA, 18CP2IA, 191FR4ED, 1A1FR2ED, 1A1FR4ED, 1D1FR2ED, 1D1FR4ED, 71RA, 91RA, FC101, FC101E, FC1011G, FC101E, FC1221E, FC1221G, FC241, FC241E, FC241G, FC61, FC61E, FC611G, FC61E, FCV101, FCV101DM, FCV101DS, FCV101E, FCV101EDM, FCV101EDS, FCV141, FCV141DM, FCV141DS, FCV141E, FCV141EDM, FCV141EDS...(Other models you can see in the webshop) |                 |         |

2



|                    |  |                 |         |
|--------------------|--|-----------------|---------|
| <b>GEV No.</b>     | 358671   | <b>Ref. No.</b> | 3200020 |
| <b>description</b> | fine fuse size ø5x20mm 1A fast-acting rated 250V Qty 10 pcs  |                 |         |
| <b>For models:</b> | 06WBR3E, 0G1BR3E, 191BR1E, 191BR1GA, 191BR2E, 191BR2EA, 191BR2GA, 1A1BR1E, 1A1BR1GA, 1A1BR2E, 1A1BR2EA, 1A1BR2GA, 1D1BR1E, 1D1BR1GA, 1D1BR2E, 1D1BR2EA, 1D1BR2GA, 1G1BR3E, 291BR1E, 291BR1GA, 291BR2E, 291BR2EA, 291BR2GA, 2A1BR1E, 2A1BR1GA, 2A1BR2E, 2A1BR2EA, 2A1BR2GA, 2D1BR1E, 2D1BR1GA, 2D1BR2E, 2D1BR2EA, 2D1BR2GA, 71ARE, 91ARE, FCV401DM, FCV401EDM |                 |         |

1



|                    |  |                 |         |
|--------------------|--|-----------------|---------|
| <b>GEV No.</b>     | 358031   | <b>Ref. No.</b> | 32V6210 |
| <b>description</b> | fine fuse size ø10x38mm 10A rated 500V type Gg fast-acting Qty 1 pcs   |                 |         |
| <b>For models:</b> | BX101E, BX101E-VERS.122013, BX122E, BX122E-VERS.122013, BX61E, BX61E-VERS.122013, BX82E, BX82E-VERS.122013, FC1011E, FC1221E, FC611E, FM1011E1, FM1011E1-VERS.2006, FM1011E2, FM1011E2-VERS.2006, FM1011E3, FM1011E3-VERS.2006, FM1221E1, FM1221E1-VERS.2006, FM1221E2, FM1221E2-VERS.2006, FM1221E3-VERS.2006, FM2011E2-VERS.2006, FM2011E3-VERS.2006, FM2021E1, FM2021E2, FM2021E2-VERS.2006, FM2021E3, FM2021E3-VERS.2006, FM611E1, FM611E1-VERS.2006, FM611E2, FM611E2-VERS.2006, FM611E3, FM611E3-VERS.2006, FM721E1, FM721E1-VERS.2006, FM721E2, FM721E2-VERS.2006, FM721E3, FM721E3-VERS.2006, FX101E1, FX101E1R, FX101E2, FX101E2C, FX101E2C-VERS.032014, FX101E2R, FX101E2R-VERS.032014, FX101E2-VERS.032014, FX101E3...(Other models you can see in the webshop) |                 |         |

cables earthing cables

1



|                    |  |                 |                    |
|--------------------|--|-----------------|--------------------|
| <b>GEV No.</b>     | 100171   | <b>Ref. No.</b> | 32A2400<br>32A2401 |
| <b>description</b> | earthing cable connection F2.8mm / lug M5 cable length 1200mm  |                 |                    |
| <b>For models:</b> | 1A1FA1G, 1A1FA2G, 1A1FA4G, 1A1FA5G, 1A1FAAG, 1A1FABG, 1A1FAS2G, 1A1FASG, 1A1TP0G, 1A1TP0G-VERS.2002, 1B1FAS2G, 1B1FASG, 1D1FA1G, 1D1FA2G, 1D1FA4G, 1D1FA5G, 1D1FAAG, 1D1FABG, 1D1FAS2G, 1D1FASG, 1D1TP0G, 1D1TP0G-VERS.2002, 1G1BR1G, 2A1FA1G, 2A1FA4G, 2A1FAAG, 2A1FAS2G, 2A1FASG, 2A1TP3G, 2A1TP6G, 2A1TPCG, 2A1TPSG, 2D1FA1G, 2D1FA4G, 2D1FAAG, 2D1FAS2G, 2D1FASG, 2D1TP3G, 2D1TP6G, 2D1TPCG, 2D1TPSG, 3A1FA1G, 3A1FA4G, 3A1FAAG, 3A1FASG, 3D1FA1G, 3D1FA4G, 3D1FAAG, 3D1FASG, 60SM |                 |                    |

1



|                    |  |                 |         |
|--------------------|--|-----------------|---------|
| <b>GEV No.</b>     | 104684   | <b>Ref. No.</b> | 3113500 |
| <b>description</b> | earthing cable connection F2.8mm / lug M5 cable length 350mm 1.5mm <sup>2</sup>  |                 |         |
| <b>For models:</b> | BX101G, BX101G-VERS.122013, BX122G, BX122G-VERS.122013, BX61G, BX61G-VERS.122013, BX82G, BX82G-VERS.122013, FC1011G, FC611G, FM1011G1, FM1011G1-VERS.2006, FM1011G2, FM1011G2-VERS.2006, FM1011G3, FM1011G3-VERS.2006, FM2011G2-VERS.2006, FM2011G3-VERS.2006, FM611G1, FM611G1-VERS.2006, FM611G2, FM611G2-VERS.2006, FM611G3, FM611G3-VERS.2006, FM721G1, FM721G1-VERS.2006, FM721G2, FM721G2-VERS.2006, FM721G3, FM721G3-VERS.2006, FX101G1, FX101G1R, FX101G2, FX101G2C, FX101G2C-VERS.032014, FX101G2R, FX101G2R-VERS.032014, FX101G2-VERS.032014, FX101G3, FX101G3C, FX101G3C-VERS.022014, FX101G3R, FX101G3R-VERS.022014, FX101G3-VERS.022014, FX10G2CR, FX10G2CR-VERS.032014, FX10G3CR, FX10G3CR-VERS.022014, FX122G1, FX122G2...(Other models you can see in the webshop) |                 |         |

1



|                    |  |                 |         |
|--------------------|--|-----------------|---------|
| <b>GEV No.</b>     | 100173   | <b>Ref. No.</b> | 32A0441 |
| <b>description</b> | earthing cable connection F2.8mm / lug M5 cable length 620mm   |                 |         |
| <b>For models:</b> | 031FT04, 031FT06, 070FT04, 070FT05, 071FT04, 071FT06, 090BM1G, 090FT04, 090FT05, 091FT04, 091FT06, 0A0FT1G, 0A0FT2G, 0A0FT4G, 0A0FT5G, 0A0GRG, 0B0FT1G, 0B0FT2G, 0B0FT4G, 0B0FT5G, 0D0FT1G, 0D0FT2G, 0D0FT4G, 0D0FT5G, 0D0GRG, 0G0FT1G, 0G0FT2G, 0G0FT4G, 0G0FT5G, 190BM2G, 1A0FT1G, 1A0FT2G, 1A0FT3G, 1A0FT4G, 1A0FT6G, 1A0GRG, 1B0FT1G, 1B0FT2G, 1B0FT3G, 1B0FT4G, 1B0FT6G, 1D0FT1G, 1D0FT2G, 1D0FT3G, 1D0FT4G, 1D0FT6G, 1D0GRG, 1G0FT1G, 1G0FT2G, 1G0FT3G...(Other models you can see in the webshop) |                 |         |

1



|                    |   |                 |         |
|--------------------|---|-----------------|---------|
| <b>GEV No.</b>     | 100183  | <b>Ref. No.</b> | 32A2530 |
| <b>description</b> | earthing cable connection F2.8mm / lug M5 cable length 900mm  |                 |         |
| <b>For models:</b> | 08WCP1GM, 0A0BMG, 0A0FAVA, 0A1CP1G, 0B1CP1G, 0D0BMG, 0D0FAVA, 0D1CP1G, 0G1CP1G, 10WTPGE, 10WTPGV, 1A0BMG, 1A0FA2, 1A0FA5, 1A0FAB, 1A0FAS2, 1A0TP0, 1A1CP1G, 1A1CP2G, 1A1FA2G, 1A1FA5G, 1A1FABG, 1A1FAS2G, 1A1FASG, 1A1PD1G, 1A1PD2G, 1A1PI1G, 1A1PI1GA, 1A1TP0G, 1A1TP0G-VERS.2002, 1B0FAS2, 1B0TP0, 1B1FAS2G, 1D0BMG, 1D0FA2, 1D0FA5, 1D0FAB, 1D0FAS2, 1D0TP0, 1D1CP1G, 1D1CP2G, 1D1FA2G, 1D1FA5G, 1D1FABG, 1D1FAS2G, 1D1PD1G, 1D1PD2G, 1D1PI1G, 1D1PI1GA, 1D1TP0G...(Other models you can see in the webshop) |                 |         |

electric components



|                    |   |                 |         |
|--------------------|---|-----------------|---------|
| <b>GEV No.</b>     | 104798  | <b>Ref. No.</b> | 3113480 |
| <b>description</b> | earthing cable connection F2.8mm/lug M6 cable length 600mm 1.5mm <sup>2</sup>   |                 |         |
| <b>For models:</b> | FM1221G1, FM1221G1-VERS.2006, FM1221G2, FM1221G2-VERS.2006, FM1221G3, FM1221G3-VERS.2006, FM2021G1, FM2021G2, FM2021G2-VERS.2006, FM2021G3, FM2021G3-VERS.2006, FM721G1, FM721G2, FM721G3 |                 |         |

## ribbon cables

## group 1



|                    |   |                 |         |
|--------------------|---|-----------------|---------|
| <b>GEV No.</b>     | 400066  | <b>Ref. No.</b> | 3099170 |
| <b>description</b> | ribbon cable 10-pole L 1000mm plug type FC-10P raster size 2.54mm |                 |         |
| <b>For models:</b> | KD85E, KD85EA, KD85EAT, KD85EPS, KD85EPSA, LP70                   |                 |         |



|                    |  |                 |         |
|--------------------|--|-----------------|---------|
| <b>GEV No.</b>     | 403293   | <b>Ref. No.</b> | 32A2290 |
| <b>description</b> | ribbon cable 16-pole L 1500mm plug type 2 row coded plug: number of poles 16   |                 |         |
| <b>For models:</b> | 06WFR3GD, 08WFR4ED, 091FR1GD, 091FR3GD, 0A1FR1ED, 0A1FR1GD, 0A1FR1GD-VERS.2004, 0A1FR3GD, 0B1FR1GD, 0D1FR1ED, 0D1FR1GD, 0D1FR1GD-VERS.2004, 0D1FR3GD, 0G0FR3ED, 0G1FR3GD, 10WFR4GD, 191FR2GD, 191FR4GD, 1A1FR2ED, 1A1FR2GD, 1A1FR2GD-VERS.2004, 1D1FR2ED, 1D1FR2GD, 1D1FR2GD-VERS.2004, 1G1FR4GD |                 |         |

## connection cables



|                    |  |                 |         |
|--------------------|--|-----------------|---------|
| <b>GEV No.</b>     | 579007   | <b>Ref. No.</b> | 3116170 |
| <b>description</b> | data cable L 1000mm 8-pole for combi-steamer suitable for ANGELO PO plug type RJ45   |                 |         |
| <b>For models:</b> | BX122G, BX122G-VERS.122013, BX82G, BX82G-VERS.122013, FX101E1, FX101E1R, FX101E2, FX101E2C, FX101E2C-VERS.032014, FX101E2R, FX101E2R-VERS.032014, FX101E2-VERS.032014, FX101E3, FX101E3C, FX101E3C-VERS.022014, FX101E3R, FX101E3R-VERS.022014, FX101E3-VERS.022014, FX101G1, FX101G1R, FX101G2, FX101G2C, FX101G2C-VERS.032014, FX101G2R, FX101G2R-VERS.032014, FX101G2-VERS.032014, FX101G3, FX101G3C, FX101G3C-VERS.022014, FX101G3R, FX101G3R-VERS.022014, FX101G3-VERS.022014, FX10E2CR, FX10E2CR-VERS.032014, FX10E3CR, FX10E3CR-VERS.022014, FX10G2CR, FX10G2CR-VERS.032014, FX10G3CR, FX10G3CR-VERS.022014, FX122E1, FX122E2, FX122E2C, FX122E2T, FX122E2T-VERS.032014, FX122E3, FX122E3C, FX122E3T, FX122E3T-VERS.022014, FX122G1...(Other models you can see in the webshop) |                 |         |

## terminals and connectors

insulated  
plug connectors

|                    |  |                 |         |
|--------------------|--|-----------------|---------|
| <b>GEV No.</b>     | 550326   | <b>Ref. No.</b> | 32D0080 |
| <b>description</b> | connection terminal 12-pole connection male faston 6.3mm temp.-resist. 140°C   |                 |         |
| <b>For models:</b> | 0A1FR3G, 0A1FR3GD, 0D1FR3G, 0D1FR3GD, 0G1FR3G, 0G1FR3GD, 191BR1G, 191BR1GA, 191BR2G, 191BR2GA, 1A1BR1G, 1A1BR1GA, 1A1BR2G, 1A1BR2GA, 1A1FR4G, 1A1FR4GD, 1D1BR1G, 1D1BR1GA, 1D1BR2G, 1D1BR2GA, 1D1FR4G, 1D1FR4GD, 1G1FR4G, 1G1FR4GD, 291BR1G, 291BR1GA, 291BR2G, 291BR2GA, 2A1BR1G, 2A1BR1GA, 2A1BR2G, 2A1BR2GA, 2D1BR1G, 2D1BR1GA, 2D1BR2G, 2D1BR2GA |                 |         |

## plug connectors



|                    |                         |                 |         |
|--------------------|-------------------------|-----------------|---------|
| <b>GEV No.</b>     | 550952                  | <b>Ref. No.</b> | 32D0420 |
| <b>description</b> | connecting piece 2-pole |                 |         |



|                    |                                 |                 |         |
|--------------------|---------------------------------|-----------------|---------|
| <b>GEV No.</b>     | 550171                          | <b>Ref. No.</b> | 32D0140 |
| <b>description</b> | plug connector 10-pole STV 2/10 |                 |         |

## terminals

## porcelain clamps



|                    |  |                 |         |
|--------------------|--|-----------------|---------|
| <b>GEV No.</b>     | 550112   | <b>Ref. No.</b> | 3000060 |
| <b>description</b> | porcelain terminal block 2-pole 2.5mm <sup>2</sup> max. 10A max 250V t.max. 200°C L 22mm W 17mm H 15mm mounting distancemm Qty 1 pcs |                 |         |



Зип Общепит

vsezip.ru

+7(812)987-08-81

terminal blocks



|                    |  |                 |         |
|--------------------|--|-----------------|---------|
| 1                  |  |                 |         |
| <b>GEV No.</b>     | 550232   | <b>Ref. No.</b> | 32D1450 |
| <b>description</b> | lustre terminal 12-pole cross section 2.5mm <sup>2</sup> max. 32A max 450V temp.-resist. 150°C   |                 |         |
| <b>For models:</b> | 031FT04, 031FT06, 04WBMEV, 04WCP1EM, 04WFR3ED, 04WPE4V, 04WPBEV, 04WVT3RV, 06WBR3E, 06WFT1EV, 06WFT2EV, 06WFT3EV, 06WFT4EV, 06WFT6EV, 06WFT7EV, 070FT04, 070FT05, 071FT04, 071FT06, 08WFR4ED, 08WFT1EV, 08WFT2EV, 08WFT3EV, 08WFT4EV, 08WFT4GV, 08WFT6EV, 08WFT6GV, 08WFT7EV, 08WPE4V, 08WPBEV, 08WTPEV, 090BM1G, 090FT04, 090FT05, 090FT1G, 090FT2G, 090FT4G, 090FT5G, 090FT7G, 090GRG, 090PE4, 090VTR, 091CP1E, 091CP1G, 091FR1EA, 091FR1EX, 091FR3E, 091FR3ED, 091FT04, 091FT06...(Other models you can see in the webshop) |                 |         |

connection terminals with screw/faston connections



|                    |  |                 |         |
|--------------------|--|-----------------|---------|
| 1                  |  |                 |         |
| <b>GEV No.</b>     | 550278   | <b>Ref. No.</b> | 32D0171 |
| <b>description</b> | power terminal block 3-pole max. 40A max 400V connection ø6mm <sup>2</sup> / F6.3 temp.-resist. 150°C cross section 6mm <sup>2</sup> |                 |         |



|                    |  |                 |         |
|--------------------|--|-----------------|---------|
| 1                  |  |                 |         |
| <b>GEV No.</b>     | 550349   | <b>Ref. No.</b> | 32D1800 |
| <b>description</b> | power terminal block 4-pole max. 40A max 400V connection ø6mm <sup>2</sup> / F6.3 temp.-resist. 150°C cross section 6mm <sup>2</sup> |                 |         |



|                    |  |                 |                    |
|--------------------|--|-----------------|--------------------|
| 1                  |  |                 |                    |
| <b>GEV No.</b>     | 550411   | <b>Ref. No.</b> | 32D0250<br>32D0251 |
| <b>description</b> | power terminal block 6-pole max. 40A max 450V connection ø6mm <sup>2</sup> / F6.3 temp.-resist. 150°C cross section 6mm <sup>2</sup> |                 |                    |

connection terminals with screw connection



|                    |  |                 |         |
|--------------------|--|-----------------|---------|
| <b>GEV No.</b>     | 550507   | <b>Ref. No.</b> | 32D1800 |
| <b>description</b> | power terminal block 4-pole max. 40A max 400V connection M6/M6 temp.-resist. 150°C |                 |         |

connection terminals with strain relief



|                    |   |                 |         |
|--------------------|---|-----------------|---------|
| 1                  |   |                 |         |
| <b>GEV No.</b>     | 550951  | <b>Ref. No.</b> | 32D0380 |
| <b>description</b> | power terminal block 3-pole cross section 2.5mm <sup>2</sup> with strain relief   |                 |         |
| <b>For models:</b> | 030BME, 030EBM, 031BME, 031EBM, 090FAA, 090FAVA, 090GRG, 0M0BME, 0M0SP1E, 190FAA, 190FAB, 190GRG, 190TP0, 191FAAG, 191FABG, 191FADG, 191FAG, 191PD2G, 191PI1G, 191PI1GA, 191PI2G, 191PI2GA, 191TPG, 1G1FA0GV, 1M0BME, 291FAG, 291TPCG, 2G1FA0GV, 30F1, 30F1B, 30F52, 30F52B, 31TC, 32TC, 391FAG, 70F1, 70F1B, 71F2, 71F2B, 91F223B, G1FAGS, G1FAGST |                 |         |

plug-in terminal blocks



|                    |  |                 |         |
|--------------------|--|-----------------|---------|
| 1                  |  |                 |         |
| <b>GEV No.</b>     | 550950   | <b>Ref. No.</b> | 32D0240 |
| <b>description</b> | plug-in terminal block 16-pole max. 16A max 380V |                 |         |

rail-mounted terminals

miscellaneous



|                    |   |                 |         |
|--------------------|---|-----------------|---------|
| 1                  |   |                 |         |
| <b>GEV No.</b>     | 550947  | <b>Ref. No.</b> | 32D0470 |
| <b>description</b> | rail-mounted terminal profile C   |                 |         |
| <b>For models:</b> | 030E, 030FE, 030FE1, 030FE1B, 030FTE, 030FTE, 031E, 031FTE, 031FTE, 031FTE, 070BME, 070E, 070FTE, 070FTE, 071BME, 071E, 071FTE, 071FTE, 071FTE, 090BME, 090E, 090FTE, 090FTE, 091BME, 091E, 091FE28, 091FE28B, 091FTE, 091FTE, 091FTE, 091FTE, 30CPSE, 30FES, 30FES2, 30FES2B, 31GE, 31PIE6, 31RE, 70CPE, 70FE, 70FE1, 70FE1B, 70FES, 70FES2, 70FES2B, 71PIE15, 71PIE15A, 90CPE, 91PIE15, 91PIE15A, FS30E |                 |         |

electric components



1

|                    |  |                 |         |
|--------------------|--|-----------------|---------|
| <b>GEV No.</b>     | 550949   | <b>Ref. No.</b> | 32D0480 |
| <b>description</b> | rail-mounted terminal yellow/green profile C   |                 |         |
| <b>For models:</b> | 030E, 030FE, 030FE1, 030FE1B, 030FTE, 030FTE1, 030FTE2, 030FTE3, 031E, 031FTE, 031FTE1, 031FTE2, 070BME, 070E, 070FTE, 070FTE1, 070FTE2, 071BME, 071E, 071FTE, 071FTE1, 071FTE2, 090BME, 090E, 090FTE, 090FTE1, 090FTE2, 091BME, 091E, 091FTE28, 091FTE28B, 091FTE, 091FTE1, 091FTE2, 091FTE2B, 30CPSE, 30FES, 30FES2, 30FES2B, 31GE, 31PIE6, 31RE, 70CPE, 70FE, 70FE1, 70FE1B, 70FES, 70FES2, 70FES2B, 71PIE15, 71PIE15A, 90CPE, 91PIE15, 91PIE15A, FS30E |                 |         |

## accessories universal

## terminal block end brackets



1

|                    |   |                 |         |
|--------------------|---|-----------------|---------|
| <b>GEV No.</b>     | 550948  | <b>Ref. No.</b> | 32D0490 |
| <b>description</b> | isolation barrier profile C   |                 |         |
| <b>For models:</b> | 030E, 030FE, 030FE1, 030FE1B, 030FTE, 030FTE1, 030FTE2, 031E, 031FTE, 031FTE1, 031FTE2, 070BME, 070E, 070FTE, 070FTE1, 070FTE2, 071BME, 071E, 071FTE, 071FTE1, 071FTE2, 090BME, 090E, 090FTE, 090FTE1, 090FTE2, 091BME, 091E, 091FTE28, 091FTE28B, 091FTE, 091FTE1, 091FTE2, 091FTE2B, 30CPSE, 30FES, 30FES2, 30FES2B, 31GE, 31PIE6, 31RE, 70CPE, 70FE, 70FE1, 70FE1B, 70FES, 70FES2, 70FES2B, 71PIE15, 71PIE15A, 90CPE, 91PIE15, 91PIE15A, FS30E |                 |         |



1

|                    |   |                 |         |
|--------------------|---|-----------------|---------|
| <b>GEV No.</b>     | 550946  | <b>Ref. No.</b> | 32D0060 |
| <b>description</b> | terminal block end bracket profile C  |                 |         |
| <b>For models:</b> | 030E, 030FE, 030FE1, 030FE1B, 030FTE, 030FTE1, 030FTE2, 031E, 031FTE, 031FTE1, 031FTE2, 070BME, 070E, 070FTE, 070FTE1, 070FTE2, 071BME, 071E, 071FTE, 071FTE1, 071FTE2, 090BME, 090E, 090FTE, 090FTE1, 090FTE2, 091BME, 091E, 091FTE28, 091FTE28B, 091FTE, 091FTE1, 091FTE2, 091FTE2B, 30CPSE, 30FES, 30FES2, 30FES2B, 31GE, 31PIE6, 31RE, 70CPE, 70FE, 70FE1, 70FE1B, 70FES, 70FES2, 70FES2B, 71FE, 71FE2, 71FE2B, 71PIE15, 71PIE15A, 90CPE...(Other models you can see in the web-shop) |                 |         |

Зип.Общепит  
electronic components

miscellaneous

vsezip.ru

+7(812)987-08-81



1

|                    |  |                 |         |
|--------------------|--|-----------------|---------|
| <b>GEV No.</b>     | 400958   | <b>Ref. No.</b> | 32Z5500 |
| <b>description</b> | bounce control electronic L 80mm W 17mm H 45mm 180-260V input current 3A 50/60Hz |                 |         |
| <b>For models:</b> | 030FE1, 091FE28, 30F1, 30FES2, 30FS2, 70F1, 70FE1, 70FES2, 71F2, 71FE2, 91F210   |                 |         |

## gas taps

## PEL

## 20S series



1

|   |  |                 |                         |
|---|--|-----------------|-------------------------|
| <b>GEV No.</b>  | 101068   | <b>Ref. No.</b> | 33A0070<br>6004730      |
| <b>description</b>  | gas tap PEL type 20S gas inlet M16x1.5 (tube $\phi$ 10mm) bypass nozzle $\phi$ 0.2mm gas outlet 1/4" (tube $\phi$ 6mm) thermocouple connection M8x1 pilot connection shaft $\phi$ 8x6.5mm shaft L 22/15mm shaft flat upper conversion kit tube $\phi$ 10mm |                 |                         |
| <b>spare parts for</b>  | 101068   |                 |                         |
|  | <b>GEV No.</b>   | 101060          | <b>Ref. No.</b> 32Z1520 |
|   | magnet unit standard L 39mm D1 $\phi$ 15.4mm D2 $\phi$ 11mm suitable for PEL20-21/JUNKERS/EGA  |                 |                         |
|  | <b>GEV No.</b>   | 101205          | <b>Ref. No.</b> —       |
|   | gas tap front part shaft $\phi$ 8x6.5mm shaft L 22/15mm shaft flat upper/lower suitable for PEL20  |                 |                         |
|  | <b>GEV No.</b>   | 101230          | <b>Ref. No.</b> —       |
|   | thermocouple nut T1: M8x1 T2: M18x1 aluminium  |                 |                         |
|  | <b>GEV No.</b>   | 101278          | <b>Ref. No.</b> 36Q0080 |
|   | olive for pipe $\phi$ 10mm Qty 1 pcs   |                 |                         |
|  | <b>GEV No.</b>   | 101300          | <b>Ref. No.</b> 36Q0830 |
|   | union nut thread M16x1.5 tube $\phi$ 10mm  |                 |                         |
| <b>accessories for</b>  | 101068   |                 |                         |
|  | <b>GEV No.</b>   | 110081          | <b>Ref. No.</b> 36M0770 |
|   | knob $\phi$ 70mm shaft $\phi$ 8x6.5mm shaft flat universal   |                 |                         |
|  | <b>GEV No.</b>   | 110083          | <b>Ref. No.</b> —       |
|   | knob dial plate gas tap without ignition flame silver  |                 |                         |





Зип-Общепит





vsezip.ru

+7(812)987-08-81



1



|                    |  |                 |         |
|--------------------|--|-----------------|---------|
| <b>GEV No.</b>     | 103179   | <b>Ref. No.</b> | 33D3180 |
| <b>description</b> | gas tap PEL type 20S gas inlet pipe flange ø21mm bypass nozzle ø 0mm gas outlet M16x1.5 (tube ø 10/8mm) thermocouple connection M9x1 pilot connection shaft ø 8x6.5mm shaft L 22/15mm shaft flat lower without ignition flame connection |                 |         |
| <b>For models:</b> | G1FAGS, G1FAGST  |                 |         |

|   |        |                |        |                 |   |
|---|--------|----------------|--------|-----------------|---|
| <b>accessories for</b>  | 101095 | <b>GEV No.</b> | 101450 | <b>Ref. No.</b> | —   |
|  |        |                |        |                 | olive for pipe ø 8mm L 12.7mm Qty 1 pcs ED ø 10mm                         |
|  |        | <b>GEV No.</b> | 101451 | <b>Ref. No.</b> | —   |
|   |        |                |        |                 | union nut thread M16x1.5 tube ø 8mm                                       |
|  |        | <b>GEV No.</b> | 110081 | <b>Ref. No.</b> | 36M0770   |
|   |        |                |        |                 | knob ø 70mm shaft ø 8x6.5mm shaft flat universal                          |
|  |        | <b>GEV No.</b> | 112206 | <b>Ref. No.</b> | —   |
|   |        |                |        |                 | knob dial plate silver gas tap PEL21/22/23 t.max.°C ED ø 63mm ID ø 45.5mm |

21S series



1

|   |   |                 |  |
|---|---|-----------------|--|
| <b>GEV No.</b>  | 101095  | <b>Ref. No.</b> | 33D1170  |
| <b>description</b>  | gas tap PEL type 21S gas inlet M16x1.5 (tube ø 10mm) bypass nozzle ø 0.35mm gas outlet M16x1.5 (tube ø 10/8mm) thermocouple connection M8x1 pilot connection M10x1 shaft ø 8x6.5mm shaft L 22/15mm shaft flat lower |                 |  |
| <b>For models:</b>  | 030, 031, 032, 31, 31GE, 31TC, 32, 32TC, 32TP, 32TPV, 32V, 605M   |                 |  |
| <b>spare parts for</b>  | 101095  |                 |  |
|  | <b>GEV No.</b>  | 100408          | <b>Ref. No.</b> 33T3630  |
|   |   |                 | bypass nozzle type PEL20/21 bore ø 0.35mm thread M5x0.5                                      |
|  | <b>GEV No.</b>  | 101060          | <b>Ref. No.</b> 32Z1520  |
|   |   |                 | magnet unit standard L 39mm D1 ø 15.4mm D2 ø 11mm suitable for PEL20-21/JUNKERS/EGA          |
|  | <b>GEV No.</b>  | 101206          | <b>Ref. No.</b> —  |
|   |   |                 | gas tap front part shaft ø 8x6.5mm shaft L 22/15mm shaft flat upper/lower suitable for PEL21 |
|  | <b>GEV No.</b>  | 101230          | <b>Ref. No.</b> —  |
|   |   |                 | thermocouple nut T1: M8x1 T2: M18x1 aluminium  |
| <b>accessories for</b>  | 101095  |                 |  |
|  | <b>GEV No.</b>  | 100908          | <b>Ref. No.</b> 36Q1000  |
|   |   |                 | union screw thread M10x1 for pipe ø 4mm Qty 1 pcs  |
|  | <b>GEV No.</b>  | 100909          | <b>Ref. No.</b> 36Q0060  |
|   |   |                 | union screw thread M10x1 for pipe ø 6mm Qty 1 pcs  |
|  | <b>GEV No.</b>  | 101246          | <b>Ref. No.</b> —  |
|   |   |                 | olive for pipe ø 4mm Qty 1 pcs   |
|  | <b>GEV No.</b>  | 101278          | <b>Ref. No.</b> 36Q0080  |
|   |   |                 | olive for pipe ø 10mm Qty 1 pcs  |
|  | <b>GEV No.</b>  | 101286          | <b>Ref. No.</b> 36Q0020  |
|   |   |                 | olive ID ø 6mm Qty 1 pcs   |
|  | <b>GEV No.</b>  | 101300          | <b>Ref. No.</b> 36Q0830  |
|   |   |                 | union nut thread M16x1.5 tube ø 10mm   |



1

|   |   |                 |  |
|---|---|-----------------|--|
| <b>GEV No.</b>  | 109515  | <b>Ref. No.</b> | 3064310  |
| <b>description</b>  | gas tap PEL type 21S gas inlet pipe flange ø21mm bypass nozzle ø 0mm gas outlet M16x1.5 (tube ø 10/8mm) thermocouple connection M8x1 pilot connection M10x1 shaft ø 8x6.5mm shaft L 22/15mm shaft flat upper  |                 |  |
| <b>For models:</b>  | 04WFAAV, 08WFA4E, 08WFA4G, 08WFAAE, 08WFAAG, 08WFAAV, 090FAA, 0G0FA0, 0G1CP1G-VERS.2004, 12WFA6E, 12WFA6G, 12WFAAA, 12WFAAE, 12WFAAG, 12WFAAN, 190FA, 190FAA, 190FAB, 190FAD, 191FAAE, 191FAAG, 191FABG, 191FADG, 191FAE, 191FAG, 1G0FA0, 1G0FA0B, 1G0GRG, 1G0TPO, 1G1CP1G-VERS.2004, 1G1CP2G-VERS.2004, 1G1FA0E, 1G1FA0EV, 1G1FA0G, 1G1FA0GV, 1G1FABG, 1G1FAPG, 1G1TPOG, 290FA, 291FAG, 291FAGF, 291TPCG, 2G0FA0, 2G0FA0A, 2G0FA0B, 2G1FA0E, 2G1FA0G, 2G1FA0GV, 2G1FABG, 2G1FACG...(Other models you can see in the webshop) |                 |  |
| <b>spare parts for</b>  | 109515  |                 |  |
|  | <b>GEV No.</b>  | 101060          | <b>Ref. No.</b> 32Z1520  |
|   |   |                 | magnet unit standard L 39mm D1 ø 15.4mm D2 ø 11mm suitable for PEL20-21/JUNKERS/EGA          |
|  | <b>GEV No.</b>  | 101206          | <b>Ref. No.</b> —  |
|   |   |                 | gas tap front part shaft ø 8x6.5mm shaft L 22/15mm shaft flat upper/lower suitable for PEL21 |
|  | <b>GEV No.</b>  | 101230          | <b>Ref. No.</b> —  |
|   |   |                 | thermocouple nut T1: M8x1 T2: M18x1 aluminium  |
| <b>accessories for</b>  | 109515  |                 |  |
|  | <b>GEV No.</b>  | 100908          | <b>Ref. No.</b> 36Q1000  |
|   |   |                 | union screw thread M10x1 for pipe ø 4mm Qty 1 pcs  |
|  | <b>GEV No.</b>  | 100909          | <b>Ref. No.</b> 36Q0060  |
|   |   |                 | union screw thread M10x1 for pipe ø 6mm Qty 1 pcs  |
|  | <b>GEV No.</b>  | 101246          | <b>Ref. No.</b> —  |
|   |   |                 | olive for pipe ø 4mm Qty 1 pcs   |
|  | <b>GEV No.</b>  | 101278          | <b>Ref. No.</b> 36Q0080  |
|   |   |                 | olive for pipe ø 10mm Qty 1 pcs  |
|  | <b>GEV No.</b>  | 101286          | <b>Ref. No.</b> 36Q0020  |
|   |   |                 | olive ID ø 6mm Qty 1 pcs   |

Table continues overleaf













1 gas components





Зип-Общепит

vsezip.ru

+7(812)987-08-81

1

|   |  |                 |                         |
|---|--|-----------------|-------------------------|
| <b>GEV No.</b>  | 106234   | <b>Ref. No.</b> | 33A0090                 |
| <b>description</b>  | gas tap PEL type 22N/O gas inlet M20x1.5 (tube ø 12mm) bypass nozzle ø 0.35mm gas outlet M20x1.5 (flanged tube ø 12/10mm) thermocouple connection pilot connection M10x1 shaft ø 10x8mm shaft L 28/13mm shaft flat lower |                 |                         |
| <b>spare parts for</b>  | 106234   |                 |                         |
|    | <b>GEV No.</b>   | 100259          | <b>Ref. No.</b> 33T1180 |
|   | bypass nozzle type PEL22 bore ø 0.35mm thread M6x0.5   |                 |                         |
|    | <b>GEV No.</b>   | 101203          | <b>Ref. No.</b> —       |
|   | gas tap front part shaft ø 9x10mm shaft L 28/13mm shaft flat upper/lower suitable for PEL22  |                 |                         |
|    | <b>GEV No.</b>   | 101240          | <b>Ref. No.</b> —       |
|   | gas connection thread M20x1.5 tube ø 12/10mm for PEL gas taps with gasket and screws horizontal  |                 |                         |
|    | <b>GEV No.</b>   | 101331          | <b>Ref. No.</b> —       |
|   | adapter suitable for PEL22 for flanged cable 10/12mm   |                 |                         |
|   | <b>GEV No.</b>   | 101460          | <b>Ref. No.</b> —       |
|   | O-ring ø 12.37mm D1 ø 2.62mm suitable for PEL22  |                 |                         |
|  | <b>GEV No.</b>   | 101461          | <b>Ref. No.</b> —       |
|   | screw kit suitable for PEL22 Qty 4 pcs   |                 |                         |
| <b>accessories for</b>  | 106234   |                 |                         |
|  | <b>GEV No.</b>   | 100908          | <b>Ref. No.</b> 36Q1000 |
|   | union screw thread M10x1 for pipe ø 4mm Qty 1 pcs  |                 |                         |
|  | <b>GEV No.</b>   | 100909          | <b>Ref. No.</b> 36Q0060 |
|   | union screw thread M10x1 for pipe ø 6mm Qty 1 pcs  |                 |                         |
|  | <b>GEV No.</b>   | 101246          | <b>Ref. No.</b> —       |
|   | olive for pipe ø 4mm Qty 1 pcs   |                 |                         |
|  | <b>GEV No.</b>   | 101248          | <b>Ref. No.</b> 36Q0030 |
|   | olive for pipe ø 12mm Qty 1 pcs suitable for PEL   |                 |                         |
|  | <b>GEV No.</b>   | 101249          | <b>Ref. No.</b> 36Q1700 |
|   | olive for pipe ø 10mm Qty 1 pcs  |                 |                         |
|  | <b>GEV No.</b>   | 101250          | <b>Ref. No.</b> 36Q0610 |
|   | union nut thread M20x1.5 for pipe ø 10mm   |                 |                         |
|  | <b>GEV No.</b>   | 101251          | <b>Ref. No.</b> 36Q0050 |
|   | union nut thread M20x1.5 for pipe ø 12mm   |                 |                         |
|  | <b>GEV No.</b>   | 101286          | <b>Ref. No.</b> 36Q0020 |
|   | olive ID ø 6mm Qty 1 pcs   |                 |                         |

|   |   |        |                         |
|---|---|--------|-------------------------|
| <b>accessories for</b>  | 109515  |        |                         |
|  | <b>GEV No.</b>  | 101300 | <b>Ref. No.</b> 36Q0830 |
|   | union nut thread M16x1.5 tube ø 10mm                                      |        |                         |
|  | <b>GEV No.</b>  | 101450 | <b>Ref. No.</b> —       |
|   | olive for pipe ø 8mm L 12.7mm Qty 1 pcs ED ø 10mm                         |        |                         |
|  | <b>GEV No.</b>  | 101451 | <b>Ref. No.</b> —       |
|   | union nut thread M16x1.5 tube ø 8mm                                       |        |                         |
|  | <b>GEV No.</b>  | 110078 | <b>Ref. No.</b> —       |
|   | knob without symbol ø 70mm shaft ø 6x4.6mm shaft flat universal           |        |                         |
|  | <b>GEV No.</b>  | 112206 | <b>Ref. No.</b> —       |
|   | knob dial plate silver gas tap PEL21/22/23 t.max.°C ED ø 63mm ID ø 45.5mm |        |                         |

|   |   |                 |                         |
|---|---|-----------------|-------------------------|
|    | 1   |                 |                         |
| <b>GEV No.</b>  | 106231  | <b>Ref. No.</b> | 33D1930                 |
| <b>description</b>  | gas tap PEL type 21S gas inlet pipe flange ø21mm bypass nozzle ø 1.05mm gas outlet M16x1.5 (tube ø 10/8mm) thermocouple connection M8x1 pilot connection M10x1 shaft ø 8x6.5mm shaft L 22/15mm shaft flat lower   |                 |                         |
| <b>For models:</b>  | 0A0FA1, 0A0FA4, 0A0FAA, 0D0FA1, 0D0FA4, 0D0FAA, 0G0FA0, 0G1CP1G, 0G1CP1G-VERS.2004, 1A0FA1, 1A0FA2, 1A0FA4, 1A0FA5, 1A0FAA, 1A0FAB, 1A1FA1G, 1A1FA2G, 1A1FA4G, 1A1FA5G, 1A1FAAG, 1A1FABG, 1D0FA1, 1D0FA2, 1D0FA4, 1D0FA5, 1D0FAA, 1D0FAB, 1D1FA1G, 1D1FA2G, 1D1FA4G, 1D1FA5G, 1D1FAAG, 1D1FABG, 1G0FA0, 1G0GRG, 1G0TP0, 1G1CP1G, 1G1CP1G-VERS.2004, 1G1CP2G, 1G1CP2G-VERS.2004, 1G1FA0E, 1G1FA0EV, 1G1FA0G, 1G1FA0GV, 1G1FAPG, 1G1TP0G, 2A0FA1, 2A0FA4, 2A0FAA, 2A1FA1G...(Other models you can see in the webshop) |                 |                         |
| <b>spare parts for</b>  | 106231  |                 |                         |
|  | <b>GEV No.</b>  | 100557          | <b>Ref. No.</b> 33T3670 |
|   | bypass nozzle type PEL20/21 bore ø 1.05mm thread M5x0.5   |                 |                         |
|  | <b>GEV No.</b>  | 101060          | <b>Ref. No.</b> 32Z1520 |
|   | magnet unit standard L 39mm D1 ø 15.4mm D2 ø 11mm suitable for PEL20-21/JUNKERS/EGA   |                 |                         |
|  | <b>GEV No.</b>  | 101230          | <b>Ref. No.</b> —       |
|   | thermocouple nut T1: M8x1 T2: M18x1 aluminium   |                 |                         |
|  | <b>GEV No.</b>  | 101880          | <b>Ref. No.</b> —       |
|   | gasket Viton ED ø 14mm ID ø 9mm thickness 7.7mm Qty 1 pcs   |                 |                         |
| <b>accessories for</b>  | 106231  |                 |                         |
|  | <b>GEV No.</b>  | 101277          | <b>Ref. No.</b> 36Q1630 |
|   | olive ID ø 8mm Qty 1 pcs  |                 |                         |
|  | <b>GEV No.</b>  | 101278          | <b>Ref. No.</b> 36Q0080 |
|   | olive for pipe ø 10mm Qty 1 pcs   |                 |                         |
|  | <b>GEV No.</b>  | 101300          | <b>Ref. No.</b> 36Q0830 |
|   | union nut thread M16x1.5 tube ø 10mm  |                 |                         |
|  | <b>GEV No.</b>  | 101451          | <b>Ref. No.</b> —       |
|   | union nut thread M16x1.5 tube ø 8mm   |                 |                         |



Зип Общежит

225/O series

vsezip.ru

+7(812)987-08-81

1

|   |  |                 |                         |
|---|--|-----------------|-------------------------|
|    |  |                 |                         |
| <b>GEV No.</b>  | 106233   | <b>Ref. No.</b> | 33A1110                 |
| <b>description</b>  | gas tap PEL type 22N/O gas inlet M20x1.5 (tube ø 12mm) bypass nozzle ø 0.35mm gas outlet M20x1.5 (tube ø 12/10mm) thermocouple connection pilot connection M10x1 shaft ø 10x8mm shaft L 28/13mm shaft flat lower |                 |                         |
| <b>spare parts for</b>  | 106233   |                 |                         |
|    | <b>GEV No.</b>   | 100259          | <b>Ref. No.</b> 33T1180 |
|   | bypass nozzle type PEL22 bore ø 0.35mm thread M6x0.5   |                 |                         |
|    | <b>GEV No.</b>   | 101203          | <b>Ref. No.</b> —       |
|   | gas tap front part shaft ø 9x10mm shaft L 28/13mm shaft flat upper/lower suitable for PEL22  |                 |                         |
|    | <b>GEV No.</b>   | 101240          | <b>Ref. No.</b> —       |
|   | gas connection thread M20x1.5 tube ø 12/10mm for PEL gas taps with gasket and screws horizontal  |                 |                         |
|    | <b>GEV No.</b>   | 101460          | <b>Ref. No.</b> —       |
|   | O-ring ø 12.37mm D1 ø 2.62mm suitable for PEL22  |                 |                         |
|   | <b>GEV No.</b>   | 101461          | <b>Ref. No.</b> —       |
|   | screw kit suitable for PEL22 Qty 4 pcs   |                 |                         |
| <b>accessories for</b>  | 106233   |                 |                         |
|  | <b>GEV No.</b>   | 100908          | <b>Ref. No.</b> 36Q1000 |
|   | union screw thread M10x1 for pipe ø 4mm Qty 1 pcs  |                 |                         |
|  | <b>GEV No.</b>   | 100909          | <b>Ref. No.</b> 36Q0060 |
|   | union screw thread M10x1 for pipe ø 6mm Qty 1 pcs  |                 |                         |
|  | <b>GEV No.</b>   | 101246          | <b>Ref. No.</b> —       |
|   | olive for pipe ø 4mm Qty 1 pcs   |                 |                         |
|  | <b>GEV No.</b>   | 101248          | <b>Ref. No.</b> 36Q0030 |
|   | olive for pipe ø 12mm Qty 1 pcs suitable for PEL   |                 |                         |
|  | <b>GEV No.</b>   | 101249          | <b>Ref. No.</b> 36Q1700 |
|   | olive for pipe ø 10mm Qty 1 pcs  |                 |                         |
|  | <b>GEV No.</b>   | 101250          | <b>Ref. No.</b> 36Q0610 |
|   | union nut thread M20x1.5 for pipe ø 10mm   |                 |                         |
|  | <b>GEV No.</b>   | 101251          | <b>Ref. No.</b> 36Q0050 |
|   | union nut thread M20x1.5 for pipe ø 12mm   |                 |                         |
|  | <b>GEV No.</b>   | 101286          | <b>Ref. No.</b> 36Q0020 |
|   | olive ID ø 6mm Qty 1 pcs   |                 |                         |

|   |  |                 |                         |
|---|--|-----------------|-------------------------|
|   |  |                 |                         |
| <b>GEV No.</b>  | 101085   | <b>Ref. No.</b> | 33A0100<br>33A1040      |
| <b>description</b>  | gas tap PEL type 22S/O gas inlet M20x1.5 (tube ø 12mm) bypass nozzle ø 0.35mm gas outlet M20x1.5 (flanged tube ø 12/10mm) thermocouple connection M8x1 pilot connection M10x1 shaft ø 10x9mm shaft L 28/13mm shaft flat upper  |                 |                         |
| <b>For models:</b>  | 031TP, 070D, 070DGG, 070FT, 070FTR, 0712D, 0712VA, 071D, 071DGG, 071FT, 071FTR, 071FTRL, 071TP, 072D, 072DGG, 090, 090FT, 090FTR, 090GG, 091, 091FT, 091FTR, 091FTRL, 091GG, 091TP, 092, 092GG, 092VA, 092VAGG, 30CPS, 31PD6, 31PI6, 31TP, 32TP, 32TPV, 70CP, 712D, 712VA, 71CP, 71CP2, 71D, 71DGG, 71GE, 71GEGG, 71PD10, 71PD15, 71PI10, 71PI10A, 71TP, 72D...(Other models you can see in the webshop) |                 |                         |
| <b>spare parts for</b>  | 101085   |                 |                         |
|    | <b>GEV No.</b>   | 100259          | <b>Ref. No.</b> 33T1180 |
|   | bypass nozzle type PEL22 bore ø 0.35mm thread M6x0.5   |                 |                         |
|    | <b>GEV No.</b>   | 101058          | <b>Ref. No.</b> 32Z1460 |
|   | magnet unit L 39mm D1 ø 15.4mm D2 ø 13.5mm suitable for PEL22/EGA24197 standard  |                 |                         |
|    | <b>GEV No.</b>   | 101203          | <b>Ref. No.</b> —       |
|   | gas tap front part shaft ø 9x10mm shaft L 28/13mm shaft flat upper/lower suitable for PEL22  |                 |                         |
|  | <b>GEV No.</b>   | 101230          | <b>Ref. No.</b> —       |
|   | thermocouple nut T1: M8x1 T2: M18x1 aluminium  |                 |                         |
|  | <b>GEV No.</b>   | 101240          | <b>Ref. No.</b> —       |
|   | gas connection thread M20x1.5 tube ø 12/10mm for PEL gas taps with gasket and screws horizontal  |                 |                         |
|  | <b>GEV No.</b>   | 101460          | <b>Ref. No.</b> —       |
|   | O-ring ø 12.37mm D1 ø 2.62mm suitable for PEL22  |                 |                         |
|  | <b>GEV No.</b>   | 101461          | <b>Ref. No.</b> —       |
|   | screw kit suitable for PEL22 Qty 4 pcs   |                 |                         |
| <b>accessories for</b>  | 101085   |                 |                         |
|  | <b>GEV No.</b>   | 100908          | <b>Ref. No.</b> 36Q1000 |
|   | union screw thread M10x1 for pipe ø 4mm Qty 1 pcs  |                 |                         |
|  | <b>GEV No.</b>   | 100909          | <b>Ref. No.</b> 36Q0060 |
|   | union screw thread M10x1 for pipe ø 6mm Qty 1 pcs  |                 |                         |
|  | <b>GEV No.</b>   | 101241          | <b>Ref. No.</b> —       |
|   | gas connection thread M20x1.5 tube ø 12/10mm for PEL gas taps vertical   |                 |                         |
|  | <b>GEV No.</b>   | 101246          | <b>Ref. No.</b> —       |
|   | olive for pipe ø 4mm Qty 1 pcs   |                 |                         |
|  | <b>GEV No.</b>   | 101248          | <b>Ref. No.</b> 36Q0030 |
|   | olive for pipe ø 12mm Qty 1 pcs suitable for PEL   |                 |                         |
|  | <b>GEV No.</b>   | 101249          | <b>Ref. No.</b> 36Q1700 |
|   | olive for pipe ø 10mm Qty 1 pcs  |                 |                         |





Table continues overleaf

1 gas components

Зип-Общепит

vsezip.ru

+7(812)987-08-81

| accessories for   |  | 101085 |          |                    |
|---|--|--------|----------|--------------------|
|  | GEV No.  | 101250 | Ref. No. | 36Q0610            |
|   | union nut thread M20x1.5 for pipe ø 10mm                           |        |          |                    |
|  | GEV No.  | 101251 | Ref. No. | 36Q0050            |
|   | union nut thread M20x1.5 for pipe ø 12mm                           |        |          |                    |
|  | GEV No.  | 101286 | Ref. No. | 36Q0020            |
|   | olive ID ø 6mm Qty 1 pcs   |        |          |                    |
|  | GEV No.  | 101331 | Ref. No. | —                  |
|   | adapter suitable for PEL22 for flanged cable 10/12mm               |        |          |                    |
|  | GEV No.  | 110140 | Ref. No. | 36M2390<br>36M5140 |
|   | knob switch zero mark ø 67mm shaft ø 10x9mm shaft flat upper black |        |          |                    |

22S/V series



1

| GEV No.   | 101457  | Ref. No. | 33A0580  |         |
|---|---|----------|----------|---------|
| <b>description</b>  | gas tap alternatives to JUNKERS type CH110 gas inlet M20x1.5 (tube ø 12mm) bypass nozzle ø 0.35mm gas outlet M20x1.5 (tube ø 12/10mm) thermocouple connection M8x1 pilot connection M10x1 shaft ø 10mm shaft L 25mm shaft flat with pipe outlet |          |          |         |
| <b>spare parts for</b>  | 101457  |          |          |         |
|  | GEV No.   | 100259   | Ref. No. | 33T1180 |
|   | bypass nozzle type PEL22 bore ø 0.35mm thread M6x0.5  |          |          |         |
|  | GEV No.   | 100908   | Ref. No. | 36Q1000 |
|   | union screw thread M10x1 for pipe ø 4mm Qty 1 pcs   |          |          |         |
|  | GEV No.   | 101058   | Ref. No. | 32Z1460 |
|   | magnet unit L 39mm D1 ø 15.4mm D2 ø 13.5mm suitable for PEL22/EGA24197 standard   |          |          |         |
|  | GEV No.   | 101200   | Ref. No. | —       |
|   | gas tap front part shaft ø 10mm shaft L 25mm shaft flat suitable for 22S/O  |          |          |         |
|  | GEV No.   | 101230   | Ref. No. | —       |
|   | thermocouple nut T1: M8x1 T2: M18x1 aluminium   |          |          |         |
|  | GEV No.   | 101241   | Ref. No. | —       |
|   | gas connection thread M20x1.5 tube ø 12/10mm for PEL gas taps vertical  |          |          |         |
|  | GEV No.   | 101246   | Ref. No. | —       |
|   | olive for pipe ø 4mm Qty 1 pcs  |          |          |         |
|  | GEV No.   | 101460   | Ref. No. | —       |
|   | O-ring ø 12.37mm D1 ø 2.62mm suitable for PEL22   |          |          |         |
|  | GEV No.   | 101461   | Ref. No. | —       |
|   | screw kit suitable for PEL22 Qty 4 pcs  |          |          |         |

| accessories for   |  | 101457 |          |         |
|---|--|--------|----------|---------|
|    | GEV No.  | 100945 | Ref. No. | —       |
|   | roll pin ø 3.2mm L 10mm                                    |        |          |         |
|    | GEV No.  | 101218 | Ref. No. | —       |
|   | shaft extension L 25mm JUNKERS                             |        |          |         |
|    | GEV No.  | 101219 | Ref. No. | —       |
|   | shaft extension L 25mm JUNKERS                             |        |          |         |
|    | GEV No.  | 101231 | Ref. No. | —       |
|   | thermocouple nut T1: M9x1 T2: M18x1                        |        |          |         |
|    | GEV No.  | 101248 | Ref. No. | 36Q0030 |
|   | olive for pipe ø 12mm Qty 1 pcs suitable for PEL           |        |          |         |
|    | GEV No.  | 101249 | Ref. No. | 36Q1700 |
|   | olive for pipe ø 10mm Qty 1 pcs                            |        |          |         |
|    | GEV No.  | 101250 | Ref. No. | 36Q0610 |
|   | union nut thread M20x1.5 for pipe ø 10mm                   |        |          |         |
|    | GEV No.  | 101251 | Ref. No. | 36Q0050 |
|   | union nut thread M20x1.5 for pipe ø 12mm                   |        |          |         |
|    | GEV No.  | 101290 | Ref. No. | —       |
|   | thermocouple nut T1: M10x1 T2: M18x1 suitable for PEL20/21 |        |          |         |
|   | GEV No.  | 110064 | Ref. No. | 36M0660 |
|   | knob   |        |          |         |
|  | GEV No.  | 110066 | Ref. No. | —       |
|   | knob screw   |        |          |         |
|  | GEV No.  | 550396 | Ref. No. | —       |
|   | shaft extension L 25mm JUNKERS                             |        |          |         |

| 1   |  | 33D1990<br>33D1991 |          |         |
|---|--|--------------------|----------|---------|
| <b>GEV No.</b>  | 101661   | <b>Ref. No.</b>    |          |         |
| <b>description</b>  | gas tap PEL type 22S/V gas inlet pipe flange ø21mm bypass nozzle ø 0.35mm gas outlet M20x1.5 (tube ø 12/10mm) thermocouple connection M8x1 pilot connection M10x1 shaft ø 10x8.5mm shaft L 28/13mm shaft flat upper  |                    |          |         |
| <b>For models:</b>  | 06WCP1GM, 08WCP1GM, 08WGRGV, 090FAVA, 090GRG, 091CP1G, 0A0FAS, 0A0FAVA, 0A0GRG, 0A1CP1G, 0B0FAS, 0B1CP1G, 0D0FAS, 0D0FAVA, 0D0GRG, 0D1CP1G, 10WTPGE, 10WTPGV, 190FAB, 190GRG, 190TPO, 191CP1G, 191CP2G, 191FABG, 191PD2G, 191PI1G, 191PI1GA, 191PI2G, 191PI2GA, 191TPG, 1A0FA2, 1A0FA5, 1A0FAB, 1A0FAS, 1A0FAS2, 1A0GRG, 1A0TPO, 1A1CP1G, 1A1CP2G, 1A1FA2G, 1A1FASG, 1A1FABG, 1A1FAS2G, 1A1FASG, 1A1PD1G, 1A1PD2G, 1A1PI1G, 1A1PI1GA, 1A1TPOG, 1A1TPOG-VERS.2002...(Other models you can see in the webshop) |                    |          |         |
| <b>spare parts for</b>  | 101661   |                    |          |         |
|  | GEV No.  | 100259             | Ref. No. | 33T1180 |
|   | bypass nozzle type PEL22 bore ø 0.35mm thread M6x0.5   |                    |          |         |

Table continues overleaf



Зип Общежит

vsezip.ru

+7(812)987-08-81

| spare parts for   |   | 101661 |                  |
|---|---|--------|------------------|
|    | GEV No.   | 101058 | Ref. No. 32Z1460 |
|   | magnet unit L 39mm D1 ø 15.4mm D2 ø 13.5mm suitable for PEL22/ EGA24197 standard            |        |                  |
|    | GEV No.   | 101203 | Ref. No. —       |
|   | gas tap front part shaft ø 9x10mm shaft L 28/13mm shaft flat upper/lower suitable for PEL22 |        |                  |
|    | GEV No.   | 101230 | Ref. No. —       |
|   | thermocouple nut T1: M8x1 T2: M18x1 aluminium   |        |                  |
|    | GEV No.   | 101237 | Ref. No. —       |
|   | flange thread M20x1.5 tube ø 21mm suitable for PEL22  |        |                  |
|    | GEV No.   | 101241 | Ref. No. —       |
|   | gas connection thread M20x1.5 tube ø 12/10mm for PEL gas taps vertical                      |        |                  |
|    | GEV No.   | 101460 | Ref. No. —       |
|   | O-ring ø 12.37mm D1 ø 2.62mm suitable for PEL22   |        |                  |
|    | GEV No.   | 101461 | Ref. No. —       |
|   | screw kit suitable for PEL22 Qty 4 pcs  |        |                  |
|    | GEV No.   | 101536 | Ref. No. —       |
|   | gasket D1 ø 17mm D2 ø 11.5mm thickness 4.7mm  |        |                  |
| accessories for   |   | 101661 |                  |
|   | GEV No.   | 100908 | Ref. No. 36Q1000 |
|   | union screw thread M10x1 for pipe ø 4mm Qty 1 pcs   |        |                  |
|  | GEV No.   | 100909 | Ref. No. 36Q0060 |
|   | union screw thread M10x1 for pipe ø 6mm Qty 1 pcs   |        |                  |
|  | GEV No.   | 101246 | Ref. No. —       |
|   | olive for pipe ø 4mm Qty 1 pcs  |        |                  |
|  | GEV No.   | 101248 | Ref. No. 36Q0030 |
|   | olive for pipe ø 12mm Qty 1 pcs suitable for PEL  |        |                  |
|  | GEV No.   | 101249 | Ref. No. 36Q1700 |
|   | olive for pipe ø 10mm Qty 1 pcs   |        |                  |
|  | GEV No.   | 101250 | Ref. No. 36Q0610 |
|   | union nut thread M20x1.5 for pipe ø 10mm  |        |                  |
|  | GEV No.   | 101251 | Ref. No. 36Q0050 |
|   | union nut thread M20x1.5 for pipe ø 12mm  |        |                  |
|  | GEV No.   | 101286 | Ref. No. 36Q0020 |
|   | olive ID ø 6mm Qty 1 pcs  |        |                  |

| 235/O  |   | 33A1530 |                  |
|--|---|---------|------------------|
|  | GEV No.   | 109107  | Ref. No. 33A1530 |
|  | description gas tap PEL type 235/O gas inlet M28x1.5 (tube ø 20mm) bypass nozzle ø 0mm gas outlet M24x1.5 (tube ø 16mm) thermocouple connection M9x1 pilot connection M10x1 shaft ø 10x8mm shaft L 35/19mm shaft flat upper |         |                  |
|  | For models: 191CP1GA, 1A1CP1GA, 1A1PI2G, 1A1PI2GA, 1D1CP1GA, 1D1PI2G, 1D1PI2GA, 291PD3G, 291PI3G, 2A1PD3G, 2A1PI3G, 2D1PI3G, MCF20, MCF40   |         |                  |

alternatives to JUNKERS









|   |   |        |                  |
|---|---|--------|------------------|
|   | GEV No.   | 101457 | Ref. No. 33A0580 |
|   | description gas tap alternatives to JUNKERS type CH110 gas inlet M20x1.5 (tube ø 12mm) bypass nozzle ø 0.35mm gas outlet M20x1.5 (tube ø 12/10mm) thermocouple connection M8x1 pilot connection M10x1 shaft ø 10mm shaft L 25mm shaft flat with pipe outlet |        |                  |
|   | spare parts for 101457  |        |                  |
|  | GEV No.   | 100259 | Ref. No. 33T1180 |
|   | bypass nozzle type PEL22 bore ø 0.35mm thread M6x0.5  |        |                  |
|  | GEV No.   | 100908 | Ref. No. 36Q1000 |
|   | union screw thread M10x1 for pipe ø 4mm Qty 1 pcs   |        |                  |
|  | GEV No.   | 101058 | Ref. No. 32Z1460 |
|   | magnet unit L 39mm D1 ø 15.4mm D2 ø 13.5mm suitable for PEL22/ EGA24197 standard  |        |                  |
|  | GEV No.   | 101200 | Ref. No. —       |
|   | gas tap front part shaft ø 10mm shaft L 25mm shaft flat suitable for 225/O  |        |                  |
|  | GEV No.   | 101230 | Ref. No. —       |
|   | thermocouple nut T1: M8x1 T2: M18x1 aluminium   |        |                  |
|  | GEV No.   | 101241 | Ref. No. —       |
|   | gas connection thread M20x1.5 tube ø 12/10mm for PEL gas taps vertical  |        |                  |
|  | GEV No.   | 101246 | Ref. No. —       |
|   | olive for pipe ø 4mm Qty 1 pcs  |        |                  |
|  | GEV No.   | 101460 | Ref. No. —       |
|   | O-ring ø 12.37mm D1 ø 2.62mm suitable for PEL22   |        |                  |
|  | GEV No.   | 101461 | Ref. No. —       |
|   | screw kit suitable for PEL22 Qty 4 pcs  |        |                  |

Table continues overleaf



Зип Общепит

vsezip.ru

+7(812)987-08-81

| accessories for |  | 101457 |          |         |
|-----------------|--|--------|----------|---------|
|                 | GEV No.  | 100945 | Ref. No. | —       |
|                 | roll pin ø 3.2mm L 10mm                                    |        |          |         |
|                 | GEV No.  | 101218 | Ref. No. | —       |
|                 | shaft extension JUNKERS                                    |        |          |         |
|                 | GEV No.  | 101219 | Ref. No. | —       |
|                 | shaft extension L 25mm JUNKERS                             |        |          |         |
|                 | GEV No.  | 101231 | Ref. No. | —       |
|                 | thermocouple nut T1: M9x1 T2: M18x1                        |        |          |         |
|                 | GEV No.  | 101248 | Ref. No. | 36Q0030 |
|                 | olive for pipe ø 12mm Qty 1 pcs suitable for PEL           |        |          |         |
|                 | GEV No.  | 101249 | Ref. No. | 36Q1700 |
|                 | olive for pipe ø 10mm Qty 1 pcs                            |        |          |         |
|                 | GEV No.  | 101250 | Ref. No. | 36Q0610 |
|                 | union nut thread M20x1.5 for pipe ø 10mm                   |        |          |         |
|                 | GEV No.  | 101251 | Ref. No. | 36Q0050 |
|                 | union nut thread M20x1.5 for pipe ø 12mm                   |        |          |         |
|                 | GEV No.  | 101290 | Ref. No. | —       |
|                 | thermocouple nut T1: M10x1 T2: M18x1 suitable for PEL20/21 |        |          |         |
|                 | GEV No.  | 110064 | Ref. No. | 36M0660 |
|                 | knob   |        |          |         |
|                 | GEV No.  | 110066 | Ref. No. | —       |
|                 | knob screw   |        |          |         |
|                 | GEV No.  | 550396 | Ref. No. | —       |
|                 | shaft extension L 25mm JUNKERS                             |        |          |         |

|  |                    |  |                 |         |
|--|--------------------|--|-----------------|---------|
|  | <b>GEV No.</b>     | 103310   | <b>Ref. No.</b> | 3041750 |
|  | <b>description</b> | gas thermostat type 630 Eurosit series 110-190°C |                 |         |
|  | <b>For models:</b> | 0G0FR5G, 0G1FR7G, 1G0FR6G, 1G1FR8G               |                 |         |



|                        |   |                 |                    |         |
|------------------------|---|-----------------|--------------------|---------|
| <b>GEV No.</b>         | 101413  | <b>Ref. No.</b> | 33A0491<br>6300478 |         |
| <b>description</b>     | gas thermostat type 630 Eurosit series t.max. 100°C 30-100°C gas inlet 3/8" gas outlet 3/8" thermocouple connection M9x1 pilot connection M10x1 probe ø 5mm probe L 122mm capillary pipe 1050mm SIT |                 |                    |         |
| <b>For models:</b>     | 0A0BMG, 0D0BMG, 1A0BMG, 1D0BMG  |                 |                    |         |
| <b>accessories for</b> | 101413  |                 |                    |         |
|                        | GEV No.   | 100904          | Ref. No.           | —       |
|                        | locking screw M10x1 for pipe ø 4mm Qty 1 pcs  |                 |                    |         |
|                        | GEV No.   | 100905          | Ref. No.           | —       |
|                        | locking screw M10x1 for pipe ø 6mm Qty 1 pcs  |                 |                    |         |
|                        | GEV No.   | 101273          | Ref. No.           | —       |
|                        | olive for pipe ø 12mm L 9.5mm brass Qty 1 pcs suitable for universal  |                 |                    |         |
|                        | GEV No.   | 101276          | Ref. No.           | 36Q0710 |
|                        | union screw thread 3/8" tube ø 12mm Qty 1 pcs   |                 |                    |         |
|                        | GEV No.   | 101333          | Ref. No.           | 36R0010 |
|                        | plug thread 3/8" with O-ring  |                 |                    |         |

## gas thermostats

### SIT

#### 630 Eurosit series



|                    |  |                 |         |
|--------------------|--|-----------------|---------|
| <b>GEV No.</b>     | 107688   | <b>Ref. No.</b> | 3315970 |
| <b>description</b> | gas thermostat 100-340°C gas inlet 3/8" gas outlet 3/8" thermocouple connection M9x1 pilot connection M10x1 probe ø 4mm probe L 72mm capillary pipe 1050mm |                 |         |



Зип Общепит

vsezip.ru

+7(812)987-08-81



1

|   |  |                 |                         |
|---|--|-----------------|-------------------------|
| <b>GEV No.</b>  | 101915   | <b>Ref. No.</b> | 33A0941                 |
| <b>description</b>  | gas thermostat type 630 Eurosit series t.max. 320°C 80-320°C gas inlet 3/8" gas outlet 3/8" thermocouple connection M9x1 pilot connection M10x1 probe ø 4mm probe L 72mm capillary pipe 1050mm SIT |                 |                         |
| <b>For models:</b>  | 1A1FAS2G, 1A1FASG, 1A1TP0G, 1D1FAS2G, 1D1FASG, 1D1TP0G, 2A1FAS2G, 2A1FASG, 2A1TPSG, 2D1FAS2G, 2D1FASG, 2D1TPSG, 3A1FASG, 3D1FASG   |                 |                         |
| <b>accessories for</b>  | 101915   |                 |                         |
|    | <b>GEV No.</b>   | 100825          | <b>Ref. No.</b> 33Q3480 |
|   | gas tap spindle shaft ø 8x6.5mm shaft L 22/14mm suitable for EUROSIT   |                 |                         |
|    | <b>GEV No.</b>   | 100904          | <b>Ref. No.</b> —       |
|   | locking screw M10x1 for pipe ø 4mm Qty 1 pcs   |                 |                         |
|    | <b>GEV No.</b>   | 100905          | <b>Ref. No.</b> —       |
|   | locking screw M10x1 for pipe ø 6mm Qty 1 pcs   |                 |                         |
|   | <b>GEV No.</b>   | 100949          | <b>Ref. No.</b> 3152280 |
|   | gasket suitable for 630 Eurosit series   |                 |                         |
|  | <b>GEV No.</b>   | 101273          | <b>Ref. No.</b> —       |
|   | olive for pipe ø 12mm L 9.5mm brass Qty 1 pcs suitable for universal   |                 |                         |
|  | <b>GEV No.</b>   | 101276          | <b>Ref. No.</b> 36Q0710 |
|   | union screw thread 3/8" tube ø 12mm Qty 1 pcs  |                 |                         |
|  | <b>GEV No.</b>   | 101333          | <b>Ref. No.</b> 36R0010 |
|   | plug thread 3/8" with O-ring   |                 |                         |
|  | <b>GEV No.</b>   | 101390          | <b>Ref. No.</b> —       |
|   | gas tap spindle shaft ø 6x4.6mm shaft L 32/15mm gas tap with ignition flame suitable for ZANUSSI, MARENO for gas thermostat EUROSIT  |                 |                         |
|  | <b>GEV No.</b>   | 101392          | <b>Ref. No.</b> 33A0920 |
|   | adapter suitable for 630 Eurosit series  |                 |                         |
|  | <b>GEV No.</b>   | 110357          | <b>Ref. No.</b> —       |
|   | gas tap spindle shaft ø 8x6.5mm shaft L 36/12mm suitable for 630 Eurosit series  |                 |                         |
|  | <b>GEV No.</b>   | 110358          | <b>Ref. No.</b> —       |
|   | adapter shaft ø 10x8mm shaft L 29/18mm suitable for 630 Eurosit series   |                 |                         |



1

|   |   |                 |                         |
|---|---|-----------------|-------------------------|
| <b>GEV No.</b>  | 106164  | <b>Ref. No.</b> | 3041720<br>6018970      |
| <b>description</b>  | gas thermostat type 630 Eurosit series t.max. 340°C 100-340°C gas inlet 3/8" gas outlet 3/8" thermocouple connection M9x1 pilot connection M10x1 probe ø 4mm probe L 72mm capillary pipe 1050mm pressure regulator 13-18mbar ambient temperature max. 0-120°C   |                 |                         |
| <b>For models:</b>  | 08WFA4G, 08WFAAG, 08WFT1GV, 08WFT2GV, 08WFT3GV, 08WFT-7GV, 090FT1G, 090FT2G, 090FT4G, 090FT5G, 090FT7G, 0G0FT1G-VERS.032008, 0G0FT2G-VERS.032008, 0G0FT7G, 0G1BR3G, 12WFA6G, 12WFAAG, 190FT15G, 190FT1G, 190FT2G, 190FT3G, 190FT42G, 190FT4G, 190FT6G, 190FT72G, 190FT7G, 191FAAG, 191FABG, 191FADG, 191FAG, 191TPG, 1A1FA1G, 1A1FA2G, 1A1FA4G, 1A1FA5G, 1A1FAAG, 1A1FABG, 1A1TP0G-VERS.2002, 1B1FAS2G, 1B1FASG, 1D1FA1G, 1D1FA2G, 1D1FA4G, 1D1FA5G, 1D1FAAG, 1D1FABG, 1D1TP0G-VERS.2002, 1G0FT1G-VERS.032008, 1G0FT2G-VERS.032008, 1G0FT3G-VERS.032008...(Other models you can see in the webshop) |                 |                         |
| <b>accessories for</b>  | 106164  |                 |                         |
|    | <b>GEV No.</b>  | 100904          | <b>Ref. No.</b> —       |
|   | locking screw M10x1 for pipe ø 4mm Qty 1 pcs  |                 |                         |
|   | <b>GEV No.</b>  | 100905          | <b>Ref. No.</b> —       |
|   | locking screw M10x1 for pipe ø 6mm Qty 1 pcs  |                 |                         |
|  | <b>GEV No.</b>  | 101273          | <b>Ref. No.</b> —       |
|   | olive for pipe ø 12mm L 9.5mm brass Qty 1 pcs suitable for universal  |                 |                         |
|  | <b>GEV No.</b>  | 101276          | <b>Ref. No.</b> 36Q0710 |
|   | union screw thread 3/8" tube ø 12mm Qty 1 pcs   |                 |                         |
|  | <b>GEV No.</b>  | 101333          | <b>Ref. No.</b> 36R0010 |
|   | plug thread 3/8" with O-ring  |                 |                         |

Зип Общепит

vsezip.ru

+7(812)987-08-81



|   |   |                 |                         |
|---|---|-----------------|-------------------------|
| <b>GEV No.</b>  | 101125  | <b>Ref. No.</b> | 33A0570<br>33A0571      |
| <b>description</b>  | gas thermostat type 630 Eurosit series t.max. 340°C 100-340°C gas inlet 3/8" gas outlet 3/8" thermocouple connection M9x1 pilot connection M10x1 probe ø 4mm probe L 72mm capillary pipe 1050mm SIT   |                 |                         |
| <b>For models:</b>  | 08WFAAG, 0G1BR3G, 12WFAAG, 1A1FA1G, 1A1FA2G, 1A1FA4G, 1A1FA5G, 1A1FAAG, 1A1FABG, 1A1TP0G-VERS.2002, 1B1FAS2G, 1B1FASG, 1D1FA1G, 1D1FA2G, 1D1FA4G, 1D1FA5G, 1D1FAAG, 1D1FABG, 1D1TP0G-VERS.2002, 1G1BR3G, 2A1FA1G, 2A1FA4G, 2A1FAAG, 2A1TP3G, 2A1TP6G, 2A1TPCG, 2D1FA1G, 2D1FA4G, 2D1FAAG, 2D1TP3G, 2D1TP6G, 2D1TPCG, 3A1FA1G, 3A1FA4G, 3A1FAAG, 3D1FA1G, 3D1FA4G, 3D1FAAG |                 |                         |
| <b>accessories for</b>  | 101125  |                 |                         |
|   | <b>GEV No.</b>  | 100825          | <b>Ref. No.</b> 33Q3480 |
| gas tap spindle shaft ø 8x6.5mm shaft L 22/14mm suitable for EUROSIT  |   |                 |                         |
|   | <b>GEV No.</b>  | 100904          | <b>Ref. No.</b> —       |
| locking screw M10x1 for pipe ø 4mm Qty 1 pcs  |   |                 |                         |
|   | <b>GEV No.</b>  | 100905          | <b>Ref. No.</b> —       |
| locking screw M10x1 for pipe ø 6mm Qty 1 pcs  |   |                 |                         |
|   | <b>GEV No.</b>  | 100949          | <b>Ref. No.</b> 3152280 |
| gasket suitable for 630 Eurosit series  |   |                 |                         |
|   | <b>GEV No.</b>  | 101273          | <b>Ref. No.</b> —       |
| olive for pipe ø 12mm L 9.5mm brass Qty 1 pcs suitable for universal  |   |                 |                         |
|   | <b>GEV No.</b>  | 101276          | <b>Ref. No.</b> 36Q0710 |
| union screw thread 3/8" tube ø 12mm Qty 1 pcs   |   |                 |                         |
|   | <b>GEV No.</b>  | 101333          | <b>Ref. No.</b> 36R0010 |
| plug thread 3/8" with O-ring  |   |                 |                         |
|   | <b>GEV No.</b>  | 101390          | <b>Ref. No.</b> —       |
| gas tap spindle shaft ø 6x4.6mm shaft L 32/15mm gas tap with ignition flame suitable for ZANUSSI, MARENO for gas thermostat EUROSIT |   |                 |                         |
|   | <b>GEV No.</b>  | 101392          | <b>Ref. No.</b> 33A0920 |
| adapter suitable for 630 Eurosit series   |   |                 |                         |
|   | <b>GEV No.</b>  | 110357          | <b>Ref. No.</b> —       |
| gas tap spindle shaft ø 8x6.5mm shaft L 36/12mm suitable for 630 Eurosit series   |   |                 |                         |
|   | <b>GEV No.</b>  | 110358          | <b>Ref. No.</b> —       |
| adapter shaft ø 10x8mm shaft L 29/18mm suitable for 630 Eurosit series  |   |                 |                         |



|   |   |                 |                         |
|---|---|-----------------|-------------------------|
| <b>GEV No.</b>  | 101971  | <b>Ref. No.</b> | 6300479                 |
| <b>description</b>  | gas thermostat type 630 Eurosit series t.max. 340°C 100-340°C SIT |                 |                         |
| <b>spare parts for</b>  | 101971  |                 |                         |
|   | <b>GEV No.</b>  | 100825          | <b>Ref. No.</b> 33Q3480 |
| gas tap spindle shaft ø 8x6.5mm shaft L 22/14mm suitable for EUROSIT  |   |                 |                         |
|   | <b>GEV No.</b>  | 101392          | <b>Ref. No.</b> 33A0920 |
| adapter suitable for 630 Eurosit series   |   |                 |                         |
| <b>accessories for</b>  | 101971  |                 |                         |
|   | <b>GEV No.</b>  | 100825          | <b>Ref. No.</b> 33Q3480 |
| gas tap spindle shaft ø 8x6.5mm shaft L 22/14mm suitable for EUROSIT  |   |                 |                         |
|   | <b>GEV No.</b>  | 100904          | <b>Ref. No.</b> —       |
| locking screw M10x1 for pipe ø 4mm Qty 1 pcs  |   |                 |                         |
|   | <b>GEV No.</b>  | 100905          | <b>Ref. No.</b> —       |
| locking screw M10x1 for pipe ø 6mm Qty 1 pcs  |   |                 |                         |
|   | <b>GEV No.</b>  | 100949          | <b>Ref. No.</b> 3152280 |
| gasket suitable for 630 Eurosit series  |   |                 |                         |
|   | <b>GEV No.</b>  | 101273          | <b>Ref. No.</b> —       |
| olive for pipe ø 12mm L 9.5mm brass Qty 1 pcs suitable for universal  |   |                 |                         |
|   | <b>GEV No.</b>  | 101276          | <b>Ref. No.</b> 36Q0710 |
| union screw thread 3/8" tube ø 12mm Qty 1 pcs   |   |                 |                         |
|   | <b>GEV No.</b>  | 101333          | <b>Ref. No.</b> 36R0010 |
| plug thread 3/8" with O-ring  |   |                 |                         |
|   | <b>GEV No.</b>  | 101390          | <b>Ref. No.</b> —       |
| gas tap spindle shaft ø 6x4.6mm shaft L 32/15mm gas tap with ignition flame suitable for ZANUSSI, MARENO for gas thermostat EUROSIT |   |                 |                         |
|   | <b>GEV No.</b>  | 101392          | <b>Ref. No.</b> 33A0920 |
| adapter suitable for 630 Eurosit series   |   |                 |                         |
|   | <b>GEV No.</b>  | 110357          | <b>Ref. No.</b> —       |
| gas tap spindle shaft ø 8x6.5mm shaft L 36/12mm suitable for 630 Eurosit series   |   |                 |                         |
|   | <b>GEV No.</b>  | 110358          | <b>Ref. No.</b> —       |
| adapter shaft ø 10x8mm shaft L 29/18mm suitable for 630 Eurosit series  |   |                 |                         |





Зип-Общепит

vsezip.ru

+7(812)987-08-81



|                    |   |                 |         |
|--------------------|---|-----------------|---------|
| <b>GEV No.</b>     | 107846  | <b>Ref. No.</b> | 6300641 |
| <b>description</b> | gas thermostat type EUROSIT 80-320°C gas inlet 3/8" gas outlet 3/8" thermocouple connection M9x1 pilot connection M10x1 probe L 72mm capillary pipe 980mm SIT |                 |         |
| <b>For models:</b> | 1A1FAS2G, 1A1FASG, 1A1TP0G, 1D1FAS2G, 1D1FASG, 1D1TP0G, 2A1FAS2G, 2A1FASG, 2A1TPSG, 2D1FAS2G, 2D1FASG, 2D1TPSG, 3A1FASG, 3D1FASG                              |                 |         |

|                        |        |                |  |                 |         |
|------------------------|--------|----------------|--|-----------------|---------|
| <b>accessories for</b> | 106241 | <b>GEV No.</b> | 101269   | <b>Ref. No.</b> | —       |
|                        |        |                | gas connection thread 1/2" angled with O-ring MINISIT 710            |                 |         |
|                        |        | <b>GEV No.</b> | 101270   | <b>Ref. No.</b> | —       |
|                        |        |                | screw connection IT 3/8" ET 3/8" L 28mm                              |                 |         |
|                        |        | <b>GEV No.</b> | 101272   | <b>Ref. No.</b> | —       |
|                        |        |                | screw connection IT 1/2" ET 3/8" L 57mm                              |                 |         |
|                        |        | <b>GEV No.</b> | 101273   | <b>Ref. No.</b> | —       |
|                        |        |                | olive for pipe ø 12mm L 9,5mm brass Qty 1 pcs suitable for universal |                 |         |
|                        |        | <b>GEV No.</b> | 101274   | <b>Ref. No.</b> | —       |
|                        |        |                | olive for pipe ø 16mm Qty 1 pcs                                      |                 |         |
|                        |        | <b>GEV No.</b> | 101275   | <b>Ref. No.</b> | —       |
|                        |        |                | union screw thread 1/2" for pipe ø 16mm Qty 1 pcs                    |                 |         |
|                        |        | <b>GEV No.</b> | 101276   | <b>Ref. No.</b> | 36Q0710 |
|                        |        |                | union screw thread 3/8" tube ø 12mm Qty 1 pcs                        |                 |         |
|                        |        | <b>GEV No.</b> | 110068   | <b>Ref. No.</b> | 36M0950 |
|                        |        |                | knob suitable for Minisit ø 37mm                                     |                 |         |

### 710 Minisit series



|                        |   |   |                         |
|------------------------|---|---|-------------------------|
| <b>GEV No.</b>         | 106241  | <b>Ref. No.</b>   | 6000380                 |
| <b>description</b>     | gas thermostat SIT type MINISIT 710 t.max. 190°C 50-190°C pressure controller yes |   |                         |
| <b>spare parts for</b> | 106241  |   |                         |
|                        | <b>GEV No.</b>  | 101053  | <b>Ref. No.</b> 32Z1490 |
|                        |   | magnet unit T1: M9x1 T2: M24x1 L 45mm ø 17mm suitable for Minisit                 |                         |
| <b>accessories for</b> | 106241  |   |                         |
|                        | <b>GEV No.</b>  | 100809  | <b>Ref. No.</b> —       |
|                        |   | O-ring EPDM thickness 2mm ID ø 21mm Qty 1 pcs                                     |                         |
|                        | <b>GEV No.</b>  | 100904  | <b>Ref. No.</b> —       |
|                        |   | locking screw M10x1 for pipe ø 4mm Qty 1 pcs                                      |                         |
|                        | <b>GEV No.</b>  | 100905  | <b>Ref. No.</b> —       |
|                        |   | locking screw M10x1 for pipe ø 6mm Qty 1 pcs                                      |                         |
|                        | <b>GEV No.</b>  | 101054  | <b>Ref. No.</b> —       |
|                        |   | magnet unit T1: M10x1 T2: M24x1 L 45mm ø 17mm suitable for Minisit                |                         |
|                        | <b>GEV No.</b>  | 101136  | <b>Ref. No.</b> —       |
|                        |   | piezoelectric igniter suitable for Minisit with cover cap ømm connection F6.3x0.8 |                         |
|                        | <b>GEV No.</b>  | 101137  | <b>Ref. No.</b> —       |
|                        |   | cover cap without piezoelectric igniter   |                         |
|                        | <b>GEV No.</b>  | 101267  | <b>Ref. No.</b> —       |
|                        |   | reducer IT 3/8" ET 1/2" L 21mm  |                         |
|                        | <b>GEV No.</b>  | 101268  | <b>Ref. No.</b> —       |
|                        |   | gas connection thread 3/8" angled with O-ring MINISIT 710                         |                         |



|                        |   |  |                         |
|------------------------|---|--|-------------------------|
| <b>GEV No.</b>         | 106239  | <b>Ref. No.</b>  | 33A1031                 |
| <b>description</b>     | gas thermostat SIT type MINISIT 710 t.max. 340°C 100-340°C gas inlet 1/2" gas outlet 3/8" thermocouple connection M9x1 pilot connection M10x1 probe ø 4mm probe L 72mm capillary pipe 1050mm probe type type C1 pressure controller yes pressure regulator 3-18mbar gland nut |  |                         |
| <b>For models:</b>     | 031FT04, 031FT06, 070FT04, 070FT05, 071FT04, 071FT06, 090FT04, 090FT05, 091FT04, 091FT06, 1G1BR1G, 31R, 712D, 712VA, 71D, 71DGG, 71TP, 72D, 72DGG, 72TP, 72TPGG, 72VA, 72VAGG, 72VAS, 72VASGG, 73D, 73DGG, 73VA, 73VAD, 73VADGG, 73VAGG, FS30                                 |  |                         |
| <b>spare parts for</b> | 106239  |  |                         |
|                        | <b>GEV No.</b>  | 101053   | <b>Ref. No.</b> 32Z1490 |
|                        |   | magnet unit T1: M9x1 T2: M24x1 L 45mm ø 17mm suitable for Minisit  |                         |
|                        | <b>GEV No.</b>  | 102107   | <b>Ref. No.</b> —       |
|                        |   | probe 100-340°C probe ø 4mm probe L 72mm capillary pipe 1050mm t.max. 340°C oven/grill probe type type C1 suitable for MINISIT 710 |                         |
| <b>accessories for</b> | 106239  |  |                         |
|                        | <b>GEV No.</b>  | 100809   | <b>Ref. No.</b> —       |
|                        |   | O-ring EPDM thickness 2mm ID ø 21mm Qty 1 pcs  |                         |
|                        | <b>GEV No.</b>  | 100904   | <b>Ref. No.</b> —       |
|                        |   | locking screw M10x1 for pipe ø 4mm Qty 1 pcs   |                         |

Table continues overleaf

1 gas components

Зип-Общепит

vsezip.ru



+7(812)987-08-81

| accessories for   |         | 106239 |                  |
|---|---------|--------|------------------|
|    | GEV No. | 100905 | Ref. No. —       |
| locking screw M10x1 for pipe ø 6mm Qty 1 pcs  |         |        |                  |
|    | GEV No. | 101137 | Ref. No. —       |
| cover cap without piezoelectric igniter   |         |        |                  |
|    | GEV No. | 101267 | Ref. No. —       |
| reducer IT 3/8" ET 1/2" L 21mm  |         |        |                  |
|    | GEV No. | 101268 | Ref. No. —       |
| gas connection thread 3/8" angled with O-ring MINISIT 710                           |         |        |                  |
|    | GEV No. | 101269 | Ref. No. —       |
| gas connection thread 1/2" angled with O-ring MINISIT 710                           |         |        |                  |
|    | GEV No. | 101270 | Ref. No. —       |
| screw connection IT 3/8" ET 3/8" L 28mm   |         |        |                  |
|    | GEV No. | 101272 | Ref. No. —       |
| screw connection IT 1/2" ET 3/8" L 57mm   |         |        |                  |
|    | GEV No. | 101273 | Ref. No. —       |
| olive for pipe ø 12mm L 9.5mm brass Qty 1 pcs suitable for universal                |         |        |                  |
|   | GEV No. | 101274 | Ref. No. —       |
| olive for pipe ø 16mm Qty 1 pcs   |         |        |                  |
|  | GEV No. | 101275 | Ref. No. —       |
| union screw thread 1/2" for pipe ø 16mm Qty 1 pcs                                   |         |        |                  |
|  | GEV No. | 101276 | Ref. No. 36Q0710 |
| union screw thread 3/8" tube ø 12mm Qty 1 pcs                                       |         |        |                  |
|  | GEV No. | 110068 | Ref. No. 36M0950 |
| knob suitable for Minisit ø 37mm  |         |        |                  |

| accessories for   |         | 106240 |                  |
|---|---------|--------|------------------|
|  | GEV No. | 100905 | Ref. No. —       |
| locking screw M10x1 for pipe ø 6mm Qty 1 pcs                                      |         |        |                  |
|  | GEV No. | 101137 | Ref. No. —       |
| cover cap without piezoelectric igniter   |         |        |                  |
|  | GEV No. | 101273 | Ref. No. —       |
| olive for pipe ø 12mm L 9.5mm brass Qty 1 pcs suitable for universal              |         |        |                  |
|  | GEV No. | 101276 | Ref. No. 36Q0710 |
| union screw thread 3/8" tube ø 12mm Qty 1 pcs                                     |         |        |                  |
|  | GEV No. | 101505 | Ref. No. —       |
| gas connection thread 3/8" angled without O-ring MINISIT 710                      |         |        |                  |
|  | GEV No. | 101516 | Ref. No. —       |
| flat-headed bolt thread M4 thread L 16mm SS DIN 7985/ISO 7045 Qty 1 pcs           |         |        |                  |
|  | GEV No. | 110068 | Ref. No. 36M0950 |
| knob suitable for Minisit ø 37mm  |         |        |                  |

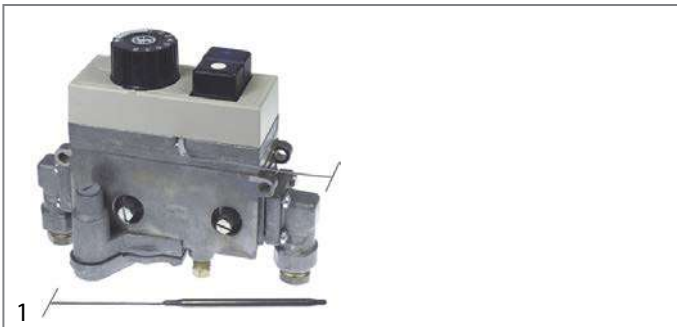
| accessories for   |         | 106240 |                  |
|---|---------|--------|------------------|
|    | GEV No. | 100904 | Ref. No. —       |
| locking screw M10x1 for pipe ø 4mm Qty 1 pcs  |         |        |                  |
|   | GEV No. | 101267 | Ref. No. —       |
| reducer IT 3/8" ET 1/2" L 21mm  |         |        |                  |
|  | GEV No. | 101268 | Ref. No. —       |
| gas connection thread 3/8" angled with O-ring MINISIT 710                           |         |        |                  |
|  | GEV No. | 101269 | Ref. No. —       |
| gas connection thread 1/2" angled with O-ring MINISIT 710                           |         |        |                  |
|  | GEV No. | 101270 | Ref. No. —       |
| screw connection IT 3/8" ET 3/8" L 28mm   |         |        |                  |
|  | GEV No. | 101272 | Ref. No. —       |
| screw connection IT 1/2" ET 3/8" L 57mm   |         |        |                  |
|  | GEV No. | 101273 | Ref. No. —       |
| olive for pipe ø 12mm L 9.5mm brass Qty 1 pcs suitable for universal                |         |        |                  |
|  | GEV No. | 101274 | Ref. No. —       |
| olive for pipe ø 16mm Qty 1 pcs   |         |        |                  |
|  | GEV No. | 101275 | Ref. No. —       |
| union screw thread 1/2" for pipe ø 16mm Qty 1 pcs                                   |         |        |                  |
|  | GEV No. | 101276 | Ref. No. 36Q0710 |
| union screw thread 3/8" tube ø 12mm Qty 1 pcs                                       |         |        |                  |



|   |  |                 |                    |
|---|--|-----------------|--------------------|
| <b>GEV No.</b>  | 106240   | <b>Ref. No.</b> | 33A1910<br>6000370 |
| <b>description</b>  | gas thermostat SIT type MINISIT 710 t.max. 340°C 100-340°C pressure controller yes   |                 |                    |
| <b>For models:</b>  | 0M0FT1G, 0M0FT2G, 0M0FT4G, 0M0FT5G, 1M0FT1G, 1M0FT2G, 1M0FT3G, 1M0FT4G, 1M0FT5G, 1M0FT6G, 2M0FT1G, 2M0FT2G, 2M0FT3G, 2M0FT4G, 2M0FT5G, 2M0FT6G |                 |                    |
| <b>spare parts for</b>  | 106240   |                 |                    |
|  | GEV No.  | 100068          | Ref. No. —         |
| pilot burner 2 flames gas connection 6mm  |  |                 |                    |
|  | GEV No.  | 100809          | Ref. No. —         |
| O-ring EPDM thickness 2mm ID ø 21mm Qty 1 pcs                                       |  |                 |                    |







Зип-Общепит





vsezip.ru

+7(812)987-08-81











|   |   |                 |                         |
|---|---|-----------------|-------------------------|
| <b>GEV No.</b>  | 101910 <sup>1</sup>   | <b>Ref. No.</b> | 33A1130                 |
| <b>description</b>  | gas thermostat SIT type MINISIT 710 t.max. 90°C 20-90°C gas inlet 1/2" gas outlet 3/8" thermocouple connection M9x1 pilot connection M10x1 probe ø 10.5mm probe L 19mm capillary pipe 1050mm probe type type F2 pressure controller yes pressure regulator 3-18mbar gland nut probe thread 1/4" |                 |                         |
| <b>For models:</b>  | 070BM, 071BM, 090BM, 091BM  |                 |                         |
| <b>spare parts for</b>  | 101910  |                 |                         |
|    | <b>GEV No.</b>  | 101053          | <b>Ref. No.</b> 32Z1490 |
|   | magnet unit T1: M9x1 T2: M24x1 L 45mm ø 17mm suitable for Minisit   |                 |                         |
|    | <b>GEV No.</b>  | 106223          | <b>Ref. No.</b> —       |
|   | probe 20-90°C probe ø 11mm probe thread 1/4" probe L 19mm capillary pipe 1050mm t.max. 90°C bain marie probe type type F2   |                 |                         |
| <b>accessories for</b>  | 101910  |                 |                         |
|    | <b>GEV No.</b>  | 100809          | <b>Ref. No.</b> —       |
|   | O-ring EPDM thickness 2mm ID ø 21mm Qty 1 pcs   |                 |                         |
|  | <b>GEV No.</b>  | 100904          | <b>Ref. No.</b> —       |
|   | locking screw M10x1 for pipe ø 4mm Qty 1 pcs  |                 |                         |
|  | <b>GEV No.</b>  | 100905          | <b>Ref. No.</b> —       |
|   | locking screw M10x1 for pipe ø 6mm Qty 1 pcs  |                 |                         |
|  | <b>GEV No.</b>  | 101054          | <b>Ref. No.</b> —       |
|   | magnet unit T1: M10x1 T2: M24x1 L 45mm ø 17mm suitable for Minisit  |                 |                         |
|  | <b>GEV No.</b>  | 101136          | <b>Ref. No.</b> —       |
|   | piezoelectric igniter suitable for Minisit with cover cap ømm connection F6.3x0.8   |                 |                         |
|  | <b>GEV No.</b>  | 101137          | <b>Ref. No.</b> —       |
|   | cover cap without piezoelectric igniter   |                 |                         |
|  | <b>GEV No.</b>  | 101267          | <b>Ref. No.</b> —       |
|   | reducer IT 3/8" ET 1/2" L 21mm  |                 |                         |
|  | <b>GEV No.</b>  | 101268          | <b>Ref. No.</b> —       |
|   | gas connection thread 3/8" angled with O-ring MINISIT 710   |                 |                         |
|  | <b>GEV No.</b>  | 101269          | <b>Ref. No.</b> —       |
|   | gas connection thread 1/2" angled with O-ring MINISIT 710   |                 |                         |
|  | <b>GEV No.</b>  | 101270          | <b>Ref. No.</b> —       |
|   | screw connection IT 3/8" ET 3/8" L 28mm   |                 |                         |
|  | <b>GEV No.</b>  | 101272          | <b>Ref. No.</b> —       |
|   | screw connection IT 1/2" ET 3/8" L 57mm   |                 |                         |
|  | <b>GEV No.</b>  | 101273          | <b>Ref. No.</b> —       |
|   | olive for pipe ø 12mm L 9.5mm brass Qty 1 pcs suitable for universal  |                 |                         |

<sup>1</sup>probe thread 1/4"

|   |   |        |                         |
|---|---|--------|-------------------------|
| <b>accessories for</b>  | 101910  |        |                         |
|  | <b>GEV No.</b>                                    | 101274 | <b>Ref. No.</b> —       |
|   | olive for pipe ø 16mm Qty 1 pcs                   |        |                         |
|  | <b>GEV No.</b>                                    | 101275 | <b>Ref. No.</b> —       |
|   | union screw thread 1/4" for pipe ø 16mm Qty 1 pcs |        |                         |
|  | <b>GEV No.</b>                                    | 101276 | <b>Ref. No.</b> 36Q0710 |
|   | union screw thread 3/8" tube ø 12mm Qty 1 pcs     |        |                         |
|  | <b>GEV No.</b>                                    | 110068 | <b>Ref. No.</b> 36M0950 |
|   | knob suitable for Minisit ø 37mm                  |        |                         |



|   |   |                 |                         |
|---|---|-----------------|-------------------------|
| <b>GEV No.</b>  | 101114 <sup>1</sup>   | <b>Ref. No.</b> | 33A1370<br>6000480      |
| <b>description</b>  | gas thermostat with pressure controller SIT type MINISIT 710 t.max. 190°C 110-190°C gas inlet 1/2" gas outlet 3/8" thermocouple connection M9x1 pilot connection M10x1 probe ø 10.5mm probe L 26mm capillary pipe 1050mm probe type type F3 pressure controller yes pressure regulator 3-18mbar gland nut |                 |                         |
| <b>For models:</b>  | 30F, 30FS, 70F, 71F   |                 |                         |
| <b>spare parts for</b>  | 101114  |                 |                         |
|  | <b>GEV No.</b>  | 101053          | <b>Ref. No.</b> 32Z1490 |
|   | magnet unit T1: M9x1 T2: M24x1 L 45mm ø 17mm suitable for Minisit   |                 |                         |
|  | <b>GEV No.</b>  | 102104          | <b>Ref. No.</b> —       |
|   | probe 110-190°C probe ø 11mm probe thread 1/4" probe L 26mm capillary pipe 1050mm t.max. 190°C fryer probe type type F3 suitable for MINISIT 710  |                 |                         |
| <b>accessories for</b>  | 101114  |                 |                         |
|  | <b>GEV No.</b>  | 100809          | <b>Ref. No.</b> —       |
|   | O-ring EPDM thickness 2mm ID ø 21mm Qty 1 pcs   |                 |                         |
|  | <b>GEV No.</b>  | 100820          | <b>Ref. No.</b> —       |
|   | gland duct ET M14x1.5 IT M10x0.75 probe ø max. 6.5mm WS 22  |                 |                         |
|  | <b>GEV No.</b>  | 100904          | <b>Ref. No.</b> —       |
|   | locking screw M10x1 for pipe ø 4mm Qty 1 pcs  |                 |                         |
|  | <b>GEV No.</b>  | 100905          | <b>Ref. No.</b> —       |
|   | locking screw M10x1 for pipe ø 6mm Qty 1 pcs  |                 |                         |
|  | <b>GEV No.</b>  | 101054          | <b>Ref. No.</b> —       |
|   | magnet unit T1: M10x1 T2: M24x1 L 45mm ø 17mm suitable for Minisit  |                 |                         |
|  | <b>GEV No.</b>  | 101136          | <b>Ref. No.</b> —       |
|   | piezoelectric igniter suitable for Minisit with cover cap ømm connection F6.3x0.8   |                 |                         |
|  | <b>GEV No.</b>  | 101137          | <b>Ref. No.</b> —       |
|   | cover cap without piezoelectric igniter   |                 |                         |

<sup>1</sup>probe thread 1/4"  
Table continues overleaf

Зип-Общепит

vsezip.ru

+7(812)987-08-81

| accessories for  |         | 101114 |                  |
|--|---------|--------|------------------|
|  | GEV No. | 101267 | Ref. No. —       |
| reducer IT 3/8" ET 1/2" L 21mm                                     |         |        |                  |
|  | GEV No. | 101268 | Ref. No. —       |
| gas connection thread 3/8" angled with O-ring MINISIT 710          |         |        |                  |
|  | GEV No. | 101269 | Ref. No. —       |
| gas connection thread 1/2" angled with O-ring MINISIT 710          |         |        |                  |
|  | GEV No. | 101270 | Ref. No. —       |
| screw connection IT 3/8" ET 3/8" L 28mm                            |         |        |                  |
|  | GEV No. | 101272 | Ref. No. —       |
| screw connection IT 1/2" ET 3/8" L 57mm                            |         |        |                  |
|  | GEV No. | 101273 | Ref. No. —       |
| olive for pipe 12mm L 9.5mm brass Qty 1 pcs suitable for universal |         |        |                  |
|  | GEV No. | 101274 | Ref. No. —       |
| olive for pipe 16mm Qty 1 pcs                                      |         |        |                  |
|  | GEV No. | 101275 | Ref. No. —       |
| union screw thread 1/2" for pipe 16mm Qty 1 pcs                    |         |        |                  |
|  | GEV No. | 101276 | Ref. No. 36Q0710 |
| union screw thread 3/8" tube 12mm Qty 1 pcs                        |         |        |                  |
|  | GEV No. | 110068 | Ref. No. 36M0950 |
| knob suitable for Minisit 37mm                                     |         |        |                  |
|  | GEV No. | 361182 | Ref. No. 3117580 |
| nut thread 1/4" H 5mm nickel-plated brass WS 17 Qty 1 pcs          |         |        |                  |
|  | GEV No. | 532520 | Ref. No. 3150390 |
| O-ring silicone thickness 2.62mm ID 15.08mm Qty 1 pcs              |         |        |                  |



|                    |  |                 |                    |
|--------------------|--|-----------------|--------------------|
| <b>GEV No.</b>     | 101432   | <b>Ref. No.</b> | 32Z0360<br>33A0800 |
| <b>description</b> | gas thermostat with push button SIT type MINISIT 710 t.max. 90°C 30-90°C gas inlet 1/2" gas outlet 1/2" thermocouple connection M9x1 pilot connection M10x1 probe 8mm probe L 100mm capillary pipe 1050mm probe type type E2 pressure controller yes pressure regulator 3-18mbar gland nut |                 |                    |

| spare parts for                             |         | 101432 |            |
|---|---------|--------|------------|
|   | GEV No. | 100809 | Ref. No. — |
| O-ring EPDM thickness 2mm ID 21mm Qty 1 pcs |         |        |            |
|   | GEV No. | 100905 | Ref. No. — |
| locking screw M10x1 for pipe 6mm Qty 1 pcs  |         |        |            |

| spare parts for  |         | 101432 |                  |
|--|---------|--------|------------------|
|  | GEV No. | 101053 | Ref. No. 32Z1490 |
| magnet unit T1: M9x1 T2: M24x1 L 45mm 17mm suitable for Minisit  |         |        |                  |
|  | GEV No. | 101269 | Ref. No. —       |
| gas connection thread 1/2" angled with O-ring MINISIT 710  |         |        |                  |
|  | GEV No. | 102117 | Ref. No. —       |
| probe 30-90°C probe 8mm probe L 100mm capillary pipe 1050mm t.max. 90°C bain marie probe type type E2 suitable for MINISIT 710 |         |        |                  |
|  | GEV No. | 110068 | Ref. No. 36M0950 |
| knob suitable for Minisit 37mm   |         |        |                  |
| accessories for  |         | 101432 |                  |
|  | GEV No. | 100904 | Ref. No. —       |
| locking screw M10x1 for pipe 4mm Qty 1 pcs   |         |        |                  |
|  | GEV No. | 101054 | Ref. No. —       |
| magnet unit T1: M10x1 T2: M24x1 L 45mm 17mm suitable for Minisit   |         |        |                  |
|  | GEV No. | 101136 | Ref. No. —       |
| piezoelectric igniter suitable for Minisit with cover cap 8mm connection F6.3x0.8  |         |        |                  |
|  | GEV No. | 101137 | Ref. No. —       |
| cover cap without piezoelectric igniter  |         |        |                  |
|  | GEV No. | 101267 | Ref. No. —       |
| reducer IT 3/8" ET 1/2" L 21mm   |         |        |                  |
|  | GEV No. | 101268 | Ref. No. —       |
| gas connection thread 3/8" angled with O-ring MINISIT 710  |         |        |                  |
|  | GEV No. | 101270 | Ref. No. —       |
| screw connection IT 3/8" ET 3/8" L 28mm  |         |        |                  |
|  | GEV No. | 101272 | Ref. No. —       |
| screw connection IT 1/2" ET 3/8" L 57mm  |         |        |                  |
|  | GEV No. | 101273 | Ref. No. —       |
| olive for pipe 12mm L 9.5mm brass Qty 1 pcs suitable for universal   |         |        |                  |
|  | GEV No. | 101274 | Ref. No. —       |
| olive for pipe 16mm Qty 1 pcs  |         |        |                  |
|  | GEV No. | 101275 | Ref. No. —       |
| union screw thread 1/2" for pipe 16mm Qty 1 pcs  |         |        |                  |
|  | GEV No. | 101276 | Ref. No. 36Q0710 |
| union screw thread 3/8" tube 12mm Qty 1 pcs  |         |        |                  |



Зип-Общепит

vsezip.ru

+7(812)987-08-81

|                        |   |                 |                         |
|------------------------|---|-----------------|-------------------------|
|                        |   |                 |                         |
| <b>GEV No.</b>         | 101131  | <b>Ref. No.</b> | 33A0300                 |
| <b>description</b>     | gas thermostat without cap, button and angle SIT type MINISIT 710 t.max. 190°C 50-190°C gas inlet 1/2" gas outlet 3/8" thermocouple connection M9x1 pilot connection M10x1 probe ø 5mm probe L 98mm capillary pipe 1200mm probe type type A2 pressure controller no pressure regulator mbar gland nut |                 |                         |
| <b>For models:</b>     | B1101S, BF101L, BF101S, IS102S, IS102SR, IS102SR-0NR01, IS102SW, SM2L, SM2LW, SM2S, SM2SW, SM4SR, VS101L, XA72S, XS101L, XS101S, XS72S  |                 |                         |
| <b>spare parts for</b> | 101131  |                 |                         |
|                        | <b>GEV No.</b>  | 101053          | <b>Ref. No.</b> 32Z1490 |
|                        | magnet unit T1: M9x1 T2: M24x1 L 45mm ø 17mm suitable for Minisit   |                 |                         |
|                        | <b>GEV No.</b>  | 102103          | <b>Ref. No.</b> —       |
|                        | probe 60-200°C probe ø 5mm probe L 98mm capillary pipe 1050mm t.max. 200°C fryer probe type type A2 suitable for MINISIT 710  |                 |                         |
| <b>accessories for</b> | 101131  |                 |                         |
|                        | <b>GEV No.</b>  | 100809          | <b>Ref. No.</b> —       |
|                        | O-ring EPDM thickness 2mm ID ø 21mm Qty 1 pcs   |                 |                         |
|                        | <b>GEV No.</b>  | 100820          | <b>Ref. No.</b> —       |
|                        | gland duct ET M14x1.5 IT M10x0.75 probe ø max. 6.5mm WS 22  |                 |                         |
|                        | <b>GEV No.</b>  | 100904          | <b>Ref. No.</b> —       |
|                        | locking screw M10x1 for pipe ø 4mm Qty 1 pcs  |                 |                         |
|                        | <b>GEV No.</b>  | 100905          | <b>Ref. No.</b> —       |
|                        | locking screw M10x1 for pipe ø 6mm Qty 1 pcs  |                 |                         |
|                        | <b>GEV No.</b>  | 101054          | <b>Ref. No.</b> —       |
|                        | magnet unit T1: M10x1 T2: M24x1 L 45mm ø 17mm suitable for Minisit  |                 |                         |
|                        | <b>GEV No.</b>  | 101136          | <b>Ref. No.</b> —       |
|                        | piezoelectric igniter suitable for Minisit with cover cap ømm connection F6.3x0.8   |                 |                         |
|                        | <b>GEV No.</b>  | 101137          | <b>Ref. No.</b> —       |
|                        | cover cap without piezoelectric igniter   |                 |                         |
|                        | <b>GEV No.</b>  | 101267          | <b>Ref. No.</b> —       |
|                        | reducer IT 3/8" ET 1/2" L 21mm  |                 |                         |
|                        | <b>GEV No.</b>  | 101268          | <b>Ref. No.</b> —       |
|                        | gas connection thread 3/8" angled with O-ring MINISIT 710   |                 |                         |
|                        | <b>GEV No.</b>  | 101269          | <b>Ref. No.</b> —       |
|                        | gas connection thread 1/2" angled with O-ring MINISIT 710   |                 |                         |
|                        | <b>GEV No.</b>  | 101270          | <b>Ref. No.</b> —       |
|                        | screw connection IT 3/8" ET 3/8" L 28mm   |                 |                         |
|                        | <b>GEV No.</b>  | 101272          | <b>Ref. No.</b> —       |
|                        | screw connection IT 1/2" ET 3/8" L 57mm   |                 |                         |

|                        |  |        |                         |
|------------------------|--|--------|-------------------------|
| <b>accessories for</b> | 101131   |        |                         |
|                        | <b>GEV No.</b>   | 101273 | <b>Ref. No.</b> —       |
|                        | olive for pipe ø 12mm L 9.5mm brass Qty 1 pcs suitable for universal |        |                         |
|                        | <b>GEV No.</b>   | 101274 | <b>Ref. No.</b> —       |
|                        | olive for pipe ø 16mm Qty 1 pcs                                      |        |                         |
|                        | <b>GEV No.</b>   | 101275 | <b>Ref. No.</b> —       |
|                        | union screw thread 1/2" for pipe ø 16mm Qty 1 pcs                    |        |                         |
|                        | <b>GEV No.</b>   | 101276 | <b>Ref. No.</b> 36Q0710 |
|                        | union screw thread 3/8" tube ø 12mm Qty 1 pcs                        |        |                         |
|                        | <b>GEV No.</b>   | 110068 | <b>Ref. No.</b> 36M0950 |
|                        | knob suitable for Minisit ø 37mm                                     |        |                         |

PEL

24ST series

|                        |   |                 |                         |
|------------------------|---|-----------------|-------------------------|
|                        |   |                 |                         |
| <b>GEV No.</b>         | 106197  | <b>Ref. No.</b> | 33A1850                 |
| <b>description</b>     | gas thermostat PEL type 24ST 120-280°C gas inlet pipe flange ø21mm bypass nozzle ø 0.35mm gas outlet M20x1.5 (tube ø 12/10mm) thermocouple connection M9x1 pilot connection M10x1 capillary pipe 1200mm probe ø 6mm probe L 120mm shaft ø 10x8mm shaft L 31/15mm shaft flat upper |                 |                         |
| <b>For models:</b>     | 0A0FT4G, 0A0FT5G, 0B0FT1G, 0B0FT2G, 0B0FT4G, 0B0FT5G, 0D0FT4G, 0D0FT5G, 0G0FT4G, 0G0FT5G, 1A0FT4G, 1A0FT6G, 1B0FT4G, 1B0FT6G, 1D0FT4G, 1D0FT6G, 1G0FT4G, 1G0FT6G  |                 |                         |
| <b>spare parts for</b> | 106197  |                 |                         |
|                        | <b>GEV No.</b>  | 100455          | <b>Ref. No.</b> —       |
|                        | bypass nozzle type PEL23/24 bore ø 0.35mm thread M8x0.5   |                 |                         |
|                        | <b>GEV No.</b>  | 101058          | <b>Ref. No.</b> 32Z1460 |
|                        | magnet unit L 39mm D1 ø 15.4mm D2 ø 13.5mm suitable for PEL22/ EGA24197 standard  |                 |                         |
|                        | <b>GEV No.</b>  | 106165          | <b>Ref. No.</b> —       |
|                        | gasket ø 27mm   |                 |                         |
|                        | <b>GEV No.</b>  | 106200          | <b>Ref. No.</b> —       |
|                        | nut thread M9x1 suitable for PEL 24/25S   |                 |                         |
| <b>accessories for</b> | 106197  |                 |                         |
|                        | <b>GEV No.</b>  | 100908          | <b>Ref. No.</b> 36Q1000 |
|                        | union screw thread M10x1 for pipe ø 4mm Qty 1 pcs   |                 |                         |
|                        | <b>GEV No.</b>  | 100909          | <b>Ref. No.</b> 36Q0060 |
|                        | union screw thread M10x1 for pipe ø 6mm Qty 1 pcs   |                 |                         |
|                        | <b>GEV No.</b>  | 101246          | <b>Ref. No.</b> —       |
|                        | olive for pipe ø 4mm Qty 1 pcs  |                 |                         |

Table continues overleaf

1 gas components

Зип-Общепит

vsezip.ru

+7(812)987-08-81

| accessories for |        | 106197   |  |  |
|-----------------|--------|----------|--|--|
| GEV No.         |        | Ref. No. |  |  |
|                 | 101248 | 36Q0030  | olive for pipe ø 12mm Qty 1 pcs suitable for PEL     |  |
|                 | 101249 | 36Q1700  | olive for pipe ø 10mm Qty 1 pcs                      |  |
|                 | 101250 | 36Q0610  | union nut thread M20x1.5 for pipe ø 10mm             |  |
|                 | 101251 | 36Q0050  | union nut thread M20x1.5 for pipe ø 12mm             |  |
|                 | 101286 | 36Q0020  | olive ID ø 6mm Qty 1 pcs                             |  |
|                 | 101331 | —        | adapter suitable for PEL22 for flanged cable 10/12mm |  |

| accessories for |        | 106198   |  |  |
|-----------------|--------|----------|--|--|
| GEV No.         |        | Ref. No. |  |  |
|                 | 101249 | 36Q1700  | olive for pipe ø 10mm Qty 1 pcs                      |  |
|                 | 101250 | 36Q0610  | union nut thread M20x1.5 for pipe ø 10mm             |  |
|                 | 101251 | 36Q0050  | union nut thread M20x1.5 for pipe ø 12mm             |  |
|                 | 101286 | 36Q0020  | olive ID ø 6mm Qty 1 pcs                             |  |
|                 | 101331 | —        | adapter suitable for PEL22 for flanged cable 10/12mm |  |



| GEV No.   | Ref. No. |  |  |
|---|----------|--|--|
| 106198  | 33A1790  | gas thermostat PEL type 24ST 140-340°C gas inlet pipe flange ø21mm bypass nozzle ø 0mm gas outlet M20x1.5 (tube ø 12/10mm) thermocouple connection M8x1 pilot connection M10x1 capillary pipe 1200mm probe ø 6mm probe L 100mm shaft ø 10x9mm shaft L 27/17mm shaft flat upper |  |
| <b>For models:</b> 0A0FT1G, 0A0FT2G, 0D0FT1G, 0D0FT2G, 0G0FT1G, 0G0FT2G, 1A0FT1G, 1A0FT2G, 1A0FT3G, 1B0FT1G, 1B0FT2G, 1B0FT3G, 1D0FT1G, 1D0FT2G, 1D0FT3G, 1G0FT1G, 1G0FT2G, 1G0FT3G |          |  |  |
| <b>spare parts for</b> 106198   |          |  |  |
|   | 100455   | —  |  |
|   | 101058   | 32Z1460  |  |
|   | 101536   | —  |  |
|   | 106199   | —  |  |
| <b>accessories for</b> 106198   |          |  |  |
|   | 100908   | 36Q1000  |  |
|   | 100909   | 36Q0060  |  |
|   | 101246   | —  |  |
|   | 101248   | 36Q0030  |  |

| GEV No.  | Ref. No. |  |  |
|--|----------|--|--|
| 101900   | 33A2840  | gas thermostat PEL type 24ST up to 280°C gas inlet M20x1.5 (tube ø 12mm) bypass nozzle ø 0.8mm gas outlet M20x1.5 (tube ø 12/10mm) thermocouple connection M8x1 pilot connection M10x1 capillary pipe 1200mm probe ø 6mm probe L 120mm shaft ø 10x9mm shaft L 31/15mm shaft flat upper |  |
| <b>For models:</b> 030FT, 030FTR, 031FT, 031FTR, 031FTRL, 31, 31TC, 31TP, 32, 32TC, 32TP, 32TPV, 32V |          |  |  |
| <b>spare parts for</b> 101900  |          |  |  |
|  | 100497   | 33T4060  |  |
|  | 101058   | 32Z1460  |  |
|  | 106199   | —  |  |
| <b>accessories for</b> 101900  |          |  |  |
|  | 100908   | 36Q1000  |  |
|  | 100909   | 36Q0060  |  |
|  | 101246   | —  |  |
|  | 101248   | 36Q0030  |  |
|  | 101249   | 36Q1700  |  |
|  | 101250   | 36Q0610  |  |
|  | 101251   | 36Q0050  |  |



Table continues overleaf





Зип-Общепит



vsezip.ru

+7(812)987-08-81

| accessories for   |         | 101900 |          |         |
|---|---------|--------|----------|---------|
|  | GEV No. | 101286 | Ref. No. | 36Q0020 |
| olive ID ø 6mm Qty 1 pcs  |         |        |          |         |
|  | GEV No. | 110079 | Ref. No. | —       |
| knob dial plate gas thermostat 1-8 silver   |         |        |          |         |
|  | GEV No. | 110080 | Ref. No. | 3FL1230 |
| knob ø 70mm shaft ø 10x8mm shaft flat universal                                   |         |        |          |         |

| accessories for   |         | 101161 |          |         |
|---|---------|--------|----------|---------|
|  | GEV No. | 101461 | Ref. No. | —       |
| screw kit suitable for PEL22 Qty 4 pcs  |         |        |          |         |
|  | GEV No. | 110079 | Ref. No. | —       |
| knob dial plate gas thermostat 1-8 silver   |         |        |          |         |
|  | GEV No. | 110080 | Ref. No. | 3FL1230 |
| knob ø 70mm shaft ø 10x8mm shaft flat universal                                   |         |        |          |         |

| 24STS series  |   |          |                    |         |
|---|---|----------|--------------------|---------|
|                |   |          |                    |         |
| 1              |   |          |                    |         |
| GEV No.   | 101161  | Ref. No. | 33A0060<br>6003911 |         |
| description   | gas thermostat PEL type 24STS 120-320°C gas inlet M20x1.5 (tube ø 12/10mm) bypass nozzle ø 0.35mm gas outlet M20x1.5 (tube ø 12/10mm) thermocouple connection M9x1 pilot connection M10x1 capillary pipe 1200mm probe ø 6mm probe L 100mm shaft ø 10x8mm shaft L 27/17mm shaft flat upper |          |                    |         |
| spare parts for   | 101161  |          |                    |         |
|               | GEV No.   | 101058   | Ref. No.           | 32Z1460 |
| magnet unit L 39mm D1 ø 15.4mm D2 ø 13.5mm suitable for PEL22/EGA24197 standard                 |   |          |                    |         |
| accessories for   | 101161  |          |                    |         |
|              | GEV No.   | 101235   | Ref. No.           | —       |
| gas connection thread M20x1.5 tube ø 12/10mm for PEL gas taps horizontal                        |   |          |                    |         |
|              | GEV No.   | 101236   | Ref. No.           | —       |
| gas connection thread M20x1.5 tube ø 12/10mm for PEL gas taps vertical                          |   |          |                    |         |
|              | GEV No.   | 101240   | Ref. No.           | —       |
| gas connection thread M20x1.5 tube ø 12/10mm for PEL gas taps with gasket and screws horizontal |   |          |                    |         |
|              | GEV No.   | 101241   | Ref. No.           | —       |
| gas connection thread M20x1.5 tube ø 12/10mm for PEL gas taps vertical                          |   |          |                    |         |
|              | GEV No.   | 101248   | Ref. No.           | 36Q0030 |
| olive for pipe ø 12mm Qty 1 pcs suitable for PEL  |   |          |                    |         |
|              | GEV No.   | 101249   | Ref. No.           | 36Q1700 |
| olive for pipe ø 10mm Qty 1 pcs   |   |          |                    |         |
|              | GEV No.   | 101250   | Ref. No.           | 36Q0610 |
| union nut thread M20x1.5 for pipe ø 10mm  |   |          |                    |         |
|              | GEV No.   | 101251   | Ref. No.           | 36Q0050 |
| union nut thread M20x1.5 for pipe ø 12mm  |   |          |                    |         |
|              | GEV No.   | 101365   | Ref. No.           | —       |
| gas connection thread M20x1.5 tube ø 12mm for PEL gas taps horizontal                           |   |          |                    |         |
|              | GEV No.   | 101460   | Ref. No.           | —       |
| O-ring ø 12.37mm D1 ø 2.62mm suitable for PEL22   |   |          |                    |         |

| 25ST series  |  |          |         |  |
|--|--|----------|---------|--|
|    |  |          |         |  |
| 1  |  |          |         |  |
| GEV No.  | 101565   | Ref. No. | 33A0660 |  |
| description  | gas thermostat PEL type 25ST up to 280°C gas inlet pipe flange ø 21mm bypass nozzle ø 0mm gas outlet M16x1.5 (tube ø 10/8mm) thermocouple connection M9x1 pilot connection M10x1 capillary pipe 1200mm probe ø 6mm probe L 122mm shaft ø 8x6.5mm shaft L 21/15mm shaft flat upper pipe input ø 9mm |          |         |  |
| For models:  | 1G1FA0G, 1G1FA0GV, 1G1FABG, 1G1FAPG, 1G1TP0G, 2G1FA0G, 2G1FA0GV, 2G1FABG, 2G1FACG, 2G1FADG, 2G1FADGV, 2G1FAPG, 2G1TP3G, G1FAGS, G1FAGST  |          |         |  |

## gas valves and ignition boxes

### gas control valves

| HONEYWELL   |  |          |          |   |
|---|--|----------|----------|---|
|   |  |          |          |   |
| 1   |  |          |          |   |
| GEV No.   | 106004   | Ref. No. | 32V5810  |   |
| description   | gas valve type VK4105C 220-240V 50/60Hz gas inlet flange 32x32mm gas outlet flange 32x32mm thermocouple connection pilot connection pressure range 15-60mbar max 60mbar operator type pressure controller type V5306E 1234 1 suitable for HONEYWELL flange 32x32mm |          |          |   |
| For models:   | FCV61DS-CSA  |          |          |   |
| accessories for   | 106004   |          |          |   |
|    | GEV No.  | 102845   | Ref. No. | — |
| gas connection angled 1/2" flange 32x32mm hole distance 24x24mm Tandem                |  |          |          |   |
|    | GEV No.  | 102846   | Ref. No. | — |
| gas connection straight 1/2" flange 32x32mm hole distance 24x24mm suitable for Tandem |  |          |          |   |



SIT

ELETTROSIT



1

|   |   |                 |                         |
|---|---|-----------------|-------------------------|
| <b>GEV No.</b>  | 101993  | <b>Ref. No.</b> | 33A0590                 |
| <b>description</b>  | gas valve SIT type ELETTROSIT 230V gas inlet 1/2" gas outlet 1/2" thermocouple connection M9x1 pilot connection M10x1 lateral equiv. no. 0.810.126  |                 |                         |
| <b>For models:</b>  | 30F1, 30F1B, 30FS2, 30FS2B, 70F1, 70F1B, 71AR, 71F2, 71F2B, 71RA, 90F110B, 91AR, 91F210, 91F210B, 91F223B, 91RA, FC101, FC61, FCV101, FCV101DM, FCV101DS, FCV241GDM, FCV241GDS, FCV401DM, FCV61, FCV61DM, FCV61DS |                 |                         |
| <b>spare parts for</b>  | 101993  |                 |                         |
|    | <b>GEV No.</b>  | 101312          | <b>Ref. No.</b> 33A0020 |
|   | microswitch   |                 |                         |
|   | <b>GEV No.</b>  | 101352          | <b>Ref. No.</b> —       |
|   | solenoid coil 230V 50Hz suitable for ELETTROSIT   |                 |                         |
| <b>accessories for</b>  | 101993  |                 |                         |
|  | <b>GEV No.</b>  | 100006          | <b>Ref. No.</b> —       |
|   | piezoelectric igniter suitable for ELETTROSIT body plastic blowing connection ø2.4mm ø 14mm   |                 |                         |
|  | <b>GEV No.</b>  | 100904          | <b>Ref. No.</b> —       |
|   | locking screw M10x1 for pipe ø 4mm Qty 1 pcs  |                 |                         |
|  | <b>GEV No.</b>  | 100905          | <b>Ref. No.</b> —       |
|   | locking screw M10x1 for pipe ø 6mm Qty 1 pcs  |                 |                         |
|  | <b>GEV No.</b>  | 101301          | <b>Ref. No.</b> —       |
|   | gas connection thread 1/2" straight ELETTROSIT screw with O-ring  |                 |                         |
|  | <b>GEV No.</b>  | 101303          | <b>Ref. No.</b> —       |
|   | gas connection straight thread 3/4" ELETTROSIT  |                 |                         |
|  | <b>GEV No.</b>  | 101309          | <b>Ref. No.</b> —       |
|   | extension   |                 |                         |
|  | <b>GEV No.</b>  | 103104          | <b>Ref. No.</b> —       |
|   | ignition switch   |                 |                         |
|  | <b>GEV No.</b>  | 541504          | <b>Ref. No.</b> 33Q5880 |
|   | double nipple thread 1/2" - 1/2"  |                 |                         |

Зип Общепит

vsezip.ru

+7(812)987-08-81



1

|   |  |                 |                         |
|---|--|-----------------|-------------------------|
| <b>GEV No.</b>  | 101127   | <b>Ref. No.</b> | 33A0530                 |
| <b>description</b>  | gas valve SIT type ELETTROSIT 230V gas inlet 3/4" gas outlet 3/4" thermocouple connection M9x1 pilot connection M10x1 lateral equiv. no. 0.810.175 |                 |                         |
| <b>For models:</b>  | FC241, FC241G, FCV141, FCV141DM, FCV141DS, FCV241, FCV241DM, FCV241DS, FCV241G   |                 |                         |
| <b>spare parts for</b>  | 101127   |                 |                         |
|    | <b>GEV No.</b>   | 101312          | <b>Ref. No.</b> 33A0020 |
|   | microswitch  |                 |                         |
|    | <b>GEV No.</b>   | 101352          | <b>Ref. No.</b> —       |
|   | solenoid coil 230V 50Hz suitable for ELETTROSIT  |                 |                         |
| <b>accessories for</b>  | 101127   |                 |                         |
|   | <b>GEV No.</b>   | 100006          | <b>Ref. No.</b> —       |
|   | piezoelectric igniter suitable for ELETTROSIT body plastic blowing connection ø2.4mm ø 14mm  |                 |                         |
|  | <b>GEV No.</b>   | 100904          | <b>Ref. No.</b> —       |
|   | locking screw M10x1 for pipe ø 4mm Qty 1 pcs   |                 |                         |
|  | <b>GEV No.</b>   | 100905          | <b>Ref. No.</b> —       |
|   | locking screw M10x1 for pipe ø 6mm Qty 1 pcs   |                 |                         |
|  | <b>GEV No.</b>   | 101301          | <b>Ref. No.</b> —       |
|   | gas connection thread 1/2" straight ELETTROSIT screw with O-ring   |                 |                         |
|  | <b>GEV No.</b>   | 101303          | <b>Ref. No.</b> —       |
|   | gas connection straight thread 3/4" ELETTROSIT   |                 |                         |
|  | <b>GEV No.</b>   | 101309          | <b>Ref. No.</b> —       |
|   | extension  |                 |                         |





Зип-Общепит

vsezip.ru



+7(812)987-08-81

NOVASIT



1

|   |  |                 |                         |
|---|--|-----------------|-------------------------|
| <b>GEV No.</b>  | 101760   | <b>Ref. No.</b> | 33A1640                 |
| <b>description</b>  | gas valve SIT series Novasit 820 220V 50Hz gas inlet 1/2" gas outlet 1/2" thermocouple connection M9x1 pilot connection M10x1 ignition pressure 3-5mbar pressure range 3-30mbar pressure regulator connection blind equiv. no. 0.820.060 |                 |                         |
| <b>For models:</b>  | 091FR1G, 091FR3G, 191FR2GD, 191FR4GD   |                 |                         |
| <b>spare parts for</b>  | 101760   |                 |                         |
|    | <b>GEV No.</b>   | 101065          | <b>Ref. No.</b> —       |
|   | magnet unit with cable L 44mm D1 ø 30mm D2 ø 20mm suitable for NOVASIT   |                 |                         |
|    | <b>GEV No.</b>   | 101867          | <b>Ref. No.</b> —       |
|   | solenoid coil 220V 60Hz  |                 |                         |
| <b>accessories for</b>  | 101760   |                 |                         |
|   | <b>GEV No.</b>   | 100006          | <b>Ref. No.</b> —       |
|   | piezoelectric igniter suitable for ELETTROSIT body plastic blowing connection ø2.4mm ø 14mm  |                 |                         |
|  | <b>GEV No.</b>   | 100904          | <b>Ref. No.</b> —       |
|   | locking screw M10x1 for pipe ø 4mm Qty 1 pcs   |                 |                         |
|  | <b>GEV No.</b>   | 100905          | <b>Ref. No.</b> —       |
|   | locking screw M10x1 for pipe ø 6mm Qty 1 pcs   |                 |                         |
|  | <b>GEV No.</b>   | 101305          | <b>Ref. No.</b> —       |
|   | gas connection straight 1/2" flange 45x45mm ELETTROSIT/V4400/4600/4605 suitable for SIT/HONEYWELL hole distance 36x36mm  |                 |                         |
|  | <b>GEV No.</b>   | 101306          | <b>Ref. No.</b> —       |
|   | gas connection angled flange 45x45mm hole distance 36x36mm 1/2" ELETTROSIT/V4400/4600/4605 screw with O-ring suitable for SIT/HONEYWELL  |                 |                         |
|  | <b>GEV No.</b>   | 101307          | <b>Ref. No.</b> —       |
|   | gas connection straight flange 45x45mm hole distance 36x36mm 3/4" ELETTROSIT/V4400/4600/4605 screw with O-ring suitable for SIT/HONEYWELL  |                 |                         |
|  | <b>GEV No.</b>   | 101308          | <b>Ref. No.</b> —       |
|   | gas connection angled flange 45x45mm hole distance 36x36mm 3/4" ELETTROSIT/V4400/4600/4605 screw with O-ring suitable for SIT/HONEYWELL  |                 |                         |
|  | <b>GEV No.</b>   | 101312          | <b>Ref. No.</b> 33A0020 |
|   | microswitch  |                 |                         |
|  | <b>GEV No.</b>   | 101313          | <b>Ref. No.</b> —       |
|   | solenoid coil 230V 50Hz  |                 |                         |
|  | <b>GEV No.</b>   | 101314          | <b>Ref. No.</b> —       |
|   | solenoid coil 24V 50Hz   |                 |                         |
|  | <b>GEV No.</b>   | 101317          | <b>Ref. No.</b> —       |
|   | plug with cable L 1000mm suitable for NOVASIT  |                 |                         |

|   |  |        |                   |
|---|--|--------|-------------------|
| <b>accessories for</b>  | 101760   |        |                   |
|  | <b>GEV No.</b>                                   | 101318 | <b>Ref. No.</b> — |
|   | cover cap for solenoid coil suitable for NOVASIT |        |                   |
|  | <b>GEV No.</b>                                   | 101503 | <b>Ref. No.</b> — |
|   | O-ring EPDM thickness 2mm ID ø 32mm Qty 1 pcs    |        |                   |



1









|   |   |                 |                         |
|---|---|-----------------|-------------------------|
| <b>GEV No.</b>  | 101162  | <b>Ref. No.</b> | 33A0460                 |
| <b>description</b>  | gas valve SIT series Novasit 820 230V 50Hz gas inlet 1/2" gas outlet 1/2" thermocouple connection M9x1 pilot connection M10x1 ignition pressure 3-5mbar pressure range 3-30mbar pressure regulator connection blind equiv. no. 0.820.010  |                 |                         |
| <b>For models:</b>  | 06WFR3GD, 091FR1G, 091FR1GD, 091FR3G, 091FR3GD, 0A1FR1G, 0A1FR1GD, 0A1FR1GD-VERS.2004, 0A1FR1G-VERS.2004, 0A1FR3G, 0A1FR3GD, 0B1FR1G, 0B1FR1GD, 0D1FR1G, 0D1FR1GD, 0D1FR1GD-VERS.2004, 0D1FR1G-VERS.2004, 0D1FR3G, 0D1FR3GD, 0G1FR3G, 0G1FR3GD, 10WFR4GD, 191FR2G, 191FR2GD, 191FR4G, 191FR4GD, 1A1FR2G, 1A1FR2GD, 1A1FR2GD-VERS.2004, 1A1FR2G-VERS.2004, 1A1FR4G, 1A1FR4GD, 1D1FR2G, 1D1FR2GD, 1D1FR2GD-VERS.2004, 1D1FR2G-VERS.2004, 1D1FR4G, 1D1FR4GD, 1G1FR4G, 1G1FR4GD, FC101, FC241G, FC61, FCV101, FCV101DM, FCV101DS, FCV141, FCV141DM, FCV141DS, FCV241G...(Other models you can see in the webshop) |                 |                         |
| <b>spare parts for</b>  | 101162  |                 |                         |
|  | <b>GEV No.</b>  | 101065          | <b>Ref. No.</b> —       |
|   | magnet unit with cable L 44mm D1 ø 30mm D2 ø 20mm suitable for NOVASIT  |                 |                         |
|  | <b>GEV No.</b>  | 101313          | <b>Ref. No.</b> —       |
|   | solenoid coil 230V 50Hz   |                 |                         |
| <b>accessories for</b>  | 101162  |                 |                         |
|  | <b>GEV No.</b>  | 100006          | <b>Ref. No.</b> —       |
|   | piezoelectric igniter suitable for ELETTROSIT body plastic blowing connection ø2.4mm ø 14mm   |                 |                         |
|  | <b>GEV No.</b>  | 101305          | <b>Ref. No.</b> —       |
|   | gas connection straight 1/2" flange 45x45mm ELETTROSIT/V4400/4600/4605 suitable for SIT/HONEYWELL hole distance 36x36mm   |                 |                         |
|  | <b>GEV No.</b>  | 101306          | <b>Ref. No.</b> —       |
|   | gas connection angled flange 45x45mm hole distance 36x36mm 1/2" ELETTROSIT/V4400/4600/4605 screw with O-ring suitable for SIT/HONEYWELL   |                 |                         |
|  | <b>GEV No.</b>  | 101307          | <b>Ref. No.</b> —       |
|   | gas connection straight flange 45x45mm hole distance 36x36mm 3/4" ELETTROSIT/V4400/4600/4605 screw with O-ring suitable for SIT/HONEYWELL   |                 |                         |
|  | <b>GEV No.</b>  | 101308          | <b>Ref. No.</b> —       |
|   | gas connection angled flange 45x45mm hole distance 36x36mm 3/4" ELETTROSIT/V4400/4600/4605 screw with O-ring suitable for SIT/HONEYWELL   |                 |                         |
|  | <b>GEV No.</b>  | 101312          | <b>Ref. No.</b> 33A0020 |
|   | microswitch   |                 |                         |



Table continues overleaf





1 gas components

Зип-Общепит

vsezip.ru

+7(812)987-08-81

| accessories for   |  | 101162   |   |
|---|--|----------|---|
| GEV No.   | 101314   | Ref. No. | — |
|  | solenoid coil 24V 50Hz                           |          |   |
| GEV No.   | 101317   | Ref. No. | — |
|  | plug with cable L 1000mm suitable for NOVASIT    |          |   |
| GEV No.   | 101318   | Ref. No. | — |
|  | cover cap for solenoid coil suitable for NOVASIT |          |   |

| accessories for   |  | 101688   |         |
|---|--|----------|---------|
| GEV No.   | 101312   | Ref. No. | 33A0020 |
|  | microswitch                                      |          |         |
| GEV No.   | 101314   | Ref. No. | —       |
|  | solenoid coil 24V 50Hz                           |          |         |
| GEV No.   | 101317   | Ref. No. | —       |
|  | plug with cable L 1000mm suitable for NOVASIT    |          |         |
| GEV No.   | 101318   | Ref. No. | —       |
|  | cover cap for solenoid coil suitable for NOVASIT |          |         |
| GEV No.   | 101503   | Ref. No. | —       |
|  | O-ring EPDM thickness 2mm ID ø 32mm Qty 1 pcs    |          |         |



| GEV No.   | 101688   | Ref. No. | 33A0930 |
|---|--|----------|---------|
| <b>description</b>  | gas valve SIT series Novasit 824 230V 50Hz gas inlet 1/2" gas outlet 1/2" thermocouple connection M9x1 pilot connection M10x1 ignition pressurembar pressure range 2-50mbar pressure regulator connection equiv. no. 0.824.011     |          |         |
| <b>For models:</b>  | 191BR1G, 191BR1GA, 191BR2G, 191BR2GA, 1A1BR1G, 1A1BR1GA, 1A1BR2G, 1A1BR2GA, 1D1BR1G, 1D1BR1GA, 1D1BR2G, 1D1BR2GA, 291BR1G, 291BR1GA, 291BR2G, 291BR2GA, 2A1BR1G, 2A1BR1GA, 2A1BR2G, 2A1BR2GA, 2D1BR1G, 2D1BR1GA, 2D1BR2G, 2D1BR2GA |          |         |
| <b>spare parts for</b>  | 101688   |          |         |
| GEV No.   | 101065   | Ref. No. | —       |
|  | magnet unit with cable L 44mm D1 ø 30mm D2 ø 20mm suitable for NOVASIT   |          |         |
| GEV No.   | 101313   | Ref. No. | —       |
|  | solenoid coil 230V 50Hz  |          |         |
| <b>accessories for</b>  | 101688   |          |         |
| GEV No.   | 100006   | Ref. No. | —       |
|  | piezoelectric igniter suitable for ELETTROSIT body plastic blowing connection ø2.4mm ø 14mm  |          |         |
| GEV No.   | 100904   | Ref. No. | —       |
|  | locking screw M10x1 for pipe ø 4mm Qty 1 pcs   |          |         |
| GEV No.   | 100905   | Ref. No. | —       |
|  | locking screw M10x1 for pipe ø 6mm Qty 1 pcs   |          |         |
| GEV No.   | 101305   | Ref. No. | —       |
|  | gas connection straight 1/2" flange 45x45mm ELETTROSIT/V4400/4600/4605 suitable for SIT/HONEYWELL hole distance 36x36mm  |          |         |
| GEV No.   | 101306   | Ref. No. | —       |
|  | gas connection angled flange 45x45mm hole distance 36x36mm 1/2" ELETTROSIT/V4400/4600/4605 screw with O-ring suitable for SIT/HONEYWELL  |          |         |
| GEV No.   | 101307   | Ref. No. | —       |
|  | gas connection straight flange 45x45mm hole distance 36x36mm 3/4" ELETTROSIT/V4400/4600/4605 screw with O-ring suitable for SIT/HONEYWELL  |          |         |
| GEV No.   | 101308   | Ref. No. | —       |
|  | gas connection angled flange 45x45mm hole distance 36x36mm 3/4" ELETTROSIT/V4400/4600/4605 screw with O-ring suitable for SIT/HONEYWELL  |          |         |

SIGMA



| GEV No.            | 107893   | Ref. No. | 3041070 |
|--------------------|--|----------|---------|
| <b>description</b> | gas valve type 0840028 220V 60Hz gas inlet 3/4" gas outlet 3/4" pressure range 2-50mbar  |          |         |
| <b>For models:</b> | 091FR11, 091FR11A, 091FR11D, 091FR11D-VERS.052012, 091FR11-VERS.032012, 091FR7G, 091FR7GS, 091FR7G-VERS.052012, 091FR7GX, 191FR21, 191FR21D, 191FR21D-VERS.092012, 191FR21-VERS.032012, FC1011G, FC1221G, FC611G, FM1011G1, FM1011G1-VERS.2006, FM1011G2, FM1011G2-VERS.2006, FM1011G3, FM1011G3-VERS.2006, FM2011G2-VERS.2006, FM2011G3-VERS.2006, FM2021G1, FM2021G2, FM2021G2-VERS.2006, FM2021G3, FM2021G3-VERS.2006, FM611G1, FM611G1-VERS.2006, FM611G2, FM611G2-VERS.2006, FM611G3, FM611G3-VERS.2006, FM721G1, FM721G1-VERS.2006, FM721G2, FM721G2-VERS.2006, FM721G3, FM721G3-VERS.2006 |          |         |



Зип Общепит

vsezip.ru

+7(812)987-08-81



1

|                    |  |                 |         |
|--------------------|--|-----------------|---------|
| <b>GEV No.</b>     | 107894   | <b>Ref. No.</b> | 6300749 |
| <b>description</b> | gas valve type 0848083 230V 50Hz gas inlet 3/4" gas outlet 3/4" pressure range 0.5-12mbar incl reducer 1/2" - 3/4"   |                 |         |
| <b>For models:</b> | BX101G, BX101G-VERS.122013, BX122G, BX122G-VERS.122013, BX61G, BX61G-VERS.122013, BX82G, BX82G-VERS.122013, FX101G1, FX101G1R, FX101G2, FX101G2C, FX101G2C-VERS.032014, FX101G2R, FX101G2R-VERS.032014, FX101G2-VERS.032014, FX101G3, FX101G3C, FX101G3C-VERS.022014, FX101G3R, FX101G3R-VERS.022014, FX101G3-VERS.022014, FX10G2CR, FX10G2CR-VERS.032014, FX10G3CR, FX10G3CR-VERS.022014, FX122G1, FX122G2, FX122G2C, FX122G2T, FX122G2T-VERS.032014, FX122G3, FX122G3C, FX122G3T, FX122G3T-VERS.022014, FX12G3CT, FX12G3CT-VERS.022014, FX201G2, FX201G2P, FX201G2P-VERS.032014, FX201G2-VERS.032014, FX201G3P, FX201G3-VERS.022014, FX202G2, FX202G2-VERS.032014, FX202G3, FX202G3-VERS.022014, FX61G1, FX61G1R, FX61G2...(Other models you can see in the webshop) |                 |         |





1

|   |   |                 |                         |
|---|---|-----------------|-------------------------|
| <b>GEV No.</b>  | 107241  | <b>Ref. No.</b> | 32V5800                 |
| <b>description</b>  | gas valve type Sigma 230V 50Hz gas inlet 3/4" gas outlet 3/4" pressure range 2-50mbar   |                 |                         |
| <b>For models:</b>  | FC1011G, FC611G, FM1011G1, FM1011G1-VERS.2006, FM1011G2, FM1011G2-VERS.2006, FM1011G3, FM1011G3-VERS.2006, FM2011G2, FM2011G2-VERS.2006, FM2011G3-VERS.2006, FM2021G1, FM2021G2, FM2021G2-VERS.2006, FM2021G3, FM2021G3-VERS.2006, FM611G1, FM611G1-VERS.2006, FM611G2, FM611G2-VERS.2006, FM611G3, FM611G3-VERS.2006, FM721G1, FM721G1-VERS.2006, FM721G2, FM721G2-VERS.2006, FM721G3, FM721G3-VERS.2006 |                 |                         |
| <b>spare parts for</b>  | 107241  |                 |                         |
|  | <b>GEV No.</b>  | 106214          | <b>Ref. No.</b> 3188170 |
|   | solenoid coil 230V 50Hz Sigma   |                 |                         |
| <b>accessories for</b>  | 107241  |                 |                         |
|  | <b>GEV No.</b>  | 107222          | <b>Ref. No.</b> —       |
|   | plug for solenoid valve 3-pole cable length 1070mm  |                 |                         |



2

|   |  |                 |                         |
|---|--|-----------------|-------------------------|
| <b>GEV No.</b>  | 107547   | <b>Ref. No.</b> | 3011580                 |
| <b>description</b>  | gas valve type Sigma 230V 50Hz gas inlet 3/4" ET gas outlet 3/4" ET pressure range 2-50mbar equiv. no. 0063AS4831  |                 |                         |
| <b>For models:</b>  | 091FR1I, 091FR1IA, 091FR1ID, 091FR1ID-VERS.052012, 091FR1I-VERS.032012, 091FR7G, 091FR7G, 091FR7G-VERS.052012, 091FR7GX, 191FR2I, 191FR2ID, 191FR2ID-VERS.092012, 191FR2I-VERS.032012, FC1221G, FM1221G1, FM1221G1-VERS.2006, FM1221G2, FM1221G2-VERS.2006, FM1221G3, FM1221G3-VERS.2006 |                 |                         |
| <b>spare parts for</b>  | 107547   |                 |                         |
|  | <b>GEV No.</b>   | 106214          | <b>Ref. No.</b> 3188170 |
|   | solenoid coil 230V 50Hz Sigma  |                 |                         |
| <b>accessories for</b>  | 107547   |                 |                         |
|  | <b>GEV No.</b>   | 107222          | <b>Ref. No.</b> —       |
|   | plug for solenoid valve 3-pole cable length 1070mm   |                 |                         |

ignition boxes

BRAHMA



1

|                    |  |                 |         |
|--------------------|--|-----------------|---------|
| <b>GEV No.</b>     | 107545   | <b>Ref. No.</b> | 3128260 |
| <b>description</b> | ignition box BRAHMA type ECM113 electrodes 3 waiting time 1.5s safety time 3s 100-240V 15VA 50-60Hz  |                 |         |
| <b>For models:</b> | 091FR1I, 091FR1IA, 091FR1ID, 091FR1ID-VERS.052012, 091FR1I-VERS.032012, 091FR7G, 091FR7G, 091FR7G-VERS.052012, 091FR7GX, 10CP1IA, 12CP1IA, 18CP2IA, 191FR2I, 191FR2ID, 191FR2ID-VERS.092012, 191FR2I-VERS.032012 |                 |         |

miscellaneous



|                    |  |                 |                    |
|--------------------|--|-----------------|--------------------|
| <b>GEV No.</b>     | 103221   | <b>Ref. No.</b> | 32V5850<br>32V5851 |
| <b>description</b> | ignition box RV CONSTRUCTIONS ELECTRIQUES type 0526 waiting time 7s safety time 10s 230V 50/60Hz   |                 |                    |
| <b>For models:</b> | FC1011G, FC1221G, FC611G, FM1011G1, FM1011G1-VERS.2006, FM1011G2, FM1011G2-VERS.2006, FM1011G3, FM1011G3-VERS.2006, FM1221G1, FM1221G1-VERS.2006, FM1221G2, FM1221G2-VERS.2006, FM1221G3, FM1221G3-VERS.2006, FM2011G2-VERS.2006, FM2011G3-VERS.2006, FM2021G1, FM2021G2, FM2021G2-VERS.2006, FM2021G3, FM2021G3-VERS.2006, FM611G1, FM611G1-VERS.2006, FM611G2, FM611G2-VERS.2006, FM611G3, FM611G3-VERS.2006, FM721G1, FM721G1-VERS.2006, FM721G2, FM721G2-VERS.2006, FM721G3, FM721G3-VERS.2006 |                 |                    |

safety valves

SIT

440 series



|                        |   |                 |                 |   |
|------------------------|---|-----------------|-----------------|---|
| <b>GEV No.</b>         | 101101  | <b>Ref. No.</b> | 33A0430         |   |
| <b>description</b>     | gas valve pressure range 50mbar gas inlet 3/4" gas outlet 3/4" pilot connection M10x1 (tube ø 6mm) thermocouple connection M9x1 type SIT D3 |                 |                 |   |
| <b>accessories for</b> | 101101  |                 |                 |   |
|                        | <b>GEV No.</b>  | 100904          | <b>Ref. No.</b> | — |
|                        | locking screw M10x1 for pipe ø 4mm Qty 1 pcs  |                 |                 |   |
|                        | <b>GEV No.</b>  | 100905          | <b>Ref. No.</b> | — |
|                        | locking screw M10x1 for pipe ø 6mm Qty 1 pcs  |                 |                 |   |

Зип-Общепит

gas solenoid valves

BRAHMA  
vsezip.ru  
BRAHMA



|                        |   |                 |                 |   |
|------------------------|---|-----------------|-----------------|---|
| <b>GEV No.</b>         | 101948 <sup>1</sup>   | <b>Ref. No.</b> | 33A1650         |   |
| <b>description</b>     | solenoid valve 230VAC DN 15mm connection 1/2" L 72mm BRAHMA coil type 18811003 p max 0.5bar reg. no. 63AQ0626 |                 |                 |   |
| <b>For models:</b>     | 1A1PI2G, 1A1PI2GA, 1D1PI2G, 1D1PI2GA, 291PI3G, 2A1PI3G, 2D1PI3G   |                 |                 |   |
| <b>spare parts for</b> | 101948  |                 |                 |   |
|                        | <b>GEV No.</b>  | 101968          | <b>Ref. No.</b> | — |
|                        | solenoid valve 230VAC 20VA seat ø 17mm coil type 13902001 BRAHMA  |                 |                 |   |

<sup>1</sup>aluminium housing

ignition parts

pilot burners

SIT

100 series



|                        |   |                 |                    |         |
|------------------------|---|-----------------|--------------------|---------|
| <b>GEV No.</b>         | 106905  | <b>Ref. No.</b> | 33A0410<br>6000290 |         |
| <b>description</b>     | pilot burner SIT type 100 series 2 flames nozzle ø 0.2mm gas connection 6mm |                 |                    |         |
| <b>spare parts for</b> | 106905  |                 |                    |         |
|                        | <b>GEV No.</b>  | 100245          | <b>Ref. No.</b>    | —       |
|                        | pilot burner nozzle LPG code 20 bore ø 0.2mm Qty 1 pcs thread M8x0.75       |                 |                    |         |
|                        | <b>GEV No.</b>  | 100855          | <b>Ref. No.</b>    | 33S0950 |
|                        | pilot burner bracket triple   |                 |                    |         |
|                        | <b>GEV No.</b>  | 100885          | <b>Ref. No.</b>    | 33A0970 |
|                        | air mixing sleeve for pilot burner Qty 1 pcs                                |                 |                    |         |
|                        | <b>GEV No.</b>  | 100916          | <b>Ref. No.</b>    | —       |
|                        | compression spring for pilot burner Qty 1 pcs                               |                 |                    |         |
|                        | <b>GEV No.</b>  | 100917          | <b>Ref. No.</b>    | —       |
|                        | gasket for pilot burner Qty 1 pcs aluminium                                 |                 |                    |         |











Table continues overleaf













Зип-Общепит

vsezip.ru

+7(812)987-08-81

| spare parts for   |         | 106905 |                  |
|---|---------|--------|------------------|
|    | GEV No. | 100918 | Ref. No. —       |
| screw for pilot burner  |         |        |                  |
|    | GEV No. | 107161 | Ref. No. —       |
| pilot burner cap SIT 2 flames Hmm Lmm Qty 1 pcs                                     |         |        |                  |
|    | GEV No. | 107701 | Ref. No. —       |
| pilot burner bottom part SIT 100 series nozzle $\phi$ 0.2mm                         |         |        |                  |
| accessories for   |         | 106905 |                  |
|    | GEV No. | 100246 | Ref. No. 33T0410 |
| pilot burner nozzle natural gas bore $\phi$ 0.35mm Qty 1 pcs thread M8x0.75         |         |        |                  |
|    | GEV No. | 100904 | Ref. No. —       |
| locking screw M10x1 for pipe $\phi$ 4mm Qty 1 pcs                                   |         |        |                  |
|    | GEV No. | 100905 | Ref. No. —       |
| locking screw M10x1 for pipe $\phi$ 6mm Qty 1 pcs                                   |         |        |                  |
|    | GEV No. | 102110 | Ref. No. —       |
| pilot tube copper pipe $\phi$ 4mm thickness 1mm L 3000mm                            |         |        |                  |
|    | GEV No. | 102111 | Ref. No. —       |
| pilot tube copper pipe $\phi$ 6mm thickness 1mm L 3000mm                            |         |        |                  |
|    | GEV No. | 107171 | Ref. No. 33T0340 |
| pilot burner nozzle SIT natural/liquid gas bore $\phi$ 0.25mm Qty 1 pcs             |         |        |                  |
|  | GEV No. | 107700 | Ref. No. 33A0960 |
| pilot burner bottom part SIT 100 series nozzle $\phi$ 0.25mm                        |         |        |                  |
|  | GEV No. | 107702 | Ref. No. 33A2900 |
| pilot burner bottom part SIT 100 series nozzle $\phi$ 0.35mm                        |         |        |                  |

|  <p>1</p> |  |                 |                  |
|--|--|-----------------|------------------|
| <b>GEV No.</b>   | 106906   | <b>Ref. No.</b> | 6000350          |
| <b>description</b>   | pilot burner SIT type 100 series 3 flames nozzle $\phi$ 0.2mm gas connection 6mm |                 |                  |
| <b>For models:</b>   | 71AR, 91AR, FS30   |                 |                  |
| spare parts for  |  | 106906          |                  |
|           | GEV No.  | 100245          | Ref. No. —       |
| pilot burner nozzle LPG code 20 bore $\phi$ 0.2mm Qty 1 pcs thread M8x0.75                   |  |                 |                  |
|           | GEV No.  | 100855          | Ref. No. 33S0950 |
| pilot burner bracket triple  |  |                 |                  |
|           | GEV No.  | 100885          | Ref. No. 33A0970 |
| air mixing sleeve for pilot burner Qty 1 pcs   |  |                 |                  |
|           | GEV No.  | 100916          | Ref. No. —       |
| compression spring for pilot burner Qty 1 pcs  |  |                 |                  |

| spare parts for   |         | 106906 |                             |
|---|---------|--------|-----------------------------|
|    | GEV No. | 100917 | Ref. No. —                  |
| gasket for pilot burner Qty 1 pcs aluminium   |         |        |                             |
|    | GEV No. | 100918 | Ref. No. —                  |
| screw for pilot burner  |         |        |                             |
|    | GEV No. | 107162 | Ref. No. 33A1080<br>33A1081 |
| pilot burner cap SIT 3 flames Hmm Lmm Qty 1 pcs                                     |         |        |                             |
|    | GEV No. | 107701 | Ref. No. —                  |
| pilot burner bottom part SIT 100 series nozzle $\phi$ 0.2mm                         |         |        |                             |
| accessories for   |         | 106906 |                             |
|    | GEV No. | 100245 | Ref. No. —                  |
| pilot burner nozzle LPG code 20 bore $\phi$ 0.2mm Qty 1 pcs thread M8x0.75          |         |        |                             |
|    | GEV No. | 100246 | Ref. No. 33T0410            |
| pilot burner nozzle natural gas bore $\phi$ 0.35mm Qty 1 pcs thread M8x0.75         |         |        |                             |
|    | GEV No. | 100904 | Ref. No. —                  |
| locking screw M10x1 for pipe $\phi$ 4mm Qty 1 pcs                                   |         |        |                             |
|    | GEV No. | 100905 | Ref. No. —                  |
| locking screw M10x1 for pipe $\phi$ 6mm Qty 1 pcs                                   |         |        |                             |
|    | GEV No. | 102110 | Ref. No. —                  |
| pilot tube copper pipe $\phi$ 4mm thickness 1mm L 3000mm                            |         |        |                             |
|  | GEV No. | 102111 | Ref. No. —                  |
| pilot tube copper pipe $\phi$ 6mm thickness 1mm L 3000mm                            |         |        |                             |
|  | GEV No. | 107171 | Ref. No. 33T0340            |
| pilot burner nozzle SIT natural/liquid gas bore $\phi$ 0.25mm Qty 1 pcs             |         |        |                             |
|  | GEV No. | 107700 | Ref. No. 33A0960            |
| pilot burner bottom part SIT 100 series nozzle $\phi$ 0.25mm                        |         |        |                             |
|  | GEV No. | 107702 | Ref. No. 33A2900            |
| pilot burner bottom part SIT 100 series nozzle $\phi$ 0.35mm                        |         |        |                             |

accessories

pilot burner caps



|                    |  |                 |         |
|--------------------|--|-----------------|---------|
| <b>GEV No.</b>     | 100832   | <b>Ref. No.</b> | 33A1070 |
| <b>description</b> | pilot burner cap 1 flame suitable for 100 series Hmm Lmm Qty 1 pcs   |                 |         |
| <b>For models:</b> | 030, 031, 032, 070D, 070DGG, 0712D, 0712VA, 071D, 071DGG, 072D, 072DGG, 090, 090GG, 091, 091GG, 092, 092GG, 092VA, 092VAGG, 0A0FAS, 0B0FAS, 0D0FAS, 1A0FAS, 1A0FAS2, 1A1FAS2G, 1A1FASG, 1B0FAS, 1B0FAS2, 1B1FAS2G, 1B1FASG, 1D0FAS, 1D0FAS2, 1D1FAS2G, 1D1FASG, 2A0FAS2, 2A1FAS2G, 2A1FASG, 2A1TPSG, 2D0FAS2, 2D1FAS2G, 2D1FASG, 2D1TPSG, 31, 31GE, 31TC, 32, 32TC, 32TP, 32TPV, 32V...(Other models you can see in the webshop) |                 |         |



|                    |   |                 |         |
|--------------------|---|-----------------|---------|
| <b>GEV No.</b>     | 100835  | <b>Ref. No.</b> | 32Z2241 |
| <b>description</b> | pilot burner cap 3 flames suitable for 100 series H 35mm L 48mm Qty 1 pcs W 52mm  |                 |         |
| <b>For models:</b> | 090BM1G, 0A0BMG, 0A1FR1G, 0A1FR1GD, 0B1FR1G, 0B1FR1GD, 0D0BMG, 0D1FR1G, 0D1FR1GD, 190BM2G, 1A0BMG, 1A1FR2G, 1A1FR2GD, 1D0BMG, 1D1FR2G, 1D1FR2GD, 30CPS, 30F, 30F1, 30F1B, 30FS, 30FS2, 30FS2B, 60SM, 70CP, 70F, 70F1, 70F1B, 71CP, 71CP2, 71F, 71F2, 71F2B, 90CP, 90F110B, 91CP, 91F210, 91F210B, 91F223B |                 |         |



|                    |   |                 |                    |
|--------------------|---|-----------------|--------------------|
| <b>GEV No.</b>     | 107162  | <b>Ref. No.</b> | 33A1080<br>33A1081 |
| <b>description</b> | pilot burner cap SIT 3 flames Hmm Lmm Qty 1 pcs   |                 |                    |
| <b>For models:</b> | 030FT, 030FTR, 031FT, 031FT04, 031FT06, 031FTR, 031FTRL, 031TP, 06WCP1GM, 06WFR3GD, 070BM, 070FT, 070FT04, 070FT05, 070FTR, 0712VA, 071BM, 071FT, 071FT04, 071FT06, 071FTR, 071FTRL, 071TP, 08WCP1GM, 08WFA4G, 08WFAAG, 08WFT1GV, 08WFT2GV, 08WFT3GV, 08WFT4GV, 08WFT6GV, 08WFT7GV, 090BM, 090FAVA, 090FT, 090FT04, 090FT05, 090FT1G, 090FT2G, 090FT4G, 090FT5G, 090FT7G, 090FTR, 091BM, 091CP1G, 091FR1G, 091FR1GD, 091FR3G, 091FR3GD, 091FT...(Other models you can see in the webshop) |                 |                    |



|                    |   |                 |         |
|--------------------|---|-----------------|---------|
| <b>GEV No.</b>     | 107166  | <b>Ref. No.</b> | 33A0380 |
| <b>description</b> | pilot burner head SIT 1 flame Hmm Lmm Qty 1 pcs |                 |         |



|                    |  |                 |         |
|--------------------|--|-----------------|---------|
| <b>GEV No.</b>     | 100998   | <b>Ref. No.</b> | 33A0200 |
| <b>description</b> | pilot burner bottom part nozzle ø 0.21mm suitable for 100 series |                 |         |
| <b>For models:</b> | 030, 031, 032, 31, 31GE, 31TC, 32, 32TC, 32TP, 32TPV, 32V        |                 |         |



|                    |  |                 |         |
|--------------------|--|-----------------|---------|
| <b>GEV No.</b>     | 107700   | <b>Ref. No.</b> | 33A0960 |
| <b>description</b> | pilot burner bottom part SIT 100 series nozzle ø 0.25mm  |                 |         |
| <b>For models:</b> | 031FT04, 031FT06, 06WFR3GD, 070FT04, 070FT05, 071FT04, 071FT06, 08WCP1GM, 08WFT1GV, 08WFT2GV, 08WFT3GV, 08WFT4GV, 08WFT6GV, 08WFT7GV, 090FT04, 090FT05, 091FT04, 091FT06, 0A0FAVA, 0A1FR3G, 0A1FR3GD, 0D0FAVA, 0D1FR3G, 0D1FR3GD, 0G0FT1G, 0G0FT2G, 0G0FT4G, 0G0FT5G, 0G1CP1G, 0G1FR3G, 0G1FR3GD, 10WFR4GD, 1A1FR4G, 1A1FR4GD, 1D1FR4G, 1D1FR4GD, 1G0FT1G, 1G0FT2G, 1G0FT3G, 1G0FT4G, 1G0FT6G, 1G0TP0, 1G1BR1G, 1G1CP1G, 1G1CP2G, 1G1FA0G, 1G1FABG, 1G1FAPG, 1G1FR4G, 1G1FR4GD...(Other models you can see in the webshop) |                 |         |

|                        |   |        |                 |   |
|------------------------|---|--------|-----------------|---|
| <b>spare parts for</b> | 107700  |        |                 |   |
|                        | <b>GEV No.</b>  | 100916 | <b>Ref. No.</b> | — |
|                        | compression spring for pilot burner Qty 1 pcs           |        |                 |   |
|                        | <b>GEV No.</b>  | 100917 | <b>Ref. No.</b> | — |
|                        | gasket for pilot burner Qty 1 pcs aluminium             |        |                 |   |
|                        | <b>GEV No.</b>  | 100918 | <b>Ref. No.</b> | — |
|                        | screw for pilot burner                                  |        |                 |   |
|                        | <b>GEV No.</b>  | 102742 | <b>Ref. No.</b> | — |
|                        | pilot burner nozzle LPG code 25 bore ø 0.25mm Qty 1 pcs |        |                 |   |











|                        |  |        |                 |         |
|------------------------|--|--------|-----------------|---------|
| <b>accessories for</b> | 107700   |        |                 |         |
|                        | <b>GEV No.</b>   | 100245 | <b>Ref. No.</b> | —       |
|                        | pilot burner nozzle LPG code 20 bore ø 0.2mm Qty 1 pcs thread M8x0.75  |        |                 |         |
|                        | <b>GEV No.</b>   | 100246 | <b>Ref. No.</b> | 33T0410 |
|                        | pilot burner nozzle natural gas bore ø 0.35mm Qty 1 pcs thread M8x0.75 |        |                 |         |
|                        | <b>GEV No.</b>   | 100904 | <b>Ref. No.</b> | —       |
|                        | locking screw M10x1 for pipe ø 4mm Qty 1 pcs                           |        |                 |         |
|                        | <b>GEV No.</b>   | 100905 | <b>Ref. No.</b> | —       |
|                        | locking screw M10x1 for pipe ø 6mm Qty 1 pcs                           |        |                 |         |
|                        | <b>GEV No.</b>   | 102110 | <b>Ref. No.</b> | —       |
|                        | pilot tube copper pipe ø 4mm thickness 1mm L 3000mm                    |        |                 |         |
|                        | <b>GEV No.</b>   | 102111 | <b>Ref. No.</b> | —       |
|                        | pilot tube copper pipe ø 6mm thickness 1mm L 3000mm                    |        |                 |         |



Зип Общепит

vsezip.ru

+7(812)987-08-81





|  |  |                 |                         |
|--|--|-----------------|-------------------------|
|  <p>1</p> |  |                 |                         |
| <b>GEV No.</b>   | 107702   | <b>Ref. No.</b> | 33A2900                 |
| <b>description</b>   | pilot burner bottom part SIT 100 series nozzle $\varnothing$ 0.35mm  |                 |                         |
| <b>For models:</b>   | 030FT, 030FTR, 031FT, 031FTR, 031FTRL, 031TP, 070BM, 070D, 070DGG, 070FT, 070FTR, 0712D, 0712VA, 071BM, 071D, 071DGG, 071FT, 071FTR, 071FTRL, 071TP, 072D, 072DGG, 090, 090BM, 090FT, 090FTR, 090GG, 091, 091BM, 091FT, 091FTR, 091FTRL, 091GG, 091TP, 092, 092GG, 092VA, 092VAGG, 0A0BMG, 0A0FAS, 0A0FT1G, 0A0FT2G, 0A0FT4G, 0A0FT5G, 0A1FR1G, 0A1FR1GD, 0D0BMG, 0D0FAS, 0D0FT1G, 0D0FT2G...(Other models you can see in the webshop) |                 |                         |
| <b>spare parts for</b>   | 107702   |                 |                         |
|           | <b>GEV No.</b>   | 100246          | <b>Ref. No.</b> 33T0410 |
|  | pilot burner nozzle natural gas bore $\varnothing$ 0.35mm Qty 1 pcs thread M8x0.75   |                 |                         |
|           | <b>GEV No.</b>   | 100916          | <b>Ref. No.</b> —       |
|  | compression spring for pilot burner Qty 1 pcs  |                 |                         |
|           | <b>GEV No.</b>   | 100917          | <b>Ref. No.</b> —       |
|  | gasket for pilot burner Qty 1 pcs aluminium  |                 |                         |
|           | <b>GEV No.</b>   | 100918          | <b>Ref. No.</b> —       |
|  | screw for pilot burner   |                 |                         |
| <b>accessories for</b>   | 107702   |                 |                         |
|         | <b>GEV No.</b>   | 100245          | <b>Ref. No.</b> —       |
|  | pilot burner nozzle LPG code 20 bore $\varnothing$ 0.2mm Qty 1 pcs thread M8x0.75  |                 |                         |
|         | <b>GEV No.</b>   | 100904          | <b>Ref. No.</b> —       |
|  | locking screw M10x1 for pipe $\varnothing$ 4mm Qty 1 pcs   |                 |                         |
|         | <b>GEV No.</b>   | 100905          | <b>Ref. No.</b> —       |
|  | locking screw M10x1 for pipe $\varnothing$ 6mm Qty 1 pcs   |                 |                         |
|         | <b>GEV No.</b>   | 102110          | <b>Ref. No.</b> —       |
|  | pilot tube copper pipe $\varnothing$ 4mm thickness 1mm L 3000mm  |                 |                         |
|         | <b>GEV No.</b>   | 102111          | <b>Ref. No.</b> —       |
|  | pilot tube copper pipe $\varnothing$ 6mm thickness 1mm L 3000mm  |                 |                         |
|         | <b>GEV No.</b>   | 102742          | <b>Ref. No.</b> —       |
|  | pilot burner nozzle LPG code 25 bore $\varnothing$ 0.25mm Qty 1 pcs  |                 |                         |

|  |  |                 |         |
|--|--|-----------------|---------|
|  <p>1</p> |  |                 |         |
| <b>GEV No.</b>   | 100880   | <b>Ref. No.</b> | 33A0690 |
| <b>description</b>   | pilot burner bottom part SIT 100 series nozzle $\varnothing$ 0.4mm |                 |         |

|   |   |                 |         |
|---|---|-----------------|---------|
|  <p>1</p> |   |                 |         |
| <b>GEV No.</b>  | 100887  | <b>Ref. No.</b> | 33A0950 |
| <b>description</b>  | opposite support for pilot burner suitable for 100 series   |                 |         |
| <b>For models:</b>  | 030, 030FT, 030FTR, 031, 031FT, 031FTRL, 031FT04, 031FT06, 031FTR, 031FTRL, 031TP, 032, 06WCP1GM, 06WFR3GD, 070BM, 070D, 070DGG, 070FT, 070FT04, 070FT05, 070FTR, 0712D, 0712VA, 071BM, 071D, 071DGG, 071FT, 071FT04, 071FT06, 071FTR, 071FTRL, 071TP, 072D, 072DGG, 08WCP1GM, 08WFA4G, 08WFAAG, 08WFT1GV, 08WFT2GV, 08WFT3GV, 08WFT4GV, 08WFT6GV, 08WFT7GV, 090, 090BM, 090BM1G, 090FAVA, 090FT, 090FT04, 090FT05, 090FT1G...(Other models you can see in the webshop) |                 |         |

|   |   |                 |         |
|---|---|-----------------|---------|
|  <p>1</p> |   |                 |         |
| <b>GEV No.</b>  | 100894  | <b>Ref. No.</b> | 33A1100 |
| <b>description</b>  | opposite support for pilot burner suitable for 100 series |                 |         |

|  |   |                 |         |
|--|---|-----------------|---------|
|  <p>1</p> |   |                 |         |
| <b>GEV No.</b>   | 100886  | <b>Ref. No.</b> | 33A1000 |
| <b>description</b>   | pilot burner bracket suitable for 100 series 3-piece  |                 |         |
| <b>For models:</b>   | 030FT, 030FTR, 031FT, 031FTR, 031FTRL, 070BM, 070FT, 070FTR, 0712VA, 071BM, 071FT, 071FTR, 071FTRL, 071TP, 08WFA4G, 08WFAAG, 08WFT1GV, 08WFT2GV, 08WFT3GV, 08WFT4GV, 08WFT6GV, 08WFT7GV, 090BM, 090FAVA, 090FT, 090FTR, 091BM, 091FT, 091FTR, 091FTRL, 091TP, 092VA, 092VAGG, 0A0FAVA, 0D0FAVA, 10WTPGE, 10WTPGV, 12WFA6G, 12WFAAG, 190FAB, 190TPO, 191BR1G, 191BR1GA, 191BR2G, 191BR2GA, 191FAAG, 191FABG, 191FADG, 191TPG, 1A0FA2...(Other models you can see in the webshop) |                 |         |

|   |  |                 |                         |
|---|--|-----------------|-------------------------|
|  <p>1</p> |  |                 |                         |
| <b>GEV No.</b>  | 100855   | <b>Ref. No.</b> | 33S0950                 |
| <b>description</b>  | pilot burner bracket triple                          |                 |                         |
| <b>accessories for</b>  | 100855   |                 |                         |
|            | <b>GEV No.</b>                                       | 100855          | <b>Ref. No.</b> 33S0950 |
|   | pilot burner bracket triple                          |                 |                         |
|            | <b>GEV No.</b>                                       | 100886          | <b>Ref. No.</b> 33A1000 |
|   | pilot burner bracket suitable for 100 series 3-piece |                 |                         |
|            | <b>GEV No.</b>                                       | 100888          | <b>Ref. No.</b> 33A0980 |
|   | screw bolt for pilot burner                          |                 |                         |

1 gas components

Зип Общепит

vsezip.ru

+7(812)987-08-81

|   |  |                 |         |
|---|--|-----------------|---------|
|  |  |                 |         |
| 1   |  |                 |         |
| <b>GEV No.</b>  | 100888   | <b>Ref. No.</b> | 33A0980 |
| <b>description</b>  | screw bolt for pilot burner  |                 |         |
| <b>For models:</b>  | 030FT, 030FTR, 031FT, 031FTR, 031FTRL, 070BM, 070FT, 070FT04, 070FT05, 070FTR, 0712VA, 071BM, 071FT, 071FT04, 071FT06, 071FTR, 071FTRL, 071TP, 090BM, 090FT, 090FTR, 091BM, 091FT, 091FTR, 091FTRL, 091TP, 30F, 30FS, 31, 31PD6, 31PI6, 31R, 31TC, 31TP, 32, 32TC, 32TP, 32TPV, 32V, 60SM, 70F, 712D, 712VA, 71AR, 71D, 71DGG, 71F, 71PD10, 71PD15, 71PI10...(Other models you can see in the webshop) |                 |         |

|   |   |                 |         |
|---|---|-----------------|---------|
| producer-specific   |   |                 |         |
|  |   |                 |         |
| 1   |   |                 |         |
| <b>GEV No.</b>  | 100168  | <b>Ref. No.</b> | 35V9130 |
| <b>description</b>  | pilot burner bracket SIT type 100 series  |                 |         |
| <b>For models:</b>  | 030, 031, 031TP, 032, 070D, 070DGG, 0712D, 0712VA, 071D, 071DGG, 072D, 072DGG, 090, 090GG, 091, 091GG, 092, 092GG, 092VA, 092VAGG, 0A0FAS, 0B0FAS, 0D0FAS, 1A0FAS, 1A0FAS2, 1A1FAS2G, 1A1FASG, 1B0FAS, 1B0FAS2, 1B1FAS2G, 1B1FASG, 1D0FAS, 1D0FAS2, 1D1FAS2G, 1D1FASG, 2A0FAS2, 2A1FAS2G, 2A1FASG, 2A1TPSG, 2D0FAS2, 2D1FAS2G, 2D1FASG, 2D1TPSG, 31, 31GE, 31TC, 31TP, 32, 32TC, 32TP...(Other models you can see in the webshop) |                 |         |

|   |  |                 |                    |
|---|--|-----------------|--------------------|
|  |  |                 |                    |
| 1   |  |                 |                    |
| <b>GEV No.</b>  | 100169   | <b>Ref. No.</b> | 35S0690<br>35V9140 |
| <b>description</b>  | pilot burner bracket SIT type 100 series   |                 |                    |
| <b>For models:</b>  | 070D, 070DGG, 0712D, 0712VA, 071D, 071DGG, 072D, 072DGG, 090, 090GG, 091, 091GG, 092, 092GG, 092VA, 092VAGG, 0A0FAS, 0B0FAS, 0D0FAS, 1A0FAS, 1A0FAS2, 1A1FAS2G, 1A1FASG, 1B0FAS, 1B0FAS2, 1B1FAS2G, 1B1FASG, 1D0FAS, 1D0FAS2, 1D1FAS2G, 1D1FASG, 2A0FAS2, 2A1FAS2G, 2A1FASG, 2A1TPSG, 2D0FAS2, 2D1FAS2G, 2D1FASG, 2D1TPSG, 3A1FASG, 3D1FASG, 712D, 712VA, 71D, 71DGG, 71GE, 71GEGG, 72D, 72DGG, 72TP...(Other models you can see in the webshop) |                 |                    |

|   |   |                 |         |
|---|---|-----------------|---------|
|  |   |                 |         |
| 1   |   |                 |         |
| <b>GEV No.</b>  | 100184  | <b>Ref. No.</b> | 35V2570 |
| <b>description</b>  | pilot burner bracket SIT type 100 series  |                 |         |
| <b>For models:</b>  | 031FT04, 031FT06, 070FT04, 070FT05, 071FT04, 071FT06, 090FT04, 090FT05, 090FT1G, 090FT2G, 090FT4G, 090FT5G, 090FT7G, 091FT04, 091FT06, 0A0FT1G, 0A0FT2G, 0A0FT4G, 0A0FT5G, 0B0FT1G, 0B0FT2G, 0B0FT4G, 0B0FT5G, 0D0FT1G, 0D0FT2G, 0D0FT4G, 0D0FT5G, 0G0FT1G, 0G0FT1G-VERS.032008, 0G0FT2G, 0G0FT2G-VERS.032008, 0G0FT4G, 0G0FT4G-VERS.032008, 0G0FT5G, 0G0FT5G-VERS.032008, 0G0FT7G, 190FT15G, 190FT1G, 190FT2G, 190FT3G, 190FT42G, 190FT4G, 190FT6G, 190FT72G, 190FT7G, 1A0FT1G, 1A0FT2G, 1A0FT3G, 1A0FT4G, 1A0FT6G...(Other models you can see in the webshop) |                 |         |

|  |   |                 |         |
|--|---|-----------------|---------|
|  |   |                 |         |
| 1  |   |                 |         |
| <b>GEV No.</b>   | 100185  | <b>Ref. No.</b> | 35S5080 |
| <b>description</b>   | pilot burner bracket SIT type 100 series  |                 |         |
| <b>For models:</b>   | 30CPS, 30F1, 30F1B, 30FS2, 30FS2B, 70CP, 70F1, 70F1B, 71CP, 71CP2, 71F2, 71F2B, 90CP, 90F110B, 91CP, 91F210, 91F210B, 91F223B |                 |         |

|  |   |                 |         |
|--|---|-----------------|---------|
|  |   |                 |         |
| 1  |   |                 |         |
| <b>GEV No.</b>   | 100188  | <b>Ref. No.</b> | 35R3540 |
| <b>description</b>   | pilot burner bracket SIT type 100 series  |                 |         |
| <b>For models:</b>   | 0A1FR1G, 0A1FR1GD, 0B1FR1G, 0B1FR1GD, 0D1FR1G, 0D1FR1GD, 1A1FR2G, 1A1FR2GD, 1D1FR2G, 1D1FR2GD |                 |         |

|  |  |                 |         |
|--|--|-----------------|---------|
|  |  |                 |         |
| 1  |  |                 |         |
| <b>GEV No.</b>   | 100812   | <b>Ref. No.</b> | 35R0100 |
| <b>description</b>   | pilot burner bracket suitable for 100 series     |                 |         |
| <b>For models:</b>   | 71PD10, 71PD15, 71PI10, 71PI10A, 91PI10, 91PI10A |                 |         |

|  |  |                 |         |
|--|--|-----------------|---------|
|  |  |                 |         |
| 1  |  |                 |         |
| <b>GEV No.</b>   | 100850   | <b>Ref. No.</b> | 35R1460 |
| <b>description</b>   | pilot burner bracket suitable for 100 series   |                 |         |
| <b>For models:</b>   | 06WCP1GM, 08WCP1GM, 090BM1G, 091CP1G, 0A0BMG, 0D0BMG, 0G0FR5G, 0G1CP1G, 0G1CP1G-VERS.2004, 190BM2G, 191CP2G, 191PD2G, 191PI1G, 191PI1GA, 191PI2G, 191PI2GA, 1A0BMG, 1D0B-MG, 1G0FR6G, 1G0TP0, 1G1CP1G, 1G1CP1G-VERS.2004, 1G1CP2G, 1G1CP2G-VERS.2004, 1G1FA0G, 1G1FAPG, 1G1TP0G, 2G1FA0G, 2G1FADG, 2G1FADGV, 2G1FAPG, 2G1TP3G, G1FAGS, G1FAGST |                 |         |

|  |  |                 |         |
|--|--|-----------------|---------|
|  |  |                 |         |
| 1  |  |                 |         |
| <b>GEV No.</b>   | 102968                                       | <b>Ref. No.</b> | 35S0090 |
| <b>description</b>   | pilot burner bracket suitable for 100 series |                 |         |







Зип-Общепит

vsezip.ru

+7(812)987-08-81

| pilot burner nozzles  |  |                 |         |
|---|--|-----------------|---------|
|  |  |                 |         |
| <b>GEV No.</b>  | 100246   | <b>Ref. No.</b> | 33T0410 |
| <b>description</b>  | pilot burner nozzle natural gas bore $\varnothing$ 0.35mm Qty 1 pcs thread M8x0.75 |                 |         |
|  |  |                 |         |
| <b>GEV No.</b>  | 102972   | <b>Ref. No.</b> | 33T3130 |
| <b>description</b>  | pilot burner nozzle natural gas code 40 bore $\varnothing$ 0.4mm Qty 1 pcs         |                 |         |

| ignition electrodes   |   |                 |         |
|---|---|-----------------|---------|
|  |   |                 |         |
| <b>GEV No.</b>  | 100706  | <b>Ref. No.</b> | 32T0320 |
| <b>description</b>  | ignition electrode connection M4 Qty 1 pcs  |                 |         |
| <b>For models:</b>  | 191CP1GA, 1A1CP1GA, 1A1PI2G, 1A1PI2GA, 1D1CP1GA, 1D1PI2G, 1D1PI2GA, 291PD3G, 291PI3G, 2A1PD3G, 2A1PI3G, 2D1PI3G |                 |         |

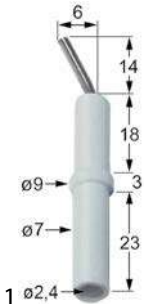
|   |  |                 |         |
|---|--|-----------------|---------|
|  |  |                 |         |
| <b>GEV No.</b>  | 100707   | <b>Ref. No.</b> | 3232960 |
| <b>description</b>  | ignition electrode D1 $\varnothing$ 7mm D2 $\varnothing$ 9mm connection $\varnothing$ 2.4mm L1 14mm L2 6mm L3 18mm L4 3mm L5 23mm to clip Qty 1 pcs  |                 |         |
| <b>For models:</b>  | 06WCP1GM, 08WCP1GM, 08WFA4G, 08WFAAG, 090BM1G, 090FAVA, 090FT1G, 090FT2G, 090FT4G, 090FT5G, 090FT7G, 091CP1G, 091FR1G, 091FR1GD, 091FR3G, 091FR3GD, 0G0FT1G-VERS.032008, 0G0FT2G-VERS.032008, 0G0FT4G-VERS.032008, 0G0FT5G-VERS.032008, 0G0FT7G, 0G1CP1G-VERS.2004, 0G1FR3G, 0G1FR3GD, 0G1FR7G, 10WTPGE, 10WTPGV, 12WFA6G, 12WFAAG, 190BM2G, 190FAB, 190FT15G, 190FT1G, 190FT2G, 190FT3G, 190FT42G, 190FT4G, 190FT6G, 190FT72G, 190FT7G, 190TP0, 191BR1G, 191BR1GA, 191BR2G, 191BR2GA, 191CP2G, 191FAAG, 191FABG, 191FADG, 191FR2G...(Other models you can see in the webshop) |                 |         |

|   |   |                 |         |
|---|---|-----------------|---------|
|  |   |                 |         |
| <b>GEV No.</b>  | 100885  | <b>Ref. No.</b> | 33A0970 |
| <b>description</b>  | air mixing sleeve for pilot burner Qty 1 pcs  |                 |         |
| <b>For models:</b>  | 030, 030FT, 030FTR, 031, 031FT, 031FT04, 031FT06, 031FTR, 031FTRL, 031TP, 032, 06WCP1GM, 06WFR3GD, 070BM, 070D, 070DGG, 070FT, 070FT04, 070FT05, 070FTR, 0712D, 0712VA, 071BM, 071D, 071DGG, 071FT, 071FT04, 071FT06, 071FTR, 071FTRL, 071TP, 072D, 072DGG, 08WCP1GM, 08WFA4G, 08WFAAG, 08WFT1GV, 08WFT2GV, 08WFT-3GV, 08WFT4GV, 08WFT6GV, 08WFT7GV, 090, 090BM, 090BM1G, 090FAVA, 090FT, 090FT04, 090FT05, 090FT1G...(Other models you can see in the webshop) |                 |         |







| 160 series  |   |   |                 |
|---|---|---|-----------------|
|   |   |   |                 |
| <b>GEV No.</b>  | 100109  | <b>Ref. No.</b>   | 33A1630         |
| <b>description</b>  | pilot burner SIT type 160 series 1 flame nozzle $\varnothing$ mm gas connectionmm |   |                 |
| <b>For models:</b>  | 08WGRGV, 090GRG, 0A0GRG, 0D0GRG, 190GRG, 1A0GRG, 1D0GRG, 1G0GRG, 6042120-08WGRGV  |   |                 |
| <b>spare parts for</b>  | 100109  |   |                 |
|   | <b>GEV No.</b>  | 100907  | <b>Ref. No.</b> |
|   |   |   | —               |
|   |   | screw connection thread M10x1 Qty 1 pcs type SEF 1 $\varnothing$ mm for thermocouple                  |                 |
| <b>accessories for</b>  | 100109  |   |                 |
|  | <b>GEV No.</b>  | 100202  | <b>Ref. No.</b> |
|   |   |   | —               |
|   |   | pilot burner nozzle natural gas code 41 Qty 1 pcs nozzle $\varnothing$ 0.41mm                         |                 |
|  | <b>GEV No.</b>  | 100203  | <b>Ref. No.</b> |
|   |   |   | —               |
|   |   | pilot burner nozzle LPG code 25 Qty 1 pcs nozzle $\varnothing$ 0.25mm                                 |                 |
|  | <b>GEV No.</b>  | 100701  | <b>Ref. No.</b> |
|   |   |   | 32T0190         |
|   |   | ignition electrode connection M4 Qty 1 pcs  |                 |
|  | <b>GEV No.</b>  | 100801  | <b>Ref. No.</b> |
|   |   |   | —               |
|   |   | gasket for pilot burner Qty 1 pcs   |                 |
|  | <b>GEV No.</b>  | 100869  | <b>Ref. No.</b> |
|   |   |   | —               |
|   |   | pilot burner nozzle natural gas code 51 Qty 1 pcs suitable for 160 series nozzle $\varnothing$ 0.51mm |                 |
|  | <b>GEV No.</b>  | 100906  | <b>Ref. No.</b> |
|   |   |   | 36Q1050         |
|   |   | screw connection thread M10x1 for ignition electrode brass Qty 1 pcs WS 10                            |                 |
|  | <b>GEV No.</b>  | 100908  | <b>Ref. No.</b> |
|   |   |   | 36Q1000         |
|   |   | union screw thread M10x1 for pipe $\varnothing$ 4mm Qty 1 pcs   |                 |
|  | <b>GEV No.</b>  | 100909  | <b>Ref. No.</b> |
|   |   |   | 36Q0060         |
|   |   | union screw thread M10x1 for pipe $\varnothing$ 6mm Qty 1 pcs   |                 |
|  | <b>GEV No.</b>  | 101282  | <b>Ref. No.</b> |
|   |   |   | —               |
|   |   | olive for pipe $\varnothing$ 4mm L 7.4mm Qty 1 pcs  |                 |
|  | <b>GEV No.</b>  | 101287  | <b>Ref. No.</b> |
|   |   |   | 36Q0150         |
|   |   | olive for pipe $\varnothing$ 6mm Qty 1 pcs  |                 |

Table continues overleaf













Зип-Общепит

vsezip.ru

+7(812)987-08-81















|   |  |        |          |         |
|---|--|--------|----------|---------|
| <b>accessories for</b>  | 100109   |        |          |         |
|   | GEV No.  | 102110 | Ref. No. | —       |
|  | pilot tube copper pipe ø4mm thickness 1mm L 3000mm |        |          |         |
|   | GEV No.  | 102111 | Ref. No. | —       |
|  | pilot tube copper pipe ø6mm thickness 1mm L 3000mm |        |          |         |
|  | GEV No.  | 107650 | Ref. No. | 33T3310 |
|   | pilot burner nozzle SIT LPG code 30 Qty 1 pcs      |        |          |         |



|   |   |                 |          |         |
|---|---|-----------------|----------|---------|
| <b>GEV No.</b>  | 100053  | <b>Ref. No.</b> | 33A0750  |         |
| <b>description</b>  | pilot burner SIT type 160 series 2 flames nozzle ømm gas connectionmm                     |                 |          |         |
| <b>For models:</b>  | 1A1PD1G, 1A1PD2G, 1A1P1G, 1A1P1GA, 1D1PD1G, 1D1PD2G, 1D1P1G, 1D1P1GA                      |                 |          |         |
| <b>spare parts for</b>  | 100053  |                 |          |         |
|    | GEV No.   | 100907          | Ref. No. | —       |
|   | screw connection thread M10x1 Qty 1 pcs type SEF 1 ømm for thermocouple                   |                 |          |         |
| <b>accessories for</b>  | 100053  |                 |          |         |
|   | GEV No.   | 100202          | Ref. No. | —       |
|   | pilot burner nozzle natural gas code 41 Qty 1 pcs nozzle ø 0.41mm                         |                 |          |         |
|  | GEV No.   | 100203          | Ref. No. | —       |
|   | pilot burner nozzle LPG code 25 Qty 1 pcs nozzle ø 0.25mm                                 |                 |          |         |
|  | GEV No.   | 100701          | Ref. No. | 32T0190 |
|   | ignition electrode connection M4 Qty 1 pcs  |                 |          |         |
|  | GEV No.   | 100801          | Ref. No. | —       |
|   | gasket for pilot burner Qty 1 pcs   |                 |          |         |
|  | GEV No.   | 100869          | Ref. No. | —       |
|   | pilot burner nozzle natural gas code 51 Qty 1 pcs suitable for 160 series nozzle ø 0.51mm |                 |          |         |
|  | GEV No.   | 100906          | Ref. No. | 36Q1050 |
|   | screw connection thread M10x1 for ignition electrode brass Qty 1 pcs WS 10                |                 |          |         |
|  | GEV No.   | 100908          | Ref. No. | 36Q1000 |
|   | union screw thread M10x1 for pipe ø4mm Qty 1 pcs  |                 |          |         |
|  | GEV No.   | 100909          | Ref. No. | 36Q0060 |
|   | union screw thread M10x1 for pipe ø6mm Qty 1 pcs  |                 |          |         |
|  | GEV No.   | 101282          | Ref. No. | —       |
|   | olive for pipe ø4mm L 7.4mm Qty 1 pcs   |                 |          |         |
|  | GEV No.   | 101287          | Ref. No. | 36Q0150 |
|   | olive for pipe ø6mm Qty 1 pcs   |                 |          |         |
|  | GEV No.   | 102110          | Ref. No. | —       |
|   | pilot tube copper pipe ø4mm thickness 1mm L 3000mm  |                 |          |         |
|  | GEV No.   | 102111          | Ref. No. | —       |
|   | pilot tube copper pipe ø6mm thickness 1mm L 3000mm  |                 |          |         |

|   |   |        |          |         |
|---|---|--------|----------|---------|
| <b>accessories for</b>  | 100053  |        |          |         |
|  | GEV No.                                       | 107650 | Ref. No. | 33T3310 |
|   | pilot burner nozzle SIT LPG code 30 Qty 1 pcs |        |          |         |



|   |   |                 |          |         |
|---|---|-----------------|----------|---------|
| <b>GEV No.</b>  | 100054  | <b>Ref. No.</b> | 33A0880  |         |
| <b>description</b>  | pilot burner SIT type 160 series 2 flames nozzle ømm gas connectionmm                     |                 |          |         |
| <b>For models:</b>  | 0A1CP1G, 0B1CP1G, 0D1CP1G, 191CP1G, 1A1CP1G, 1A1CP2G, 1D1CP1G, 1D1CP2G                    |                 |          |         |
| <b>spare parts for</b>  | 100054  |                 |          |         |
|    | GEV No.   | 100907          | Ref. No. | —       |
|   | screw connection thread M10x1 Qty 1 pcs type SEF 1 ømm for thermocouple                   |                 |          |         |
| <b>accessories for</b>  | 100054  |                 |          |         |
|    | GEV No.   | 100202          | Ref. No. | —       |
|   | pilot burner nozzle natural gas code 41 Qty 1 pcs nozzle ø 0.41mm                         |                 |          |         |
|    | GEV No.   | 100203          | Ref. No. | —       |
|   | pilot burner nozzle LPG code 25 Qty 1 pcs nozzle ø 0.25mm                                 |                 |          |         |
|   | GEV No.   | 100701          | Ref. No. | 32T0190 |
|   | ignition electrode connection M4 Qty 1 pcs  |                 |          |         |
|  | GEV No.   | 100801          | Ref. No. | —       |
|   | gasket for pilot burner Qty 1 pcs   |                 |          |         |
|  | GEV No.   | 100869          | Ref. No. | —       |
|   | pilot burner nozzle natural gas code 51 Qty 1 pcs suitable for 160 series nozzle ø 0.51mm |                 |          |         |
|  | GEV No.   | 100906          | Ref. No. | 36Q1050 |
|   | screw connection thread M10x1 for ignition electrode brass Qty 1 pcs WS 10                |                 |          |         |
|  | GEV No.   | 100908          | Ref. No. | 36Q1000 |
|   | union screw thread M10x1 for pipe ø4mm Qty 1 pcs  |                 |          |         |
|  | GEV No.   | 100909          | Ref. No. | 36Q0060 |
|   | union screw thread M10x1 for pipe ø6mm Qty 1 pcs  |                 |          |         |
|  | GEV No.   | 101282          | Ref. No. | —       |
|   | olive for pipe ø4mm L 7.4mm Qty 1 pcs   |                 |          |         |
|  | GEV No.   | 101287          | Ref. No. | 36Q0150 |
|   | olive for pipe ø6mm Qty 1 pcs   |                 |          |         |
|  | GEV No.   | 102110          | Ref. No. | —       |
|   | pilot tube copper pipe ø4mm thickness 1mm L 3000mm  |                 |          |         |
|  | GEV No.   | 102111          | Ref. No. | —       |
|   | pilot tube copper pipe ø6mm thickness 1mm L 3000mm  |                 |          |         |
|  | GEV No.   | 107650          | Ref. No. | 33T3310 |
|   | pilot burner nozzle SIT LPG code 30 Qty 1 pcs   |                 |          |         |



Зип Общежит

vsezip.ru

+7(812)987-08-81

| JUNKERS   |  |                 |                         |
|---|--|-----------------|-------------------------|
| CB 503 series   |  |                 |                         |
| pilot burners   |  |                 |                         |
|    |  |                 |                         |
| <b>GEV No.</b>  | 100058   | <b>Ref. No.</b> | 33A0470                 |
| <b>description</b>  | pilot burner JUNKERS type CB503006 natural gas nozzle no.26 gas connection 4mm                     |                 |                         |
| <b>spare parts for</b>  | 100058   |                 |                         |
|    | <b>GEV No.</b>   | 100224          | <b>Ref. No.</b> 33T0560 |
|   | pilot burner nozzle natural gas gas pressure 25mbar code 26 Qty 1 pcs suitable for JUNKERS CB503_  |                 |                         |
|    | <b>GEV No.</b>   | 101281          | <b>Ref. No.</b> —       |
|   | olive for pipe ø 4mm L 8.7mm Qty 1 pcs suitable for CB 502/503                                     |                 |                         |
|    | <b>GEV No.</b>   | 101283          | <b>Ref. No.</b> —       |
|   | union screw thread M10x1 for pipe ø 4mm Qty 1 pcs  |                 |                         |
| <b>accessories for</b>  | 100058   |                 |                         |
|   | <b>GEV No.</b>   | 100220          | <b>Ref. No.</b> 33T0540 |
|   | pilot burner nozzle LPG gas pressure 50mbar code 2 Qty 1 pcs suitable for JUNKERS CB503_           |                 |                         |
|  | <b>GEV No.</b>   | 100221          | <b>Ref. No.</b> —       |
|   | pilot burner nozzle LPG gas pressure 30mbar code 29 Qty 1 pcs suitable for JUNKERS CB50203_        |                 |                         |
|  | <b>GEV No.</b>   | 100222          | <b>Ref. No.</b> —       |
|   | pilot burner nozzle LPG gas pressure 50mbar code 5 Qty 1 pcs suitable for JUNKERS CB50203_         |                 |                         |
|  | <b>GEV No.</b>   | 100223          | <b>Ref. No.</b> —       |
|   | pilot burner nozzle natural gas gas pressure 20mbar code 3 Qty 1 pcs suitable for JUNKERS CB503_   |                 |                         |
|  | <b>GEV No.</b>   | 100226          | <b>Ref. No.</b> —       |
|   | pilot burner nozzle LPG gas pressure 50mbar code 15 suitable for JUNKERS                           |                 |                         |
|  | <b>GEV No.</b>   | 100227          | <b>Ref. No.</b> —       |
|   | pilot burner nozzle natural gas gas pressure 25mbar code 6 Qty 1 pcs suitable for JUNKERS CB50203_ |                 |                         |
|  | <b>GEV No.</b>   | 100909          | <b>Ref. No.</b> 36Q0060 |
|   | union screw thread M10x1 for pipe ø 6mm Qty 1 pcs  |                 |                         |
|  | <b>GEV No.</b>   | 101287          | <b>Ref. No.</b> 36Q0150 |
|   | olive for pipe ø 6mm Qty 1 pcs   |                 |                         |
|  | <b>GEV No.</b>   | 102110          | <b>Ref. No.</b> —       |
|   | pilot tube copper pipe ø 4mm thickness 1mm L 3000mm  |                 |                         |
|  | <b>GEV No.</b>   | 102111          | <b>Ref. No.</b> —       |
|   | pilot tube copper pipe ø 6mm thickness 1mm L 3000mm  |                 |                         |















| ANGELO PO   |  |                 |                         |
|---|--|-----------------|-------------------------|
| pilot burners   |  |                 |                         |
|   |  |                 |                         |
| <b>GEV No.</b>  | 100187   | <b>Ref. No.</b> | 6000280                 |
| <b>description</b>  | pilot burner SIT type 100 series 3 flames nozzle ø 0.25mm gas connectionmm       |                 |                         |
| <b>For models:</b>  | 30F, 30FS, 70F, 71F  |                 |                         |
| <b>spare parts for</b>  | 100187   |                 |                         |
|    | <b>GEV No.</b>   | 100835          | <b>Ref. No.</b> 32Z2241 |
|   | pilot burner cap 3 flames suitable for 100 series H 35mm L 48mm Qty 1 pcs W 52mm |                 |                         |
|    | <b>GEV No.</b>   | 100855          | <b>Ref. No.</b> 33S0950 |
|   | pilot burner bracket triple  |                 |                         |
|   | <b>GEV No.</b>   | 100882          | <b>Ref. No.</b> —       |
|   | pilot burner bottom part PRO-GAS 100 series nozzle ø 0.25mm                      |                 |                         |
|  | <b>GEV No.</b>   | 100885          | <b>Ref. No.</b> 33A0970 |
|   | air mixing sleeve for pilot burner Qty 1 pcs                                     |                 |                         |
|  | <b>GEV No.</b>   | 100916          | <b>Ref. No.</b> —       |
|   | compression spring for pilot burner Qty 1 pcs                                    |                 |                         |
|  | <b>GEV No.</b>   | 100917          | <b>Ref. No.</b> —       |
|   | gasket for pilot burner Qty 1 pcs aluminium                                      |                 |                         |
|  | <b>GEV No.</b>   | 100918          | <b>Ref. No.</b> —       |
|   | screw for pilot burner   |                 |                         |
|  | <b>GEV No.</b>   | 102742          | <b>Ref. No.</b> —       |
|   | pilot burner nozzle LPG code 25 bore ø 0.25mm Qty 1 pcs                          |                 |                         |
| <b>accessories for</b>  | 100187   |                 |                         |
|  | <b>GEV No.</b>   | 100245          | <b>Ref. No.</b> —       |
|   | pilot burner nozzle LPG code 20 bore ø 0.2mm Qty 1 pcs thread M8x0.75            |                 |                         |
|  | <b>GEV No.</b>   | 100246          | <b>Ref. No.</b> 33T0410 |
|   | pilot burner nozzle natural gas bore ø 0.35mm Qty 1 pcs thread M8x0.75           |                 |                         |
|  | <b>GEV No.</b>   | 100881          | <b>Ref. No.</b> —       |
|   | pilot burner bottom part PRO-GAS 100 series nozzle ø 0.2mm                       |                 |                         |
|  | <b>GEV No.</b>   | 100883          | <b>Ref. No.</b> —       |
|   | pilot burner bottom part PRO-GAS 100 series nozzle ø 0.35mm                      |                 |                         |
|  | <b>GEV No.</b>   | 100904          | <b>Ref. No.</b> —       |
|   | locking screw M10x1 for pipe ø 4mm Qty 1 pcs                                     |                 |                         |

Table continues overleaf

1 gas components

Зип-Общепит

vsezip.ru

+7(812)987-08-81

|   |  |        |          |   |
|---|--|--------|----------|---|
| <b>accessories for</b>  | 100187                                       |        |          |   |
|  | GEV No.                                      | 100905 | Ref. No. | — |
|   | locking screw M10x1 for pipe ø 6mm Qty 1 pcs |        |          |   |

Combi / Major series



|                |        |                 |         |
|----------------|--------|-----------------|---------|
| <b>GEV No.</b> | 100065 | <b>Ref. No.</b> | 6000170 |
|----------------|--------|-----------------|---------|

**description** pilot burner 1 flame gas connectionmm without nozzle

**spare parts for** 100065

|   |                             |        |          |   |
|---|-----------------------------|--------|----------|---|
|  | GEV No.                     | 100831 | Ref. No. | — |
|   | pilot burner head Qty 1 pcs |        |          |   |

**accessories for** 100065

|   |   |        |          |         |
|---|---|--------|----------|---------|
|  | GEV No.   | 100240 | Ref. No. | 33T0240 |
|   | pilot burner nozzle LPG code 39 gas pressure 30mbar brass |        |          |         |

|  |  |        |          |         |
|--|--|--------|----------|---------|
|  | GEV No.  | 100241 | Ref. No. | 33T0050 |
|  | pilot burner nozzle natural gas code 13 gas pressure 25mbar bore ø 0.4mm Qty 1 pcs brass |        |          |         |

|   |   |        |          |         |
|---|---|--------|----------|---------|
|  | GEV No.   | 100909 | Ref. No. | 36Q0060 |
|   | union screw thread M10x1 for pipe ø 6mm Qty 1 pcs |        |          |         |

|   |  |        |          |   |
|---|--|--------|----------|---|
|  | GEV No.                                | 101282 | Ref. No. | — |
|   | olive for pipe ø 4mm L 7.4mm Qty 1 pcs |        |          |   |

|   |   |        |          |   |
|---|---|--------|----------|---|
|  | GEV No.   | 101283 | Ref. No. | — |
|   | union screw thread M10x1 for pipe ø 4mm Qty 1 pcs |        |          |   |

|   |   |        |          |   |
|---|---|--------|----------|---|
|  | GEV No.   | 101288 | Ref. No. | — |
|   | olive for pipe ø 6mm L 6mm aluminium Qty 1 pcs ED ø 8.5mm |        |          |   |

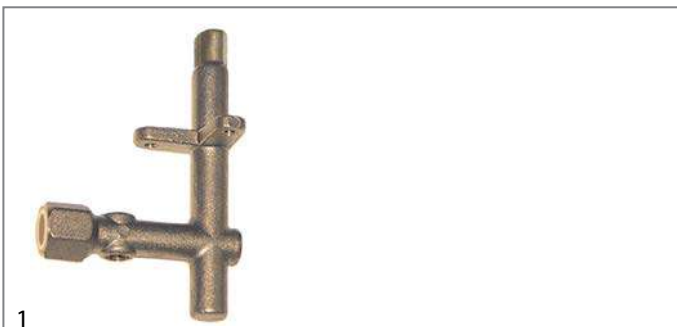







|                |        |                 |         |
|----------------|--------|-----------------|---------|
| <b>GEV No.</b> | 101777 | <b>Ref. No.</b> | 34A0010 |
|----------------|--------|-----------------|---------|

**description** pilot burner gas connectionmm without nozzle

**accessories for** 101777

|   |   |        |          |         |
|---|---|--------|----------|---------|
|  | GEV No.   | 100240 | Ref. No. | 33T0240 |
|   | pilot burner nozzle LPG code 39 gas pressure 30mbar brass |        |          |         |

|   |  |        |          |         |
|---|--|--------|----------|---------|
|  | GEV No.  | 100241 | Ref. No. | 33T0050 |
|   | pilot burner nozzle natural gas code 13 gas pressure 25mbar bore ø 0.4mm Qty 1 pcs brass |        |          |         |

|   |   |        |          |         |
|---|---|--------|----------|---------|
| <b>accessories for</b>  | 101777  |        |          |         |
|  | GEV No.   | 100831 | Ref. No. | —       |
|   | pilot burner head Qty 1 pcs                               |        |          |         |
|  | GEV No.   | 100909 | Ref. No. | 36Q0060 |
|   | union screw thread M10x1 for pipe ø 6mm Qty 1 pcs         |        |          |         |
|  | GEV No.   | 101282 | Ref. No. | —       |
|   | olive for pipe ø 4mm L 7.4mm Qty 1 pcs                    |        |          |         |
|  | GEV No.   | 101283 | Ref. No. | —       |
|   | union screw thread M10x1 for pipe ø 4mm Qty 1 pcs         |        |          |         |
|  | GEV No.   | 101288 | Ref. No. | —       |
|   | olive for pipe ø 6mm L 6mm aluminium Qty 1 pcs ED ø 8.5mm |        |          |         |

new series



|                |        |                 |     |
|----------------|--------|-----------------|-----|
| <b>GEV No.</b> | 107541 | <b>Ref. No.</b> | N/A |
|----------------|--------|-----------------|-----|

**description** pilot burner 2 flames gas connection 4/6mm without nozzle

**accessories for** 107541

|   |   |        |          |         |
|---|---|--------|----------|---------|
|  | GEV No.   | 100240 | Ref. No. | 33T0240 |
|   | pilot burner nozzle LPG code 39 gas pressure 30mbar brass |        |          |         |

|   |  |        |          |         |
|---|--|--------|----------|---------|
|  | GEV No.  | 100241 | Ref. No. | 33T0050 |
|   | pilot burner nozzle natural gas code 13 gas pressure 25mbar bore ø 0.4mm Qty 1 pcs brass |        |          |         |

miscellaneous



|                |        |                 |         |
|----------------|--------|-----------------|---------|
| <b>GEV No.</b> | 104299 | <b>Ref. No.</b> | 3060930 |
|----------------|--------|-----------------|---------|

**description** pilot burner

**For models:** 190FA, 190FAD, 191FADG, 191FAE, 191FAG, 290FA, 291FAG, 291FAGF, 391FAG



electrodes

Зип Общепит

vsezip.ru

+7(812)987-08-81

1 gas components

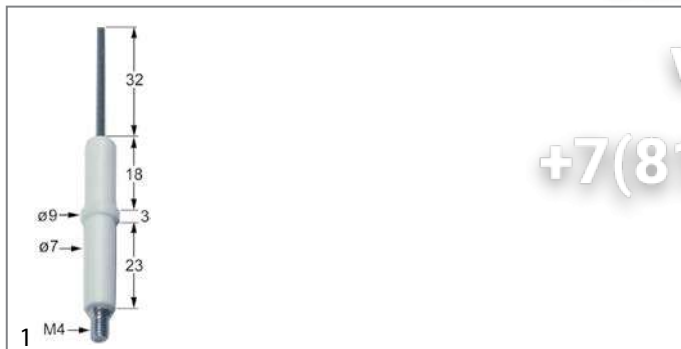

|   |  |                 |                         |
|---|--|-----------------|-------------------------|
| <b>GEV No.</b>  | 100701   | <b>Ref. No.</b> | 32T0190                 |
| <b>description</b>  | ignition electrode connection M4 Qty 1 pcs   |                 |                         |
| <b>For models:</b>  | 08WGRGV, 090GRG, 0A0GRG, 0A1CP1G, 0B1CP1G, 0D0GRG, 0D1CP1G, 190GRG, 191CP1G, 1A0GRG, 1A1CP1G, 1A1CP2G, 1A1PD1G, 1A1PD2G, 1A1PI1G, 1A1PI1GA, 1D0GRG, 1D1CP1G, 1D1CP2G, 1D1PD1G, 1D1PD2G, 1D1PI1G, 1D1PI1GA, 1G0GRG, 6042120-08WGRGV |                 |                         |
| <b>accessories for</b>  | 100701   |                 |                         |
|  | <b>GEV No.</b>   | 100906          | <b>Ref. No.</b> 36Q1050 |
|   | screw connection thread M10x1 for ignition electrode brass Qty 1 pcs WS 10   |                 |                         |

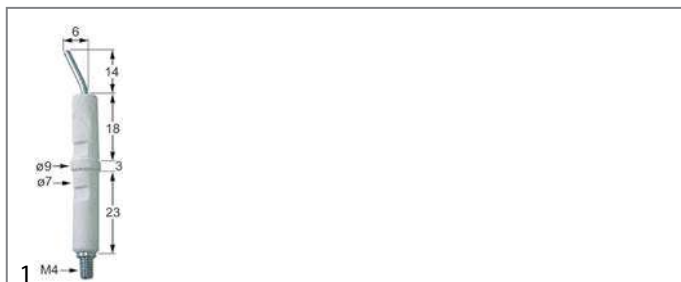

|                    |   |                 |         |
|--------------------|---|-----------------|---------|
| <b>GEV No.</b>     | 100706  | <b>Ref. No.</b> | 32T0320 |
| <b>description</b> | ignition electrode connection M4 Qty 1 pcs  |                 |         |
| <b>For models:</b> | 191CP1GA, 1A1CP1GA, 1A1PI2G, 1A1PI2GA, 1D1CP1GA, 1D1PI2G, 1D1PI2GA, 291PD3G, 291PI3G, 2A1PD3G, 2A1PI3G, 2D1PI3G |                 |         |

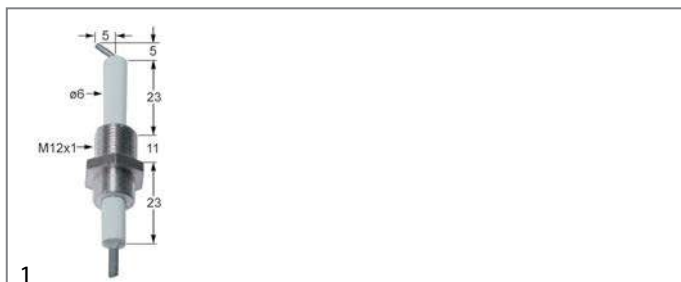

|                    |   |                 |         |
|--------------------|---|-----------------|---------|
| <b>GEV No.</b>     | 100712  | <b>Ref. No.</b> | 32T0080 |
| <b>description</b> | ignition electrode D1 ø 6mm L1 5mm L2 5mm BL1 23mm BL2 11mm BL3 23mm connection F 2.8x0.8mm M12x1 |                 |         |

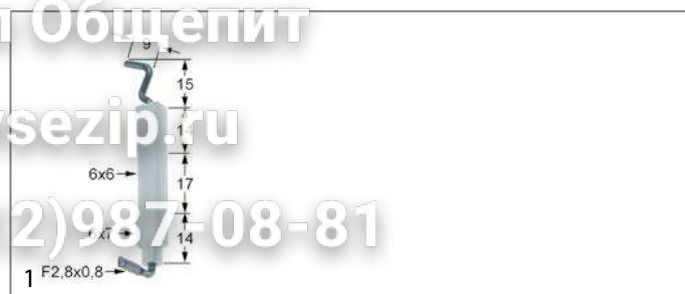

|                    |   |                 |                    |
|--------------------|---|-----------------|--------------------|
| <b>GEV No.</b>     | 100736  | <b>Ref. No.</b> | 32T0141<br>32T0142 |
| <b>description</b> | ignition electrode D1 ø 6x7mm connection F 2.8x0.8mm BL1 14mm BL2 16mm BL3 14mm   |                 |                    |
| <b>For models:</b> | 030FT, 030FTR, 031FT, 031FT04, 031FT06, 031FTR, 031FTRL, 031TP, 06WCP1GM, 06WFR3GD, 070BM, 070FT, 070FT04, 070FT05, 070FTR, 0712VA, 071BM, 071FT, 071FT04, 071FT06, 071FTR, 071FTRL, 071TP, 08WCP1GM, 08WFAAG, 08WFT1GV, 08WFT2GV, 08WFT3GV, 08WFT4GV, 08WFT6GV, 08WFT7GV, 090BM, 090FAVA, 090FT, 090FT04, 090FT05, 090FT1G, 090FT2G, 090FT4G, 090FT5G, 090FT7G, 090FTR, 091BM, 091CP1G, 091FR1G, 091FR1GD, 091FR3G, 091FR3GD, 091FT, 091FT04...(Other models you can see in the webshop) |                 |                    |



|                    |   |                 |                    |
|--------------------|---|-----------------|--------------------|
| <b>GEV No.</b>     | 100798  | <b>Ref. No.</b> | 32T0010<br>32T0060 |
| <b>description</b> | ignition electrode D1 ø 6x7mm connection F 2.8x0.8mm D2 ø 6x6mm L1 15mm L2 10mm BL1 14mm BL2 17mm BL3 14mm to clip  |                 |                    |
| <b>For models:</b> | 030FT, 030FTR, 031FT, 031FT04, 031FT06, 031FTR, 031FTRL, 031TP, 06WCP1GM, 06WFR3GD, 070BM, 070FT, 070FT04, 070FT05, 070FTR, 0712VA, 071BM, 071FT, 071FT04, 071FT06, 071FTR, 071FTRL, 071TP, 08WCP1GM, 08WFA4G, 08WFAAG, 08WFT1GV, 08WFT2GV, 08WFT3GV, 08WFT4GV, 08WFT6GV, 08WFT7GV, 090BM, 090BM1G, 090FAVA, 090FT, 090FT04, 090FT05, 090FT1G, 090FT2G, 090FT4G, 090FT5G, 090FT7G, 090FTR, 091BM, 091CP1G, 091FR1G, 091FR1GD, 091FR3G, 091FR3GD...(Other models you can see in the webshop) |                 |                    |

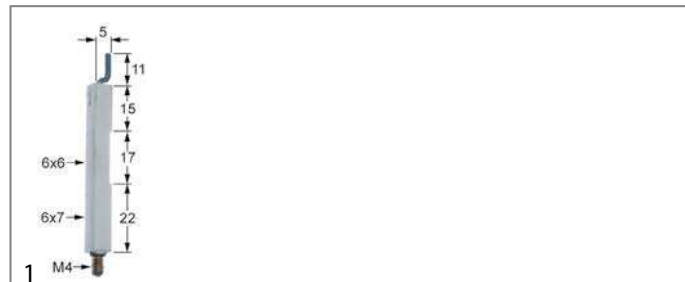

|                    |  |                 |         |
|--------------------|--|-----------------|---------|
| <b>GEV No.</b>     | 100708   | <b>Ref. No.</b> | 32T0140 |
| <b>description</b> | ignition electrode D1 ø 6x7mm connection M4 D2 ø 6x6mm L1 11mm L2 5mm BL1 15mm BL2 16mm BL3 23mm |                 |         |
| <b>For models:</b> | 71AR, 91AR, FS30   |                 |         |



Зип Общепит

vsezip.ru

+7(812)987-08-81



|                    |  |                 |         |
|--------------------|--|-----------------|---------|
| <b>GEV No.</b>     | 100707   | <b>Ref. No.</b> | 3232960 |
| <b>description</b> | ignition electrode D1 ø 7mm D2 ø 9mm connection ø2.4mm L1 14mm L2 6mm BL1 18mm BL2 3mm BL3 23mm to clip Qty 1 pcs  |                 |         |
| <b>For models:</b> | 06WCP1GM, 08WCP1GM, 08WFA4G, 08WFAAG, 090BM1G, 090FAVA, 090FT1G, 090FT2G, 090FT4G, 090FT5G, 090FT7G, 091CP1G, 091FR1G, 091FR1GD, 091FR3G, 091FR3GD, 0G0FT1G-VERS.032008, 0G0FT2G-VERS.032008, 0G0FT4G-VERS.032008, 0G0FT5G-VERS.032008, 0G0FT7G, 0G1CP1G-VERS.2004, 0G1FR3G, 0G1FR3GD, 0G1FR7G, 10WTPGE, 10WTPGV, 12WFA6G, 12WFAAG, 190BM2G, 190FAB, 190FT15G, 190FT1G, 190FT2G, 190FT3G, 190FT42G, 190FT4G, 190FT6G, 190FT72G, 190FT7G, 190TP0, 191BR1G, 191BR1GA, 191BR2G, 191BR2GA, 191CP2G, 191FAAG, 191FABG, 191FADG, 191FR2G...(Other models you can see in the webshop) |                 |         |



|                    |   |                 |         |
|--------------------|---|-----------------|---------|
| <b>GEV No.</b>     | 104800  | <b>Ref. No.</b> | 32V4670 |
| <b>description</b> | ignition electrode flange length 55mm flange width 55mm D1 ø 9mm D2 ø 7mm L1 119mm L2 145mm BL1 60mm BL2 55mm |                 |         |



|                    |   |                 |         |
|--------------------|---|-----------------|---------|
| <b>GEV No.</b>     | 106743  | <b>Ref. No.</b> | 6300568 |
| <b>description</b> | ignition electrode flange length 55mm flange width 55mm D1 ø 9.3mm D2 ø 5.85mm L1 80mm BL1 80mm BL2 33.5mm BL3 29.5mm BL4 24.5mm with fixing flange with mounting material connection ø 4mm   |                 |         |
| <b>For models:</b> | FC1221G, FM1221G1, FM1221G1-VERS.2006, FM1221G2, FM1221G2-VERS.2006, FM1221G3, FM1221G3-VERS.2006, FM2021G1, FM2021G2, FM2021G2-VERS.2006, FM2021G3, FM2021G3-VERS.2006, FM721G1, FM721G1-VERS.2006, FM721G2, FM721G2-VERS.2006, FM721G3, FM721G3-VERS.2006 |                 |         |



|                    |   |                 |                    |
|--------------------|---|-----------------|--------------------|
| <b>GEV No.</b>     | 104683  | <b>Ref. No.</b> | 3106670<br>3106671 |
| <b>description</b> | ignition electrode flange length 56mm flange width 22mm   |                 |                    |
| <b>For models:</b> | 091FR11, 091FR11A, 091FR11D, 091FR11D-VERS.052012, 091FR11-VERS.032012, 091FR7G, 091FR7GX, 191FR21, 191FR21D, 191FR21D-VERS.092012, 191FR21-VERS.032012 |                 |                    |



|                    |   |                 |         |
|--------------------|---|-----------------|---------|
| <b>GEV No.</b>     | 104801  | <b>Ref. No.</b> | 6300567 |
| <b>description</b> | ignition electrode flange length 55mm flange width 55mm D1 ø 9mm D2 ø 7mm L1 118mm L2 145mm BL1 77mm BL2 65mm   |                 |         |
| <b>For models:</b> | FC1011G, FC611G, FM1011G1, FM1011G1-VERS.2006, FM1011G2, FM1011G2-VERS.2006, FM1011G3, FM1011G3-VERS.2006, FM2011G2-VERS.2006, FM2011G3-VERS.2006, FM611G1, FM611G1-VERS.2006, FM611G2, FM611G2-VERS.2006, FM611G3, FM611G3-VERS.2006 |                 |         |



|                    |   |                 |         |
|--------------------|---|-----------------|---------|
| <b>GEV No.</b>     | 104799  | <b>Ref. No.</b> | 6300747 |
| <b>description</b> | ignition electrode flange length 56mm flange width 22mm D1 ø 9x62mm D2 ø 9x62mm L1 130mm L2 140mm   |                 |         |
| <b>For models:</b> | BX122G, BX122G-VERS.122013, BX82G, BX82G-VERS.122013, FX122G1, FX122G2, FX122G2C, FX122G2T, FX122G2T-VERS.032014, FX122G3, FX122G3C, FX122G3T, FX122G3T-VERS.022014, FX12G3CT, FX12G3CT-VERS.022014, FX202G2, FX202G2-VERS.032014, FX202G3, FX202G3-VERS.022014, FX82G1, FX82G2, FX82G2C, FX82G2T, FX82G2T-VERS.032014, FX82G3, FX82G3C, FX82G3CT, FX82G3CT-VERS.022014, FX82G3T, FX82G3T-VERS.022014 |                 |         |



Зип Общепит

vsezip.ru

+7(812)9800000

1 gas components

|                    |   |                 |         |
|--------------------|---|-----------------|---------|
|                    |   |                 |         |
| <b>1</b>           |   |                 |         |
| <b>GEV No.</b>     | 103287  | <b>Ref. No.</b> | 6300746 |
| <b>description</b> | ignition electrode kit flange length 56mm flange width 22mm D1 ø 3mm D2 ø 9.5mm mounting distance 47mm  |                 |         |
| <b>For models:</b> | BX101G, BX101G-VERS.122013, BX61G, BX61G-VERS.122013, FX101G1, FX101G1R, FX101G2, FX101G2C, FX101G2C-VERS.032014, FX101G2R, FX101G2R-VERS.032014, FX101G2-VERS.032014, FX101G3, FX101G3C, FX101G3C-VERS.022014, FX101G3R, FX101G3R-VERS.022014, FX101G3-VERS.022014, FX10G2CR, FX10G2CR-VERS.032014, FX10G3CR, FX10G3CR-VERS.022014, FX201G2, FX201G2P, FX201G2P-VERS.032014, FX201G2-VERS.032014, FX201G3P, FX201G3-VERS.022014, FX61G1, FX61G1R, FX61G2, FX61G2C, FX61G2CR, FX61G2CR-VERS.032014, FX61G2C-VERS.032014, FX61G2R, FX61G2R-VERS.032014, FX61G2-VERS.032014, FX61G3, FX61G3C, FX61G3CR, FX61G3CR-VERS.022014, FX61G3C-VERS.022014, FX61G3R, FX61G3R-VERS.022014, FX61G3-VERS.022014 |                 |         |

|                    |  |                 |         |
|--------------------|--|-----------------|---------|
|                    |  |                 |         |
| <b>1</b>           |  |                 |         |
| <b>GEV No.</b>     | 100906   | <b>Ref. No.</b> | 36Q1050 |
| <b>description</b> | screw connection thread M10x1 for ignition electrode brass Qty 1 pcs WS 10   |                 |         |
| <b>For models:</b> | 08WGRGV, 090GRG, 0A0GRG, 0A1CP1G, 0B1CP1G, 0D0GRG, 0D1CP1G, 190GRG, 191CP1G, 1A0GRG, 1A1CP1G, 1A1CP2G, 1A1PD1G, 1A1PD2G, 1A1PI1G, 1A1PI1GA, 1D0GRG, 1D1CP1G, 1D1CP2G, 1D1PD1G, 1D1PD2G, 1D1PI1G, 1D1PI1GA, 1G0GRG, 6042120-08WGRGV |                 |         |

|                    |  |                 |         |
|--------------------|--|-----------------|---------|
|                    |  |                 |         |
| <b>1</b>           |  |                 |         |
| <b>GEV No.</b>     | 100179   | <b>Ref. No.</b> | 32A2540 |
| <b>description</b> | ignition cable cable length 1200mm connection F2.8mm / ø2.4mm  |                 |         |
| <b>For models:</b> | 08WGRGV, 090GRG, 0A0BMG, 0A0FAVA, 0D0BMG, 0D0FAVA, 0G0FR5G, 0G1CP1G, 0G1CP1G-VERS.2004, 0G1FR7G, 190GRG, 1G1CP1G, 1G1CP1G-VERS.2004, 1A0FA2, 1A0FA5, 1A0FAB, 1A0FAS2, 1A0TP0, 1A1FA2G, 1A1FASG, 1A1FABG, 1A1FAS2G, 1A1FASG, 1A1TP0G, 1A1TP0G-VERS.2002, 1B0FAS2, 1B0TP0, 1B1FAS2G, 1D0BMG, 1D0FA2, 1D0FA5, 1D0FAB, 1D0FAS2, 1D0TP0, 1D1FA2G, 1D1FASG, 1D1FABG, 1D1FAS2G, 1D1FASG, 1D1TP0G, 1D1TP0G-VERS.2002, 1G0FR6G, 1G1CP1G, 1G1CP1G-VERS.2004, 1G1CP2G, 1G1CP2G-VERS.2004, 1G1FR8G, 2A0FAS2, 2A1FAS2G, 2A1FASG...(Other models you can see in the webshop) |                 |         |

|                    |   |                 |         |
|--------------------|---|-----------------|---------|
|                    |   |                 |         |
| <b>1</b>           |   |                 |         |
| <b>GEV No.</b>     | 102163  | <b>Ref. No.</b> | 32A3080 |
| <b>description</b> | ignition cable cable length 1500mm connection F2.8mm / ø2.4mm   |                 |         |
| <b>For models:</b> | 08WFA4G, 12WFA6G, 190TP0, 191FAAG, 191FADG, 191FAG, 191PD2G, 191PI1G, 191PI1GA, 191PI2G, 191PI2GA, 191TPG, 1G1FA0G, 1G1FAPG, 1G1TP0G, 291FAG, 291TPCG, 2A1PI3G, 2D1PI3G, 2G1FA0G, 2G1FADG, 2G1FADGV, 2G1FAPG, 2G1TP3G, 391FAG |                 |         |

|                    |  |                 |                    |
|--------------------|--|-----------------|--------------------|
|                    |  |                 |                    |
| <b>1</b>           |  |                 |                    |
| <b>GEV No.</b>     | 100189   | <b>Ref. No.</b> | 3059160<br>32A1640 |
| <b>description</b> | ignition cable cable length 150mm connection F2.8mm / lug M4   |                 |                    |
| <b>For models:</b> | 090FT1G, 090FT2G, 090FT4G, 090FT5G, 090FT7G, 090GRG, 091CP1G, 091FR1G, 091FR1GD, 091FR3G, 091FR3GD, 0A1FR1G, 0A1FR1GD, 0A1FR1GD-VERS.2004, 0A1FR1G-VERS.2004, 0A1FR3G, 0A1FR3GD, 0B1FR1G, 0B1FR1GD, 0D1FR1G, 0D1FR1GD, 0D1FR1GD-VERS.2004, 0D1FR1G-VERS.2004, 0D1FR3G, 0D1FR3GD, 0G1FR3G, 0G1FR3GD, 10WTPGE, 191BR1G, 191BR1GA, 191BR2G, 191BR2GA, 1A1BR1G, 1A1BR1GA, 1A1BR2G, 1A1BR2GA, 1D1BR1G, 1D1BR1GA, 1D1BR2G, 1D1BR2GA, 1G1FR4G, 1G1FR4GD, 291BR1G, 291BR1GA, 291BR2G, 291BR2GA, 2A1BR1G, 2A1BR1GA, 2A1BR2G, 2A1BR2GA...(Other models you can see in the webshop) |                 |                    |

|                    |   |                 |         |
|--------------------|---|-----------------|---------|
|                    |   |                 |         |
| <b>1</b>           |   |                 |         |
| <b>GEV No.</b>     | 103353  | <b>Ref. No.</b> | 3113510 |
| <b>description</b> | ignition cable cable length 350mm connection F2.8/F6.3  |                 |         |
| <b>For models:</b> | FC1011G, FC611G, FM1011G1, FM1011G1-VERS.2006, FM1011G2, FM1011G2-VERS.2006, FM1011G3, FM1011G3-VERS.2006, FM2011G2-VERS.2006, FM2011G3-VERS.2006, FM611G1, FM611G1-VERS.2006, FM611G2, FM611G2-VERS.2006, FM611G3, FM611G3-VERS.2006, FM721G1, FM721G1-VERS.2006, FM721G2, FM721G2-VERS.2006, FM721G3, FM721G3-VERS.2006 |                 |         |

|                    |  |                 |                    |
|--------------------|--|-----------------|--------------------|
|                    |  |                 |                    |
| <b>1</b>           |  |                 |                    |
| <b>GEV No.</b>     | 100036   | <b>Ref. No.</b> | 32A0040<br>32A0050 |
| <b>description</b> | ignition cable cable length 500mm connection F2.8mm / F2.8mm |                 |                    |

|                    |  |                 |         |
|--------------------|--|-----------------|---------|
|                    |  |                 |         |
| <b>1</b>           |  |                 |         |
| <b>GEV No.</b>     | 103352   | <b>Ref. No.</b> | 3113490 |
| <b>description</b> | ignition cable cable length 550mm connection F2.8mm / F6.3mm   |                 |         |
| <b>For models:</b> | FM1221G1, FM1221G1-VERS.2006, FM1221G2, FM1221G2-VERS.2006, FM1221G3, FM1221G3-VERS.2006, FM2021G1, FM2021G2, FM2021G2-VERS.2006, FM2021G3, FM2021G3-VERS.2006, FM721G1, FM721G2, FM721G3, FX201G2, FX201G2P, FX201G2P-VERS.032014, FX201G2-VERS.032014, FX201G3P, FX201G3-VERS.022014, FX202G2, FX202G2-VERS.032014, FX202G3, FX202G3-VERS.022014 |                 |         |

ignition cables

pre-assembled cables

|                    |   |                 |                    |
|--------------------|---|-----------------|--------------------|
|                    |   |                 |                    |
| <b>1</b>           |   |                 |                    |
| <b>GEV No.</b>     | 100190  | <b>Ref. No.</b> | 32A0061<br>32A0390 |
| <b>description</b> | ignition cable cable length 1200mm connection F2.8mm / F2.8mm   |                 |                    |
| <b>For models:</b> | 06WFR3GD, 071TP, 08WFAAG, 08WFT1GV, 08WFT2GV, 08WFT3GV, 08WFT4GV, 08WFT6GV, 08WFT7GV, 090FAVA, 091FR1G, 091FR1GD, 091FR3G, 091FR3GD, 091TP, 0A1FR1G, 0A1FR1GD, 0A1FR1GD-VERS.2004, 0A1FR1G-VERS.2004, 0A1FR3G, 0A1FR3GD, 0B1FR1G, 0B1FR1GD, 0D1FR1G, 0D1FR1GD, 0D1FR1GD-VERS.2004, 0D1FR1G-VERS.2004, 0D1FR3G, 0D1FR3GD, 0G1FR3G, 0G1FR3GD, 10WFR4GD, 12WFAAG, 190FAB, 191BR1G, 191BR1GA, 191BR2G, 191BR2GA, 191CP1GA, 191FABG, 191FR2G, 191FR2GD, 191FR4G, 191FR4GD, 1A1BR1G, 1A1BR1GA, 1A1BR2G, 1A1BR2GA, 1A1CP1GA, 1A1FR2G...(Other models you can see in the webshop) |                 |                    |



|                    |  |                 |         |
|--------------------|--|-----------------|---------|
| <b>GEV No.</b>     | 102159   | <b>Ref. No.</b> | 32A0140 |
| <b>description</b> | ignition cable cable length 600mm connection F2.8mm / F2.8mm |                 |         |



|                    |  |                 |         |
|--------------------|--|-----------------|---------|
| <b>GEV No.</b>     | 100197   | <b>Ref. No.</b> | 32A0430 |
| <b>description</b> | ignition cable cable length 600mm connection F2.8mm / ø2.4mm   |                 |         |
| <b>For models:</b> | 031FT04, 031FT06, 070FT04, 070FT05, 071FT04, 071FT06, 090FT04, 090FT05, 091FT04, 091FT06, 0A0FT1G, 0A0FT2G, 0A0FT4G, 0A0FT5G, 0B0FT1G, 0B0FT2G, 0B0FT4G, 0B0FT5G, 0D0FT1G, 0D0FT2G, 0D0FT4G, 0D0FT5G, 0G0FT1G, 0G0FT1G-VERS.032008, 0G0FT2G, 0G0FT2G-VERS.032008, 0G0FT4G, 0G0FT4G-VERS.032008, 0G0FT5G, 0G0FT5G-VERS.032008, 1A0FT1G, 1A0FT2G, 1A0FT3G, 1A0FT4G, 1A0FT6G, 1B0FT1G, 1B0FT2G, 1B0FT3G, 1B0FT4G, 1B0FT6G, 1D0FT1G, 1D0FT2G, 1D0FT3G, 1D0FT4G, 1D0FT6G, 1G0FT1G, 1G0FT1G-VERS.032008, 1G0FT2G, 1G0FT2G-VERS.032008, 1G0FT3G...(Other models you can see in the webshop) |                 |         |



|                    |  |                 |         |
|--------------------|--|-----------------|---------|
| <b>GEV No.</b>     | 100025   | <b>Ref. No.</b> | 32A0051 |
| <b>description</b> | ignition cable cable length 600mm connection ø4mm / F6.3mm |                 |         |



|                    |  |                 |         |
|--------------------|--|-----------------|---------|
| <b>GEV No.</b>     | 107550   | <b>Ref. No.</b> | 3211850 |
| <b>description</b> | ignition cable cable length 700mm connection ø4mm / F2.8mm with earthing cable   |                 |         |
| <b>For models:</b> | 091FR11, 091FR11A, 091FR11D, 091FR11D-VERS.052012, 091FR11-VERS.032012, 191FR21, 191FR21D, 191FR21D-VERS.092012, 191FR21-VERS.032012 |                 |         |



|                    |   |                 |                               |
|--------------------|---|-----------------|-------------------------------|
| <b>GEV No.</b>     | 100037  | <b>Ref. No.</b> | 32A0010<br>32A0060<br>32A0210 |
| <b>description</b> | ignition cable cable length 900mm connection F2.8mm / F2.8mm  |                 |                               |
| <b>For models:</b> | 030FT, 030FTR, 031FT, 031FTR, 031FTRL, 031TP, 070BM, 070FT, 070FTR, 0712VA, 071BM, 071FT, 071FTR, 071FTRL, 090BM, 090BM1G, 090FT, 090FTR, 091BM, 091FT, 091FTR, 091FTRL, 092VA, 092VAGG, 135PVX, 190BM2G, 1G0TP0, 1G1TP0G, 2G1TP3G, 30CPS, 30F, 30FS, 31TP, 32TP, 32TPV, 70CP, 70F, 712D, 712VA, 71CP2, 71D, 71DGG, 71F, 71TP, 72D, 72DGG, 72TP, 72TPGG, 72VA, 72VAGG...(Other models you can see in the webshop) |                 |                               |



|                    |  |                 |         |
|--------------------|--|-----------------|---------|
| <b>GEV No.</b>     | 103307   | <b>Ref. No.</b> | 32A2541 |
| <b>description</b> | ignition cable cable length 900mm connection F2.8mm / ø2.4mm   |                 |         |
| <b>For models:</b> | 06WCP1GM, 08WCP1GM, 08WGRGV, 090FAA, 090FT1G, 090FT2G, 090FT4G, 090FT5G, 090FT7G, 090GRG, 091CP1G, 0A0BMG, 0A0FAVA, 0D0BMG, 0D0FAVA, 0G0FR5G, 0G1CP1G, 0G1CP1G-VERS.2004, 0G1FR7G, 10WTPGV, 190FAA, 190FT15G, 190FT1G, 190FT2G, 190FT3G, 190FT42G, 190FT4G, 190FT6G, 190FT72G, 190FT7G, 190GRG, 191CP1G, 191CP2G, 1A0BMG, 1A0FA2, 1A0FA5, 1A0FAB, 1A0FAS2, 1A0TP0, 1A1FA2G, 1A1FA5G, 1A1FABG, 1A1FAS2G, 1A1FASG, 1A1TP0G, 1A1TP0G-VERS.2002, 1B0FAS2, 1B0TP0, 1B1FAS2G, 1D0BMG...(Other models you can see in the webshop) |                 |         |



|                    |   |                 |         |
|--------------------|---|-----------------|---------|
| <b>GEV No.</b>     | 100016  | <b>Ref. No.</b> | 32A2550 |
| <b>description</b> | ignition cable cable length 900mm connection ø2.4mm / ø2.4mm  |                 |         |
| <b>For models:</b> | 0A1CP1G, 0B1CP1G, 0D1CP1G, 0G1CP1G-VERS.2004, 0G1FR7G, 1A1CP1G, 1A1CP2G, 1A1PD1G, 1A1PD2G, 1A1PI1G, 1A1PI1GA, 1D1CP1G, 1D1CP2G, 1D1PD1G, 1D1PD2G, 1D1PI1G, 1D1PI1GA, 1G0FR6G, 1G1CP1G-VERS.2004, 1G1CP2G-VERS.2004, 1G1FR8G, 1G1PD1G, 1G1PI1G |                 |         |

various





|                    |  |                 |         |
|--------------------|--|-----------------|---------|
| <b>GEV No.</b>     | 102986   | <b>Ref. No.</b> | 32A1600 |
| <b>description</b> | ignition cable 10000hm   |                 |         |
| <b>For models:</b> | FCV101DM, FCV101DS, FCV141DM, FCV141DS, FCV241DM, FCV241DS, FCV241GDM, FCV241GDS, FCV401DM, FCV61DM, FCV61DS |                 |         |

piezoelectric igniters  
mounting diameter 18mm



|                    |   |                 |         |
|--------------------|---|-----------------|---------|
| <b>GEV No.</b>     | 100002  | <b>Ref. No.</b> | 32T0130 |
| <b>description</b> | piezoelectric igniter body metal rotary mounting ø 18mm connection F2.8x0.8   |                 |         |
| <b>For models:</b> | 030FT, 030FTR, 031FT, 031FTR, 031FTRL, 031TP, 070BM, 070FT, 070FTR, 0712VA, 071BM, 071FT, 071FTR, 071FTRL, 071TP, 090BM, 090FT, 090FTR, 091BM, 091FT, 091FTR, 091FTRL, 091TP, 092VA, 092VAGG, 30CPS, 30F, 30FS, 31, 31PD6, 31PI6, 31R, 31TC, 31TP, 32, 32TC, 32TP, 32TPV, 32V, 60SM, 70CP, 70F, 712D, 712VA, 71CP, 71CP2, 71D, 71DGG, 71F, 71PD10...(Other models you can see in the webshop) |                 |         |



|   |  |                 |                         |
|---|--|-----------------|-------------------------|
| <b>GEV No.</b>  | 100012   | <b>Ref. No.</b> | 32T0150                 |
| <b>description</b>  | piezoelectric igniter body plastic blowing mounting ø 18mm connection ø2.4mm   |                 |                         |
| <b>For models:</b>  | 031FT04, 031FT06, 070FT04, 070FT05, 071FT04, 071FT06, 090FT04, 090FT05, 091FT04, 091FT06, 0A0BMG, 0A0FT1G, 0A0FT2G, 0A0FT4G, 0A0FT5G, 0A0GRG, 0A1CP1G, 0B0FT1G, 0B0FT2G, 0B0FT4G, 0B0FT5G, 0B1CP1G, 0D0BMG, 0D0FT1G, 0D0FT2G, 0D0FT4G, 0D0FT5G, 0D0GRG, 0D1CP1G, 0G0FT1G, 0G0FT2G, 0G0FT4G, 0G0FT5G, 0G1CP1G, 0M0FA1, 0M0FR1G, 0M0FT1G, 0M0FT2G, 0M0FT4G, 0M0FT5G, 0M0GL1G, 0M0GL2G, 1A0BMG, 1A0FA2, 1A0FA5, 1A0FAS2, 1A0FT1G, 1A0FT2G, 1A0FT3G, 1A0FT4G...(Other models you can see in the webshop) |                 |                         |
| <b>spare parts for</b>  | 100012   |                 |                         |
|  | <b>GEV No.</b>   | 101339          | <b>Ref. No.</b> 37Q2100 |
|   | cover cap for piezoelectric igniter  |                 |                         |







Зип Общепит

ignition parts

vsezip.ru

+7(812)987-08-81

|  |   |                 |                    |
|--|---|-----------------|--------------------|
|  <p>1</p> |   |                 |                    |
| <b>GEV No.</b>   | 100009  | <b>Ref. No.</b> | 3005500<br>3166990 |
| <b>description</b>   | piezoelectric igniter body plastic blowing mounting ø 18mm connection ø2.4mm front measurements 26mm M18x1.5  |                 |                    |
| <b>For models:</b>   | 031FT04, 031FT06, 070FT04, 070FT05, 071FT04, 071FT06, 090FT04, 090FT05, 091FT04, 091FT06, 0A0BMG, 0A0FAVA, 0A0FT1G, 0A0FT2G, 0A0FT4G, 0A0FT5G, 0A0GRG, 0A1CP1G, 0B0FT1G, 0B0FT2G, 0B0FT4G, 0B0FT5G, 0B1CP1G, 0D0BMG, 0D0FAVA, 0D0FT1G, 0D0FT2G, 0D0FT4G, 0D0FT5G, 0D0GRG, 0D1CP1G, 0G0FR5G, 0G0FT1G, 0G0FT1G-VERS.032008, 0G0FT2G, 0G0FT2G-VERS.032008, 0G0FT4G, 0G0FT4G-VERS.032008, 0G0FT5G, 0G0FT5G-VERS.032008, 0G0FT7G, 0G1BR3G, 0G1CP1G, 0G1CP1G-VERS.2004, 0G1FR7G, 0M0FA1, 0M0FR1G, 0M0FT1G, 0M0FT2G, 0M0FT4G...(Other models you can see in the webshop) |                 |                    |
| <b>accessories for</b>   | 100009  |                 |                    |
|  <p>1</p> |   |                 |                    |
| <b>GEV No.</b>   | 101339  | <b>Ref. No.</b> | 37Q2100            |
| <b>description</b>   | cover cap for piezoelectric igniter   |                 |                    |
|  <p>1</p> |   |                 |                    |
| <b>GEV No.</b>   | 106869  | <b>Ref. No.</b> | —                  |
| <b>description</b>   | cover cap for piezoelectric igniter ID ø 22mm ED ø 35mm H 25mm  |                 |                    |
|  <p>1</p> |   |                 |                    |
| <b>GEV No.</b>   | 107931  | <b>Ref. No.</b> | —                  |
| <b>description</b>   | cover cap for piezoelectric igniter ID ø 21mm ED ø 36mm   |                 |                    |

|  |   |                 |         |
|--|---|-----------------|---------|
| <b>accessories</b>   |   |                 |         |
|  <p>1</p> |   |                 |         |
| <b>GEV No.</b>   | 101339  | <b>Ref. No.</b> | 37Q2100 |
| <b>description</b>   | cover cap for piezoelectric igniter   |                 |         |
| <b>For models:</b>   | 0A0BMG, 0A0FAVA, 0A0FT1G, 0A0FT2G, 0A0FT4G, 0A0FT5G, 0A0GRG, 0A1CP1G, 0B0FT1G, 0B0FT2G, 0B0FT4G, 0B0FT5G, 0B1CP1G, 0D0BMG, 0D0FAVA, 0D0FT1G, 0D0FT2G, 0D0FT4G, 0D0FT5G, 0D0GRG, 0D1CP1G, 0G0FR5G, 0G0FT1G, 0G0FT1G-VERS.032008, 0G0FT2G, 0G0FT2G-VERS.032008, 0G0FT4G, 0G0FT4G-VERS.032008, 0G0FT5G, 0G0FT5G-VERS.032008, 0G0FT7G, 0G1BR3G, 0G1CP1G, 0G1CP1G-VERS.2004, 0G1FR7G, 191BR2EA, 1A0BMG, 1A0FA2, 1A0FA5, 1A0FAB, 1A0FAS2, 1A0FT1G, 1A0FT2G, 1A0FT3G, 1A0FT4G, 1A0FT6G, 1A0GRG, 1A0TP0, 1A1BR1E, 1A1BR2E...(Other models you can see in the webshop) |                 |         |

|  |  |                 |         |
|--|--|-----------------|---------|
|  <p>1</p> |  |                 |         |
| <b>GEV No.</b>   | 101730   | <b>Ref. No.</b> | 3191100 |
| <b>description</b>   | disc ID ø 18mm ED ø 31mm H 2mm   |                 |         |
| <b>For models:</b>   | 0A0BMG, 0A0FAVA, 0A0FT1G, 0A0FT2G, 0A0FT4G, 0A0FT5G, 0A0GRG, 0A1CP1G, 0B0FT1G, 0B0FT2G, 0B0FT4G, 0B0FT5G, 0B1CP1G, 0D0BMG, 0D0FAVA, 0D0FT1G, 0D0FT2G, 0D0FT4G, 0D0FT5G, 0D0GRG, 0D1CP1G, 0G0FR5G, 0G0FT1G, 0G0FT2G, 0G0FT4G, 0G0FT5G, 0G1BR3G, 0G1CP1G, 0G1CP1G-VERS.2004, 0G1FR7G, 1A0BMG, 1A0FA2, 1A0FA5, 1A0FAB, 1A0FAS2, 1A0FT1G, 1A0FT2G, 1A0FT3G, 1A0FT4G, 1A0FT6G, 1A0GRG, 1A0TP0, 1A1CP1G, 1A1CP2G, 1A1FA1G, 1A1FA2G, 1A1FA4G, 1A1FA5G, 1A1FAAG, 1A1FABG...(Other models you can see in the webshop) |                 |         |

|   |  |                 |  |
|---|--|-----------------|--|
|  <p>1</p> |  |                 |  |
| <b>GEV No.</b>  | 102485   | <b>Ref. No.</b> | 32T0040<br>32T0041<br>32T0050<br>32T0210 |
| <b>description</b>  | ignition unit outputs 2 220-240VAC 0.6VA 50-60Hz   |                 |  |
| <b>For models:</b>  | 04WFAAV, 06WCP1GM, 06WFR3GD, 08WCP1GM, 08WFT1GV, 08WFT2GV, 08WFT3GV, 08WFT4GV, 08WFT6GV, 08WFT7GV, 08WGRGV, 090BM1G, 090FAA, 090FAVA, 090FT1G, 090FT2G, 090FT4G, 090FT5G, 090FT7G, 090GRG, 091CP1G, 091FR1G, 091FR1GD, 091FR3G, 091FR3GD, 0A1FR1G, 0A1FR1GD, 0A1FR1GD-VERS.2004, 0A1FR1G-VERS.2004, 0A1FR3G, 0A1FR3GD, 0B1FR1G, 0B1FR1GD, 0D1FR1G, 0D1FR1GD, 0D1FR1GD-VERS.2004, 0D1FR1G-VERS.2004, 0D1FR3G, 0D1FR3GD, 0G1FR3G, 0G1FR3GD, 10CP1GA, 10WFR4GD, 10WTPGV, 12CP1GA, 12WFA6G, 18CP2GA, 190BM2G, 190FAB, 190FT15G...(Other models you can see in the webshop) |                 |  |

|   |   |                 |         |
|---|---|-----------------|---------|
|  <p>1</p> |   |                 |         |
| <b>GEV No.</b>  | 103334  | <b>Ref. No.</b> | 3144130 |
| <b>description</b>  | ignition unit outputs 2 220-240VAC dimensions 83x42x32mm mounting distance 34mm inlet F2.8 outlet F2.8 type TSM 17VA 50/60Hz  |                 |         |
| <b>For models:</b>  | BX101G, BX101G-VERS.122013, BX122G, BX122G-VERS.122013, BX61G, BX61G-VERS.122013, BX82G, BX82G-VERS.122013, FX101G1R, FX101G2, FX101G2C, FX101G2C-VERS.032014, FX101G2R, FX101G2R-VERS.032014, FX101G2-VERS.032014, FX101G3, FX101G3C, FX101G3C-VERS.022014, FX101G3R, FX101G3R-VERS.022014, FX101G3-VERS.022014, FX10G2CR, FX10G2CR-VERS.032014, FX10G3CR, FX10G3CR-VERS.022014, FX122G1, FX122G2, FX122G2C, FX122G2T, FX122G2T-VERS.032014, FX122G3, FX122G3C, FX122G3T, FX122G3T-VERS.022014, FX12G3CT, FX12G3CT-VERS.022014, FX201G2, FX201G2P, FX201G2P-VERS.032014, FX201G2-VERS.032014, FX201G3P, FX201G3-VERS.022014, FX202G2, FX202G2-VERS.032014, FX202G3, FX202G3-VERS.022014, FX61G1, FX61G1R, FX61G2...(Other models you can see in the webshop) |                 |         |

|  |   |                 |         |
|--|---|-----------------|---------|
|  <p>1</p> |   |                 |         |
| <b>GEV No.</b>   | 101002  | <b>Ref. No.</b> | 3107650 |
| <b>description</b>   | ignition unit outputs 2 230VAC dimensions 88x23x34mm mounting distance 73mm inlet F6.3x0.8 outlet F2.8x0.8 0.6VA 50/60Hz  |                 |         |
| <b>For models:</b>   | 091FR1ID-VERS.052012, 091FR11-VERS.032012, 091FR7G, 091FR7G5, 091FR7G-VERS.052012, 091FR7GX, 10CP11A, 12CP11A, 18CP21A, 191FR2ID-VERS.092012, 191FR21-VERS.032012 |                 |         |

|   |  |                 |         |
|---|--|-----------------|---------|
|  <p>1</p> |  |                 |         |
| <b>GEV No.</b>  | 107548   | <b>Ref. No.</b> | 3134640 |
| <b>description</b>  | ignition unit outputs 4 220VAC dimensions 110x22x40mm mounting distance 100mm inlet F6.3x0.8 outlet F2.8x0.8 50-60Hz |                 |         |
| <b>For models:</b>  | 091FR11, 091FR11A, 091FR11D, 190FAA, 191FR21, 191FR21D   |                 |         |

1 gas components

Зип Общежит

vsezip.ru

7(812)987-08-81



1

|                    |  |                 |         |
|--------------------|--|-----------------|---------|
| <b>GEV No.</b>     | 102388   | <b>Ref. No.</b> | 32T0030 |
| <b>description</b> | ignition unit outputs 4 230VAC dimensions 111x23x34mm mounting distance 100mm inlet F6.3x0.8 outlet F2.8x0.8 type WAC-T4 0.6VA 50/60Hz |                 |         |



1

|                    |  |                 |         |
|--------------------|--|-----------------|---------|
| <b>GEV No.</b>     | 102389   | <b>Ref. No.</b> | 3015000 |
| <b>description</b> | ignition unit outputs 6 230VAC dimensions 135x23x34mm mounting distance 123mm inlet F6.3x0.8 outlet F2.8x0.8 0.6VA 50/60Hz |                 |         |
| <b>For models:</b> | 08WFA4E, 08WFA4G, 08WFAAE, 08WFAAG, 08WFAAV, 10WTPGE, 12WFA6E, 12WFA6G, 12WFAAA, 12WFAAE, 12WFAAG, 12WFAAN                 |                 |         |



1

|                    |  |                 |         |
|--------------------|--|-----------------|---------|
| <b>GEV No.</b>     | 101004   | <b>Ref. No.</b> | 32T0070 |
| <b>description</b> | ignition unit outputs 6 230VAC inlet F6.3x0.8 outlet F2.8x0.8 50Hz mounting ø 88mm |                 |         |



1

|                    |   |                 |         |
|--------------------|---|-----------------|---------|
| <b>GEV No.</b>     | 101005  | <b>Ref. No.</b> | 32T0020 |
| <b>description</b> | ignition unit outputs 8 230VAC dimensions 92x68x33mm mounting distance 88mm inlet F6.3x0.8 outlet F2.8x0.8 type BK 40086-00 0.6VA 50-60Hz |                 |         |

thermocouples

plug-in thermocouples

plug-in thermocouples standard

with barrel socket ø6mm

type Junkers with aluminised tip

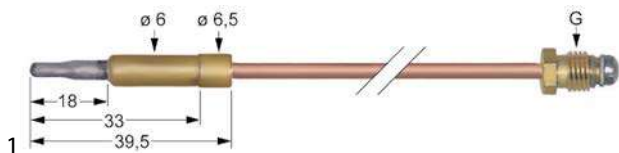

1

|                    |  |                 |         |
|--------------------|--|-----------------|---------|
| <b>GEV No.</b>     | 102229   | <b>Ref. No.</b> | 33A0360 |
| <b>description</b> | thermocouple M10x1 L 1000mm plug connection ø6.0mm |                 |         |

with barrel socket ø6(6.5)mm

thermocouples SIT

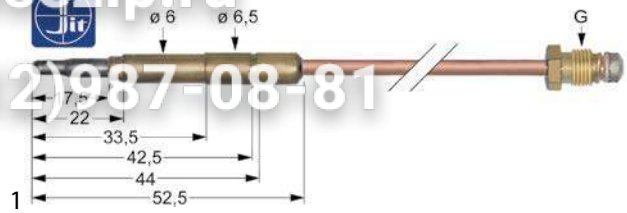

1

|                    |   |                 |         |
|--------------------|---|-----------------|---------|
| <b>GEV No.</b>     | 107621  | <b>Ref. No.</b> | 33A0370 |
| <b>description</b> | thermocouple SIT M10x1 L 1500mm plug connection ø6.0(6.5)mm |                 |         |

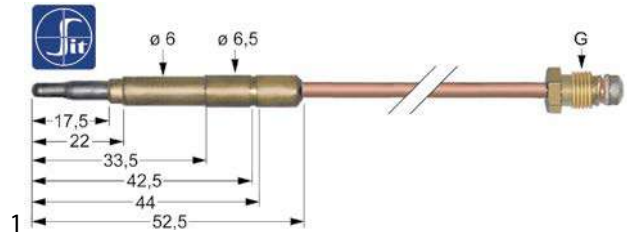

1

|                    |  |                 |                    |
|--------------------|--|-----------------|--------------------|
| <b>GEV No.</b>     | 107605   | <b>Ref. No.</b> | 33A0520<br>33A0890 |
| <b>description</b> | thermocouple SIT M8x1 L 1500mm plug connection ø6.0(6.5)mm   |                 |                    |
| <b>For models:</b> | 071TP, 091TP, 1G1PD1G, 30CPS, 31, 31PD6, 31TC, 31TP, 32, 32TC, 32TP, 32TPV, 32V, 70CP, 71CP, 71CP2, 71PD10, 71PD15, 71TP, 72TP, 72TPGG, 90CP, 91CP |                 |                    |

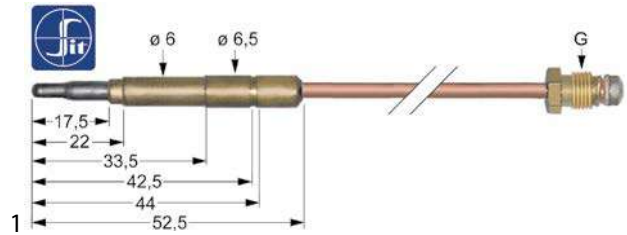

1

|                    |   |                 |         |
|--------------------|---|-----------------|---------|
| <b>GEV No.</b>     | 107600  | <b>Ref. No.</b> | 33A0390 |
| <b>description</b> | thermocouple SIT M8x1 L 320mm plug connection ø6.0(6.5)mm |                 |         |

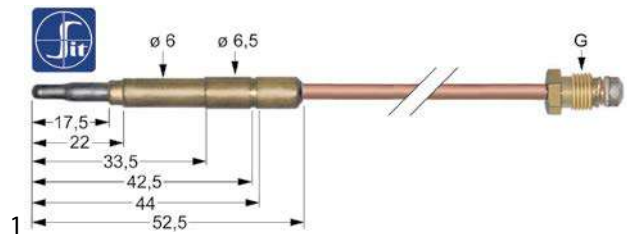

1

|                    |  |                 |                    |
|--------------------|--|-----------------|--------------------|
| <b>GEV No.</b>     | 107601   | <b>Ref. No.</b> | 33A0400<br>33A1060 |
| <b>description</b> | thermocouple SIT M8x1 L 600mm plug connection ø6.0(6.5)mm  |                 |                    |
| <b>For models:</b> | 030, 030FT, 030FTR, 031, 031FT, 031FTR, 031FTRL, 031TP, 032, 070D, 070DGG, 070FT, 070FTR, 0712D, 0712VA, 071D, 071DGG, 071FT, 071FTR, 071FTRL, 072D, 072DGG, 090, 090FT, 090FTR, 090GG, 091, 091FT, 091FTR, 091FTRL, 091GG, 092, 092GG, 092VA, 092VAGG, 0A0FAS, 0B0FAS, 0D0FAS, 1A0FA2, 1A0FAS, 1A0FAB, 1A0FAS, 1A0FAS2, 1A1FA2G, 1A1FA5G, 1A1FABG, 1A1FAS2G, 1A1FASG, 1B0FAS, 1B0FAS2...(Other models you can see in the webshop) |                 |                    |



Зип Общежит

vsezip.ru

+7(812)987-08-81

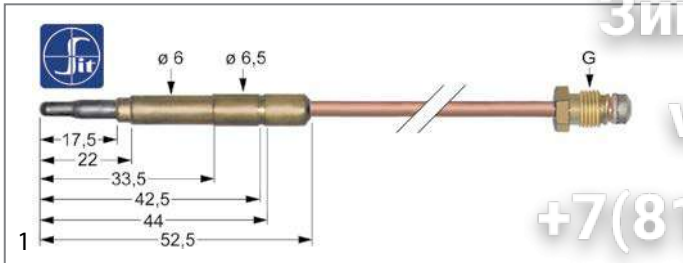

|                    |  |                 |         |
|--------------------|--|-----------------|---------|
| <b>GEV No.</b>     | 107612   | <b>Ref. No.</b> | 32A0310 |
| <b>description</b> | thermocouple SIT M9x1 L 1000mm plug connection ø6.0(6.5)mm |                 |         |

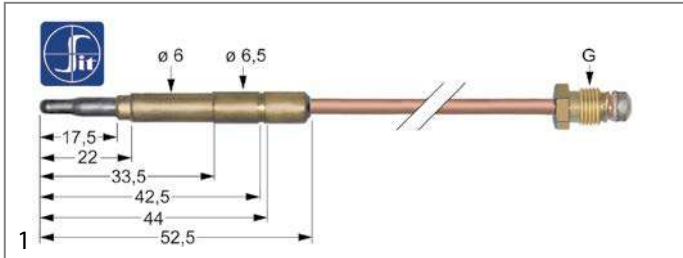

|                    |  |                 |         |
|--------------------|--|-----------------|---------|
| <b>GEV No.</b>     | 107614   | <b>Ref. No.</b> | 33A0320 |
| <b>description</b> | thermocouple SIT M9x1 L 1500mm plug connection ø6.0(6.5)mm |                 |         |

**For models:**  
08WFA4G, 08WFAAG, 10WTPGE, 10WTPGV, 12WFA6G, 12WFAAG, 191FAAG, 191FABG, 191FADG, 191TPG, 1A1BR1G, 1A1BR1GA, 1A1BR2G, 1A1BR2GA, 1A1FA1G, 1A1FA2G, 1A1FA4G, 1A1FA5G, 1A1FAAG, 1A1FABG, 1A1TP0G-VERS.2002, 1B1FAS2G, 1B1FASG, 1D1BR1G, 1D1BR1GA, 1D1BR2G, 1D1BR2GA, 1D1FA1G, 1D1FA2G, 1D1FA4G, 1D1FA5G, 1D1FAAG, 1D1FABG, 1D1TP0G-VERS.2002, 1G1FA0G, 1G1FA0GV, 1G1FABG, 1G1FAPG, 1G1TP0G, 291FAG, 291TPCG, 2A1BR1G, 2A1BR1GA, 2A1BR2G, 2A1BR2GA, 2A1FA1G, 2A1FA4G, 2A1FAAG, 2A1TP3G, 2A1TP6G...(Other models you can see in the webshop)

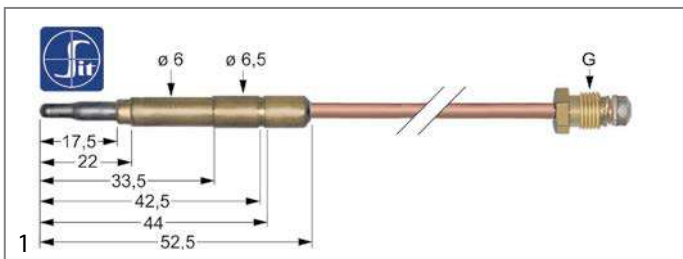

|                    |   |                 |                    |
|--------------------|---|-----------------|--------------------|
| <b>GEV No.</b>     | 107609  | <b>Ref. No.</b> | 33A0310<br>33A0340 |
| <b>description</b> | thermocouple SIT M9x1 L 600mm plug connection ø6.0(6.5)mm |                 |                    |

**For models:**  
GR4A-ONR01, SM1L, SM1LA, SM1LAW, SM1LW, SM2L, SM2LR, SM2LW, SM2S, SM2SR, SM2SW, SM3S, SM3SR

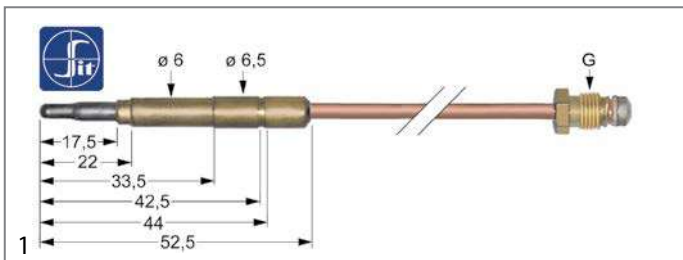

|                    |   |                 |                    |
|--------------------|---|-----------------|--------------------|
| <b>GEV No.</b>     | 107611  | <b>Ref. No.</b> | 33A1140<br>33A1190 |
| <b>description</b> | thermocouple SIT M9x1 L 850mm plug connection ø6.0(6.5)mm |                 |                    |

**For models:**  
06WCP1GM, 070BM, 071BM, 08WCP1GM, 08WFT1GV, 08WFT2GV, 08WFT3GV, 08WFT7GV, 090BM, 091BM, 10WTPGE, 10WTPGV, 191BR1G, 191BR1GA, 191BR2G, 191BR2GA, 1A1FAS2G, 1A1FASG, 1A1PD1G, 1A1PD2G, 1A1PI1G, 1A1PI1GA, 1A1TP0G, 1D1FAS2G, 1D1FASG, 1D1PD1G, 1D1PD2G, 1D1PI1G, 1D1PI1GA, 1D1TP0G, 1G1BR1G, 291BR1G, 291BR1GA, 291BR2G, 291BR2GA, 2A1FAS2G, 2A1FASG, 2A1TPSG, 2D1FAS2G, 2D1FASG, 2D1TPSG, 31R, 3A1FASG, 3D1FASG, 6040560, 6042490, 6042500, 6043200, 712D, 712VA...(Other models you can see in the webshop)



|                    |  |                 |         |
|--------------------|--|-----------------|---------|
| <b>GEV No.</b>     | 102998   | <b>Ref. No.</b> | 33A0680 |
| <b>description</b> | thermocouple M8x1 L 600mm plug connection ø6.0mm |                 |         |

**For models:**  
030, 030FT, 030FTR, 031, 031FT, 031FTR, 031FTRL, 031TP, 032, 04WFAAV, 070D, 070DGG, 070FT, 070FTR, 0712D, 0712VA, 071D, 071DGG, 071FT, 071FTR, 071FTRL, 072D, 072DGG, 08WFA4E, 08WFA4G, 08WFAAE, 08WFAAG, 08WFAAV, 08WGRGV, 090, 090FAA, 090FAVA, 090FT, 090FT1G, 090FT2G, 090FT7G, 090FTR, 090GG, 090GRG, 091, 091CP1G, 091FT, 091FTR, 091FTRL, 091GG, 092, 092GG, 092VA, 092VAGG, 0A0FA1...(Other models you can see in the webshop)

plug-in thermocouples with interruption

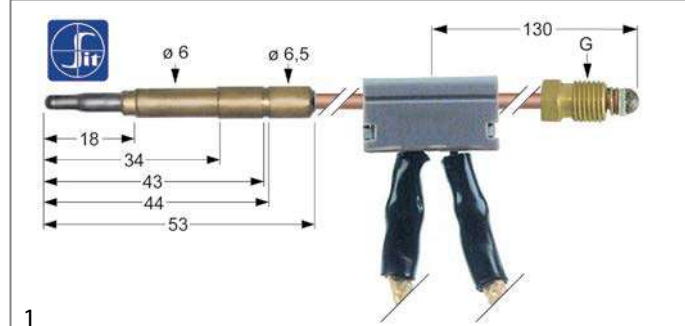

|                    |   |                 |         |
|--------------------|---|-----------------|---------|
| <b>GEV No.</b>     | 107863  | <b>Ref. No.</b> | 6021770 |
| <b>description</b> | thermocouple SIT with interrupter M9x1 L 1000mm plug connection ø6.0(6.5)mm cable 820mm |                 |         |

**For models:**  
06WCP1GM, 06WFR3GD, 091CP1G, 091FR1G, 091FR1GD, 0G0FR5G, 0G1CP1G-VERS.2004, 0M0FR1G, 0M0FT4G, 0M0FT5G, 10CP1GA, 10WFR4GD, 12CP1GA, 18CP2GA, 191CP1G, 191CP2G, 191FR2G, 191FR2GD, 191PI1G, 191PI1GA, 191PI2G, 191PI2GA, 1A1FR2G, 1A1FR2GD, 1A1FR2GD-VERS.2004, 1A1FR2G-VERS.2004, 1A1FR4G, 1A1FR4GD, 1A1PI1G, 1A1PI1GA, 1D1FR2G, 1D1FR2GD, 1D1FR2GD-VERS.2004, 1D1FR2G-VERS.2004, 1D1FR4G, 1D1FR4GD, 1D1PI1G, 1D1PI1GA, 1G0FR6G, 1G1CP1G-VERS.2004, 1G1CP2G-VERS.2004, 1G1FR4G, 1G1FR4GD, 1G1PI1G, 1M0FR2G, 1M0FT4G, 1M0FT5G, 1M0FT6G, 291FAG, 2M0FT4G...(Other models you can see in the webshop)

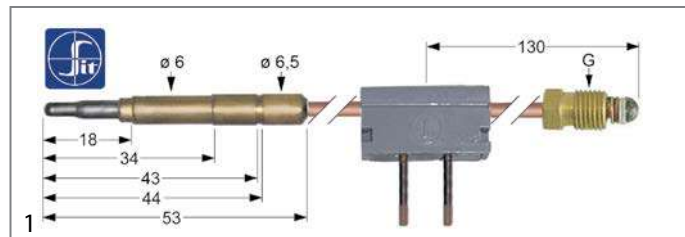

|                    |  |                 |         |
|--------------------|--|-----------------|---------|
| <b>GEV No.</b>     | 107164   | <b>Ref. No.</b> | 33A0900 |
| <b>description</b> | thermocouple SIT with interrupter M9x1 L 1000mm plug connection ø6.0(6.5)mm soldering connection |                 |         |

**For models:**  
0M0FR1G, 0M0FT4G, 0M0FT5G, 191PI1G, 191PI1GA, 191PI2G, 191PI2GA, 1A1PI1G, 1A1PI1GA, 1D1PI1G, 1D1PI1GA, 1G1PI1G, 1M0FR2G, 1M0FT4G, 1M0FT5G, 1M0FT6G, 2M0FT4G, 2M0FT5G, 2M0FT6G, 30F, 30F1, 30F1B, 30FS, 30FS2, 30FS2B, 31PI6, 70F, 70F1, 70F1B, 71F, 71F2, 71F2B, 71PI10, 71PI10A, 90F110B, 91F210, 91F210B, 91F223B, 91PI10, 91PI10A, FC101, FC241, FC241G, FC61, FCV101, FCV101DM, FCV101DS, FCV141, FCV141DM, FCV141DS...(Other models you can see in the webshop)

1 gas components



gas components

Зип.Общепит

vsezip.ru

+7(812)987-08-81

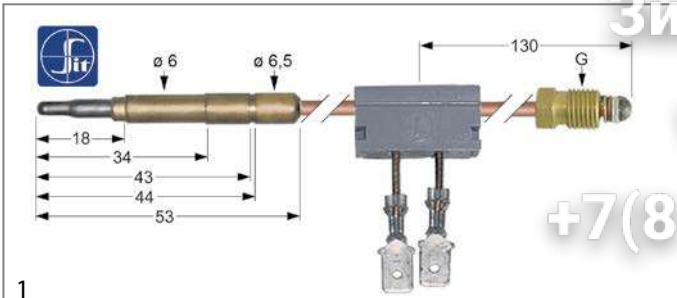

|                    |   |                 |         |
|--------------------|---|-----------------|---------|
| <b>GEV No.</b>     | 107177  | <b>Ref. No.</b> | 33A0140 |
| <b>description</b> | thermocouple SIT with interrupter M9x1 L 600mm plug connection ø6.0mm F 6.3mm   |                 |         |
| <b>For models:</b> | 031FT04, 031FT06, 070FT04, 070FT05, 071FT04, 071FT06, 08WFT-4GV, 08WFT6GV, 090BM1G, 090FT04, 090FT05, 090FT4G, 090FT5G, 091FR3G, 091FR3GD, 091FT04, 091FT06, 0A0BMG, 0A0FT1G, 0A0FT2G, 0A0FT4G, 0A0FT5G, 0A1FR1G, 0A1FR1GD, 0A1FR1GD-VERS.2004, 0A1FR1G-VERS.2004, 0A1FR3G, 0A1FR3GD, 0B0FT1G, 0B0FT2G, 0B0FT4G, 0B0FT5G, 0B1FR1G, 0B1FR1GD, 0D0BMG, 0D0FT1G, 0D0FT2G, 0D0FT4G, 0D0FT5G, 0D1FR1G, 0D1FR1GD, 0D1FR1GD-VERS.2004, 0D1FR1G-VERS.2004, 0D1FR3G, 0D1FR3GD, 0G0FR5G, 0G0FT4G, 0G0FT5G, 0G1BR3G, 0G1FR3G...(Other models you can see in the webshop) |                 |         |

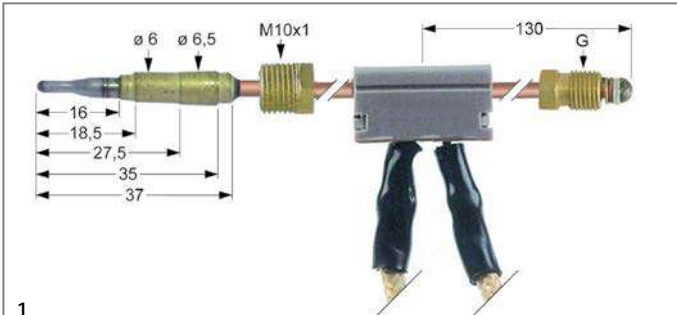

|                    |   |                 |                    |
|--------------------|---|-----------------|--------------------|
| <b>GEV No.</b>     | 102252  | <b>Ref. No.</b> | 33A1410<br>6021780 |
| <b>description</b> | thermocouple with interrupter M9x1 L 600mm plug connection ø6.0mm cable 650mm   |                 |                    |
| <b>For models:</b> | 06WFR3GD, 090BM1G, 090FT4G, 090FT5G, 091FR1G, 091FR1GD, 091FR3G, 091FR3GD, 0A0BMG, 0A1FR1G, 0A1FR1GD, 0A1FR1GD-VERS.2004, 0A1FR1G-VERS.2004, 0B1FR1G, 0B1FR1GD, 0D0BMG, 0D1FR1G, 0D1FR1GD, 0D1FR1GD-VERS.2004, 0D1FR1G-VERS.2004, 0G0FT4G, 0G0FT4G-VERS.032008, 0G0FT5G, 0G0FT5G-VERS.032008, 0G1BR3G, 0G1FR3G, 0G1FR3GD, 0G1FR7G, 10WFR4GD, 190BM2G, 190FT15G, 190FT42G, 190FT4G, 190FT6G, 191FR2G, 191FR2GD, 191FR4G, 191FR4GD, 1A0BMG, 1A1FR2G, 1A1FR2GD, 1A1FR2GD-VERS.2004, 1A1FR2G-VERS.2004, 1A1FR4G, 1A1FR4GD, 1D0BMG, 1D1FR2G, 1D1FR2GD, 1D1FR2GD-VERS.2004, 1D1FR2G-VERS.2004...(Other models you can see in the webshop) |                 |                    |

extensions



|   |  |                 |                    |
|---|--|-----------------|--------------------|
| <b>GEV No.</b>  | 102013   | <b>Ref. No.</b> | 33A0130<br>33A1270 |
| <b>description</b>  | thermocouple extension thread M9x1 L 500mm   |                 |                    |
| <b>For models:</b>  | 031FT04, 031FT06, 1A1BR1G, 1A1BR1GA, 1A1BR2G, 1A1BR2GA, 1D1BR1G, 1D1BR1GA, 1D1BR2G, 1D1BR2GA, 2A1BR1G, 2A1BR1GA, 2A1BR2G, 2A1BR2GA, 2D1BR1G, 2D1BR1GA, 2D1BR2G, 2D1BR2GA |                 |                    |
| <b>accessories for</b>  | 102013   |                 |                    |
|  | <b>GEV No.</b>   | 101261          | <b>Ref. No.</b> —  |
|   | thermocouple fitting thread M9x1 Qty 1 pcs   |                 |                    |

accessories

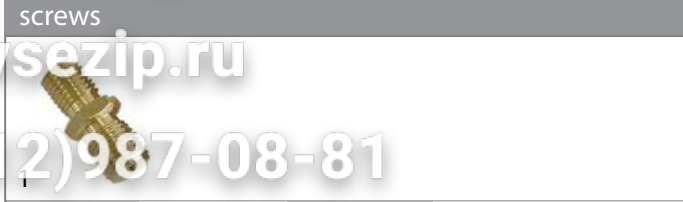

|                    |  |                 |         |
|--------------------|--|-----------------|---------|
| <b>GEV No.</b>     | 100920   | <b>Ref. No.</b> | 33Q2940 |
| <b>description</b> | thermocouple fitting thread M8x1 / M9x1 Qty 1 pcs  |                 |         |
| <b>For models:</b> | 06WCP1GM, 08WCP1GM, 090FT1G, 090FT2G, 090FT7G, 091CP1G, 0A0FT4G, 0A0FT5G, 0B0FT1G, 0B0FT2G, 0B0FT4G, 0B0FT5G, 0D0FT4G, 0D0FT5G, 0G0FT4G, 0G0FT5G, 0G1CP1G-VERS.2004, 190FT1G, 190FT2G, 190FT3G, 190FT4G, 190FT6G, 190FT7G, 191CP1G, 191CP2G, 1A0FT4G, 1A0FT6G, 1A1PD2G, 1A1PI1G, 1A1PI1GA, 1B0FT4G, 1B0FT6G, 1D0FT4G, 1D0FT6G, 1D1PD2G, 1D1PI1G, 1D1PI1GA, 1G0FT4G, 1G0FT6G, 1G1CP1G-VERS.2004, 1G1CP2G-VERS.2004, 1G1PI1G, 31PI6, 71PI10, 71PI10A, 91PI10, 91PI10A, G1FAGS, G1FAGST |                 |         |

miscellaneous



|                    |                           |                 |         |
|--------------------|---------------------------|-----------------|---------|
| <b>GEV No.</b>     | 100950                    | <b>Ref. No.</b> | 35T0680 |
| <b>description</b> | fastening angle Qty 1 pcs |                 |         |

gas burners

hob burners

producer-specific hob burners

ANGELO PO

Alpha (1), Delta (2), Gamma series



|                    |   |                 |         |
|--------------------|---|-----------------|---------|
| <b>GEV No.</b>     | 104792  | <b>Ref. No.</b> | 34A2040 |
| <b>description</b> | burner cap ø 110mm  |                 |         |
| <b>For models:</b> | 0A0FA1, 0A0FA4, 0D0FA1, 0G0FA0, 1A0FA1, 1A0FA2, 1A1FA1G, 1A1FA2G, 1D0FA1, 1D0FA2, 1D1FA1G, 1D1FA2G, 1G0FA0, 1G1FA0E, 1G1FA0EV, 1G1FA0G, 1G1FA0GV, 1G1FAPG, 2A0FA1, 2A1FA1G, 2A1TP3G, 2D0FA1, 2D1FA1G, 2D1TP3G, 2G0FA0, 2G1FA0G, 2G1FAPG, 2G1TP3G, 3A1FA1G, 3D1FA1G, 6FA |                 |         |



|                    |  |                 |         |
|--------------------|--|-----------------|---------|
| <b>GEV No.</b>     | 104790   | <b>Ref. No.</b> | 34A2060 |
| <b>description</b> | burner cap ø 130mm 7.5kW   |                 |         |
| <b>For models:</b> | 0A0FA1, 0A0FA4, 0D0FA1, 0D0FA4, 1A0FA1, 1A0FA2, 1A0FA4, 1A0FA5, 1A1FA1G, 1A1FA2G, 1A1FA4G, 1A1FA5G, 1D0FA1, 1D0FA2, 1D0FA4, 1D0FA5, 1D1FA1G, 1D1FA2G, 1D1FA4G, 1D1FA5G, 2A0FA1, 2A0FA4, 2A1FA1G, 2A1FA4G, 2A1TP3G, 2A1TP6G, 2D0FA1, 2D0FA4, 2D1FA1G, 2D1FA4G, 2D1TP3G, 2D1TP6G, 3A1FA1G, 3A1FA4G, 3D1FA1G, 3D1FA4G |                 |         |



Зип Общепит

vsezip.ru

+7(812)987

|   |   |                 |                    |
|---|---|-----------------|--------------------|
|  |   |                 |                    |
| <b>GEV No.</b>  | 104756  | <b>Ref. No.</b> | 34A2030<br>34A2032 |
| <b>description</b>  | burner head for burner cap ø 110mm new edition  |                 |                    |
| <b>For models:</b>  | 0A0FA1, 0A0FA4, 0D0FA1, 0G0FA0, 1A0FA1, 1A0FA2, 1A1FA1G, 1A1FA2G, 1D0FA1, 1D0FA2, 1D1FA1G, 1D1FA2G, 1G0FA0, 1G1FA0E, 1G1FA0EV, 1G1FA0G, 1G1FA0GV, 1G1FAPG, 2A0FA1, 2A1FA1G, 2A1TP3G, 2D0FA1, 2D1FA1G, 2D1TP3G, 2G0FA0, 2G1FA0G, 2G1FADG, 2G1FADGV, 2G1FAPG, 2G1TP3G, 3A1FA1G, 3D1FA1G |                 |                    |

|   |  |                 |                               |
|---|--|-----------------|-------------------------------|
|  |  |                 |                               |
| <b>GEV No.</b>  | 104794   | <b>Ref. No.</b> | 34A2050<br>34A2051<br>34A2052 |
| <b>description</b>  | burner head for burner cap ø 130mm new edition   |                 |                               |
| <b>For models:</b>  | 0A0FA1, 0A0FA4, 0D0FA1, 0D0FA4, 1A0FA1, 1A0FA2, 1A0FA4, 1A0FA5, 1A1FA1G, 1A1FA2G, 1A1FA4G, 1A1FA5G, 1D0FA1, 1D0FA2, 1D0FA4, 1D0FA5, 1D1FA1G, 1D1FA2G, 1D1FA4G, 1D1FA5G, 2A0FA1, 2A0FA4, 2A1FA1G, 2A1FA4G, 2A1TP3G, 2A1TP6G, 2D0FA1, 2D0FA4, 2D1FA1G, 2D1FA4G, 2D1TP3G, 2D1TP6G, 3A1FA1G, 3A1FA4G, 3D1FA1G, 3D1FA4G |                 |                               |



|   |   |                 |                               |
|---|---|-----------------|-------------------------------|
|  |   |                 |                               |
| <b>GEV No.</b>  | 104059  | <b>Ref. No.</b> | 3311911<br>34A2070<br>34A2071 |
| <b>description</b>  | burner lower part for burner cap ø 80/110mm   |                 |                               |
| <b>For models:</b>  | 08WFA4E, 090FAA, 0A0FA1, 0A0FA4, 0D0FA1, 0D0FA4, 0G0FA0, 12WFA6E, 190FA, 190FAA, 190FAB, 190FAD, 191FAAE, 191FAAG, 191FABG, 191FADG, 191FAE, 191FAG, 1A0FA1, 1A0FA2, 1A0FA4, 1A0FA5, 1A1FA1G, 1A1FA2G, 1A1FA4G, 1A1FA5G, 1D0FA1, 1D0FA2, 1D0FA4, 1D0FA5, 1D1FA1G, 1D1FA2G, 1D1FA4G, 1D1FA5G, 1G0FA0, 1G0FA0B, 1G1FA0E, 1G1FA0EV, 1G1FA0G, 1G1FA0GV, 1G1FABG, 1G1FAPG, 290FA, 291FAG, 291FAGF, 291TPCG, 2A0FA1, 2A0FA4, 2A1FA1G, 2A1FA4G...(Other models you can see in the webshop) |                 |                               |

|   |   |                 |         |
|---|---|-----------------|---------|
|  |   |                 |         |
| <b>GEV No.</b>  | 104006  | <b>Ref. No.</b> | 34A2020 |
| <b>description</b>  | nozzle holder   |                 |         |
| <b>For models:</b>  | 08WFA4E, 090FAA, 0A0FA1, 0A0FA4, 0D0FA1, 0D0FA4, 0G0FA0, 12WFA6E, 190FA, 190FAA, 190FAB, 190FAD, 191FAAE, 191FAAG, 191FABG, 191FADG, 191FAE, 191FAG, 1A0FA1, 1A0FA2, 1A0FA4, 1A0FA5, 1A1FA1G, 1A1FA2G, 1A1FA4G, 1A1FA5G, 1D0FA1, 1D0FA2, 1D0FA4, 1D0FA5, 1D1FA1G, 1D1FA2G, 1D1FA4G, 1D1FA5G, 1G0FA0, 1G0FA0B, 1G1FA0E, 1G1FA0EV, 1G1FA0G, 1G1FA0GV, 1G1FABG, 1G1FAPG, 290FA, 291FAG, 291FAGF, 291TPCG, 2A0FA1, 2A0FA4, 2A1FA1G, 2A1FA4G...(Other models you can see in the webshop) |                 |         |

|   |  |                 |         |
|---|--|-----------------|---------|
|  |  |                 |         |
| <b>GEV No.</b>  | 532541   | <b>Ref. No.</b> | 3152040 |
| <b>description</b>  | O-ring silicone thickness 1.78mm ID ø 47.35mm Qty 1 pcs  |                 |         |
| <b>For models:</b>  | 04WFAAV, 08WFA4E, 08WFA4G, 08WFAAE, 08WFAAG, 08WFAAV, 090FAA, 0A0FA1, 0A0FA4, 0D0FA1, 0D0FA4, 0D0FAA, 0G0FA0, 12WFA6E, 12WFA6G, 12WFAA, 12WFAAE, 12WFAAG, 12WFAAN, 190FA, 190FAA, 190FAB, 190FAD, 191FAAE, 191FAAG, 191FABG, 191FADG, 191FAE, 191FAG, 1A0FA1, 1A0FA2, 1A0FA4, 1A0FA5, 1A0FAA, 1A0FAB, 1A1FA1G, 1A1FA2G, 1A1FA4G, 1A1FA5G, 1A1FAAG, 1A1FABG, 1D0FA1, 1D0FA2, 1D0FA4, 1D0FA5, 1D0FAA, 1D0FAB, 1D1FA1G, 1D1FA2G...(Other models you can see in the webshop) |                 |         |

|   |  |                 |         |
|---|--|-----------------|---------|
|  |  |                 |         |
| <b>GEV No.</b>  | 104793   | <b>Ref. No.</b> | 34A2010 |
| <b>description</b>  | venturi ø 12mm   |                 |         |
| <b>For models:</b>  | 0A0FA1, 0A0FA4, 0D0FA1, 0G0FA0, 1A0FA1, 1A0FA2, 1A1FA1G, 1A1FA2G, 1D0FA1, 1D0FA2, 1D1FA1G, 1D1FA2G, 1G0FA0, 1G0FA0B, 1G1FA0E, 1G1FA0EV, 1G1FA0G, 1G1FA0GV, 1G1FABG, 1G1FAPG, 2A0FA1, 2A1FA1G, 2A1TP3G, 2D0FA1, 2D1FA1G, 2D1TP3G, 2G0FA0, 2G0FA0B, 2G1FA0E, 2G1FA0G, 2G1FA0GV, 2G1FABG, 2G1FACG, 2G1FADG, 2G1FADGV, 2G1FAPG, 2G1TP3G, 3A1FA1G, 3D1FA1G, 6FA |                 |         |



|  |  |                 |         |
|--|--|-----------------|---------|
|  |  |                 |         |
| <b>GEV No.</b>   | 104005   | <b>Ref. No.</b> | 34A2000 |
| <b>description</b>   | venturi ø 14.5mm   |                 |         |
| <b>For models:</b>   | 08WFA4E, 090FAA, 0A0FA1, 0A0FA4, 0D0FA1, 0D0FA4, 12WFA6E, 190FA, 190FAA, 190FAB, 190FAD, 191FAAE, 191FAAG, 191FABG, 191FADG, 191FAE, 191FAG, 1A0FA1, 1A0FA2, 1A0FA4, 1A0FA5, 1A1FA1G, 1A1FA2G, 1A1FA4G, 1A1FA5G, 1D0FA1, 1D0FA2, 1D0FA4, 1D0FA5, 1D1FA1G, 1D1FA2G, 1D1FA4G, 1D1FA5G, 290FA, 291FAG, 291FAGF, 291TPCG, 2A0FA1, 2A0FA4, 2A1FA1G, 2A1FA4G, 2A1TP3G, 2A1TP6G, 2D0FA1, 2D0FA4, 2D1FA1G, 2D1FA4G, 2D1TP3G, 2D1TP6G, 391FAG...(Other models you can see in the webshop) |                 |         |

|   |  |                 |                               |
|---|--|-----------------|-------------------------------|
| Serie Alpha (2), Delta (3), Omega (2)   |  |                 |                               |
|  |  |                 |                               |
| <b>GEV No.</b>  | 104740   | <b>Ref. No.</b> | 3019390                       |
| <b>description</b>  | burner cap ø 110mm 7kW   |                 |                               |
| <b>For models:</b>  | 04WFAAV, 08WFA4E, 08WFA4G, 08WFAAE, 08WFAAG, 08WFAAV, 090FAA, 0A0FAA, 0D0FAA, 0G0FA0, 12WFA6E, 12WFA6G, 12WFAAA, 12WFAAE, 12WFAAG, 12WFAAN, 190FA, 190FAA, 190FAB, 190FAD, 191FAAE, 191FAAG, 191FABG, 191FADG, 191FAE, 191FAG, 1A0FAA, 1A0FAB, 1A1FAAG, 1A1FABG, 1D0FAA, 1D0FAB, 1D1FABG, 1G0FA0, 1G0FA0B, 1G1FA0E, 1G1FA0EV, 1G1FA0G, 1G1FA0GV, 1G1FABG, 1G1FAPG, 290FA, 291FAG, 291FAGF, 291TPCG, 2A0FAA, 2A1FAAG, 2A1TPCG, 2D0FAA...(Other models you can see in the webshop) |                 |                               |
| <b>accessories for</b>  | 104740   |                 |                               |
|  |  |                 |                               |
| <b>GEV No.</b>  | 104739   | <b>Ref. No.</b> | 3019380                       |
| <b>description</b>  | burner head for burner cap ø 110mm 7kW   |                 |                               |
|  |  |                 |                               |
| <b>GEV No.</b>  | 108142   | <b>Ref. No.</b> | 6013760<br>6013761<br>6013762 |
| <b>description</b>  | venturi for burner cap ø 110mm suitable for burner 7kW   |                 |                               |

1 gas components

Зип Общепит  
vsezip.ru  
+7(812)987 08 81



|   |   |                 |         |
|---|---|-----------------|---------|
|  |   |                 |         |
| <b>1</b>  |   |                 |         |
| <b>GEV No.</b>  | 104081  | <b>Ref. No.</b> | 3019370 |
| <b>description</b>  | burner cap ø 130mm 10kW   |                 |         |
| <b>For models:</b>  | 04WFAAV, 08WFA4E, 08WFA4G, 08WFAAE, 08WFAAG, 08WFAAV, 090FAA, 0A0FAA, 0D0FAA, 12WFA6E, 12WFA6G, 12WFAAA, 12WFAAE, 12WFAAG, 12WFAAN, 190FA, 190FAA, 190FAB, 191FAAE, 191FAAG, 191FABG, 191FAE, 191FAG, 1A0FAA, 1A0FAB, 1A1FAAG, 1A1FABG, 1D0FAA, 1D0FAB, 1D1FAAG, 1D1FABG, 290FA, 291FAG, 291FAGF, 291TPCG, 2A0FAA, 2A1FAAG, 2A1TPCG, 2D0FAA, 2D1FAAG, 2D1TPCG, 391FAG, 3A1FAAG, 3D1FAAG |                 |         |

|  |  |                 |                                    |
|--|--|-----------------|------------------------------------|
|   |  |                 |                                    |
| <b>1</b>   |  |                 |                                    |
| <b>GEV No.</b>   | 104298   | <b>Ref. No.</b> | 3057610                            |
| <b>description</b>   | burner cap ø 80mm 4kW  |                 |                                    |
| <b>For models:</b>   | 190FA, 190FAD, 191FADG, 191FAE, 191FAG, 1G0FA0, 1G1FA0E, 1G1FA0EV, 1G1FA0G, 1G1FA0GV, 290FA, 291FAG, 291FAGF, 2G0FA0, 2G0FA0A, 2G1FA0E, 2G1FA0G, 2G1FA0GV, 2G1FACG, 2G1FADG, 2G1FADGV, 391FAG, 6FA, 6FA1 |                 |                                    |
| <b>accessories for</b>   | 104298   |                 |                                    |
|   | <b>GEV No.</b>   | 104297          | <b>Ref. No.</b> 3057600            |
| burner head for burner cap ø 80mm 4kW  |  |                 |                                    |
|  | <b>GEV No.</b>   | 108141          | <b>Ref. No.</b> 6020730<br>6020731 |
| venturi for burner cap ø 80mm suitable for burner 4kW                              |  |                 |                                    |

|   |   |                 |   |
|---|---|-----------------|---|
|  |   |                 |   |
| <b>1</b>  |   |                 |   |
| <b>GEV No.</b>  | 104739  | <b>Ref. No.</b> | 3019380                                       |
| <b>description</b>  | burner head for burner cap ø 110mm 7kW  |                 |   |
| <b>For models:</b>  | 04WFAAV, 08WFA4E, 08WFA4G, 08WFAAE, 08WFAAG, 08WFAAV, 090FAA, 0A0FAA, 0D0FAA, 0G0FA0, 12WFA6E, 12WFA6G, 12WFAAA, 12WFAAE, 12WFAAG, 12WFAAN, 190FA, 190FAA, 190FAB, 190FAD, 191FAAE, 191FAAG, 191FABG, 191FADG, 191FAE, 191FAG, 1A0FAA, 1A0FAB, 1A1FAAG, 1A1FABG, 1D0FAA, 1D0FAB, 1D1FAAG, 1D1FABG, 1G0FA0, 1G0FA0B, 1G1FA0E, 1G1FA0EV, 1G1FA0G, 1G1FA0GV, 1G1FABG, 1G1FAPG, 290FA, 291FAG, 291FAGF, 291TPCG, 2A0FAA, 2A1FAAG, 2A1TPCG, 2D0FAA...(Other models you can see in the webshop) |                 |   |
| <b>accessories for</b>  | 104739  |                 |   |
|  | <b>GEV No.</b>  | 104740          | <b>Ref. No.</b> 3019390                       |
| burner cap ø 110mm 7kW  |   |                 |   |
|  | <b>GEV No.</b>  | 108142          | <b>Ref. No.</b> 6013760<br>6013761<br>6013762 |
| venturi for burner cap ø 110mm suitable for burner 7kW                              |   |                 |   |

|   |   |                 |   |
|---|---|-----------------|---|
|  |   |                 |   |
| <b>1</b>  |   |                 |   |
| <b>GEV No.</b>  | 104097  | <b>Ref. No.</b> | 3019360                                       |
| <b>description</b>  | burner head for burner cap ø 130mm 10kW   |                 |   |
| <b>For models:</b>  | 04WFAAV, 08WFA4E, 08WFA4G, 08WFAAE, 08WFAAG, 08WFAAV, 090FAA, 0A0FAA, 0D0FAA, 12WFA6E, 12WFA6G, 12WFAAA, 12WFAAE, 12WFAAG, 12WFAAN, 190FA, 190FAA, 190FAB, 191FAAE, 191FAAG, 191FABG, 191FAE, 191FAG, 1A0FAA, 1A0FAB, 1A1FAAG, 1A1FABG, 1D0FAA, 1D0FAB, 1D1FAAG, 1D1FABG, 290FA, 291FAG, 291FAGF, 291TPCG, 2A0FAA, 2A1FAAG, 2A1TPCG, 2D0FAA, 2D1FAAG, 2D1TPCG, 391FAG, 3A1FAAG, 3D1FAAG |                 |   |
| <b>accessories for</b>  | 104097  |                 |   |
|  | <b>GEV No.</b>  | 104007          | <b>Ref. No.</b> 6014830<br>6014831<br>6014832 |
| burner lower part for burner cap ø 130mm complete with venturi and nozzle holder  |   |                 |   |

|   |  |                 |                                    |
|---|--|-----------------|------------------------------------|
|    |  |                 |                                    |
| <b>1</b>  |  |                 |                                    |
| <b>GEV No.</b>  | 104297   | <b>Ref. No.</b> | 3057600                            |
| <b>description</b>  | burner head for burner cap ø 80mm 4kW  |                 |                                    |
| <b>For models:</b>  | 190FA, 190FAD, 191FADG, 191FAE, 191FAG, 1G0FA0, 1G1FA0E, 1G1FA0EV, 1G1FA0G, 1G1FA0GV, 290FA, 291FAG, 291FAGF, 2G0FA0, 2G0FA0A, 2G1FA0E, 2G1FA0G, 2G1FA0GV, 2G1FACG, 2G1FADG, 2G1FADGV, 391FAG, 6FA, 6FA1 |                 |                                    |
| <b>accessories for</b>  | 104297   |                 |                                    |
|  | <b>GEV No.</b>   | 104298          | <b>Ref. No.</b> 3057610            |
| burner cap ø 80mm 4kW   |  |                 |                                    |
|  | <b>GEV No.</b>   | 108141          | <b>Ref. No.</b> 6020730<br>6020731 |
| venturi for burner cap ø 80mm suitable for burner 4kW                               |  |                 |                                    |

|  |   |                 |                               |
|--|---|-----------------|-------------------------------|
|  |   |                 |                               |
| <b>1</b>   |   |                 |                               |
| <b>GEV No.</b>   | 104007  | <b>Ref. No.</b> | 6014830<br>6014831<br>6014832 |
| <b>description</b>   | burner lower part for burner cap ø 130mm complete with venturi and nozzle holder  |                 |                               |
| <b>For models:</b>   | 04WFAAV, 08WFA4E, 08WFA4G, 08WFAAE, 08WFAAG, 08WFAAV, 090FAA, 0A0FAA, 0D0FAA, 12WFA6E, 12WFA6G, 12WFAAA, 12WFAAE, 12WFAAG, 12WFAAN, 190FA, 190FAA, 190FAB, 191FAAE, 191FAAG, 191FABG, 191FAE, 191FAG, 1A0FAA, 1A0FAB, 1A1FAAG, 1A1FABG, 1D0FAA, 1D0FAB, 1D1FAAG, 1D1FABG, 290FA, 291FAG, 291FAGF, 291TPCG, 2A0FAA, 2A1FAAG, 2A1TPCG, 2D0FAA, 2D1FAAG, 2D1TPCG, 391FAG, 3A1FAAG, 3D1FAAG |                 |                               |
| <b>accessories for</b>   | 104007  |                 |                               |
|   | <b>GEV No.</b>  | 104097          | <b>Ref. No.</b> 3019360       |
| burner head for burner cap ø 130mm 10kW  |   |                 |                               |



Зип Общепит

vsezip.ru



87(812)987-08-81

|   |   |                 |                               |
|---|---|-----------------|-------------------------------|
|  |   |                 |                               |
| 1   |   |                 |                               |
| <b>GEV No.</b>  | 104059  | <b>Ref. No.</b> | 3311911<br>34A2070<br>34A2071 |
| <b>description</b>  | burner lower part for burner cap ø 80/110mm   |                 |                               |
| <b>For models:</b>  | 08WFA4E, 090FAA, 0A0FA1, 0A0FA4, 0D0FA1, 0D0FA4, 0G0FA0, 12WFA6E, 190FA, 190FAA, 190FAB, 190FAD, 191FAAE, 191FAAG, 191FABG, 191FADG, 191FAE, 191FAG, 1A0FA1, 1A0FA2, 1A0FA4, 1A0FA5, 1A1FA1G, 1A1FA2G, 1A1FA4G, 1A1FA5G, 1D0FA1, 1D0FA2, 1D0FA4, 1D0FA5, 1D1FA1G, 1D1FA2G, 1D1FA4G, 1D1FA5G, 1G0FA0, 1G0FA0B, 1G1FA0E, 1G1FA0EV, 1G1FA0G, 1G1FA0GV, 1G1FABG, 1G1FAPG, 290FA, 291FAG, 291FAGF, 291TPCG, 2A0FA1, 2A0FA4, 2A1FA1G, 2A1FA4G...(Other models you can see in the webshop) |                 |                               |

|   |   |                 |         |
|---|---|-----------------|---------|
|  |   |                 |         |
| 1   |   |                 |         |
| <b>GEV No.</b>  | 104006  | <b>Ref. No.</b> | 34A2020 |
| <b>description</b>  | nozzle holder   |                 |         |
| <b>For models:</b>  | 08WFA4E, 090FAA, 0A0FA1, 0A0FA4, 0D0FA1, 0D0FA4, 0G0FA0, 12WFA6E, 190FA, 190FAA, 190FAB, 190FAD, 191FAAE, 191FAAG, 191FABG, 191FADG, 191FAE, 191FAG, 1A0FA1, 1A0FA2, 1A0FA4, 1A0FA5, 1A1FA1G, 1A1FA2G, 1A1FA4G, 1A1FA5G, 1D0FA1, 1D0FA2, 1D0FA4, 1D0FA5, 1D1FA1G, 1D1FA2G, 1D1FA4G, 1D1FA5G, 1G0FA0, 1G0FA0B, 1G1FA0E, 1G1FA0EV, 1G1FA0G, 1G1FA0GV, 1G1FABG, 1G1FAPG, 290FA, 291FAG, 291FAGF, 291TPCG, 2A0FA1, 2A0FA4, 2A1FA1G, 2A1FA4G...(Other models you can see in the webshop) |                 |         |



|   |   |                 |         |
|---|---|-----------------|---------|
|  |   |                 |         |
| 1   |   |                 |         |
| <b>GEV No.</b>  | 532541  | <b>Ref. No.</b> | 3152040 |
| <b>description</b>  | O-ring silicone thickness 1.78mm ID ø 47.35mm Qty 1 pcs   |                 |         |
| <b>For models:</b>  | 04WFAAV, 08WFA4E, 08WFA4G, 08WFAAE, 08WFAAG, 08WFAAV, 090FAA, 0A0FA1, 0A0FA4, 0A0FAA, 0D0FA1, 0D0FA4, 0D0FAA, 0G0FA0, 12WFA6E, 12WFA6G, 12WFAAA, 12WFAAE, 12WFAAG, 12WFAAN, 190FA, 190FAA, 190FAB, 190FAD, 191FAAE, 191FAAG, 191FABG, 191FADG, 191FAE, 191FAG, 1A0FA1, 1A0FA2, 1A0FA4, 1A0FA5, 1A0FAA, 1A0FAB, 1A1FA1G, 1A1FA2G, 1A1FA4G, 1A1FA5G, 1A1FAAG, 1A1FABG, 1D0FA1, 1D0FA2, 1D0FA4, 1D0FA5, 1D0FAB, 1D1FA1G, 1D1FA2G...(Other models you can see in the webshop) |                 |         |

|   |  |                 |                               |
|---|--|-----------------|-------------------------------|
|  |  |                 |                               |
| 1   |  |                 |                               |
| <b>GEV No.</b>  | 108142   | <b>Ref. No.</b> | 6013760<br>6013761<br>6013762 |
| <b>description</b>  | venturi for burner cap ø 110mm suitable for burner 7kW   |                 |                               |
| <b>For models:</b>  | 04WFAAV, 08WFA4E, 08WFA4G, 08WFAAE, 08WFAAG, 08WFAAV, 090FAA, 0A0FAA, 0D0FAA, 12WFA6E, 12WFA6G, 12WFAAA, 12WFAAE, 12WFAAG, 12WFAAN, 190FA, 190FAA, 190FAB, 190FAD, 191FAAE, 191FAAG, 191FABG, 191FADG, 191FAE, 191FAG, 1A0FAA, 1A0FAB, 1A1FAAG, 1A1FABG, 1D0FAA, 1D0FAB, 1D1FAAG, 1D1FABG, 290FA, 291FAG, 291FAGF, 291TPCG, 2A0FAA, 2A1FAAG, 2A1TPCG, 2D0FAA, 2D1FAAG, 2D1TPCG, 391FAG, 3A1FAAG, 3D1FAAG |                 |                               |
| <b>accessories for</b>  | 108142   |                 |                               |
|  | <b>GEV No.</b>   | 104739          | <b>Ref. No.</b>               |
|   |  |                 | 3019380                       |
|   | burner head for burner cap ø 110mm 7kW   |                 |                               |
|  | <b>GEV No.</b>   | 104740          | <b>Ref. No.</b>               |
|   |  |                 | 3019390                       |
|   | burner cap ø 110mm 7kW   |                 |                               |

|   |   |                 |                    |
|---|---|-----------------|--------------------|
|  |   |                 |                    |
| 1   |   |                 |                    |
| <b>GEV No.</b>  | 108141  | <b>Ref. No.</b> | 6020730<br>6020731 |
| <b>description</b>  | venturi for burner cap ø 80mm suitable for burner 4kW   |                 |                    |
| <b>For models:</b>  | 190FA, 190FAD, 191FADG, 191FAE, 191FAG, 1G0FA0, 1G1FA0E, 1G1FA0EV, 1G1FA0G, 1G1FA0GV, 290FA, 291FAG, 291FAGF, 2G0FA0, 2G0FA0A, 2G1FA0E, 2G1FA0G, 2G1FA0GV, 2G1FACG, 2G1FADG, 2G1FADGV, 391FAG |                 |                    |
| <b>accessories for</b>  | 108141  |                 |                    |
|  | <b>GEV No.</b>  | 104297          | <b>Ref. No.</b>    |
|   |   |                 | 3057600            |
|   | burner head for burner cap ø 80mm 4kW   |                 |                    |
|  | <b>GEV No.</b>  | 104298          | <b>Ref. No.</b>    |
|   |   |                 | 3057610            |
|   | burner cap ø 80mm 4kW   |                 |                    |

|   |  |                 |         |
|---|--|-----------------|---------|
|  |  |                 |         |
| 1   |  |                 |         |
| <b>GEV No.</b>  | 104058   | <b>Ref. No.</b> | 3057620 |
| <b>description</b>  | venturi ø 11mm   |                 |         |
| <b>For models:</b>  | 190FA, 190FAD, 191FADG, 191FAE, 191FAG, 1G0FA0, 1G1FA0E, 1G1FA0EV, 1G1FA0G, 1G1FA0GV, 290FA, 291FAG, 291FAGF, 2G0FA0, 2G0FA0A, 2G1FA0E, 2G1FA0G, 2G1FA0GV, 2G1FACG, 2G1FADG, 2G1FADGV, 391FAG, 6FA, 6FA1 |                 |         |

|   |  |                 |         |
|---|--|-----------------|---------|
|  |  |                 |         |
| 1   |  |                 |         |
| <b>GEV No.</b>  | 104005   | <b>Ref. No.</b> | 34A2000 |
| <b>description</b>  | venturi ø 14.5mm   |                 |         |
| <b>For models:</b>  | 08WFA4E, 090FAA, 0A0FA1, 0A0FA4, 0D0FA1, 0D0FA4, 12WFA6E, 190FA, 190FAA, 190FAB, 190FAD, 191FAAE, 191FAAG, 191FABG, 191FADG, 191FAE, 191FAG, 1A0FA1, 1A0FA2, 1A0FA4, 1A0FA5, 1A1FA1G, 1A1FA2G, 1A1FA4G, 1A1FA5G, 1D0FA1, 1D0FA2, 1D0FA4, 1D0FA5, 1D1FA1G, 1D1FA2G, 1D1FA4G, 1D1FA5G, 290FA, 291FAG, 291FAGF, 291TPCG, 2A0FA1, 2A0FA4, 2A1FA1G, 2A1FA4G, 2A1TP3G, 2A1TP6G, 2D0FA1, 2D0FA4, 2D1FA1G, 2D1FA4G, 2D1TP3G, 2D1TP6G, 391FAG...(Other models you can see in the webshop) |                 |         |

|   |   |                 |                 |
|---|---|-----------------|-----------------|
| <b>Combi, Junior (1), Major series</b>  |   |                 |                 |
|  |   |                 |                 |
| 1   |   |                 |                 |
| <b>GEV No.</b>  | 103014  | <b>Ref. No.</b> | 34A0050         |
| <b>description</b>  | burner cap ø 110mm  |                 |                 |
| <b>accessories for</b>  | 103014  |                 |                 |
|  | <b>GEV No.</b>  | 104018          | <b>Ref. No.</b> |
|   |   |                 | 36D0070         |
|   | burner holder for burner cap ø 60/90/110mm with nozzle holder gas inlet M20x1.5 |                 |                 |
|  | <b>GEV No.</b>  | 104026          | <b>Ref. No.</b> |
|   |   |                 | 34A0090         |
|   | burner head for burner cap ø 110mm  |                 |                 |

1 gas components

Зип Общепит

|                |        |                 |         |
|----------------|--------|-----------------|---------|
| <b>GEV No.</b> | 103010 | <b>Ref. No.</b> | 34A0070 |
|----------------|--------|-----------------|---------|

**description** burner cap ø 60mm

**accessories for** 103010

|                |        |                 |         |
|----------------|--------|-----------------|---------|
| <b>GEV No.</b> | 104017 | <b>Ref. No.</b> | 36D0060 |
|----------------|--------|-----------------|---------|

**description** burner holder with nozzle holder gas inlet 1/4"

|                |        |                 |         |
|----------------|--------|-----------------|---------|
| <b>GEV No.</b> | 104024 | <b>Ref. No.</b> | 34A0060 |
|----------------|--------|-----------------|---------|

**description** burner head for burner cap ø 60mm

|                        |  |                 |                               |
|------------------------|--|-----------------|-------------------------------|
| <b>GEV No.</b>         | 103015   | <b>Ref. No.</b> | 34A1130<br>34A1131<br>34A1133 |
| <b>description</b>     | burner cap ø 110mm   |                 |                               |
| <b>For models:</b>     | 030, 031, 032, 0712D, 071D, 071DGG, 072D, 072DGG, 091, 091GG, 092, 092GG, 092VA, 092VAGG, 1A0FAS, 1B0FAS, 1B1FASG, 1D0FAS, 1D1FASG, 2A0FAS2, 2A1FAS2G, 2D0FAS2, 2D1FAS2G, 2D1FASG, 31, 31GE, 31TC, 32, 32TC, 32TP, 32TPV, 32V, 3D1FASG, 712D, 71D, 71DGG, 71GE, 71GEGG, 72D, 72DGG, 72VA, 72VAGG, 72VAS, 72VASGG, 73D, 73DGG, 73VA, 73VAD, 73VADGG, 73VAGG |                 |                               |
| <b>accessories for</b> | 103015   |                 |                               |
| <b>GEV No.</b>         | 104015   | <b>Ref. No.</b> | 34A1110                       |
| <b>description</b>     | burner head for burner cap ø 110mm   |                 |                               |
| <b>GEV No.</b>         | 104018   | <b>Ref. No.</b> | 36D0070                       |
| <b>description</b>     | burner holder for burner cap ø 60/90/110mm with nozzle holder gas inlet M20x1.5  |                 |                               |

|                    |                                      |                 |         |
|--------------------|--------------------------------------|-----------------|---------|
| <b>GEV No.</b>     | 103056                               | <b>Ref. No.</b> | 34A0540 |
| <b>description</b> | burner cap ø 119mm with central hole |                 |         |

|                        |  |                 |                    |
|------------------------|--|-----------------|--------------------|
| <b>GEV No.</b>         | 103016   | <b>Ref. No.</b> | 34A1140<br>34A1141 |
| <b>description</b>     | burner cap ø 140mm   |                 |                    |
| <b>For models:</b>     | 070D, 070DGG, 0712D, 0712VA, 071D, 071DGG, 072D, 072DGG, 090, 090GG, 091, 091GG, 092, 092GG, 092VA, 092VAGG, 0A0FAS, 0B0FAS, 0D0FAS, 1A0FAS, 1A0FAS2, 1A1FAS2G, 1A1FASG, 1B0FAS, 1B0FAS2, 1B1FAS2G, 1B1FASG, 1D0FAS, 1D0FAS2, 1D1FAS2G, 1D1FASG, 2A0FAS2, 2A1FAS2G, 2A1FASG, 2A1TPSG, 2D0FAS2, 2D1FAS2G, 2D1FASG, 2D1TPSG, 3A1FASG, 3D1FASG, 712D, 712VA, 71D, 71DGG, 71GE, 71GEGG, 72D, 72DGG, 72TP...(Other models you can see in the webshop) |                 |                    |
| <b>accessories for</b> | 103016   |                 |                    |
| <b>GEV No.</b>         | 104016   | <b>Ref. No.</b> | 34A1090<br>34A6760 |
| <b>description</b>     | burner head for burner cap ø 140mm   |                 |                    |
| <b>GEV No.</b>         | 104019   | <b>Ref. No.</b> | 36D1230            |
| <b>description</b>     | burner holder for burner cap ø 140mm gas inlet M20x1.5   |                 |                    |
| <b>GEV No.</b>         | 104022   | <b>Ref. No.</b> | 34A1401            |
| <b>description</b>     | burner head ø 139.5mm seat ø 122.8mm for burner cap ø 140mm int. ø 192.8mm int. ø 285.2mm  |                 |                    |
| <b>GEV No.</b>         | 104023   | <b>Ref. No.</b> | 36D2771            |
| <b>description</b>     | burner holder seat ø 35mm with nozzle holder   |                 |                    |

|                        |  |                 |  |
|------------------------|--|-----------------|--|
| <b>GEV No.</b>         | 103013   | <b>Ref. No.</b> | 34A0740<br>34A1120<br>34A1121<br>34A1123 |
| <b>description</b>     | burner cap ø 90mm  |                 |  |
| <b>For models:</b>     | 030, 031, 032, 070D, 070DGG, 0712D, 0712VA, 071D, 071DGG, 072D, 072DGG, 090, 090GG, 091, 091GG, 092, 092GG, 092VA, 092VAGG, 0A0FAS, 0B0FAS, 0D0FAS, 1A0FAS, 1A0FAS2, 1A1FAS2G, 1A1FASG, 1B0FAS, 1B0FAS2, 1B1FAS2G, 1B1FASG, 1D0FAS, 1D0FAS2, 1D1FAS2G, 1D1FASG, 2A0FAS2, 2A1FAS2G, 2A1FASG, 2A1TPSG, 2D0FAS2, 2D1FAS2G, 2D1FASG, 2D1TPSG, 31, 31GE, 31TC, 32, 32TC, 32TP, 32TPV, 32V...(Other models you can see in the webshop) |                 |  |
| <b>accessories for</b> | 103013   |                 |  |
| <b>GEV No.</b>         | 104014   | <b>Ref. No.</b> | 34A1100                                  |
| <b>description</b>     | burner head for burner cap ø 90mm  |                 |  |
| <b>GEV No.</b>         | 104018   | <b>Ref. No.</b> | 36D0070                                  |
| <b>description</b>     | burner holder for burner cap ø 60/90/110mm with nozzle holder gas inlet M20x1.5  |                 |  |

|                        |   |                 |                    |
|------------------------|---|-----------------|--------------------|
| <b>GEV No.</b>         | 103011  | <b>Ref. No.</b> | 34A0750<br>34A1580 |
| <b>description</b>     | burner cap ø 60mm   |                 |                    |
| <b>accessories for</b> | 103011  |                 |                    |
| <b>GEV No.</b>         | 104013  | <b>Ref. No.</b> | 34A0570            |
| <b>description</b>     | burner head for burner cap ø 60mm   |                 |                    |
| <b>GEV No.</b>         | 104018  | <b>Ref. No.</b> | 36D0070            |
| <b>description</b>     | burner holder for burner cap ø 60/90/110mm with nozzle holder gas inlet M20x1.5 |                 |                    |

|                        |   |                 |         |
|------------------------|---|-----------------|---------|
| <b>GEV No.</b>         | 103012  | <b>Ref. No.</b> | 34A0040 |
| <b>description</b>     | burner cap ø 90mm   |                 |         |
| <b>accessories for</b> | 103012  |                 |         |
| <b>GEV No.</b>         | 104018  | <b>Ref. No.</b> | 36D0070 |
| <b>description</b>     | burner holder for burner cap ø 60/90/110mm with nozzle holder gas inlet M20x1.5 |                 |         |
| <b>GEV No.</b>         | 104025  | <b>Ref. No.</b> | 34A0080 |
| <b>description</b>     | burner head for burner cap ø 90mm   |                 |         |

|                        |  |                 |  |
|------------------------|--|-----------------|--|
| <b>GEV No.</b>         | 103013   | <b>Ref. No.</b> | 34A0740<br>34A1120<br>34A1121<br>34A1123 |
| <b>description</b>     | burner cap ø 90mm  |                 |  |
| <b>For models:</b>     | 030, 031, 032, 070D, 070DGG, 0712D, 0712VA, 071D, 071DGG, 072D, 072DGG, 090, 090GG, 091, 091GG, 092, 092GG, 092VA, 092VAGG, 0A0FAS, 0B0FAS, 0D0FAS, 1A0FAS, 1A0FAS2, 1A1FAS2G, 1A1FASG, 1B0FAS, 1B0FAS2, 1B1FAS2G, 1B1FASG, 1D0FAS, 1D0FAS2, 1D1FAS2G, 1D1FASG, 2A0FAS2, 2A1FAS2G, 2A1FASG, 2A1TPSG, 2D0FAS2, 2D1FAS2G, 2D1FASG, 2D1TPSG, 31, 31GE, 31TC, 32, 32TC, 32TP, 32TPV, 32V...(Other models you can see in the webshop) |                 |  |
| <b>accessories for</b> | 103013   |                 |  |
| <b>GEV No.</b>         | 104014   | <b>Ref. No.</b> | 34A1100                                  |
| <b>description</b>     | burner head for burner cap ø 90mm  |                 |  |
| <b>GEV No.</b>         | 104018   | <b>Ref. No.</b> | 36D0070                                  |
| <b>description</b>     | burner holder for burner cap ø 60/90/110mm with nozzle holder gas inlet M20x1.5  |                 |  |



Table continues overleaf









Зип Общепит  
vsezip.ru

+7(812)987-08-81

| <b>accessories for</b> 103013   |   |          |         |          |         |  |  |  |  |
|---|---|----------|---------|----------|---------|--|--|--|--|
|  | <table border="1"> <tr> <th>GEV No.</th> <th>104020</th> <th>Ref. No.</th> <th>34A1380</th> </tr> <tr> <td colspan="4">burner head for burner cap ø 90mm</td> </tr> </table>            | GEV No.  | 104020  | Ref. No. | 34A1380 | burner head for burner cap ø 90mm            |  |  |  |
| GEV No.   | 104020  | Ref. No. | 34A1380 |          |         |  |  |  |  |
| burner head for burner cap ø 90mm   |   |          |         |          |         |  |  |  |  |
|  | <table border="1"> <tr> <th>GEV No.</th> <th>104023</th> <th>Ref. No.</th> <th>36D2771</th> </tr> <tr> <td colspan="4">burner holder seat ø 35mm with nozzle holder</td> </tr> </table> | GEV No.  | 104023  | Ref. No. | 36D2771 | burner holder seat ø 35mm with nozzle holder |  |  |  |
| GEV No.   | 104023  | Ref. No. | 36D2771 |          |         |  |  |  |  |
| burner holder seat ø 35mm with nozzle holder                                      |   |          |         |          |         |  |  |  |  |

|   |                                     |                 |         |
|---|-------------------------------------|-----------------|---------|
|  |                                     |                 |         |
| 1   |                                     |                 |         |
| <b>GEV No.</b>  | 103055                              | <b>Ref. No.</b> | 34A0530 |
| <b>description</b>  | burner cap ø 95mm with central hole |                 |         |

|   |                                    |                 |         |
|---|------------------------------------|-----------------|---------|
|  |                                    |                 |         |
| 1   |                                    |                 |         |
| <b>GEV No.</b>  | 104015                             | <b>Ref. No.</b> | 34A1110 |
| <b>description</b>  | burner head for burner cap ø 110mm |                 |         |



|   |  |                 |         |          |         |   |  |  |  |
|---|--|-----------------|---------|----------|---------|---|--|--|--|
| 1   |  |                 |         |          |         |   |  |  |  |
| <b>GEV No.</b>  | 104026   | <b>Ref. No.</b> | 34A0090 |          |         |   |  |  |  |
| <b>description</b>  | burner head for burner cap ø 110mm   |                 |         |          |         |   |  |  |  |
| <b>accessories for</b>  | 104026   |                 |         |          |         |   |  |  |  |
|  | <table border="1"> <tr> <th>GEV No.</th> <th>103014</th> <th>Ref. No.</th> <th>34A0050</th> </tr> <tr> <td colspan="4">burner cap ø 110mm</td> </tr> </table>  | GEV No.         | 103014  | Ref. No. | 34A0050 | burner cap ø 110mm  |  |  |  |
| GEV No.   | 103014   | Ref. No.        | 34A0050 |          |         |   |  |  |  |
| burner cap ø 110mm  |  |                 |         |          |         |   |  |  |  |
|  | <table border="1"> <tr> <th>GEV No.</th> <th>104018</th> <th>Ref. No.</th> <th>36D0070</th> </tr> <tr> <td colspan="4">burner holder for burner cap ø 60/90/110mm with nozzle holder gas inlet M20x1.5</td> </tr> </table> | GEV No.         | 104018  | Ref. No. | 36D0070 | burner holder for burner cap ø 60/90/110mm with nozzle holder gas inlet M20x1.5 |  |  |  |
| GEV No.   | 104018   | Ref. No.        | 36D0070 |          |         |   |  |  |  |
| burner holder for burner cap ø 60/90/110mm with nozzle holder gas inlet M20x1.5     |  |                 |         |          |         |   |  |  |  |



|   |                                    |                 |                    |
|---|------------------------------------|-----------------|--------------------|
|  |                                    |                 |                    |
| 1   |                                    |                 |                    |
| <b>GEV No.</b>  | 104016                             | <b>Ref. No.</b> | 34A1090<br>34A6760 |
| <b>description</b>  | burner head for burner cap ø 140mm |                 |                    |

|   |                                   |                 |         |
|---|-----------------------------------|-----------------|---------|
|  |                                   |                 |         |
| 1   |                                   |                 |         |
| <b>GEV No.</b>  | 104013                            | <b>Ref. No.</b> | 34A0570 |
| <b>description</b>  | burner head for burner cap ø 60mm |                 |         |

|  |  |                 |         |          |         |   |  |  |  |
|---|--|-----------------|---------|----------|---------|---|--|--|--|
| 1   |  |                 |         |          |         |   |  |  |  |
| <b>GEV No.</b>  | 104024   | <b>Ref. No.</b> | 34A0060 |          |         |   |  |  |  |
| <b>description</b>  | burner head for burner cap ø 60mm  |                 |         |          |         |   |  |  |  |
| <b>accessories for</b>  | 104024   |                 |         |          |         |   |  |  |  |
|  | <table border="1"> <tr> <th>GEV No.</th> <th>104018</th> <th>Ref. No.</th> <th>36D0070</th> </tr> <tr> <td colspan="4">burner holder for burner cap ø 60/90/110mm with nozzle holder gas inlet M20x1.5</td> </tr> </table> | GEV No.         | 104018  | Ref. No. | 36D0070 | burner holder for burner cap ø 60/90/110mm with nozzle holder gas inlet M20x1.5 |  |  |  |
| GEV No.   | 104018   | Ref. No.        | 36D0070 |          |         |   |  |  |  |
| burner holder for burner cap ø 60/90/110mm with nozzle holder gas inlet M20x1.5   |  |                 |         |          |         |   |  |  |  |

|    |  |                 |  |          |  |   |  |  |  |
|---|--|-----------------|--|----------|--|---|--|--|--|
| 1   |  |                 |  |          |  |   |  |  |  |
| <b>GEV No.</b>  | 104014   | <b>Ref. No.</b> | 34A1100                                  |          |  |   |  |  |  |
| <b>description</b>  | burner head for burner cap ø 90mm  |                 |  |          |  |   |  |  |  |
| <b>accessories for</b>  | 104014   |                 |  |          |  |   |  |  |  |
|    | <table border="1"> <tr> <th>GEV No.</th> <th>103013</th> <th>Ref. No.</th> <th>34A0740<br/>34A1120<br/>34A1121<br/>34A1123</th> </tr> <tr> <td colspan="4">burner cap ø 90mm</td> </tr> </table>                           | GEV No.         | 103013                                   | Ref. No. | 34A0740<br>34A1120<br>34A1121<br>34A1123 | burner cap ø 90mm   |  |  |  |
| GEV No.   | 103013   | Ref. No.        | 34A0740<br>34A1120<br>34A1121<br>34A1123 |          |  |   |  |  |  |
| burner cap ø 90mm   |  |                 |  |          |  |   |  |  |  |
|  | <table border="1"> <tr> <th>GEV No.</th> <th>104018</th> <th>Ref. No.</th> <th>36D0070</th> </tr> <tr> <td colspan="4">burner holder for burner cap ø 60/90/110mm with nozzle holder gas inlet M20x1.5</td> </tr> </table> | GEV No.         | 104018                                   | Ref. No. | 36D0070                                  | burner holder for burner cap ø 60/90/110mm with nozzle holder gas inlet M20x1.5 |  |  |  |
| GEV No.   | 104018   | Ref. No.        | 36D0070                                  |          |  |   |  |  |  |
| burner holder for burner cap ø 60/90/110mm with nozzle holder gas inlet M20x1.5     |  |                 |  |          |  |   |  |  |  |

|  |  |                 |         |          |         |   |  |  |  |
|---|--|-----------------|---------|----------|---------|---|--|--|--|
| 1   |  |                 |         |          |         |   |  |  |  |
| <b>GEV No.</b>  | 104025   | <b>Ref. No.</b> | 34A0080 |          |         |   |  |  |  |
| <b>description</b>  | burner head for burner cap ø 90mm  |                 |         |          |         |   |  |  |  |
| <b>accessories for</b>  | 104025   |                 |         |          |         |   |  |  |  |
|  | <table border="1"> <tr> <th>GEV No.</th> <th>103012</th> <th>Ref. No.</th> <th>34A0040</th> </tr> <tr> <td colspan="4">burner cap ø 90mm</td> </tr> </table>   | GEV No.         | 103012  | Ref. No. | 34A0040 | burner cap ø 90mm   |  |  |  |
| GEV No.   | 103012   | Ref. No.        | 34A0040 |          |         |   |  |  |  |
| burner cap ø 90mm   |  |                 |         |          |         |   |  |  |  |
|  | <table border="1"> <tr> <th>GEV No.</th> <th>104018</th> <th>Ref. No.</th> <th>36D0070</th> </tr> <tr> <td colspan="4">burner holder for burner cap ø 60/90/110mm with nozzle holder gas inlet M20x1.5</td> </tr> </table> | GEV No.         | 104018  | Ref. No. | 36D0070 | burner holder for burner cap ø 60/90/110mm with nozzle holder gas inlet M20x1.5 |  |  |  |
| GEV No.   | 104018   | Ref. No.        | 36D0070 |          |         |   |  |  |  |
| burner holder for burner cap ø 60/90/110mm with nozzle holder gas inlet M20x1.5     |  |                 |         |          |         |   |  |  |  |

|  |   |                 |                    |          |                    |                    |  |  |  |
|---|---|-----------------|--------------------|----------|--------------------|--------------------|--|--|--|
| 1   |   |                 |                    |          |                    |                    |  |  |  |
| <b>GEV No.</b>  | 104019  | <b>Ref. No.</b> | 36D1230            |          |                    |                    |  |  |  |
| <b>description</b>  | burner holder for burner cap ø 140mm gas inlet M20x1.5  |                 |                    |          |                    |                    |  |  |  |
| <b>accessories for</b>  | 104019  |                 |                    |          |                    |                    |  |  |  |
|  | <table border="1"> <tr> <th>GEV No.</th> <th>103016</th> <th>Ref. No.</th> <th>34A1140<br/>34A1141</th> </tr> <tr> <td colspan="4">burner cap ø 140mm</td> </tr> </table> | GEV No.         | 103016             | Ref. No. | 34A1140<br>34A1141 | burner cap ø 140mm |  |  |  |
| GEV No.   | 103016  | Ref. No.        | 34A1140<br>34A1141 |          |                    |                    |  |  |  |
| burner cap ø 140mm  |   |                 |                    |          |                    |                    |  |  |  |



|  |   |                 |                    |          |                    |                    |  |  |  |
|---|---|-----------------|--------------------|----------|--------------------|--------------------|--|--|--|
| 1   |   |                 |                    |          |                    |                    |  |  |  |
| <b>GEV No.</b>  | 104019  | <b>Ref. No.</b> | 36D1230            |          |                    |                    |  |  |  |
| <b>description</b>  | burner holder for burner cap ø 140mm gas inlet M20x1.5  |                 |                    |          |                    |                    |  |  |  |
| <b>accessories for</b>  | 104019  |                 |                    |          |                    |                    |  |  |  |
|  | <table border="1"> <tr> <th>GEV No.</th> <th>103016</th> <th>Ref. No.</th> <th>34A1140<br/>34A1141</th> </tr> <tr> <td colspan="4">burner cap ø 140mm</td> </tr> </table> | GEV No.         | 103016             | Ref. No. | 34A1140<br>34A1141 | burner cap ø 140mm |  |  |  |
| GEV No.   | 103016  | Ref. No.        | 34A1140<br>34A1141 |          |                    |                    |  |  |  |
| burner cap ø 140mm  |   |                 |                    |          |                    |                    |  |  |  |

Table continues overleaf

Зип-Общепит

Delta, Omega 2, Omega, Senior series

vsezip.ru

+7(812)987-08-81

1 gas components

|   |                |        |                                    |
|---|----------------|--------|------------------------------------|
| <b>accessories for</b>  | 104019         |        |                                    |
|  | <b>GEV No.</b> | 104016 | <b>Ref. No.</b> 34A1090<br>34A6760 |
| burner head for burner cap ø 140mm  |                |        |                                    |

|  |        |                 |         |
|--|--------|-----------------|---------|
|                   | 1      |                 |         |
| <b>GEV No.</b>   | 104018 | <b>Ref. No.</b> | 36D0070 |
| <b>description</b> burner holder for burner cap ø 60/90/110mm with nozzle holder gas inlet M20x1.5 |        |                 |         |

|   |                |        |                         |
|---|----------------|--------|-------------------------|
| <b>accessories for</b>  | 104018         |        |                         |
|  | <b>GEV No.</b> | 103012 | <b>Ref. No.</b> 34A0040 |
| burner cap ø 90mm   |                |        |                         |

|   |                |        |  |
|---|----------------|--------|--|
|  | <b>GEV No.</b> | 103013 | <b>Ref. No.</b> 34A0740<br>34A1120<br>34A1121<br>34A1123 |
| burner cap ø 90mm   |                |        |  |

|   |                |        |                         |
|---|----------------|--------|-------------------------|
|  | <b>GEV No.</b> | 103014 | <b>Ref. No.</b> 34A0050 |
| burner cap ø 110mm  |                |        |                         |

|  |                |        |   |
|--|----------------|--------|---|
|  | <b>GEV No.</b> | 103015 | <b>Ref. No.</b> 34A1130<br>34A1131<br>34A1133 |
| burner cap ø 110mm   |                |        |   |

|   |                |        |                         |
|---|----------------|--------|-------------------------|
|  | <b>GEV No.</b> | 104014 | <b>Ref. No.</b> 34A1100 |
| burner head for burner cap ø 90mm   |                |        |                         |

|   |                |        |                         |
|---|----------------|--------|-------------------------|
|  | <b>GEV No.</b> | 104025 | <b>Ref. No.</b> 34A0080 |
| burner head for burner cap ø 90mm   |                |        |                         |

|   |                |        |                         |
|---|----------------|--------|-------------------------|
|  | <b>GEV No.</b> | 104026 | <b>Ref. No.</b> 34A0090 |
| burner head for burner cap ø 110mm  |                |        |                         |

|   |        |                 |         |
|---|--------|-----------------|---------|
|  | 1      |                 |         |
| <b>GEV No.</b>  | 104017 | <b>Ref. No.</b> | 36D0060 |
| <b>description</b> burner holder with nozzle holder gas inlet 1/4"                  |        |                 |         |

|   |                |        |                         |
|---|----------------|--------|-------------------------|
| <b>accessories for</b>  | 104019         |        |                         |
|  | <b>GEV No.</b> | 104019 | <b>Ref. No.</b> 36D1230 |
| burner holder for burner cap ø 140mm gas inlet M20x1.5                              |                |        |                         |

|  |                |        |                         |
|--|----------------|--------|-------------------------|
|             | <b>GEV No.</b> | 104022 | <b>Ref. No.</b> 34A1401 |
| burner head ø 139.5mm seat ø 122.8mm for burner cap ø 140mm<br>int. ø 1 92.8mm int. ø 2 85.2mm |                |        |                         |

|   |                |        |                         |
|---|----------------|--------|-------------------------|
|  | <b>GEV No.</b> | 104023 | <b>Ref. No.</b> 36D2771 |
| burner holder seat ø 35mm with nozzle holder  |                |        |                         |

|   |                |        |   |
|---|----------------|--------|---|
|  | <b>GEV No.</b> | 103015 | <b>Ref. No.</b> 34A1130<br>34A1131<br>34A1133 |
| <b>description</b> burner cap ø 110mm   |                |        |   |

|   |  |        |                         |
|---|--|--------|-------------------------|
| <b>For models:</b>  | 030, 031, 032, 0712D, 071D, 071DGG, 072D, 072DGG, 091, 091GG, 092, 092GG, 092VA, 092VAGG, 1A0FAS, 1B0FAS, 1B1FASG, 1D0FAS, 1D1FASG, 2A0FAS2, 2A1FAS2G, 2D0FAS2, 2D1FAS2G, 2D1FASG, 31, 31GE, 31TC, 32, 32TC, 32TP, 32TPV, 32V, 3D1FASG, 712D, 71D, 71DGG, 71GE, 71GEGG, 72D, 72DGG, 72VA, 72VAGG, 72VAS, 72VASGG, 73D, 73DGG, 73VA, 73VAD, 73VADGG, 73VAGG |        |                         |
| <b>accessories for</b>  | 103015   |        |                         |
|  | <b>GEV No.</b>   | 104015 | <b>Ref. No.</b> 34A1110 |
| burner head for burner cap ø 110mm  |  |        |                         |

|   |                |        |                         |
|---|----------------|--------|-------------------------|
|  | <b>GEV No.</b> | 104018 | <b>Ref. No.</b> 36D0070 |
| burner holder for burner cap ø 60/90/110mm with nozzle holder gas inlet M20x1.5   |                |        |                         |

|  |        |                 |                    |
|--|--------|-----------------|--------------------|
|  | 1      |                 |                    |
| <b>GEV No.</b>   | 103016 | <b>Ref. No.</b> | 34A1140<br>34A1141 |
| <b>description</b> burner cap ø 140mm  |        |                 |                    |

|   |  |        |                                    |
|---|--|--------|------------------------------------|
| <b>For models:</b>  | 070D, 070DGG, 0712D, 0712VA, 071D, 071DGG, 072D, 072DGG, 090, 090GG, 091, 091GG, 092, 092GG, 092VA, 092VAGG, 0A0FAS, 0B0FAS, 0D0FAS, 1A0FAS, 1A0FAS2, 1A1FAS2G, 1A1FASG, 1B0FAS, 1B0FAS2, 1B1FAS2G, 1B1FASG, 1D0FAS, 1D0FAS2, 1D1FAS2G, 1D1FASG, 2A0FAS2, 2A1FAS2G, 2A1FASG, 2A1TPSG, 2D0FAS2, 2D1FAS2G, 2D1FASG, 2D1TPSG, 3A1FASG, 3D1FASG, 712D, 712VA, 71D, 71DGG, 71GE, 71GEGG, 72D, 72DGG, 72TP...(Other models you can see in the webshop) |        |                                    |
| <b>accessories for</b>  | 103016   |        |                                    |
|  | <b>GEV No.</b>   | 104016 | <b>Ref. No.</b> 34A1090<br>34A6760 |
| burner head for burner cap ø 140mm  |  |        |                                    |

|   |                |        |                         |
|---|----------------|--------|-------------------------|
|  | <b>GEV No.</b> | 104019 | <b>Ref. No.</b> 36D1230 |
| burner holder for burner cap ø 140mm gas inlet M20x1.5                              |                |        |                         |

|  |                |        |                         |
|--|----------------|--------|-------------------------|
|             | <b>GEV No.</b> | 104022 | <b>Ref. No.</b> 34A1401 |
| burner head ø 139.5mm seat ø 122.8mm for burner cap ø 140mm<br>int. ø 1 92.8mm int. ø 2 85.2mm |                |        |                         |

|   |                |        |                         |
|---|----------------|--------|-------------------------|
|  | <b>GEV No.</b> | 104023 | <b>Ref. No.</b> 36D2771 |
| burner holder seat ø 35mm with nozzle holder  |                |        |                         |

|   |        |                 |                    |
|---|--------|-----------------|--------------------|
|  | 1      |                 |                    |
| <b>GEV No.</b>  | 103011 | <b>Ref. No.</b> | 34A0750<br>34A1580 |
| <b>description</b> burner cap ø 60mm  |        |                 |                    |

|   |                |        |                         |
|---|----------------|--------|-------------------------|
| <b>accessories for</b>  | 103011         |        |                         |
|  | <b>GEV No.</b> | 104013 | <b>Ref. No.</b> 34A0570 |
| burner head for burner cap ø 60mm   |                |        |                         |

Table continues overleaf







Зип Общепит



vsezip.ru

+7(812)987-08-81

| accessories for 103011  |   |          |         |          |         |
|---|---|----------|---------|----------|---------|
|  | <table border="1"> <tr> <th>GEV No.</th> <td>104018</td> <th>Ref. No.</th> <td>36D0070</td> </tr> </table> <p>burner holder for burner cap ø 60/90/110mm with nozzle holder gas inlet M20x1.5</p> | GEV No.  | 104018  | Ref. No. | 36D0070 |
| GEV No.   | 104018  | Ref. No. | 36D0070 |          |         |

|  <p>1</p> |  |                 |  |          |         |  |  |
|--|--|-----------------|--|----------|---------|--|--|
| <b>GEV No.</b>   | 103013   | <b>Ref. No.</b> | 34A0740<br>34A1120<br>34A1121<br>34A1123 |          |         |  |  |
| <b>description</b>   | burner cap ø 90mm  |                 |  |          |         |  |  |
| <b>For models:</b>   | 030, 031, 032, 070D, 070DGG, 0712D, 0712VA, 071D, 071DGG, 072D, 072DGG, 090, 090GG, 091, 091GG, 092, 092GG, 092VA, 092VAGG, 0A0FAS, 0B0FAS, 0D0FAS, 1A0FAS, 1A0FAS2, 1A1FAS2G, 1A1FASG, 1B0FAS, 1B0FAS2, 1B1FAS2G, 1B1FASG, 1D0FAS, 1D0FAS2, 1D1FAS2G, 1D1FASG, 2A0FAS2, 2A1FAS2G, 2A1FASG, 2A1TPSG, 2D0FAS2, 2D1FAS2G, 2D1FASG, 2D1TPSG, 31, 31GE, 31TC, 32, 32TC, 32TP, 32TPV, 32V...(Other models you can see in the webshop) |                 |  |          |         |  |  |
| accessories for 103013   |  |                 |  |          |         |  |  |
|           | <table border="1"> <tr> <th>GEV No.</th> <td>104014</td> <th>Ref. No.</th> <td>34A1100</td> </tr> </table> <p>burner head for burner cap ø 90mm</p>  | GEV No.         | 104014                                   | Ref. No. | 34A1100 |  |  |
| GEV No.  | 104014   | Ref. No.        | 34A1100                                  |          |         |  |  |
|           | <table border="1"> <tr> <th>GEV No.</th> <td>104018</td> <th>Ref. No.</th> <td>36D0070</td> </tr> </table> <p>burner holder for burner cap ø 60/90/110mm with nozzle holder gas inlet M20x1.5</p>  | GEV No.         | 104018                                   | Ref. No. | 36D0070 |  |  |
| GEV No.  | 104018   | Ref. No.        | 36D0070                                  |          |         |  |  |
|          | <table border="1"> <tr> <th>GEV No.</th> <td>104020</td> <th>Ref. No.</th> <td>34A1380</td> </tr> </table> <p>burner head for burner cap ø 90mm</p>  | GEV No.         | 104020                                   | Ref. No. | 34A1380 |  |  |
| GEV No.  | 104020   | Ref. No.        | 34A1380                                  |          |         |  |  |
|         | <table border="1"> <tr> <th>GEV No.</th> <td>104023</td> <th>Ref. No.</th> <td>36D2771</td> </tr> </table> <p>burner holder seat ø 35mm with nozzle holder</p>   | GEV No.         | 104023                                   | Ref. No. | 36D2771 |  |  |
| GEV No.  | 104023   | Ref. No.        | 36D2771                                  |          |         |  |  |

|  <p>1</p> |  |                 |                               |          |                               |  |  |
|--|--|-----------------|-------------------------------|----------|-------------------------------|--|--|
| <b>GEV No.</b>   | 104021   | <b>Ref. No.</b> | 34A1390<br>34A1391            |          |                               |  |  |
| <b>description</b>   | burner head for burner cap ø 110mm   |                 |                               |          |                               |  |  |
| <b>For models:</b>   | 030, 031, 032, 0712D, 071D, 071DGG, 072D, 072DGG, 091, 091GG, 092, 092GG, 092VA, 092VAGG, 1A0FAS, 1B0FAS, 1B1FASG, 1D0FAS, 1D1FASG, 2A0FAS2, 2A1FAS2G, 2D0FAS2, 2D1FAS2G, 2D1FASG, 31, 31GE, 31TC, 32, 32TC, 32TP, 32TPV, 32V, 3D1FASG, 712D, 71D, 71DGG, 71GE, 71GEGG, 72D, 72DGG, 72VA, 72VAGG, 72VAS, 72VASGG, 73D, 73DGG, 73VA, 73VAD, 73VADGG, 73VAGG |                 |                               |          |                               |  |  |
| accessories for 104021   |  |                 |                               |          |                               |  |  |
|           | <table border="1"> <tr> <th>GEV No.</th> <td>103015</td> <th>Ref. No.</th> <td>34A1130<br/>34A1131<br/>34A1133</td> </tr> </table> <p>burner cap ø 110mm</p>   | GEV No.         | 103015                        | Ref. No. | 34A1130<br>34A1131<br>34A1133 |  |  |
| GEV No.  | 103015   | Ref. No.        | 34A1130<br>34A1131<br>34A1133 |          |                               |  |  |
|           | <table border="1"> <tr> <th>GEV No.</th> <td>104023</td> <th>Ref. No.</th> <td>36D2771</td> </tr> </table> <p>burner holder seat ø 35mm with nozzle holder</p>   | GEV No.         | 104023                        | Ref. No. | 36D2771                       |  |  |
| GEV No.  | 104023   | Ref. No.        | 36D2771                       |          |                               |  |  |

|  <p>1</p> |   |                 |                    |          |                    |  |  |
|---|---|-----------------|--------------------|----------|--------------------|--|--|
| <b>GEV No.</b>  | 103053  | <b>Ref. No.</b> | 34A1570            |          |                    |  |  |
| <b>description</b>  | burner head for burner cap ø 60mm   |                 |                    |          |                    |  |  |
| accessories for 103053  |   |                 |                    |          |                    |  |  |
|            | <table border="1"> <tr> <th>GEV No.</th> <td>103011</td> <th>Ref. No.</th> <td>34A0750<br/>34A1580</td> </tr> </table> <p>burner cap ø 60mm</p> | GEV No.         | 103011             | Ref. No. | 34A0750<br>34A1580 |  |  |
| GEV No.   | 103011  | Ref. No.        | 34A0750<br>34A1580 |          |                    |  |  |

|  <p>1</p> |  |                 |  |          |  |  |  |
|---|--|-----------------|--|----------|--|--|--|
| <b>GEV No.</b>  | 104020   | <b>Ref. No.</b> | 34A1380                                  |          |  |  |  |
| <b>description</b>  | burner head for burner cap ø 90mm  |                 |  |          |  |  |  |
| <b>For models:</b>  | 030, 031, 032, 070D, 070DGG, 0712D, 0712VA, 071D, 071DGG, 072D, 072DGG, 090, 090GG, 091, 091GG, 092, 092GG, 092VA, 092VAGG, 0A0FAS, 0B0FAS, 0D0FAS, 1A0FAS, 1A0FAS2, 1A1FAS2G, 1A1FASG, 1B0FAS, 1B0FAS2, 1B1FAS2G, 1B1FASG, 1D0FAS, 1D0FAS2, 1D1FAS2G, 1D1FASG, 2A0FAS2, 2A1FAS2G, 2A1FASG, 2A1TPSG, 2D0FAS2, 2D1FAS2G, 2D1FASG, 2D1TPSG, 31, 31GE, 31TC, 32, 32TC, 32TP, 32TPV, 32V...(Other models you can see in the webshop) |                 |  |          |  |  |  |
| accessories for 104020  |  |                 |  |          |  |  |  |
|          | <table border="1"> <tr> <th>GEV No.</th> <td>103013</td> <th>Ref. No.</th> <td>34A0740<br/>34A1120<br/>34A1121<br/>34A1123</td> </tr> </table> <p>burner cap ø 90mm</p>  | GEV No.         | 103013                                   | Ref. No. | 34A0740<br>34A1120<br>34A1121<br>34A1123 |  |  |
| GEV No.   | 103013   | Ref. No.        | 34A0740<br>34A1120<br>34A1121<br>34A1123 |          |  |  |  |
|          | <table border="1"> <tr> <th>GEV No.</th> <td>104023</td> <th>Ref. No.</th> <td>36D2771</td> </tr> </table> <p>burner holder seat ø 35mm with nozzle holder</p>   | GEV No.         | 104023                                   | Ref. No. | 36D2771                                  |  |  |
| GEV No.   | 104023   | Ref. No.        | 36D2771                                  |          |  |  |  |

1 gas components

Зип-Общепит

solid top

vsezip.ru

+7(812)987-08-81



|                    |  |                 |         |
|--------------------|--|-----------------|---------|
| <b>GEV No.</b>     | 104022   | <b>Ref. No.</b> | 34A1401 |
| <b>description</b> | burner head $\phi$ 139.5mm seat $\phi$ 122.8mm for burner cap $\phi$ 140mm int. $\phi$ 192.8mm int. $\phi$ 285.2mm   |                 |         |
| <b>For models:</b> | 070D, 070DGG, 0712D, 0712VA, 071D, 071DGG, 072D, 072DGG, 090, 090GG, 091, 091GG, 092, 092GG, 092VA, 092VAGG, 0A0FAS, 0B0FAS, 0D0FAS, 1A0FAS, 1A0FAS2, 1A1FAS2G, 1A1FASG, 1B0FAS, 1B0FAS2, 1B1FAS2G, 1B1FASG, 1D0FAS, 1D0FAS2, 1D1FAS2G, 1D1FASG, 2A0FAS2, 2A1FAS2G, 2A1FASG, 2A1TPSG, 2D0FAS2, 2D1FAS2G, 2D1FASG, 2D1TPSG, 3A1FASG, 3D1FASG, 712D, 712VA, 71D, 71DGG, 71GE, 71GEGG, 72D, 72DGG, 72TP...(Other models you can see in the webshop) |                 |         |

|                        |   |        |                    |
|------------------------|---|--------|--------------------|
| <b>accessories for</b> | 104022  |        |                    |
|                        | <b>GEV No.</b>                                    | 103016 | <b>Ref. No.</b>    |
|                        |   |        | 34A1140<br>34A1141 |
|                        | burner cap $\phi$ 140mm                           |        |                    |
|                        | <b>GEV No.</b>                                    | 104023 | <b>Ref. No.</b>    |
|                        |   |        | 36D2771            |
|                        | burner holder seat $\phi$ 35mm with nozzle holder |        |                    |



|                    |  |                 |         |
|--------------------|--|-----------------|---------|
| <b>GEV No.</b>     | 104023   | <b>Ref. No.</b> | 36D2771 |
| <b>description</b> | burner holder seat $\phi$ 35mm with nozzle holder  |                 |         |
| <b>For models:</b> | 030, 031, 032, 070D, 070DGG, 0712D, 0712VA, 071D, 071DGG, 072D, 072DGG, 090, 090GG, 091, 091GG, 092, 092GG, 092VA, 092VAGG, 0A0FAS, 0B0FAS, 0D0FAS, 1A0FAS, 1A0FAS2, 1A1FAS2G, 1A1FASG, 1B0FAS, 1B0FAS2, 1B1FAS2G, 1B1FASG, 1D0FAS, 1D0FAS2, 1D1FAS2G, 1D1FASG, 2A0FAS2, 2A1FAS2G, 2A1FASG, 2A1TPSG, 2D0FAS2, 2D1FAS2G, 2D1FASG, 2D1TPSG, 31, 31GE, 31TC, 32, 32TC, 32TP, 32TPV, 32V...(Other models you can see in the webshop) |                 |         |

|                        |  |        |  |
|------------------------|--|--------|--|
| <b>accessories for</b> | 104023   |        |  |
|                        | <b>GEV No.</b>   | 103013 | <b>Ref. No.</b>                          |
|                        |  |        | 34A0740<br>34A1120<br>34A1121<br>34A1123 |
|                        | burner cap $\phi$ 90mm   |        |  |
|                        | <b>GEV No.</b>   | 103015 | <b>Ref. No.</b>                          |
|                        |  |        | 34A1130<br>34A1131<br>34A1133            |
|                        | burner cap $\phi$ 110mm  |        |  |
|                        | <b>GEV No.</b>   | 103016 | <b>Ref. No.</b>                          |
|                        |  |        | 34A1140<br>34A1141                       |
|                        | burner cap $\phi$ 140mm  |        |  |
|                        | <b>GEV No.</b>   | 104020 | <b>Ref. No.</b>                          |
|                        |  |        | 34A1380                                  |
|                        | burner head for burner cap $\phi$ 90mm   |        |  |
|                        | <b>GEV No.</b>   | 104021 | <b>Ref. No.</b>                          |
|                        |  |        | 34A1390<br>34A1391                       |
|                        | burner head for burner cap $\phi$ 110mm  |        |  |
|                        | <b>GEV No.</b>   | 104022 | <b>Ref. No.</b>                          |
|                        |  |        | 34A1401                                  |
|                        | burner head $\phi$ 139.5mm seat $\phi$ 122.8mm for burner cap $\phi$ 140mm int. $\phi$ 192.8mm int. $\phi$ 285.2mm |        |  |



|                    |   |                 |         |
|--------------------|---|-----------------|---------|
| <b>GEV No.</b>     | 105333                                  | <b>Ref. No.</b> | 34A0120 |
| <b>description</b> | round burner $\phi$ 260mm for solid top |                 |         |
| <b>For models:</b> | 071TP, 091TP, 71TP, 72TP, 72TPGG        |                 |         |

pan supports



|                    |                             |                 |         |
|--------------------|-----------------------------|-----------------|---------|
| <b>GEV No.</b>     | 210100                      | <b>Ref. No.</b> | 36A0110 |
| <b>description</b> | pan support W 312mm L 632mm |                 |         |



|                    |   |                 |         |
|--------------------|---|-----------------|---------|
| <b>GEV No.</b>     | 210101  | <b>Ref. No.</b> | 36A2600 |
| <b>description</b> | pan support W 315mm L 315mm for 700                       |                 |         |
| <b>For models:</b> | 030, 031, 032, 31, 31GE, 31TC, 32, 32TC, 32TP, 32TPV, 32V |                 |         |



|                    |  |                 |                    |
|--------------------|--|-----------------|--------------------|
| <b>GEV No.</b>     | 210247   | <b>Ref. No.</b> | 36A4970<br>36A4971 |
| <b>description</b> | pan support W 345mm L 585mm  |                 |                    |
| <b>For models:</b> | 0G0FA0, 1G0FA0, 1G0FA0B, 1G1FA0E, 1G1FA0EV, 1G1FA0G, 1G1FA0GV, 1G1FABG, 1G1FAPG, 2G0FA0, 2G0FA0A, 2G0FA0B, 2G1FA0E, 2G1FA0G, 2G1FA0GV, 2G1FABG, 2G1FACG, 2G1FADG, 2G1FADGV, 2G1FAPG, 2G1TP3G |                 |                    |



Зип Общепит

vsezip.ru

(812) 987 08 81

|  |  |                 |                               |
|--|--|-----------------|-------------------------------|
|  <p>1</p> |  |                 |                               |
| <b>GEV No.</b>   | 210261   | <b>Ref. No.</b> | 36A2001<br>36A2002<br>6029680 |
| <b>description</b>   | pan support W 365mm L 395mm H 75mm   |                 |                               |
| <b>For models:</b>   | 04WFAAV, 08WFA4E, 08WFA4G, 08WFAAE, 08WFAAG, 08WFAAV, 090FAA, 0A0FA1, 0A0FA4, 0A0FAA, 0D0FA1, 0D0FA4, 0D0FAA, 12WFA6E, 12WFA6G, 12WFAAA, 12WFAAE, 12WFAAG, 12WFAAN, 190FA, 190FAA, 190FAB, 190FAD, 191FAAE, 191FAAG, 191FABG, 191FADG, 191FAE, 191FAG, 1A0FA1, 1A0FA2, 1A0FA4, 1A0FA5, 1A0FAA, 1A0FAB, 1A1FA1G, 1A1FA2G, 1A1FA4G, 1A1FA5G, 1A1FAAG, 1A1FABG, 1D0FA1, 1D0FA2, 1D0FA4, 1D0FA5, 1D0FAA, 1D0FAB, 1D1FA1G, 1D1FA2G, 1D1FA4G...(Other models you can see in the webshop) |                 |                               |

|  |   |                 |         |
|--|---|-----------------|---------|
|  <p>2</p> |   |                 |         |
| <b>GEV No.</b>   | 210179  | <b>Ref. No.</b> | 36A2610 |
| <b>description</b>   | pan support W 370mm L 370mm   |                 |         |
| <b>For models:</b>   | 070DGG, 0712D, 0712VA, 071DGG, 072DGG, 090GG, 091GG, 092GG, 092VAGG, 0A0FAS, 0B0FAS, 0D0FAS, 1A0FAS, 1A0FAS2, 1A1FAS2G, 1A1FASG, 1B0FAS, 1B0FAS2, 1B1FAS2G, 1B1FASG, 1D0FAS, 1D0FAS2, 1D1FAS2G, 1D1FASG, 2A0FAS2, 2A1FAS2G, 2A1FASG, 2A1TPSG, 2D0FAS2, 2D1FAS2G, 2D1FASG, 2D1TPSG, 3A1FASG, 3D1FASG, 712D, 712VA, 71DGG, 71GEGG, 72DGG, 72TPGG, 72VAGG, 72VASGG, 73DGG, 73VADGG, 73VAGG |                 |         |

|  |  |                 |                    |
|--|--|-----------------|--------------------|
| <b>reducers for pan supports</b>   |  |                 |                    |
|  <p>1</p> |  |                 |                    |
| <b>GEV No.</b>   | 210005   | <b>Ref. No.</b> | 3012090<br>36A0491 |
| <b>description</b>   | reducer for pan support L 205mm W 205mm chrome-plated steel suitable for ANGELO PO |                 |                    |

|  |   |                 |                    |
|--|---|-----------------|--------------------|
|  <p>1</p> |   |                 |                    |
| <b>GEV No.</b>   | 210006  | <b>Ref. No.</b> | 36A2160<br>36A5450 |
| <b>description</b>   | reducer for pan support L 385mm W 190mm Qty 2 pcs |                 |                    |

|   |  |                 |         |
|---|--|-----------------|---------|
|  <p>1</p> |  |                 |         |
| <b>GEV No.</b>  | 103152   | <b>Ref. No.</b> | 36A0350 |
| <b>description</b>  | burner cap ø 125mm cast iron   |                 |         |
| <b>For models:</b>  | 0712VA, 090FAVA, 092VA, 092VAGG, 0A0FAVA, 0D0FAVA, 190FAB, 191FABG, 1A0FA2, 1A0FA5, 1A0FAB, 1A0FAS2, 1A1FA2G, 1A1FA5G, 1A1FABG, 1A1FAS2G, 1B0FAS2, 1B1FAS2G, 1D0FA2, 1D0FA5, 1D0FAB, 1D0FAS2, 1D1FA2G, 1D1FA5G, 1D1FABG, 1D1FAS2G, 2A0FAS2, 2A1FAS2G, 2D0FAS2, 2D1FAS2G, 712VA, 72VA, 72VAGG, 72VAS, 72VASGG, 73VA, 73VAD, 73VADGG, 73VAGG |                 |         |

|  |   |                 |                    |
|--|---|-----------------|--------------------|
| <b>miscellaneous</b>   |   |                 |                    |
|  <p>1</p> |   |                 |                    |
| <b>GEV No.</b>   | 104324  | <b>Ref. No.</b> | 31V0240<br>31V0241 |
| <b>description</b>   | pin ø 7.4mm L 22mm WS 8 thread M5   |                 |                    |
| <b>For models:</b>   | 04WFAAV, 08WFA4E, 08WFA4G, 08WFAAE, 08WFAAG, 08WFAAV, 090FAA, 0A0FA1, 0A0FA4, 0A0FAA, 0D0FA1, 0D0FA4, 0D0FAA, 0G0FA0, 12WFA6E, 12WFA6G, 12WFAAA, 12WFAAE, 12WFAAG, 12WFAAN, 190FA, 190FAA, 190FAB, 190FAD, 191FAAE, 191FAAG, 191FABG, 191FADG, 191FAE, 191FAG, 1A0FA1, 1A0FA2, 1A0FA4, 1A0FA5, 1A0FAA, 1A0FAB, 1A1FA1G, 1A1FA2G, 1A1FA4G, 1A1FA5G, 1A1FAAG, 1A1FABG, 1D0FA1, 1D0FA2, 1D0FA4, 1D0FA5, 1D0FAA, 1D0FAB, 1D1FA1G, 1D1FA2G...(Other models you can see in the webshop) |                 |                    |

|   |  |                 |                    |
|---|--|-----------------|--------------------|
| <b>accessories</b>  |  |                 |                    |
| <b>reducers for pan supports</b>  |  |                 |                    |
|  <p>1</p> |  |                 |                    |
| <b>GEV No.</b>  | 210005   | <b>Ref. No.</b> | 3012090<br>36A0491 |
| <b>description</b>  | reducer for pan support L 205mm W 205mm chrome-plated steel suitable for ANGELO PO |                 |                    |

|   |   |                 |                    |
|---|---|-----------------|--------------------|
|  <p>1</p> |   |                 |                    |
| <b>GEV No.</b>  | 210006  | <b>Ref. No.</b> | 36A2160<br>36A5450 |
| <b>description</b>  | reducer for pan support L 385mm W 190mm Qty 2 pcs |                 |                    |

1 gas components

pan supports



1

|                    |                             |                 |         |
|--------------------|-----------------------------|-----------------|---------|
| <b>GEV No.</b>     | 210100                      | <b>Ref. No.</b> | 36A0110 |
| <b>description</b> | pan support W 312mm L 632mm |                 |         |



1

|                    |   |                 |         |
|--------------------|---|-----------------|---------|
| <b>GEV No.</b>     | 210101  | <b>Ref. No.</b> | 36A2600 |
| <b>description</b> | pan support W 315mm L 315mm for 700                       |                 |         |
| <b>For models:</b> | 030, 031, 032, 31, 31GE, 31TC, 32, 32TC, 32TP, 32TPV, 32V |                 |         |



1

|                    |  |                 |                    |
|--------------------|--|-----------------|--------------------|
| <b>GEV No.</b>     | 210247   | <b>Ref. No.</b> | 36A4970<br>36A4971 |
| <b>description</b> | pan support W 345mm L 585mm  |                 |                    |
| <b>For models:</b> | 0G0FA0, 1G0FA0, 1G0FA0B, 1G1FA0E, 1G1FA0EV, 1G1FA0G, 1G1FA0GV, 1G1FABG, 1G1FAPG, 2G0FA0, 2G0FA0A, 2G0FA0B, 2G1FA0E, 2G1FA0G, 2G1FA0GV, 2G1FABG, 2G1FACG, 2G1FADG, 2G1FADGV, 2G1FAPG, 2G1TP3G |                 |                    |



1

|                    |  |                 |                               |
|--------------------|--|-----------------|-------------------------------|
| <b>GEV No.</b>     | 210261   | <b>Ref. No.</b> | 36A2001<br>36A2002<br>6029680 |
| <b>description</b> | pan support W 365mm L 395mm H 75mm   |                 |                               |
| <b>For models:</b> | 04WFAAV, 08WFA4E, 08WFA4G, 08WFAAE, 08WFAAG, 08WFAAV, 090FAA, 0A0FA1, 0A0FA4, 0A0FAA, 0D0FA1, 0D0FA4, 0D0FAA, 12WFA6E, 12WFA6G, 12WFAAA, 12WFAAE, 12WFAAG, 12WFAAN, 190FA, 190FAA, 190FAB, 190FAD, 191FAAE, 191FAAG, 191FABG, 191FADG, 191FAE, 191FAG, 1A0FA1, 1A0FA2, 1A0FA4, 1A0FA5, 1A0FAA, 1A0FAB, 1A1FA1G, 1A1FA2G, 1A1FA4G, 1A1FA5G, 1A1FAAG, 1A1FABG, 1D0FA1, 1D0FA2, 1D0FA4, 1D0FA5, 1D0FAA, 1D0FAB, 1D1FA1G, 1D1FA2G, 1D1FA4G...(Other models you can see in the webshop) |                 |                               |

Зип Общепит

vsezip.ru

+7(812)987-08-81



1

|                    |   |                 |         |
|--------------------|---|-----------------|---------|
| <b>GEV No.</b>     | 210179  | <b>Ref. No.</b> | 36A2610 |
| <b>description</b> | pan support W 370mm L 370mm   |                 |         |
| <b>For models:</b> | 070DGG, 0712D, 0712VA, 071DGG, 072DGG, 090GG, 091GG, 092GG, 092VAGG, 0A0FAS, 0B0FAS, 0D0FAS, 1A0FAS, 1A0FAS2, 1A1FAS2G, 1A1FASG, 1B0FAS, 1B0FAS2, 1B1FAS2G, 1B1FASG, 1D0FAS, 1D0FAS2, 1D1FAS2G, 1D1FASG, 2A0FAS2, 2A1FAS2G, 2A1FASG, 2A1TPSG, 2D0FAS2, 2D1FAS2G, 2D1FASG, 2D1TPSG, 3A1FASG, 3D1FASG, 712D, 712VA, 71DGG, 71GEGG, 72DGG, 72TPGG, 72VAGG, 72VASGG, 73DGG, 73VADGG, 73VAGG |                 |         |

air mixers



1

|                    |  |                 |         |
|--------------------|--|-----------------|---------|
| <b>GEV No.</b>     | 102200   | <b>Ref. No.</b> | 36C1210 |
| <b>description</b> | air mixing tube L 27mm D1 ø 24mm D2 ø 20mm ID ø 15mm thickness 2.6mm |                 |         |
| <b>For models:</b> | 0A0GRG, 0D0GRG, 1A0GRG, 1D0GRG                                       |                 |         |

bar burners

bar burners



1

|                    |   |                 |                    |
|--------------------|---|-----------------|--------------------|
| <b>GEV No.</b>     | 104760  | <b>Ref. No.</b> | 34A2520<br>34A2521 |
| <b>description</b> | bar burner 2 row L 370mm W 200mm ømm H 45mm 6kW chargrill |                 |                    |
| <b>For models:</b> | 1G0GRG  |                 |                    |



1

|                    |  |                 |         |
|--------------------|--|-----------------|---------|
| <b>GEV No.</b>     | 105345   | <b>Ref. No.</b> | 34A0350 |
| <b>description</b> | bar burner 2 row L 525mm W 167mm ømm H 50mm pasta cooker               |                 |         |
| <b>For models:</b> | 0A1CP1G, 0B1CP1G, 0D1CP1G, 191CP1G, 1A1CP1G, 1A1CP2G, 1D1CP1G, 1D1CP2G |                 |         |





Зип Общепит  
vsezip.ru

+7(812)987-08-81

|  |  |                 |                               |
|--|--|-----------------|-------------------------------|
|  <p>1</p> |  |                 |                               |
| <b>GEV No.</b>   | 105373   | <b>Ref. No.</b> | 34A2080<br>34A2081<br>34A2082 |
| <b>description</b>   | bar burner 2 row L 560mm W 220mm ømm 9kW chargrill                       |                 |                               |
| <b>For models:</b>   | 08WGRGV, 090GRG, 0A0GRG, 0D0GRG, 190GRG, 1A0GRG, 1D0GRG, 6042120-08WGRGV |                 |                               |

|   |  |                 |         |
|---|--|-----------------|---------|
|  <p>1</p> |  |                 |         |
| <b>GEV No.</b>  | 105334   | <b>Ref. No.</b> | 34A0900 |
| <b>description</b>  | bar burner 4 row L 545mm W 300mm ømm 12kW solid top  |                 |         |
| <b>For models:</b>  | 190TP0, 191TPG, 1A0TP0, 1A1FASG, 1A1TP0G, 1A1TP0G-VERS.2002, 1B0TP0, 1D0TP0, 1D1TP0G, 1D1TP0G-VERS.2002, 291TPCG, 2A1FASG, 2A1TP3G, 2A1TP6G, 2A1TPCG, 2A1TPSG, 2D1TP3G, 2D1TP6G, 2D1TPCG, 2D1TPSG, 3A1FASG |                 |         |

|  |  |                 |         |
|--|--|-----------------|---------|
|  <p>1</p> |  |                 |         |
| <b>GEV No.</b>   | 104163   | <b>Ref. No.</b> | 34A0580 |
| <b>description</b>   | bar burner 2 row L 600mm W 300mm ømm griddle   |                 |         |
| <b>For models:</b>   | 071FT, 071FTR, 071FTRL, 091FT, 091FTR, 091FTRL |                 |         |

|   |  |                 |         |
|---|--|-----------------|---------|
|  <p>1</p> |  |                 |         |
| <b>GEV No.</b>  | 105369   | <b>Ref. No.</b> | 34A0730 |
| <b>description</b>  | bar burner 6 row L 445mm W 620mm ømm tilting bratt pan |                 |         |
| <b>For models:</b>  | 71RA, 91RA   |                 |         |

|   |   |                 |         |
|---|---|-----------------|---------|
|  <p>1</p> |   |                 |         |
| <b>GEV No.</b>  | 105339  | <b>Ref. No.</b> | 34A0110 |
| <b>description</b>  | bar burner 3 row L 460mm W 280mm ømm H 90mm griddle   |                 |         |
| <b>For models:</b>  | 031FT04, 031FT06, 08WFT1GV, 08WFT2GV, 08WFT3GV, 08WFT4GV, 08WFT6GV, 08WFT7GV, 0G0FT1G, 0G0FT1G-VERS.032008, 0G0FT2G, 0G0FT2G-VERS.032008, 0G0FT4G, 0G0FT4G-VERS.032008, 0G0FT5G, 0G0FT5G-VERS.032008, 0G0FT7G, 1G0FT1G, 1G0FT1G-VERS.032008, 1G0FT2G, 1G0FT2G-VERS.032008, 1G0FT3G, 1G0FT3G-VERS.032008, 1G0FT4G, 1G0FT4G-VERS.032008, 1G0FT6E, 1G0FT6G, 1G0FT6G-VERS.032008, 1G0FT7G, 6040560, 6042490, 6042500, 6043200 |                 |         |

|   |  |                 |         |
|---|--|-----------------|---------|
|  <p>1</p> |  |                 |         |
| <b>GEV No.</b>  | 105335   | <b>Ref. No.</b> | 34A1520 |
| <b>description</b>  | bar burner angled L 605mm W 247mm ømm Hmm oven |                 |         |
| <b>For models:</b>  | 31, 31TC, 31TP, 32, 32TC, 32TP, 32TPV, 32V     |                 |         |

|   |   |                 |         |
|---|---|-----------------|---------|
|  <p>1</p> |   |                 |         |
| <b>GEV No.</b>  | 105337  | <b>Ref. No.</b> | 34A1880 |
| <b>description</b>  | bar burner angled L 765mm W 345mm ømm Hmm oven  |                 |         |
| <b>For models:</b>  | 191FAAG, 191FABG, 191FADG, 191TPG, 1A1FA1G, 1A1FA2G, 1A1FA4G, 1A1FASG, 1A1FAAG, 1A1FABG, 1A1FAS2G, 1A1FASG, 1A1TP0G, 1A1TP0G-VERS.2002, 1D1FA1G, 1D1FA2G, 1D1FA4G, 1D1FA5G, 1D1FAAG, 1D1FABG, 1D1FAS2G, 1D1FASG, 1D1TP0G, 1D1TP0G-VERS.2002, 291FAG, 291TPCG, 2A1FA1G, 2A1FA4G, 2A1FAAG, 2A1FAS2G, 2A1FASG, 2A1TP3G, 2A1TP6G, 2A1TPCG, 2A1TPSG, 2D1FA1G, 2D1FA4G, 2D1FAAG, 2D1FAS2G, 2D1FASG, 2D1TP3G, 2D1TP6G, 2D1TPCG, 2D1TPSG, 391FAG, 3A1FA1G, 3A1FA4G, 3A1FAAG, 3A1FASG, 3D1FA1G...(Other models you can see in the webshop) |                 |         |

|  |  |                 |                    |
|--|--|-----------------|--------------------|
|  <p>1</p> |  |                 |                    |
| <b>GEV No.</b>   | 105343   | <b>Ref. No.</b> | 34A1840<br>34A1841 |
| <b>description</b>   | bar burner 3 row L 585mm W 270mm ømm griddle   |                 |                    |
| <b>For models:</b>   | 070FT04, 070FT05, 071FT04, 071FT06, 090FT04, 090FT05, 090FT1G, 090FT2G, 090FT4G, 090FT5G, 090FT7G, 091FT04, 091FT06, 0A0FT1G, 0A0FT2G, 0A0FT4G, 0A0FT5G, 0B0FT1G, 0B0FT2G, 0B0FT4G, 0B0FT5G, 0D0FT1G, 0D0FT2G, 0D0FT4G, 0D0FT5G, 190FT15G, 190FT1G, 190FT2G, 190FT3G, 190FT42G, 190FT4G, 190FT6G, 190FT72G, 190FT7G, 1A0FT1G, 1A0FT2G, 1A0FT3G, 1A0FT4G, 1A0FT6G, 1B0FT1G, 1B0FT2G, 1B0FT3G, 1B0FT4G, 1B0FT6G, 1D0FT1G, 1D0FT2G, 1D0FT3G, 1D0FT4G, 1D0FT6G |                 |                    |

|   |  |                 |         |
|---|--|-----------------|---------|
|  <p>1</p> |  |                 |         |
| <b>GEV No.</b>  | 105279   | <b>Ref. No.</b> | 34A1370 |
| <b>description</b>  | bar burner angled L 770mm W 345mm ømm Hmm oven   |                 |         |
| <b>For models:</b>  | 71D, 71DGG, 71TP, 72D, 72DGG, 72TP, 72TPGG, 72VA, 72VAGG, 72VAS, 72VASGG, 73D, 73DGG, 73VA, 73VAD, 73VADGG, 73VAGG, FS30 |                 |         |

|   |  |                 |                    |
|---|--|-----------------|--------------------|
|  <p>1</p> |  |                 |                    |
| <b>GEV No.</b>  | 105304   | <b>Ref. No.</b> | 34A1640<br>34A1641 |
| <b>description</b>  | bar burner ø 27mm Wmm Hmm L 425mm salamander grill |                 |                    |
| <b>For models:</b>  | 60SM   |                 |                    |

Зип Общепит



Image not available

+7(812)987-08-81

|                    |  |                 |         |
|--------------------|--|-----------------|---------|
| 1                  |  |                 |         |
| <b>GEV No.</b>     | 105347                                       | <b>Ref. No.</b> | 34A1510 |
| <b>description</b> | bar burner ø 27mm Wmm Hmm L 440mm bain marie |                 |         |
| <b>For models:</b> | 090BM1G, 0A0BMG, 0D0BMG                      |                 |         |

|                    |                                  |                 |                    |
|--------------------|----------------------------------|-----------------|--------------------|
| 1                  |                                  |                 |                    |
| <b>GEV No.</b>     | 105367                           | <b>Ref. No.</b> | 34A1790<br>34A1793 |
| <b>description</b> | bar burner ømm tilting bratt pan |                 |                    |
| <b>For models:</b> | 1G1BR1G, 31R                     |                 |                    |

|                    |  |                 |         |
|--------------------|--|-----------------|---------|
| 1                  |  |                 |         |
| <b>GEV No.</b>     | 107843   | <b>Ref. No.</b> | 34A0500 |
| <b>description</b> | bar burner ø 50mm L 550mm flange width 57mm flange length 57mm 15kW combi-steamer                        |                 |         |
| <b>For models:</b> | FC241G, FCV241G, FCV241G-CSA, FCV241GDM, FCV241GDM-CSA, FCV241GDS, FCV241GDS-CSA, FCV401DM, FCV401DM-CSA |                 |         |

|                    |                                  |                 |         |
|--------------------|----------------------------------|-----------------|---------|
| 1                  |                                  |                 |         |
| <b>GEV No.</b>     | 105368                           | <b>Ref. No.</b> | 34A1480 |
| <b>description</b> | bar burner ømm tilting bratt pan |                 |         |
| <b>For models:</b> | 71AR, 91AR                       |                 |         |

|                    |   |                 |                      |
|--------------------|---|-----------------|----------------------|
| 1                  |   |                 |                      |
| <b>GEV No.</b>     | 105502  | <b>Ref. No.</b> | 34A1690<br>34A1690-2 |
| <b>description</b> | bar burner ø 50mm Wmm Hmm L 424mm convection oven                         |                 |                      |
| <b>For models:</b> | FC101, FCV101, FCV101-CSA, FCV101DM, FCV101DM-CSA, FCV101DS, FCV101DS-CSA |                 |                      |

|                    |  |                 |         |
|--------------------|--|-----------------|---------|
| 1                  |  |                 |         |
| <b>GEV No.</b>     | 104136   | <b>Ref. No.</b> | 34A0230 |
| <b>description</b> | bar burner ømm W 28mm H 42mm L 335mm flange width 35mm flange length 80mm kettle |                 |         |
| <b>For models:</b> | 71PD10, 71PD15, 71PI10, 71PI10A, 91PI10, 91PI10A                                 |                 |         |

|                    |   |                 |         |
|--------------------|---|-----------------|---------|
| 1                  |   |                 |         |
| <b>GEV No.</b>     | 105697  | <b>Ref. No.</b> | 34A2310 |
| <b>description</b> | bar burner ø 50mm Wmm Hmm L 450mm with bolt M5x12 flange width 65mm flange length 71mm kettle |                 |         |

|                    |  |                 |         |
|--------------------|--|-----------------|---------|
| 1                  |  |                 |         |
| <b>GEV No.</b>     | 104162   | <b>Ref. No.</b> | 34A1461 |
| <b>description</b> | bar burner T-shape L 560mm Wmm ø 40mm solid top  |                 |         |
| <b>For models:</b> | 070FT, 070FTR, 0712VA, 090FAVA, 090FT, 090FTR, 092VA, 092VAGG, 0A0FAVA, 0D0FAVA, 190FAB, 191FABG, 1A0FA2, 1A0FA5, 1A0FAB, 1A0FAS2, 1A1FA2G, 1A1FA5G, 1A1FABG, 1A1FAS2G, 1B0FAS2, 1B1FAS2G, 1D0FA2, 1D0FA5, 1D0FAB, 1D0FAS2, 1D1FA2G, 1D1FA5G, 1D1FABG, 1D1FAS2G, 2A0FAS2, 2A1FAS2G, 2D0FAS2, 2D1FAS2G, 712VA, 72VA, 72VAGG, 72VAS, 72VASGG, 73VA, 73VAD, 73VADGG, 73VAGG |                 |         |

|                    |                                |                 |         |
|--------------------|--------------------------------|-----------------|---------|
| 1                  |                                |                 |         |
| <b>GEV No.</b>     | 105372                         | <b>Ref. No.</b> | 34A1850 |
| <b>description</b> | bar burner ømm kettle          |                 |         |
| <b>For models:</b> | 1G1PD1G, 1G1PI1G, 31PD6, 31PI6 |                 |         |

|                    |   |                 |         |
|--------------------|---|-----------------|---------|
| 1                  |   |                 |         |
| <b>GEV No.</b>     | 105346  | <b>Ref. No.</b> | 34A1450 |
| <b>description</b> | bar burner U-shape L 610mm W 205mm ømm Hmm bain marie |                 |         |
| <b>For models:</b> | 070BM, 071BM, 090BM, 091BM                            |                 |         |







Зип Общежит  
tube burners



vsezip.ru

+7(812)987-08-81



|   |  |                 |                    |
|---|--|-----------------|--------------------|
|  |  |                 |                    |
| 1   |  |                 |                    |
| <b>GEV No.</b>  | 105370   | <b>Ref. No.</b> | 34A1430<br>34A1431 |
| <b>description</b>  | burner ømm tilting bratt pan   |                 |                    |
| <b>For models:</b>  | 1A1BR1G, 1A1BR1GA, 1A1BR2G, 1A1BR2GA, 1D1BR1G, 1D1BR1GA, 1D1BR2G, 1D1BR2GA |                 |                    |

|   |  |                 |                    |
|---|--|-----------------|--------------------|
|  |  |                 |                    |
| 1   |  |                 |                    |
| <b>GEV No.</b>  | 105371   | <b>Ref. No.</b> | 34A1890<br>34A1891 |
| <b>description</b>  | burner ømm tilting bratt pan   |                 |                    |
| <b>For models:</b>  | 2A1BR1G, 2A1BR1GA, 2A1BR2G, 2A1BR2GA, 2D1BR1G, 2D1BR1GA, 2D1BR2G, 2D1BR2GA |                 |                    |

|   |  |                 |                    |
|---|--|-----------------|--------------------|
|  |  |                 |                    |
| 1   |  |                 |                    |
| <b>GEV No.</b>  | 211057   | <b>Ref. No.</b> | 3193150<br>36A5540 |
| <b>description</b>  | lava rock grid L 419mm W 282mm H 23.2mm suitable for ANGELO PO |                 |                    |
| <b>For models:</b>  | 1G0GRG   |                 |                    |

|   |                                       |                 |                         |
|---|---------------------------------------|-----------------|-------------------------|
|  |                                       |                 |                         |
| 1   |                                       |                 |                         |
| <b>GEV No.</b>  | 211000                                | <b>Ref. No.</b> | 36A4230<br>36A5290      |
| <b>description</b>  | lava rock grid L 600mm W 330mm H 22mm |                 |                         |
| <b>For models:</b>  | 0A0GRG, 0D0GRG, 1A0GRG, 1D0GRG        |                 |                         |
| <b>accessories for</b>  | 211000                                |                 |                         |
|  | <b>GEV No.</b>                        | 693000          | <b>Ref. No.</b> 35Y2780 |
| spring for lava rock grid   |                                       |                 |                         |

lava rock grids

|   |                                       |                 |                         |
|---|---------------------------------------|-----------------|-------------------------|
|  |                                       |                 |                         |
| 1   |                                       |                 |                         |
| <b>GEV No.</b>  | 211000                                | <b>Ref. No.</b> | 36A4230<br>36A5290      |
| <b>description</b>  | lava rock grid L 600mm W 330mm H 22mm |                 |                         |
| <b>For models:</b>  | 0A0GRG, 0D0GRG, 1A0GRG, 1D0GRG        |                 |                         |
| <b>accessories for</b>  | 211000                                |                 |                         |
|  | <b>GEV No.</b>                        | 693000          | <b>Ref. No.</b> 35Y2780 |
| spring for lava rock grid   |                                       |                 |                         |

|   |  |                 |                    |
|---|--|-----------------|--------------------|
|  |  |                 |                    |
| 1   |  |                 |                    |
| <b>GEV No.</b>  | 105401   | <b>Ref. No.</b> | 3007720<br>34A2120 |
| <b>description</b>  | burner L 300mm W 75mm H 42mm for fryer   |                 |                    |
| <b>For models:</b>  | 06WFR3GD, 091FR1G, 091FR1GD, 091FR11, 091FR11A, 091FR11D, 091FR11D-VERS.052012, 091FR11-VERS.032012, 091FR3G, 091FR3GD, 0A1FR1GD-VERS.2004, 0A1FR1G-VERS.2004, 0A1FR3G, 0A1FR3GD, 0D1FR1GD-VERS.2004, 0D1FR1G-VERS.2004, 0D1FR3G, 0D1FR3GD, 0G1FR3G, 0G1FR3GD, 10WFR4GD, 191FR2G, 191FR2GD, 191FR2I, 191FR2ID, 191FR2ID-VERS.092012, 191FR2I-VERS.032012, 191FR4G, 191FR4GD, 1A1FR2GD-VERS.2004, 1A1FR2G-VERS.2004, 1A1FR4G, 1A1FR4GD, 1D1FR2GD-VERS.2004, 1D1FR2G-VERS.2004, 1D1FR4G, 1D1FR4GD, 1G1FR4G, 1G1FR4GD |                 |                    |

|  |  |                 |         |
|--|--|-----------------|---------|
|  |  |                 |         |
| 1  |  |                 |         |
| <b>GEV No.</b>   | 105344   | <b>Ref. No.</b> | 34A1670 |
| <b>description</b>   | tubular burner L 305mm W 55mm H 63mm for fryer/pasta cooker oval   |                 |         |
| <b>For models:</b>   | 0A1FR1G, 0A1FR1GD, 0B1FR1G, 0B1FR1GD, 0D1FR1G, 0D1FR1GD, 1A1FR2G, 1A1FR2GD, 1D1FR2G, 1D1FR2GD, 30CPS, 30F1, 30F1B, 30FS2, 30FS2B, 70CP, 70F1, 70F1B, 71CP, 71CP2, 71F2, 71F2B, 90CP, 90F110B, 91CP, 91F210, 91F210B, 91F223B |                 |         |

solid top burners

|  |  |                 |         |
|--|--|-----------------|---------|
|  |  |                 |         |
| 1  |  |                 |         |
| <b>GEV No.</b>   | 105332   | <b>Ref. No.</b> | 34A1650 |
| <b>description</b>   | solid top burner ø 162mm H 117mm L 330mm           |                 |         |
| <b>For models:</b>   | 031TP, 1G0TP0, 1G1TP0G, 2G1TP3G, 31TP, 32TP, 32TPV |                 |         |



## forced air burners

Зип.Общепит

gas nozzles  
vsezip.ru

|                    |  |                 |         |
|--------------------|--|-----------------|---------|
| <b>GEV No.</b>     | 108153   | <b>Ref. No.</b> | 6300748 |
| <b>description</b> | burner blower combi-steamer 230V 65W hole distance 50mm NRG118/0800-3612-030204  |                 |         |
| <b>For models:</b> | BX101G, BX101G-VERS.122013, BX122G, BX122G-VERS.122013, BX61G, BX61G-VERS.122013, BX82G, BX82G-VERS.122013, FX101G1, FX101G1R, FX101G2, FX101G2C, FX101G2C-VERS.032014, FX101G2R, FX101G2R-VERS.032014, FX101G2-VERS.032014, FX101G3, FX101G3C, FX101G3C-VERS.022014, FX101G3R, FX101G3R-VERS.022014, FX101G3-VERS.022014, FX10G2CR, FX10G2CR-VERS.032014, FX10G3CR, FX10G3CR-VERS.022014, FX122G1, FX122G2, FX122G2C, FX122G2T, FX122G2T-VERS.032014, FX122G3, FX122G3C, FX122G3T, FX122G3T-VERS.022014, FX12G3CT, FX12G3CT-VERS.022014, FX201G2, FX201G2P, FX201G2P-VERS.032014, FX201G2-VERS.032014, FX201G3P, FX201G3-VERS.022014, FX202G2, FX202G2-VERS.032014, FX202G3, FX202G3-VERS.022014, FX61G1, FX61G1R, FX61G2...(Other models you can see in the webshop) |                 |         |

## accessories

## gaskets



|                    |  |                 |         |
|--------------------|--|-----------------|---------|
| <b>GEV No.</b>     | 109208   | <b>Ref. No.</b> | 36E3770 |
| <b>description</b> | gasket L 89mm W 89mm D1 ø 76mm thickness 1mm hole ø 6mm hole distance 69mm for burner chamber combi-steamer  |                 |         |
| <b>For models:</b> | FC1011G, FC1221G, FC611G, FM1011G1, FM1011G1-VERS.2006, FM1011G2, FM1011G2-VERS.2006, FM1011G3, FM1011G3-VERS.2006, FM1221G1, FM1221G1-VERS.2006, FM1221G2, FM1221G2-VERS.2006, FM1221G3, FM1221G3-VERS.2006, FM2011G2-VERS.2006, FM2011G3-VERS.2006, FM2021G1, FM2021G2, FM2021G2-VERS.2006, FM2021G3, FM2021G3-VERS.2006, FM611G1, FM611G1-VERS.2006, FM611G2, FM611G2-VERS.2006, FM611G3, FM611G3-VERS.2006, FM721G1, FM721G1-VERS.2006, FM721G2, FM721G2-VERS.2006, FM721G3, FM721G3-VERS.2006 |                 |         |



|                    |  |                 |         |
|--------------------|--|-----------------|---------|
| <b>GEV No.</b>     | 109207   | <b>Ref. No.</b> | 36E3390 |
| <b>description</b> | gasket L 89mm W 89mm ø 76mm thickness 3mm hole ø 4mm hole distance 69mm for burner chamber combi-steamer   |                 |         |
| <b>For models:</b> | FC1011G, FC1221G, FC611G, FM1011G1, FM1011G1-VERS.2006, FM1011G2, FM1011G2-VERS.2006, FM1011G3, FM1011G3-VERS.2006, FM1221G1, FM1221G1-VERS.2006, FM1221G2, FM1221G2-VERS.2006, FM1221G3, FM1221G3-VERS.2006, FM2011G2-VERS.2006, FM2011G3-VERS.2006, FM2021G1, FM2021G2, FM2021G2-VERS.2006, FM2021G3, FM2021G3-VERS.2006, FM611G1, FM611G1-VERS.2006, FM611G2, FM611G2-VERS.2006, FM611G3, FM611G3-VERS.2006, FM721G1, FM721G1-VERS.2006, FM721G2, FM721G2-VERS.2006, FM721G3, FM721G3-VERS.2006 |                 |         |

## main nozzles

gas nozzles M6x0.75



|                    |  |                 |         |
|--------------------|--|-----------------|---------|
| <b>GEV No.</b>     | 102570   | <b>Ref. No.</b> | 33T3060 |
| <b>description</b> | gas injector thread M6x0.75 WS 8 bore ø 1.15mm |                 |         |



|                    |   |                 |         |
|--------------------|---|-----------------|---------|
| <b>GEV No.</b>     | 106744  | <b>Ref. No.</b> | 33T4490 |
| <b>description</b> | gas injector thread M6x0.75 WS 8 bore ø 1.3mm |                 |         |



|                    |   |                 |         |
|--------------------|---|-----------------|---------|
| <b>GEV No.</b>     | 102571  | <b>Ref. No.</b> | 3033010 |
| <b>description</b> | gas injector thread M6x0.75 WS 8 bore ø 1.4mm |                 |         |



|                    |  |                 |         |
|--------------------|--|-----------------|---------|
| <b>GEV No.</b>     | 106745   | <b>Ref. No.</b> | 3033000 |
| <b>description</b> | gas injector thread M6x0.75 WS 8 bore ø 1.55mm |                 |         |



|                    |   |                 |         |
|--------------------|---|-----------------|---------|
| <b>GEV No.</b>     | 102569  | <b>Ref. No.</b> | 33T4480 |
| <b>description</b> | gas injector thread M6x0.75 WS 8 bore ø 1.5mm |                 |         |



|                    |  |                 |         |
|--------------------|--|-----------------|---------|
| <b>GEV No.</b>     | 102564   | <b>Ref. No.</b> | 33T4230 |
| <b>description</b> | gas injector thread M6x0.75 WS 8 bore ø 1.65mm |                 |         |



|                    |  |                 |         |
|--------------------|--|-----------------|---------|
| <b>GEV No.</b>     | 102565   | <b>Ref. No.</b> | 33T4250 |
| <b>description</b> | gas injector thread M6x0.75 WS 8 bore ø 1.75mm |                 |         |



|                    |  |                 |         |
|--------------------|--|-----------------|---------|
| <b>GEV No.</b>     | 102961   | <b>Ref. No.</b> | 33T4240 |
| <b>description</b> | gas injector thread M6x0.75 WS 8 bore ø 1.85mm |                 |         |

+7(812)987-08-81



Зип Общепит

vsezip.ru

+7(812)987-08-81

|   |   |                 |         |
|---|---|-----------------|---------|
|  |   |                 |         |
| 1   |   |                 |         |
| <b>GEV No.</b>  | 102567                                      | <b>Ref. No.</b> | 33T3050 |
| <b>description</b>  | gas injector thread M6x0.75 WS 8 bore ø 1mm |                 |         |

|  |  |                 |         |
|--|--|-----------------|---------|
|  |  |                 |         |
| 1  |  |                 |         |
| <b>GEV No.</b>   | 101974   | <b>Ref. No.</b> | 33T3910 |
| <b>description</b>   | gas injector thread M10x1 bore ø 1.35mm L 30mm WS 12 |                 |         |

gas nozzles M8x1

|   |   |                 |         |
|---|---|-----------------|---------|
|  |   |                 |         |
| 1   |   |                 |         |
| <b>GEV No.</b>  | 104737  | <b>Ref. No.</b> | 3032930 |
| <b>description</b>  | gas injector thread M8x1 WS 10 bore ø 0.5mm   |                 |         |
| <b>For models:</b>  | BX61E, BX61E-VERS.122013, BX61G, BX61G-VERS.122013, FC611E, FC611G, FM1221E1-VERS.2006, FM1221E2-VERS.2006, FM1221E3-VERS.2006, FM1221G1-VERS.2006, FM1221G2-VERS.2006, FM1221G3-VERS.2006, FM2011E2-VERS.2006, FM2011E3-VERS.2006, FM2011G2-VERS.2006, FM2011G3-VERS.2006, FM2021E2-VERS.2006, FM2021E3-VERS.2006, FM2021G2-VERS.2006, FM2021G3-VERS.2006, FM611E1, FM611E1-VERS.2006, FM611E2, FM611E2-VERS.2006, FM611E3, FM611E3-VERS.2006, FM611G1, FM611G1-VERS.2006, FM611G2, FM611G2-VERS.2006, FM611G3, FM611G3-VERS.2006, FX61E1, FX61E1R, FX61E2, FX61E2C, FX61E2CR, FX61E2CR-VERS.032014, FX61E2C-VERS.032014, FX61E2R, FX61E2R-VERS.032014, FX61E2-VERS.032014, FX61E3, FX61E3C, FX61E3CR, FX61E3CR-VERS.022014, FX61E3C-VERS.022014, FX61E3R, FX61E3R-VERS.022014, FX61E3-VERS.022014...(Other models you can see in the webshop) |                 |         |

|  |  |                 |         |
|--|--|-----------------|---------|
|  |  |                 |         |
| 1  |  |                 |         |
| <b>GEV No.</b>   | 101975   | <b>Ref. No.</b> | 33T3980 |
| <b>description</b>   | gas injector thread M10x1 bore ø 1.55mm L 30mm WS 12 |                 |         |

|  |  |                 |         |
|--|--|-----------------|---------|
|  |  |                 |         |
| 1  |  |                 |         |
| <b>GEV No.</b>   | 100816                                       | <b>Ref. No.</b> | 33T3900 |
| <b>description</b>   | gas injector thread M10x1 bore ø 1.5mm WS 12 |                 |         |

|  |   |                 |         |
|--|---|-----------------|---------|
|  |   |                 |         |
| 1  |   |                 |         |
| <b>GEV No.</b>   | 100153  | <b>Ref. No.</b> | 33T1700 |
| <b>description</b>   | gas injector thread M10x1 bore ø 1.6mm L 30mm WS 12 |                 |         |

|  |  |                 |         |
|--|--|-----------------|---------|
|  |  |                 |         |
| 1  |  |                 |         |
| <b>GEV No.</b>   | 106402   | <b>Ref. No.</b> | 33T0710 |
| <b>description</b>   | gas injector thread M10x1 bore ø 1.75mm L 30mm WS 12 |                 |         |

|  |  |                 |         |
|--|--|-----------------|---------|
|  |  |                 |         |
| 1  |  |                 |         |
| <b>GEV No.</b>   | 106407   | <b>Ref. No.</b> | 33T1750 |
| <b>description</b>   | gas injector thread M10x1 bore ø 1.85mm L 30mm WS 12 |                 |         |

|  |   |                 |         |
|--|---|-----------------|---------|
|  |   |                 |         |
| 1  |   |                 |         |
| <b>GEV No.</b>   | 106403  | <b>Ref. No.</b> | 33T1920 |
| <b>description</b>   | gas injector thread M10x1 bore ø 1.9mm L 30mm WS 12 |                 |         |

|  |  |                 |         |
|--|--|-----------------|---------|
|  |  |                 |         |
| 1  |  |                 |         |
| <b>GEV No.</b>   | 104736   | <b>Ref. No.</b> | 3032920 |
| <b>description</b>   | gas injector thread M8x1 WS 10 bore ø 1.85mm   |                 |         |
| <b>For models:</b>   | FC1011E, FC1011G, FC1221E, FC1221G, FC611E, FC611G, FM1011E1, FM1011E1-VERS.2006, FM1011E2, FM1011E2-VERS.2006, FM1011E3, FM1011E3-VERS.2006, FM1011G1, FM1011G1-VERS.2006, FM1011G2, FM1011G2-VERS.2006, FM1011G3, FM1011G3-VERS.2006, FM1221E1-VERS.2006, FM1221E2-VERS.2006, FM1221E3, FM1221E3-VERS.2006, FM1221G1-VERS.2006, FM1221G2-VERS.2006, FM1221G3, FM1221G3-VERS.2006, FM2011E2-VERS.2006, FM2011E3-VERS.2006, FM2011G2-VERS.2006, FM2011G3-VERS.2006, FM611E1, FM611E1-VERS.2006, FM611E2, FM611E2-VERS.2006, FM611E3, FM611E3-VERS.2006, FM611G1, FM611G1-VERS.2006, FM611G2, FM611G2-VERS.2006, FM611G3, FM611G3-VERS.2006, FM721E3, FM721G3 |                 |         |

gas nozzles M10x1

|   |   |                 |         |
|---|---|-----------------|---------|
|  |   |                 |         |
| 1   |   |                 |         |
| <b>GEV No.</b>  | 100670  | <b>Ref. No.</b> | 33T3880 |
| <b>description</b>  | gas injector thread M10x1 bore ø 0.9mm L 30mm WS 12 |                 |         |

|  |   |                 |         |
|--|---|-----------------|---------|
|  |   |                 |         |
| 1  |   |                 |         |
| <b>GEV No.</b>   | 100676  | <b>Ref. No.</b> | 33T0690 |
| <b>description</b>   | gas injector thread M10x1 bore ø 1mm L 30mm WS 12 |                 |         |

|   |   |                 |         |
|---|---|-----------------|---------|
|  |   |                 |         |
| 1   |   |                 |         |
| <b>GEV No.</b>  | 106400  | <b>Ref. No.</b> | 33T0650 |
| <b>description</b>  | gas injector thread M10x1 bore ø 1.1mm L 30mm WS 12 |                 |         |

|  |  |                 |         |
|--|--|-----------------|---------|
|  |  |                 |         |
| 1  |  |                 |         |
| <b>GEV No.</b>   | 100673   | <b>Ref. No.</b> | 33T1990 |
| <b>description</b>   | gas injector thread M10x1 bore ø 2.05mm L 30mm WS 12 |                 |         |

1 gas components

Зип Общепит

vsezip.ru

+7(812)987-08-81

|                    |   |
|--------------------|---|
| 1                  |  |
| <b>GEV No.</b>     | 106401  |
| <b>Ref. No.</b>    | 33T0720   |
| <b>description</b> | gas injector thread M10x1 bore $\varnothing$ 2.2mm L 30mm WS 12                   |

|                    |   |
|--------------------|---|
| 1                  |  |
| <b>GEV No.</b>     | 101973  |
| <b>Ref. No.</b>    | 33T3920   |
| <b>description</b> | gas injector thread M10x1 bore $\varnothing$ 2.3mm L 30mm WS 12                   |

|                    |   |
|--------------------|---|
| 1                  |  |
| <b>GEV No.</b>     | 107898  |
| <b>Ref. No.</b>    | 33T0550   |
| <b>description</b> | gas injector thread M10x1 bore $\varnothing$ 2.7mm L 30mm WS 12                   |

|                    |   |
|--------------------|---|
| 1                  |  |
| <b>GEV No.</b>     | 106404  |
| <b>Ref. No.</b>    | 33T0750   |
| <b>description</b> | gas injector thread M10x1 bore $\varnothing$ 2.8mm L 30mm WS 12                   |

|                    |   |
|--------------------|---|
| 1                  |  |
| <b>GEV No.</b>     | 106405  |
| <b>Ref. No.</b>    | 33T3360   |
| <b>description</b> | gas injector thread M10x1 bore $\varnothing$ 2mm L 30mm WS 12                     |

|                    |   |
|--------------------|---|
| 1                  |  |
| <b>GEV No.</b>     | 106406  |
| <b>Ref. No.</b>    | 33T2280   |
| <b>description</b> | gas injector thread M10x1 bore $\varnothing$ 3.5mm L 30mm WS 12                     |

|                    |   |
|--------------------|---|
| 1                  |  |
| <b>GEV No.</b>     | 101972  |
| <b>Ref. No.</b>    | 33T4030   |
| <b>description</b> | gas injector thread M10x1 bore $\varnothing$ 3.6mm L 30mm WS 12                     |

|                    |   |
|--------------------|---|
| 1                  |  |
| <b>GEV No.</b>     | 106408  |
| <b>Ref. No.</b>    | 33T3370   |
| <b>description</b> | gas injector thread M10x1 bore $\varnothing$ 3mm L 30mm WS 12                       |

|                    |   |
|--------------------|---|
| 1                  |  |
| <b>GEV No.</b>     | 106471  |
| <b>Ref. No.</b>    | 33T1520   |
| <b>description</b> | gas injector thread M10x1 WS 12 bore $\varnothing$ 0.7mm                            |

|                    |   |
|--------------------|---|
| 1                  |  |
| <b>GEV No.</b>     | 106472  |
| <b>Ref. No.</b>    | 33T1550   |
| <b>description</b> | gas injector thread M10x1 WS 12 bore $\varnothing$ 0.85mm                         |

|                    |   |
|--------------------|---|
| 1                  |  |
| <b>GEV No.</b>     | 106465  |
| <b>Ref. No.</b>    | 33T1540   |
| <b>description</b> | gas injector thread M10x1 WS 12 bore $\varnothing$ 0.8mm                          |

|                    |   |
|--------------------|---|
| 1                  |  |
| <b>GEV No.</b>     | 106451  |
| <b>Ref. No.</b>    | 33T1560   |
| <b>description</b> | gas injector thread M10x1 WS 12 bore $\varnothing$ 0.9mm                          |

|                    |  |
|--------------------|--|
| 1                  |  |
| <b>GEV No.</b>     | 106473   |
| <b>Ref. No.</b>    | 33T1590  |
| <b>description</b> | gas injector thread M10x1 WS 12 bore $\varnothing$ 1.05mm                          |

|                    |   |
|--------------------|---|
| 1                  |  |
| <b>GEV No.</b>     | 106466  |
| <b>Ref. No.</b>    | 33T1610   |
| <b>description</b> | gas injector thread M10x1 WS 12 bore $\varnothing$ 1.15mm                           |

|                    |   |
|--------------------|---|
| 1                  |  |
| <b>GEV No.</b>     | 106611  |
| <b>Ref. No.</b>    | 33T1630   |
| <b>description</b> | gas injector thread M10x1 WS 12 bore $\varnothing$ 1.25mm                           |



Зип Общепит

vsezip.ru

+7(812)987-08-81

|   |   |                 |                 |         |                    |   |  |  |   |                |        |                 |         |                    |   |  |  |
|---|---|-----------------|-----------------|---------|--------------------|---|--|--|---|----------------|--------|-----------------|---------|--------------------|---|--|--|
|  <p>1</p>  |  <p>1</p>   |                 |                 |         |                    |   |  |  |   |                |        |                 |         |                    |   |  |  |
| <table border="1"> <tr> <td><b>GEV No.</b></td> <td>106452</td> <td><b>Ref. No.</b></td> <td>33T3760</td> </tr> <tr> <td><b>description</b></td> <td colspan="3">gas injector thread M10x1 WS 12 bore <math>\varnothing</math> 1.35mm</td> </tr> </table> | <b>GEV No.</b>  | 106452          | <b>Ref. No.</b> | 33T3760 | <b>description</b> | gas injector thread M10x1 WS 12 bore $\varnothing$ 1.35mm |  |  | <table border="1"> <tr> <td><b>GEV No.</b></td> <td>106454</td> <td><b>Ref. No.</b></td> <td>33T1740</td> </tr> <tr> <td><b>description</b></td> <td colspan="3">gas injector thread M10x1 WS 12 bore <math>\varnothing</math> 1.8mm</td> </tr> </table>  | <b>GEV No.</b> | 106454 | <b>Ref. No.</b> | 33T1740 | <b>description</b> | gas injector thread M10x1 WS 12 bore $\varnothing$ 1.8mm  |  |  |
| <b>GEV No.</b>  | 106452  | <b>Ref. No.</b> | 33T3760         |         |                    |   |  |  |   |                |        |                 |         |                    |   |  |  |
| <b>description</b>  | gas injector thread M10x1 WS 12 bore $\varnothing$ 1.35mm                                     |                 |                 |         |                    |   |  |  |   |                |        |                 |         |                    |   |  |  |
| <b>GEV No.</b>  | 106454  | <b>Ref. No.</b> | 33T1740         |         |                    |   |  |  |   |                |        |                 |         |                    |   |  |  |
| <b>description</b>  | gas injector thread M10x1 WS 12 bore $\varnothing$ 1.8mm                                      |                 |                 |         |                    |   |  |  |   |                |        |                 |         |                    |   |  |  |
|  <p>1</p>  |  <p>1</p>   |                 |                 |         |                    |   |  |  |   |                |        |                 |         |                    |   |  |  |
| <table border="1"> <tr> <td><b>GEV No.</b></td> <td>106453</td> <td><b>Ref. No.</b></td> <td>33T1660</td> </tr> <tr> <td><b>description</b></td> <td colspan="3">gas injector thread M10x1 WS 12 bore <math>\varnothing</math> 1.4mm</td> </tr> </table>  | <b>GEV No.</b>  | 106453          | <b>Ref. No.</b> | 33T1660 | <b>description</b> | gas injector thread M10x1 WS 12 bore $\varnothing$ 1.4mm  |  |  | <table border="1"> <tr> <td><b>GEV No.</b></td> <td>106456</td> <td><b>Ref. No.</b></td> <td>33T1770</td> </tr> <tr> <td><b>description</b></td> <td colspan="3">gas injector thread M10x1 WS 12 bore <math>\varnothing</math> 1.95mm</td> </tr> </table> | <b>GEV No.</b> | 106456 | <b>Ref. No.</b> | 33T1770 | <b>description</b> | gas injector thread M10x1 WS 12 bore $\varnothing$ 1.95mm |  |  |
| <b>GEV No.</b>  | 106453  | <b>Ref. No.</b> | 33T1660         |         |                    |   |  |  |   |                |        |                 |         |                    |   |  |  |
| <b>description</b>  | gas injector thread M10x1 WS 12 bore $\varnothing$ 1.4mm                                      |                 |                 |         |                    |   |  |  |   |                |        |                 |         |                    |   |  |  |
| <b>GEV No.</b>  | 106456  | <b>Ref. No.</b> | 33T1770         |         |                    |   |  |  |   |                |        |                 |         |                    |   |  |  |
| <b>description</b>  | gas injector thread M10x1 WS 12 bore $\varnothing$ 1.95mm                                     |                 |                 |         |                    |   |  |  |   |                |        |                 |         |                    |   |  |  |
|  <p>1</p>  |  <p>1</p>   |                 |                 |         |                    |   |  |  |   |                |        |                 |         |                    |   |  |  |
| <table border="1"> <tr> <td><b>GEV No.</b></td> <td>101961</td> <td><b>Ref. No.</b></td> <td>33T3490</td> </tr> <tr> <td><b>description</b></td> <td colspan="3">gas injector thread M10x1 WS 12 bore <math>\varnothing</math> 1.55mm</td> </tr> </table> | <b>GEV No.</b>  | 101961          | <b>Ref. No.</b> | 33T3490 | <b>description</b> | gas injector thread M10x1 WS 12 bore $\varnothing$ 1.55mm |  |  | <table border="1"> <tr> <td><b>GEV No.</b></td> <td>106457</td> <td><b>Ref. No.</b></td> <td>33T1790</td> </tr> <tr> <td><b>description</b></td> <td colspan="3">gas injector thread M10x1 WS 12 bore <math>\varnothing</math> 2.05mm</td> </tr> </table> | <b>GEV No.</b> | 106457 | <b>Ref. No.</b> | 33T1790 | <b>description</b> | gas injector thread M10x1 WS 12 bore $\varnothing$ 2.05mm |  |  |
| <b>GEV No.</b>  | 101961  | <b>Ref. No.</b> | 33T3490         |         |                    |   |  |  |   |                |        |                 |         |                    |   |  |  |
| <b>description</b>  | gas injector thread M10x1 WS 12 bore $\varnothing$ 1.55mm                                     |                 |                 |         |                    |   |  |  |   |                |        |                 |         |                    |   |  |  |
| <b>GEV No.</b>  | 106457  | <b>Ref. No.</b> | 33T1790         |         |                    |   |  |  |   |                |        |                 |         |                    |   |  |  |
| <b>description</b>  | gas injector thread M10x1 WS 12 bore $\varnothing$ 2.05mm                                     |                 |                 |         |                    |   |  |  |   |                |        |                 |         |                    |   |  |  |
|  <p>1</p>   |  <p>1</p>  |                 |                 |         |                    |   |  |  |   |                |        |                 |         |                    |   |  |  |
| <table border="1"> <tr> <td><b>GEV No.</b></td> <td>106467</td> <td><b>Ref. No.</b></td> <td>33T0790</td> </tr> <tr> <td><b>description</b></td> <td colspan="3">gas injector thread M10x1 WS 12 bore <math>\varnothing</math> 1.6mm</td> </tr> </table>  | <b>GEV No.</b>  | 106467          | <b>Ref. No.</b> | 33T0790 | <b>description</b> | gas injector thread M10x1 WS 12 bore $\varnothing$ 1.6mm  |  |  | <table border="1"> <tr> <td><b>GEV No.</b></td> <td>106458</td> <td><b>Ref. No.</b></td> <td>33T1800</td> </tr> <tr> <td><b>description</b></td> <td colspan="3">gas injector thread M10x1 WS 12 bore <math>\varnothing</math> 2.1mm</td> </tr> </table>  | <b>GEV No.</b> | 106458 | <b>Ref. No.</b> | 33T1800 | <b>description</b> | gas injector thread M10x1 WS 12 bore $\varnothing$ 2.1mm  |  |  |
| <b>GEV No.</b>  | 106467  | <b>Ref. No.</b> | 33T0790         |         |                    |   |  |  |   |                |        |                 |         |                    |   |  |  |
| <b>description</b>  | gas injector thread M10x1 WS 12 bore $\varnothing$ 1.6mm                                      |                 |                 |         |                    |   |  |  |   |                |        |                 |         |                    |   |  |  |
| <b>GEV No.</b>  | 106458  | <b>Ref. No.</b> | 33T1800         |         |                    |   |  |  |   |                |        |                 |         |                    |   |  |  |
| <b>description</b>  | gas injector thread M10x1 WS 12 bore $\varnothing$ 2.1mm                                      |                 |                 |         |                    |   |  |  |   |                |        |                 |         |                    |   |  |  |
|  <p>1</p>  |  <p>1</p> |                 |                 |         |                    |   |  |  |   |                |        |                 |         |                    |   |  |  |
| <table border="1"> <tr> <td><b>GEV No.</b></td> <td>106468</td> <td><b>Ref. No.</b></td> <td>33T1720</td> </tr> <tr> <td><b>description</b></td> <td colspan="3">gas injector thread M10x1 WS 12 bore <math>\varnothing</math> 1.7mm</td> </tr> </table>  | <b>GEV No.</b>  | 106468          | <b>Ref. No.</b> | 33T1720 | <b>description</b> | gas injector thread M10x1 WS 12 bore $\varnothing$ 1.7mm  |  |  | <table border="1"> <tr> <td><b>GEV No.</b></td> <td>106475</td> <td><b>Ref. No.</b></td> <td>33T1820</td> </tr> <tr> <td><b>description</b></td> <td colspan="3">gas injector thread M10x1 WS 12 bore <math>\varnothing</math> 2.2mm</td> </tr> </table>  | <b>GEV No.</b> | 106475 | <b>Ref. No.</b> | 33T1820 | <b>description</b> | gas injector thread M10x1 WS 12 bore $\varnothing$ 2.2mm  |  |  |
| <b>GEV No.</b>  | 106468  | <b>Ref. No.</b> | 33T1720         |         |                    |   |  |  |   |                |        |                 |         |                    |   |  |  |
| <b>description</b>  | gas injector thread M10x1 WS 12 bore $\varnothing$ 1.7mm                                      |                 |                 |         |                    |   |  |  |   |                |        |                 |         |                    |   |  |  |
| <b>GEV No.</b>  | 106475  | <b>Ref. No.</b> | 33T1820         |         |                    |   |  |  |   |                |        |                 |         |                    |   |  |  |
| <b>description</b>  | gas injector thread M10x1 WS 12 bore $\varnothing$ 2.2mm                                      |                 |                 |         |                    |   |  |  |   |                |        |                 |         |                    |   |  |  |
|  <p>1</p>  |  <p>1</p> |                 |                 |         |                    |   |  |  |   |                |        |                 |         |                    |   |  |  |
| <table border="1"> <tr> <td><b>GEV No.</b></td> <td>106455</td> <td><b>Ref. No.</b></td> <td>33T1380</td> </tr> <tr> <td><b>description</b></td> <td colspan="3">gas injector thread M10x1 WS 12 bore <math>\varnothing</math> 1.85mm</td> </tr> </table> | <b>GEV No.</b>  | 106455          | <b>Ref. No.</b> | 33T1380 | <b>description</b> | gas injector thread M10x1 WS 12 bore $\varnothing$ 1.85mm |  |  | <table border="1"> <tr> <td><b>GEV No.</b></td> <td>106459</td> <td><b>Ref. No.</b></td> <td>33T1840</td> </tr> <tr> <td><b>description</b></td> <td colspan="3">gas injector thread M10x1 WS 12 bore <math>\varnothing</math> 2.4mm</td> </tr> </table>  | <b>GEV No.</b> | 106459 | <b>Ref. No.</b> | 33T1840 | <b>description</b> | gas injector thread M10x1 WS 12 bore $\varnothing$ 2.4mm  |  |  |
| <b>GEV No.</b>  | 106455  | <b>Ref. No.</b> | 33T1380         |         |                    |   |  |  |   |                |        |                 |         |                    |   |  |  |
| <b>description</b>  | gas injector thread M10x1 WS 12 bore $\varnothing$ 1.85mm                                     |                 |                 |         |                    |   |  |  |   |                |        |                 |         |                    |   |  |  |
| <b>GEV No.</b>  | 106459  | <b>Ref. No.</b> | 33T1840         |         |                    |   |  |  |   |                |        |                 |         |                    |   |  |  |
| <b>description</b>  | gas injector thread M10x1 WS 12 bore $\varnothing$ 2.4mm                                      |                 |                 |         |                    |   |  |  |   |                |        |                 |         |                    |   |  |  |

Зип Общепит  
vsezip.ru  
+7(812)987-08-81

|   |  |                 |         |
|---|--|-----------------|---------|
|  |  |                 |         |
| 1   |  |                 |         |
| <b>GEV No.</b>  | 106469                                       | <b>Ref. No.</b> | 33T1950 |
| <b>description</b>  | gas injector thread M10x1 WS 12 bore ø 2.5mm |                 |         |

|   |  |                 |         |
|---|--|-----------------|---------|
|  |  |                 |         |
| 1   |  |                 |         |
| <b>GEV No.</b>  | 106463                                     | <b>Ref. No.</b> | 33T1900 |
| <b>description</b>  | gas injector thread M10x1 WS 12 bore ø 3mm |                 |         |

|   |  |                 |         |
|---|--|-----------------|---------|
|  |  |                 |         |
| 1   |  |                 |         |
| <b>GEV No.</b>  | 106460                                       | <b>Ref. No.</b> | 33T1860 |
| <b>description</b>  | gas injector thread M10x1 WS 12 bore ø 2.6mm |                 |         |

|   |  |                 |         |
|---|--|-----------------|---------|
|  |  |                 |         |
| 1   |  |                 |         |
| <b>GEV No.</b>  | 101997                                       | <b>Ref. No.</b> | 33T4210 |
| <b>description</b>  | gas injector thread M10x1 WS 11 bore ø 1.4mm |                 |         |

|   |  |                 |         |
|---|--|-----------------|---------|
|  |  |                 |         |
| 1   |  |                 |         |
| <b>GEV No.</b>  | 106461                                       | <b>Ref. No.</b> | 33T1880 |
| <b>description</b>  | gas injector thread M10x1 WS 12 bore ø 2.8mm |                 |         |

|   |  |                 |         |
|---|--|-----------------|---------|
|  |  |                 |         |
| 1   |  |                 |         |
| <b>GEV No.</b>  | 100380                                       | <b>Ref. No.</b> | 33T0070 |
| <b>description</b>  | gas injector thread M10x1 WS 12 bore ø 0.7mm |                 |         |

|  |  |                 |         |
|--|--|-----------------|---------|
|  |  |                 |         |
| 1  |  |                 |         |
| <b>GEV No.</b>   | 106462                                       | <b>Ref. No.</b> | 33T3750 |
| <b>description</b>   | gas injector thread M10x1 WS 12 bore ø 2.9mm |                 |         |

|  |   |                 |         |
|--|---|-----------------|---------|
|  |   |                 |         |
| 1  |   |                 |         |
| <b>GEV No.</b>   | 100381  | <b>Ref. No.</b> | 33T0080 |
| <b>description</b>   | gas injector thread M10x1 WS 12 bore ø 0.85mm |                 |         |

|   |  |                 |         |
|---|--|-----------------|---------|
|  |  |                 |         |
| 1   |  |                 |         |
| <b>GEV No.</b>  | 106474                                     | <b>Ref. No.</b> | 33T1780 |
| <b>description</b>  | gas injector thread M10x1 WS 12 bore ø 2mm |                 |         |

|   |   |                 |         |
|---|---|-----------------|---------|
|  |   |                 |         |
| 1   |   |                 |         |
| <b>GEV No.</b>  | 100382  | <b>Ref. No.</b> | 33T0090 |
| <b>description</b>  | gas injector thread M10x1 WS 12 bore ø 1.05mm |                 |         |

|   |  |                 |         |
|---|--|-----------------|---------|
|  |  |                 |         |
| 1   |  |                 |         |
| <b>GEV No.</b>  | 106464                                       | <b>Ref. No.</b> | 33T1930 |
| <b>description</b>  | gas injector thread M10x1 WS 12 bore ø 3.4mm |                 |         |





|   |   |                 |         |
|---|---|-----------------|---------|
|  |   |                 |         |
| 1   |   |                 |         |
| <b>GEV No.</b>  | 100539  | <b>Ref. No.</b> | 33T0390 |
| <b>description</b>  | gas injector thread M10x1 WS 12 bore ø 1.15mm |                 |         |



Зип Общепит

vsezip.ru

+7(812)987-08-81

|   |   |                 |                 |         |                    |   |  |  |   |                |        |                 |         |                    |   |  |  |
|---|---|-----------------|-----------------|---------|--------------------|---|--|--|---|----------------|--------|-----------------|---------|--------------------|---|--|--|
|  <p>1</p>  |  <p>1</p>   |                 |                 |         |                    |   |  |  |   |                |        |                 |         |                    |   |  |  |
| <table border="1"> <tr> <td><b>GEV No.</b></td> <td>100540</td> <td><b>Ref. No.</b></td> <td>33T1620</td> </tr> <tr> <td><b>description</b></td> <td colspan="3">gas injector thread M10x1 WS 12 bore <math>\varnothing</math> 1.2mm</td> </tr> </table>  | <b>GEV No.</b>  | 100540          | <b>Ref. No.</b> | 33T1620 | <b>description</b> | gas injector thread M10x1 WS 12 bore $\varnothing$ 1.2mm  |  |  | <table border="1"> <tr> <td><b>GEV No.</b></td> <td>100537</td> <td><b>Ref. No.</b></td> <td>33T1580</td> </tr> <tr> <td><b>description</b></td> <td colspan="3">gas injector thread M10x1 WS 12 bore <math>\varnothing</math> 1mm</td> </tr> </table>    | <b>GEV No.</b> | 100537 | <b>Ref. No.</b> | 33T1580 | <b>description</b> | gas injector thread M10x1 WS 12 bore $\varnothing$ 1mm    |  |  |
| <b>GEV No.</b>  | 100540  | <b>Ref. No.</b> | 33T1620         |         |                    |   |  |  |   |                |        |                 |         |                    |   |  |  |
| <b>description</b>  | gas injector thread M10x1 WS 12 bore $\varnothing$ 1.2mm                                      |                 |                 |         |                    |   |  |  |   |                |        |                 |         |                    |   |  |  |
| <b>GEV No.</b>  | 100537  | <b>Ref. No.</b> | 33T1580         |         |                    |   |  |  |   |                |        |                 |         |                    |   |  |  |
| <b>description</b>  | gas injector thread M10x1 WS 12 bore $\varnothing$ 1mm  |                 |                 |         |                    |   |  |  |   |                |        |                 |         |                    |   |  |  |
|  <p>1</p>  |  <p>1</p>   |                 |                 |         |                    |   |  |  |   |                |        |                 |         |                    |   |  |  |
| <table border="1"> <tr> <td><b>GEV No.</b></td> <td>100387</td> <td><b>Ref. No.</b></td> <td>33T1670</td> </tr> <tr> <td><b>description</b></td> <td colspan="3">gas injector thread M10x1 WS 12 bore <math>\varnothing</math> 1.45mm</td> </tr> </table> | <b>GEV No.</b>  | 100387          | <b>Ref. No.</b> | 33T1670 | <b>description</b> | gas injector thread M10x1 WS 12 bore $\varnothing$ 1.45mm |  |  | <table border="1"> <tr> <td><b>GEV No.</b></td> <td>100386</td> <td><b>Ref. No.</b></td> <td>33T0160</td> </tr> <tr> <td><b>description</b></td> <td colspan="3">gas injector thread M10x1 WS 12 bore <math>\varnothing</math> 2.2mm</td> </tr> </table>  | <b>GEV No.</b> | 100386 | <b>Ref. No.</b> | 33T0160 | <b>description</b> | gas injector thread M10x1 WS 12 bore $\varnothing$ 2.2mm  |  |  |
| <b>GEV No.</b>  | 100387  | <b>Ref. No.</b> | 33T1670         |         |                    |   |  |  |   |                |        |                 |         |                    |   |  |  |
| <b>description</b>  | gas injector thread M10x1 WS 12 bore $\varnothing$ 1.45mm                                     |                 |                 |         |                    |   |  |  |   |                |        |                 |         |                    |   |  |  |
| <b>GEV No.</b>  | 100386  | <b>Ref. No.</b> | 33T0160         |         |                    |   |  |  |   |                |        |                 |         |                    |   |  |  |
| <b>description</b>  | gas injector thread M10x1 WS 12 bore $\varnothing$ 2.2mm                                      |                 |                 |         |                    |   |  |  |   |                |        |                 |         |                    |   |  |  |
|  <p>1</p>  |  <p>1</p>   |                 |                 |         |                    |   |  |  |   |                |        |                 |         |                    |   |  |  |
| <table border="1"> <tr> <td><b>GEV No.</b></td> <td>102151</td> <td><b>Ref. No.</b></td> <td>33T0110</td> </tr> <tr> <td><b>description</b></td> <td colspan="3">gas injector thread M10x1 WS 12 bore <math>\varnothing</math> 1.4mm</td> </tr> </table>  | <b>GEV No.</b>  | 102151          | <b>Ref. No.</b> | 33T0110 | <b>description</b> | gas injector thread M10x1 WS 12 bore $\varnothing$ 1.4mm  |  |  | <table border="1"> <tr> <td><b>GEV No.</b></td> <td>100388</td> <td><b>Ref. No.</b></td> <td>33T0170</td> </tr> <tr> <td><b>description</b></td> <td colspan="3">gas injector thread M10x1 WS 12 bore <math>\varnothing</math> 2.3mm</td> </tr> </table>  | <b>GEV No.</b> | 100388 | <b>Ref. No.</b> | 33T0170 | <b>description</b> | gas injector thread M10x1 WS 12 bore $\varnothing$ 2.3mm  |  |  |
| <b>GEV No.</b>  | 102151  | <b>Ref. No.</b> | 33T0110         |         |                    |   |  |  |   |                |        |                 |         |                    |   |  |  |
| <b>description</b>  | gas injector thread M10x1 WS 12 bore $\varnothing$ 1.4mm                                      |                 |                 |         |                    |   |  |  |   |                |        |                 |         |                    |   |  |  |
| <b>GEV No.</b>  | 100388  | <b>Ref. No.</b> | 33T0170         |         |                    |   |  |  |   |                |        |                 |         |                    |   |  |  |
| <b>description</b>  | gas injector thread M10x1 WS 12 bore $\varnothing$ 2.3mm                                      |                 |                 |         |                    |   |  |  |   |                |        |                 |         |                    |   |  |  |
|  <p>1</p>   |  <p>1</p>  |                 |                 |         |                    |   |  |  |   |                |        |                 |         |                    |   |  |  |
| <table border="1"> <tr> <td><b>GEV No.</b></td> <td>100383</td> <td><b>Ref. No.</b></td> <td>33T0120</td> </tr> <tr> <td><b>description</b></td> <td colspan="3">gas injector thread M10x1 WS 12 bore <math>\varnothing</math> 1.6mm</td> </tr> </table>  | <b>GEV No.</b>  | 100383          | <b>Ref. No.</b> | 33T0120 | <b>description</b> | gas injector thread M10x1 WS 12 bore $\varnothing$ 1.6mm  |  |  | <table border="1"> <tr> <td><b>GEV No.</b></td> <td>106430</td> <td><b>Ref. No.</b></td> <td>33T0190</td> </tr> <tr> <td><b>description</b></td> <td colspan="3">gas injector thread M10x1 WS 12 bore <math>\varnothing</math> 2.6mm</td> </tr> </table>  | <b>GEV No.</b> | 106430 | <b>Ref. No.</b> | 33T0190 | <b>description</b> | gas injector thread M10x1 WS 12 bore $\varnothing$ 2.6mm  |  |  |
| <b>GEV No.</b>  | 100383  | <b>Ref. No.</b> | 33T0120         |         |                    |   |  |  |   |                |        |                 |         |                    |   |  |  |
| <b>description</b>  | gas injector thread M10x1 WS 12 bore $\varnothing$ 1.6mm                                      |                 |                 |         |                    |   |  |  |   |                |        |                 |         |                    |   |  |  |
| <b>GEV No.</b>  | 106430  | <b>Ref. No.</b> | 33T0190         |         |                    |   |  |  |   |                |        |                 |         |                    |   |  |  |
| <b>description</b>  | gas injector thread M10x1 WS 12 bore $\varnothing$ 2.6mm                                      |                 |                 |         |                    |   |  |  |   |                |        |                 |         |                    |   |  |  |
|  <p>1</p>  |  <p>1</p> |                 |                 |         |                    |   |  |  |   |                |        |                 |         |                    |   |  |  |
| <table border="1"> <tr> <td><b>GEV No.</b></td> <td>100384</td> <td><b>Ref. No.</b></td> <td>33T0130</td> </tr> <tr> <td><b>description</b></td> <td colspan="3">gas injector thread M10x1 WS 12 bore <math>\varnothing</math> 1.8mm</td> </tr> </table>  | <b>GEV No.</b>  | 100384          | <b>Ref. No.</b> | 33T0130 | <b>description</b> | gas injector thread M10x1 WS 12 bore $\varnothing$ 1.8mm  |  |  | <table border="1"> <tr> <td><b>GEV No.</b></td> <td>107466</td> <td><b>Ref. No.</b></td> <td>33T4640</td> </tr> <tr> <td><b>description</b></td> <td colspan="3">gas injector thread M10x1 WS 12 bore <math>\varnothing</math> 3.05mm</td> </tr> </table> | <b>GEV No.</b> | 107466 | <b>Ref. No.</b> | 33T4640 | <b>description</b> | gas injector thread M10x1 WS 12 bore $\varnothing$ 3.05mm |  |  |
| <b>GEV No.</b>  | 100384  | <b>Ref. No.</b> | 33T0130         |         |                    |   |  |  |   |                |        |                 |         |                    |   |  |  |
| <b>description</b>  | gas injector thread M10x1 WS 12 bore $\varnothing$ 1.8mm                                      |                 |                 |         |                    |   |  |  |   |                |        |                 |         |                    |   |  |  |
| <b>GEV No.</b>  | 107466  | <b>Ref. No.</b> | 33T4640         |         |                    |   |  |  |   |                |        |                 |         |                    |   |  |  |
| <b>description</b>  | gas injector thread M10x1 WS 12 bore $\varnothing$ 3.05mm                                     |                 |                 |         |                    |   |  |  |   |                |        |                 |         |                    |   |  |  |
|  <p>1</p>  |  <p>1</p> |                 |                 |         |                    |   |  |  |   |                |        |                 |         |                    |   |  |  |
| <table border="1"> <tr> <td><b>GEV No.</b></td> <td>100544</td> <td><b>Ref. No.</b></td> <td>33T1760</td> </tr> <tr> <td><b>description</b></td> <td colspan="3">gas injector thread M10x1 WS 12 bore <math>\varnothing</math> 1.9mm</td> </tr> </table>  | <b>GEV No.</b>  | 100544          | <b>Ref. No.</b> | 33T1760 | <b>description</b> | gas injector thread M10x1 WS 12 bore $\varnothing$ 1.9mm  |  |  | <table border="1"> <tr> <td><b>GEV No.</b></td> <td>106431</td> <td><b>Ref. No.</b></td> <td>33T0510</td> </tr> <tr> <td><b>description</b></td> <td colspan="3">gas injector thread M10x1 WS 12 bore <math>\varnothing</math> 3.3mm</td> </tr> </table>  | <b>GEV No.</b> | 106431 | <b>Ref. No.</b> | 33T0510 | <b>description</b> | gas injector thread M10x1 WS 12 bore $\varnothing$ 3.3mm  |  |  |
| <b>GEV No.</b>  | 100544  | <b>Ref. No.</b> | 33T1760         |         |                    |   |  |  |   |                |        |                 |         |                    |   |  |  |
| <b>description</b>  | gas injector thread M10x1 WS 12 bore $\varnothing$ 1.9mm                                      |                 |                 |         |                    |   |  |  |   |                |        |                 |         |                    |   |  |  |
| <b>GEV No.</b>  | 106431  | <b>Ref. No.</b> | 33T0510         |         |                    |   |  |  |   |                |        |                 |         |                    |   |  |  |
| <b>description</b>  | gas injector thread M10x1 WS 12 bore $\varnothing$ 3.3mm                                      |                 |                 |         |                    |   |  |  |   |                |        |                 |         |                    |   |  |  |
| <table border="1"> <tr> <td><b>For models:</b></td> <td colspan="3">91AR</td> </tr> </table>  | <b>For models:</b>  | 91AR            |                 |         |                    |   |  |  |   |                |        |                 |         |                    |   |  |  |
| <b>For models:</b>  | 91AR  |                 |                 |         |                    |   |  |  |   |                |        |                 |         |                    |   |  |  |

Зип Общепит

vsezip.ru

+7(812)987-08-81

|   |                       |                         |
|---|-----------------------|-------------------------|
|  | <b>GEV No.</b> 106300 | <b>Ref. No.</b> 33T2420 |
| <b>description</b> gas injector thread M10x1 WS 12 bore ø 0.9mm L 31mm            |                       |                         |

|   |                       |                         |
|---|-----------------------|-------------------------|
|  | <b>GEV No.</b> 106301 | <b>Ref. No.</b> 33T0310 |
| <b>description</b> gas injector thread M10x1 WS 12 bore ø 1.05mm L 31mm           |                       |                         |

|   |                       |                         |
|---|-----------------------|-------------------------|
|  | <b>GEV No.</b> 106302 | <b>Ref. No.</b> 33T2140 |
| <b>description</b> gas injector thread M10x1 WS 12 bore ø 1.25mm L 31mm           |                       |                         |

|   |                       |                         |
|---|-----------------------|-------------------------|
|  | <b>GEV No.</b> 106305 | <b>Ref. No.</b> 33T3210 |
| <b>description</b> gas injector thread M10x1 WS 12 bore ø 1.5mm L 31mm            |                       |                         |

|   |                       |                         |
|---|-----------------------|-------------------------|
|  | <b>GEV No.</b> 102236 | <b>Ref. No.</b> 33T1310 |
| <b>description</b> gas injector thread M10x1 WS 12 bore ø 2.1mm                   |                       |                         |

|   |                       |                         |
|---|-----------------------|-------------------------|
|  | <b>GEV No.</b> 106303 | <b>Ref. No.</b> 33T0320 |
| <b>description</b> gas injector thread M10x1 WS 12 bore ø 2.3mm L 31mm              |                       |                         |

**pilot burner nozzles**

**pilot burner nozzle AB**

|   |                       |                         |
|---|-----------------------|-------------------------|
|        | <b>GEV No.</b> 106237 | <b>Ref. No.</b> 33T1510 |
| <b>description</b> pilot burner nozzle natural/liquid gas code 25 bore ø 0.25mm Qty 1 pcs |                       |                         |

**pilot burner nozzles JUNKERS**

**CB 50203\_/503\_ series**

|   |                       |                         |
|---|-----------------------|-------------------------|
|                          | <b>GEV No.</b> 100220 | <b>Ref. No.</b> 33T0540 |
| <b>description</b> pilot burner nozzle LPG gas pressure 50mbar code 2 Qty 1 pcs suitable for JUNKERS CB503_ |                       |                         |

|  |                       |                         |
|--|-----------------------|-------------------------|
|                                     | <b>GEV No.</b> 100224 | <b>Ref. No.</b> 33T0560 |
| <b>description</b> pilot burner nozzle natural gas gas pressure 25mbar code 26 Qty 1 pcs suitable for JUNKERS CB503_ |                       |                         |

**pilot burner nozzles SIT**

**100 series**

|   |                       |                         |
|---|-----------------------|-------------------------|
|          | <b>GEV No.</b> 100246 | <b>Ref. No.</b> 33T0410 |
| <b>description</b> pilot burner nozzle natural gas bore ø 0.35mm Qty 1 pcs thread M8x0.75 |                       |                         |

|   |                       |                         |
|---|-----------------------|-------------------------|
|  | <b>GEV No.</b> 102972 | <b>Ref. No.</b> 33T3130 |
| <b>description</b> pilot burner nozzle natural gas code 40 bore ø 0.4mm Qty 1 pcs |                       |                         |

|   |                       |                         |
|---|-----------------------|-------------------------|
|      | <b>GEV No.</b> 107171 | <b>Ref. No.</b> 33T0340 |
| <b>description</b> pilot burner nozzle SIT natural/liquid gas bore ø 0.25mm Qty 1 pcs |                       |                         |

**160 series**

|   |                       |                         |
|---|-----------------------|-------------------------|
|  | <b>GEV No.</b> 107649 | <b>Ref. No.</b> 33T4300 |
| <b>description</b> pilot burner nozzle SIT LPG code 20 Qty 1 pcs                    |                       |                         |

|   |                       |                         |
|---|-----------------------|-------------------------|
|  | <b>GEV No.</b> 107650 | <b>Ref. No.</b> 33T3310 |
| <b>description</b> pilot burner nozzle SIT LPG code 30 Qty 1 pcs                    |                       |                         |

|  |                       |                         |
|--|-----------------------|-------------------------|
|                               | <b>GEV No.</b> 107173 | <b>Ref. No.</b> 33T4310 |
| <b>description</b> pilot burner nozzle SIT natural gas code 35 Qty 1 pcs suitable for 160 series nozzle ø 0.35mm |                       |                         |





Зип Общепит

bypass nozzles

bypass nozzles EGA

|                    |  |
|--------------------|--|
| 1                  |  |
| <b>GEV No.</b>     | 100357   |
| <b>Ref. No.</b>    | 33T2340  |
| <b>description</b> | bypass nozzle EGA type 31248 series bore ø 0.7mm |

|                    |   |
|--------------------|---|
| 1                  |   |
| <b>GEV No.</b>     | 107174  |
| <b>Ref. No.</b>    | 33T2870   |
| <b>description</b> | pilot burner nozzle SIT natural gas code 41 Qty 1 pcs |

pilot burner nozzles (other)

ANGELO PO

|                    |  |
|--------------------|--|
| 1                  |  |
| <b>GEV No.</b>     | 100253   |
| <b>Ref. No.</b>    | 33T0040  |
| <b>description</b> | pilot burner nozzle LPG code 2 gas pressure 50mbar Qty 1 pcs brass |

|                    |   |
|--------------------|---|
| 1                  |   |
| <b>GEV No.</b>     | 100240  |
| <b>Ref. No.</b>    | 33T0240   |
| <b>description</b> | pilot burner nozzle LPG code 39 gas pressure 30mbar brass |

|                        |        |
|------------------------|--------|
| <b>accessories for</b> | 100240 |
|------------------------|--------|

|  |                |        |                 |   |
|--|----------------|--------|-----------------|---|
|  | <b>GEV No.</b> | 100240 | <b>Ref. No.</b> | 33T0240   |
|  |                |        |                 | pilot burner nozzle LPG code 39 gas pressure 30mbar brass |

|  |                |        |                 |  |
|--|----------------|--------|-----------------|--|
|  | <b>GEV No.</b> | 100241 | <b>Ref. No.</b> | 33T0050  |
|  |                |        |                 | pilot burner nozzle natural gas code 13 gas pressure 25mbar bore ø 0.4mm Qty 1 pcs brass |

|  |                |        |                 |   |
|--|----------------|--------|-----------------|---|
|  | <b>GEV No.</b> | 100909 | <b>Ref. No.</b> | 36Q0060   |
|  |                |        |                 | union screw thread M10x1 for pipe ø 6mm Qty 1 pcs |

|  |                |        |                 |  |
|--|----------------|--------|-----------------|--|
|  | <b>GEV No.</b> | 101282 | <b>Ref. No.</b> | —                                      |
|  |                |        |                 | olive for pipe ø 4mm L 7.4mm Qty 1 pcs |

|  |                |        |                 |   |
|--|----------------|--------|-----------------|---|
|  | <b>GEV No.</b> | 101283 | <b>Ref. No.</b> | —   |
|  |                |        |                 | union screw thread M10x1 for pipe ø 4mm Qty 1 pcs |

|  |                |        |                 |   |
|--|----------------|--------|-----------------|---|
|  | <b>GEV No.</b> | 101288 | <b>Ref. No.</b> | —   |
|  |                |        |                 | olive for pipe ø 6mm L 6mm aluminium Qty 1 pcs ED ø 8.5mm |

|                    |  |
|--------------------|--|
| 1                  |  |
| <b>GEV No.</b>     | 100241   |
| <b>Ref. No.</b>    | 33T0050  |
| <b>description</b> | pilot burner nozzle natural gas code 13 gas pressure 25mbar bore ø 0.4mm Qty 1 pcs brass |

|                    |  |
|--------------------|--|
| 1                  |  |
| <b>GEV No.</b>     | 100328   |
| <b>Ref. No.</b>    | 33T2370  |
| <b>description</b> | bypass nozzle EGA type 31248 series bore ø 0.8mm |

|                    |  |
|--------------------|--|
| 1                  |  |
| <b>GEV No.</b>     | 100363   |
| <b>Ref. No.</b>    | 33T2360  |
| <b>description</b> | bypass nozzle EGA type 31248 series bore ø 1.5mm |

|                    |  |
|--------------------|--|
| 1                  |  |
| <b>GEV No.</b>     | 106236   |
| <b>Ref. No.</b>    | 33T2350  |
| <b>description</b> | bypass nozzle EGA type 31248 series bore ø 1.7mm |

bypass nozzles PEL20/21

|                    |   |
|--------------------|---|
| 1                  |   |
| <b>GEV No.</b>     | 100408  |
| <b>Ref. No.</b>    | 33T3630   |
| <b>description</b> | bypass nozzle type PEL20/21 bore ø 0.35mm thread M5x0.5 |

|                    |  |
|--------------------|--|
| 1                  |  |
| <b>GEV No.</b>     | 100553   |
| <b>Ref. No.</b>    | 33T1450  |
| <b>description</b> | bypass nozzle type PEL20/21 bore ø 0.4mm thread M5x0.5 |

|                    |   |
|--------------------|---|
| 1                  |   |
| <b>GEV No.</b>     | 100550  |
| <b>Ref. No.</b>    | 33T3530   |
| <b>description</b> | bypass nozzle type PEL20/21 bore ø 0.55mm thread M5x0.5 |

|                    |   |
|--------------------|---|
| 1                  |   |
| <b>GEV No.</b>     | 100548  |
| <b>Ref. No.</b>    | 33T3640   |
| <b>description</b> | bypass nozzle type PEL20/21 bore ø 0.65mm thread M5x0.5 |

|                    |   |
|--------------------|---|
| 1                  |   |
| <b>GEV No.</b>     | 100278  |
| <b>Ref. No.</b>    | 33T2640   |
| <b>description</b> | bypass nozzle type PEL20/21 bore ø 0.75mm thread M5x0.5 |

Зип Общепит

vsezip.ru

+7(812)987-08-81

|                    |   |                 |         |
|--------------------|---|-----------------|---------|
| 1                  |  |                 |         |
| <b>GEV No.</b>     | 100552  | <b>Ref. No.</b> | 33T3650 |
| <b>description</b> | bypass nozzle type PEL20/21 bore ø 0.7mm thread M5x0.5                            |                 |         |

|                    |   |                 |         |
|--------------------|---|-----------------|---------|
| 1                  |  |                 |         |
| <b>GEV No.</b>     | 100281  | <b>Ref. No.</b> | 33T1690 |
| <b>description</b> | bypass nozzle type PEL22 bore ø 0.4mm thread M6x0.5                               |                 |         |

|                    |   |                 |         |
|--------------------|---|-----------------|---------|
| 1                  |  |                 |         |
| <b>GEV No.</b>     | 100527  | <b>Ref. No.</b> | 33T3660 |
| <b>description</b> | bypass nozzle type PEL20/21 bore ø 0.85mm thread M5x0.5                           |                 |         |

|                    |   |                 |         |
|--------------------|---|-----------------|---------|
| 1                  |  |                 |         |
| <b>GEV No.</b>     | 100391  | <b>Ref. No.</b> | 33T2120 |
| <b>description</b> | bypass nozzle type PEL22 bore ø 0.55mm thread M6x0.5                              |                 |         |

|                    |   |                 |         |
|--------------------|---|-----------------|---------|
| 1                  |  |                 |         |
| <b>GEV No.</b>     | 100555  | <b>Ref. No.</b> | 33T3540 |
| <b>description</b> | bypass nozzle type PEL20/21 bore ø 0.8mm thread M5x0.5                            |                 |         |

|                    |   |                 |         |
|--------------------|---|-----------------|---------|
| 1                  |  |                 |         |
| <b>GEV No.</b>     | 100390  | <b>Ref. No.</b> | 33T1190 |
| <b>description</b> | bypass nozzle type PEL22 bore ø 0.5mm thread M6x0.5                               |                 |         |

|                    |   |                 |         |
|--------------------|---|-----------------|---------|
| 1                  |  |                 |         |
| <b>GEV No.</b>     | 100556  | <b>Ref. No.</b> | 33T3810 |
| <b>description</b> | bypass nozzle type PEL20/21 bore ø 0.95mm thread M5x0.5                           |                 |         |

|                    |   |                 |         |
|--------------------|---|-----------------|---------|
| 1                  |  |                 |         |
| <b>GEV No.</b>     | 100428  | <b>Ref. No.</b> | 33T1210 |
| <b>description</b> | bypass nozzle type PEL22 bore ø 0.65mm thread M6x0.5                              |                 |         |

|                    |   |                 |         |
|--------------------|---|-----------------|---------|
| 1                  |  |                 |         |
| <b>GEV No.</b>     | 100557  | <b>Ref. No.</b> | 33T3670 |
| <b>description</b> | bypass nozzle type PEL20/21 bore ø 1.05mm thread M5x0.5                           |                 |         |

|                    |   |                 |         |
|--------------------|---|-----------------|---------|
| 1                  |  |                 |         |
| <b>GEV No.</b>     | 100432  | <b>Ref. No.</b> | 33T2160 |
| <b>description</b> | bypass nozzle type PEL22 bore ø 0.75mm thread M6x0.5                              |                 |         |

|                    |   |                 |         |
|--------------------|---|-----------------|---------|
| 1                  |  |                 |         |
| <b>GEV No.</b>     | 100530  | <b>Ref. No.</b> | 33T4260 |
| <b>description</b> | bypass nozzle type PEL20/21 bore ø 1.1mm thread M5x0.5                              |                 |         |

|                    |   |                 |         |
|--------------------|---|-----------------|---------|
| 1                  |  |                 |         |
| <b>GEV No.</b>     | 100409  | <b>Ref. No.</b> | 33T3970 |
| <b>description</b> | bypass nozzle type PEL22 bore ø 0.8mm thread M6x0.5                                 |                 |         |

|                    |   |                 |         |
|--------------------|---|-----------------|---------|
| 1                  |  |                 |         |
| <b>GEV No.</b>     | 100532  | <b>Ref. No.</b> | 33T4270 |
| <b>description</b> | bypass nozzle type PEL20/21 bore ø 1.2mm thread M5x0.5                              |                 |         |

|                    |   |                 |         |
|--------------------|---|-----------------|---------|
| 1                  |  |                 |         |
| <b>GEV No.</b>     | 100433  | <b>Ref. No.</b> | 33T3850 |
| <b>description</b> | bypass nozzle type PEL22 bore ø 0.9mm thread M6x0.5                                 |                 |         |

|                    |   |                 |         |
|--------------------|---|-----------------|---------|
| 1                  |  |                 |         |
| <b>GEV No.</b>     | 100533  | <b>Ref. No.</b> | 33T4290 |
| <b>description</b> | bypass nozzle type PEL20/21 bore ø 1.3mm thread M5x0.5                              |                 |         |

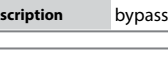
|                    |   |                 |         |
|--------------------|---|-----------------|---------|
| 1                  |  |                 |         |
| <b>GEV No.</b>     | 100435  | <b>Ref. No.</b> | 33T2250 |
| <b>description</b> | bypass nozzle type PEL22 bore ø 1.05mm thread M6x0.5                                |                 |         |

|                      |   |                 |         |
|----------------------|---|-----------------|---------|
| bypass nozzles PEL22 |   |                 |         |
| 1                    |  |                 |         |
| <b>GEV No.</b>       | 100259  | <b>Ref. No.</b> | 33T1180 |
| <b>description</b>   | bypass nozzle type PEL22 bore ø 0.35mm thread M6x0.5                                |                 |         |

|                    |   |                 |         |
|--------------------|---|-----------------|---------|
| 1                  |  |                 |         |
| <b>GEV No.</b>     | 102974  | <b>Ref. No.</b> | 33T0590 |
| <b>description</b> | bypass nozzle type PEL22 bore ø 1.25mm thread M6x0.5                                |                 |         |



Зип Общепит gas nozzles sets

vsezip.ru

+7(812)987-08-81

bypass nozzles PEL23/24

|   |  |
|---|--|
|    | 1  |
| <b>GEV No.</b>  | 106235   |
| <b>Ref. No.</b>   | 33T1480  |
| <b>description</b>  | bypass nozzle type PEL23/24 bore $\phi$ 0.4mm thread M8x0.5  |
|    | 1  |
| <b>GEV No.</b>  | 100448   |
| <b>Ref. No.</b>   | 33T2500  |
| <b>description</b>  | bypass nozzle type PEL23/24 bore $\phi$ 0.5mm thread M8x0.5  |
|    | 1  |
| <b>GEV No.</b>  | 100494   |
| <b>Ref. No.</b>   | 33T4050  |
| <b>description</b>  | bypass nozzle type PEL23/24 bore $\phi$ 0.75mm thread M8x0.5 |
|    | 1  |
| <b>GEV No.</b>  | 100497   |
| <b>Ref. No.</b>   | 33T4060  |
| <b>description</b>  | bypass nozzle type PEL23/24 bore $\phi$ 0.8mm thread M8x0.5  |
|   | 1  |
| <b>GEV No.</b>  | 100598   |
| <b>Ref. No.</b>   | 33T2490  |
| <b>description</b>  | bypass nozzle type PEL23/24 bore $\phi$ 0.95mm thread M8x0.5 |
|  | 1  |
| <b>GEV No.</b>  | 100597   |
| <b>Ref. No.</b>   | 33T2690  |
| <b>description</b>  | bypass nozzle type PEL23/24 bore $\phi$ 0.9mm thread M8x0.5  |
|  | 1  |
| <b>GEV No.</b>  | 100628   |
| <b>Ref. No.</b>   | 33T3280  |
| <b>description</b>  | bypass nozzle type PEL23/24 bore $\phi$ 1.05mm thread M8x0.5 |
|  | 1  |
| <b>GEV No.</b>  | 100667   |
| <b>Ref. No.</b>   | 33T2720  |
| <b>description</b>  | bypass nozzle type PEL23/24 bore $\phi$ 1.35mm thread M8x0.5 |
|  | 1  |
| <b>GEV No.</b>  | 100677   |
| <b>Ref. No.</b>   | 33T2660  |
| <b>description</b>  | bypass nozzle type PEL23/24 bore $\phi$ 1.45mm thread M8x0.5 |

|  |  |
|--|--|
|    | 1  |
| <b>GEV No.</b>   | 102171   |
| <b>Ref. No.</b>  | 6018090  |
| <b>description</b>   | gas injector set   |
|    | 1  |
| <b>GEV No.</b>   | 102610   |
| <b>Ref. No.</b>  | 6018330<br>60A0640   |
| <b>description</b>   | gas injector set LPG 2 flames ANGELO PO  |
|   | 1  |
| <b>GEV No.</b>   | 102622   |
| <b>Ref. No.</b>  | 6012660  |
| <b>description</b>   | gas injector set LPG ANGELO PO   |
| <b>For models:</b>   | 1A1FA1G, 1A1FA2G, 1A1FA4G, 1A1FA5G, 1A1TP0G-VERS.2002, 1D1FA1G, 1D1FA2G, 1D1FA4G, 1D1FA5G, 1D1TP0G-VERS.2002, 2A1FA1G, 2A1FA4G, 2A1TP3G, 2A1TP6G, 2D1FA1G, 2D1FA4G, 2D1TP3G, 2D1TP6G, 3A1FA1G, 3A1FA4G, 3D1FA1G, 3D1FA4G |
|  | 1  |
| <b>GEV No.</b>   | 102613   |
| <b>Ref. No.</b>  | 6018340<br>60A0650   |
| <b>description</b>   | gas injector set LPG for gas range 4 ANGELO PO   |

1 gas components

Зип Общепит

vsezip.ru

+7(812)987-08-81



1

|                    |  |                 |                    |
|--------------------|--|-----------------|--------------------|
| <b>GEV No.</b>     | 102611   | <b>Ref. No.</b> | 6018360<br>60A0670 |
| <b>description</b> | gas injector set LPG for gas range 4 with gas oven ANGELO PO |                 |                    |



1

|                    |   |                 |                    |
|--------------------|---|-----------------|--------------------|
| <b>GEV No.</b>     | 102618  | <b>Ref. No.</b> | 6018250<br>60A0560 |
| <b>description</b> | gas injector set LPG gas fryer 2 basins ANGELO PO |                 |                    |



1

|                    |  |                 |                    |
|--------------------|--|-----------------|--------------------|
| <b>GEV No.</b>     | 102619   | <b>Ref. No.</b> | 6018430<br>60A0740 |
| <b>description</b> | gas injector set LPG for solid top range with gas hob and gas oven ANGELO PO |                 |                    |



1

|                    |   |                 |                    |
|--------------------|---|-----------------|--------------------|
| <b>GEV No.</b>     | 102625  | <b>Ref. No.</b> | 6018270<br>60A0580 |
| <b>description</b> | gas injector set LPG gas fryer 2 basins ANGELO PO |                 |                    |



1

|                    |  |                 |                    |
|--------------------|--|-----------------|--------------------|
| <b>GEV No.</b>     | 102626   | <b>Ref. No.</b> | 6018260<br>60A0570 |
| <b>description</b> | gas injector set LPG gas fryer 1 basin ANGELO PO |                 |                    |



1

|                    |  |                 |                    |
|--------------------|--|-----------------|--------------------|
| <b>GEV No.</b>     | 102617   | <b>Ref. No.</b> | 6018180<br>60A0490 |
| <b>description</b> | gas injector set LPG gas pasta cooker 2 basins ANGELO PO |                 |                    |



1

|                    |  |                 |                    |
|--------------------|--|-----------------|--------------------|
| <b>GEV No.</b>     | 102629   | <b>Ref. No.</b> | 6018240<br>60A0550 |
| <b>description</b> | gas injector set LPG gas fryer 1 basin ANGELO PO |                 |                    |



1

|                    |   |                 |                    |
|--------------------|---|-----------------|--------------------|
| <b>GEV No.</b>     | 102623  | <b>Ref. No.</b> | 6018190<br>60A0500 |
| <b>description</b> | gas injector set LPG gas pasta cooker ANGELO PO |                 |                    |



Зип Общепит

vsezip.ru

+7(812)987-08-81



1

|                    |   |                 |                    |
|--------------------|---|-----------------|--------------------|
| <b>GEV No.</b>     | 102624  | <b>Ref. No.</b> | 6018170<br>60A0480 |
| <b>description</b> | gas injector set LPG gas pasta cooker ANGELO PO |                 |                    |

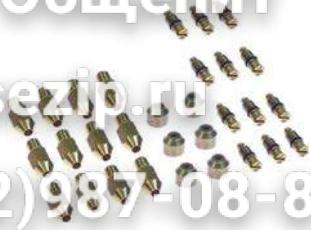

1

|                    |  |                 |         |
|--------------------|--|-----------------|---------|
| <b>GEV No.</b>     | 106808                                 | <b>Ref. No.</b> | 6025800 |
| <b>description</b> | gas injector set natural gas ANGELO PO |                 |         |



1

|                    |  |                 |         |
|--------------------|--|-----------------|---------|
| <b>GEV No.</b>     | 102621   | <b>Ref. No.</b> | 6012700 |
| <b>description</b> | gas injector set LPG nominal power 5.5KW ANGELO PO   |                 |         |
| <b>For models:</b> | 0A0FA1, 0A0FA4, 0D0FA1, 0D0FA4, 1A0FA1, 1A0FA2, 1A0FA4, 1A0FA5, 1A1FA1G, 1A1FA2G, 1A1FA4G, 1A1FA5G, 1D0FA1, 1D0FA2, 1D0FA4, 1D0FA5, 1D1FA1G, 1D1FA2G, 1D1FA4G, 1D1FA5G, 2A0FA1, 2A0FA4, 2A1FA1G, 2A1FA4G, 2A1TP3G, 2A1TP6G, 2D0FA1, 2D0FA4, 2D1FA1G, 2D1FA4G, 2D1TP3G, 2D1TP6G, 3A1FA1G, 3A1FA4G, 3D1FA1G, 3D1FA4G |                 |         |



1

|                    |  |                 |                    |
|--------------------|--|-----------------|--------------------|
| <b>GEV No.</b>     | 106807                                       | <b>Ref. No.</b> | 6018060<br>60A0370 |
| <b>description</b> | gas injector set natural gas ANGELO PO 0G0FT |                 |                    |



1

|                    |  |                 |         |
|--------------------|--|-----------------|---------|
| <b>GEV No.</b>     | 102620   | <b>Ref. No.</b> | 6012680 |
| <b>description</b> | gas injector set LPG nominal power 7.5KW ANGELO PO |                 |         |



1

|                    |  |                 |                    |
|--------------------|--|-----------------|--------------------|
| <b>GEV No.</b>     | 102614   | <b>Ref. No.</b> | 6018290<br>60A0600 |
| <b>description</b> | gas injector set natural gas for gas range 4 ANGELO PO |                 |                    |



1

|                    |  |                 |                    |
|--------------------|--|-----------------|--------------------|
| <b>GEV No.</b>     | 102616   | <b>Ref. No.</b> | 6018410<br>60A0720 |
| <b>description</b> | gas injector set LPG solid top range ANGELO PO |                 |                    |



1

|                    |  |                 |                    |
|--------------------|--|-----------------|--------------------|
| <b>GEV No.</b>     | 102612   | <b>Ref. No.</b> | 6018320<br>60A0630 |
| <b>description</b> | gas injector set natural gas for gas range 6 with gas oven ANGELO PO |                 |                    |



1

|                    |  |                 |                    |
|--------------------|--|-----------------|--------------------|
| <b>GEV No.</b>     | 102615   | <b>Ref. No.</b> | 6018420<br>60A0730 |
| <b>description</b> | gas injector set LPG solid top range with gas oven ANGELO PO |                 |                    |



1

|                    |                          |                 |                    |
|--------------------|--------------------------|-----------------|--------------------|
| <b>GEV No.</b>     | 106550                   | <b>Ref. No.</b> | 6018370<br>60A0680 |
| <b>description</b> | nozzle set LPG ANGELO PO |                 |                    |

1 gas components

auxiliary gas parts

screw connections

adapters



|                    |  |                 |         |
|--------------------|--|-----------------|---------|
| <b>GEV No.</b>     | 103097   | <b>Ref. No.</b> | 33Q2870 |
| <b>description</b> | screw connection for thermostat  |                 |         |
| <b>For models:</b> | 1A1P11G, 1A1P11GA, 1D1P11G, 1D1P11GA, 1G1P11G, 31P16, 71P110, 71P110A, 91P110, 91P110A |                 |         |

olives



|                    |   |                 |         |
|--------------------|---|-----------------|---------|
| <b>GEV No.</b>     | 103325  | <b>Ref. No.</b> | 3034890 |
| <b>description</b> | olive for pipe ø 10mm D2 ø 9mm L 8mm  |                 |         |
| <b>For models:</b> | 08WFA4G, 090FT1G, 090FT2G, 090FT4G, 090FT5G, 090FT7G, 0G0FR5G, 0G0FT1G-VERS.032008, 0G0FT2G-VERS.032008, 0G0FT4G-VERS.032008, 0G0FT5G-VERS.032008, 0G0FT7G, 0G1FR7G, 12WFA6G, 190FT15G, 190FT1G, 190FT2G, 190FT3G, 190FT42G, 190FT4G, 190FT6G, 190FT72G, 190FT7G, 191FAAG, 191FABG, 191FADG, 191FAG, 191TPG, 1A1FAAG, 1A1FABG, 1D1FAAG, 1D1FABG, 1G0FR6G, 1G0FT1G-VERS.032008, 1G0FT2G-VERS.032008, 1G0FT3G-VERS.032008, 1G0FT4G-VERS.032008, 1G0FT6E, 1G0FT6G-VERS.032008, 1G0FT7G, 1G1BR1G, 1G1FR8G, 291FAG, 291FAGE, 291TPCG, 2A1FAAG, 2A1TPCG, 2D1FAAG, 2D1TPCG, 391FAG...(Other models you can see in the webshop) |                 |         |



|                    |  |                 |         |
|--------------------|--|-----------------|---------|
| <b>GEV No.</b>     | 101249   | <b>Ref. No.</b> | 36Q1700 |
| <b>description</b> | olive for pipe ø 10mm Qty 1 pcs  |                 |         |
| <b>For models:</b> | 06WCP1GM, 08WCP1GM, 08WGRGV, 090FAVA, 090GRG, 091CP1G, 091FR3G, 091FR3GD, 0A0BMG, 0A0FAS, 0A0FT1G, 0A0FT2G, 0A0FT4G, 0A0FT5G, 0A0GRG, 0A1CP1G, 0B0FAS, 0B0FT1G, 0B0FT2G, 0B0FT4G, 0B0FT5G, 0B1CP1G, 0D0BMG, 0D0FAS, 0D0FT1G, 0D0FT2G, 0D0FT4G, 0D0FT5G, 0D0GRG, 0D1CP1G, 0G0FR5G, 0G0FT1G, 0G0FT2G, 0G0FT4G, 0G0FT5G, 0G1BR3G, 10WTPGE, 10WTPGV, 190FAB, 190GRG, 190TP0, 191CP1G, 191CP2G, 191FABG, 191FR4G, 191FR4GD, 191PD2G, 191P11G, 191P11GA, 191P12G...(Other models you can see in the webshop) |                 |         |



|                    |  |                 |         |
|--------------------|--|-----------------|---------|
| <b>GEV No.</b>     | 101250                                   | <b>Ref. No.</b> | 36Q0610 |
| <b>description</b> | union nut thread M20x1.5 for pipe ø 10mm |                 |         |

Зип Общепит

vsezip.ru

+7(812)987-08-81

|                        |   |                 |         |
|------------------------|---|-----------------|---------|
| <b>GEV No.</b>         | 101278  | <b>Ref. No.</b> | 36Q0080 |
| <b>description</b>     | olive for pine ø 10mm Qty 1 pcs   |                 |         |
| <b>For models:</b>     | 030, 051, 032, 040, 041, 042, 043, 044, 045, 046, 047, 048, 049, 050, 051, 052, 053, 054, 055, 056, 057, 058, 059, 060, 061, 062, 063, 064, 065, 066, 067, 068, 069, 070, 071, 072, 073, 074, 075, 076, 077, 078, 079, 080, 081, 082, 083, 084, 085, 086, 087, 088, 089, 090, 091, 092, 093, 094, 095, 096, 097, 098, 099, 100, 101, 102, 103, 104, 105, 106, 107, 108, 109, 110, 111, 112, 113, 114, 115, 116, 117, 118, 119, 120, 121, 122, 123, 124, 125, 126, 127, 128, 129, 130, 131, 132, 133, 134, 135, 136, 137, 138, 139, 140, 141, 142, 143, 144, 145, 146, 147, 148, 149, 150, 151, 152, 153, 154, 155, 156, 157, 158, 159, 160, 161, 162, 163, 164, 165, 166, 167, 168, 169, 170, 171, 172, 173, 174, 175, 176, 177, 178, 179, 180, 181, 182, 183, 184, 185, 186, 187, 188, 189, 190, 191, 192, 193, 194, 195, 196, 197, 198, 199, 200, 201, 202, 203, 204, 205, 206, 207, 208, 209, 210, 211, 212, 213, 214, 215, 216, 217, 218, 219, 220, 221, 222, 223, 224, 225, 226, 227, 228, 229, 230, 231, 232, 233, 234, 235, 236, 237, 238, 239, 240, 241, 242, 243, 244, 245, 246, 247, 248, 249, 250, 251, 252, 253, 254, 255, 256, 257, 258, 259, 260, 261, 262, 263, 264, 265, 266, 267, 268, 269, 270, 271, 272, 273, 274, 275, 276, 277, 278, 279, 280, 281, 282, 283, 284, 285, 286, 287, 288, 289, 290, 291, 292, 293, 294, 295, 296, 297, 298, 299, 300, 301, 302, 303, 304, 305, 306, 307, 308, 309, 310, 311, 312, 313, 314, 315, 316, 317, 318, 319, 320, 321, 322, 323, 324, 325, 326, 327, 328, 329, 330, 331, 332, 333, 334, 335, 336, 337, 338, 339, 340, 341, 342, 343, 344, 345, 346, 347, 348, 349, 350, 351, 352, 353, 354, 355, 356, 357, 358, 359, 360, 361, 362, 363, 364, 365, 366, 367, 368, 369, 370, 371, 372, 373, 374, 375, 376, 377, 378, 379, 380, 381, 382, 383, 384, 385, 386, 387, 388, 389, 390, 391, 392, 393, 394, 395, 396, 397, 398, 399, 400, 401, 402, 403, 404, 405, 406, 407, 408, 409, 410, 411, 412, 413, 414, 415, 416, 417, 418, 419, 420, 421, 422, 423, 424, 425, 426, 427, 428, 429, 430, 431, 432, 433, 434, 435, 436, 437, 438, 439, 440, 441, 442, 443, 444, 445, 446, 447, 448, 449, 450, 451, 452, 453, 454, 455, 456, 457, 458, 459, 460, 461, 462, 463, 464, 465, 466, 467, 468, 469, 470, 471, 472, 473, 474, 475, 476, 477, 478, 479, 480, 481, 482, 483, 484, 485, 486, 487, 488, 489, 490, 491, 492, 493, 494, 495, 496, 497, 498, 499, 500, 501, 502, 503, 504, 505, 506, 507, 508, 509, 510, 511, 512, 513, 514, 515, 516, 517, 518, 519, 520, 521, 522, 523, 524, 525, 526, 527, 528, 529, 530, 531, 532, 533, 534, 535, 536, 537, 538, 539, 540, 541, 542, 543, 544, 545, 546, 547, 548, 549, 550, 551, 552, 553, 554, 555, 556, 557, 558, 559, 560, 561, 562, 563, 564, 565, 566, 567, 568, 569, 570, 571, 572, 573, 574, 575, 576, 577, 578, 579, 580, 581, 582, 583, 584, 585, 586, 587, 588, 589, 590, 591, 592, 593, 594, 595, 596, 597, 598, 599, 600, 601, 602, 603, 604, 605, 606, 607, 608, 609, 610, 611, 612, 613, 614, 615, 616, 617, 618, 619, 620, 621, 622, 623, 624, 625, 626, 627, 628, 629, 630, 631, 632, 633, 634, 635, 636, 637, 638, 639, 640, 641, 642, 643, 644, 645, 646, 647, 648, 649, 650, 651, 652, 653, 654, 655, 656, 657, 658, 659, 660, 661, 662, 663, 664, 665, 666, 667, 668, 669, 670, 671, 672, 673, 674, 675, 676, 677, 678, 679, 680, 681, 682, 683, 684, 685, 686, 687, 688, 689, 690, 691, 692, 693, 694, 695, 696, 697, 698, 699, 700, 701, 702, 703, 704, 705, 706, 707, 708, 709, 710, 711, 712, 713, 714, 715, 716, 717, 718, 719, 720, 721, 722, 723, 724, 725, 726, 727, 728, 729, 730, 731, 732, 733, 734, 735, 736, 737, 738, 739, 740, 741, 742, 743, 744, 745, 746, 747, 748, 749, 750, 751, 752, 753, 754, 755, 756, 757, 758, 759, 760, 761, 762, 763, 764, 765, 766, 767, 768, 769, 770, 771, 772, 773, 774, 775, 776, 777, 778, 779, 780, 781, 782, 783, 784, 785, 786, 787, 788, 789, 790, 791, 792, 793, 794, 795, 796, 797, 798, 799, 800, 801, 802, 803, 804, 805, 806, 807, 808, 809, 810, 811, 812, 813, 814, 815, 816, 817, 818, 819, 820, 821, 822, 823, 824, 825, 826, 827, 828, 829, 830, 831, 832, 833, 834, 835, 836, 837, 838, 839, 840, 841, 842, 843, 844, 845, 846, 847, 848, 849, 850, 851, 852, 853, 854, 855, 856, 857, 858, 859, 860, 861, 862, 863, 864, 865, 866, 867, 868, 869, 870, 871, 872, 873, 874, 875, 876, 877, 878, 879, 880, 881, 882, 883, 884, 885, 886, 887, 888, 889, 890, 891, 892, 893, 894, 895, 896, 897, 898, 899, 900, 901, 902, 903, 904, 905, 906, 907, 908, 909, 910, 911, 912, 913, 914, 915, 916, 917, 918, 919, 920, 921, 922, 923, 924, 925, 926, 927, 928, 929, 930, 931, 932, 933, 934, 935, 936, 937, 938, 939, 940, 941, 942, 943, 944, 945, 946, 947, 948, 949, 950, 951, 952, 953, 954, 955, 956, 957, 958, 959, 960, 961, 962, 963, 964, 965, 966, 967, 968, 969, 970, 971, 972, 973, 974, 975, 976, 977, 978, 979, 980, 981, 982, 983, 984, 985, 986, 987, 988, 989, 990, 991, 992, 993, 994, 995, 996, 997, 998, 999, 1000 |                 |         |
| <b>accessories for</b> | 101278  |                 |         |
| <b>GEV No.</b>         | 100943  | <b>Ref. No.</b> | —       |
| <b>description</b>     | union nut thread M17x1 tube ø 10mm  |                 |         |
| <b>GEV No.</b>         | 101300  | <b>Ref. No.</b> | 36Q0830 |
| <b>description</b>     | union nut thread M16x1.5 tube ø 10mm  |                 |         |
| <b>GEV No.</b>         | 101478  | <b>Ref. No.</b> | —       |
| <b>description</b>     | union nut thread 3/8" for pipe ø 10mm   |                 |         |



|                    |   |                 |         |
|--------------------|---|-----------------|---------|
| <b>GEV No.</b>     | 101248  | <b>Ref. No.</b> | 36Q0030 |
| <b>description</b> | olive for pipe ø 12mm Qty 1 pcs suitable for PEL  |                 |         |
| <b>For models:</b> | 030FT, 030FTR, 031FT, 031FT04, 031FT06, 031FTR, 031FTRL, 031TP, 032, 070BM, 070D, 070DGG, 070FT, 070FT04, 070FT05, 070FTR, 0712D, 0712VA, 071BM, 071D, 071DGG, 071FT, 071FT04, 071FT06, 071FTR, 071FTRL, 071TP, 072D, 072DGG, 090, 090BM, 090FT, 090FT04, 090FT05, 090FT1G, 090FT2G, 090FT4G, 090FT5G, 090FT7G, 090FTR, 090GG, 090GRG, 091, 091BM, 091FR1G, 091FR1GD, 091FR11, 091FR11A, 091FR11D, 091FR11D-VERS.052012...(Other models you can see in the webshop) |                 |         |



|                        |  |                 |         |
|------------------------|--|-----------------|---------|
| <b>accessories for</b> | 101248                                   |                 |         |
| <b>GEV No.</b>         | 101251                                   | <b>Ref. No.</b> | 36Q0050 |
| <b>description</b>     | union nut thread M20x1.5 for pipe ø 12mm |                 |         |



|                    |   |                 |         |
|--------------------|---|-----------------|---------|
| <b>GEV No.</b>     | 101428  | <b>Ref. No.</b> | 36Q0310 |
| <b>description</b> | olive for pipe ø 14mm L 9mm Qty 1 pcs ED ø 16mm   |                 |         |
| <b>For models:</b> | 04WFAAV, 08WFAAE, 08WFAAG, 08WFAAV, 12WFAAE, 12WFAAG, 191BR1G, 191BR1GA, 191BR2G, 191BR2GA, 1A1BR1G, 1A1BR1GA, 1A1BR2G, 1A1BR2GA, 1D1BR1G, 1D1BR1GA, 1D1BR2G, 1D1BR2GA, 291BR1G, 291BR1GA, 291BR2G, 291BR2GA, 2A1BR1G, 2A1BR1GA, 2A1BR2G, 2A1BR2GA, 2D1BR1G, 2D1BR1GA, 2D1BR2G, 2D1BR2GA, FC241, FCV141, FCV141DM, FCV141DS, FCV241, FCV241DM, FCV241DS |                 |         |





Зип Общепит

vsezip.ru



7(812)987-08-81



|  |  |                 |         |
|--|--|-----------------|---------|
|  <p>1</p> |  |                 |         |
| <b>GEV No.</b>   | 100870   | <b>Ref. No.</b> | 36Q1040 |
| <b>description</b>   | olive for pipe ø 4mm Qty 1 pcs suitable for 160 series for pilot burner  |                 |         |
| <b>For models:</b>   | 04WFAAV, 06WCP1GM, 06WFR3GD, 08WFA4E, 08WFA4G, 08WFA4E, 08WFAAG, 08WFAAV, 08WFT1GV, 08WFT2GV, 08WFT3GV, 08WFT4GV, 08WFT6GV, 08WFT7GV, 08WGRGV, 090BM1G, 090FAA, 090FAVA, 090FT1G, 090FT2G, 090FT4G, 090FT5G, 090FT7G, 090GRG, 091FR1G, 091FR1GD, 091FR3G, 091FR3GD, 0A0FA1, 0A0FA4, 0A0FAA, 0A0FT1G, 0A0FT2G, 0A0FT4G, 0A0FT5G, 0A0GRG, 0A1CP1G, 0B0FT1G, 0B0FT2G, 0B0FT4G, 0B0FT5G, 0B1CP1G, 0D0FA1, 0D0FA4, 0D0FAA, 0D0FT1G, 0D0FT2G, 0D0FT4G, 0D0FT5G, 0D0GRG...(Other models you can see in the webshop) |                 |         |

|  |   |                 |                         |
|--|---|-----------------|-------------------------|
|  <p>1</p> |   |                 |                         |
| <b>GEV No.</b>   | 101286  | <b>Ref. No.</b> | 36Q0020                 |
| <b>description</b>   | olive ID ø 6mm Qty 1 pcs  |                 |                         |
| <b>For models:</b>   | 04WFAAV, 08WFA4E, 08WFA4G, 08WFAAE, 08WFAAG, 08WFAAV, 090FAA, 0A0FA1, 0A0FA4, 0A0FAA, 0D0FA1, 0D0FA4, 0D0FAA, 0G0FA0, 12WFA6E, 12WFA6G, 12WFAAA, 12WFAAE, 12WFAAG, 12WFAAN, 190FA, 190FAA, 190FAB, 190FAD, 191FAAE, 191FAAG, 191FABG, 191FADG, 191FAE, 191FAG, 1A0FA1, 1A0FA2, 1A0FA4, 1A0FA5, 1A0FAA, 1A0FAB, 1A1FA1G, 1A1FA2G, 1A1FA4G, 1A1FA5G, 1A1FAAG, 1A1FABG, 1D0FA1, 1D0FA2, 1D0FA4, 1D0FA5, 1D0FAA, 1D0FAB, 1D1FA1G, 1D1FA2G...(Other models you can see in the webshop) |                 |                         |
| <b>accessories for</b>   | 101286  |                 |                         |
|  | <b>GEV No.</b>  | 100909          | <b>Ref. No.</b> 36Q0060 |
|  |  <p>union screw thread M10x1 for pipe ø 6mm Qty 1 pcs</p>   |                 |                         |
|  | <b>GEV No.</b>  | 101464          | <b>Ref. No.</b> —       |
|  |  <p>union nut thread M12x1 for pipe ø 6mm</p>  |                 |                         |

|  |  |                 |         |
|--|--|-----------------|---------|
| <p>T-pieces</p>  <p>1</p> |  |                 |         |
| <b>GEV No.</b>   | 541502   | <b>Ref. No.</b> | 33Q0140 |
| <b>description</b>   | T-piece thread 3/8" ET - 3/8" ET - 3/8" ET brass   |                 |         |
| <b>For models:</b>   | 1A1CP1G, 1D1CP1G, 1G1CP2G, 1G1PD1G, 1G1PI1E, 1G1PI1G, 31PD6, 31PI6, 31PIE6, 71CP, 71CP2, 71PD10, 71PD15, 71PI10, 71PI10A, 71PIE15, 71PIE15A, 71PV15, 71PV15A, 91CP, 91PI10, 91PI10A, 91PIE15, 91PIE15A |                 |         |

|  |   |                 |         |
|--|---|-----------------|---------|
|  <p>1</p> |   |                 |         |
| <b>GEV No.</b>   | 520666  | <b>Ref. No.</b> | 36Q0590 |
| <b>description</b>   | union nut thread 1/2" H 12mm  |                 |         |
| <b>For models:</b>   | 091FR11, 091FR11A, 091FR11D, 091FR11D-VERS.052012, 091FR11-VERS.032012, 091FR7G, 091FR7GS, 091FR7G-VERS.052012, 091FR7GX, 0A1CP1E, 0A1CP1G, 0B1CP1G, 0D1CP1E, 0D1CP1G, 10CP11A, 12CP11A, 18CP21A, 191FR21, 191FR21D, 191FR21D-VERS.092012, 191FR21-VERS.032012, 1A1BR1E, 1A1BR1G, 1A1BR1GA, 1A1BR2E, 1A1BR2EA, 1A1BR2G, 1A1BR2GA, 1A1CP1G, 1A1CP2G, 1A1PD1G, 1A1PD2G, 1A1PI1G, 1A1PI1GA, 1A1PI2E, 1A1PI2EA, 1A1PI2V, 1A1PI-2VA, 1D1BR1E, 1D1BR1G, 1D1BR1GA, 1D1BR2E, 1D1BR2EA, 1D1BR2G, 1D1BR2GA, 1D1CP1G, 1D1CP2G, 1D1PD1G, 1D1PD2G, 1D1PI1G...(Other models you can see in the webshop) |                 |         |

|  |   |                 |                         |
|--|---|-----------------|-------------------------|
|  <p>1</p> |   |                 |                         |
| <b>GEV No.</b>   | 101300  | <b>Ref. No.</b> | 36Q0830                 |
| <b>description</b>   | union nut thread M16x1.5 tube ø 10mm  |                 |                         |
| <b>For models:</b>   | 030, 031, 032, 04WFAAV, 06WCP1GM, 06WFR3GD, 08WCP1GM, 08WFA4E, 08WFA4G, 08WFAAE, 08WFAAG, 08WFAAV, 08WFT1GV, 08WFT2GV, 08WFT3GV, 08WFT4GV, 08WFT6GV, 08WFT7GV, 08WGRGV, 090FAA, 090GRG, 091CP1G, 0A0BMG, 0A0FA1, 0A0FA4, 0A0FAA, 0A0GRG, 0D0BMG, 0D0FA1, 0D0FA4, 0D0FAA, 0D0GRG, 0G0FA0, 0G0FR5G, 0G1BR3G, 0G1CP1G, 0G1CP1G-VERS.2004, 0G1FR7G, 10WFR4GD, 12WFA6E, 12WFA6G, 12WFAAA, 12WFAAE, 12WFAAG, 12WFAAN, 190FA, 190FAA, 190FAB, 190FAD, 190GRG...(Other models you can see in the webshop) |                 |                         |
| <b>accessories for</b>   | 101300  |                 |                         |
|  | <b>GEV No.</b>  | 101278          | <b>Ref. No.</b> 36Q0080 |
|  |  <p>olive for pipe ø 10mm Qty 1 pcs</p>  |                 |                         |

|  |   |                 |                   |
|--|---|-----------------|-------------------|
|  <p>1</p> |   |                 |                   |
| <b>GEV No.</b>   | 100944  | <b>Ref. No.</b> | 36Q0040           |
| <b>description</b>   | union nut thread M18x1.5 for pipe ø 12mm  |                 |                   |
| <b>accessories for</b>   | 100944  |                 |                   |
|  | <b>GEV No.</b>  | 101273          | <b>Ref. No.</b> — |
|  |  <p>olive for pipe ø 12mm L 9.5mm brass Qty 1 pcs suitable for universal</p> |                 |                   |

1 gas components

Зип.Общепит

union screw

vsezip.ru

+7(812)987-08-81

gas components



1

|                        |  |                 |                         |
|------------------------|--|-----------------|-------------------------|
| <b>GEV No.</b>         | 101250   | <b>Ref. No.</b> | 36Q0610                 |
| <b>description</b>     | union nut thread M20x1.5 for pipe ø 10mm   |                 |                         |
| <b>For models:</b>     | 04WFAAV, 06WCP1GM, 06WFR3GD, 08WCP1GM, 08WFA4E, 08WFA4G, 08WFAAE, 08WFAAG, 08WFAAV, 08WGRGV, 090FAA, 090FAVA, 090FT1G, 090FT2G, 090FT4G, 090FT5G, 090FT7G, 090GRG, 091CP1G, 091FR3G, 091FR3GD, 0A0FA1, 0A0FA4, 0A0FAA, 0A0FAS, 0A0FT1G, 0A0FT2G, 0A0FT4G, 0A0FT5G, 0A0GRG, 0A1CP1G, 0A1FR3G, 0A1FR3GD, 0B0FAS, 0B0FT1G, 0B0FT2G, 0B0FT4G, 0B0FT5G, 0B1CP1G, 0D0FA1, 0D0FA4, 0D0FAA, 0D0FAS, 0D0FT1G, 0D0FT2G, 0D0FT4G, 0D0FT5G, 0D0GRG, 0D1CP1G, 0D1FR3G...(Other models you can see in the webshop) |                 |                         |
| <b>accessories for</b> | 101250   |                 |                         |
|                        | <b>GEV No.</b>   | 101249          | <b>Ref. No.</b> 36Q1700 |
|                        | olive for pipe ø 10mm Qty 1 pcs  |                 |                         |



1

|                        |   |                 |                         |
|------------------------|---|-----------------|-------------------------|
| <b>GEV No.</b>         | 101251  | <b>Ref. No.</b> | 36Q0050                 |
| <b>description</b>     | union nut thread M20x1.5 for pipe ø 12mm  |                 |                         |
| <b>For models:</b>     | 030FT, 030FTR, 031FT, 031FTR, 031FTRL, 031TP, 032, 070D, 070DGG, 070FT, 070FTR, 0712D, 0712VA, 071BM, 071D, 071DGG, 071FT, 071FTR, 071FTRL, 071TP, 072D, 072DGG, 090, 090FT, 090FT1G, 090FT2G, 090FT4G, 090FT5G, 090FT7G, 090FTR, 090GG, 090GRG, 091, 091FR1G, 091FR1GD, 091FR1I, 091FR1IA, 091FR1ID, 091FR1ID-VERS.052012, 091FR1I-VERS.032012, 091FR3G, 091FR3GD, 091FR7G, 091FR7GS, 091FR7G-VERS.052012, 091FR7GX, 091FT, 091FTR, 091FTRL, 091GG...(Other models you can see in the webshop) |                 |                         |
| <b>accessories for</b> | 101251  |                 |                         |
|                        | <b>GEV No.</b>  | 101248          | <b>Ref. No.</b> 36Q0030 |
|                        | olive for pipe ø 12mm Qty 1 pcs suitable for PEL  |                 |                         |



1

|                    |  |                 |         |
|--------------------|--|-----------------|---------|
| <b>GEV No.</b>     | 107892   | <b>Ref. No.</b> | 36Q0210 |
| <b>description</b> | union nut thread M20x1.5 for pipe ø 14 WS 25   |                 |         |
| <b>For models:</b> | 04WFAAV, 08WFA4E, 08WFA4G, 08WFAAE, 08WFAAG, 08WFAAV, 12WFA6E, 12WFA6G, 12WFAAA, 12WFAAE, 12WFAAG, 12WFAAN, 191BR2G, 1A1BR1G, 1A1BR1GA, 1A1BR2G, 1A1BR2GA, 1D1BR1G, 1D1BR1GA, 1D1BR2G, 2A1BR1G, 2A1BR1GA, 2A1BR2G, 2A1BR2GA, 2D1BR1G, 2D1BR1GA, 2D1BR2G, 2D1BR2GA, 71AR, 71AR, 91AR, 91RA, FC241, FCV141, FCV141DM, FCV141DS, FCV241, FCV241DM, FCV241DS |                 |         |



1

|                    |  |                 |         |
|--------------------|--|-----------------|---------|
| <b>GEV No.</b>     | 100906   | <b>Ref. No.</b> | 36Q1050 |
| <b>description</b> | screw connection thread M10x1 for ignition electrode brass Qty 1 pcs WS 10   |                 |         |
| <b>For models:</b> | 08WGRGV, 090GRG, 0A0GRG, 0A1CP1G, 0B1CP1G, 0D0GRG, 0D1CP1G, 190GRG, 191CP1G, 1A0GRG, 1A1CP1G, 1A1CP2G, 1A1PD1G, 1A1PD2G, 1A1PI1G, 1A1PI1GA, 1D0GRG, 1D1CP1G, 1D1CP2G, 1D1PD1G, 1D1PD2G, 1D1PI1G, 1D1PI1GA, 1G0GRG, 6042120-08WGRGV |                 |         |



1

|                    |  |                 |         |
|--------------------|--|-----------------|---------|
| <b>GEV No.</b>     | 101279   | <b>Ref. No.</b> | 3032790 |
| <b>description</b> | union screw thread 3/8" for pipe ø 10mm Qty 1 pcs  |                 |         |
| <b>For models:</b> | 06WFR3GD, 08WFA4G, 090BM1G, 090FT1G, 090FT2G, 090FT4G, 090FT5G, 090FT7G, 091FR1EX, 091FR3G, 091FR3GD, 091FR7GS, 091FR7GX, 0A1FR3G, 0A1FR3GD, 0D1FR3G, 0D1FR3GD, 0G0FR5G, 0G0FT1G-VERS.032008, 0G0FT2G-VERS.032008, 0G0FT4G-VERS.032008, 0G0FT5G-VERS.032008, 0G0FT7G, 0G1FR3G, 0G1FR3GD, 0G1FR7G, 10WFR4GD, 12WFA6G, 190BM2G, 190FT15G, 190FT1G, 190FT2G, 190FT3G, 190FT42G, 190FT4G, 190FT6G, 190FT72G, 190FT7G, 191FAAG, 191FABG, 191FADG, 191FAG, 191FR4G, 191FR4GD, 191TPG, 1A1FAAG, 1A1FABG, 1A1FR4G, 1A1FR4GD, 1D1FAAG...(Other models you can see in the webshop) |                 |         |



1

|                    |  |                 |         |
|--------------------|--|-----------------|---------|
| <b>GEV No.</b>     | 100908   | <b>Ref. No.</b> | 36Q1000 |
| <b>description</b> | union screw thread M10x1 for pipe ø 4mm Qty 1 pcs  |                 |         |
| <b>For models:</b> | 04WFAAV, 06WCP1GM, 06WFR3GD, 08WFA4E, 08WFA4G, 08WFAAE, 08WFAAG, 08WFAAV, 08WFT1GV, 08WFT2GV, 08WFT3GV, 08WFT4GV, 08WFT6GV, 08WFT7GV, 08WGRGV, 090BM1G, 090FAA, 090FAVA, 090FT1G, 090FT2G, 090FT4G, 090FT5G, 090FT7G, 090GRG, 091FR1G, 091FR1GD, 091FR3G, 091FR3GD, 0A0FA1, 0A0FA4, 0A0FAA, 0A0FT1G, 0A0FT2G, 0A0FT4G, 0A0FT5G, 0A0GRG, 0A1CP1G, 0B0FT1G, 0B0FT2G, 0B0FT4G, 0B0FT5G, 0B1CP1G, 0D0FA1, 0D0FA4, 0D0FAA, 0D0FT1G, 0D0FT2G, 0D0FT4G, 0D0FT5G, 0D0GRG...(Other models you can see in the webshop) |                 |         |

|                        |   |        |                   |
|------------------------|---|--------|-------------------|
| <b>accessories for</b> | 100908  |        |                   |
|                        | <b>GEV No.</b>                                  | 100897 | <b>Ref. No.</b> — |
|                        | olive for pipe ø 4mm Qty 1 pcs for pilot burner |        |                   |
|                        | <b>GEV No.</b>                                  | 101246 | <b>Ref. No.</b> — |
|                        | olive for pipe ø 4mm Qty 1 pcs                  |        |                   |
|                        | <b>GEV No.</b>                                  | 101280 | <b>Ref. No.</b> — |
|                        | olive for pipe ø 4mm Qty 1 pcs                  |        |                   |
|                        | <b>GEV No.</b>                                  | 101282 | <b>Ref. No.</b> — |
|                        | olive for pipe ø 4mm L 7.4mm Qty 1 pcs          |        |                   |







Зип Общепит

vsezip.ru

+7(812)987-08-81

|   |   |                 |                         |
|---|---|-----------------|-------------------------|
|  |   |                 |                         |
| 1   |   |                 |                         |
| <b>GEV No.</b>  | 100909  | <b>Ref. No.</b> | 36Q0060                 |
| <b>description</b>  | union screw thread M10x1 for pipe ø 6mm Qty 1 pcs   |                 |                         |
| <b>For models:</b>  | 04WFAAV, 08WFA4E, 08WFA4G, 08WFAAE, 08WFAAG, 08WFAAV, 090FAA, 0A0FA1, 0A0FA4, 0A0FAA, 0D0FA1, 0D0FA4, 0D0FAA, 0G0FA0, 12WFA6E, 12WFA6G, 12WFAAA, 12WFAAE, 12WFAAG, 12WFAAN, 190FA, 190FAA, 190FAB, 190FAD, 191FAAE, 191FAAG, 191FABG, 191FADG, 191FAE, 191FAG, 1A0FA1, 1A0FA2, 1A0FA4, 1A0FA5, 1A0FAA, 1A0FAB, 1A1FA1G, 1A1FA2G, 1A1FA4G, 1A1FA5G, 1A1FAAG, 1A1FABG, 1D0FA1, 1D0FA2, 1D0FA4, 1D0FA5, 1D0FAA, 1D0FAB, 1D1FA1G, 1D1FA2G...(Other models you can see in the webshop) |                 |                         |
| <b>accessories for</b>  | 100909  |                 |                         |
|  | <b>GEV No.</b>  | 100898          | <b>Ref. No.</b> —       |
|   | olive for pipe ø 6mm Qty 1 pcs for pilot burner   |                 |                         |
|  | <b>GEV No.</b>  | 101286          | <b>Ref. No.</b> 36Q0020 |
|   | olive ID ø 6mm Qty 1 pcs  |                 |                         |
|  | <b>GEV No.</b>  | 101287          | <b>Ref. No.</b> 36Q0150 |
|   | olive for pipe ø 6mm Qty 1 pcs  |                 |                         |
|  | <b>GEV No.</b>  | 101288          | <b>Ref. No.</b> —       |
|   | olive for pipe ø 6mm L 6mm aluminium Qty 1 pcs ED ø 8.5mm   |                 |                         |

|  |  |                 |         |
|--|--|-----------------|---------|
|  |  |                 |         |
| 1  |  |                 |         |
| <b>GEV No.</b>   | 107551   | <b>Ref. No.</b> | 30Z2040 |
| <b>description</b>   | gas line tube ø 21mm L 745mm W 180mm H 70mm steel  |                 |         |
| <b>For models:</b>   | 1A0FT1G, 1A0FT2G, 1A0FT3G, 1A0FT4G, 1A0FT6G, 1D0FT1G, 1D0FT2G, 1D0FT3G, 1D0FT4G, 1D0FT6G |                 |         |

|  |   |                 |         |
|--|---|-----------------|---------|
| <b>universal</b>   |   |                 |         |
|  |   |                 |         |
| 1  |   |                 |         |
| <b>GEV No.</b>   | 107589  | <b>Ref. No.</b> | 3029620 |
| <b>description</b>   | gas line connection ø10mm L 1250mm ED ø 13mm SS flexible thickness 1mm connection length 30mm   |                 |         |
| <b>For models:</b>   | 08WFT1GV, 08WFT2GV, 08WFT3GV, 08WFT4GV, 08WFT6GV, 08WFT-7GV, 1G1FA0G, 1G1FABG, 1G1FAPG, 1G1TP0G, 2G1FA0G, 2G1FABG, 2G1FACG, 2G1FADG, 2G1FADGV, 2G1FAPG, 2G1TP3G |                 |         |

|  |   |                 |         |
|--|---|-----------------|---------|
|  |   |                 |         |
| 1  |   |                 |         |
| <b>GEV No.</b>   | 102990  | <b>Ref. No.</b> | 35Z6650 |
| <b>description</b>   | gas line connection ø10mm L 320mm ED ø 13mm SS with screw connection thickness 1mm connection length 30mm |                 |         |
| <b>For models:</b>   | 071FT, 071FTR, 071FTRL, 091FT, 091FTR, 091FTRL  |                 |         |

|  |  |                 |         |
|--|--|-----------------|---------|
|  |  |                 |         |
| 1  |  |                 |         |
| <b>GEV No.</b>   | 102987   | <b>Ref. No.</b> | 3014320 |
| <b>description</b>   | gas line connection ø10mm L 400mm ED ø 13mm SS flexible thickness 1mm connection length 30mm   |                 |         |
| <b>For models:</b>   | 04WFAAV, 08WFA4E, 08WFA4G, 08WFAAE, 08WFAAG, 08WFAAV, 08WFT1GV, 08WFT2GV, 08WFT3GV, 08WFT4GV, 08WFT6GV, 08WFT-7GV, 08WGRGV, 090BM1G, 090FAA, 090FAVA, 090FT1G, 090FT2G, 090FT4G, 090FT5G, 090FT7G, 090GRG, 091FR3G, 091FR3GD, 0A0BMG, 0A0FAA, 0A0FT1G, 0A0FT2G, 0A0FT4G, 0A0FT5G, 0A0GRG, 0A1FR3G, 0A1FR3GD, 0B0FT1G, 0B0FT2G, 0B0FT4G, 0B0FT5G, 0D0BMG, 0D0FAA, 0D0FT1G, 0D0FT2G, 0D0FT4G, 0D0FT5G, 0D0GRG, 0D1FR3G, 0D1FR3GD, 0G0FA0, 0G0FR5G, 0G0FT1G, 0G0FT1G-VERS.032008... (Other models you can see in the webshop) |                 |         |

|  |   |                 |         |
|--|---|-----------------|---------|
|  |   |                 |         |
| 1  |   |                 |         |
| <b>GEV No.</b>   | 106655  | <b>Ref. No.</b> | 3029630 |
| <b>description</b>   | gas line connection ø10mm L 800mm ED ø 13mm SS flexible   |                 |         |
| <b>For models:</b>   | 06WFR3GD, 08WCP1GM, 08WFA4G, 10WFR4GD, 12WFA6G, 191FAAG, 191FABG, 191FADG, 191FAG, 191FR4G, 191FR4GD, 191PD2G, 191PI1G, 191PI1GA, 191PI2G, 191PI2GA, 191TPG, 1A1FAAG, 1A1FABG, 1A1FR4G, 1A1FR4GD, 1A1PD1G, 1A1PD2G, 1A1PI1G, 1A1PI1GA, 1D1FAAG, 1D1FABG, 1D1FR4G, 1D1FR4GD, 1D1PD1G, 1D1PD2G, 1D1PI1G, 1D1PI1GA, 1G1BR1G, 1G1FR4G, 1G1FR4GD, 1G1PD1G, 1G1PI1G, 291FAG, 291FAGF, 291TPCG, 2A1FAAG, 2A1TPCG, 2D1FAAG, 2D1TPCG, 391FAG, 3A1FAAG, 3D1FAAG |                 |         |

gas lines

main gas lines

producer-specific

|   |  |                 |         |
|---|--|-----------------|---------|
|  |  |                 |         |
| 1   |  |                 |         |
| <b>GEV No.</b>  | 102991   | <b>Ref. No.</b> | 35Z4960 |
| <b>description</b>  | gas line tube ø 10mm L 300mm with screw connection   |                 |         |
| <b>For models:</b>  | 070D, 070DGG, 0712D, 0712VA, 071D, 071DGG, 072D, 072DGG, 090, 090GG, 091, 091GG, 092, 092GG, 092VA, 092VAGG, 712D, 712VA, 71D, 71DGG, 71GE, 71GEGG, 72D, 72DGG, 72TP, 72TPGG, 72VA, 72VAGG, 72VAS, 72VASGG, 73D, 73DGG, 73VA, 73VAD, 73VADGG, 73VAGG |                 |         |

Зип Общепит

vsezip.ru

+7(812)987-08-81



|                    |  |                 |                    |
|--------------------|--|-----------------|--------------------|
| <b>GEV No.</b>     | 102460   | <b>Ref. No.</b> | 3079320<br>32Z0640 |
| <b>description</b> | gas line connection ø4mm L 750mm ED ø 12mm SS flexible thickness 0.75mm connection length 20mm   |                 |                    |
| <b>For models:</b> | 06WCP1GM, 06WFR3GD, 08WFT1GV, 08WFT2GV, 08WFT3GV, 08WFT4GV, 08WFT6GV, 08WFT7GV, 090BM1G, 090FAVA, 091FR1G, 091FR1GD, 091FR3G, 091FR3GD, 0G1CP1G, 0G1CP1G-VERS.2004, 0G1FR3G, 0G1FR3GD, 0G1FR7G, 10WFR4GD, 190BM2G, 190FAB, 190TP0, 191CP1G, 191FABG, 191FR2G, 191FR2GD, 191PD2G, 191PI1G, 191PI1GA, 191PI2G, 191PI2GA, 191TPG, 1A1FR2GD-VERS.2004, 1A1FR2G-VERS.2004, 1A1PD1G, 1A1PD2G, 1A1PI1G, 1A1PI1GA, 1D1FR2GD-VERS.2004, 1D1FR2G-VERS.2004, 1D1PD1G, 1D1PD2G, 1D1PI1G, 1D1PI1GA, 1G0FT1G, 1G0FT2G, 1G0FT3G, 1G0FT4G, 1G0FT6G...(Other models you can see in the webshop) |                 |                    |



|                    |                               |                 |         |
|--------------------|-------------------------------|-----------------|---------|
| <b>GEV No.</b>     | 102988                        | <b>Ref. No.</b> | 35Z7410 |
| <b>description</b> | pilot tube tube ø 5mm L 400mm |                 |         |

**pilot tubes**

**producer-specific**



|                    |   |                 |         |
|--------------------|---|-----------------|---------|
| <b>GEV No.</b>     | 106991  | <b>Ref. No.</b> | 3079290 |
| <b>description</b> | pilot tube tube ø 4mm L 400mm aluminium flexible  |                 |         |
| <b>For models:</b> | 04WFAAV, 08WFA4E, 08WFA4G, 08WFAAE, 08WFAAG, 08WFAAV, 08WGRGV, 090BM1G, 090FT1G, 090FT2G, 090FT4G, 090FT5G, 090FT7G, 090GRG, 0G0FR5G, 0G0FT1G-VERS.032008, 0G0FT2G-VERS.032008, 0G0FT4G-VERS.032008, 0G0FT5G-VERS.032008, 0G0FT7G, 0G1BR3G, 12WFA6E, 12WFA6G, 12WFAAA, 12WFAAE, 12WFAAG, 12WFAAN, 190BM2G, 190FT15G, 190FT1G, 190FT2G, 190FT3G, 190FT42G, 190FT4G, 190FT6G, 190FT72G, 190FT7G, 190GRG, 191BR1G, 191BR1GA, 191BR2G, 191BR2GA, 1G0FR6G, 1G0FT1G-VERS.032008, 1G0FT2G-VERS.032008, 1G0FT3G-VERS.032008, 1G0FT4G-VERS.032008, 1G0FT6E, 1G0FT6G-VERS.032008, 1G0FT7G...(Other models you can see in the webshop) |                 |         |

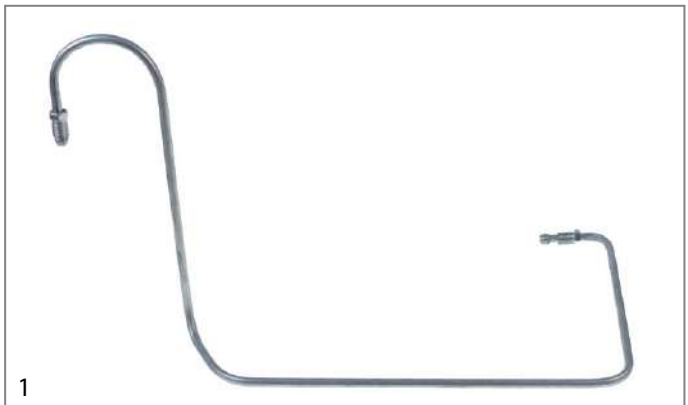

|                    |   |                 |         |
|--------------------|---|-----------------|---------|
| <b>GEV No.</b>     | 102296  | <b>Ref. No.</b> | 35X4590 |
| <b>description</b> | pilot tube tube ø 6mm T1: M10 T2: M10   |                 |         |
| <b>For models:</b> | FC101, FC61, FCV101, FCV101-CSA, FCV101DM, FCV101DM-CSA, FCV101DS, FCV101DS-CSA, FCV61, FCV61-CSA, FCV61DM, FCV61DM-CSA, FCV61DS, FCV61DS-CSA |                 |         |



|                    |   |                 |         |
|--------------------|---|-----------------|---------|
| <b>GEV No.</b>     | 102989  | <b>Ref. No.</b> | 35Z7400 |
| <b>description</b> | pilot tube tube ø 5mm L 130mm                             |                 |         |
| <b>For models:</b> | 030, 031, 032, 31, 31GE, 31TC, 32, 32TC, 32TP, 32TPV, 32V |                 |         |

**consumables**

**lava rocks / ceramic briquetts**

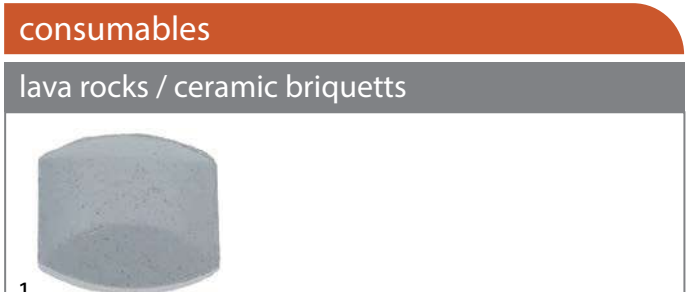

|                    |  |                 |         |
|--------------------|--|-----------------|---------|
| <b>GEV No.</b>     | 211049   | <b>Ref. No.</b> | 37T1320 |
| <b>description</b> | ceramic briquetts size 50x50x26mm Qty 40 pieces (2.4kg)                          |                 |         |
| <b>For models:</b> | 08WGRGV, 090GRG, 0A0GRG, 0D0GRG, 190GRG, 1A0GRG, 1D0GRG, 1G0GRG, 6042120-08WGRGV |                 |         |



equipment-specific units

for slicers

adjustment knobs

|  |   |                 |         |
|--|---|-----------------|---------|
|  <p>1</p> |   |                 |         |
| <b>GEV No.</b>   | 697796  | <b>Ref. No.</b> | 36M3680 |
| <b>description</b>   | adjusting knob $\varnothing$ 68mm shaft $\varnothing$ 18mm shaft L 73mm handle $\varnothing$ 68mm turn direction left |                 |         |

eccentric disc for slice thickness

|  |  |                 |         |
|--|--|-----------------|---------|
|  <p>1</p> |  |                 |         |
| <b>GEV No.</b>   | 697508   | <b>Ref. No.</b> | 3FL0209 |
| <b>description</b>   | eccentrics for cutting thickness hole $\varnothing$ 18mm groove width 8mm ED $\varnothing$ 85mm thickness 24.5mm |                 |         |

hand guard

|   |   |                 |         |
|---|---|-----------------|---------|
|  <p>1</p> |   |                 |         |
| <b>GEV No.</b>  | 698212                                  | <b>Ref. No.</b> | 35Q9820 |
| <b>description</b>  | hand protection                         |                 |         |
| <b>For models:</b>  | AFT30MS, AFT30S, AFT33MS, AFT33S, AFT35 |                 |         |

blades

standard

|  |   |                 |         |
|--|---|-----------------|---------|
|  <p>1</p> |   |                 |         |
| <b>GEV No.</b>   | 697463  | <b>Ref. No.</b> | 36G8610 |
| <b>description</b>   | slicing machine blade ED $\varnothing$ 350mm seat $\varnothing$ 57mm 4 hole ID $\varnothing$ 280mm H 22.5mm 100Cr6 standard |                 |         |
| <b>For models:</b>   | AFC35, AFT35, AFT35VS   |                 |         |

Зип Общежит

grindstones

|   |                   |                 |         |
|---|-------------------|-----------------|---------|
|  <p>1</p> |                   |                 |         |
| <b>GEV No.</b>  | 699007            | <b>Ref. No.</b> | 36G1030 |
| <b>description</b>  | grindstone 1 pair |                 |         |

|   |  |                 |         |
|---|--|-----------------|---------|
|  <p>1</p> |  |                 |         |
| <b>GEV No.</b>  | 698340                                 | <b>Ref. No.</b> | 36G3950 |
| <b>description</b>  | pair of grindstones 1 pair             |                 |         |
| <b>For models:</b>  | AFC35, AFT33MS, AFT33S, AFT35, AFT35VS |                 |         |

for bandsaws

saw blades

|   |   |                 |             |
|---|---|-----------------|-------------|
| <p>width 16mm</p>  <p>1</p> |   |                 |             |
| <b>GEV No.</b>  | 699003  | <b>Ref. No.</b> | LF152020U16 |
| <b>description</b>  | saw blade L 2020mm W 16mm thickness 0.5mm tooth spacing 6mm |                 |             |

for meat mincers

gear wheels

|  |  |                 |         |
|--|--|-----------------|---------|
|  <p>1</p> |  |                 |         |
| <b>GEV No.</b>   | 698205   | <b>Ref. No.</b> | 36G0390 |
| <b>description</b>   | gear wheel double $\varnothing$ 32/70mm shaft intake $\varnothing$ 15mm W 30mm teeth 18/41 splitting tooth width 14/11mm DIN/ISO Mod.12-22 |                 |         |

for cutters

drive shafts

|   |  |                 |         |
|---|--|-----------------|---------|
|  <p>1</p> |  |                 |         |
| <b>GEV No.</b>  | 694061   | <b>Ref. No.</b> | 36G7000 |
| <b>description</b>  | drive shaft $\varnothing$ 22mm stainless steel L 137mm CL3 |                 |         |
| <b>For models:</b>  | Q3, Q3M  |                 |         |

Зип-Общепит

vsezip.ru

+7(812)987-08-81

lids



|   |                    |   |                 |         |
|---|--------------------|---|-----------------|---------|
| 1 | <b>GEV No.</b>     | 698209  | <b>Ref. No.</b> | 6000920 |
|   | <b>description</b> | lid complete ø 215mm ID ø 210mm with magnet Q 3-5-8 |                 |         |
|   | <b>For models:</b> | Q3, Q3M, Q5, Q52, Q5M, Q8, Q82                      |                 |         |



|   |                    |   |                 |         |
|---|--------------------|---|-----------------|---------|
| 1 | <b>GEV No.</b>     | 691664  | <b>Ref. No.</b> | 3031610 |
|   | <b>description</b> | lid for cutter ø 225mm ID ø 204mm plastic with gasket C4-C6 edition since 08/2003 |                 |         |
|   | <b>For models:</b> | SC4, SC6  |                 |         |



|   |                    |   |                 |         |
|---|--------------------|---|-----------------|---------|
| 1 | <b>GEV No.</b>     | 694243  | <b>Ref. No.</b> | 36Z0665 |
|   | <b>description</b> | lid ø 215mm ID ø 210mm plastic with magnet CL 3-5-8 |                 |         |

blades

spacer rings



|   |                    |  |                 |         |
|---|--------------------|--|-----------------|---------|
| 1 | <b>GEV No.</b>     | 697106   | <b>Ref. No.</b> | 36G0650 |
|   | <b>description</b> | spacer ring ED ø 63mm int. ø 1 39mm mounting distance 52mm hole ø 5.5mm plastic CL 3-5-8 |                 |         |
|   | <b>For models:</b> | Q5, Q52, Q5M, Q8, Q82  |                 |         |

holders

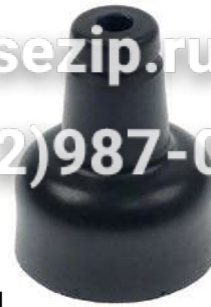

|   |                    |   |                 |         |
|---|--------------------|---|-----------------|---------|
| 1 | <b>GEV No.</b>     | 651037  | <b>Ref. No.</b> | 36G7010 |
|   | <b>description</b> | blade holder ED ø 63mm int. ø 1 39mm int. ø 2 10mm H 81.5mm mounting distance 52mm thread M5 plastic CL 3-5-8 |                 |         |
|   | <b>For models:</b> | Q3, Q3M, Q5, Q52, Q5M, Q8, Q82  |                 |         |

blades

blades smooth



|   |                    |   |                 |         |
|---|--------------------|---|-----------------|---------|
| 1 | <b>GEV No.</b>     | 696177  | <b>Ref. No.</b> | 3017950 |
|   | <b>description</b> | knife mounting pos. lower L 93mm seat ø 33mm mounting distance 46mm 4 hole hole ø 4.4mm thickness 2mm model C4-C6 |                 |         |
|   | <b>For models:</b> | SC4, SC6  |                 |         |



|   |                    |  |                 |         |
|---|--------------------|--|-----------------|---------|
| 1 | <b>GEV No.</b>     | 696173   | <b>Ref. No.</b> | 36G7030 |
|   | <b>description</b> | knife mounting pos. upper seat ø 42mm mounting distance 52mm hole ø 5.5mm thickness 2mm model CL 3-5-8 |                 |         |
|   | <b>For models:</b> | Q3, Q3M, Q5, Q52, Q5M, Q8, Q82   |                 |         |

for vegetable slicers

ejector discs



|   |                    |   |                 |         |
|---|--------------------|---|-----------------|---------|
| 1 | <b>GEV No.</b>     | 699011  | <b>Ref. No.</b> | 36G6960 |
|   | <b>description</b> | ejector disc H 7mm ø 195mm shaft diameter 22x27mm |                 |         |
|   | <b>For models:</b> | TV1, TV1M, TV2L                                   |                 |         |



Зип Общежит

vsezip.ru

+7(812)987-08-81

miscellaneous



1

|                    |   |                 |         |
|--------------------|---|-----------------|---------|
| <b>GEV No.</b>     | 692145  | <b>Ref. No.</b> | 36G6600 |
| <b>description</b> | pulley disc ø 157mm disc width 31mm shaft intake ø 15mm overall width 30mm plastic for potato peeler device |                 |         |
| <b>For models:</b> | LCV, P10, P102, P10M, P20, P202, P5, TV1, TV1M, TV2L  |                 |         |

abrasive elements

grinding discs



1

|                    |  |                 |         |
|--------------------|--|-----------------|---------|
| <b>GEV No.</b>     | 696769   | <b>Ref. No.</b> | 3030900 |
| <b>description</b> | peeling disk ø 383mm for potato peeler device C565 |                 |         |
| <b>For models:</b> | MPK10, MPK10I, PK10, PK10I                         |                 |         |

for potato peelers

drive shafts



1

|                    |  |                 |         |
|--------------------|--|-----------------|---------|
| <b>GEV No.</b>     | 692147                                       | <b>Ref. No.</b> | 36G6590 |
| <b>description</b> | drive shaft for potato peeler device L 134mm |                 |         |
| <b>For models:</b> | P10, P102, P10M, P20, P202, P5               |                 |         |

miscellaneous



1

|                    |                                |                 |         |
|--------------------|--------------------------------|-----------------|---------|
| <b>GEV No.</b>     | 696412                         | <b>Ref. No.</b> | 3600870 |
| <b>description</b> | bottom plastic                 |                 |         |
| <b>For models:</b> | P10, P102, P10M, P20, P202, P5 |                 |         |

lids



1

|                    |  |                 |         |
|--------------------|--|-----------------|---------|
| <b>GEV No.</b>     | 696454   | <b>Ref. No.</b> | 36Z6501 |
| <b>description</b> | lid for potato peeler device ø 430mm ID ø 380mm plastic mounting distance 220mm H 80mm |                 |         |
| <b>For models:</b> | LCV, P10, P102, P10M, P20, P202, P5  |                 |         |

|   |  |        |                 |
|---|--|--------|-----------------|
| <b>accessories for</b>  | 696454   |        |                 |
|  | <b>GEV No.</b>   | 901522 | <b>Ref. No.</b> |
|   |  |        | —               |
|   | lid gasket suitable for FIMAR for potato peeler device L 1280mm external height 12mm external width 12mm |        |                 |



1

|                    |  |                 |         |
|--------------------|--|-----------------|---------|
| <b>GEV No.</b>     | 696408   | <b>Ref. No.</b> | 36G5950 |
| <b>description</b> | bush for potato peeler device ED ø 20mm ID ø 16mm thickness 2mm L 19.4mm |                 |         |
| <b>For models:</b> | LCV, P10, P102, P10M, P20, P202, P5                                      |                 |         |



1

|                    |  |                 |         |
|--------------------|--|-----------------|---------|
| <b>GEV No.</b>     | 696407   | <b>Ref. No.</b> | 36D9660 |
| <b>description</b> | deflector for potato peeler device plastic L 144mm W 38mm H 130mm thread 1/4"/M6 |                 |         |
| <b>For models:</b> | P10, P102, P10M, P20, P202   |                 |         |



1

|                    |   |                 |         |
|--------------------|---|-----------------|---------|
| <b>GEV No.</b>     | 696406  | <b>Ref. No.</b> | 3190830 |
| <b>description</b> | disc for potato peeler device ED ø 42mm ID ø 28.7mm thickness 4.5mm |                 |         |
| <b>For models:</b> | LCV, P10, P102, P10M, P20, P202, P5                                 |                 |         |

## for planetary mixers

### beaters



1

|                    |   |                 |              |
|--------------------|---|-----------------|--------------|
| <b>GEV No.</b>     | 699393  | <b>Ref. No.</b> | KA/W10731415 |
| <b>description</b> | whisk shaft intake ø 12.7mm H 185mm suitable for KitchenAid |                 |              |

## for fridges

### spare parts and accessories



1

|                    |   |                 |         |
|--------------------|---|-----------------|---------|
| <b>GEV No.</b>     | 691195  | <b>Ref. No.</b> | 36G5250 |
| <b>description</b> | bracket for rack plastic  |                 |         |
| <b>For models:</b> | 135, 135BX, 135CPX, SP135, SP135B, SP135BN, SP135CP, SP135NN, SP65, SP65B, SP65NB |                 |         |

Зип.Общепит

miscellaneous

vsezip.ru

+7(812)987-08-81



1

|                    |   |                 |         |
|--------------------|---|-----------------|---------|
| <b>GEV No.</b>     | 695580  | <b>Ref. No.</b> | 36D1250 |
| <b>description</b> | frame L 1528mm W 55mm   |                 |         |
| <b>For models:</b> | 120, 120B, 120PV, 135, 135-4, 135A, 135B, 135BA, 135BX, 135BXE, 135BXR, 135CPX, 135PVX, 135X, 135X-3, 135X-4, 135XE, 135XR, SP120, SP120B, SP135, SP135B, SP135CP |                 |         |

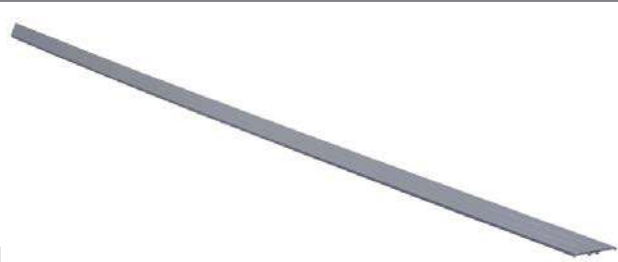

1

|                    |  |                 |         |
|--------------------|--|-----------------|---------|
| <b>GEV No.</b>     | 695581   | <b>Ref. No.</b> | 36D1290 |
| <b>description</b> | frame L 1639mm W 55mm  |                 |         |
| <b>For models:</b> | 120, 120B, 120NN, 120PV, 135, 135-4, 135A, 135B, 135BA, 135BN, 135BNX, 135BX, 135BXE, 135BXR, 135CPX, 135NN, 135NNX, 135PVX, 135X, 135X-3, 135X-4, 135XE, 135XR, 55, 55B, 55PV, 65, 65A, 65B, 65BA, 65BX, 65BX-2, 65BXE, 65BXR, 65NB, 65NBX, 65NN, 65NNX, 65PVX, 65X, 65X-2, 65XE, 65XR, SP120, SP120B, SP120BN, SP120NN, SP135, SP135B, SP135BN...(Other models you can see in the webshop) |                 |         |

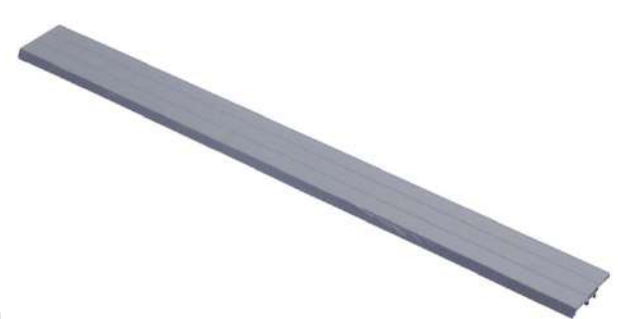

1

|                    |   |                 |         |
|--------------------|---|-----------------|---------|
| <b>GEV No.</b>     | 695579  | <b>Ref. No.</b> | 36D1260 |
| <b>description</b> | frame L 621mm W 55mm  |                 |         |
| <b>For models:</b> | 135-4, 135CPX, 135X-3, 135X-4, 65BX-2, 65NB, 65NBX, 65NN, 65NNX, 65X-2, SP135CP, SP65NB, SP65NN |                 |         |





3zip Общепит  
for refrigerated counters

lid hinges  
vsezip.ru

+7(812)987-08-81

|   |   |                 |         |
|---|---|-----------------|---------|
|  |   |                 |         |
| 1   |   |                 |         |
| <b>GEV No.</b>  | 694636  | <b>Ref. No.</b> | 33Q6300 |
| <b>description</b>  | hose ID ø 21mm ED ø 27mm L 66mm ø 40mm thickness 3.5mm  |                 |         |
| <b>For models:</b>  | AF2B, AF2B-OPR01, AF2N, AF2N-OPR01, PGA20, PGA30, PGA40, PGA60, PGA80, PGW20, PGW30, PGW40, PGW60, PGW80, SM4SR |                 |         |

|  |                                  |                 |         |
|--|----------------------------------|-----------------|---------|
|  |                                  |                 |         |
| 1  |                                  |                 |         |
| <b>GEV No.</b>   | 691099                           | <b>Ref. No.</b> | 35G4630 |
| <b>description</b>   | hinge for lid mounting pos. left |                 |         |
| <b>For models:</b>   | SA87                             |                 |         |

|   |                          |                 |         |
|---|--------------------------|-----------------|---------|
|  |                          |                 |         |
| 1   |                          |                 |         |
| <b>GEV No.</b>  | 690689                   | <b>Ref. No.</b> | 35X3460 |
| <b>description</b>  | spacer ring              |                 |         |
| <b>For models:</b>  | 40EV, 40EVP, 40PV, 40XPV |                 |         |

|  |   |                 |         |
|--|---|-----------------|---------|
| spare parts and accessories  |   |                 |         |
|  |   |                 |         |
| 1  |   |                 |         |
| <b>GEV No.</b>   | 691189  | <b>Ref. No.</b> | 36G8660 |
| <b>description</b>   | bush L 9mm ID ø 7mm ext. ø 10   |                 |         |
| <b>For models:</b>   | 6BMA11A, 6BMA11B, 6BMA11M, 6BMA11Z, 6BMA2A, 6BMA2B, 6BMA2M, 6BMA2Z, 6BMA3A, 6BMA3B, 6BMA3M, 6BMA3Z, 6BMAA, 6BMAB, 6BMABA, 6BMABB, 6BMABM, 6BMABZ, 6BMAM, 6BMAZ, 6BMB11A, 6BMB11B, 6BMB11M, 6BMB11Z, 6BMB22A, 6BMB22B, 6BMB22M, 6BMB22Z, 6BMB2A, 6BMB2B, 6BMB2M, 6BMB2Z, 6BMB3A, 6BMB3B, 6BMB3M, 6BMB3Z, 6BMB4A, 6BMB4B, 6BMB4M, 6BMB4Z, 6BMB, 6BMBB, 6BMBBA, 6BMBBB, 6BMBBM, 6BMBBZ, 6BMBM, 6BMBZ, 6BMC11A, 6BMC11B...(Other models you can see in the webshop) |                 |         |

|   |                          |                 |         |
|---|--------------------------|-----------------|---------|
|  |                          |                 |         |
| 1   |                          |                 |         |
| <b>GEV No.</b>  | 690691                   | <b>Ref. No.</b> | 36C2440 |
| <b>description</b>  | spacer ring              |                 |         |
| <b>For models:</b>  | 40EV, 40EVP, 40PV, 40XPV |                 |         |

|  |   |                 |         |
|--|---|-----------------|---------|
|  |   |                 |         |
| 1  |   |                 |         |
| <b>GEV No.</b>   | 698475  | <b>Ref. No.</b> | 3048360 |
| <b>description</b>   | drain pipe W 65mm H 145mm for refrigerated counters plastic Qty 1 pcs   |                 |         |
| <b>For models:</b>   | 6EA, 6EA11, 6EA11A, 6EA11M, 6EA13, 6EA13A, 6EA13M, 6EA2, 6EA2A, 6EA2M, 6EAA, 6EAB, 6EABA, 6EABM, 6EAM, 6EB, 6EB11, 6EB11A, 6EB11M, 6EB13, 6EB13A, 6EB13M, 6EB2, 6EB22, 6EB22A, 6EB22M, 6EB2A, 6EB2M, 6EB4, 6EB4A, 6EB4M, 6EBA, 6EBB, 6EBBA, 6EBBM, 6EBM, 6EC, 6EC11, 6EC11A, 6EC11M, 6EC13, 6EC13A, 6EC13M, 6EC2, 6EC22, 6EC22A, 6EC22M, 6EC2A, 6EC2M, 6EC4...(Other models you can see in the webshop) |                 |         |

|   |   |                 |         |
|---|---|-----------------|---------|
|  |   |                 |         |
| 1   |   |                 |         |
| <b>GEV No.</b>  | 698476  | <b>Ref. No.</b> | 36E3990 |
| <b>description</b>  | thermostatic steam trap W 55mm H 45mm for fridge D1 ø 22mm D2 ø 16mm  |                 |         |
| <b>For models:</b>  | 6EA, 6EA11, 6EA11A, 6EA11M, 6EA13, 6EA13A, 6EA13M, 6EA2, 6EA2A, 6EA2M, 6EAA, 6EAB, 6EABA, 6EABM, 6EAM, 6EB, 6EB11, 6EB11A, 6EB11M, 6EB13, 6EB13A, 6EB13M, 6EB2, 6EB22, 6EB22A, 6EB22M, 6EB2A, 6EB2M, 6EB4, 6EB4A, 6EB4M, 6EBA, 6EBB, 6EBBA, 6EBBM, 6EBM, 6EC, 6EC11, 6EC11A, 6EC11M, 6EC13, 6EC13A, 6EC13M, 6EC2, 6EC22, 6EC22A, 6EC22M, 6EC2A, 6EC2M, 6EC4...(Other models you can see in the webshop) |                 |         |

Зип-Общепит

for ice-cube maker

ice chutes

vsezip.ru

slide grates

+7(812)987-08-81



1

|                    |   |                 |         |
|--------------------|---|-----------------|---------|
| <b>GEV No.</b>     | 694145  | <b>Ref. No.</b> | 3020430 |
| <b>description</b> | slide grate for ice-cube maker L 250mm W 170mm H 25mm |                 |         |
| <b>For models:</b> | PG22C, PG23CW   |                 |         |



1

|                    |   |                 |         |
|--------------------|---|-----------------|---------|
| <b>GEV No.</b>     | 697867  | <b>Ref. No.</b> | 3300030 |
| <b>description</b> | drain tray for condensation water plastic   |                 |         |
| <b>For models:</b> | 120B, 135, 135-4, 135A, 135B, 135BA, 135BN, 135BNX, 135BX, 135BXE, 135BXR, 135CPX, 135NN, 135NNX, 135PVX, 135X, 135X-3, 135X-4, 135XE, 135XR, 40CP, 40CPX, 55B, 65, 65A, 65B, 65BA, 65BX, 65BX-2, 65BXE, 65BXR, 65NB, 65NBX, 65NN, 65NNX, 65PVX, 65X, 65X-2, 65XE, 65XR, 6BEA11A, 6BEA11B, 6BEA11M, 6BEA11Z, 6BEA2A, 6BEA2B, 6BEA2M, 6BEA2Z, 6BEA3A, 6BEA3B...(Other models you can see in the webshop) |                 |         |

## for freezer cabinets

## glass panels



1

|                    |  |                 |         |
|--------------------|--|-----------------|---------|
| <b>GEV No.</b>     | 700682   | <b>Ref. No.</b> | 37W0270 |
| <b>description</b> | glass panel L 190mm W 310mm mounting pos. lateral  |                 |         |
| <b>For models:</b> | AL1433V, AL1437V, AL1633V, AL1637V, AL2033V, AL2037V, AL2533V, AL2537V, AR143V, AR147V, AR163V, AR167V, AR203V, AR207V, AR253V, AR257V, BP53V, BP64V, BP83V, BP94V, BPZ163A, BPZ163B, BPZ163S, BPZ167A, BPZ167B, BPZ167S, BPZ203A, BPZ203B, BPZ203S, BPZ207A, BPZ207B, BPZ207S, BPZ253A, BPZ253B, BPZ257A, BPZ257B, PE1633V, PE2033V, PM1633V, PM2033V, PZ1633A, PZ1633B, PZ1637A, PZ1637B, PZ2033A, PZ2033B, PZ2037A, PZ2037B, PZ2533A, PZ2533B...(Other models you can see in the webshop) |                 |         |

## for display coolers

## glass panels

## accessories



1

|                    |  |                 |         |
|--------------------|--|-----------------|---------|
| <b>GEV No.</b>     | 519386   | <b>Ref. No.</b> | 3190800 |
| <b>description</b> | knurled nut for glass plate thread M4  |                 |         |
| <b>For models:</b> | BRPRV, BRVRV, SE14PRV, SE14PRW, SE14VRV, SE14VRW, SI14PRV, SI14PRW, SI14VRV, SI14VRW, SL14RPRV, SL14RPRW, SL14RVRV, SL14RVRW, TPRV, TVRV |                 |         |

## hoses

## miscellaneous



1

|                    |   |                 |         |
|--------------------|---|-----------------|---------|
| <b>GEV No.</b>     | 694636  | <b>Ref. No.</b> | 33Q6300 |
| <b>description</b> | hose ID ø 21mm ED ø 27mm L 66mm ø 40mm thickness 3.5mm  |                 |         |
| <b>For models:</b> | AF2B, AF2B-OPR01, AF2N, AF2N-OPR01, PGA20, PGA30, PGA40, PGA60, PGA80, PGW20, PGW30, PGW40, PGW60, PGW80, SM45R |                 |         |

## for espresso machines

## brewing units

## filter holder gaskets

## O-rings



1

|                    |   |                 |                               |
|--------------------|---|-----------------|-------------------------------|
| <b>GEV No.</b>     | 510409  | <b>Ref. No.</b> | 3150430<br>3151960<br>37Q5260 |
| <b>description</b> | O-ring EPDM thickness 5.34mm ID ø 56.52mm Qty 1 pcs   |                 |                               |
| <b>For models:</b> | 091CP1E, 0A1CP1E, 0G1CP1E, 0G1CP1EC, 0G1CP1E-VERS.2004, 191PI2E, 191PI2EA, 1A1PI2E, 1A1PI2EA, 1D1PI2E, 1D1PI2EA, 1G1PI1E, 30CPSE, 31PIE6, 6040090, 6040310, 6043850, 6043980, 70CPE, 71PIE15, 71PIE15A, 90CPE, 91PIE15, 91PIE15A, F60P, F60PR, F60T, F80P, F80PR, KD100, KD100A, KD100PSD, KD130, KD130A, KD130E, KD130EAT, KD60, KD60E, KD60EAT, KD60M, KD60MA, KD60ME, KD60MPS, KD60MPSA, KD60PS, KD60PSD, KD6EATSD, KD85, KD85A, KD85E...(Other models you can see in the webshop) |                 |                               |





screw connections

reducers



|                    |  |                 |         |
|--------------------|--|-----------------|---------|
| <b>GEV No.</b>     | 520700   | <b>Ref. No.</b> | 33Q5650 |
| <b>description</b> | reducer thread 3/4" IT - 1/2" ET brass   |                 |         |
| <b>For models:</b> | FCV101, FCV101-CSA, FCV101DM, FCV101DM-CSA, FCV101DS, FCV101DS-CSA, FCV101E, FCV101EDM, FCV101EDM-UL, FCV101EDS, FCV101EDS-UL, FCV101E-UL, FCV141, FCV141-CSA, FCV141DM, FCV141DM-CSA, FCV141DS, FCV141DS-CSA, FCV141E, FCV141EDM, FCV141EDS, FCV241, FCV241DM, FCV241DS, FCV241E, FCV241EDM, FCV241EDM-UL, FCV241EDS, FCV241EDS-UL, FCV241E-UL, FCV241G, FCV241G-CSA, FCV241GDM, FCV241GDM-CSA, FCV241GDS, FCV241GDS-CSA, FCV3EM, FCV401DM, FCV401DM-CSA, FCV401EDM, FCV401EDM-UL, FCV4E, FCV4EDS, FCV4EM, FCV61, FCV61-CSA, FCV61DM, FCV61DM-CSA, FCV61DS, FCV61DS-CSA...(Other models you can see in the webshop) |                 |         |

for bain marie

housing and bezels



|                    |   |                 |         |
|--------------------|---|-----------------|---------|
| <b>GEV No.</b>     | 691183  | <b>Ref. No.</b> | 36D3430 |
| <b>description</b> | end cap for control panel mounting pos. left  |                 |         |
| <b>For models:</b> | 030, 030BME, 030E, 030EBM, 030FE, 030FE1, 030FE1B, 030FT, 030FTE, 030FTER, 030FTR, 031, 031BME, 031E, 031EBM, 031FT, 031FT04, 031FT06, 031FTE, 031FTE04, 031FTE06, 031FTER, 031FTERL, 031FTR, 031FTRL, 031TP, 032, 070BM, 070BME, 070D, 070DGG, 070E, 070FT, 070FT04, 070FT05, 070FTE, 070FTE04, 070FTE05, 070FTER, 070FTR, 0712D, 0712VA, 071BM, 071BME, 071D, 071DGG, 071E, 071FT, 071FT04, 071FT06...(Other models you can see in the webshop) |                 |         |



|                    |   |                 |         |
|--------------------|---|-----------------|---------|
| <b>GEV No.</b>     | 691184  | <b>Ref. No.</b> | 36D3420 |
| <b>description</b> | end cap for control panel mounting pos. right   |                 |         |
| <b>For models:</b> | 030, 030BME, 030E, 030EBM, 030FE, 030FE1, 030FE1B, 030FT, 030FTE, 030FTER, 030FTR, 031, 031BME, 031E, 031EBM, 031FT, 031FT04, 031FT06, 031FTE, 031FTE04, 031FTE06, 031FTER, 031FTERL, 031FTR, 031FTRL, 031TP, 032, 070BM, 070BME, 070D, 070DGG, 070E, 070FT, 070FT04, 070FT05, 070FTE, 070FTE04, 070FTE05, 070FTER, 070FTR, 0712D, 0712VA, 071BM, 071BME, 071D, 071DGG, 071E, 071FT, 071FT04, 071FT06...(Other models you can see in the webshop) |                 |         |

Зип Общепит

for deep fryers

vsezip.ru

+7(812)987-08-81

housing and bezels



|                    |   |                 |         |
|--------------------|---|-----------------|---------|
| <b>GEV No.</b>     | 691183  | <b>Ref. No.</b> | 36D3430 |
| <b>description</b> | end cap for control panel mounting pos. left  |                 |         |
| <b>For models:</b> | 030, 030BME, 030E, 030EBM, 030FE, 030FE1, 030FE1B, 030FT, 030FTE, 030FTER, 030FTR, 031, 031BME, 031E, 031EBM, 031FT, 031FT04, 031FT06, 031FTE, 031FTE04, 031FTE06, 031FTER, 031FTERL, 031FTR, 031FTRL, 031TP, 032, 070BM, 070BME, 070D, 070DGG, 070E, 070FT, 070FT04, 070FT05, 070FTE, 070FTE04, 070FTE05, 070FTER, 070FTR, 0712D, 0712VA, 071BM, 071BME, 071D, 071DGG, 071E, 071FT, 071FT04, 071FT06...(Other models you can see in the webshop) |                 |         |



|                    |   |                 |         |
|--------------------|---|-----------------|---------|
| <b>GEV No.</b>     | 691184  | <b>Ref. No.</b> | 36D3420 |
| <b>description</b> | end cap for control panel mounting pos. right   |                 |         |
| <b>For models:</b> | 030, 030BME, 030E, 030EBM, 030FE, 030FE1, 030FE1B, 030FT, 030FTE, 030FTER, 030FTR, 031, 031BME, 031E, 031EBM, 031FT, 031FT04, 031FT06, 031FTE, 031FTE04, 031FTE06, 031FTER, 031FTERL, 031FTR, 031FTRL, 031TP, 032, 070BM, 070BME, 070D, 070DGG, 070E, 070FT, 070FT04, 070FT05, 070FTE, 070FTE04, 070FTE05, 070FTER, 070FTR, 0712D, 0712VA, 071BM, 071BME, 071D, 071DGG, 071E, 071FT, 071FT04, 071FT06...(Other models you can see in the webshop) |                 |         |

glass panels



|                    |  |                 |                    |
|--------------------|--|-----------------|--------------------|
| <b>GEV No.</b>     | 693397   | <b>Ref. No.</b> | 3070970<br>37N1420 |
| <b>description</b> | glass panel L 29mm W 29mm thickness 3.5mm square   |                 |                    |
| <b>For models:</b> | 06WCP1GM, 08WCP1GM, 08WFT1GV, 08WFT2GV, 08WFT3GV, 08WFT4GV, 08WFT6GV, 08WFT7GV, 090FT1G, 090FT2G, 090FT4G, 090FT5G, 090FT7G, 091CP1G, 091FR7G, 091FR7GS, 091FR7G-VERS.052012, 091FR7GX, 0A0FT1G, 0A0FT2G, 0A0FT4G, 0A0FT5G, 0A1CP1G, 0B0FT1G, 0B0FT2G, 0B0FT4G, 0B0FT5G, 0B1CP1G, 0D0FT1G, 0D0FT2G, 0D0FT4G, 0D0FT5G, 0D1CP1G, 0G0FT1G, 0G0FT1G-VERS.032008, 0G0FT2G, 0G0FT2G-VERS.032008, 0G0FT4G, 0G0FT4G-VERS.032008, 0G0FT5G, 0G0FT5G-VERS.032008, 0G0FT7G, 0G1CP1G, 0G1CP1G-VERS.2004, 0G1FR7G, 10CP1GA, 10CP1IA, 10WTPGE, 10WTPGV, 12CP1GA...(Other models you can see in the webshop) |                 |                    |

miscellaneous



|                    |  |                 |         |
|--------------------|--|-----------------|---------|
| <b>GEV No.</b>     | 691164   | <b>Ref. No.</b> | 36D6960 |
| <b>description</b> | bar for spacer L 180mm thread M6x1                                   |                 |         |
| <b>For models:</b> | 030FE1, 030FE1B, 091FE28, 091FE28B, 30FES2, 30FES2B, 70FES2, 70FES2B |                 |         |

1 

|                    |                                    |                 |         |
|--------------------|------------------------------------|-----------------|---------|
| <b>GEV No.</b>     | 691163                             | <b>Ref. No.</b> | 36D6950 |
| <b>description</b> | bar for spacer L 270mm thread M6x1 |                 |         |
| <b>For models:</b> | 70FE1, 70FE1B, 71FE2, 71FE2B       |                 |         |

1 

|                    |  |                 |         |
|--------------------|--|-----------------|---------|
| <b>GEV No.</b>     | 541506   | <b>Ref. No.</b> | 33Q5730 |
| <b>description</b> | screw connection complete thread 1"                        |                 |         |
| <b>For models:</b> | 30CPS, 30CPSE, 70CP, 70CPE, 71CP, 71CP2, 90CP, 90CPE, 91CP |                 |         |

1 

|                    |  |                 |         |
|--------------------|--|-----------------|---------|
| <b>GEV No.</b>     | 691121   | <b>Ref. No.</b> | 36D7150 |
| <b>description</b> | support bracket for heating element                                  |                 |         |
| <b>For models:</b> | 030FE1, 030FE1B, 091FE28, 091FE28B, 30FES2, 30FES2B, 70FES2, 70FES2B |                 |         |

## for grills



|                    |  |                 |         |
|--------------------|--|-----------------|---------|
| <b>GEV No.</b>     | 690425   | <b>Ref. No.</b> | 3600770 |
| <b>description</b> | base plate L 105mm W 35mm H 7mm hole distance 76mm hole ø 12mm   |                 |         |
| <b>For models:</b> | 120, 120B, 120NN, 120PV, 135, 135-4, 135A, 135B, 135BA, 135BN, 135BNX, 135BX, 135BXE, 135BXR, 135CPX, 135NN, 135NNX, 135PVX, 135X, 135X-3, 135X-4, 135XE, 135XR, 55, 55B, 55PV, 65, 65A, 65B, 65BA, 65BX, 65BX-2, 65BXE, 65BXR, 65NB, 65NBX, 65NN, 65NNX, 65PVX, 65X, 65X-2, 65XE, 65XR, ART1LD, ART1LDA, ART2LD, ART2SD, ART3SD, S125, S125-4...(Other models you can see in the webshop) |                 |         |

## Zip-Общепит

for griddles

spare parts and accessories

vsezip.ru

+7(812)987-08-81



|                    |  |                 |         |
|--------------------|--|-----------------|---------|
| <b>GEV No.</b>     | 691169   | <b>Ref. No.</b> | 35T2260 |
| <b>description</b> | hook for solid top   |                 |         |
| <b>For models:</b> | 031TP, 071TP, 091TP, 31TP, 32TP, 32TPV, 71TP, 72TP, 72TPGG |                 |         |



|                    |   |                 |         |
|--------------------|---|-----------------|---------|
| <b>GEV No.</b>     | 693000  | <b>Ref. No.</b> | 35Y2780 |
| <b>description</b> | spring for lava rock grid                                       |                 |         |
| <b>For models:</b> | 08WGRGV, 090GRG, 0A0GRG, 0D0GRG, 190GRG, 1A0GRG, 1D0GRG, 1G0GRG |                 |         |

## housing and bezels

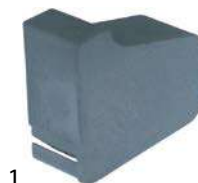

|                    |   |                 |         |
|--------------------|---|-----------------|---------|
| <b>GEV No.</b>     | 691183  | <b>Ref. No.</b> | 36D3430 |
| <b>description</b> | end cap for control panel mounting pos. left  |                 |         |
| <b>For models:</b> | 030, 030BME, 030E, 030EBM, 030FE, 030FE1, 030FE1B, 030FT, 030FTE, 030FTER, 030FTR, 031, 031BME, 031E, 031EBM, 031FT, 031FT04, 031FT06, 031FTE, 031FTE04, 031FTE06, 031FTER, 031FTERL, 031FTR, 031FTRL, 031TP, 032, 070BM, 070BME, 070D, 070DGG, 070E, 070FT, 070FT04, 070FT05, 070FTE, 070FTE04, 070FTE05, 070FTER, 070FTR, 0712D, 0712VA, 071BM, 071BME, 071D, 071DGG, 071E, 071FT, 071FT04, 071FT06...(Other models you can see in the webshop) |                 |         |



|                    |   |                 |         |
|--------------------|---|-----------------|---------|
| <b>GEV No.</b>     | 691184  | <b>Ref. No.</b> | 36D3420 |
| <b>description</b> | end cap for control panel mounting pos. right   |                 |         |
| <b>For models:</b> | 030, 030BME, 030E, 030EBM, 030FE, 030FE1, 030FE1B, 030FT, 030FTE, 030FTER, 030FTR, 031, 031BME, 031E, 031EBM, 031FT, 031FT04, 031FT06, 031FTE, 031FTE04, 031FTE06, 031FTER, 031FTERL, 031FTR, 031FTRL, 031TP, 032, 070BM, 070BME, 070D, 070DGG, 070E, 070FT, 070FT04, 070FT05, 070FTE, 070FTE04, 070FTE05, 070FTER, 070FTR, 0712D, 0712VA, 071BM, 071BME, 071D, 071DGG, 071E, 071FT, 071FT04, 071FT06...(Other models you can see in the webshop) |                 |         |



sumps



1

|                    |  |                 |         |
|--------------------|--|-----------------|---------|
| <b>GEV No.</b>     | 691207   | <b>Ref. No.</b> | 35N2250 |
| <b>description</b> | grease collecting tray L 540mm W 32mm H 15mm   |                 |         |
| <b>For models:</b> | 0A0FT1E, 0A0FT1G, 0A0FT2E, 0A0FT2G, 0A0FT4E, 0A0FT4G, 0A0FT5E, 0A0FT5G, 0B0FT1G, 0B0FT2G, 0B0FT4G, 0B0FT5G, 0D0FT1E, 0D0FT1G, 0D0FT2E, 0D0FT2G, 0D0FT4E, 0D0FT4G, 0D0FT5E, 0D0FT5G, 0G0FT1E, 0G0FT1G, 0G0FT1G-VERS.032008, 0G0FT2E, 0G0FT2G, 0G0FT2G-VERS.032008, 0G0FT4E, 0G0FT4G, 0G0FT4G-VERS.032008, 0G0FT5E, 0G0FT5G, 0G0FT5G-VERS.032008, 0G0FT7E, 0G0FT7G |                 |         |

drain stoppers



1

|                    |  |                 |                               |
|--------------------|--|-----------------|-------------------------------|
| <b>GEV No.</b>     | 691190   | <b>Ref. No.</b> | 3062770<br>3115040<br>36C0360 |
| <b>description</b> | outflow plug PTFE L 52mm D1 ø 40mm D2 ø 33mm D3 ø 28mm   |                 |                               |
| <b>For models:</b> | 031FT04, 031FT06, 031FTE04, 031FTE06, 06WFT1EV, 06WFT2EV, 06WFT3EV, 06WFT4EV, 06WFT6EV, 06WFT7EV, 070FT04, 070FT05, 070FTE04, 070FTE05, 071FT04, 071FT06, 071FTE04, 071FTE06, 08WFT1EV, 08WFT1GV, 08WFT2EV, 08WFT2GV, 08WFT3EV, 08WFT3GV, 08WFT4EV, 08WFT4GV, 08WFT6EV, 08WFT6GV, 08WFT7EV, 08WFT7GV, 08WGREV, 090FT04, 090FT05, 090FT1E, 090FT1G, 090FT2E, 090FT2G, 090FT4E, 090FT4G, 090FT5E, 090FT5G, 090FT7E, 090FT7G, 090FTE04, 090FTE05, 091FT04, 091FT06, 091FT1E, 091FT2E, 091FT5E...(Other models you can see in the webshop) |                 |                               |

3ип Общепит for convection ovens/combi-steamers

drain valves



1

|                    |  |                 |         |
|--------------------|--|-----------------|---------|
| <b>GEV No.</b>     | 696773   | <b>Ref. No.</b> | 6300833 |
| <b>description</b> | drain fitting set for combi-steamer hose ø 8mm   |                 |         |
| <b>For models:</b> | FX101E3, FX101E3C, FX101E3C-VERS.022014, FX101E3R, FX101E3R-VERS.022014, FX101E3-VERS.022014, FX101G3, FX101G3C, FX101G3C-VERS.022014, FX101G3R, FX101G3R-VERS.022014, FX101G3-VERS.022014, FX10E3CR, FX10E3CR-VERS.022014, FX10G3CR, FX10G3CR-VERS.022014, FX122E3, FX122E3C, FX122E3T, FX122E3T-VERS.022014, FX122G3, FX122G3C, FX122G3T, FX122G3T-VERS.022014, FX12E3CT, FX12E3CT-VERS.022014, FX12G3CT, FX12G3CT-VERS.022014, FX201E3, FX201E3P, FX201E3P-VERS.022014, FX201E3-VERS.022014, FX201G3P, FX201G3-VERS.022014, FX202E3, FX202E3-230V-3-50Hz-60Hz, FX202E3-230V-3-50Hz-60Hz-VERS.022014, FX202E3-VERS.022014, FX202G3, FX202G3-VERS.022014, FX61E3, FX61E3C, FX61E3CR, FX61E3CR-VERS.022014, FX61E3C-VERS.022014, FX61E3R, FX61E3R-VERS.022014, FX61E3-VERS.022014, FX61G3, FX61G3C...(Other models you can see in the webshop) |                 |         |



1

|                    |  |                 |         |
|--------------------|--|-----------------|---------|
| <b>GEV No.</b>     | 696790   | <b>Ref. No.</b> | 30Z3011 |
| <b>description</b> | drain pipe thread 1 1/2" IT angled 90° plastic ID ø 37mm ED ø 40mm for combi-steamer   |                 |         |
| <b>For models:</b> | FC1011E, FC1011G, FC1221E, FC1221G, FC611E, FC611G, FM1011E1-VERS.2006, FM1011E2-VERS.2006, FM1011E3-VERS.2006, FM1011G1-VERS.2006, FM1011G2-VERS.2006, FM1011G3-VERS.2006, FM1221E1-VERS.2006, FM1221E2-VERS.2006, FM1221E3-VERS.2006, FM1221G1-VERS.2006, FM1221G2-VERS.2006, FM1221G3-VERS.2006, FM2011E2-VERS.2006, FM2011E3-VERS.2006, FM2011G2-VERS.2006, FM2011G3-VERS.2006, FM2021E2-VERS.2006, FM2021E3-VERS.2006, FM2021G2-VERS.2006, FM2021G3-VERS.2006, FM611E1-VERS.2006, FM611E2-VERS.2006, FM611E3-VERS.2006, FM611G1-VERS.2006, FM611G2-VERS.2006, FM611G3-VERS.2006, FM721E1-VERS.2006, FM721E2-VERS.2006, FM721E3-VERS.2006, FM721G1-VERS.2006, FM721G2-VERS.2006, FM721G3-VERS.2006 |                 |         |

Зип Общепит

vsezip.ru

+7(812)987-08-81



1

|                    |  |                 |                    |
|--------------------|--|-----------------|--------------------|
| <b>GEV No.</b>     | 696788   | <b>Ref. No.</b> | 3120620<br>3215240 |
| <b>description</b> | drain pipe thread 1 1/2" IT T-piece plastic ID ø 37mm ED ø 40mm for combi-steamer  |                 |                    |
| <b>For models:</b> | BX101E, BX101E-VERS.122013, BX101G, BX101G-VERS.122013, BX61E, BX61E-VERS.122013, BX61G, BX61G-VERS.122013, FX101E1, FX101E1R, FX101E2, FX101E2C, FX101E2C-VERS.032014, FX101E2R, FX101E2R-VERS.032014, FX101E2-VERS.032014, FX101E3, FX101E3C, FX101E3C-VERS.022014, FX101E3R, FX101E3R-VERS.022014, FX101E3-VERS.022014, FX101G1, FX101G1R, FX101G2, FX101G2C, FX101G2C-VERS.032014, FX101G2R, FX101G2R-VERS.032014, FX101G2-VERS.032014, FX101G3, FX101G3C, FX101G3C-VERS.022014, FX101G3R, FX101G3R-VERS.022014, FX101G3-VERS.022014, FX10E2CR, FX10E2CR-VERS.032014, FX10E3CR, FX10E3CR-VERS.022014, FX10G2CR, FX10G2CR-VERS.032014, FX10G3CR, FX10G3CR-VERS.022014, FX61E1, FX61E1R, FX61E2, FX61E2C, FX61E2CR, FX61E2CR-VERS.032014...(Other models you can see in the webshop) |                 |                    |



1

|                    |   |                 |                    |
|--------------------|---|-----------------|--------------------|
| <b>GEV No.</b>     | 692880  | <b>Ref. No.</b> | 36A3400<br>36A3401 |
| <b>description</b> | bush ID ø 34mm ED ø 60mm L 20mm thread 1 1/4" ET  |                 |                    |
| <b>For models:</b> | BX101E, BX101E-VERS.122013, BX101G, BX101G-VERS.122013, BX122E, BX122E-VERS.122013, BX122G, BX122G-VERS.122013, BX61E, BX61E-VERS.122013, BX61G, BX61G-VERS.122013, BX82E, BX82E-VERS.122013, BX82G, BX82G-VERS.122013, FC101, FC1011E, FC1011G, FC101E, FC1221E, FC1221G, FC241, FC241E, FC241G, FC61, FC611E, FC611G, FC61E, FCV101, FCV101-CSA, FCV101DM, FCV101DM-CSA, FCV101DS, FCV101DS-CSA, FCV101E, FCV101EDM, FCV101EDM-UL, FCV101EDS, FCV101EDS-UL, FCV101E-UL, FCV141, FCV141-CSA, FCV141DM, FCV141DM-CSA, FCV141DS, FCV141DS-CSA, FCV141E, FCV141EDM, FCV141EDS...(Other models you can see in the webshop) |                 |                    |

steam pipes



1

|                    |  |                 |         |
|--------------------|--|-----------------|---------|
| <b>GEV No.</b>     | 691639   | <b>Ref. No.</b> | 33Q6230 |
| <b>description</b> | bush stainless steel L 31mm ID ø 33mm ED ø 35mm  |                 |         |
| <b>For models:</b> | FC101, FC241, FC241G, FC61, FCV101, FCV101-CSA, FCV101DM, FCV101DM-CSA, FCV101DS, FCV101DS-CSA, FCV141, FCV141-CSA, FCV141DM, FCV141DM-CSA, FCV141DS, FCV141DS-CSA, FCV241, FCV241DM, FCV241DS, FCV241G, FCV241G-CSA, FCV241GDM, FCV241GDM-CSA, FCV241GDS, FCV241GDS-CSA, FCV401DM, FCV401DM-CSA, FCV61, FCV61-CSA, FCV61DM, FCV61DM-CSA, FCV61DS, FCV61DS-CSA |                 |         |



1

|                    |   |                 |         |
|--------------------|---|-----------------|---------|
| <b>GEV No.</b>     | 540906  | <b>Ref. No.</b> | 33Q5980 |
| <b>description</b> | steam nozzle plastic L 78.5mm ID ø 12.5mm ED ø 40mm   |                 |         |
| <b>For models:</b> | FC101, FC1011E, FC1011G, FC101E, FC1221E, FC1221G, FC241, FC241E, FC241G, FC61, FC611E, FC611G, FC61E, FCV101, FCV101-CSA, FCV101DM, FCV101DM-CSA, FCV101DS, FCV101DS-CSA, FCV101E, FCV101EDM, FCV101EDM-UL, FCV101EDS, FCV101EDS-UL, FCV101E-UL, FCV141, FCV141-CSA, FCV141DM, FCV141DM-CSA, FCV141DS, FCV141DS-CSA, FCV141E, FCV141EDM, FCV141EDS, FCV241, FCV241DM, FCV241DS, FCV241E, FCV241EDM, FCV241EDM-UL, FCV241EDS, FCV241EDS-UL, FCV241E-UL, FCV241G, FCV241G-CSA, FCV241GDM, FCV241GDM-CSA, FCV241GDS, FCV241GDS-CSA, FCV61...(Other models you can see in the webshop) |                 |         |

injection nozzles





1

|                    |  |                 |                    |
|--------------------|--|-----------------|--------------------|
| <b>GEV No.</b>     | 692721   | <b>Ref. No.</b> | 33Q5441<br>33Q5442 |
| <b>description</b> | injection nozzle bore ø 0.5mm D1 ø 12mm D2 ø 12mm L 60mm WS 17 brass for combi-steamer thread 1/8"   |                 |                    |
| <b>For models:</b> | FC61, FC61E, FCV61, FCV61-CSA, FCV61DM, FCV61DM-CSA, FCV61DS, FCV61DS-CSA, FCV61E, FCV61EDM, FCV61EDM-UL, FCV61EDS, FCV61EDS-UL, FCV61E-UL, FM611E1, FM611E2, FM611E3, FM611G1, FM611G2, FM611G3 |                 |                    |



1

|   |  |                 |                         |
|---|--|-----------------|-------------------------|
| <b>GEV No.</b>  | 541487   | <b>Ref. No.</b> | 33Q5910<br>33Q5911      |
| <b>description</b>  | injection nozzle bore ø 7/0.6mm D1 ø 12mm D2 ø 12mm L 60mm WS 17 brass for combi-steamer thread 1/8"   |                 |                         |
| <b>For models:</b>  | FC101, FC101E, FCV101, FCV101-CSA, FCV101DM, FCV101DM-CSA, FCV101DS, FCV101DS-CSA, FCV101E, FCV101EDM, FCV101EDM-UL, FCV101EDS, FCV101EDS-UL, FCV101E-UL, FCV401DM, FM1011E1, FM1011E2, FM1011E3, FM1011G1, FM1011G2, FM1011G3 |                 |                         |
| <b>accessories for</b>  | 541487   |                 |                         |
|  | <b>GEV No.</b>   | 541508          | <b>Ref. No.</b> 33D1680 |
|   | manometer ø 40mm pressure range 0-4bar connection thread 1/8"  |                 |                         |



1

|                    |  |                 |         |
|--------------------|--|-----------------|---------|
| <b>GEV No.</b>     | 542427   | <b>Ref. No.</b> | 33Q6081 |
| <b>description</b> | injection nozzle bore ø 7/0.7mm D1 ø 12mm D2 ø 12mm L 60mm WS 17 brass for combi-steamer thread 1/8"   |                 |         |
| <b>For models:</b> | FC241E, FC241G, FCV141, FCV141-CSA, FCV141DM, FCV141DM-CSA, FCV141DS, FCV141DS-CSA, FCV141E, FCV141EDM, FCV141EDS, FCV241E, FCV241EDM, FCV241EDM-UL, FCV241EDS, FCV241EDS-UL, FCV241E-UL, FCV241G, FCV241G-CSA, FCV241GDM, FCV241GDM-CSA, FCV241GDS, FCV241GDS-CSA, FCV401EDM, FCV401EDM-UL, FCV72EDM-UL, FCV72EDS-UL, FCV72E-UL, FM1221E1, FM1221E2, FM1221E3, FM1221G1, FM1221G2, FM1221G3, FM721E1, FM721E2, FM721E3, FM721G1, FM721G2, FM721G3 |                 |         |





Зип Общепит spare parts and accessories

vsezip.ru

+7(812)987-08-81

|   |  |                 |                    |
|---|--|-----------------|--------------------|
|  |  |                 |                    |
| 1   |  |                 |                    |
| <b>GEV No.</b>  | 542425   | <b>Ref. No.</b> | 33Q5920<br>33Q5921 |
| <b>description</b>  | injection nozzle bore $\varnothing$ 7/4.5mm D1 $\varnothing$ 12mm D2 $\varnothing$ 12mm L 60mm WS 17 brass for combi-steamer thread 1/8"   |                 |                    |
| <b>For models:</b>  | FC101, FC101E, FC241, FC241E, FC241G, FC61, FC61E, FCV101, FCV101-CSA, FCV101DM, FCV101DM-CSA, FCV101DS, FCV101DS-CSA, FCV101E, FCV101EDM, FCV101EDM-UL, FCV101EDS, FCV101EDS-UL, FCV101E-UL, FCV141, FCV141-CSA, FCV141DM, FCV141DM-CSA, FCV141DS, FCV141DS-CSA, FCV141E, FCV141EDM, FCV141EDS, FCV241, FCV241DM, FCV241DS, FCV241E, FCV241EDM, FCV241EDM-UL, FCV241EDS, FCV241EDS-UL, FCV241E-UL, FCV241G, FCV241G-CSA, FCV241GDM, FCV241GDM-CSA, FCV241GDS, FCV241GDS-CSA, FCV401DM, FCV401DM-CSA, FCV401EDM, FCV401EDM-UL, FCV61, FCV61-CSA, FCV61DM...(Other models you can see in the webshop) |                 |                    |

|   |  |                 |         |
|---|--|-----------------|---------|
|  |  |                 |         |
| 1   |  |                 |         |
| <b>GEV No.</b>  | 542429   | <b>Ref. No.</b> | 33T4450 |
| <b>description</b>  | nozzle bore $\varnothing$ 5/3.65mm L 24mm WS 12 brass thread M10x1 |                 |         |

|   |   |                 |                    |
|---|---|-----------------|--------------------|
|  |   |                 |                    |
| 1   |   |                 |                    |
| <b>GEV No.</b>  | 541507  | <b>Ref. No.</b> | 33T4110            |
| <b>description</b>  | nozzle cooling thread 1/8"  |                 |                    |
| <b>For models:</b>  | FCV3EM, FCV4E, FCV4EDS, FCV4EM, FM423E1, FM423E2                                    |                 |                    |
| <b>accessories for</b>  | 541507  |                 |                    |
|   |  | <b>GEV No.</b>  | 541488             |
|   |   | <b>Ref. No.</b> | 33Q5591<br>33Q5592 |
|   | hose connector thread M14x1 ET - 1/8" IT angled                                     |                 |                    |

|   |  |                 |                    |
|---|--|-----------------|--------------------|
|  |  |                 |                    |
| 1   |  |                 |                    |
| <b>GEV No.</b>  | 541509   | <b>Ref. No.</b> | 33T3720            |
| <b>description</b>  | nozzle cooling thread 1/8"   |                 |                    |
| <b>For models:</b>  | FC101, FC101E, FC241, FC241E, FC241G, FC61, FC61E, FCV101, FCV101-CSA, FCV101DM, FCV101DM-CSA, FCV101DS, FCV101DS-CSA, FCV101E, FCV101EDM, FCV101EDM-UL, FCV101EDS, FCV101EDS-UL, FCV101E-UL, FCV141, FCV141-CSA, FCV141DM, FCV141DM-CSA, FCV141DS, FCV141DS-CSA, FCV141E, FCV141EDM, FCV141EDS, FCV241, FCV241DM, FCV241DS, FCV241E, FCV241EDM, FCV241EDM-UL, FCV241EDS, FCV241EDS-UL, FCV241E-UL, FCV241G, FCV241G-CSA, FCV241GDM, FCV241GDM-CSA, FCV241GDS, FCV241GDS-CSA, FCV401DM, FCV401DM-CSA, FCV401EDM, FCV401EDM-UL, FCV61, FCV61-CSA, FCV61DM...(Other models you can see in the webshop) |                 |                    |
| <b>accessories for</b>  | 541509   |                 |                    |
|   |   | <b>GEV No.</b>  | 541488             |
|   |  | <b>Ref. No.</b> | 33Q5591<br>33Q5592 |
|   | hose connector thread M14x1 ET - 1/8" IT angled  |                 |                    |

|  |  |                 |         |
|--|--|-----------------|---------|
|  |  |                 |         |
| 1  |  |                 |         |
| <b>GEV No.</b>   | 108153   | <b>Ref. No.</b> | 6300748 |
| <b>description</b>   | burner blower combi-steamer 230V 65W hole distance 50mm NRG118/0800-3612-030204  |                 |         |
| <b>For models:</b>   | BX101G, BX101G-VERS.122013, BX122G, BX122G-VERS.122013, BX61G, BX61G-VERS.122013, BX82G, BX82G-VERS.122013, FX101G1, FX101G1R, FX101G2, FX101G2C, FX101G2C-VERS.032014, FX101G2R, FX101G2R-VERS.032014, FX101G2-VERS.032014, FX101G3, FX101G3C, FX101G3C-VERS.022014, FX101G3R, FX101G3R-VERS.022014, FX101G3-VERS.022014, FX10G2CR, FX10G2CR-VERS.032014, FX10G3CR, FX10G3CR-VERS.022014, FX122G1, FX122G2, FX122G2C, FX122G2T, FX122G2T-VERS.032014, FX122G3, FX122G3C, FX122G3T, FX122G3T-VERS.022014, FX12G3CT, FX12G3CT-VERS.022014, FX201G2, FX201G2P, FX201G2P-VERS.032014, FX201G2-VERS.032014, FX201G3P, FX201G3-VERS.022014, FX202G2, FX202G2-VERS.032014, FX202G3, FX202G3-VERS.022014, FX61G1, FX61G1R, FX61G2...(Other models you can see in the webshop) |                 |         |

|   |   |                 |         |
|---|---|-----------------|---------|
|  |   |                 |         |
| 1   |   |                 |         |
| <b>GEV No.</b>  | 542426  | <b>Ref. No.</b> | 3007200 |
| <b>description</b>  | connecting piece for combi-steamer L 22mm $\varnothing$ 13.5mm WS 14 1/8" ET - 1/8" IT  |                 |         |
| <b>For models:</b>  | FM1011E2-VERS.2006, FM1011E3, FM1011E3-VERS.2006, FM1011G2-VERS.2006, FM1011G3, FM1011G3-VERS.2006, FM1221E2-VERS.2006, FM1221E3, FM1221E3-VERS.2006, FM1221G2-VERS.2006, FM1221G3, FM1221G3-VERS.2006, FM2011E2-VERS.2006, FM2011E3-VERS.2006, FM2011G2-VERS.2006, FM2011G3-VERS.2006, FM2021E2-VERS.2006, FM2021E3, FM2021E3-VERS.2006, FM2021G2-VERS.2006, FM2021G3, FM2021G3-VERS.2006, FM423E2, FM611E2-VERS.2006, FM611E3, FM611E3-VERS.2006, FM611G2-VERS.2006, FM611G3, FM611G3-VERS.2006, FM721E2-VERS.2006, FM721E3, FM721E3-VERS.2006, FM721G2-VERS.2006, FM721G3, FM721G3-VERS.2006 |                 |         |

|  |   |                 |         |
|--|---|-----------------|---------|
|  |   |                 |         |
| 1  |   |                 |         |
| <b>GEV No.</b>   | 551447  | <b>Ref. No.</b> | 3091170 |
| <b>description</b>   | connecting piece for combi-steamer stainless steel L 162mm $\varnothing$ 10mm |                 |         |

|  |  |                 |         |
|--|--|-----------------|---------|
|  |  |                 |         |
| 1  |  |                 |         |
| <b>GEV No.</b>   | 552007   | <b>Ref. No.</b> | 33Q5641 |
| <b>description</b>   | connecting piece incl reducer 1/2" - 3/4" L 48mm brass for combi-steamer   |                 |         |
| <b>For models:</b>   | FCV101, FCV101-CSA, FCV101DM, FCV101DM-CSA, FCV101DS, FCV101DS-CSA, FCV101E, FCV101EDM, FCV101EDM-UL, FCV101EDS, FCV101EDS-UL, FCV101E-UL, FCV141, FCV141-CSA, FCV141DM, FCV141DM-CSA, FCV141DS, FCV141DS-CSA, FCV141E, FCV141EDM, FCV141EDS, FCV241, FCV241DM, FCV241DS, FCV241E, FCV241EDM, FCV241EDM-UL, FCV241EDS, FCV241EDS-UL, FCV241E-UL, FCV241G, FCV241G-CSA, FCV241GDM, FCV241GDM-CSA, FCV241GDS, FCV241GDS-CSA, FCV3EM, FCV401DM, FCV401DM-CSA, FCV401EDM, FCV401EDM-UL, FCV4E, FCV4EDS, FCV4EM, FCV61, FCV61-CSA, FCV61DM, FCV61DM-CSA, FCV61DS, FCV61DS-CSA...(Other models you can see in the webshop) |                 |         |

Зип Общепит

vsezip.ru

8(12)98448881



|                    |   |                 |         |
|--------------------|---|-----------------|---------|
| 1                  |   |                 |         |
| <b>GEV No.</b>     | 551446  | <b>Ref. No.</b> | 3003760 |
| <b>description</b> | connecting piece L 42mm WS 14 1/8" IT - 1/8" ET   |                 |         |
| <b>For models:</b> | FM1011E2-VERS.2006, FM1011E3, FM1011E3-VERS.2006, FM1011G2-VERS.2006, FM1011G3, FM1011G3-VERS.2006, FM1221E2-VERS.2006, FM1221E3, FM1221E3-VERS.2006, FM1221G2-VERS.2006, FM1221G3-VERS.2006, FM2011E2-VERS.2006, FM2011E3-VERS.2006, FM2011G2-VERS.2006, FM2011G3-VERS.2006, FM2021E2-VERS.2006, FM2021E3, FM2021E3-VERS.2006, FM2021G2-VERS.2006, FM2021G3, FM2021G3-VERS.2006, FM611E2-VERS.2006, FM611E3, FM611E3-VERS.2006, FM611G2-VERS.2006, FM611G3, FM611G3-VERS.2006, FM721E2-VERS.2006, FM721E3, FM721E3-VERS.2006, FM721G2-VERS.2006, FM721G3, FM721G3-VERS.2006, FX201E3, FX201E3P, FX201E3P-VERS.022014, FX201E3-VERS.022014, FX201G3P, FX201G3-VERS.022014, FX202E3, FX202E3-230V-3-50Hz-60Hz, FX202E3-230V-3-50Hz-60Hz-VERS.022014, FX202E3-VERS.022014, FX202G3, FX202G3-VERS.022014 |                 |         |



|                    |  |                 |         |
|--------------------|--|-----------------|---------|
| 1                  |  |                 |         |
| <b>GEV No.</b>     | 691742   | <b>Ref. No.</b> | 3120030 |
| <b>description</b> | disc ext. ø 30                                 |                 |         |
| <b>For models:</b> | FCV241G-CSA, FCV241GDM-CSA, FCV241GDS-CSA, L80 |                 |         |



|                    |  |                 |         |
|--------------------|--|-----------------|---------|
| 1                  |  |                 |         |
| <b>GEV No.</b>     | 541503   | <b>Ref. No.</b> | 33Q0530 |
| <b>description</b> | end cap for hot air oven thread 3/8"   |                 |         |
| <b>For models:</b> | FC1011E, FC1011G, FC1221E, FC1221G, FC611E, FC611G, FCV101DM, FCV101DM-CSA, FCV101DS, FCV101DS-CSA, FCV101EDM, FCV101EDM-UL, FCV101EDS, FCV101EDS-UL, FCV141DM, FCV141DM-CSA, FCV141DS, FCV141DS-CSA, FCV141EDM, FCV141EDS, FCV241DM, FCV241DS, FCV241EDM, FCV241EDM-UL, FCV241EDS, FCV241EDS-UL, FCV241GDM, FCV241GDM-CSA, FCV241GDS, FCV241GDS-CSA, FCV401DM, FCV401DM-CSA, FCV61DM, FCV61DM-CSA, FCV61DS, FCV61DS-CSA, FCV61EDM, FCV61EDM-UL, FCV61EDS, FCV61EDS-UL, FCV72EDM-UL, FCV72EDS-UL, FM1011E1-VERS.2006, FM1011E2, FM1011E3, FM1011G1-VERS.2006, FM1011G2, FM1011G3, FM1221E1-VERS.2006, FM1221G1-VERS.2006...(Other models you can see in the webshop) |                 |         |



|                    |        |                 |         |
|--------------------|--------|-----------------|---------|
| 1                  |        |                 |         |
| <b>GEV No.</b>     | 691192 | <b>Ref. No.</b> | 36D0360 |
| <b>description</b> | flange |                 |         |

|                    |  |                 |         |
|--------------------|--|-----------------|---------|
|                    |  |                 |         |
| <b>GEV No.</b>     | 521194   | <b>Ref. No.</b> | 36E2350 |
| <b>description</b> | gas/let for heat exchanger combi-steamer ID ø 40mm hole distance 52mm thickness 3mm  |                 |         |
| <b>For models:</b> | BX101G, BX101G-VERS.122013, BX61G, BX61G-VERS.122013, FC1011G, FM1011G1, FM1011G1-VERS.2006, FM1011G2, FM1011G2-VERS.2006, FM1011G3, FM1011G3-VERS.2006, FX101G1, FX101G1R, FX101G2, FX101G2C, FX101G2C-VERS.032014, FX101G2R, FX101G2R-VERS.032014, FX101G2-VERS.032014, FX101G3, FX101G3C, FX101G3C-VERS.022014, FX101G3R, FX101G3R-VERS.022014, FX101G3-VERS.022014, FX10G2CR, FX10G2CR-VERS.032014, FX10G3CR, FX10G3CR-VERS.022014, FX201G2, FX201G2P, FX201G2P-VERS.032014, FX201G2-VERS.032014, FX201G3P, FX201G3-VERS.022014, FX61G1, FX61G1R, FX61G2, FX61G2C, FX61G2CR, FX61G2CR-VERS.032014, FX61G2C-VERS.032014, FX61G2R, FX61G2R-VERS.032014, FX61G2-VERS.032014, FX61G3, FX61G3C, FX61G3CR, FX61G3CR-VERS.022014, FX61G3C-VERS.022014...(Other models you can see in the webshop) |                 |         |



|                    |  |                 |         |
|--------------------|--|-----------------|---------|
| 1                  |  |                 |         |
| <b>GEV No.</b>     | 691199   | <b>Ref. No.</b> | 36G5380 |
| <b>description</b> | guide counterweight ø 37mm   |                 |         |
| <b>For models:</b> | FC101, FC101E, FC241, FC241E, FC241G, FC61, FC61E, FCV101, FCV101-CSA, FCV101DM, FCV101DM-CSA, FCV101DS, FCV101DS-CSA, FCV101E, FCV101EDM, FCV101EDM-UL, FCV101EDS, FCV101EDS-UL, FCV101E-UL, FCV141, FCV141-CSA, FCV141DM, FCV141DM-CSA, FCV141DS, FCV141DS-CSA, FCV141E, FCV141EDM, FCV141EDS, FCV241, FCV241DM, FCV241DS, FCV241E, FCV241EDM, FCV241EDM-UL, FCV241EDS, FCV241EDS-UL, FCV241E-UL, FCV241G, FCV241G-CSA, FCV241GDM, FCV241GDM-CSA, FCV241GDS, FCV241GDS-CSA, FCV61, FCV61-CSA, FCV61DM, FCV61DM-CSA, FCV61DS, FCV61DS-CSA, FCV61E...(Other models you can see in the webshop) |                 |         |



|                    |                    |                 |         |
|--------------------|--------------------|-----------------|---------|
| 1                  |                    |                 |         |
| <b>GEV No.</b>     | 691176             | <b>Ref. No.</b> | 35T0080 |
| <b>description</b> | guide plate ø 60mm |                 |         |





|                    |                               |                 |         |
|--------------------|-------------------------------|-----------------|---------|
| 1                  |                               |                 |         |
| <b>GEV No.</b>     | 691177                        | <b>Ref. No.</b> | 35S8650 |
| <b>description</b> | mounting ring for bulb socket |                 |         |



Зип Общепит  
vsozip.ru  
7(812)987-08-81

|   |   |                 |                    |
|---|---|-----------------|--------------------|
|  |   |                 |                    |
| 1   |   |                 |                    |
| <b>GEV No.</b>  | 696791  | <b>Ref. No.</b> | 3011590<br>3253680 |
| <b>description</b>  | protective covering for igniter L 80mm 7/9 rubber   |                 |                    |
| <b>For models:</b>  | 091FR1I, 091FR1IA, 091FR1ID, 091FR1ID-VERS.052012, 091FR1I-VERS.032012, 091FR7G, 091FR7GS, 091FR7G-VERS.052012, 091FR7GX, 10CP1IA, 12CP1IA, 18CP2IA, 191FR2I, 191FR2ID, 191FR2ID-VERS.092012, 191FR2I-VERS.032012, BX101G, BX122G, BX61G, BX82G, FC1011G, FC1221G, FC611G, FM1011G1, FM1011G1-VERS.2006, FM1011G2, FM1011G2-VERS.2006, FM1011G3, FM1011G3-VERS.2006, FM1221G1, FM1221G1-VERS.2006, FM1221G2, FM1221G2-VERS.2006, FM1221G3, FM1221G3-VERS.2006, FM2011G2-VERS.2006, FM2011G3-VERS.2006, FM2021G1, FM2021G2, FM2021G2-VERS.2006, FM2021G3, FM2021G3-VERS.2006, FM611G1, FM611G1-VERS.2006, FM611G2, FM611G2-VERS.2006, FM611G3, FM611G3-VERS.2006, FM721G1, FM721G1-VERS.2006...(Other models you can see in the webshop) |                 |                    |

|   |  |                 |         |
|---|--|-----------------|---------|
|  |  |                 |         |
| 2   |  |                 |         |
| <b>GEV No.</b>  | 541495   | <b>Ref. No.</b> | 33Q5630 |
| <b>description</b>  | reducer for hot air oven L 44mm WS 21 IT 3/8" ET M16x1.5   |                 |         |
| <b>For models:</b>  | FC101, FC101E, FC241, FC241E, FC241G, FC61, FC61E, FCV101, FCV101-CSA, FCV101DM, FCV101DM-CSA, FCV101DS, FCV101DS-CSA, FCV101E, FCV101EDM, FCV101EDM-UL, FCV101EDS, FCV101EDS-UL, FCV101E-UL, FCV141, FCV141-CSA, FCV141DM, FCV141DM-CSA, FCV141DS, FCV141DS-CSA, FCV141E, FCV141EDM, FCV141EDS, FCV241, FCV241DM, FCV241DS, FCV241E, FCV241EDM, FCV241EDM-UL, FCV241EDS, FCV241EDS-UL, FCV241E-UL, FCV241G, FCV241G-CSA, FCV241GDM, FCV241GDM-CSA, FCV241GDS, FCV241GDS-CSA, FCV401DM, FCV401DM-CSA, FCV401EDM, FCV401EDM-UL, FCV61, FCV61-CSA, FCV61DM...(Other models you can see in the webshop) |                 |         |

|   |  |                 |         |
|---|--|-----------------|---------|
|  |  |                 |         |
| 1   |  |                 |         |
| <b>GEV No.</b>  | 691167                                   | <b>Ref. No.</b> | 36D9150 |
| <b>description</b>  | ring ID ø 26mm ext. ø 30 thickness 1.5mm |                 |         |

|   |   |                 |         |
|---|---|-----------------|---------|
|  |   |                 |         |
| 1   |   |                 |         |
| <b>GEV No.</b>  | 541498  | <b>Ref. No.</b> | 33Q5410 |
| <b>description</b>  | screw connection WS 50 thread 1/4" ID ø 31mm  |                 |         |
| <b>For models:</b>  | FC101, FC101E, FC241, FC241E, FC241G, FC61, FC61E, FCV101, FCV101-CSA, FCV101DM, FCV101DM-CSA, FCV101DS, FCV101DS-CSA, FCV101E, FCV101EDM, FCV101EDM-UL, FCV101EDS, FCV101EDS-UL, FCV101E-UL, FCV141, FCV141-CSA, FCV141DM, FCV141DM-CSA, FCV141DS, FCV141DS-CSA, FCV141E, FCV141EDM, FCV141EDS, FCV241, FCV241DM, FCV241DS, FCV241E, FCV241EDM, FCV241EDM-UL, FCV241EDS, FCV241EDS-UL, FCV241E-UL, FCV241G, FCV241G-CSA, FCV241GDM, FCV241GDM-CSA, FCV241GDS, FCV241GDS-CSA, FCV401DM, FCV401DM-CSA, FCV401EDM, FCV401EDM-UL, FCV61, FCV61-CSA, FCV61DM, FCV61DM-CSA...(Other models you can see in the webshop) |                 |         |
| <b>accessories for</b>  | 541498  |                 |         |
|   | <b>GEV No.</b>  | <b>Ref. No.</b> |         |
|  | 541499  | 3151450         |         |
|   | gasket suitable for ANGELO PO size 1/4"   |                 |         |

|  |              |                 |         |
|--|--------------|-----------------|---------|
|  |              |                 |         |
| 1  |              |                 |         |
| <b>GEV No.</b>   | 091160       | <b>Ref. No.</b> | 36G0060 |
| <b>description</b>   | spring guide |                 |         |

|   |  |                 |         |
|---|--|-----------------|---------|
|  |  |                 |         |
| 1   |  |                 |         |
| <b>GEV No.</b>  | 551445   | <b>Ref. No.</b> | 3004791 |
| <b>description</b>  | water distributor for combi-steamer chrome-plated sheet steel L 92mm ø 35mm  |                 |         |
| <b>For models:</b>  | FM1011E1, FM1011E1-VERS.2006, FM1011E2, FM1011E2-VERS.2006, FM1011E3, FM1011E3-VERS.2006, FM1011G1, FM1011G1-VERS.2006, FM1011G2, FM1011G2-VERS.2006, FM1011G3, FM1011G3-VERS.2006, FM1221E1, FM1221E1-VERS.2006, FM1221E2, FM1221E2-VERS.2006, FM1221E3, FM1221E3-VERS.2006, FM1221G1, FM1221G1-VERS.2006, FM1221G2, FM1221G2-VERS.2006, FM1221G3, FM1221G3-VERS.2006, FM2011E2-VERS.2006, FM2011E3-VERS.2006, FM2011G2-VERS.2006, FM2011G3-VERS.2006, FM2021E1, FM2021E2, FM2021E2-VERS.2006, FM2021E3, FM2021E3-VERS.2006, FM2021G1, FM2021G2, FM2021G2-VERS.2006, FM2021G3, FM2021G3-VERS.2006, FM611E1, FM611E1-VERS.2006, FM611E2, FM611E2-VERS.2006, FM611E3, FM611E3-VERS.2006, FM611G1, FM611G1-VERS.2006, FM611G2, FM611G2-VERS.2006, FM611G3, FM611G3-VERS.2006...(Other models you can see in the webshop) |                 |         |

|   |                     |                 |         |
|---|---------------------|-----------------|---------|
|  |                     |                 |         |
| 1   |                     |                 |         |
| <b>GEV No.</b>  | 691165              | <b>Ref. No.</b> | 36G0190 |
| <b>description</b>  | wheel W 35mm ø 44mm |                 |         |

|   |  |                 |         |
|---|--|-----------------|---------|
|  |  |                 |         |
| 1   |  |                 |         |
| <b>GEV No.</b>  | 521197   | <b>Ref. No.</b> | 36E4290 |
| <b>description</b>  | Y-piece thread 1/8" IT - 1/8" IT - 1/8" IT stainless steel WS 13           |                 |         |
| <b>For models:</b>  | FM1011E3, FM1011G3, FM1221E3, FM1221G3, FM611E3, FM611G3, FM721E3, FM721G3 |                 |         |

|   |  |                 |                    |
|---|--|-----------------|--------------------|
| <b>glass panels</b>   |  |                 |                    |
|  |  |                 |                    |
| 1   |  |                 |                    |
| <b>GEV No.</b>  | 693397   | <b>Ref. No.</b> | 3070970<br>37N1420 |
| <b>description</b>  | glass panel L 29mm W 29mm thickness 3.5mm square   |                 |                    |
| <b>For models:</b>  | 06WCP1GM, 08WCP1GM, 08WFT1GV, 08WFT2GV, 08WFT3GV, 08WFT4GV, 08WFT6GV, 08WFT7GV, 090FT1G, 090FT2G, 090FT4G, 090FT5G, 090FT7G, 091CP1G, 091FR7G, 091FR7GS, 091FR7G-VERS.052012, 091FR7GX, 0A0FT1G, 0A0FT2G, 0A0FT4G, 0A0FT5G, 0A1CP1G, 0B0FT1G, 0B0FT2G, 0B0FT4G, 0B0FT5G, 0B1CP1G, 0D0FT1G, 0D0FT2G, 0D0FT4G, 0D0FT5G, 0D1CP1G, 0G0FT1G, 0G0FT1G-VERS.032008, 0G0FT2G, 0G0FT2G-VERS.032008, 0G0FT4G, 0G0FT4G-VERS.032008, 0G0FT5G, 0G0FT5G-VERS.032008, 0G0FT7G, 0G1CP1G, 0G1CP1G-VERS.2004, 0G1FR7G, 10CP1GA, 10CP1IA, 10WTPGE, 10WTPGV, 12CP1GA...(Other models you can see in the webshop) |                 |                    |

Зип Общежит

|                    |   |                 |         |
|--------------------|---|-----------------|---------|
| <b>GEV No.</b>     | 521196  | <b>Ref. No.</b> | 30Z2050 |
| <b>description</b> | water pipe L 180mm W 120mm ø 11/12mm thread M16x1.5   |                 |         |
| <b>For models:</b> | FC101, FC1011E, FC1011G, FC101E, FC1221E, FC1221G, FC241E, FC241G, FC61E, FC611E, FC611G, FC61E, FCV101, FCV101-CSA, FCV101DM, FCV101DM-CSA, FCV101DS, FCV101DS-CSA, FCV101E, FCV101EDM, FCV101EDM-UL, FCV101EDS, FCV101E-UL, FCV141, FCV141-CSA, FCV141DM, FCV141DM-CSA, FCV141DS, FCV141DS-CSA, FCV141E, FCV141EDM, FCV141EDS, FCV241E, FCV241EDM, FCV241EDM-UL, FCV241EDS, FCV241EDS-UL, FCV241E-UL, FCV241G, FCV241G-CSA, FCV241GDM, FCV241GDM-CSA, FCV241GDS, FCV241GDS-CSA, FCV401DM, FCV401DM-CSA, FCV401EDM, FCV401EDM-UL, FCV61, FCV61-CSA...(Other models you can see in the webshop) |                 |         |

hoses

|                    |  |                 |         |
|--------------------|--|-----------------|---------|
| <b>GEV No.</b>     | 696792   | <b>Ref. No.</b> | 3067460 |
| <b>description</b> | hose ID ø 32mm ED ø 40mm L 1000mm combi-steamer  |                 |         |
| <b>For models:</b> | 08WGREV, 091CP1E, 091CP1G, 10CP1EA, 10CP1GA, 10CP1IA, 12CP1EA, 12CP1GA, 12CP1IA, 18CP2EA, 18CP2GA, 18CP2IA, 191CP1G, 191CP2G, 6040090, 6040310, 6043850, 6043980, FMS, FMSX, PIER-06HD, PIER15HD |                 |         |

service kits

|                    |  |                 |         |
|--------------------|--|-----------------|---------|
| <b>GEV No.</b>     | 696773   | <b>Ref. No.</b> | 6300833 |
| <b>description</b> | drain fitting set for combi-steamer hose ø 8mm   |                 |         |
| <b>For models:</b> | FX101E3, FX101E3C, FX101E3C-VERS.022014, FX101E3R, FX101E3R-VERS.022014, FX101E3-VERS.022014, FX101G3, FX101G3C, FX101G3C-VERS.022014, FX101G3R, FX101G3R-VERS.022014, FX101G3-VERS.022014, FX10E3CR, FX10E3CR-VERS.022014, FX10G3CR, FX10G3CR-VERS.022014, FX122E3, FX122E3C, FX122E3T, FX122E3T-VERS.022014, FX122G3, FX122G3C, FX122G3T, FX122G3T-VERS.022014, FX12E3CT, FX12E3CT-VERS.022014, FX12G3CT, FX12G3CT-VERS.022014, FX201E3, FX201E3P, FX201E3P-VERS.022014, FX201E3-VERS.022014, FX201G3P, FX201G3-VERS.022014, FX202E3, FX202E3-230V-3-50Hz-60Hz, FX202E3-230V-3-50Hz-60Hz-VERS.022014, FX202E3-VERS.022014, FX202G3, FX202G3-VERS.022014, FX61E3, FX61E3C, FX61E3CR, FX61E3CR-VERS.022014, FX61E3C-VERS.022014, FX61E3R, FX61E3R-VERS.022014, FX61E3-VERS.022014, FX61G3, FX61G3C...(Other models you can see in the webshop) |                 |         |

|                    |   |                 |         |
|--------------------|---|-----------------|---------|
| <b>GEV No.</b>     | 691146  | <b>Ref. No.</b> | 3000770 |
| <b>description</b> | glass panel L 515mm W 505mm thickness 6mm rectangular |                 |         |
| <b>For models:</b> | FM611E1, FM611E2, FM611E3, FM611G1, FM611G2, FM611G3  |                 |         |

|                    |  |                 |         |
|--------------------|--|-----------------|---------|
| <b>GEV No.</b>     | 691147   | <b>Ref. No.</b> | 3000760 |
| <b>description</b> | glass panel L 720mm W 515mm thickness 6mm rectangular      |                 |         |
| <b>For models:</b> | FM1011E1, FM1011E2, FM1011E3, FM1011G1, FM1011G2, FM1011G3 |                 |         |

cleaning system

nozzles

|                    |                                      |                 |                    |
|--------------------|--------------------------------------|-----------------|--------------------|
| <b>GEV No.</b>     | 510626                               | <b>Ref. No.</b> | 33T1120<br>33T1121 |
| <b>description</b> | rinse jet ø 0.7/1.5mm thread 1/8" ET |                 |                    |
| <b>For models:</b> | L100, L40, L40S, L60, L80            |                 |                    |

screw connections

|                    |  |                 |         |
|--------------------|--|-----------------|---------|
| <b>GEV No.</b>     | 362028   | <b>Ref. No.</b> | 3041000 |
| <b>description</b> | manifold 4+2 L 116mm plastic thread M10 IT   |                 |         |
| <b>For models:</b> | FM1011E3-VERS.2006, FM1011G3-VERS.2006, FM1221E3-VERS.2006, FM1221G3-VERS.2006, FM2011E3-VERS.2006, FM2011G3-VERS.2006, FM611E3-VERS.2006, FM611G3-VERS.2006, FM721E3-VERS.2006, FM721G3-VERS.2006 |                 |         |

pipes

|                    |   |                 |         |
|--------------------|---|-----------------|---------|
| <b>GEV No.</b>     | 521196  | <b>Ref. No.</b> | 3120710 |
| <b>description</b> | drain pipe L 568mm W 182mm ø 30mm for combi-steamer ID ø 21mm EPDM  |                 |         |
| <b>For models:</b> | BX101E, BX101E-VERS.122013, BX122E, BX122E-VERS.122013, BX122G, BX122G-VERS.122013, BX61E, BX61E-VERS.122013, BX82E, BX82E-VERS.122013, BX82G, BX82G-VERS.122013, FM423E1, FM423E2, FX101E1, FX101E1R, FX101E2, FX101E2C, FX101E2C-VERS.032014, FX101E2R, FX101E2R-VERS.032014, FX101E2-VERS.032014, FX101E3, FX101E3C, FX101E3C-VERS.022014, FX101E3R, FX101E3R-VERS.022014, FX101E3-VERS.022014, FX101G1, FX101G1R, FX101G2, FX101G2C, FX101G2R, FX101G3, FX101G3C, FX101G3R, FX10E2CR, FX10E2CR-VERS.032014, FX10E3CR, FX10E3CR-VERS.022014, FX10G2CR, FX10G3CR, FX122E1, FX122E2, FX122E2C, FX122E2T, FX122E2T-VERS.032014, FX122E3, FX122E3C, FX122E3T...(Other models you can see in the webshop) |                 |         |





door mechanics

holders



|                    |   |                 |         |
|--------------------|---|-----------------|---------|
| <b>GEV No.</b>     | 692858  | <b>Ref. No.</b> | 6300798 |
| <b>description</b> | bracket for glass door combi-steamer  |                 |         |
| <b>For models:</b> | FX101E1, FX101E2, FX101E2C, FX101E2C-VERS.032014, FX101E2-VERS.032014, FX101E3, FX101E3C, FX101E3C-VERS.022014, FX101E3R, FX101E3-VERS.022014, FX101G1, FX101G2, FX101G2C, FX101G2C-VERS.032014, FX101G2-VERS.032014, FX101G3, FX101G3C, FX101G3C-VERS.022014, FX101G3-VERS.022014, FX10E2CR-VERS.032014, FX122E1, FX122E2, FX122E2C, FX122E2T, FX122E2T-VERS.032014, FX122E3, FX122E3C, FX122E3T, FX122E3T-VERS.022014, FX122G1, FX122G3, FX122G3C, FX122G3T, FX122G3T-VERS.022014, FX12E3CT, FX12E3CT-VERS.022014, FX12G3CT, FX12G3CT-VERS.022014, FX61E1, FX61E2, FX61E2C, FX61E2C-VERS.032014, FX61E2-VERS.032014, FX61E3, FX61E3C, FX61E3C-VERS.022014, FX61E3-VERS.022014, FX61G1, FX61G2, FX61G2C... (Other models you can see in the webshop) |                 |         |

locking mechanism



|                        |   |                 |                         |
|------------------------|---|-----------------|-------------------------|
| <b>GEV No.</b>         | 698503  | <b>Ref. No.</b> | 6300965                 |
| <b>description</b>     | espagnolette lock complete  |                 |                         |
| <b>For models:</b>     | FX201E2, FX201E2P, FX201E2P-VERS.032014, FX201E2-VERS.032014, FX201E3, FX201E3P, FX201E3P-VERS.022014, FX201E3-VERS.022014, FX201G2, FX201G2P, FX201G2P-VERS.032014, FX201G2-VERS.032014, FX201G3P, FX201G3-VERS.022014, FX202E2, FX202E2-VERS.032014, FX202E3, FX202E3-230V-3-50Hz-60Hz, FX202E3-230V-3-50Hz-60Hz-VERS.022014, FX202E3-VERS.022014, FX202G2, FX202G2-VERS.032014, FX202G3, FX202G3-VERS.022014 |                 |                         |
| <b>accessories for</b> | 698503  |                 |                         |
|                        | <b>GEV No.</b>  | 690041          | <b>Ref. No.</b> 3088460 |
|                        | <b>GEV No.</b>  | 694409          | <b>Ref. No.</b> —       |
|                        | <b>GEV No.</b>  | 700604          | <b>Ref. No.</b> —       |

accessories



|                    |  |                 |         |
|--------------------|--|-----------------|---------|
| <b>GEV No.</b>     | 696775   | <b>Ref. No.</b> | 36E2781 |
| <b>description</b> | buffer for door ø 15mm silicone L 20mm   |                 |         |
| <b>For models:</b> | BX101E, BX101E-VERS.122013, BX101G, BX101G-VERS.122013, BX122E, BX122E-VERS.122013, BX122G, BX122G-VERS.122013, BX61E, BX61E-VERS.122013, BX61G, BX61G-VERS.122013, BX82E, BX82E-VERS.122013, BX82G, BX82G-VERS.122013, FC1011E, FC1011G, FC1221E, FC1221G, FC611E, FC611G, FM1011E1, FM1011E1-VERS.2006, FM1011E2, FM1011E2-VERS.2006, FM1011E3, FM1011E3-VERS.2006, FM1011G1, FM1011G1-VERS.2006, FM1011G2, FM1011G2-VERS.2006, FM1011G3, FM1011G3-VERS.2006, FM1221E1, FM1221E1-VERS.2006, FM1221E2, FM1221E2-VERS.2006, FM1221E3, FM1221E3-VERS.2006, FM1221G1, FM1221G1-VERS.2006, FM1221G2, FM1221G2-VERS.2006, FM1221G3, FM1221G3-VERS.2006, FM2011E2-VERS.2006, FM2011E3-VERS.2006, FM2011G2-VERS.2006, FM2011G3-VERS.2006...(Other models you can see in the webshop) |                 |         |

Зип Общепит



vsezip.ru

+7(812)987-08-81

|                    |   |                 |         |
|--------------------|---|-----------------|---------|
| <b>GEV No.</b>     | 696774  | <b>Ref. No.</b> | 3171920 |
| <b>description</b> | washer for door handle ø13mm hole ø 20mm plastic  |                 |         |
| <b>For models:</b> | FX101E1, FX101E2, FX101E2C, FX101E2C-VERS.032014, FX101E2-VERS.032014, FX101E3, FX101E3C, FX101E3C-VERS.022014, FX101E3R, FX101E3-VERS.022014, FX101G1, FX101G2, FX101G2C, FX101G2C-VERS.032014, FX101G2-VERS.032014, FX101G3, FX101G3C, FX101G3C-VERS.022014, FX101G3-VERS.022014, FX10E2CR-VERS.032014, FX122E1, FX122E2, FX122E2C, FX122E2T, FX122E2T-VERS.032014, FX122E3, FX122E3C, FX122E3T, FX122E3T-VERS.022014, FX122G1, FX122G3, FX122G3C, FX122G3T, FX122G3T-VERS.022014, FX12E3CT, FX12E3CT-VERS.022014, FX12G3CT, FX12G3CT-VERS.022014, FX61E1, FX61E2, FX61E2C, FX61E2C-VERS.032014, FX61E2-VERS.032014, FX61E3, FX61E3C, FX61E3C-VERS.022014, FX61E3-VERS.022014, FX61G1, FX61G2, FX61G2C... (Other models you can see in the webshop) |                 |         |



|                    |   |                 |         |
|--------------------|---|-----------------|---------|
| <b>GEV No.</b>     | 692859  | <b>Ref. No.</b> | 3019510 |
| <b>description</b> | fixing plate for catch W 42mm zinc-plated sheet steel L 93.5mm  |                 |         |
| <b>For models:</b> | FC1011E, FC1011G, FC1221E, FC1221G, FC611E, FC611G, FM1011E1, FM1011E1-VERS.2006, FM1011E2, FM1011E2-VERS.2006, FM1011E3, FM1011E3-VERS.2006, FM1011G1, FM1011G1-VERS.2006, FM1011G2, FM1011G2-VERS.2006, FM1011G3, FM1011G3-VERS.2006, FM1221E1, FM1221E1-VERS.2006, FM1221E2, FM1221E2-VERS.2006, FM1221E3, FM1221E3-VERS.2006, FM1221G1, FM1221G1-VERS.2006, FM1221G2, FM1221G2-VERS.2006, FM1221G3, FM1221G3-VERS.2006, FM2011E2-VERS.2006, FM2011E3-VERS.2006, FM2011G2-VERS.2006, FM2011G3-VERS.2006, FM2021E1, FM2021E2, FM2021E2-VERS.2006, FM2021E3, FM2021E3-VERS.2006, FM2021G1, FM2021G2, FM2021G2-VERS.2006, FM2021G3, FM2021G3-VERS.2006, FM611E1, FM611E1-VERS.2006, FM611E2, FM611E2-VERS.2006, FM611E3, FM611E3-VERS.2006... (Other models you can see in the webshop) |                 |         |

vibration pumps



|                    |  |                 |                    |
|--------------------|--|-----------------|--------------------|
| <b>GEV No.</b>     | 500972   | <b>Ref. No.</b> | 32M7000<br>32M7001 |
| <b>description</b> | vibration pump 230V 47W 50Hz inlet ø 7 outlet ø 1/8" IT CEME type E507   |                 |                    |
| <b>For models:</b> | FM1011E3, FM1011E3-VERS.2006, FM1011G3, FM1011G3-VERS.2006, FM1221E3, FM1221E3-VERS.2006, FM1221G3-VERS.2006, FM2011E3-VERS.2006, FM2011G3-VERS.2006, FM2021E3, FM2021E3-VERS.2006, FM2021G3, FM2021G3-VERS.2006, FM611E3, FM611E3-VERS.2006, FM611G3, FM611G3-VERS.2006, FM721E3, FM721E3-VERS.2006, FM721G3, FM721G3-VERS.2006 |                 |                    |

## heat exchangers



|                    |  |                 |         |
|--------------------|--|-----------------|---------|
| <b>GEV No.</b>     | 521194   | <b>Ref. No.</b> | 36E2350 |
| <b>description</b> | gasket for heat exchanger combi-steamer ID ø 40mm hole distance ø 52mm thickness 4mm   |                 |         |
| <b>For models:</b> | BX101G, BX101G-VERS.122013, BX61G, BX61G-VERS.122013, FC1011G, FM1011G1, FM1011G1-VERS.2006, FM1011G2, FM1011G2-VERS.2006, FM1011G3, FM1011G3-VERS.2006, FX101G1, FX101G1R, FX101G2, FX101G2C, FX101G2C-VERS.032014, FX101G2R, FX101G2R-VERS.032014, FX101G2-VERS.032014, FX101G3, FX101G3C, FX101G3C-VERS.022014, FX101G3R, FX101G3R-VERS.022014, FX101G3-VERS.022014, FX10G2CR, FX10G2CR-VERS.032014, FX10G3CR, FX10G3CR-VERS.022014, FX201G2, FX201G2P, FX201G2P-VERS.032014, FX201G2-VERS.032014, FX201G3P, FX201G3-VERS.022014, FX61G1, FX61G1R, FX61G2, FX61G2C, FX61G2CR, FX61G2CR-VERS.032014, FX61G2C-VERS.032014, FX61G2R, FX61G2R-VERS.032014, FX61G2-VERS.032014, FX61G3, FX61G3C, FX61G3CR, FX61G3CR-VERS.022014, FX61G3C-VERS.022014...(Other models you can see in the webshop) |                 |         |



|                    |  |                 |         |
|--------------------|--|-----------------|---------|
| <b>GEV No.</b>     | 521195   | <b>Ref. No.</b> | 36E3570 |
| <b>description</b> | gasket for heat exchanger combi-steamer ID ø 52mm hole distance 63mm thickness 3mm   |                 |         |
| <b>For models:</b> | BX122G, BX122G-VERS.122013, BX82G, BX82G-VERS.122013, FC1221G, FM1221G1, FM1221G1-VERS.2006, FM1221G2, FM1221G2-VERS.2006, FM1221G3, FM1221G3-VERS.2006, FM2021G1, FM2021G2, FM2021G2-VERS.2006, FM2021G3, FM2021G3-VERS.2006, FM721G1, FM721G1-VERS.2006, FM721G2, FM721G2-VERS.2006, FM721G3, FM721G3-VERS.2006, FX122G1, FX122G2, FX122G2C, FX122G2T, FX122G2T-VERS.032014, FX122G3, FX122G3C, FX122G3T, FX122G3T-VERS.022014, FX12G3CT, FX12G3CT-VERS.022014, FX202G2, FX202G2-VERS.032014, FX202G3, FX202G3-VERS.022014, FX82G1, FX82G2, FX82G2C, FX82G2T, FX82G2T-VERS.032014, FX82G3, FX82G3C, FX82G3CT, FX82G3CT-VERS.022014, FX82G3T, FX82G3T-VERS.022014 |                 |         |

## miscellaneous



|                        |  |                 |                         |
|------------------------|--|-----------------|-------------------------|
| <b>GEV No.</b>         | 691179   | <b>Ref. No.</b> | 33Q0730                 |
| <b>description</b>     | bush thread M10x1 ø 5mm  |                 |                         |
| <b>For models:</b>     | FCV101DM, FCV101DM-CSA, FCV101DS, FCV101DS-CSA, FCV101EDM, FCV101EDM-UL, FCV101EDS, FCV101EDS-UL, FCV141DM, FCV141DM-CSA, FCV141DS, FCV141DS-CSA, FCV141EDM, FCV141EDS, FCV241DM, FCV241DS, FCV241EDM, FCV241EDM-UL, FCV241EDS, FCV241EDS-UL, FCV241GDM, FCV241GDM-CSA, FCV241GDS, FCV241GDS-CSA, FCV401DM, FCV401DM-CSA, FCV401EDM, FCV401EDM-UL, FCV4EDS, FCV61DM, FCV61DM-CSA, FCV61DS, FCV61DS-CSA, FCV61EDM, FCV61EDM-UL, FCV61EDS, FCV61EDS-UL, FCV72EDM-UL, FCV72EDS-UL, FM101E2, FM101E3, FM101G2, FM101G3, FM1221E2, FM1221E3, FM1221G2, FM1221G3, FM2021E2, FM2021E3, FM2021G2...(Other models you can see in the webshop) |                 |                         |
| <b>accessories for</b> | 691179   |                 |                         |
|                        | <b>GEV No.</b>   | 519385          | <b>Ref. No.</b> 3150220 |
|                        | <b>GEV No.</b>   | 691180          | <b>Ref. No.</b> 3120100 |

Зип Общепит

vsezip.ru

7(812)987-08-81



|                    |  |                 |         |
|--------------------|--|-----------------|---------|
| <b>GEV No.</b>     | 691123   | <b>Ref. No.</b> | 36E2060 |
| <b>description</b> | duct for door opener                             |                 |         |
| <b>For models:</b> | FCV3EM, FCV4E, FCV4EDS, FCV4EM, FM423E1, FM423E2 |                 |         |



|                        |   |                 |         |
|------------------------|---|-----------------|---------|
| <b>GEV No.</b>         | 541486  | <b>Ref. No.</b> | 33Q5901 |
| <b>description</b>     | hose connector for manometer bore ø 0.4mm thread 1/8" |                 |         |
| <b>For models:</b>     | FM423E1, FM423E2                                      |                 |         |
| <b>accessories for</b> | 541486  |                 |         |

|  |                |        |                         |
|--|----------------|--------|-------------------------|
|  | <b>GEV No.</b> | 541508 | <b>Ref. No.</b> 33D1680 |
|--|----------------|--------|-------------------------|



|                    |  |                 |         |
|--------------------|--|-----------------|---------|
| <b>GEV No.</b>     | 542121   | <b>Ref. No.</b> | 3032890 |
| <b>description</b> | hose connector for manometer L 60mm WS 17 brass thread 1/8" ø 12mm T2: M8  |                 |         |
| <b>For models:</b> | BX101E, BX101E-VERS.122013, BX101G, BX101G-VERS.122013, FC1011E, FC1011G, FC1221E, FC1221G, FC611E, FC611G, FM1011E1, FM1011E1-VERS.2006, FM1011E2, FM1011E2-VERS.2006, FM1011E3, FM1011E3-VERS.2006, FM1011G1, FM1011G1-VERS.2006, FM1011G2, FM1011G2-VERS.2006, FM1011G3, FM1011G3-VERS.2006, FM1221E1-VERS.2006, FM1221E2-VERS.2006, FM1221E3, FM1221E3-VERS.2006, FM1221G1-VERS.2006, FM1221G2-VERS.2006, FM1221G3, FM1221G3-VERS.2006, FM2011E2-VERS.2006, FM2011E3-VERS.2006, FM2011G2-VERS.2006, FM2011G3-VERS.2006, FM2021E1, FM2021E2, FM2021E2-VERS.2006, FM2021E3, FM2021E3-VERS.2006, FM2021G1, FM2021G2, FM2021G2-VERS.2006, FM2021G3, FM2021G3-VERS.2006, FM611E1, FM611E1-VERS.2006, FM611E2, FM611E2-VERS.2006, FM611E3, FM611E3-VERS.2006...(Other models you can see in the webshop) |                 |         |



3ип Общежит  
for tilting bratt pans

drive shafts  
vsezip.ru

+7(812)987-08-81



1

|                    |  |                 |         |
|--------------------|--|-----------------|---------|
| <b>GEV No.</b>     | 697869   | <b>Ref. No.</b> | 3010750 |
| <b>description</b> | mounting flange for fan steel  |                 |         |
| <b>For models:</b> | FM1011G1, FM1011G2, FM1011G3, FM611G1, FM611G2, FM611G3, FM721G1, FM721G2, FM721G3 |                 |         |



Image not available

1

|                    |   |                 |         |
|--------------------|---|-----------------|---------|
| <b>GEV No.</b>     | 691180  | <b>Ref. No.</b> | 3120100 |
| <b>description</b> | plain washer  |                 |         |
| <b>For models:</b> | 10CP1EA, 10CP1GA, 10CP1IA, 12CP1EA, 12CP1GA, 12CP1IA, 18CP2EA, 18CP2GA, 18CP2IA, C304AD, C304AS, C304AVD, C304AVS, CS370AD, CS370AS, CS370AVD, CS370AVS, CS466AD, CS466AS, CS466AVD, CS466AVS, FCV101DM, FCV101DM-CSA, FCV101DS, FCV101DS-CSA, FCV101EDM, FCV101EDM-UL, FCV101EDS, FCV101EDS-UL, FCV141DM, FCV141DM-CSA, FCV141DS, FCV141DS-CSA, FCV141EDM, FCV141EDS, FCV241DM, FCV241DS, FCV241EDM, FCV241EDM-UL, FCV241EDS, FCV241EDS-UL, FCV241GDM, FCV241GDM-CSA, FCV241GDS, FCV241GDS-CSA, FCV401DM, FCV401DM-CSA, FCV401EDM, FCV401EDM-UL, FCV4EDS...(Other models you can see in the webshop) |                 |         |



1

|                    |   |                 |         |
|--------------------|---|-----------------|---------|
| <b>GEV No.</b>     | 697870  | <b>Ref. No.</b> | 3010670 |
| <b>description</b> | protector for aspiration  |                 |         |
| <b>For models:</b> | FM1011G1, FM1011G2, FM1011G3, FM1221G1, FM1221G2, FM1221G3, FM2021G1, FM2021G2, FM2021G3, FM611G1, FM611G2, FM611G3 |                 |         |



1

|                    |  |                 |         |
|--------------------|--|-----------------|---------|
| <b>GEV No.</b>     | 514043   | <b>Ref. No.</b> | 36G1290 |
| <b>description</b> | spindle for tilting bratt pan seat $\phi$ 16mm |                 |         |
| <b>For models:</b> | 1G1BR1E, 1G1BR1G, 31R, 31RE                    |                 |         |

spare parts and accessories



1

|                    |  |                 |         |
|--------------------|--|-----------------|---------|
| <b>GEV No.</b>     | 693824                                       | <b>Ref. No.</b> | 36G6431 |
| <b>description</b> | extension L 255mm thread M14x1.5 $\phi$ 25mm |                 |         |



1

|                    |  |                 |         |
|--------------------|--|-----------------|---------|
| <b>GEV No.</b>     | 700735   | <b>Ref. No.</b> | 36E0870 |
| <b>description</b> | spacer piece   |                 |         |
| <b>For models:</b> | 191BR1E, 191BR1G, 191BR1GA, 191BR2E, 191BR2EA, 191BR2G, 191BR2GA, 1A1BR1E, 1A1BR1G, 1A1BR1GA, 1A1BR2E, 1A1BR2EA, 1A1BR2G, 1A1BR2GA, 1D1BR1E, 1D1BR1G, 1D1BR1GA, 1D1BR2E, 1D1BR2EA, 1D1BR2G, 1D1BR2GA, 291BR1E, 291BR1G, 291BR1GA, 291BR2E, 291BR2EA, 291BR2G, 291BR2GA, 2A1BR1E, 2A1BR1G, 2A1BR1GA, 2A1BR2E, 2A1BR2EA, 2A1BR2G, 2A1BR2GA, 2D1BR1E, 2D1BR1G, 2D1BR1GA, 2D1BR2E, 2D1BR2EA, 2D1BR2G, 2D1BR2GA |                 |         |



1

|                    |  |                 |         |
|--------------------|--|-----------------|---------|
| <b>GEV No.</b>     | 700734   | <b>Ref. No.</b> | 36E0440 |
| <b>description</b> | thread bolt thread M5 D1 $\phi$ 18mm D2 $\phi$ 12mm  |                 |         |
| <b>For models:</b> | 191BR1E, 191BR1G, 191BR1GA, 191BR2E, 191BR2EA, 191BR2G, 191BR2GA, 1A1BR1E, 1A1BR1G, 1A1BR1GA, 1A1BR2E, 1A1BR2EA, 1A1BR2G, 1A1BR2GA, 1D1BR1E, 1D1BR1G, 1D1BR1GA, 1D1BR2E, 1D1BR2EA, 1D1BR2G, 1D1BR2GA, 291BR1E, 291BR1G, 291BR1GA, 291BR2E, 291BR2EA, 291BR2G, 291BR2GA, 2A1BR1E, 2A1BR1G, 2A1BR1GA, 2A1BR2E, 2A1BR2EA, 2A1BR2G, 2A1BR2GA, 2D1BR1E, 2D1BR1G, 2D1BR1GA, 2D1BR2E, 2D1BR2EA, 2D1BR2G, 2D1BR2GA |                 |         |

housing and bezels



|                    |   |                 |         |
|--------------------|---|-----------------|---------|
| <b>GEV No.</b>     | 691183  | <b>Ref. No.</b> | 36D3430 |
| <b>description</b> | end cap for control panel mounting pos. left  |                 |         |
| <b>For models:</b> | 030, 030BME, 030E, 030EBM, 030FE, 030FE1, 030FE1B, 030FT, 030FTE, 030FTER, 030FTR, 031, 031BME, 031E, 031EBM, 031FT, 031FT04, 031FT06, 031FTE, 031FTE04, 031FTE06, 031FTER, 031FTERL, 031FTR, 031FTRL, 031TP, 032, 070BM, 070BME, 070D, 070DGG, 070E, 070FT, 070FT04, 070FT05, 070FTE, 070FTE04, 070FTE05, 070FTER, 070FTR, 0712D, 0712VA, 071BM, 071BME, 071D, 071DGG, 071E, 071FT, 071FT04, 071FT06...(Other models you can see in the webshop) |                 |         |



|                    |   |                 |         |
|--------------------|---|-----------------|---------|
| <b>GEV No.</b>     | 691184  | <b>Ref. No.</b> | 36D3420 |
| <b>description</b> | end cap for control panel mounting pos. right   |                 |         |
| <b>For models:</b> | 030, 030BME, 030E, 030EBM, 030FE, 030FE1, 030FE1B, 030FT, 030FTE, 030FTER, 030FTR, 031, 031BME, 031E, 031EBM, 031FT, 031FT04, 031FT06, 031FTE, 031FTE04, 031FTE06, 031FTER, 031FTERL, 031FTR, 031FTRL, 031TP, 032, 070BM, 070BME, 070D, 070DGG, 070E, 070FT, 070FT04, 070FT05, 070FTE, 070FTE04, 070FTE05, 070FTER, 070FTR, 0712D, 0712VA, 071BM, 071BME, 071D, 071DGG, 071E, 071FT, 071FT04, 071FT06...(Other models you can see in the webshop) |                 |         |

glass panels



|                    |  |                 |                    |
|--------------------|--|-----------------|--------------------|
| <b>GEV No.</b>     | 693397   | <b>Ref. No.</b> | 3070970<br>37N1420 |
| <b>description</b> | glass panel L 29mm W 29mm thickness 3.5mm square   |                 |                    |
| <b>For models:</b> | 06WCP1GM, 08WCP1GM, 08WFT1GV, 08WFT2GV, 08WFT3GV, 08WFT4GV, 08WFT6GV, 08WFT7GV, 090FT1G, 090FT2G, 090FT4G, 090FT5G, 090FT7G, 091CP1G, 091FR7G, 091FR7GS, 091FR7G-VERS.052012, 091FR7GX, 0A0FT1G, 0A0FT2G, 0A0FT4G, 0A0FT5G, 0A1CP1G, 0B0FT1G, 0B0FT2G, 0B0FT4G, 0B0FT5G, 0B1CP1G, 0D0FT1G, 0D0FT2G, 0D0FT4G, 0D0FT5G, 0D1CP1G, 0G0FT1G, 0G0FT1G-VERS.032008, 0G0FT2G, 0G0FT2G-VERS.032008, 0G0FT4G, 0G0FT4G-VERS.032008, 0G0FT5G, 0G0FT5G-VERS.032008, 0G0FT7G, 0G1CP1G, 0G1CP1G-VERS.2004, 0G1FR7G, 10CP1GA, 10CP1IA, 10WTPGE, 10WTPGV, 12CP1GA...(Other models you can see in the webshop) |                 |                    |

spindles



|                    |  |                 |         |
|--------------------|--|-----------------|---------|
| <b>GEV No.</b>     | 514064   | <b>Ref. No.</b> | 36C0940 |
| <b>description</b> | bearing block for tilting bratt pan ID ø 19/35mm ED ø 14mm |                 |         |
| <b>For models:</b> | 1G1BR1E, 1G1BR1G, 31R, 31RE                                |                 |         |

Зип, Общепит

|                    |  |                 |         |
|--------------------|--|-----------------|---------|
| <b>GEV No.</b>     | 514044   | <b>Ref. No.</b> | 36G8110 |
| <b>description</b> | threaded rod thread M10x1.5 L 640mm ø 20mm   |                 |         |
| <b>For models:</b> | 191BR1E, 191BR1G, 191BR2E, 191BR2G, 1A1BR1E, 1A1BR1G, 1A1BR2E, 1A1BR2G, 1D1BR1E, 1D1BR1G, 1D1BR2E, 1D1BR2G, 291BR1E, 291BR1G, 291BR2E, 291BR2G, 2A1BR1E, 2A1BR2E, 2D1BR1E, 2D1BR2E |                 |         |



|                    |  |                 |         |
|--------------------|--|-----------------|---------|
| <b>GEV No.</b>     | 693099                                   | <b>Ref. No.</b> | 36G6440 |
| <b>description</b> | threaded rod thread M14x1 L 300mm ø 24mm |                 |         |

|                        |        |
|------------------------|--------|
| <b>accessories for</b> | 693099 |
|------------------------|--------|

|                    |               |                 |         |
|--------------------|---------------|-----------------|---------|
| <b>GEV No.</b>     | 693645        | <b>Ref. No.</b> | 36G6450 |
| <b>description</b> | threaded bush |                 |         |

|                    |   |                 |         |
|--------------------|---|-----------------|---------|
| <b>GEV No.</b>     | 693824                                  | <b>Ref. No.</b> | 36G6431 |
| <b>description</b> | extension L 255mm thread M14x1.5 ø 25mm |                 |         |



|                    |  |                 |         |
|--------------------|--|-----------------|---------|
| <b>GEV No.</b>     | 514041                                     | <b>Ref. No.</b> | 36G1170 |
| <b>description</b> | threaded rod thread M14x1.5 L 615mm ø 25mm |                 |         |
| <b>For models:</b> | 31R, 31RE                                  |                 |         |

miscellaneous



|                    |  |                 |         |
|--------------------|--|-----------------|---------|
| <b>GEV No.</b>     | 514046   | <b>Ref. No.</b> | 36C2830 |
| <b>description</b> | bracket for bearing  |                 |         |
| <b>For models:</b> | 191BR1E, 191BR1G, 191BR2E, 191BR2G, 1A1BR1E, 1A1BR1G, 1A1BR2E, 1A1BR2G, 1D1BR1E, 1D1BR1G, 1D1BR2E, 1D1BR2G, 291BR1E, 291BR1G, 291BR2E, 291BR2G, 2A1BR1E, 2A1BR1G, 2A1BR2E, 2A1BR2G, 2D1BR1E, 2D1BR1G, 2D1BR2E, 2D1BR2G |                 |         |



|                    |   |                 |         |
|--------------------|---|-----------------|---------|
| <b>GEV No.</b>     | 691187                                  | <b>Ref. No.</b> | 36D9390 |
| <b>description</b> | bushing ø 15/20mm for tilting bratt pan |                 |         |
| <b>For models:</b> | 1G1BR1E, 1G1BR1G, 31R, 31RE             |                 |         |





1

| GEV No.     | 691184   | Ref. No. | 36D3420 |
|-------------|--|----------|---------|
| description | end cap for control panel mounting pos. right  |          |         |
| For models: | 030, 030BME, 030E, 030EBM, 030FE, 030FE1, 030FE1B, 030FT, 030FTE, 030FTR, 030FTR, 031, 031BME, 031E, 031EBM, 031FT, 031FT04, 031FT06, 031FTE, 031FTE04, 031FTE06, 031FTR, 031FTRL, 031FTR, 031TP, 032, 070BM, 070BME, 070D, 070DGG, 070E, 070FT, 070FT04, 070FT05, 070FTE, 070FTE04, 070FTE05, 070FTR, 070FTR, 0712D, 0712VA, 071BM, 071BME, 071D, 071DGG, 071E, 071FT, 071FT04, 071FT06...(Other models you can see in the webshop) |          |         |

## glass panels



1

| GEV No.     | 693397  | Ref. No. | 3070970<br>37N1420 |
|-------------|---|----------|--------------------|
| description | glass panel L 29mm W 29mm thickness 3.5mm square  |          |                    |
| For models: | 06WCP1GM, 08WCP1GM, 08WFT1GV, 08WFT2GV, 08WFT3GV, 08WFT4GV, 08WFT6GV, 08WFT7GV, 090FT1G, 090FT2G, 090FT4G, 090FT5G, 090FT7G, 091CP1G, 091FR7G, 091FR7GS, 091FR7G-VERS.052012, 091FR7GX, 0A0FT1G, 0A0FT2G, 0A0FT4G, 0A0FT5G, 0A1CP1G, 0B0FT1G, 0B0FT2G, 0B0FT4G, 0B0FT5G, 0B1CP1G, 0D0FT1G, 0D0FT2G, 0D0FT4G, 0D0FT5G, 0D1CP1G, 0G0FT1G, 0G0FT1G-VERS.032008, 0G0FT2G, 0G0FT2G-VERS.032008, 0G0FT4G, 0G0FT4G-VERS.032008, 0G0FT5G, 0G0FT5G-VERS.032008, 0G0FT7G, 0G1CP1G, 0G1CP1G-VERS.2004, 0G1FR7G, 10CP1GA, 10CP1A, 10WTPGE, 10WTPGV, 12CP1GA...(Other models you can see in the webshop) |          |                    |

## miscellaneous



1

| GEV No.   | 514386  | Ref. No.      | 36M0830  |         |
|---|---|---------------|----------|---------|
| description   | closing clamp for kettle                              |               |          |         |
| For models:   | 71PI10A, 71PIE15A, 71PV15A, 91PI10, 91PI10A, 91PIE15A |               |          |         |
| accessories for   | 514386  |               |          |         |
|  | GEV No.   | 514387        | Ref. No. | 36M0840 |
|   |   | locking screw |          |         |

Зип-Общепит

for ovens

spare parts and accessories

vsezip.ru

+7(812)987-08-81



1

| GEV No.     | 691172   | Ref. No. | 3555970 |
|-------------|--|----------|---------|
| description | guide for guide counterweight  |          |         |
| For models: | FC101, FC101E, FC241, FC241E, FC241G, FC61, FC61E, FCV101, FCV101-CSA, FCV101DM, FCV101DM-CSA, FCV101DS, FCV101DS-CSA, FCV101E, FCV101EDM, FCV101EDM-UL, FCV101EDS, FCV101EDS-UL, FCV101E-UL, FCV141, FCV141-CSA, FCV141DM, FCV141DM-CSA, FCV141DS, FCV141DS-CSA, FCV141E, FCV141EDM, FCV141EDS, FCV241, FCV241DM, FCV241DS, FCV241E, FCV241EDM, FCV241EDM-UL, FCV241EDS, FCV241EDS-UL, FCV241E-UL, FCV241G, FCV241G-CSA, FCV241GDM, FCV241GDM-CSA, FCV241GDS, FCV241GDS-CSA, FCV61, FCV61-CSA, FCV61DM, FCV61DM-CSA, FCV61DS, FCV61DS-CSA, FCV61E...(Other models you can see in the webshop) |          |         |

## housing and bezels



1

| GEV No.     | 691183   | Ref. No. | 36D3430 |
|-------------|--|----------|---------|
| description | end cap for control panel mounting pos. left   |          |         |
| For models: | 030, 030BME, 030E, 030EBM, 030FE, 030FE1, 030FE1B, 030FT, 030FTE, 030FTR, 030FTR, 031, 031BME, 031E, 031EBM, 031FT, 031FT04, 031FT06, 031FTE, 031FTE04, 031FTE06, 031FTR, 031FTRL, 031FTR, 031TP, 032, 070BM, 070BME, 070D, 070DGG, 070E, 070FT, 070FT04, 070FT05, 070FTE, 070FTE04, 070FTE05, 070FTR, 070FTR, 0712D, 0712VA, 071BM, 071BME, 071D, 071DGG, 071E, 071FT, 071FT04, 071FT06...(Other models you can see in the webshop) |          |         |



1

| GEV No.     | 691184   | Ref. No. | 36D3420 |
|-------------|--|----------|---------|
| description | end cap for control panel mounting pos. right  |          |         |
| For models: | 030, 030BME, 030E, 030EBM, 030FE, 030FE1, 030FE1B, 030FT, 030FTE, 030FTR, 030FTR, 031, 031BME, 031E, 031EBM, 031FT, 031FT04, 031FT06, 031FTE, 031FTE04, 031FTE06, 031FTR, 031FTRL, 031FTR, 031TP, 032, 070BM, 070BME, 070D, 070DGG, 070E, 070FT, 070FT04, 070FT05, 070FTE, 070FTE04, 070FTE05, 070FTR, 070FTR, 0712D, 0712VA, 071BM, 071BME, 071D, 071DGG, 071E, 071FT, 071FT04, 071FT06...(Other models you can see in the webshop) |          |         |



cast plates



1

|                    |  |                 |         |
|--------------------|--|-----------------|---------|
| <b>GEV No.</b>     | 109719   | <b>Ref. No.</b> | 35D4340 |
| <b>description</b> | cast plate L 530mm W 545mm   |                 |         |
| <b>For models:</b> | 08WFA4E, 08WFA4G, 08WFAAE, 08WFAAG, 10WTPGE, 12WFA6E, 12WFA6G, 12WFAAE, 12WFAAG, 1B1FAS2G, 1B1FASG, 1G1FA0EV, 1G1FA0GV, 1G1PE1EV, 1G1PE2EV, 2G1FA0GV, 2G1PE1EV, 2G1PE2EV, 31, 31GE, 31TC, 31TCE, 31TP, 32, 32TC, 32TCE, 32TP, 32TPV, 32V, 6043590, 712D, 712VA |                 |         |

miscellaneous



1

|                    |   |                 |         |
|--------------------|---|-----------------|---------|
| <b>GEV No.</b>     | 698478  | <b>Ref. No.</b> | 3142670 |
| <b>description</b> | coupling for oven for door L 80mm W 26mm intake 7.8 x 7.8   |                 |         |
| <b>For models:</b> | FX201E2, FX201E2P, FX201E2P-VERS.032014, FX201E2-VERS.032014, FX201E3, FX201E3P, FX201E3P-VERS.022014, FX201E3-VERS.022014, FX201G2, FX201G2P, FX201G2P-VERS.032014, FX201G2-VERS.032014, FX201G3P, FX201G3-VERS.022014, FX202E2, FX202E2-VERS.032014, FX202E3, FX202E3-230V-3-50Hz-60Hz, FX202E3-230V-3-50Hz-60Hz-VERS.022014, FX202E3-VERS.022014, FX202G2, FX202G2-VERS.032014, FX202G3, FX202G3-VERS.022014 |                 |         |

for dishwashers

drain and intake components

ANGELO PO

drain /intake bodies



1

|                    |   |                 |         |
|--------------------|---|-----------------|---------|
| <b>GEV No.</b>     | 510681                                  | <b>Ref. No.</b> | 36G9130 |
| <b>description</b> | body hose ø 32mm                        |                 |         |
| <b>For models:</b> | LC100-VERS.2001, LC130, LC130-VERS.2001 |                 |         |

Зип Общепит

vsezip.ru

+7(812)987-08-81

|                    |                           |                 |                    |
|--------------------|---------------------------|-----------------|--------------------|
| <b>GEV No.</b>     | 511440                    | <b>Ref. No.</b> | 33Q2110<br>6000340 |
| <b>description</b> | drain connection complete |                 |                    |
| <b>For models:</b> | L40, L40S, L60            |                 |                    |



1

|                        |  |                 |         |
|------------------------|--|-----------------|---------|
| <b>GEV No.</b>         | 517182   | <b>Ref. No.</b> | 3030150 |
| <b>description</b>     | drain connection thread 1" ID ø 27mm hose ø 30mm                           |                 |         |
| <b>For models:</b>     | KD37, KD40, LP202, LP202HC, LP302, LP302HC, LP402, LP402HC, LP402V, LPG300 |                 |         |
| <b>accessories for</b> | 517182   |                 |         |
| <b>GEV No.</b>         | 517180   | <b>Ref. No.</b> | 3030170 |
| <b>description</b>     | nut thread 1" H 5mm WS 36 SS Qty 1 pcs                                     |                 |         |
| <b>GEV No.</b>         | 517181   | <b>Ref. No.</b> | 3030160 |
| <b>description</b>     | flat gasket rubber ED ø 44mm ID ø 32mm thickness 3mm Qty 1 pcs             |                 |         |



1

|                        |  |                 |         |
|------------------------|--|-----------------|---------|
| <b>GEV No.</b>         | 511914   | <b>Ref. No.</b> | 33M0170 |
| <b>description</b>     | drain fitting ED ø 110mm ID ø 80mm hose ø 28/45mm          |                 |         |
| <b>For models:</b>     | F60P, F60PR, F60T, F80P, F80PR, L45                        |                 |         |
| <b>spare parts for</b> | 511914   |                 |         |
| <b>GEV No.</b>         | 511915   | <b>Ref. No.</b> | 33M0180 |
| <b>description</b>     | flange for filter fixing                                   |                 |         |
| <b>GEV No.</b>         | 519383   | <b>Ref. No.</b> | 3150290 |
| <b>description</b>     | gasket rubber ED ø 110mm ID ø 83mm thickness 3mm Qty 1 pcs |                 |         |
| <b>accessories for</b> | 511914   |                 |         |
| <b>GEV No.</b>         | 519383   | <b>Ref. No.</b> | 3150290 |
| <b>description</b>     | gasket rubber ED ø 110mm ID ø 83mm thickness 3mm Qty 1 pcs |                 |         |



1

|                    |  |                 |         |
|--------------------|--|-----------------|---------|
| <b>GEV No.</b>     | 507574   | <b>Ref. No.</b> | 33Q2740 |
| <b>description</b> | drain fitting thread 1 1/4" ED ø 54mm H 40mm ID ø 36/33mm  |                 |         |
| <b>For models:</b> | C165D, C165S, C165VD, C165VS, C207D, C207D-VERS.2006, C207S, C207S-VERS.2006, C207VD, C207VD-VERS.2006, C207VS, C207VS-VERS.2006, C304AD, C304AD-VERS.2006, C304AS, C304AS-VERS.2006, C304AVD, C304AVD-VERS.2006, C304AVS, C304AVS-VERS.2006, C304D, C304D-VERS.2006, C304S, C304S-VERS.2006, C304VD, C304VD-VERS.2006, C304VS, C304VS-VERS.2006, C92D-VERS.2006, C92S-VERS.2006, C92VD-VERS.2006, C92VS-VERS.2006, CS243D, CS243D-VERS.2006, CS243S, CS243S-VERS.2006, CS243VD, CS243VD-VERS.2006, CS243VS, CS243VS-VERS.2006, CS370AD, CS370AD-VERS.2006, CS370AS, CS370AS-VERS.2006, CS370AVD, CS370AVD-VERS.2006, CS370AVS, CS370AVS-VERS.2006, CS370D, CS370D-VERS.2006...(Other models you can see in the webshop) |                 |         |



2

|                        |  |                 |                         |
|------------------------|--|-----------------|-------------------------|
| <b>GEV No.</b>         | 519232   | <b>Ref. No.</b> | 33D3090<br>33Q2290      |
| <b>description</b>     | drain fitting thread 1 1/4" ED ø 54mm ID ø 35mm  |                 |                         |
| <b>For models:</b>     | C165D, C165S, C165VD, C165VS, C207D, C207S, C207VD, C207VS, C304AD, C304AS, C304AVD, C304AVS, C304D, C304S, C304VD, C304VS, CS243D, CS243S, CS243VD, CS243VS, CS370AD, CS370AS, CS370AVD, CS370AVS, CS370D, CS370S, CS370VD, CS370VS, CS466AD, CS466AS, CS466AVD, CS466AVS, CS466D, CS466S, CS466VD, CS466VS, LC100-VERS.2001, LC130-VERS.2001, LF50E, LF50EM, LF50EMPS, LF50E-VERS.2007, LP124, LP124S-VERS.052006, LP124V, LP124-VERS.052006, LP124VS-VERS.052006, LP124V-VERS.052006, LP84, LP84S-VERS.052006...(Other models you can see in the webshop) |                 |                         |
| <b>accessories for</b> | 519232   |                 |                         |
|                        | <b>GEV No.</b>   | 519055          | <b>Ref. No.</b> —       |
| <b>description</b>     | locknut thread 1 1/4"  |                 |                         |
|                        | <b>GEV No.</b>   | 519179          | <b>Ref. No.</b> 3151930 |
| <b>description</b>     | O-ring EPDM thickness 3.53mm ID ø 41.28mm Qty 1 pcs  |                 |                         |



1

|                        |   |                 |                         |
|------------------------|---|-----------------|-------------------------|
| <b>GEV No.</b>         | 503505  | <b>Ref. No.</b> | 33Q3050                 |
| <b>description</b>     | drain fitting thread 1 1/2"                         |                 |                         |
| <b>For models:</b>     | L100, L40, L40S, L60, L80                           |                 |                         |
| <b>accessories for</b> | 503505  |                 |                         |
|                        | <b>GEV No.</b>                                      | 532114          | <b>Ref. No.</b> 3150240 |
| <b>description</b>     | O-ring EPDM thickness 3.53mm ID ø 50.8mm Qty 10 pcs |                 |                         |



1

|                        |  |                 |                   |
|------------------------|--|-----------------|-------------------|
| <b>GEV No.</b>         | 517254   | <b>Ref. No.</b> | 33D3340           |
| <b>description</b>     | drain fitting thread 2 1/4" H ø 64mm ID ø 43mm                 |                 |                   |
| <b>For models:</b>     | KD100, KD100A, KD100PSD, LP151                                 |                 |                   |
| <b>accessories for</b> | 517254   |                 |                   |
|                        | <b>GEV No.</b>   | 517205          | <b>Ref. No.</b> — |
| <b>description</b>     | flat gasket rubber ED ø 75mm ID ø 58mm thickness 3mm Qty 1 pcs |                 |                   |
|                        | <b>GEV No.</b>   | 517206          | <b>Ref. No.</b> — |
| <b>description</b>     | nut thread 2"  |                 |                   |



1

|                    |  |                 |         |
|--------------------|--|-----------------|---------|
| <b>GEV No.</b>     | 517181   | <b>Ref. No.</b> | 3030160 |
| <b>description</b> | flat gasket rubber ED ø 44mm ID ø 32mm thickness 3mm Qty 1 pcs   |                 |         |
| <b>For models:</b> | KD37, KD40, LP202, LP202HC, LP302, LP302HC, LP402, LP402HC, LP402V, N100D, N100S, N100VD, N100VS, N38D, N38S, N38VD, N38VS, N42D, N42S, N42VD, N42VS, N50D, N50S, N50VD, N50VS, N66D, N66S, N66VD, N66VS, N70D, N70S, N70VD, N70VS, N85D, N85S, N85VD, N85VS |                 |         |



1

|                    |  |                 |         |
|--------------------|--|-----------------|---------|
| <b>GEV No.</b>     | 517180   | <b>Ref. No.</b> | 3030170 |
| <b>description</b> | nut thread 1" H 5mm WS 36 SS Qty 1 pcs   |                 |         |
| <b>For models:</b> | KD37, KD37PS, KD37-VERS.112009, KD40, LP202, LP202HC, LP302, LP302HC, LP402, LP402HC, LP402V, LPG300, N100D, N100S, N100VD, N100VS, N38D, N38S, N38VD, N38VS, N42D, N42S, N42VD, N42VS, N50D, N50S, N50VD, N50VS, N66D, N66S, N66VD, N66VS, N70D, N70S, N70VD, N70VS, N85D, N85S, N85VD, N85VS |                 |         |





1

|                    |  |                 |         |
|--------------------|--|-----------------|---------|
| <b>GEV No.</b>     | 505505   | <b>Ref. No.</b> | 33Q2160 |
| <b>description</b> | nut thread 1 1/2" WS 55 plastic  |                 |         |
| <b>For models:</b> | C165D, C165S, C165VD, C165VS, C207D, C207D-VERS.2006, C207S, C207S-VERS.2006, C207VD, C207VD-VERS.2006, C207VS, C207VS-VERS.2006, C304AD, C304AD-VERS.2006, C304AS, C304AS-VERS.2006, C304AVD, C304AVD-VERS.2006, C304AVS, C304AVS-VERS.2006, C304D, C304D-VERS.2006, C304S, C304S-VERS.2006, C304VD, C304VD-VERS.2006, C304VS, C304VS-VERS.2006, C92D-VERS.2006, C92S-VERS.2006, C92VD-VERS.2006, C92VS-VERS.2006, CS243D, CS243D-VERS.2006, CS243S, CS243S-VERS.2006, CS243VD, CS243VD-VERS.2006, CS243VS, CS243VS-VERS.2006, CS370AD, CS370AD-VERS.2006, CS370AS, CS370AS-VERS.2006, CS370AVD, CS370AVD-VERS.2006, CS370AVS, CS370AVS-VERS.2006, CS370D, CS370D-VERS.2006...(Other models you can see in the webshop) |                 |         |







Зип Общепит  
vsezip.ru  
+7(812)987-08-81

|   |  |                 |                 |
|---|--|-----------------|-----------------|
|  |  |                 |                 |
| 1   |  |                 |                 |
| <b>GEV No.</b>  | 510356   | <b>Ref. No.</b> | 33Q2320         |
| <b>description</b>  | nut thread 1 1/2"  |                 |                 |
| <b>accessories for</b>  | 510356   |                 |                 |
|  | <b>GEV No.</b>   | 510876          | <b>Ref. No.</b> |
|   | flat gasket rubber ED ø 45mm ID ø 33mm thickness 3mm Qty 1 pcs |                 |                 |
|  | <b>GEV No.</b>   | 511298          | <b>Ref. No.</b> |
|   | hose connector hose ø 35mm                                     |                 |                 |

|   |  |                 |         |
|---|--|-----------------|---------|
|  |  |                 |         |
| 1   |  |                 |         |
| <b>GEV No.</b>  | 511309   | <b>Ref. No.</b> | 33Q0240 |
| <b>description</b>  | nut thread 1 1/2" ø 66mm H 9mm WS 51 brass Qty 1 pcs |                 |         |
| <b>For models:</b>  | L100, L40, L40S, L60, L80                            |                 |         |

|   |  |                 |         |
|---|--|-----------------|---------|
|  |  |                 |         |
| 1   |  |                 |         |
| <b>GEV No.</b>  | 519179   | <b>Ref. No.</b> | 3151930 |
| <b>description</b>  | O-ring EPDM thickness 3.53mm ID ø 41.28mm Qty 1 pcs  |                 |         |
| <b>For models:</b>  | C165D, C165S, C165VD, C165VS, C207D, C207D-VERS.2006, C207S, C207S-VERS.2006, C207VD, C207VD-VERS.2006, C207VS, C207VS-VERS.2006, C304AD, C304AD-VERS.2006, C304AS, C304AS-VERS.2006, C304AVD, C304AVD-VERS.2006, C304AVS, C304AVS-VERS.2006, C304D, C304D-VERS.2006, C304S, C304S-VERS.2006, C304VD, C304VD-VERS.2006, C304VS, C304VS-VERS.2006, C92D-VERS.2006, C92S-VERS.2006, C92VD-VERS.2006, C92VS-VERS.2006, CS243D, CS243D-VERS.2006, CS243S, CS243S-VERS.2006, CS243VD, CS243VD-VERS.2006, CS243VS, CS243VS-VERS.2006, CS370AD, CS370AD-VERS.2006, CS370AS, CS370AS-VERS.2006, CS370AVD, CS370AVD-VERS.2006, CS370AVS, CS370AVS-VERS.2006, CS370D, CS370D-VERS.2006...(Other models you can see in the webshop) |                 |         |

|   |   |                 |         |
|---|---|-----------------|---------|
|  |   |                 |         |
| 1   |   |                 |         |
| <b>GEV No.</b>  | 532114  | <b>Ref. No.</b> | 3150240 |
| <b>description</b>  | O-ring EPDM thickness 3.53mm ID ø 50.8mm Qty 10 pcs |                 |         |
| <b>For models:</b>  | L100, L40, L40S, L60, L80                           |                 |         |

|   |   |                 |         |
|---|---|-----------------|---------|
| <b>filters</b>  |   |                 |         |
|  |   |                 |         |
| 1   |   |                 |         |
| <b>GEV No.</b>  | 504251                                  | <b>Ref. No.</b> | 30Q0490 |
| <b>description</b>  | drain filter ø 105mm H 80mm hole ø 40mm |                 |         |
| <b>For models:</b>  | F60P, F60T, F80P, L45                   |                 |         |

|   |                            |                 |                    |
|---|----------------------------|-----------------|--------------------|
|  |                            |                 |                    |
| 1   |                            |                 |                    |
| <b>GEV No.</b>  | 519064                     | <b>Ref. No.</b> | 30Q0300<br>30Q1510 |
| <b>description</b>  | chain filter ø 96mm H 81mm |                 |                    |
| <b>For models:</b>  | F60P, F60PR, F80PR, L45    |                 |                    |

|   |   |                 |         |
|---|---|-----------------|---------|
|  |   |                 |         |
| 1   |   |                 |         |
| <b>GEV No.</b>  | 519063  | <b>Ref. No.</b> | 30Q1330 |
| <b>description</b>  | filter H 75mm L 160mm W 75mm  |                 |         |
| <b>For models:</b>  | CS243D-VERS.2006, CS243S-VERS.2006, CS243VD-VERS.2006, CS243VS-VERS.2006, CS370AD-VERS.2006, CS370AS-VERS.2006, CS370AVD-VERS.2006, CS370AVS-VERS.2006, CS370D-VERS.2006, CS370S-VERS.2006, CS370VD-VERS.2006, CS370VS-VERS.2006, CS466AD-VERS.2006, CS466AS-VERS.2006, CS466AVD-VERS.2006, CS466AVS-VERS.2006, CS466D-VERS.2006, CS466S-VERS.2006, CS466VD-VERS.2006, CS466VS-VERS.2006, LF50, LF50E, LF50EM, LF50EMPS-VERS.122012, LF50EM-VERS.122012, LF50E-VERS.122012, LF50E-VERS.2007, LP70 |                 |         |

|   |                                     |                 |         |
|---|-------------------------------------|-----------------|---------|
|  |                                     |                 |         |
| 1   |                                     |                 |         |
| <b>GEV No.</b>  | 511915                              | <b>Ref. No.</b> | 33M0180 |
| <b>description</b>  | flange for filter fixing            |                 |         |
| <b>For models:</b>  | F60P, F60PR, F60T, F80P, F80PR, L45 |                 |         |

|  |                             |                 |         |
|--|-----------------------------|-----------------|---------|
|  |                             |                 |         |
| 1  |                             |                 |         |
| <b>GEV No.</b>   | 507381                      | <b>Ref. No.</b> | 30G0140 |
| <b>description</b>   | flat filter L 295mm W 195mm |                 |         |
| <b>For models:</b>   | L100, L80                   |                 |         |

|  |   |                 |         |
|--|---|-----------------|---------|
|  |   |                 |         |
| 1  |   |                 |         |
| <b>GEV No.</b>   | 510002                                    | <b>Ref. No.</b> | 30Q3280 |
| <b>description</b>   | flat filter ø 50mm H 95mm L 383mm W 136mm |                 |         |
| <b>For models:</b>   | KD100, KD100A, KD100PSD, LP151            |                 |         |

|   |                              |                 |         |
|---|------------------------------|-----------------|---------|
|  |                              |                 |         |
| 1   |                              |                 |         |
| <b>GEV No.</b>  | 519391                       | <b>Ref. No.</b> | 35Q1030 |
| <b>description</b>  | intake filter ø 77mm H 100mm |                 |         |



1

|                    |   |                 |         |
|--------------------|---|-----------------|---------|
| <b>GEV No.</b>     | 511439                                    | <b>Ref. No.</b> | 30G0150 |
| <b>description</b> | rectangular filter H 42mm L 114mm W 104mm |                 |         |
| <b>For models:</b> | L100, L80                                 |                 |         |



1

|                    |   |                 |         |
|--------------------|---|-----------------|---------|
| <b>GEV No.</b>     | 511438                                    | <b>Ref. No.</b> | 30Q2120 |
| <b>description</b> | rectangular filter H 70mm L 160mm W 145mm |                 |         |



1

|                    |  |                 |         |
|--------------------|--|-----------------|---------|
| <b>GEV No.</b>     | 505268                                       | <b>Ref. No.</b> | 30Q1440 |
| <b>description</b> | round filters $\varnothing$ 184mm H 103mm SS |                 |         |
| <b>For models:</b> | LC100  |                 |         |



1

|                    |  |                 |         |
|--------------------|--|-----------------|---------|
| <b>GEV No.</b>     | 516079                                   | <b>Ref. No.</b> | 35Q9940 |
| <b>description</b> | round filters $\varnothing$ 508mm H 55mm |                 |         |
| <b>For models:</b> | LT10R, LT20F, LT25F                      |                 |         |

### overflow pipes



1

|                    |  |                 |         |
|--------------------|--|-----------------|---------|
| <b>GEV No.</b>     | 517175                                   | <b>Ref. No.</b> | 3018870 |
| <b>description</b> | overflow pipe L 107mm $\varnothing$ 28mm |                 |         |
| <b>For models:</b> | KD40                                     |                 |         |



1

|                    |                       |                 |         |
|--------------------|-----------------------|-----------------|---------|
| <b>GEV No.</b>     | 519266                | <b>Ref. No.</b> | 33D2360 |
| <b>description</b> | overflow pipe L 115mm |                 |         |

Зип Общепит

vsezip.ru

+7(812)987-08-81



1

|                    |  |                 |         |
|--------------------|--|-----------------|---------|
| <b>GEV No.</b>     | 519378                                   | <b>Ref. No.</b> | 33D3080 |
| <b>description</b> | overflow pipe L 115mm $\varnothing$ 28mm |                 |         |
| <b>For models:</b> | LF50E, LF50EM, LP70                      |                 |         |



1

|                    |  |                 |         |
|--------------------|--|-----------------|---------|
| <b>GEV No.</b>     | 516252                                   | <b>Ref. No.</b> | 33D0390 |
| <b>description</b> | overflow pipe L 120mm $\varnothing$ 29mm |                 |         |
| <b>For models:</b> | LT10R, LT20F, LT25F                      |                 |         |



1

|                    |  |                 |         |
|--------------------|--|-----------------|---------|
| <b>GEV No.</b>     | 519387                                   | <b>Ref. No.</b> | 33D0341 |
| <b>description</b> | overflow pipe L 185mm $\varnothing$ 36mm |                 |         |
| <b>For models:</b> | L40, L60                                 |                 |         |



1



|                        |  |                 |         |
|------------------------|--|-----------------|---------|
| <b>GEV No.</b>         | 517185   | <b>Ref. No.</b> | 33D3350 |
| <b>description</b>     | overflow pipe L 185mm $\varnothing$ 40mm   |                 |         |
| <b>For models:</b>     | KD100, KD100A, KD100PSD, KN50, KN50M, KN50MPS, KN50PS, KN50PSD, KN50PSDD, KN80, KN80PS, LP70 |                 |         |
| <b>accessories for</b> | 517185   |                 |         |



|                    |   |                 |         |
|--------------------|---|-----------------|---------|
| <b>GEV No.</b>     | 517189  | <b>Ref. No.</b> | 37Q5140 |
| <b>description</b> | gasket $\varnothing$ 28mm D1 $\varnothing$ 40mm thickness 6mm |                 |         |





Зип Общепит  
vsezip.ru  
+7(812)987-0881

|   |   |                 |                         |
|---|---|-----------------|-------------------------|
|  |   |                 |                         |
| 1   |   |                 |                         |
| <b>GEV No.</b>  | 517186  | <b>Ref. No.</b> | 33D3360                 |
| <b>description</b>  | overflow pipe L 210mm ø 40mm  |                 |                         |
| <b>For models:</b>  | KD100, KD100A, KD100PSD, KD60, KD60E, KD60EAT, KD60M, KD60MA, KD60ME, KD6EATSD, KD85, KD85A, KD85E, KD85EA, KD85EAT, KD85EATS, KD85EPS, KD85EPSA, KD85PS, KD85PSA, KN1100, KN1100SD, KN11PSDD, KN800, KN800PSD, LP151 |                 |                         |
| <b>accessories for</b>  | 517186  |                 |                         |
|  | <b>GEV No.</b>  | 517189          | <b>Ref. No.</b> 37Q5140 |
|   | gasket ø 28mm D1 ø 40mm thickness 6mm   |                 |                         |

|   |                              |                 |         |
|---|------------------------------|-----------------|---------|
|  |                              |                 |         |
| 1   |                              |                 |         |
| <b>GEV No.</b>  | 516081                       | <b>Ref. No.</b> | 33D0140 |
| <b>description</b>  | overflow pipe L 223mm ø 30mm |                 |         |
| <b>For models:</b>  | F60P, F60PR, F80PR, L45      |                 |         |

|  |                              |                 |         |
|--|------------------------------|-----------------|---------|
|  |                              |                 |         |
| 1  |                              |                 |         |
| <b>GEV No.</b>   | 510679                       | <b>Ref. No.</b> | 33D2320 |
| <b>description</b>   | overflow pipe L 245mm ø 35mm |                 |         |
| <b>For models:</b>   | LC100, LC80                  |                 |         |

|   |                                       |                 |                         |
|---|---------------------------------------|-----------------|-------------------------|
|  |                                       |                 |                         |
| 1   |                                       |                 |                         |
| <b>GEV No.</b>  | 517357                                | <b>Ref. No.</b> | 3056130                 |
| <b>description</b>  | overflow pipe L 420mm ø 44mm          |                 |                         |
| <b>For models:</b>  | KD130, KD130A, KD130E, KD130EAT       |                 |                         |
| <b>accessories for</b>  | 517357                                |                 |                         |
|  | <b>GEV No.</b>                        | 517189          | <b>Ref. No.</b> 37Q5140 |
|   | gasket ø 28mm D1 ø 40mm thickness 6mm |                 |                         |

|   |  |                 |         |
|---|--|-----------------|---------|
|  |  |                 |         |
| 1   |  |                 |         |
| <b>GEV No.</b>  | 519390   | <b>Ref. No.</b> | 33D2880 |
| <b>description</b>  | overflow pipe L 430mm ø 35mm   |                 |         |
| <b>For models:</b>  | C165D, C165S, C165VD, C165VS, C207D, C207S, C207VD, C207VD-VERS.2006, C207VS, C207VS-VERS.2006, C304AD, C304AS, C304AVD, C304AVD-VERS.2006, C304AVS, C304AVS-VERS.2006, C304D, C304S, C304VD, C304VD-VERS.2006, C304VS, C304VS-VERS.2006, C92VD-VERS.2006, C92VS-VERS.2006, CS243D, CS243S, CS243VD, CS243VD-VERS.2006, CS243VS, CS243VS-VERS.2006, CS370AD, CS370AS, CS370AVD, CS370AVD-VERS.2006, CS370AVS, CS370AVS-VERS.2006, CS370D, CS370S, CS370VD, CS370VD-VERS.2006, CS370VS, CS370VS-VERS.2006, CS466AD, CS466AD-VERS.2006, CS466AS, CS466AS-VERS.2006, CS466AVD, CS466AVD-VERS.2006, CS466AVS, CS466AVS-VERS.2006...(Other models you can see in the webshop) |                 |         |

|  |                              |                 |         |
|--|------------------------------|-----------------|---------|
|  |                              |                 |         |
| 1  |                              |                 |         |
| <b>GEV No.</b>   | 519381                       | <b>Ref. No.</b> | 33D0050 |
| <b>description</b>   | overflow pipe L 430mm ø 42mm |                 |         |
| <b>For models:</b>   | L100, L80                    |                 |         |

|  |                             |                 |         |
|--|-----------------------------|-----------------|---------|
|  |                             |                 |         |
| 1  |                             |                 |         |
| <b>GEV No.</b>   | 517177                      | <b>Ref. No.</b> | 3081150 |
| <b>description</b>   | overflow pipe L 96mm ø 28mm |                 |         |
| <b>For models:</b>   | KD37                        |                 |         |

containers

dosing containers

|   |   |                 |         |
|---|---|-----------------|---------|
|  |   |                 |         |
| 1   |   |                 |         |
| <b>GEV No.</b>  | 361736  | <b>Ref. No.</b> | 36A4160 |
| <b>description</b>  | rinse aid container   |                 |         |
| <b>For models:</b>  | LF50, LF50E, LF50EM, LF50EM-VERS.122012, LF50E-VERS.122012, LF50E-VERS.2007 |                 |         |

|  |                                     |                 |         |
|--|-------------------------------------|-----------------|---------|
|  |                                     |                 |         |
| 1  |                                     |                 |         |
| <b>GEV No.</b>   | 519380                              | <b>Ref. No.</b> | 33D0660 |
| <b>description</b>   | rinse aid container                 |                 |         |
| <b>For models:</b>   | F60P, F60PR, F60T, F80P, F80PR, L45 |                 |         |

boilers

boilers for dishwashers



|                    |                     |                 |         |
|--------------------|---------------------|-----------------|---------|
| 1                  |                     |                 |         |
| <b>GEV No.</b>     | 516163              | <b>Ref. No.</b> | 34A0700 |
| <b>description</b> | boiler              |                 |         |
| <b>For models:</b> | LT10R, LT20F, LT25F |                 |         |



|                    |  |                 |         |
|--------------------|--|-----------------|---------|
| 1                  |  |                 |         |
| <b>GEV No.</b>     | 517294                                       | <b>Ref. No.</b> | 3022510 |
| <b>description</b> | boiler ø 113mm L 320mm                       |                 |         |
| <b>For models:</b> | KD37, KD37PS, KD37-VERS.112009, KN35, KN37PS |                 |         |



|                    |   |                 |         |
|--------------------|---|-----------------|---------|
| 1                  |   |                 |         |
| <b>GEV No.</b>     | 517295  | <b>Ref. No.</b> | 3023900 |
| <b>description</b> | boiler ø 113mm L 370mm                                |                 |         |
| <b>For models:</b> | KD40, KD40PS, KD40-VERS.112009, KN40, KN40PS, KN40PSD |                 |         |



|                    |                        |                 |         |
|--------------------|------------------------|-----------------|---------|
| 1                  |                        |                 |         |
| <b>GEV No.</b>     | 519022                 | <b>Ref. No.</b> | 34A1950 |
| <b>description</b> | boiler ø 150mm L 400mm |                 |         |
| <b>For models:</b> | LF50, LF50E, LF50EM    |                 |         |

Зип Общепит

vsezip.ru

+7(812)987-08-81



|                        |   |                 |                 |
|------------------------|---|-----------------|-----------------|
| 1                      |   |                 |                 |
| <b>GEV No.</b>         | 517302  | <b>Ref. No.</b> | 34A2560         |
| <b>description</b>     | boiler with insulation ø 160mm L 500mm  |                 |                 |
| <b>For models:</b>     | KD100, KD100A, KD100PSD, KD130, KD130A, KD85, KD85A, KD85E, KD85EA, KD85EAT, KD85EATS, KD85EPS, KD85EPSA, KD85PS, KD85PSA, KN1100, KN1100SD, KN11PSDD, KN800, KN800PSD, LP151 |                 |                 |
| <b>accessories for</b> | 517302  |                 |                 |
|                        | <b>GEV No.</b>  | 517337          | <b>Ref. No.</b> |
|                        |   |                 | —               |
|                        | insulating mat boiler ø 160mm   |                 |                 |

spare parts and accessories



|                    |  |                 |         |
|--------------------|--|-----------------|---------|
| 1                  |  |                 |         |
| <b>GEV No.</b>     | 691742   | <b>Ref. No.</b> | 3120030 |
| <b>description</b> | disc ext. ø 30                                 |                 |         |
| <b>For models:</b> | FCV241G-CSA, FCV241GDM-CSA, FCV241GDS-CSA, L80 |                 |         |

hood mechanics for dishwashers

bolts



|                    |                                  |                 |         |
|--------------------|----------------------------------|-----------------|---------|
| 1                  |                                  |                 |         |
| <b>GEV No.</b>     | 510595                           | <b>Ref. No.</b> | 3100100 |
| <b>description</b> | bolt thread M6x1 for hood handle |                 |         |
| <b>For models:</b> | L100, L80                        |                 |         |

bushes



|                    |                      |                 |     |
|--------------------|----------------------|-----------------|-----|
| 1                  |                      |                 |     |
| <b>GEV No.</b>     | 512423               | <b>Ref. No.</b> | N/A |
| <b>description</b> | bush for hood handle |                 |     |



|                    |  |                 |         |
|--------------------|--|-----------------|---------|
| 1                  |  |                 |         |
| <b>GEV No.</b>     | 519205   | <b>Ref. No.</b> | 36C3560 |
| <b>description</b> | bush hood mechanics                                  |                 |         |
| <b>For models:</b> | LC100, LC100-VERS.2001, LC130, LC130-VERS.2001, LC80 |                 |         |



Зип Общежит

vsezip.ru

+7(812)987-08-81

|   |                                   |                 |         |
|---|-----------------------------------|-----------------|---------|
|  |                                   |                 |         |
| 1   |                                   |                 |         |
| <b>GEV No.</b>  | 524445                            | <b>Ref. No.</b> | 35Z0770 |
| <b>description</b>  | bush L 22mm for handle rod ø 12mm |                 |         |
| <b>For models:</b>  | L100, L80                         |                 |         |

|   |                                  |                 |         |
|---|----------------------------------|-----------------|---------|
|  |                                  |                 |         |
| 1   |                                  |                 |         |
| <b>GEV No.</b>  | 524446                           | <b>Ref. No.</b> | 35Z4410 |
| <b>description</b>  | bush L 35mm for handle rod ø 8mm |                 |         |

spring holders

|   |  |                 |         |
|---|--|-----------------|---------|
|  |  |                 |         |
| 1   |  |                 |         |
| <b>GEV No.</b>  | 519243   | <b>Ref. No.</b> | 36H0450 |
| <b>description</b>  | bush for spring holder hood mechanics                |                 |         |
| <b>For models:</b>  | LC100, LC100-VERS.2001, LC130, LC130-VERS.2001, LC80 |                 |         |

|  |               |                 |         |
|--|---------------|-----------------|---------|
|  |               |                 |         |
| 1  |               |                 |         |
| <b>GEV No.</b>   | 516094        | <b>Ref. No.</b> | 36G0210 |
| <b>description</b>   | spring holder |                 |         |
| <b>For models:</b>   | L100, L80     |                 |         |



guide bars



|   |  |                 |         |
|---|--|-----------------|---------|
|  |  |                 |         |
| 1   |  |                 |         |
| <b>GEV No.</b>  | 517378   | <b>Ref. No.</b> | 3036440 |
| <b>description</b>  | guide bar L 650mm mounting pos. left for hood mechanics thickness 25mm |                 |         |
| <b>For models:</b>  | KD100, KD100A, KD100PSD, KD130, KD130A, KD130E, KD130EAT               |                 |         |



|   |  |                 |         |
|---|--|-----------------|---------|
|  |  |                 |         |
| 1   |  |                 |         |
| <b>GEV No.</b>  | 513019   | <b>Ref. No.</b> | 3036430 |
| <b>description</b>  | guide bar L 695mm mounting pos. right thickness 25mm     |                 |         |
| <b>For models:</b>  | KD100, KD100A, KD100PSD, KD130, KD130A, KD130E, KD130EAT |                 |         |

|  |                                       |                 |     |
|--|---------------------------------------|-----------------|-----|
|  |                                       |                 |     |
| <b>GEV No.</b>   | 510864                                | <b>Ref. No.</b> | N/A |
| <b>description</b>   | bush for spring holder hood mechanics |                 |     |

air traps



|  |   |                 |                         |
|--|---|-----------------|-------------------------|
|  |   |                 |                         |
| 1  |   |                 |                         |
| <b>GEV No.</b>   | 510344  | <b>Ref. No.</b> | 33D0360                 |
| <b>description</b>   | air trap  |                 |                         |
| <b>For models:</b>   | L100, L40, L40S, L60, L80                                 |                 |                         |
| <b>accessories for</b>   | 510344  |                 |                         |
|   | <b>GEV No.</b>  | 361182          | <b>Ref. No.</b> 3117580 |
|  | nut thread 1/4" H 5mm nickel-plated brass WS 17 Qty 1 pcs |                 |                         |
|  | <b>GEV No.</b>  | 511512          | <b>Ref. No.</b> 3150410 |
|  | O-ring EPDM thickness 2.62mm ID ø 18.72mm Qty 10 pcs      |                 |                         |

|  |                                     |                 |                         |
|--|-------------------------------------|-----------------|-------------------------|
|  |                                     |                 |                         |
| 1  |                                     |                 |                         |
| <b>GEV No.</b>   | 511450                              | <b>Ref. No.</b> | 33M0220                 |
| <b>description</b>   | air trap                            |                 |                         |
| <b>For models:</b>   | F60P, F60PR, F60T, F80P, F80PR, L45 |                 |                         |
| <b>accessories for</b>   | 511450                              |                 |                         |
|   | <b>GEV No.</b>                      | 511197          | <b>Ref. No.</b> 3151770 |
|  | gasket L 46mm W 33mm for air trap   |                 |                         |

|   |  |                 |                   |
|---|--|-----------------|-------------------|
|  |  |                 |                   |
| 1   |  |                 |                   |
| <b>GEV No.</b>  | 516241   | <b>Ref. No.</b> | 3060029           |
| <b>description</b>  | air trap   |                 |                   |
| <b>accessories for</b>  | 516241   |                 |                   |
|  | <b>GEV No.</b>                                     | 528485          | <b>Ref. No.</b> — |
|   | O-ring EPDM thickness 1.78mm ID ø 6.07mm Qty 1 pcs |                 |                   |





1

|   |  |                 |                 |
|---|--|-----------------|-----------------|
| <b>GEV No.</b>  | 519263   | <b>Ref. No.</b> | 33M0510         |
| <b>description</b>  | air trap   |                 |                 |
| <b>For models:</b>  | CS243D, CS243S, CS243VD, CS243VS, CS370AD, CS370AS, CS370AVD, CS370AVS, CS370D, CS370S, CS370VD, CS370VS, CS466AD, CS466AS, CS466AVD, CS466AVS, CS466D, CS466S, CS466VD, CS466VS, LF50, LF50E, LF50EM, LF50EMPS, LF50E-VERS.2007, LP70 |                 |                 |
| <b>accessories for</b>  | 519263   |                 |                 |
|  | <b>GEV No.</b>   | 519057          | <b>Ref. No.</b> |
|   |  |                 | —               |
|   | nut thread 3/8" WS 25 H 6mm brass  |                 |                 |
|  | <b>GEV No.</b>   | 519114          | <b>Ref. No.</b> |
|   |  |                 | 3151890         |
|   | flat gasket rubber ED ø 25mm ID ø 16.5mm thickness 2mm Qty 1 pcs   |                 |                 |





1

|   |  |                 |                 |
|---|--|-----------------|-----------------|
| <b>GEV No.</b>  | 519319   | <b>Ref. No.</b> | 33D1390         |
| <b>description</b>  | air trap   |                 |                 |
| <b>For models:</b>  | C165D, C165S, C165VD, C165VS, C207D, C207D-VERS.2006, C207S, C207S-VERS.2006, C207VD, C207VD-VERS.2006, C207VS, C207VS-VERS.2006, C304AD, C304AD-VERS.2006, C304AS, C304AS-VERS.2006, C304AVD, C304AVD-VERS.2006, C304AVS, C304AVS-VERS.2006, C304D, C304D-VERS.2006, C304S, C304S-VERS.2006, C304VD, C304VD-VERS.2006, C304VS, C304VS-VERS.2006, C92D-VERS.2006, C92S-VERS.2006, C92VD-VERS.2006, C92VS-VERS.2006, CS243D, CS243D-VERS.2006, CS243S, CS243S-VERS.2006, CS243VD, CS243VD-VERS.2006, CS243VS, CS243VS-VERS.2006, CS370AD, CS370AD-VERS.2006, CS370AS, CS370AS-VERS.2006, CS370AVD, CS370AVD-VERS.2006, CS370AVS, CS370AVS-VERS.2006, CS370D, CS370D-VERS.2006...(Other models you can see in the webshop) |                 |                 |
| <b>accessories for</b>  | 519319   |                 |                 |
|  | <b>GEV No.</b>   | 519057          | <b>Ref. No.</b> |
|   |  |                 | —               |
|   | nut thread 3/8" WS 25 H 6mm brass  |                 |                 |
|  | <b>GEV No.</b>   | 519114          | <b>Ref. No.</b> |
|   |  |                 | 3151890         |
|   | flat gasket rubber ED ø 25mm ID ø 16.5mm thickness 2mm Qty 1 pcs   |                 |                 |



1

|   |  |                 |                    |
|---|--|-----------------|--------------------|
| <b>GEV No.</b>  | 517168   | <b>Ref. No.</b> | 33D3330            |
| <b>description</b>  | air trap H 56mm  |                 |                    |
| <b>accessories for</b>  | 517168   |                 |                    |
|  | <b>GEV No.</b>   | 517173          | <b>Ref. No.</b>    |
|   |  |                 | 37Q5130            |
|   | flat gasket FIBER ED ø 14mm ID ø 8mm thickness 1.5mm Qty 1 pcs           |                 |                    |
|  | <b>GEV No.</b>   | 517174          | <b>Ref. No.</b>    |
|   |  |                 | 3110050<br>33Q6470 |
|   | nut thread M8 H 6.5mm WS 13 SS DIN/ISO DIN 934 / ISO 4032/8673 Qty 1 pcs |                 |                    |

Зип Общепит

vsezip.ru

+7(812)987-08-81



1

|                    |   |                 |         |
|--------------------|---|-----------------|---------|
| <b>GEV No.</b>     | 517308  | <b>Ref. No.</b> | 33D3320 |
| <b>description</b> | air trap H 45mm   |                 |         |
| <b>For models:</b> | KD100, KD100A, KD100PSD, KN35, KN37, KN37PS, KN40, KN40PS, KN40PSD, LP151 |                 |         |

## air trap accessories



1

|                    |                                     |                 |         |
|--------------------|-------------------------------------|-----------------|---------|
| <b>GEV No.</b>     | 511385                              | <b>Ref. No.</b> | 35Z0050 |
| <b>description</b> | flange L 46mm W 32mm for air trap   |                 |         |
| <b>For models:</b> | F60P, F60PR, F60T, F80P, F80PR, L45 |                 |         |



1

|                    |                                     |                 |         |
|--------------------|-------------------------------------|-----------------|---------|
| <b>GEV No.</b>     | 511197                              | <b>Ref. No.</b> | 3151770 |
| <b>description</b> | gasket L 46mm W 33mm for air trap   |                 |         |
| <b>For models:</b> | F60P, F60PR, F60T, F80P, F80PR, L45 |                 |         |

## mechanics for flight type dishwashers



1

|                    |  |                 |         |
|--------------------|--|-----------------|---------|
| <b>GEV No.</b>     | 691638   | <b>Ref. No.</b> | 36G7550 |
| <b>description</b> | tappet   |                 |         |
| <b>For models:</b> | C165D, C165S, C165VD, C165VS, C207D, C207D-VERS.2006, C207S, C207S-VERS.2006, C207VD, C207VD-VERS.2006, C207VS, C207VS-VERS.2006, C304AD, C304AD-VERS.2006, C304AS, C304AS-VERS.2006, C304AVD, C304AVD-VERS.2006, C304AVS, C304AVS-VERS.2006, C304D, C304D-VERS.2006, C304S, C304S-VERS.2006, C304VD, C304VD-VERS.2006, C304VS, C304VS-VERS.2006, C92D-VERS.2006, C92S-VERS.2006, C92VD-VERS.2006, C92VS-VERS.2006, CAD, CAS, CS243D, CS243D-VERS.2006, CS243S, CS243S, CS243VD, CS243VD-VERS.2006, CS243VS, CS243VS-VERS.2006, CS370AD, CS370AD-VERS.2006, CS370AS, CS370AS-VERS.2006, CS370AVD, CS370AVD-VERS.2006, CS370AVS, CS370AVS-VERS.2006, CS370D...(Other models you can see in the webshop) |                 |         |



Зип Общежит

vsezip.ru

+7(812)987-08-81

backflow preventers

backflow preventers



|                    |                    |                 |                               |
|--------------------|--------------------|-----------------|-------------------------------|
| <b>GEV No.</b>     | 504140             | <b>Ref. No.</b> | 33D0650<br>33D2100<br>33D2330 |
| <b>description</b> | backflow preventer |                 |                               |



|   |   |                 |                    |
|---|---|-----------------|--------------------|
| <b>GEV No.</b>  | 516101  | <b>Ref. No.</b> | 33D0650<br>33D2330 |
| <b>description</b>  | backflow preventer dishwasher hose ø 12mm   |                 |                    |
| <b>For models:</b>  | C165D, C165S, C207D, C207S, C304AD, C304AS, C304D, C304S, CS243D, CS243S, CS243VD, CS243VS, CS370AD, CS370AS, CS370A-VD, CS370AVS, CS370D, CS370S, CS370VD, CS370VS, CS466AD, CS466AS, CS466AVD, CS466AVS, CS466D, CS466S, CS466VD, CS466VS, F60P, KD100, KD100PSD, KD130, KD130E, KD37, KD40, KD40EPSD, KD40LEPS, KD40LSPS, KD40LUX, KD40LUXE, KD60, KD60M, KD60MPS, KD60PS, KD60PSD, KD85, KD85PS, L100, L45, L80...(Other models you can see in the webshop) |                 |                    |
| <b>spare parts for</b>  | 516101  |                 |                    |
|   | <b>GEV No.</b>  | 506367          | <b>Ref. No.</b> —  |
|  | flat gasket rubber ED ø 40mm ID ø 28mm thickness 1.8mm Qty 1 pcs  |                 |                    |

miscellaneous



|                    |   |                 |         |
|--------------------|---|-----------------|---------|
| <b>GEV No.</b>     | 506160  | <b>Ref. No.</b> | 3120050 |
| <b>description</b> | plain washer ID ø 8.6mm ED ø 16mm thickness 1.5mm SS Qty 1 pcs  |                 |         |
| <b>For models:</b> | 091FR1EX, 091FR7GS, 091FR7GX, BRE21HD, BRE31HD, FM1011E2-VERS.2006, FM1011E3-VERS.2006, FM1011G2-VERS.2006, FM1011G3-VERS.2006, FM1221E2-VERS.2006, FM1221E3-VERS.2006, FM1221G2-VERS.2006, FM1221G3-VERS.2006, FM611E2-VERS.2006, FM611E3-VERS.2006, FM611G2-VERS.2006, FM611G3-VERS.2006, FM721E3-VERS.2006, FM721G3-VERS.2006, FX101E2C, FX101E3C, FX101G2C, FX101G3C, FX10E2CR, FX10E3CR, FX10G2CR, FX10G3CR, FX122E2C, FX122E3, FX122E3C, FX122E3T, FX122E3T-VERS.022014, FX122G2C, FX122G3, FX122G3C, FX122G3T, FX122G3T-VERS.022014, FX12E3CT, FX12E3CT-VERS.022014, FX12G3CT, FX12G3CT-VERS.022014, FX61E2C, FX61E2CR, FX61E3CR, FX61G2C, FX61G2CR, FX61G3C, FX61G3CR, FX82E2C, FX82E3C...(Other models you can see in the webshop) |                 |         |

bolts



|                    |   |                 |                               |
|--------------------|---|-----------------|-------------------------------|
| <b>GEV No.</b>     | 514283  | <b>Ref. No.</b> | 36D7060<br>36D7061<br>36D7062 |
| <b>description</b> | bolt with flattening 7mm ø 10mm L 20mm for door   |                 |                               |
| <b>For models:</b> | BX101E, BX101E-VERS.122013, BX101G, BX101G-VERS.122013, BX122E, BX122E-VERS.122013, BX122G, BX122G-VERS.122013, BX61E, BX61E-VERS.122013, BX61G, BX61G-VERS.122013, BX82E, BX82E-VERS.122013, BX82G, BX82G-VERS.122013, FC101, FC1011E, FC1011G, FC101E, FC1221E, FC1221G, FC241, FC241E, FC241G, FC61, FC611E, FC611G, FC61E, FCV101, FCV101-CSA, FCV101DM, FCV101DM-CSA, FCV101DS, FCV101DS-CSA, FCV101E, FCV101EDM, FCV101EDM-UL, FCV101EDS, FCV101EDS-UL, FCV141, FCV141-CSA, FCV141DM, FCV141DM-CSA, FCV141DS, FCV141DS-CSA, FCV141E, FCV141EDM, FCV141EDS, FCV241...(Other models you can see in the webshop) |                 |                               |

springs

roller springs



|                    |   |                 |         |
|--------------------|---|-----------------|---------|
| <b>GEV No.</b>     | 519340  | <b>Ref. No.</b> | 36G8430 |
| <b>description</b> | roller spring   |                 |         |
| <b>For models:</b> | LP124, LP124S-VERS.052006, LP124V, LP124-VERS.052006, LP124VS-VERS.052006, LP124V-VERS.052006 |                 |         |

sliding plates



|                    |               |                 |         |
|--------------------|---------------|-----------------|---------|
| <b>GEV No.</b>     | 518584        | <b>Ref. No.</b> | 36M1230 |
| <b>description</b> | sliding plate |                 |         |

hinges



|                    |                        |                 |         |
|--------------------|------------------------|-----------------|---------|
| <b>GEV No.</b>     | 510594                 | <b>Ref. No.</b> | 3190130 |
| <b>description</b> | door bolt ø 8mm L 42mm |                 |         |
| <b>For models:</b> | L40, L40S, L60         |                 |         |

Зип Общепит

vsezip.ru

7(812)987-08-81



1

|   |                |                 |                        |
|---|----------------|-----------------|------------------------|
| <b>GEV No.</b>  | 510593         | <b>Ref. No.</b> | 35S1930                |
| <b>description</b>  | door hinge     |                 |                        |
| <b>For models:</b>  | L40, L40S, L60 |                 |                        |
| <b>accessories for</b>  | 510593         |                 |                        |
|   | <b>GEV No.</b> | <b>Ref. No.</b> |                        |
|  | 510594         | 3190130         | door bolt ø 8mm L 42mm |



1

|                    |                                    |                 |         |
|--------------------|------------------------------------|-----------------|---------|
| <b>GEV No.</b>     | 516089                             | <b>Ref. No.</b> | 36G7400 |
| <b>description</b> | spring assisted hinge spring hinge |                 |         |
| <b>For models:</b> | LT10R, LT20F, LT25F                |                 |         |

## door shafts



1

|                    |                                    |                 |         |
|--------------------|------------------------------------|-----------------|---------|
| <b>GEV No.</b>     | 695575                             | <b>Ref. No.</b> | 3011520 |
| <b>description</b> | door shaft ø 10mm L 458mm icemaker |                 |         |
| <b>For models:</b> | PG23C, PG24CW, PG30C, PG31CW       |                 |         |

## locks



1

|   |                         |                 |            |
|---|-------------------------|-----------------|------------|
| <b>GEV No.</b>  | 510210                  | <b>Ref. No.</b> | 36M0030    |
| <b>description</b>  | counterpart counterpart |                 |            |
| <b>For models:</b>  | L40, L40S, L60          |                 |            |
| <b>accessories for</b>  | 510210                  |                 |            |
|   | <b>GEV No.</b>          | <b>Ref. No.</b> |            |
|  | 510209                  | 36M0020         | door catch |





1

|   |                |                 |                         |
|---|----------------|-----------------|-------------------------|
| <b>GEV No.</b>  | 510209         | <b>Ref. No.</b> | 36M0020                 |
| <b>description</b>  | door catch     |                 |                         |
| <b>For models:</b>  | L40, L40S, L60 |                 |                         |
| <b>accessories for</b>  | 510209         |                 |                         |
|   | <b>GEV No.</b> | <b>Ref. No.</b> |                         |
|  | 510210         | 36M0030         | counterpart counterpart |



1

|   |                  |                 |                        |
|---|------------------|-----------------|------------------------|
| <b>GEV No.</b>  | 517276           | <b>Ref. No.</b> | 3030100                |
| <b>description</b>  | door catch catch |                 |                        |
| <b>accessories for</b>  | 517276           |                 |                        |
|   | <b>GEV No.</b>   | <b>Ref. No.</b> |                        |
|  | 517277           | —               | gasket for catch       |
|   | <b>GEV No.</b>   | <b>Ref. No.</b> |                        |
|  | 517278           | —               | counterpart door catch |



1

|   |  |                 |  |
|---|--|-----------------|--|
| <b>GEV No.</b>  | 519247   | <b>Ref. No.</b> | 31W0061  |
| <b>description</b>  | door catch door locking catch  |                 |  |
| <b>For models:</b>  | F60P, F60PR, F60T, F80P, F80PR, L45, LF50, LF50E, LF50EM, LF50EMPS, LF50EMPS-VERS.122012, LF50EM-VERS.122012, LF50E-VERS.122012, LF50E-VERS.2007 |                 |  |
| <b>accessories for</b>  | 519247   |                 |  |
|   | <b>GEV No.</b>   | <b>Ref. No.</b> |  |
|  | 519050   | —               | nut thread M12x1.75 H 4mm WS 16 SS Qty 1 pcs for snap lock |

## miscellaneous



1

|                    |   |                 |         |
|--------------------|---|-----------------|---------|
| <b>GEV No.</b>     | 504435  | <b>Ref. No.</b> | 3152010 |
| <b>description</b> | flat gasket plastic ED ø 18mm ID ø 9.5mm thickness 2.5mm for door hinge Qty 1 pcs |                 |         |





screw connections

Зип Общежит

curtains

vsezip.ru

7(812)987-08-81



1

|                    |                                 |                 |     |
|--------------------|---------------------------------|-----------------|-----|
| <b>GEV No.</b>     | 519008                          | <b>Ref. No.</b> | N/A |
| <b>description</b> | locknut thread 2 1/4" Qty 1 pcs |                 |     |



1

|                    |        |                 |         |
|--------------------|--------|-----------------|---------|
| <b>GEV No.</b>     | 505506 | <b>Ref. No.</b> | 33Q0220 |
| <b>description</b> | nut    |                 |         |



1

|                    |                                 |                 |         |
|--------------------|---------------------------------|-----------------|---------|
| <b>GEV No.</b>     | 505505                          | <b>Ref. No.</b> | 33Q2160 |
| <b>description</b> | nut thread 1 1/4" WS 55 plastic |                 |         |

**For models:** C165D, C165S, C165VD, C165VS, C207D, C207D-VERS.2006, C207S, C207S-VERS.2006, C207VD, C207VD-VERS.2006, C207VS, C207VS-VERS.2006, C304AD, C304AD-VERS.2006, C304AS, C304AS-VERS.2006, C304AVD, C304AVD-VERS.2006, C304AVS, C304AVS-VERS.2006, C304D, C304D-VERS.2006, C304S, C304S-VERS.2006, C304VD, C304VD-VERS.2006, C304VS, C304VS-VERS.2006, C92D-VERS.2006, C92S-VERS.2006, C92VD-VERS.2006, C92VS-VERS.2006, CS243D, CS243D-VERS.2006, CS243S, CS243S-VERS.2006, CS243VD, CS243VD-VERS.2006, CS243VS, CS243VS-VERS.2006, CS370AD, CS370AD-VERS.2006, CS370AS, CS370AS-VERS.2006, CS370AVD, CS370AVD-VERS.2006, CS370AVS, CS370AVS-VERS.2006, CS370D, CS370D-VERS.2006...(Other models you can see in the webshop)



1

|                    |  |                 |         |
|--------------------|--|-----------------|---------|
| <b>GEV No.</b>     | 506278   | <b>Ref. No.</b> | 33Q4700 |
| <b>description</b> | nut thread M26x1.5 H 15mm WS 32 plastic Qty 1 pcs 12 |                 |         |
| <b>For models:</b> | F60PR, F60T, F80P, F80PR                             |                 |         |

curtains



1

|                    |   |                 |         |
|--------------------|---|-----------------|---------|
| <b>GEV No.</b>     | 533016  | <b>Ref. No.</b> | 36Z0720 |
| <b>description</b> | curtain W 640mm H 410mm plastic thickness 1.5mm warewashing |                 |         |

washing and rinsing systems



1

|                    |                      |                 |         |
|--------------------|----------------------|-----------------|---------|
| <b>GEV No.</b>     | 505508               | <b>Ref. No.</b> | 33Q0280 |
| <b>description</b> | bearing for wash arm |                 |         |



1

|                    |   |                 |         |
|--------------------|---|-----------------|---------|
| <b>GEV No.</b>     | 524877  | <b>Ref. No.</b> | 36D0740 |
| <b>description</b> | bush for rinse arm ø 20mm ID ø 16mm H 8mm ED ø 26mm |                 |         |
| <b>For models:</b> | L100, L40, L40S, L60, L80                           |                 |         |



1

|                    |  |                 |         |
|--------------------|--|-----------------|---------|
| <b>GEV No.</b>     | 510053   | <b>Ref. No.</b> | 36G8460 |
| <b>description</b> | bush for rinse arm ø 24mm H 5.7mm  |                 |         |
| <b>For models:</b> | LP124, LP124S-VERS.052006, LP124V, LP124V-VERS.052006, LP124VS-VERS.052006, LP124V-VERS.052006, LP84, LP84S-VERS.052006, LP84V, LP84V-VERS.052006, LP84VS-VERS.052006, LP84V-VERS.052006 |                 |         |



1

|                    |                   |                 |         |
|--------------------|-------------------|-----------------|---------|
| <b>GEV No.</b>     | 519088            | <b>Ref. No.</b> | 36G9110 |
| <b>description</b> | bush for wash arm |                 |         |



1

|   |  |                 |                         |
|---|--|-----------------|-------------------------|
| <b>GEV No.</b>  | 519167   | <b>Ref. No.</b> | 33Q370<br>33Q3700       |
| <b>description</b>  | bush for wash arm  |                 |                         |
| <b>For models:</b>  | LP124, LP124S-VERS.052006, LP124V, LP124-VERS.052006, LP124VS-VERS.052006, LP124V-VERS.052006, LP84, LP84S-VERS.052006, LP84V, LP84-VERS.052006, LP84VS-VERS.052006, LP84V-VERS.052006 |                 |                         |
| <b>accessories for</b>  | 519167   |                 |                         |
|  | <b>GEV No.</b>   | 519087          | <b>Ref. No.</b> 36G8720 |
| locknut for wash arm  |  |                 |                         |



1

|                    |  |                 |         |
|--------------------|--|-----------------|---------|
| <b>GEV No.</b>     | 695590   | <b>Ref. No.</b> | 31Z0250 |
| <b>description</b> | bush for wash arm  |                 |         |
| <b>For models:</b> | KD100, KD100A, KD100PSD, KD37, KD37PS, KD37-VERS.112009, KD40PS, KD40-VERS.112009, KD85, KD85A, KD85PS, KD85PSA, KN35, KN37, KN37PS, KN40, KN40PS, KN40PSD |                 |         |



1

|                    |   |                 |         |
|--------------------|---|-----------------|---------|
| <b>GEV No.</b>     | 517341  | <b>Ref. No.</b> | 33Q6600 |
| <b>description</b> | bush ID $\varnothing$ 16mm ED $\varnothing$ 48mm  |                 |         |
| <b>For models:</b> | KD100, KD100A, KD100PSD, KD130, KD130A, KD130E, KD130EAT, KN1100, KN1100SD, KN11PSDD, LP151, N100D, N100S, N100VD, N100VS, N38D, N38S, N38VD, N38VS, N42D, N42S, N42VD, N42VS, N50D, N50S, N50VD, N50VS, N66D, N66S, N66VD, N66VS, N70D, N70S, N70VD, N70VS, N85D, N85S, N85VD, N85VS |                 |         |



1

|                    |   |                 |         |
|--------------------|---|-----------------|---------|
| <b>GEV No.</b>     | 541505  | <b>Ref. No.</b> | 33Q0740 |
| <b>description</b> | connecting piece thread 1/2" $\varnothing$ 14mm |                 |         |
| <b>For models:</b> | L100, L40, L60, L80                             |                 |         |



1

|                    |                           |                 |         |
|--------------------|---------------------------|-----------------|---------|
| <b>GEV No.</b>     | 518075                    | <b>Ref. No.</b> | 36Q0180 |
| <b>description</b> | end cap thread 1/4" WS 14 |                 |         |
| <b>For models:</b> | L100, L40, L40S, L60, L80 |                 |         |



1

|                    |        |                 |         |
|--------------------|--------|-----------------|---------|
| <b>GEV No.</b>     | 519047 | <b>Ref. No.</b> | 36U0740 |
| <b>description</b> | flange |                 |         |
| <b>For models:</b> | LF50   |                 |         |



1

|                    |                           |                 |         |
|--------------------|---------------------------|-----------------|---------|
| <b>GEV No.</b>     | 517095                    | <b>Ref. No.</b> | 3021600 |
| <b>description</b> | flange $\varnothing$ 60mm |                 |         |



1

|                    |  |                 |         |
|--------------------|--|-----------------|---------|
| <b>GEV No.</b>     | 519122   | <b>Ref. No.</b> | 37Q4200 |
| <b>description</b> | flat gasket for rinse arm  |                 |         |
| <b>For models:</b> | C165D, C165S, C207D, C207S, C304AD, C304AS, C304D, C304S, CS243D, CS243S, CS243VD, CS243VS, CS370AD, CS370AS, CS370AVD, CS370AVS, CS370D, CS370S, CS370VD, CS370VS, CS466AD, CS466AS, CS466AVD, CS466AVS, CS466D, CS466S, CS466VD, CS466VS, LC100, LC100-VERS.2001, LC130, LC130-VERS.2001, LC80, N303D, N303S, N303VD, N303VS, N354D, N354S, N354VD, N354VS, N506D, N506S, N506VD, N506VS, N607D, N607S, N607VD, N607VS, N760D... (Other models you can see in the webshop) |                 |         |



1

|                    |   |                 |         |
|--------------------|---|-----------------|---------|
| <b>GEV No.</b>     | 691730  | <b>Ref. No.</b> | 33Q0510 |
| <b>description</b> | knurled nut thread M10x1.5 $\varnothing$ 36mm H 3.5mm stainless steel |                 |         |
| <b>For models:</b> | L100, L40S, L60, L80  |                 |         |



1

|                    |         |                 |         |
|--------------------|---------|-----------------|---------|
| <b>GEV No.</b>     | 519006  | <b>Ref. No.</b> | 33Q4220 |
| <b>description</b> | locknut |                 |         |

Зип Общепит

vsezip.ru

+7(812)987-08-81







Зип-Общепит

vsezip.ru

+7(812)987-08-81

|  |  |                 |         |
|--|--|-----------------|---------|
|  <p>1</p> |  |                 |         |
| <b>GEV No.</b>   | 519087   | <b>Ref. No.</b> | 36G8720 |
| <b>description</b>   | locknut for wash arm   |                 |         |
| <b>For models:</b>   | LC100, LC100-VERS.2001, LC130, LC130-VERS.2001, LP124, LP124S-VERS.052006, LP124V, LP124-VERS.052006, LP124VS-VERS.052006, LP124V-VERS.052006, LP84, LP84S-VERS.052006, LP84V, LP84-VERS.052006, LP84VS-VERS.052006, LP84V-VERS.052006 |                 |         |

|  |  |                |        |                 |         |
|--|--|----------------|--------|-----------------|---------|
|  <p>1</p> |  | <b>GEV No.</b> | 518075 | <b>Ref. No.</b> | 36Q0180 |
| <b>description</b> end cap thread 1/4" WS 14   |  |                |        |                 |         |
|  <p>1</p> |  | <b>GEV No.</b> | 524877 | <b>Ref. No.</b> | 36D0740 |
| <b>description</b> push for rinse arm ø 2mm ID ø 16mm H 8mm ED ø 26mm                      |  |                |        |                 |         |
|  <p>1</p> |  | <b>GEV No.</b> | 691730 | <b>Ref. No.</b> | 33Q0510 |
| <b>description</b> knurled nut thread M10x1.5 ø 36mm H 3.5mm stainless steel               |  |                |        |                 |         |

|  |                                |                 |         |
|--|--------------------------------|-----------------|---------|
|  <p>1</p> |                                |                 |         |
| <b>GEV No.</b>   | 510183                         | <b>Ref. No.</b> | 33T0270 |
| <b>description</b>   | opposite support for rinse jet |                 |         |



|   |                           |                 |         |
|---|---------------------------|-----------------|---------|
|  <p>1</p> |                           |                 |         |
| <b>GEV No.</b>  | 505502                    | <b>Ref. No.</b> | 36D0720 |
| <b>description</b>  | rinse arm shaft           |                 |         |
| <b>For models:</b>  | L100, L40, L40S, L60, L80 |                 |         |

|  |                               |                 |         |
|--|-------------------------------|-----------------|---------|
|  <p>1</p> |                               |                 |         |
| <b>GEV No.</b>   | 510181                        | <b>Ref. No.</b> | 33T0280 |
| <b>description</b>   | opposite support for wash jet |                 |         |

|   |                     |                 |         |
|---|---------------------|-----------------|---------|
|  <p>1</p> |                     |                 |         |
| <b>GEV No.</b>  | 517332              | <b>Ref. No.</b> | 33Q0420 |
| <b>description</b>  | rinse arm shaft     |                 |         |
| <b>For models:</b>  | L100, L40, L60, L80 |                 |         |

|  |   |                 |         |
|--|---|-----------------|---------|
|  <p>1</p> |   |                 |         |
| <b>GEV No.</b>   | 532536  | <b>Ref. No.</b> | 3152400 |
| <b>description</b>   | O-ring for rinse jet  |                 |         |
| <b>For models:</b>   | C207D-VERS.2006, C207S-VERS.2006, C207VD-VERS.2006, C207VS-VERS.2006, C304AD-VERS.2006, C304AS-VERS.2006, C304AVD-VERS.2006, C304AVS-VERS.2006, C304D-VERS.2006, C304S-VERS.2006, C304VD-VERS.2006, C304VS-VERS.2006, C92D-VERS.2006, C92S-VERS.2006, C92VD-VERS.2006, C92VS-VERS.2006, CS243D-VERS.2006, CS243S-VERS.2006, CS243VD-VERS.2006, CS243VS-VERS.2006, CS370AD-VERS.2006, CS370AS-VERS.2006, CS370AVD-VERS.2006, CS370AVS-VERS.2006, CS370D-VERS.2006, CS370S-VERS.2006, CS370VD-VERS.2006, CS370VS-VERS.2006, CS466AD-VERS.2006, CS466AS-VERS.2006, CS466AVD-VERS.2006, CS466AVS-VERS.2006, CS466D-VERS.2006, CS466S-VERS.2006, CS466VD-VERS.2006, CS466VS-VERS.2006, LC100, LC100-VERS.2001, LC130, LC130-VERS.2001, LC80, LF50, LF50E, LF50EM, LF50EMPS |                 |         |

|   |                                      |                 |                    |
|---|--------------------------------------|-----------------|--------------------|
|  <p>1</p> |                                      |                 |                    |
| <b>GEV No.</b>  | 510626                               | <b>Ref. No.</b> | 33T1120<br>33T1121 |
| <b>description</b>  | rinse jet ø 0.7/1.5mm thread 1/8" ET |                 |                    |
| <b>For models:</b>  | L100, L40, L40S, L60, L80            |                 |                    |

|  |                                      |                 |                    |                 |                    |
|--|--------------------------------------|-----------------|--------------------|-----------------|--------------------|
|  <p>1</p> |                                      |                 |                    |                 |                    |
| <b>GEV No.</b>   | 505516                               | <b>Ref. No.</b> | 30Z0240<br>6001920 |                 |                    |
| <b>description</b>   | rinse arm L 495mm nozzles 4 complete |                 |                    |                 |                    |
| <b>For models:</b>   | L100, L40, L40S, L60, L80            |                 |                    |                 |                    |
| <b>spare parts for</b>   | 505516                               |                 |                    |                 |                    |
|  <p>1</p> |                                      | <b>GEV No.</b>  | 505502             | <b>Ref. No.</b> | 36D0720            |
| <b>description</b> rinse arm shaft   |                                      |                 |                    |                 |                    |
|  <p>1</p> |                                      | <b>GEV No.</b>  | 510626             | <b>Ref. No.</b> | 33T1120<br>33T1121 |
| <b>description</b> rinse jet ø 0.7/1.5mm thread 1/8" ET                                      |                                      |                 |                    |                 |                    |

|  |            |                 |         |
|--|------------|-----------------|---------|
|  <p>1</p> |            |                 |         |
| <b>GEV No.</b>   | 519201     | <b>Ref. No.</b> | 36G9080 |
| <b>description</b>   | rinse pipe |                 |         |
| <b>For models:</b>   | LC80, LF50 |                 |         |

Зип Общепит



vsezip.ru



7(812)987 08 81

|   |  |                 |         |
|---|--|-----------------|---------|
|  |  |                 |         |
| 1   |  |                 |         |
| <b>GEV No.</b>  | 517333                                     | <b>Ref. No.</b> | 33Q5070 |
| <b>description</b>  | sleeve thread M16x1 ø 25mm stainless steel |                 |         |
| <b>For models:</b>  | L40, L40S, L60                             |                 |         |

|  |               |                 |         |
|--|---------------|-----------------|---------|
|  |               |                 |         |
| 1  |               |                 |         |
| <b>GEV No.</b>   | 505510        | <b>Ref. No.</b> | 33Q1400 |
| <b>description</b>   | wash arm boss |                 |         |

|   |   |                 |         |
|---|---|-----------------|---------|
|  |   |                 |         |
| 1   |   |                 |         |
| <b>GEV No.</b>  | 519085  | <b>Ref. No.</b> | 33Q3710 |
| <b>description</b>  | Thumb screw ø 34mm thread M6  |                 |         |
| <b>For models:</b>  | LC100, LC100-VERS.2001, LC130, LC130-VERS.2001, LC80, LF50, LF50E, LF50EM, LF50EMPS, LF50EMPS-VERS.122012, LF50EM-VERS.122012, LF50E-VERS.122012, LF50E-VERS.2007, LP124, LP124V, LP84, LP84V |                 |         |

|   |                  |                 |                 |
|---|------------------|-----------------|-----------------|
|  |                  |                 |                 |
| 1   |                  |                 |                 |
| <b>GEV No.</b>  | 511911           | <b>Ref. No.</b> | 36D7750         |
| <b>description</b>  | wash arm support |                 |                 |
| <b>accessories for</b>  | 511911           |                 |                 |
|  | <b>GEV No.</b>   | 510884          | <b>Ref. No.</b> |
|   |                  |                 | —               |
|   |                  |                 | gasket          |

|   |  |                 |   |
|---|--|-----------------|---|
|    |  |                 |   |
| 1   |  |                 |   |
| <b>GEV No.</b>  | 524804   | <b>Ref. No.</b> | 3036730   |
| <b>description</b>  | Thumb screw thread M5 thread L 7mm ø 30mm H 5mm SS Qty 1 pcs   |                 |   |
| <b>For models:</b>  | KD100, KD100A, KD100PSD, KD130, KD130A, KD130E, KD130EAT, KD40EPSD, KD40LEPS, KD40LUXE, KD60, KD60E, KD60EAT, KD60M, KD60MA, KD60ME, KD60MPS, KD60MPSA, KD60PS, KD60PSD, KD6E-ATSD, KD85, KD85A, KD85E, KD85EA, KD85EAT, KD85EATS, KD85EPS, KD85EPSA, KD85PS, KD85PSA, KN1100, KN1100SD, KN11PSDD, KN80, KN80PS, LP151, LP202, LP202HC, LP302, LP302HC, LP402, LP402HC, LP402V, LP70 |                 |   |
| <b>accessories for</b>  | 524804   |                 |   |
|  | <b>GEV No.</b>   | 505277          | <b>Ref. No.</b>                                       |
|   |  |                 | 3036720<br>33q6400                                    |
|   |  |                 | rinse arm shaft warewashing ø 14mm H 38mm thread 1/4" |

|   |                  |                 |                 |
|---|------------------|-----------------|-----------------|
|   |                  |                 |                 |
| 1   |                  |                 |                 |
| <b>GEV No.</b>  | 511912           | <b>Ref. No.</b> | 33M0820         |
| <b>description</b>  | wash arm support |                 |                 |
| <b>accessories for</b>  | 511912           |                 |                 |
|  | <b>GEV No.</b>   | 510884          | <b>Ref. No.</b> |
|   |                  |                 | —               |
|   |                  |                 | gasket          |

|   |   |                 |     |
|---|---|-----------------|-----|
|  |   |                 |     |
| 1   |   |                 |     |
| <b>GEV No.</b>  | 510338  | <b>Ref. No.</b> | N/A |
| <b>description</b>  | union nut dosing pump thread 1/2" ø 32mm H 15mm for dosing pump |                 |     |

|   |  |                 |         |
|---|--|-----------------|---------|
|  |  |                 |         |
| 1   |  |                 |         |
| <b>GEV No.</b>  | 511561                                       | <b>Ref. No.</b> | 3021590 |
| <b>description</b>  | wash arm support mounting pos. lower H 103mm |                 |         |
| <b>For models:</b>  | KD40   |                 |         |

|   |                  |                 |         |
|---|------------------|-----------------|---------|
|  |                  |                 |         |
| 1   |                  |                 |         |
| <b>GEV No.</b>  | 505507           | <b>Ref. No.</b> | 33Q1380 |
| <b>description</b>  | wash arm bearing |                 |         |

|  |                                     |                 |         |
|--|-------------------------------------|-----------------|---------|
|  |                                     |                 |         |
| 1  |                                     |                 |         |
| <b>GEV No.</b>   | 504779                              | <b>Ref. No.</b> | 33Q3380 |
| <b>description</b>   | wash arm support ø 43mm H 36.5mm M4 |                 |         |
| <b>For models:</b>   | L100, L40, L40S, L60, L80           |                 |         |



Зип Общепит  
vsezip.ru  
17(812)987-08-81



1

|                    |          |                 |         |
|--------------------|----------|-----------------|---------|
| <b>GEV No.</b>     | 519388   | <b>Ref. No.</b> | 33T0970 |
| <b>description</b> | wash jet |                 |         |



1

|                    |          |                 |         |
|--------------------|----------|-----------------|---------|
| <b>GEV No.</b>     | 519389   | <b>Ref. No.</b> | 33T0260 |
| <b>description</b> | wash jet |                 |         |



1

|   |  |                 |                   |
|---|--|-----------------|-------------------|
| <b>GEV No.</b>  | 110117   | <b>Ref. No.</b> | 36M0750           |
| <b>description</b>  | knob energy regulator 1-3 t.max.°C ø 60mm shaft ø 6x4.6mm shaft flat upper black |                 |                   |
| <b>spare parts for</b>  | 110117   |                 |                   |
|  | <b>GEV No.</b>   | 112495          | <b>Ref. No.</b> — |
|   | knob spring L 10.5mm W 8.5mm Qty 1 pcs   |                 |                   |

for vacuum packers

PTFE tapes



1

|                    |                         |                 |        |
|--------------------|-------------------------|-----------------|--------|
| <b>GEV No.</b>     | 692155                  | <b>Ref. No.</b> | 304184 |
| <b>description</b> | PTFE tape W 50mm Qty 1m |                 |        |



1

|                    |  |                 |         |
|--------------------|--|-----------------|---------|
| <b>GEV No.</b>     | 110111   | <b>Ref. No.</b> | 36M0590 |
| <b>description</b> | knob switch 5-position ø 60mm shaft ø 6x4.6mm shaft flat upper black |                 |         |



1

|                    |   |                 |                    |
|--------------------|---|-----------------|--------------------|
| <b>GEV No.</b>     | 110116  | <b>Ref. No.</b> | 3110114<br>3110117 |
| <b>description</b> | knob thermostat t.max. 110°C ø 60mm shaft ø 6x4.6mm shaft flat upper black temperature range 30-110°C rotation 270° |                 |                    |

knobs

universal knobs



1

|   |   |                 |                   |
|---|---|-----------------|-------------------|
| <b>GEV No.</b>  | 111934  | <b>Ref. No.</b> | 36M0700           |
| <b>description</b>  | knob thermostat t.max. 90°C ø 50mm shaft ø 6x4.6mm shaft flat upper black temperature range 30-90°C rotation 270° |                 |                   |
| <b>For models:</b>  | L100, L40, L40S, L60, L80   |                 |                   |
| <b>accessories for</b>  | 111934  |                 |                   |
|  | <b>GEV No.</b>  | 110135          | <b>Ref. No.</b> — |
|   | rosette knob up to ø 52mm   |                 |                   |



1

|                    |   |                 |         |
|--------------------|---|-----------------|---------|
| <b>GEV No.</b>     | 110114  | <b>Ref. No.</b> | 36M0610 |
| <b>description</b> | knob thermostat t.max. 300°C ø 60mm shaft ø 6x4.6mm shaft flat upper black temperature range 50-300°C rotation 270° |                 |         |

producer-specific knobs

ANGELO PO



|                    |   |                 |         |
|--------------------|---|-----------------|---------|
| <b>GEV No.</b>     | 110899  | <b>Ref. No.</b> | 6300489 |
| <b>description</b> | knob gas tap with ignition flame t.max.°C°C ø 77mm shaft ø 10x9mm shaft flat upper red  |                 |         |
| <b>For models:</b> | 0A0FAS, 0A0FAVA, 0A0GRG, 0A1CP1G, 0B0FAS, 0B1CP1G, 0D0FAS, 0D0FAVA, 0D0GRG, 0D1CP1G, 1A0FA2, 1A0FA5, 1A0FAB, 1A0FAS, 1A0FAS2, 1A0GRG, 1A0TP0, 1A1CP1G, 1A1CP2G, 1A1FA2G, 1A1FASG, 1A1FABG, 1A1FAS2G, 1A1FASG, 1A1PD1G, 1A1PD2G, 1A1PI1G, 1A1PI1GA, 1A1TP0G, 1A1TP0G-VERS.2002, 1B0FAS, 1B0FAS2, 1B0TP0, 1B1FAS2G, 1B1FASG, 1D0FA2, 1D0FA5, 1D0FAB, 1D0FAS, 1D0FAS2, 1D0GRG, 1D0TP0, 1D1CP1G, 1D1CP2G, 1D1FA2G, 1D1FA5G, 1D1FABG, 1D1FAS2G, 1D1FASG, 1D1PD1G...(Other models you can see in the webshop) |                 |         |



|                    |   |                 |                    |
|--------------------|---|-----------------|--------------------|
| <b>GEV No.</b>     | 112192  | <b>Ref. No.</b> | 6300518<br>6300521 |
| <b>description</b> | knob gas tap with ignition flame t.max.°C°C ø 77mm shaft ø 8x6.5mm shaft flat upper red   |                 |                    |
| <b>For models:</b> | 0A0FA1, 0A0FA4, 0A0FAA, 0D0FA1, 0D0FA4, 0D0FAA, 0G0FA0, 0G1CP1G, 0G1CP1G-VERS.2004, 1A0FA1, 1A0FA2, 1A0FA4, 1A0FA5, 1A0FAA, 1A0FAB, 1A1FA1G, 1A1FA2G, 1A1FA4G, 1A1FA5G, 1A1FAAG, 1A1FABG, 1D0FA1, 1D0FA2, 1D0FA4, 1D0FA5, 1D0FAA, 1D0FAB, 1D1FA1G, 1D1FA2G, 1D1FA4G, 1D1FA5G, 1D1FAAG, 1D1FABG, 1G0FA0, 1G0GRG, 1G0TP0, 1G1CP1G, 1G1CP1G-VERS.2004, 1G1CP2G, 1G1CP2G-VERS.2004, 1G1FA0E, 1G1FA0EV, 1G1FA0G, 1G1FA0GV, 1G1FAPG, 1G1TP0G, 2A0FA1, 2A0FA4, 2A0FAA, 2A1FA1G...(Other models you can see in the webshop) |                 |                    |



|                    |   |                 |         |
|--------------------|---|-----------------|---------|
| <b>GEV No.</b>     | 110924  | <b>Ref. No.</b> | 6300486 |
| <b>description</b> | knob gas thermostat t.max. 100°C 30-100°C ø 77mm shaft ø 8x6.5mm shaft flat upper red |                 |         |
| <b>For models:</b> | 0A0BMG, 0D0BMG, 1A0BMG, 1D0BMG  |                 |         |



|                    |  |                 |         |
|--------------------|--|-----------------|---------|
| <b>GEV No.</b>     | 112191   | <b>Ref. No.</b> | 6300504 |
| <b>description</b> | knob gas thermostat t.max. 280°C 100-280°C shaft ø 10x9mm shaft flat upper red   |                 |         |
| <b>For models:</b> | 0A0FT4G, 0A0FT5G, 0B0FT1G, 0B0FT2G, 0B0FT4G, 0B0FT5G, 0D0FT4G, 0D0FT5G, 0G0FT4G, 0G0FT5G, 1A0FT4G, 1A0FT6G, 1B0FT4G, 1B0FT6G, 1D0FT4G, 1D0FT6G, 1G0FT4G, 1G0FT6G |                 |         |



|                    |  |                 |         |
|--------------------|--|-----------------|---------|
| <b>GEV No.</b>     | 112187   | <b>Ref. No.</b> | 6300488 |
| <b>description</b> | knob gas thermostat t.max. 280°C 100-280°C shaft ø 8x6.5mm shaft flat upper red  |                 |         |
| <b>For models:</b> | 0A0FT1G, 0A0FT2G, 0A0FT4G, 0A0FT5G, 0D0FT1G, 0D0FT2G, 0D0FT4G, 0D0FT5G, 0G1BR3G, 1A0FT1G, 1A0FT2G, 1A0FT3G, 1A0FT4G, 1A0FT6G, 1D0FT1G, 1D0FT2G, 1D0FT3G, 1D0FT4G, 1D0FT6G, 1G1BR3G |                 |         |



|                    |  |                 |         |
|--------------------|--|-----------------|---------|
| <b>GEV No.</b>     | 112186   | <b>Ref. No.</b> | 6300553 |
| <b>description</b> | knob gas thermostat t.max. 280°C 160-280°C shaft ø 8x6.5mm shaft flat upper red                              |                 |         |
| <b>For models:</b> | 1G1FA0G, 1G1FA0GV, 1G1FAPG, 1G1TP0G, 2G1FA0G, 2G1FA0GV, 2G1FADG, 2G1FADGV, 2G1FAPG, 2G1TP3G, G1FAGS, G1FAGST |                 |         |



|                    |   |                 |         |
|--------------------|---|-----------------|---------|
| <b>GEV No.</b>     | 112710  | <b>Ref. No.</b> | 6300510 |
| <b>description</b> | knob gas thermostat t.max. 300°C 100-300°C ø 79mm shaft ø 8x6.5mm shaft flat upper black/red  |                 |         |
| <b>For models:</b> | 1A1FA1G, 1A1FA2G, 1A1FA4G, 1A1FA5G, 1A1FAAG, 1A1FABG, 1A1TP0G-VERS.2002, 1B1FAS2G, 1B1FASG, 1D1FA1G, 1D1FA2G, 1D1FA4G, 1D1FA5G, 1D1FAAG, 1D1FABG, 1D1TP0G-VERS.2002, 2A1FA1G, 2A1FA4G, 2A1FAAG, 2A1TP3G, 2A1TP6G, 2A1TPCG, 2D1FA1G, 2D1FA4G, 2D1FAAG, 2D1TP3G, 2D1TP6G, 2D1TPCG, 3A1FA1G, 3A1FA4G, 3A1FAAG, 3D1FA1G, 3D1FA4G, 3D1FAAG |                 |         |

Зип Общепит

vsezip.ru

+7(812)987-08-81



Зип Общепит

vsezip.ru

+7(812)987-08-81

1



|                    |  |                 |         |
|--------------------|--|-----------------|---------|
| <b>GEV No.</b>     | 112189   | <b>Ref. No.</b> | 6300563 |
| <b>description</b> | knob gas thermostat t.max. 340°C 160-340°C shaft ø 10x9mm shaft flat upper red   |                 |         |
| <b>For models:</b> | 0A0FT1G, 0A0FT2G, 0D0FT1G, 0D0FT2G, 0G0FT1G, 0G0FT2G, 1A0FT1G, 1A0FT2G, 1A0FT3G, 1B0FT1G, 1B0FT2G, 1B0FT3G, 1D0FT1G, 1D0FT2G, 1D0FT3G, 1G0FT1G, 1G0FT2G, 1G0FT3G |                 |         |

1



|   |  |                 |                         |
|---|--|-----------------|-------------------------|
| <b>GEV No.</b>  | 112188   | <b>Ref. No.</b> | 6300556                 |
| <b>description</b>  | knob switch 7-position t.max. °C°C shaft ø 6x4.6mm shaft flat upper red  |                 |                         |
| <b>For models:</b>  | 0G0PE1, 0G0PE2, 0G1PE2, 1G0PE1, 1G0PE2, 1G1PE1E, 1G1PE1EV, 1G1PE2, 1G1PE2E, 1G1PE2EV, 2G0PE1, 2G0PE2, 2G1PE1E, 2G1PE1EV, 2G1PE2E, 2G1PE2EV |                 |                         |
| <b>spare parts for</b>  | 112188   |                 |                         |
|  | <b>GEV No.</b>   | 550965          | <b>Ref. No.</b> 3170290 |
|   | knob spring ø 6x4.6mm Qty 1 pcs  |                 |                         |

1



|                    |  |                 |         |
|--------------------|--|-----------------|---------|
| <b>GEV No.</b>     | 110927   | <b>Ref. No.</b> | 6300481 |
| <b>description</b> | knob switch 0-1-0-1 t.max. °C°C ø 77mm shaft ø 6x4.6mm shaft flat upper red  |                 |         |
| <b>For models:</b> | 0A1FR1ED, 0A1FR1GD, 0A1FR1GD-VERS.2004, 0B1FR1GD, 0D1FR1ED, 0D1FR1GD, 0D1FR1GD-VERS.2004, 0G0FR3ED, 0G1FR3GD, 1A1FR2ED, 1A1FR2GD, 1A1FR2GD-VERS.2004, 1A1PI2G, 1A1PI2GA, 1D1FR2ED, 1D1FR2GD, 1D1FR2GD-VERS.2004, 1D1PI2G, 1D1PI2GA, 1G1FR4GD |                 |         |

1



|                    |  |                 |         |
|--------------------|--|-----------------|---------|
| <b>GEV No.</b>     | 110926   | <b>Ref. No.</b> | 6300480 |
| <b>description</b> | knob thermostat t.max. 190°C 110-190°C shaft ø 6x4.6mm shaft flat upper red temperature range 110-190°C  |                 |         |
| <b>For models:</b> | 0A1FR1E, 0A1FR1G, 0A1FR1G-VERS.2004, 0A1FR3E, 0A1FR3ED, 0A1FR3G, 0A1FR3GD, 0B1FR1G, 0D1FR1E, 0D1FR1G, 0D1FR1G-VERS.2004, 0D1FR3E, 0D1FR3ED, 0D1FR3G, 0D1FR3GD, 0G0FR3E, 0G1FR3G, 1A1FR2E, 1A1FR2G, 1A1FR2G-VERS.2004, 1A1FR4E, 1A1FR4ED, 1A1FR4G, 1A1FR4GD, 1D1FR2G, 1D1FR2G-VERS.2004, 1D1FR4E, 1D1FR4ED, 1D1FR4G, 1D1FR4GD, 1G0FR4E, 1G1FR4G |                 |         |

1



|                    |   |                 |         |
|--------------------|---|-----------------|---------|
| <b>GEV No.</b>     | 110908  | <b>Ref. No.</b> | 6300485 |
| <b>description</b> | knob switch 5-position t.max. °C°C ø 77mm shaft ø 6x4.6mm shaft flat upper red  |                 |         |
| <b>For models:</b> | 0A0PE4, 0A1CP1E, 0D0PE4, 0D1CP1E, 0G1CP1E, 0G1CP1E-VERS.2004, 1A0PE4, 1A1PE4E, 1A1PEFTE, 1A1PI2E, 1A1PI2EA, 1D0PE4, 1D1PE4E, 1D1PI2E, 1D1PI2EA, 1G1PI1E |                 |         |

1



|                    |   |                 |         |
|--------------------|---|-----------------|---------|
| <b>GEV No.</b>     | 110923  | <b>Ref. No.</b> | 6300492 |
| <b>description</b> | knob thermostat t.max. 270°C 100-270°C shaft ø 6x4.6mm shaft flat upper red rotation 270°   |                 |         |
| <b>For models:</b> | 0A0FT1E, 0A0FT2E, 0A0FT4E, 0A0FT5E, 0D0FT1E, 0D0FT2E, 0D0FT4E, 0D0FT5E, 0G0FT1E, 0G0FT2E, 0G0FT4E, 0G0FT5E, 0G1FT2E, 0G1FT4E, 1A0FT1E, 1A0FT2E, 1A0FT3E, 1A0FT4E, 1A0FT6E, 1D0FT1E, 1D0FT2E, 1D0FT3E, 1D0FT4E, 1D0FT6E, 1G0FT1E, 1G0FT2E, 1G0FT3E, 1G0FT4E, 1G1FT2E, 1G1FT4E, 1G1FT6E |                 |         |

1



|                    |  |                 |         |
|--------------------|--|-----------------|---------|
| <b>GEV No.</b>     | 112275   | <b>Ref. No.</b> | 6300522 |
| <b>description</b> | knob switch 7-position t.max. °C°C ø 84mm shaft ø 6x4.6mm shaft flat upper red |                 |         |
| <b>For models:</b> | 60SME  |                 |         |

1



|                    |   |                 |         |
|--------------------|---|-----------------|---------|
| <b>GEV No.</b>     | 112190  | <b>Ref. No.</b> | 6300554 |
| <b>description</b> | knob thermostat t.max. 300°C 80-300°C shaft ø 6x4.6mm shaft flat upper red                    |                 |         |
| <b>For models:</b> | 1G1FA0E, 1G1FA0EV, 1G1PE1E, 1G1PE1EV, 1G1PE2E, 1G1PE2EV, 2G1PE1E, 2G1PE1EV, 2G1PE2E, 2G1PE2EV |                 |         |

Зип Общепит

vsezip.ru

+7(812)987-08-81



1

|                    |   |                 |         |
|--------------------|---|-----------------|---------|
| <b>GEV No.</b>     | 110934  | <b>Ref. No.</b> | 6300493 |
| <b>description</b> | knob energy regulators 1-8 t.max.°C°C shaft ø 6x4.6mm shaft flat upper red  |                 |         |
| <b>For models:</b> | OG1BR3E, 1A1BR1E, 1A1BR2E, 1A1BR2EA, 1D1BR1E, 1D1BR2E, 1D1BR2EA, 1G1BR3E, 2A1BR1E, 2A1BR2E, 2A1BR2EA, 2A1PI3E, 2D1BR1E, 2D1BR2E, 2D1BR2EA |                 |         |



1

|                    |   |                 |         |
|--------------------|---|-----------------|---------|
| <b>GEV No.</b>     | 110919  | <b>Ref. no.</b> | 6300483 |
| <b>description</b> | knob thermostat t.max. 300°C 100-300°C ø 65mm shaft ø 6x4.6mm shaft flat upper red  |                 |         |
| <b>For models:</b> | 0M0FT1E, 0M0FT2E, 0M0FT4E, 0M0FT5E, 1A1PE4E, 1A1PEFE, 1A1FBE, 1D1PE4E, 1D1FBE, 1M0FT1E, 1M0FT2E, 1M0FT3E, 1M0FT4E, 1M0FT5E, 1M0FT6E, 2M0FT1E, 2M0FT2E, 2M0FT3E, 2M0FT4E, 2M0FT5E, 2M0FT6E |                 |         |



1

|                    |  |                 |         |
|--------------------|--|-----------------|---------|
| <b>GEV No.</b>     | 110909   | <b>Ref. No.</b> | 6300487 |
| <b>description</b> | knob gas thermostat t.max. 300°C 100-300°C shaft ø 8x6.5mm shaft flat upper  |                 |         |
| <b>For models:</b> | 1A1FAS2G, 1A1FASG, 1A1TP0G, 1D1FAS2G, 1D1FASG, 1D1TP0G, 2A1FAS2G, 2A1FASG, 2A1TPSG, 2D1FAS2G, 2D1FASG, 2D1TPSG, 3A1FASG, 3D1FASG |                 |         |



1

|                    |  |                 |         |
|--------------------|--|-----------------|---------|
| <b>GEV No.</b>     | 112193   | <b>Ref. No.</b> | 6300490 |
| <b>description</b> | knob dial plate gas valves t.max.°C°C ø 65mm shaft ø 8x6.5mm shaft flat upper NOVASIT  |                 |         |
| <b>For models:</b> | 1A1BR1G, 1A1BR1GA, 1A1BR2G, 1A1BR2GA, 1D1BR1G, 1D1BR1GA, 1D1BR2G, 1D1BR2GA, 2A1BR1G, 2A1BR1GA, 2A1BR2G, 2A1BR2GA, 2D1BR1G, 2D1BR1GA, 2D1BR2G, 2D1BR2GA |                 |         |



1

|                    |   |                 |         |
|--------------------|---|-----------------|---------|
| <b>GEV No.</b>     | 110922  | <b>Ref. No.</b> | 6300484 |
| <b>description</b> | knob switch 4-position t.max.°C°C ø 65mm shaft ø 6x4.6mm shaft flat upper red |                 |         |
| <b>For models:</b> | 1A1PE4E, 1A1PEFE, 1A1FBE, 1D1PE4E, 1D1FBE                                     |                 |         |



1

|                    |  |                 |         |
|--------------------|--|-----------------|---------|
| <b>GEV No.</b>     | 112798   | <b>Ref. No.</b> | 3015731 |
| <b>description</b> | knob gas tap with ignition flame t.max.°C°C ø 72mm shaft ø 10x8mm shaft flat upper red   |                 |         |
| <b>For models:</b> | 06WCP1GM, 08WCP1GM, 08WGRGV, 090FAVA, 090GRG, 091CP1G, 10CP1GA, 10WTPGE, 10WTPGV, 190FAB, 190GRG, 190TP0, 191CP1G, 191CP2G, 191FABG, 191PD1G, 191PD2G, 191PI1G, 191PI1GA, 191PI2G, 191PI2GA, 191TPG, 1G1PD1G, 1G1PI1G, 291PD3G, 291PI3G, 291TPCG |                 |         |



1

|                    |   |                 |         |
|--------------------|---|-----------------|---------|
| <b>GEV No.</b>     | 110933  | <b>Ref. No.</b> | 6300491 |
| <b>description</b> | knob thermostat t.max. 270°C 100-270°C shaft ø 6x4.6mm shaft flat upper red temperature range 100-270°C   |                 |         |
| <b>For models:</b> | OG1BR3E, 1A1BR1E, 1A1BR1G, 1A1BR1GA, 1A1BR2E, 1A1BR2EA, 1A1BR2G, 1A1BR2GA, 1D1BR1E, 1D1BR1G, 1D1BR1GA, 1D1BR2E, 1D1BR2EA, 1D1BR2G, 1D1BR2GA, 1G1BR1E, 1G1BR3E, 2A1BR1E, 2A1BR1G, 2A1BR1GA, 2A1BR2E, 2A1BR2EA, 2A1BR2G, 2A1BR2GA, 2D1BR1E, 2D1BR1G, 2D1BR1GA, 2D1BR2E, 2D1BR2EA, 2D1BR2G, 2D1BR2GA |                 |         |



1

|                    |   |                 |                    |
|--------------------|---|-----------------|--------------------|
| <b>GEV No.</b>     | 112636  | <b>Ref. No.</b> | 3013170<br>3013171 |
| <b>description</b> | knob gas tap with ignition flame t.max.°C°C ø 72mm shaft ø 8x6.5mm shaft flat upper red   |                 |                    |
| <b>For models:</b> | 04WFAAV, 08WFA4E, 08WFA4G, 08WFAAE, 08WFAAG, 08WFAAV, 090FAA, 0G0FA0, 0G1CP1G-VERS.2004, 10WTPGE, 12WFA6E, 12WFA6G, 12WFAAA, 12WFAAE, 12WFAAG, 12WFAAN, 190FA, 190FAA, 190FAB, 190FAD, 191FAAE, 191FAAG, 191FABG, 191FADG, 191FAE, 191FAG, 1G0FA0, 1G0FA0B, 1G0GRG, 1G0TP0, 1G1CP1G-VERS.2004, 1G1CP2G-VERS.2004, 1G1FA0E, 1G1FA0EV, 1G1FA0G, 1G1FA0GV, 1G1FABG, 1G1FAPG, 1G1TP0G, 290FA, 291FAG, 291FAGF, 291TPCG, 2G0FA0, 2G0FA0A, 2G0FA0B, 2G1FA0E, 2G1FA0G, 2G1FA0GV, 2G1FABG...(Other models you can see in the webshop) |                 |                    |







Зип Общепит

vsezip.ru

+7(812)987-08-81

|   |  |                 |         |
|---|--|-----------------|---------|
|  |  |                 |         |
| 1   |  |                 |         |
| <b>GEV No.</b>  | 112774   | <b>Ref. No.</b> | 3144110 |
| <b>description</b>  | knob gas thermostat t.max. 250°C 100-250°C ø 72mm shaft ø 8x6.5mm shaft flat upper red   |                 |         |
| <b>For models:</b>  | 0G0FT1G-VERS.032008, 0G0FT2G-VERS.032008, 0G0FT4G-VERS.032008, 0G0FT5G-VERS.032008, 0G0FT7G, 1G0FT1G-VERS.032008, 1G0FT2G-VERS.032008, 1G0FT3G-VERS.032008, 1G0FT4G-VERS.032008, 1G0FT6E, 1G0FT6G-VERS.032008, 1G0FT7G |                 |         |

|  |   |                 |                    |
|--|---|-----------------|--------------------|
|  |   |                 |                    |
| 1  |   |                 |                    |
| <b>GEV No.</b>   | 112638  | <b>Ref. No.</b> | 3020250<br>3020251 |
| <b>description</b>   | knob switch 4-position t.max.°C ø 72mm shaft ø 6x4.6mm shaft flat upper red |                 |                    |
| <b>For models:</b>   | 08WFA4E, 08WFAAE, 10WTPGE, 12WFA6E, 12WFAAE, 191FAAE, 191FAE, 191PE4E       |                 |                    |

|   |   |                 |                    |
|---|---|-----------------|--------------------|
|  |   |                 |                    |
| 1   |   |                 |                    |
| <b>GEV No.</b>  | 112641  | <b>Ref. No.</b> | 3010330<br>3010331 |
| <b>description</b>  | knob gas thermostat t.max. 270°C 140-270°C ø 72mm shaft ø 8x6.5mm shaft flat upper red  |                 |                    |
| <b>For models:</b>  | 08WFA4G, 08WFAAG, 08WFT1GV, 08WFT2GV, 08WFT3GV, 08WFT4GV, 08WFT6GV, 08WFT7GV, 090FT1G, 090FT2G, 090FT4G, 090FT5G, 090FT7G, 12WFA6G, 12WFAAG, 190FT15G, 190FT1G, 190FT2G, 190FT3G, 190FT42G, 190FT4G, 190FT6G, 190FT72G, 190FT7G, 191FAAG, 191FABG, 191FADG, 191FAG, 191TPG, 1G1BR1G, 291FAG, 291FAGF, 291TPCG, 391FAG |                 |                    |

|  |  |                 |                    |
|--|--|-----------------|--------------------|
|  |  |                 |                    |
| 1  |  |                 |                    |
| <b>GEV No.</b>   | 112634   | <b>Ref. No.</b> | 3015940<br>3015941 |
| <b>description</b>   | knob switch 5-position t.max.°C ø 72mm shaft ø 6x4.6mm shaft flat upper red              |                 |                    |
| <b>For models:</b>   | 04WPE4V, 08WPE4V, 090PE4, 0G1CP1E-VERS.2004, 190PE4, 191PE4E, 191PI2E, 191PI2EA, 1G1PI1E |                 |                    |

|   |  |                 |                    |
|---|--|-----------------|--------------------|
|  |  |                 |                    |
| 1   |  |                 |                    |
| <b>GEV No.</b>  | 112643   | <b>Ref. No.</b> | 3015990<br>3015991 |
| <b>description</b>  | knob switch 0-10 t.max.°C ø 72mm shaft ø 6x4.6mm shaft flat upper  |                 |                    |
| <b>For models:</b>  | 04WVT1V, 04WVT1IV-VERS.022010, 04WVT2IV, 04WVT2IV-VERS.022010, 08WVT1IV, 08WVT1IV-VERS.112009, 08WVT2IV, 08WVT2IV-VERS.112009, 090VT1I, 090VT1I-VERS.112010, 090VT1W, 090VT1W-VERS.102008, 091VT1I, 091VT1I-VERS.2009, 091VT1W, 091VT2I, 091VT2I-VERS.2009, 0G0VT1I, 0G0VT1I-VERS.112010, 0G0VT1IW, 190VT1I, 190VT1I-VERS.112010, 191VT1I, 191VT1I-VERS.2009, 191VT2I, 191VT2I-VERS.2009, 1G0VT1I, 1G0VT1I-VERS.122010 |                 |                    |

|   |  |                 |         |
|---|--|-----------------|---------|
|  |  |                 |         |
| 1   |  |                 |         |
| <b>GEV No.</b>  | 112635   | <b>Ref. No.</b> | 3015831 |
| <b>description</b>  | knob thermostat t.max. 190°C 110-190°C ø 72mm shaft ø 6x4.6mm shaft flat upper red   |                 |         |
| <b>For models:</b>  | 091FR1E, 091FR1G, 091FR1I, 091FR1I-VERS.032012, 091FR3E, 091FR3G, 091FR7G, 091FR7G-VERS.052012, 0G0FR3E, 0G1FR3G, 191FR2E, 191FR2G, 191FR2I, 191FR2I-VERS.032012, 191FR4E, 191FR4G, 1G0FR4E, 1G1FR4G |                 |         |

|   |  |                 |                    |
|---|--|-----------------|--------------------|
|  |  |                 |                    |
| 1   |  |                 |                    |
| <b>GEV No.</b>  | 112640   | <b>Ref. No.</b> | 3015850<br>3015851 |
| <b>description</b>  | knob switch 0-1-0-1 t.max.°C ø 72mm shaft ø 6x4.6mm shaft flat upper red   |                 |                    |
| <b>For models:</b>  | 04WFR3ED, 06WFR3GD, 08WFR4ED, 08WGREV, 091FR1ED, 091FR1GD, 091FR3ED, 091FR3GD, 0G0FR3ED, 0G1FR3GD, 10WFR4GD, 190GRE, 191FR2ED, 191FR2GD, 191FR4ED, 191FR4GD, 1G0GRE, 1G1FR4GD, 291PI3G, 2A1PI3G, 2D1PI3G |                 |                    |

|  |  |                 |                    |
|--|--|-----------------|--------------------|
|  |  |                 |                    |
| 1  |  |                 |                    |
| <b>GEV No.</b>   | 112797   | <b>Ref. No.</b> | 3015870<br>3015871 |
| <b>description</b>   | knob thermostat t.max. 270°C 110-270°C ø 72mm shaft ø 6x4.6mm shaft flat upper red   |                 |                    |
| <b>For models:</b>   | 06WBR3E, 06WFT1EV, 06WFT2EV, 06WFT3EV, 06WFT4EV, 06WFT6EV, 06WFT7EV, 08WFT1EV, 08WFT2EV, 08WFT3EV, 08WFT4EV, 08WFT6EV, 08WFT7EV, 090FT1E, 090FT2E, 090FT4E, 090FT5E, 090FT7E, 091FT1E, 091FT2E, 091FT4E, 091FT5E, 091FT7E, 0G0FT1E, 0G0FT2E, 0G0FT4E, 0G0FT5E, 0G0FT7E, 0G1BR3E, 0G1FT2E, 0G1FT4E, 0G1FT5E, 0G1FT7E, 190FT15E, 190FT1E, 190FT2E, 190FT3E, 190FT42E, 190FT4E, 190FT5E, 190FT6E, 190FT72E, 190FT7E, 191BR1E, 191BR1G, 191BR1GA, 191BR2E, 191BR2EA, 191BR2G, 191BR2GA...(Other models you can see in the webshop) |                 |                    |

Зип Общепит

vsezip.ru

+7(812)987-08-81



1

|                    |  |                 |                    |
|--------------------|--|-----------------|--------------------|
| <b>GEV No.</b>     | 112639   | <b>Ref. No.</b> | 3015900<br>3015901 |
| <b>description</b> | knob thermostat t.max. 300°C 100-300°C ø 72mm shaft ø 6x4.6mm shaft flat upper red |                 |                    |
| <b>For models:</b> | 08WFA4E, 08WFAAE, 10WTPGE, 12WFA6E, 12WFAAE, 191FAAE, 191FAE, 191PE4E              |                 |                    |



1

|                    |   |                 |         |
|--------------------|---|-----------------|---------|
| <b>GEV No.</b>     | 110141  | <b>Ref. No.</b> | 36M3050 |
| <b>description</b> | knob switch zero mark ø 67mm shaft ø 8x6.5mm shaft flat upper black |                 |         |
| <b>For models:</b> | 030, 031, 032, 31, 31GE, 31TC, 32, 32TC, 32TP, 32TPV, 32V, 60SM     |                 |         |



1

|                    |  |                 |                    |
|--------------------|--|-----------------|--------------------|
| <b>GEV No.</b>     | 112637   | <b>Ref. No.</b> | 3019901<br>3112000 |
| <b>description</b> | knob water t.max. °C ø 72mm shaft ø 6x4.6mm shaft flat upper red   |                 |                    |
| <b>For models:</b> | 04WCP1EM, 06WCP1GM, 08WCP1GM, 091CP1E, 091CP1G, 0G1CP1EC, 0G1CP1E-VERS.2004, 0G1CP1G-VERS.2004, 191CP1G, 191CP2G, 1G1CP1G-VERS.2004, 1G1CP2G-VERS.2004 |                 |                    |



1

|                    |  |                 |         |
|--------------------|--|-----------------|---------|
| <b>GEV No.</b>     | 111745   | <b>Ref. No.</b> | 36M4970 |
| <b>description</b> | knob switch zero mark ø 45mm shaft ø 6x4.6mm shaft flat upper blue/black |                 |         |
| <b>For models:</b> | FCV3EM, FCV4EM   |                 |         |



1

|                    |  |                 |                    |
|--------------------|--|-----------------|--------------------|
| <b>GEV No.</b>     | 110140   | <b>Ref. No.</b> | 36M2390<br>36M5140 |
| <b>description</b> | knob switch zero mark ø 67mm shaft ø 10x9mm shaft flat upper black   |                 |                    |
| <b>For models:</b> | 030FT, 030FTR, 031FT, 031FTR, 031FTRL, 031TP, 070D, 070DGG, 070FT, 070FTR, 0712D, 0712VA, 071D, 071DGG, 071FT, 071FTR, 071FTRL, 071TP, 072D, 072DGG, 090, 090FT, 090FTR, 090GG, 091, 091FT, 091FTR, 091FTRL, 091GG, 091TP, 092, 092GG, 092VA, 092VAGG, 30CPS, 31, 31PD6, 31PI6, 31TC, 31TP, 32, 32TC, 32TP, 32TPV, 32V, 70CP, 712D, 712VA, 71CP, 71CP2...(Other models you can see in the webshop) |                 |                    |



1

|                        |  |                 |         |
|------------------------|--|-----------------|---------|
| <b>GEV No.</b>         | 110925   | <b>Ref. No.</b> | 36M4560 |
| <b>description</b>     | knob switch zero mark ø 45mm shaft ø 6x4.6mm shaft flat upper red  |                 |         |
| <b>For models:</b>     | 030FE1B, 091FE28B, 30F1B, 30FES2B, 30FS2B, 70F1B, 70FE1B, 70FES2, 70FES2B, 71F2B, 71FE2B, 90F110B, 91AR, 91ARE, 91F210B, 91F223B, 91RA, FC101, FC101E, FC241, FC241E, FC241G, FC61, FC61E, FCV101, FCV101-CSA, FCV101E, FCV101E-UL, FCV141, FCV141-CSA, FCV141E, FCV241, FCV241E, FCV241E-UL, FCV241G, FCV241G-CSA, FCV61, FCV61-CSA, FCV61E, FCV61E-UL, FCV72E-UL |                 |         |
| <b>accessories for</b> | 110925   |                 |         |
|                        |   | <b>GEV No.</b>  | 550965  |
|                        |  | <b>Ref. No.</b> | 3170290 |
|                        | knob spring ø 6x4.6mm Qty 1 pcs  |                 |         |



1

|                    |  |                 |         |
|--------------------|--|-----------------|---------|
| <b>GEV No.</b>     | 110142   | <b>Ref. No.</b> | 36M2400 |
| <b>description</b> | knob switch zero mark ø 67mm shaft ø 6x4.6mm shaft flat upper black  |                 |         |
| <b>For models:</b> | 030BME, 030E, 030EBM, 030FE, 030FE1, 030FTE, 030FTE04, 030FTE06, 030FTE08, 031BME, 031E, 031EBM, 031FTE, 031FTE04, 031FTE06, 031FTE08, 031FTE08L, 070BME, 070E, 070FTE, 070FTE04, 070FTE05, 070FTE08, 071BME, 071E, 071FTE, 071FTE04, 071FTE06, 071FTE08, 071FTE08L, 30CPSE, 30F1, 30FES, 30FES2, 30FS2, 31GE, 31PIE6, 31TCE, 32TCE, 60SME, 70CPE, 70F1, 70FE, 70FE1, 70FES, 70FES2, 71E, 71F2, 71FE, 71FE2, 71PIE15, 71PIE15A |                 |         |



1

|                    |  |                 |         |
|--------------------|--|-----------------|---------|
| <b>GEV No.</b>     | 112910   | <b>Ref. No.</b> | 36M5270 |
| <b>description</b> | knob switch zero mark ø 45mm shaft ø 6x4.6mm shaft flat upper silver |                 |         |



Зип Общепит

vsezip.ru

+7(812)987-08-81

|   |   |                 |         |
|---|---|-----------------|---------|
|  |   |                 |         |
| 1   |   |                 |         |
| <b>GEV No.</b>  | 110143  | <b>Ref. No.</b> | 36M0500 |
| <b>description</b>  | knob gas tap with ignition flame ø 65mm shaft ø 10x8mm shaft flat lower black |                 |         |

|  |                                  |                 |         |
|--|----------------------------------|-----------------|---------|
|  |                                  |                 |         |
| 1  |                                  |                 |         |
| <b>GEV No.</b>   | 112860                           | <b>Ref. No.</b> | 3104143 |
| <b>description</b>   | knob ø 60mm shaft ø 6x9mm silver |                 |         |

|   |   |                 |         |
|---|---|-----------------|---------|
|  |   |                 |         |
| 1   |   |                 |         |
| <b>GEV No.</b>  | 110292  | <b>Ref. No.</b> | 36M2800 |
| <b>description</b>  | cover cap switch zero mark t.max.°C ø 32mm shaft ø 6mm shaft flat red knob  |                 |         |
| <b>For models:</b>  | 031FT04, 031FT06, 070BM, 070FT04, 070FT05, 071BM, 071FT04, 071FT06, 090BM, 090FT04, 090FT05, 091BM, 091FT04, 091FT06, 30F, 30FS, 31R, 31RE, 70F, 712D, 712VA, 71AR, 71ARE, 71D, 71DGG, 71E, 71F, 71GE, 71GEGG, 71RA, 71TP, 72D, 72DGG, 72TP, 72TPGG, 72VA, 72VAGG, 72VAS, 72VASGG, 73D, 73DGG, 73VA, 73VAD, 73VADGG, 73VAGG, A12A1E, A12B1E, A12B2E, A12M1E, A12Z1E...(Other models you can see in the webshop) |                 |         |

|  |  |                 |                    |
|--|--|-----------------|--------------------|
|  |  |                 |                    |
| 1  |  |                 |                    |
| <b>GEV No.</b>   | 112570   | <b>Ref. No.</b> | 36H0900<br>36H0901 |
| <b>description</b>   | knob potentiometer ø 62mm shaft ø 6x4.6mm shaft flat universal black   |                 |                    |
| <b>For models:</b>   | FM1011E1, FM1011E1-VERS.2006, FM1011E2, FM1011E2-VERS.2006, FM1011E3, FM1011E3-VERS.2006, FM1011G1, FM1011G1-VERS.2006, FM1011G2, FM1011G2-VERS.2006, FM1011G3, FM1011G3-VERS.2006, FM1221E1, FM1221E1-VERS.2006, FM1221E2, FM1221E2-VERS.2006, FM1221E3, FM1221E3-VERS.2006, FM1221G1, FM1221G1-VERS.2006, FM1221G2, FM1221G2-VERS.2006, FM1221G3, FM1221G3-VERS.2006, FM2011E2-VERS.2006, FM2011E3-VERS.2006, FM2011G2-VERS.2006, FM2011G3-VERS.2006, FM2021E1, FM2021E2, FM2021E2-VERS.2006, FM2021E3, FM2021E3-VERS.2006, FM2021G1, FM2021G2, FM2021G2-VERS.2006, FM2021G3, FM2021G3-VERS.2006, FM423E1, FM423E2, FM611E1, FM611E1-VERS.2006, FM611E2, FM611E2-VERS.2006, FM611E3, FM611E3-VERS.2006, FM611G1, FM611G1-VERS.2006, FM611G2, FM611G2-VERS.2006...(Other models you can see in the webshop) |                 |                    |

|  |  |                 |         |
|--|--|-----------------|---------|
|  |  |                 |         |
| 1  |  |                 |         |
| <b>GEV No.</b>   | 110293   | <b>Ref. No.</b> | 36M2580 |
| <b>description</b>   | knob gas regulator t.max.°C ø 44mm shaft ø Minisitmm black   |                 |         |
| <b>For models:</b>   | 031FT04, 031FT06, 070BM, 070FT04, 070FT05, 071BM, 071FT04, 071FT06, 090BM, 090FT04, 090FT05, 091BM, 091FT04, 091FT06, 1G1BR1G, 30F, 30FS, 31R, 70F, 712D, 712VA, 71D, 71DGG, 71F, 71TP, 72D, 72DGG, 72TP, 72TPGG, 72VA, 72VAGG, 72VAS, 72VASGG, 73D, 73DGG, 73VA, 73VAD, 73VADGG, 73VAGG, F530 |                 |         |

|  |   |                 |             |
|--|---|-----------------|-------------|
|  |   |                 |             |
| 1  |   |                 |             |
| <b>GEV No.</b>   | 111213  | <b>Ref. No.</b> | 36M1590 alt |
| <b>description</b>   | knob switch zero mark ø 38mm shaft ø 6x4.6mm shaft flat lower black |                 |             |

|   |  |                 |         |
|---|--|-----------------|---------|
|  |  |                 |         |
| 1   |  |                 |         |
| <b>GEV No.</b>  | 110294   | <b>Ref. No.</b> | 36M2620 |
| <b>description</b>  | knob t.max.°C ø 44mm shaft ø 8x5.5mm shaft flat universal black  |                 |         |
| <b>For models:</b>  | 31RE, 71AR, 71ARE, 71E, 71GE, 71GEGG, 71RA, A12A1E, A12B1E, A12B2E, A12M1E, A12Z1E, A12Z2E, A14A1E, A14B1E, A14B2E, A14M1E, A14Z1E, A14Z2E, A16A1E, A16B1E, A16B2E, A16M1E, A16Z1E, A16Z2E, A18A1E, A18B1E, A18B2E, A18M1E, A18Z1E, A18Z2E, A20A1E, A20B1E, A20B2E, A20M1E, A20Z1E, A20Z2E, ACBM, ACBM218, ACPN, ACPN218, AJ12AE, AJ12ME, AJ14AE, AJ14ME, AJ16AE, AJ16ME, AJ18AE, AJ18ME, AJ20AE...(Other models you can see in the webshop) |                 |         |

|  |  |                 |         |
|--|--|-----------------|---------|
|  |  |                 |         |
| 1  |  |                 |         |
| <b>GEV No.</b>   | 111215   | <b>Ref. No.</b> | 36M1511 |
| <b>description</b>   | knob switch zero mark ø 38mm shaft ø 6x4.6mm shaft flat upper black            |                 |         |
| <b>For models:</b>   | F60P, F60PR, F60T, F80P, F80PR, L100, L40, L40S, L45, L60, L80, SM-1LAM, SM1LM |                 |         |

Зип.Общепит

gaskets

vsezip.ru

+7(812)987-08-81

mechanical components, equipment accessories



1

|                    |   |                 |         |
|--------------------|---|-----------------|---------|
| <b>GEV No.</b>     | 111212  | <b>Ref. No.</b> | 36M1800 |
| <b>description</b> | knob switch zero mark ø 40mm shaft ø 6x4.6mm shaft flat upper black |                 |         |



1

|                    |   |                 |         |
|--------------------|---|-----------------|---------|
| <b>GEV No.</b>     | 111218  | <b>Ref. No.</b> | 36M4620 |
| <b>description</b> | knob switch zero mark ø 44mm shaft ø 6x4.6mm shaft flat upper black |                 |         |
| <b>For models:</b> | K16APGPZ, K16XPZAP, SA16AGB, SA16GB, SI14VB, SI21VB                 |                 |         |



1

|                        |  |                 |                 |   |
|------------------------|--|-----------------|-----------------|---|
| <b>GEV No.</b>         | 110918   | <b>Ref. No.</b> | 36M4710         |   |
| <b>description</b>     | knob switch zero mark ø 45mm shaft ø 6x6mm black |                 |                 |   |
| <b>accessories for</b> | 110918   |                 |                 |   |
|                        | <b>GEV No.</b>                                   | 510923          | <b>Ref. No.</b> | — |
|                        | clamping ring for shaft ø 10mm ID ø 9.4mm H 6mm  |                 |                 |   |

### accessories

#### button springs



1

|                    |   |                 |         |
|--------------------|---|-----------------|---------|
| <b>GEV No.</b>     | 550965  | <b>Ref. No.</b> | 3170290 |
| <b>description</b> | knob spring ø 6x4.6mm Qty 1 pcs   |                 |         |
| <b>For models:</b> | 030BME, 030E, 030EBM, 030FE, 030FE1, 030FE1B, 030FTE, 030FTER, 031BME, 031E, 031EBM, 031FTE, 031FTE04, 031FTE06, 031FTER, 031FTERL, 070BME, 070E, 070FTE, 070FTE04, 070FTE05, 070FTER, 071BME, 071E, 071FTE, 071FTE04, 071FTE06, 071FTER, 071FTERL, 090BME, 090E, 090FTE, 090FTE04, 090FTE05, 090FTER, 090SPE, 091BME, 091E, 091FE28, 091FE28B, 091FR1ED, 091FR3ED, 091FTE, 091FTE04, 091FTE06, 091FTER, 091FTERL, 0A0BME, 0A0FT1E, 0A0FT2E...(Other models you can see in the webshop) |                 |         |

|                    |   |                 |         |
|--------------------|---|-----------------|---------|
| <b>GEV No.</b>     | 550493  | <b>Ref. No.</b> | 3150790 |
| <b>description</b> | gasket for knob   |                 |         |
| <b>For models:</b> | 030E, 030EBM, 030FE1, 030FE1B, 030FTE, 030FTER, 031E, 031EBM, 031FTE04, 031FTE06, 04WCP1EM, 06WFR3GD, 070E, 070FTE04, 070FTE05, 071E, 071FTE04, 071FTE06, 08WCP1GM, 08WFAAE, 090, 090BM, 090BME, 090E, 090FT, 090FTE04, 090FTE05, 090FTR, 090GG, 091, 091BM, 091BME, 091CP1E, 091CP1G, 091E, 091FE28, 091FE28B, 091FR1E, 091FR1ED, 091FR1GD, 091FR3G, 091FR3GD, 091FT, 091FTE04, 091FTE06, 091FTR, 091FTRL, 091GG, 091TP, 092...(Other models you can see in the webshop) |                 |         |

|                    |   |        |                 |         |
|--------------------|---|--------|-----------------|---------|
|                    | <b>GEV No.</b>  | 101729 | <b>Ref. No.</b> | 3152250 |
| <b>description</b> | gasket knob D1 ø 70mm D2 ø 7mm thickness 1mm equiv. no. 3152250 suitable for ANGELO PO  |        |                 |         |
| <b>For models:</b> | 04WFAAV, 06WCP1GM, 08WCP1GM, 08WFA4E, 08WFA4G, 08WFAAE, 08WFAAG, 08WFAAV, 08WFT1GV, 08WFT2GV, 08WFT3GV, 08WFT4GV, 08WFT6GV, 08WFT7GV, 08WGRGV, 090BM1G, 090FT1G, 090FT2G, 090FT4G, 090FT5G, 090FT7G, 090GRG, 091CP1G, 0A0BMG, 0A0FA1, 0A0FA4, 0A0FAA, 0A0FAS, 0A0FAVA, 0A0FT1G, 0A0FT2G, 0A0FT4G, 0A0FT5G, 0A0GRG, 0A1CP1G, 0B0FAS, 0B0FT1G, 0B0FT2G, 0B0FT4G, 0B0FT5G, 0B1CP1G, 0D0BMG, 0D0FA1, 0D0FA4, 0D0FAA, 0D0FAS, 0D0FAVA, 0D0FT1G, 0D0FT2G, 0D0FT4G...(Other models you can see in the webshop) |        |                 |         |

## handles and hand wheels

### hand wheels

#### hand wheels



1

|                        |  |                 |                 |         |
|------------------------|--|-----------------|-----------------|---------|
| <b>GEV No.</b>         | 514026   | <b>Ref. No.</b> | 36M4910         |         |
| <b>description</b>     | hand wheel ø 160mm D1 ø 40mm bore ø 16mm thread M8 hole distance 9mm groove widthmm L1 22mm L2 50mm handle length 75mm with folding handle |                 |                 |         |
| <b>For models:</b>     | 1G1BR1E, 1G1BR1G, 31R, 31RE  |                 |                 |         |
| <b>accessories for</b> | 514026   |                 |                 |         |
|                        | <b>GEV No.</b>   | 560224          | <b>Ref. No.</b> | 31W0020 |
|                        | grub screw thread M8 L 10mm WS 4 Qty 1 pcs   |                 |                 |         |



Зип Общежит  
cone handles

vsezip.ru

+7(812)987-08-81



1

|                    |  |                 |                    |
|--------------------|--|-----------------|--------------------|
| <b>GEV No.</b>     | 694634   | <b>Ref. No.</b> | 3214440<br>3342840 |
| <b>description</b> | hand wheel ø 200mm D1 ø 48mm bore ø 16mm depth of bore 34mm thread groove widthmm L1 29mm L2 55mm handle length 80mm with folding handle plastic   |                 |                    |
| <b>For models:</b> | 191BR1E, 191BR1G, 191BR2E, 191BR2G, 1A1BR1E, 1A1BR1G, 1A1BR2E, 1A1BR2G, 1D1BR1E, 1D1BR1G, 1D1BR2E, 1D1BR2G, 291BR1E, 291BR1G, 291BR2E, 291BR2G, 2A1BR1E, 2A1BR1G, 2A1BR2E, 2A1BR2G, 2D1BR1E, 2D1BR1G, 2D1BR2E, 2D1BR2G |                 |                    |



1

|                        |  |                 |                               |
|------------------------|--|-----------------|-------------------------------|
| <b>GEV No.</b>         | 690249   | <b>Ref. No.</b> | 36M5560<br>36M5561<br>36M5562 |
| <b>description</b>     | hand wheel ø 200mm D1 ø 48mm bore ø 20mm hole ø 7mm thread hole distance 11mm groove widthmm L1 30mm L2 60mm handle length 82mm with folding handle  |                 |                               |
| <b>For models:</b>     | 191BR1E, 191BR1G, 191BR2E, 191BR2G, 1A1BR1E, 1A1BR1G, 1A1BR2E, 1A1BR2G, 1D1BR1E, 1D1BR1G, 1D1BR2E, 1D1BR2G, 291BR1E, 291BR1G, 291BR2E, 291BR2G, 2A1BR1E, 2A1BR1G, 2A1BR2E, 2A1BR2G, 2D1BR1E, 2D1BR1G, 2D1BR2E, 2D1BR2G |                 |                               |
| <b>spare parts for</b> | 690249   |                 |                               |
|                        |   | <b>GEV No.</b>  | 514255                        |
|                        |  | <b>Ref. No.</b> | —                             |
|                        | folding handle ø 26mm total length 85mm seat ø 20mm shaft ømm thread M6 with pin L 85mm  |                 |                               |

cylindrical handles

fixed



1

|                    |   |                 |         |
|--------------------|---|-----------------|---------|
| <b>GEV No.</b>     | 514065  | <b>Ref. No.</b> | 36M5750 |
| <b>description</b> | cylindrical handle thread M12 ø 23mm L 65mm   |                 |         |
| <b>For models:</b> | 091FR1E, 091FR1EA, 091FR1ED, 0A1FR1E, 0A1FR1ED, 0D1FR1E, 0D1FR1ED, 191FR2E, 191FR2ED, 1A1FR2E, 1A1FR2ED, 1D1FR2ED |                 |         |



1

|                    |   |                 |         |
|--------------------|---|-----------------|---------|
| <b>GEV No.</b>     | G94633  | <b>Ref. No.</b> | 3000900 |
| <b>description</b> | cone handle thread M8x1.25 ø 28mm plastic L 105mm black thread L 25mm   |                 |         |
| <b>For models:</b> | 08WGRGV, 090GRG, 0A0GRG, 0D0GRG, 190GRG, 191PD1G, 191PD2G, 191PI1G, 191PI1GA, 191PI2E, 191PI2EA, 191PI2G, 191PI2GA, 191PI2V, 191PI2VA, 1A0GRG, 1D0GRG, 1G0GRG |                 |         |

handle bars

handle bars



1

|                    |                           |                 |         |
|--------------------|---------------------------|-----------------|---------|
| <b>GEV No.</b>     | 691148                    | <b>Ref. No.</b> | 36M4830 |
| <b>description</b> | handle rod H 40mm L 450mm |                 |         |



1

|                    |   |                 |         |
|--------------------|---|-----------------|---------|
| <b>GEV No.</b>     | 691149  | <b>Ref. No.</b> | 36M2441 |
| <b>description</b> | handle rod H 40mm L 615mm   |                 |         |
| <b>For models:</b> | 712D, 712VA, 71D, 71DGG, 71E, 71GE, 71GEGG, 71TP, 72D, 72DGG, 72TP, 72TPGG, 72VA, 72VAGG, 72VAS, 72VASGG, 73D, 73DGG, 73VA, 73VAD, 73VADGG, 73VAGG, FS30, FS30E |                 |         |

consoles



1

|                    |  |                 |         |
|--------------------|--|-----------------|---------|
| <b>GEV No.</b>     | 691135   | <b>Ref. No.</b> | 36M2910 |
| <b>description</b> | console for door handle  |                 |         |
| <b>For models:</b> | 091T, 60SM, 60SME, 70CP, 70CPE, 70F, 70F1, 70F1B, 70FE, 70FE1, 70FE1B, 70FES, 70FES2, 70FES2B, 712D, 712VA, 71CP, 71CP2, 71D, 71DGG, 71E, 71F, 71F2, 71F2B, 71FE, 71FE2, 71FE2B, 71GE, 71GEGG, 71TP, 72D, 72DGG, 72TP, 72TPGG, 72VA, 72VAGG, 72VAS, 72VASGG, 73D, 73DGG, 73VA, 73VAD, 73VADGG, 73VAGG, 90CP, 90CPE, 91CP, 91F223B, FS30, FS30E |                 |         |

Зип Общепит

vsezip.ru

+7(812)987-08-81

|   |                   |                 |         |
|---|-------------------|-----------------|---------|
|  |                   |                 |         |
| 1   |                   |                 |         |
| <b>GEV No.</b>  | 690297            | <b>Ref. No.</b> | 36D0230 |
| <b>description</b>  | console Qty 1 pcs |                 |         |

|  |  |                 |         |
|--|--|-----------------|---------|
|  |  |                 |         |
| 1  |  |                 |         |
| <b>GEV No.</b>   | 690451   | <b>Ref. No.</b> | 36M4040 |
| <b>description</b>   | pull handle L 426mm H 40mm mounting distance 376mm black |                 |         |
| <b>For models:</b>   | 40EVP, 40PV, 40XPV, 55PV                                 |                 |         |

### handle rails

#### ANGELO PO

|   |  |                 |         |
|---|--|-----------------|---------|
|  |  |                 |         |
| 1   |  |                 |         |
| <b>GEV No.</b>  | 691153   | <b>Ref. No.</b> | 36M3590 |
| <b>description</b>  | handle rail hole distance 650mm                                |                 |         |
| <b>For models:</b>  | 31, 31GE, 31TC, 31TCE, 31TP, 32, 32TC, 32TCE, 32TP, 32TPV, 32V |                 |         |

### covers

|  |                          |                 |         |
|--|--------------------------|-----------------|---------|
|  |                          |                 |         |
| 1  |                          |                 |         |
| <b>GEV No.</b>   | 691158                   | <b>Ref. No.</b> | 3002970 |
| <b>description</b>   | cover for handle plastic |                 |         |
| <b>For models:</b>   | PG22C, PG23CW            |                 |         |

### handle rails

|   |  |                 |         |
|---|--|-----------------|---------|
|  |  |                 |         |
| 1   |  |                 |         |
| <b>GEV No.</b>  | 691153   | <b>Ref. No.</b> | 36M3590 |
| <b>description</b>  | handle rail hole distance 650mm                                |                 |         |
| <b>For models:</b>  | 31, 31GE, 31TC, 31TCE, 31TP, 32, 32TC, 32TCE, 32TP, 32TPV, 32V |                 |         |

### fasteners

#### locking screws

|   |                          |                 |                         |
|---|--------------------------|-----------------|-------------------------|
|  |                          |                 |                         |
| 1   |                          |                 |                         |
| <b>GEV No.</b>  | 514387                   | <b>Ref. No.</b> | 36M0840                 |
| <b>description</b>  | locking screw            |                 |                         |
| <b>accessories for</b>  | 514387                   |                 |                         |
|  | <b>GEV No.</b>           | 514386          | <b>Ref. No.</b> 36M0830 |
|   | closing clamp for kettle |                 |                         |

### bracket handles

|   |  |                 |  |
|---|--|-----------------|--|
|  |  |                 |  |
| 1   |  |                 |  |
| <b>GEV No.</b>  | 692176   | <b>Ref. No.</b> | 3010570<br>3010571<br>3010572<br>3010573 |
| <b>description</b>  | pull handle L 295mm H 40mm mounting distance 255mm thread M5 chrome-plated   |                 |  |
| <b>For models:</b>  | 04WBMEV, 04WCP1EM, 04WF AAV, 04WFR3ED, 04WPE4V, 04WPEBV, 04WVT1IV, 04WVT1IV-VERS.022010, 04WVT2IV, 04WVT2IV-VERS.022010, 04WVT3RV, 06WBR3E, 06WCP1GM, 06WFR3GD, 06WFT1EV, 06WFT2EV, 06WFT3EV, 06WFT4EV, 06WFT6EV, 06WFT7EV, 08WCP1GM, 08WF AAV, 08WFR4ED, 08WFT1EV, 08WFT1GV, 08WFT2EV, 08WFT2GV, 08WFT3EV, 08WFT3GV, 08WFT4EV, 08WFT4GV, 08WFT6EV, 08WFT6GV, 08WFT7EV, 08WFT7GV, 08WGRGV, 08WPE4V, 08WPEBV, 08WTPEV, 08WVT1IV, 08WVT1IV-VERS.112009, 08WVT2IV, 08WVT2IV-VERS.112009, 091CP1E, 091CP1G, 091FR1E, 091FR1EA, 091FR1ED, 091FR1EX, 091FR1G...(Other models you can see in the webshop) |                 |  |

### miscellaneous

|  |                       |                 |         |
|--|-----------------------|-----------------|---------|
|  |                       |                 |         |
| 1  |                       |                 |         |
| <b>GEV No.</b>   | 110146                | <b>Ref. No.</b> | 36M1100 |
| <b>description</b>   | handle L 195mm W 65mm |                 |         |



Зип Общепит  
vsezip.ru  
+7(812)987-08-81

|   |  |                 |         |
|---|--|-----------------|---------|
|  |  |                 |         |
| 1   |  |                 |         |
| <b>GEV No.</b>  | 691193   | <b>Ref. No.</b> | 36M4640 |
| <b>description</b>  | handle thread M5   |                 |         |
| <b>For models:</b>  | BRPRV, BRVRV, SE14PRV, SE14VRV, S114PRV, S114VRV, SL14RPRV, SL14RVRV, TPRV, TVRV |                 |         |

|   |  |                 |                    |
|---|--|-----------------|--------------------|
|  |  |                 |                    |
| 1   |  |                 |                    |
| <b>GEV No.</b>  | 690662   | <b>Ref. No.</b> | 36M0140<br>36M5020 |
| <b>description</b>  | key cylinder with slide latch ø 23mm thread M19x1 cam width 11mm mounting measurements 16.5x19mm hub 20-28mm thread L 15mm   |                 |                    |
| <b>For models:</b>  | 135, 135-4, 135A, 135B, 135BA, 135BN, 135BNX, 135BX, 135BXE, 135BXR, 135CPX, 135NN, 135NNX, 135PVX, 135X, 135X-3, 135X-4, 135XE, 135XR, 40B, 40CP, 40CPX, 40EV, 40EVP, 65, 65A, 65B, 65BA, 65BX, 65BX-2, 65BXE, 65BXR, 65NB, 65NBX, 65NN, 65NNX, 65PVX, 65X, 65X-2, 65XE, 65XR, S125, S125-4, S125B, S125B-4, S125BE, S125BX, S125BX-4, S125E, S125X...(Other models you can see in the webshop) |                 |                    |

accessories







miscellaneous

|   |  |                 |         |
|---|--|-----------------|---------|
|  |  |                 |         |
| 1   |  |                 |         |
| <b>GEV No.</b>  | 691134   | <b>Ref. No.</b> | 36M3720 |
| <b>description</b>  | spacer piece for door handle   |                 |         |
| <b>For models:</b>  | 30CPS, 30CPSE, 30F1, 30F1B, 30FES2, 30FES2B, 30FS2, 30FS2B, 31, 31GE, 31TC, 31TCE, 31TP, 32, 32TC, 32TCE, 32TP, 32TPV, 32V |                 |         |

turning lever locks

universal

RAHRBACH



|   |  |                 |  |
|---|--|-----------------|--|
|   |  |                 |  |
| 1   |  |                 |  |
| <b>GEV No.</b>  | 690500   | <b>Ref. No.</b> | 36M0880<br>36M3180<br>36M6380<br>6300421 |
| <b>description</b>  | handle latch right L 185mm H 66mm handle material plastic type 6300 series   |                 |  |
| <b>For models:</b>  | FC101, FC101E, FC241, FC241E, FC241G, FC61, FC61E, FCV101, FCV101-CSA, FCV101DM, FCV101DM-CSA, FCV101DS, FCV101DS-CSA, FCV101E, FCV101EDM, FCV101EDM-UL, FCV101EDS, FCV101EDS-UL, FCV101E-UL, FCV141, FCV141-CSA, FCV141DM, FCV141DM-CSA, FCV141DS, FCV141DS-CSA, FCV141E, FCV141EDM, FCV141EDS, FCV241, FCV241DM, FCV241DS, FCV241E, FCV241EDM, FCV241EDM-UL, FCV241EDS, FCV241EDS-UL, FCV241E-UL, FCV241G, FCV241G-CSA, FCV241GDM, FCV241GDM-CSA, FCV241GDS, FCV241GDS-CSA, FCV401DM, FCV401DM-CSA, FCV401EDM, FCV401EDM-UL, FCV61, FCV61-CSA, FCV61DM...(Other models you can see in the webshop) |                 |  |
| <b>spare parts for</b>  | 690500   |                 |  |
|  | <b>GEV No.</b>   | 699841          | <b>Ref. No.</b> —                        |
|   | cover cap for turning lever lock ø 32mm H 14mm   |                 |  |
| <b>accessories for</b>  | 690500   |                 |  |
|  | <b>GEV No.</b>   | 514281          | <b>Ref. No.</b> 36M1570                  |
|   | base plate L 110mm W 35mm for door catch thickness 10mm  |                 |  |
|  | <b>GEV No.</b>   | 690136          | <b>Ref. No.</b> 3FL0197                  |
|   | sliding plate mounting pos. right L 28mm H 3mm W 21mm H2 12.5mm  |                 |  |
|  | <b>GEV No.</b>   | 691174          | <b>Ref. No.</b> 35V9050                  |
|   | counterpart L 90mm W 60mm for door latch   |                 |  |
|  | <b>GEV No.</b>   | 700091          | <b>Ref. No.</b> —                        |
|   | door catch mounting pos. right off-set 20mm L 110mm H 56mm W 33mm mounting distance 68/68mm zinc die cast series 6300  |                 |  |
|  | <b>GEV No.</b>   | 700098          | <b>Ref. No.</b> 36M0820                  |
|   | door catch mounting pos. right off-set 38mm L 110mm H 74mm W 33mm mounting distance 68/68mm series 1750  |                 |  |

locks

locking devices

producer-specific

ANGELO PO

|   |   |                 |                   |
|---|---|-----------------|-------------------|
|  |   |                 |                   |
| 1   |   |                 |                   |
| <b>GEV No.</b>  | 690462  | <b>Ref. No.</b> | 36M7070           |
| <b>description</b>  | key cylinder ø 23mm thread M19x1 mounting measurements 16.5x19mm hub 38-45mm shaft ø 11mm thread L 12mm   |                 |                   |
| <b>For models:</b>  | AF1B, AF1B-OPR01, AF1N, AF1N-OPR01, AF2B, AF2B-OPR01, AF2N, AF2N-OPR01, AGL6B, CX120, CX120B, CX120NN, CX130, CX130B, CX130NN, CX140, CX140B, CX140BN, CX140BR, CX140CP, CX140NN, CX140R, CX150, CX150B, CX150BN, CX150BR, CX150CP, CX150NN, CX150R, CX55, CX55B, CX60, CX60B, CX65, CX652, CX65B, CX65BR, CX65NB, CX65NCP, CX65NN, CX65R, CX70, CX702, CX70B, CX70BR, CX70NB, CX70NN, CX70R, FG2B, FSD1B...(Other models you can see in the webshop) |                 |                   |
| <b>spare parts for</b>  | 690462  |                 |                   |
|  | <b>GEV No.</b>  | 691589          | <b>Ref. No.</b> — |
|   | spare keys for key cylinder 690462 key number 9233  |                 |                   |

Зип-Общепит

vsezip.ru



+7(812)987-08-81

|   |  |                         |
|---|--|-------------------------|
|  | <b>GEV No.</b> 700098  | <b>Ref. No.</b> 36M0820 |
| <b>description</b>  | door catch mounting pos. right off-set 38mm L 110mm H 74mm W 33mm mounting distance 68/68mm series 1750  |                         |
| <b>For models:</b>  | FC101, FC101E, FC241, FC241E, FC241G, FC61, FC61E, FCV101, FCV101-CSA, FCV101DM, FCV101DM-CSA, FCV101DS, FCV101DS-CSA, FCV101E, FCV101EDM, FCV101EDM-UL, FCV101EDS, FCV101EDS-UL, FCV101E-UL, FCV141, FCV141-CSA, FCV141DM, FCV141DM-CSA, FCV141DS, FCV141DS-CSA, FCV141E, FCV141EDM, FCV141EDS, FCV241, FCV241DM, FCV241DS, FCV241E, FCV241EDM, FCV241EDM-UL, FCV241EDS, FCV241EDS-UL, FCV241E-UL, FCV241G, FCV241G-CSA, FCV241GDM, FCV241GDM-CSA, FCV241GDS, FCV241GDS-CSA, FCV401DM, FCV401DM-CSA, FCV401EDM, FCV401EDM-UL, FCV61, FCV61-CSA, FCV61DM...(Other models you can see in the webshop) |                         |
| <b>spare parts for</b>  | 700098   |                         |
|  | <b>GEV No.</b> 690136  | <b>Ref. No.</b> 3FL0197 |
| <b>accessories for</b>  | 700098   |                         |
|  | <b>GEV No.</b> 514281  | <b>Ref. No.</b> 36M1570 |
|   | base plate L 110mm W 35mm for door catch thickness 10mm  |                         |

|   |   |                                    |
|---|---|------------------------------------|
|  | <b>GEV No.</b> 690137   | <b>Ref. No.</b> 36E2530<br>6300843 |
| <b>description</b>  | sliding plate mounting pos. left L 28mm H 3mm W 21mm H2 12.5mm  |                                    |
| <b>For models:</b>  | FC101, FC1011E, FC1011G, FC101E, FC1221E, FC1221G, FC241, FC241E, FC241G, FC61, FC611E, FC611G, FC61E, FCV101, FCV101DM, FCV101DS, FCV101E, FCV101EDM, FCV101EDS, FCV141, FCV141DM, FCV141DS, FCV141E, FCV141EDM, FCV141EDS, FCV241, FCV241DM, FCV241DS, FCV241E, FCV241EDM, FCV241EDS, FCV241G, FCV241GDM, FCV241GDS, FCV401DM, FCV401EDM, FCV61, FCV61DM, FCV61DS, FCV61E, FCV61EDM, FCV61EDS, FM1011E1, FM1011E1-VERS.2006, FM1011E2, FM1011E2-VERS.2006, FM1011E3, FM1011E3-VERS.2006, FM1011G1, FM1011G1-VERS.2006...(Other models you can see in the webshop) |                                    |

|   |  |                         |
|---|--|-------------------------|
|  | <b>GEV No.</b> 690136  | <b>Ref. No.</b> 3FL0197 |
| <b>description</b>  | sliding plate mounting pos. right L 28mm H 3mm W 21mm H2 12.5mm  |                         |
| <b>For models:</b>  | FCV101-CSA, FCV101DM-CSA, FCV101DS-CSA, FCV101EDM-UL, FCV101EDS-UL, FCV101E-UL, FCV141-CSA, FCV141DM-CSA, FCV141DS-CSA, FCV241EDM-UL, FCV241EDS-UL, FCV241E-UL, FCV241G-CSA, FCV241GDM-CSA, FCV241GDS-CSA, FCV401DM-CSA, FCV401EDM-UL, FCV61-CSA, FCV61DM-CSA, FCV61DS-CSA, FCV61EDM-UL, FCV61EDS-UL, FCV61E-UL, FCV72EDM-UL, FCV72EDS-UL, FCV72E-UL |                         |

|   |  |                         |
|---|--|-------------------------|
|  | <b>GEV No.</b> 700098  | <b>Ref. No.</b> 36M0820 |
| <b>description</b>  | door catch mounting pos. right off-set 38mm L 110mm H 74mm W 33mm mounting distance 68/68mm series 1750  |                         |
| <b>For models:</b>  | FC101, FC101E, FC241, FC241E, FC241G, FC61, FC61E, FCV101, FCV101-CSA, FCV101DM, FCV101DM-CSA, FCV101DS, FCV101DS-CSA, FCV101E, FCV101EDM, FCV101EDM-UL, FCV101EDS, FCV101EDS-UL, FCV101E-UL, FCV141, FCV141-CSA, FCV141DM, FCV141DM-CSA, FCV141DS, FCV141DS-CSA, FCV141E, FCV141EDM, FCV141EDS, FCV241, FCV241DM, FCV241DS, FCV241E, FCV241EDM, FCV241EDM-UL, FCV241EDS, FCV241EDS-UL, FCV241E-UL, FCV241G, FCV241G-CSA, FCV241GDM, FCV241GDM-CSA, FCV241GDS, FCV241GDS-CSA, FCV401DM, FCV401DM-CSA, FCV401EDM, FCV401EDM-UL, FCV61, FCV61-CSA, FCV61DM...(Other models you can see in the webshop) |                         |
| <b>accessories for</b>  | 700098   |                         |
|  | <b>GEV No.</b> 514281  | <b>Ref. No.</b> 36M1570 |
|   | base plate L 110mm W 35mm for door catch thickness 10mm  |                         |

|   |  |                                    |  |
|---|--|------------------------------------|--|
| <b>producer-specific</b>  |  |                                    |  |
| <b>ANGELO PO</b>  |  |                                    |  |
|    | <b>GEV No.</b> 694640  | <b>Ref. No.</b> 36E2580<br>36E2581 |  |
| <b>description</b>  | door catch H 42mm mounting pos. left L 98mm W 42mm for turning lever lock  |                                    |  |
| <b>For models:</b>  | FC1011E, FC1011G, FC1221E, FC1221G, FC611E, FC611G, FM1011E1, FM1011E1-VERS.2006, FM1011E2, FM1011E2-VERS.2006, FM1011E3, FM1011E3-VERS.2006, FM1011G1, FM1011G1-VERS.2006, FM1011G2, FM1011G2-VERS.2006, FM1011G3, FM1011G3-VERS.2006, FM1221E1, FM1221E1-VERS.2006, FM1221E2, FM1221E2-VERS.2006, FM1221E3, FM1221E3-VERS.2006, FM1221G1, FM1221G1-VERS.2006, FM1221G2, FM1221G2-VERS.2006, FM1221G3, FM1221G3-VERS.2006, FM2011E2-VERS.2006, FM2011E3-VERS.2006, FM2011G2-VERS.2006, FM2011G3-VERS.2006, FM2021E1, FM2021E2, FM2021E2-VERS.2006, FM2021E3, FM2021E3-VERS.2006, FM2021G1, FM2021G2, FM2021G2-VERS.2006, FM2021G3, FM2021G3-VERS.2006, FM611E1, FM611E1-VERS.2006, FM611E2, FM611E2-VERS.2006, FM611E3, FM611E3-VERS.2006...(Other models you can see in the webshop) |                                    |  |
| <b>accessories for</b>  | 694640   |                                    |  |
|  | <b>GEV No.</b> 694227  | <b>Ref. No.</b> 36E2570            |  |
|   | handle latch convection oven   |                                    |  |







Зип Общепит

vsezip.ru



+7(812)987-08-81

|   |   |  |                    |        |                 |                    |   |
|---|---|--|--------------------|--------|-----------------|--------------------|---|
|  |   |  |                    |        |                 |                    |   |
| 1   |   |  |                    |        |                 |                    |   |
| <b>GEV No.</b>  | 694227  | <b>Ref. No.</b>  | 36E2570            |        |                 |                    |   |
| <b>description</b>  | handle latch convection oven  |  |                    |        |                 |                    |   |
| <b>For models:</b>  | FC1011E, FC1011G, FC1221E, FC1221G, FC611E, FC611G, FM1011E1, FM1011E1-VERS.2006, FM1011E2, FM1011E2-VERS.2006, FM1011E3, FM1011E3-VERS.2006, FM1011G1, FM1011G1-VERS.2006, FM1011G2, FM1011G2-VERS.2006, FM1011G3, FM1011G3-VERS.2006, FM1221E1, FM1221E1-VERS.2006, FM1221E2, FM1221E2-VERS.2006, FM1221E3, FM1221E3-VERS.2006, FM1221G1, FM1221G1-VERS.2006, FM1221G2, FM1221G2-VERS.2006, FM1221G3, FM1221G3-VERS.2006, FM2011E2-VERS.2006, FM2011E3-VERS.2006, FM2011G2-VERS.2006, FM2011G3-VERS.2006, FM2021E1, FM2021E2, FM2021E2-VERS.2006, FM2021E3, FM2021E3-VERS.2006, FM2021G1, FM2021G2, FM2021G2-VERS.2006, FM2021G3, FM2021G3-VERS.2006, FM611E1, FM611E1-VERS.2006, FM611E2, FM611E2-VERS.2006, FM611E3, FM611E3-VERS.2006... (Other models you can see in the webshop) |  |                    |        |                 |                    |   |
| <b>accessories for</b>  | 694227  |  |                    |        |                 |                    |   |
|   |    | <table border="1"> <tr> <td><b>GEV No.</b></td> <td>694640</td> <td><b>Ref. No.</b></td> <td>36E2580<br/>36E2581</td> </tr> </table> | <b>GEV No.</b>     | 694640 | <b>Ref. No.</b> | 36E2580<br>36E2581 | door catch H 42mm mounting pos. left L 98mm W 42mm for turning lever lock |
| <b>GEV No.</b>  | 694640  | <b>Ref. No.</b>  | 36E2580<br>36E2581 |        |                 |                    |   |

|  |   |                 |         |
|--|---|-----------------|---------|
|  |   |                 |         |
| 1  |   |                 |         |
| <b>GEV No.</b>   | 514281  | <b>Ref. No.</b> | 36M1570 |
| <b>description</b>   | base plate L 110mm W 35mm for door catch thickness 10mm   |                 |         |
| <b>For models:</b>   | FC101, FC101E, FC241, FC241E, FC241G, FC61, FC61E, FCV101, FCV101-CSA, FCV101DM, FCV101DM-CSA, FCV101DS, FCV101DS-CSA, FCV101E, FCV101EDM, FCV101EDM-UL, FCV101EDS, FCV101EDS-UL, FCV101E-UL, FCV141, FCV141-CSA, FCV141DM, FCV141DM-CSA, FCV141DS, FCV141DS-CSA, FCV141E, FCV141EDM, FCV141EDS, FCV241, FCV241DM, FCV241DS, FCV241E, FCV241EDM, FCV241EDM-UL, FCV241EDS, FCV241EDS-UL, FCV241E-UL, FCV241G, FCV241G-CSA, FCV241GDM, FCV241GDM-CSA, FCV241GDS, FCV241GDS-CSA, FCV61, FCV61-CSA, FCV61DM, FCV61DM-CSA, FCV61DS, FCV61DS-CSA, FCV61E... (Other models you can see in the webshop) |                 |         |

|   |   |                 |         |
|---|---|-----------------|---------|
|  |   |                 |         |
| 1   |   |                 |         |
| <b>GEV No.</b>  | 691174  | <b>Ref. No.</b> | 35V9050 |
| <b>description</b>  | counterpart L 90mm W 60mm for door latch  |                 |         |
| <b>For models:</b>  | FC101, FC101E, FC241E, FC241G, FC61, FC61E, FCV101, FCV101-CSA, FCV101DM, FCV101DM-CSA, FCV101DS, FCV101DS-CSA, FCV101E, FCV101EDM, FCV101EDM-UL, FCV101EDS, FCV101EDS-UL, FCV101E-UL, FCV141, FCV141-CSA, FCV141DM, FCV141DM-CSA, FCV141DS, FCV141DS-CSA, FCV141E, FCV141EDM, FCV141EDS, FCV241E, FCV241EDM, FCV241EDM-UL, FCV241EDS, FCV241EDS-UL, FCV241G, FCV241G-CSA, FCV241GDM, FCV241GDM-CSA, FCV241GDS, FCV241GDS-CSA, FCV61, FCV61-CSA, FCV61DM, FCV61DM-CSA, FCV61DS, FCV61DS-CSA, FCV61E, FCV61EDM, FCV61EDM-UL, FCV61EDS, FCV61EDS-UL, FCV61E-UL... (Other models you can see in the webshop) |                 |         |







|  |   |  |                |        |                 |         |   |
|--|---|--|----------------|--------|-----------------|---------|---|
|  |   |  |                |        |                 |         |   |
| 1  |   |  |                |        |                 |         |   |
| <b>GEV No.</b>   | 700711  | <b>Ref. No.</b>  | 6300420        |        |                 |         |   |
| <b>description</b>   | door catch  |  |                |        |                 |         |   |
| <b>For models:</b>   | FC101, FC101E, FC241, FC241E, FC241G, FC61, FC61E, FCV101, FCV101-CSA, FCV101DM, FCV101DM-CSA, FCV101DS, FCV101DS-CSA, FCV101E, FCV101EDM, FCV101EDM-UL, FCV101EDS, FCV101EDS-UL, FCV101E-UL, FCV141, FCV141-CSA, FCV141DM, FCV141DM-CSA, FCV141DS, FCV141DS-CSA, FCV141E, FCV141EDM, FCV141EDS, FCV241, FCV241DM, FCV241DS, FCV241E, FCV241EDM, FCV241EDM-UL, FCV241EDS, FCV241EDS-UL, FCV241E-UL, FCV241G, FCV241G-CSA, FCV241GDM, FCV241GDM-CSA, FCV241GDS, FCV241GDS-CSA, FCV401DM, FCV401DM-CSA, FCV401EDM, FCV401EDM-UL, FCV61, FCV61-CSA, FCV61DM... (Other models you can see in the webshop) |  |                |        |                 |         |   |
| <b>accessories for</b>   | 700711  |  |                |        |                 |         |   |
|  |    | <table border="1"> <tr> <td><b>GEV No.</b></td> <td>514281</td> <td><b>Ref. No.</b></td> <td>36M1570</td> </tr> </table> | <b>GEV No.</b> | 514281 | <b>Ref. No.</b> | 36M1570 | base plate L 110mm W 35mm for door catch thickness 10mm   |
| <b>GEV No.</b>   | 514281  | <b>Ref. No.</b>  | 36M1570        |        |                 |         |   |
|  |    | <table border="1"> <tr> <td><b>GEV No.</b></td> <td>700098</td> <td><b>Ref. No.</b></td> <td>36M0820</td> </tr> </table> | <b>GEV No.</b> | 700098 | <b>Ref. No.</b> | 36M0820 | door catch mounting pos. right off-set 38mm L 110mm H 74mm W 33mm mounting distance 68/68mm series 1750 |
| <b>GEV No.</b>   | 700098  | <b>Ref. No.</b>  | 36M0820        |        |                 |         |   |

|  |   |  |                |        |                 |         |   |
|--|---|--|----------------|--------|-----------------|---------|---|
|  |   |  |                |        |                 |         |   |
| 1  |   |  |                |        |                 |         |   |
| <b>GEV No.</b>   | 700098  | <b>Ref. No.</b>  | 36M0820        |        |                 |         |   |
| <b>description</b>   | door catch mounting pos. right off-set 38mm L 110mm H 74mm W 33mm mounting distance 68/68mm series 1750   |  |                |        |                 |         |   |
| <b>For models:</b>   | FC101, FC101E, FC241, FC241E, FC241G, FC61, FC61E, FCV101, FCV101-CSA, FCV101DM, FCV101DM-CSA, FCV101DS, FCV101DS-CSA, FCV101E, FCV101EDM, FCV101EDM-UL, FCV101EDS, FCV101EDS-UL, FCV101E-UL, FCV141, FCV141-CSA, FCV141DM, FCV141DM-CSA, FCV141DS, FCV141DS-CSA, FCV141E, FCV141EDM, FCV141EDS, FCV241, FCV241DM, FCV241DS, FCV241E, FCV241EDM, FCV241EDM-UL, FCV241EDS, FCV241EDS-UL, FCV241E-UL, FCV241G, FCV241G-CSA, FCV241GDM, FCV241GDM-CSA, FCV241GDS, FCV241GDS-CSA, FCV401DM, FCV401DM-CSA, FCV401EDM, FCV401EDM-UL, FCV61, FCV61-CSA, FCV61DM... (Other models you can see in the webshop) |  |                |        |                 |         |   |
| <b>spare parts for</b>   | 700098  |  |                |        |                 |         |   |
|  |    | <table border="1"> <tr> <td><b>GEV No.</b></td> <td>690136</td> <td><b>Ref. No.</b></td> <td>3FL0197</td> </tr> </table> | <b>GEV No.</b> | 690136 | <b>Ref. No.</b> | 3FL0197 | sliding plate mounting pos. right L 28mm H 3mm W 21mm H2 12.5mm |
| <b>GEV No.</b>   | 690136  | <b>Ref. No.</b>  | 3FL0197        |        |                 |         |   |
| <b>accessories for</b>   | 700098  |  |                |        |                 |         |   |
|  |    | <table border="1"> <tr> <td><b>GEV No.</b></td> <td>514281</td> <td><b>Ref. No.</b></td> <td>36M1570</td> </tr> </table> | <b>GEV No.</b> | 514281 | <b>Ref. No.</b> | 36M1570 | base plate L 110mm W 35mm for door catch thickness 10mm         |
| <b>GEV No.</b>   | 514281  | <b>Ref. No.</b>  | 36M1570        |        |                 |         |   |

Зип Общепит

vsezip.ru

+7(812)987-09-81

|   |  |                 |  |
|---|--|-----------------|--|
|    |  |                 |  |
| <b>1</b>  |  |                 |  |
| <b>GEV No.</b>  | 690500   | <b>Ref. No.</b> | 36M0880<br>36M3180<br>36M6380<br>6300421 |
| <b>description</b>  | handle latch right L 185mm H 66mm handle material plastic type 6300 series   |                 |  |
| <b>For models:</b>  | FC101, FC101E, FC241, FC241E, FC241G, FC61, FC61E, FCV101, FCV101-CSA, FCV101DM, FCV101DM-CSA, FCV101DS, FCV101DS-CSA, FCV101E, FCV101EDM, FCV101EDM-UL, FCV101EDS, FCV101EDS-UL, FCV101E-UL, FCV141, FCV141-CSA, FCV141DM, FCV141DM-CSA, FCV141DS, FCV141DS-CSA, FCV141E, FCV141EDM, FCV141EDS, FCV241, FCV241DM, FCV241DS, FCV241E, FCV241EDM, FCV241EDM-UL, FCV241EDS, FCV241EDS-UL, FCV241E-UL, FCV241G, FCV241G-CSA, FCV241GDM, FCV241GDM-CSA, FCV241GDS, FCV241GDS-CSA, FCV401DM, FCV401DM-CSA, FCV401EDM, FCV401EDM-UL, FCV61, FCV61-CSA, FCV61DM...(Other models you can see in the webshop) |                 |  |
| <b>spare parts for</b>  | 690500   |                 |  |
|    | <b>GEV No.</b>   | 699841          | <b>Ref. No.</b> —                        |
|   | cover cap for turning lever lock ø 32mm H 14mm   |                 |  |
| <b>accessories for</b>  | 690500   |                 |  |
|   | <b>GEV No.</b>   | 514281          | <b>Ref. No.</b> 36M1570                  |
|   | base plate L 110mm W 35mm for door catch thickness 10mm  |                 |  |
|  | <b>GEV No.</b>   | 690136          | <b>Ref. No.</b> 3FL0197                  |
|   | sliding plate mounting pos. right L 28mm H 3mm W 21mm H2 12.5mm  |                 |  |
|  | <b>GEV No.</b>   | 691174          | <b>Ref. No.</b> 35V9050                  |
|   | counterpart L 90mm W 60mm for door latch   |                 |  |
|  | <b>GEV No.</b>   | 700091          | <b>Ref. No.</b> —                        |
|   | door catch mounting pos. right off-set 20mm L 110mm H 56mm W 33mm mounting distance 68/68mm zinc die cast series 6300  |                 |  |
|  | <b>GEV No.</b>   | 700098          | <b>Ref. No.</b> 36M0820                  |
|   | door catch mounting pos. right off-set 38mm L 110mm H 74mm W 33mm mounting distance 68/68mm series 1750  |                 |  |

|   |   |                 |         |
|---|---|-----------------|---------|
|  |   |                 |         |
| <b>1</b>  |   |                 |         |
| <b>GEV No.</b>  | 111786  | <b>Ref. No.</b> | 37M4040 |
| <b>description</b>  | knob dial plate   |                 |         |
| <b>For models:</b>  | FC101, FC101E, FC241, FC241E, FC241G, FC61, FC61E, FCV101, FCV101-CSA, FCV101DM, FCV101DS, FCV101E, FCV101EDM, FCV101EDS, FCV101EDS-UL, FCV101E-UL, FCV141, FCV141DM, FCV141DS, FCV141E, FCV141EDM, FCV141EDS, FCV241, FCV241DM, FCV241DS, FCV241E, FCV241EDM, FCV241EDM-UL, FCV241EDS, FCV241EDS-UL, FCV241G, FCV241G-CSA, FCV241GDM, FCV241GDS, FCV401DM, FCV401EDM, FCV4E, FCV4EDS, FCV61, FCV61DM, FCV61DS, FCV61E, FCV61EDM, FCV61EDS, FCV61E-UL, FCV72EDM-UL, FCV72EDS-UL |                 |         |

|                    |  |                 |         |
|--------------------|--|-----------------|---------|
| <b>1</b>           |  |                 |         |
| <b>GEV No.</b>     | 690136   | <b>Ref. No.</b> | 3FL0197 |
| <b>description</b> | sliding plate mounting pos. right L 28mm H 3mm W 21mm H2 12.5mm  |                 |         |
| <b>For models:</b> | FCV101-CSA, FCV101DM-CSA, FCV101DS-CSA, FCV101EDM-UL, FCV101EDS-UL, FCV101E-UL, FCV141-CSA, FCV141DM-CSA, FCV141DS-CSA, FCV241EDM-UL, FCV241EDS-UL, FCV241E-UL, FCV241G-CSA, FCV241GDM-CSA, FCV241GDS-CSA, FCV401DM-CSA, FCV401EDM-UL, FCV61-CSA, FCV61DM-CSA, FCV61DS-CSA, FCV61EDM-UL, FCV61EDS-UL, FCV61E-UL, FCV72EDM-UL, FCV72EDS-UL, FCV72E-UL |                 |         |

handle latches

universal

inside fixing

locks











|   |  |                 |   |
|---|--|-----------------|---|
|  |  |                 |   |
| <b>1</b>  |  |                 |   |
| <b>GEV No.</b>  | 694054   | <b>Ref. No.</b> | 36M7000                                       |
| <b>description</b>  | door handle for headed units L 145mm W 40mm H 62mm spring length 33mm inner black  |                 |   |
| <b>For models:</b>  | BX101E, BX101E-VERS.122013, BX101G, BX101G-VERS.122013, BX122E, BX122E-VERS.122013, BX122G, BX122G-VERS.122013, BX61E, BX61E-VERS.122013, BX61G, BX61G-VERS.122013, BX82E, BX82E-VERS.122013, BX82G, BX82G-VERS.122013, FCV3EM, FCV4E, FCV4EDS, FCV4EM, FM423E1, FM423E2 |                 |   |
| <b>spare parts for</b>  | 694054   |                 |   |
|  | <b>GEV No.</b>   | 514390          | <b>Ref. No.</b> 3005920<br>3236250            |
|   | spring for door handle ø 6mm L 54mm W 27.5mm   |                 |   |
|  | <b>GEV No.</b>   | 694675          | <b>Ref. No.</b> —                             |
|   | door catch L 88mm W 40mm H 37mm spring length 33mm mounting distance 60mm  |                 |   |
|  | <b>GEV No.</b>   | 694734          | <b>Ref. No.</b> —                             |
|   | door handle L 165mm W 40mm H 25mm black  |                 |   |
|  | <b>GEV No.</b>   | 694735          | <b>Ref. No.</b> —                             |
|   | cap ø 32mm black   |                 |   |
| <b>accessories for</b>  | 694054   |                 |   |
|  | <b>GEV No.</b>   | 691123          | <b>Ref. No.</b> 36E2060                       |
|   | duct for door opener   |                 |   |
|  | <b>GEV No.</b>   | 694055          | <b>Ref. No.</b> 3238740<br>3238750<br>36C4391 |
|   | door catch L 25mm W 14mm total length 54mm thread M8 thread L 29mm   |                 |   |
|  | <b>GEV No.</b>   | 694066          | <b>Ref. No.</b> —                             |
|   | door catch with spigot 2-stage L 28mm W 14mm H 15mm H1 16mm total length 51mm thread M8 thread L 23mm stainless steel  |                 |   |

Table continues overleaf



|   |         |        |                  |
|---|---------|--------|------------------|
| accessories for 694054  |         |        |                  |
|  | GEV No. | 694067 | Ref. No. 3108770 |
| door catch with spigot 1-stage L 26mm total length 51mm thread M8                 |         |        |                  |



|   |         |        |                  |
|---|---------|--------|------------------|
| producer-specific   |         |        |                  |
| ANGELO PO   |         |        |                  |
|  |         |        |                  |
| 1   | GEV No. | 514289 | Ref. No. 36D3670 |
| description bush for door mechanism   |         |        |                  |
| For models: FCV3EM, FCV4E, FCV4EDS, FCV4EM  |         |        |                  |



|   |         |        |                  |
|---|---------|--------|------------------|
|  |         |        |                  |
| 1   | GEV No. | 514287 | Ref. No. 36Q1360 |
| description bush H 8mm thickness 2mm D1 ø 14mm D2 ø 10mm                          |         |        |                  |
| For models: FCV3EM, FCV4E, FCV4EDS, FCV4EM  |         |        |                  |

|   |         |        |                             |
|---|---------|--------|-----------------------------|
|  |         |        |                             |
| 1   | GEV No. | 514288 | Ref. No. 30G1650<br>30G2192 |
| description door catch ø 10mm L 102mm door catch height 24mm T1: M8 T2: M20x1.5   |         |        |                             |
| For models: FCV3EM, FCV4E, FCV4EDS, FCV4EM  |         |        |                             |

|   |         |        |                  |
|---|---------|--------|------------------|
| accessories for 514288  |         |        |                  |
|  | GEV No. | 514287 | Ref. No. 36Q1360 |
| bush H 8mm thickness 2mm D1 ø 14mm D2 ø 10mm  |         |        |                  |

|   |         |        |                  |
|---|---------|--------|------------------|
|    |         |        |                  |
| 1   | GEV No. | 514290 | Ref. No. 36M5340 |
| description door handle L 150mm W 42mm H 57mm black plastic shaft 8x8mm intake square |         |        |                  |
| For models: FCV3EM, FCV4E, FCV4EDS, FCV4EM  |         |        |                  |

|   |         |        |                  |
|---|---------|--------|------------------|
| accessories for 514290  |         |        |                  |
|  | GEV No. | 111746 | Ref. No. 37M4700 |
| knob dial plate W 1mm ø 36mm  |         |        |                  |
|  | GEV No. | 111786 | Ref. No. 37M4040 |
| knob dial plate   |         |        |                  |
|  | GEV No. | 514286 | Ref. No. 36D8011 |
| sleeve L 15mm M20x1.5   |         |        |                  |

|   |         |        |                             |
|---|---------|--------|-----------------------------|
| accessories for 514290  |         |        |                             |
|  | GEV No. | 514287 | Ref. No. 36Q1360            |
| bush H 8mm thickness 2mm D1 ø 14mm D2 ø 10mm                                      |         |        |                             |
|  | GEV No. | 514288 | Ref. No. 30G1650<br>30G2192 |
| door catch ø 10mm L 102mm door catch height 24mm T1: M8 T2: M20x1.5               |         |        |                             |
|  | GEV No. | 514289 | Ref. No. 36D3670            |
| bush for door mechanism   |         |        |                             |

|   |         |        |                  |
|---|---------|--------|------------------|
|    |         |        |                  |
| 1   | GEV No. | 111786 | Ref. No. 37M4040 |
| description knob dial plate   |         |        |                  |
| For models: FC101, FC101E, FC241, FC241E, FC241G, FC61, FC61E, FCV101, FCV101-CSA, FCV101DM, FCV101DS, FCV101E, FCV101EDM, FCV101EDS, FCV101EDS-UL, FCV101E-UL, FCV141, FCV141DM, FCV141DS, FCV141E, FCV141EDM, FCV141EDS, FCV241, FCV241DM, FCV241DS, FCV241E, FCV241EDM, FCV241EDM-UL, FCV241EDS, FCV241EDS-UL, FCV241G, FCV241G-CSA, FCV241GDM, FCV241GDS, FCV401DM, FCV401EDM, FCV4E, FCV4EDS, FCV61, FCV61DM, FCV61DS, FCV61E, FCV61EDM, FCV61EDS, FCV61E-UL, FCV72EDM-UL, FCV72EDS-UL |         |        |                  |

|  |         |        |                  |
|--|---------|--------|------------------|
|  |         |        |                  |
| 1  | GEV No. | 111746 | Ref. No. 37M4700 |
| description knob dial plate W 1mm ø 36mm   |         |        |                  |
| For models: FCV3EM, FCV4EM   |         |        |                  |



|   |         |        |                  |
|---|---------|--------|------------------|
|  |         |        |                  |
| 1   | GEV No. | 514286 | Ref. No. 36D8011 |
| description sleeve L 15mm M20x1.5   |         |        |                  |
| For models: FCV3EM, FCV4E, FCV4EDS, FCV4EM  |         |        |                  |

Зип-Общепит

vsezip.ru

8 (812) 987-08-81





|  |  |                 |                               |
|--|--|-----------------|-------------------------------|
|  <p>1</p> |  |                 |                               |
| <b>GEV No.</b>   | 694055   | <b>Ref. No.</b> | 3238740<br>3238750<br>36C4391 |
| <b>description</b>   | door catch L 25mm W 14mm total length 54mm thread M8 thread L 29mm   |                 |                               |
| <b>For models:</b>   | BX101E, BX101E-VERS.122013, BX101G, BX101G-VERS.122013, BX122E, BX122E-VERS.122013, BX122G, BX122G-VERS.122013, BX61E, BX61E-VERS.122013, BX61G, BX61G-VERS.122013, BX82E, BX82E-VERS.122013, BX82G, BX82G-VERS.122013, FCV3EM, FCV4E, FCV4EDS, FCV4EM, FM423E1, FM423E2, FX101E1, FX101E1R, FX101E2, FX101E2C, FX101E2C-VERS.032014, FX101E2R, FX101E2R-VERS.032014, FX101E2-VERS.032014, FX101E3, FX101E3C, FX101E3C-VERS.022014, FX101E3R, FX101E3R-VERS.022014, FX101E3-VERS.022014, FX101G1, FX101G1R, FX101G2, FX101G2C, FX101G2C-VERS.032014, FX101G2R, FX101G2R-VERS.032014, FX101G2-VERS.032014, FX101G3, FX101G3C, FX101G3C-VERS.022014, FX101G3R, FX101G3R-VERS.022014, FX101G3-VERS.022014...(Other models you can see in the webshop) |                 |                               |
| <b>accessories for</b>   | 694055   |                 |                               |
|  |  <p>GEV No. 694772 Ref. No. 36E2490</p> <p>protection cap for door catch ø 21mm</p>   |                 |                               |

|  |   |                 |                               |
|--|---|-----------------|-------------------------------|
|  <p>1</p> |   |                 |                               |
| <b>GEV No.</b>   | 694055  | <b>Ref. No.</b> | 3238740<br>3238750<br>36C4391 |
| <b>description</b>   | door catch L 25mm W 14mm total length 54mm thread M8 thread L 29mm  |                 |                               |
|  |  <p>GEV No. 694066 Ref. No. —</p> <p>door catch with spigot 2-stage L 28mm W 14mm H 15mm H1 16mm total length 51mm thread M8 thread L 23mm stainless steel</p> |                 |                               |
|  |  <p>GEV No. 694067 Ref. No. 3108770</p> <p>door catch with spigot 1-stage L 26mm total length 51mm thread M8</p>   |                 |                               |

|  |  |                 |         |
|--|--|-----------------|---------|
|  <p>1</p> |  |                 |         |
| <b>GEV No.</b>   | 691123   | <b>Ref. No.</b> | 36E2060 |
| <b>description</b>   | duct for door opener                             |                 |         |
| <b>For models:</b>   | FCV3EM, FCV4E, FCV4EDS, FCV4EM, FM423E1, FM423E2 |                 |         |

|  |  |                 |                    |
|--|--|-----------------|--------------------|
|  <p>1</p> |  |                 |                    |
| <b>GEV No.</b>   | 517174   | <b>Ref. No.</b> | 3110050<br>33Q6470 |
| <b>description</b>   | nut thread M8 H 6.5mm WS 13 SS DIN/ISO DIN 934 / ISO 4032/8673 Qty 1 pcs |                 |                    |

|  |  |                 |         |
|--|--|-----------------|---------|
|  <p>1</p> |  |                 |         |
| <b>GEV No.</b>   | 694772   | <b>Ref. No.</b> | 36E2490 |
| <b>description</b>   | protection cap for door catch ø 21mm   |                 |         |
| <b>For models:</b>   | BX101E, BX101E-VERS.122013, BX101G, BX101G-VERS.122013, BX122E, BX122E-VERS.122013, BX122G, BX122G-VERS.122013, BX61E, BX61E-VERS.122013, BX61G, BX61G-VERS.122013, BX82E, BX82E-VERS.122013, BX82G, BX82G-VERS.122013, FCV3EM, FCV4E, FCV4EDS, FCV4EM, FM423E1, FM423E2, FX101E1, FX101E1R, FX101E2, FX101E2C, FX101E2C-VERS.032014, FX101E2R, FX101E2R-VERS.032014, FX101E2-VERS.032014, FX101E3, FX101E3C, FX101E3C-VERS.022014, FX101E3R, FX101E3R-VERS.022014, FX101E3-VERS.022014, FX101G1, FX101G1R, FX101G2, FX101G2C, FX101G2C-VERS.032014, FX101G2R, FX101G2R-VERS.032014, FX101G2-VERS.032014, FX101G3, FX101G3C, FX101G3C-VERS.022014, FX101G3R, FX101G3R-VERS.022014, FX101G3-VERS.022014...(Other models you can see in the webshop) |                 |         |

|   |  |                 |         |
|---|--|-----------------|---------|
|  <p>1</p> |  |                 |         |
| <b>GEV No.</b>  | 694054   | <b>Ref. No.</b> | 36M7000 |
| <b>description</b>  | door handle for headed units L 145mm W 40mm H 62mm spring length 33mm inner black  |                 |         |
| <b>For models:</b>  | BX101E, BX101E-VERS.122013, BX101G, BX101G-VERS.122013, BX122E, BX122E-VERS.122013, BX122G, BX122G-VERS.122013, BX61E, BX61E-VERS.122013, BX61G, BX61G-VERS.122013, BX82E, BX82E-VERS.122013, BX82G, BX82G-VERS.122013, FCV3EM, FCV4E, FCV4EDS, FCV4EM, FM423E1, FM423E2 |                 |         |
| <b>spare parts for</b>  | 694054   |                 |         |
|   |  <p>GEV No. 514390 Ref. No. 3005920<br/>3236250</p> <p>spring for door handle ø 6mm L 54mm W 27.5mm</p>   |                 |         |
|   |  <p>GEV No. 694675 Ref. No. —</p> <p>door catch L 88mm W 40mm H 37mm spring length 33mm mounting distance 60mm</p>  |                 |         |
|   |  <p>GEV No. 694734 Ref. No. —</p> <p>door handle L 165mm W 40mm H 25mm black</p>  |                 |         |
|   |  <p>GEV No. 694735 Ref. No. —</p> <p>cap ø 32mm black</p>   |                 |         |
| <b>accessories for</b>  | 694054   |                 |         |
|   |  <p>GEV No. 691123 Ref. No. 36E2060</p> <p>duct for door opener</p>   |                 |         |







Зип Общепит edge mount latches

handle latches

vsezip.ru

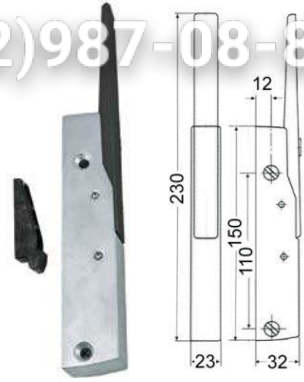
+7(812)987-08-81

|   |  |                 |                    |
|---|--|-----------------|--------------------|
|  |  |                 |                    |
| <b>GEV No.</b>  | 514390   | <b>Ref. No.</b> | 3005920<br>3236250 |
| <b>description</b>  | spring for door handle ø 6mm L 54mm W 27.5mm   |                 |                    |
| <b>For models:</b>  | BX101E, BX101E-VERS.122013, BX101G, BX101G-VERS.122013, BX122E, BX122E-VERS.122013, BX122G, BX122G-VERS.122013, BX61E, BX61E-VERS.122013, BX61G, BX61G-VERS.122013, BX82E, BX82E-VERS.122013, BX82G, BX82G-VERS.122013, FCV3EM, FCV4E, FCV4EDS, FCV4EM, FM423E1, FM423E2, FX101E1R, FX101E2R, FX101E2R-VERS.032014, FX101E3R, FX101E3R-VERS.022014, FX101G1R, FX101G2R, FX101G2R-VERS.032014, FX101G3R, FX101G3R-VERS.022014, FX10E2CR, FX10E2CR-VERS.032014, FX10E3CR, FX10E3CR-VERS.022014, FX10G2CR, FX10G2CR-VERS.032014, FX10G3CR, FX10G3CR-VERS.022014, FX61E1R, FX61E2CR, FX61E2CR-VERS.032014, FX61E2R, FX61E2R-VERS.032014, FX61E3CR, FX61E3CR-VERS.022014, FX61E3R, FX61E3R-VERS.022014, FX61G1R...(Other models you can see in the webshop) |                 |                    |

|   |   |                 |                         |
|---|---|-----------------|-------------------------|
|   |   |                 |                         |
| <b>GEV No.</b>  | 690454  | <b>Ref. No.</b> | 36M0470                 |
| <b>description</b>  | handle latch L 150mm mounting distance 110mm matt chrome-plated/Rilsan non lockable heated units 560 black complete with door catch |                 |                         |
| <b>spare parts for</b>  | 690454  |                 |                         |
|    | <b>GEV No.</b>  | 690429          | <b>Ref. No.</b> —       |
| door catch CT 25.5mm  |   |                 |                         |
| <b>accessories for</b>  | 690454  |                 |                         |
|   | <b>GEV No.</b>  | 690428          | <b>Ref. No.</b> 36M0480 |
| door catch H 51mm W 13.9mm mounting distance 30mm plastic CT 16.5mm                 |   |                 |                         |
|  | <b>GEV No.</b>  | 690445          | <b>Ref. No.</b> —       |
| base plate H 2mm  |   |                 |                         |
|  | <b>GEV No.</b>  | 690446          | <b>Ref. No.</b> —       |
| base plate H 5mm L 56mm W 18mm  |   |                 |                         |

|  |   |                 |                               |
|--|---|-----------------|-------------------------------|
| <p>handles</p>  |   |                 |                               |
| <b>GEV No.</b>   | 694631  | <b>Ref. No.</b> | 3104201<br>3104202<br>3104203 |
| <b>description</b>   | door handle for combi-steamer L 210mm W 170mm H 55mm silver plastic   |                 |                               |
| <b>For models:</b>   | FX101E1, FX101E2, FX101E2C, FX101E2C-VERS.032014, FX101E2-VERS.032014, FX101E3, FX101E3C, FX101E3C-VERS.022014, FX101E3R, FX101E3-VERS.022014, FX101G1, FX101G2, FX101G2C, FX101G2C-VERS.032014, FX101G2-VERS.032014, FX101G3, FX101G3C, FX101G3C-VERS.022014, FX101G3-VERS.022014, FX10E2CR-VERS.032014, FX122E1, FX122E2, FX122E2C, FX122E2T, FX122E2T-VERS.032014, FX122E3, FX122E3C, FX122E3T, FX122E3T-VERS.022014, FX122G1, FX122G3, FX122G3C, FX122G3T, FX122G3T-VERS.022014, FX12E3CT, FX12E3CT-VERS.022014, FX12G3CT, FX12G3CT-VERS.022014, FX201E2, FX201E2P, FX201E2P-VERS.032014, FX201E2-VERS.032014, FX201E3, FX201E3P, FX201E3P-VERS.022014, FX201E3-VERS.022014, FX201G2, FX201G2P, FX201G2P-VERS.032014, FX201G2-VERS.032014...(Other models you can see in the webshop) |                 |                               |

Зип.Общедит

product reference

vsezip.ru

+7(812)987-08-81

RAHRBACH

6201 DUPLO series

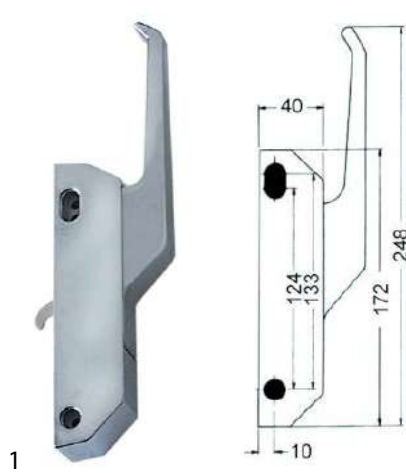

|                        |   |                 |                   |
|------------------------|---|-----------------|-------------------|
| <b>GEV No.</b>         | 690024  | <b>Ref. No.</b> | 36M0600           |
| <b>description</b>     | handle latch L 172mm mounting distance 124/133mm chrome-plated non lockable refrigeration units 6201 H 65mm type DUPLO total length 248mm |                 |                   |
| <b>accessories for</b> | 690024  |                 |                   |
|                        | <b>GEV No.</b>  | 690123          | <b>Ref. No.</b> — |
|                        | door catch with roller  |                 |                   |

door catches



|                    |   |                 |         |
|--------------------|---|-----------------|---------|
| <b>GEV No.</b>     | 690428  | <b>Ref. No.</b> | 36M0480 |
| <b>description</b> | door catch H 51mm W 13.9mm mounting distance 30mm plastic CT 16.5mm |                 |         |

snap locks

universal



|                    |  |                 |         |
|--------------------|--|-----------------|---------|
| <b>GEV No.</b>     | 690596   | <b>Ref. No.</b> | 36M3600 |
| <b>description</b> | snap lock L 60mm W 15mm H 36mm mounting distance 48/28mm spring thickness 1.5mm complete with door catch zamak |                 |         |

espagnolette locks

universal



|                    |                                    |                 |         |
|--------------------|------------------------------------|-----------------|---------|
| <b>GEV No.</b>     | 690041                             | <b>Ref. No.</b> | 3088460 |
| <b>description</b> | cam L 148mm mounting distance 32mm |                 |         |

ANGELO PO



|                    |   |                 |         |
|--------------------|---|-----------------|---------|
| <b>GEV No.</b>     | 698478  | <b>Ref. No.</b> | 3142670 |
| <b>description</b> | coupling for oven for door L 80mm W 26mm intake 7.8 x 7.8   |                 |         |
| <b>For models:</b> | FX201E2, FX201E2P, FX201E2P-VERS.032014, FX201E2-VERS.032014, FX201E3, FX201E3P, FX201E3P-VERS.022014, FX201E3-VERS.022014, FX201G2, FX201G2P, FX201G2P-VERS.032014, FX201G2-VERS.032014, FX201G3P, FX201G3-VERS.022014, FX202E2, FX202E2-VERS.032014, FX202E3, FX202E3-230V-3-50Hz-60Hz, FX202E3-230V-3-50Hz-60Hz-VERS.022014, FX202E3-VERS.022014, FX202G2, FX202G2-VERS.032014, FX202G3, FX202G3-VERS.022014 |                 |         |



|                    |   |                 |                    |
|--------------------|---|-----------------|--------------------|
| <b>GEV No.</b>     | 692718  | <b>Ref. No.</b> | 3104152<br>3104153 |
| <b>description</b> | cover cap ø 38.5mm  |                 |                    |
| <b>For models:</b> | FX101E1, FX101E2, FX101E2C, FX101E2C-VERS.032014, FX101E2-VERS.032014, FX101E3, FX101E3C, FX101E3C-VERS.022014, FX101E3R, FX101E3-VERS.022014, FX101G1, FX101G2, FX101G2C, FX101G2C-VERS.032014, FX101G2-VERS.032014, FX101G3, FX101G3C, FX101G3C-VERS.022014, FX101G3-VERS.022014, FX10E2CR-VERS.032014, FX122E1, FX122E2, FX122E2C, FX122E2T, FX122E2T-VERS.032014, FX122E3, FX122E3C, FX122E3T, FX122E3T-VERS.022014, FX122G1, FX122G3, FX122G3C, FX122G3T, FX122G3T-VERS.022014, FX12E3CT, FX12E3CT-VERS.022014, FX12G3CT, FX12G3CT-VERS.022014, FX201E2, FX201E2P, FX201E2P-VERS.032014, FX201E2-VERS.032014, FX201E3, FX201E3P, FX201E3P-VERS.022014, FX201E3-VERS.022014, FX201G2, FX201G2P, FX201G2P-VERS.032014, FX201G2-VERS.032014...(Other models you can see in the webshop) |                 |                    |



|                    |   |                 |                               |
|--------------------|---|-----------------|-------------------------------|
| <b>GEV No.</b>     | 694631  | <b>Ref. No.</b> | 3104201<br>3104202<br>3104203 |
| <b>description</b> | door handle for combi-steamer L 210mm W 170mm H 55mm silver plastic   |                 |                               |
| <b>For models:</b> | FX101E1, FX101E2, FX101E2C, FX101E2C-VERS.032014, FX101E2-VERS.032014, FX101E3, FX101E3C, FX101E3C-VERS.022014, FX101E3R, FX101E3-VERS.022014, FX101G1, FX101G2, FX101G2C, FX101G2C-VERS.032014, FX101G2-VERS.032014, FX101G3, FX101G3C, FX101G3C-VERS.022014, FX101G3-VERS.022014, FX10E2CR-VERS.032014, FX122E1, FX122E2, FX122E2C, FX122E2T, FX122E2T-VERS.032014, FX122E3, FX122E3C, FX122E3T, FX122E3T-VERS.022014, FX122G1, FX122G3, FX122G3C, FX122G3T, FX122G3T-VERS.022014, FX12E3CT, FX12E3CT-VERS.022014, FX12G3CT, FX12G3CT-VERS.022014, FX201E2, FX201E2P, FX201E2P-VERS.032014, FX201E2-VERS.032014, FX201E3, FX201E3P, FX201E3P-VERS.022014, FX201E3-VERS.022014, FX201G2, FX201G2P, FX201G2P-VERS.032014, FX201G2-VERS.032014...(Other models you can see in the webshop) |                 |                               |

Зип-Общепит

hinges  
piano hinges  
universal

(2)987-08-81

|   |   |                 |                         |
|---|---|-----------------|-------------------------|
|  |   |                 |                         |
| <b>GEV No.</b>  | 698503  | <b>Ref. No.</b> | 6300965                 |
| <b>description</b>  | espagnolette lock complete  |                 |                         |
| <b>For models:</b>  | FX201E2, FX201E2P, FX201E2P-VERS.032014, FX201E2-VERS.032014, FX201E3, FX201E3P, FX201E3P-VERS.022014, FX201E3-VERS.022014, FX201G2, FX201G2P, FX201G2P-VERS.032014, FX201G2-VERS.032014, FX201G3P, FX201G3-VERS.022014, FX202E2, FX202E2-VERS.032014, FX202E3, FX202E3-230V-3-50Hz-60Hz, FX202E3-230V-3-50Hz-60Hz-VERS.022014, FX202E3-VERS.022014, FX202G2, FX202G2-VERS.032014, FX202G3, FX202G3-VERS.022014 |                 |                         |
| <b>accessories for</b>  | 698503  |                 |                         |
|  | <b>GEV No.</b>  | 690041          | <b>Ref. No.</b> 3088460 |
| <b>description</b>  | cam L 148mm mounting distance 32mm  |                 |                         |
|  | <b>GEV No.</b>  | 694409          | <b>Ref. No.</b> —       |
| <b>description</b>  | mounting set for espagnolette lock 694382   |                 |                         |
|  | <b>GEV No.</b>  | 700604          | <b>Ref. No.</b> —       |
| <b>description</b>  | latch gear opening to the right shaft intake $\varnothing$ 8x8mm L 170mm W 40mm H 40mm  |                 |                         |

|   |   |                 |         |
|---|---|-----------------|---------|
|  |   |                 |         |
| <b>GEV No.</b>  | 692720  | <b>Ref. No.</b> | 3101630 |
| <b>description</b>  | gasket for door latch PTFE D1 $\varnothing$ 26mm D2 $\varnothing$ 11.7mm thickness 2mm  |                 |         |
| <b>For models:</b>  | FX201E2, FX201E2P, FX201E2P-VERS.032014, FX201E2-VERS.032014, FX201E3, FX201E3P, FX201E3P-VERS.022014, FX201E3-VERS.022014, FX201G2, FX201G2P, FX201G2P-VERS.032014, FX201G2-VERS.032014, FX201G3P, FX201G3-VERS.022014, FX202E2, FX202E2-VERS.032014, FX202E3, FX202E3-230V-3-50Hz-60Hz, FX202E3-230V-3-50Hz-60Hz-VERS.022014, FX202E3-VERS.022014, FX202G2, FX202G2-VERS.032014, FX202G3, FX202G3-VERS.022014 |                 |         |

miscellaneous

|   |            |                 |         |
|---|------------|-----------------|---------|
|  |            |                 |         |
| <b>GEV No.</b>  | 518585     | <b>Ref. No.</b> | 36M1240 |
| <b>description</b>  | door catch |                 |         |

|  |  |                 |         |
|--|--|-----------------|---------|
|  |  |                 |         |
| <b>GEV No.</b>   | 692866   | <b>Ref. No.</b> | 3085860 |
| <b>description</b>   | hinge L 25mm mounting distance 14mm hole $\varnothing$ 3mm thickness 1mm   |                 |         |
| <b>For models:</b>   | BX101E, BX101E-VERS.122013, BX101G, BX101G-VERS.122013, BX122E, BX122E-VERS.122013, BX122G, BX122G-VERS.122013, BX61E, BX61E-VERS.122013, BX61G, BX61G-VERS.122013, BX82E, BX82E-VERS.122013, BX82G, BX82G-VERS.122013, FX101E1, FX101E1R, FX101E2, FX101E2C, FX101E2C-VERS.032014, FX101E2R, FX101E2R-VERS.032014, FX101E2-VERS.032014, FX101E3, FX101E3C, FX101E3C-VERS.022014, FX101E3R, FX101E3R-VERS.022014, FX101E3-VERS.022014, FX101G1, FX101G1R, FX101G2, FX101G2C, FX101G2C-VERS.032014, FX101G2R, FX101G2R-VERS.032014, FX101G2-VERS.032014, FX101G3, FX101G3C, FX101G3C-VERS.022014, FX101G3R, FX101G3R-VERS.022014, FX101G3-VERS.022014, FX10E2CR, FX10E2CR-VERS.032014, FX10E3CR, FX10E3CR-VERS.022014, FX10G2CR, FX10G2CR-VERS.032014...(Other models you can see in the webshop) |                 |         |

spring assisted hinges

universal

CAFF/FERMOD

group 2

|  |  |                 |         |
|--|--|-----------------|---------|
|  |  |                 |         |
| <b>GEV No.</b>   | 690574   | <b>Ref. No.</b> | 36M2460 |
| <b>description</b>   | spring assisted hinge series 176 mounting pos. left/right L 75mm W 25.6mm A 11mm B 15mm mounting measurements 22x22mm intake 7.5x7.5 |                 |         |

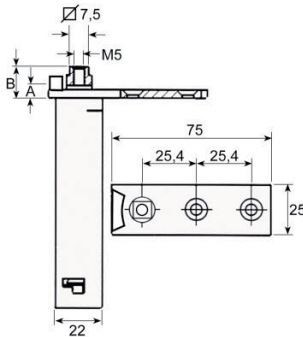

INTERKLIMAT

hinges

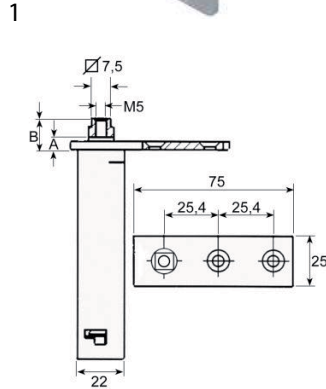

|                    |  |                 |         |
|--------------------|--|-----------------|---------|
| <b>GEV No.</b>     | 690622   | <b>Ref. No.</b> | 36G6520 |
| <b>description</b> | spring assisted hinge series 28L mounting pos. left/right L 75mm W 25mm H 103mm A 13mm B 18mm mounting measurements 22x22mm intake 7.5x7.5 refrigeration units |                 |         |

accessories



|                    |   |                 |         |
|--------------------|---|-----------------|---------|
| <b>GEV No.</b>     | 690747  | <b>Ref. No.</b> | 3178300 |
| <b>description</b> | bush for hinge ID ø 7.5mm L 25.5mm W 25.5mm mounting measurements 22x22mm H 4.5mm   |                 |         |
| <b>For models:</b> | 120, 120B, 120NN, 135, 135-4, 135A, 135B, 135BA, 135BN, 135BNX, 135BX, 135BXE, 135BXR, 135CPX, 135NN, 135NNX, 135X, 135X-3, 135X-4, 135XE, 135XR, 55, 55B, 65, 65A, 65B, 65BA, 65BX, 65BX-2, 65BXE, 65BXR, 65NB, 65NBX, 65NN, 65NNX, 65X, 65X-2, 65XE, 65XR, AF1B, AF1N, AF2B, AF2N, ART1L, ART1LA, ART1LD, ART1LDA, ART2LD, ART2SD, ART3SD...(Other models you can see in the webshop) |                 |         |

producer-specific

ANGELO PO



|                    |  |                 |         |
|--------------------|--|-----------------|---------|
| <b>GEV No.</b>     | 691198   | <b>Ref. No.</b> | 36G2650 |
| <b>description</b> | bar for spring hinge L 345mm ø 12mm  |                 |         |
| <b>For models:</b> | 191PD1G, 191PD2G, 191PI1G, 191PI1GA, 191PI2E, 191PI2EA, 191PI2G, 191PI2GA, 191PI2V, 191PI2VA, 1A1PD1G, 1A1PD2G, 1A1PI1G, 1A1PI1GA, 1A1PI2E, 1A1PI2EA, 1A1PI2G, 1A1PI2GA, 1A1PI2V, 1A1PI2VA, 1D1PD1G, 1D1PD2G, 1D1PI1G, 1D1PI1GA, 1D1PI2E, 1D1PI2EA, 1D1PI2G, 1D1PI2GA, 1D1PI2V, 1D1PI2VA, 1G1BR1E, 1G1BR1G, 1G1PD1G, 1G1PI1E, 1G1PI1G, 31PD6, 31PI6, 31PIE6, 31R, 31RE, 71AR, 71ARE, 71PD10, 71PD15, 71PI10, 71PI10A, 71PIE15, 71PIE15A, 71PV15, 71PV15A...(Other models you can see in the webshop) |                 |         |

Зип Общепит

vsezip.ru

+7(812)98708301

|                    |   |                 |         |
|--------------------|---|-----------------|---------|
| <b>GEV No.</b>     | 690747  | <b>Ref. No.</b> | 3178300 |
| <b>description</b> | bush for hinge ID ø 7.5mm L 25.5mm W 25.5mm mounting measurements 22x22mm H 4.5mm   |                 |         |
| <b>For models:</b> | 120, 120B, 120NN, 135, 135-4, 135A, 135B, 135BA, 135BN, 135BNX, 135BX, 135BXE, 135BXR, 135CPX, 135NN, 135NNX, 135X, 135X-3, 135X-4, 135XE, 135XR, 55, 55B, 65, 65A, 65B, 65BA, 65BX, 65BX-2, 65BXE, 65BXR, 65NB, 65NBX, 65NN, 65NNX, 65X, 65X-2, 65XE, 65XR, AF1B, AF1N, AF2B, AF2N, ART1L, ART1LA, ART1LD, ART1LDA, ART2LD, ART2SD, ART3SD...(Other models you can see in the webshop) |                 |         |



|                    |  |                 |         |
|--------------------|--|-----------------|---------|
| <b>GEV No.</b>     | 691185   | <b>Ref. No.</b> | 36D2800 |
| <b>description</b> | hinge camp mounting pos. left  |                 |         |
| <b>For models:</b> | 31PD6, 31PI6, 31PIE6, 31R, 31RE, 71AR, 71ARE, 71PD10, 71PD15, 71PI10, 71PI10A, 71PIE15, 71PIE15A, 71PV15, 71PV15A, 71RA, 91AR, 91ARE, 91PI10, 91PI10A, 91PIE15, 91PIE15A, 91RA |                 |         |



|                    |  |                 |         |
|--------------------|--|-----------------|---------|
| <b>GEV No.</b>     | 691186   | <b>Ref. No.</b> | 36D2790 |
| <b>description</b> | hinge camp mounting pos. right   |                 |         |
| <b>For models:</b> | 31PD6, 31PI6, 31PIE6, 31R, 31RE, 71AR, 71ARE, 71PD10, 71PD15, 71PI10, 71PI10A, 71PIE15, 71PIE15A, 71PV15, 71PV15A, 71RA, 91AR, 91ARE, 91PI10, 91PI10A, 91PIE15, 91PIE15A, 91RA |                 |         |



|                    |                            |                 |         |
|--------------------|----------------------------|-----------------|---------|
| <b>GEV No.</b>     | 690675                     | <b>Ref. No.</b> | 6008500 |
| <b>description</b> | spring assisted hinge left |                 |         |
| <b>For models:</b> | 135PVX                     |                 |         |



|                    |   |                 |                    |
|--------------------|---|-----------------|--------------------|
| <b>GEV No.</b>     | 690573  | <b>Ref. No.</b> | 30M0350<br>36M0350 |
| <b>description</b> | spring assisted hinge left refrigerator suitable for SAGI |                 |                    |





Зип Общепит

vsezip.ru

+7(812)987-08-81



1

|                    |  |                 |         |
|--------------------|--|-----------------|---------|
| <b>GEV No.</b>     | 690674   | <b>Ref. No.</b> | 6008490 |
| <b>description</b> | spring assisted hinge right L 128mm spring thickness 2.5mm |                 |         |
| <b>For models:</b> | 135PVX, 55PV   |                 |         |



1

|                    |                            |                 |         |
|--------------------|----------------------------|-----------------|---------|
| <b>GEV No.</b>     | 690675                     | <b>Ref. No.</b> | 6008500 |
| <b>description</b> | spring assisted hinge left |                 |         |
| <b>For models:</b> | 135PVX                     |                 |         |



1

|                    |  |                 |         |
|--------------------|--|-----------------|---------|
| <b>GEV No.</b>     | 690572   | <b>Ref. No.</b> | 36M0340 |
| <b>description</b> | spring assisted hinge right refrigerator suitable for SAGI |                 |         |



1

|                    |   |                 |                    |
|--------------------|---|-----------------|--------------------|
| <b>GEV No.</b>     | 690573  | <b>Ref. No.</b> | 30M0350<br>36M0350 |
| <b>description</b> | spring assisted hinge left refrigerator suitable for SAGI |                 |                    |

ELECTROLUX/ZANUSSI



1

|                    |   |                 |         |
|--------------------|---|-----------------|---------|
| <b>GEV No.</b>     | 690747  | <b>Ref. No.</b> | 3178300 |
| <b>description</b> | bush for hinge ID $\varnothing$ 7.5mm L 25.5mm W 25.5mm white mounting measurements 22x22mm H 4.5mm   |                 |         |
| <b>For models:</b> | 120, 120B, 120NN, 135, 135-4, 135A, 135B, 135BA, 135BN, 135BNX, 135BX, 135BXE, 135BXR, 135CPX, 135NN, 135NNX, 135X, 135X-3, 135X-4, 135XE, 135XR, 55, 55B, 65, 65A, 65B, 65BA, 65BX, 65BX-2, 65BXE, 65BXR, 65NB, 65NBX, 65NN, 65NNX, 65X, 65X-2, 65XE, 65XR, AF1B, AF1N, AF2B, AF2N, ART1L, ART1LA, ART1LD, ART1LDA, ART2LD, ART2SD, ART3SD...(Other models you can see in the webshop) |                 |         |



1

|                    |  |                 |         |
|--------------------|--|-----------------|---------|
| <b>GEV No.</b>     | 690674   | <b>Ref. No.</b> | 6008490 |
| <b>description</b> | spring assisted hinge right L 128mm spring thickness 2.5mm |                 |         |
| <b>For models:</b> | 135PVX, 55PV   |                 |         |

SAGI



1

|                    |  |                 |         |
|--------------------|--|-----------------|---------|
| <b>GEV No.</b>     | 691198   | <b>Ref. No.</b> | 36G2650 |
| <b>description</b> | bar for spring hinge L 345mm $\varnothing$ 12mm  |                 |         |
| <b>For models:</b> | 191PD1G, 191PD2G, 191PI1G, 191PI1GA, 191PI2E, 191PI2EA, 191PI2G, 191PI2GA, 191PI2V, 191PI2VA, 1A1PD1G, 1A1PD2G, 1A1PI1G, 1A1PI1GA, 1A1PI2E, 1A1PI2EA, 1A1PI2G, 1A1PI2GA, 1A1PI2V, 1A1PI2VA, 1D1PD1G, 1D1PD2G, 1D1PI1G, 1D1PI1GA, 1D1PI2E, 1D1PI2EA, 1D1PI2G, 1D1PI2GA, 1D1PI2V, 1D1PI2VA, 1G1BR1E, 1G1BR1G, 1G1PD1G, 1G1PI1E, 1G1PI1G, 31PD6, 31PI6, 31PIE6, 31R, 31RE, 71AR, 71ARE, 71PD10, 71PD15, 71PI10, 71PI10A, 71PIE15, 71PIE15A, 71PV15, 71PV15A...(Other models you can see in the webshop) |                 |         |



1

|                    |  |                 |         |
|--------------------|--|-----------------|---------|
| <b>GEV No.</b>     | 690572   | <b>Ref. No.</b> | 36M0340 |
| <b>description</b> | spring assisted hinge right refrigerator suitable for SAGI |                 |         |



1

|                    |   |                 |         |
|--------------------|---|-----------------|---------|
| <b>GEV No.</b>     | 690747  | <b>Ref. No.</b> | 3178300 |
| <b>description</b> | bush for hinge ID $\varnothing$ 7.5mm L 25.5mm W 25.5mm white mounting measurements 22x22mm H 4.5mm   |                 |         |
| <b>For models:</b> | 120, 120B, 120NN, 135, 135-4, 135A, 135B, 135BA, 135BN, 135BNX, 135BX, 135BXE, 135BXR, 135CPX, 135NN, 135NNX, 135X, 135X-3, 135X-4, 135XE, 135XR, 55, 55B, 65, 65A, 65B, 65BA, 65BX, 65BX-2, 65BXE, 65BXR, 65NB, 65NBX, 65NN, 65NNX, 65X, 65X-2, 65XE, 65XR, AF1B, AF1N, AF2B, AF2N, ART1L, ART1LA, ART1LD, ART1LDA, ART2LD, ART2SD, ART3SD...(Other models you can see in the webshop) |                 |         |

oven hinges

Зип Общепит

vsezip.ru

+7(812)987-08-81



|                    |   |                 |         |
|--------------------|---|-----------------|---------|
| <b>GEV No.</b>     | 109720  | <b>Ref. No.</b> | 35U3170 |
| <b>description</b> | cover mounting distance 94mm L 124mm W 20mm oven hinge  |                 |         |
| <b>For models:</b> | 08WFA4E, 08WFA4G, 08WFAAE, 08WFAAG, 10WTPGE, 12WFA6E, 12WFA6G, 12WFAAE, 12WFAAG, 191FAAE, 191FAAG, 191FABG, 191FADG, 191FAE, 191FAG, 191PE4E, 191TPG, 1A1FA1G, 1A1FA2G, 1A1FA4G, 1A1FA5G, 1A1FAAG, 1A1FABG, 1A1FAS2G, 1A1FASG, 1A1PE4E, 1A1PEFTE, 1A1TP0G, 1A1TP0G-VERS.2002, 1A1FBE, 1B1FAS2G, 1B1FASG, 1D1FA1G, 1D1FA2G, 1D1FA4G, 1D1FA5G, 1D1FAAG, 1D1FABG, 1D1FAS2G, 1D1FASG, 1D1PE4E, 1D1TP0G, 1D1TP0G-VERS.2002, 1D1FBE, 1G1FA0E, 1G1FA0EV, 1G1FA0G, 1G1FA0GV, 1G1FAPG, 1G1PE1E...(Other models you can see in the webshop) |                 |         |

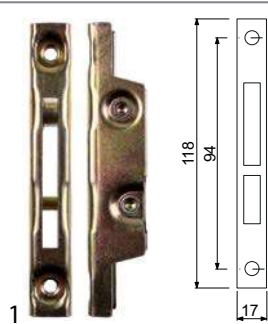

|                    |   |                 |                               |
|--------------------|---|-----------------|-------------------------------|
| <b>GEV No.</b>     | 700001  | <b>Ref. No.</b> | 3094780<br>36M0120<br>36M0270 |
| <b>description</b> | opposite support L 118mm W 17mm mounting distance 94mm  |                 |                               |
| <b>For models:</b> | 08WFA4E, 08WFA4G, 08WFAAE, 08WFAAG, 10WTPGE, 12WFA6E, 12WFA6G, 12WFAAE, 12WFAAG, 191FAAE, 191FAAG, 191FABG, 191FADG, 191FAE, 191FAG, 191PE4E, 191TPG, 1A1FA1G, 1A1FA2G, 1A1FA4G, 1A1FA5G, 1A1FAAG, 1A1FABG, 1A1FAS2G, 1A1FASG, 1A1PE4E, 1A1PEFTE, 1A1TP0G, 1A1TP0G-VERS.2002, 1A1FBE, 1B1FAS2G, 1B1FASG, 1D1FA1G, 1D1FA2G, 1D1FA4G, 1D1FA5G, 1D1FAAG, 1D1FABG, 1D1FAS2G, 1D1FASG, 1D1PE4E, 1D1TP0G, 1D1TP0G-VERS.2002, 1D1FBE, 1G1FA0E, 1G1FA0EV, 1G1FA0G, 1G1FA0GV, 1G1FABG, 1G1FAPG...(Other models you can see in the webshop) |                 |                               |



|                    |   |                 |         |
|--------------------|---|-----------------|---------|
| <b>GEV No.</b>     | 700704 <sup>1</sup>   | <b>Ref. No.</b> | 36M0190 |
| <b>description</b> | oven hinge mounting distance 120mm lug mounting 13mm lever length 115mm groove distance 7mm spring thickness 2.2mm mounting ear position left/right spring length 52mm W 27mm |                 |         |

<sup>1</sup>with opposite support



|                        |   |                 |                    |                               |
|------------------------|---|-----------------|--------------------|-------------------------------|
| <b>GEV No.</b>         | 700006  | <b>Ref. No.</b> | 36M0100<br>36M2420 |                               |
| <b>description</b>     | oven hinge mounting distance 173mm mounting distance 2 105mm lug mounting 14mm lever length 120mm groove distance 11mm spring thickness 3.5mm mounting ear position left spring length 112mm W 25mm   |                 |                    |                               |
| <b>For models:</b>     | 08WFA4E, 08WFA4G, 08WFAAE, 08WFAAG, 10WTPGE, 12WFA6E, 12WFA6G, 12WFAAE, 12WFAAG, 191FAAE, 191FAAG, 191FABG, 191FADG, 191FAE, 191FAG, 191PE4E, 191TPG, 1A1FA1G, 1A1FA2G, 1A1FA4G, 1A1FA5G, 1A1FAAG, 1A1FABG, 1A1FAS2G, 1A1FASG, 1A1PE4E, 1A1PEFTE, 1A1TP0G, 1A1TP0G-VERS.2002, 1A1FBE, 1B1FAS2G, 1B1FASG, 1D1FA1G, 1D1FA2G, 1D1FA4G, 1D1FA5G, 1D1FAAG, 1D1FABG, 1D1FAS2G, 1D1FASG, 1D1PE4E, 1D1TP0G, 1D1TP0G-VERS.2002, 1D1FBE, 1G1FA0E, 1G1FA0EV, 1G1FA0G, 1G1FA0GV, 1G1FABG, 1G1FAPG...(Other models you can see in the webshop) |                 |                    |                               |
| <b>accessories for</b> | 700006  |                 |                    |                               |
|                        | <b>GEV No.</b>  | 700001          | <b>Ref. No.</b>    | 3094780<br>36M0120<br>36M0270 |
|                        | opposite support L 118mm W 17mm mounting distance 94mm  |                 |                    |                               |
|                        | <b>GEV No.</b>  | 700007          | <b>Ref. No.</b>    | 36M0110<br>36M2430            |
|                        | oven hinge mounting distance 173mm mounting distance 2 105mm lug mounting 14mm lever length 120mm groove distance 11mm spring thickness 3.5mm mounting ear position right spring length 112mm W 25mm  |                 |                    |                               |

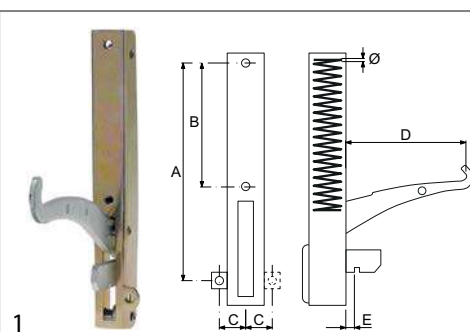

|                        |   |                 |                    |                               |
|------------------------|---|-----------------|--------------------|-------------------------------|
| <b>GEV No.</b>         | 700007  | <b>Ref. No.</b> | 36M0110<br>36M2430 |                               |
| <b>description</b>     | oven hinge mounting distance 173mm mounting distance 2 105mm lug mounting 14mm lever length 120mm groove distance 11mm spring thickness 3.5mm mounting ear position right spring length 112mm W 25mm  |                 |                    |                               |
| <b>For models:</b>     | 08WFA4E, 08WFA4G, 08WFAAE, 08WFAAG, 10WTPGE, 12WFA6E, 12WFA6G, 12WFAAE, 12WFAAG, 191FAAE, 191FAAG, 191FABG, 191FADG, 191FAE, 191FAG, 191PE4E, 191TPG, 1A1FA1G, 1A1FA2G, 1A1FA4G, 1A1FA5G, 1A1FAAG, 1A1FABG, 1A1FAS2G, 1A1FASG, 1A1PE4E, 1A1PEFTE, 1A1TP0G, 1A1TP0G-VERS.2002, 1A1FBE, 1B1FAS2G, 1B1FASG, 1D1FA1G, 1D1FA2G, 1D1FA4G, 1D1FA5G, 1D1FAAG, 1D1FABG, 1D1FAS2G, 1D1FASG, 1D1PE4E, 1D1TP0G, 1D1TP0G-VERS.2002, 1D1FBE, 1G1FA0E, 1G1FA0EV, 1G1FA0G, 1G1FA0GV, 1G1FABG, 1G1FAPG...(Other models you can see in the webshop) |                 |                    |                               |
| <b>accessories for</b> | 700007  |                 |                    |                               |
|                        | <b>GEV No.</b>  | 700001          | <b>Ref. No.</b>    | 3094780<br>36M0120<br>36M0270 |
|                        | opposite support L 118mm W 17mm mounting distance 94mm  |                 |                    |                               |

door bearing

Зип Общепит

vsezip.ru

+7(812)987-08-81



1

|                    |   |                 |         |
|--------------------|---|-----------------|---------|
| <b>GEV No.</b>     | 690686  | <b>Ref. No.</b> | 36G2810 |
| <b>description</b> | bush for door hinge   |                 |         |
| <b>For models:</b> | 40, 40B, 40CP, 40CPX, 40PL, 40X, ART1L7, ART1L7A, ART1L7M, ART1LD7, ART1LD7A, ART1LD7M, BRPR, BRPR218, BRPR21C, BRPRV, BRVR, BRVR218, BRVR21C, BRVRV, K16APGPZ, K16XPZAP, SA16AGB, SA16GB, SA87, SM03LT7, SM03LT7A, SM03LT7M, SM1L7, SM1L7A, SM1L7FCV, SM1L7M, SM1LT7, SM1LT7A, SM1LT7M |                 |         |



1

|                    |   |                 |         |
|--------------------|---|-----------------|---------|
| <b>GEV No.</b>     | 690742  | <b>Ref. No.</b> | 36D4610 |
| <b>description</b> | bush for door hinge   |                 |         |
| <b>For models:</b> | 6BEA11Z, 6BEA2Z, 6BEA3Z, 6BEABA, 6BEABB, 6BEABM, 6BEABZ, 6BEAZ, 6BEB11Z, 6BEB22Z, 6BEB2Z, 6BEB3Z, 6BEB4Z, 6BEBBA, 6BEBB, 6BEBBM, 6BEBBZ, 6BEBZ, 6BEC11Z, 6BEC22Z, 6BEC2Z, 6BEC33Z, 6BEC3Z, 6BEC4Z, 6BEC6Z, 6BECBA, 6BECBB, 6BECBM, 6BECBZ, 6BECZ, 6BMA11A, 6BMA11B, 6BMA11M, 6BMA11Z, 6BMA2A, 6BMA2B, 6BMA2M, 6BMA2Z, 6BMA3A, 6BMA3B, 6BMA3M, 6BMA3Z, 6BMAA, 6BMAB, 6BMABA, 6BMABB, 6BMABM, 6BMABZ, 6BMAM, 6BMAZ... (Other models you can see in the webshop) |                 |         |



1

|                    |   |                 |         |
|--------------------|---|-----------------|---------|
| <b>GEV No.</b>     | 690743  | <b>Ref. No.</b> | 36D4700 |
| <b>description</b> | bush for door hinge   |                 |         |
| <b>For models:</b> | 6BEA11Z, 6BEA2Z, 6BEA3Z, 6BEABA, 6BEABB, 6BEABM, 6BEABZ, 6BEAZ, 6BEB11Z, 6BEB22Z, 6BEB2Z, 6BEB3Z, 6BEB4Z, 6BEBBA, 6BEBB, 6BEBBM, 6BEBBZ, 6BEBZ, 6BEC11Z, 6BEC22Z, 6BEC2Z, 6BEC33Z, 6BEC3Z, 6BEC4Z, 6BEC6Z, 6BECBA, 6BECBB, 6BECBM, 6BECBZ, 6BECZ, 6BMA11Z, 6BMA2Z, 6BMA3Z, 6BMABA, 6BMABB, 6BMABM, 6BMABZ, 6BMAZ, 6BMB11Z, 6BMB22Z, 6BMB2Z, 6BMB3Z, 6BMB4Z, 6BMBBZ, 6BMBZ, 6BMC11Z, 6BMC22Z, 6BMC2Z, 6BMC33Z, 6BMC3Z... (Other models you can see in the webshop) |                 |         |



1

|                    |  |                 |         |
|--------------------|--|-----------------|---------|
| <b>GEV No.</b>     | 695571   | <b>Ref. No.</b> | 36M0090 |
| <b>description</b> | bush for door hinge  |                 |         |
| <b>For models:</b> | 135-4, 135CPX, 135X-3, 135X-4, 65BX-2, 65NB, 65NBX, 65NN, 65NNX, 65X-2, CX140CP, CX150CP, CX652, CX65NB, CX65NCP, CX65NN, CX702, CX70NB, CX70NN, FSD2B2-OPR01, FSD2N2, FSD2N2-OPR01, FSDR2B2-OPR01, FSE2B2, FSE2B2-OPR01, FSE2N2, FSE2N2-OPR01, FSER2B2-OPR01, FSER2N2-OPR01, ISFEB, ISFEB-OPR01, ISFEN, ISFEN-OPR01, MD1504, MD150B4, MD702, MD70B2, MD70NB, MD70NCP, MD70NN, PD150CP, PD702, PD70B2, S12004, S1200B4, S125-4, S125B-4, S125BX-4, S125X-4, S6002... (Other models you can see in the webshop) |                 |         |



1

|                    |   |                 |         |
|--------------------|---|-----------------|---------|
| <b>GEV No.</b>     | 690479  | <b>Ref. No.</b> | 3170250 |
| <b>description</b> | bush H 20mm ø 7mm mounting measurements 22x22mm external size 26.5x26.5mm                       |                 |         |
| <b>For models:</b> | 135-4, 135CPX, 135X-3, 135X-4, 65BX-2, 65NB, 65NBX, 65NN, 65NNX, 65X-2, SP135CP, SP65NB, SP65NN |                 |         |



1

|                    |  |                 |         |
|--------------------|--|-----------------|---------|
| <b>GEV No.</b>     | 690795   | <b>Ref. No.</b> | 36D9490 |
| <b>description</b> | counterpart for spring hinge   |                 |         |
| <b>For models:</b> | 120, 120B, 120NN, 135, 135-4, 135A, 135B, 135BA, 135BN, 135BNX, 135BX, 135BXE, 135BXR, 135CPX, 135NN, 135NNX, 135X, 135X-3, 135X-4, 135XE, 135XR, 55, 55B, 65, 65A, 65B, 65BA, 65BX, 65BX-2, 65BXE, 65BXR, 65NB, 65NBX, 65NN, 65NNX, 65X, 65X-2, 65XE, 65XR, ART1L, ART1LA, ART1LD, ART1LDA, ART2LD, ART2SD, ART3SD, S125, S125-4, S125B, S125B-4... (Other models you can see in the webshop) |                 |         |



1

|                    |                                       |                 |         |
|--------------------|---------------------------------------|-----------------|---------|
| <b>GEV No.</b>     | 691157                                | <b>Ref. No.</b> | 30T2000 |
| <b>description</b> | door hinge mounting pos. bottom right |                 |         |



1

|                    |        |                 |         |
|--------------------|--------|-----------------|---------|
| <b>GEV No.</b>     | 690563 | <b>Ref. No.</b> | 3AG0040 |
| <b>description</b> | hinge  |                 |         |



1

|                    |   |                 |         |
|--------------------|---|-----------------|---------|
| <b>GEV No.</b>     | 690489  | <b>Ref. No.</b> | 30T5910 |
| <b>description</b> | hinge L 138mm mounting pos. upper/lower   |                 |         |
| <b>For models:</b> | 135-4, 135CPX, 135X-3, 135X-4, 65BX-2, 65NB, 65NBX, 65NN, 65NNX, 65X-2, S125-4, S125B-4, S125BX-4, S125X-4, S60-2, S60B-2, S60BX-2, S60X-2, SP135CP, SP65NB, SP65NN |                 |         |

Зип Общепит

vsezip.ru

+7(812)987 08 81

|   |  |                 |         |
|---|--|-----------------|---------|
|  |  |                 |         |
| 1   |  |                 |         |
| <b>GEV No.</b>  | 695570   | <b>Ref. No.</b> | 36M2490 |
| <b>description</b>  | hinge mounting pos. bottom left  |                 |         |
| <b>For models:</b>  | 71CP, 71CP2, 71F, 71F2, 71F2B, 71FE, 71FE2, 71FE2B, 91CP, 91F210, 91F210B, 91F223B |                 |         |

|   |                                  |                 |         |
|---|----------------------------------|-----------------|---------|
|  |                                  |                 |         |
| 1   |                                  |                 |         |
| <b>GEV No.</b>  | 690793                           | <b>Ref. No.</b> | 30T4780 |
| <b>description</b>  | hinge mounting pos. bottom right |                 |         |
| <b>For models:</b>  | 120PV, 135PVX, 55PV, 65PVX       |                 |         |

|   |                                      |                 |                    |
|---|--------------------------------------|-----------------|--------------------|
|  |                                      |                 |                    |
| 1   |                                      |                 |                    |
| <b>GEV No.</b>  | 690788                               | <b>Ref. No.</b> | 36M0320<br>36M2610 |
| <b>description</b>  | hinge mounting pos. centre with bolt |                 |                    |

|   |   |                 |                    |
|---|---|-----------------|--------------------|
|  |   |                 |                    |
| 1   |   |                 |                    |
| <b>GEV No.</b>  | 700740  | <b>Ref. No.</b> | 3043190<br>3088700 |
| <b>description</b>  | hinge mounting pos. lower   |                 |                    |
| <b>For models:</b>  | 3G65A, 3G65A2, 3G65A4, 4G65B, 4G65B2, 4G65B4, 4G65B6, 6BR15V, 6BR15VC, 6BR19V, 6BR19VC, 6EA, 6EA11, 6EA11A, 6EA11M, 6EA13, 6EA13A, 6EA13M, 6EA2, 6EA2A, 6EA2M, 6EAA, 6EAB, 6EABA, 6EABM, 6EAM, 6EB, 6EB11, 6EB11A, 6EB11M, 6EB13, 6EB13A, 6EB13M, 6EB2, 6EB22, 6EB22A, 6EB22M, 6EB2A, 6EB2M, 6EB4, 6EB4A, 6EB4M, 6EBA, 6EBB, 6EBBA, 6EBBM, 6EBM, 6EC, 6EC11, 6EC11A...(Other models you can see in the webshop) |                 |                    |

|   |   |                 |         |
|---|---|-----------------|---------|
|  |   |                 |         |
| 1   |   |                 |         |
| <b>GEV No.</b>  | 700741  | <b>Ref. No.</b> | 3043180 |
| <b>description</b>  | hinge mounting pos. upper   |                 |         |
| <b>For models:</b>  | 3G65A, 3G65A2, 3G65A4, 4G65B, 4G65B2, 4G65B4, 4G65B6, 6BR15V, 6BR15VC, 6BR19V, 6BR19VC, 6EA, 6EA11, 6EA11A, 6EA11M, 6EA13, 6EA13A, 6EA13M, 6EA2, 6EA2A, 6EA2M, 6EAA, 6EAB, 6EABA, 6EABM, 6EAM, 6EB, 6EB11, 6EB11A, 6EB11M, 6EB13, 6EB13A, 6EB13M, 6EB2, 6EB22, 6EB22A, 6EB22M, 6EB2A, 6EB2M, 6EB4, 6EB4A, 6EB4M, 6EBA, 6EBB, 6EBBA, 6EBBM, 6EBM, 6EC, 6EC11, 6EC11A...(Other models you can see in the webshop) |                 |         |

|  |                                |                 |         |
|--|--------------------------------|-----------------|---------|
|  |                                |                 |         |
| 1  |                                |                 |         |
| <b>GEV No.</b>   | 690787                         | <b>Ref. No.</b> | 30T1980 |
| <b>description</b>   | hinge mounting pos. upper left |                 |         |

|  |                                |                 |         |
|--|--------------------------------|-----------------|---------|
|  |                                |                 |         |
| 1  |                                |                 |         |
| <b>GEV No.</b>   | 690794                         | <b>Ref. No.</b> | 30T4800 |
| <b>description</b>   | hinge mounting pos. upper left |                 |         |
| <b>For models:</b>   | 120PV, 135PVX                  |                 |         |

|  |                                 |                 |         |
|--|---------------------------------|-----------------|---------|
|  |                                 |                 |         |
| 1  |                                 |                 |         |
| <b>GEV No.</b>   | 690790                          | <b>Ref. No.</b> | 30T1080 |
| <b>description</b>   | hinge mounting pos. upper right |                 |         |

|  |   |                 |         |
|--|---|-----------------|---------|
|  |   |                 |         |
| 1  |   |                 |         |
| <b>GEV No.</b>   | 700719  | <b>Ref. No.</b> | 36M2541 |
| <b>description</b>   | hinge mounting pos. upper right   |                 |         |
| <b>For models:</b>   | 30CPS, 30CPSE, 30F1, 30F1B, 30FES2, 30FES2B, 30FS2, 30FS2B, 32TC, 32TCE, 32TPV, 32V, 70CP, 70CPE, 70F, 70F1, 70F1B, 70FE, 70FE1, 70FE1B, 70FES, 70FES2, 70FES2B, 71CP, 71CP2, 71F, 71F2, 71F2B, 71FE, 71FE2, 71FE2B, 72D, 72DGG, 72TP, 72TPGG, 72VA, 72VAGG, 72VAS, 72VASGG, 90CP, 90CPE, 90F110B, 91CP, 91F210, 91F210B, 91F223B |                 |         |

|  |  |                 |         |
|--|--|-----------------|---------|
|  |  |                 |         |
| 1  |  |                 |         |
| <b>GEV No.</b>   | 690746   | <b>Ref. No.</b> | 30T5900 |
| <b>description</b>   | hinge bearing mounting pos. centre with bolt   |                 |         |
| <b>For models:</b>   | 135-4, 135CPX, 135X-3, 135X-4, 65BX-2, 65NB, 65NN, 65NNX, 65X-2, S125-4, S125B-4, S125BX-4, S125X-4, S60-2, S60B-2, S60BX-2, S60X-2, SP135CP, SP65NB, SP65NN |                 |         |



Зип Общепит

vsezip.ru

+7(812)98708181



1

|                    |  |                 |         |
|--------------------|--|-----------------|---------|
| <b>GEV No.</b>     | 690741   | <b>Ref. No.</b> | 30T6230 |
| <b>description</b> | hinge bearing mounting pos. lower with bolt  |                 |         |
| <b>For models:</b> | 6BEA11Z, 6BEA2Z, 6BEA3Z, 6BEABA, 6BEABB, 6BEABM, 6BEABZ, 6BEAZ, 6BEB11Z, 6BEB22Z, 6BEB2Z, 6BEB3Z, 6BEB4Z, 6BEBBA, 6BEBBB, 6BEBBM, 6BEBBZ, 6BEBZ, 6BEC11Z, 6BEC22Z, 6BEC2Z, 6BEC33Z, 6BEC3Z, 6BEC4Z, 6BEC6Z, 6BECBA, 6BECBB, 6BECBM, 6BECBZ, 6BECZ, 6BMA11Z, 6BMA2Z, 6BMA3Z, 6BMABA, 6BMABB, 6BMABM, 6BMABZ, 6BMAZ, 6BMB11Z, 6BMB22Z, 6BMB2Z, 6BMB3Z, 6BMB4Z, 6BMBBA, 6BMBBB, 6BMBBM, 6BMBBZ, 6BMBZ, 6BMC11Z, 6BMC22Z...(Other models you can see in the webshop) |                 |         |



1

|                    |  |                 |         |
|--------------------|--|-----------------|---------|
| <b>GEV No.</b>     | 690672   | <b>Ref. No.</b> | 30T5970 |
| <b>description</b> | hinge bearing mounting pos. upper left with bolt |                 |         |
| <b>For models:</b> | 120PV, 135PVX                                    |                 |         |



1

|                    |   |                 |         |
|--------------------|---|-----------------|---------|
| <b>GEV No.</b>     | 690755                                      | <b>Ref. No.</b> | 30T1950 |
| <b>description</b> | hinge bearing mounting pos. lower with bolt |                 |         |



1

|                    |  |                 |         |
|--------------------|--|-----------------|---------|
| <b>GEV No.</b>     | 690792   | <b>Ref. No.</b> | 30T4810 |
| <b>description</b> | hinge bearing mounting pos. upper left with bolt |                 |         |



1

|                    |  |                 |         |
|--------------------|--|-----------------|---------|
| <b>GEV No.</b>     | 690749   | <b>Ref. No.</b> | 36M2740 |
| <b>description</b> | hinge bearing mounting pos. lower without bolt |                 |         |
| <b>For models:</b> | K16APGPZ, K16XPZAP, SA16AGB, SA16GB            |                 |         |



1

|                    |   |                 |         |
|--------------------|---|-----------------|---------|
| <b>GEV No.</b>     | 690671  | <b>Ref. No.</b> | 30T5800 |
| <b>description</b> | hinge bearing mounting pos. upper right with bolt |                 |         |
| <b>For models:</b> | 120PV, 135PVX, 55PV, 65PVX                        |                 |         |



1

|                    |   |                 |         |
|--------------------|---|-----------------|---------|
| <b>GEV No.</b>     | 514282  | <b>Ref. No.</b> | 36M4122 |
| <b>description</b> | hinge bearing mounting pos. right/left without bolt   |                 |         |
| <b>For models:</b> | FC101, FC101E, FC241, FC241E, FC241G, FC61, FC61E, FCV101, FCV101-CSA, FCV101DM, FCV101DM-CSA, FCV101DS, FCV101DS-CSA, FCV101E, FCV101EDM, FCV101EDM-UL, FCV101EDS, FCV101EDS-UL, FCV101E-UL, FCV141, FCV141-CSA, FCV141DM, FCV141DM-CSA, FCV141DS, FCV141DS-CSA, FCV141E, FCV141EDM, FCV141EDS, FCV241, FCV241DM, FCV241DS, FCV241E, FCV241EDM, FCV241EDM-UL, FCV241EDS, FCV241EDS-UL, FCV241E-UL, FCV241G, FCV241G-CSA, FCV241GDM, FCV241GDM-CSA, FCV241GDS, FCV241GDS-CSA, FCV3EM, FCV401DM, FCV401DM-CSA, FCV401EDM, FCV401EDM-UL, FCV4E, FCV4EDS...(Other models you can see in the webshop) |                 |         |



1

|                    |   |                 |         |
|--------------------|---|-----------------|---------|
| <b>GEV No.</b>     | 690748  | <b>Ref. No.</b> | 36M2730 |
| <b>description</b> | hinge bearing mounting pos. upper right with bolt |                 |         |
| <b>For models:</b> | K16APGPZ, K16XPZAP, SA16AGB, SA16GB               |                 |         |

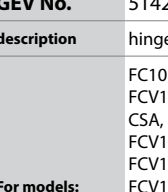

1

|                    |   |                 |         |
|--------------------|---|-----------------|---------|
| <b>GEV No.</b>     | 514282  | <b>Ref. No.</b> | 36M4122 |
| <b>description</b> | hinge bearing mounting pos. right/left without bolt   |                 |         |
| <b>For models:</b> | FC101, FC101E, FC241, FC241E, FC241G, FC61, FC61E, FCV101, FCV101-CSA, FCV101DM, FCV101DM-CSA, FCV101DS, FCV101DS-CSA, FCV101E, FCV101EDM, FCV101EDM-UL, FCV101EDS, FCV101EDS-UL, FCV101E-UL, FCV141, FCV141-CSA, FCV141DM, FCV141DM-CSA, FCV141DS, FCV141DS-CSA, FCV141E, FCV141EDM, FCV141EDS, FCV241, FCV241DM, FCV241DS, FCV241E, FCV241EDM, FCV241EDM-UL, FCV241EDS, FCV241EDS-UL, FCV241E-UL, FCV241G, FCV241G-CSA, FCV241GDM, FCV241GDM-CSA, FCV241GDS, FCV241GDS-CSA, FCV3EM, FCV401DM, FCV401DM-CSA, FCV401EDM, FCV401EDM-UL, FCV4E, FCV4EDS...(Other models you can see in the webshop) |                 |         |



1

|                    |  |                 |         |
|--------------------|--|-----------------|---------|
| <b>GEV No.</b>     | 690740   | <b>Ref. No.</b> | 30T6220 |
| <b>description</b> | hinge bearing mounting pos. upper with bolt  |                 |         |
| <b>For models:</b> | 6BEA11Z, 6BEA2Z, 6BEA3Z, 6BEABA, 6BEABB, 6BEABM, 6BEABZ, 6BEAZ, 6BEB11Z, 6BEB22Z, 6BEB2Z, 6BEB3Z, 6BEB4Z, 6BEBBA, 6BEBBB, 6BEBBM, 6BEBBZ, 6BEBZ, 6BEC11Z, 6BEC22Z, 6BEC2Z, 6BEC33Z, 6BEC3Z, 6BEC4Z, 6BEC6Z, 6BECBA, 6BECBB, 6BECBM, 6BECBZ, 6BECZ, 6BMA11Z, 6BMA2Z, 6BMA3Z, 6BMABA, 6BMABB, 6BMABM, 6BMABZ, 6BMAZ, 6BMB11Z, 6BMB22Z, 6BMB2Z, 6BMB3Z, 6BMB4Z, 6BMBBA, 6BMBBB, 6BMBBM, 6BMBBZ, 6BMBZ, 6BMC11Z, 6BMC22Z...(Other models you can see in the webshop) |                 |         |

Зип Общепит  
vsezip.ru  
+7(812)987-08-81



|                    |  |                 |         |
|--------------------|--|-----------------|---------|
| <b>GEV No.</b>     | 690684   | <b>Ref. No.</b> | 35V7760 |
| <b>description</b> | hinge bearing mounting pos. upper without bolt |                 |         |
| <b>For models:</b> | 40, 40B, 40CP, 40CPX, 40PL, 40X                |                 |         |



|                    |   |                 |         |
|--------------------|---|-----------------|---------|
| <b>GEV No.</b>     | 692861  | <b>Ref. No.</b> | 36E2680 |
| <b>description</b> | hinge bearing without bolt mounting pos. upper right  |                 |         |
| <b>For models:</b> | FC1011E, FC1011G, FC1221E, FC1221G, FC611E, FC611G, FM1011E1, FM1011E1-VERS.2006, FM1011E2, FM1011E2-VERS.2006, FM1011E3, FM1011E3-VERS.2006, FM1011G1, FM1011G1-VERS.2006, FM1011G2, FM1011G2-VERS.2006, FM1011G3, FM1011G3-VERS.2006, FM1221E1, FM1221E1-VERS.2006, FM1221E2, FM1221E2-VERS.2006, FM1221E3, FM1221E3-VERS.2006, FM1221G1, FM1221G1-VERS.2006, FM1221G2, FM1221G2-VERS.2006, FM1221G3, FM1221G3-VERS.2006, FM2011E2-VERS.2006, FM2011E3-VERS.2006, FM2011G2-VERS.2006, FM2011G3-VERS.2006, FM2021E1, FM2021E2, FM2021E2-VERS.2006, FM2021E3, FM2021E3-VERS.2006, FM2021G1, FM2021G2, FM2021G2-VERS.2006, FM2021G3, FM2021G3-VERS.2006, FM611E1, FM611E1-VERS.2006, FM611E2, FM611E2-VERS.2006, FM611E3, FM611E3-VERS.2006... (Other models you can see in the webshop) |                 |         |



|                    |  |                 |         |
|--------------------|--|-----------------|---------|
| <b>GEV No.</b>     | 690688   | <b>Ref. No.</b> | 35V8800 |
| <b>description</b> | hinge bearing mounting pos. upper without bolt |                 |         |
| <b>For models:</b> | 40EV, 40EVP, 40PV, 40XPV                       |                 |         |



|                    |  |                 |         |
|--------------------|--|-----------------|---------|
| <b>GEV No.</b>     | 690571   | <b>Ref. No.</b> | 30T5810 |
| <b>description</b> | hinge bearing with bolt suitable for SAGI  |                 |         |
| <b>For models:</b> | 120, 120B, 120NN, 135, 135A, 135B, 135BA, 135BN, 135BNX, 135BX, 135BXE, 135BXR, 135CPX, 135NN, 135NNX, 135X, 135X-3, 135XE, 135XR, 55, 55B, 65, 65A, 65B, 65BA, 65BX, 65BXE, 65BXR, 65X, 65XE, 65XR, S125, S125B, S125BE, S125BX, S125E, S125X, S60, S60B, S60BE, S60BX, S60E, S60X, SP120, SP120B, SP120BN, SP120NN, SP135, SP135B, SP135BN...(Other models you can see in the webshop) |                 |         |



|                    |                                |                 |         |
|--------------------|--------------------------------|-----------------|---------|
| <b>GEV No.</b>     | 505513                         | <b>Ref. No.</b> | 30T1350 |
| <b>description</b> | spring assisted hinge left     |                 |         |
| <b>For models:</b> | F60P, F60PR, F60T, F80P, F80PR |                 |         |



|                    |   |                 |         |
|--------------------|---|-----------------|---------|
| <b>GEV No.</b>     | 690751                                    | <b>Ref. No.</b> | 30T2051 |
| <b>description</b> | hinge bearing with bolt suitable for SAGI |                 |         |
| <b>For models:</b> | K16APGPZ, K16XPZAP, SA16AGB, SA16GB       |                 |         |



|                    |                                |                 |         |
|--------------------|--------------------------------|-----------------|---------|
| <b>GEV No.</b>     | 505512                         | <b>Ref. No.</b> | 30T1340 |
| <b>description</b> | spring assisted hinge right    |                 |         |
| <b>For models:</b> | F60P, F60PR, F60T, F80P, F80PR |                 |         |



|                    |  |                 |         |
|--------------------|--|-----------------|---------|
| <b>GEV No.</b>     | 692862   | <b>Ref. No.</b> | 3108730 |
| <b>description</b> | hinge bearing without bolt mounting pos. bottom right  |                 |         |
| <b>For models:</b> | BX101E, BX101E-VERS.122013, BX101G, BX101G-VERS.122013, BX122E, BX122E-VERS.122013, BX122G, BX122G-VERS.122013, BX61E, BX61E-VERS.122013, BX61G, BX61G-VERS.122013, BX82E, BX82E-VERS.122013, BX82G, BX82G-VERS.122013, FX101E1, FX101E1R, FX101E2, FX101E2C, FX101E2C-VERS.032014, FX101E2R, FX101E2R-VERS.032014, FX101E2-VERS.032014, FX101E3, FX101E3C, FX101E3C-VERS.022014, FX101E3R, FX101E3R-VERS.022014, FX101E3-VERS.022014, FX101G1, FX101G1R, FX101G2, FX101G2C, FX101G2C-VERS.032014, FX101G2R, FX101G2R-VERS.032014, FX101G2-VERS.032014, FX101G3, FX101G3C, FX101G3C-VERS.022014, FX101G3R, FX101G3R-VERS.022014, FX101G3-VERS.022014, FX10E2CR, FX10E2CR-VERS.032014, FX10E3CR, FX10E3CR-VERS.022014, FX10G2CR, FX10G2CR-VERS.032014...(Other models you can see in the webshop) |                 |         |

**miscellaneous**



Image not available

|                    |                                |                 |         |
|--------------------|--------------------------------|-----------------|---------|
| <b>GEV No.</b>     | 700715                         | <b>Ref. No.</b> | 30T3150 |
| <b>description</b> | hinge mounting pos. left/right |                 |         |
| <b>For models:</b> | L45                            |                 |         |



Зип Общепит

vsezip.ru

+7(812)987-08-81

|   |   |                 |         |
|---|---|-----------------|---------|
|  |   |                 |         |
| 1   |   |                 |         |
| <b>GEV No.</b>  | 698474  | <b>Ref. No.</b> | 36E2820 |
| <b>description</b>  | hinge block total length 50mm overall height 14mm suitable for ANGELO PO  |                 |         |
| <b>For models:</b>  | FC1011E, FC1011G, FC1221E, FC1221G, FC611E, FC611G, FM1011E1, FM1011E1-VERS.2006, FM1011E2, FM1011E2-VERS.2006, FM1011E3, FM1011E3-VERS.2006, FM1011G1, FM1011G1-VERS.2006, FM1011G2, FM1011G2-VERS.2006, FM1011G3, FM1011G3-VERS.2006, FM1221E1, FM1221E1-VERS.2006, FM1221E2, FM1221E2-VERS.2006, FM1221E3, FM1221E3-VERS.2006, FM1221G1, FM1221G1-VERS.2006, FM1221G2, FM1221G2-VERS.2006, FM1221G3, FM1221G3-VERS.2006, FM2011E2-VERS.2006, FM2011E3-VERS.2006, FM2011G2-VERS.2006, FM2011G3-VERS.2006, FM2021E1, FM2021E2, FM2021E2-VERS.2006, FM2021E3, FM2021E3-VERS.2006, FM2021G1, FM2021G2, FM2021G2-VERS.2006, FM2021G3, FM2021G3-VERS.2006, FM611E1, FM611E1-VERS.2006, FM611E2, FM611E2-VERS.2006, FM611E3, FM611E3-VERS.2006... (Other models you can see in the webshop) |                 |         |

|  |                          |                 |         |
|--|--------------------------|-----------------|---------|
|  |                          |                 |         |
| 1  |                          |                 |         |
| <b>GEV No.</b>   | 690689                   | <b>Ref. No.</b> | 35X3460 |
| <b>description</b>   | spacer ring              |                 |         |
| <b>For models:</b>   | 40EV, 40EVP, 40PV, 40XPV |                 |         |

accessories

miscellaneous

|   |   |                 |         |
|---|---|-----------------|---------|
|  |   |                 |         |
| 1   |   |                 |         |
| <b>GEV No.</b>  | 692864  | <b>Ref. No.</b> | 3108741 |
| <b>description</b>  | hinge bearing latching with bolt mounting pos. bottom right |                 |         |

|   |   |                 |         |
|---|---|-----------------|---------|
|  |   |                 |         |
| 1   |   |                 |         |
| <b>GEV No.</b>  | 692863  | <b>Ref. No.</b> | 36E2660 |
| <b>description</b>  | hinge bearing latching without bolt mounting pos. bottom right  |                 |         |
| <b>For models:</b>  | FC1011E, FC1011G, FC1221E, FC1221G, FC611E, FC611G, FM1011E1, FM1011E1-VERS.2006, FM1011E2, FM1011E2-VERS.2006, FM1011E3, FM1011E3-VERS.2006, FM1011G1, FM1011G1-VERS.2006, FM1011G2, FM1011G2-VERS.2006, FM1011G3, FM1011G3-VERS.2006, FM1221E1, FM1221E1-VERS.2006, FM1221E2, FM1221E2-VERS.2006, FM1221E3, FM1221E3-VERS.2006, FM1221G1, FM1221G1-VERS.2006, FM1221G2, FM1221G2-VERS.2006, FM1221G3, FM1221G3-VERS.2006, FM2011E2-VERS.2006, FM2011E3-VERS.2006, FM2011G2-VERS.2006, FM2011G3-VERS.2006, FM2021E1, FM2021E2, FM2021E2-VERS.2006, FM2021E3, FM2021E3-VERS.2006, FM2021G1, FM2021G2, FM2021G2-VERS.2006, FM2021G3, FM2021G3-VERS.2006, FM611E1, FM611E1-VERS.2006, FM611E2, FM611E2-VERS.2006, FM611E3, FM611E3-VERS.2006... (Other models you can see in the webshop) |                 |         |

|   |                                       |                 |         |
|---|---------------------------------------|-----------------|---------|
|  |                                       |                 |         |
| 1   |                                       |                 |         |
| <b>GEV No.</b>  | 690687                                | <b>Ref. No.</b> | 36D2880 |
| <b>description</b>  | plain washer                          |                 |         |
| <b>For models:</b>  | 40, 40B, 40CP, 40CPX, 40PL, 40X, SA87 |                 |         |



|  |                          |                 |         |
|--|--------------------------|-----------------|---------|
|  |                          |                 |         |
| 1  |                          |                 |         |
| <b>GEV No.</b>   | 690691                   | <b>Ref. No.</b> | 36C2440 |
| <b>description</b>   | spacer ring              |                 |         |
| <b>For models:</b>   | 40EV, 40EVP, 40PV, 40XPV |                 |         |

pullouts

drawer slides

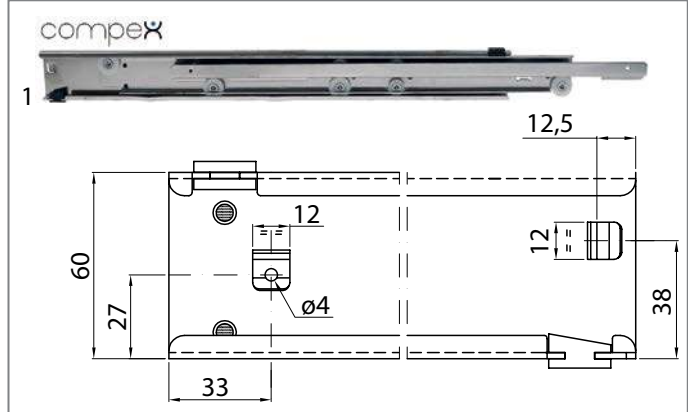
universal



|   |   |                 |                    |   |
|---|---|-----------------|--------------------|---|
|  |   |                 |                    |   |
| 1   |   |                 |                    |   |
| <b>GEV No.</b>  | 696714 <sup>1</sup>   | <b>Ref. No.</b> | 36M8080<br>36M8090 |   |
| <b>description</b>  | drawer slide L 550mm pull-out length 610mm total length 1160mm Qty 1 pair capacity 50kg W 16mm H 60mm SS telescopic   |                 |                    |   |
| <b>For models:</b>  | 3G6SA, 3G6SA2, 3G6SA4, 4G6SB, 4G6SB2, 4G6SB4, 4G6SB6, 6BR15V, 6BR15VC, 6BR19V, 6BR19VC, 6EA11, 6EA11A, 6EA11M, 6EA13, 6EA13A, 6EA13M, 6EA2, 6EA2A, 6EA2M, 6EB11, 6EB11A, 6EB11M, 6EB13, 6EB13A, 6EB13M, 6EB2, 6EB22, 6EB22A, 6EB22M, 6EB2A, 6EB2M, 6EB4, 6EB4A, 6EB4M, 6EC11, 6EC11A, 6EC11M, 6EC13, 6EC13A, 6EC13M, 6EC2, 6EC22, 6EC22A, 6EC22M, 6EC2A, 6EC2M, 6EC4, 6EC4A, 6EC4M... (Other models you can see in the webshop) |                 |                    |   |
| <b>spare parts for</b>  | 696714  |                 |                    |   |
|  | <b>GEV No.</b>  | 690750          | <b>Ref. No.</b>    | — |
|   | stop for telescopic rail L 20mm plastic H 12mm D 9mm  |                 |                    |   |
|  | <b>GEV No.</b>  | 696333          | <b>Ref. No.</b>    | — |
|   | stop for telescopic rail L 20mm plastic H 15mm D 8mm  |                 |                    |   |

<sup>1</sup>multiple slide (60mm more than nominal length)



Зип.ОбщениТ

product specification

vsezip.ru

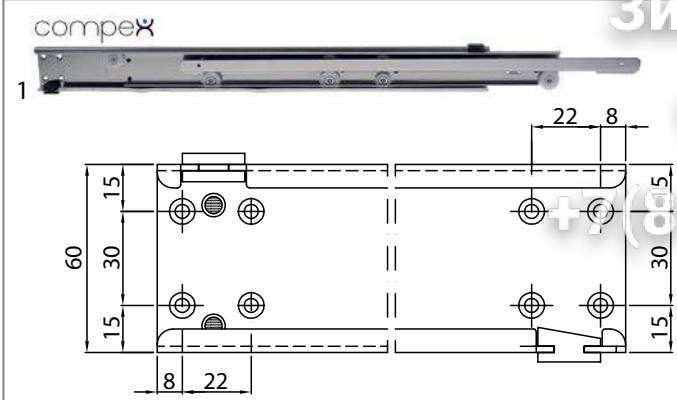

+7 (812) 987-08-81

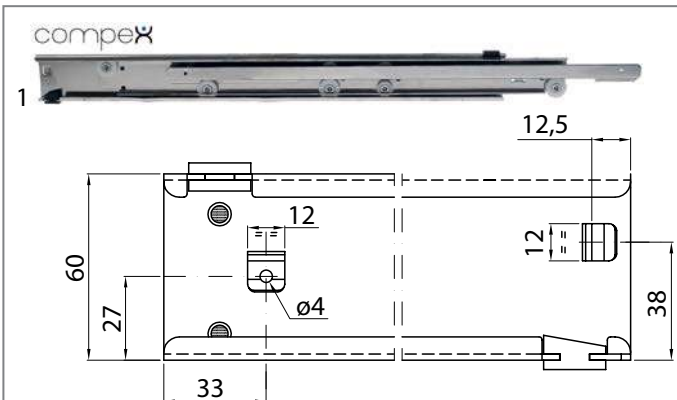

|   |  |                 |  |
|---|--|-----------------|--|
| <b>GEV No.</b>  | 690752 <sup>1</sup>  | <b>Ref. No.</b> | 36M2700<br>36M2710<br>36M4920<br>36M4940 |
| <b>description</b>  | drawer slide L 600mm pull-out length 660mm total length 1260mm Qty 1 pair capacity 45kg H 60mm SS telescopic |                 |  |
| <b>spare parts for</b>  | 690752   |                 |  |
|  | <b>GEV No.</b>   | 690750          | <b>Ref. No.</b> —                        |
|   | stop for telescopic rail L 20mm plastic H 12mm D 9mm   |                 |  |
|  | <b>GEV No.</b>   | 696333          | <b>Ref. No.</b> —                        |
|   | stop for telescopic rail L 20mm plastic H 15mm D 8mm   |                 |  |

<sup>1</sup>multiple slide (60mm more than nominal length)



|   |  |                 |                    |
|---|--|-----------------|--------------------|
| <b>GEV No.</b>  | 690744 <sup>1</sup>  | <b>Ref. No.</b> | 36M5380<br>36M5390 |
| <b>description</b>  | drawer slide L 600mm pull-out length 660mm total length 1260mm Qty 1 pair capacity 45kg W 17mm H 60mm mounting pos. right/left SS telescopic   |                 |                    |
| <b>For models:</b>  | 6BEA11A, 6BEA11B, 6BEA11M, 6BEA11Z, 6BEA2A, 6BEA2B, 6BEA2M, 6BEA2Z, 6BEA3A, 6BEA3B, 6BEA3M, 6BEA3Z, 6BEB11A, 6BEB11B, 6BEB11M, 6BEB11Z, 6BEB22A, 6BEB22B, 6BEB22M, 6BEB22Z, 6BEB2A, 6BEB2B, 6BEB2M, 6BEB2Z, 6BEB3A, 6BEB3B, 6BEB3M, 6BEB3Z, 6BEB4A, 6BEB4B, 6BEB4M, 6BEB4Z, 6BEC11A, 6BEC11B, 6BEC11M, 6BEC11Z, 6BEC22A, 6BEC22B, 6BEC22M, 6BEC22Z, 6BEC2A, 6BEC2B, 6BEC2M, 6BEC2Z, 6BEC33A, 6BEC33B, 6BEC33M, 6BEC33Z, 6BEC3A, 6BEC3B...(Other models you can see in the webshop) |                 |                    |
| <b>spare parts for</b>  | 690744   |                 |                    |
|  | <b>GEV No.</b>   | 690750          | <b>Ref. No.</b> —  |
|   | stop for telescopic rail L 20mm plastic H 12mm D 9mm   |                 |                    |
|  | <b>GEV No.</b>   | 696333          | <b>Ref. No.</b> —  |
|   | stop for telescopic rail L 20mm plastic H 15mm D 8mm   |                 |                    |

<sup>1</sup>multiple slide (60mm more than nominal length)



|                    |  |                 |                    |
|--------------------|--|-----------------|--------------------|
| <b>GEV No.</b>     | 690770   | <b>Ref. No.</b> | 30A2660<br>36M2660 |
| <b>description</b> | drawer slide L 500mm pull-out length 400mm Qty 1 piece W 23mm mounting pos. left |                 |                    |

|                    |   |                 |                    |
|--------------------|---|-----------------|--------------------|
| <b>GEV No.</b>     | 690771  | <b>Ref. No.</b> | 30A2650<br>36M2650 |
| <b>description</b> | drawer slide L 500mm pull-out length 400mm Qty 1 piece W 23mm mounting pos. right |                 |                    |

rollers

rollers

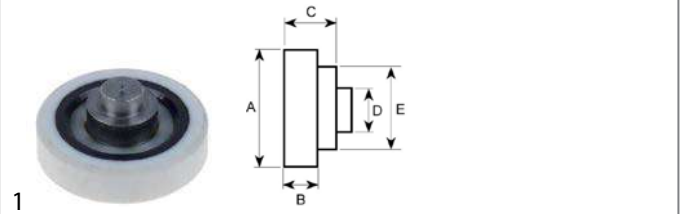

|                    |   |                 |         |
|--------------------|---|-----------------|---------|
| <b>GEV No.</b>     | 690680  | <b>Ref. No.</b> | 36G2810 |
| <b>description</b> | roller rollerø 24mm B1 6mm overall width 9mm A 24mm B 6mm C 9mm D 6mm E 10mm ceramic bearing ball bearing |                 |         |

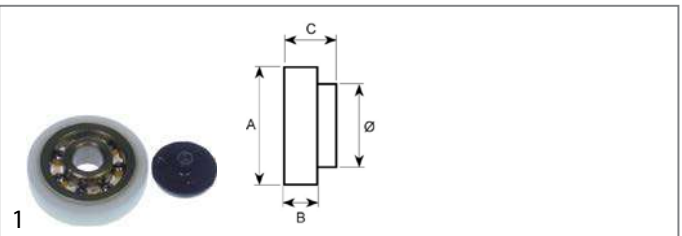

|                    |   |                 |         |
|--------------------|---|-----------------|---------|
| <b>GEV No.</b>     | 691127  | <b>Ref. No.</b> | 36F0440 |
| <b>description</b> | roller rollerø 24mm B1 6mm overall width 7.5mm A 24mm B 6mm C 7.5mm ø 10mm plastic tread plastic bore ø 6mm |                 |         |







1

|   |   |                 |                 |
|---|---|-----------------|-----------------|
| <b>GEV No.</b>  | 691197  | <b>Ref. No.</b> | 36G3940         |
| <b>description</b>  | roller rollerø 30mm overall width 10mm A 90mm B 10mm plastic  |                 |                 |
| <b>For models:</b>  | A12A1E, A12B1E, A12B2E, A12M1E, A12Z1E, A12Z2E, A14A1E, A14B1E, A14B2E, A14M1E, A14Z1E, A14Z2E, A16A1E, A16B1E, A16B2E, A16M1E, A16Z1E, A16Z2E, A18A1E, A18B1E, A18B2E, A18M1E, A18Z1E, A18Z2E, A20A1E, A20B1E, A20B2E, A20M1E, A20Z1E, A20Z2E, ACBM, ACBM218, ACPN, ACPN218, AJ12AE, AJ12ME, AJ14AE, AJ14ME, AJ16AE, AJ16ME, AJ18AE, AJ18ME, AJ20AE, AJ20ME, ANBM, ANBM218, ART1LD, ART1LDA, ART2LD, ART2SD... (Other models you can see in the webshop) |                 |                 |
| <b>accessories for</b>  | 691197  |                 |                 |
|  | <b>GEV No.</b>  | 691126          | <b>Ref. No.</b> |
|   |   |                 | 36D4440         |
|   | bushing H 11mm for roller   |                 |                 |

accessories



1

|                    |   |                 |         |
|--------------------|---|-----------------|---------|
| <b>GEV No.</b>     | 691126  | <b>Ref. No.</b> | 36D4440 |
| <b>description</b> | bushing H 11mm for roller   |                 |         |
| <b>For models:</b> | A12A1E, A12B1E, A12B2E, A12M1E, A12Z1E, A12Z2E, A14A1E, A14B1E, A14B2E, A14M1E, A14Z1E, A14Z2E, A16A1E, A16B1E, A16B2E, A16M1E, A16Z1E, A16Z2E, A18A1E, A18B1E, A18B2E, A18M1E, A18Z1E, A18Z2E, A20A1E, A20B1E, A20B2E, A20M1E, A20Z1E, A20Z2E, ACBM, ACBM218, ACPN, ACPN218, AJ12AE, AJ12ME, AJ14AE, AJ14ME, AJ16AE, AJ16ME, AJ18AE, AJ18ME, AJ20AE, AJ20ME, ANBM, ANBM218, ART1LD, ART1LDA, ART2LD, ART2SD... (Other models you can see in the webshop) |                 |         |

fittings for catering equipment

outlet taps

universal



1

|                    |  |                 |         |
|--------------------|--|-----------------|---------|
| <b>GEV No.</b>     | 540685   | <b>Ref. No.</b> | 33D0853 |
| <b>description</b> | outlet tap stainless steel angled W 46mm H 40mm thread 3/4" IT |                 |         |
| <b>For models:</b> | 030FE1, 030FE1B  |                 |         |

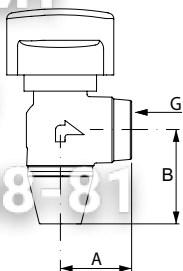



1

|                    |   |                 |         |
|--------------------|---|-----------------|---------|
| <b>GEV No.</b>     | 540699                                  | <b>Ref. No.</b> | 3072720 |
| <b>description</b> | outlet tap W 35mm H 35mm thread 3/4" IT |                 |         |
| <b>For models:</b> | 6BM, 6CP, 6FR                           |                 |         |

producer-specific

ANGELO PO



1

|                    |                                       |                 |         |
|--------------------|---------------------------------------|-----------------|---------|
| <b>GEV No.</b>     | 540683                                | <b>Ref. No.</b> | 36D4080 |
| <b>description</b> | adapter thread                        |                 |         |
| <b>For models:</b> | 030BME, 030EBM, 030FE, 031BME, 031EBM |                 |         |



1

|                    |  |                 |         |
|--------------------|--|-----------------|---------|
| <b>GEV No.</b>     | 540730   | <b>Ref. No.</b> | 33D0170 |
| <b>description</b> | ball valve connection 3/4" IT - 3/4" IT DN20 total length 70mm with lever handle length 95mm                               |                 |         |
| <b>For models:</b> | 030BME, 030EBM, 030FE, 031BME, 031EBM, 070BM, 070BME, 071BM, 071BME, 090BM, 090BME, 091BM, 091BME, 30F, 30FES, 30FS, 70FES |                 |         |



1

|                    |                                  |                 |         |
|--------------------|----------------------------------|-----------------|---------|
| <b>GEV No.</b>     | 540681                           | <b>Ref. No.</b> | 36D4070 |
| <b>description</b> | drain pipe L 97mm thread 3/4" ET |                 |         |
| <b>For models:</b> | 030BME, 030FE, 031BME            |                 |         |



1

|                    |   |                 |         |
|--------------------|---|-----------------|---------|
| <b>GEV No.</b>     | 514153  | <b>Ref. No.</b> | 3AZ0100 |
| <b>description</b> | drain pipe thread   |                 |         |
| <b>For models:</b> | 091FR1E, 091FR1EA, 091FR1ED, 091FR1G, 091FR1GD, 091FR1I, 091FR1IA, 091FR1ID, 091FR1I-VERS.032012, 091FR7G, 091FR7G-VERS.052012, 0A1FR1E, 0A1FR1ED, 0A1FR1G, 0A1FR1GD, 0A1FR1GD-VERS.2004, 0A1FR1G-VERS.2004, 0B1FR1G, 0B1FR1GD, 0D1FR1E, 0D1FR1ED, 0D1FR1G, 0D1FR1GD, 0D1FR1GD-VERS.2004, 0D1FR1G-VERS.2004, 191FR2E, 191FR2ED, 191FR2G, 191FR2GD, 191FR2I, 191FR2ID, 191FR2I-VERS.032012, 1A1FR2E, 1A1FR2ED, 1A1FR2G, 1A1FR2GD, 1A1FR2GD-VERS.2004, 1A1FR2G-VERS.2004, 1D1FR2ED, 1D1FR2G, 1D1FR2GD, 1D1FR2GD-VERS.2004, 1D1FR2G-VERS.2004, 70F1, 70F1B, 70FE1, 70FE1B, 71F2, 71F2B, 71FE2... (Other models you can see in the webshop) |                 |         |

Зип Общепит





vsezip.ru





(812)987-08-81

|   |  |                 |                    |
|---|--|-----------------|--------------------|
|  |  |                 |                    |
| <b>1</b>  |  |                 |                    |
| <b>GEV No.</b>  | 541530   | <b>Ref. No.</b> | 3268961<br>3AZ0090 |
| <b>description</b>  | drain pipe thread  |                 |                    |
| <b>For models:</b>  | 04WFR3ED, 06WFR3GD, 08WFR4ED, 091FE28, 091FE28B, 091FR3E, 091FR3ED, 091FR3G, 091FR3GD, 0A1FR3E, 0A1FR3ED, 0A1FR3G, 0A1FR3GD, 0D1FR3E, 0D1FR3ED, 0D1FR3G, 0D1FR3GD, 0G1FR3G, 0G1FR3GD, 0G1FR7G, 10WFR4GD, 191FR4E, 191FR4ED, 191FR4G, 191FR4GD, 1A1FR4E, 1A1FR4ED, 1A1FR4G, 1A1FR4GD, 1D1FR4E, 1D1FR4ED, 1D1FR4G, 1D1FR4GD, 1G1FR4G, 1G1FR4GD, 1G1FR8G, 30F1, 30F1B, 30FES2, 30FES2B, 30FS2, 30FS2B, 90F110B, 91F210, 91F210B |                 |                    |

|   |   |                 |         |
|---|---|-----------------|---------|
|  |   |                 |         |
| <b>1</b>  |   |                 |         |
| <b>GEV No.</b>  | 540684  | <b>Ref. No.</b> | 33Q5020 |
| <b>description</b>  | drain pipe thread total length 54mm shaft intake ø 22mm |                 |         |
| <b>For models:</b>  | 030BME, 030EBM, 030FE, 031BME, 031EBM                   |                 |         |

|   |   |                 |         |
|---|---|-----------------|---------|
|  |   |                 |         |
| <b>1</b>  |   |                 |         |
| <b>GEV No.</b>  | 540952  | <b>Ref. No.</b> | 33D2840 |
| <b>description</b>  | outlet tap L 84mm fryer lever handle grommet ø 30mm grommet length 29mm thread 3/4" IT handle length 81mm |                 |         |
| <b>For models:</b>  | 0M0BME, 0M0FR1E, 0M0FR1G, 1M0BME, 1M0CP1E, 1M0FR2E, 1M0FR2G   |                 |         |

|   |  |                 |                         |
|---|--|-----------------|-------------------------|
|  |  |                 |                         |
| <b>1</b>  |  |                 |                         |
| <b>GEV No.</b>  | 540759   | <b>Ref. No.</b> | 3111510<br>33D1760      |
| <b>description</b>  | outlet tap without handle thread 1" IT   |                 |                         |
| <b>For models:</b>  | 091FR1E, 091FR1EA, 091FR1ED, 091FR1G, 091FR1GD, 091FR1I, 091FR1IA, 091FR1ID, 091FR1ID-VERS.052012, 091FR1I-VERS.032012, 091FR7G, 091FR7G-VERS.052012, 0A1FR1E, 0A1FR1ED, 0A1FR1G, 0A1FR1GD, 0A1FR1GD-VERS.2004, 0A1FR1G-VERS.2004, 0B1FR1G, 0B1FR1GD, 0D1FR1E, 0D1FR1ED, 0D1FR1G, 0D1FR1GD, 0D1FR1GD-VERS.2004, 0D1FR1G-VERS.2004, 191FR2E, 191FR2ED, 191FR2G, 191FR2GD, 191FR2I, 191FR2ID, 191FR2ID-VERS.092012, 191FR2I-VERS.032012, 1A1FR2E, 1A1FR2ED, 1A1FR2G, 1A1FR2GD, 1A1FR2GD-VERS.2004, 1A1FR2G-VERS.2004, 1D1FR2ED, 1D1FR2G, 1D1FR2GD, 1D1FR2GD-VERS.2004, 1D1FR2G-VERS.2004, 70F1, 70F1B, 70FE1, 70FE1B, 71F2...(Other models you can see in the webshop) |                 |                         |
| <b>spare parts for</b>  | 540759   |                 |                         |
|  | <b>GEV No.</b>   | 504561          | <b>Ref. No.</b> 3151080 |
|   | O-ring EPDM thickness 2.62mm ID ø 29.82mm Qty 1 pcs  |                 |                         |
| <b>accessories for</b>  | 540759   |                 |                         |
|  | <b>GEV No.</b>   | 504561          | <b>Ref. No.</b> 3151080 |
|   | O-ring EPDM thickness 2.62mm ID ø 29.82mm Qty 1 pcs  |                 |                         |
|  | <b>GEV No.</b>   | 540530          | <b>Ref. No.</b> —       |
|   | handle plastic white L 109mm   |                 |                         |
|  | <b>GEV No.</b>   | 541529          | <b>Ref. No.</b> —       |
|   | drain pipe L 110mm thread  |                 |                         |

|  |   |                 |                                    |
|--|---|-----------------|------------------------------------|
|  |   |                 |                                    |
| <b>1</b>   |   |                 |                                    |
| <b>GEV No.</b>   | 540689  | <b>Ref. No.</b> | 33D1770                            |
| <b>description</b>   | outlet tap without handle thread 3/4" IT  |                 |                                    |
| <b>For models:</b>   | 04WFR3ED, 06WFR3GD, 08WFR4ED, 091FE28, 091FE28B, 091FR3E, 091FR3ED, 091FR3G, 091FR3GD, 0A1FR3E, 0A1FR3ED, 0A1FR3G, 0A1FR3GD, 0D1FR3E, 0D1FR3ED, 0D1FR3G, 0D1FR3GD, 0G1FR3G, 0G1FR3GD, 0G1FR7G, 10WFR4GD, 191FR4E, 191FR4ED, 191FR4G, 191FR4GD, 1A1FR4E, 1A1FR4ED, 1A1FR4G, 1A1FR4GD, 1D1FR4E, 1D1FR4ED, 1D1FR4G, 1D1FR4GD, 1G1FR4G, 1G1FR4GD, 1G1FR8G, 30F1, 30F1B, 30FES2, 30FES2B, 30FS2, 30FS2B, 6043840, 6043970, 70FES2, 70FES2B, 90F110B, 91F210, 91F210B |                 |                                    |
| <b>accessories for</b>   | 540689  |                 |                                    |
|   | <b>GEV No.</b>  | 514217          | <b>Ref. No.</b> —                  |
|  | handle for outlet tap   |                 |                                    |
|   | <b>GEV No.</b>  | 532487          | <b>Ref. No.</b> 3150690            |
|  | O-ring Viton thickness 2.62mm ID ø 25.07mm Qty 1 pcs  |                 |                                    |
|   | <b>GEV No.</b>  | 541530          | <b>Ref. No.</b> 3268961<br>3AZ0090 |
|  | drain pipe thread   |                 |                                    |

aerators and air bleeders

|  |  |                 |         |
|--|--|-----------------|---------|
|  |  |                 |         |
| <b>1</b>   |  |                 |         |
| <b>GEV No.</b>   | 540827   | <b>Ref. No.</b> | 33G0170 |
| <b>description</b>   | aerator and air bleeder thread 3/4" ET chrome-plated L 45mm ø 36mm   |                 |         |
| <b>For models:</b>   | 31PI6, 31PIE6, 71PI10, 71PI10A, 71PIE15, 71PIE15A, 71PV15, 71PV15A, 91PI10, 91PI10A, 91PIE15, 91PIE15A, BPV2, MCF40V, PV200, PV200A, PV300, PV300A |                 |         |

|  |  |                 |         |
|--|--|-----------------|---------|
|  |  |                 |         |
| <b>1</b>   |  |                 |         |
| <b>GEV No.</b>   | 540825   | <b>Ref. No.</b> | 33G0650 |
| <b>description</b>   | aerator and air bleeder thread 3/8" ET WS 24 chrome-plated L 37mm  |                 |         |
| <b>For models:</b>   | 191PI1G, 191PI1GA, 191PI2E, 191PI2EA, 191PI2G, 191PI2GA, 191PI2V, 191PI2VA, 1A1PI1G, 1A1PI1GA, 1A1PI2E, 1A1PI2EA, 1A1PI2G, 1A1PI2GA, 1A1PI2V, 1A1PI2VA, 1D1PI1G, 1D1PI1GA, 1D1PI2E, 1D1PI2EA, 1D1PI2G, 1D1PI2GA, 1D1PI2V, 1D1PI2VA, 2A1PI3G, 2D1PI3G, PV200, PV200A, PV300, PV300A |                 |         |



steam valves

Зип Общепит

vsezip.ru

+7(812)987-08-81

|  |  |                 |                    |
|--|--|-----------------|--------------------|
|  <p>1</p> |  |                 |                    |
| <b>GEV No.</b>   | 520000   | <b>Ref. No.</b> | 33G0030<br>33G0031 |
| <b>description</b>   | steam valve angled connection 1 1/4" IT total length 52mm H 190mm brass  |                 |                    |
| <b>For models:</b>   | 191PI2V, 191PI2VA, 1A1PI2V, 1A1PI2VA, 1D1PI2V, 1D1PI2VA, 71PV15, 71PV15A, PV200, PV200A, PV300, PV300A                                       |                 |                    |
| <b>spare parts for</b>   | 520000   |                 |                    |
|  | <b>GEV No.</b>   | 541566          | <b>Ref. No.</b> —  |
|  |  <p>tap head for steam tap 1 1/4" shaft 9x9mm</p>           |                 |                    |
|  | <b>GEV No.</b>   | 541567          | <b>Ref. No.</b> —  |
|  |  <p>star handle shaft 9x9mm ø 74mm L 24mm black plastic</p> |                 |                    |

|   |  |                 |         |
|---|--|-----------------|---------|
|  <p>1</p> |  |                 |         |
| <b>GEV No.</b>  | 692705   | <b>Ref. No.</b> | 36C2590 |
| <b>description</b>  | bracket mounting pos. right mounting distance 45mm for lid   |                 |         |
| <b>For models:</b>  | 10CP1EA, 10CP1GA, 12CP1EA, 12CP1GA, 18CP2EA, 18CP2GA, 191BR1E, 191BR1G, 191BR1GA, 191BR2E, 191BR2EA, 191BR2G, 191BR2GA, 191PD1G, 191PD2G, 191PI1G, 191PI1GA, 191PI2E, 191PI2EA, 191PI2G, 191PI2GA, 191PI2V, 191PI2VA, 1A1BR1E, 1A1BR1G, 1A1BR1GA, 1A1BR2E, 1A1BR2EA, 1A1BR2G, 1A1BR2GA, 1A1PD1G, 1A1PD2G, 1A1PI1G, 1A1PI1GA, 1A1PI2E, 1A1PI2EA, 1A1PI2G, 1A1PI2GA, 1A1PI2V, 1A1PI2VA, 1D1BR1E, 1D1BR1G, 1D1BR1GA, 1D1BR2E, 1D1BR2EA, 1D1BR2G, 1D1BR2GA, 1D1PD1G, 1D1PD2G, 1D1PI1G... (Other models you can see in the webshop) |                 |         |

lid hinges

ANGELO PO

|  |  |                 |         |
|--|--|-----------------|---------|
|  <p>1</p> |  |                 |         |
| <b>GEV No.</b>   | 692704   | <b>Ref. No.</b> | 36C2600 |
| <b>description</b>   | bracket mounting pos. left mounting distance 45mm for lid  |                 |         |
| <b>For models:</b>   | 10CP1EA, 10CP1GA, 12CP1EA, 12CP1GA, 18CP2EA, 18CP2GA, 191BR1E, 191BR1G, 191BR1GA, 191BR2E, 191BR2EA, 191BR2G, 191BR2GA, 191PD1G, 191PD2G, 191PI1G, 191PI1GA, 191PI2E, 191PI2EA, 191PI2G, 191PI2GA, 191PI2V, 191PI2VA, 1A1BR1E, 1A1BR1G, 1A1BR1GA, 1A1BR2E, 1A1BR2EA, 1A1BR2G, 1A1BR2GA, 1A1PD1G, 1A1PD2G, 1A1PI1G, 1A1PI1GA, 1A1PI2E, 1A1PI2EA, 1A1PI2G, 1A1PI2GA, 1A1PI2V, 1A1PI2VA, 1D1BR1E, 1D1BR1G, 1D1BR1GA, 1D1BR2E, 1D1BR2EA, 1D1BR2G, 1D1BR2GA, 1D1PD1G, 1D1PD2G, 1D1PI1G... (Other models you can see in the webshop) |                 |         |

|   |  |                 |         |
|---|--|-----------------|---------|
|  <p>1</p> |  |                 |         |
| <b>GEV No.</b>  | 692706   | <b>Ref. No.</b> | 36H0260 |
| <b>description</b>  | spindle L 445mm ø 12mm for lid   |                 |         |
| <b>For models:</b>  | 10CP1EA, 10CP1GA, 10CP1IA, 12CP1EA, 12CP1GA, 12CP1IA, 18CP2EA, 18CP2GA, 18CP2IA, 191BR1E, 191BR1G, 191BR1GA, 191BR2E, 191BR2EA, 191BR2G, 191BR2GA, 1A1BR1E, 1A1BR1G, 1A1BR1GA, 1A1BR2E, 1A1BR2EA, 1A1BR2G, 1A1BR2GA, 1D1BR1E, 1D1BR1G, 1D1BR1GA, 1D1BR2E, 1D1BR2EA, 1D1BR2G, 1D1BR2GA, 291BR1E, 291BR1G, 291BR1GA, 291BR2E, 291BR2EA, 291BR2G, 291BR2GA, 2A1BR1E, 2A1BR1G, 2A1BR1GA, 2A1BR2E, 2A1BR2EA, 2A1BR2G, 2A1BR2GA, 2D1BR1E, 2D1BR1G, 2D1BR1GA, 2D1BR2E, 2D1BR2EA, 2D1BR2G... (Other models you can see in the webshop) |                 |         |

miscellaneous

spare parts



|   |  |                 |         |
|---|--|-----------------|---------|
|  <p>1</p> |  |                 |         |
| <b>GEV No.</b>  | 700683   | <b>Ref. No.</b> | 36G2680 |
| <b>description</b>  | bolt for torsion spring  |                 |         |
| <b>For models:</b>  | 12CP1GA, 12CP1IA, 191BR1E, 191BR1G, 191BR1GA, 191BR2E, 191BR2EA, 191BR2G, 191BR2GA, 191PD1G, 191PD2G, 191PI1G, 191PI1GA, 191PI2E, 191PI2EA, 191PI2G, 191PI2GA, 191PI2V, 191PI2VA, 1A1BR1E, 1A1BR1G, 1A1BR1GA, 1A1BR2E, 1A1BR2EA, 1A1BR2G, 1A1BR2GA, 1A1PD1G, 1A1PD2G, 1A1PI1G, 1A1PI1GA, 1A1PI2E, 1A1PI2EA, 1A1PI2G, 1A1PI2GA, 1A1PI2V, 1A1PI2VA, 1D1BR1E, 1D1BR1G, 1D1BR1GA, 1D1BR2E, 1D1BR2EA, 1D1BR2G, 1D1BR2GA, 1D1PD1G, 1D1PD2G, 1D1PI1G, 1D1PI1GA, 1D1PI2E, 1D1PI2EA, 1D1PI2G... (Other models you can see in the webshop) |                 |         |

drain taps

brass

drain taps



|   |   |                 |                   |
|---|---|-----------------|-------------------|
| <b>GEV No.</b>  | 540131                                  | <b>Ref. No.</b> | 33D0080           |
| <b>description</b>  | drain tap 1 1/4" IT chrome-plated brass |                 |                   |
| <b>spare parts for</b>  | 540131                                  |                 |                   |
|  | <b>GEV No.</b>                          | 540213          | <b>Ref. No.</b> — |
|   | handle ID ø 5mm L 117mm                 |                 |                   |
|  | <b>GEV No.</b>                          | 540461          | <b>Ref. No.</b> — |
|   | shim for drain tap                      |                 |                   |
|  | <b>GEV No.</b>                          | 540464          | <b>Ref. No.</b> — |
|   | nut for drain tap thread 1 1/2"         |                 |                   |





|   |   |                 |                   |
|---|---|-----------------|-------------------|
| <b>GEV No.</b>  | 540134  | <b>Ref. No.</b> | 33D2291           |
| <b>description</b>  | drain tap 2" IT fixed A 115mm B1 90mm B2 165mm chrome-plated brass  |                 |                   |
| <b>For models:</b>  | 191CP1GA, 191PD1G, 191PD2G, 191PI1G, 191PI1GA, 191PI2E, 191PI2EA, 191PI2G, 191PI2GA, 191PI2V, 191PI2VA, 1A1CP1GA, 1A1PD1G, 1A1PD2G, 1A1PI1G, 1A1PI1GA, 1A1PI2E, 1A1PI2EA, 1A1PI2G, 1A1PI2GA, 1A1PI2V, 1A1PI2VA, 1D1CP1GA, 1D1PD1G, 1D1PD2G, 1D1PI1G, 1D1PI1GA, 1D1PI2E, 1D1PI2EA, 1D1PI2G, 1D1PI2GA, 1D1PI2V, 1D1PI2VA, 1G1PD1G, 1G1PI1E, 1G1PI1G, 291PD3G, 291PI3E, 291PI3G, 2A1PD3G, 2A1PI3E, 2A1PI3G, 2D1PI3G, 31PD6, 31PI6, 31PIE6, 71PD10, 71PD15, 71PI10, 71PI10A...(Other models you can see in the webshop) |                 |                   |
| <b>spare parts for</b>  | 540134  |                 |                   |
|  | <b>GEV No.</b>  | 540214          | <b>Ref. No.</b> — |
|   | handle ID ø 6mm L 145mm   |                 |                   |
|  | <b>GEV No.</b>  | 540462          | <b>Ref. No.</b> — |
|   | ring for drain tap  |                 |                   |
|  | <b>GEV No.</b>  | 540465          | <b>Ref. No.</b> — |
|   | nut for drain tap thread 2 3/4"   |                 |                   |
| <b>accessories for</b>  | 540134  |                 |                   |
|  | <b>GEV No.</b>  | 529484          | <b>Ref. No.</b> — |
|   | flat gasket fibre ED ø 58mm ID ø 50mm thickness 2mm Qty 1 pcs   |                 |                   |

Зип Общепит



vsezip.ru

+7(812)987-08481



|   |   |                 |                   |
|---|---|-----------------|-------------------|
| <b>GEV No.</b>  | 540275  | <b>Ref. No.</b> | 33D0600           |
| <b>description</b>  | drain tap 2" IT with union nut A 90mm B 151mm B1 80mm chrome-plated brass   |                 |                   |
| <b>For models:</b>  | 31PD6, 31PI6, 31PIE6, 71PD10, 71PD15, 71PI10, 71PI10A, 71PIE15, 71PIE15A, 71PV15, 71PV15A, 91PI10, 91PI10A, 91PIE15, 91PIE15A |                 |                   |
| <b>spare parts for</b>  | 540275  |                 |                   |
|  | <b>GEV No.</b>  | 540214          | <b>Ref. No.</b> — |
|   | handle ID ø 6mm L 145mm   |                 |                   |
| <b>accessories for</b>  | 540275  |                 |                   |
|  | <b>GEV No.</b>  | 529484          | <b>Ref. No.</b> — |
|   | flat gasket fibre ED ø 58mm ID ø 50mm thickness 2mm Qty 1 pcs   |                 |                   |
|  | <b>GEV No.</b>  | 542448          | <b>Ref. No.</b> — |
|   | gasket silicone 60x49x2 for drain tap 2"  |                 |                   |



|   |   |                 |                   |
|---|---|-----------------|-------------------|
| <b>GEV No.</b>  | 540267  | <b>Ref. No.</b> | 33D2290           |
| <b>description</b>  | drain tap connection with union nut thread 2"   |                 |                   |
| <b>For models:</b>  | 191CP1GA, 191PD1G, 191PD2G, 191PI1G, 191PI1GA, 191PI2E, 191PI2EA, 191PI2G, 191PI2GA, 191PI2V, 191PI2VA, 1A1CP1GA, 1A1PD1G, 1A1PD2G, 1A1PI1G, 1A1PI1GA, 1A1PI2E, 1A1PI2EA, 1A1PI2G, 1A1PI2GA, 1A1PI2V, 1A1PI2VA, 1D1CP1GA, 1D1PD1G, 1D1PD2G, 1D1PI1G, 1D1PI1GA, 1D1PI2E, 1D1PI2EA, 1D1PI2G, 1D1PI2GA, 1D1PI2V, 1D1PI2VA, 1G1PD1G, 1G1PI1E, 1G1PI1G, 291PD3G, 291PI3E, 291PI3G, 2A1PD3G, 2A1PI3E, 2A1PI3G, 2D1PI3G, 31PD6, 31PI6, 31PIE6, 71PD10, 71PD15, 71PI10, 71PI10A...(Other models you can see in the webshop) |                 |                   |
| <b>spare parts for</b>  | 540267  |                 |                   |
|  | <b>GEV No.</b>  | 505517          | <b>Ref. No.</b> — |
|   | O-ring EPDM thickness 5.34mm ID ø 53.34mm Qty 1 pcs   |                 |                   |
|  | <b>GEV No.</b>  | 540214          | <b>Ref. No.</b> — |
|   | handle ID ø 6mm L 145mm   |                 |                   |



Зип Общежит

vsezip.ru

77(812)987-08-81

accessories

|   |   |                 |         |
|---|---|-----------------|---------|
|  |   |                 |         |
| 1   |   |                 |         |
| <b>GEV No.</b>  | 541485  | <b>Ref. No.</b> | 3525100 |
| <b>description</b>  | screw-in socket for drain tap thread 2" L 167mm   |                 |         |
| <b>For models:</b>  | 71PD10, 71PD15, 71PI10, 71PI10A, 71PIE15, 71PIE15A, 71PV15, 71PV15A, 91PI10, 91PI10A, 91PIE15, 91PIE15A |                 |         |

test taps

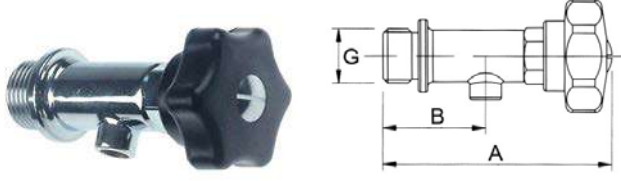
|   |  |                 |         |
|---|--|-----------------|---------|
|  |  |                 |         |
| 1   |  |                 |         |
| <b>GEV No.</b>  | 540818   | <b>Ref. No.</b> | 3028010 |
| <b>description</b>  | test tap thread 1/2" ET W 88mm W1 38mm   |                 |         |
| <b>For models:</b>  | 191PI1G, 191PI1GA, 191PI2E, 191PI2EA, 191PI2G, 191PI2GA, 1A1PI1G, 1A1PI1GA, 1A1PI2E, 1A1PI2EA, 1D1PI1G, 1D1PI1GA, 1D1PI2E, 1D1PI2EA, 1G1PI1E, 1G1PI1G, 31PI6, 31PIE6, 71PI10, 71PI10A, 71PIE15, 71PIE15A, 91PI10, 91PI10A, 91PIE15, 91PIE15A |                 |         |

accessories

|   |   |                 |         |
|---|---|-----------------|---------|
|  |   |                 |         |
| 1   |   |                 |         |
| <b>GEV No.</b>  | 515105  | <b>Ref. No.</b> | 37M0590 |
| <b>description</b>  | rosette   |                 |         |
| <b>For models:</b>  | 1A1PI1G, 1A1PI1GA, 1A1PI2E, 1A1PI2EA, 1D1PI1G, 1D1PI1GA, 1D1PI2E, 1D1PI2EA, 1G1PI1E, 1G1PI1G, 31PI6, 31PIE6, 71PI10, 71PI10A, 71PIE15, 71PIE15A, 91PI10, 91PI10A, 91PIE15, 91PIE15A |                 |         |

safety fittings

|   |  |   |                 |
|---|--|---|-----------------|
|   |  |   |                 |
| 1   |  |   |                 |
| <b>GEV No.</b>  | 514275   | <b>Ref. No.</b>   | 3006310         |
| <b>description</b>  | safety fitting thread 3/4" 0.45bar with manometer and aerator/air bleeder 3.3kg H 200mm W 150mm  |   |                 |
| <b>For models:</b>  | 191PI1G, 191PI1GA, 191PI2E, 191PI2EA, 191PI2G, 191PI2GA, 191PI2V, 191PI2VA, 1A1PI1G, 1A1PI1GA, 1A1PI2E, 1A1PI2EA, 1A1PI2G, 1A1PI2GA, 1A1PI2V, 1A1PI2VA, 1D1PI1G, 1D1PI1GA, 1D1PI2E, 1D1PI2EA, 1D1PI2G, 1D1PI2GA, 1D1PI2V, 1D1PI2VA, 1G1PI1E, 1G1PI1G, 291PI3E, 291PI3G, 2A1PI3G, 2D1PI3G, PV200, PV200A, PV300, PV300A |   |                 |
| <b>spare parts for</b>  | 514275   |   |                 |
|    | <b>GEV No.</b>   | 514094  | <b>Ref. No.</b> |
|   |  |   | —               |
|   | <b>description</b>   | angle piece thread 3/8"   |                 |
|    | <b>GEV No.</b>   | 514276  | <b>Ref. No.</b> |
|   |  |   | —               |
|   | <b>description</b>   | safety fitting thread 3/4" 0.45bar H 165mm ø 65mm                               |                 |
|  | <b>GEV No.</b>   | 540825  | <b>Ref. No.</b> |
|   |  |   | 33G0650         |
|   | <b>description</b>   | aerator and air bleeder thread 3/8" ET WS 24 chrome-plated L 37mm               |                 |
|  | <b>GEV No.</b>   | 540828  | <b>Ref. No.</b> |
|   |  |   | —               |
|   | <b>description</b>   | manometer siphon thread 3/8"  |                 |
|  | <b>GEV No.</b>   | 541579  | <b>Ref. No.</b> |
|   |  |   | —               |
|   | <b>description</b>   | manometer ø 52mm pressure range 0 up to 1bar connection marking 0.5 thread 1/4" |                 |

accessories

|   |  |                 |         |
|---|--|-----------------|---------|
|  |  |                 |         |
| 1   |  |                 |         |
| <b>GEV No.</b>  | 540633   | <b>Ref. No.</b> | 33G0560 |
| <b>description</b>  | fitting support thread 1/2" IT   |                 |         |
| <b>For models:</b>  | 1A1PI1G, 1A1PI1GA, 1A1PI2E, 1A1PI2EA, 1A1PI2V, 1A1PI2VA, 1D1PI1G, 1D1PI1GA, 1D1PI2E, 1D1PI2EA, 1D1PI2V, 1D1PI2VA |                 |         |

|   |  |                 |         |
|---|--|-----------------|---------|
|  |  |                 |         |
| 1   |  |                 |         |
| <b>GEV No.</b>  | 540821   | <b>Ref. No.</b> | 33G0130 |
| <b>description</b>  | fitting support thread 1/4"  |                 |         |
| <b>For models:</b>  | 31PI6, 31PIE6, 71PI10, 71PI10A, 71PIE15, 71PIE15A, 71PV15, 71PV15A, 91PI10, 91PI10A, 91PIE15, 91PIE15A |                 |         |

Зип-Общепит

vsezip.ru

+7(812)987-08-81



1

|                    |                                    |                 |         |
|--------------------|------------------------------------|-----------------|---------|
| <b>GEV No.</b>     | 540830                             | <b>Ref. No.</b> | 33G0160 |
| <b>description</b> | pressure gauge tap IT 1/4" ET 1/4" |                 |         |



1

|                    |  |                 |         |
|--------------------|--|-----------------|---------|
| <b>GEV No.</b>     | 541501                                       | <b>Ref. No.</b> | 33Q4650 |
| <b>description</b> | reducer for safety fitting IT 1 1/4" ET 3/4" |                 |         |

safety valves



1

|  |  |                 |                         |
|--|--|-----------------|-------------------------|
| <b>GEV No.</b>   | 540721   | <b>Ref. No.</b> | 33G0200                 |
| <b>description</b>   | safety valve triggering pressure 0.5bar M88 thread 1 1/4"  |                 |                         |
| <b>For models:</b>   | 31PI6, 31PIE6, 71PI10, 71PI10A, 71PIE15, 71PIE15A, 71PV15, 71PV15A, 91PI10, 91PI10A, 91PIE15, 91PIE15A, PV200, PV200A, PV300, PV300A |                 |                         |
| <b>accessories for</b>   | 540721   |                 |                         |
|  | <b>GEV No.</b>   | 541501          | <b>Ref. No.</b> 33Q4650 |
|  | reducer for safety fitting IT 1 1/4" ET 3/4"   |                 |                         |



1

|                    |  |                 |         |
|--------------------|--|-----------------|---------|
| <b>GEV No.</b>     | 540722   | <b>Ref. No.</b> | 33G0150 |
| <b>description</b> | safety valve with outlet for lid   |                 |         |
| <b>For models:</b> | 191PI1GA, 191PI2EA, 191PI2GA, 191PI2VA, 1A1PI1GA, 1A1PI2EA, 1A1PI2GA, 1A1PI2VA, 1D1PI1GA, 1D1PI2E, 1D1PI2EA, 1D1PI2GA, 1D1PI2VA, 71PI10A, 71PIE15A, 71PV15A, 91PI10A, 91PIE15A, PV200A, PV300A |                 |         |

air filters



1

|                    |  |                 |         |
|--------------------|--|-----------------|---------|
| <b>GEV No.</b>     | 750164   | <b>Ref. No.</b> | 36D5560 |
| <b>description</b> | air filter L 240mm W 190mm H 5mm   |                 |         |
| <b>For models:</b> | AL1433, AL1433V, AL1437, AL1437V, AL1633, AL1633V, AL2033, AL2033V, AL2533, AL2533V, PE1633, PE1633V, PE2033, PE2033V, PM1633, PM1633V, PM2033, PM2033V, PZ1633A, PZ1633B, PZ2033A, PZ2033B, PZ2533A, PZ2533B, SP120, SP120BN, SP120NN, SP135, SP135BN, SP135CP, SP135NN, SP55, SP65, SP65NN |                 |         |

equipment feet and end caps

equipment feet

with screw mounting



1

|                    |   |                 |         |
|--------------------|---|-----------------|---------|
| <b>GEV No.</b>     | 701638  | <b>Ref. No.</b> | 3313390 |
| <b>description</b> | equipment foot tube ø 63.5mm thread M10 IT H 145-230mm SS Qty 1 pcs |                 |         |

components



1

|                    |  |                 |         |
|--------------------|--|-----------------|---------|
| <b>GEV No.</b>     | 701091                                 | <b>Ref. No.</b> | 6000150 |
| <b>description</b> | equipment foot H 125mm WS 55 1 1/2" IT |                 |         |



Зип Общепит

vsezip.ru

+7(812)987-08-81

with fixing plate

|  |   |                 |                    |
|--|---|-----------------|--------------------|
|  <p>1</p> |   |                 |                    |
| <b>GEV No.</b>   | 701379  | <b>Ref. No.</b> | 3137690<br>36C5600 |
| <b>description</b>   | equipment foot tube ø 64mm plate size 80-100mm hole distance 60-80mm H 105-155mm SS size 2 1/2" Qty 1 pcs   |                 |                    |
| <b>For models:</b>   | 3G6SA, 3G6SA2, 3G6SA4, 4G6SB, 4G6SB2, 4G6SB4, 4G6SB6, 6SA, 6SA2, 6SA2M, 6SAM, 6SB, 6SB2, 6SB2M, 6SBM, AF1B, AF1B-OPR01, AF1N, AF1N-OPR01, AF2B, AF2B-OPR01, AF2N, AF2N-OPR01, AGL6B, B1101S, BF101L, BF101S, C12Q1M, C12Q2M, CX120, CX120B, CX120NN, CX130, CX130B, CX130NN, CX140, CX140B, CX140BN, CX140BR, CX140CP, CX140NN, CX140PV, CX140R, CX150, CX150B, CX150BN, CX150BR, CX150CP, CX150NN, CX150PV...(Other models you can see in the webshop) |                 |                    |

|  |  |                 |                        |
|--|--|-----------------|------------------------|
|  <p>1</p> |  |                 |                        |
| <b>GEV No.</b>   | 700708   | <b>Ref. No.</b> | 36C4540<br>36C4540 old |
| <b>description</b>   | equipment foot tube ø 64mm plate size 90x90mm hole distance 70x70mm H 140-195mm SS size 2 1/2" Qty 1 pcs |                 |                        |

|  |   |                 |         |
|--|---|-----------------|---------|
|  <p>2</p> |   |                 |         |
| <b>GEV No.</b>   | 700709  | <b>Ref. No.</b> | 36C5550 |
| <b>description</b>   | equipment foot tube ø 64mm plate size 80x100mm hole distance 60x80mm H 115-170mm SS size 2 2/3" Qty 1 pcs   |                 |         |
| <b>For models:</b>   | 3G6SA, 3G6SA2, 3G6SA4, 4G6SB, 4G6SB2, 4G6SB4, 4G6SB6, 6MRA, 6MRA2, 6MRA2A, 6MRA2M, 6MRA2Z, 6MRA4, 6MRA4A, 6MRA4M, 6MRA4Z, 6MRAA, 6MRAM, 6MRAZ, 6MRB, 6MRB11, 6MRB11A, 6MRB11M, 6MRB11Z, 6MRB2, 6MRB2A, 6MRB2M, 6MRB2Z, 6MRB4, 6MRB4A, 6MRB4M, 6MRB4Z, 6MRB6, 6MRB6A, 6MRB6M, 6MRB6Z, 6MRBA, 6MRBM, 6MRBZ, 6MRC, 6MRC11, 6MRC11A, 6MRC11M, 6MRC11Z, 6MRC2, 6MRC2A, 6MRC2M, 6MRC2Z, 6MRC4, 6MRC4A...(Other models you can see in the webshop) |                 |         |

|  |  |                 |         |
|--|--|-----------------|---------|
| <p>components</p>  <p>1</p> |  |                 |         |
| <b>GEV No.</b>   | 701091                                 | <b>Ref. No.</b> | 6000150 |
| <b>description</b>   | equipment foot H 125mm WS 55 1 1/2" IT |                 |         |

|  |   |                 |                    |
|--|---|-----------------|--------------------|
|  <p>1</p> |   |                 |                    |
| <b>GEV No.</b>   | 701378  | <b>Ref. No.</b> | 3145280<br>36C4540 |
| <b>description</b>   | equipment foot tube ø 64mm plate size 80x100mm hole distance 60x80mm H 150-200mm SS size 2 1/2" Qty 1 pcs   |                 |                    |
| <b>For models:</b>   | 6BR15V, 6BR15VC, 6BR19V, 6BR19VC, 6EA, 6EA11, 6EA11A, 6EA11M, 6EA13, 6EA13A, 6EA13M, 6EA2, 6EA2A, 6EA2M, 6EAA, 6EAB, 6EABA, 6EABM, 6EAM, 6EB, 6EB11, 6EB11A, 6EB11M, 6EB13, 6EB13A, 6EB13M, 6EB2, 6EB22, 6EB22A, 6EB22M, 6EB2A, 6EB2M, 6EB4, 6EB4A, 6EB4M, 6EBA, 6EBB, 6EBBA, 6EBBM, 6EBM, 6EC, 6EC11, 6EC11A, 6EC11M, 6EC13, 6EC13A, 6EC13M, 6EC2, 6EC22, 6EC22A...(Other models you can see in the webshop) |                 |                    |

|   |  |                 |         |
|---|--|-----------------|---------|
|  <p>1</p> |  |                 |         |
| <b>GEV No.</b>  | 701090   | <b>Ref. No.</b> | 36D4000 |
| <b>description</b>  | equipment foot tube ø 51mm plate size 80mm hole distance 145mm plastic size 2" ET Qty 1 pcs  |                 |         |
| <b>For models:</b>  | 30CPS, 30CPSE, 30F, 30F1, 30F1B, 30FES, 30FES2, 30FES2B, 30FS, 30FS2, 30FS2B, 31, 31GE, 31PD6, 31PI6, 31PIE6, 31R, 31RE, 31TC, 31TCE, 31TP, 32, 32TC, 32TCE, 32TP, 32TPV, 32V, 40, 40B, 40CP, 40CPX, 40EV, 40EVP, 40PV, 40X, 40XPV |                 |         |

|  |                                     |                 |         |
|--|-------------------------------------|-----------------|---------|
| <p>miscellaneous</p>  <p>1</p> |                                     |                 |         |
| <b>GEV No.</b>   | 691162                              | <b>Ref. No.</b> | 36D0160 |
| <b>description</b>   | equipment foot H 25mm WS 46 plastic |                 |         |

Зип, Общепит

Baskets

fryer baskets

vsezip.ru

ANGELO-PO

+7(812)987-08-81



1

|   |   |                 |            |
|---|---|-----------------|------------|
| <b>GEV No.</b>  | 691161  | <b>Ref. No.</b> | 36D0150    |
| <b>description</b>  | equipment foot H 41mm WS 56 bottom part plastic |                 |            |
| <b>spare parts for</b>  | 691161  |                 |            |
|  | GEV No.   | 694485          | Ref. No. — |
|   | sign for walk-in cold room catch Exit ø 78mm    |                 |            |

## screw-in feet



1

|                    |   |                 |         |
|--------------------|---|-----------------|---------|
| <b>GEV No.</b>     | 695601  | <b>Ref. No.</b> | 3095690 |
| <b>description</b> | equipment foot thread M17 thread L 23mm ø 24mm H 11mm plastic WS 24 Qty 1 pcs |                 |         |



1

|                    |   |                 |         |
|--------------------|---|-----------------|---------|
| <b>GEV No.</b>     | 697815  | <b>Ref. No.</b> | 36D4430 |
| <b>description</b> | equipment foot thread M8 thread L 10mm ø 48mm H 47mm rubber Qty 1 pcs |                 |         |



1

|                    |  |                 |         |
|--------------------|--|-----------------|---------|
| <b>GEV No.</b>     | 697770   | <b>Ref. No.</b> | 36D5690 |
| <b>description</b> | equipment foot thread M8 thread L 12mm ø 47mm H 35mm Qty 1 pcs |                 |         |
| <b>For models:</b> | FCV3EM, FCV4E, FCV4EDS, FCV4EM, FM423E1, FM423E2, FMS, FMSX    |                 |         |



1

|                    |   |                 |         |
|--------------------|---|-----------------|---------|
| <b>GEV No.</b>     | 691122  | <b>Ref. No.</b> | 36E0010 |
| <b>description</b> | equipment foot thread M8 thread L 24mm ø 38mm H 13mm Qty 1 pcs  |                 |         |
| <b>For models:</b> | 6CP, 6FA, 6FA1, 6FR, 6FTL, 6FTR, 6PC, 6VTIM, 6VTIMM, 6VTIW, 6VTIWM, 6VTR, 6VTR2, F60P, F60PR, F60T, L45 |                 |         |



1

|                    |  |                 |                    |
|--------------------|--|-----------------|--------------------|
| <b>GEV No.</b>     | 970547   | <b>Ref. No.</b> | 3007210<br>3007220 |
| <b>description</b> | fryer basket L1 280mm W1 225mm H1 115mm  |                 |                    |
| <b>For models:</b> | 04WFR3ED, 06WFR3GD, 08WFR4ED, 091FR3E, 091FR3ED, 091FR3G, 091FR3GD, 0A1FR3E, 0A1FR3ED, 0A1FR3G, 0A1FR3GD, 0D1FR3E, 0D1FR3ED, 0D1FR3G, 0D1FR3GD, 0G0FR3E, 0G0FR3ED, 0G1FR3G, 0G1FR3GD, 0G1FR7G, 10WFR4GD, 191FR4E, 191FR4ED, 191FR4G, 191FR4GD, 1A1FR4E, 1A1FR4ED, 1A1FR4G, 1A1FR4GD, 1D1FR4E, 1D1FR4ED, 1D1FR4G, 1D1FR4GD, 1G0FR4E, 1G1FR4G, 1G1FR4GD, 1G1FR8G, 6043840, 6043970 |                 |                    |



1

|                    |  |                 |         |
|--------------------|--|-----------------|---------|
| <b>GEV No.</b>     | 970175   | <b>Ref. No.</b> | 36A2640 |
| <b>description</b> | fryer basket L1 288mm W1 190mm H1 115mm L2 570mm H2 135mm H3 185mm chrome-plated steel |                 |         |
| <b>For models:</b> | 030FE, 30F, 30FES, 30FS, 70FES   |                 |         |



1

|                    |  |                 |         |
|--------------------|--|-----------------|---------|
| <b>GEV No.</b>     | 970338   | <b>Ref. No.</b> | 36A3481 |
| <b>description</b> | fryer basket L1 290mm W1 190mm H1 115mm L2 520mm H2 210mm H3 260mm chrome-plated steel plastic/rubber with holder          |                 |         |
| <b>For models:</b> | 030FE1, 030FE1B, 091FE28, 091FE28B, 30F1, 30F1B, 30FES2, 30FES2B, 30FS2, 30FS2B, 70FES2, 70FES2B, 90F110B, 91F210, 91F210B |                 |         |



1

|                    |   |                 |         |
|--------------------|---|-----------------|---------|
| <b>GEV No.</b>     | 970551                                  | <b>Ref. No.</b> | 36A5350 |
| <b>description</b> | fryer basket L1 305mm W1 225mm H1 115mm |                 |         |





Зип Общепит

vsezip.ru

47(812)987-08-81

|   |   |                 |         |
|---|---|-----------------|---------|
| 1  |   |                 |         |
| <b>GEV No.</b>  | 970172  | <b>Ref. No.</b> | 36A1300 |
| <b>description</b>  | fryer basket L1 315mm W1 210mm H1 120mm L2 495mm H2 170mm chrome-plated steel |                 |         |

|  |   |                 |                 |
|--|---|-----------------|-----------------|
| 1  |   |                 |                 |
| <b>GEV No.</b>   | 970775                                  | <b>Ref. No.</b> | 55AL942 C3830AD |
| <b>description</b>   | fryer basket W1 300mm L1 365mm H1 120mm |                 |                 |

|   |  |                 |         |
|---|--|-----------------|---------|
| 1  |  |                 |         |
| <b>GEV No.</b>  | 970174   | <b>Ref. No.</b> | 36A2020 |
| <b>description</b>  | fryer basket L1 368mm W1 150mm H1 120mm L2 700mm H2 140mm H3 200mm chrome-plated steel |                 |         |
| <b>For models:</b>  | 70F, 70FE, 71F, 71FE   |                 |         |

pasta baskets

ANGELO PO

ANGELO PO

|   |  |                 |         |
|---|--|-----------------|---------|
| 1  |  |                 |         |
| <b>GEV No.</b>  | 970339   | <b>Ref. No.</b> | 36A3491 |
| <b>description</b>  | fryer basket L1 368mm W1 150mm H1 120mm L2 700mm H2 210mm H3 250mm chrome-plated steel |                 |         |
| <b>For models:</b>  | 70F1, 70F1B, 70FE1, 70FE1B, 71F2, 71F2B, 71FE2, 71FE2B, 91F223B                        |                 |         |

|  |   |                 |               |
|--|---|-----------------|---------------|
| 1  |   |                 |               |
| <b>GEV No.</b>   | 970952  | <b>Ref. No.</b> | 55AG018 C3023 |
| <b>description</b>   | pasta basket H1 200mm W1 230mm L1 306mm L2 480mm H2 250mm H3 310mm SS holder length 165mm |                 |               |

|   |  |                 |         |
|---|--|-----------------|---------|
| 1  |  |                 |         |
| <b>GEV No.</b>  | 970340   | <b>Ref. No.</b> | 36A2340 |
| <b>description</b>  | fryer basket L1 370mm W1 150mm H1 120mm chrome-plated steel  |                 |         |
| <b>For models:</b>  | 091FR1E, 091FR1ED, 091FR1G, 091FR1GD, 091FR1I, 091FR1ID, 091FR1ID-VERS.052012, 091FR1I-VERS.032012, 0A1FR1E, 0A1FR1ED, 0A1FR1G, 0A1FR1GD, 0A1FR1GD-VERS.2004, 0A1FR1G-VERS.2004, 0B1FR1G, 0B1FR1GD, 0D1FR1E, 0D1FR1ED, 0D1FR1G, 0D1FR1GD, 0D1FR1GD-VERS.2004, 0D1FR1G-VERS.2004, 191FR2E, 191FR2ED, 191FR2G, 191FR2GD, 191FR2I, 191FR2ID, 191FR2ID-VERS.092012, 191FR2I-VERS.032012, 1A1FR2E, 1A1FR2ED, 1A1FR2G, 1A1FR2GD, 1A1FR2GD-VERS.2004, 1A1FR2G-VERS.2004, 1D1FR2ED, 1D1FR2G, 1D1FR2GD, 1D1FR2GD-VERS.2004, 1D1FR2G-VERS.2004 |                 |         |

|  |   |                 |       |
|--|---|-----------------|-------|
| 1  |   |                 |       |
| <b>GEV No.</b>   | 970678                                  | <b>Ref. No.</b> | C4627 |
| <b>description</b>   | pasta basket H1 200mm W1 270mm L1 460mm |                 |       |

|   |  |                 |         |
|---|--|-----------------|---------|
| 1  |  |                 |         |
| <b>GEV No.</b>  | 970173   | <b>Ref. No.</b> | 36A0901 |
| <b>description</b>  | fryer basket L1 400mm W1 230mm H1 130mm L2 185mm H2 165mm H3 180mm |                 |         |

|  |   |                 |               |
|--|---|-----------------|---------------|
| 1  |   |                 |               |
| <b>GEV No.</b>   | 970563  | <b>Ref. No.</b> | 3012120 C1011 |
| <b>description</b>   | pasta basket L1 110mm W1 100mm H1 150mm size GN 1/8 stainless steel |                 |               |

Зип Общепит

vsezip.ru

+7(812)987-08-81



1

|                    |   |                 |         |
|--------------------|---|-----------------|---------|
| <b>GEV No.</b>     | 970565  | <b>Ref. No.</b> | 3012140 |
| <b>description</b> | pasta basket L1 280mm W1 300mm H1 150mm size GN 3/4 stainless steel |                 |         |



1

|                    |  |                 |                   |
|--------------------|--|-----------------|-------------------|
| <b>GEV No.</b>     | 970777   | <b>Ref. No.</b> | 55AG028<br>KCP40G |
| <b>description</b> | pasta basket set 4 pieces L1 265mm H1 200mm W1 115mm |                 |                   |



1

|                    |  |                 |         |
|--------------------|--|-----------------|---------|
| <b>GEV No.</b>     | 970337   | <b>Ref. No.</b> | 36A2582 |
| <b>description</b> | pasta basket L1 295mm W1 100mm H1 150mm size GN 2/8 L2 470mm H2 230mm H3 310mm stainless steel |                 |         |
| <b>For models:</b> | 30CPS, 30CPSE, 70CP, 70CPE, 71CP, 71CP2, 90CP, 90CPE, 91CP                                     |                 |         |

accessories



1

|                    |   |                 |         |
|--------------------|---|-----------------|---------|
| <b>GEV No.</b>     | 692119  | <b>Ref. No.</b> | 36A4631 |
| <b>description</b> | chargrill grid L 500mm W 296mm H 83mm for pasta cooker  |                 |         |
| <b>For models:</b> | 06WCP1GM, 08WCP1GM, 091CP1G, 0A1CP1G, 0B1CP1G, 0D1CP1G, 191CP2G, 1A1CP2G, 1D1CP2G, 1G1CP1G, 1G1CP1G-VERS.2004 |                 |         |



1

|                    |   |                 |                             |
|--------------------|---|-----------------|-----------------------------|
| <b>GEV No.</b>     | 970564  | <b>Ref. No.</b> | 3012130<br>51AL961<br>C2028 |
| <b>description</b> | pasta basket L1 295mm W1 180mm H1 150mm size GN 1/2 stainless steel |                 |                             |

crumb screens



1

|                    |   |                 |         |
|--------------------|---|-----------------|---------|
| <b>GEV No.</b>     | 970553  | <b>Ref. No.</b> | 36A2591 |
| <b>description</b> | crumb screen L 340mm W 330mm H handle 185mm stainless steel suitable for pasta cooker |                 |         |
| <b>For models:</b> | 70CP, 71CP2, 90CP   |                 |         |



1

|                    |   |                 |                  |
|--------------------|---|-----------------|------------------|
| <b>GEV No.</b>     | 970548  | <b>Ref. No.</b> | 3240680<br>C0930 |
| <b>description</b> | pasta basket L1 305mm W1 95mm H1 205mm size GN 2/8 H3 320mm stainless steel |                 |                  |





1

|                    |  |                 |         |
|--------------------|--|-----------------|---------|
| <b>GEV No.</b>     | 970554   | <b>Ref. No.</b> | 36A2270 |
| <b>description</b> | crumb screen L 500mm W 295mm H 135mm                 |                 |         |
| <b>For models:</b> | 0A1CP1E, 0A1CP1G, 0D1CP1E, 0D1CP1G, 1A1CP2G, 1D1CP2G |                 |         |



Зип Общепит  
vsezip.ru  
+7(812)987-08-81

|  |   |                 |         |
|--|---|-----------------|---------|
|  <p>Image not available</p> |   |                 |         |
| 1  |   |                 |         |
| <b>GEV No.</b>   | 970573  | <b>Ref. No.</b> | 36A2301 |
| <b>description</b>   | crumb screen L 650mm W 340mm H handle 175mm stainless steel suitable for pasta cooker |                 |         |
| <b>For models:</b>   | 71CP, 91CP  |                 |         |

|  |  |                 |         |
|--|--|-----------------|---------|
|  |  |                 |         |
| 1  |  |                 |         |
| <b>GEV No.</b>   | 970951   | <b>Ref. No.</b> | 36A5260 |
| <b>description</b>   | grate L 340mm W 240mm H 100mm for pasta cooker   |                 |         |
| <b>For models:</b>   | 0G1CP1E, 0G1CP1EC, 0G1CP1E-VERS.2004, 0G1CP1G, 0G1CP1G-VERS.2004, 1G1CP2G, 1G1CP2G-VERS.2004 |                 |         |

|   |   |                 |         |
|---|---|-----------------|---------|
|  |   |                 |         |
| 1   |   |                 |         |
| <b>GEV No.</b>  | 970560  | <b>Ref. No.</b> | 3006800 |
| <b>description</b>  | crumb screen L 335mm W 235mm suitable for fryer   |                 |         |
| <b>For models:</b>  | 091FR3E, 091FR3ED, 0A1FR3E, 0A1FR3ED, 0D1FR3E, 0D1FR3ED, 0G0FR3E, 0G0FR3ED, 0G0FR5G, 191FR4E, 191FR4ED, 1A1FR4E, 1A1FR4ED, 1D1FR4E, 1D1FR4ED, 1G0FR4E, 1G0FR6G, 6043840, 6043970, 6FR |                 |         |

|  |  |                 |         |
|--|--|-----------------|---------|
|  |  |                 |         |
| 1  |  |                 |         |
| <b>GEV No.</b>   | 970849   | <b>Ref. No.</b> | 3007230 |
| <b>description</b>   | crumb screen L 335mm W 235mm H 148mm fryer   |                 |         |
| <b>For models:</b>   | 091FR3G, 091FR3GD, 0A1FR3G, 0A1FR3GD, 0D1FR3G, 0D1FR3GD, 0G1FR3G, 0G1FR3GD, 0G1FR7G, 191FR4G, 191FR4GD, 1A1FR4G, 1A1FR4GD, 1D1FR4G, 1D1FR4GD, 1G1FR4G, 1G1FR4GD, 1G1FR8G |                 |         |

|  |  |                 |         |
|--|--|-----------------|---------|
|  |  |                 |         |
| 1  |  |                 |         |
| <b>GEV No.</b>   | 970552   | <b>Ref. No.</b> | 36A2320 |
| <b>description</b>   | crumb screen L 430mm W 310mm H 190mm suitable for fryer  |                 |         |
| <b>For models:</b>   | 091FR1E, 091FR1ED, 091FR1G, 091FR1GD, 091FR1I, 091FR1ID, 091FR1ID-VERS.052012, 091FR1I-VERS.032012, 0A1FR1E, 0A1FR1ED, 0A1FR1G, 0A1FR1GD, 0A1FR1GD-VERS.2004, 0A1FR1G-VERS.2004, 0B1FR1G, 0B1FR1GD, 0D1FR1E, 0D1FR1ED, 0D1FR1G, 0D1FR1GD, 0D1FR1GD-VERS.2004, 0D1FR1G-VERS.2004, 191FR2E, 191FR2ED, 191FR2G, 191FR2GD, 191FR2I, 191FR2ID, 191FR2ID-VERS.092012, 191FR2I-VERS.032012, 1A1FR2E, 1A1FR2ED, 1A1FR2G, 1A1FR2GD, 1A1FR2GD-VERS.2004, 1A1FR2G-VERS.2004, 1D1FR2ED, 1D1FR2G, 1D1FR2GD, 1D1FR2GD-VERS.2004, 1D1FR2G-VERS.2004 |                 |         |

warewashing baskets

steel wire baskets round

mix baskets

|  |  |                 |         |
|--|--|-----------------|---------|
|  |  |                 |         |
| 1  |  |                 |         |
| <b>GEV No.</b>   | 970323                                     | <b>Ref. No.</b> | 3053810 |
| <b>description</b>   | mix basket ED ø 370mm H 145mm seat ø 325mm |                 |         |

plastic baskets round

|  |  |                 |         |
|--|--|-----------------|---------|
|  |  |                 |         |
| 1  |  |                 |         |
| <b>GEV No.</b>   | 970699   | <b>Ref. No.</b> | 3053810 |
| <b>description</b>   | mix basket ED ø 380mm H 170mm seat ø 325mm plastic |                 |         |

|   |   |                 |                    |
|---|---|-----------------|--------------------|
|  |   |                 |                    |
| 1   |   |                 |                    |
| <b>GEV No.</b>  | 970949  | <b>Ref. No.</b> | 36A4641<br>36A4642 |
| <b>description</b>  | crumb screen L 500mm W 295mm H 105mm stainless steel for pasta cooker |                 |                    |
| <b>For models:</b>  | 04WCP1EM, 091CP1E, 6040090, 6040310, 6043850, 6043980                 |                 |                    |

## shelves and shelf rails

## chargrill grids



1

|                    |  |                 |                    |
|--------------------|--|-----------------|--------------------|
| <b>GEV No.</b>     | 210042   | <b>Ref. No.</b> | 3000930<br>3000931 |
| <b>description</b> | chargrill grid L 470mm W 300mm H 55mm cast iron suitable for ANGELO PO chargrill |                 |                    |
| <b>For models:</b> | 1G0GRG   |                 |                    |

## grates

## universal

## without upstand



1

|                        |   |                 |                   |
|------------------------|---|-----------------|-------------------|
| <b>GEV No.</b>         | 970120  | <b>Ref. No.</b> | 36M3540<br>G610   |
| <b>description</b>     | grate W 325mm D 530mm GN 1/1 chrome-plated steel wire gauge frame 7mm lengthwise wires gauge 4mm crossing wires 1 |                 |                   |
| <b>For models:</b>     | 31GE, 31TC, 31TCE, 32TC, 32TCE  |                 |                   |
| <b>accessories for</b> | 970120  |                 |                   |
|                        | <b>GEV No.</b>  | <b>690330</b>   | <b>Ref. No.</b> — |
|                        | rack L 1000mm W 22mm H 4mm aperture 3x8mm hole distance 12.5mm stainless steel                                    |                 |                   |
|                        | <b>GEV No.</b>  | <b>694700</b>   | <b>Ref. No.</b> — |
|                        | shelf support L 31/28mm W 22mm H 18mm SS Qty 12 pcs   |                 |                   |
|                        | <b>GEV No.</b>  | <b>694701</b>   | <b>Ref. No.</b> — |
|                        | shelf support L 31/28mm W 22mm H 17mm SS with hook Qty 12 pcs   |                 |                   |

Зип Общепит

vsezip.ru

+7(812)987-08-81



1

|                        |   |                 |                   |
|------------------------|---|-----------------|-------------------|
| <b>GEV No.</b>         | 970122  | <b>Ref. No.</b> | G610X             |
| <b>description</b>     | grate W 325mm D 530mm GN 1/1 H 8mm stainless steel wire gauge frame 7mm lengthwise wires gauge 4mm crossing wires 1 |                 |                   |
| <b>accessories for</b> | 970122  |                 |                   |
|                        | <b>GEV No.</b>  | <b>690330</b>   | <b>Ref. No.</b> — |
|                        | rack L 1000mm W 22mm H 4mm aperture 3x8mm hole distance 12.5mm stainless steel                                      |                 |                   |
|                        | <b>GEV No.</b>  | <b>694700</b>   | <b>Ref. No.</b> — |
|                        | shelf support L 31/28mm W 22mm H 18mm SS Qty 12 pcs   |                 |                   |
|                        | <b>GEV No.</b>  | <b>694701</b>   | <b>Ref. No.</b> — |
|                        | shelf support L 31/28mm W 22mm H 17mm SS with hook Qty 12 pcs   |                 |                   |



1

|                        |  |                 |                    |
|------------------------|--|-----------------|--------------------|
| <b>GEV No.</b>         | 970125   | <b>Ref. No.</b> | 32A2430<br>36A2430 |
| <b>description</b>     | grate W 325mm D 530mm GN 1/1 plastic-coated steel crossing wires 1 white suitable for refrigerator |                 |                    |
| <b>For models:</b>     | BRPR218, BRPR21C, BRVR218, BRVR21C, K16APGPZ, K16XPZAP, SA16AGB, SA16GB, SL21RPR, SL21RVR          |                 |                    |
| <b>accessories for</b> | 970125   |                 |                    |
|                        | <b>GEV No.</b>   | <b>690330</b>   | <b>Ref. No.</b> —  |
|                        | rack L 1000mm W 22mm H 4mm aperture 3x8mm hole distance 12.5mm stainless steel                     |                 |                    |
|                        | <b>GEV No.</b>   | <b>694700</b>   | <b>Ref. No.</b> —  |
|                        | shelf support L 31/28mm W 22mm H 18mm SS Qty 12 pcs  |                 |                    |
|                        | <b>GEV No.</b>   | <b>694701</b>   | <b>Ref. No.</b> —  |
|                        | shelf support L 31/28mm W 22mm H 17mm SS with hook Qty 12 pcs                                      |                 |                    |



Зип Общежит

vsezip.ru

+7(812)987-08-81



|                        |   |                 |         |
|------------------------|---|-----------------|---------|
| <b>GEV No.</b>         | 970132  | <b>Ref. No.</b> | 36A0131 |
| <b>description</b>     | grate W 400mm D 600mm plastic-coated steel crossing wires 1 white suitable for refrigerator |                 |         |
| <b>For models:</b>     | 40, 40-OPR01, 40CP, 40CP-OPR01, 40CPX, 40CPX-OPR01, 40PV, 40PV-OPR01, 40X, 40X-OPR01, 40XPV |                 |         |
| <b>accessories for</b> | 970132  |                 |         |
|                        | <b>GEV No.</b>  | <b>Ref. No.</b> | —       |
|                        | 690330  |                 |         |
|                        | rack L 1000mm W 22mm H 4mm aperture 3x8mm hole distance 12.5mm stainless steel              |                 |         |
|                        | <b>GEV No.</b>  | <b>Ref. No.</b> | —       |
|                        | 694700  |                 |         |
|                        | shelf support L 31/28mm W 22mm H 18mm SS Qty 12 pcs   |                 |         |
|                        | <b>GEV No.</b>  | <b>Ref. No.</b> | —       |
|                        | 694701  |                 |         |
|                        | shelf support L 31/28mm W 22mm H 17mm SS with hook Qty 12 pcs                               |                 |         |



|                        |   |                 |       |
|------------------------|---|-----------------|-------|
| <b>GEV No.</b>         | 970123  | <b>Ref. No.</b> | G241X |
| <b>description</b>     | grate W 650mm D 530mm GN 2/1 stainless steel wire gauge frame 7.8mm lengthwise wires gauge 3.8mm crossing wires 2 suitable for refrigerator |                 |       |
| <b>accessories for</b> | 970123  |                 |       |
|                        | <b>GEV No.</b>  | <b>Ref. No.</b> | —     |
|                        | 690330  |                 |       |
|                        | rack L 1000mm W 22mm H 4mm aperture 3x8mm hole distance 12.5mm stainless steel  |                 |       |
|                        | <b>GEV No.</b>  | <b>Ref. No.</b> | —     |
|                        | 694700  |                 |       |
|                        | shelf support L 31/28mm W 22mm H 18mm SS Qty 12 pcs   |                 |       |
|                        | <b>GEV No.</b>  | <b>Ref. No.</b> | —     |
|                        | 694701  |                 |       |
|                        | shelf support L 31/28mm W 22mm H 17mm SS with hook Qty 12 pcs   |                 |       |

|                    |  |                 |         |
|--------------------|--|-----------------|---------|
| <b>GEV No.</b>     | 970558   | <b>Ref. No.</b> | 3012000 |
| <b>description</b> | grate W 325mm D 530mm GN 1/1 chrome-plated iron  |                 |         |
| <b>For models:</b> | 1G1FA0EV, 1G1FA0GV, 1G1PE1EV, 1G1PE2EV, 2G1FA0GV, 2G1PE1EV, 2G1PE2EV, 31GE, 31TC, 31TCE, 32TC, 32TCE |                 |         |

|                        |   |                 |                 |
|------------------------|---|-----------------|-----------------|
| <b>GEV No.</b>         | 970527  | <b>Ref. No.</b> | 36A0990<br>G241 |
| <b>description</b>     | grate W 530mm D 650mm GN 2/1 chrome-plated steel with hinge camp crossing wires 2 suitable for refrigerator |                 |                 |
| <b>accessories for</b> | 970527  |                 |                 |
|                        | <b>GEV No.</b>  | <b>Ref. No.</b> | —               |
|                        | 690330  |                 |                 |
|                        | rack L 1000mm W 22mm H 4mm aperture 3x8mm hole distance 12.5mm stainless steel                              |                 |                 |
|                        | <b>GEV No.</b>  | <b>Ref. No.</b> | —               |
|                        | 694700  |                 |                 |
|                        | shelf support L 31/28mm W 22mm H 18mm SS Qty 12 pcs   |                 |                 |
|                        | <b>GEV No.</b>  | <b>Ref. No.</b> | —               |
|                        | 694701  |                 |                 |
|                        | shelf support L 31/28mm W 22mm H 17mm SS with hook Qty 12 pcs   |                 |                 |

|                    |  |                 |         |
|--------------------|--|-----------------|---------|
| <b>GEV No.</b>     | 970555   | <b>Ref. No.</b> | 36A0990 |
| <b>description</b> | grate W 530mm D 650mm GN 2/1 chrome-plated steel with hinge camp for fridge  |                 |         |
| <b>For models:</b> | 191FAAE, 191FAAG, 191FABG, 191FADG, 191FAE, 191FAG, 191PE4E, 191TPG, 1A1FA1G, 1A1FA2G, 1A1FA4G, 1A1FA5G, 1A1FAAG, 1A1FABG, 1A1FAS2G, 1A1FASG, 1A1PE4E, 1A1PEFTE, 1A1TP0G, 1A1TP0G-VERS.2002, 1A1FBE, 1D1FA1G, 1D1FA2G, 1D1FA4G, 1D1FA5G, 1D1FAAG, 1D1FABG, 1D1FAS2G, 1D1FASG, 1D1PE4E, 1D1TP0G, 1D1TP0G-VERS.2002, 1D1FBE, 1G1FA0E, 1G1FA0G, 1G1FABG, 1G1FAPG, 1G1PE1E, 1G1PE2E, 1G1TP0G, 291FAG, 291TPCG, 2A1FA1G, 2A1FA4G, 2A1FAAG, 2A1FAS2G, 2A1FASG, 2A1TP3G, 2A1TP6G, 2A1TPCG...<br>(Other models you can see in the webshop) |                 |         |

Зип Общепит

vsezip.ru

+7(812)987-08-81

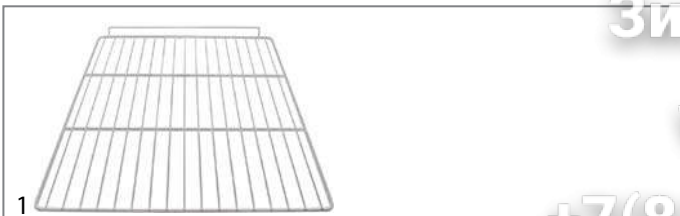

|                        |  |                 |  |
|------------------------|--|-----------------|--|
| <b>GEV No.</b>         | 970556   | <b>Ref. No.</b> | 36A0710<br>36A1040<br>36A3630<br>RGP/2-1 |
| <b>description</b>     | grate W 530mm D 650mm GN 2/1 plastic-coated steel with hinge camp wire gauge frame 9mm lengthwise wires gauge 5mm crossing wires 2 white suitable for refrigerator   |                 |  |
| <b>For models:</b>     | 135, 135-4, 135A, 135B, 135BA, 135BN, 135BNX, 135BX, 135BXE, 135BXR, 135CPX, 135NN, 135NNX, 135PVX, 135X, 135X-3, 135X-4, 135XE, 135XR, 65, 65A, 65B, 65BA, 65BX, 65BX-2, 65BXE, 65BXR, 65NB, 65NBX, 65NN, 65NNX, 65PVX, 65X, 65X-2, 65XE, 65XR, CX140, CX140B, CX140BN, CX140BR, CX140CP, CX140NN, CX140PV, CX140R, CX150, CX150B, CX150BN, CX150BR, CX150CP, CX150NN...(Other models you can see in the webshop) |                 |  |
| <b>accessories for</b> | 970556   |                 |  |
|                        | <b>GEV No.</b>   | <b>Ref. No.</b> | —  |
|                        | 690330   |                 |  |
|                        | rack L 1000mm W 22mm H 4mm aperture 3x8mm hole distance 12.5mm stainless steel   |                 |  |
|                        | <b>GEV No.</b>   | <b>Ref. No.</b> | —  |
|                        | 690332   |                 |  |
|                        | shelf support L 31/28mm W 22mm H 17mm SS with hook Qty 1 pcs   |                 |  |
|                        | <b>GEV No.</b>   | <b>Ref. No.</b> | —  |
|                        | 694700   |                 |  |
|                        | shelf support L 31/28mm W 22mm H 18mm SS Qty 12 pcs  |                 |  |
|                        | <b>GEV No.</b>   | <b>Ref. No.</b> | —  |
|                        | 694701   |                 |  |
|                        | shelf support L 31/28mm W 22mm H 17mm SS with hook Qty 12 pcs  |                 |  |



|                        |  |                 |         |
|------------------------|--|-----------------|---------|
| <b>GEV No.</b>         | 970643   | <b>Ref. No.</b> | 36A3010 |
| <b>description</b>     | grate W 555mm D 510mm H 60mm plastic-coated steel with hinge camp crossing wires 1   |                 |         |
| <b>For models:</b>     | 120, 120B, 120NN, 120PV, 55, 55B, 55PV, SP120, SP120B, SP120BN, SP120NN, SP55, SP55B |                 |         |
| <b>accessories for</b> | 970643   |                 |         |
|                        | <b>GEV No.</b>   | <b>Ref. No.</b> | —       |
|                        | 690330   |                 |         |
|                        | rack L 1000mm W 22mm H 4mm aperture 3x8mm hole distance 12.5mm stainless steel       |                 |         |
|                        | <b>GEV No.</b>   | <b>Ref. No.</b> | —       |
|                        | 694700   |                 |         |
|                        | shelf support L 31/28mm W 22mm H 18mm SS Qty 12 pcs                                  |                 |         |
|                        | <b>GEV No.</b>   | <b>Ref. No.</b> | —       |
|                        | 694701   |                 |         |
|                        | shelf support L 31/28mm W 22mm H 17mm SS with hook Qty 12 pcs                        |                 |         |



|                        |   |                 |         |
|------------------------|---|-----------------|---------|
| <b>GEV No.</b>         | 970557  | <b>Ref. No.</b> | 36A3020 |
| <b>description</b>     | grate W 555mm D 670mm plastic-coated steel with hinge camp crossing wires 2 suitable for refrigerator |                 |         |
| <b>accessories for</b> | 970557  |                 |         |
|                        | <b>GEV No.</b>  | <b>Ref. No.</b> | —       |
|                        | 690330  |                 |         |
|                        | rack L 1000mm W 22mm H 4mm aperture 3x8mm hole distance 12.5mm stainless steel                        |                 |         |
|                        | <b>GEV No.</b>  | <b>Ref. No.</b> | —       |
|                        | 694700  |                 |         |
|                        | shelf support L 31/28mm W 22mm H 18mm SS Qty 12 pcs   |                 |         |
|                        | <b>GEV No.</b>  | <b>Ref. No.</b> | —       |
|                        | 694701  |                 |         |
|                        | shelf support L 31/28mm W 22mm H 17mm SS with hook Qty 12 pcs   |                 |         |

grates



|                    |  |                 |         |
|--------------------|--|-----------------|---------|
| <b>GEV No.</b>     | 210248   | <b>Ref. No.</b> | 36C4230 |
| <b>description</b> | chimney grate  |                 |         |
| <b>For models:</b> | 08WFA4E, 08WFA4G, 12WFA6E, 12WFA6G, 12WFAAN, 1B0FAS, 1B0FAS2, 1B1FAS2G, 1B1FASG, 6043590 |                 |         |

grid attachments



|                    |   |                 |         |
|--------------------|---|-----------------|---------|
| <b>GEV No.</b>     | 695572  | <b>Ref. No.</b> | 36M7340 |
| <b>description</b> | rack support  |                 |         |
| <b>For models:</b> | 6MRA, 6MRA2, 6MRA2A, 6MRA2M, 6MRA2Z, 6MRA4, 6MRA4A, 6MRA4M, 6MRA4Z, 6MRAA, 6MRAAM, 6MRAZ, 6MRB, 6MRB11, 6MRB11A, 6MRB11M, 6MRB11Z, 6MRB2, 6MRB2A, 6MRB2M, 6MRB2Z, 6MRB4, 6MRB4A, 6MRB4M, 6MRB4Z, 6MRB6, 6MRB6A, 6MRB6M, 6MRB6Z, 6MRBA, 6MRBM, 6MRBZ, 6MRC, 6MRC11, 6MRC11A, 6MRC11M, 6MRC11Z, 6MRC2, 6MRC2A, 6MRC2M, 6MRC2Z, 6MRC4, 6MRC4A, 6MRC4M, 6MRC4Z, 6MRC6, 6MRC6A, 6MRC6M, 6MRC6Z, 6MRC6... (Other models you can see in the webshop) |                 |         |



Зип Общепит

vsezip.ru

+7(812)98708781



1

|                    |  |                 |         |
|--------------------|--|-----------------|---------|
| <b>GEV No.</b>     | 695577   | <b>Ref. No.</b> | 36G8640 |
| <b>description</b> | rack support L 20mm H 15.5mm W 11mm plastic  |                 |         |
| <b>For models:</b> | 6JA, 6JA2, 6JA2A, 6JA2M, 6JAA, 6JAM, 6JB, 6JB2, 6JB2A, 6JB2M, 6JB4A, 6JB4M, 6JBA, 6JBM, 6MRA, 6MRA2, 6MRA2A, 6MRA2M, 6MRA2Z, 6MRA4, 6MRA4A, 6MRA4M, 6MRA4Z, 6MRAA, 6MRAM, 6MRAZ, 6MRB, 6MRB11, 6MRB11A, 6MRB11M, 6MRB11Z, 6MRB2, 6MRB2A, 6MRB2M, 6MRB2Z, 6MRB4, 6MRB4A, 6MRB4M, 6MRB4Z, 6MRB6, 6MRB6A, 6MRB6M, 6MRB6Z, 6MRBA, 6MRBM, 6MRBZ, 6MRC, 6MRC11, 6MRC11A, 6MRC11M...(Other models you can see in the webshop) |                 |         |



1

|                    |  |                 |         |
|--------------------|--|-----------------|---------|
| <b>GEV No.</b>     | 691925   | <b>Ref. No.</b> | 35V6610 |
| <b>description</b> | guide U-shape L 430mm W 13mm mounting pos. right inner height 21mm |                 |         |
| <b>For models:</b> | 40CP, 40CPX  |                 |         |

shelf rails and supports

producer-specific



1

|                    |  |                 |         |
|--------------------|--|-----------------|---------|
| <b>GEV No.</b>     | 701465   | <b>Ref. No.</b> | 3069950 |
| <b>description</b> | guide L-shape L 600mm W 20mm H 30mm mounting pos. left   |                 |         |
| <b>For models:</b> | BP53G, BP53V, BP53X, BP64G, BP64V, BP64X, BP83A, BP83G, BP83M, BP83V, BP83X, BP94G, BP94V, BP94X, BPZ16, BPZ163A, BPZ163B, BPZ163S, BPZ167A, BPZ167B, BPZ167S, BPZ20, BPZ203A, BPZ203B, BPZ203S, BPZ207A, BPZ207B, BPZ207S, BPZ25, BPZ253A, BPZ253B, BPZ257A, BPZ257B, BS11, BS11A, BS11M, BS16, BS16A, BS16M, BS21, BS21A, BS21M, BSR11, BSR11A, BSR11M, BSR16, BSR16A, BSR16M, BSR21, BSR21A...(Other models you can see in the webshop) |                 |         |

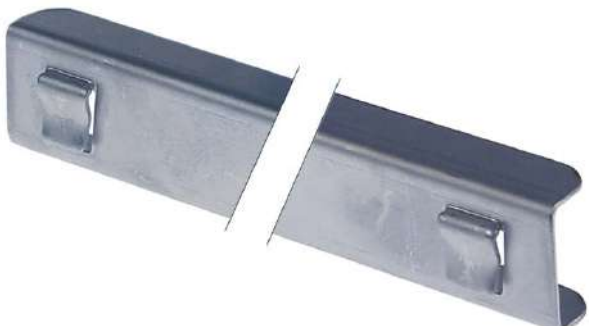

1

|                    |   |                 |         |
|--------------------|---|-----------------|---------|
| <b>GEV No.</b>     | 970888  | <b>Ref. No.</b> | 35R9140 |
| <b>description</b> | guide U-shape L 638mm W 13mm H 20mm mounting pos. right/left  |                 |         |
| <b>For models:</b> | CX140, CX140B, CX140BN, CX140BR, CX140CP, CX140NN, CX140PV, CX140R, CX150, CX150B, CX150BN, CX150BR, CX150CP, CX150NN, CX150PV, CX150R, CX65, CX65B, CX65BR, CX65NB, CX65NCP, CX65NN, CX65PV, CX65R, CX70, CX702, CX70B, CX70BR, CX70NB, CX70NN, CX70PV, CX70R, FX150, FX150B, FX150NN, FX70, FX70B, ISFEB, ISFEN, MD150, MD150A, MD150B, MD150B4, MD150BB, MD150BN, MD150BPV, MD150BR, MD150NCP, MD150NN...(Other models you can see in the webshop) |                 |         |



1

|                    |  |                 |         |
|--------------------|--|-----------------|---------|
| <b>GEV No.</b>     | 701466   | <b>Ref. No.</b> | 3069940 |
| <b>description</b> | guide L-shape L 600mm W 20mm H 30mm mounting pos. right  |                 |         |
| <b>For models:</b> | BP53G, BP53V, BP53X, BP64G, BP64V, BP64X, BP83A, BP83G, BP83M, BP83V, BP83X, BP94G, BP94V, BP94X, BPZ16, BPZ163A, BPZ163B, BPZ163S, BPZ167A, BPZ167B, BPZ167S, BPZ20, BPZ203A, BPZ203B, BPZ203S, BPZ207A, BPZ207B, BPZ207S, BPZ25, BPZ253A, BPZ253B, BPZ257A, BPZ257B, BS11, BS11A, BS11M, BS16, BS16A, BS16M, BS21, BS21A, BS21M, BSR11, BSR11A, BSR11M, BSR16, BSR16A, BSR16M, BSR21, BSR21A...(Other models you can see in the webshop) |                 |         |



1

|                    |  |                 |         |
|--------------------|--|-----------------|---------|
| <b>GEV No.</b>     | 690657   | <b>Ref. No.</b> | 36D9470 |
| <b>description</b> | rack L 650mm W 34mm H 57mm mounting pos. vertical  |                 |         |
| <b>For models:</b> | 120PV, 135, 135-4, 135A, 135B, 135BA, 135BN, 135BNX, 135BX, 135BXE, 135BXR, 135CPX, 135NN, 135NNX, 135X, 135X-3, 135X-4, 135XE, 135XR, 55PV, 65, 65A, 65B, 65BA, 65BX, 65BX-2, 65BXE, 65BXR, 65PVX, 65X, 65X-2, 65XE, 65XR |                 |         |



1

|                    |   |                 |         |
|--------------------|---|-----------------|---------|
| <b>GEV No.</b>     | 691841  | <b>Ref. No.</b> | 35V6620 |
| <b>description</b> | guide U-shape L 430mm W 13mm mounting pos. left inner height 21mm |                 |         |
| <b>For models:</b> | 40CP, 40CPX   |                 |         |

Зип Общепит

vsezip.ru

+7(812)987-08-81

mechanical components, equipment accessories

**gaskets**

refrigeration gaskets

plug-in gaskets

profile 9048

We offer custom-made gaskets for this profile

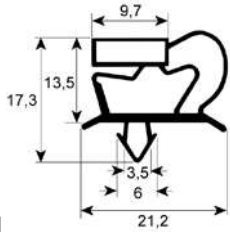

|                    |   |                 |         |
|--------------------|---|-----------------|---------|
| <b>GEV No.</b>     | 900863  | <b>Ref. No.</b> | 37Q4730 |
| <b>description</b> | refrigeration gasket profile 9048 W 138mm L 373mm plug size   |                 |         |
| <b>For models:</b> | 6BMA11A, 6BMA11M, 6BMA11Z, 6BMA3A, 6BMA3M, 6BMA3Z, 6BMB11A, 6BMB11M, 6BMB11Z, 6BMB22A, 6BMB22M, 6BMB22Z, 6BMB3A, 6BMB3M, 6BMB3Z, 6BMC11A, 6BMC11M, 6BMC11Z, 6BMC22A, 6BMC22M, 6BMC22Z, 6BMC33A, 6BMC33M, 6BMC33Z, 6BMC3A, 6BMC3M, 6BMC3Z, 6EA11, 6EA11A, 6EA11M, 6EA13, 6EA13A, 6EA13M, 6EB11, 6EB11A, 6EB11M, 6EB13, 6EB13A, 6EB13M, 6EB22, 6EB22A, 6EB22M, 6EC11, 6EC11A, 6EC11M, 6EC13, 6EC13A, 6EC13M, 6EC22, 6EC22A... (Other models you can see in the webshop) |                 |         |

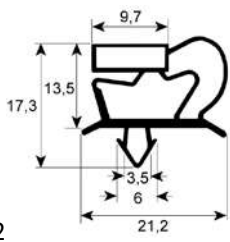

|                    |  |                 |         |
|--------------------|--|-----------------|---------|
| <b>GEV No.</b>     | 900862   | <b>Ref. No.</b> | 37Q4720 |
| <b>description</b> | refrigeration gasket profile 9048 W 246mm L 373mm plug size  |                 |         |
| <b>For models:</b> | 6BMA2A, 6BMA2M, 6BMA2Z, 6BMB2A, 6BMB2M, 6BMB2Z, 6BMB4A, 6BMB4M, 6BMB4Z, 6BMC2A, 6BMC2M, 6BMC2Z, 6BMC4A, 6BMC4M, 6BMC4Z, 6BMC6A, 6BMC6M, 6BMC6Z, 6EA2, 6EA2A, 6EA2M, 6EB2, 6EB2A, 6EB2M, 6EB4, 6EB4A, 6EB4M, 6EC2, 6EC2A, 6EC2M, 6EC4, 6EC4A, 6EC4M, 6ERA2, 6ERA2A, 6ERA2M, 6ERB2, 6ERB2A, 6ERB2M, 6ERB4, 6ERB4A, 6ERB4M, 6ERC2, 6ERC2A, 6ERC2M, 6MA2, 6MA2A, 6MA2M, 6MB2, 6MB2A... (Other models you can see in the webshop) |                 |         |

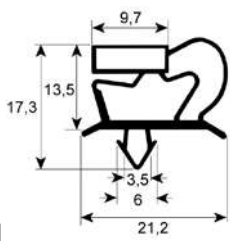

|                    |  |                 |         |
|--------------------|--|-----------------|---------|
| <b>GEV No.</b>     | 900860   | <b>Ref. No.</b> | 37Q3950 |
| <b>description</b> | refrigeration gasket profile 9048 W 253mm L 373mm plug size  |                 |         |
| <b>For models:</b> | 6JA2, 6JA2A, 6JA2M, 6JB2, 6JB2A, 6JB2M, 6JB4A, 6JB4M, 6SMA2, 6SMA2A, 6SMA2B, 6SMA2M, 6SMA2Z, 6SMA4Z, 6SMB2, 6SMB2A, 6SMB2B, 6SMB2M, 6SMB2Z, 6SMB4, 6SMB4A, 6SMB4B, 6SMB4M, 6SMB4Z, 6SMB6Z, 6SMC2, 6SMC2A, 6SMC2B, 6SMC2M, 6SMC2Z, 6SMC4, 6SMC4A, 6SMC4B, 6SMC4M, 6SMC4Z, 6SMC6, 6SMC6A, 6SMC6B, 6SMC6M, 6SMC6Z, 6SMC8Z |                 |         |



|                    |   |                 |         |
|--------------------|---|-----------------|---------|
| <b>GEV No.</b>     | 900864  | <b>Ref. No.</b> | 37Q4740 |
| <b>description</b> | refrigeration gasket profile 9048 W 354mm L 373mm plug size   |                 |         |
| <b>For models:</b> | 6BMA11A, 6BMA11M, 6BMA11Z, 6BMB11A, 6BMB11M, 6BMB11Z, 6BMB22A, 6BMB22M, 6BMB22Z, 6BMC11A, 6BMC11M, 6BMC11Z, 6BMC22A, 6BMC22M, 6BMC22Z, 6BMC33A, 6BMC33M, 6BMC33Z, 6EA11, 6EA11A, 6EA11M, 6EB11, 6EB11A, 6EB11M, 6EB22, 6EB22A, 6EB22M, 6EC11, 6EC11A, 6EC11M, 6EC22, 6EC22A, 6EC22M, 6MB11, 6MB11A, 6MB11M, 6MC11, 6MC11A, 6MC11M, 6MRB11, 6MRB11A, 6MRB11M, 6MRB11Z, 6MRC11, 6MRC11A, 6MRC11M, 6MRC11Z, 6RB11, 6RB11A, 6RB11M... (Other models you can see in the webshop) |                 |         |

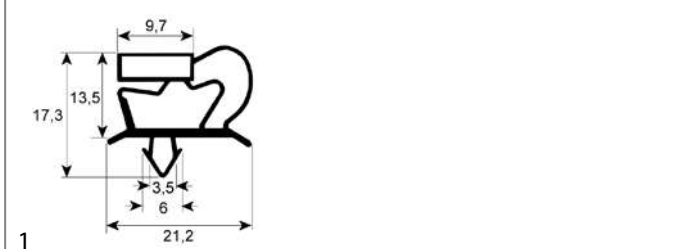

|                    |   |                 |         |
|--------------------|---|-----------------|---------|
| <b>GEV No.</b>     | 900861  | <b>Ref. No.</b> | 37Q4710 |
| <b>description</b> | refrigeration gasket profile 9048 W 373mm L 570mm plug size   |                 |         |
| <b>For models:</b> | 6BMA11A, 6BMA11B, 6BMA11M, 6BMA11Z, 6BMA2A, 6BMA2B, 6BMA2M, 6BMA2Z, 6BMA3A, 6BMA3B, 6BMA3M, 6BMA3Z, 6BMAA, 6BMAAB, 6BMAAM, 6BMAZ, 6BMB11A, 6BMB11B, 6BMB11M, 6BMB11Z, 6BMB22A, 6BMB22B, 6BMB22M, 6BMB22Z, 6BMB2A, 6BMB2B, 6BMB2M, 6BMB2Z, 6BMB3A, 6BMB3B, 6BMB3M, 6BMB3Z, 6BMB4A, 6BMB4B, 6BMB4M, 6BMB4Z, 6BMBB, 6BMBB, 6BMBB, 6BMBZ, 6BMC11A, 6BMC11B, 6BMC11M, 6BMC11Z, 6BMC22A, 6BMC22B, 6BMC22M, 6BMC22Z, 6BMC2A, 6BMC2B... (Other models you can see in the webshop) |                 |         |

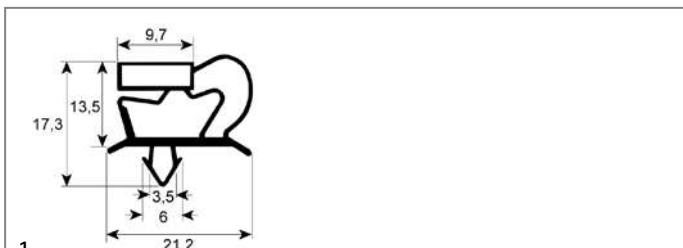

|                    |  |                 |         |
|--------------------|--|-----------------|---------|
| <b>GEV No.</b>     | 900709   | <b>Ref. No.</b> | 37Q3870 |
| <b>description</b> | refrigeration gasket profile 9048 W 373mm L 580mm plug size  |                 |         |
| <b>For models:</b> | 6JA, 6JA2, 6JA2A, 6JA2M, 6JAA, 6JAM, 6JB, 6JB2, 6JB2A, 6JB2M, 6JB4A, 6JB4M, 6JBA, 6JBM, 6SMA, 6SMA2, 6SMA2A, 6SMA2B, 6SMA2M, 6SMA2Z, 6SMAA, 6SMAB, 6SMAM, 6SMAZ, 6SMB, 6SMB2, 6SMB2A, 6SMB2B, 6SMB2M, 6SMB2Z, 6SMB4, 6SMB4A, 6SMB4B, 6SMB4M, 6SMB4Z, 6SMBB, 6SMBB, 6SMBM, 6SMBZ, 6SMC, 6SMC2, 6SMC2A, 6SMC2B, 6SMC2M, 6SMC2Z, 6SMC4, 6SMC4A, 6SMC4B, 6SMC4M, 6SMC4Z... (Other models you can see in the webshop) |                 |         |





Зип Общепит

vsezip.ru

+7(812)987-08-81

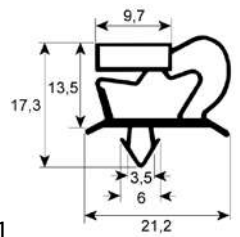

|                    |   |                 |         |
|--------------------|---|-----------------|---------|
| <b>GEV No.</b>     | 900812  | <b>Ref. No.</b> | 37Q4490 |
| <b>description</b> | refrigeration gasket profile 9048 W 400mm L 650mm plug size for blast chiller   |                 |         |
| <b>For models:</b> | ART1L7, ART1L7A, ART1L7M, ART1LD7, ART1LD7A, ART1LD7M, B151M, BF51M, DA51, DA51A, DA51M, DS31, DS31A, DS31C, DS31M, DS51, DS51A, DS51C, DS51M, IA51, IA51A, IA51C, IA51M, IS51, IS51A, IS51AR, IS51C, IS51CR, IS51M, IS51MR, IS51R, IS51W, IS51WA, IS51WC, IS51WM, SM03LT7, SM03LT7A, SM03LT7M, SM1L7, SM1L7A, SM1L7FCV, SM1L7M, SM1LT7, SM1LT7A, SM1LT7M, VA51, VA51M, VS31, VS31M, VS51...(Other models you can see in the webshop) |                 |         |

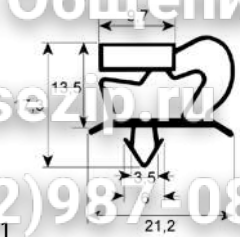

|                    |  |                 |         |
|--------------------|--|-----------------|---------|
| <b>GEV No.</b>     | 900710   | <b>Ref. No.</b> | 37Q5450 |
| <b>description</b> | refrigeration gasket profile 9048 W 655mm L 1500mm plug size   |                 |         |
| <b>For models:</b> | AGL6B, CX120, CX120B, CX120NN, CX140, CX140B, CX140BN, CX140BR, CX140CP, CX140NN, CX140R, CX55, CX55B, CX65, CX65B, CX65BR, CX65R, GD150, GD150B, GD70, GD70B, MD130, MD130B, MD130BN, MD130NN, MD150, MD150B, MD150BB, MD150BN, MD150BR, MD150NCP, MD150NN, MD150R, MD60, MD60B, MD70, MD70B, MD70BR, MD70CP, MD70R, MDE150, MDE150B, MDE70, MDE70B, MX120, MX120B, MX120NN, MX140, MX140B, MX140NN...(Other models you can see in the webshop) |                 |         |

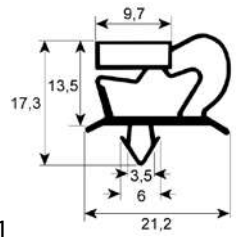

|                    |   |                 |         |
|--------------------|---|-----------------|---------|
| <b>GEV No.</b>     | 901207  | <b>Ref. No.</b> | 37Q3810 |
| <b>description</b> | refrigeration gasket profile 9048 W 429mm L 675mm plug size for blast chiller   |                 |         |
| <b>For models:</b> | ART1L, ART1LA, ART1LD, ART1LDA, BF51H, DS351H, IS51H, IS51HW, SM1L, SM1LA, SM1LAM, SM1LAR, SM1LAT, SM1LAW, SM1LM, SM1LR, SM1LT, SM1LW |                 |         |

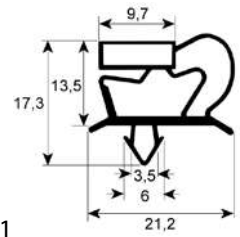

|                    |  |                 |         |
|--------------------|--|-----------------|---------|
| <b>GEV No.</b>     | 901329   | <b>Ref. No.</b> | 37Q5460 |
| <b>description</b> | refrigeration gasket profile 9048 W 655mm L 704mm plug size  |                 |         |
| <b>For models:</b> | CX140CP, CX652, CX65NB, CX65NCP, CX65NN, MD1504, MD150B4, MD702, MD70B2, MD70NB, MD70NCP, MD70NN, PD150CP, PD702, PD70B2 |                 |         |



|                    |   |                 |         |
|--------------------|---|-----------------|---------|
| <b>GEV No.</b>     | 902533  | <b>Ref. No.</b> | 37Q4140 |
| <b>description</b> | refrigeration gasket profile 9048 W 450mm L 600mm plug size |                 |         |

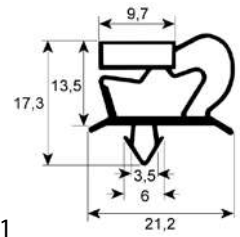

|                    |   |                 |         |
|--------------------|---|-----------------|---------|
| <b>GEV No.</b>     | 900706  | <b>Ref. No.</b> | 37Q4370 |
| <b>description</b> | refrigeration gasket profile 9048 W 660mm L 1610mm plug size  |                 |         |
| <b>For models:</b> | CX130, CX130B, CX130NN, CX150, CX150B, CX150BN, CX150BR, CX150CP, CX150NN, CX150R, CX60, CX60B, CX70, CX70B, CX70BR, CX70R, FX150, FX150B, FX150NN, FX70, FX70B, MX130, MX130B, MX130NN, MX150, MX150B, MX150NN, MX60, MX60B, MX70, MX70B |                 |         |

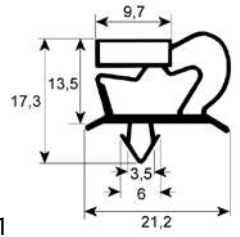

|                    |  |                 |                    |
|--------------------|--|-----------------|--------------------|
| <b>GEV No.</b>     | 900712   | <b>Ref. No.</b> | 37Q1020<br>37Q4850 |
| <b>description</b> | refrigeration gasket profile 9048 W 595mm L 1590mm plug size   |                 |                    |
| <b>For models:</b> | S1200, S1200B, S1200BE, S1200E, S125, S125B, S125BE, S125BX, S125E, S125X, S60, S600, S600B, S600BE, S600E, S60B, S60BE, S60BX, S60E, S60X |                 |                    |

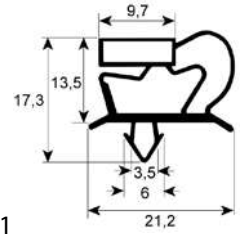

|                    |   |                 |         |
|--------------------|---|-----------------|---------|
| <b>GEV No.</b>     | 900350  | <b>Ref. No.</b> | 37Q2600 |
| <b>description</b> | refrigeration gasket profile 9048 W 670mm L 760mm plug size 1/2 door                            |                 |         |
| <b>For models:</b> | 135-4, 135CPX, 135X-3, 135X-4, 65BX-2, 65NB, 65NBX, 65NN, 65NNX, 65X-2, SP135CP, SP65NB, SP65NN |                 |         |

Зип Общепит

vsezip.ru

+7(812)987-08-81

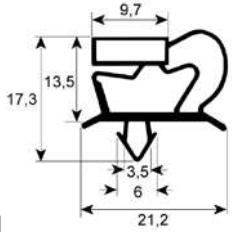

|                    |  |                 |         |
|--------------------|--|-----------------|---------|
| <b>GEV No.</b>     | 900351   | <b>Ref. No.</b> | 37Q2590 |
| <b>description</b> | refrigeration gasket profile 9048 W 672mm L 1587mm plug size door  |                 |         |
| <b>For models:</b> | 120, 120B, 120NN, 135, 135A, 135B, 135BA, 135BN, 135BNX, 135BX, 135BXE, 135BXR, 135CPX, 135NN, 135NNX, 135X, 135X-3, 135XE, 135XR, 55, 55B, 55PV, 65, 65A, 65B, 65BA, 65BX, 65BXE, 65BXR, 65X, 65XE, 65XR, SP120, SP120B, SP120BN, SP120NN, SP135, SP135B, SP135BN, SP135CP, SP135NN, SP55, SP55B, SP65, SP65B |                 |         |

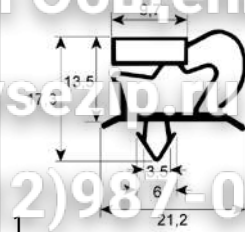

|                    |  |                 |         |
|--------------------|--|-----------------|---------|
| <b>GEV No.</b>     | 901205   | <b>Ref. No.</b> | 37Q5340 |
| <b>description</b> | refrigeration gasket profile 9048 W 690mm L 835mm plug size for blast chiller  |                 |         |
| <b>For models:</b> | B1101S, BF101L, BF101S, IA101L, IA101S, IS101L, IS101LR, IS101LW, IS101S, IS101SR, IS101SW, VS101L, XA101L, XA101S, XS101L, XS101S |                 |         |

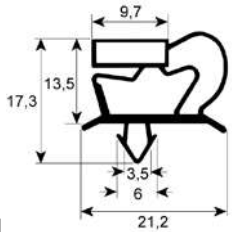

|                    |   |                 |         |
|--------------------|---|-----------------|---------|
| <b>GEV No.</b>     | 900328  | <b>Ref. No.</b> | 37Q1370 |
| <b>description</b> | refrigeration gasket profile 9048 W 675mm L 1525mm plug size glass door |                 |         |
| <b>For models:</b> | 40EV, 40EVP, 40PV, 40XPV  |                 |         |

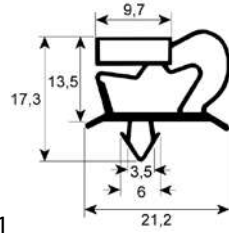

|                    |  |                 |         |
|--------------------|--|-----------------|---------|
| <b>GEV No.</b>     | 901204   | <b>Ref. No.</b> | 37Q5380 |
| <b>description</b> | refrigeration gasket profile 9048 W 941mm L 1002mm plug size for blast chiller |                 |         |
| <b>For models:</b> | IA72S, IS102S, IS102SR, IS102SR-0NR01, IS102SW, IS72S, IS72SR, IS72SW          |                 |         |

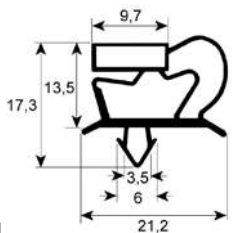

|                    |   |                 |         |
|--------------------|---|-----------------|---------|
| <b>GEV No.</b>     | 901206  | <b>Ref. No.</b> | 37Q3800 |
| <b>description</b> | refrigeration gasket profile 9048 W 675mm L 820mm plug size for blast chiller |                 |         |
| <b>For models:</b> | ART2LD, ART2SD, SM2L, SM2LR, SM2LW, SM2S, SM2SR, SM2SW                        |                 |         |

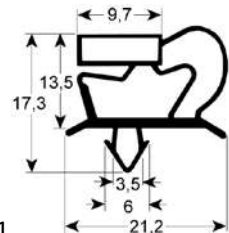

|                    |  |                 |     |
|--------------------|--|-----------------|-----|
| <b>GEV No.</b>     | 902258   | <b>Ref. No.</b> | N/A |
| <b>description</b> | refrigeration gasket profile 9048 Wmm L 2500mm |                 |     |

profile 9046

We offer custom-made gaskets for this profile

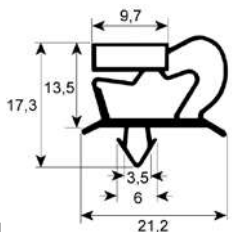

|                    |   |                 |         |
|--------------------|---|-----------------|---------|
| <b>GEV No.</b>     | 900326  | <b>Ref. No.</b> | 37Q1380 |
| <b>description</b> | refrigeration gasket profile 9048 W 685mm L 1600mm plug size glass door |                 |         |
| <b>For models:</b> | 120PV, 135PVX, 65PVX  |                 |         |

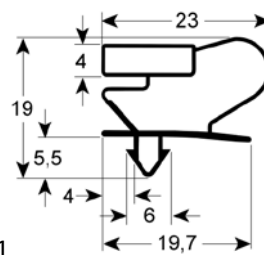

|                    |  |                 |         |
|--------------------|--|-----------------|---------|
| <b>GEV No.</b>     | 902515   | <b>Ref. No.</b> | 3125970 |
| <b>description</b> | refrigeration gasket profile 9046 W 377mm L 395mm plug size  |                 |         |
| <b>For models:</b> | 3G6SA, 3G6SA2, 3G6SA4, 4G6SB, 4G6SB2, 4G6SB4, 4G6SB6, 6BR15V, 6BR15VC, 6BR19V, 6BR19VC, 6SA, 6SA2, 6SA2M, 6SAM, 6SB, 6SB2, 6SB2M, 6SBM |                 |         |



Зип Общепит

vsezip.ru

+7(812)987-08-81

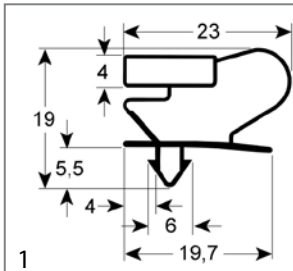

|                    |  |                 |         |
|--------------------|--|-----------------|---------|
| <b>GEV No.</b>     | 902314   | <b>Ref. No.</b> | 37Q5510 |
| <b>description</b> | refrigeration gasket profile 9046 W 520mm L 1495mm plug size   |                 |         |
| <b>For models:</b> | AF1B, AF1B-OPR01, AF1N, AF1N-OPR01, FSD1B, FSD1B-OPR01, FSD1N, FSD1N-OPR01, FSDR1B-OPR01, FSDR1N-OPR01 |                 |         |

profile 9046

We offer custom-made gaskets for this profile



|                    |  |                 |     |
|--------------------|--|-----------------|-----|
| <b>GEV No.</b>     | 900875   | <b>Ref. No.</b> | N/A |
| <b>description</b> | refrigeration gasket profile 9753 Wmm L 2500mm |                 |     |

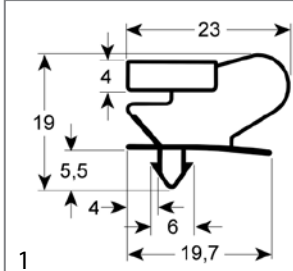

|                    |   |                 |         |
|--------------------|---|-----------------|---------|
| <b>GEV No.</b>     | 901801  | <b>Ref. No.</b> | 37Q4470 |
| <b>description</b> | refrigeration gasket profile 9046 W 650mm L 750mm plug size |                 |         |
| <b>For models:</b> | CX150CP, CX702, CX70NB, CX70NN                              |                 |         |

profile 9333

We offer custom-made gaskets for this profile

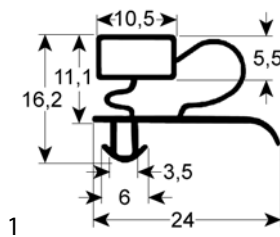

|                    |   |                 |         |
|--------------------|---|-----------------|---------|
| <b>GEV No.</b>     | 900016  | <b>Ref. No.</b> | 37Q1890 |
| <b>description</b> | refrigeration gasket profile 9333 W 650mm L 1550mm plug size 1/2 door |                 |         |

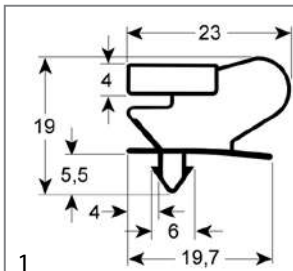

|                    |  |                 |     |
|--------------------|--|-----------------|-----|
| <b>GEV No.</b>     | 902257   | <b>Ref. No.</b> | N/A |
| <b>description</b> | refrigeration gasket profile 9046 Wmm L 2500mm |                 |     |

profile 9012

We offer custom-made gaskets for this profile

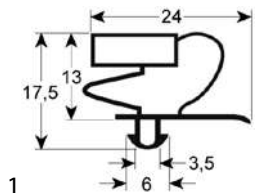

|                    |  |                 |         |
|--------------------|--|-----------------|---------|
| <b>GEV No.</b>     | 900354   | <b>Ref. No.</b> | 37Q7730 |
| <b>description</b> | refrigeration gasket profile 9012 W 130mm L 367mm plug size drawer size 1/3  |                 |         |
| <b>For models:</b> | 6BEA11A, 6BEA11B, 6BEA11M, 6BEA11Z, 6BEA3A, 6BEA3B, 6BEA3M, 6BEA3Z, 6BEB11A, 6BEB11M, 6BEB11Z, 6BEB22A, 6BEB22M, 6BEB22Z, 6BEB3A, 6BEB3B, 6BEB3M, 6BEB3Z, 6BEC11A, 6BEC11B, 6BEC11M, 6BEC11Z, 6BEC22A, 6BEC22B, 6BEC22M, 6BEC22Z, 6BEC33A, 6BEC33B, 6BEC33M, 6BEC33Z, 6BEC3A, 6BEC3B, 6BEC3M, 6BEC3Z, 6BMA11A, 6BMA11B, 6BMA11M, 6BMA11Z, 6BMA3A, 6BMA3M, 6BMA3Z, 6BMB11A, 6BMB11B, 6BMB11M, 6BMB11Z, 6BMB22A, 6BMB22B, 6BMB22M, 6BMB22Z, 6BMB3A...(Other models you can see in the webshop) |                 |         |

profile 9704

We offer custom-made gaskets for this profile

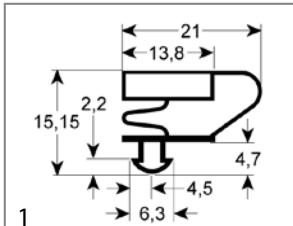

|                    |  |                 |         |
|--------------------|--|-----------------|---------|
| <b>GEV No.</b>     | 902315   | <b>Ref. No.</b> | 37Q5490 |
| <b>description</b> | refrigeration gasket profile 9704 W 655mm L 1500mm plug size                           |                 |         |
| <b>For models:</b> | CX140PV, CX65PV, MD150BPV, MD150PV, MD70BPV, MD70PV, PD70B-PV, PD70PV, TE140PV, TE65PV |                 |         |





Зип Общепит

vsezip.ru

+7(812)987-08-81

|                    |  |                 |         |
|--------------------|--|-----------------|---------|
| <b>GEV No.</b>     | 901005   | <b>Ref. No.</b> | 37Q0450 |
| <b>description</b> | refrigeration gasket profile 9031 W 660mm L 1360mm external size |                 |         |

|                    |   |                 |         |
|--------------------|---|-----------------|---------|
| <b>GEV No.</b>     | 900717  | <b>Ref. No.</b> | 37Q2380 |
| <b>description</b> | refrigeration gasket profile 9140 W 575mm L 610mm external size |                 |         |

profile 9140

We offer custom-made gaskets for this profile

|                    |   |                 |         |
|--------------------|---|-----------------|---------|
| <b>GEV No.</b>     | 900705  | <b>Ref. No.</b> | 37Q2050 |
| <b>description</b> | refrigeration gasket profile 9140 W 295mm L 380mm external size |                 |         |
| <b>For models:</b> | K16APGPZ, K16XPZAP, SA16AGB, SA16GB                             |                 |         |

|                    |   |                 |         |
|--------------------|---|-----------------|---------|
| <b>GEV No.</b>     | 901606  | <b>Ref. No.</b> | 37Q3320 |
| <b>description</b> | refrigeration gasket profile 9140 W 600mm L 645mm external size |                 |         |
| <b>For models:</b> | BRPR, BRPR218, BRPR21C, BRPRV, BRVR, BRVR218, BRVR21C, BRVRV    |                 |         |

|                    |   |                 |         |
|--------------------|---|-----------------|---------|
| <b>GEV No.</b>     | 900009  | <b>Ref. No.</b> | 37Q2040 |
| <b>description</b> | refrigeration gasket profile 9140 W 380mm L 610mm external size |                 |         |
| <b>For models:</b> | K16APGPZ, K16XPZAP, SA16AGB, SA16GB                             |                 |         |

|                    |  |                 |         |
|--------------------|--|-----------------|---------|
| <b>GEV No.</b>     | 901657   | <b>Ref. No.</b> | 37Q0760 |
| <b>description</b> | refrigeration gasket profile 9140 W 655mm L 1555mm external size |                 |         |

|                    |   |                 |         |
|--------------------|---|-----------------|---------|
| <b>GEV No.</b>     | 900858  | <b>Ref. No.</b> | 37Q3210 |
| <b>description</b> | refrigeration gasket profile 9140 W 383mm L 531mm external size |                 |         |
| <b>For models:</b> | SA87  |                 |         |

|                    |  |                 |     |
|--------------------|--|-----------------|-----|
| <b>GEV No.</b>     | 902264   | <b>Ref. No.</b> | N/A |
| <b>description</b> | refrigeration gasket profile 9140 Wmm L 2500mm |                 |     |

profile 9106

We offer custom-made gaskets for this profile

|                    |   |                 |         |
|--------------------|---|-----------------|---------|
| <b>GEV No.</b>     | 900859  | <b>Ref. No.</b> | 37Q3250 |
| <b>description</b> | refrigeration gasket profile 9140 W 459mm L 613mm external size |                 |         |

|                    |  |                 |     |
|--------------------|--|-----------------|-----|
| <b>GEV No.</b>     | 902262   | <b>Ref. No.</b> | N/A |
| <b>description</b> | refrigeration gasket profile 9106 Wmm L 2500mm |                 |     |

profile 9207

We offer custom-made gaskets for this profile

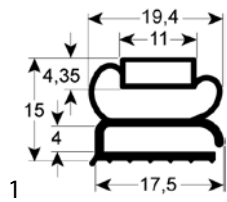

|                    |   |                 |         |
|--------------------|---|-----------------|---------|
| <b>GEV No.</b>     | 901004  | <b>Ref. No.</b> | 37Q0770 |
| <b>description</b> | refrigeration gasket profile 9207 W 660mm L 755mm external size |                 |         |

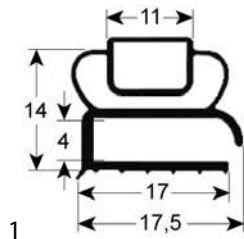

|                    |  |                 |     |
|--------------------|--|-----------------|-----|
| <b>GEV No.</b>     | 902277   | <b>Ref. No.</b> | N/A |
| <b>description</b> | refrigeration gasket profile 9207 Wmm L 2500mm |                 |     |

gaskets for heated units

window seals

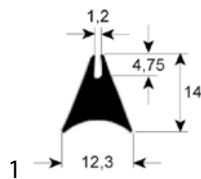

|                    |  |                 |         |
|--------------------|--|-----------------|---------|
| <b>GEV No.</b>     | 900058   | <b>Ref. No.</b> | 37Q2470 |
| <b>description</b> | window gasket profile 1620 Qty supplied by meter |                 |         |

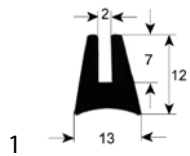

|                    |  |                 |                    |
|--------------------|--|-----------------|--------------------|
| <b>GEV No.</b>     | 900442   | <b>Ref. No.</b> | 37Q7400<br>37Q7401 |
| <b>description</b> | window gasket profile 1630 L 1075mm Qty 1        |                 |                    |
| <b>For models:</b> | FCV3EM, FCV4E, FCV4EDS, FCV4EM, FM423E1, FM423E2 |                 |                    |

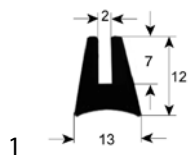

|                    |  |                 |                    |
|--------------------|--|-----------------|--------------------|
| <b>GEV No.</b>     | 900447   | <b>Ref. No.</b> | 37Q2981<br>37Q2982 |
| <b>description</b> | window gasket profile 1630 L 1350mm Qty 1  |                 |                    |
| <b>For models:</b> | 71AR, 71ARE, 71RA, 91AR, 91ARE, 91RA, FC61, FC61E, FCV61, FCV61-CSA, FCV61DM, FCV61DM-CSA, FCV61DS, FCV61DS-CSA, FCV61E, FCV61EDM, FCV61EDM-UL, FCV61EDS, FCV61EDS-UL, FCV61E-UL |                 |                    |

Зип Общепит

vsezip.ru

+7(812)987 08 81



|                    |  |                 |                    |
|--------------------|--|-----------------|--------------------|
| <b>GEV No.</b>     | 900443   | <b>Ref. No.</b> | 37Q2991<br>37Q2992 |
| <b>description</b> | window gasket profile 1630 L 1800mm Qty 1  |                 |                    |
| <b>For models:</b> | FC101, FC101E, FCV101, FCV101-CSA, FCV101DM, FCV101DM-CSA, FCV101DS, FCV101DS-CSA, FCV101E, FCV101EDM, FCV101EDM-UL, FCV101EDS, FCV101EDS-UL, FCV101E-UL |                 |                    |

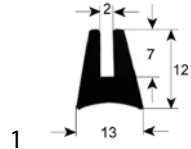

|                    |  |                 |                    |
|--------------------|--|-----------------|--------------------|
| <b>GEV No.</b>     | 900449   | <b>Ref. No.</b> | 37Q7530<br>37Q7531 |
| <b>description</b> | window gasket profile 1630 L 2050mm Qty 1  |                 |                    |
| <b>For models:</b> | FCV141, FCV141-CSA, FCV141DM, FCV141DM-CSA, FCV141DS, FCV141DS-CSA, FCV141E, FCV141EDM, FCV141EDS, FCV72EDM-UL, FCV72EDS-UL, FCV72E-UL |                 |                    |

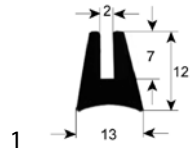

|                    |  |                 |                    |
|--------------------|--|-----------------|--------------------|
| <b>GEV No.</b>     | 900450   | <b>Ref. No.</b> | 37Q3000<br>37Q3001 |
| <b>description</b> | window gasket profile 1630 L 2700mm Qty 1  |                 |                    |
| <b>For models:</b> | FC241, FC241E, FC241G, FCV241, FCV241DM, FCV241DS, FCV241E, FCV241EDM, FCV241EDM-UL, FCV241EDS, FCV241EDS-UL, FCV241E-UL, FCV241G, FCV241G-CSA, FCV241GDM, FCV241GDM-CSA, FCV241GDS, FCV241GDS-CSA |                 |                    |

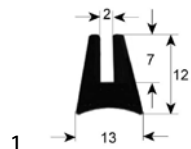

|                    |  |                 |     |
|--------------------|--|-----------------|-----|
| <b>GEV No.</b>     | 900730   | <b>Ref. No.</b> | N/A |
| <b>description</b> | window gasket profile 1630 Qty supplied by meter |                 |     |

door seals

Зип Общепит

vsezip.ru

+7(812)981-08-81

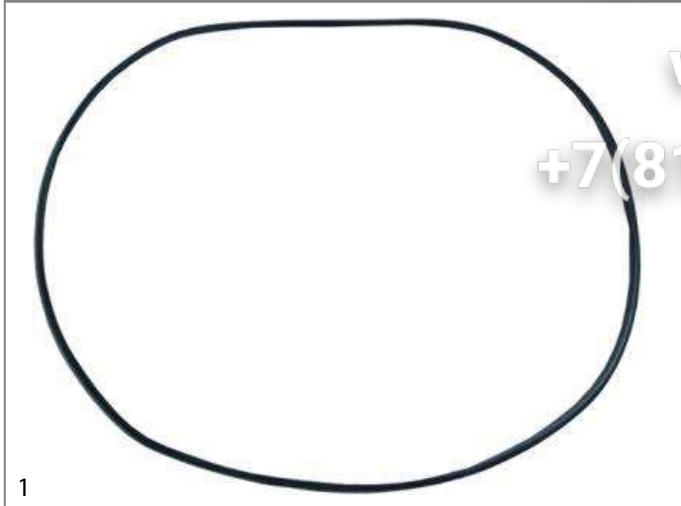

|                    |   |                 |         |
|--------------------|---|-----------------|---------|
| <b>GEV No.</b>     | 900725  | <b>Ref. No.</b> | 37Q7621 |
| <b>description</b> | door seal                                       |                 |         |
| <b>For models:</b> | FCV401DM, FCV401DM-CSA, FCV401EDM, FCV401EDM-UL |                 |         |



|                    |   |                 |         |
|--------------------|---|-----------------|---------|
| <b>GEV No.</b>     | 900720  | <b>Ref. No.</b> | 3031880 |
| <b>description</b> | door seal profile 1855 Qty supplied by meter  |                 |         |
| <b>For models:</b> | 1G1FA0E, 1G1FA0G, 1G1FABG, 1G1FAPG, 1G1PE1E, 1G1PE2E, 1G1TP0G, 2G1FAGF, 2G1FA0E, 2G1FA0G, 2G1FABG, 2G1FACG, 2G1FADG, 2G1FADGV, 2G1FAPG, 2G1PE1E, 2G1PE2E, 2G1TP3G |                 |         |

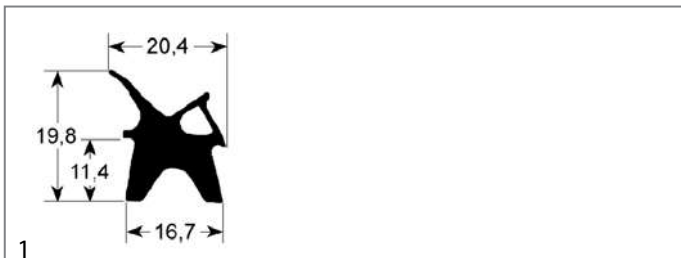

|                    |  |                 |         |
|--------------------|--|-----------------|---------|
| <b>GEV No.</b>     | 900059                                       | <b>Ref. No.</b> | 37Q2480 |
| <b>description</b> | door seal profile 2410 Qty supplied by meter |                 |         |

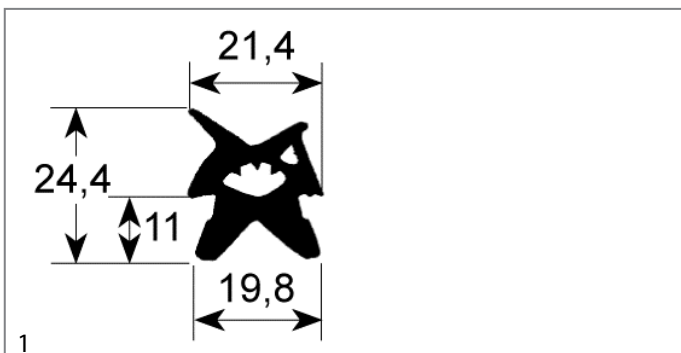

|                    |  |                 |                    |
|--------------------|--|-----------------|--------------------|
| <b>GEV No.</b>     | 900441   | <b>Ref. No.</b> | 37Q1001<br>37Q1002 |
| <b>description</b> | door seal profile 2420 W 330mm L 410mm external size Qty 1 |                 |                    |
| <b>For models:</b> | FCV3EM, FCV4E, FCV4EDS, FCV4EM                             |                 |                    |

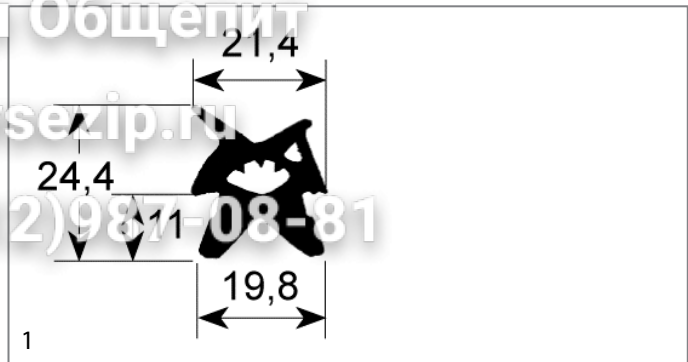

|                    |  |                 |                    |
|--------------------|--|-----------------|--------------------|
| <b>GEV No.</b>     | 900443   | <b>Ref. No.</b> | 37Q0951<br>37Q0952 |
| <b>description</b> | door seal profile 2420 W 450mm L 460mm outer plug size Qty 1 suitable for CONVOTHERM   |                 |                    |
| <b>For models:</b> | FC61, FC61E, FCV61, FCV61-CSA, FCV61DM, FCV61DM-CSA, FCV61DS, FCV61DS-CSA, FCV61E, FCV61EDM, FCV61EDM-UL, FCV61EDS, FCV61EDS-UL, FCV61E-UL |                 |                    |

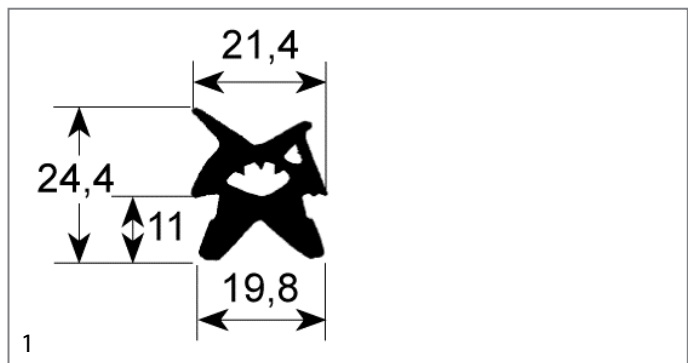

|                    |  |                 |         |
|--------------------|--|-----------------|---------|
| <b>GEV No.</b>     | 900713   | <b>Ref. No.</b> | 37Q2952 |
| <b>description</b> | door seal profile 2420 W 450mm L 700mm external size Qty 1 |                 |         |

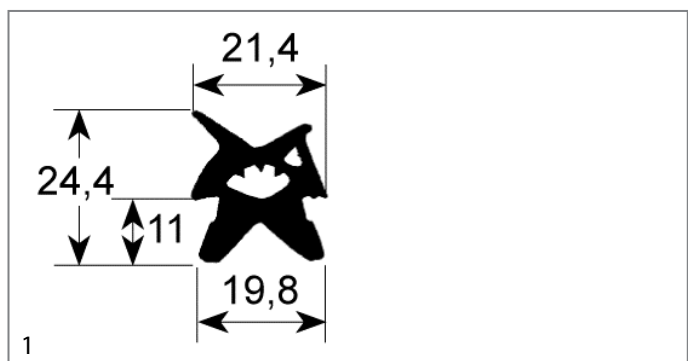

|                    |  |                 |                               |
|--------------------|--|-----------------|-------------------------------|
| <b>GEV No.</b>     | 900444   | <b>Ref. No.</b> | 37Q0970<br>37Q0971<br>37Q0972 |
| <b>description</b> | door seal profile 2420 W 450mm L 700mm outer plug size Qty 1 suitable for CONVOTHERM   |                 |                               |
| <b>For models:</b> | FC101, FC101E, FCV101, FCV101-CSA, FCV101DM, FCV101DM-CSA, FCV101DS, FCV101DS-CSA, FCV101E, FCV101EDM, FCV101EDM-UL, FCV101EDS, FCV101EDS-UL, FCV101E-UL |                 |                               |

Зип Общепит

vsezip.ru

+7(812)987-08-81

|                    |  |                 |                    |
|--------------------|--|-----------------|--------------------|
| <b>GEV No.</b>     | 900445   | <b>Ref. No.</b> | 37Q0981<br>37Q0982 |
| <b>description</b> | door seal profile 2420 W 565mm L 680mm external size Qty 1   |                 |                    |
| <b>For models:</b> | FCV141, FCV141-CSA, FCV141DM, FCV141DM-CSA, FCV141DS, FCV141DS-CSA, FCV141E, FCV141EDM, FCV141EDS, FCV141EDS-UL, FCV72EDM-UL, FCV72EDS-UL, FCV72E-UL |                 |                    |

|                    |  |                 |         |
|--------------------|--|-----------------|---------|
| <b>GEV No.</b>     | 901394   | <b>Ref. No.</b> | 37Q4980 |
| <b>description</b> | door seal profile 2438 W 330mm L 410mm external size |                 |         |
| <b>For models:</b> | FCV3EM, FCV4E, FCV4EDS, FCV4EM, FM423E1, FM423E2     |                 |         |

|                    |  |                 |                               |
|--------------------|--|-----------------|-------------------------------|
| <b>GEV No.</b>     | 900446   | <b>Ref. No.</b> | 37Q0990<br>37Q0991<br>37Q0992 |
| <b>description</b> | door seal profile 2420 W 670mm L 860mm external size Qty 1   |                 |                               |
| <b>For models:</b> | FC241, FC241E, FC241G, FCV241, FCV241DM, FCV241DS, FCV241E, FCV241EDM, FCV241EDM-UL, FCV241EDS, FCV241EDS-UL, FCV241E-UL, FCV241G, FCV241G-CSA, FCV241GDM, FCV241GDM-CSA, FCV241GDS, FCV241GDS-CSA |                 |                               |

|                    |  |                 |         |
|--------------------|--|-----------------|---------|
| <b>GEV No.</b>     | 900748   | <b>Ref. No.</b> | 3050160 |
| <b>description</b> | door seal profile 2780 W 475mm L 1360mm external size Qty 1                    |                 |         |
| <b>For models:</b> | FM2011E2-VERS.2006, FM2011E3-VERS.2006, FM2011G2-VERS.2006, FM2011G3-VERS.2006 |                 |         |

|                    |   |                 |         |
|--------------------|---|-----------------|---------|
| <b>GEV No.</b>     | 900721  | <b>Ref. No.</b> | 37Q7633 |
| <b>description</b> | door seal profile 2420 W 680mm L 1380mm external size Qty 1 |                 |         |
| <b>For models:</b> | FCV401DM, FCV401DM-CSA, FCV401EDM, FCV401EDM-UL             |                 |         |

|                    |  |                 |                    |
|--------------------|--|-----------------|--------------------|
| <b>GEV No.</b>     | 900716   | <b>Ref. No.</b> | 36E3030<br>36E3031 |
| <b>description</b> | door seal profile 2780 W 485mm L 485mm external size Qty 1   |                 |                    |
| <b>For models:</b> | FC611E, FC611G, FM611E1, FM611E1-VERS.2006, FM611E2, FM611E2-VERS.2006, FM611E3, FM611E3-VERS.2006, FM611G1, FM611G1-VERS.2006, FM611G2, FM611G2-VERS.2006, FM611G3, FM611G3-VERS.2006 |                 |                    |

|                    |  |                 |                    |
|--------------------|--|-----------------|--------------------|
| <b>GEV No.</b>     | 900715   | <b>Ref. No.</b> | 36E3020<br>36E3021 |
| <b>description</b> | door seal profile 2780 W 490mm L 700mm external size Qty 1   |                 |                    |
| <b>For models:</b> | FC1011E, FC1011G, FM1011E1, FM1011E1-VERS.2006, FM1011E2, FM1011E2-VERS.2006, FM1011E3, FM1011E3-VERS.2006, FM1011G1, FM1011G1-VERS.2006, FM1011G2, FM1011G2-VERS.2006, FM1011G3, FM1011G3-VERS.2006 |                 |                    |





Зип Общепит

vsezip.ru

+7(812)987-08-81

|                    |  |                 |         |
|--------------------|--|-----------------|---------|
| <b>GEV No.</b>     | 900749   | <b>Ref. No.</b> | 36E4061 |
| <b>description</b> | door seal profile 2780 W 630mm L 690mm external size Qty 1   |                 |         |
| <b>For models:</b> | FM721E1, FM721E1-VERS.2006, FM721E2, FM721E2-VERS.2006, FM721E3, FM721E3-VERS.2006, FM721G1, FM721G1-VERS.2006, FM721G2, FM721G2-VERS.2006, FM721G3, FM721G3-VERS.2006 |                 |         |

|                    |  |                 |                               |
|--------------------|--|-----------------|-------------------------------|
| <b>GEV No.</b>     | 901622   | <b>Ref. No.</b> | 3077260<br>3077261<br>3077262 |
| <b>description</b> | door seal profile 2781 W 475mm L 475mm external size suitable for ANGELO PO  |                 |                               |
| <b>For models:</b> | BX61E, BX61E-VERS.122013, BX61G, BX61G-VERS.122013, FX61E1, FX61E1R, FX61E2, FX61E2C, FX61E2CR, FX61E2CR-VERS.032014, FX61E2C-VERS.032014, FX61E2R, FX61E2R-VERS.032014, FX61E2-VERS.032014, FX61E3, FX61E3C, FX61E3CR, FX61E3CR-VERS.022014, FX61E3C-VERS.022014, FX61E3R, FX61E3R-VERS.022014, FX61E3-VERS.022014, FX61G1, FX61G1R, FX61G2, FX61G2C, FX61G2CR, FX61G2CR-VERS.032014, FX61G2C-VERS.032014, FX61G2R, FX61G2R-VERS.032014, FX61G2-VERS.032014, FX61G3, FX61G3C, FX61G3CR, FX61G3CR-VERS.022014, FX61G3C-VERS.022014, FX61G3R, FX61G3R-VERS.022014, FX61G3-VERS.022014 |                 |                               |

|                    |  |                 |         |
|--------------------|--|-----------------|---------|
| <b>GEV No.</b>     | 900746   | <b>Ref. No.</b> | 36E3921 |
| <b>description</b> | door seal profile 2780 W 690mm L 1360mm external size Qty 1  |                 |         |
| <b>For models:</b> | FM2021E1, FM2021E2, FM2021E2-VERS.2006, FM2021E3, FM2021E3-VERS.2006, FM2021G1, FM2021G2, FM2021G2-VERS.2006, FM2021G3, FM2021G3-VERS.2006 |                 |         |

|                    |  |                 |                               |
|--------------------|--|-----------------|-------------------------------|
| <b>GEV No.</b>     | 901623   | <b>Ref. No.</b> | 3077270<br>3077271<br>3077272 |
| <b>description</b> | door seal profile 2781 W 475mm L 725mm external size suitable for ANGELO PO  |                 |                               |
| <b>For models:</b> | BX101E, BX101E-VERS.122013, BX101G, BX101G-VERS.122013, FX101E1, FX101E1R, FX101E2, FX101E2C, FX101E2C-VERS.032014, FX101E2R, FX101E2R-VERS.032014, FX101E2-VERS.032014, FX101E3, FX101E3C, FX101E3C-VERS.022014, FX101E3R, FX101E3R-VERS.022014, FX101E3-VERS.022014, FX101G1, FX101G1R, FX101G2, FX101G2C, FX101G2C-VERS.032014, FX101G2R, FX101G2R-VERS.032014, FX101G2-VERS.032014, FX101G3, FX101G3C, FX101G3C-VERS.022014, FX101G3R, FX101G3R-VERS.022014, FX101G3-VERS.022014, FX10E2CR, FX10E2CR-VERS.032014, FX10E3CR, FX10E3CR-VERS.022014, FX10G2CR, FX10G2CR-VERS.032014, FX10G3CR, FX10G3CR-VERS.022014 |                 |                               |

|                    |  |                 |                    |
|--------------------|--|-----------------|--------------------|
| <b>GEV No.</b>     | 900747   | <b>Ref. No.</b> | 36E3520<br>36E3521 |
| <b>description</b> | door seal profile 2780 W 690mm L 860mm external size Qty 1   |                 |                    |
| <b>For models:</b> | FC1221E, FC1221G, FM1221E1, FM1221E1-VERS.2006, FM1221E2, FM1221E2-VERS.2006, FM1221E3, FM1221E3-VERS.2006, FM1221G1, FM1221G1-VERS.2006, FM1221G2, FM1221G2-VERS.2006, FM1221G3, FM1221G3-VERS.2006 |                 |                    |

|                    |   |                 |                               |
|--------------------|---|-----------------|-------------------------------|
| <b>GEV No.</b>     | 901624  | <b>Ref. No.</b> | 3077280<br>3077281<br>3077282 |
| <b>description</b> | door seal profile 2781 W 475mm L 1410mm external size suitable for ANGELO PO  |                 |                               |
| <b>For models:</b> | FX201E2, FX201E2P, FX201E2P-VERS.032014, FX201E2-VERS.032014, FX201E3, FX201E3P, FX201E3P-VERS.022014, FX201E3-VERS.022014, FX201G2, FX201G2P, FX201G2P-VERS.032014, FX201G2-VERS.032014, FX201G3P, FX201G3-VERS.022014 |                 |                               |

Зип-Общепит  
gaskets for tray rack trolleys  
vsezip.ru  
+7(812)987-08-81

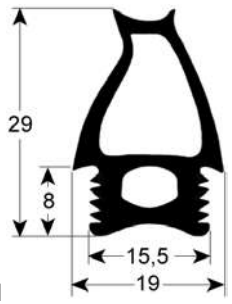

1

|                    |  |                 |                               |
|--------------------|--|-----------------|-------------------------------|
| <b>GEV No.</b>     | 901625   | <b>Ref. No.</b> | 3077290<br>3077291<br>3077292 |
| <b>description</b> | door seal profile 2781 W 628mm L 686mm external size suitable for ANGELO PO  |                 |                               |
| <b>For models:</b> | BX82E, BX82E-VERS.122013, BX82G, BX82G-VERS.122013, FX82E1, FX82E2, FX82E2C, FX82E2T, FX82E2T-VERS.032014, FX82E3, FX82E3C, FX82E3CT, FX82E3CT-VERS.022014, FX82E3T, FX82E3T-VERS.022014, FX82G1, FX82G2, FX82G2C, FX82G2T, FX82G2T-VERS.032014, FX82G3, FX82G3C, FX82G3CT, FX82G3CT-VERS.022014, FX82G3T, FX82G3T-VERS.022014 |                 |                               |

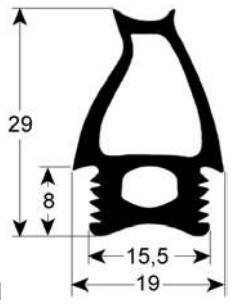

1

|                    |  |                 |                               |
|--------------------|--|-----------------|-------------------------------|
| <b>GEV No.</b>     | 901627   | <b>Ref. No.</b> | 3077310<br>3077311<br>3077312 |
| <b>description</b> | door seal profile 2781 W 688mm L 1410mm external size suitable for ANGELO PO   |                 |                               |
| <b>For models:</b> | FX202E2, FX202E2-VERS.032014, FX202E3, FX202E3-230V-3-50Hz-60Hz, FX202E3-230V-3-50Hz-60Hz-VERS.022014, FX202E3-VERS.022014, FX202G2, FX202G2-VERS.032014, FX202G3, FX202G3-VERS.022014 |                 |                               |

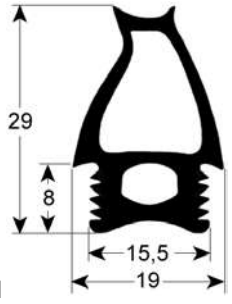

1

|                    |   |                 |                               |
|--------------------|---|-----------------|-------------------------------|
| <b>GEV No.</b>     | 901626  | <b>Ref. No.</b> | 3077300<br>3077301<br>3077302 |
| <b>description</b> | door seal profile 2781 W 688mm L 886mm external size suitable for ANGELO PO   |                 |                               |
| <b>For models:</b> | BX122E, BX122E-VERS.122013, BX122G, BX122G-VERS.122013, FX122E1, FX122E2, FX122E2C, FX122E2T, FX122E2T-VERS.032014, FX122E3, FX122E3C, FX122E3T, FX122E3T-VERS.022014, FX122G1, FX122G3, FX122G3C, FX122G3T, FX122G3T-VERS.022014, FX12E3CT, FX12E3CT-VERS.022014, FX12G3CT, FX12G3CT-VERS.022014 |                 |                               |

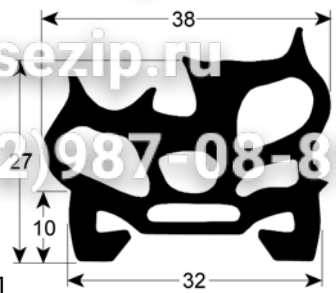

1

|                    |  |                 |         |
|--------------------|--|-----------------|---------|
| <b>GEV No.</b>     | 902513   | <b>Ref. No.</b> | 3040480 |
| <b>description</b> | tray rack trolley gasket profile 4110 L 510mm Qty 1                            |                 |         |
| <b>For models:</b> | FM2011E2-VERS.2006, FM2011E3-VERS.2006, FM2011G2-VERS.2006, FM2011G3-VERS.2006 |                 |         |

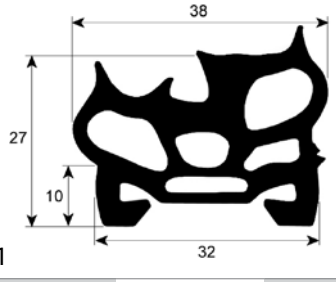

1

|                    |  |                 |         |
|--------------------|--|-----------------|---------|
| <b>GEV No.</b>     | 901396   | <b>Ref. No.</b> | 3039710 |
| <b>description</b> | tray rack trolley gasket profile 4110 L 712mm Qty 1                            |                 |         |
| <b>For models:</b> | FM2021E2-VERS.2006, FM2021E3-VERS.2006, FM2021G2-VERS.2006, FM2021G3-VERS.2006 |                 |         |

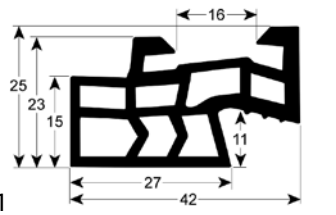

1

|                    |   |                 |                    |
|--------------------|---|-----------------|--------------------|
| <b>GEV No.</b>     | 902520  | <b>Ref. No.</b> | 3091160<br>3199570 |
| <b>description</b> | tray rack trolley gasket profile 4140 L 515mm Qty 1   |                 |                    |
| <b>For models:</b> | FX201E2, FX201E2P, FX201E2P-VERS.032014, FX201E2-VERS.032014, FX201E3, FX201E3P, FX201E3P-VERS.022014, FX201E3-VERS.022014, FX201G2, FX201G2P, FX201G2P-VERS.032014, FX201G2-VERS.032014, FX201G3P, FX201G3-VERS.022014 |                 |                    |



O-rings

EPDM

|                    |  |                 |                    |
|--------------------|--|-----------------|--------------------|
| <b>GEV No.</b>     | 540682   | <b>Ref. No.</b> | 3150840<br>37Q1210 |
| <b>description</b> | O-ring EPDM thickness 1.78mm ID ø 18.77mm Qty 1 pcs  |                 |                    |
| <b>For models:</b> | 030BME, 030EBM, 030FE, 031BME, 031EBM, 04WBMEV, 08WGREV, 090BM1E, 090BM1G, 091CP1E, 091CP1G, 091FR1EX, 091FR7GS, 091FR7GX, 0A1CP1E, 0A1CP1G, 0B1CP1G, 0D1CP1E, 0D1CP1G, 0G1CP1E, 0G1CP1E-VERS.2004, 0G1CP1G, 0G1CP1G-VERS.2004, 190BM2E, 190BM2G, 190GRE, 191CP1G, 191CP2G, 1A1CP1G, 1A1CP2G, 1D1CP1G, 1D1CP2G, 1G0GRE, 1G1CP1G, 1G1CP1G-VERS.2004, 1G1CP2G, 1G1CP2G-VERS.2004, 30CP5, 30CPSE, 6040090, 6040110, 6040310, 6042680, 6043850, 6043980, 70CP, 71CP2, 90CP |                 |                    |

|                    |   |                 |         |
|--------------------|---|-----------------|---------|
| <b>GEV No.</b>     | 510303  | <b>Ref. No.</b> | 3152180 |
| <b>description</b> | O-ring EPDM thickness 1.78mm ID ø 6.75mm Qty 1 pcs  |                 |         |
| <b>For models:</b> | LC100, LC100-VERS.2001, LC130, LC130-VERS.2001, LC80, LF50, LF50E, LF50EM, LF50EMPS, LP124, LP124S-VERS.052006, LP124V, LP124-VERS.052006, LP124VS-VERS.052006, LP124V-VERS.052006, LP84, LP84S-VERS.052006, LP84V, LP84-VERS.052006, LP84VS-VERS.052006, LP84V-VERS.052006 |                 |         |

|                    |  |                 |                    |
|--------------------|--|-----------------|--------------------|
| <b>GEV No.</b>     | 510177   | <b>Ref. No.</b> | 3035830<br>3152210 |
| <b>description</b> | O-ring EPDM thickness 1.78mm ID ø 7.66mm Qty 1 pcs |                 |                    |

|                    |  |                 |         |
|--------------------|--|-----------------|---------|
| <b>GEV No.</b>     | 519181                                       | <b>Ref. No.</b> | 3152400 |
| <b>description</b> | O-ring EPDM thickness 1mm ID ø 5mm Qty 1 pcs |                 |         |

|                    |   |                 |         |
|--------------------|---|-----------------|---------|
| <b>GEV No.</b>     | 102997  | <b>Ref. No.</b> | 3152550 |
| <b>description</b> | O-ring EPDM thickness 1mm ID ø 6mm Qty 1 pcs  |                 |         |
| <b>For models:</b> | 04WFAAV, 08WFA4E, 08WFA4G, 08WFAAE, 08WFAAG, 08WFAAV, 090FAA, 0A0FA1, 0A0FA4, 0A0FAA, 0D0FA1, 0D0FA4, 0D0FAA, 0G0FA0, 12WFA6E, 12WFA6G, 12WFAAA, 12WFAAE, 12WFAAG, 12WFAAN, 190FA, 190FAA, 190FAB, 190FAD, 191FAAE, 191FAAG, 191FABG, 191FADG, 191FAE, 191FAG, 1A0FA1, 1A0FA2, 1A0FA4, 1A0FA5, 1A0FAA, 1A0FAB, 1A1FA1G, 1A1FA2G, 1A1FA4G, 1A1FA5G, 1A1FAAG, 1A1FABG, 1D0FA1, 1D0FA2, 1D0FA4, 1D0FA5, 1D0FAA, 1D0FAB, 1D1FA1G, 1D1FA2G...(Other models you can see in the webshop) |                 |         |

|                    |   |                 |         |
|--------------------|---|-----------------|---------|
| <b>GEV No.</b>     | 528223  | <b>Ref. No.</b> | 3152100 |
| <b>description</b> | O-ring EPDM thickness 2.62mm ID ø 11.91mm Qty 1 pcs |                 |         |

|                    |   |                 |     |
|--------------------|---|-----------------|-----|
| <b>GEV No.</b>     | 518227  | <b>Ref. No.</b> | N/A |
| <b>description</b> | O-ring EPDM thickness 2.62mm ID ø 12.37mm Qty 1 pcs |                 |     |

|                    |  |                 |         |
|--------------------|--|-----------------|---------|
| <b>GEV No.</b>     | 528333   | <b>Ref. No.</b> | 3152410 |
| <b>description</b> | O-ring EPDM thickness 2.62mm ID ø 13.1mm Qty 1 pcs |                 |         |
| <b>For models:</b> | LC80   |                 |         |

|                    |   |                 |         |
|--------------------|---|-----------------|---------|
| <b>GEV No.</b>     | 516026  | <b>Ref. No.</b> | 3186287 |
| <b>description</b> | O-ring EPDM thickness 2.62mm ID ø 17.86mm Qty 1 pcs |                 |         |

Зип Общежит  
vsezip.ru  
7(812)987-08-81



|                    |  |                 |         |
|--------------------|--|-----------------|---------|
| <b>GEV No.</b>     | 504590   | <b>Ref. No.</b> | 3152170 |
| <b>description</b> | O-ring EPDM thickness 2.62mm ID ø 18.72mm Qty 1 pcs  |                 |         |
| <b>For models:</b> | C165D, C165S, C165VD, C165VS, C207D, C207D-VERS.2006, C207S, C207S-VERS.2006, C207VD, C207VD-VERS.2006, C207VS, C207VS-VERS.2006, C304AD, C304AD-VERS.2006, C304AS, C304AS-VERS.2006, C304AVD, C304AVD-VERS.2006, C304AVS, C304AVS-VERS.2006, C304D, C304D-VERS.2006, C304S, C304S-VERS.2006, C304VD, C304VD-VERS.2006, C304VS, C304VS-VERS.2006, C92D-VERS.2006, C92S-VERS.2006, C92VD-VERS.2006, C92VS-VERS.2006, CS243D, CS243D-VERS.2006, CS243S, CS243S-VERS.2006, CS243VD, CS243VD-VERS.2006, CS243VS, CS243VS-VERS.2006, CS370AD, CS370AD-VERS.2006, CS370AS, CS370AS-VERS.2006, CS370AVD, CS370AVD-VERS.2006, CS370AVS, CS370AVS-VERS.2006, CS370D, CS370D-VERS.2006...(Other models you can see in the webshop) |                 |         |



|                    |   |                 |         |
|--------------------|---|-----------------|---------|
| <b>GEV No.</b>     | 511518  | <b>Ref. No.</b> | 3150520 |
| <b>description</b> | O-ring EPDM thickness 3.53mm ID ø 23.4mm Qty 10 pcs |                 |         |
| <b>For models:</b> | F60P, F60PR, F80PR, L45                             |                 |         |

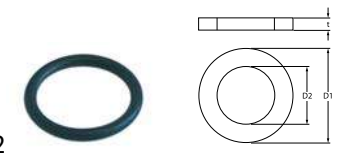

|                    |   |                 |         |
|--------------------|---|-----------------|---------|
| <b>GEV No.</b>     | 511512  | <b>Ref. No.</b> | 3150410 |
| <b>description</b> | O-ring EPDM thickness 2.62mm ID ø 18.72mm Qty 10 pcs  |                 |         |
| <b>For models:</b> | 090BME, 091BME, L100, L40, L40S, L60, L80, PGA20, PGA30, PGA40, PGA60, PGA80, PGW20, PGW30, PGW40, PGW60, PGW80 |                 |         |

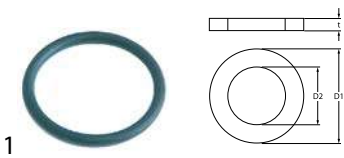

|                    |  |                 |         |
|--------------------|--|-----------------|---------|
| <b>GEV No.</b>     | 511524   | <b>Ref. No.</b> | 3150260 |
| <b>description</b> | O-ring EPDM thickness 3.53mm ID ø 32.93mm Qty 10 pcs |                 |         |
| <b>For models:</b> | L100, L40, L40S, L60, L80                            |                 |         |

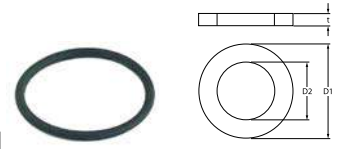

|                    |  |                 |         |
|--------------------|--|-----------------|---------|
| <b>GEV No.</b>     | 504561   | <b>Ref. No.</b> | 3151080 |
| <b>description</b> | O-ring EPDM thickness 2.62mm ID ø 29.82mm Qty 1 pcs  |                 |         |
| <b>For models:</b> | 091FR1E, 091FR1EA, 091FR1ED, 091FR1G, 091FR1GD, 091FR1I, 091FR1IA, 091FR1ID, 091FR1ID-VERS.052012, 091FR1I-VERS.032012, 091FR7G, 091FR7G-VERS.052012, 0A1FR1E, 0A1FR1ED, 0A1FR1G, 0A1FR1GD, 0A1FR1GD-VERS.2004, 0A1FR1G-VERS.2004, 0B1FR1G, 0B1FR1GD, 0D1FR1E, 0D1FR1ED, 0D1FR1G, 0D1FR1GD, 0D1FR1GD-VERS.2004, 0D1FR1G-VERS.2004, 191FR2E, 191FR2ED, 191FR2G, 191FR2GD, 191FR2I, 191FR2ID, 191FR2ID-VERS.092012, 191FR2I-VERS.032012, 1A1FR2E, 1A1FR2ED, 1A1FR2G, 1A1FR2GD, 1A1FR2GD-VERS.2004, 1A1FR2G-VERS.2004, 1D1FR2ED, 1D1FR2G, 1D1FR2GD, 1D1FR2GD-VERS.2004, 1D1FR2G-VERS.2004, 70F1, 70F1B, 70FE1, 70FE1B, 71F2...(Other models you can see in the webshop) |                 |         |

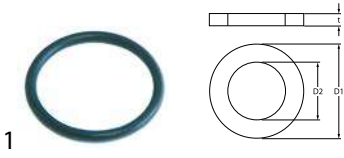

|                    |   |                 |         |
|--------------------|---|-----------------|---------|
| <b>GEV No.</b>     | 511526  | <b>Ref. No.</b> | 3150010 |
| <b>description</b> | O-ring EPDM thickness 3.53mm ID ø 36.1mm Qty 10 pcs |                 |         |
| <b>For models:</b> | F60P, F60PR, F60T, F80P, F80PR, L40, L40S, L45, L60 |                 |         |

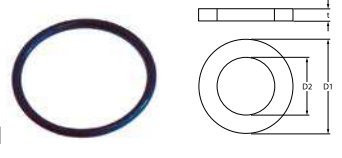

|                    |  |                 |         |
|--------------------|--|-----------------|---------|
| <b>GEV No.</b>     | 532064   | <b>Ref. No.</b> | 3150140 |
| <b>description</b> | O-ring EPDM thickness 2.62mm ID ø 32.99mm Qty 10 pcs |                 |         |
| <b>For models:</b> | L100, L40, L40S, L60, L80                            |                 |         |

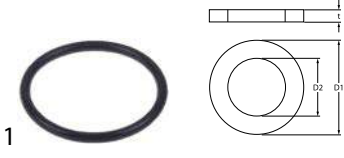

|                    |  |                 |         |
|--------------------|--|-----------------|---------|
| <b>GEV No.</b>     | 519179   | <b>Ref. No.</b> | 3151930 |
| <b>description</b> | O-ring EPDM thickness 3.53mm ID ø 41.28mm Qty 1 pcs  |                 |         |
| <b>For models:</b> | C165D, C165S, C165VD, C165VS, C207D, C207D-VERS.2006, C207S, C207S-VERS.2006, C207VD, C207VD-VERS.2006, C207VS, C207VS-VERS.2006, C304AD, C304AD-VERS.2006, C304AS, C304AS-VERS.2006, C304AVD, C304AVD-VERS.2006, C304AVS, C304AVS-VERS.2006, C304D, C304D-VERS.2006, C304S, C304S-VERS.2006, C304VD, C304VD-VERS.2006, C304VS, C304VS-VERS.2006, C92D-VERS.2006, C92S-VERS.2006, C92VD-VERS.2006, C92VS-VERS.2006, CS243D, CS243D-VERS.2006, CS243S, CS243S-VERS.2006, CS243VD, CS243VD-VERS.2006, CS243VS, CS243VS-VERS.2006, CS370AD, CS370AD-VERS.2006, CS370AS, CS370AS-VERS.2006, CS370AVD, CS370AVD-VERS.2006, CS370AVS, CS370AVS-VERS.2006, CS370D, CS370D-VERS.2006...(Other models you can see in the webshop) |                 |         |

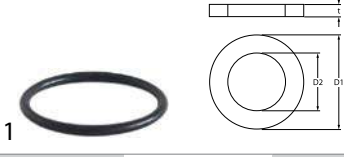

|                    |  |                 |         |
|--------------------|--|-----------------|---------|
| <b>GEV No.</b>     | 532109   | <b>Ref. No.</b> | 3150360 |
| <b>description</b> | O-ring EPDM thickness 3.53mm ID ø 42.86mm Qty 10 pcs |                 |         |



Зип Общепит

vsezip.ru

7(812)987-08-81

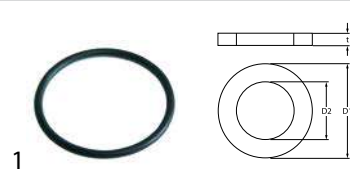

|                    |   |                 |         |
|--------------------|---|-----------------|---------|
| <b>GEV No.</b>     | 532114  | <b>Ref. No.</b> | 3150240 |
| <b>description</b> | O-ring EPDM thickness 3.53mm ID ø 50.8mm Qty 10 pcs |                 |         |
| <b>For models:</b> | L100, L40, L40S, L60, L80                           |                 |         |

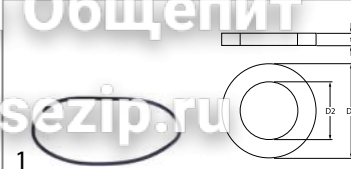

|                    |  |                 |         |
|--------------------|--|-----------------|---------|
| <b>GEV No.</b>     | 510551   | <b>Ref. No.</b> | 3FL1123 |
| <b>description</b> | pump cover gasket ID ø 158.3mm pump type 1214/1293/1225/2243/1226/1204/3473/1241 thickness 3.53mm EPDM Qty 1 pcs |                 |         |

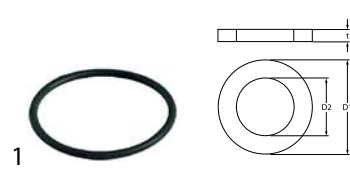

|                    |   |                 |         |
|--------------------|---|-----------------|---------|
| <b>GEV No.</b>     | 511331  | <b>Ref. No.</b> | 3152390 |
| <b>description</b> | O-ring EPDM thickness 3.53mm ID ø 53.57mm Qty 1 pcs |                 |         |

silicone



|                    |   |                 |         |
|--------------------|---|-----------------|---------|
| <b>GEV No.</b>     | 532521  | <b>Ref. No.</b> | 3152370 |
| <b>description</b> | O-ring silicone thickness 1.78mm ID ø 34.65mm Qty 1 pcs   |                 |         |
| <b>For models:</b> | 04WFAAV, 08WFA4E, 08WFA4G, 08WFAAE, 08WFAAG, 08WFAAV, 090FAA, 0A0FA1, 0A0FA4, 0A0FAA, 0D0FA1, 0D0FA4, 0D0FAA, 0G0FA0, 12WFA6E, 12WFA6G, 12WFAAA, 12WFAAE, 12WFAAG, 12WFAAN, 190FA, 190FAA, 190FAB, 190FAD, 191FAAE, 191FAAG, 191FABG, 191FADG, 191FAE, 191FAG, 1A0FA1, 1A0FA2, 1A0FA4, 1A0FA5, 1A0FAA, 1A0FAB, 1A1FA1G, 1A1FA2G, 1A1FA4G, 1A1FA5G, 1A1FAAG, 1A1FABG, 1D0FA1, 1D0FA2, 1D0FA4, 1D0FA5, 1D0FAA, 1D0FAB, 1D1FA1G, 1D1FA2G...(Other models you can see in the webshop) |                 |         |

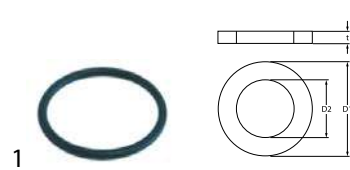

|                    |  |                 |                    |
|--------------------|--|-----------------|--------------------|
| <b>GEV No.</b>     | 521120   | <b>Ref. No.</b> | 3035850<br>3152160 |
| <b>description</b> | O-ring EPDM thickness 5.34mm ID ø 37.47mm Qty 1 pcs  |                 |                    |
| <b>For models:</b> | C165D, C165S, C165VD, C165VS, C207D, C207D-VERS.2006, C207S, C207S-VERS.2006, C207VD, C207VS, C304AD, C304AD-VERS.2006, C304AS, C304AS-VERS.2006, C304AVD, C304AVS, C304D, C304D-VERS.2006, C304S, C304S-VERS.2006, C304VD, C304VS, C92D-VERS.2006, C92S-VERS.2006, CS243D, CS243D-VERS.2006, CS243S, CS243S-VERS.2006, CS243VD, CS243VS, CS370AD, CS370AD-VERS.2006, CS370AS, CS370AS-VERS.2006, CS370AVD, CS370AVS, CS370D, CS370D-VERS.2006, CS370S, CS370S-VERS.2006, CS370VD, CS370VS, CS466AD, CS466AD-VERS.2006, CS466AS, CS466AS-VERS.2006, CS466AVD, CS466AVS, CS466D, CS466D-VERS.2006...(Other models you can see in the webshop) |                 |                    |

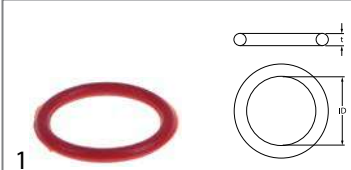

|                    |   |                 |         |
|--------------------|---|-----------------|---------|
| <b>GEV No.</b>     | 532541  | <b>Ref. No.</b> | 3152040 |
| <b>description</b> | O-ring silicone thickness 1.78mm ID ø 47.35mm Qty 1 pcs   |                 |         |
| <b>For models:</b> | 04WFAAV, 08WFA4E, 08WFA4G, 08WFAAE, 08WFAAG, 08WFAAV, 090FAA, 0A0FA1, 0A0FA4, 0A0FAA, 0D0FA1, 0D0FA4, 0D0FAA, 0G0FA0, 12WFA6E, 12WFA6G, 12WFAAA, 12WFAAE, 12WFAAG, 12WFAAN, 190FA, 190FAA, 190FAB, 190FAD, 191FAAE, 191FAAG, 191FABG, 191FADG, 191FAE, 191FAG, 1A0FA1, 1A0FA2, 1A0FA4, 1A0FA5, 1A0FAA, 1A0FAB, 1A1FA1G, 1A1FA2G, 1A1FA4G, 1A1FA5G, 1A1FAAG, 1A1FABG, 1D0FA1, 1D0FA2, 1D0FA4, 1D0FA5, 1D0FAA, 1D0FAB, 1D1FA1G, 1D1FA2G...(Other models you can see in the webshop) |                 |         |



|                    |  |                 |         |
|--------------------|--|-----------------|---------|
| <b>GEV No.</b>     | 510408   | <b>Ref. No.</b> | 3152650 |
| <b>description</b> | O-ring EPDM thickness 5.34mm ID ø 47mm Qty 1 pcs |                 |         |

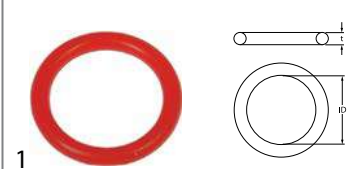

|                    |  |                 |         |
|--------------------|--|-----------------|---------|
| <b>GEV No.</b>     | 532520   | <b>Ref. No.</b> | 3150390 |
| <b>description</b> | O-ring silicone thickness 2.62mm ID ø 15.08mm Qty 1 pcs  |                 |         |
| <b>For models:</b> | 030BME, 030FE, 031BME, 070BM, 070BME, 071BM, 071BME, 090BM, 090BME, 091BM, 091BME, 1A1PI1G, 1A1PI1GA, 1D1PI1G, 1D1PI1GA, 1G1PI1G, 30F, 30FES, 30FS, 31PI6, 70F, 70FE, 70FES, 71F, 71FE, 71PI10, 71PI10A, 91PI10, 91PI10A |                 |         |

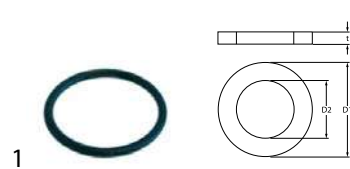

|                    |   |                 |                               |
|--------------------|---|-----------------|-------------------------------|
| <b>GEV No.</b>     | 510409  | <b>Ref. No.</b> | 3150430<br>3151960<br>37Q5260 |
| <b>description</b> | O-ring EPDM thickness 5.34mm ID ø 56.52mm Qty 1 pcs   |                 |                               |
| <b>For models:</b> | 091CP1E, 0A1CP1E, 0G1CP1E, 0G1CP1EC, 0G1CP1E-VERS.2004, 191PI2E, 191PI2EA, 1A1PI2E, 1A1PI2EA, 1D1PI2E, 1D1PI2EA, 1G1PI1E, 30CPSE, 31PIE6, 6040090, 6040310, 6043850, 6043980, 70CPE, 71PIE15, 71PIE15A, 90CPE, 91PIE15, 91PIE15A, F60P, F60PR, F60T, F80P, F80PR, KD100, KD100A, KD100PSD, KD130, KD130A, KD130E, KD130EAT, KD60, KD60E, KD60EAT, KD60M, KD60MA, KD60ME, KD60MPS, KD60MPSA, KD60PS, KD60PSD, KD6EATSD, KD85, KD85A, KD85E...(Other models you can see in the webshop) |                 |                               |

Зип-Общепит

HNBR

vsezip.ru

+7(812)987-08-81

|  |  |                 |         |
|--|--|-----------------|---------|
|  |  |                 |         |
| <b>GEV No.</b>   | 532519   | <b>Ref. No.</b> | 3152331 |
| <b>description</b>   | O-ring silicone thickness 5.34mm ID $\varnothing$ 53.34mm Qty 1 pcs  |                 |         |
| <b>For models:</b>   | 191CP1GA, 191PD1G, 191PD2G, 191PI1G, 191PI1GA, 191PI2E, 191PI2EA, 191PI2G, 191PI2GA, 191PI2V, 191PI2VA, 1A1CP1GA, 1A1PD1G, 1A1PD2G, 1A1PI1G, 1A1PI1GA, 1A1PI2E, 1A1PI2EA, 1A1PI2G, 1A1PI2GA, 1A1PI2V, 1A1PI2VA, 1D1CP1GA, 1D1PD1G, 1D1PD2G, 1D1PI1G, 1D1PI1GA, 1D1PI2E, 1D1PI2EA, 1D1PI2G, 1D1PI2GA, 1D1PI2V, 1D1PI2VA, 1G1PD1G, 1G1PI1E, 1G1PI1G, 291PD3G, 291PI3E, 291PI3G, 2A1PD3G, 2A1PI3E, 2A1PI3G, 2D1PI3G, PV200, PV200A, PV300, PV300A |                 |         |

|  |   |                 |         |
|--|---|-----------------|---------|
|  |   |                 |         |
| <b>GEV No.</b>   | 526272  | <b>Ref. No.</b> | 3152151 |
| <b>description</b>   | O-ring HNBR thickness 3.53mm ID $\varnothing$ 47.22mm Qty 1 pcs |                 |         |

## sealing washers

## fibre gaskets

|  |   |                 |         |
|--|---|-----------------|---------|
|  |   |                 |         |
| <b>GEV No.</b>   | 532487  | <b>Ref. No.</b> | 3150690 |
| <b>description</b>   | O-ring Viton thickness 2.62mm ID $\varnothing$ 25.07mm Qty 1 pcs  |                 |         |
| <b>For models:</b>   | 04WFR3ED, 06WFR3GD, 08WFR4ED, 091FE28, 091FE28B, 091FR3E, 091FR3ED, 091FR3G, 091FR3GD, 0A1FR3E, 0A1FR3ED, 0A1FR3G, 0A1FR3GD, 0D1FR3E, 0D1FR3ED, 0D1FR3G, 0D1FR3GD, 0G1FR3G, 0G1FR3GD, 0G1FR7G, 10WFR4GD, 191FR4E, 191FR4ED, 191FR4G, 191FR4GD, 1A1FR4E, 1A1FR4ED, 1A1FR4G, 1A1FR4GD, 1D1FR4E, 1D1FR4ED, 1D1FR4G, 1D1FR4GD, 1G1FR4G, 1G1FR4GD, 1G1FR8G, 30F1, 30F1B, 30FES2, 30FES2B, 30FS2, 30FS2B, 70FES2, 70FES2B, 90F110B, 91F210, 91F210B, FC1011G, FC1221G, FC611G...(Other models you can see in the webshop) |                 |         |

|  |  |                 |         |
|--|--|-----------------|---------|
|  |  |                 |         |
| <b>GEV No.</b>   | 517173   | <b>Ref. No.</b> | 37Q5130 |
| <b>description</b>   | flat gasket FIBER ED $\varnothing$ 14mm ID $\varnothing$ 8mm thickness 1.5mm Qty 1 pcs |                 |         |

|  |   |                 |         |
|--|---|-----------------|---------|
|  |   |                 |         |
| <b>GEV No.</b>   | 506071  | <b>Ref. No.</b> | 37Q2340 |
| <b>description</b>   | flat gasket FIBER ED $\varnothing$ 25mm ID $\varnothing$ 18mm thickness 2mm Qty 1 pcs |                 |         |

|  |  |                 |         |
|--|--|-----------------|---------|
|  |  |                 |         |
| <b>GEV No.</b>   | 510123   | <b>Ref. No.</b> | 37Q4070 |
| <b>description</b>   | flat gasket FIBER ED $\varnothing$ 60mm ID $\varnothing$ 46mm thickness 2mm Qty 1 pcs  |                 |         |
| <b>For models:</b>   | 191PD1G, 191PD2G, 191PI1G, 191PI1GA, 191PI2E, 191PI2EA, 191PI2G, 191PI2GA, 191PI2V, 191PI2VA, 1A1PI2G, 1A1PI2GA, 1D1PI2G, 1D1PI2GA, MCF20, MCF40, PV200, PV200A, PV300, PV300A |                 |         |

|  |   |                 |                    |
|--|---|-----------------|--------------------|
|  |   |                 |                    |
| <b>GEV No.</b>   | 550494  | <b>Ref. No.</b> | 3152150<br>3152151 |
| <b>description</b>   | O-ring Viton thickness 3.53mm ID $\varnothing$ 47.22mm Qty 1 pcs  |                 |                    |
| <b>For models:</b>   | 0A1FR1E, 0A1FR1ED, 0D1FR1E, 0D1FR1ED, 1A1FR2E, 1A1FR2ED, 1D1FR2ED |                 |                    |

|  |   |                 |     |
|--|---|-----------------|-----|
|  |   |                 |     |
| <b>GEV No.</b>   | 510405  | <b>Ref. No.</b> | N/A |
| <b>description</b>   | flat gasket fibre ED $\varnothing$ 56mm ID $\varnothing$ 42mm thickness 2mm for thread 1/4" Qty 1 pcs |                 |     |

|  |   |                 |         |
|--|---|-----------------|---------|
|  |   |                 |         |
| <b>GEV No.</b>   | 532609  | <b>Ref. No.</b> | 3151750 |
| <b>description</b>   | O-ring NBR thickness 7mm ID $\varnothing$ 387mm Qty 1 pcs |                 |         |
| <b>For models:</b>   | LCV, P10, P102, P10M, P20, P202, P5                       |                 |         |



Зип Общепит

vsezip.ru

+7(812)98...

|   |  |                 |         |
|---|--|-----------------|---------|
| rubber gaskets  |  |                 |         |
|  |  |                 |         |
| 1   |  |                 |         |
| <b>GEV No.</b>  | 505405   | <b>Ref. No.</b> | 3045960 |
| <b>description</b>  | flat gasket NBR ED ø 58mm ID ø 40mm thickness 3mm drain  |                 |         |
| <b>For models:</b>  | BX101E, BX101E-VERS.122013, BX101G, BX101G-VERS.122013, BX122E, BX122E-VERS.122013, BX122G, BX122G-VERS.122013, BX61E, BX61E-VERS.122013, BX61G, BX61G-VERS.122013, BX82E, BX82E-VERS.122013, BX82G, BX82G-VERS.122013, FC1011E, FC1011G, FC1221E, FC1221G, FC611E, FC611G, FM1011E1, FM1011E1-VERS.2006, FM1011E2, FM1011E2-VERS.2006, FM1011E3, FM1011E3-VERS.2006, FM1011G1, FM1011G1-VERS.2006, FM1011G2, FM1011G2-VERS.2006, FM1011G3, FM1011G3-VERS.2006, FM1221E1, FM1221E1-VERS.2006, FM1221E2, FM1221E2-VERS.2006, FM1221E3, FM1221E3-VERS.2006, FM1221G1, FM1221G1-VERS.2006, FM1221G2, FM1221G2-VERS.2006, FM1221G3, FM1221G3-VERS.2006, FM2011E2-VERS.2006, FM2011E3-VERS.2006, FM2011G2-VERS.2006, FM2011G3-VERS.2006...(Other models you can see in the webshop) |                 |         |

|   |  |                 |         |
|---|--|-----------------|---------|
|  |  |                 |         |
| 1   |  |                 |         |
| <b>GEV No.</b>  | 519141   | <b>Ref. No.</b> | 3151980 |
| <b>description</b>  | flat gasket rubber ED ø 40mm ID ø 5.5mm thickness 2mm Qty 1 pcs  |                 |         |
| <b>For models:</b>  | C165D, C165S, C165VD, C165VS, C207D, C207D-VERS.2006, C207S, C207S-VERS.2006, C207VD, C207VD-VERS.2006, C207VS, C207VS-VERS.2006, C304AD, C304AD-VERS.2006, C304AS, C304AS-VERS.2006, C304AVD, C304AVD-VERS.2006, C304AVS, C304AVS-VERS.2006, C304D, C304D-VERS.2006, C304S, C304S-VERS.2006, C304VD, C304VD-VERS.2006, C304VS, C304VS-VERS.2006, C92D-VERS.2006, C92S-VERS.2006, C92VD-VERS.2006, C92VS-VERS.2006, CS243D, CS243D-VERS.2006, CS243S, CS243S-VERS.2006, CS243VD, CS243VD-VERS.2006, CS243VS, CS243VS-VERS.2006, CS370AD, CS370AD-VERS.2006, CS370AS, CS370AS-VERS.2006, CS370AVD, CS370AVD-VERS.2006, CS370AVS, CS370AVS-VERS.2006, CS370D, CS370D-VERS.2006...(Other models you can see in the webshop) |                 |         |

|   |   |                 |         |
|---|---|-----------------|---------|
|  |   |                 |         |
| 2   |   |                 |         |
| <b>GEV No.</b>  | 520054 <sup>1</sup>   | <b>Ref. No.</b> | 3152480 |
| <b>description</b>  | flat gasket rubber ED ø 23.5mm ID ø 14mm thickness 2.3mm Qty 10 pcs |                 |         |

|   |  |                 |         |
|---|--|-----------------|---------|
|  |  |                 |         |
| 1   |  |                 |         |
| <b>GEV No.</b>  | 517181   | <b>Ref. No.</b> | 3030160 |
| <b>description</b>  | flat gasket rubber ED ø 44mm ID ø 32mm thickness 3mm Qty 1 pcs   |                 |         |
| <b>For models:</b>  | KD37, KD40, LP202, LP202HC, LP302, LP302HC, LP402, LP402HC, LP402V, N100D, N100S, N100VD, N100VS, N38D, N38S, N38VD, N38VS, N42D, N42S, N42VD, N42VS, N50D, N50S, N50VD, N50VS, N66D, N66S, N66VD, N66VS, N70D, N70S, N70VD, N70VS, N85D, N85S, N85VD, N85VS |                 |         |

<sup>1</sup>Qty 10 pieces

|   |  |                 |         |
|---|--|-----------------|---------|
|  |  |                 |         |
| 1   |  |                 |         |
| <b>GEV No.</b>  | 519114   | <b>Ref. No.</b> | 3151890 |
| <b>description</b>  | flat gasket rubber ED ø 25mm ID ø 16.5mm thickness 2mm Qty 1 pcs   |                 |         |
| <b>For models:</b>  | C165D, C165S, C165VD, C165VS, C207D, C207D-VERS.2006, C207S, C207S-VERS.2006, C207VD, C207VD-VERS.2006, C207VS, C207VS-VERS.2006, C304AD, C304AD-VERS.2006, C304AS, C304AS-VERS.2006, C304AVD, C304AVD-VERS.2006, C304AVS, C304AVS-VERS.2006, C304D, C304D-VERS.2006, C304S, C304S-VERS.2006, C304VD, C304VD-VERS.2006, C304VS, C304VS-VERS.2006, C92D-VERS.2006, C92S-VERS.2006, C92VD-VERS.2006, C92VS-VERS.2006, CS243D, CS243D-VERS.2006, CS243S, CS243S-VERS.2006, CS243VD, CS243VD-VERS.2006, CS243VS, CS243VS-VERS.2006, CS370AD, CS370AD-VERS.2006, CS370AS, CS370AS-VERS.2006, CS370AVD, CS370AVD-VERS.2006, CS370AVS, CS370AVS-VERS.2006, CS370D, CS370D-VERS.2006...(Other models you can see in the webshop) |                 |         |

|  |  |                 |         |
|--|--|-----------------|---------|
|  |  |                 |         |
| 1  |  |                 |         |
| <b>GEV No.</b>   | 511435   | <b>Ref. No.</b> | 37Q3420 |
| <b>description</b>   | flat gasket rubber ED ø 47mm ID ø 39mm thickness 2mm Qty 1 pcs |                 |         |

|   |  |                 |         |
|---|--|-----------------|---------|
|  |  |                 |         |
| 1   |  |                 |         |
| <b>GEV No.</b>  | 519117   | <b>Ref. No.</b> | 37Q4220 |
| <b>description</b>  | flat gasket rubber ED ø 60mm ID ø 47mm thickness 3mm Qty 1 pcs |                 |         |

|   |  |                 |         |
|---|--|-----------------|---------|
|  |  |                 |         |
| 1   |  |                 |         |
| <b>GEV No.</b>  | 507360   | <b>Ref. No.</b> | 3150060 |
| <b>description</b>  | flat gasket rubber ED ø 30mm ID ø 21mm thickness 2mm Qty 1 pcs |                 |         |
| <b>For models:</b>  | L100, L80  |                 |         |

|   |   |                 |         |
|---|---|-----------------|---------|
|  |   |                 |         |
| 1   |   |                 |         |
| <b>GEV No.</b>  | 519118  | <b>Ref. No.</b> | 37Q4190 |
| <b>description</b>  | flat gasket rubber ED ø 70mm ID ø 52mm thickness 3mm Qty 1 pcs  |                 |         |
| <b>For models:</b>  | LF50, LF50E, LF50EM, LF50EMPS, LF50EMPS-VERS.122012, LF50EM-VERS.122012, LF50E-VERS.122012, LF50E-VERS.2007, LP70 |                 |         |

|   |  |                 |         |
|---|--|-----------------|---------|
|  |  |                 |         |
| 1   |  |                 |         |
| <b>GEV No.</b>  | 511318   | <b>Ref. No.</b> | 37Q1580 |
| <b>description</b>  | flat gasket rubber ED ø 75mm ID ø 59mm thickness 2mm Qty 1 pcs |                 |         |
| <b>For models:</b>  | KSV25P, KSV325P  |                 |         |



|                    |  |                 |         |
|--------------------|--|-----------------|---------|
| <b>GEV No.</b>     | 510680   | <b>Ref. No.</b> | 37Q4210 |
| <b>description</b> | flat gasket rubber ED ø 82mm ID ø 62mm thickness 2mm Qty 1 pcs |                 |         |
| <b>For models:</b> | LC100, LC100-VERS.2001, LC130, LC130-VERS.2001                 |                 |         |



|                    |  |                 |         |
|--------------------|--|-----------------|---------|
| <b>GEV No.</b>     | 519383   | <b>Ref. No.</b> | 3150290 |
| <b>description</b> | gasket rubber ED ø 110mm ID ø 83mm thickness 3mm Qty 1 pcs |                 |         |
| <b>For models:</b> | F60P, F60PR, F60T, F80P, F80PR, L45                        |                 |         |

### plastic gaskets



|                    |   |                 |         |
|--------------------|---|-----------------|---------|
| <b>GEV No.</b>     | 504435  | <b>Ref. No.</b> | 3152010 |
| <b>description</b> | flat gasket plastic ED ø 18mm ID ø 9.5mm thickness 2.5mm for door hinge Qty 1 pcs |                 |         |

### copper gaskets

#### DIN-7603-A



|                    |   |                 |         |
|--------------------|---|-----------------|---------|
| <b>GEV No.</b>     | 506411  | <b>Ref. No.</b> | 3151730 |
| <b>description</b> | flat gasket copper ED ø 32.9mm ID ø 27mm thickness 1.5mm  |                 |         |
| <b>For models:</b> | FC101, FC101E, FC241E, FC241G, FC61, FC61E, FCV101, FCV101-CSA, FCV101DM, FCV101DM-CSA, FCV101DS, FCV101DS-CSA, FCV101E, FCV101EDM, FCV101EDM-UL, FCV101EDS, FCV101EDS-UL, FCV101E-UL, FCV141, FCV141-CSA, FCV141DM, FCV141DM-CSA, FCV141DS, FCV141DS-CSA, FCV141E, FCV141EDM, FCV141EDS, FCV241E, FCV241EDM, FCV241EDM-UL, FCV241EDS, FCV241EDS-UL, FCV241E-UL, FCV241G, FCV241G-CSA, FCV241GDM, FCV241GDM-CSA, FCV241GDS, FCV241GDS-CSA, FCV3EM, FCV401DM, FCV401DM-CSA, FCV401EDM, FCV401EDM-UL, FCV4E, FCV4EDS, FCV4EM, FCV61, FCV61-CSA, FCV61DM...(Other models you can see in the webshop) |                 |         |

### silicone gaskets



|                    |  |                 |         |
|--------------------|--|-----------------|---------|
| <b>GEV No.</b>     | 694916   | <b>Ref. No.</b> | 36E3320 |
| <b>description</b> | gasket silicone ED ø 45mm ID ø 34mm thickness 5mm  |                 |         |
| <b>For models:</b> | BX101E, BX101E-VERS.122013, BX101G, BX101G-VERS.122013, BX122E, BX122E-VERS.122013, BX122G, BX122G-VERS.122013, BX61E, BX61E-VERS.122013, BX61G, BX61G-VERS.122013, BX82E, BX82E-VERS.122013, BX82G, BX82G-VERS.122013, FC1011E, FC1011G, FC1221E, FC1221G, FC611E, FC611G, FM1011E1, FM1011E1-VERS.2006, FM1011E2, FM1011E2-VERS.2006, FM1011E3, FM1011E3-VERS.2006, FM1011G1, FM1011G1-VERS.2006, FM1011G2, FM1011G2-VERS.2006, FM1011G3, FM1011G3-VERS.2006, FM1221E1, FM1221E1-VERS.2006, FM1221E2, FM1221E2-VERS.2006, FM1221E3, FM1221E3-VERS.2006, FM1221G1, FM1221G1-VERS.2006, FM1221G2, FM1221G2-VERS.2006, FM1221G3, FM1221G3-VERS.2006, FM2011E2-VERS.2006, FM2011E3-VERS.2006, FM2011G2-VERS.2006, FM2011G3-VERS.2006...(Other models you can see in the webshop) |                 |         |

## Зип-Общепит

foam rubber gaskets



|                    |  |                 |         |
|--------------------|--|-----------------|---------|
| <b>GEV No.</b>     | 901678   | <b>Ref. No.</b> | 3022960 |
| <b>description</b> | foam rubber gasket Qty 1200mm incl. adhesive for lid |                 |         |
| <b>For models:</b> | DP10   |                 |         |

### shaft gaskets

#### shaft gaskets



|                    |  |                 |         |
|--------------------|--|-----------------|---------|
| <b>GEV No.</b>     | 520473   | <b>Ref. No.</b> | 3004400 |
| <b>description</b> | gasket   |                 |         |
| <b>For models:</b> | FC1011E, FC1011G, FC1221E, FC1221G, FC611E, FC611G, FM1011E1, FM1011E1-VERS.2006, FM1011E2, FM1011E2-VERS.2006, FM1011E3, FM1011E3-VERS.2006, FM1011G1, FM1011G1-VERS.2006, FM1011G2, FM1011G2-VERS.2006, FM1011G3, FM1011G3-VERS.2006, FM1221E1, FM1221E1-VERS.2006, FM1221E2, FM1221E2-VERS.2006, FM1221E3, FM1221E3-VERS.2006, FM1221G1, FM1221G1-VERS.2006, FM1221G2, FM1221G2-VERS.2006, FM1221G3, FM1221G3-VERS.2006, FM2011E2-VERS.2006, FM2011E3-VERS.2006, FM2011G2-VERS.2006, FM2011G3-VERS.2006, FM2021E1, FM2021E2, FM2021E2-VERS.2006, FM2021E3, FM2021E3-VERS.2006, FM2021G1, FM2021G2, FM2021G2-VERS.2006, FM2021G3, FM2021G3-VERS.2006, FM611E1, FM611E1-VERS.2006, FM611E2, FM611E2-VERS.2006, FM611E3, FM611E3-VERS.2006...(Other models you can see in the webshop) |                 |         |



|                    |  |                 |         |
|--------------------|--|-----------------|---------|
| <b>GEV No.</b>     | 550685                                       | <b>Ref. No.</b> | 3151670 |
| <b>description</b> | shaft seal ID ø 12mm ED ø 32mm thickness 7mm |                 |         |
| <b>For models:</b> | FCV3EM, FCV4E, FCV4EDS, FCV4EM               |                 |         |



|                    |  |                 |         |
|--------------------|--|-----------------|---------|
| <b>GEV No.</b>     | 698207                                       | <b>Ref. No.</b> | 3FL1137 |
| <b>description</b> | shaft seal ID ø 30mm ED ø 40mm thickness 7mm |                 |         |





special gaskets

for combi-steamers



|                    |  |                 |         |
|--------------------|--|-----------------|---------|
| <b>GEV No.</b>     | 505405   | <b>Ref. No.</b> | 3045960 |
| <b>description</b> | flat gasket NBR ED $\varnothing$ 58mm ID $\varnothing$ 40mm thickness 3mm drain  |                 |         |
| <b>For models:</b> | BX101E, BX101E-VERS.122013, BX101G, BX101G-VERS.122013, BX122E, BX122E-VERS.122013, BX122G, BX122G-VERS.122013, BX61E, BX61E-VERS.122013, BX61G, BX61G-VERS.122013, BX82E, BX82E-VERS.122013, BX82G, BX82G-VERS.122013, FC1011E, FC1011G, FC1221E, FC1221G, FC611E, FC611G, FM1011E1, FM1011E1-VERS.2006, FM1011E2, FM1011E2-VERS.2006, FM1011E3, FM1011E3-VERS.2006, FM1011G1, FM1011G1-VERS.2006, FM1011G2, FM1011G2-VERS.2006, FM1011G3, FM1011G3-VERS.2006, FM1221E1, FM1221E1-VERS.2006, FM1221E2, FM1221E2-VERS.2006, FM1221E3, FM1221E3-VERS.2006, FM1221G1, FM1221G1-VERS.2006, FM1221G2, FM1221G2-VERS.2006, FM1221G3, FM1221G3-VERS.2006, FM2011E2-VERS.2006, FM2011E3-VERS.2006, FM2011G2-VERS.2006, FM2011G3-VERS.2006...(Other models you can see in the webshop) |                 |         |



|                    |   |                 |         |
|--------------------|---|-----------------|---------|
| <b>GEV No.</b>     | 699497  | <b>Ref. No.</b> | 3332580 |
| <b>description</b> | gasket ED $\varnothing$ 92.5mm ID $\varnothing$ 51mm graphite thickness 2mm |                 |         |



|                    |  |                 |         |
|--------------------|--|-----------------|---------|
| <b>GEV No.</b>     | 696776   | <b>Ref. No.</b> | 36E3780 |
| <b>description</b> | gasket for heat exchanger L 50mm W 50mm flange ID $\varnothing$ 34mm thickness 1mm hole distance 40mm  |                 |         |
| <b>For models:</b> | FM1011G1, FM1011G2, FM1011G3, FM1221G1, FM1221G2, FM1221G3, FM2021G1, FM2021G2, FM2021G3, FM611G1, FM611G2, FM611G3, FM721G1, FM721G2, FM721G3 |                 |         |



|                    |  |                 |         |
|--------------------|--|-----------------|---------|
| <b>GEV No.</b>     | 696779   | <b>Ref. No.</b> | 36E3400 |
| <b>description</b> | gasket for heat exchanger L 60mm W 60mm flange ID $\varnothing$ 34mm thickness 3mm hole distance 40mm  |                 |         |
| <b>For models:</b> | FC1011G, FC1221G, FC611G, FM1011G1, FM1011G1-VERS.2006, FM1011G2, FM1011G2-VERS.2006, FM1011G3, FM1011G3-VERS.2006, FM1221G1, FM1221G1-VERS.2006, FM1221G2, FM1221G2-VERS.2006, FM1221G3, FM1221G3-VERS.2006, FM2011G2-VERS.2006, FM2011G3-VERS.2006, FM2021G1, FM2021G2, FM2021G2-VERS.2006, FM2021G3, FM2021G3-VERS.2006, FM611G1, FM611G1-VERS.2006, FM611G2, FM611G2-VERS.2006, FM611G3, FM611G3-VERS.2006, FM721G1, FM721G1-VERS.2006, FM721G2, FM721G2-VERS.2006, FM721G3, FM721G3-VERS.2006 |                 |         |

3шт. Общепит. door seals for dish washers



|                    |   |                 |         |
|--------------------|---|-----------------|---------|
| <b>GEV No.</b>     | 518254  | <b>Ref. No.</b> | 37Q3910 |
| <b>description</b> | door seal L 450mm W 28mm H 6mm Qty 1 with 5 holes |                 |         |
| <b>For models:</b> | LT10R, LT20F, LT25F                               |                 |         |

miscellaneous



|                    |  |                 |         |
|--------------------|--|-----------------|---------|
| <b>GEV No.</b>     | 901678   | <b>Ref. No.</b> | 3022960 |
| <b>description</b> | foam rubber gasket Qty 1200mm incl. adhesive for lid |                 |         |
| <b>For models:</b> | DP10   |                 |         |



|                    |  |                 |         |
|--------------------|--|-----------------|---------|
| <b>GEV No.</b>     | 519385   | <b>Ref. No.</b> | 3150220 |
| <b>description</b> | gasket for core temperature probe ED $\varnothing$ 8mm ID $\varnothing$ 4mm thickness 5mm  |                 |         |
| <b>For models:</b> | FCV101DM, FCV101DM-CSA, FCV101DS, FCV101DS-CSA, FCV101EDM, FCV101EDM-UL, FCV101EDS, FCV101EDS-UL, FCV141DM, FCV141DM-CSA, FCV141DS, FCV141DS-CSA, FCV141EDM, FCV141EDS, FCV241DM, FCV241DS, FCV241EDM, FCV241EDM-UL, FCV241EDS, FCV241EDS-UL, FCV241GDM, FCV241GDM-CSA, FCV241GDS, FCV241GDS-CSA, FCV401DM, FCV401DM-CSA, FCV401EDM, FCV401EDM-UL, FCV4EDS, FCV61DM, FCV61DM-CSA, FCV61DS, FCV61DS-CSA, FCV61EDM, FCV61EDM-UL, FCV61EDS, FCV61EDS-UL, FCV72EDM-UL, FCV72EDS-UL, FM1011E2, FM1011E3, FM1011G2, FM1011G3, FM1221E2, FM1221E3, FM1221G2, FM1221G3, FM2021E2, FM2021E3, FM2021G2...(Other models you can see in the webshop) |                 |         |



|                    |   |                 |     |
|--------------------|---|-----------------|-----|
| <b>GEV No.</b>     | 510847  | <b>Ref. No.</b> | N/A |
| <b>description</b> | gasket polishing agent dosing ID $\varnothing$ 22mm ED $\varnothing$ 32mm external height 5mm |                 |     |

Зип Общепит  
vsezip.ru  
+7(812)987-08-81



1

|                    |  |                 |         |
|--------------------|--|-----------------|---------|
| <b>GEV No.</b>     | 541499   | <b>Ref. No.</b> | 3151450 |
| <b>description</b> | gasket suitable for ANGELO PO size 1 1/4"  |                 |         |
| <b>For models:</b> | FC101, FC1011E, FC1011G, FC101E, FC1221E, FC1221G, FC241, FC241E, FC241G, FC61, FC611E, FC611G, FC61E, FCV101, FCV101-CSA, FCV101DM, FCV101DM-CSA, FCV101DS, FCV101DS-CSA, FCV101E, FCV101EDM, FCV101EDM-UL, FCV101EDS, FCV101EDS-UL, FCV101E-UL, FCV141, FCV141-CSA, FCV141DM, FCV141DM-CSA, FCV141DS, FCV141DS-CSA, FCV141E, FCV141EDM, FCV141EDS, FCV241, FCV241DM, FCV241DS, FCV241E, FCV241EDM, FCV241EDM-UL, FCV241EDS, FCV241EDS-UL, FCV241E-UL, FCV241G, FCV241G-CSA, FCV241GDM, FCV241GDM-CSA, FCV241GDS, FCV241GDS-CSA, FCV401DM...(Other models you can see in the webshop) |                 |         |



1

|                    |   |                 |                    |
|--------------------|---|-----------------|--------------------|
| <b>GEV No.</b>     | 510167  | <b>Ref. No.</b> | 3150270<br>315Q270 |
| <b>description</b> | gasket for thermostat ED ø 41mm ID ø 18mm Qty ANGELO PO/ ZANUSSI pcs equiv. no. 3150270/66717 |                 |                    |
| <b>For models:</b> | 030BME, 031BME  |                 |                    |

**gaskets for wash arm support**



1

|                    |   |                 |         |
|--------------------|---|-----------------|---------|
| <b>GEV No.</b>     | 519445  | <b>Ref. No.</b> | 3150230 |
| <b>description</b> | gasket D1 ø 80mm D2 ø 50mm thickness 3mm with 4 screw holes   |                 |         |
| <b>For models:</b> | F60P, F60PR, F60T, F80P, F80PR, FCV61EDS, FCV61EDS-UL, L45, LF50E, LF50EM, LF50EMPS, LF50EMPS-VERS.122012, LF50EM-VERS.122012, LF50E-VERS.122012, LF50E-VERS.2007, LP70 |                 |         |



2

|                    |   |                 |         |
|--------------------|---|-----------------|---------|
| <b>GEV No.</b>     | 519384  | <b>Ref. No.</b> | 3150880 |
| <b>description</b> | gasket thickness 3mm hole ø 40mm dimensions 100x100mm |                 |         |



1

|                    |  |                 |         |
|--------------------|--|-----------------|---------|
| <b>GEV No.</b>     | 900854   | <b>Ref. No.</b> | 37Q4440 |
| <b>description</b> | oven gasket L 332mm W 128mm mineral wool               |                 |         |
| <b>For models:</b> | FPZ14E, FPZ16E, FPZ24E, FPZ2635E, FPZ26E, FPZ4G, FPZ6G |                 |         |

**thermostat gaskets**



1

|                    |  |                 |         |
|--------------------|--|-----------------|---------|
| <b>GEV No.</b>     | 550492   | <b>Ref. No.</b> | 3152240 |
| <b>description</b> | gasket for thermostat  |                 |         |
| <b>For models:</b> | 04WBMEV, 04WCP1EM, 04WVT1IV, 04WVT1IV-VERS.022010, 04WVT2IV, 04WVT2IV-VERS.022010, 04WVT3RV, 06WBR3E, 06WCP1GM, 06WFT1EV, 06WFT2EV, 06WFT3EV, 06WFT4EV, 06WFT6EV, 06WFT7EV, 08WCP1GM, 08WFA4E, 08WFAAE, 08WFT1EV, 08WFT2EV, 08WFT3EV, 08WFT4EV, 08WFT6EV, 08WFT7EV, 08WVT1IV, 08WVT1IV-VERS.112009, 08WVT2IV, 08WVT2IV-VERS.112009, 090FT1E, 090FT2E, 090FT4E, 090FT5E, 090FT7E, 090PE4, 090VT1I, 090VT1I-VERS.112010, 090VT1W, 090VT1W-VERS.102008, 090VTR, 091CP1E, 091FR1E, 091FR1ED, 091FR1G, 091FR1GD, 091FR1I, 091FR1I-VERS.032012, 091FR3ED, 091FR3G, 091FR3GD, 091FR7G...(Other models you can see in the webshop) |                 |         |

**refrigeration cycle components**

**valves**

**expansion valves**

**DANFOSS**

**valves**

**type TS2/TE2**



1

|                    |  |                 |         |
|--------------------|--|-----------------|---------|
| <b>GEV No.</b>     | 750520   | <b>Ref. No.</b> | 33A0500 |
| <b>description</b> | expansion valve DANFOSS type TES2 coolant R404a/R507 angled 90° inlet 3/8" SAE outlet 12mm soldering connection 6mm soldering connection p max 34bar capillary pipe 1500mm |                 |         |
| <b>For models:</b> | IS102S, IS102SR, IS102SR-ONR01, IS102SW, SM2L, SM2LR, SM2LW, SM2S, SM2SR, SM2SW, SM3S, SM3SR, SM4SR  |                 |         |



1

|                    |  |                 |         |
|--------------------|--|-----------------|---------|
| <b>GEV No.</b>     | 750304   | <b>Ref. No.</b> | 33A0870 |
| <b>description</b> | expansion valve DANFOSS type TES2 coolant R404a/R507 angled 90° thermostatically controlled inlet 3/8" SAE outlet 12mm soldering connection 6mm soldering connection p max 34bar -40 up to +10°C capillary pipe 1500mm |                 |         |
| <b>For models:</b> | ART2LD, ART2SD, ART3SD, GR4A-ONR01, IA101L, IA101S, IA72S, XA101L, XA101S, XA72S   |                 |         |



filter driers

miscellaneous



|                |        |                 |         |
|----------------|--------|-----------------|---------|
| <b>GEV No.</b> | 750177 | <b>Ref. No.</b> | 33A0180 |
|----------------|--------|-----------------|---------|

**description** dryer ø 24mm L 155mm connection 6,3/6,3mm

**For models:** 120, 120NN, 120PV, 135, 135-4, 135A, 135BN, 135BNX, 135CPX, 135NN, 135NNX, 135PVX, 135X, 135X-3, 135X-4, 135XE, 3G6SA, 3G6SA2, 3G6SA4, 40, 40-OPR01, 40B, 40B-OPR01, 40BX-OPR01, 40CP, 40CP-OPR01, 40CPX, 40CPX-OPR01, 40EV, 40EV-OPR01, 40EVP, 40PL, 40PV, 40PV-OPR01, 40X, 40X-OPR01, 40XPV, 4G6SB, 4G6SB2, 4G6SB4, 4G6SB6, 55, 55B, 55PV, 65, 65A, 65B, 65BA, 65BX, 65BX-2...(Other models you can see in the webshop)



|                |        |                 |         |
|----------------|--------|-----------------|---------|
| <b>GEV No.</b> | 750058 | <b>Ref. No.</b> | 33A1150 |
|----------------|--------|-----------------|---------|

**description** dryer ø 24mm L 158mm connection 3.1/6.3mm

**For models:** 120PV, 55, 55PV, TVRV

evaporators

for fridges

producer-specific



|                |        |                 |         |
|----------------|--------|-----------------|---------|
| <b>GEV No.</b> | 750248 | <b>Ref. No.</b> | 34E0640 |
|----------------|--------|-----------------|---------|

**description** evaporator complete with fan

**For models:** MX120, MX130, MX140, MX150

Зип Общепит

vsezip.ru

+7(812)987-08-81

|                    |  |                 |         |
|--------------------|--|-----------------|---------|
| <b>GEV No.</b>     | 750049                                 | <b>Ref. No.</b> | 34D0360 |
| <b>description</b> | evaporator L 1340mm W 430mm H 5mm type |                 |         |
| <b>For models:</b> | 120, 120NN, 120PV, 55, 55PV            |                 |         |



|                |        |                 |         |
|----------------|--------|-----------------|---------|
| <b>GEV No.</b> | 750247 | <b>Ref. No.</b> | 32Z3420 |
|----------------|--------|-----------------|---------|

**description** evaporator L 255mm H 255mm W 50mm

**For models:** 6BEA11A, 6BEA11B, 6BEA11M, 6BEA11Z, 6BEA2A, 6BEA2B, 6BEA2M, 6BEA2Z, 6BEA3A, 6BEA3B, 6BEA3M, 6BEA3Z, 6BEAA, 6BEAB, 6BEAM, 6BEAZ, 6BEB11A, 6BEB11B, 6BEB11M, 6BEB11Z, 6BEB22A, 6BEB22B, 6BEB22M, 6BEB22Z, 6BEB2A, 6BEB2B, 6BEB2M, 6BEB2Z, 6BEB3A, 6BEB3B, 6BEB3M, 6BEB3Z, 6BEB4A, 6BEB4B, 6BEB4M, 6BEB4Z, 6BEBA, 6BEBB, 6BEBM, 6BEBZ, 6BMA11A, 6BMA11B, 6BMA11M, 6BMA11Z, 6BMA2A, 6BMA2B, 6BMA2M, 6BMA2Z, 6BMA3A, 6BMA3B...(Other models you can see in the webshop)

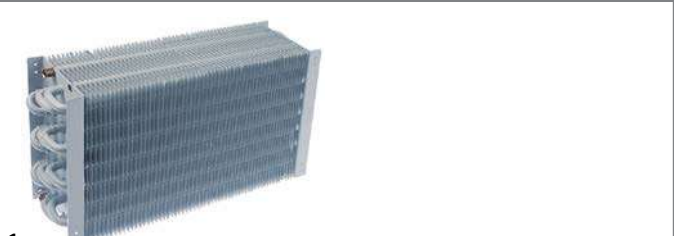

|                |        |                 |         |
|----------------|--------|-----------------|---------|
| <b>GEV No.</b> | 750230 | <b>Ref. No.</b> | 34D3390 |
|----------------|--------|-----------------|---------|

**description** evaporator L 360mm W 110mm H 200mm

**For models:** 6BEA11A, 6BEA11B, 6BEA11M, 6BEA2A, 6BEA2B, 6BEA2M, 6BEA3A, 6BEA3B, 6BEA3M, 6BEAA, 6BEAB, 6BEAM, 6BMA11A, 6BMA11B, 6BMA11M, 6BMA2A, 6BMA2B, 6BMA2M, 6BMA3A, 6BMA3B, 6BMA3M, 6BMAA, 6BMAB, 6BMAM, 6RMA2A, 6RMA2B, 6RMA2M, 6RMA2Z, 6RMAA, 6RMAB, 6RMAM, 6RMAZ, 6RMB2A, 6RMB2B, 6RMB2M, 6RMB2Z, 6RMB4A, 6RMB4B, 6RMB4M, 6RMB4Z, 6RMBA, 6RMBB, 6RMBM, 6RMBZ, BE1A, BE1A-11, BE1A-2, BE1A-3, BM1A, BM1A-11...(Other models you can see in the webshop)

Зип.Общепит

CONDENSORS

condensers  
vsezip.ru

+7(812)987-08-81



|   |                    |   |                 |         |
|---|--------------------|---|-----------------|---------|
| 1 | <b>GEV No.</b>     | 750118  | <b>Ref. No.</b> | 34D4260 |
|   | <b>description</b> | evaporator L 410mm W 90mm H 130mm   |                 |         |
|   | <b>For models:</b> | CX120NN, CX130NN, CX140BN, CX140CP, CX140NN, CX150BN, CX150CP, CX150NN, CX55, CX60, CX65, CX652, CX65NB, CX65NCP, CX65NN, CX65PV, CX70, CX702, CX70NB, CX70NN, CX70PV, CX70R, ISFEN, S60, S60-2, S60E, S60X, S60X-2 |                 |         |



|   |                    |  |                 |         |
|---|--------------------|--|-----------------|---------|
| 1 | <b>GEV No.</b>     | 750658   | <b>Ref. No.</b> | 34E2930 |
|   | <b>description</b> | evaporator L 415mm W 105mm H 330mm   |                 |         |
|   | <b>For models:</b> | 6EB, 6EB11, 6EB11A, 6EB11M, 6EB13, 6EB13A, 6EB13M, 6EB2, 6EB22, 6EB22A, 6EB22M, 6EB2A, 6EB2M, 6EB4, 6EB4A, 6EB4M, 6EBA, 6EBM, 6EC, 6EC11, 6EC11A, 6EC11M, 6EC13, 6EC13A, 6EC13M, 6EC2, 6EC22, 6EC22A, 6EC22M, 6EC2A, 6EC2M, 6EC4, 6EC4A, 6EC4M, 6ECA, 6ECM, 6ERB, 6ERB2, 6ERB2A, 6ERB2M, 6ERB4, 6ERB4A, 6ERB4M, 6ERBA, 6ERBM, 6ERC, 6ERC2, 6ERC2A, 6ERC2M, 6ERC4...(Other models you can see in the webshop) |                 |         |



|   |                    |  |                 |         |
|---|--------------------|--|-----------------|---------|
| 1 | <b>GEV No.</b>     | 750069   | <b>Ref. No.</b> | 34D7670 |
|   | <b>description</b> | evaporator L 420mm W 47mm H 300mm  |                 |         |
|   | <b>For models:</b> | 6JA, 6JA2, 6JA2A, 6JA2M, 6JAA, 6JAM, 6JB, 6JB2, 6JB2A, 6JB2M, 6JB4A, 6JB4M, 6JBA, 6JBM |                 |         |



|   |                    |   |                 |         |
|---|--------------------|---|-----------------|---------|
| 1 | <b>GEV No.</b>     | 750000  | <b>Ref. No.</b> | 34D4300 |
|   | <b>description</b> | evaporator L 730mm W 90mm H 130mm   |                 |         |
|   | <b>For models:</b> | CX120, CX130, CX140, CX140PV, CX150, CX150PV, CX150R, S125, S125-4, S125E, S125X, S125X-4 |                 |         |



|   |                    |   |                 |         |
|---|--------------------|---|-----------------|---------|
| 1 | <b>GEV No.</b>     | 605131  | <b>Ref. No.</b> | 34D4831 |
|   | <b>description</b> | condenser W 260mm D 110mm H 260mm   |                 |         |
|   | <b>For models:</b> | 135XE, 55B, 65BA, 65BXE, CX60B, DS31, DS31A, DS31C, DS31M, FX70B, MX60B, MX70B, S125, S125X, S600B, S600B2, S600BE, S60BE, SM03LT7, SM03LT7A, SM03LT7M, SP120BN, SP55B, VS31, VS31M |                 |         |



|   |                    |  |                 |         |
|---|--------------------|--|-----------------|---------|
| 1 | <b>GEV No.</b>     | 750543   | <b>Ref. No.</b> | 34d6180 |
|   | <b>description</b> | condenser W 275mm D 100mm H 260mm  |                 |         |
|   | <b>For models:</b> | 135BN, 135BNX, 135CPX, 55, 55PV, 65, 65A, 65PVX, 65X, 65X-2, 65XE, 6FMB11A, 6FMB11B, 6FMB11M, 6FMB11Z, 6FMB2A, 6FMB2B, 6FMB2M, 6FMB2Z, 6FMB4A, 6FMB4B, 6FMB4M, 6FMB4Z, 6FMB4A, 6FMB4B, 6FMB4M, 6FMB4Z, 6FMB4A, 6FMB4B, 6FMB4M, 6FMB4Z, 6FMC11A, 6FMC11B, 6FMC11M, 6FMC11Z, 6FMC2A, 6FMC2B, 6FMC2M, 6FMC2Z, 6FMC4A, 6FMC4B, 6FMC4M, 6FMC4Z, 6FMC4A, 6FMC4B, 6FMC4M, 6FMC4Z, 6JB, 6JB2, 6JB2A, 6JB2M, 6JB4A, 6JB4M, 6JBA...(Other models you can see in the webshop) |                 |         |



evaporation and condensing trays

evaporation trays

1 

|                    |   |                 |         |
|--------------------|---|-----------------|---------|
| <b>GEV No.</b>     | 750716  | <b>Ref. No.</b> | 36Z0300 |
| <b>description</b> | evaporation tray L 610mm W 295mm H 50mm   |                 |         |
| <b>For models:</b> | 120, 120B, 120NN, 120PV, 135, 135-4, 135A, 135B, 135BA, 135BN, 135BNX, 135BX, 135BXE, 135BXR, 135CPX, 135NN, 135NNX, 135PVX, 135X, 135X-3, 135X-4, 135XE, 135XR, 55, 55B, 55PV, 65, 65A, 65B, 65BA, 65BX, 65BX-2, 65BXE, 65BXR, 65NB, 65NBX, 65NN, 65NNX, 65PVX, 65X, 65X-2, 65XE, 65XR, 6FMA11A, 6FMA11B, 6FMA11M, 6FMA11Z, 6FMA2A, 6FMA2B, 6FMA2M...(Other models you can see in the webshop) |                 |         |

miscellaneous

1 

|                    |  |                 |         |
|--------------------|--|-----------------|---------|
| <b>GEV No.</b>     | 750059   | <b>Ref. No.</b> | 36Z6471 |
| <b>description</b> | evaporation tray for condenser L 440mm W 357mm                       |                 |         |
| <b>For models:</b> | 135BN, 135BNX, 65B, 65BA, 65BX, 65BX-2, 65BXE, 65BXR, SP135BN, SP65B |                 |         |

transmission technology and ball bearings

drive belts

poly-v belts

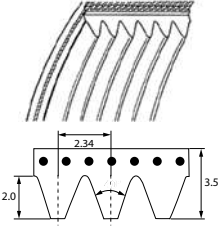
1  

|                    |  |                 |         |
|--------------------|--|-----------------|---------|
| <b>GEV No.</b>     | 692144   | <b>Ref. No.</b> | 36G6610 |
| <b>description</b> | poly-v belt grooves 12 W 28mm L 559mm profile J      |                 |         |
| <b>For models:</b> | LCV, P10, P102, P10M, P20, P202, P5, TV1, TV1M, TV2L |                 |         |

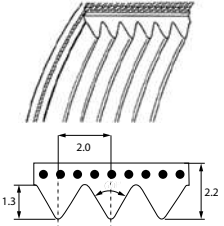
1  

|                    |   |                 |         |
|--------------------|---|-----------------|---------|
| <b>GEV No.</b>     | 698156  | <b>Ref. No.</b> | 36G6630 |
| <b>description</b> | poly-v belt grooves 14 W 28mm L 430mm profile TB2 |                 |         |

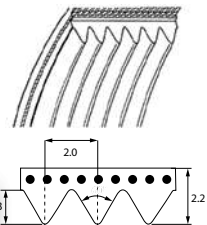
1  

|                    |  |                 |         |
|--------------------|--|-----------------|---------|
| <b>GEV No.</b>     | 698223   | <b>Ref. No.</b> | 3042690 |
| <b>description</b> | poly-v belt grooves 6 W 12mm L 660mm profile TB2 |                 |         |
| <b>For models:</b> | SC4, SC6   |                 |         |

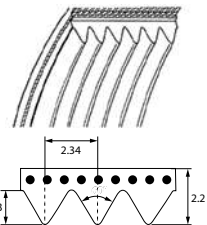
1  

|                    |  |                 |         |
|--------------------|--|-----------------|---------|
| <b>GEV No.</b>     | 698206   | <b>Ref. No.</b> | 36G4900 |
| <b>description</b> | poly-v belt grooves 12 W 28mm L 457mm profile TB2.34 |                 |         |

springs

torsion springs

1 

|                    |   |                 |         |
|--------------------|---|-----------------|---------|
| <b>GEV No.</b>     | 516090                                      | <b>Ref. No.</b> | 36G8360 |
| <b>description</b> | torsion spring mounting pos. right for door |                 |         |

1 

|                    |  |                 |         |
|--------------------|--|-----------------|---------|
| <b>GEV No.</b>     | 700221   | <b>Ref. No.</b> | 36E0220 |
| <b>description</b> | torsion spring $\phi$ 17mm wire gauge $\phi$ 1.5mm L1 48mm |                 |         |
| <b>For models:</b> | C1424  |                 |         |

1 

|                    |   |                 |         |
|--------------------|---|-----------------|---------|
| <b>GEV No.</b>     | 700185  | <b>Ref. No.</b> | 36G1300 |
| <b>description</b> | torsion spring $\phi$ 30.5mm wire gauge $\phi$ 4.7mm L1 30mm L2 295mm L3 30mm |                 |         |
| <b>For models:</b> | 1G1BR1E, 1G1BR1G, 1G1PD1G, 1G1PI1E, 1G1PI1G, 31PD6, 31PI6, 31PIE6, 31R, 31RE  |                 |         |

Зип-Общепит

roller springs

roller springs  
vsezip.ru

812)987-08-81

|   |   |                 |         |
|---|---|-----------------|---------|
|  |   |                 |         |
| <b>GEV No.</b>  | 700186  | <b>Ref. No.</b> | 36G2640 |
| <b>description</b>  | torsion spring $\varnothing$ 31.7mm wire gauge $\varnothing$ 5.5mm L1 30mm L2 300mm L3 30mm   |                 |         |
| <b>For models:</b>  | 191PD1G, 191PD2G, 191PI1G, 191PI1GA, 191PI2E, 191PI2EA, 191PI2G, 191PI2GA, 191PI2V, 191PI2VA, 1A1PD1G, 1A1PD2G, 1A1PI1G, 1A1PI1GA, 1A1PI2E, 1A1PI2EA, 1A1PI2G, 1A1PI2GA, 1A1PI2V, 1A1PI2VA, 1D1PD1G, 1D1PD2G, 1D1PI1G, 1D1PI1GA, 1D1PI2E, 1D1PI2EA, 1D1PI2G, 1D1PI2GA, 1D1PI2V, 1D1PI2VA, 71AR, 71ARE, 71PD10, 71PD15, 71PI10, 71PI10A, 71PIE15, 71PIE15A, 71PV15, 71PV15A, 71RA, 91AR, 91ARE, 91PI10, 91PI10A, 91PIE15, 91PIE15A, 91RA |                 |         |

|   |  |                 |         |
|---|--|-----------------|---------|
|  |  |                 |         |
| <b>GEV No.</b>  | 517338   | <b>Ref. No.</b> | 36G7650 |
| <b>description</b>  | roller spring  |                 |         |
| <b>For models:</b>  | N303D, N303S, N303VD, N303VS, N354D, N354S, N354VD, N354VS, N506D, N506S, N506VD, N506VS, N607D, N607S, N607VD, N607VS, N760D, N760S, N760VD, N760VS, N886D, N886S, N886VD, N886VS |                 |         |

|   |   |                 |         |
|---|---|-----------------|---------|
|  |   |                 |         |
| <b>GEV No.</b>  | 691182  | <b>Ref. No.</b> | 36G9970 |
| <b>description</b>  | torsion spring $\varnothing$ 52mm wire gauge $\varnothing$ 6mm L1 110mm L2 30mm L3 30mm Qty 2 pcs |                 |         |
| <b>For models:</b>  | PV200A, PV300   |                 |         |

compression springs

|   |  |                 |         |
|---|--|-----------------|---------|
|  |  |                 |         |
| <b>GEV No.</b>  | 516247                                       | <b>Ref. No.</b> | 36G1730 |
| <b>description</b>  | compression spring $\varnothing$ 18mm L 30mm |                 |         |
| <b>For models:</b>  | LT10R, LT20F, LT25F                          |                 |         |

|  |   |                 |         |
|--|---|-----------------|---------|
|  |   |                 |         |
| <b>GEV No.</b>   | 519340  | <b>Ref. No.</b> | 36G8430 |
| <b>description</b>   | roller spring   |                 |         |
| <b>For models:</b>   | LP124, LP124S-VERS.052006, LP124V, LP124-VERS.052006, LP124VS-VERS.052006, LP124V-VERS.052006 |                 |         |

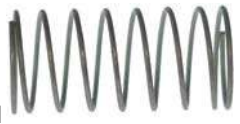
|   |   |                 |         |
|---|---|-----------------|---------|
|  |   |                 |         |
| <b>GEV No.</b>  | 514284  | <b>Ref. No.</b> | 36G5320 |
| <b>description</b>  | compression spring $\varnothing$ 9mm L 18mm wire gauge $\varnothing$ 0.5mm  |                 |         |
| <b>For models:</b>  | 04WCP1EM, 08WCP1GM, BX101E, BX101E-VERS.122013, BX101G, BX101G-VERS.122013, BX122E, BX122E-VERS.122013, BX122G, BX122G-VERS.122013, BX61E, BX61E-VERS.122013, BX61G, BX61G-VERS.122013, BX82E, BX82E-VERS.122013, BX82G, BX82G-VERS.122013, FC101, FC1011E, FC1011G, FC101E, FC1221E, FC1221G, FC241, FC241E, FC241G, FC61, FC611E, FC611G, FC61E, FCV101, FCV101-CSA, FCV101DM, FCV101DM-CSA, FCV101DS, FCV101DS-CSA, FCV101E, FCV101EDM, FCV101EDM-UL, FCV101EDS, FCV101EDS-UL, FCV101E-UL, FCV141, FCV141-CSA, FCV141DM, FCV141DM-CSA, FCV141DS, FCV141DS-CSA, FCV141E...(Other models you can see in the webshop) |                 |         |

|   |  |                 |         |
|---|--|-----------------|---------|
|  |  |                 |         |
| <b>GEV No.</b>  | 519616   | <b>Ref. No.</b> | 36G8740 |
| <b>description</b>  | roller spring W 40mm ID $\varnothing$ 36mm lug length 50mm   |                 |         |
| <b>For models:</b>  | C165D, C165S, C165VD, C165VS, C207D, C207D-VERS.2006, C207S, C207S-VERS.2006, C207VD, C207VD-VERS.2006, C207VS, C207VS-VERS.2006, C304AD, C304AD-VERS.2006, C304AS, C304AS-VERS.2006, C304AVD, C304AVD-VERS.2006, C304AVS, C304AVS-VERS.2006, C304D, C304D-VERS.2006, C304S, C304S-VERS.2006, C304VD, C304VD-VERS.2006, C304VS, C304VS-VERS.2006, C92D-VERS.2006, C92S-VERS.2006, C92VD-VERS.2006, C92VS-VERS.2006, CS243D, CS243D-VERS.2006, CS243S, CS243S-VERS.2006, CS243VD, CS243VD-VERS.2006, CS243VS, CS243VS-VERS.2006, CS370AD, CS370AD-VERS.2006, CS370AS, CS370AS-VERS.2006, CS370AVD, CS370AVD-VERS.2006, CS370AVS, CS370AVS-VERS.2006, CS370D, CS370D-VERS.2006...(Other models you can see in the webshop) |                 |         |



Зип Общепит  
vsezip.ru  
+7(812)987-08-81  
kitchen accessories



|                    |   |  |                 |         |
|--------------------|---|--|-----------------|---------|
| 1                  | <b>GEV No.</b>  | 519619   | <b>Ref. No.</b> | 36G8750 |
|                    | <b>description</b>  | roller spring with holder W 40mm ID ø 36.5mm lug length 60mm mounting distance 18mm bore ø 5mm |                 |         |
| <b>For models:</b> | C207D-VERS.2006, C207S-VERS.2006, C207VD-VERS.2006, C207VS-VERS.2006, C304AD, C304AD-VERS.2006, C304AS, C304AS-VERS.2006, C304AVD, C304AVD-VERS.2006, C304AVS, C304AVS-VERS.2006, C304D, C304D-VERS.2006, C304S, C304S-VERS.2006, C304VD, C304VD-VERS.2006, C304VS, C304VS-VERS.2006, C92D-VERS.2006, C92S-VERS.2006, C92VD-VERS.2006, C92VS-VERS.2006, CS243D, CS243D-VERS.2006, CS243S, CS243VD, CS243VD-VERS.2006, CS243VS, CS243VS-VERS.2006, CS370AD, CS370AD-VERS.2006, CS370AS, CS370AS-VERS.2006, CS370AVD, CS370AVD-VERS.2006, CS370AVS, CS370AVS-VERS.2006, CS370D, CS370D-VERS.2006, CS370S, CS370S-VERS.2006, CS370VD, CS370VD-VERS.2006, CS370VS, CS370VS-VERS.2006, CS466AD, CS466AD-VERS.2006, CS466AS...(Other models you can see in the webshop) |  |                 |         |

|                    |  |  |                 |         |
|--------------------|--|--|-----------------|---------|
| 1                  | <b>GEV No.</b>                                       | 519163   | <b>Ref. No.</b> | 36G8870 |
|                    | <b>description</b>                                   | tension spring ø 38.5mm total length 394mm wire gauge ø 6.5mm for hood |                 |         |
| <b>For models:</b> | LC100, LC100-VERS.2001, LC130, LC130-VERS.2001, LC80 |  |                 |         |

shock absorbers



|   |                    |                |                 |         |
|---|--------------------|----------------|-----------------|---------|
| 1 | <b>GEV No.</b>     | 691188         | <b>Ref. No.</b> | 36G1370 |
|   | <b>description</b> | shock absorber |                 |         |

gastronorm

bridges



|                    |                    |  |                 |         |
|--------------------|--------------------|--|-----------------|---------|
| 1                  | <b>GEV No.</b>     | 691173   | <b>Ref. No.</b> | 35S6320 |
|                    | <b>description</b> | bridge for Gastronorm container L1 175mm L2 155mm SS W 25mm H 15mm Qty 1 pcs |                 |         |
| <b>For models:</b> | SA87               |  |                 |         |

tension springs



|                    |                                     |  |                 |         |
|--------------------|-------------------------------------|--|-----------------|---------|
| 1                  | <b>GEV No.</b>                      | 505501   | <b>Ref. No.</b> | 36G1340 |
|                    | <b>description</b>                  | tension spring ø 11mm wire gauge ø 1.5mm L 220mm |                 |         |
| <b>For models:</b> | F60P, F60PR, F60T, F80P, F80PR, L45 |  |                 |         |

manometers



|                    |   |   |                 |         |
|--------------------|---|---|-----------------|---------|
| 1                  | <b>GEV No.</b>  | 541508  | <b>Ref. No.</b> | 33D1680 |
|                    | <b>description</b>  | manometer ø 40mm pressure range 0-4bar connection thread 1/8" |                 |         |
| <b>For models:</b> | BX101E, BX101E-VERS.122013, BX101G, BX101G-VERS.122013, BX122E, BX122E-VERS.122013, BX122G, BX122G-VERS.122013, BX61E, BX61E-VERS.122013, BX61G, BX61G-VERS.122013, BX82E, BX82E-VERS.122013, BX82G, BX82G-VERS.122013, FCV101, FCV101-CSA, FCV101DM, FCV101DM-CSA, FCV101DS, FCV101DS-CSA, FCV101E, FCV101EDM, FCV101EDM-UL, FCV101EDS, FCV101EDS-UL, FCV101E-UL, FCV141, FCV141-CSA, FCV141DM, FCV141DM-CSA, FCV141DS, FCV141DS-CSA, FCV141E, FCV141EDM, FCV141EDS, FCV241, FCV241DM, FCV241DS, FCV241E, FCV241EDM, FCV241EDM-UL, FCV241EDS, FCV241EDS-UL, FCV241E-UL, FCV241G, FCV241G-CSA, FCV241GDM, FCV241GDM-CSA...(Other models you can see in the webshop) |   |                 |         |



|   |                    |   |                 |         |
|---|--------------------|---|-----------------|---------|
| 1 | <b>GEV No.</b>     | 501296  | <b>Ref. No.</b> | 36H1430 |
|   | <b>description</b> | tension spring ø 12mm total length 275mm wire gauge ø 1.6mm |                 |         |



|                    |   |  |                 |         |
|--------------------|---|--|-----------------|---------|
| 1                  | <b>GEV No.</b>  | 700718   | <b>Ref. No.</b> | 36G5240 |
|                    | <b>description</b>  | tension spring ø 16.4mm total length 79.2mm wire gauge ø 2.9mm |                 |         |
| <b>For models:</b> | 0A1CP1E, 0A1CP1G, 0A1FR1E, 0A1FR1ED, 0A1FR1G, 0A1FR1GD, 0A1FR1GD-VERS.2004, 0A1FR1G-VERS.2004, 0A1FR3G, 0A1FR3GD, 0B1CP1G, 0B1FR1G, 0B1FR1GD, 0D1CP1E, 0D1CP1G, 0D1FR1E, 0D1FR1ED, 0D1FR1G, 0D1FR1GD, 0D1FR1GD-VERS.2004, 0D1FR1G-VERS.2004, 0D1FR3G, 0D1FR3GD, 1A1CP1G, 1A1CP2G, 1A1FR2E, 1A1FR2ED, 1A1FR2G, 1A1FR2GD, 1A1FR2GD-VERS.2004, 1A1FR2G-VERS.2004, 1A1FR4G, 1A1FR4GD, 1D1CP1G, 1D1CP2G, 1D1FR2ED, 1D1FR2G, 1D1FR2GD, 1D1FR2GD-VERS.2004, 1D1FR2G-VERS.2004, 1D1FR4G, 1D1FR4GD, 30CPS, 30CPSE, 30F1, 30F1B, 30FES2, 30FES2B, 30FS2, 30FS2B...(Other models you can see in the webshop) |  |                 |         |



|   |                    |  |                 |             |
|---|--------------------|--|-----------------|-------------|
| 1 | <b>GEV No.</b>     | 541880   | <b>Ref. No.</b> | 33D1680-old |
|   | <b>description</b> | manometer ø 41mm pressure range 0-6bar thread 1/8" 0-90PSI |                 |             |



|                    |  |   |                 |         |
|--------------------|--|---|-----------------|---------|
| 1                  | <b>GEV No.</b>   | 517286  | <b>Ref. No.</b> | 36H1460 |
|                    | <b>description</b>                                       | tension spring ø 35mm total length 865mm wire gauge ø 5mm |                 |         |
| <b>For models:</b> | KD100, KD100A, KD100PSD, KD130, KD130A, KD130E, KD130EAT |   |                 |         |

Зип Общепит

vsezip.ru

+7(812)987-08-81



1

|                    |  |                 |         |
|--------------------|--|-----------------|---------|
| <b>GEV No.</b>     | 541334   | <b>Ref. No.</b> | 32V0940 |
| <b>description</b> | manometer ø 60mm pressure range 0 up to 1bar thread 1/8" marking 0.5 kettle connection on the backside   |                 |         |
| <b>For models:</b> | 1A1PI1G, 1A1PI1GA, 1A1PI2E, 1A1PI2EA, 1A1PI2G, 1A1PI2GA, 1A1PI2V, 1A1PI2VA, 1D1PI1G, 1D1PI1GA, 1D1PI2E, 1D1PI2EA, 1D1PI2G, 1D1PI2GA, 1D1PI2V, 1D1PI2VA, 2A1PI3G, 2D1PI3G |                 |         |



1

|                        |   |                 |                 |
|------------------------|---|-----------------|-----------------|
| <b>GEV No.</b>         | 541062  | <b>Ref. No.</b> | 32Z0060         |
| <b>description</b>     | manometer ø 63mm pressure range 0 up to 1bar connection marking adjustable kettle thread 1/4"   |                 |                 |
| <b>For models:</b>     | 191PI1G, 191PI1GA, 191PI2E, 191PI2EA, 191PI2G, 191PI2GA, 191PI2V, 191PI2VA, 1A1PI1G, 1A1PI1GA, 1A1PI2E, 1A1PI2EA, 1A1PI2V, 1A1PI2VA, 1D1PI1G, 1D1PI1GA, 1D1PI2E, 1D1PI2EA, 1D1PI2V, 1D1PI2VA, 1G1PI1E, 1G1PI1G, 291PI3E, 291PI3G, 2A1PI3E, 31PI6, 31PIE6, 71PI10, 71PI10A, 71PIE15, 71PIE15A, 71PV15, 71PV15A, 91PI10, 91PI10A, 91PIE15, 91PIE15A, BPV2, PV200, PV200A, PV300, PV300A |                 |                 |
| <b>spare parts for</b> | 541062  |                 |                 |
|                        | <b>GEV No.</b>  | 541130          | <b>Ref. No.</b> |
|                        | glass panel ø 58mm thickness 2mm  |                 |                 |

hose reels and spray guns

spray guns



1

|                        |  |                 |                 |
|------------------------|--|-----------------|-----------------|
| <b>GEV No.</b>         | 691048   | <b>Ref. No.</b> | 33D1700         |
| <b>description</b>     | spray gun for appliances 1/2" ET L 225mm type STAR             |                 |                 |
| <b>spare parts for</b> | 691048   |                 |                 |
|                        | <b>GEV No.</b>   | 507309          | <b>Ref. No.</b> |
|                        | O-ring EPDM thickness 2.62mm ID ø 17.13mm Qty 1 pcs            |                 |                 |
|                        | <b>GEV No.</b>   | 510322          | <b>Ref. No.</b> |
|                        | O-ring EPDM thickness 1.78mm ID ø 17.17mm Qty 1 pcs            |                 |                 |
|                        | <b>GEV No.</b>   | 524055          | <b>Ref. No.</b> |
|                        | flat gasket rubber ED ø 18mm ID ø 12mm thickness 2mm Qty 1 pcs |                 |                 |
|                        | <b>GEV No.</b>   | 528485          | <b>Ref. No.</b> |
|                        | O-ring EPDM thickness 1.78mm ID ø 6.07mm Qty 1 pcs             |                 |                 |
|                        | <b>GEV No.</b>   | 528494          | <b>Ref. No.</b> |
|                        | gasket rubber ED ø 13mm ID ø 4mm thickness 4mm Qty 1 pcs       |                 |                 |



1

|                    |  |                 |         |
|--------------------|--|-----------------|---------|
| <b>GEV No.</b>     | 542068   | <b>Ref. No.</b> | 33D1700 |
| <b>description</b> | spray gun for appliances 1/2" IT L 219mm with D-ring type KLARCO |                 |         |



1

|                    |             |                 |                    |
|--------------------|-------------|-----------------|--------------------|
| <b>GEV No.</b>     | 540675      | <b>Ref. No.</b> | 3212740<br>3FL0182 |
| <b>description</b> | shower head |                 |                    |

dosing pumps

peristaltic dosing pumps

BORES

built-in version

with flow control



1

|                        |   |                 |                 |
|------------------------|---|-----------------|-----------------|
| <b>GEV No.</b>         | 361028  | <b>Ref. No.</b> | 33D0750         |
| <b>description</b>     | dosing pump BORES flow control 0.39l/h 230VAC rinse aid hose ø 4x6mm hose silicone type Perios built-in version with integrated non-return valve CODE P1B |                 |                 |
| <b>For models:</b>     | F60PR, F60T, F80P, F80PR  |                 |                 |
| <b>spare parts for</b> | 361028  |                 |                 |
|                        | <b>GEV No.</b>  | 361127          | <b>Ref. No.</b> |
|                        | pump hose Perios rinse aid hose ø 3x6mm hose type silicone L 120mm  |                 |                 |
|                        | <b>GEV No.</b>  | 361464          | <b>Ref. No.</b> |
|                        | roller assembly rinse aid/detergent hose type Santoprene/silicone pump type Perios  |                 |                 |
| <b>accessories for</b> | 361028  |                 |                 |
|                        | <b>GEV No.</b>  | 361142          | <b>Ref. No.</b> |
|                        | mounting set detergent hose type 4x6mm hose length 2m PVC 2x hose/container filter/tank intake transparent  |                 |                 |
|                        | <b>GEV No.</b>  | 520090          | <b>Ref. No.</b> |
|                        | PVC hose ID ø 4mm ED ø 6mm L 2m thickness 1mm t.max. 60°C transparent   |                 |                 |
|                        | <b>GEV No.</b>  | 520091          | <b>Ref. No.</b> |
|                        | nylon hose ID ø 4mm ED ø 6mm L 2m thickness 1mm operating p. 10bar burst p. 50bar t.max. 100°C transparent  |                 |                 |





Зип-Общепит

vsezip.ru

+7(812)987-08-81

|   |  |                 |         |
|---|--|-----------------|---------|
| SEKO  |  |                 |         |
| spare parts   |  |                 |         |
|  |  |                 |         |
| 1   |  |                 |         |
| <b>GEV No.</b>  | 362021   | <b>Ref. No.</b> | 3183560 |
| <b>description</b>  | pump hose SEKO hose ø 6x10mm hose Santoprene   |                 |         |
| <b>For models:</b>  | FX101E3, FX101E3C, FX101E3C-VERS.022014, FX101E3R, FX101E3R-VERS.022014, FX101E3-VERS.022014, FX101G3, FX101G3C, FX101G3C-VERS.022014, FX101G3R, FX101G3R-VERS.022014, FX101G3-VERS.022014, FX10E3CR, FX10E3CR-VERS.022014, FX10G3CR, FX10G3CR-VERS.022014, FX122E3, FX122E3C, FX122E3T, FX122E3T-VERS.022014, FX122G3, FX122G3C, FX122G3T, FX122G3T-VERS.022014, FX12E3CT, FX12E3CT-VERS.022014, FX12G3CT, FX12G3CT-VERS.022014, FX201E3, FX201E3P, FX201E3P-VERS.022014, FX201E3-VERS.022014, FX201G3P, FX201G3-VERS.022014, FX202E3, FX202E3-230V-3-50Hz-60Hz, FX202E3-230V-3-50Hz-60Hz-VERS.022014, FX202E3-VERS.022014, FX202G3, FX202G3-VERS.022014, FX61E3, FX61E3C, FX61E3CR, FX61E3CR-VERS.022014, FX61E3C-VERS.022014, FX61E3R, FX61E3R-VERS.022014, FX61E3-VERS.022014, FX61G3, FX61G3C...(Other models you can see in the webshop) |                 |         |

|                        |  |                 |   |
|------------------------|--|-----------------|---|
| spare parts for 361003 |  |                 |   |
| <b>GEV No.</b>         | 361123   | <b>Ref. No.</b> | — |
| <b>description</b>     | membrane type DELTA  |                 |   |
| <b>GEV No.</b>         | 361169   | <b>Ref. No.</b> | — |
| <b>description</b>     | nose connector type DELTA  |                 |   |
| <b>GEV No.</b>         | 361188   | <b>Ref. No.</b> | — |
| <b>description</b>     | disc type DELTA  |                 |   |
| <b>GEV No.</b>         | 361319   | <b>Ref. No.</b> | — |
| <b>description</b>     | flat gasket rubber ID ø 9mm ED ø 14.5mm thickness 1mm type DELTA |                 |   |

piston pumps

|  |                                   |                 |   |
|--|-----------------------------------|-----------------|---|
| spare parts  |                                   |                 |   |
|  |                                   |                 |   |
| 1  |                                   |                 |   |
| <b>GEV No.</b>   | 361113                            | <b>Ref. No.</b> | — |
| <b>description</b>   | solenoid coil 230VAC for type DB2 |                 |   |

|   |                           |                 |   |
|---|---------------------------|-----------------|---|
| spare parts   |                           |                 |   |
|  |                           |                 |   |
| 1   |                           |                 |   |
| <b>GEV No.</b>  | 361169                    | <b>Ref. No.</b> | — |
| <b>description</b>  | hose connector type DELTA |                 |   |

|   |  |                 |     |
|---|--|-----------------|-----|
|  |  |                 |     |
| 1   |  |                 |     |
| <b>GEV No.</b>  | 510298                                     | <b>Ref. No.</b> | N/A |
| <b>description</b>  | lip valve dosing pump suitable for DB2/DS5 |                 |     |

|   |                     |                 |   |
|---|---------------------|-----------------|---|
|  |                     |                 |   |
| 1   |                     |                 |   |
| <b>GEV No.</b>  | 361123              | <b>Ref. No.</b> | — |
| <b>description</b>  | membrane type DELTA |                 |   |

membrane dosing pumps

|   |   |                 |         |
|---|---|-----------------|---------|
| electric dosing pumps   |   |                 |         |
| Delta   |   |                 |         |
|  |   |                 |         |
| 1   |   |                 |         |
| <b>GEV No.</b>  | 361003  | <b>Ref. No.</b> | 32Z1610 |
| <b>description</b>  | dosing pump 220V rinse aid duty cycle 25% type EL-1 valve lip valve |                 |         |
| <b>spare parts for</b>  | 361003  |                 |         |
| <b>GEV No.</b>  | 361122  | <b>Ref. No.</b> | —       |
| <b>description</b>  | lip valve type DELTA  |                 |         |





|  |   |                 |         |
|--|---|-----------------|---------|
| self-priming   |   |                 |         |
| LANG   |   |                 |         |
|  |   |                 |         |
| 1  |   |                 |         |
| <b>GEV No.</b>   | 361575  | <b>Ref. No.</b> | 33D2300 |
| <b>description</b>   | dosing pump type N6 rinse aid pressure connection ø straight, 4x6mm suction connection ø angled, 6mm LANG |                 |         |
| <b>spare parts for</b>   | 361575  |                 |         |
| <b>GEV No.</b>   | 361079  | <b>Ref. No.</b> | —       |
| <b>description</b>   | spring for type N5/N6 for ball  |                 |         |
| <b>GEV No.</b>   | 361080  | <b>Ref. No.</b> | —       |
| <b>description</b>   | O-ring EPDM thickness 2mm ID ø 16mm Qty 1 pcs   |                 |         |
| <b>GEV No.</b>   | 361085  | <b>Ref. No.</b> | —       |
| <b>description</b>   | O-ring EPDM thickness 2mm ID ø 8mm Qty 1 pcs  |                 |         |
| <b>GEV No.</b>   | 361309  | <b>Ref. No.</b> | —       |
| <b>description</b>   | ball for type N5/N6   |                 |         |
| <b>GEV No.</b>   | 361310  | <b>Ref. No.</b> | —       |
| <b>description</b>   | bracket for type N6 ball guide  |                 |         |

Table continues overleaf

Зип-Общепит

vsezip.ru

+7(812)987-08-81



| spare parts for   |  | 361575   |   |
|---|--|----------|---|
| GEV No.   | 361311   | Ref. No. | — |
|  | O-ring EPDM thickness 2mm ID ø 6mm Qty 1 pcs for type N6 |          |   |
|  | 361314   | Ref. No. | — |
| valve ring for type N6 holder for O-ring  |  |          |   |
|  | 361317   | Ref. No. | — |
| sealing disc for type N6  |  |          |   |
|  | 361886   | Ref. No. | — |
| non-return valve inletmm outletmm outlet ø 12.4mm L 12.7mm                        |  |          |   |

accessories



1



| GEV No.            | 101286  | Ref. No. | 36Q0020 |
|--------------------|---|----------|---------|
| <b>description</b> | olive ID ø 6mm Qty 1 pcs  |          |         |
| <b>For models:</b> | 04WFAAV, 08WFA4E, 08WFA4G, 08WFAAE, 08WFAAG, 08WFAAV, 090FAA, 0A0FA1, 0A0FA4, 0A0FAA, 0D0FA1, 0D0FA4, 0D0FAA, 0G0FA0, 12WFA6E, 12WFA6G, 12WFAAA, 12WFAAE, 12WFAAG, 12WFAAN, 190FA, 190FAA, 190FAB, 190FAD, 191FAAE, 191FAAG, 191FABG, 191FADG, 191FAE, 191FAG, 1A0FA1, 1A0FA2, 1A0FA4, 1A0FA5, 1A0FAA, 1A0FAB, 1A1FA1G, 1A1FA2G, 1A1FA4G, 1A1FA5G, 1A1FAAG, 1A1FABG, 1D0FA1, 1D0FA2, 1D0FA4, 1D0FA5, 1D0FAA, 1D0FAB, 1D1FA1G, 1D1FA2G...(Other models you can see in the webshop) |          |         |





| accessories for   |   | 101286   |         |
|---|---|----------|---------|
| GEV No.   | 100909  | Ref. No. | 36Q0060 |
|  | union screw thread M10x1 for pipe ø 6mm Qty 1 pcs |          |         |
|  | 101464  | Ref. No. | —       |
| union nut thread M12x1 for pipe ø 6mm   |   |          |         |

various



1

| GEV No.   | 361002  | Ref. No. | 33D0060<br>33D0061 |
|---|---|----------|--------------------|
| <b>description</b>  | dosing pump rinse aid inlet 6x8mm outlet 4x6mm pressure connection ø 4x6mm suction connection ø 6x8mm |          |                    |
| <b>For models:</b>  | F60P, L100, L40, L40S, L45, L60, L80  |          |                    |
| spare parts for   |   | 361002   |                    |
|                  | 510297  | Ref. No. | N/A                |
| membrane for dosing pump ED ø 83mm thickness 1mm dosing pump equiv. no. 630614 suitable for COMENDA |   |          |                    |
|                  | 510298  | Ref. No. | N/A                |
| lip valve dosing pump suitable for DB2/DS5  |   |          |                    |

| spare parts for   |                                | 361002   |     |
|---|--------------------------------|----------|-----|
| GEV No.   | 510299                         | Ref. No. | N/A |
|  | hose connector for dosing pump |          |     |
|  | 510338                         | Ref. No. | N/A |
| union nut dosing pump thread 1/2" ø 32mm H 15mm for dosing pump                   |                                |          |     |
|  | 510847                         | Ref. No. | N/A |
| gasket polishing agent dosing ID ø 22mm ED ø 32mm external height 5mm             |                                |          |     |
|  | 510870                         | Ref. No. | N/A |
| filter support for dosing pump  |                                |          |     |
|  | 510916                         | Ref. No. | N/A |
| filter for dosing pump  |                                |          |     |

spare parts



1

| GEV No.            | 510916                 | Ref. No. | N/A |
|--------------------|------------------------|----------|-----|
| <b>description</b> | filter for dosing pump |          |     |



1

| GEV No.            | 510870                         | Ref. No. | N/A |
|--------------------|--------------------------------|----------|-----|
| <b>description</b> | filter support for dosing pump |          |     |



1

| GEV No.            | 510847  | Ref. No. | N/A |
|--------------------|---|----------|-----|
| <b>description</b> | gasket polishing agent dosing ID ø 22mm ED ø 32mm external height 5mm |          |     |



1

| GEV No.            | 510298                                     | Ref. No. | N/A |
|--------------------|--|----------|-----|
| <b>description</b> | lip valve dosing pump suitable for DB2/DS5 |          |     |





Зип Общепит

GERMANY

vsezip.ru

77(812)987-08-81

|   |   |                 |     |
|---|---|-----------------|-----|
|  |   |                 |     |
| 1   |   |                 |     |
| <b>GEV No.</b>  | 510297  | <b>Ref. No.</b> | N/A |
| <b>description</b>  | membrane for dosing pump ED ø 83mm thickness 1mm dosing pump equiv. no. 630614 suitable for COMENDA |                 |     |

|   |   |                 |     |
|---|---|-----------------|-----|
|  |   |                 |     |
| 1   |   |                 |     |
| <b>GEV No.</b>  | 510338  | <b>Ref. No.</b> | N/A |
| <b>description</b>  | union nut dosing pump thread 1/2" ø 32mm H 15mm for dosing pump |                 |     |

self-priming with supporting pressure

DIHR

|   |   |                 |                   |
|---|---|-----------------|-------------------|
|   |   |                 |                   |
| 1   |   |                 |                   |
| <b>GEV No.</b>  | 361744  | <b>Ref. No.</b> | 33D3240           |
| <b>description</b>  | dosing pump type DW with auxiliary pressure connection rinse aid inlet 4mm outlet 8mm suction connection ø 4mm auxiliary pressure connection 10mm   |                 |                   |
| <b>For models:</b>  | KD100, KD100A, KD100PSD, KD130E, KD130EAT, KD37, KD40, KD40E-PSD, KD40LEPS, KD40LSPS, KD40LUX, KD40LUXE, KD40-VERS.112009, KD60, KD60M, KD60MA, KD60MPS, KD60MPSA, KD60PS, KD60PSD, KD85, KD85A, KD85E, KD85EA, KD85EAT, KD85EATS, KD85EPS, KD85E-PSA, KD85PS, KD85PSA, KN1100, KN1100SD, KN11PSDD, KN35, KN37, KN37PS, KN40, KN40PS, KN40PSD, KN50, KN50M, KN50MPS, KN50PS, KN50PSD, KN50PSDD, KN80, KN800, KN800PSD, KN80PS, LP70 |                 |                   |
| <b>spare parts for</b>  | 361744  |                 |                   |
|  | <b>GEV No.</b>  | 520026          | <b>Ref. No.</b> — |
|   | PVC hose ID ø 4mm ED ø 6mm L 10m thickness 1mm t.max. 60°C transparent  |                 |                   |
|  | <b>GEV No.</b>  | 520090          | <b>Ref. No.</b> — |
|   | PVC hose ID ø 4mm ED ø 6mm L 2m thickness 1mm t.max. 60°C transparent   |                 |                   |

ELETTROBAR

|   |  |                 |     |
|---|--|-----------------|-----|
|  |  |                 |     |
| 1   |  |                 |     |
| <b>GEV No.</b>  | 510298                                     | <b>Ref. No.</b> | N/A |
| <b>description</b>  | lip valve dosing pump suitable for DB2/DS5 |                 |     |

|   |  |                 |     |
|---|--|-----------------|-----|
| <b>spare parts</b>  |  |                 |     |
|  |  |                 |     |
| 1   |  |                 |     |
| <b>GEV No.</b>  | 510298                                     | <b>Ref. No.</b> | N/A |
| <b>description</b>  | lip valve dosing pump suitable for DB2/DS5 |                 |     |

accessories

|  |  |                 |   |
|--|--|-----------------|---|
|  |  |                 |   |
| 1  |  |                 |   |
| <b>GEV No.</b>   | 361829                                       | <b>Ref. No.</b> | — |
| <b>description</b>   | container filter complete plastic hose ø 5mm |                 |   |

hose couplings

metal

|  |  |                 |         |
|--|--|-----------------|---------|
|  |  |                 |         |
| 1  |  |                 |         |
| <b>GEV No.</b>   | 361507   | <b>Ref. No.</b> | 3016150 |
| <b>description</b>   | screw pipe fitting angled nickel-plated brass thread 1/4" hose ø 6/8mm Qty 1 pcs |                 |         |

|   |   |                 |         |
|---|---|-----------------|---------|
|  |   |                 |         |
| 1   |   |                 |         |
| <b>GEV No.</b>  | 361506  | <b>Ref. No.</b> | 3014470 |
| <b>description</b>  | screw pipe fitting angled nickel-plated brass thread 1/8" hose ø 6/8mm Qty 1 pcs  |                 |         |
| <b>For models:</b>  | FM1011E2-VERS.2006, FM1011E3, FM1011E3-VERS.2006, FM1011G2-VERS.2006, FM1011G3, FM1011G3-VERS.2006, FM1221E2-VERS.2006, FM1221E3, FM1221E3-VERS.2006, FM1221G2-VERS.2006, FM1221G3, FM1221G3-VERS.2006, FM2011E2-VERS.2006, FM2011E3-VERS.2006, FM2011G2-VERS.2006, FM2011G3-VERS.2006, FM2021E2-VERS.2006, FM2021E3-VERS.2006, FM2021G2-VERS.2006, FM2021G3-VERS.2006, FM423E2, FM611E2-VERS.2006, FM611E3, FM611E3-VERS.2006, FM611G2-VERS.2006, FM611G3, FM611G3-VERS.2006, FM721E2-VERS.2006, FM721E3, FM721E3-VERS.2006, FM721G2-VERS.2006, FM721G3, FM721G3-VERS.2006, FX101E2, FX101E2C, FX101E2C-VERS.032014, FX101E2R, FX101E2R-VERS.032014, FX101E3, FX101E3C, FX101E3C-VERS.022014, FX101E3R, FX101E3R-VERS.022014, FX101E3-VERS.022014, FX101G2, FX101G2C, FX101G2C-VERS.032014, FX101G2R, FX101G2R-VERS.032014...(Other models you can see in the webshop) |                 |         |

|   |   |                 |         |
|---|---|-----------------|---------|
|  |   |                 |         |
| 1   |   |                 |         |
| <b>GEV No.</b>  | 361182  | <b>Ref. No.</b> | 3117580 |
| <b>description</b>  | nut thread 1/4" H 5mm nickel-plated brass WS 17 Qty 1 pcs |                 |         |
| <b>For models:</b>  | L100, L40, L40S, L60, L80, P5                             |                 |         |

T-pieces

without non-return valve



|                    |   |                 |         |
|--------------------|---|-----------------|---------|
| <b>GEV No.</b>     | 516082  | <b>Ref. No.</b> | 35Z1090 |
| <b>description</b> | T-piece plastic hose ø 12-7-12mm 3-way hose ø 12-7-12mmmm |                 |         |





|                    |   |                 |         |
|--------------------|---|-----------------|---------|
| <b>GEV No.</b>     | 519217  | <b>Ref. No.</b> | 33Q3070 |
| <b>description</b> | T-piece plastic hose ø 12-9-12mm 3-way hose ø 12-9-12mmmm             |                 |         |
| <b>For models:</b> | F60P, L45, LC100, LC100-VERS.2001, LC130, LC130-VERS.2001, LC80, LF50 |                 |         |

hoses

supply hoses

PVC supply hoses



|   |  |                 |                         |
|---|--|-----------------|-------------------------|
| <b>GEV No.</b>  | 520010   | <b>Ref. No.</b> | 33M0350                 |
| <b>description</b>  | supply hose PVC straight-curved DN13 connections 3/4" L 1500mm operating p. 10bar burst p. 32bar t.max. 90°C blue approval VDE flat seal |                 |                         |
| <b>accessories for</b>  | 520010   |                 |                         |
|  | <b>GEV No.</b>   | 520053          | <b>Ref. No.</b> —       |
|   | screen connection 3/4" D1 ø 26mm D2 ø 15mm Qty 10 pcs rubber thickness 8mm   |                 |                         |
|  | <b>GEV No.</b>   | 520054          | <b>Ref. No.</b> 3152480 |
|   | flat gasket rubber ED ø 23.5mm ID ø 14mm thickness 2.3mm Qty 10 pcs  |                 |                         |

drain hoses



|                    |  |                 |         |
|--------------------|--|-----------------|---------|
| <b>GEV No.</b>     | 530608   | <b>Ref. No.</b> | 33M1660 |
| <b>description</b> | drain hose DN24 L 1500mm A int. ø 24mm A ext. ø 28mm B int. ø 28mm B ext. ø 35mm outer hose ø 29mm temp.-resist. 90°C  |                 |         |
| <b>For models:</b> | KD100, KD100A, KD100PSD, KD40, KD40EPSD, KD40LEPS, KD40LSPS, KD40PS, KD60, KD60E, KD60EAT, KD60M, KD60MA, KD60ME, KD60MPS, KD60MPSA, KD60PS, KD60PSD, KD60EATSD, KN1100, KN1100SD, KN11PSDD, KN35, KN37PS, KN40PS, KN50MPS, KN50PS, KN50PSD, KN50PSDD, KN800, KN800PSD, KN80PS, N100D, N100S, N100VD, N100VS, N38D, N38S, N38VD, N38VS, N42D, N42S, N42VD, N42VS, N50D, N50S, N50VD, N50VS, N66D, N66S...(Other models you can see in the webshop) |                 |         |

Зип Общепит

vsezip.ru

+7(812)987-08-81



|                    |  |                 |         |
|--------------------|--|-----------------|---------|
| <b>GEV No.</b>     | 530574   | <b>Ref. No.</b> | 3033760 |
| <b>description</b> | drain hose DN24 L 2000mm A int. ø 31mm A ext. ø 35mm B int. ø 40mm B ext. ø 46mm outer hose ø 38mm |                 |         |
| <b>For models:</b> | KD85EATS, KD85EPS, KD85EPSA  |                 |         |



|                    |  |                 |                    |
|--------------------|--|-----------------|--------------------|
| <b>GEV No.</b>     | 519272   | <b>Ref. No.</b> | 3029590<br>36U0730 |
| <b>description</b> | drain hose DN24 L 1500mm straight ø inside 32mm straight ext. ø 35mm elbow ø inside 40mm elbow ext. ø 46mm outer hose ø 38mm                 |                 |                    |
| <b>For models:</b> | LC100, LC100-VERS.2001, LC130, LC130-VERS.2001, LC80, LF50, LF50E, LF50EM, LF50EMPS-VERS.122012, LF50EM-VERS.122012, LF50E-VERS.122012, LP70 |                 |                    |

industrial hoses

Niplaflex hoses



|                    |  |                 |  |
|--------------------|--|-----------------|--|
| <b>GEV No.</b>     | 530561   | <b>Ref. No.</b> | 111AA05<br>131AA12<br>131AA14<br>131AA16 |
| <b>description</b> | pressure hose ID ø 10mm ED ø 17mm L 5m thickness 3.5mm operating p. 10bar burst p. 30bar t.max. 110°C  |                 |  |
| <b>For models:</b> | 04WBMEV, 04WCP1EM, 06WCP1GM, 06WFR3GD, 08WCP1GM, 08WGREV, 090BM1E, 090BM1G, 091CP1E, 091CP1G, 0G1CP1EC, 0G1CP1E-VERS.2004, 0G1CP1G-VERS.2004, 10CP1EA, 10CP1GA, 10CP1IA, 10WFR4GD, 12CP1EA, 12CP1GA, 12CP1IA, 18CP2EA, 18CP2GA, 18CP2IA, 190BM2E, 190BM2G, 190GRE, 191BR1E, 191BR1G, 191BR1GA, 191BR2E, 191BR2EA, 191BR2G, 191BR2GA, 191CP1G, 191CP2G, 1G0GRE, 1G1CP1G-VERS.2004, 1G1CP2G-VERS.2004, 291BR1E, 291BR1G, 291BR1GA, 291BR2E, 291BR2EA, 291BR2G, 291BR2GA, 6040090, 6040110, 6040310, 6042610, 6042630...(Other models you can see in the webshop) |                 |  |

pressure control hoses



|                    |   |                 |         |
|--------------------|---|-----------------|---------|
| <b>GEV No.</b>     | 530560  | <b>Ref. No.</b> | 111AA04 |
| <b>description</b> | pressure control hose ID ø 5mm ED ø 9mm L 5m operating p. 30bar burst p. 90bar temp.-resist. 60°C |                 |         |



Зип-Общепит

vsezip.ru

+7(812)987-08-81

PU hoses



1

|                    |   |                 |         |
|--------------------|---|-----------------|---------|
| <b>GEV No.</b>     | 512475  | <b>Ref. No.</b> | 3003920 |
| <b>description</b> | dosing hose ED ø 8mm ID ø 6mm polyurethane blue Qty supplied by meter   |                 |         |
| <b>For models:</b> | FM1011E3, FM1011E3-VERS.2006, FM1011G3, FM1011G3-VERS.2006, FM1221E3, FM1221E3-VERS.2006, FM1221G3-VERS.2006, FM2011E3-VERS.2006, FM2011G3-VERS.2006, FM2021E3, FM2021E3-VERS.2006, FM2021G3, FM2021G3-VERS.2006, FM611E3, FM611E3-VERS.2006, FM611G3, FM611G3-VERS.2006, FM721E3, FM721E3-VERS.2006, FM721G3, FM721G3-VERS.2006, FX101E3, FX101E3C, FX101E3C-VERS.022014, FX101E3R, FX101E3R-VERS.022014, FX101E3-VERS.022014, FX101G3, FX101G3C, FX101G3C-VERS.022014, FX101G3R, FX101G3R-VERS.022014, FX101G3-VERS.022014, FX10E3CR, FX10E3CR-VERS.022014, FX10G3CR, FX10G3CR-VERS.022014, FX122E3, FX122E3C, FX122E3T, FX122E3T-VERS.022014, FX122G3, FX122G3C, FX122G3T, FX122G3T-VERS.022014, FX12E3CT, FX12E3CT-VERS.022014, FX12G3CT, FX12G3CT-VERS.022014, FX201E3...(Other models you can see in the webshop) |                 |         |



1

|                    |  |                 |         |
|--------------------|--|-----------------|---------|
| <b>GEV No.</b>     | 510677   | <b>Ref. No.</b> | 3000290 |
| <b>description</b> | dosing hose ED ø 8mm ID ø 6mm polyurethane red Qty supplied by meter   |                 |         |
| <b>For models:</b> | FM1011E3, FM1011E3-VERS.2006, FM1011G3, FM1011G3-VERS.2006, FM1221E3, FM1221E3-VERS.2006, FM1221G3-VERS.2006, FM2011E3-VERS.2006, FM2011G3-VERS.2006, FM2021E3, FM2021E3-VERS.2006, FM2021G3, FM2021G3-VERS.2006, FM611E3, FM611E3-VERS.2006, FM611G3, FM611G3-VERS.2006, FM721E3, FM721E3-VERS.2006, FM721G3, FM721G3-VERS.2006, FX101E3, FX101E3C, FX101E3R, FX101G3, FX101G3C, FX101G3R, FX10E3CR, FX10G3CR, FX122E3, FX122E3C, FX122G3, FX122G3C, FX201E3, FX202E3, FX61E3, FX61E3C, FX61E3CR, FX61E3R, FX61G3, FX61G3C, FX61G3CR, FX61G3R, FX82E3, FX82E3C, FX82G3, FX82G3C |                 |         |



1

|                    |  |                 |         |
|--------------------|--|-----------------|---------|
| <b>GEV No.</b>     | 519160   | <b>Ref. No.</b> | 33M1260 |
| <b>description</b> | formed hose L 150mm warewashing L-shape equiv. no. 903876 W 110mm hose int. ø 40mm |                 |         |
| <b>For models:</b> | LF50, LF50E, LF50EM, LP70  |                 |         |



1

|                    |  |                 |         |
|--------------------|--|-----------------|---------|
| <b>GEV No.</b>     | 517228   | <b>Ref. No.</b> | 3115800 |
| <b>description</b> | formed hose warewashing L-shape equiv. no. 15032/A |                 |         |
| <b>For models:</b> | KD130, KD130A, KD130E, KD130EAT                    |                 |         |



1

|                    |  |                 |         |
|--------------------|--|-----------------|---------|
| <b>GEV No.</b>     | 519382   | <b>Ref. No.</b> | 3300230 |
| <b>description</b> | formed hose warewashing L-shape hose int. ø 44mm |                 |         |
| <b>For models:</b> | F60P, F60PR, F60T, L45                           |                 |         |



1

|                    |  |                 |         |
|--------------------|--|-----------------|---------|
| <b>GEV No.</b>     | 512384   | <b>Ref. No.</b> | 32Z2810 |
| <b>description</b> | formed hose warewashing L-shape L2 100mm hose ext. ø 65mm hose int. ø 45mm |                 |         |

formed hoses

straight



1

|                    |  |                 |         |
|--------------------|--|-----------------|---------|
| <b>GEV No.</b>     | 506412   | <b>Ref. No.</b> | 111AA08 |
| <b>description</b> | formed hose dishwasher straight hose ext. ø 60mm hose int. ø 50mm  |                 |         |
| <b>For models:</b> | FM1221E1, FM1221E2, FM1221E3, FM1221G1, FM1221G2, FM1221G3, FM2021E1, FM2021E2, FM2021E3, FM2021G1, FM2021G2, FM2021G3, FM721E1, FM721E2, FM721E3, FM721G1, FM721G2, FM721G3, FX101E1, FX101E1R, FX101E2, FX101E2C, FX101E2R, FX101E3, FX101E3C, FX101E3R, FX101G1, FX101G1R, FX101G2, FX101G2C, FX101G2R, FX101G3, FX101G3C, FX101G3R, FX10E2CR, FX10E3CR, FX10G2CR, FX10G3CR, FX61E1, FX61E1R, FX61E2, FX61E2C, FX61E2CR, FX61E2R, FX61E3, FX61E3C, FX61E3CR, FX61E3R, FX61G1, FX61G1R...(Other models you can see in the webshop) |                 |         |



with branch



1

|                    |   |                 |         |
|--------------------|---|-----------------|---------|
| <b>GEV No.</b>     | 517364  | <b>Ref. No.</b> | 3031860 |
| <b>description</b> | formed hose ext. ø 58 D1 ø 50mm D2 ø 35mm L 455mm black Qty 1 |                 |         |
| <b>For models:</b> | KD130, KD130A, KD130E, KD130EAT                               |                 |         |



1

|                    |                                  |                 |         |
|--------------------|----------------------------------|-----------------|---------|
| <b>GEV No.</b>     | 517361                           | <b>Ref. No.</b> | 3031860 |
| <b>description</b> | formed hose L 450mm rubber Qty 1 |                 |         |

form S



1

|                    |   |                 |         |
|--------------------|---|-----------------|---------|
| <b>GEV No.</b>     | 510678  | <b>Ref. No.</b> | 3300240 |
| <b>description</b> | formed hose hose ext. ø 48mm hose int. ø 39mm L 235mm Qty 1 S-shape |                 |         |
| <b>For models:</b> | F60P, F60PR, F60T, L45  |                 |         |

Зип-Общепит

for dishwashers

miscellaneous

vsezip.ru



|                    |   |                 |         |
|--------------------|---|-----------------|---------|
| <b>GEV No.</b>     | 530590  | <b>Ref. no.</b> | 33M1310 |
| <b>description</b> | hose ED ø 15mm ID ø 8mm equiv. no. 200117 Qty supplied by meter |                 |         |

fittings, hose and pipe connectors

hose connectors

without screw connection



1

|                    |   |                 |         |
|--------------------|---|-----------------|---------|
| <b>GEV No.</b>     | 519216  | <b>Ref. No.</b> | 36G9050 |
| <b>description</b> | T-piece plastic hose ø 12-12-12mm 3-way   |                 |         |
| <b>For models:</b> | LC100, LC100-VERS.2001, LC130, LC130-VERS.2001, LC80, LF50, LF50E, LF50EM, LP70 |                 |         |



1

|                    |   |                 |         |
|--------------------|---|-----------------|---------|
| <b>GEV No.</b>     | 516082  | <b>Ref. No.</b> | 35Z1090 |
| <b>description</b> | T-piece plastic hose ø 12-7-12mm 3-way hose ø 12-7-12mmmm |                 |         |



1

|                    |   |                 |         |
|--------------------|---|-----------------|---------|
| <b>GEV No.</b>     | 519217  | <b>Ref. No.</b> | 33Q3070 |
| <b>description</b> | T-piece plastic hose ø 12-9-12mm 3-way hose ø 12-9-12mmmm             |                 |         |
| <b>For models:</b> | F60P, L45, LC100, LC100-VERS.2001, LC130, LC130-VERS.2001, LC80, LF50 |                 |         |



Зип-Общепит

vsezip.ru

+7(812)987-08-81



1

|                    |  |                 |         |
|--------------------|--|-----------------|---------|
| <b>GEV No.</b>     | 519630   | <b>Ref. No.</b> | 3008090 |
| <b>description</b> | T-piece plastic hose ø 6x6x6mm 3-way   |                 |         |
| <b>For models:</b> | 191CP1G, 1G1CP1G-VERS.2004, FM1011E3, FM1011E3-VERS.2006, FM1011G3, FM1011G3-VERS.2006, FM1221E3-VERS.2006, FM1221G3-VERS.2006, FM2011E3-VERS.2006, FM2011G3-VERS.2006, FM2021E3-VERS.2006, FM2021G3-VERS.2006, FM611E3, FM611E3-VERS.2006, FM611G3, FM611G3-VERS.2006, FM721E3-VERS.2006, FM721G3-VERS.2006 |                 |         |



1

|                    |  |                 |         |
|--------------------|--|-----------------|---------|
| <b>GEV No.</b>     | 520700   | <b>Ref. No.</b> | 33Q5650 |
| <b>description</b> | reducer thread 3/4" IT - 1/2" ET brass   |                 |         |
| <b>For models:</b> | FCV101, FCV101-CSA, FCV101DM, FCV101DM-CSA, FCV101DS, FCV101DS-CSA, FCV101E, FCV101EDM, FCV101EDM-UL, FCV101EDS, FCV101EDS-UL, FCV101E-UL, FCV141, FCV141-CSA, FCV141DM, FCV141DM-CSA, FCV141DS, FCV141DS-CSA, FCV141E, FCV141EDM, FCV141EDS, FCV241, FCV241DM, FCV241DS, FCV241E, FCV241EDM, FCV241EDM-UL, FCV241EDS, FCV241EDS-UL, FCV241E-UL, FCV241G, FCV241G-CSA, FCV241GDM, FCV241GDM-CSA, FCV241GDS, FCV241GDS-CSA, FCV3EM, FCV401DM, FCV401DM-CSA, FCV401EDM, FCV401EDM-UL, FCV4E, FCV4EDS, FCV4EM, FCV61, FCV61-CSA, FCV61DM, FCV61DM-CSA, FCV61DS, FCV61DS-CSA...(Other models you can see in the webshop) |                 |         |

fittings

double nipples



1

|                    |  |                 |         |
|--------------------|--|-----------------|---------|
| <b>GEV No.</b>     | 520160   | <b>Ref. No.</b> | 3005480 |
| <b>description</b> | double nipple nickel-plated brass thread 1/8" - 1/8" Qty 1 pcs |                 |         |



1

|                    |  |                 |         |
|--------------------|--|-----------------|---------|
| <b>GEV No.</b>     | 520177   | <b>Ref. No.</b> | 3040920 |
| <b>description</b> | reducer thread 1/4" ET - 1/8" IT nickel-plated brass total length 13mm WS 17 |                 |         |



1

|                    |   |                 |         |
|--------------------|---|-----------------|---------|
| <b>GEV No.</b>     | 541504  | <b>Ref. No.</b> | 33Q5880 |
| <b>description</b> | double nipple thread 1/2" - 1/2"  |                 |         |
| <b>For models:</b> | FC101, FC241G, FC61, FCV101, FCV101-CSA, FCV101DM, FCV101DM-CSA, FCV101DS, FCV101DS-CSA, FCV141-CSA, FCV141DM-CSA, FCV141DS-CSA, FCV241G, FCV241G-CSA, FCV241GDM, FCV241GDM-CSA, FCV241GDS, FCV241GDS-CSA, FCV401DM, FCV401DM-CSA, FCV61, FCV61-CSA, FCV61DM, FCV61DM-CSA, FCV61DS, FCV61DS-CSA |                 |         |

angle pieces



1

|                    |   |                 |         |
|--------------------|---|-----------------|---------|
| <b>GEV No.</b>     | 541924  | <b>Ref. No.</b> | 33Q4790 |
| <b>description</b> | angle piece thread 1/2" IT - 1/2" IT brass  |                 |         |
| <b>For models:</b> | C165D, C165S, C165VD, C165VS, C207D, C207S, C207VD, C207VD-VERS.2006, C207VS, C207VS-VERS.2006, C304AD, C304AS, C304AVD, C304AVD-VERS.2006, C304AVS, C304AVS-VERS.2006, C304D, C304S, C304VD, C304VD-VERS.2006, C304VS, C304VS-VERS.2006, C92VD-VERS.2006, C92VS-VERS.2006, CS243D, CS243S, CS243VD, CS243VD-VERS.2006, CS243VS, CS243VS-VERS.2006, CS370AD, CS370AS, CS370AVD, CS370AVD-VERS.2006, CS370AVS, CS370A-VS-VERS.2006, CS370D, CS370S, CS370VD, CS370VD-VERS.2006, CS370VS, CS370VS-VERS.2006, CS466AD, CS466AS, CS466AVD, CS466AVD-VERS.2006, CS466AVS, CS466AVS-VERS.2006, CS466D, CS466S...(Other models you can see in the webshop) |                 |         |



1

|                    |   |                 |         |
|--------------------|---|-----------------|---------|
| <b>GEV No.</b>     | 520883  | <b>Ref. No.</b> | 3020420 |
| <b>description</b> | reducer SS thread 1" - 1/4" Qty 1 pcs L1 15mm L2 7mm WS 50  |                 |         |
| <b>For models:</b> | KD100, KD100A, KD100PSD, N100D, N100S, N100VD, N100VS, N38D, N38S, N38VD, N38VS, N42D, N42S, N42VD, N42VS, N50D, N50S, N50VD, N50VS, N66D, N66S, N66VD, N66VS, N70D, N70S, N70VD, N70VS, N85D, N85S, N85VD, N85VS |                 |         |



Зип Общепит  
vsezip.ru  
+7(812)987-08-81

|  |  |                 |         |
|--|--|-----------------|---------|
|  |  |                 |         |
| 1  |  |                 |         |
| <b>GEV No.</b>   | 541493   | <b>Ref. No.</b> | 33Q3900 |
| <b>description</b>   | angle piece thread 1/2" IT - 1/2" ET chrome-plated brass   |                 |         |
| <b>For models:</b>   | 1A1PI1G, 1A1PI1GA, 1A1PI2E, 1A1PI2EA, 1A1PI2V, 1A1PI2VA, 1D1PI1G, 1D1PI1GA, 1D1PI2E, 1D1PI2EA, 1D1PI2V, 1D1PI2VA, 2A1PI3G, 2D1PI3G |                 |         |

|   |   |                 |         |
|---|---|-----------------|---------|
|  |   |                 |         |
| <b>GEV No.</b>  | 541492  | <b>Ref. No.</b> | 33Q0570 |
| <b>description</b>  | angle piece thread 1/2" IT - 1/2" ET chrome-plated brass  |                 |         |
| <b>For models:</b>  | FCV3EM, FCV4E, FCV4EDS, FCV4EM, FM1011E3, FM1011G3, FM1221E3, FM1221G3, FM423E1, FM423E2, FM611E3, FM611G3, FM721E3, FM721G3, L100, L40S, L80, PIER06HD, PIER15HD |                 |         |

|  |  |                 |         |
|--|--|-----------------|---------|
|  |  |                 |         |
| 1  |  |                 |         |
| <b>GEV No.</b>   | 520821   | <b>Ref. No.</b> | 33Q4360 |
| <b>description</b>   | angle piece thread 1/4" IT - 1/4" IT nickel-plated brass   |                 |         |
| <b>For models:</b>   | LC100, LC100-VERS.2001, LC130, LC130-VERS.2001, LC80, LP124S-VERS.052006, LP124-VERS.052006, LP124VS-VERS.052006, LP124V-VERS.052006, LP84S-VERS.052006, LP84-VERS.052006, LP84VS-VERS.052006, LP84V-VERS.052006 |                 |         |

|  |   |                 |         |
|--|---|-----------------|---------|
| <b>T-pieces</b>  |   |                 |         |
| nickel-plated brass  |   |                 |         |
|  |   |                 |         |
| 1  |   |                 |         |
| <b>GEV No.</b>   | 520385  | <b>Ref. No.</b> | 3003770 |
| <b>description</b>   | T-piece thread 1/8" IT - 1/8" IT - 1/8" IT nickel-plated brass L 35mm |                 |         |
| <b>For models:</b>   | FM1011E3, FM1011G3, FM1221E3, FM611E3, FM611G3, FM721E3, FM721G3      |                 |         |

|  |  |                 |         |
|--|--|-----------------|---------|
|  |  |                 |         |
| 1  |  |                 |         |
| <b>GEV No.</b>   | 520824   | <b>Ref. No.</b> | 3003750 |
| <b>description</b>   | angle piece thread 1/8" ET - 1/8" IT nickel-plated brass                     |                 |         |
| <b>For models:</b>   | FM1011E3, FM1011G3, FM1221E3, FM1221G3, FM2021E3, FM2021G3, FM611E3, FM611G3 |                 |         |

|  |  |                 |         |
|--|--|-----------------|---------|
| <b>Y-pieces</b>  |  |                 |         |
|  |  |                 |         |
| 1  |  |                 |         |
| <b>GEV No.</b>   | 521197   | <b>Ref. No.</b> | 36E4290 |
| <b>description</b>   | Y-piece thread 1/8" IT - 1/8" IT - 1/8" IT stainless steel WS 13           |                 |         |
| <b>For models:</b>   | FM1011E3, FM1011G3, FM1221E3, FM1221G3, FM611E3, FM611G3, FM721E3, FM721G3 |                 |         |

|   |  |                 |         |
|---|--|-----------------|---------|
|  |  |                 |         |
| 1   |  |                 |         |
| <b>GEV No.</b>  | 541496   | <b>Ref. No.</b> | 33Q5280 |
| <b>description</b>  | angle piece thread 1/2" ET - 3/4" IT zinc-coated cast iron |                 |         |

|  |  |                 |         |
|--|--|-----------------|---------|
| <b>hose connectors</b>   |  |                 |         |
| plastic  |  |                 |         |
|  |  |                 |         |
| 1  |  |                 |         |
| <b>GEV No.</b>   | 361735   | <b>Ref. No.</b> | 33Q5040 |
| <b>description</b>   | hose connector plastic angled thread 1/4" hose ø 7mm Qty 1 pcs |                 |         |

|   |  |                 |         |
|---|--|-----------------|---------|
|  |  |                 |         |
| 1   |  |                 |         |
| <b>GEV No.</b>  | 541494   | <b>Ref. No.</b> | 33Q0600 |
| <b>description</b>  | angle piece thread 3/4" ET - 3/4" IT zinc-coated cast iron   |                 |         |
| <b>For models:</b>  | ACBM, ACBM218, ANBM, ANBM218, ANBM75, L100, L80, SE14VB, SE21VB, S114VB, S121VB, SL14CVB, SL14NVB, SL21CVB, SL21NVB, SL7NVB, TBM, TBM218 |                 |         |





Зип Общежит

product specification

vsezip.ru

+7(812)987-08-81

nickel-plated brass

|   |   |                 |         |
|---|---|-----------------|---------|
|  |   |                 |         |
| 1   |   |                 |         |
| <b>GEV No.</b>  | 520159  | <b>Ref. No.</b> | 3007950 |
| <b>description</b>  | hose connector nickel-plated brass straight thread 1/8" hose ø 6mm Qty 1 pcs WS 12 total length 32mm thread L 7.5mm grommet ø 6mm grommet length 19.5mm |                 |         |
| <b>For models:</b>  | FM1011E3, FM1011G3, FM1221E3, FM1221G3, FM2021E3, FM2021G3, FM423E2, FM611E3, FM611G3, FM721E3, FM721G3   |                 |         |

|   |   |                 |         |
|---|---|-----------------|---------|
|  |   |                 |         |
| 1   |   |                 |         |
| <b>GEV No.</b>  | 517108  | <b>Ref. No.</b> | 3110340 |
| <b>description</b>  | hose connector nickel-plated brass angled thread 3/8" ET - M10x1 IT hose ø 12mm Qty 1 pcs |                 |         |

|   |  |                 |         |
|---|--|-----------------|---------|
|  |  |                 |         |
| 1   |  |                 |         |
| <b>GEV No.</b>  | 519239   | <b>Ref. No.</b> | 33Q4270 |
| <b>description</b>  | hose connector nickel-plated brass thread 1/4" hose ø 11mm Qty 1 pcs |                 |         |

|   |  |                 |         |
|---|--|-----------------|---------|
|  |  |                 |         |
| 1   |  |                 |         |
| <b>GEV No.</b>  | 361507   | <b>Ref. No.</b> | 3016150 |
| <b>description</b>  | screw pipe fitting angled nickel-plated brass thread 1/4" hose ø 6/8mm Qty 1 pcs |                 |         |

|   |  |                 |         |
|---|--|-----------------|---------|
|  |  |                 |         |
| 1   |  |                 |         |
| <b>GEV No.</b>  | 361506   | <b>Ref. No.</b> | 3014470 |
| <b>description</b>  | screw pipe fitting angled nickel-plated brass thread 1/8" hose ø 6/8mm Qty 1 pcs   |                 |         |
| <b>For models:</b>  | FM1011E2-VERS.2006, FM1011E3, FM1011E3-VERS.2006, FM1011G2-VERS.2006, FM1011G3, FM1011G3-VERS.2006, FM1221E2-VERS.2006, FM1221E3, FM1221E3-VERS.2006, FM1221G2-VERS.2006, FM1221G3, FM1221G3-VERS.2006, FM2011E2-VERS.2006, FM2011E3-VERS.2006, FM2011G2-VERS.2006, FM2011G3-VERS.2006, FM2021E2-VERS.2006, FM2021E3-VERS.2006, FM2021G2-VERS.2006, FM2021G3-VERS.2006, FM423E2, FM611E2-VERS.2006, FM611E3, FM611E3-VERS.2006, FM611G2-VERS.2006, FM611G3, FM611G3-VERS.2006, FM721E2-VERS.2006, FM721E3, FM721E3-VERS.2006, FM721G2-VERS.2006, FM721G3, FM721G3-VERS.2006, FX101E2, FX101E2C, FX101E2C-VERS.032014, FX101E2R, FX101E2R-VERS.032014, FX101E2-VERS.032014, FX101E3, FX101E3C, FX101E3C-VERS.022014, FX101E3R, FX101E3R-VERS.022014, FX101E3-VERS.022014, FX101G2, FX101G2C, FX101G2C-VERS.032014, FX101G2R, FX101G2R-VERS.032014...(Other models you can see in the webshop) |                 |         |

|  |                |                 |         |
|--|----------------|-----------------|---------|
|  |                |                 |         |
| 1  |                |                 |         |
| <b>GEV No.</b>   | 519291         | <b>Ref. No.</b> | 3012220 |
| <b>description</b>   | hose connector |                 |         |

|  |   |                 |         |
|--|---|-----------------|---------|
|  |   |                 |         |
| 1  |   |                 |         |
| <b>GEV No.</b>   | 541490  | <b>Ref. No.</b> | 33Q0590 |
| <b>description</b>   | hose connector thread 1/2" grommet ø 15mm       |                 |         |
| <b>For models:</b>   | ACBM, ACBM218, ANBM75, SL14CVB, SL21CVB, SL7NVB |                 |         |

|  |  |                 |         |
|--|--|-----------------|---------|
|  |  |                 |         |
| 1  |  |                 |         |
| <b>GEV No.</b>   | 541489                                       | <b>Ref. No.</b> | 33Q0150 |
| <b>description</b>   | hose connector thread 1/2" IT grommet ø 15mm |                 |         |
| <b>For models:</b>   | L40, L60                                     |                 |         |

|  |  |                 |         |
|--|--|-----------------|---------|
|  |  |                 |         |
| 1  |  |                 |         |
| <b>GEV No.</b>   | 520337   | <b>Ref. No.</b> | 3007980 |
| <b>description</b>   | hose connector thread 1/4" grommet ø 7mm ID ø 4.5mm grommet length 19mm WS 14 total length 35mm thread L 10mm  |                 |         |
| <b>For models:</b>   | 04WCP1EM, 06WCP1GM, 08WCP1GM, 091CP1E, 091CP1G, 0G1CP1EC, 0G1CP1E-VERS.2004, 0G1CP1G-VERS.2004, 191CP1G, 191CP2G, 1G1CP1G-VERS.2004, 1G1CP2G-VERS.2004, 6040090, 6040310, 6043850, 6043980, FM1011E3, FM1011G3, FM1221E3, FM1221G3, FM611E3, FM611G3, FM721E3, FM721G3 |                 |         |

|  |   |                 |         |
|--|---|-----------------|---------|
|  |   |                 |         |
| 1  |   |                 |         |
| <b>GEV No.</b>   | 541491                                    | <b>Ref. No.</b> | 33Q1060 |
| <b>description</b>   | hose connector thread 3/4" grommet ø 19mm |                 |         |

Зип-Общепит

vsezip.ru

+7(812)987-08-81



1

|                    |   |                 |         |
|--------------------|---|-----------------|---------|
| <b>GEV No.</b>     | 541497  | <b>Ref. No.</b> | 33Q5450 |
| <b>description</b> | hose connector thread 3/4" grommet ø 28mm   |                 |         |
| <b>For models:</b> | FC101, FC101E, FC241, FC241E, FC241G, FC61, FC61E, FCV101, FCV101-CSA, FCV101DM, FCV101DM-CSA, FCV101DS, FCV101DS-CSA, FCV101E, FCV101EDM, FCV101EDM-UL, FCV101EDS, FCV101EDS-UL, FCV101E-UL, FCV141, FCV141-CSA, FCV141DM, FCV141DM-CSA, FCV141DS, FCV141DS-CSA, FCV141E, FCV141EDM, FCV141EDS, FCV241, FCV241DM, FCV241DS, FCV241E, FCV241EDM, FCV241EDM-UL, FCV241EDS, FCV241EDS-UL, FCV241E-UL, FCV241G, FCV241G-CSA, FCV241GDM, FCV241GDM-CSA, FCV241GDS, FCV241GDS-CSA, FCV3EM, FCV401DM, FCV401DM-CSA, FCV4E, FCV4EDS, FCV4EM, FCV61...(Other models you can see in the webshop) |                 |         |

ball valve with lever handle





1

|                    |  |                 |         |
|--------------------|--|-----------------|---------|
| <b>GEV No.</b>     | 540730   | <b>Ref. No.</b> | 33D0170 |
| <b>description</b> | ball valve connection 3/4" IT - 3/4" IT DN20 total length 70mm with lever handle handle length 95mm                        |                 |         |
| <b>For models:</b> | 030BME, 030EBM, 030FE, 031BME, 031EBM, 070BM, 070BME, 071BM, 071BME, 090BM, 090BME, 091BM, 091BME, 30F, 30FES, 30FS, 70FES |                 |         |



2

|   |   |                 |                         |
|---|---|-----------------|-------------------------|
| <b>GEV No.</b>  | 541488  | <b>Ref. No.</b> | 33Q5591<br>33Q5592      |
| <b>description</b>  | hose connector thread M14x1 ET - 1/8" IT angled   |                 |                         |
| <b>For models:</b>  | FC101, FC101E, FC241, FC241E, FC241G, FC61, FC61E, FCV101, FCV101-CSA, FCV101DM, FCV101DM-CSA, FCV101DS, FCV101DS-CSA, FCV101E, FCV101EDM, FCV101EDM-UL, FCV101EDS, FCV101EDS-UL, FCV101E-UL, FCV141, FCV141-CSA, FCV141DM, FCV141DM-CSA, FCV141DS, FCV141DS-CSA, FCV141E, FCV141EDM, FCV141EDS, FCV241, FCV241DM, FCV241DS, FCV241E, FCV241EDM, FCV241EDM-UL, FCV241EDS, FCV241EDS-UL, FCV241E-UL, FCV241G, FCV241G-CSA, FCV241GDM, FCV241GDM-CSA, FCV241GDS, FCV241GDS-CSA, FCV3EM, FCV401DM, FCV401DM-CSA, FCV401EDM, FCV401EDM-UL, FCV4E, FCV4EDS...(Other models you can see in the webshop) |                 |                         |
| <b>accessories for</b>  | 541488  |                 |                         |
|  | <b>GEV No.</b>  | 541507          | <b>Ref. No.</b> 33T4110 |
|   | nozzle cooling thread 1/8"  |                 |                         |
|  | <b>GEV No.</b>  | 541509          | <b>Ref. No.</b> 33T3720 |
|   | nozzle cooling thread 1/8"  |                 |                         |

producer-specific

ANGELO PO



1

|                    |  |                 |         |
|--------------------|--|-----------------|---------|
| <b>GEV No.</b>     | 514080   | <b>Ref. No.</b> | 33D1530 |
| <b>description</b> | ball valve handle length 70mm L 83mm inlet 3/4" IT lever handle outlet ø30mm |                 |         |



1

|                    |   |                 |         |
|--------------------|---|-----------------|---------|
| <b>GEV No.</b>     | 540687  | <b>Ref. No.</b> | 33D0890 |
| <b>description</b> | ball valve inlet 1" ET outlet 1" IT L 92mm without handle shaft ø 13x10mm |                 |         |
| <b>For models:</b> | 70F, 71F, 71FE  |                 |         |

## valves and tank inlets

### ball valves

#### universal

#### ball valves with butterfly handle



1

|                    |  |                 |         |
|--------------------|--|-----------------|---------|
| <b>GEV No.</b>     | 542182   | <b>Ref. No.</b> | 33A0850 |
| <b>description</b> | ball valve connection 1/2" IT - 1/2" IT DN15 total length 50mm |                 |         |



1



|                    |   |                 |         |
|--------------------|---|-----------------|---------|
| <b>GEV No.</b>     | 514392  | <b>Ref. No.</b> | 33D0250 |
| <b>description</b> | ball valve inlet 1" IT outlet 1" IT L 69mm without handle shaft ø 9x12mm shaft L 54mm |                 |         |



shut-off valves

universal





|  |  |                 |                         |
|--|--|-----------------|-------------------------|
| <b>GEV No.</b>   | 540694   | <b>Ref. No.</b> | 33D2040                 |
| <b>description</b>   | shut-off valve connection 1/2" 1/2" without handle total length 124.5mm mounting pos. any shaft L 15mm rosette thread G2 1" shaft ø 7.8mm  |                 |                         |
| <b>For models:</b>   | 0A1CP1E, 0A1CP1G, 0B1CP1G, 0D1CP1E, 0D1CP1G, 191CP1GA, 1A1BR1E, 1A1BR1G, 1A1BR1GA, 1A1BR2E, 1A1BR2EA, 1A1BR2G, 1A1BR2GA, 1A1CP1G, 1A1CP1GA, 1A1CP2G, 1A1PD1G, 1A1PD2G, 1A1PI1G, 1A1PI1GA, 1A1PI2E, 1A1PI2EA, 1A1PI2G, 1A1PI2GA, 1A1PI2V, 1A1PI2VA, 1D1BR1E, 1D1BR1G, 1D1BR1GA, 1D1BR2E, 1D1BR2EA, 1D1BR2G, 1D1BR2GA, 1D1CP1G, 1D1CP1GA, 1D1CP2G, 1D1PD1G, 1D1PD2G, 1D1PI1G, 1D1PI1GA, 1D1PI2E, 1D1PI2EA, 1D1PI2G, 1D1PI2GA, 1D1PI2V, 1D1PI2VA, 2A1BR1E, 2A1BR1G, 2A1BR1GA, 2A1BR2E...(Other models you can see in the webshop) |                 |                         |
| <b>accessories for</b>   | 540694   |                 |                         |
|   | <b>GEV No.</b>   | 514090          | <b>Ref. No.</b> —       |
|  | star handle cold/warm  |                 |                         |
|   | <b>GEV No.</b>   | 520666          | <b>Ref. No.</b> 36Q0590 |
|  | union nut thread 1/2" H 12mm   |                 |                         |
|  | <b>GEV No.</b>   | 541818          | <b>Ref. No.</b> —       |
|  | rosette chrome-plated thread 28x19G ø 58mm H 25mm WS   |                 |                         |

producer-specific

ANGELO PO



|   |   |                 |                                    |
|---|---|-----------------|------------------------------------|
| <b>GEV No.</b>  | 514385  | <b>Ref. No.</b> | 3005990<br>33D2930                 |
| <b>description</b>  | shut-off valve connection 3/8" 3/8" without handle mounting pos. any  |                 |                                    |
| <b>For models:</b>  | 0A0BME, 0A0BMG, 0A1CP1E, 0A1CP1G, 0B1CP1G, 0D0BME, 0D0BMG, 0D1CP1E, 0D1CP1G, 0G1CP1E, 0G1CP1G, 191PD1G, 191PD2G, 191PI1G, 191PI1GA, 191PI2E, 191PI2EA, 191PI2G, 191PI2GA, 191PI2V, 191PI2VA, 1A0BME, 1A0BMG, 1A1BR1E, 1A1BR1G, 1A1BR1GA, 1A1BR2E, 1A1BR2EA, 1A1BR2G, 1A1BR2GA, 1A1CP1G, 1A1CP2G, 1A1PD1G, 1A1PD2G, 1A1PI1G, 1A1PI1GA, 1A1PI2E, 1A1PI2EA, 1A1PI2G, 1A1PI2GA, 1A1PI2V, 1A1PI2VA, 1D0BME, 1D0BMG, 1D1BR1E, 1D1BR1G, 1D1BR1GA, 1D1BR2E, 1D1BR2EA, 1D1BR2G...(Other models you can see in the webshop) |                 |                                    |
| <b>spare parts for</b>  | 514385  |                 |                                    |
|  | <b>GEV No.</b>  | 541533          | <b>Ref. No.</b> —                  |
|   | handle cold water H 39.5mm blue ID ø 32.5mm ED ø 50mm   |                 |                                    |
|  | <b>GEV No.</b>  | 541813          | <b>Ref. No.</b> 36M2631<br>36M2632 |
|   | star handle cold total length 36mm shaft intake ø 8mm plastic for valve   |                 |                                    |

3ип Общепит  
vsezip.ru  
+7(812)987-08-81

|                    |  |                 |         |
|--------------------|--|-----------------|---------|
| <b>GEV No.</b>     | 541587   | <b>Ref. No.</b> | 6300728 |
| <b>description</b> | shut-off valve connection 3/8" conversion kit  |                 |         |
| <b>For models:</b> | 1A1BR1E, 1A1BR1G, 1A1BR1GA, 1A1BR2E, 1A1BR2EA, 1A1BR2G, 1A1BR2GA, 1D1BR1E, 1D1BR1G, 1D1BR1GA, 1D1BR2E, 1D1BR2EA, 1D1BR2G, 1D1BR2GA, 2A1BR1E, 2A1BR1G, 2A1BR1GA, 2A1BR2E, 2A1BR2EA, 2A1BR2G, 2A1BR2GA, 2D1BR1E, 2D1BR1G, 2D1BR1GA, 2D1BR2E, 2D1BR2EA, 2D1BR2G, 2D1BR2GA |                 |         |



|                    |  |                 |         |
|--------------------|--|-----------------|---------|
| <b>GEV No.</b>     | 541588   | <b>Ref. No.</b> | 6300729 |
| <b>description</b> | shut-off valve connection 3/8" conversion kit                                    |                 |         |
| <b>For models:</b> | 0A1CP1E, 0A1CP1G, 0D1CP1E, 0D1CP1G, 191CP1GA, 1A1CP1G, 1A1CP2G, 1D1CP1G, 1D1CP2G |                 |         |



|                    |  |                 |         |
|--------------------|--|-----------------|---------|
| <b>GEV No.</b>     | 541589   | <b>Ref. No.</b> | 6300727 |
| <b>description</b> | shut-off valve connection 3/8" conversion kit                  |                 |         |
| <b>For models:</b> | 0A0BME, 0A0BMG, 0D0BME, 0D0BMG, 1A0BME, 1A0BMG, 1D0BME, 1D0BMG |                 |         |



|                    |  |                 |         |
|--------------------|--|-----------------|---------|
| <b>GEV No.</b>     | 541584   | <b>Ref. No.</b> | 6300730 |
| <b>description</b> | shut-off valve connection 3/8" conversion kit Qty 2 pcs                  |                 |         |
| <b>For models:</b> | 1A1PD1G, 1A1PD2G, 1A1PI1G, 1A1PI1GA, 1D1PD1G, 1D1PD2G, 1D1PI1G, 1D1PI1GA |                 |         |

Зип Общепит



vsezip.ru

+7(812)987-08-81



|                    |  |                 |         |
|--------------------|--|-----------------|---------|
| 1                  |  |                 |         |
| <b>GEV No.</b>     | 541590   | <b>Ref. No.</b> | 6300731 |
| <b>description</b> | shut-off valve connection 3/8" ET conversion kit total length 97mm |                 |         |



|   |   |                 |                                    |
|---|---|-----------------|------------------------------------|
| 1   |   |                 |                                    |
| <b>GEV No.</b>  | 540690  | <b>Ref. No.</b> | 33D0590                            |
| <b>description</b>  | shut-off valve connection 3/8" total length 27mm mounting pos. angled shaft intake ø M4mm rosette thread G2 1" shaft star-shaped  |                 |                                    |
| <b>For models:</b>  | 070BM, 070BME, 071BM, 071BME, 090BM, 090BME, 091BM, 091BME, 30CPS, 30CPE, 31PD6, 31PI6, 31PIE6, 70CP, 70CPE, 71AR, 71ARE, 71CP, 71CP2, 71PD10, 71PD15, 71PI10, 71PI10A, 71PIE15, 71PIE15A, 71PV15, 71PV15A, 71RA, 90CP, 90CPE, 91AR, 91ARE, 91CP, 91PI10, 91PI10A, 91PIE15, 91PIE15A, 91RA, ACBM, ACBM218, ANBM, ANBM218, ANBM75, SE14VB, SE21VB, SI14VB, SI21VB, SL14CVB, SL14NVB, SL21CVB...(Other models you can see in the webshop) |                 |                                    |
| <b>spare parts for</b>  | 540690  |                 |                                    |
|   | <b>GEV No.</b>  | 514357          | <b>Ref. No.</b> 36M2642<br>36M4010 |
|   | tap handle hot water for valve plastic total length 36mm shaft diameter ø8mmmm  |                 |                                    |
|  | <b>GEV No.</b>  | 541813          | <b>Ref. No.</b> 36M2631<br>36M2632 |
|   | star handle cold total length 36mm shaft intake ø 8mm plastic for valve   |                 |                                    |



|                    |  |                 |                    |
|--------------------|--|-----------------|--------------------|
| 1                  |  |                 |                    |
| <b>GEV No.</b>     | 541813   | <b>Ref. No.</b> | 36M2631<br>36M2632 |
| <b>description</b> | star handle cold total length 36mm shaft intake ø 8mm plastic for valve  |                 |                    |
| <b>For models:</b> | 191PD1G, 191PD2G, 191PI1G, 191PI1GA, 191PI2E, 191PI2EA, 191PI2G, 191PI2GA, 191PI2V, 191PI2VA, 1A1PD1G, 1A1PD2G, 1A1PI1G, 1A1PI1GA, 1A1PI2E, 1A1PI2EA, 1A1PI2V, 1A1PI2VA, 1D1PD1G, 1D1PD2G, 1D1PI1G, 1D1PI1GA, 1D1PI2E, 1D1PI2EA, 1D1PI2V, 1D1PI2VA, 1G1PD1G, 1G1PI1E, 1G1PI1G, 291PI3E, 291PI3G, 31PD6, 31PI6, 31PIE6, 71AR, 71ARE, 71PD10, 71PD15, 71PI10, 71PI10A, 71PIE15, 71PIE15A, 71PV15, 71PV15A, 71RA, 91AR, 91ARE, 91PI10, 91PI10A, 91PIE15...(Other models you can see in the webshop) |                 |                    |



|                    |  |                 |         |
|--------------------|--|-----------------|---------|
| 1                  |  |                 |         |
| <b>GEV No.</b>     | 514383   | <b>Ref. No.</b> | 36M2641 |
| <b>description</b> | star handle hot total length 36mm shaft intake ø 8mm plastic for valve   |                 |         |
| <b>For models:</b> | 070BM, 070BME, 071BM, 071BME, 090BM, 090BME, 091BM, 091BME, 0A0BME, 0A0BMG, 0A1CP1E, 0A1CP1G, 0B1CP1G, 0D0BME, 0D0BMG, 0D1CP1E, 0D1CP1G, 0G1CP1E, 0G1CP1G, 191PD1G, 191PD2G, 191PI1G, 191PI1GA, 191PI2E, 191PI2EA, 191PI2G, 191PI2GA, 191PI2V, 191PI2VA, 1A0BME, 1A0BMG, 1A1BR1E, 1A1BR1G, 1A1BR1GA, 1A1BR2E, 1A1BR2EA, 1A1BR2G, 1A1BR2GA, 1A1CP1G, 1A1CP2G, 1A1PD1G, 1A1PD2G, 1A1PI1G, 1A1PI1GA, 1A1PI2E, 1A1PI2EA, 1A1PI2V, 1A1PI2VA, 1D0BME, 1D0BMG, 1D1BR1E, 1D1BR1G, 1D1BR1GA, 1D1BR2E, 1D1BR2EA, 1D1BR2G, 1D1BR2GA, 1D1CP1G, 1D1CP2G...(Other models you can see in the webshop) |                 |         |



|                    |   |                 |                    |
|--------------------|---|-----------------|--------------------|
| <b>GEV No.</b>     | 514357  | <b>Ref. No.</b> | 36M2642<br>36M4010 |
| <b>description</b> | tap handle hot water for valve plastic total length 36mm shaft diameter ø8mmmm  |                 |                    |
| <b>For models:</b> | 070BM, 070BME, 071BM, 071BME, 090BM, 090BME, 091BM, 091BME, 0A1CP1E, 0A1CP1G, 0B1CP1G, 0D1CP1E, 0D1CP1G, 1A1BR1E, 1A1BR1G, 1A1BR1GA, 1A1BR2E, 1A1BR2EA, 1A1BR2G, 1A1BR2GA, 1A1CP1G, 1A1CP2G, 1A1PD1G, 1A1PD2G, 1A1PI1G, 1A1PI1GA, 1A1PI2E, 1A1PI2EA, 1A1PI2G, 1A1PI2GA, 1A1PI2V, 1A1PI2VA, 1D1BR1E, 1D1BR1G, 1D1BR1GA, 1D1BR2E, 1D1BR2EA, 1D1BR2G, 1D1BR2GA, 1D1CP1G, 1D1CP2G, 1D1PD1G, 1D1PD2G, 1D1PI1G, 1D1PI1GA, 1D1PI2E, 1D1PI2EA, 1D1PI2G, 1D1PI2GA, 1D1PI2V...(Other models you can see in the webshop) |                 |                    |

accessories



|                    |  |                 |         |
|--------------------|--|-----------------|---------|
| 1                  |  |                 |         |
| <b>GEV No.</b>     | 540696   | <b>Ref. No.</b> | 36M4030 |
| <b>description</b> | hood handle for valve blue   |                 |         |
| <b>For models:</b> | 04WBMEV, 191CP1GA, 1A1CP1GA, 1A1PD1G, 1A1PD2G, 1A1PI1G, 1A1PI1GA, 1A1PI2E, 1A1PI2EA, 1A1PI2G, 1A1PI2GA, 1A1PI2V, 1A1PI2VA, 1D1CP1GA, 1D1PD1G, 1D1PD2G, 1D1PI1G, 1D1PI1GA, 1D1PI2E, 1D1PI2EA, 1D1PI2G, 1D1PI2GA, 1D1PI2V, 1D1PI2VA, 291PD3G, 2A1PD3G, 2A1PI3E, 2A1PI3G, 2D1PI3G |                 |         |



|                    |   |                 |         |
|--------------------|---|-----------------|---------|
| 1                  |   |                 |         |
| <b>GEV No.</b>     | 514438  | <b>Ref. No.</b> | 3162200 |
| <b>description</b> | star handle plastic thread 7.5 ø 50mm H 50mm WS chrome-plated shaft star-shaped   |                 |         |
| <b>For models:</b> | 0A0BME, 0A0BMG, 0A1CP1E, 0A1CP1G, 0D0BME, 0D0BMG, 0D1CP1E, 0D1CP1G, 0G1CP1E, 0G1CP1G, 191PD1G, 191PD2G, 191PI1G, 191PI1GA, 191PI2E, 191PI2EA, 191PI2G, 191PI2GA, 191PI2V, 191PI2VA, 1A0BME, 1A0BMG, 1A1BR1E, 1A1BR1G, 1A1BR1GA, 1A1BR2E, 1A1BR2EA, 1A1BR2G, 1A1BR2GA, 1A1CP1G, 1A1CP2G, 1A1PD1G, 1A1PD2G, 1A1PI1G, 1A1PI1GA, 1A1PI2E, 1A1PI2EA, 1A1PI2V, 1A1PI2VA, 1D0BME, 1D0BMG, 1D1BR1E, 1D1BR1G, 1D1BR1GA, 1D1BR2E, 1D1BR2EA, 1D1BR2G, 1D1BR2GA, 1D1CP1G, 1D1CP2G...(Other models you can see in the webshop) |                 |         |



Зип Общепит

vsezip.ru

+7(812)987-08-81

steam valves



|                        |  |                 |                    |
|------------------------|--|-----------------|--------------------|
| <b>GEV No.</b>         | 520000   | <b>Ref. No.</b> | 33G0030<br>33G0031 |
| <b>description</b>     | steam valve angled connection 1 1/4" IT total length 52mm H 190mm brass                                |                 |                    |
| <b>For models:</b>     | 191PI2V, 191PI2VA, 1A1PI2V, 1A1PI2VA, 1D1PI2V, 1D1PI2VA, 71PV15, 71PV15A, PV200, PV200A, PV300, PV300A |                 |                    |
| <b>spare parts for</b> | 520000   |                 |                    |
|                        | <b>GEV No.</b>   | 541566          | <b>Ref. No.</b> —  |
|                        | tap head for steam tap 1/4" shaft 9x9mm  |                 |                    |

|                        |   |                 |                                    |
|------------------------|---|-----------------|------------------------------------|
| <b>GEV No.</b>         | 514081  | <b>Ref. No.</b> | 3003440<br>3003441<br>33Q3500      |
| <b>description</b>     | inlet spout connection 3/8" ET tube ø 10mm projection 50mm overall height 56mm spout height 25mm rotation°  |                 |                                    |
| <b>For models:</b>     | 04WCP1EM, 06WCP1GM, 08WCP1GM, 091CP1E, 091CP1G, 0A1CP1E, 0A1CP1G, 0B1CP1G, 0D1CP1E, 0D1CP1G, 0G1CP1E, 0G1CP1EC, 0G1CP1E-VERS.2004, 0G1CP1G, 0G1CP1G-VERS.2004, 191CP1G, 191CP2G, 1A1CP1G, 1A1CP2G, 1D1CP1G, 1D1CP2G, 1G1CP1G, 1G1CP1G-VERS.2004, 1G1CP2G, 1G1CP2G-VERS.2004, 6040090, 6040310, 6043850, 6043980 |                 |                                    |
| <b>accessories for</b> | 514081  |                 |                                    |
|                        | <b>GEV No.</b>  | 503042          | <b>Ref. No.</b> 33Q2190<br>36Q1110 |
|                        | nut thread 3/8" H 6mm brass WS 22 Qty 1 pcs   |                 |                                    |
|                        | <b>GEV No.</b>  | 540682          | <b>Ref. No.</b> 3150840<br>37Q1210 |
|                        | O-ring EPDM thickness 1.78mm ID ø 18.77mm Qty 1 pcs   |                 |                                    |

inlet taps



|                        |   |                 |                                    |
|------------------------|---|-----------------|------------------------------------|
| <b>GEV No.</b>         | 514078  | <b>Ref. No.</b> | 33Q2730                            |
| <b>description</b>     | inlet spout connection 3/8" ET tube ø 10mm projection 48mm overall height 46mm spout height 25mm                      |                 |                                    |
| <b>For models:</b>     | 070BM, 070BME, 071BM, 071BME, 090BM, 090BME, 091BM, 091BME, 30CPS, 30CPE, 70CP, 70CPE, 71CP, 71CP2, 90CP, 90CPE, 91CP |                 |                                    |
| <b>accessories for</b> | 514078  |                 |                                    |
|                        | <b>GEV No.</b>  | 101278          | <b>Ref. No.</b> 36Q0080            |
|                        | olive for pipe ø 10mm Qty 1 pcs   |                 |                                    |
|                        | <b>GEV No.</b>  | 101478          | <b>Ref. No.</b> —                  |
|                        | union nut thread 3/8" for pipe ø 10mm   |                 |                                    |
|                        | <b>GEV No.</b>  | 506024          | <b>Ref. No.</b> —                  |
|                        | nut thread 3/8" H 6mm SS WS 22 Qty 1 pcs  |                 |                                    |
|                        | <b>GEV No.</b>  | 514079          | <b>Ref. No.</b> 3120740            |
|                        | washer ED ø 30mm ID ø 17mm thickness 3mm  |                 |                                    |
|                        | <b>GEV No.</b>  | 540682          | <b>Ref. No.</b> 3150840<br>37Q1210 |
|                        | O-ring EPDM thickness 1.78mm ID ø 18.77mm Qty 1 pcs   |                 |                                    |

|  |  |                 |         |
|--|--|-----------------|---------|
| <br>Image not available |  |                 |         |
| <b>GEV No.</b>   | 541816   | <b>Ref. No.</b> | 33Q4690 |
| <b>description</b>   | inlet spout connection 3/8" IT for bain marie                  |                 |         |
| <b>For models:</b>   | 0A0BME, 0A0BMG, 0D0BME, 0D0BMG, 1A0BME, 1A0BMG, 1D0BME, 1D0BMG |                 |         |

|                    |   |                 |         |
|--------------------|---|-----------------|---------|
| <b>GEV No.</b>     | 540693  | <b>Ref. No.</b> | 33Q2582 |
| <b>description</b> | inlet spout for kettle type series 700/900  |                 |         |
| <b>For models:</b> | 31PD6, 31PI6, 31PIE6, 71PD10, 71PD15, 71PI10, 71PI10A, 71PIE15, 71PIE15A, 71PV15, 71PV15A, 91PI10, 91PI10A, 91PIE15, 91PIE15A |                 |         |



Зип Общепит

vsezip.ru

+7(812)987-08-81



|                    |   |                 |                    |
|--------------------|---|-----------------|--------------------|
| <b>GEV No.</b>     | 540697  | <b>Ref. No.</b> | 3003430<br>33Q3570 |
| <b>description</b> | inlet spout tube ø 18mm thread 1/2" IT for kettle   |                 |                    |
| <b>For models:</b> | 191PD1G, 191PD2G, 191PI1G, 191PI1GA, 191PI2E, 191PI2EA, 191PI2G, 191PI2GA, 191PI2V, 191PI2VA, 1A1PD1G, 1A1PD2G, 1A1PI1G, 1A1PI1GA, 1A1PI2E, 1A1PI2EA, 1A1PI2G, 1A1PI2GA, 1A1PI2V, 1A1PI2VA, 1D1PD1G, 1D1PD2G, 1D1PI1G, 1D1PI1GA, 1D1PI2E, 1D1PI2EA, 1D1PI2G, 1D1PI2GA, 1D1PI2V, 1D1PI2VA, 1G1PD1G, 1G1PI1E, 1G1PI1G |                 |                    |



|                    |   |                 |         |
|--------------------|---|-----------------|---------|
| <b>GEV No.</b>     | 540691  | <b>Ref. No.</b> | 36M2640 |
| <b>description</b> | hood handle for valve red   |                 |         |
| <b>For models:</b> | 070BM, 070BME, 071BM, 071BME, 090BM, 090BME, 091BM, 091BME, 0A0BME, 0A0BMG, 0A1CP1E, 0A1CP1G, 0B1CP1G, 0D0BME, 0D0BMG, 0D1CP1E, 0D1CP1G, 0G1CP1E, 0G1CP1G, 1A0BME, 1A0BMG, 1A1BR1E, 1A1BR1G, 1A1BR1GA, 1A1BR2E, 1A1BR2EA, 1A1BR2G, 1A1BR2GA, 1A1CP1G, 1A1CP2G, 1A1PD1G, 1A1PD2G, 1A1PI1G, 1A1PI1GA, 1A1PI2E, 1A1PI2EA, 1A1PI2V, 1A1PI2VA, 1D0BME, 1D0BMG, 1D1BR1E, 1D1BR1G, 1D1BR1GA, 1D1BR2E, 1D1BR2EA, 1D1BR2G, 1D1BR2GA, 1D1CP1G, 1D1CP2G, 1D1PD1G...(Other models you can see in the webshop) |                 |         |

accessories

turning handles



|                    |  |                 |         |
|--------------------|--|-----------------|---------|
| <b>GEV No.</b>     | 540692   | <b>Ref. No.</b> | 36M2630 |
| <b>description</b> | hood handle for valve blue   |                 |         |
| <b>For models:</b> | 1A1PD1G, 1A1PD2G, 1A1PI1G, 1A1PI1GA, 1A1PI2E, 1A1PI2EA, 1A1PI2V, 1A1PI2VA, 1D1PD1G, 1D1PD2G, 1D1PI1G, 1D1PI1GA, 1D1PI2E, 1D1PI2EA, 1D1PI2V, 1D1PI2VA, 1G1PD1G, 1G1PI1E, 1G1PI1G, 31PD6, 31PI6, 31PIE6, 71AR, 71ARE, 71PD10, 71PD15, 71PI10, 71PI10A, 71PIE15, 71PIE15A, 71PV15, 71PV15A, 71RA, 91AR, 91ARE, 91PI10, 91PI10A, 91PIE15, 91PIE15A, 91RA |                 |         |



|                    |  |                 |         |
|--------------------|--|-----------------|---------|
| <b>GEV No.</b>     | 540696   | <b>Ref. No.</b> | 36M4030 |
| <b>description</b> | hood handle for valve blue   |                 |         |
| <b>For models:</b> | 04WBMEV, 191CP1GA, 1A1CP1GA, 1A1PD1G, 1A1PD2G, 1A1PI1G, 1A1PI1GA, 1A1PI2E, 1A1PI2EA, 1A1PI2G, 1A1PI2GA, 1A1PI2V, 1A1PI2VA, 1D1CP1GA, 1D1PD1G, 1D1PD2G, 1D1PI1G, 1D1PI1GA, 1D1PI2E, 1D1PI2EA, 1D1PI2G, 1D1PI2GA, 1D1PI2V, 1D1PI2VA, 291PD3G, 2A1PD3G, 2A1PI3E, 2A1PI3G, 2D1PI3G |                 |         |

beverage technology

valves

non-return valves



|                    |   |                 |         |
|--------------------|---|-----------------|---------|
| <b>GEV No.</b>     | 440729  | <b>Ref. No.</b> | 3114800 |
| <b>description</b> | non-return valve John Guest pipe connection 5/16" - 5/16" operating pressure at 20°C 10bar opening pressure 0.02bar POM   |                 |         |
| <b>For models:</b> | FM1011E3-VERS.2006, FM1011G3-VERS.2006, FM1221E3-VERS.2006, FM1221G3-VERS.2006, FM2011E3-VERS.2006, FM2011G3-VERS.2006, FM2021E3-VERS.2006, FM2021G3-VERS.2006, FM611E3-VERS.2006, FM611G3-VERS.2006, FM721E3-VERS.2006, FM721G3-VERS.2006, FX101E3, FX101E3C, FX101E3C-VERS.022014, FX101E3R, FX101E3R-VERS.022014, FX101E3-VERS.022014, FX101G3, FX101G3C, FX101G3C-VERS.022014, FX101G3R, FX101G3R-VERS.022014, FX101G3-VERS.022014, FX10E3CR, FX10E3CR-VERS.022014, FX10G3CR, FX10G3CR-VERS.022014, FX122E3, FX122E3C, FX122E3T, FX122E3T-VERS.022014, FX122G3, FX122G3C, FX122G3T, FX122G3T-VERS.022014, FX12E3CT, FX12E3CT-VERS.022014, FX12G3CT, FX12G3CT-VERS.022014, FX201E3, FX201E3P, FX201E3P-VERS.022014, FX201E3-VERS.022014, FX201G3P, FX201G3-VERS.022014, FX202E3, FX202E3-230V-3-50Hz-60Hz, FX202E3-230V-3-50Hz-60Hz-VERS.022014, FX202E3-VERS.022014...(Other models you can see in the webshop) |                 |         |



water cycle components

Зип.Общепит. ancillary products

pressure reduction valves

pressure reduction valves

universal



|  |                |        |                 |         |
|--|----------------|--------|-----------------|---------|
| 1  | <b>GEV No.</b> | 520271 | <b>Ref. No.</b> | 33D1650 |
| <b>description</b> pressure reduction valve connection 1/2" default setting 3bar setting range 1 up to 7bar p max 20bar t.max. 80°C  |                |        |                 |         |
| <b>For models:</b> BX101E, BX101E-VERS.122013, BX101G, BX101G-VERS.122013, BX122E, BX122E-VERS.122013, BX122G, BX122G-VERS.122013, BX61E, BX61E-VERS.122013, BX61G, BX61G-VERS.122013, BX82E, BX82E-VERS.122013, BX82G, BX82G-VERS.122013, FCV101, FCV101-CSA, FCV101DM, FCV101DM-CSA, FCV101DS, FCV101DS-CSA, FCV101E, FCV101EDM, FCV101EDM-UL, FCV101EDS, FCV101EDS-UL, FCV101E-UL, FCV141, FCV141-CSA, FCV141DM, FCV141DM-CSA, FCV141DS, FCV141DS-CSA, FCV141E, FCV141EDM, FCV141EDS, FCV241, FCV241DM, FCV241DS, FCV241E, FCV241EDM, FCV241EDM-UL, FCV241EDS, FCV241EDS-UL, FCV241E-UL, FCV241G, FCV241G-CSA, FCV241GDM, FCV241GDM-CSA...(Other models you can see in the webshop) |                |        |                 |         |

supply filters



|  |                |        |                 |         |
|--|----------------|--------|-----------------|---------|
| 1  | <b>GEV No.</b> | 520261 | <b>Ref. No.</b> | 35Q2780 |
| <b>description</b> supply filter thread 1/2" IT - 1/2" IT total length 58mm red brass mesh opening 0.4mm |                |        |                 |         |



|   |                |        |                 |                               |
|---|----------------|--------|-----------------|-------------------------------|
| 1   | <b>GEV No.</b> | 520262 | <b>Ref. No.</b> | 33Q6090<br>33Q6091<br>35Q2790 |
| <b>description</b> supply filter thread 3/4" IT - 3/4" IT total length 70mm red brass DN20 mesh opening 0.4mm |                |        |                 |                               |

clamps

hose clamps

DIN 3017 -W2



|  |                |        |                 |         |
|--|----------------|--------|-----------------|---------|
| 1  | <b>GEV No.</b> | 520111 | <b>Ref. No.</b> | 36E4320 |
| <b>description</b> hose clamp ø 10-16mm width 9mm Qty 10 pcs DIN 3017  |                |        |                 |         |
| <b>For models:</b> FM1011E2-VERS.2006, FM1011E3, FM1011E3-VERS.2006, FM1011G2-VERS.2006, FM1011G3, FM1011G3-VERS.2006, FM1221E2-VERS.2006, FM1221E3, FM1221E3-VERS.2006, FM1221G2-VERS.2006, FM1221G3, FM1221G3-VERS.2006, FM2011E2-VERS.2006, FM2011E3-VERS.2006, FM2011G2-VERS.2006, FM2011G3-VERS.2006, FM2021E2-VERS.2006, FM2021E3, FM2021E3-VERS.2006, FM2021G2-VERS.2006, FM2021G3, FM2021G3-VERS.2006, FM423E2, FM611E2-VERS.2006, FM611E3, FM611E3-VERS.2006, FM611G2-VERS.2006, FM611G3, FM611G3-VERS.2006, FM721E2-VERS.2006, FM721E3, FM721E3-VERS.2006, FM721G2-VERS.2006, FM721G3, FM721G3-VERS.2006 |                |        |                 |         |



|   |                |        |                 |         |
|---|----------------|--------|-----------------|---------|
| 1   | <b>GEV No.</b> | 520115 | <b>Ref. No.</b> | 3140220 |
| <b>description</b> hose clamp ø 25-40mm width 9mm Qty 10 pcs DIN 3017 |                |        |                 |         |



|  |                |        |                 |         |
|--|----------------|--------|-----------------|---------|
| 1  | <b>GEV No.</b> | 520119 | <b>Ref. No.</b> | 3140200 |
| <b>description</b> hose clamp ø 60-80mm width 9mm Qty 5 pcs DIN 3017                 |                |        |                 |         |
| <b>For models:</b> L100, L80, LP202, LP202HC, LP302, LP302HC, LP402, LP402HC, LP402V |                |        |                 |         |

Зип.Общепит

Ø52mm

vsezip.ru

+7(812)987-08-81

tools, fastening materials, consumables

tools

hand tools

pullers



|   |  |                 |                         |
|---|--|-----------------|-------------------------|
| <b>GEV No.</b>  | 801197   | <b>Ref. No.</b> | 3018670<br>6003060      |
| <b>description</b>  | puller for fan wheel seat Ø 27-33mm thread M16x1.5 WS 17   |                 |                         |
| <b>For models:</b>  | FM1011E1, FM1011E2, FM1011E3, FM1011G1, FM1011G2, FM1011G3, FM1221E1, FM1221E2, FM1221E3, FM1221G1, FM1221G2, FM1221G3, FM611E1, FM611E2, FM611E3, FM611G1, FM611G2, FM611G3 |                 |                         |
| <b>spare parts for</b>  | 801197   |                 |                         |
|  | <b>GEV No.</b>   | 801198          | <b>Ref. No.</b> 3019160 |
| screw for puller thread M16x1.5 L 63mm WS 17                                      |  |                 |                         |



|                    |  |                 |         |
|--------------------|--|-----------------|---------|
| <b>GEV No.</b>     | 801198                                       | <b>Ref. No.</b> | 3019160 |
| <b>description</b> | screw for puller thread M16x1.5 L 63mm WS 17 |                 |         |

measuring equipment

thermometers

built-in thermometers



|                    |   |                 |                    |
|--------------------|---|-----------------|--------------------|
| <b>GEV No.</b>     | 541086  | <b>Ref. No.</b> | 32V1900<br>32z0020 |
| <b>description</b> | thermometer mounting measurements 58x25.5mm 0 up to +120°C capillary pipe 2000mm probe Ø 6mm probe L 23mm |                 |                    |
| <b>For models:</b> | LC100, LC100-VERS.2001, LC130, LC130-VERS.2001  |                 |                    |



|                    |   |                 |         |
|--------------------|---|-----------------|---------|
| <b>GEV No.</b>     | 541305  | <b>Ref. No.</b> | 32V7230 |
| <b>description</b> | thermometer mounting measurements 62x11mm +20 up to +120°C capillary pipe 1500mm probe Ø 6.5mm probe L 16mm |                 |         |



|                    |  |                 |         |
|--------------------|--|-----------------|---------|
| <b>GEV No.</b>     | 541065   | <b>Ref. No.</b> | 32z2930 |
| <b>description</b> | thermometer mounting Ø 52mm t.max. 120°C 0 up to +120°C probe Ø 6.5mm probe L 28mm capillary pipe 1500mm |                 |         |



|                    |  |                 |         |
|--------------------|--|-----------------|---------|
| <b>GEV No.</b>     | 541347   | <b>Ref. No.</b> | 32Z0151 |
| <b>description</b> | thermometer mounting Ø 52mm t.max. 350°C +50 up to +350°C probe Ø 4mm probe L 60mm capillary pipe 1000mm |                 |         |
| <b>For models:</b> | FC101, FC1011E, FC1011G, FC101E, FC1221E, FC1221G, FC241, FC241E, FC241G, FC61, FC611E, FC611G, FC61E    |                 |         |



|                    |  |                 |         |
|--------------------|--|-----------------|---------|
| <b>GEV No.</b>     | 541582   | <b>Ref. No.</b> | 32Z0040 |
| <b>description</b> | thermometer mounting Ø 52mm t.max. 350°C +50 up to +350°C probe Ø 6mm probe L 17mm capillary pipe 1700mm |                 |         |

Ø60mm



|                    |   |                 |         |
|--------------------|---|-----------------|---------|
| <b>GEV No.</b>     | 541082  | <b>Ref. No.</b> | 32Z3190 |
| <b>description</b> | thermometer mounting Ø 60mm t.max. 40°C -40 up to +40°C probe Ø 6mm probe L 135mm capillary pipe 2000mm |                 |         |





Зип Общепит

vsezip.ru

+7(812)987-08-81

external power supply



1

|                    |  |                 |                     |
|--------------------|--|-----------------|---------------------|
| <b>GEV No.</b>     | 541193   | <b>Ref. No.</b> | 32Z 367J<br>32Z3680 |
| <b>description</b> | thermometer mounting measurements 58x25.5mm -40 up to +40°C cable length 2500mm probe ø 6mm probe L 40mm |                 |                     |
| <b>For models:</b> | SA87   |                 |                     |

grub screws

DIN 914/ISO 4027



|                    |   |                 |         |
|--------------------|---|-----------------|---------|
| <b>GEV No.</b>     | 560224  | <b>Ref. No.</b> | 31W0020 |
| <b>description</b> | grub screw thread M8 L 10mm WS 4 Qty 1 pcs  |                 |         |
| <b>For models:</b> | 1A1BR1E, 1A1BR1G, 1A1BR2E, 1A1BR2G, 1D1BR1E, 1D1BR1G, 1D1BR2E, 1D1BR2G, 1G1BR1E, 1G1BR1G, 2A1BR1E, 2A1BR1G, 2A1BR2E, 2A1BR2G, 2D1BR1E, 2D1BR1G, 2D1BR2E, 2D1BR2G, 31R, 31RE |                 |         |

fastening material

screws

countersunk screws



1

|                    |   |                 |         |
|--------------------|---|-----------------|---------|
| <b>GEV No.</b>     | 698481  | <b>Ref. No.</b> | 31C0070 |
| <b>description</b> | screw thread M4 L 8mm SS DIN 965/ISO 7046 Qty 1 pcs intake Phillips head ø 7mm      |                 |         |
| <b>For models:</b> | LC100, LC100-VERS.2001, LC130, LC130-VERS.2001, LC80, LF50, LF50E, LF50EM, LF50EMPS |                 |         |

hexagonal screws



1

|                    |  |                 |         |
|--------------------|--|-----------------|---------|
| <b>GEV No.</b>     | 506445   | <b>Ref. No.</b> | 3016470 |
| <b>description</b> | hexagonal screw thread M10 thread L 35mm SS WS 17 Qty 1 pcs DIN 933 / ISO 4017   |                 |         |
| <b>For models:</b> | BX101E, BX101E-VERS.122013, BX101G, BX101G-VERS.122013, BX122E, BX122E-VERS.122013, BX122G, BX122G-VERS.122013, BX61E, BX61E-VERS.122013, BX61G, BX61G-VERS.122013, BX82E, BX82E-VERS.122013, BX82G, BX82G-VERS.122013, FC1011E, FC1011G, FC1221E, FC1221G, FC611E, FC611G, FM1011E1, FM1011E1-VERS.2006, FM1011E2, FM1011E2-VERS.2006, FM1011E3, FM1011E3-VERS.2006, FM1011G1, FM1011G1-VERS.2006, FM1011G2, FM1011G2-VERS.2006, FM1011G3, FM1011G3-VERS.2006, FM1221E1, FM1221E1-VERS.2006, FM1221E2, FM1221E2-VERS.2006, FM1221E3, FM1221E3-VERS.2006, FM1221G1, FM1221G1-VERS.2006, FM1221G2, FM1221G2-VERS.2006, FM1221G3, FM1221G3-VERS.2006, FM2011E2-VERS.2006, FM2011E3-VERS.2006, FM2011G2-VERS.2006, FM2011G3-VERS.2006...(Other models you can see in the webshop) |                 |         |



1

|                    |  |                 |         |
|--------------------|--|-----------------|---------|
| <b>GEV No.</b>     | 560086   | <b>Ref. No.</b> | 31A0560 |
| <b>description</b> | hexagonal screw thread M6 thread L 10mm SS WS 10 Qty 20 pcs DIN 933 / ISO 4017   |                 |         |
| <b>For models:</b> | BX101E, BX101E-VERS.122013, BX101G, BX101G-VERS.122013, BX122E, BX122E-VERS.122013, BX122G, BX122G-VERS.122013, BX61E, BX61E-VERS.122013, BX61G, BX61G-VERS.122013, BX82E, BX82E-VERS.122013, BX82G, BX82G-VERS.122013, FX101E1, FX101E1R, FX101E2, FX101E2C, FX101E2C-VERS.032014, FX101E2R, FX101E2R-VERS.032014, FX101E2-VERS.032014, FX101E3, FX101E3C, FX101E3C-VERS.022014, FX101E3R, FX101E3R-VERS.022014, FX101E3-VERS.022014, FX101G1, FX101G1R, FX101G2, FX101G2C, FX101G2C-VERS.032014, FX101G2R, FX101G2R-VERS.032014, FX101G2-VERS.032014, FX101G3, FX101G3C, FX101G3C-VERS.022014, FX101G3R, FX101G3R-VERS.022014, FX101G3-VERS.022014, FX10E2CR, FX10E2CR-VERS.032014, FX10E3CR, FX10E3CR-VERS.022014, FX10G2CR, FX10G2CR-VERS.032014...(Other models you can see in the webshop) |                 |         |

knurled screws



1

|   |  |                 |                    |
|---|--|-----------------|--------------------|
| <b>GEV No.</b>  | 524804   | <b>Ref. No.</b> | 3036730            |
| <b>description</b>  | Thumb screw thread M5 thread L 7mm ø 30mm H 5mm SS Qty 1 pcs   |                 |                    |
| <b>For models:</b>  | KD100, KD100A, KD100PSD, KD130, KD130A, KD130E, KD130EAT, KD40EPSD, KD40LEPS, KD40LUXE, KD60, KD60E, KD60EAT, KD60M, KD60MA, KD60ME, KD60MPS, KD60MPSA, KD60PS, KD60PSD, KD6E-ATSD, KD85, KD85A, KD85E, KD85EA, KD85EAT, KD85EATS, KD85EPS, KD85EPSA, KD85PS, KD85PSA, KN1100, KN1100SD, KN11PSDD, KN80, KN80PS, LP151, LP202, LP202HC, LP302, LP302HC, LP402, LP402HC, LP402V, LP70 |                 |                    |
| <b>accessories for</b>  | 524804   |                 |                    |
|  | <b>GEV No.</b>   | 505277          | <b>Ref. No.</b>    |
|   |  |                 | 3036720<br>33q6400 |
|   | rinse arm shaft warewashing ø 14mm H 38mm thread 1/4"  |                 |                    |

miscellaneous



1

|                    |   |                 |         |
|--------------------|---|-----------------|---------|
| <b>GEV No.</b>     | 514285  | <b>Ref. No.</b> | 3190040 |
| <b>description</b> | screw   |                 |         |
| <b>For models:</b> | 090GRG, 190GRG, FC101, FC1011E, FC1011G, FC101E, FC1221E, FC1221G, FC241, FC241E, FC241G, FC61, FC611E, FC611G, FC61E, FCV101, FCV101-CSA, FCV101DM, FCV101DM-CSA, FCV101DS, FCV101DS-CSA, FCV101E, FCV101EDM, FCV101EDM-UL, FCV101EDS, FCV101EDS-UL, FCV101E-UL, FCV141, FCV141-CSA, FCV141DM, FCV141DM-CSA, FCV141DS, FCV141DS-CSA, FCV141E, FCV141EDM, FCV141EDS, FCV241, FCV241DM, FCV241DS, FCV241E, FCV241EDM, FCV241EDM-UL, FCV241EDS, FCV241EDS-UL, FCV241E-UL, FCV241G, FCV241G-CSA, FCV241GDM, FCV241GDM-CSA, FCV241GDS...(Other models you can see in the webshop) |                 |         |

Зип-Общепит  
hexagonal nuts metric (without norm)

vsezip.ru

+7(812)987-08-81



1

**GEV No.** 691459 **Ref. No.** 3190020**description** screw thread M6 L 10mm WS 14**For models:** FC101, FC1011E, FC1011G, FC101E, FC1221E, FC1221G, FC241, FC241E, FC241G, FC61, FC611E, FC611G, FC61E, FCV101, FCV101-CSA, FCV101DM, FCV101DM-CSA, FCV101DS, FCV101DS-CSA, FCV101E, FCV101EDM, FCV101EDM-UL, FCV101EDS, FCV101EDS-UL, FCV101E-UL, FCV141, FCV141-CSA, FCV141DM, FCV141DM-CSA, FCV141DS, FCV141DS-CSA, FCV141E, FCV141EDM, FCV141EDS, FCV241, FCV241DM, FCV241DS, FCV241E, FCV241EDM, FCV241EDM-UL, FCV241EDS, FCV241EDS-UL, FCV241E-UL, FCV241G, FCV241G-CSA, FCV241GDM, FCV241GDM-CSA, FCV241GDS, FCV241GDS-CSA, FCV3EM...(Other models you can see in the webshop)

hexagonal nuts inch thread

**GEV No.** 521103 **Ref. No.** N/A**description** nut thread M4 H 3mm WS 7 brass Qty 20 pcs

hexagonal nuts inch thread



1

**GEV No.** 517180 **Ref. No.** 3030170**description** nut thread 1" H 5mm WS 36 SS Qty 1 pcs**For models:** KD37, KD37PS, KD37-VERS.112009, KD40, LP202, LP202HC, LP302, LP302HC, LP402, LP402HC, LP402V, LPG300, N100D, N100S, N100VD, N100VS, N38D, N38S, N38VD, N38VS, N42D, N42S, N42VD, N42VS, N50D, N50S, N50VD, N50VS, N66D, N66S, N66VD, N66VS, N70D, N70S, N70VD, N70VS, N85D, N85S, N85VD, N85VS

nuts

wing nuts



1

**GEV No.** 560147 **Ref. No.** 33Q3200**description** wing nuts thread M6 SS DIN/ISO DIN 315 Qty 20 pcs**For models:** LT10R, LT20F, LT25F

knurled nuts



1

**GEV No.** 519386 **Ref. No.** 3190800**description** knurled nut for glass plate thread M4**For models:** BRPRV, BRVRV, SE14PRV, SE14PRW, SE14VRV, SE14VRW, SI14PRV, SI14PRW, SI14VRV, SI14VRW, SL14RPRV, SL14RPRW, SL14RVRV, SL14RVRW, TPRV, TVRV

1

**GEV No.** 503155 **Ref. No.** 33Q4410**description** nut thread 1/2" H 7mm WS 25 brass Qty 1 pcs**For models:** LT10R, LT20F, LT25F

1

**GEV No.** 361182 **Ref. No.** 3117580**description** nut thread 1/4" H 5mm nickel-plated brass WS 17 Qty 1 pcs**For models:** L100, L40, L40S, L60, L80, P5

hexagonal nuts

DIN 934 / ISO 4032/8673



1

**GEV No.** 517174 **Ref. No.** 3110050  
33Q6470**description** nut thread M8 H 6.5mm WS 13 SS DIN/ISO DIN 934 / ISO 4032/8673 Qty 1 pcs

1

**GEV No.** 503042 **Ref. No.** 33Q2190  
36Q1110**description** nut thread 3/8" H 6mm brass WS 22 Qty 1 pcs**For models:** 030FT, 030FTR, 031FT, 031FT04, 031FT06, 031FTR, 031FTRL, 04WB-MEV, 06WFR3GD, 070BM, 070BME, 070FT, 070FT04, 070FT05, 070FTR, 0712VA, 071BM, 071BME, 071FT, 071FT04, 071FT06, 071FTR, 071FTRL, 08WGREV, 090BM, 090BM1E, 090BM1G, 090BME, 090FAVA, 090FT, 090FT04, 090FT05, 090FT1G, 090FT2G, 090FT4G, 090FT5G, 090FT7G, 090FTR, 091BM, 091BME, 091CP1E, 091CP1G, 091FR1EA, 091FR1EX, 091FR1I, 091FR1IA, 091FR1ID, 091FR1ID-VERS.052012, 091FR1I-VERS.032012, 091FR7G...(Other models you can see in the webshop)





Зип Общежит

vsezip.ru

+7(812)987-08-81

|   |  |                 |         |
|---|--|-----------------|---------|
|  |  |                 |         |
| 1   |  |                 |         |
| <b>GEV No.</b>  | 511182   | <b>Ref. No.</b> | 33Q2190 |
| <b>description</b>  | nut thread 3/8" H 8mm brass WS 24 Qty 1 pcs  |                 |         |
| <b>For models:</b>  | C165D, C165S, C165VD, C165VS, C207D, C207D-VERS.2006, C207S, C207S-VERS.2006, C207VD, C207VD-VERS.2006, C207VS, C207VS-VERS.2006, C304AD, C304AD-VERS.2006, C304AS, C304AS-VERS.2006, C304AVD, C304AVD-VERS.2006, C304AVS, C304AVS-VERS.2006, C304D, C304D-VERS.2006, C304S, C304S-VERS.2006, C304VD, C304VD-VERS.2006, C304VS, C304VS-VERS.2006, C92D-VERS.2006, C92S-VERS.2006, C92VD-VERS.2006, C92VS-VERS.2006, CS243D, CS243D-VERS.2006, CS243S, CS243S-VERS.2006, CS243VD, CS243VD-VERS.2006, CS243VS, CS243VS-VERS.2006, CS370AD, CS370AD-VERS.2006, CS370AS, CS370AS-VERS.2006, CS370AVD, CS370AVD-VERS.2006, CS370AVS, CS370AVS-VERS.2006, CS370D, CS370D-VERS.2006...(Other models you can see in the webshop) |                 |         |

|   |   |                 |         |
|---|---|-----------------|---------|
| <b>WASHERS</b>  |   |                 |         |
| DIN 125A  |   |                 |         |
|  |   |                 |         |
| 1   |   |                 |         |
| <b>GEV No.</b>  | 560312  | <b>Ref. No.</b> | 3120080 |
| <b>description</b>  | plain washer ID ø 10.5mm ED ø 20mm thickness 2mm SS Qty 1 pcs DIN 125A for thread M10   |                 |         |
| <b>For models:</b>  | 10CP1EA, 10CP1GA, 10CP1IA, 12CP1EA, 12CP1GA, 12CP1IA, 18CP2EA, 18CP2GA, 18CP2IA, BRE21HD, BRE31HD, FCV101-CSA, FCV101DM-CSA, FCV101DS-CSA, FCV101EDM-UL, FCV101EDS-UL, FCV101E-UL, FCV141-CSA, FCV141DM-CSA, FCV141DS-CSA, FCV241EDM-UL, FCV241EDS-UL, FCV241E-UL, FCV401DM-CSA, FCV401EDM-UL, FCV61-CSA, FCV61DM-CSA, FCV61DS-CSA, FCV61EDM-UL, FCV61EDS-UL, FCV61E-UL, FCV72EDS-UL, FCV72E-UL, PIER06HD, PIER10HD, PIER15HD |                 |         |

|   |  |                 |         |
|---|--|-----------------|---------|
|  |  |                 |         |
| 1   |  |                 |         |
| <b>GEV No.</b>  | 511309   | <b>Ref. No.</b> | 33Q0240 |
| <b>description</b>  | nut thread 1 1/2" ø 66mm H 9mm WS 51 brass Qty 1 pcs |                 |         |
| <b>For models:</b>  | L100, L40, L40S, L60, L80                            |                 |         |

|   |  |                 |         |
|---|--|-----------------|---------|
|  |  |                 |         |
| 1   |  |                 |         |
| <b>GEV No.</b>  | 560113   | <b>Ref. No.</b> | 3121480 |
| <b>description</b>  | plain washer ID ø 6.4mm ED ø 12mm thickness 1.6mm SS Qty 20 pcs DIN 125A for thread M6 |                 |         |
| <b>For models:</b>  | 030FE1, 30F1, 30FES2, 30FS2, 70F1, 70FE1, 70FES2, 70FES2B, 71F2, 71FE2, 91F210         |                 |         |

|  |  |                 |         |
|--|--|-----------------|---------|
| <b>union nuts</b>  |  |                 |         |
|  |  |                 |         |
| 1  |  |                 |         |
| <b>GEV No.</b>   | 520667   | <b>Ref. No.</b> | 36Q0100 |
| <b>description</b>   | union nut thread 1/4" H 11mm steel WS 17 Qty 1 pcs |                 |         |

|   |  |                 |         |
|---|--|-----------------|---------|
| <b>DIN 9021</b>   |  |                 |         |
|  |  |                 |         |
| 1   |  |                 |         |
| <b>GEV No.</b>  | 560210   | <b>Ref. No.</b> | 3014810 |
| <b>description</b>  | plain washer ID ø 11mm ED ø 30mm thickness 2mm SS Qty 1 pcs DIN 9021 for thread M10  |                 |         |
| <b>For models:</b>  | FC1011E, FC1011G, FC1221E, FC1221G, FC611E, FC611G, FM1011E1, FM1011E1-VERS.2006, FM1011E2, FM1011E2-VERS.2006, FM1011E3, FM1011E3-VERS.2006, FM1011G1, FM1011G1-VERS.2006, FM1011G2, FM1011G2-VERS.2006, FM1011G3, FM1011G3-VERS.2006, FM1221E1, FM1221E1-VERS.2006, FM1221E2, FM1221E2-VERS.2006, FM1221E3, FM1221E3-VERS.2006, FM1221G1, FM1221G1-VERS.2006, FM1221G2, FM1221G2-VERS.2006, FM1221G3, FM1221G3-VERS.2006, FM2011E2-VERS.2006, FM2011E3-VERS.2006, FM2011G2-VERS.2006, FM2011G3-VERS.2006, FM2021E1, FM2021E2, FM2021E2-VERS.2006, FM2021E3, FM2021E3-VERS.2006, FM2021G1, FM2021G2, FM2021G2-VERS.2006, FM2021G3, FM2021G3-VERS.2006, FM611E1, FM611E1-VERS.2006, FM611E2, FM611E2-VERS.2006, FM611E3, FM611E3-VERS.2006...(Other models you can see in the webshop) |                 |         |

|   |   |                 |         |
|---|---|-----------------|---------|
| <b>washers</b>  |   |                 |         |
| <b>spring rings</b>   |   |                 |         |
|  |   |                 |         |
| 1   |   |                 |         |
| <b>GEV No.</b>  | 560209  | <b>Ref. No.</b> | 3000860 |
| <b>description</b>  | lock washer ID ø 10.3mm ED ø 17.2mm SS Qty 1 pcs for thread M10 |                 |         |
| <b>For models:</b>  | 08WGRGV, 090GRG, 0A0GRG, 0D0GRG, 190GRG, 1A0GRG, 1D0GRG         |                 |         |

|   |                                       |                 |         |
|---|---------------------------------------|-----------------|---------|
| <b>miscellaneous</b>  |                                       |                 |         |
|  |                                       |                 |         |
| 1   |                                       |                 |         |
| <b>GEV No.</b>  | 690687                                | <b>Ref. No.</b> | 36D2880 |
| <b>description</b>  | plain washer                          |                 |         |
| <b>For models:</b>  | 40, 40B, 40CP, 40CPX, 40PL, 40X, SA87 |                 |         |

Зип Общепит

vsezip.ru

+7(812)987 08 01



1

| GEV No.     | 691180  | Ref. No. | 3120100 |
|-------------|---|----------|---------|
| description | plain washer  |          |         |
| For models: | 10CP1EA, 10CP1GA, 10CP1IA, 12CP1EA, 12CP1GA, 12CP1IA, 18CP2EA, 18CP2GA, 18CP2IA, C304AD, C304AS, C304AVD, C304AVS, CS370AD, CS370AS, CS370AVD, CS370AVS, CS466AD, CS466AS, CS466AVD, CS466AVS, FCV101DM, FCV101DM-CSA, FCV101DS, FCV101DS-CSA, FCV101EDM, FCV101EDM-UL, FCV101EDS, FCV101EDS-UL, FCV141DM, FCV141DM-CSA, FCV141DS, FCV141DS-CSA, FCV141EDM, FCV141EDS, FCV241DM, FCV241DS, FCV241EDM, FCV241EDM-UL, FCV241EDS, FCV241EDS-UL, FCV241GDM, FCV241GDM-CSA, FCV241GDS, FCV241GDS-CSA, FCV401DM, FCV401DM-CSA, FCV401EDM, FCV401EDM-UL, FCV4EDS...(Other models you can see in the webshop) |          |         |

1

| GEV No.     | 520115   | Ref. No. | 3140220 |
|-------------|--|----------|---------|
| description | hose clamp ø 25-40mm width 9mm Qty 10 pcs DIN 3017 |          |         |

1

| GEV No.     | 520119  | Ref. No. | 3140200 |
|-------------|---|----------|---------|
| description | hose clamp ø 60-80mm width 9mm Qty 5 pcs DIN 3017                 |          |         |
| For models: | L100, L80, LP202, LP202HC, LP302, LP302HC, LP402, LP402HC, LP402V |          |         |



2

| GEV No.     | 506160  | Ref. No. | 3120050 |
|-------------|---|----------|---------|
| description | plain washer ID ø 8.6mm ED ø 16mm thickness 1.5mm SS Qty 1 pcs  |          |         |
| For models: | 091FR1EX, 091FR7GS, 091FR7GX, BRE21HD, BRE31HD, FM1011E2-VERS.2006, FM1011E3-VERS.2006, FM1011G2-VERS.2006, FM1011G3-VERS.2006, FM1221E2-VERS.2006, FM1221E3-VERS.2006, FM1221G2-VERS.2006, FM1221G3-VERS.2006, FM611E2-VERS.2006, FM611E3-VERS.2006, FM611G2-VERS.2006, FM611G3-VERS.2006, FM721E3-VERS.2006, FM721G3-VERS.2006, FX101E2C, FX101E3C, FX101G2C, FX101G3C, FX10E2CR, FX10E3CR, FX10G2CR, FX10G3CR, FX122E2C, FX122E3, FX122E3C, FX122E3T, FX122E3T-VERS.022014, FX122G2C, FX122G3, FX122G3C, FX122G3T, FX122G3T-VERS.022014, FX12E3CT, FX12E3CT-VERS.022014, FX12G3CT, FX12G3CT-VERS.022014, FX61E2C, FX61E2CR, FX61E3CR, FX61G2C, FX61G2CR, FX61G3C, FX61G3CR, FX82E2C, FX82E3C...(Other models you can see in the webshop) |          |         |

## retaining rings

DIN 6799



1

| GEV No.     | 518557  | Ref. No. | 3120460 |
|-------------|---|----------|---------|
| description | retaining ring E D1 ø 5mm D2 ø 11mm SS DIN 6799 thickness 0.7mm   |          |         |
| For models: | 04WFAAV, 04WVT1IV, 04WVT2IV, 08WFA4E, 08WFA4G, 08WFAAE, 08WFAAG, 08WFAAV, 08WVT1IV, 08WVT2IV, 090FAA, 091VT1I, 091VT2I, 0A0FA1, 0A0FA4, 0A0FAA, 0A1VT1I, 0A1VT2I, 0D0FA1, 0D0FA4, 0D0FAA, 0D1VT1I, 0D1VT2I, 0G0FA0, 12WFA6E, 12WFA6G, 12WFAAA, 12WFAAE, 12WFAAG, 12WFAAN, 190FA, 190FAA, 190FAB, 190FAD, 191FAAE, 191FAAG, 191FABG, 191FADG, 191FAE, 191FAG, 191VT1I, 191VT2I, 1A0FA1, 1A0FA2, 1A0FA4, 1A0FA5, 1A0FAA, 1A0FAB, 1A1FA1G, 1A1FA2G...(Other models you can see in the webshop) |          |         |

## fasteners

## clamps

## hose clamps

## DIN 3017 - W2



1

| GEV No.     | 520111  | Ref. No. | 36E4320 |
|-------------|---|----------|---------|
| description | hose clamp ø 10-16mm width 9mm Qty 10 pcs DIN 3017  |          |         |
| For models: | FM1011E2-VERS.2006, FM1011E3, FM1011E3-VERS.2006, FM1011G2-VERS.2006, FM1011G3, FM1011G3-VERS.2006, FM1221E2-VERS.2006, FM1221E3, FM1221E3-VERS.2006, FM1221G2-VERS.2006, FM1221G3, FM1221G3-VERS.2006, FM2011E2-VERS.2006, FM2011E3-VERS.2006, FM2011G2-VERS.2006, FM2011G3-VERS.2006, FM2021E2-VERS.2006, FM2021E3, FM2021E3-VERS.2006, FM2021G2-VERS.2006, FM2021G3, FM2021G3-VERS.2006, FM423E2, FM611E2-VERS.2006, FM611E3, FM611E3-VERS.2006, FM611G2-VERS.2006, FM611G3, FM611G3-VERS.2006, FM721E2-VERS.2006, FM721E3, FM721E3-VERS.2006, FM721G2-VERS.2006, FM721G3, FM721G3-VERS.2006 |          |         |

## roll pins



1

| GEV No.     | 691398  | Ref. No. | 31Z8930 |
|-------------|---|----------|---------|
| description | roll pin ø 3mm L 16mm   |          |         |
| For models: | 0A0BMG, 0A0FT1G, 0A0FT2G, 0A0FT4G, 0A0FT5G, 0D0BMG, 0D0FT1G, 0D0FT2G, 0D0FT4G, 0D0FT5G, 1A0BMG, 1A0FT1G, 1A0FT2G, 1A0FT3G, 1A0FT4G, 1A0FT6G, 1A1BR1G, 1A1BR1GA, 1A1BR2G, 1A1BR2GA, 1A1FA1G, 1A1FA2G, 1A1FA4G, 1A1FA5G, 1A1FAS2G, 1A1FASG, 1A1TP0G, 1A1TP0G-VERS.2002, 1B1FAS2G, 1B1FASG, 1D0B-MG, 1D0FT1G, 1D0FT2G, 1D0FT3G, 1D0FT4G, 1D0FT6G, 1D1BR1G, 1D1BR1GA, 1D1BR2G, 1D1BR2GA, 1D1FA1G, 1D1FA2G, 1D1FA4G, 1D1FA5G, 1D1FAS2G, 1D1FASG, 1D1TP0G, 1D1TP0G-VERS.2002, 2A1BR1G, 2A1BR1GA...(Other models you can see in the webshop) |          |         |



screw caps

Зип Общепит

vsezip.ru

+7(812)987-08-81

|                    |  |                 |         |
|--------------------|--|-----------------|---------|
|                    |  |                 |         |
| 1                  |  |                 |         |
| <b>GEV No.</b>     | 512516   | <b>Ref. No.</b> | 3005450 |
| <b>description</b> | screw cap thread 1/2" thread L 8mm SS Qty 1 WS 17 head thickness 4.5mm |                 |         |
| <b>For models:</b> | FM1011E3, FM1011G3, FM1221E3, FM611E3, FM611G3, FM721E3, FM721G3       |                 |         |

|                    |  |                 |         |
|--------------------|--|-----------------|---------|
| <b>GEV No.</b>     | 358671   | <b>Ref. No.</b> | 3200020 |
| <b>description</b> | fine fuse size ø5x20mm 1A fast-acting rated 250V Qty 10 pcs  |                 |         |
| <b>For models:</b> | 06WBR3E, 0G1BR3E, 191BR1E, 191BR1GA, 191BR2E, 191BR2EA, 191BR2GA, 1A1BR1E, 1A1BR1GA, 1A1BR2E, 1A1BR2EA, 1A1BR2GA, 1D1BR1E, 1D1BR1GA, 1D1BR2E, 1D1BR2EA, 1D1BR2GA, 1G1BR3E, 291BR1E, 291BR1GA, 291BR2E, 291BR2EA, 291BR2GA, 2A1BR1E, 2A1BR1GA, 2A1BR2E, 2A1BR2EA, 2A1BR2GA, 2D1BR1E, 2D1BR1GA, 2D1BR2E, 2D1BR2EA, 2D1BR2GA, 71ARE, 91ARE, FCV401DM, FCV401EDM |                 |         |

consumables

lava rocks / ceramic briquetts

|                    |  |                 |         |
|--------------------|--|-----------------|---------|
|                    |  |                 |         |
| 1                  |  |                 |         |
| <b>GEV No.</b>     | 211049   | <b>Ref. No.</b> | 37T1320 |
| <b>description</b> | ceramic briquetts size 50x50x26mm Qty 40 pieces (2.4kg)                          |                 |         |
| <b>For models:</b> | 08WGRGV, 090GRG, 0A0GRG, 0D0GRG, 190GRG, 1A0GRG, 1D0GRG, 1G0GRG, 6042120-08WGRGV |                 |         |

|                    |  |                 |         |
|--------------------|--|-----------------|---------|
|                    |  |                 |         |
| 1                  |  |                 |         |
| <b>GEV No.</b>     | 358031   | <b>Ref. No.</b> | 32V6210 |
| <b>description</b> | fine fuse size ø10x38mm 10A rated 500V type Gg fast-acting Qty 1 pcs   |                 |         |
| <b>For models:</b> | BX101E, BX101E-VERS.122013, BX122E, BX122E-VERS.122013, BX61E, BX61E-VERS.122013, BX82E, BX82E-VERS.122013, FC1011E, FC1221E, FC611E, FM1011E1, FM1011E1-VERS.2006, FM1011E2, FM1011E2-VERS.2006, FM1011E3, FM1011E3-VERS.2006, FM1221E1, FM1221E1-VERS.2006, FM1221E2, FM1221E2-VERS.2006, FM1221E3-VERS.2006, FM2011E2-VERS.2006, FM2011E3-VERS.2006, FM2021E1, FM2021E2, FM2021E2-VERS.2006, FM2021E3, FM2021E3-VERS.2006, FM611E1, FM611E1-VERS.2006, FM611E2, FM611E2-VERS.2006, FM611E3, FM611E3-VERS.2006, FM721E1, FM721E1-VERS.2006, FM721E2, FM721E2-VERS.2006, FM721E3, FM721E3-VERS.2006, FX101E1, FX101E1R, FX101E2, FX101E2C, FX101E2C-VERS.032014, FX101E2R, FX101E2R-VERS.032014, FX101E2-VERS.032014, FX101E3...(Other models you can see in the webshop) |                 |         |

fuses

fine fuses

|                    |   |                 |         |
|--------------------|---|-----------------|---------|
|                    |   |                 |         |
| 1                  |   |                 |         |
| <b>GEV No.</b>     | 358668  | <b>Ref. No.</b> | 3201540 |
| <b>description</b> | fine fuse size ø5x20mm 0.5A fast-acting rated 250V Qty 10 pcs   |                 |         |
| <b>For models:</b> | 04WFR3ED, 08WFR4ED, 08WGREV, 091FR3ED, 0A1FR1ED, 0A1FR3ED, 0D1FR1ED, 0D1FR3ED, 0G0FR3ED, 10CP1EA, 10CP1GA, 10CP1IA, 12CP1EA, 12CP1GA, 12CP1IA, 18CP2EA, 18CP2GA, 18CP2IA, 191FR4ED, 1A1FR2ED, 1A1FR4ED, 1D1FR2ED, 1D1FR4ED, 71RA, 91RA, FC101, FC101E, FC101G, FC101E, FC1221E, FC1221G, FC241, FC241E, FC241G, FC61, FC61E, FC61G, FC61E, FCV101, FCV101DM, FCV101DS, FCV101E, FCV101EDM, FCV101EDS, FCV141, FCV141DM, FCV141DS, FCV141E, FCV141EDM, FCV141EDS...(Other models you can see in the webshop) |                 |         |

**Зип Общепит**

**vsezip.ru**

**+7(812)987-08-81**

Зип Общепит

vsezip.ru

+7(812)987-08-81

|   |              |   |          |
|---|--------------|---|----------|
| <b>A</b>  |              | fastening material                        | 297      |
| alarm devices                                   | 59           | filter driers                             | 275      |
| axial fans                                      | 90           | float switches                            | 108      |
| <b>B</b>  |              | fine fuses                                | 301      |
| ball valves                                     | 290          | fittings                                  | 287      |
| bar burners                                     | 158          | foam rubber gaskets                       | 41       |
| beverage technology                             | 294          | forced air burners                        | 272      |
| bi-metal thermostats                            | 19, 19       | formed hoses                              | 162      |
| booster pumps I                                 | 106          | fridge lamps                              | 285      |
|   |              | fuses                                     | 51       |
|   |              |   | 109, 301 |
| <b>C</b>  |              | <b>G</b>                                  |          |
| cables  | 109          | gas burners                               | 148      |
| cam switches                                    | 41           | gas control valves                        | 127      |
| clamps  | 34, 295, 300 | gas lines                                 | 177      |
| coil heating elements                           | 9            | gas nozzles                               | 162      |
| cold air circulating fans (complete)            | 94           | gas solenoid valves                       | 132      |
| compressors                                     | 88           | gas taps                                  | 112      |
| condensators & interference suppression filters | 107          | gas thermostats                           | 118      |
| condensing trays heated                         | 90           | gaskets for heated units                  | 262      |
| connection cables                               | 110          | gaskets for tray rack trolleys            | 266      |
| consumables                                     | 301          | gaskets for wash arm support              | 274      |
| contactors                                      | 60           | gastronorm                                | 279      |
| container filters                               | 283          | grates                                    | 252      |
| control equipment                               | 45           | grub screws                               | 297      |
| control thermostats                             | 20, 30       |   |          |
| countersunk screws                              | 297          | <b>H</b>                                  |          |
| cross flow fans                                 | 94           | halogen lamp                              | 51       |
|   |              | hand tools                                | 296      |
| <b>D</b>  |              | handle latches                            | 229      |
| defrost timers                                  | 59           | heater battery                            | 9        |
| door catches                                    | 230          | heating cables                            | 8        |
| door seals                                      | 263          | heating cartridges                        | 9        |
| door seals for dishwashers                      | 273          | heating elements                          | 3        |
| dosing pumps                                    | 280          | heating elements for bain maries          | 4        |
| double nipples                                  | 287          | heating elements for charrills            | 8        |
| drain hoses                                     | 284          | heating elements for convection           | 16       |
| drain pumps                                     | 106          | heating elements for defrosting           | 7        |
|   |              | heating elements for fryers               | 5        |
| <b>E</b>  |              | heating elements for griddles             | 6        |
| earthing cables                                 | 109          | heating elements for heating bridges      | 8        |
| edgemount latches                               | 229          | heating elements for ovens                | 3        |
| electric accessories                            | 109          | heating elements for pasta cookers        | 7        |
| electronic controllers                          | 64           | heating elements for refrigeration        | 7        |
| energy regulators                               | 19           | heating elements for salamanders/toasters | 8        |
| espagnolette locks                              | 230          | heating elements for tilting bratt pan    | 7        |
| evaporators                                     | 275          | hexagonal nuts                            | 298      |
| expansion valves                                | 274          | hexagonal screws                          | 297      |
|   |              | hob burners                               | 148      |
| <b>F</b>  |              | hose clamps                               | 295, 300 |
| fans  | 90           | hose connectors                           | 286, 288 |
| fasteners                                       | 300          |   |          |

|                                |          |                                  |          |
|--------------------------------|----------|----------------------------------|----------|
| hose couplings                 | 283      | pressure switches                | 85       |
| hoses                          | 284      | probe clips                      | 34       |
| hot air fans                   | 99       | probes                           | 68       |
| hot air motors                 | 95       | programme timers                 | 55       |
| hot plates                     | 110      | PU hoses                         | 285      |
|                                |          | pulleys                          | 296      |
| <b>I</b>                       |          | pumps                            | 100      |
| ignition boxes                 | 131      | pumps for ice machines           | 107      |
| ignition cables                | 143      | push/momentary push switches     | 35       |
| ignition units                 | 145      | PVC supply hoses                 | 284      |
| immersion heating elements     | 10       |                                  |          |
| indicator lights               | 48       | <b>R</b>                         |          |
| indicator lights (complete)    | 48       | radial fans                      | 99       |
| industrial hoses               | 284      | radiation heaters                | 17       |
| inlet spouts                   | 293      | reducers                         | 287      |
| inlet taps                     | 293      | refrigeration cycle components   | 274      |
|                                |          | refrigeration fans               | 91       |
| <b>K</b>                       |          | refrigeration gaskets            | 256      |
| knurled nuts                   | 298      | refrigeration motors universal   | 91       |
| knurled screws                 | 297      | refrigeration thermostats        | 32       |
|                                |          | relays                           | 62       |
| <b>L</b>                       |          | retaining rings                  | 300      |
| lamp accessories               | 55       | ribbon cables                    | 110      |
| lamps                          | 48       | rocker/momentary rocker switches | 35       |
| lava rocks / ceramic briquetts | 178, 301 | roll pins                        | 300      |
| light bulbs                    | 50       | rotary switches                  | 43       |
|                                |          |                                  |          |
| <b>M</b>                       |          | <b>S</b>                         |          |
| magnetic switches              | 44       | safety bi-metal thermostats      | 19       |
| measuring equipment            | 296      | safety thermostats               | 23, 31   |
| mechanical timers              | 58       | safety valves                    | 132      |
| microswitches                  | 37       | screw caps                       | 301      |
|                                |          | screw-in gaskets                 | 260      |
| <b>N</b>                       |          | screws                           | 297      |
| Niplaflex hoses                | 284      | sealing washers                  | 270      |
| non-return valves              | 294      | shaft gaskets                    | 272      |
| nuts                           | 298      | shelves and shelf rails          | 252      |
|                                |          | shut-off valves                  | 291      |
| <b>O</b>                       |          | snap locks                       | 230      |
| operating capacitors           | 108      | solenoid valves                  | 76       |
| O-rings                        | 267      | solid top burners                | 161      |
| oven hinges                    | 234      | spray guns                       | 280      |
| oven lamps                     | 51       | spray guns with external thread  | 280      |
|                                |          | spring assisted hinges           | 231      |
| <b>P</b>                       |          | spring rings                     | 299      |
| piano hinges                   | 231      | starting capacitors              | 107      |
| piezoelectric igniters         | 144      | steam valves                     | 293      |
| pilot burners                  | 132      | supply filters                   | 295, 295 |
| plug connectors                | 110, 110 | supply hoses                     | 284      |
| plug-in gaskets                | 256      | switches and momentary switches  | 35       |
| position switches              | 40       | system switches (ROLD)           | 40       |
| pressure control hoses         | 284      |                                  |          |
| pressure reduction valves      | 295, 295 |                                  |          |



Зип Общепит

vsezip.ru

+7(812)987-08-81

**T**

|                          |     |
|--------------------------|-----|
| temperature probes       | 68  |
| terminals                | 110 |
| terminals and connectors | 110 |
| thermocouples            | 146 |
| thermostat gaskets       | 274 |
| thermostats              | 19  |
| timers                   | 55  |
| tools                    | 296 |
| transformers             | 63  |
| tube burners             | 161 |
| turning lever locks      | 223 |

**U**

|                  |     |
|------------------|-----|
| union nuts       | 299 |
| universal probes | 68  |

**V**

|                        |     |
|------------------------|-----|
| valves                 | 294 |
| valves and tank inlets | 290 |
| vibration pumps        | 107 |

**W**

|                        |     |
|------------------------|-----|
| wash and rinse pumps   | 100 |
| washers                | 299 |
| water cycle components | 295 |
| window seals           | 262 |
| wing nuts              | 298 |